



January 1999

Volume 67 No 1

Amateur Radio

Journal of the Wireless Institute of Australia

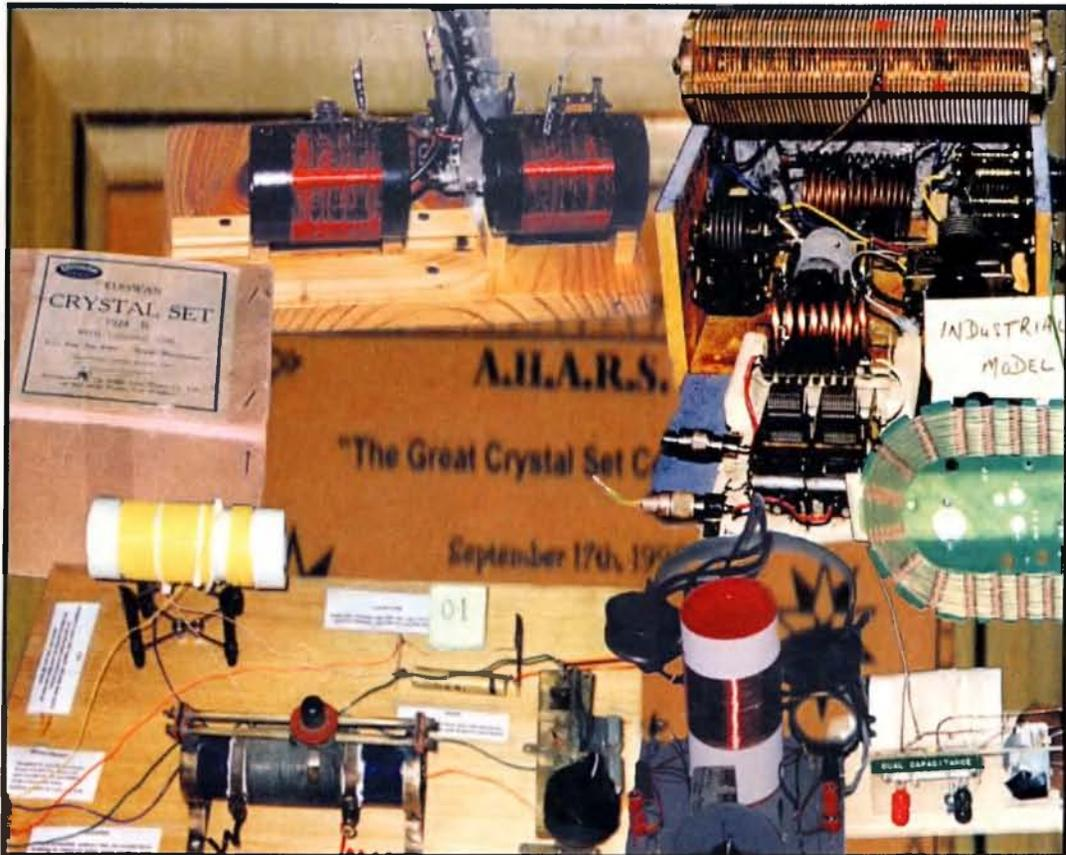

Full of the latest amateur radio news, information and technical articles, including...

- **The Great AHARS Crystal Set Competition**
- **A Current Indicator for Open Wire Transmission Line**
- **Narrow Band Voice Transmission**
- **St. Brandon - 3B7RF**

Plus *lots of other articles, news and special interest columns.*

QMS - 7

Antenna Coupler System

Quick Mount System
for mobile HF and VHF use



SG-230 MICROPROCESSOR CONTROLLED ANTENNA COUPLER (1.6-30MHz) 200W Smarttuner

The SG-230 Smarttuner automatic antenna coupler can be used within its power rating with any HF Transceiver in range of 1.6-30MHz. Designed for marine, portable and fixed base applications. For antenna types: 23ft marine whip for 1.6 to 30MHz and with 9ft. minimum antenna for 3-30 MHz operation

Number of channels unlimited
Frequency range 1.6-30 MHz
Power rating 200 watts PEP maximum 12 VDC. operation
SWR: Less than 1:1.5
Tune power: 3 watts nominal
Weight: 8Lbs.
Dimensions: 12.5 x 10.5 x 3
Supplied with 9ft. cable for coaxial and DC power.

- QMS-7 offers unsurpassed frequency agility without user intervention
- SG-231 Smarttuner automatic antenna coupler, SG-307 extended full-range antenna, and weather resistant QMS-7 package
- 1 to 60 Mhz-continuous-instant tuning while you drive
- Rated for use on moving vehicles at up to 75 Miles (120km) per hour



Terlin
OUTbacker

PO BOX 1197
Canning Vale W.A. 6155
www.outbacker.com.au
terlin@outbacker.com.au

Ph (08) 9455 4288
Fax (08) 9455 4289



Amateur Radio

Volume 67
Number 1
January 1999

The Journal of the Wireless
Institute of Australia

ISSN 0002-6859

Amateur Radio is published by the Wireless Institute of Australia ACN004 920 745 as its official Journal on the last Friday of each month

Editorial

Editor: Bill Rice* VK3ABP
 Production Manager: Bob Harper VK4KNH
 Snr Technical Editor: Peter Gibson* VK3AZL
 Technical Editors: Evan Jarman* VK3ANI
 Gill Sones* VK3AUI
 Don Graham VK6HK
 Contributing Editors: Ron Fisher* VK3OM
 Don Jackson* VK3DBB
 WIA News Editor: David Thompson VK2NH
 *Publications Committee member

Advertising

Mrs June Fox
 WIA Federal Office
 PO Box 2175 CAULFIELD JUNCTION VIC 3161
 Tel: (03) 9528 5962 Fax (03) 9523 8191
 email amag@hotkey.net.au

Amateur Radio Correspondence

All correspondence, contributions and queries about the **content** should be sent to:

The Editor **Amateur Radio**
 PO Box 2175
 CAULFIELD JUNCTION VIC 3161
 email amag@hotkey.net.au
 Tel: (03) 9528 5962 Fax (03) 9523 8191

Amateur Radio Delivery

All queries regarding delivery should be directed to:

Amateur Radio Federal Office
 PO Box 2175 Caulfield Junction Vic 3161
 email amag@hotkey.net.au
 Tel: (03) 9528 5962 Fax (03) 9523 8191

Registered Office

10/229 Balaclava Road
 Caulfield North VIC 3161
 Tel: (03) 9528 5962 Fax (03) 9523 8191
 email amag@hotkey.net.au
 Business hours: 9.30am-3pm weekdays

Editorial & Display Booking Deadlines

February 12/1/99
 March 12/2/99
 April 12/3/99

Hamad & Display Material Deadline

February 22/1/99
 March 19/2/99
 April 19/3/99

Production

Administration, Drafting & Sub-editing
 Shadetree Publishing & Imaging
 PO Box 288 BEERWAH OLD 4519

Final assembly, prepress, print and mail management
 Newsletters Unlimited (03) 9428 3458

Printed by Streamline Press, Melbourne (03) 9417 2766

Mailed by IMS, Melbourne (03) 9291 5888

Receipt of Amateur Radio by mail

This issue was delivered to Australia Post on Thursday Jan. 7
 If you are a financial member and have not received your copy by the 15th of the month please check with your local Post Office before contacting the registered office of the WIA.

Copyright and Reproduction

The copyright in this magazine, except where specifically noted, is held by Wireless Institute of Australia ©WIA 1999.

Permission to republish articles in any form must be obtained in writing from the Institute (other than for purposes of 'fair dealing'). This permission is usually freely given for information purposes.

Technical

The Great Crystal Set Competition	6
<i>Christine Taylor VK5CTY.</i>	
What use would you be in a catastrophe	8
<i>Chris Hill VK6KCH</i>	
St Brandon DX-pedition	9
<i>Stephen Pail</i>	
A Current Indicator for Open Transmission Lines	15
<i>Drew Diamond VK3XU</i>	
Narrow Band Voice Transmission	18
<i>Lloyd Butler VK5BR</i>	

General

The 14 Second Doughnut	16
<i>Ian Jackson VK3BUF</i>	
Demonstrating Amateur Radio in a School	20
<i>Graeme Scott VK2KE</i>	
Remember the First Time	21
<i>Sam Wright VK6YN</i>	
How to Write For Amateur Radio	26
<i>John Nieman</i>	
The Amateur Radio Cover Photo Quest	26
<i>Bob Harper VK4KNH</i>	
Annual Index for 1998	45
<i>Bill Roper VK3BR, Bill Rice VK3ABP, Bob Harper VK4KNH</i>	

Columns

Advertisers' Index	56	Hamads	55
ALARA	31	HF Predictions	52
AMSAT Australia	33	Over To You	54
ARDF	35	Pounding Brass	32
Awards	51	Repeater Link	43
Club News	25	Silent Keys	54
Contests	49	Spotlight on SWLing	36
WIA Divisions News		Technical Abstracts	23
VK1 Notes	41	VHF/UHF - An Expanding World	37
VK4 Notes	41	WIA Comment	3
VK5 and VK8 Notes	42	WIA News	3
VK7 Notes	43	WIA Division Directory	56
Editor's Comment	2	WIA Federal Directory	2

Our cover this month

Adelaide Hills Amateur Radio Society— Great Crystal Set Competition

Photos: Christine Taylor VK5CTY. Montage by Bob Harper VK4KNH.

Contributions to Amateur Radio

Amateur Radio is a forum for WIA members' amateur radio experiments, experiences opinions and news. Manuscripts with drawings and or photos are always welcome and will be considered for publication. Articles on disc or email are especially welcome. The WIA cannot be responsible for loss or damage to any material. A pamphlet, How to write for Amateur Radio is available from the Federal Office on receipt of a stamped self-addressed envelope.

Back Issues

Back Issues are available directly from the WIA Federal Office (until stocks are exhausted, at \$4.00 each (including postage within Australia) to members.

Photostat copies

When back issues are no longer available, photocopies of articles are available to members at \$2.50 each (plus an additional \$2 for each additional issue in which the article appears).

Disclaimer

The opinions expressed in this publication do not necessarily reflect the official view of the WIA and the WIA cannot be held responsible for incorrect information published..

Amateur Radio Service

A radiocommunication service for the purpose of self-training, intercommunication and technical investigation carried out by amateurs; that is, by duly authorised persons interested in radio technique solely with a personal aim and without pecuniary interest.

Wireless Institute of Australia

The world's first and oldest
National Radio Society
Founded 1910

Representing
The Australian Amateur Radio Service

Member of the
International Amateur Radio Union

Registered Federal Office of the WIA

10/229 Balaclava Road
Caulfield North Vic 3161
email armag@hotkey.net.au
Tel: (03) 9528 5862
Fax: (03) 9523 8191
http://www.wia.org.au

All mail to
PO Box 2175 Caulfield Junction VIC 3161

Business hours: 9.30am-3pm weekdays

Acting Federal Secretary

Peter Naish VK2BPN

Federal Office staff

June Fox Bookkeeper
Rita Trebilco VK3IF Examinations Officer

Council

President	Peter Naish	VK2BPN
VK1 Federal Councillor	Michael Jenkins	VK1MJ
VK2 Federal Councillor	Michael Corbin	VK2YC
VK3 Federal Councillor	Brenda Edmonds	VK3KT
VK4 Federal Councillor	Ross Marren	VK4AMJ
VK5 Federal Councillor	Jim McLachlan	VK6NB
VK6 Federal Councillor	Will McGhie	VK6JU
VK7 Federal Councillor	Andrew Dixon	VK7GL

Executive

Peter Naish VK2BPN
Martin Luther VK5GN
Wally Howse VK6KZ
Neil Penfold VK6NE

Federal Coordinators

AMSAT	Graham Ratcliff	VK5AGR
Awards	John Kelleher	VK3DP
Contests	Ian Godsil	VK3DID
Education	Brenda Edmonds	VK3KT
FTAC	John Martin	VK3KWA
Historian	John Edmonds	VK3AFU
IARU	Grant Willis	VK2ZWI
Intruder Watch	Gordon Loveday	VK4KAL
ITU Conference and study group	David Wardlaw	VK3ADW
Public Relations	David Thompson	VK2NH
QSL Manager (VKS, VKO)	Neil Penfold	VK6NE
Videotapes	Don Bland	VK4TVD

ACA Liaison Team

Brenda Edmonds VK3KT
David Wardlaw VK3ADW
Peter Naish VK2BPN

EDITORS COMMENT

A Few Changes

Introducing Bob Harper

As I summarized last month, that issue was the last to be produced by Bill Roper. This issue is the first to be produced by Bob Harper. "Who is Bob Harper?", I hear you asking. There is a partial answer on page 3 of the December issue, headlined "New Production House for Amateur Radio". I would like to expand on that in the light of evolving activity.

In a circular letter to contributors, Bob introduces himself in some detail as VK4KNH, and refers to his experience in producing the VK4 newsletter "QTC News". He is well equipped for the various electronic communications procedures involved in AR production, not only from the hardware viewpoint but also experience in their use.

Proceeding electronically

This has now become vital to continuation of the job, because whereas previously all production, typesetting and printing was located in Melbourne, Bob's production facilities are in Brisbane. We are still developing procedures for getting text and other information backwards and forwards in minimal time and at minimal expense, so you will no doubt find a few differences in this issue as the result. Bear with us, we're learning fast!

"Every member get a member"

The need for different and less expensive production of our magazine has been forced upon us by the economic pressures which I mentioned in the November editorial. Basically, we need more members. How that can be achieved is a problem for all of us, not just our council and directors. "Every member get a member" is a slogan I seem to have heard many years ago. It is even more urgent now than ever before!

Bill Rice VK3ABP Editor

ar

Time to defend your bands and hard-won privileges

420-450 MHz is wanted by Australian commercial interests

RF emission regulations threaten handhelds, mobile rigs and suburban home stations with bureaucratic limits

More of **7 MHz** is wanted by global broadcasters

Renew your membership Recruit new members

WIA ACTION HAS:

- Cut the cost of licence fees
- Cut fees on beacons and repeaters
- Improved licence conditions
- Retained access to 50 MHz and 576 MHz, and more!

THE WIA MAINTAINS REPRESENTATION:

- At World Radio conferences
- To the ACA
- On the Radio Communications Consultative Committee

Strength in numbers — Subs help pay



Comment

Federal President, Peter Naish VK2BPN.

Two critical discussions on WIA's future

Two important events took place during December. These were a meeting of WIA Federal Council and a meeting between the WIA ACA Liaison Committee and the ACA.

Domestic strategic matters

The Federal Council met on December 5th via a national teleconference to discuss a number of strategic matters including the draft business plan prepared by the Directors.

Each WIA Division was represented either by its Federal Councillor or an Alternate Councillor. The business plan was generally well received although Councillors hotly debated some matters.

The principal theme of the plan is the need to restore strength to WIA Federal by winning back those radio amateurs who have for whatever reason let their membership lapse over the past five years.

Recent cost reductions in the operation of WIA Federal should ensure the immediate financial health of the organisation, but in the longer term increased membership levels are essential if we are to have the finances to support the services expected by members. It is the classic situation - members expect a high level of benefits from their membership but this can only be provided if the level of membership is adequate to fund them.

The business plan addresses this issue although there does not appear to be a single reason for declining membership nor an obvious solution to it. However, it has promoted significant positive ideas which the Directors and Council will continue to develop.

A number of other matters were discussed by Council including ways of supporting various special events to be held in 2000, including a proposal to hold the next Convention of IARU Region 3 in Australia in that year. An upgrade to the WIA Federal web page on the Internet was proposed because this is a valuable public relations asset providing as it does a universally accessible window into the WIA. It was agreed that the Annual General Meeting of WIA Federal would be held over the weekend of 1/2 May 1999.

WIA's place in the airwaves

The WIAACA Liaison Committee met with the ACA in Canberra on 9th December last. A full day was spent discussing a wide range of issues concerning the Amateur Radio Service in Australia. These included the 80 metre DX window, a possible LF amateur band at around 137 kHz, the effect on the amateur radio licence of the EMR legislation due to come into effect on 1st January 2000, the effect on our secondary usage of those bands subjected to Spectrum Licensing by the ACA, and several other key licensing matters.

The WIA sought a clarification on the ACA's intentions in regard to the future of the examination service the operation of which is currently performed by the WIA.

Time ran out before several items could be fully covered and these will have to be part of the next meeting with the ACA scheduled for April this year.

Fuller reports on both the Council meeting and that with the ACA will be prepared for publication in forthcoming issue of *Amateur Radio*.

Peter Naish, VK2BPN, WIA Federal President.

ar

WIA NEWS

WIA News Prepared, researched and compiled by
David Thompson VK2NH
Federal Public Relations Coordinator.

International Travel Host Coordinator

John Miller has been appointed International Travel Host Coordinator on the Federal team. Born in the UK, John was first licensed in 1968 as G3WIT. In 1971 he came to Australia with his parents where he took up the callsign VK3BFM, later VK3DJM, which included some of his initials.

The first job John had was as a trainee radio operator for the British government and as he says "I failed to get my cw speed up fast enough and so was retrenched". He left the RAF on medical grounds and has been employed since as an electronics technician by various firms, both in the UK and here. John's present employers are McVan Instruments (also known as BWD) where he has worked for 16 years.

Licensed continually since 1968, John has used the International Travel Host Exchange Scheme (ITHE), while travelling to the UK and, after first hearing about it in an article in *Amateur Radio*, immediately signed up. He is not able to provide accommodation, but is currently helping a Canadian couple who contacted him, via the Internet, from the ARRL listing.

John Miller VK3DJM may be contacted at work, from 0730 to 1600 local, on (03) 9582 7316 and has a voice mail box on his home phone (03) 9766 0741.

John's packet address is:

VK3DJM@VK3KSD.#MEL.VIC.AUS.OC and e-mail:

e-mail :- jayem@alphalink.com.au

Keen WIA Membership in VK7

Tasmania has the highest percentage of Amateurs as WIA members. It has been calculated at 34 per cent, but that figure is bolstered by the fact that Tasmania has the lowest number of amateurs except for the Australian Capital Territory (VK1).

VK7 President Ron Churcher has called on his division to have a 50% membership in the next 6 months, and has reminded them that if every present member recruited just one new member VK7 would be at 68%.

Illawarra Amateur Radio Society has Call for 50 Years

The Illawarra Amateur Radio Society in Wollongong, NSW has recently noted that the club's callsign VK2AMW is 50 years old. The callsign was issued to the then Wollongong Radio Club on 3 December 1948.

Phil, VK2TPH, Publicity Officer, says that, to the best of the club's knowledge, the sign never lapsed from its ownership, even when the name was changed.

To celebrate, members activated the callsign VK2AMW on Saturday 5 December, 1998 and if you did work it, your special memorial QSL card is available by sending a Stamped Self Addressed Envelope to:

QSL Manager I.A.R.S. inc,

PO BOX 1838, Wollongong, N.S.W. 2500



ICOM Clearly Ahead



"VK3LZ calling!"

More sound information from
your friends at Icom

MORE GREAT GEAR ON THE WAY FOR '99

Well the new year is with us and we hope you all had a relaxing break. Everyone is back on deck at Icom and ready to bring you an array of great gear. Last year was exceptional in terms of new product releases...the IC-706 Mk II G - the latest in a legendary line, the powerful IC-746 tri-bander, the IC-Q7A compact handheld, and the IC-207H in-dash dual bander to name just a few. But '99 looks like being a vintage year! We have some truly awesome equipment on the way so watch this column and a new series of advertisements for all the details.

RADICAL NEW UNITS SET TO CHANGE THE INDUSTRY

We can't tell you too much about these new units, it's highly confidential, except to say that they will challenge all your perceptions about performance standards, and indeed operating formats of amateur radio. Now that's a pretty big statement, but we can promise you that when we release them soon you won't believe your eyes...and ears!

2 NEW HANDHELDS ON THE WAY

There are more compact units to be released too. The team at Icom have been fortunate to have a sneak preview and we were amazed. How do they manage to pack such power and performance into such compact units? We'll bring you all the details of these new handhelds very soon.

"...73"

FreeCall 1800 338 915
290 -294 Albert Street
Brunswick, Victoria 3056
Tel : (03) 9387 0666
Fax : (03) 9387 0022
www.icom.net.au
ACN 006 092 575

U. BROWN (A.F. No. 1)

WIA NEWS

Continues

APRS Alive and Well

Despite reports that the Automatic Position Reporting System (APRS), has been very slow to take off in VK, Darryl Smith VK2TDS tells us that the mode is alive and well and gaining momentum but has indicated that details of 'who is doing what and when' is the main issue determining the use of the digital facility.

Darryl says the main challenge is to now get all the APRS groups talking to one another. This can be done by having their details on a central register which he is coordinating. To let people know the details of your APRS operations, or get further information, contact Darryl on email: vk2tds@ozemail.com.au .

Packet Bulletin boards which wish to transmit APRS beacons only need to add their grid square locator in square brackets at the beginning of their beacon text. An example of this would be [QF56] VK2TDS Beacon Text or [QF56nx] VK2TDS Beacon Text.

The latest version of WinAPRS now accepts raster (scanned) maps. WinAPRS is available at the web site: <http://aprs.rutgers.edu>. or from the packet group APRA. Even after a plea by the main players in VK2, few packet bulletin boards have added their maidenhead locator grid squares for beaconing purposes.

In the UK, G0TRT has put up WinAPRS maps for the whole of UK on his website. DOS maps for the country are being worked on and should be available when you receive this edition of AR. G0TRT's webpage locator is <http://www.bigfoot.com/~Hammie>. Thanks to Grahame VK4BB for that address.

Via ITU

World Amateur Radio Day

World Amateur Radio Day will be celebrated in 1999 on Saturday 18 September, however this is the last time that World Amateur Radio Day will take place in September. From the year 2000, the day will be marked on the anniversary of the IARU in April.

Via VK7 & QNews

TMSAT-1 (TO-31) Now Available for General Amateur Use

The satellite opened for business the weekend of November 28. The move allows Amateur Radio operators to use the store-and-forward communications transponder on the spacecraft and to download the high-resolution multi-spectral Earth images taken by the satellite.

Ground station op Chris Jackson, G7UPN/ZL2TPO expressed the hope that ground operators will take advantage of downloading the high resolution multispectral images available from TO-31 "and keep other traffic to a minimum." Due to current limitations with on-board memory, images will only be available on the satellite for a couple of days after they are taken. If other files (especially large files) are uploaded to the satellite, this will ultimately increase the amount of time taken to download images and they may therefore be deleted before they are completed.

Jackson says transmitter problems continue, however, and the downlink is not currently operating over most areas. Amateurs in Europe and Southeast Asia will find the downlink on most of the time, and it will remain on for between 15 and 30 minutes, depending on the operation of the transmitter. Work and testing continue to improve this situation.

During some of these tests, access may be limited to command stations only. Jackson requests that hams not attempt to access the satellite if the BBS indicates it is "SHUT."

The TO-31 downlink frequency is 436.925 MHz, 9600 baud FSK. The uplink frequency is 145.925 MHz, 9600 baud FSK. The BBS call sign is TMSAT1-12; the broadcast call sign is TMSAT1-11.

Chris Jackson, G7UPN/ZL2TPO
via AMSAT News Service

One New Member

That's all it takes to make the WIA strong — if every member signs up just one new member

NASA Space Weather

Bureau

For an interesting view of what is above us, N7SO in the US has written to the ARRL to remind amateurs of the NASA Space Weather Bureau Web site at: www.spaceweather.com sponsored by Marshall Space Sciences Lab. The site contains a lot of data on current conditions as well as a great 10-day animation of the sun.

This is a very interesting site to pay a visit and at the time of writing, the site contained images of the aurora updated every seven minutes, as well as information on solar flares.

Via ARRL Newsletter Vol

17 No 48

FCC Issues Warning on

Tower Lighting:

The Federal Communications Commission has warned owners of antenna structures to comply strictly with FCC antenna tower lighting and marking rules.

This followed a recent nighttime incident in Texas where a helicopter ambulance nearly hit an unlighted radio tower. The FCC notes that tenant licensees, such as repeater owners, are secondarily responsible for tower lighting.

The FCC held a public forum Dec. 7, 2-4:30 PM ET about Y2K impact on tower lighting and lighting equipment. Forum materials will be posted to the FCC Y2K site.

Via ITU

World Telecommunications

Day

The ITU has dedicated the 1999 World Telecommunications Day to be held on 17 May, 1999 to focus on the importance of doing business by electronics (E-commerce).

In Amateur Radio terms, the focus is on packet radio and digital satellites and the contribution the Amateur and Amateur Satellite Services have made to the development of digital communications which forms the backbone of E-commerce.

Item Via the FCC

56K Modem Standard Continues to Break new Ground

At the recent meeting of Study Group 16 in Geneva, the multimedia group of the Telecommunications Standardization Sector of the International Telecommunication Union, approval of the new V.90 (56 K) modem standard was unanimously completed by the Study Group.

At the same meeting, the approval process was initiated for a new all-digital version of the same technology to be known as V.91.

The ITU, a specialized agency of the United Nations, coordinates global communications standards. Study Group 16 of the ITU Telecommunication Standardization Sector (ITU-T) where the work on modem standards is carried out, is responsible for the development of standards for multimedia systems.

The new V.90 Recommendation, is already finding wide deployment for Internet and on-line service access. V.90 modems are designed for use on normal telephone lines where the connections are analogue at the customers premises and digital at the service providers premises.

Unlike other modem standards, V.90 modems take advantage of the characteristics of the digital to analogue converters present in the telephone network to achieve hitherto unobtainable high rates of transmission.

Download speeds of up to 56,000 bits per second (bit/s) are possible, depending on telephone line conditions, with upload speeds of up to 33,600 bit/s.

Manufacturers formerly producing modems based on proprietary schemes

have already largely migrated to the new standard. It is estimated that over 20 million V.90 modems have been supplied since the standard was "determined" for approval in February last year.

According to industry analysts, the V.90 Recommendation is expected to boost modem sales significantly. Point-Topic, a market researcher, estimates revenue from 56kbit/s modems will rise to \$4.3 billion in the year 2000 from \$600 million in 1997.

Work began on the development of V.90 (previously referred to as V.pcm) in the ITU-T in March 1997 and, following agreement on all substantive technical issues, the first stage of approval took place in February of this year.

With final approval now granted the new recommendation has been completed in record time.

The V.91, all-digital extension to V.90, allows modem signals to be transmitted through all-digital telephone connections which are configured for speech rather than data signals.

Such connections, which terminate digitally at both the customer's and service provider's premises, have hitherto only been able to achieve data rates of 33,600 bit/s, however the use of V.91 modems will allow data to be transmitted on these lines at close to 64,000 bit/s.

The standard is expected to be particularly useful on ISDN connections where a data bearer channel is not available or cannot be guaranteed.

New Kenwood Digital Handheld

Although this news section is not normally the place for product reviews, it is considered that this item will be of interest to many amateurs, especially those using the digital modes.

Kenwood has just released a handheld called TH-D7A with capabilities exceeding that of most home packet stations. Big statement, but the radio as well as being a dualband VHF/UHF handheld, also includes 1200 and 9600 baud modems and TNC (all built-in). This allows full duplex packet operation.

Also there is an intelligent control panel which can be used to send packet messages to other stations. The radio is

targeted at the APRS and satellite communities. In the APRS mode, the handheld plugs in to a GPS receiver, beaconing APRS positions and displaying the position of other APRS stations directly on the GPS receiver.

With the addition of a three element yagi, the station works well with the digital PacSat allowing portable satellite operation.

Although this radio has been released in the UK and USA, there has been no release date indicated yet for Australia. The US price of the TH-D7A is \$U469.00. Thanks to Darryl VK2TDS for details.

ar

THE GREAT CRYSTAL SET COMPETITION

-CRYSTAL SET-
SIX NAIL
upmarket
model



by Christine Taylor, VK5CTY
16 Fairmont Ave Black Forest
SA 5035

The smallest set present.

THE GREAT CRYSTAL SET Competition held by the Adelaide Hills Amateur Radio Society on Thursday 18th Sept 1998 was an amazing success.

The competition was suggested by Jeff VK5MFR and presented to members about six months earlier.

The committee thought there might be as many as ten or twelve sets submitted, but on the night there were 33 entries, from 16 members. Jeff himself had submitted seven entries!

Five prizes were awarded. The certificates and the accompanying plaques were designed and produced by Jeff VK5MFR - each a gem on its own. With each certificate there was a wooden plaque on which an appropriate item was mounted.

For the best construction there was a hammer; for the set with the best selectivity, a pair of scissors; for the most authentic, a crystal of galena and a cat's whisker. The set with the best performance had a tiny toy antique radio on its plaque and for the smallest there was a magnifying glass.

Two leading members of the Historical Radio Society, Peter Holland and Alan Taylor judged the sets.

Before naming the winners, the judges offered to present all the prizes to the owner of the genuine antique *Ediswan Crystal Set*, still in its original box, if he'd offer the antique as a bribe.

After all, the entry form did ask if you were prepared to offer a bribe and if so, how much? They were turned down.

Each set was tested both for selectivity and signal strength, and assessed for detail.

As an aerial, one end of a long wire was lobbed high into a convenient tree and the free end fed in through the window. Another wire was tied to a water tap to act as an earth. The output of each set was fed through an amplifier. (One set was supplied with a loudspeaker!).

Geoff Bridgland VK5NOZ was presented with the award for the Best Constructed. His set included a tuning system with a vernier drive.

Bryan VK5NOS' "Ettamogah Pub Set" was judged to be the Most Original. The enormous coil, sitting at an angle to match the famous pub, actually belongs to his mobile antenna, but he didn't tell where the very large stump came from.

Jeff, VK5MFR, won the award for the set with the best selectivity. The set had an original style flat coil on an elegant former. The judges found this a very difficult class to judge as the quality of many of the sets was very high.

Jim VK5XJT won two prizes, one for

the smallest, with a working crystal set under 10cm long, and one for the best performance overall. Although Jim had not achieved the Q of 400 he was aiming for, he did finish up with a Q of about 250. The latter set could almost have won the prize for the largest set as well. It had a loop aerial almost a metre in diameter.

A number of other sets had superfluous items such as heat sinks, fuses or enough coils to loop around the world!

Some of the sets were inductance tuned; some had dual capacitors, while others had loop tuning. The simplest set; the Six-Pin Set (with gold plated nails) submitted by Ted VK5KBM, was a non-tunable, one component unit.

Some of the sets came with a circuit diagram, and some were elegantly labelled.

There was a Utility model and an Industrial model (with an enormous chunk of glass as a pseudo crystal). One was made in a plastic slide case, and came complete with earphones (vintage models, of course). Components were sometimes crowded together and at other times they were mounted on a display board.

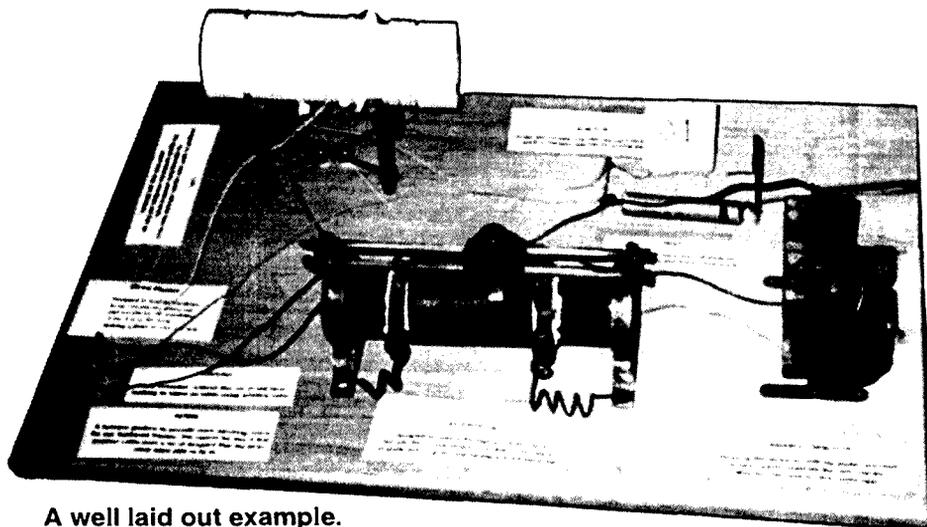
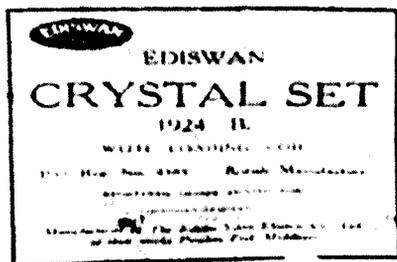

A well laid out example.

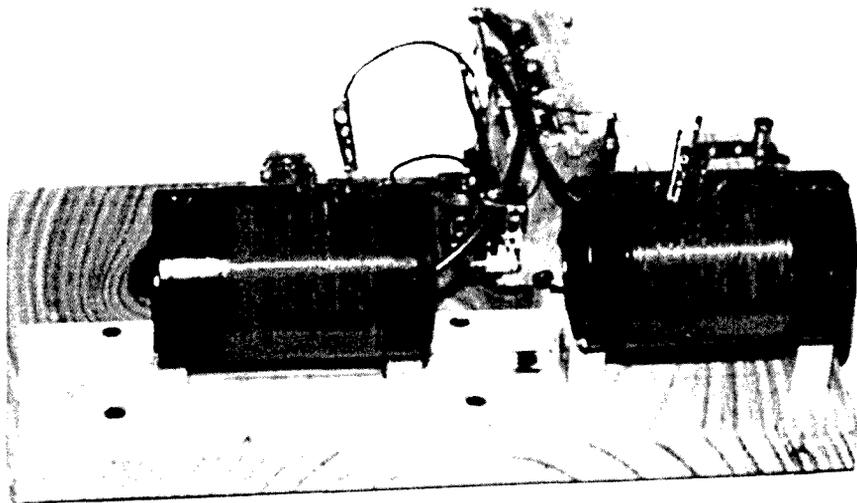

In the weeks leading up to the "Night of the Crystal Sets" many and varied were the claims made on air for some of the sets. One entrant said "his neighbours were complaining about the noise from his set". Another claimed to have "blown the cone out of his loudspeaker". Another claimed to have heard Spain and Germany on his set, and yet another entrant claimed to have had to install high power diodes to cope with the signal strength.

Some of the members said they discovered what components they had only heard of before, looked like - and what they could do! Many times people commented that they had not previously realised how many different types of circuits had been used for crystal sets and that each had their own virtues. Quite a few members submitted several sets, all working on different principles, partly to see how they compared.

News of the contest has spread far and wide both here and interstate. Let's hope that this idea is taken-up by other clubs. I'm sure they too would find that a lot of interest and activity is generated. Maybe other home-brew activities will follow.

AHARS is currently deciding what the special project for next year will be but in the meantime:

Where do you find a market for crystal sets, only used once? ar

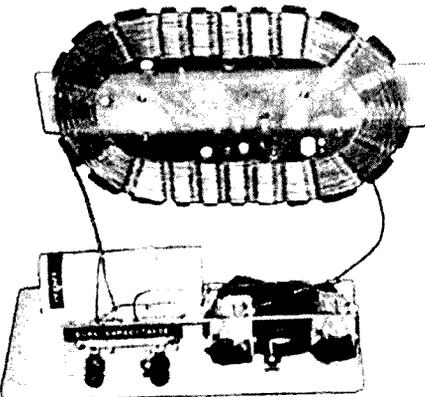

The set with the best selectivity, by Jeff VK5MFR. Note the flat coil.

One that produced more than usual interest was the "Two Can" model, demonstrating that amateurs often have more than one interest. There were almost as many different types of crystal set as there were different circuits. Lots of research had been done and many old memories revived.

The age of the entrants varied from a lad of six or seven to one "older than Methuselah". One or two of the entrants had had years of experience in the most modern electronic techniques. Others are just beginning their life in radio. All of them had to go back to the most basic ideas and methods before they could even start to build a crystal set.

Amateur Radio spans the World

Terlin
OUTbacker
 Antenna & Communications

OUTREACH \$386 inc tax

Bumper bar or tow bar mountable. Only 3.6 metres tall, with a 2.4m mainshaft that breaks down into 2 sections with a 1.2 metre tuning spike. When broken down for storage the Outreach is only 1.2m in length and comes complete with carrybag. Exceptional performance!

10-12-15m are 5/8 wave with all bands centre loaded for peak performance. Compared to any other whip you have used, you'll be amazed.

180 watts PEP and terminates with a standard 3/8 x24 (tpi) base. The Outreach can also be used as a portable antenna system provided sufficient ground plane or counterpoise is used.

Bands 160-80-75-40-30-20-17-15-12-10m.

CUSHCRAFT
 COMMUNICATIONS ANTENNAS
 Newly appointed
 Sole Australian importer
 Complete range of antenna in stock
 Please call for more details

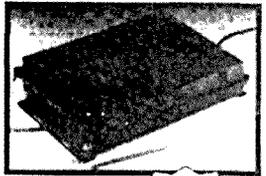

SGC-230 \$998 inc tax

The SGC-230 Automatic antenna coupler can be used within its' power rating with any HF Transceiver within 1.6 to 30 Mhz.

Designed for marine, portable and fixed base applications.

3-30 Mhz range with 9ft minimum antenna. Number of channels unlimited.

- Frequency range: 1.6-30 Mhz
- Power rating: 200watts PEP max.
- 12VDC operation
- SWR: Less than 1:1.5
- Tune power: 3 watts nominal
- Weight: 3.5kg
- Dimensions: 370x300x90mm
- Supplied with 8ft. cable for coaxial and DC power.

Ph (08) 9455 4288

Fax (08) 9455 4289

Web: www.outbacker.com.au
 Email: terlin@outbacker.com.au
 P.O. Box 1197
 Canning Vale WA 6155

What use would you be in a catastrophe?

By Chris Hill VK6KCH
PO Box 557 Willetton WA 6155
Fax 08 9354 8826
Email vk6ch@amsat.org

IMAGINE IF THERE WERE a large number of heavy industrial electric-powered machines in existence, all of which had the same hidden fault in them.

Imagine that one day, all these machines simultaneously started to draw very large currents from the public power supply network, currents much larger than the network had ever been designed for or had encountered before.

What would happen?

If you asked someone "in the know", the answer will be (justifiably) qualified as dependent on variables such as how wide spread the phenomenon is, how closely synchronised the onset of the fault condition is, how large the inrush and steady state currents are, what other loads the network is supplying at the time, and finally, what protection is offered against such faults on either the customer premises and/or supply side of the line? When pressed for a simple answer, the responses vary from "clean, orderly protective shutdown of the affected area" to "wide-spread catastrophic failure".

At the light end of the scale, a few industries and residential areas would be without power for a few hours or even a day. At the bleaker end, whole scale disruption to our entire power supply network would have a flow-on effect. There would be extended loss of power to residential areas meaning days or weeks with no electric hot water (more cold showers!), no TV, no microwave ovens, no air-conditioning, no computers, and for many, no amateur radio.

Worse still, loss of industrial supplies would mean whole business sectors standing down, affecting white collar and blue, and secondary effects would emerge, such as sewerage plants. Unable to pump

the proverbial uphill, untreated waste would be dumped into rivers and lakes.

Sound incredible? We certainly thought so until heavy dew in May 1994 saw Perth without power for 3 days. People were sent home from work when their PCs wouldn't work. Fax machines stopped and incoming phone calls couldn't be answered because there was insufficient battery back up on the PABX. Generators quickly disappeared from equipment hire businesses, and became a luxury item!

More recently, Brisbane and Auckland have discovered what a prolonged outage can mean, and Victoria lost gas supplies for nearly two weeks.

If you were to wake up tomorrow morning without power, gas or water, would you, as an Amateur Radio Operator, be an asset or a liability to the community?

What if the problem was so systemic, so widespread, that backup batteries were discharged at remote radio communication sites, backup generators ran out of fuel, and the Public Switched Telephone Network (PSTN) began to shut down in the affected areas?

The collapse of so many other everyday services would already have generated a large demand on emergency and relief services.

Loss of telephone services would add a new level of complication, especially for a society dependent on a reliable, ubiquitous telecommunications system.

Y2K and the relevance any of this has to Amateur Radio?

Right now federal, state and local authorities are developing contingency plans for just such a situation.

They are planning how to handle the unlikely, but conceivable event that a catastrophic collapse of the power, gas, tele-communications, drinking water and sewerage infrastructure "might" result from the Year 2000 problem, known as the "Millennium Bug".

Amateur Radio regularly argues that help in civil emergencies. If the tele-communications network collapses for a period of time, then hopefully Amateur Radio could live up to its promise.

I do not believe that we will see anything like the bleakest of scenarios, but it is possible. If you were to wake up to-morrow morning without power, gas or water, would you, as an Amateur Radio Operator, be an asset or a liability to the community?

How long could you provide alternate telecommunications under such conditions? Who knows about you, and how messages could be routed in and out of your Communications Post, (remember, the phone and mobile are out)

It is my perception that WICEN has been marginalised over the last decade as the government agencies they previously supported have gained easy access to advanced telecommunications over a widespread geographical area.

The push for contingency planning has highlighted the need for levels of redundancy beyond that in the existing systems. Most government authorities plan to have completed their preparations for next New Years Day by June 1999.

I believe we have a two month window in which to make ourselves known, and become formally integrated into the contingency plans.

One final call on the imagination: what if things go terribly wrong and amateur radio isn't there to help?

ar

...we have a two month window in which to make ourselves known, and become formally integrated into the contingency plans.

St Brandon DX-PEDITION

Stephen Pall

PO Box 93 Dural NSW 2158

WE ARE SITTING in the coffee shop on the 36th floor of one of the prominent international hotels near Circular Quay. Before us is the glimmering vista of Port Jackson, the official name of Sydney Harbour, the Bridge, and dozens of ferryboats criss-crossing the glimmering water.

My host is Karl, HB9JAI. We are discussing Amateur Radio, DX-ing and DX-peditions, particularly the St Brandon activity in May last year. Karl, this grey haired Swiss Amateur, was the innovator and organiser of the expedition. He is still very enthusiastic about the achievements of the DX group, formed mainly from Swiss Amateurs with representations from the US, Japan and Mauritius.

Based on an Australian Army slouch hat I had seen earlier on his hotel bed, I discovered that Karl's amateur past has an interesting Australian connection. During WWII, in 1942, Karl was living in the British mandated territory called Palestine. There was also an Australian Army contingent there, in the Jordan Valley not far from where Karl lived.

One of the diggers was an old radio amateur who gave Karl his first lessons about Amateur Radio and who, as a parting present, gave Karl an RSGB Radio Amateur Handbook. Ever since that incident, Karl has fond memories of the man whom he knows only as Mike, who initiated him into this wonderful hobby.

In memory of Mike, who by now may no longer be alive, Karl searched the specialty shops in Sydney, until he found an Australian Army slouch hat that will be proudly displayed in his hamshack when he returns to Switzerland.

Cardagos Carajo Archipelago

The full story of the St Brandon DX-pedition is contained in a twenty one-page

report compiled by Urs, HB8ABO. Here are some highlights of the report in an edited (abridged) version.

"The St Brandon (or Cardagos Carajo) Archipelago is in the St Brandon Sea, and lies at 16°30'S and 59°38'E consisting of 28 coral islands. It is not inhabited and is under protection of the UN as a wildlife area because of the unique abundance of fish and birds. Raphael, measuring a bare 200x250m, is one of the smallest islands of this archipelago. Thanks to the relative protection against typhoons, a meteorological observatory and a coast guard post were established on the island. Raphael is the island with the highest elevation in the archipelago – two metres above sea level! Nevertheless, it can happen once in every few years that it is flooded by a few centimetres of water in a cyclone.

"The ground of the island consists of coral mass and basalt covered with a thin layer of sand. A typhoon in 1995 has left its traces in the form of bent palm trees and the foundations of fishing huts that were swept away.

"Mangroves keep the soil together near the shore. There are bushes and a kind of fine conifer. On almost every branch of them are nesting birds of a species called Maquwa, which exist only in this archipelago. They are a bit slimmer than common gulls with a webbed foot of three toes. The wingspan is about 50cm; the body is black, the head grey, and the beak long and pointed. Every bird breeds one egg. They get small fish from the sea surface that they swallow and keep on stock. Most of them are also night active: their acoustic uttering such as rattling and a kind of mewing formed our nightly background sound together with the flutter of the awning of the tent in the wind. They are not afraid of man. Those who had their nest one metre above the generator had to suffer from

St Raphael. Karl, HB9JAI (left) and Kurt HB9BXE before the international flagpole.



uninterrupted QRM during two weeks of operation.

"Other inhabitants are big crabs, 10 to 20cm in length, which crawl out of their sand holes at night as well as a few dozen chickens who have the whole island at their disposal for digging. When unloading equipment Willy, Joe and Eric saw an adult dolphin. Jacky warned us of large centipedes, but only Yoshi saw one. It had crawled into his tent.

"Temperature during the day is around 28°C and 25°C during the night. Short rain showers pass several times a day. Everything feels moist and sticky. Within the tent the thermometer easily reaches 40 degrees.

How the team was formed

"Because an amateur licence for 3B7 had never been issued (except to local operators such as Jacky, 3B8CF), Karl put together plans and a team to operate from St Brandon. First he contacted members of HB9BQI, his

local Amateur Radio club in Zug. Hanspeter, HB9BXE, Joe, HB9AJW, Rene, HB9BGI, Christine, HB9BQW and Eric, HB9ADP all expressed an interest in being crew members on such a DX-pedition. In Dayton he invited George, K5KG, to participate. Later Willy, HB9AHL, Kurt, HB9AFI, Urs, HB9ABO, Hugo, HB9AFH, Yuuji, JA3IG, Walter, W7SE and Jacky, 3B8CF joined the crew.

Our Goals

"We wanted to give as many Radio Amateurs as possible the opportunity to make a contact with 3B7 while giving equal consideration to countries, continents and operating modes. Our goal was to make 40,000 QSOs. Although we wanted to have a friendly and congenial operating style, we were prepared to defend breakers and ourselves against interferers (policemen). Furthermore, we were not interested in doing any DX list operations.

Planning and Preparations

"First we established a budget and looked for prospective sponsors. After mid-1997 the group started with logistical and technical planning. In September 1997 Karl was in Mauritius for three weeks to get the licence and to charter a ship. This was a difficult venture, yet, by the time he returned to Switzerland, he had obtained written permission for a landing at Raphael Island in St Brandon and a verbal promise from the Mauritius Telecomms Authority for a 3B7 ham licence! That's how preparations began. Over the course of the next 6 months they spun up to high revs!

"In only four crew meetings – most of them without the foreign operators present the group coordinated the individual preparations. The main means of communication was electronic mail. In addition, several sub-committee meetings took place at various times and, of course; there were plenty of phone conversations and fax messages. Fortunately, we did not keep track of the telephone bills!

"Nothing was left to 'Murphy's Law'; all equipment was tested

extensively and thoroughly beforehand. A 'Field Day' was organized to evaluate masts and tune antennas. Later, on St Brandon, the well-coordinated team did not encounter many surprises.

"In the final phase starting in mid April, preparation work seemed to increase exponentially. Each crew member was occupied almost exclusively by 3B7 preparations. Family and professional obligations seemed to take a back seat to 3B7 efforts. Packing and testing of all transceivers and power amplifiers and the partial assembly, tuning and labeling of all antennas and cables was hard work that paid large dividends once on St Brandon."

The final step in the departure was transportation of the hardware to the Zurich airport and customs clearance. Karl and Eric, both experienced in international shipping of electronics, did a superb job preparing the international customs documentation. This proved to be invaluable once in Mauritius. The large volume of gear – some 900 kg and 35 cartons – had to clear customs, not only out from and back into Switzerland, but into and out from Mauritius twice for the trans-shipment to St Brandon. "Karl and Eric definitely earned Gold Stars for their efforts." writes Urs.

Sequence of Events

The DX-pedition left Zurich on the 2nd of May 1998 and after an 11 hour flight reached Mauritius Island on the 3rd. The group loaded the fishing vessel UMBRINA II with equipment, food and supplies and arrived at St Raphael Island in darkness on the 5th of May. The first QSO was made with HA5ZM on 15 metres and by the 7th of May, after a generator failure, they started the full CW activity. On the same day the SSB station came on air. By the 9th of May RTTY and PACTOR were operational. They started to dismantle the SSB station on the 16th of May. Next day was the last CW QSO. The DX-pedition made 53,518 QSOs in 12 operational days.

The return journey from St Raphael to Mauritius was not smooth. Bad weather, high seas and winds up to 55 knots, delayed the return journey by many days. They arrived back in Mauritius on

the 21st of May and landed in Switzerland on the 23rd of May.

But let's continue with the highlights of Urs' report.

Mauritius

"Mauritius welcomes us with humid and warm air, wind and clouds. We meet Karl, HB9JAI, Rene, HB9BQI, and George, K5KG, who came here one week ahead of us with 500 kg of freight to make logistical preparations. With them Jacky, 3B7CF, and Nasir Gopaul formerly of the Outer Islands Development Corporation, OI DC, the government authority responsible for St Brandon, Rodrigues and Agalega. Nasir has identified himself with our project to such a degree that he decided to come with us to 3B7! We greatly underestimated the help of these two Mauritian gentlemen. Their assistance and friendship proved to be among our greatest assets. The comprehensive support provided to us by Alain Langlois, the managing director of Raphael Fishing Co. (to whom "our" Raphael Island belongs) proved to be very valuable asset as well.

"A van takes us to the St. George's Hotel in Port Louis, the capital city of Mauritius some 45 km from the airport. In the meantime, Karl settles customs clearing for our 900 kg freight. All in all, the shipment consisted of antennas, masts, transceivers, power amplifiers, tools, cables, two Diesel generators, sleeping tents, station tents and camping toilets with their tents.

In rough seas

"Monday morning, May 4th, we loaded the Umbrina II at the pier in Port Louis. Radio equipment and food were stowed on the lower deck and the PVC tubing containing the antennas and the generators were put on the upper deck. All gear was securely lashed down for the expected rough seas, a move that paid off handsomely. Kitchen equipment, food and water, procured by the advance team in Mauritius, were also stowed on the lower deck. The last items of fresh food, procured that morning, were also stowed below.

"During the night the seas grew to six and seven metres. The ups and downs and heavy heel-overs were ceaseless. We were doing 10 knots, and

three-quarters of those aboard were seasick. There was no change until after 30 hours of rolling we reached quieter waters as we entered into the lee side of the St Brandon archipelago.

"At 17.30 we anchored off Raphael Island. Immediately the equipment was transferred into small boats with outboard motors, which were used to make the remaining 500 m to the flat sand shore. The fisherman on the island helped us to offload the boats and bring part of the goods ashore. We erected our sleeping tents in darkness (after 1800 hours local time) and stowed away our personal luggage. We had finally reached our geographical destination.



Bringing life to 3B7RF

"Early the next day we erected the round CW tent and installed the two telegraphy stations. Concurrently the CW antennas were assembled and erected on their 10-metre steel telescoping masts. Eric is the radio equipment specialist; Kurt and Willy as a team know all parts of the Cushcraft yagis, and Hugo and Urs erected the Battle Creek Special.

"On Thursday, May 7, the installation of the SSB tent and the SSB stations was completed. Our now well-trained crew erected the CUSHCRAFT X-7 antenna. In spite of its weight of 35 kg, the X-7 was quite stable atop a 7 m mast. The X-7 turned out to be our best performing yagi.

Every day life on Raphael

"During our spare time we try to sleep, go on a photo walk or take a swim in the lagoon. Low and high tides cause a difference in sea level of just about 20 cm. But those who soak their clothes in the sea have to be prepared that high tide will carry their laundry out to sea. Swimming in deep water is not recommended due to the sharks. A very easy walk around the island takes at most half an hour.

"From Friday, May 8, all four stations are fully operational. The pile-up is immense. Our four stations log an average of 5,000 to 6,000 contacts each day. In the evening we celebrate Joe's and Karl's birthdays with white wine, cognac and dessert.

"Willy and Kurt erect the ninth antenna—a delta loop that gives us a remarkable improvement on 40 m SSB over the 40-m single element on the tribander. Electric fans make the sauna-like heat in the operating tents bearable. Sometimes the wind shakes the tent so much that nothing can be heard in the earphones. The bottle of drinking water, like the key and microphone, is always within reach of the operators.

"Sunday, May 10. Today the pile-up is denser because people have time to be on the look out for us. Those who grasp our split operating concept work us easily. We try to work the weak stations as well but often have to ask the breakers to be quiet. After four hours of concentrated work, relief is really necessary.

"As there is no map of the island, Urs does a survey of the island by means of GPS satellite navigation and a compass. The compass deviation here is about 14° west. Drinking water, brought here by ship is so scarce that rainwater is collected into barrels.

"For personal hygiene, seawater has proved to be sufficient. To clean our teeth we use table water from the bottles and before meals we afford ourselves the luxury of washing the hands with the cistern water.

Good bye Raphael

"The last dinner is a celebration. We have as our guests the kitchen crew of the fishermen and meteorology officers. Karl inaugurates the little ceremony with a speech about our

successful efforts, i.e. about his dream coming true, about the good team spirit, and about the kindness of the Raphael Fishing Co. Linley, head of the fishermen, in turn thanks our team; he and his mates enjoyed the change. Little gifts such as whiskey and a Swiss Army knife with our callsign engraved move him almost to tears. The mood on the island inspired our friend Nasir Gopaul to write a romantic novel that, of course, was woven with references to a group of ham operators on an expedition. After the speeches, our cook, Richard, surprises us with a lively Sega performance – the island music of Mauritius. Linley and Claude, other fisherman, form a backing for the singer by drumming on empty jerry cans. (The basic rhythm of Sega seems to be like continuously sending the figure 4 in CW).

Rough seas again

"Monday we wake up at five. Dismantling personal gear and once again embarking on Umbrina II. On the ship we hear bad news: Due to bad weather we are unable to start our trip back. After some discussions it is decided to go to the Ile du Sud, the southernmost island of the archipelago. No problems on the two-hour trip there because we are on the leeward side of the reefs. Captain Pierre continued for a few miles into the open sea, but had to return due to high seas and strong gusts. Twice we were hit by a double wave, which made the vessel roll as much as 40 degrees! Therefore we throw

the anchors west of the Ile du Sud and stay over night.

"The next morning at 07.30 we receive the latest weather report. Last night there were gusts up to 55 knots or almost 100 km/h. A high-pressure area to the south and a perturbation line in our vicinity are the reason for this strong wind. The weather hasn't changed since yesterday! "Bad weather" in this context means: sunshine, slightly cloudy, temperature around 28°C but strong wind that blows apart the white crests of the high seas even within the reef. Eric and helpers repair the ship's onboard Raytheon HF transceiver with lots of improvisation. A defective inverter inside an integrated circuit is replaced by a transistor scavenged from an old sonic depth finder. The ship's crew was ecstatic when they realized their HF radio was working again. Now radio contacts with the freighter Eliza and Raphael Fishing Co in Port Louis are possible again, and we are able to receive weather reports. Unchanged WX bulletin at 11 hours. We are still stuck. The stormy weather remained all night. At dawn it's becoming a bit calmer and the situation improves.

"On May 21" at 11.00 Umbrina II stops engines at the pier of Port Louis. Raphael Fishing Co hosts us with sandwiches, which we eagerly gobble up after three days on a very limited menu. Unloading equipment, transport to the airport and customs clearing occupies the balance of the day. The first fresh water shower back in the St George's Hotel after 14 days of seawater is just great! Dinner in a Chinese restaurant was delightful and finally there is enough beer for everyone!

Farewell

"On Friday we take a little sightseeing trip to the southernmost part of Mauritius. In the evening we hosted an official farewell party with aperitif in the very classy Labourdonnais Hotel at the Caudan Waterfront. Invited were the ship's crew, government representatives and radio amateurs of the Mauritius Amateur Radio Society (MARS). We had decorated the place with our national flags and with the banners of our sponsors. We wore the white sweatshirts with the "3 B7 RF"

At sea. Approaching St Raphael Island, the location for 3B7RF.



markings. (Maybe this misspelling will become as famous as that of the legendary Blue Mauritius postage stamp). The representative of the Ministry of Telecommunications, Mr Beehare, was obviously pleased by the results of our operations. He phoned Karl, Christine and George at 05.30 the next morning at the hotel to wish them a pleasant journey and request a subsequent get together with Karl at the next ITU meeting in Geneva.

"After our very boisterous crew enjoyed a rollicking dinner in an Italian restaurant and a late night stopover in a local casino, everybody was busy with packing his personal affairs to be ready for departure early next morning. During the flight back home the busy DX-pedition crew went to work again. Two laptop computers were unpacked and then the first draft of the present report was formed in an altitude of 10,000m.

OPERATIONAL CONCEPTS

Split operations

"We tried to achieve our goal with a relatively wide split window of up to 15 kHz. Experience showed that we were able to work the weak "100 watt/dipole" and QRP stations. We often had difficulties, mainly in CW, in extending the split window from 2-3 kHz to a width of 15kHz. Over and over we asked our audience for a wide split by broadcasting "pse qsx up 5 to 20".

Those stations that got the messages were easily worked and, hence, worked – even the very weak ones. When tuning back to 5 kHz up there was again an unimaginable crowd of stations calling. Under such circumstances only the big guns were able to pound through the QRM.

Discipline, behavior of the other stations

"We saw that the old experiences are still valid. The best disciplined are the Japanese followed by the Americans. Most of us noted with great satisfaction how disciplined was the behaviour of Ukrainian and Russian stations.

"From 3B7 the beam direction for Europe and North America was the same. Therefore European signals were mostly louder than those from US.

So we often had to explicitly call CQ USA only, EU pse standby. Surprisingly even the Europeans sometimes would stick to our request! The repeated demand USA only after each QSO led to a certain discipline among the Europeans. Of course the QSO rate with this long CQ call is never as high as with pile-up of Japanese or stateside stations only.

"Our principle, to complete every contact despite all the breakers, cost us a lot of time. With a friendly but decisive attitude we managed to control the pile-up.

"On at least two different days we heard a pirate on 7013.7 kHz calling

Contacts made per band and mode

Band	160m	80m	40m	30m	20m	17m	15m	12m	10m	Total
SSB	0	0	1915	0	4638	3336	4829	2974	2004	19696
CW	511	2231	2976	1707	5124	4809	7315	4553	3961	33187
RTTY	0	0	0	0	296	0	477	0	0	773
Total	511	2231	4891	1707	10058	8145	12621	7527	5965	53656

CQ de 3B7RF UP, while we were transmitting on 7007. It's hard to say how many stations the pirate tricked. Even harder to understand is what the pirate intended with such a procedure. Maybe he just wanted a report. Here it is: You were 599!

Shifts, operating timetable

"The task was to operate two CW stations, two SSB stations and partly one RTTY station around the clock during 10 days with 14 operators.

Best solution seemed to be a 4-hour shift. Mostly every participant could choose himself at what station (SSB or CW) and what shift he wanted to work.

To occupy the stations around the clock, Hans-Peter sometimes had to assign night shifts that caused no problems among the participants. The shift plan was continuously established about half a day ahead, so that we were able to consider the propagation conditions and the wishes of the hams in the world. George, K5KG, and Walter, W7SE delivered propagation data as a base for the selection of working bands.

At 12 hours we have lunch; the four working operators are relieved a bit later. At 19.30 again at least ten people enjoy a common dinner, the four remaining join after their relief. That's the daily routine to simplify the task of the kitchen crew. On a bulletin board we can study the shift plan, propagation conditions, pilot's reports and even a menu plan.

Results, statistics

"With more than 53,000 QSOs in all we were able to work all ITU zones and 150 countries. Our contacts are divided among bands and modes as tabled.

QSL cards

"The club station HB9RF will manage dispatch of QSL. Mail address: HB9RF, Postfach 37, CH-6319 Allenwinden, Switzerland.

"Cards received via bureau will be replied to 100 percent. Cards sent directly will be replied to directly where return postage is provided; otherwise they will be sent via the bureau.

Description of the stations

"For CW and SSB we used Yaesu FT-1000MPs on each of the four stations. As a backup we had two FT-920s. The receiver of the FT-1000MP matched well the requirements of this expedition and every operator quickly mastered its features. As power amplifiers we used two Ameritron AL80BX and two Yaesu VL-1000, the latter for the WARC bands. Transceivers and PAs were connected via ICE band pass filters to minimize inter-station interference. When changing bands we very much appreciated the fully automatic band switching of the solid state VL-1000s. We selected the antennas by hand-connecting the well-labeled coax cable to the proper PA.

"Logging was done on Compaq Aero 4s. At the beginning we had problems due to the RF getting into the laptops. (For this reason at least one valid contact with a JA station was lost and some QSOs were erroneously run simplex because the PC inadvertently changed the transceivers controls). After we blocked all leads to the PCs with ferrite chokes the PCs worked flawlessly.

"The RTTY-Station consisted of a PC running Plusterm software, a PTC 11 modem of SCS and Yaesu FT-920. During the RTTY activity day the VL-1000 of the SSB WARC station was connected to the RTTY station.

ANTENNAS

Battle Creek Special

"This antenna is a vertical radiator for 160, 80 and 40 m with traps and 32 radials laid out on the ground. It was generously loaned to us (as well as to other DX-peditions before) by K8GG, W8UVZ and W0CM. Many thanks!

"During tests in HB9 we remarked that the high RF current to the radial net flowed across the hinge between the base tube and the base plate. HB9AFH constructed a device that could be fixed to the original mast base with just two screws. This improvement then brought us the following advantages: Good low-impedance contact to the radial net, and tensionless, easy mountable fixing of the 32 wires to the base plate.

"For 160-m operation a switch at the antenna base inserts a 2:1 impedance transformer. The Battle Creek Special yielded very good results on all bands. Results on 40 m were far better than those with the 40-m add-on to the Yagi. The signals on 160 m were very often below noise levels at our geographic latitude, which, of course, was not the fault of the vertical antenna. Obviously our signals in Europe, USA and Japan were far better than vice versa. We believe that we would have benefited by a Beverage antenna however, the impedance transformers were unfortunately left behind in HB9.

40 m delta loop

"The 3-element Yagi for the "classical" bands equipped with the 40-m add-on was not very effective on 40 m. We had difficulty to being heard. So Willy and Eric proposed a delta loop. Kurt found a centre insulator in his luggage and the last reel of coax was opened.

"As a suspension point we used SSB WARC Yagi, the mast of which was

lengthened by the boom of a 2 m 14 Element Yagi. The delta loop was suspended in our main radiation direction NW (EU and USA). It was fed in one of the two lower corners. The initial SWR of 1:1.7 was promising. During the notorious low traffic period (2200 to 0100 UTC according to conditions), Willy connected the loop. First some African stations checked in loud and clear as usual. But then some JA stations proved to be very strong too, so the expectations of this simple wire antenna were growing.

"After 10 minutes a steady pile-up between 7080 and 7100 came up to stay. This convinced us of the qualities of this antenna. During several nights we had further successes. Among others we were able to work hard-to-reach regions of the US West Coast and mid-west with good signal strengths. Thanks to this loop we worked 1915 stations on 40-m SSB. Compared to the simplicity of the antenna and keeping in mind the operating mode; this is a remarkable result.

Yagis

"Six Cushcraft Yagis were used for the four stations. The CW stations had access to two A3S Yagis (one of which was equipped with the 40 metre element) and one A3WS (with a 30 metre element) for the WARC bands. The SSB stations were configured with one A3S, one A3WS and the large X-7 triband Yagi. All antennas were installed at a height of about 8 metres on heavy duty telescoping Letrona steel masts that were guyed off to heavy aluminium stakes driven into the coral ground. We had just two beam directions: northwest for Europe and USA and northeast for the Far East. We turned the Yagis by a rope attached to the director end and tying it either to the "Europe coral" or the "JA mangrove".

Interference

"As a condition of our 3B7RF license, we were prohibited from causing interference to the HF radios used on Raphael by the Mauritius meteorology and coast guard stations. Early in our stay on Raphael we reviewed their frequencies and operating schedules. Getting on a friendly basis with the crews of these stations, carefully explaining our purpose, inviting them to inspect our installation and avoiding their 30 m frequency during their morning transmissions resulted in no interference complaints whatsoever.

"Inter-station interference was minimal. Each of the four stations was operated at all times with ICE band pass filters installed between the transceivers and the linears.

"Simultaneous operation on CW and SSB was routinely carried out on 10, 15 and 20 metres without inter-station interference. Being able to carry this simultaneous operation greatly enhanced our QSO rates during the time these bands were open. Simultaneous operations on CW and SSB on 12, 17 and 40 metres, however, were not possible due to the limited frequency separation between the modes on those bands. No doubt with greater physical separation between CW and SSB stations, simultaneous operation would have been possible.

Food and Shelter

"To avoid mutual interference during shift work each team member had his own tent. The fisherman had erected a team tent and a storage tent for us. The first dinner we had tuna fish (caught by Umbrina's crew), pasta and pumpkin puree. Rene, HB9BQI, and Christine, HB9BQW, were responsible for food.

"Examples for other menus were: Baked fish, dried potatoes, cooked pumpkin, Chinese noodles with fish, fish roasted on a spit with rice and salad, salted fish, curry fish, grilled fish, sweet-sour fish with seasoning, soup, potato salad, corned beef, macaroni with cheese dressing and cuttle-fish. Homemade (HB9BQI) wholemeal bread and filtered coffee produced a good mood at the breakfast table. There was one beer per day person (clearly not enough!).

"Once Yushi, JA3IG, served us a freshly prepared raw fish. He tells funny stories about swallowing living shrimps and sepias in Japan. The meals are simple but excellently prepared by Noel and Richard, the kitchen crew of Raphael Fishing Company.

Sanitary Equipment

"There were two camping toilets each within a tent. Sea view included. So ends the very detailed report of Urs, HB9ABO about the St Brandon DX-pedition."

How everything began

During our long and friendly encounter I felt that I had known Karl for a long time, especially after discovering that our footprints might have crossed during the early years of war in Europe.

The shadows of the pleasant afternoon were growing; it was time to go, and to say good-bye to each other.

"Ten years ago" said Karl "I visited Mauritius for the first time. The beauty of the island and its friendly multi-cultural inhabitants left me with delightful imaginations and reminiscences. In 1996 I resumed my former links with the intention to celebrate my 75th Anniversary and 50 years of ham activity in a special way. I was thinking about an expedition to the St Brandon Islands!" And he fulfilled his dream.

ar

Andrews

Communications Systems

(EST 1976 - ACN 001 968 752)

★ Factory Direct Importer

★ 3-year Warranty

★ We Sell Most Brands

Icom - Kenwood - JrcOAor -

Emotator - Mfj

Diamond - Timewave - Kantronics -

Palomar

 **ALINCO**

ALINCO DX-70TH

\$1399

HF+50MHz 100W TRANSCEIVER.

NEW "ICOM IC706IIG"

JUST ARRIVED!

WE URGENTLY WANT GOOD TRADE-INS

AND REPAIRS

*** OVER 20 YEARS OF SERVICE ***

Call us for unbeatable prices . . .

(02) 9636 9060 or (02) 9688 4301

SHOP 8, 41 BATHURST ST. GREYSTANES,
N.S.W. 2145. FAX (02) 9688 1995

A Current Indicator for Open-wire Transmission Lines

Drew Diamond VK3XU
45 Gatters Road
Wonga Park VIC 3115

Using an ASTU

A loop, or dipole antenna fed with "open-wire" transmission line probably gives the amateur, with the usual space and height restrictions, one of the best all-round multi-band antennas available. Depending upon the antenna, and transmission line lengths, we may get, at the station end of the line, "current feed" (low impedance), or "voltage feed" (high impedance), or anything in between. Also, the impedance may be resistive, or resistive with a capacitive or inductive reactance component. Unless the impedance is outrageous, a good antenna system tuning unit (ASTU) can generally make such an antenna work well on just about any HF band.

Intuitively, for each band, we generally adjust the ASTU for lowest SWR in the coax cable connection between the radio and ASTU, and leave it at that. But this SWR reading does not tell us what is actually happening on the transmission line between the ASTU and antenna.

For comparison purposes, one each of the three most popular ASTU circuit configurations were built; a "Link-coupled Transmatch", an RSGB "Z-Match", and the ARRL's favourite; a "T-network Transmatch".

The system to be "tuned" to the various

HF bands was a 160 metre dipole fed with about 10 metres of ladder-line. Each circuit was carefully adjusted for minimum SWR in the coax cable. Interestingly, for the same frequency and transmitter power level, the value of transmission line current (and hence, by reasonable assumption, RF power "up the stick") was different for each ASTU, even though the coax SWR was 1.0 in each case.

Line Balance

I'm not going to tell you which circuit appeared to give best results; that aspect has already been adequately thrashed out in this and other journals. And anyway, my ASTUs may not be as efficient as yours.

Rather, in addition to the SWR in the coax cable, we should also be interested in the relative value of current (or voltage) in each wire of the transmission line to the antenna. In this instance, we are not worried about the SWR on the open-wire (or ladder) line. It may be, and probably is, quite high. Losses are acceptably low however, because the dielectric is mainly air, and the conductors are low resistance copper. The wires are closely coupled, so if the current and voltage levels are the same in each wire (but opposite in phase), then line radiation will be minimal.

RF Ammeters

At low and moderate impedances, an RF ammeter in each wire of the line will show the relative value of current. Hopefully, if the antenna is supposed to be balanced, they should be equal, or nearly so. For a voltage, or high impedance feed, a small desk-lamp fluorescent tube placed across the open transmission line will glow (at about 10 W and above, depending on



Photo 2. A one-lamp loop-stick coupled to a single wire feed.

tube type). The tube's brightness makes a handy indicator of electric (voltage) field intensity.

RF ammeters are now rare items, particularly matched pairs. An unfortunate characteristic of the thermocouple type RF ammeter is that it is fairly easily overloaded to destruction. Many of the meters that I see at Hamfests, for instance, have "had-the-gong". You can easily check for their serviceability; turn the meter to and fro with a twisting motion. If the needle swings around freely and bounces off the stop, then the thermocouple is probably burned out. If the needle appears to be damped, the meter and thermocouple are probably good.

Substitute for RF Ammeters

Here are details of a simple device which makes a fair substitute for a pair of ammeters. Photo 1 shows two versions of a twin-lamp current indicator. The lamp type is not critical, but they must be identical. The small pea-lamps are 6 V/100 mA, #2721142 from Tandy, and the dial lamps are 6 V/150 mA, # 40 (generic). Each lamp is soldered to a three-turn hook-up wire link, which is wound upon a 70 mm (not critical) segment of ordinary loop-stick rod.

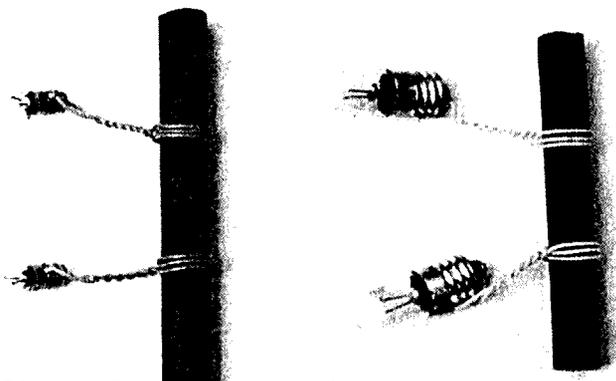

Photo 1. Two versions of the twin-lamp current indicator.

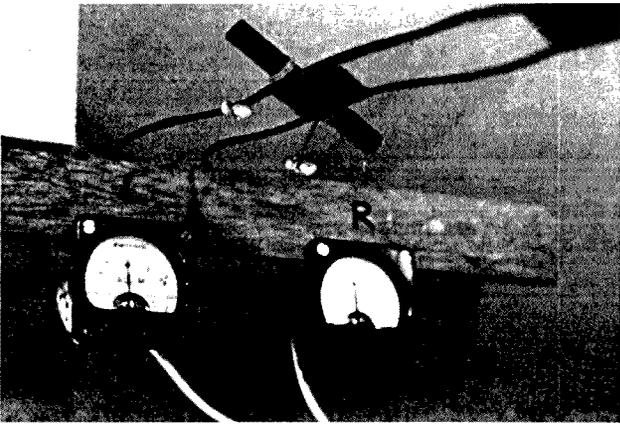

Photo 3. A one-lamp loop-stick coupled to a single wire feed.

In operation, the rod is placed, or attached (perhaps with a clothes peg) to the transmission feed line as shown in photo 2. Note how the link coils lie

immediately adjacent to the outside of each wire of the line.

When the line is energised at moderate to high power (say, 100 W), the lamps should have equal glow, indicating that the current in each wire is the same. It may be necessary to move the loop-stick further along the line to find a higher current point.

The presence of the device introduces negligible disturbance or loss to the system, and does not alter ASTU settings. When making tests and adjustments, it will be found that smallest

changes in current (and hence, resolution) may be observed when the lamps are at about half or 3/4 brilliance.

Photo 3 shows how a one-lamp loop-stick may be coupled to a single wire feed. Shown here is the station end of my inverted-L 160 metre ~ wave antenna at the 50 W power level. At higher power levels it should not be necessary to coil the antenna wire around the loop-stick; simply place the lamp link coil adjacent to the wire.

References

1. *Radio Communication Handbook*, 6th edition, RSGB.
2. *Radio Handbook*, William Orr, Howard W. Sams & Co.
3. *The ARRL Handbook*, 74th edition.

ar

The Fourteen Second Doughnut

— getting it “just right”

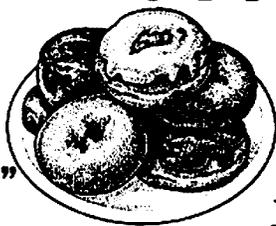

by Ian Jackson
VK3BUF
105 Franciscan Ave
Frankston Vic. 3199

with a bit of dried food stuck to one side. You scrub it hard but it stays. You get out the steel wool and it still won't come off. A trip to the workshop reveals that the chisel and the screwdriver only scratches this residue a bit. Finally the angle grinder restores the bowl to its pristine condition.

Upon your return, your spouse says “Ahh, I've been looking for that”, fills the bowl with mince and gives it to the dog. Meanwhile you realise that you've missed the first twelve minutes of a *Yes Prime Minister* episode you've been dying to see all week.

How good something has to be is the hidden variable. The next time you embark upon a project and you are figuring out shapes, size, colour, location etc, stop and think about how good it has to be. Keep the project simple and you may have time left over to read a book, watch TV, or perhaps slip in an extra project. Failure to spend enough attention to detail might mean that your assets and possibly even your life are at risk.

Oh yeah. The fourteen second doughnut. Occasionally I spoil myself with the odd pineapple doughnut. The problem is that if served cold, they are hard, greasy and stick to the roof of the mouth. The modern microwave oven is a godsend for us doughnut eaters. But be warned, if served too hot, doughnuts become limp and scalding.

In a 600 watt oven, fourteen seconds is just right.

ar

WHEN IS ROUGH ENOUGH, good enough? Occasionally everyone must ask themselves this question when performing a task. The task can be anything, erecting a fence, making a meal, building a child's cubby house or merely driving a car. Can I do better? Do I need to do better? Differences are critical, and sometimes only a matter of personal aesthetic.

We probably all know someone who has the 'She'll be right mate' attitude. Everything they do is completely casual and rough enough is always good enough. This is all fine and good, and may give that person more time for the better things in life, but would you let that person service the brakes on your car?

I have known perfectionists. Every coffee mug in the cupboard has a corresponding cup hook, their garage will have a shadow board so that each tool occupies a well defined niche. A lawn trimmed with scissors and a bed with sheets tight enough to bounce a ping-pong ball. They can spend so much time organising themselves that they will

never actually do anything. Doing something may introduce unknown and uncontrollable circumstances. Something to be avoided at all cost.

So what is this all about? It's about getting the right mix. The art of looking at a task and deciding how good it has to be to achieve the best end. For example, you are building up a little circuit. You have the soldering iron out, you chase the parts around the benchtop blobbing solder on here and there and the circuit is complete. You test it and it works. Fine, that is all you need to do if it is going to remain in the bench. But if you decide to put the circuit in a car, bumpy roads are going to break this baby apart in no time! Back to the work bench. You redo all solder joins, be careful, don't burn off all the flux and leave daggy bits jutting out when you pull the iron away, shorten all the wires, put strain relief on external cables and add four more mounting screws. All done.

Take another example. You are washing dishes (strictly hypothetical in my case) and you encounter a plastic dish

REFLECTOR SECURITY BEAM

This security beam uses infra red (IR) which is transmitted to a reflector and back again across a doorway. If the beam is broken by anyone, the buzzer will sound, and only sound while the beam is broken. The buzzer is on the end of 20 metres of cable. The range is up to 7 metres. **NEW** **Only \$119** Cat. LA-5192



SECURITY BEAM WITH TRANSMITTER/RECEIVER

This security beam is similar to the reflector type LA-5192, the difference being it has a receiver unit instead of the reflector. The receiver unit allows the effective range to be as much as 20 metres. Mains plug pack supplied. Cat. LA-5194 **NEW** **Only \$139**



LASER MODULE

Ideal for experimentors. Includes laser diode mounted on a PCB with a battery spring and on/off switch. Simply connect a 3V battery - negative to spring, positive to case, and you have an experimentors laser. 1mw output. **NEW** **\$14.95** Cat. ST-3115



KEY FOB TRANSMITTER

Problem solved! This key fob transmitter will learn the code of your transmitter. Brand name replacements are very expensive, and sometimes impossible to get. This will solve your problem. It can actually learn up to 4 different frequencies, so it can be programmed for the car alarm, the garage door, home alarm etc, etc. Supplied with full instructions. Cat. LA-8990 **NEW** **Only \$39.95**



PIR CCD CAMERA

This is a motion activated camera. When the PIR detects someone, the CCD camera is switched on, & the following can be triggered: •Alarm output. Terminals are NC, NO and common. 30VDC / 0.5A rated. This NC output will switch a mains lamp up to 500W / 2.5A. Cat. QC-3478 **NEW**



NEW JAYCAR SCREECHER CAR ALARM KIT MKII

This car alarm kit actually has the siren INSIDE the car! Updated from the original Screecher kit, the



new model is substantially smaller, has an extra buzzer for a soft early-warning alert and a high intensity deterrent LED instead of a lamp (which used too much power). Kit includes PCB, siren, all electronic components and two warning stickers. **\$29.95** Cat. KA-1813

8" 24 HOUR WALL CLOCK

Great for shift workers! Quartz timing with white face (Dia. 20cm) and black numbering. **NEW** **\$19.95** Cat. XC-0111



SMALL SPEAKER DEALS

No. 1 4" (100MM) ROUND SPEAKER 4Ω 2 WATT. Cat. AS-3009 **NEW** **Only \$2**



Buy 10 \$1.60ea

No. 2 5" (125MM) WITH SET BACK MOUNTING BRACKET 6 WATT 4Ω. Cat. AS-3011 **NEW** **Normally \$6.75**



Only \$3.50
Buy 10 \$3.00each

FAST NICAD CHARGER & DISCHARGER



Charges AA, AAA, C and D Nicads in 4 hours. See 98 Cat. page 86 for full details. Cat. MB-3500 **was \$69**

Only \$49.95

LASER LEVEL

This laser pointer level will allow you to check levels and lines in a radius of up to 10 metres. Comes in an aluminium case with a spirit level, screw thread for tripod mounting and 2 magnets. Size 145(L)x34(H)x18(W)mm. Supplied in carry pouch. Cat. ST-3110 **NEW** **\$139**



VISIT OUR WEB SITE:
www.jaycar.com.au

AURA INTERACTOR CUSHION

We have made a huge distress stock purchase from AURA in USA. We have sold thousands of the Interactor Backpacks, and now can offer a CUSHION VERSION, for a crazy low price.

THEY ARE UNDER 1/2 PRICE! This Interactor Cushion will transform low sounds into movement, so you can actually feel these through your back. Simply place in your lounge chair, or seat, and complete a 3D sound environment for added impact for home theatre, computer games etc. The Interactor Cushion can be used with almost any PC/Mac, home theatre system, CD player or video. Supplied with black cushion (with inbuilt shaker), amplifier module, 240V mains power supply and connecting lead set.



Cat. XC-1005

LESS THAN 1/2 PRICE
HUGE SURPLUS STOCK PURCHASE
FEEL THE ACTION

Only \$79.95

Military-Look Gas Torch

This Pocke Torch lighter runs on butane gas. The case is clear and it has a piezo start. The flame is adjustable and can be locked off or on. Supplied with a cap on a chain. Height with cap is 76mm. **NEW** **Only \$29.95** Cat. TS-1684



HEAVY DUTY MAINS SURGE PROTECTOR

We've made a scoop purchase of 100 only very high quality mains surge protectors. This protector is in a very heavy anodised steel case, and has 4 individually switched sockets and illuminated rocker switch. It features initial protection with a circuit breaker and spike reduction circuit, followed by two stage high frequency filtering for maximum protection. Made in Australia. SAA approved N11895. **NEW**



Size 440(L) x 100(W) x 50 (D)mm. **Normally sell for \$269**
Save about \$100 **These are only \$165** Cat. MS-4015



Jaycar stores located in - Sydney, Melbourne, Brisbane, Adelaide, Hobart, Perth, Canberra, Newcastle, Auckland NZ and Dealers in most country areas. Call Freecall 1800 022 888. Fax (02) 9743 2066. Website: www.jaycar.com.au
Special prices and deals available until January 31st

Narrow Band Voice Transmission

Lloyd Butler VK5BR
18 Ottawa Ave
Panorama SA 5041

THE MARCH 1995 ISSUE of Amateur Radio included my article "An Adjustable Audio Filter System for the Receiver". This described a system using switched capacitor filters to provide continuous adjustment of lowpass, highpass, narrow bandpass and notch filter characteristics. In the June 1995 issue, I followed up with modifications to allow control of a wide band of frequencies that could be rejected or slotted out within the audio pass band.

Having experimented with the rejection band arrangement, I observed that there was little difference in speech quality if a complete band from 500 Hz to 1500 Hz was taken right out. Only frequencies below 500 Hz and above 1500 Hz seemed important for good intelligibility. I made the point in the article that if noise or interference was concentrated in the 500 to 1500 Hz spectrum, it could be reduced without loss of speech quality by simply slotting out this part of the audio spectrum.

I didn't think much more about this until I read the Pat Hawker Technical Topics column in January 1998 issue of Radcom. He described how in December 1977 issue of QST, Dr R W Harris and JC Gorski announced a new narrow band method of voice communication. The system made use of the characteristic of speech I have just discussed and audio frequencies in the range of 600 to 1500 Hz were not transmitted.

Narrow Band Voice Modulation (NBVM)

Pat Hawker further discusses how the system was perfected by R W Harris WB6CZX and T Lott, VE2AGF/W6. The theory of their system is illustrated in figure 1. Normal speech is transmitted around 300 to 2400 Hz as shown in Figure 1a. In NBVM, frequencies from 600 Hz to 1500 Hz are dropped out as shown in Figure 1b. Frequencies

between 1500 and 2400 are then shifted down to occupy the range of 600 to 1500 Hz as shown in Figure 1c. The complete audio band is thus reduced to a range from 300 to 1500 Hz.

In effect the system emphasises the most important information bearing parts of speech (the consonants) but discards the mid range vowel sounds. On reconstruction of the frequency spectrum in reception, the original timbre and voice identification characteristics are retained.

So how is the system made to work? I found some reference in the 1982 issue of the ARRL handbook and this helped me assemble the block diagrams, figures 2 and 3, for the compander system.

Transmission

Figure 2 shows how the speech bandwidth is compressed to feed into the transmitter. The speech is fed via a 2400

Hz low pass filter to restrict upper frequency, out of range, components. A 600 Hz low-pass filter separates the lower frequencies. The whole spectrum to 2400 Hz is fed to a balanced modulator to mix with a 3000 Hz local oscillator. Output components are removed from the modulator below 600 Hz by a low-pass filter. The 1500 to 2400 Hz input components to the modulator are converted at its output to a range of 1500 to 600 Hz but in addition there are a lot of other frequency components generated above 1500 Hz. All the modulator output components above 600 Hz are then summed with the 300 to 600 Hz components at the other leg and fed through a 1500 Hz low pass filter which eliminates the unwanted components above 1500 Hz. Our audio signal is now restricted to 1500 Hz bandwidth to feed the transmitter modulator.

Reception

At the receiving end, the audio output from the receiver is in the compressed bandwidth form and it must be expanded in a reverse process to restore intelligibility. This is illustrated in figure 3. The receiver audio is first fed through a 1500 Hz low pass filter to remove any higher frequency extraneous components. The frequencies below 600 Hz pass through

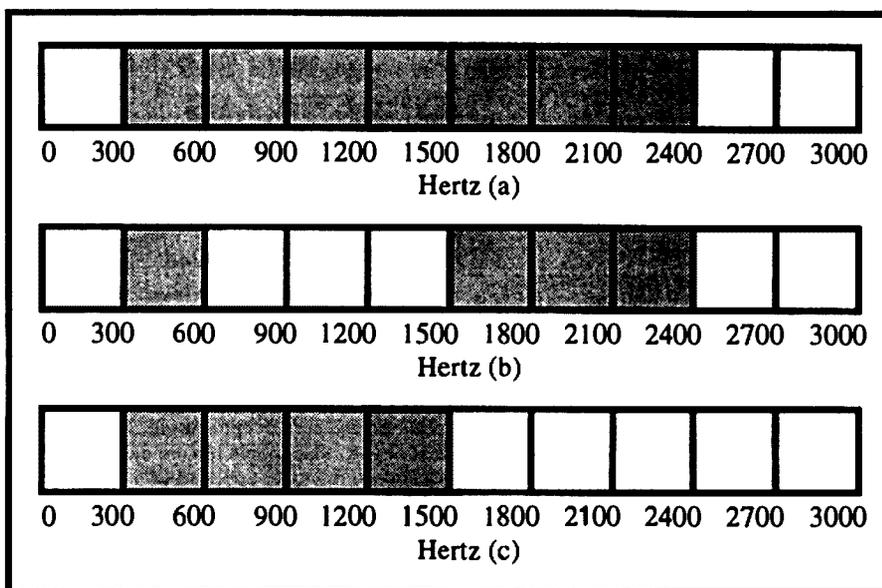

Figure 1. Compression of the voice band for Narrow Band Voice Modulation (NBVM)

- Typical normal voice bandwidth used on SSB - 300 to 2400 Hz.
- Audio range from 600 Hz to 1500 Hz deleted without loss of intelligibility.
- 1500 to 2400 Hz speech spectrum shifted to replace 600 - 1500 Hz content. Total bandwidth is now 1500 Hz.

Source: Pat Hawkins - Technical Topics - Radcom Jan.1998

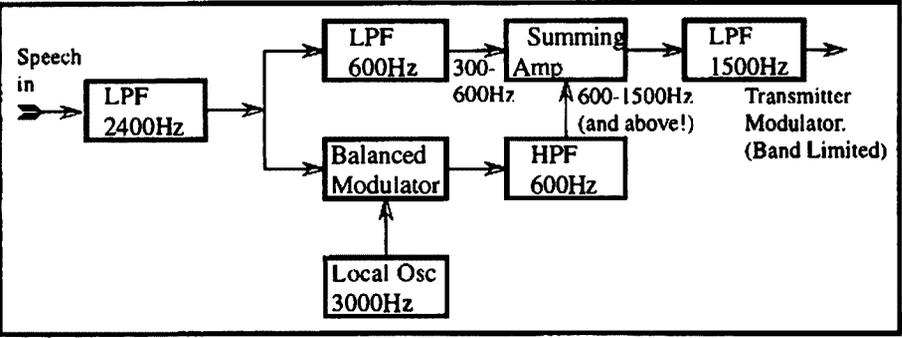

Figure 2. Block diagram showing compression technique for speech transmission.

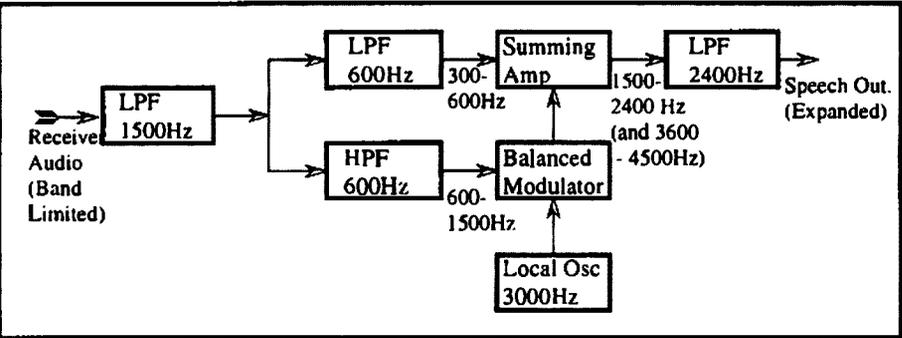

Figure 3. Block diagram showing technique for reconstructing speech on reception.

the low pass filter while those above pass through the high pass filter. The output of the high pass filter, above 600 Hz, are fed to a balanced modulator where they are mixed with a fixed 3000 Hz local oscillator.

The 1500 to 600 Hz voice components are restored at the modulator output to their original frequency spectrum, 1500 to 2400 Hz. In addition there are also other output components above 2400 Hz resulting from the modulation process. The modulator output components are then summed with the 300 to 600 Hz components from the 600 Hz low pass filter. Finally, the combined signal is passed through a 2400 Hz low pass filter to remove the unwanted higher

frequencies. We now have the restored signal that can be fed to the receiver loudspeaker.

System Features

So what are the advantages of NBVM? The introduction of single sideband reduced the bandwidth requirement to 50% of the old AM. The NBVM system reduces the bandwidth even further to 62% of SSB. Because of the reduction in bandwidth, we can fit more stations in a given band space and we can expect a nominal improvement in signal to noise ratio of around 2 dB.

The Technical Topics report indicates quite high speech quality with only the 1500 Hz transmission bandwidth. In fact

the report further indicates that if intelligibility only is required, a bandwidth of 1200 Hz or even 1000 Hz is possible by using a rejection band of greater than the 600 to 1500 Hz discussed. My own tests using the tunable filters confirmed the good speech quality for a band rejection extending up to 1500 Hz but the tests also demonstrated the loss of quality as the rejection band was extended upward above 1500 Hz.

But what are the negatives? There is the complication of providing four fixed audio filters to transmit and four to receive. On the other hand, the filtering is all done at audio level and need not involve internal modification to transmitter or receiver. Of course in this day and age of modern digital technology, the whole filtering process could be easily achieved using digital signal processing techniques and indeed it might already have been incorporated in some of the modern digital signal processing gear.

Another factor is that if you decided to transmit with this system, you could only communicate with someone who had installed the corresponding audio receiving gear. Pat Hawker writes about the lack in popularity of NBVM in amateur radio circles. He said "These disadvantages have evidently been judged to outweigh the greater spectrum efficiency and fairly modest improvement in SNR."

As I said earlier, the principle of dropping out the speech components in the frequency range of around 500/600 Hz to 1500 Hz in the NBVM system tied in nicely with what I had found experimenting with my adjustable filter unit. I thought it would be an interesting subject to reintroduce to the columns of our AR journal.

ar

References

1. Lloyd Butler VK5BR - *An Adjustable Audio Filter System for the Receiver* - Amateur Radio, March 1995.
2. Lloyd Butler VK5BR - *The VK5BR Audio Filter, Modifications to include an Adjustable Rejection Band.*
3. Pat Hawker G3VA - *Technical Topics* - Radcom, January 1998
4. *ARRL Handbook*, 1982 edition - Chapter 14, Specialised Communications Systems - Page 14-33

Amateur Radio Index on disk

From January 1968 to the current issue on an IBM format 3" floppy disk in both ASCII text file and DBF database format

Posted to you for just \$10
WIA Federal Office,
PO Box 2175
Caulfield Junction Vic 3162

Demonstrating Amateur Radio in a School

Graeme Scott VK2KE
PO Box 385 Albury NSW 2640
gscott@albury.net.au

WE NEED TO encourage young people to enter our hobby for a number of reasons:

- There is a decline in those entering the hobby.
- The Limited Novice licence makes it easy to become a ham these days and we need to populate our bands to ward off attacks from commercial interests.
- It is healthier for the dealers of gear and it offers more people who can become WIA members.
- It even expands the second hand market for pre-loved gear!

Recently, I was asked by the librarian of a local high school to put on a lunchtime demonstration of ham radio for the students. I talked it over with Greg VK2EXA and we decided to give it a go.

Demonstration Station

We planned to set up two metre FM phone, two metre packet and HF. For antennas, Greg provided two metre and HF whips on his 4WD Toyota and we set up the station in the school library at Murray High School.

The Librarian advertised the event in the school newsletter and put up posters around the school. We were asked to do it from 1 to 2 pm over two days to catch as many students and teachers as possible.

It didn't take us long to put the coax cables out through the windows and connect them to the antennas on the vehicle.

We took the precaution of setting up a few local hams who were prepared to be on air to guarantee some real QSOs.

Presentation

When the kids arrived I did a short burst on ham radio and what it's all about. Greg gave a short talk on various activities, then we did some on-air demonstrations.

The activity was short and snappy to hold their interest. We had some local QSOs with Cleaver VK2MUA, and some others

who could be on air at the time we wanted.

The packet demo was not quite so successful as it had computer problems. What we had on screen from the international link via the CSIRO in Sydney gave the students an idea of what fun packet is, similar to the Internet but without phone and provider charges.

We also had 10 metres set up in comparison for HF contacts. No DX was worked but, had more time been available, we might have got into that too!

We passed around my photo album which has the 100 QSL cards for the DXCC Certificate, and also the actual DXCC certificate in a picture frame. We prepared a handout sheet giving a brief outline of amateur radio, embellished with suitable graphics done by Dallas, Greg's wife, a graphic artist. The sheet was in a "question and answer" format to make it more meaningful. It had lead questions like, "What is ham radio? What can you do when you have your licence? How do I become a ham? How do I get my licence? How do I study for my licence?"

We finally had a brief question and answer session and the students then disappeared rapidly when the bell rang.

Your Demonstration

I'd like to urge all hams to consider putting on a demonstration like this at their local high school. It's not hard to do and, properly prepared, can attract more young people into our great hobby.

When the students ask how can we study for the licence, I can help there. To be honest I have a commercial interest — I have published four books based on the Australian ham radio licence exams.

The first one is the *Novice Operators Theory Handbook* which has sold more than 17,000 copies. The second one is the *Study Guide* which goes with the Handbook. The two together form a self-paced package anyone can use in any situation to study for the Novice Licence.

There are many blocks in the way of a candidate entering our hobby and we need to break them down. Many cannot attend a regular class in the theory so the study kit helps make it as easy as possible. Many people are in remote locations and cannot attend a WIA, TAFE or Radio Club class, so the kit now makes home study affordable and easy to achieve.

For those wishing to upgrade to the limited or full callsign we now have a *Bridging Course* and a *Study Guide* to go with it. And, if Morse code is being attempted, we have 5 wpm and 10 wpm tapes available via mail order.

Demonstration Planning

Here are some hints on how to conduct a successful demonstration in a school:

1. Check with the Principal, a librarian or a teacher if a demonstration would be welcome.
2. Check the time for the demonstration. A lunchtime is probably the most practical.
3. Ascertain what year levels are likely to attend (we had years 9 to 12).
4. Get an idea of how many may attend.
5. Look for suitable temporary antenna set-up spots.
6. Prepare a handout sheet.
7. Make sure 240 V power is available.
8. Brief some local hams to ensure some reliable on-air contacts can occur.
9. Preferably have two operators so you can help each other set up.
10. Test all the gear beforehand so any possible bugs are ironed out.
11. Stick strictly to the time allocated as the students will vacate the scene the moment the bell goes to resume classes!

If anyone wants to do a demonstration, contact me and I will post a session plan. Also, I'll post out some materials you can use, and the books to indicate the type of study materials needed for the exams. I'll even send out a master copy of the handout sheet we used to make the whole exercise as easy as possible to mount.

Why not take up the challenge to do a live demonstration of our hobby in a school! It's really quite a lot of fun and hones your skills at setting up a portable station.

ar

Remember the First Time

—Was it 599 all the way for you, too?

Sam Wright VK6YN
19 John Street
Gooseberry Hill
West Australia 6076

THE INTEREST WAS planted in the early thirties, when a memorable visit was made to the shack of a well-known English Ham and Aviator, and this led to wartime qualification as a Wireless Operator, etc.

I gained experience in standard service equipment, such as MF and HF, 1082/1083, R1155 and 1154, as well as aircraft navigation equipment; Gee and ASV. The instinct to enjoy radio, the personal satisfaction of skilled operating and simply making communications, plus the inquisitive thirst to waffle to “far away places with strange sounding names” became firmly entrenched.

Service Qualified Wireless Operators

It all seemed the way to go when peace took over from those hectic years, and a real prize, for having risked life and limb for King and Country, —and a bit of excitement thrown in for good measure. For Service Qualified Wireless Operators, a full Ham Licence was obtainable without the need for taking a test. Whacko!!

But by that time, having plied a Dalton Computer and Astro Navigation Sextant rather more than a Morse Key, the edge of my C W speed was blunted somewhat, and, of course, unfamiliarity with long-standing abbreviations used by Hams throughout the world had to be learned, including the less polite ones, such as GS the use of which in the service could have resulted in a “fizzer” (I am unable to recall the code for “send with the other foot”)

Ensnared in a densely populated suburb of South London meant a modest antenna system, but the first sally was to obtain the “Hardware”. The Radio Society of Great Britain had by now intervened in the wholesale destruction then taking place of the massive amounts

of ex-Service radio equipment. It was being thrown down disused mine shafts, quarries, crushed by tractors, etc. The RSGB obtained quantities of items suitable for Ham use, such as R1155, T1154, Class D Wavemeters, etc. But a more interesting and to me more useful type caught my attention. It was the B2 transmitter, aka “Suitcase Radio”, which really did fit into a fairly small suitcase, and was supplied to secret and underground agents in Europe. Those brave “blokes and Sheilas” who parachuted into the dark and dangerous world that Europe then was.

Unfortunately, while the design and performance of the transmitter, a Crystal Oscillator plus a 6V6 valve power amplifier giving about twenty five watts was efficient, the exterior design of the suitcase, perhaps the brain-child of a real bureaucrat, was a “dead giveaway”. No doubt on the intimidating streets of Paris, the heavy hand of the Gestapo must have grasped many coatcollars, uttering the German equivalent of, “‘Ullo ‘Ullo ‘Ullo, and what have we here, then?” Although the one I obtained had neither receiver nor power supply, they were a bargain at two pounds!.

For a receiver, I had for some reason, perhaps a throwback to my early pleasure of “tickling the old cat’s whiskers” decided that a simple OV1 using a double triode valve, 6C8G would suffice for this

purpose. But where conveniently, to obtain this precise beast. It so happened, fortuitously, that at Hendon RAF Station, from where I was “living out”, there was across the drome from our activities, an American Embassy Flight, flying Communication Aircraft, and they had the usual extensive “back-up” facilities common to all American bases.

The Americans in Britain were noted for their casual generosity so why not give it a go? The American airman who appeared to be “top dog” was a Master Sergeant, unmistakably from the South, who greeted me, the “Limey Flyer”, with great good humor. “Certainly, buddy, what would you like?”, as we entered this large hangar, wherein reposed, like a Treasure Chest, a vast hoard of radio equipment of every kind, with the BC342/348, and the associated transmitter, the B610 predominating. My request for a single valve, 6C8G, seemed to the Master Sergeant unduly modest and could possibly be regarded as an insult to the American Forces.

Anyway, due to transport problems I had no car and there was, of course, the delicate business of exiting the RAF Station too fully laden, but I was exceedingly happy with my bounty of a pristine BC348, plus a “one off” of the required valve.

The OV1, plus the power supply for this and the Suitcase Radio was quickly

“As one passed by, there was invariably a hoarse whisper of ‘like a good time Dearie?’ I found this a distraction, as in full flush of enthusiasm for my hobby, and with a modest amount of money in the pocket, the world of desirable radio parts was my oyster. My response... was, ‘But I’m having the time of my life!’”

assembled from odds and sods bought in a back street of the West End of London, known as Lisle Street. Here, for six pence or a shilling, quality components of all types could be had. Those that had escaped by routes and devices known only to the Cockney entrepreneurs.

LISLE STREET WAS visited with some circumspection. It was a haunt of the Ladies of the Night, who always seemed to be on double shift by day. With a modest few shillings to squander on radio gear, I would visit the street, perhaps on a wet Monday lunch time, with a goal fixed in my mind, of say, a 500puff variable condenser. Approaching the several stores, and this was unkempt London at its worst, just after the war, the recessed door-ways were useful lurking places for the above-mentioned ladies. As one passed by, there was invariably a hoarse whisper of "like a good time Dearie"? I found this a distraction, as in full flush of enthusiasm for my hobby, and with a modest amount of money in the pocket, the world of desirable radio parts was my oyster. My response, perhaps a touch unkind and may have set a life long trauma of rejection was, "But I'm having the time of my life!"

As usual, the erection of any type of antenna demands much thought and usually a degree of compromise. The dense residential area further aggravated the situation. However, as we were on the top floor, height would not pose any difficulty in achieving a half wave on twenty, the preferred band. A sally across the back garden and the same across the other garden to the rear of the next street unearthed an elderly gentleman resident. He was a flautist in a symphony orchestra who, after my request to use his chimney pot for holding up what I described as an innocuous piece of wire, beamed his approval, and even volunteered to affix the said piece of wire.

A 67 foot "End Fed Zepp", similar to that used on the German Airforce Zeppelins during the First World War and reputedly having an immunity to carrying sparks from lightning strikes, was strung between the opposing chimneys. The feed line consisted of Open Wire feeders, made up of fourteen gauge wire, spread six inches apart by wooden meat skewers

coated in melted candle wax, a pretty standard type of practice in those days. One end of the pair went to the end of the 67foot top and the other merely went nowhere.

The Antenna Tuning Unit was made up on plywood with a swinging link to adjust the load. Reference to basics, indicated that some bands should be current fed and others voltage fed. The mnemonic, for the type of feed is still firmly embedded in my mind. It went "Vep and Soc", which equated to Voltage Even Parallel and Series Odd Current. That is to say that when the feedline is an even number of quarter waves long, Voltage and Parallel feed. When the feedline is an odd number of quarter

"...it was 599 all the way, a real 'ice-breaker', a great moment, and the forerunner of so many satisfying conversations with so many friends all over the world"

waves long, Current and Series feed.

The B2 Transmitter and the OV1 looked lost on the six foot rack of angle iron made from an old bed frame. But again this was then the standard practice. It left room for later expansion for, say, the popular Italian Geloso VFO driving high power rigs, with several "doubblers", lumpy audio transformers, etc, all bristling with 807s, 5R4GY rectifiers etc. The whole caboodle exuding warmth and vibrations of the pleasant kind.

MY GUIDE AND MENTOR was "Ted" a Marconi Marine Operator with plenty of "Sea Time", evident in the sweetness of his keying fist and very tolerant of the real standards attained by war-time Wireless Operators. Like many with his background and talent, I assume that Ted noted incoming Morse signals not as anything other than spoken words immediately intelligible and any mental deciphering process quite unnecessary. Ah!, could but we "Sprogs" have attained this fluency and finesse in Mr Morse's art!

So now the installation was complete. Perhaps the first real live, "on air" QSO required a guiding hand. It was, after all, a giant step into the wide net of

countless radio signals pulsing around the globe unceasingly. Maybe, I thought, with appropriate trepidation, that my first fumbling QSO may break into this ordered routine and cause keys to falter and scorn be poured on my head, via of course the aforesaid invisible media.

At that time, as I recall, VFO operations had some restrictions anyway. To construct a really stable Clapp Oscillator demanded a fair knowledge of mechanical engineering to avoid the melodious notes which it emitted at even the approach of the operator's hand. I did have, however, a couple of crystals down at the bottom end of the 40m band that would nicely double to close to the edge of the 20m band. This determined the frequency of the nervously anticipated "Sked with Ted", with the time for the next day agreed upon.

As indicated, it was 599 all the way, a real "ice-breaker", a great moment, and the forerunner of so many satisfying conversations with so many friends all over the world.

Over fifty years down the track, having had six different call signs under my belt, having operated in six different countries on three different continents, the "Call of the Airways" still raises the pulse a touch, as the unknown beckons, with the faint, and perhaps elusive "CQ CQ CQ" a bit like Jack London's classic story, "The Call of the Wild" (or was it "White Fang".)

But this first contact was, however, a bit "sneaky".

All journeys, of whatever length, begin with a first small step, but in radio terms, this first QSO was an extremely small step. Ted's flat was two doors away and he also had found a friendly soul across his back garden, who saw no objection to a long piece of wire being attached to his chimney pot.

Consequently, between our two parallel identical antennas, G3ACU (Ted) and G3CYT (me) there was a space of about two wavelengths on twenty, just a touch beyond "spittin' distance"!

That's my story, how was the "First Time" for you? (Sam Wright VK6YN, aka G3CYT, ZE5JH, VQ2SW, ZE1BY and ZS5BG)

ar

TECHNICAL ABSTRACTS

Gil Sones VK3AUI
30 Moore Street Box Hill South 3128

Receiver Calibrator and Transmitter Monitor

In RadCom June 1998 Ian Braithwaite G4COL described a useful receiver calibrator and transmitter monitor. The equipment uses a comb generator to provide a comb of pulses, arranged to have fairly uniform amplitude. This is done by using the reference oscillator to drive a very narrow pulse generator. The pulse generator uses high-speed logic integrated circuits that are readily available.

The waveform and spectrum of a train of narrow pulses is shown in Fig 1. The pulse repetition period "T" is set by the reference oscillator or a division of the reference oscillator. The pulse width "t" determines the variation of amplitude of the various harmonics with frequency. In Fig 2 the envelope of the harmonic comb's spectrum is shown. In Fig 3 the lowest frequency lobe of the spectrum shown in Fig 2 is shown with a logarithmic Y-axis. The lobe is 1 dB down at 26% of the first null. This means all harmonic pulses at the repetition or reference frequency are within 1 dB. The pulse width in this case is nominally 4 nanoseconds so this means that all harmonics of the repetition or reference frequency up to in excess of the 28 MHz band will be within a dB. A spectrum analyser plot of a 5 MHz output is shown in Fig 4.

A comb generator built using readily available integrated circuits can provide a range of signals of uniform level throughout the HF range. The signals can be used both to check calibration and sensitivity since the level

can be calculated. The comb of pulses can be used also to drive a direct conversion receiver and in this way a transmitter output can be monitored. Just tune in the harmonic comb with the transceiver and then the receiver section of the equipment can provide a monitor function.

The monitor receiver uses a form of direct conversion receiver that is not often seen in amateur equipment. A CMOS switch is driven by the pulse train and acts as a demodulator. This has been used in electronic equipment and is a simple way to provide the function. A high speed CMOS switch is required but these are readily available.

A block diagram of the equipment is shown in Fig 5 (overleaf). The reference oscillator uses a 5 MHz crystal that can be calibrated against WWV. The range of harmonics is extended by using a divider that can divide by 10 or 100 to give 5 MHz, 500 kHz, and 50 kHz outputs. The pulse generator provides pulses that are 4 nanoseconds wide to generate the comb of harmonics.

Output level is given by pulse height x pulse width x repetition frequency x attenuation factor x -2. The pulse width is nominally 4 nanoseconds and the attenuation factor into a 50-Ohm load is 0.05. The pulse height is 5 volts and so for a 5 MHz repetition frequency the level of the lowest frequency teeth is 7.07 mV which is -30dBm. For 500 kHz the level is 707 μ V and for 50 kHz the level is 70.7 μ V.

A 40 dB attenuator will give a 0.7 μ V signal from the 50 kHz comb. The monitor input

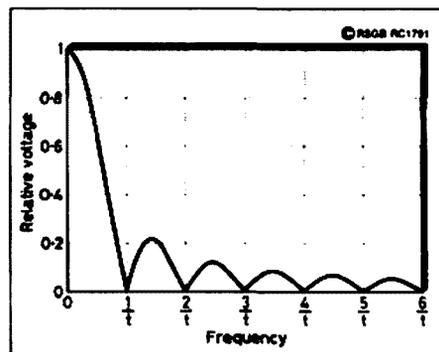

Fig 2. Envelope of Harmonic Comb Spectrum

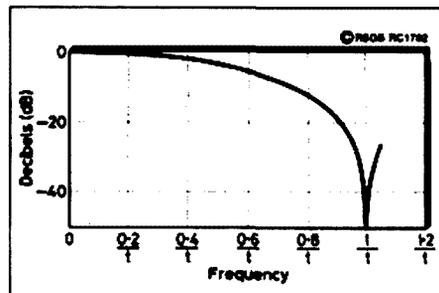

Fig 3. Lowest Frequency Lobe Of Harmonic Comb Spectrum Y axis is logarithmic

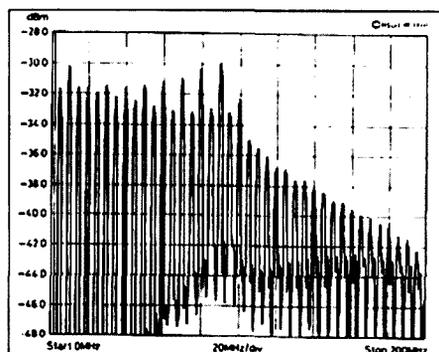

Fig 4. Spectrum Analyser Plot of 5 MHz Pulse Output

should be kept to 0 dBm and so a 40-dB attenuator will accommodate a 10-watt transmitter output. The attenuator must be able to handle 10 watts though in this case. A suitable attenuator or pickup can be made fairly simply.

The circuit of the calibrator and monitor is shown in Fig 6 (overleaf). IC2 should be a 74HC390N and IC3 should be a 74HC4066P while IC4 is a 74AC00. These ICs are readily available. Construction can be ugly construction using a piece of copper laminate or PCB as the baseboard. Bear in mind that the narrow pulses involve frequency components of hundreds of megahertz. Very short direct wiring and good bypassing and earthing are required.

The battery shown as a PP3 is a NICAD battery pack for a nominal 9V system. A PP3 battery is equivalent to our 216 type. The circuit includes a charger for the NICAD pack.

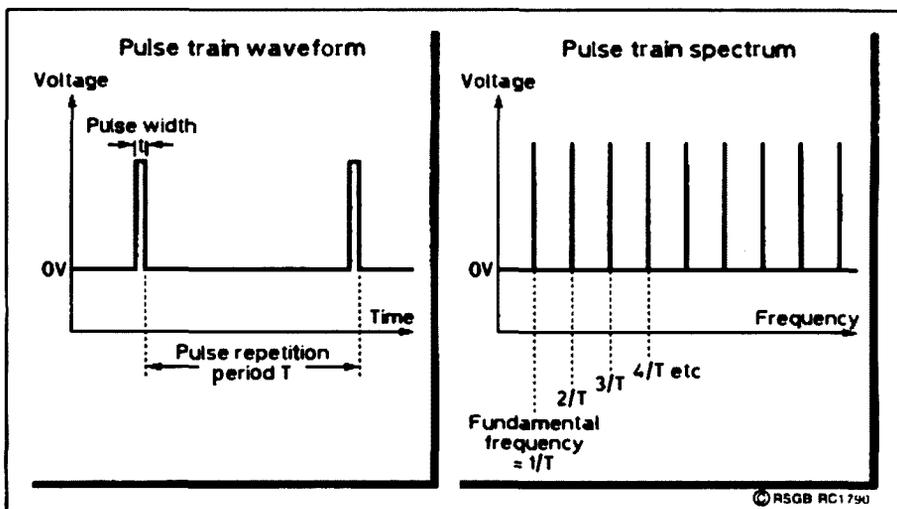

Fig 1. Waveform and Spectrum of a Train of Narrow Pulses.

Fig 5. Block Diagram.

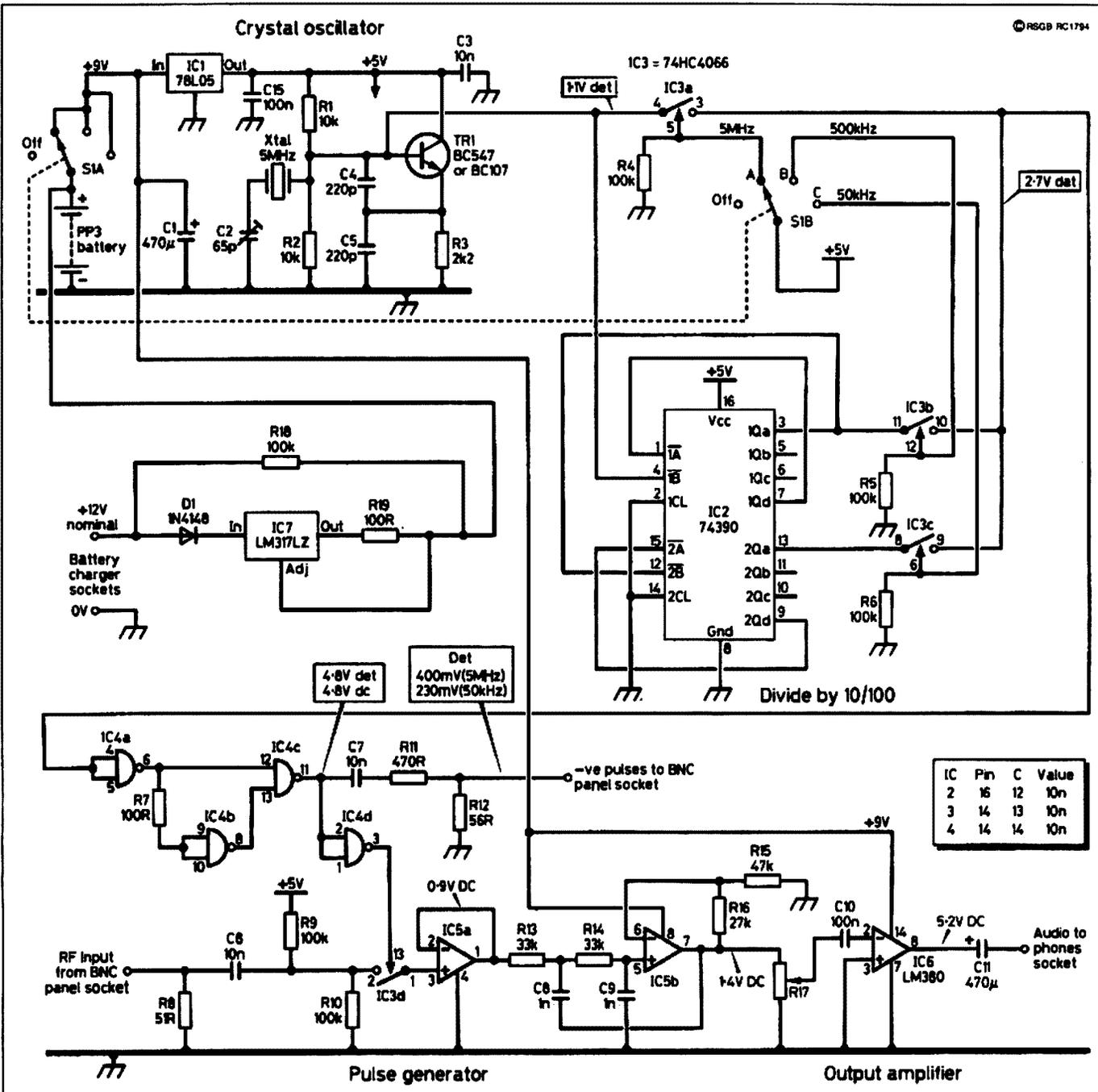
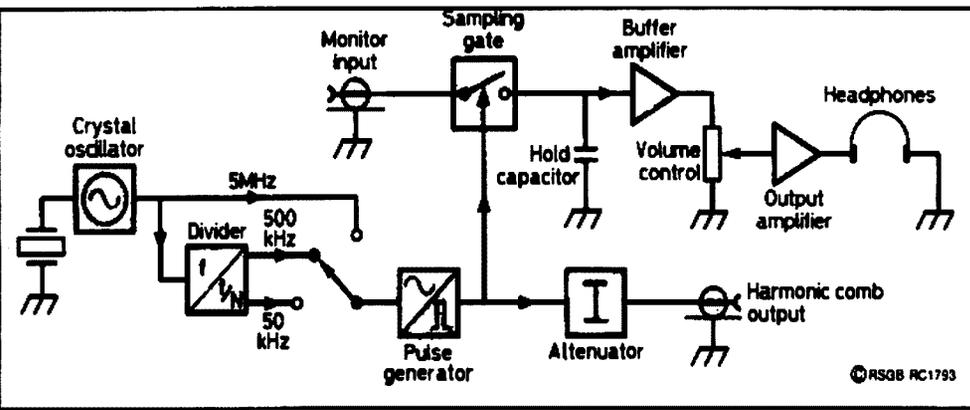

Fig 6. Circuit Diagram of Calibrator and Monitor.

Component Bending Jig

Loading printed circuit boards with components can be much easier if the component leads are bent to match the hole spacing used. Some parts come already formed but many are not.

In the *In Practice* column of Ian White G3SEK in the June 1998 edition of RadCom a simple component lead bending jig appeared. The idea is to use a piece of perforated laminate as a jig. The jig is shown in Fig 7.

The board is cut into a stepped pattern as shown to accommodate the various component sizes. The common 0.1-inch hole spacing board gives a convenient range of sizes. The example shown provides for spacings from 0.2 inch to 0.6 inch.

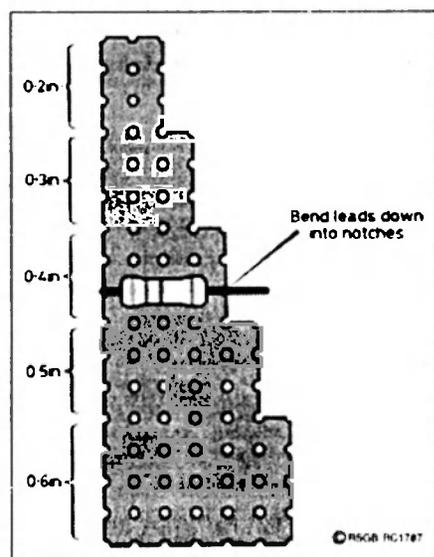

Fig 7. Component Bending Jig. ar

Central Highlands ARC of Tasmania Comes North

The small town of Dargo – a little gem – is nestled in the foothills of the Australian Alps and has been chosen for the inaugural visit (raid) into the North Island. A strong contingent of VK7 type CHARCT members and partners will use various means to cross Bass Creek and generally converge upon the said township.

All this will start on Friday 26th February 1999 and finish Sunday 28th February. Rather than keep all the fun to ourselves we extend an invitation to all amateurs and radio enthusiasts to come and join us.

Activities will include general sight seeing, winery visits, four-wheel drive trips, fishing, some radio related events and telling lies around the campfire. We also hope to have a couple of trade displays on site so you can

check out some of the latest gear.

Activities will be centered on the Dargo Caravan Park, owned and operated by Tom and Rosemary Freeman.

Planned call-in frequencies are 3.585, 7.115 and 146.45 using the club call VK7CHT – suitably qualified operators being present. We expect to be monitoring all frequencies from mid morning on the Friday 26th.

So hook up the van or chuck the tent in the boot (don't forget the esky) and come join us. Sites are available within the park for either. Some cabin accommodation is available if you get in early.

For site bookings and general inquiries contact Claireen (VK3LCM) or Dave (VK3JKY) on 03 5977 4439 (AH) or email: tssvs@peninsula.hotkey.net.au.

Central Coast Field Day

Don't miss Australia's biggest and best exhibition and sale of Radio and Communication equipment at the Central Coast Field Day on Sunday, 28th February 1999 at Wyong Race Course, just one hour north from Sydney.

The country's major electronic equipment traders will be there with special field day bargain prices and tons of disposals gear will be on offer in the flea market. See many exhibits and displays from radio and computer

clubs and other groups with interest ranging from vintage radio to packet radio and satellite communication.

Wyong Race Course is opposite the Wyong railway station. Gates open 8.30 a.m. wet or fine with undercover displays and trading. Admission: Adults \$10.00, Seniors and students \$5.00, children under 12 free.

For more details visit the site: www.ccarc.org.au or phone (02) 43402500.

Urunga Radio Convention 50th Birthday this Easter

The Urunga Radio Convention will be held at Urunga again this year at Easter. The fiftieth convention was very successful and the fiftieth birthday of the convention will be celebrated this year. So come along and have a hunt for

hidden TXs, buy some goodies from the tables of assorted gear new and used and celebrate the birthday of the oldest continuous running convention in Australia.

ar



Urunga 1998 contestants ready to start hunting three hidden Tx on two metres pedestrian.



The 50th Urunga Convention – 1998. From left are Ray Hogan VK2BBI, Leath Martin VK2EA, Alf Webb VK2UC and Brian Slarke VK2ZCQ.



How to write for Amateur Radio

(Or any publication at all)

By John Nieman
Newsletters Unlimited

I HAVE YET TO MEET AN AMATEUR that can't talk the leg off an iron pot when put in front of a microphone.

But these very same people get an attack of the "I couldn't do that syndrome" when they are asked to write an article for the mag.

Of course you can write

Writing on a subject you know, for an audience that is interested, is easy. It is just like constructing a radio project, as any written piece is made up of bits that are put together on a paper 'plug-in board' to make a whole that works. Let's consider the two types of writing, technical and general interest.

General Interest or Feature articles

Every single person has at least one general interest or feature story.

The general interest writing formula is just a case of arranging *facts, quotes and anecdotes* in such an order that the reader cannot put it down.

Start
with an anecdote to grab the reader.

Theme
State your theme. One paragraph.

Facts
Use some facts or quotes to explain your theme.

Anecdotes
Use another couple of light, bright examples to lift interest.

Facts
A few more facts and quotes.

Another anecdote

Pictures are great

Conclusion

Subject matter for AR

Anything at all that happens to an amateur operator, any interesting people you meet on the air or in the flesh is all the basis for a story.

Especially remember the golden rule: interesting subject matter makes interesting articles — *ordinary people doing extraordinary things or*

extraordinary people doing ordinary things.

Interesting DX locations make good copy and provide a great pictures.

Local events that are significant for radio amateurs are also of great general interest, especially if the lessons or relevance can be applied nationally.

Tips to make features fly

- **Use your own voice and use words that you would use in conversation.**
(Note that sentence. Only one word in the 13 has more than one syllable. Very easy reading, very easy writing)
- **Write directly and in the first person.** *I talked to Bob is infinitely better than a conversation ensued between Bob and myself*
- **Write big and edit yourself hard.** Having too much material initially is great. It means that you can prune back to a tight piece.
- **Include a picture**
Get a picture into the story, the editor will love you, the sub-editor (who makes it all fit), will love you and many more people will read it.
- **Stick to your theme**
Got another idea? Don't tack it on. Write another article

Writing Technical articles (Sourced and updated from Bill Roper's 1992 AR article)

Amateurs love simple equipment construction and design articles Most will not build the project but will rather enjoy following the steps in their mind.

But someone somewhere will build the project so it must be technically correct or the mail will pour in or even worse damage or injury may result.

Reports of experimental procedures or equipment are always popular but remember that you are writing for a great range of skills. Gear your article at entry level rather than advanced, you are talking to amateurs, not engineers.

The Plan

Outline what you want to say, and what you want to get across.
For construction articles follow this format.

Introduction

"We are going to build a better mousetrap"

Theory

"This will remove mice more efficiently"

Construction

"First take a small nuclear device .."

Alignment and adjustment

"Now it is assembled, focus the laser beam on the mouse's"

Summary

"having built this better mousetrap....."

This is often referred to as

- “ • *the tell them what you are going to tell them;*
• *tell them;*
• *then tell them what you have told them ”*”

theory of writing.

Tech Rules — OK

The general rules for interesting writing apply to technical articles.

- Use positive or direct sentences and talk in the first person rather than the third.
- Start a new paragraph with each new thought. (Any paragraph that has more than forty words is probably too long.)
- Avoid abbreviations where possible

Specifically in technical articles

- Use subheads. Capitals and lower case, never all caps
- Check the work with the computer spell checker or dictionary
- Minimise the maths, They are not usually necessary in AR construction articles. The readers prefer practical projects designed and ready to build. Graphs are next best, maths are last.
- If a mathematical derivation is necessary, show only the steps that introduce new logic.

Abbreviations, symbols.

Follow the AGPS *STYLE GUIDE* a copy of which will be in your local library.

The common abbreviations are written: Hz, kHz, MHz, GHz, μ F, pF mH, H, W, mW, μ W V, mV, kV, A, mA, μ A, dB, km, Ω , k Ω , M Ω .

Do not use full stops or pluralise these abbreviations.

Separate these abbreviations from the number, ie 10 MHz not 10MHz.

Modes of emission, and acronyms in general are capitalised AM, FM, CW, SSB, RTTY, ATV, RF, IF, DC, AC, RMS, VFO, AGC. The text flow should be informal, but keep away from *hammy* abbreviations such as xtal, XYL xmtr etc.

Find out how your computer does Greek symbols and use them. But always provide a hard copy print out of your text, in case the printer's computer has Ω where you have μ (On Macs the Keycaps under APPLE in the menu bar finds the way, on PCs in Word Insert>Symbol is the way)

Thought for a feature

Any amateur who was monitoring the recent massive Sydney-Hobart yacht race rescue operation has the makings of an excellent story for AR in February.

How you felt as it all unfolded, how it happened over the air is all riveting stuff.

Diagrams Illustrations and Schematics

Always do the drawings on separate sheets of paper and note them in your text. Do not paste them into the text.

We have draftspeople who can clean them up if necessary. But make sure that your sketches are correct, complete, neat, clean and readable.

Put parts values on the schematic and include a separate parts list. Use terms R1 and C2 etc. Label the drawings numerically; Fig 1, Fig 2, etc.

At the end of your article list the figures with a caption by each one. Put the article title, your call sign and /or your name on every piece of paper.

Photographs.

Good photos can make all the difference to the appeal of an article.

Nowadays standard colour prints taken with an automatic focussing camera and developed at the one hour shop are quite satisfactory. If you have a SLR, point the flash at various angles and take a shot at each angle, then select the shot with best definition.

Label each photo clearly, either by attaching a Post-it note with sticky tape to the back or, for preference, writing Photo (a) etc on the back or front BUT ONLY AT THE VERY EDGE OF THE IMAGE.

Photograph the completed project.

Cover Photographs

Any aspect is good, any colour photograph is good. See following page.

The last words on photos.

We have all sorts of photo manipulating ability with some computer programs so any photo that is in focus is a good one. Old scratched photos can be made like near new.

But pack them with a protective stiff cardboard.

Accompany the photo with a copyright release in the form. "I... of..., the copyright holder of this photograph(s) grant AR permission to reproduce it within their magazine at any time."

If you were involved, either in race or rescue, even better.

Call either Bob Harper, Bill Rice or Newsletters Unlimited (all details page one) if you were 'there' in body or listening and we can assist you to put it together for the magazine.

PC Board

If your project involves a PC board, send a positive of the board with your article. Separately sketch out the component layout. If the positive is not the same size as the board, tell us. Or submit as a Protel file or hard copy.

Submitting articles

Manuscript Submission

- Include a covering note itemising what you have included in the submission such as copy, schematics, photos, captions.
- Provide a brief biography, readers like to know a little about the writer. With articles of about 1000 words and up, include a headshot of yourself if you wish.
- Again, name and or call sign on every separate piece of paper.
- Number the pages.
- Laser print is better than ink jet, which is better than ribbon print, which is better than hand block capitals, which is better than script.

Electronic submission.

Formats

If you are writing your article on a computer or word processor please provide an electronic file.

We prefer Word files but .rtf and ASCII .txt files are also acceptable. If you cannot save in one of these formats, save in your format but note the type on the disc and on the manuscript cover.

If you have electronically generated diagrams, please provide these saved in as many formats as you can fit in the disc. Tiffs and EPS are usually OK.

Media

3 inch or 5 inch floppy, CD, Iomega Zip or attachments to email are all very acceptable.

Absolutely critical: Please provide a hard copy of all items printed *exactly* from the discs or files you supply us.

The editors will arrange publication of your article at the earliest possible opportunity. This may be a little time, as we may wish to include it as a special feature, or 'balance' a particular issue.

Please submit all material to

The Editor *Amateur Radio*

PO BOX 2175

CAULFIELD JUNCTION VIC 3161

email armag@hotkey.nat.au

Tel: (03) 9528 5962

Fax (03) 9523 8191

GET READY FOR 99'

Advanced Data Management Software

An advanced way to program many of the functions of Yaesu handheld and mobile transceivers. Each package consists of an interface that plugs into the serial port of a PC and connects to the transceiver via its microphone socket (for handhelds) or its Packet socket (for mobiles). Also provides easy-to-use 3.5" (inch) PC software with pull down menus that allow for programming and naming of memory channels, selection of output power. CTCSS tones, scan and battery saver operation, plus much more.

ADMS-1D suits FT-10, 11R, 50R/RD, 51R, VX-1R D 3753

ADMS-2D suits FT-3000M, 8000R, 8500, 8100R D 3759

\$89⁹⁵ea

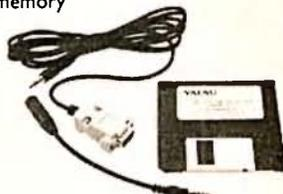

LP-1300 Log Periodic Yagi

The Maldol LP-1300 is a Log Periodic Yagi beam antenna designed to provide useful gain across the 100 to 1300MHz range. Ideal for scanner enthusiasts and ham operators needing a directional wideband antenna. Consists of a 17-element Yagi with a special feed system providing low SWR (less than 2.0:1) across the 100-1300MHz range.

Gain: 6.0dBi to 10.0dBi

Boom length: 1.46m

Suitable mast: 28-60mm diameter

Max wind speed: 40m/sec

Max power: 500W

Connector: SO-239

D 4828



\$269

Yupiteru MVT-9000EU Deluxe Scanner

The Yupiteru MVT-9000EU is an amazing new Japanese handheld scanner that provides wide 53kHz to 2039MHz frequency coverage, a large and informative backlit LCD screen and excellent sound quality. All-mode reception capabilities are provided, (FM, VV-FM, AM and SSB modes) plus there are 18 selectable step rates between 50Hz and 125kHz to allow the best tuning choice for the signals being listened to. For easy storage of popular frequencies the MVT-9000EU provides 1000 memory channels (20 banks of 50 channels each) which can store frequency step, reception mode, as well as the Attenuator setting. Selected memory banks can be scanned to check on activity at a rate of up to 30 channels per second. Search operation is provided across 20 banks, with 500 Search Pass memories provided to 'lock-out' unwanted frequencies for more efficient Search operation.

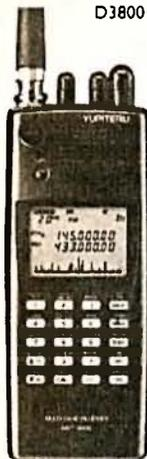

D 2797

3-15V 25A Heavy Duty Power Supply

This solidly built benchtop power supply provides current of up to 25 amps ICAS at 15V, 20 amp continuous at 13.8V and lower current at lower voltages. It has front panel metering, plus high current banana-style and low-current output connections. An internal heatsink and thermally-switched fan provides cooling without protrusions in the metal case. Specially modified for more reliable long-term operation, it uses a rugged 50 amp bridge rectifier and trifilar transformer. Also provided is extensive overload protection through dissipation limiting circuitry for the pass transistors, a 30 Amp instantaneous current limit, AC mains circuit breaker, a transformer thermal fuse and fused auxiliary secondary winding.

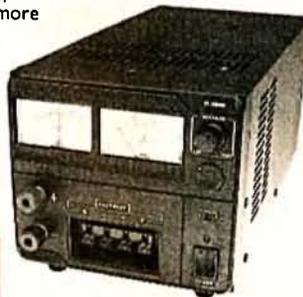

\$299

Other features include:

- Inbuilt ferrite rod for AM broadcast band reception
 - A Band Scope function allows checking of adjacent channel activity, with two selectable Scope bandwidths. Using the Marker mode you can substitute the centre frequency of the Bandscope with a movable marker, so you can see the frequency and hear the audio of specific adjacent signals
 - 10 Priority channels
 - 50 Autowrite memories to store active frequencies during Search operation
 - Title editing for Band, Bank and Channel name is provided
- Complete with NiCad batteries, AC plugpack charger, car cigarette lighter lead, antenna, carry strap and belt-clip.

YUPITERU \$999

PHONE FAX AND MAIL ORDERS

PHONE: WITHIN AUSTRALIA: 1300 366 644
(Local Call Charge)

FAX: (02) 9395 1155 within Australia and Visit our web site at
(+612) 9395 1155 from outside Australia <http://www.dse.com.au>

MAIL: DICK SMITH ELECTRONICS, Direct Link Reply Paid 160, PO Box 321,
North Ryde NSW 2113 (No Stamp Required)

**Excludes packaging and postage. All major Credit Cards accepted.
14 Day Money Back Guaranteed. If NOT completely satisfied. (Software included)**



That's where you go!

JANUARY BARGAINS

Revex W570 HF/VHF/UHF SWR/PWR Meter

Top of the line performance! The W570 provides switchable 1.6-160, 400-525, 700-1100 and 1240-1300 MHz coverage, with measurement of 3 power levels (5, 20, 200W) and SWR. External UHF sensor uses N-type sockets, with remote mounting for easier cable connection to the meter. Measures 120 x 80 x 155mm. Made in Japan.

D 1377

\$299



FT-50RD 2m/70cm Handheld

The Yaesu FT-50RD is an amazingly compact 2m/70cm Amateur band handheld transceiver which provides MIL-STD 810 shock and vibration resistance, super wideband receiver coverage, simple menu settings for most functions and compatibility with the optional Yaesu ADMS-1D software/interface package for PC programming of many functions.

Other features include:

- Tx 144-148MHz, 430-450MHz
- Rx 76-200, 300-540, 590-999MHz (cellular blocked)
- FTT-12 keypad provides Digital Voice Recording, DTMF paging, CTCSS/DCS scanning and CTCSS encode/decode
- 2m/70cm RF output: 2.5, 1.0, 0.1W standard, up to 5W with 9.6V battery or adaptor
- 'Omni-glow' LCD screen for easier night-time viewing 112 memory channels with 4 character alpha-numeric naming
- High speed scanning, 12V DC socket, Digital Code Squelch
- Dual watch allows monitoring of sub-band activity
- Direct FM modulation for better audio quality

- 5 battery saving system (Includes Rx and Tx Save, and Auto Off)
- Rear panel clamshell battery pack
- Comes with FNB-40 slimline 6V 650mA/H Nicad battery pack, flexible 2m/70cm antenna and modified M-9626 AC plugpack adaptor for Nicad charging

D 3660 **2 YEAR WARRANTY**

YAESU

\$599



BONUS OFFER! Pay only half-price for a second Nicad pack when purchased with the FT-50RD. Limit one per customer. Applies to FNB-40, 41, 42 only.

FT-3000M 70W 2m mobile

An amazing new 2m mobile transceiver with up to 70W RF output. Rock solid with MIL-STD-810C shock and vibration resistance. The FT-3000M also has wide-band receiver coverage (110-180 and 300-520MHz), a dual band or dual in-band receiver facility and 1200/9600 baud Packet socket. Up front it has an impressive backlit alpha-numeric LCD screen. The FT-3000M has a total of 81 memories, as well as a Spectrum Scope mode that allows you to view activity above and below the current operating frequency, or among six programmed memories. A programming menu holds over 50 transceiver settings for easy 'set and forget' access and includes a scrolling text Help Guide. Twin fans provide optimum cooling during long transmissions for greater component reliability. The FT-3000M is supplied with an MH-42A6J hand microphone, DC power lead and instruction manual.



Specifications

Frequency range: Tx 144-148MHz, Rx 110-180, 300-520
800-824, 849-869, 894-999MHz
RF output: 70, 50, 25, 10W
Sensitivity: 0.2uV (main Rx), 0.25uV (sub Rx)
Dimensions: 140 x 40 x 180mm (WHD)

D3700

\$699

HAM SHACK STORES

- NSW • **BANKSTOWN POWERHOUSE**
Christies Homeemaker Ctr, 173 Canterbury Rd **9793 9677**
• **NORTH RYDE**
Cnr Lane Cove Rd/Waterloo Rd **9937 3335**
• **SYDNEY** 125 York St **9267 9111**
- VIC • **CARNEGIE POWERHOUSE**
1048-1054 Dandenong Road **9569 2644**
• **MELBOURNE** 246 Bourke Street **9639 0396**
• **SPRINGVALE** Springvale/Dandenong Rds **9547 0522**
- QLD • **BURANDA**
170 Logan Road **3391 6233**

- SA • **ADELAIDE**
252 Pulteney St **8232 1200**
- WA • **PERTH**
Rains Square, 125 William St **9481 3261**

Amateur equipment only carried in Ham Shack stores, but may be ordered by all Australian Dick Smith Electronics stores and authorised stockists

DICK SMITH
ELECTRONICS

That's where you go!

• STORES IN RED ARE OPEN SUNDAYS.

STORES ACROSS AUSTRALIA & NEW ZEALAND

B 3672

The Amateur Radio Cover Photo Quest



Amateur Radio magazine has an Amateur Radio related photograph on the front cover of each edition.

Currently the stocks are running low and although there are a few remaining they are quite similar. Almost all that we have are either a man up an antenna mast or a sunset with a silhouette of an antenna system. As such I am negotiating for a sponsor to provide an incentive for each photo published on the cover of AR.

It may be a roll or two of film or something similar. I'll confirm the nature of the incentive in the next issue but promise that there will be something worthwhile in it.

- So here are the conditions;
1. The photographs must have an Amateur Radio interest such as famous/prominent amateurs, equipment (especially Home Brew), or events such as hamfests and competitions, Jota, John Moyle Field Day etc.
 2. You must own the rights to the photograph and be prepared to allow Amateur Radio Magazine the right to publish the photograph. Eg. Attach a piece of paper with the statement: "I, [your name], the

copyright owner of this photograph, grant Amateur Radio Magazine the right to publish this photograph at any time and in any manner they see fit." Then sign and date the statement immediately below.

3. All photographs should be captioned with the following information: who took the photo, where and when it was taken, what the subject is and who is depicted in it.
4. The photograph must be submitted as a colour print at least 3" by 5". Photographs should be clear, well focused and with good contrast. Avoid background clutter, poles spouting from ears etc.
5. All photographs will remain the property of the WIA and will be kept as the beginning of a photographic collection.
6. Photographs will be assessed on their content, quality and appeal. The selection of the photographs will be based on publication needs

and not necessarily on technical merit. The publication committee, Editor and Production Manager will have the final say on the selection and correspondence will not be entered into.

7. Photographs should be sent to Bob Harper, PO Box 288, Beerwah 4519 and the envelopes should be marked with the words "Photographs - DO NOT FOLD"

So please get out that camera and start shooting. Look through your old snaps and perhaps send us a copy. Minor damage such as scratches, fading and other problems may be fixed digitally by myself and particularly if the photo is of historical significance should be repaired and kept on record. Photographs currently held are also eligible, please advise whether you want them included or returned as originally agreed when submitted.

Cheers for now, Bob Harper
VK4KNH. ar

ALARA

Christine Taylor VK5CTY
16 Fairmont Avenue, Black Forest SA 5035

Combining Hobbies

Marilyn VK3DMS combines her two hobbies of amateur radio and stamp collecting in a special way.

The prize-winning collection of stamps she was asked to display and discuss at a recent meeting of the Royal Philatelic Society of Melbourne, is based on stamps and postal material that together tell the story of radio. This sort of collection, called a thematic collection, can include telegrams, envelopes, postcards as well as stamps themselves.

"Radiomania", which represents eight years of work, includes a postcard with an advertisement for radio on it, several radio licences from around the world, and a Chinese stamp that illustrates gymnastics by radio. The most recent item is a pre-stamped envelope celebrating the Centenary of the opening of the Overland Telegraph.

For her talk and display at the Royal Philatelic Society in Melbourne, Marilyn was presented with a Certificate of Appreciation but she has won three National Awards and an International one with the collection. The only Award missing is the Gold medal. She hopes one day to add that item, or dot that particular "T" to bring the Gold her way. I am sure she will reach that peak, although her relative isolation in Mildura adds a degree of difficulty to her hobby, a point not missed by her Melbourne audience. Congratulations, Marilyn.

Maxie DJ4YL

As mentioned last month, Maxie and her sister Marila were recent visitors to Australia. The story of her association with Australia illustrates one of the marvellous aspects of our hobby.

Over the years Maxie's OM Heine DJ4HB developed a radio friendship with Syd VK3ASC. When Syd was in Munich in 1968 he visited Heine and Maxie. When Syd's radio friend Bill VK5FR (also VK5KW) was to tour Europe, Syd passed on Heine's address, as a consequence Bill and Sheila visited them in 1971 and again in 1975. They continued to keep in contact by letter and radio and had become good friends.

Unfortunately, Heine became a silent key at the end of 1990. Sheila didn't hear of this for a couple of months but when she did she wrote apologising for the delay and invited Maxie to come to Australia and to stay with them in Glenelg for a time. Almost on the spur of the moment Maxie decided to accept the offer. She had a contact with Syd and told him of her plans.

Syd immediately contacted ALARA in Melbourne, and Bill, ALARA in Adelaide, resulting in Maxie being able to meet a number of YLs during her first visit in 1991. While she was in Adelaide I offered to sponsor her into ALARA and in exchange I am sponsored into DL-YL. We correspond at intervals, mostly at Christmas. Fortunately Maxie's English is good. My German allows me to read magazines with the aid of a dictionary but no more.

Maxie and Marila have come to Australia twice since that first visit: in 1995 and again recently. They love our climate and wildlife and arrange their own tours so they see what they want to. So far they have seen some of Queensland (Syd is now VK4CST), the top of Western Australia, New South Wales (I mentioned the picnic with Dot VK2DDB and family) and toured parts of Tasmania.

In South Australia they loved the look

around Kangaroo Island arranged for them by Bill and Sheila in 1995. This time they saw our bush shack near Swan Reach and visited friends they had made on one of their earlier tours, who live just out of Birdwood. These 'bush' trips are exactly what they love, as well as meeting the YLs and renewing friendships. Amateur radio is a great way to make friends!

Here in Adelaide, at one of our regular luncheons, they met again, Meg VK5AOV and Jean Shaw (a VK3 lady they had met there on the previous visit), Jean VK5TSX, Deb VK5JT, Joy VK5YJ and Deb's daughter Sarah. We were sorry we couldn't stay together longer.

Informal ALARAMEet at AHARS

As usual the ALARA ladies provided food and drink at the AHARS Buy and Sell. Many of the YLs in VK5 were there at some time during the day with a visitor, Marilyn VK3DMS, who almost considers herself as much a VK5 as she is a VK3 YL.

Altogether we had Jean VK5TSX, our State Rep., Tina VK5TMC, our Secretary, Deb VK5JT, Historian, Christine VK5CTY, Publicity Officer, and Marilyn VK3DMS, Contest Manager, all committee members, along with Meg VK5AOV, Jennifer VK5ANW, Yvonne VK5AYK and Mary Rodgers over from Rudall on the Eyre Peninsular. We are lucky in VK5 to all live in a small city so we are able to meet each other face to face, like this, quite often.

This year is the year of the ALARAMEet.

I hope you are all starting to plan your year so you can be in Brisbane at the end of September. Bev VK4NBC has planned a weekend of fun and interest plus a list of further activities for those that can stay longer. Don't forget to let Bev know if you are likely to be able to be there. She will send you out a preliminary timetable to whet your appetite further.

Help Please

If there seems to be a lot about the VK5 activities, I apologise. Please send me information about *your* activities so I can tell others.



AHARS Buy and Sell. From left: Tina VK5TMC, Jean VK5TSX, Marilyn VK3DMS, Deb VK5JT and Yvonne VK5AYK



Having lunch are Joy VK5YJ, Jean Shaw, Meg VK5AOV, Deb VK5JT, Sarah, Marila and Maxie DJ4YL

POUNDRING BRASS

S P Smith VK2SPS

Peak Street Bateau Bay NSW 2261 (02) 4334 7743

WE CAN START THE New Year by looking at some recently released American publications about telegraphy. Hopefully they will be released here in the near future.

The Books:

The Telegraph by Lewis Coe, a hard cover book with approximately 184 pages illustrated throughout. Excellent overview of the American telegraph system, cost US\$28.50

Wireless Radio (also by Coe) hard cover and well-illustrated with 204 pages.

Further information from: McFarland & Co Box 611 Jefferson, NC 28640 Telephone 919 246-4460.

For Railroad enthusiasts:

Railroad Radio — hearing and understanding Railroad Communications &

Systems by Vincent Reh. This is a 208-page book covering railroad radio history, modern rail communications systems and system use. Byron Hill Publishing Co Box 197 Grand Isle VT 05458 Telephone 802 893-1315.

Railroad Telegraphy & the Railroad

This is a very interesting publication taken from newspaper articles from 1852-1913, First edition softcover large format, 85 pages cost US\$9.95

Further information can be obtained from RWB/CG 8 Little Fawn Drive, Shelton, CT 06484.

Canadian Railway Telegraphy History

by Robbie Burnet soft cover, 250 pages with 150 plus illustrations cost US\$50.00. Further information: R G Burnet PO Box 40526 Dept W3 5230 Dundas St West Etobicoke, Ontario Canada M9B6K8.

Two items of special interest:

Signal Cipher — a monthly publication devoted to the study of early American military telecommunications. Subscription is US\$6.00 per year. Signal Cipher 10 Walnut Ave, Wilmington, DE 19805-1144.

Dots & Dashes — the official publication of the Morse Club, Inc, published 4 times a year, covering many aspects of telegraphy. It is approximately 16 pages in newspaper format and costs US \$14.00 Via First Class Mail. Further information from: Keith E Lebaron Secretary Treasurer 550 North Greenfield Drive Freeport IL 61032-4594 Telephone 815 232-2564.

I have been subscribing to *Dots & Dashes* for many years and can highly recommend it. If any readers are aware of any new publication on telegraphy I may have missed, and which may be of interest to our readers, please drop me a line and I will pass it on through my column.

Until next month, A Happy 1999 to all. See you on the bands.

73 Steve VK2SPS
ar

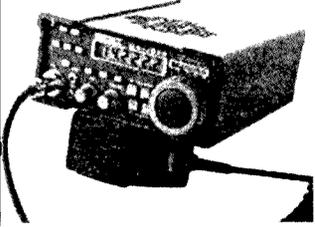

Radio and Communications

Incorporating AMATEUR RADIO ACTION and CB ACTION

Published by
ACP-ACTION,
Locked Bag 12,
Oakleigh,
Victoria 3166
(03) 9567 4200

Happy New Year! Okay, so what did Santa bring you, and what does the new year hold? Well, how about we start off with some interesting new radio gear. You see here an American radio called the SGC-SG-2020. It's tiny, it's cheap, and it goes well! Although it's been around for a year overseas, we get the upgraded model, via Terlin in Perth...

Like Santa's sack, January's R&C is stuffed to bursting with great reading for amateur radio operators! Like these...

- ANTENNAS: building a good antenna. We return to the basics in a two-part series from Steve, VK6VZ.
- AN RI-TO THE RESCUE! Could this story be real? A retired radio inspector reveals the interesting side...
- AMATEUR RADIO IN NAURU. It's 53km from the Equator. Jack, VK2GJH spent two weeks on air there.
- JUDICIOUS REX EXAMINES RADAR DETECTORS. It may be an amateur band, but his verdict? DON'T!
- CONSTRUCTION: build a superheterodyne HF receiver in steps. Part 2, by Harold Hepburn, VK3AFQ
- As usual, we have our three DX columns and lots more... the best stories and regulars every month!

Don't miss out — **RADIO and COMMUNICATIONS** is great reading for amateurs!
Check your local newsagent today!

(P.S. We also have the biggest collection of radio-oriented Classified adverts in the country. There's lots of them because they work so well.

VK3ce

AMSAT AUSTRALIA

Bill Magnusson VK3JT

RMB 1627 Milawa Vic. 3678 Email: vk3jt@amsat.org

TMSAT-1 Opened for Amateur Radio use.

This satellite has been open for amateur radio users since late November. Chris Jackson, in announcing the opening, appealed for users to go easy on uploads and to treat the satellite as a resource for downloading the multi-spectral images from its cameras. Many such image files have appeared in the directory to date. As expected, the satellite has not always been turned on when over VK/ZL but hopefully this situation will be rectified as commissioning proceeds. Colin VK5HI has uploaded version 1.08 of his "CCD Display 97" program to the digital satellites UO-22, KO-23 and KO-25. This version permits the display of images captured by TMSAT-1 earth imaging cameras, and offers four improvements over his earlier versions:

1. Provides the correct viewing of thumbnails
2. Permits image enhancement on TM00xx00.IMI (350k) files
3. Allows previewing of .ACT files
4. Offers inclusion of embryo help files.

The program operates under Windows 95/98 only.

QSL Address for the Sputnik replica RS-18.

If you were successful in hearing the signals from the 40th anniversary Sputnik replica RS-18, you can send for a QSL card confirming this event. You are requested to send a reception report along with a self addressed envelope and two International Reply Coupons to the following address:

AMSAT-France
RS-18 QSL Manager
14 bis, rue des Gourlis
92500 Rueil-Malmaison
France

New Keps for AO-10 Satellite.

Stacey Mills and James Miller have calculated a new set of keplerian elements to replace those rather old ones appearing in the regular element sets.

Satellite: AO-10
Catalog number: 14129
Epoch time: 98334.41402
Inclination: 26.8570 deg

RA of node: 56.2190 deg
Eccentricity: 0.59993
Arg of perigee: 269.7500 deg
Mean anomaly: 218.2590 deg
Mean motion: 2.05837914 rev/day
Decay rate: 0.00 rev/day²

Be warned however that this set may not automatically update. You may have to type them in by keyboard (like we did for all the satellites in the 'good ol' days'). Just alter the elements one line at a time and ignore any that aren't in the list above. It worked fine in my case and the auto-track system seems to find the satellite in the right place.

Six-Monthly Update of Amateur Radio Satellite Activity.

Here is the situation of ups and downs current at the time of writing ie. early December 1998. Those readers with internet access can obtain the very latest news from the AMSAT News Service World-Wide-Web site. You may even like to arrange to have all the latest information sent to you regularly via email. This can be requested from the site.

RS-12

Uplink 145.910 to 145.950 MHz CW/SSB
Uplink 21.210 to 21.250 MHz CW/SSB
Downlink 29.410 to 29.450 MHz CW/SSB
Downlink 145.910 to 145.950 MHz CW/SSB
Beacon 29.408 MHz
Robot Uplink 21.129 MHz Downlink 29.454 MHz

Last reported to be semi-operational, beacon only.

RS-13

Uplink 21.260 MHz to 21.300 MHz CW/SSB
Uplink 145.960 MHz to 146.000 MHz CW/SSB
Downlink 29.460 MHz to 29.500 MHz CW/SSB
Downlink 145.960 to 146.000 MHz CW/SSB
Beacon 29.504 MHz
Robot Uplink 21.140 MHz Downlink 29.458 MHz

National co-ordinator:

Graham Ratcliff VK5AGR
Email: vk5agr@amsat.org

AMSAT Australia net:

The AMSAT Australia net is held on 80 and 40 metres LSB each Sunday evening.

During daylight saving time in South Australia the net is on 7068 kHz +/- QRM with an official start time of 1000 UTC (with early check-ins at 0945 UTC).

During the rest of the year, the net is on 3685 kHz +/- QRM with an official start time of 0900 UTC (with early check-ins at 0845 UTC).

AMSAT Australia newsletter and software service:

The newsletter is published monthly by Graham VK5AGR. Subscription is \$30 for Australia, \$35 for New Zealand and \$40 for other countries by AIR MAIL. It is payable to AMSAT Australia addressed as follows:

AMSAT Australia
GPO Box 2141
Adelaide SA 5001

Keplerian Elements.

Current keps are available from the internet by accessing the AMSAT FTP site, ftp.amsat.org and following the sub-directories to "KEPS".

Last reported in mode K, the RS-12/13 satellite has seen many recent changes in operation. Modes K, T, KT and simultaneous RS-13 operation have all been reported. No mode switching schedule has been forthcoming from the controllers.

RS-15

Uplink 145.858 to 145.898 MHz CW/SSB
Downlink 29.354 to 29.394 MHz CW/SSB

Beacon 29.352 MHz (intermittent)
Semi-operational, mode A, using a 2-metre uplink and a 10-metre downlink.

RS-18/Sputnik 41

Downlink 145.812 MHz FM Russian cosmonauts successfully launched RS-18/Sputnik 41 on November 10, 1998, during a spacewalk from the Mir space station. It remains in operation at the time of writing but may well be out of power or have re-entered the atmosphere by the time you read this column.

AO-10

Uplink 435.030 to 435.180 MHz CW/LSB
Downlink 145.975 to 145.825 MHz CW/USB
Beacon 145.810 MHz (unmodulated carrier)

Operational but no longer under ground station control. AO-10 is locked into 70-cm uplink and 2-meter downlink (mode B) operation. Within these constraints AO-10 continues to function well but is subject to periodic deep QSB. This can be partially eliminated by switching antenna polarisation. Strong signals have been heard even at apogee. Also note that the apogee is approaching its most northern point. From there the apogee will begin its slow migration southward. I have checked AO-10 around apogee and found the transponder to be quite useful. Good return signals with 20 watts uplink power. You have to play with the antenna polarisation to get best results. When closer in around perigee, the signal throughput is every bit as good as it was in the early days of AO-10 operation.

AO-27

Uplink 145.850 MHz FM
Downlink 436.792 MHz FM
Operational, mode J.

As I have received no reports to the contrary it seems that this satellite is only switched to amateur radio service whilst over the northern hemisphere. Please let me know if you hear anything from this satellite.

FO-20 JAS-1b

Uplink 145.900 to 146.00 MHz CW/LSB
Downlink 435.80 to 435.90 MHz CW/USB

Operational. FO-20 is in mode JA continuously.

FO-29 JAS-2

Voice/CW Mode JA
Uplink 145.900 to 146.00 MHz CW/LSB
Downlink 435.80 to 435.90 MHz CW/USB
Digital Mode JD
Uplink 145.850 145.870 145.910 MHz FM
Downlink 435.910 MHz FM 9600 baud BPSK

JAS-1 appears to be in mode JA (voice mode) continuously. Trouble has been experienced commanding the satellite since it entered full sunlight some time ago. This situation was expected to improve when eclipses began again in December.

KITSAT KO-23

Uplink 145.900 MHz FM 9600 Baud FSK
Downlink 435.175 MHz FM

Operational. Aside from the now common situation of overheating when orbiting in full sunlight, KO-23 has been giving excellent service. Some reports indicate the downlink to be off frequency. I cannot confirm this from my own observations. It always seems to spot-on when I check the frequency.

KITSAT KO-25

Uplink 145.980 MHz FM 9600 Baud FSK
Downlink 436.50 MHz FM
Operational.

UO-22

Uplink 145.900 or 145.975 MHz FM 9600 Baud FSK
Downlink 435.120 MHz FM
Operational.

OSCAR-11

Downlink 145.825 MHz FM, 1200 Baud AFSK
Beacon 2401.500 MHz

Operational. The mode-S beacon is on, transmitting an unmodulated carrier. Telemetry indicates that it is only delivering half power. This beacon is a useful test source for those testing mode-S converters prior to the launch of P3D. The 435.025 MHz beacon is normally off.

PACSAT AO-16

Uplink 145.90/145.92/145.94/145.86 MHz FM 1200 bps Manchester FSK
Downlink 437.0513 MHz SSB, 1200 bps RC-BPSK 1200 Baud PSK
Beacon 2401.1428 MHz

Operating normally. Has anyone heard this beacon? I occasionally get requests for information on weak signal sources for checking mode S equipment. It would be nice to know if this beacon has been heard in VK/ZL.

LUSAT LO-19

Uplink 145.84/145.86/145.88/145.90 MHz FM 1200 bps Manchester FSK
Downlink 437.125 MHz SSB 1200 bps RC-BPSK

Currently semi-operational. Downlink and telemetry only.

ITAMSAT IO-26

Uplink 145.875/145.900/145.925/145.950 MHz FM 1200 Baud PSK
Downlink 435.822 MHz SSB

Semi-operational. Telemetry downlink only.

TO-31 TMSAT-1

Uplink 145.925 MHz 9600 baud FSK
Downlink 436.925 MHz 9600 baud FSK
Operational although not always turned on when over VK/ZL.

Some BBS activity but mostly used for earth imaging via the multi-spectral cameras. Many image files in the directory.

OO-32 TechSat-1B

Downlink 435.325/435.225 MHz

Undergoing commissioning. The satellite is transmitting HDLC telemetry framed so a TNC in KISS mode will decode it. There is no continuous beacon. A 9600-baud burst is transmitted every 30 seconds for a continuous 3 seconds in length, currently on 435.225 MHz. Telemetry display software is available from the internet.

The following satellites are currently non-operational:

RS-16

Attempts to command the mode A transponder 'on' have been unsuccessful to date. At this time the RS-16 transponder is non-operational. The 435 MHz beacon (only) is operational.

DOVE DO-17

Downlink 145.825 MHz FM 1200 Baud AFSK
Beacon 2401.220 MHz
Non-operational.

WEBERSAT WO-18

Downlink 437.104 MHz SSB 1200 Baud PSK AX.25
Non-operational.

SEDSAT

The controllers are experiencing problems with the uplink receiver of this new satellite which has not yet entered service. There is also a power supply problem which is making it quite difficult for them to achieve the necessary repairs.

ar

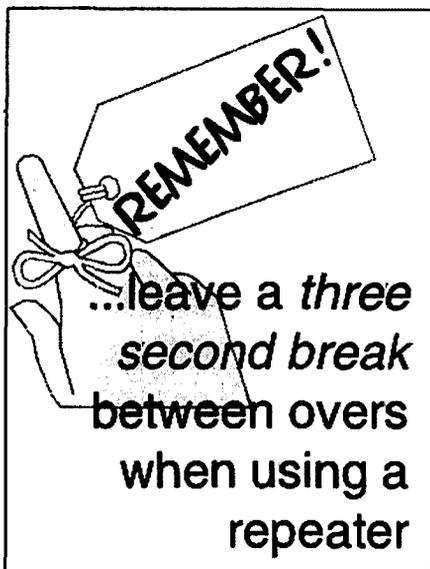

ARDF

Ron Graham, VK4BRG
PO Box 323 Sarina Qld. 4737

How does a Group or Club get started in fox hunting or ARDF? Are people really going to be interested in this aspect of the hobby? These must be common questions. In my opinion, it may be advisable to try the concept with minimal expenditure -just in case! If, it proves popular, and hopefully it does, then more money and time can be expended as the interest grows.

Hidden Transmitters

Known also as "foxes", these come in all shapes and sizes. Talking about the popular ARDF band, 2 metres, and keeping the above in mind, a handy talkie is the obvious starting point -provided someone has one available. It needs to run at "low power" so that the battery will last a reasonable amount of time. Some modern handy talkies have a number of power settings available so some experimentation should show the optimum setting. Rubber bands, including a couple of spares, are used to actuate the PTT button.

As an example of power requirements, I often use 20 mW foxes and find that they provide sufficient signal for a range of 300 metres over slightly undulating wooded

terrain. This is with a "rubber ducky" antenna and with the fox standing on the ground. The receive equipment is, what I consider to be, an average "sniffer" receiver/beam combination. I think this sort of range is all that is initially needed to explore possibilities, gain experience and have some fun locating hidden transmitters.

If needed, that range can be extended by:-

- Using a "better" antenna -say a 1/4 wave or 5/8 wave vertical.

These naturally give vertical polarisation. Should horizontal polarisation be desired, which is stipulated in the International ARDF Rules, then "turnstile" or "halo" antennae are good choices.

- Elevating the fox or just the antenna if it's separate, above ground level. In many instances, a suitable tree may be utilised - though in some respects, I am wary of dense foliage as I visualise it "sucking up" RF energy.

Security

This should be considered early in the

exercise. The person loaning the fox, in this case his "possibly best" handy talkie, to the group would not be impressed if some third party just happened to find the fox before the actual hounds, or participants. Particularly so, if that third party just picked the fox up and disappeared with it! This could be the case in a public or semi public area -you may well be observed hiding the fox, that person investigates after you have left the area and the rest is a matter of luck!

There are two ways to resolve this potential problem. One is to use private property or a sufficiently remote area to be away from other people. The other is for someone to "stand guard" over the fox. That person should try to remain out of sight of the hounds for as long as possible and should not remain too close to where the fox is hidden -just keep the area in view. This person can also act as the judge and be responsible for collecting the fox at the conclusion of the event. They are also often

...this was observed by someone else on the beach, who...collected the fox, took it back to where they were sunbaking, and placed it under their towel

the source of lots of humour after the event as they were in a position to observe the antics of the hounds!

This session on security gives me an opportunity to tell a story of how events may, at times, work out to our advantage. Although I have attended a number of the Mission Beach "do's", organised by the Townsville and Cairns Clubs, this event occurred in my absence, so it's a second hand account.

Normally some fox hunting activity takes place at these events and on this occasion the fox was hidden on or close to the beach. Apparently, this was observed by someone else on the beach, who went and collected the fox, took it back to where they were sunbaking, and placed it under their towel or clothing -naturally thinking the device was now theirs. Unfortunately for them, they didn't know just what the device was and that it was still turned on. Hounds eventually arrived on the scene and located the fox; much to the amazement of the "new owner" I gather. It was reported that some discussion then took place as to who was the real owner, with the amateurs eventually winning!

Further Fox Considerations

When one wants to get more serious and think of dedicated foxes, there are a number of requirements to be considered. In order of priority, and in my opinion, these are:

- Generate some RF.
 - what frequency?
 - power level?
 - type and size of batteries?
 - antenna arrangements/type?
 - physical size/arrangement?
 - antenna type?
- Modulation.
 - AM or FM?
 - tone/frequency?
- Carrier switching.
 - run continuously?
 - switched?
 - if so, how?
 - at what period(s)?
- Identification.
 - incorporate?
 - how?
 - details?

The above may be considered as a good starting point and, hopefully, promote further thought, challenge and comment. Naturally, one needs to carefully consider their Groups

actual requirements.

Incorporating lots of "frills" may be "nice", but adds to the complexity and expense. They become necessary as one gets more serious.

but one may start with something quite simple. Lots of potential for some "home-brewing" here!

Overseas Events

<http://www.210.100.211.57/ardf/index.htm> is the new URL for information regarding the Korean event in mid June 1999. I note that invitations to the combined Region 2 and Friendship Amateur Radio Society event have been posted to Region 2 Societies. Anyone from this part of the world would also be made welcome in Portland, Oregon, USA with the event running from 10th to 14th August 1999.

Melbourne ARDF

It was pleasing to note, via the melb-ardf Internet reflector, they had an attendance of 36 people to an ARDF event held in November -as this column is being written. It appears the organisers have managed to attract some newcomers, plus the involvement of families in the event. Hopefully, the events will gain in popularity and their success may prove an inspiration to groups in other parts of the country.

ar

WANTED

A VOLUNTEER TO MANAGE THE WIA CALL BOOK

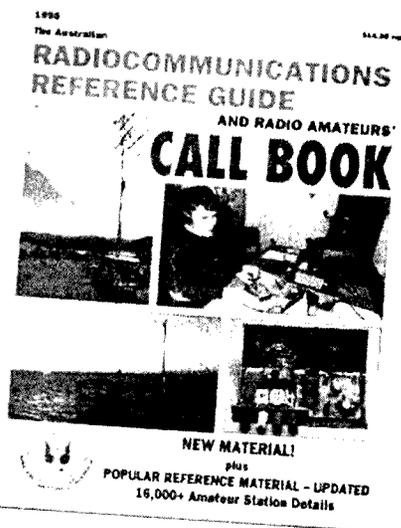

Duties are —

- to keep the Call Book information up to date
- to add new data as appropriate, and
- to arrange printing for distribution in October each year.

For further details:

Martin Luther VK5GN

AH phone: 08 8524 3440

fax: 08 8524 3836

email:

MartinL@AppDes.com.au

SPOTLIGHT ON SWLING

Robin L. Harwood VK7RH

5 Helen Street, Newstead Tasmania 7250 (03) 6344 2324

e-mail: robroy@tassie.net.au

Millennium changes

1999 has begun and the twentieth century rapidly ends. Officially the next century does not start until January 1 2001. The year 2000 has caught the public imagination with many being misinformed that it is the beginning.

Oldest station closes

At the end of last month, a significant part of radio history ended when Scheveningen Radio PCH closed down after 94 years of continuous service to the maritime industry. The station opened on December 19, 1904 and was originally located in the Dutch province of that name.

On the anniversary of its inauguration and to commemorate its closing, a special station PA6PCH was heard on the amateur bands. Also Dutch amateurs were permitted to work PCH cross band. However this privilege was not available to other amateurs because it would be against the radio regulations. PCH must certainly have been the oldest continuous wireless station until it closed down.

The American coast station WCC, formerly at Cape Cod, started in 1914 although I believe that there was an earlier station nearby. I do wonder if the historical nature of PCH's contribution may perhaps see the station continue as a wireless museum. There is a Swedish alternator on about 17 kHz dating back to 1924, which is annually re-activated.

At the end of this month, CW will no longer be required on HF and will be phased out at 2359 UTC on the 31st. This will see many signals disappearing yet the callsigns will remain because they will still be using digital modes and voice traffic. I also believe that the UK Government wants to phase out HF maritime communications and close the Portishead Facility. GKA was the callsign and it too was one of the originals. The station was located in the beginning near Bristol but it has since had several relocations. The operations of many HF coastal stations were centralised and most were referred to as Portishead Radio. HF telephone traffic has been closed for several years and only digital modes remain.

Who will occupy the channels?

Naturally a question arises. Who is going to occupy the vacated channels? Already numerous pirate operations have crept in and

it is going to be difficult to police the spectrum. The majority of these operators are on SSB and utilise either discarded marine sets or modified ham transceivers. Most of the unofficial signals I hear seem to be in SE Asia. In Europe, there are many pirate operators congregating around 6.7 MHz and causing severe interference to HF aeronautical communications.

Ten metres has for some considerable time experienced pirate operations, usually on narrow-band FM. Often signals from them are more numerous than the legitimate amateur operators. Apparently the 10 FM repeaters have been copping severe QRM from these intruders.

I did read in a recent "DX Post" that a Queensland listener sent some tapes to a language laboratory and ascertained that these were Thai truckers.

Excellent signals from Tokyo and Hanoi

One of the easiest stations I received when I first started listening to shortwave was Radio Japan. For many years they were regularly on 11850 at 0930 UTC. Now Tokyo is heard during our daytime on 17685 kHz with English to Australia. Signals are excellent from 0100.

I also recently noted that Vietnam recently vacated 10060 kHz after being there for many decades. The frequency drifted about but it was easier to hear Hanoi with its domestic service than the external service. Today it is still hard to find, although in winter, you can hear Hanoi via Siberian sites, broadcasting to North America.

I recently had a new random length antenna erected, thanks to the assistance of four local hams. This dipole replaced a 5-band vertical that was temporarily in use when I suddenly had to relocate in April 1996. I am now able to hear better and also I discovered that a coaxial switch was faulty. I would like to thank VK7HAW, VK7CC, VK7ZOO and SWL Tony Simmonds for their assistance.

I would also like to thank Bill Roper, VK3BR, past producer of this journal, for his advice and assistance with this column. That is all for this month. I hope that the summer months are interesting listening. If you have any queries you can contact me at the above address or via e-mail at robroy@tassie.net.au or robinharwood@netscape.net.

ar

WHTE AN OIAF EXPANDING WORLD

Eric Jamieson VK5LP PO Box 169 Meningie South Australia 5264

E-mail: vk5lp@ozemail.com.au Fax: 08 8575 1777

Packet: VK5LP@VK5WI.#ADL.#SA.AUS.OC

One metre days

This has been an interesting subject that periodically rises again as the result of new information. In this respect I recently received a letter from **Max Meallin VK3ATK** of Bendigo, in response to my article on the subject in November 1998 AR, which followed information from Ken VK3AFJ.

Max said he has known Ken for nearly 50 years, both on the air and personally, mentioning that he and Ken had contacted each other regularly on the one metre band in the 1950s.

Max wrote: *In 1954 I constructed a modified version of the Radio and Hobbies 288 Meg. Modulated Oscillator. I used over 300 volts on the plates of the 7193s. They did not last long unless the overs were kept short, but there was a plentiful supply of them at disposals stores.*

The one metre band was a good band for experimenting in those days and we had a lot of fun while that band lasted. Ken acquired a large quantity of bronze welding wire and gave me sufficient to construct a 16-element phased array that I fed with 300-ohm ribbon. With this beam I worked a portable station in the Pentland Hills which is well on the way to Ballarat.

The following contacts were made: 1953: Austin VK3ALO 1954: VK3s Bert AAF, Ken AFJ, Harold AHC, Geoff AHS, Max ALK, AMT, MB, John PL. 1957: VK3s Eric ADU, AFJ, Mac QO, Bruce VF, Bob ZAN, David ZAQ. 1958: VK3s Charlie AAK, ADU, AFJ, Wally AHZ, ALK, Geoff AUX, IE, OM, QO, VF, Ray ZAE, John ZAI, Bob ZAN, ZAQ, Jock ZDG, Frank ZDW, Wally ZDZ (now 3AHZ), Garth ZFA.

It is interesting to note that in all reports so far received on one metre operating, no contacts over extended distances appear to have occurred. Most were of the order of 50 to 100 km, no doubt due to the equipment used, usually relatively low power, small antennas etc. The 16-element phased array constructed by Max is about the largest to be mentioned so far. [My lowly antenna was a horizontal dipole but it provided strong signals to and from my mate 16 km distant. ... VK5LP] Thanks Max.

Beacons

Wally VK6KZ advises that the Esperance two-metre beacon has not been heard for a while but is believed to be operating. Albany is not on the air - it is to be re-located at the QTH of Tom Reid VK6TR; advice will be given when it is operating. The Cape Leeuwin beacons are ready to go but Wally so far has been unable to travel there to find a QTH.

David VK3AUU: *The Mount Gambier beacon is in here all the time with the antenna pointing at it. It is detectable with my beam on Adelaide, which on the second side lobe is down 20 dB and about the equivalent of listening on a dipole when I fire up the HAMVIEW program and have a look for it. This is fairly remarkable when you consider that the tropospheric path loss is about 220 dB over that distance. My antenna needs a lot of work at present and I have no masthead preamp so my effective noise figure is around 3db. Also I have no rotator which means I have to climb the tower to turn it.*

There are several other beacons not regarded as 24 hour.

Wally VK6KZ reports that the new Exmouth beacon on 144.576 MHz was first noticed by Cec Andrews VK6AO at about 2310 on 29/11 and then copied by VK6KZ and Don VK6HK; it was through for about two hours by tropo. They were unable to trigger the repeaters at Geraldton or Exmouth - which is not unexpected with the advantages of CW over FM!

Referring to the same beacon, **Don VK6HK** reports that VK6RSX on 50.304 is almost always audible in bursts over the 1104 km path - presumably meteor scatter but could be aircraft specular reflections too. He has been looking at the signal using one of the DSP software packages which allow 2 Hz resolution for Doppler effect and has observed up to 50 Hz shift, but usually none. The path is exactly along the route taken by many of the international flights from Asia.

Leonids Meteor Showers

Note: Unless otherwise stated, all times for this section are for the UTC day of 16/11, or the local morning of 17/11 and on two metres.

Rod VK4KZR: 2057 VK3AFW 5x7, 2059 VK2TWR 5x4; heard VK3TMP, VK3AJN, VK2ZAB, VK2KU et al. Band still very active at 2135.

Ron VK4BRG: Heard/worked: 2049

VK1BG heard 3 times, called, no response heard: 2149 VK2KU? gave 5x2 report, no report received; 2154 VK2TWR 5x1 received 5x7 good contact.

Six metres: 2118 VK2HO John, Lismore gave 4x1, received 5x1; 2122 VK2HO lot stronger ... heard 5x7 direct path.

17/11: 0004 VK2KU, 0025 Gordon VK2ZAB, both good contacts. 0026 VK2ZAB 5x9.

Ron VK3AFW:

2045 VK4TZL	5x6	5x5
2046 VK2FZ/4	5x5	5x5
2054 VK1BG	5x7	5x3
2054 VK2KU	5x4	5x3

2100-2110 Called VK8GF after phone call to Jeff. Nil heard. Listened for VK8 beacon frequently but nil heard.

2126 VK2TWR	5x2	5x3
2126 VK2ZAB	5x4	5x3
2128 VK4BKM	5x5	5x5
2135 VK3TDV	5x3	5x1
2139 VK4KZR	5x2	5x2

2147 VK4RTT/b 549, heard whenever VK2FZ/4 was strong, ie 5x9+.

2148 VK2TWR 5x9 5x9

2215-2120 Looked for beacons from west - nil.

2228 VK2FZ/4	5x5	5x5
2232 VK1MP	5x5	5x6
2237 VK4ZBH	5x2	5x9 Running

4 watts.
2250 VK4JSR 5x5 5x7
2300 VK2FZ/4 5x9+ 5x9+
2331 VK4KK 5x4 5x4

Many signals peaked up to 40 over 9 for short times. VK2FZ/4 and VK2FU were Q5 with my beam 90 degrees off them. The band wasn't open continuously, but there were many periods of five minutes or so when it seemed to be. In between there were quiet periods with occasional weak bursts. Adrian, VK2FZ/4, said the band was open two hours before I arrived. Max VK3TMP went mobile with a halo and worked VK2FZ/4, VK2ZAB, VK2KU.

17/11: 1730-1745 VK2DVZ --- 5x5 incomplete; 1845-1900 VK5NY --- 5x1 incomplete; 1900-1930 ZL3TY nil heard; 2000-2030 VK8GF nil heard; 2032 VK2TWR 5x1 5x2 aircraft; 2033 VK2ZAB --- worked VK3TMP; 2034 VK1DO 5x7 5x7 aircraft; 2110 VK2FZ/4 5x1 5x1 but not in Adrian's log; 2115 VK5NY calling and VK2FZ/4 responding; 2125 VK4KK 5x5 5x5; 2200-2209 VK4KZR 5x7 5x9; long burn wraps up sked after 9 minutes.

John VK3ATQ, tells me that he worked VK2BA and half a dozen VK4s on six metres. Also active on six were Joe VK7JG, Norm VK3DUT, VK3YY, VK3GRL, VK3DY, and VK3BQS.

Note: All times are UTC

Congratulations to Adrian VK2FZ/4 for the first VK international meteor QSO on two metres. He worked ZL1IU immediately the first sked on 16/11 commenced at 1700. ie. complete in 10 secs. They repeated this three more times over half an hour. Today (17/11) it took 45 minutes to complete. I think Adrian should be awarded the title, Master of Meteors!

18/11: VK3AFW worked Guy VK2SU on a random meteor burst on 144.1 at 2059, 5x2, 5x2. Max VK3TMP heard VK2FZ/4 a little earlier.

David VK2BA: *Thought that I should document the Leonids, from my perspective, in dark Megan near Dorrigo in northern NSW.*

Visual perspective: Very disappointing, especially after all the mis-information on the TV and radio. For us, 30 km west of Coffs Harbour and at 2500 feet ASL, with a black sky and only slight cloud, we counted a meteorite approximately every five minutes, and in 1 1/2 hours of viewing from 2.30am saw only two really "juicy" meteorites with tail etc. The rest were just little streaks of light. In all, not much more than one would normally see at that time of night from a dark country hilltop.

Radio perspective: On six metres I found

activity on 50.110 and in about one half hour from 1740, (4 am daylight saving time) I worked the following stations:

1700 VK3ATQ 5x5 5x5, VK3WRE 5x5 5x9, VK3YY 5x1 5x1, VK3DUT 5x5 5x5; 1751 VK7JG 5x5 5x5, VK1MP 5x5 ??; 1752 VK3BQS 5x5 5x7; 1757 VK4 heard calling me but call not copied; 1808 VK3WN 5x2 5x3.

In all, an interesting morning. Pings were often long enough for several short two-way exchanges. The best signals were at 1809 (5.09 am local) when VK3BDL, VK3YY and VK3WN were all 5x9 and calling together.

Norm VK2XCI: *We were blessed with clear skies, absolutely no light pollution and a beautiful evening, perfect conditions for viewing! We stirred the kids up at 0230 DST and went bush in downtown Mount Hope (pop. 12).*

For those of you cursed with clouds, haze, rain and storms, you didn't miss too much. Besides the normal sporadic rate, the rate from the radiant was only about 10/hour. There were a few spectacular single events and one really spectacular fireball but by 0430 DST that was it! Not that I expected much more as the peak was to be 0700 DST, what did surprise me was that the rate didn't seem to pick up as the peak approached.

From 0430 to 0800 DST I had two metres

running. There were a few pings on the Nimmitabel beacon lasting half to two seconds and nothing else heard on 144.100 etc.

Gordon VK2ZAB: *VK2FZ/p4 5x3 - heard in virtually every direction of the compass up to S9 for five hours. VK4TZL 5x1 - heard frequently for several hours up to S7.*

VK3TMP 5x2, VK3TDV 5x5, VK3AFW 5x3 - heard frequently up to S7, VK3AXH 5x3, VK4KZR 5x3, VK4JSR 5x3, VK4ZBH 5x4, VK3TMP/m 5x4 - heard frequently, VK3XPD 5x5, VK4BRG 5x7, - heard several times, this contact the longest distance - about 1390 km as the crow flies.

VK5NY 5x5 and VK5ACY 5x6; these two may have been Es rather than meteor scatter. There is no way of knowing for sure. Tried to talk a couple of stations into trying 432 MHz but was not sure whether or not they got the message. Anyway I tried 432.1 MHz - no joy.

Alan VK5BWG: *It was a "fizzer" here. Worth getting up and having a look but not the spectacular light show that it was made out to be. As for radio ... well, I must get my antennas back in the air!*

Roger VK5NY: *Heard a number of stations on two metres SSB starting 0012 - VK4s, VK2s. Seems like Es but could be the beginning of the Leonids? Still not sure, my time now 0400, can still hear signals on 144.100, short bursts can't identify.*

Visually a real non-event but a few good contacts on 144 MHz after sunrise at 2115 to VK1, VK2 and heard VK4, tropo to VK3TMP. Appears morning of the 17/11 (16/11 UTC) may have been the big day.

Chris VK1DO: *I have never seen such concerted enthusiasm. Lots of calling, CW and phone, lots of listening, beam turning and initial disappointment, partly confused by believing that I was hearing things. After giving up on ZL, I swung the beam north and northwest and the plethora of locals appeared. We had VKs 1DO, 1DA, 1VP, 1MP, 1ZQR, 1DC, 1BF, 1WJ, perhaps others.*

About 1740, monitoring where I thought the VK4 beacon would be, using the sub-receiver in one headphone and 144.100 in the other, it all erupted. The strongest of the VK4s observed superb protocol in attempting to move off the calling frequency, but I think these were pretty short burns.

By sunrise, local time, I had only worked two VK4s. Later found Roger VK5NY chatting. I called him, received a response, gave a report and things crashed.

Then, the most astonishing series of contacts with various VK3 stations, many of whom I can normally work on aircraft, but for instance, Norm VK3DUT whom I haven't worked on 144 since he moved to Bairnsdale, was 5x7 and so forth. About ten strong VK3 contacts. The geometry suggests this wasn't meteor

Oceania Beacons as of 13/11/98 courtesy of

JA1VOK Mobile Ham

50.014	V73SIX	RJ38	10W Loop	qsp V73AT 28.885
50.040	ZL3SIX	RE66	70W Beam	qsp ZL3TIC signs NW/NE
50.042	YB0ZZ/b	OI33	05W GPlane	qsp YB9ARA or YC0UVO.
50.0465	VK8RAS	PG66	15W X Dip	qsp VK8GF
50.0535	VK3SIX	QF02	15W Yagi	qsp VK3OT
50.0565	VK7RAE	QE37	20W X Dip	qsp VK7XR/VK3ATQ
50.057	VK8VF	PH57	100W Loop	qsp VK8AH/RH
50.058	VK4RGG	QG62	6W Vert	qsp 28.885
50.061	KH6HME/b	BK29	20W Dip	
50.065	KH6HI/b	BL01	50W halo	qsp KH7R 900m amsl
50.066	VK6RPH	OF88	10W Dip	qsp VK6HK
50.0775	VK4BRG	QG48	6W T/S	qsp VK4BRG 28.885
50.304	VK6RSX	OG77 ?	50W Omni	qsp VK6HK
50.306	VK6RBU	OF76	10W 3 el	qsp VK6HK Beaming Africa
51.029	ZL2MHB	RF80	10W Vert	qsp ZL2KT 28.885
52.325	VK2RHV	QF57	10W Vert	
52.3465	VK4ABP	QG26	4W Vert	qsp VK4ABP
52.370	VK7RST	QE38	5W Vert	Hobart 300m amsl
52.420	VK2RSY	QF56	25W T/S 240m amsl	
52.445	VK4RIK	QH23	15W Dip	
52.450	VK5VF	PF95	10W T/S 690m amsl	

JA and Regional beacons at 13/11/98 de JA1VOK.

50.010	JA2IGY	PM84	10W 5x8 GP
50.017	JA6YBR	PM51	50W T/S
50.027	JA7ZMA	QM07	50W T/S x 2
50.032	JR0YEE	PM97	2W Loop
50.037	JR6YAG	PL36	10W T/S
50.075	VR2SIX	OL72	7W 1/4 gplane - Hong Kong
50.480	JH8ZND/b	QN02	10W 5x8 ground plane
50.490	JG1ZGW	PM95	10W 7 el beaming South

scatter but more likely combinations of different propagation modes.

Heard Joe VK7JG, with the beam turning toward Sydney and made a technical mistake and thought of six metres and Joe VK4JH, sign of only two hours sleep. Heard Gordon VK2ZAB exchange reports only to realise I was looking in the wrong direction.

Followed by a number of signals in the SWW direction, peaked by Roger VK5NY who was inundated and shifted to .150 to be worked by VK1DA, VK1DO, Rod 2TWR, perhaps others. There were other VK5s initially audible, but the geometry was obviously leaning toward Clare Valley.

Barry VK3BJM: *While operating mobile 1000-1230 ESST travelling from Melbourne to Echuca, and 2000-2300 returning home, I heard one burst of "2FZ/4" and several bursts of morse on 144.1, using the halo. Oh, to have been about Tuesday morning.*

Alan VK3XPD: *Between 0700 and 1100 EDST the activity (for me) was magnificent. I have never heard so many "pings" and varied stations to work on two metres.*

There were VKs 1BG, 2FZ, 2ZAB, 2TWR, 4KK, 4IC, 4TZL, 4KZR and a few more that I probably missed. Signals were generally 5x2-5 but peaked 5x9 to me but often louder to Max VK3TMP and Ron VK3AFW. Some QSOs lasted more than 10 seconds.

Joe VK7JG: *The meteor shower produced the most exciting signals that I have ever heard on VHF. At one stage I thought that it was an E opening as the signals were most consistent. I worked VK 1, 2, 3, 4 and 7 on two and six metres, once again no signs of VK5. I was surprised at the number of amateurs that were active. I had my first contact at around 0330 am local time. My final contact for the day was with Gordon VK2ZAB on two metres, I had turned the linear off and was running only 50 watts.*

Rod VK2TWR: *At 2112 worked John VK4LP 5x9 both ways; 2113 VK4BKM; 17/11/98, three years to the day and to within one minute, as they say what goes around comes around.*

Andrew VK1DA: *1945 VK2FZ/4 5x5 559, 1950 VK4BKM 5x5 559, 2007 VK4FZ/4 5x5 5x5.*

Bob ZL3TY: *From 1900 all ZL and VK TV offsets were audible some at good strength. The VK7RAE beacon was in at around 519 between 2000 and 2100. Also audible were strong pings from the 48 MHz VK pagers.*

Mike ZL3TIC: *All morning signals were constant. I have never heard M/S like this, stations worked were: ZL3VTV/1 5x9, ZL2TPY 5x9, ZL2KT 5x9, ZL3NE/1 5x9, ZL2AGI 5x9, ZL2KT 5x9, and ZL1THQ 5x9, all on 50.110.*

Steve KL7SIX: *Today on the 45 MHz TV video an occasional meteorite in the right direction lifted the signal level from NZ over 15000 km away.*

In KL7 today (16/11) with AU Es always around it only took a burst or two to produce 5 or 6 minute burns on KL7NO at 250 miles and on VE8SIX at 750 miles. Steve KL7FZ had a burn on VE8WD 1500 miles away. But no lower 48 MHz at 2400 miles, just too far.

Here in the dark Arctic we saw long burn visual trails and actual smoke in the pure atmosphere trailing across the sky, not to be confused with vapour trails and ionised Stealth bombers.

Aurora

Wally VK6KZ: *Firstly no AU observations from over here. Several of us did look for propagation after reading the postings on the VK-VHF list. Guess our distance but more our latitude doesn't help.*

Spring Field Day

The Spring Field Day was held on the weekend of 14-15/11. Here are some of the results and comments.

Ron VK3AFW: *My QTH Mount Buller near Mansfield NE Vic. A very enjoyable Saturday afternoon. Due to battery problems I was restricted to 25 w on 6 and 10 w on 2 m. The 70-cm antenna problem proved to be too hard to fix hence 70-cm station had a nice restful day out.*

Portable stations worked: VKs 3WRE, 3BRZ 3XLD, 2TWR, 3BJM, 3DQW, 2XCI.

Best two metre contacts: (500-600 km approx) Andrew VK7XR Sheffield, Norm VK2XCI/p Mount Hope, Guy VK2FU Springwood, Fred VK2FWB Dubbo. Mount Gambier beacon heard all day but no VK5s.

Chas VK3BRZ: *What a disaster! I might have to complain to my WIA division about the weather they put on!*

David 3XLD and I operated from a site just on the northeast outskirts of Geelong (a spot called Lovely Banks, some 50 metres asl, but a good view all around). We managed a few good contacts, including VK7JG (QE38) and VK3BJM (QE23) on 1296.

More interesting though was David's QSO with Alan VK3XPD on 5760.100 MHz, distance about 60 km across Port Phillip Bay, with optical path. Alan was running 4 W, and David only 5 mW from a VK5 kit.

I also had a meteor-scatter contact with Adrian VK2FZ/4 at 1848 (Sunday morning). We heard a number of good pings, and one was good enough - 6 seconds or so.

Norm VK2XCI: *The weather was more than kind and I had a most enjoyable Field Day Contest. I hardly look on it as a contest, more of a chance to sit high on a hill with the Wedge-tails for company and enjoy the hobby. The "round the clock" system of calling and*

listening seems to be a waste of time, I'll abandon it in favour of the "wild west" system of listen, point and shoot! It amazed me how often one fortuitous contact turned into an instant pile-up, sort of like every-one waiting for someone else to break the ice! No VK4s or VK5s.

Barry VK3BJM: *Weather turned out all right, at my mountaintop at least. Very pleasant!*

Highlights were: Working Norm VK2XCI/p for the first time (487km); working Mark VK2EMA, for the first time, on 2 m and 70 cm (609km); working Bob VK3ZL, on 2 m and 70 cm - Bob was running about 3 watts on both bands (distance 235km); hearing noises from the west and finding it was VK5NY discussing the lack of contest activity with some other VK5 - then pouncing to successfully extract a contest number, just as the propagation started to weaken!

Other pleasing contacts were Laeli VK2LO, Murrumbateman on 2 m; Joe VK7JG, in QE38 on 2 m (just failed on 70 cm); VK3AEF, Nhill, QF03, on 2 m; VK1s BG, MP and ZQR on 2 m; VK2TWR/p on 2 and 70 - unfortunately no go on 1296; and working Ralph VK3WRE/p, Gippsland, on all bands 6 m through to 23 cm, several times during the contest. Also worked on 1296 were VK3s XPD, TLW, KWA, BRZ/p, and XLD/p.

Six metres

16/11 1035 VK6RSX/b 50.304 heard 599 by JR2HCB

Mike ZL3TIC: *27/11: 2200 very strong VKTV.46.240 5x9+ also 35 MHz pagers 5x9, 2245 57.240, 250, 260 all 5x9, 2300 XE2UZL/b 5x9! 2310 XE1KK/b 5x9, both of these beacons were in for 1.5 hours!*

Called on 50.110, 125 and 130, other ZL3s calling were ZL3ADT, ZL3NW and ZL3AAU. Would be interested to know if anyone heard us?

2325 55.240 (zero beat) NTSC video up to 5x9. This was possibly mainland USA or Mexico. 2330 strong VKs off back of beam.

28/11: 0005 strong ZLTV from north 45.240, 250, 260, 55.240, 250, 260 all 5x9; 0035 ZL1WTT 5x9.

Grid Square League Table

Guy Fletcher VK2KU has indicated that he will pick up the Grid Square Table in the absence of anyone else offering to run it.

Guidelines

Submit number of grid squares claimed as worked on 144, 432, and 1296 MHz. No details of actual squares/stations required. Starting date for contacts: 1st January 1990 (as for WIA Awards). No distinction between modes (CW, SSB, FM etc.) at this stage - a square is a square. EME claims to be listed separately.

All squares claimed must be worked from locations within a single limited "region", which can be encompassed by a circle of radius 50 km. Entry is open to any VK, not just subscribers to VK-VHF. The Table of Standing's will be posted on this Reflector roughly every 3 months.

Updates to me at any time by email/mail (QTHR 1999).

Comments

If you move house to a new "region", you have to start again, though your old score still stands of course. Tough, but imagine if Gordon VK2ZAB and Chas VK3BRZ exchanged homes for a month.

The intention is to encourage portable operation (up to 100 km from home) to overcome the limitations of a home QTH, but not to an extent which confers an unreasonable advantage.

If you regularly go portable to a different "region", you can keep a separate tally for the /p operation.

If Eric (VK5LP) wishes to copy the Table into his AR column from time to time, that would be nice. [He will. ... VK5LP]

There is no minimum number of squares to start - you don't need to have 50 squares on two metres! Please enter at any level so that we may all enjoy watching the growth of your tally.

I note Chas's comments about reverse contacts back into one's home square with considerable sympathy, but I want to keep it as simple as possible.

If you're not into grid squares, that's fine, but my limited experience suggests that the need for a square (on 432 MHz) which ought to be more populated than it is can act as a healthy stimulus for getting stations back on the air.

We need at least 10 or 20 people on the list to make the whole Table worthwhile.

No correspondence will be entered into by me regarding the veracity of people's claims. If you want more details from someone, please email them privately and not through the Reflector. Dire punishment for transgressors!

Guy VK2KU guy@mpce.mq.edu.au

Chris Edmondson VK3CE advises: *I'll publish the Table in Radio and Communications, Guy, if you supply it to me in an appropriate text form. I'm keen to promote activity on the bands!*

The same offer has been made by me (VK5LP) to publish the Table in Amateur Radio magazine.

Ken Ellis G5KW

Major Ken Ellis, G5KW, the well-known pioneer 5 and 6-metre operator and founder member of the UK Six Metre Group, is now of a grand age of 91 and rather unwell at present, being cared for in a residential home.

These places can be rather lonely, as we all know too well.

I know that he would be delighted to hear from his many friends, or anyone who has some six-metre stories to tell it would cheer him up tremendously. Anyone wishing to drop him a line should write to:

Major Ken Ellis, Whitegates Residential Home, Whitegates Close, Hythe, KENT, UK. Thanks, Chris, G3WOS

Microwaves

Doug VK4OE reports: *During the 'Spring Field Day' my operations were somewhat curtailed compared to my earlier plans (weather eventually became fine....Murphy must have been laughing!). I spent time only on 432 and 2403 MHz bands.*

The NSW and Queensland distance records for the 2.4 GHz band were sitting there waiting to be broken, and that's what Adrian VK2FZ/4 and I (operating portable in VK2) set out to do. Adrian had improved his system quite a lot recently, particularly involving a 1.2 metre dish.

So what did we achieve? Approximately 380 km from Adrian's QTH at Maleny about 100 km north of Brisbane, to my 'beside the highway' portable station near Ben Lomond between Armidale and Glen Innes in the New England region of NSW was our enjoyable best. There could have been more distance possible, but I didn't have the time to add another couple of hundred km to my driving total. Equipment: VK2FZ/4 20W to 1.2M dish + LNA; VK4OE/2 4W to 2 x 45 el loop yagis + LNA.

Bits and pieces

Joe Gelston VK7JG advises that after about eight years he has finally put all my antennas on the tower.

They are: 28 element loop yagi on 1296, fed with 7/8 Heliac; 48 element Jaybeam on 432; 15 element Quad driven yagi on 144; all have most head pre-amps; 6 element yagi on 50 MHz.

During the VHF contest I worked across Bass Strait on all frequencies, but to my surprise I did not hear any VK5s on the air, however VK5VF/b on 144.450 MHz was audible for most of the Saturday morning.

End of an era

One cannot but help to feel a sense of nostalgia on the realisation that the December 1998 issue of Amateur Radio was the last to be produced by Bill Roper VK3BR.

Bill and I have had a long, comfortable and amicable arrangement in our common association with AR. When I first began writing these columns in 1969, Bill was a member of the Publications Committee, moving on to become the Editor in 1972

following the introduction of the Federal Body of the WIA. In 1976 he relinquished the position but returned in 1988 as General Manager and Secretary, effectively again at the helm of AR.

In 1992 he was recognised as the Publisher of AR, moving on to becoming Production Editor. When the Federal Office decided to contract out the production of AR, in 1996 Bill formed his company vk3br Communications Pty Ltd, successfully tendering for the production of AR. Drawing on his considerable computer skills he produced a new-look AR which has continued to the present, further aided by his computer typesetting commencing in May 1998.

During the past 29 years of supplying VHF/UHF information to AR, the method of presentation has seen changes. At first it was by double spaced typewritten material and this did not change until about 1990 when Bill accepted computer disks, first the 5.25 then 3.5-inch floppy disks. These were delivered by Australia Post.

In the last couple of years another step forward has been with the transmission of information by electronic mail (e-mail). Once a few incompatibility problems with programs were worked out, the passage of information to Bill has moved smoothly.

Time marches on and changes are made. Bill will be missed for his typesetting and formatting skills, but these will now be channelled into his other considerable interests within his company. I wish him every success in his new ventures, shared with and supported by his wife Wyn. Au revoir Bill.

Welcome to Bob Harper VK4KNH of Shadetree Publishing at Beerwah, Queensland, who now takes the publishing helm in concert with Bill Rice, the Editor. If the association with Bob Harper is as amicable and productive as it was with Bill Roper, then Amateur Radio magazine will continue to be a successful mouthpiece for the Wireless Institute of Australia in particular and amateur radio in general. Good luck Bob, I'm ready to work with you.

Closure

It has been relatively quiet on the six-metre scene but with summer now with us propagation should improve. It seems inevitable that as F2 rises then Es wanes. You are urged to support the Ross Hull Memorial Contest and the VHF Field Day, both running this month.

Two thoughts for the month:

1. Man's mind, stretched to a new idea, never goes back to its original dimensions, and
2. An apology is a good way to have the last word.

from *The Voice by the Lake.*

ar



Divisional News

team wielding lawn mowers and weed trimmers went about their allotted task with much gusto only to disturb a large black snake. They beat a hasty retreat and watched closely from a safe distance as the local resident departed for quieter surrounds.

During a follow up visit a comment was made that the rack of equipment being installed on this one site, contained more 'gear' than the entire QDG network of three years ago. Many thanks go to Neville VK4TX and Ken VK4KWM the technical driving forces behind a talented band of enthusiasts.

A Ham Radio Fun Day will take place in Brisbane at 11 AM on the third Sunday in February at the Koala Park in the Daisy Hill Environment Park. If you haven't been there, it is a great place for the family. Entirely free, but BYO. The donation of a gold coin per adult would be appreciated with money raised going to the Royal Flying Doctor Service. So, mark the 21st of February in your diary today.

Don't be like this recent comment. Martin Molloy on a VK National "drive time coast to coast" FM program actually mentioned Amateur Radio, but in what many would say is a negative way. QUOTE: "Ham Radio Operators... they're the people with friends in every city in the world. None in their own home town, but friends in every other city". So, get along to that Fun Day.

Due to a major storm hitting Brisbane the afternoon of Tuesday 13th October (beware that date) the WIAQ Council meeting was postponed for 1 week.

President Col VK4ACG, Councillor Laurie VK4BLE along with visitors Graham VK4BB and Alan VK4AAE still 'fronted up' to SES HQ in Brookes Street and almost ended up working the night for the Emergency Service. Antennas were blown down, a fig tree fell across SES vans and a large branch demolished the guttering and 240V mains entry point on the side of the building intended for the meeting.

Brian Beamish VK4BBS informs us that his daughter, Sue, has taken up a position as a teacher with the School of the Air. She and husband Alan will move to the town of Charleville in Southwest Queensland from which Sue will soon be heard teaching to her students in remote locations by HF radio. This could be considered as a case of 'Amateur harmonics on the School of the Air frequencies'.

If you are around the Hervey Bay area on holidays, drop in any Saturday morning from 9 AM to the clubrooms in Dayman Park at Urangan. Believe you me, you'll not be able to miss the club, what with the signage plus the antennas. VK4CHB is the club station and the Hervey Bay repeater is on 146.650 MHz.

The recently completed 21st Anniversary Gold Coast Hamfest was another successful

It is there that a new eighteen-metre antenna mast is being put up presently by a combination of paid contractors and divisional members.

The result of this effort will be a wider and more reliable coverage for VHF/UHF in the territory and surrounding area.

Another area of interest is the membership. Generally, membership of the WIA is decreasing. VK1 Council believes that it is up to all of us to maintain and be active to increase membership in the VK1 Division. Of the 430 licensed radio amateurs in the territory, only 165 are members of the division.

However, you can help in a significant way!

Talk to your mates about the advantages of WIA membership. Give them an old copy of AR or bring them to one of our monthly meetings in the Griffin Centre. Alternatively, pick up a copy of our new brochure entitled: 'Services for Canberra Radio Amateurs' from any of the councillors, or at the meetings. Cheers, pkloppen@dynamite.com.au

QNews

VK4 Notes

Alistair Elrick VK4TL
alistair@powerup.com.au

Those tuned to the Brisbane VHF Groups 147 MHz repeater on Friday 6th of November, were treated to 'History in the Making'. A LIVE broadcast complete with a description of the new Qld Rail 'Very Fast Tilt Train', as it arrived and departed, Caboolture Rail station on the cities northern outskirts.

Noel VK4YNW set himself up to not only record but broadcast the sounds of this train, the *City of Maryborough*, on route from Rockhampton. The repeater was 'abuzz' that afternoon with Noel's exploits and much appreciated by all those 'on line'. It can be noted one of our visually impaired Hams, Noel had the railway staff a little perturbed by his 5/8 whip waving in close proximity to those overhead wires. Well done Noel.

A recent upgrading and clean-up visit was paid to the Queensland Digital Group VK4RZA site at Springbrook overlooking the beautiful Queensland Gold Coast. The garden

Forward bias

VK1 Notes

Peter Kloppenburg VK1CPK
(02) 6231 1790

As Hugh mentioned in the December issue of A.R., I am taking over the responsibilities of editing this column.

As most of you realise, this is not an easy task to do. To gather interesting items of news that are relevant to members of the VK1 Division, you would have to be everywhere at once in the ACT.

However, you can help me to a certain extent by letting me know what is happening in your neighbourhood. By helping me, you help yourself. For example, you need a hand putting up an antenna, you are looking for a roller inductor for your newly designed antenna tuner, or you want to borrow a spectrum analyser, signal generator, or an accurate RF power meter.

All of these requirements can form part of this column and will be read by an amateur near you, or in the next suburb.

Being a member of the VK1, Council means that I am on top of the information flow between the various Divisions. This is very useful, as new ideas, proposals for change, and amateur identities move about in the world of amateur radio.

My position as divisional councillor demands that I consult with members of the Division about various issues as they emerge, resulting in a consensus of opinion. This can then be passed on, via the Federal Councillor, to the Federal Office. One of the ways to inform you will be via this column. Divisional members are therefore asked to comment about issues as they appear here.

Other subjects that I will mention here are the various divisional activities that occur in the ACT. As most of you know, the division maintains amateur communication systems within the territory. They are being looked after by volunteer workers who have a professional background in a particular field of communications, such as Packet, VHF/UHF repeaters, antenna arrays and microwave links. Our site at Mt Ginini is a case in point.

presentation by the Gold Coast Amateur Radio Club. Art VK4GO took many digital pictures that may be viewed via the Internet on the homepage of John VK4JLK. Have a look and make sure you 'sign the guest book'. Point your browser to:

<http://www.winshop.com.au/vk4jlk.htm>

As the summer storm season is upon us, it is prudent to keep an eye on where the lightning strikes are coming from and prepare your shack in anticipation. A service from the Queensland power authority, Energex, is creating a lot of interest among Amateurs in the South East Queensland region and helps to do just that.

Access the up to date report on impending storms including lightning strikes, on the Internet. On the site, click the blue button on the left side and get a 2-hourly picture of the strikes within areas of the SouthEast corner. Early enough warning to disconnect those antennas. Point your browser to <http://bastion.energex.com.au/strike/>

VK5/VK8 Notes

Let me commence my notes for this year by wishing one and all the very best for a Happy and Prosperous New Year. I also wish you good health as such an important item governing so much of what we do.

As one year ends so another begins. Going back over past events may seem to serve no practical purpose; however, it is in fact incumbent upon us to learn from the lessons of the past.

Even so, looking towards the future is also a necessity if we are not to stagnate. There are some aspects of VK5 Division activities, which should be borne in mind. These could place us into a good position with regard to achievement in this New Year.

First of all comes the high likelihood of a new venue for our Divisional Headquarters. Our hope is that this, together with other activities, will result in an upsurge of activity within the Division. I will deal with this in greater detail further on in these notes.

Another item of major importance, particularly for the future good of our organisation, is the possibility of a new constitution.

This will result from the work put in by many people, and to a large degree by the members of the Constitution Review Committee under the chairmanship of Jim McLachlan VK5NB.

We have an opportunity to produce a document that will act as a valuable guide for quite some years to come. It is important that it be the best of its kind, so I urge you to take an interest in this, study the copy of the proposed constitution which has been provided and make your contribution in the way of

written comments as soon as possible. A special sheet was provided to enable you to do this, so please take the opportunity that offers now.

Thirdly, we will be able to press on with our recruiting campaign with the hope that we can bring many members back to the fold, and also impress on all that it is absolutely essential that we have effective representation to all areas of authority which impinge on our hobby.

I stress again that the WIA is the only body recognised by officialdom as representing Amateur Radio. It would seem pointless to try and re-invent the wheel, thus the best approach seems to be to strengthen our organisation in as many ways as possible.

A marked increase in membership can go a long way towards protecting our own interests. Please do all that you can to achieve such an improvement.

Given a satisfactory result from the above three areas mentioned, I feel that 1999 has the potential for being a very successful year.

Whilst on this subject I would like to point out that success is not only to be measured in numbers but even more importantly from the way we deal with each other. Selfishness will not allow a worthy contribution, whereas thoughtfulness and cooperation on the part of all will do wonders.

The Burley Griffin Building (BGB).

There are no doubts many do not listen to the weekly Sunday news broadcasts. For the benefit of such, I provide a brief update as to actions taken with regard to a solution for our headquarters location.

Negotiations with the West Torrens City Council and officers employed by that Council have been most amicable, with the Acting Mayor, Dr Reece Jennings and members of his Council being very supportive of the VK5 Division of the WIA.

So far it appears that the West Torrens Council may be inclined to retain ownership of the Burley Griffin Building as a "heritage" listed building on behalf of the general community. If this is so, that is the affair of that Council. This does not alter the situation in a major way as far as our occupancy is concerned.

If the building were retained by West Torrens it would certainly save a deal of work for the WIA by our remaining where we are. There are good things and bad things to be said regarding this venue which we have occupied for many years. Here though comes the big "HOWEVER!"

Members have shown a marked disinclination towards the BGB as a meeting place for various reasons. A survey of the membership just a few years ago indicated this

in no uncertain terms. There appear to be no reason why this situation would have changed. There are also other matters, particularly costs, to be considered in connection with continued occupancy of the BGB.

A review of the situation took place when the Property Development Officer for the City of West Torrens suggested several alternative sites that appeared suitable for our organisation.

One was selected as most suitable for our purposes. This could result in our occupying a building suitable for housing VK5WI as well as providing general facilities for small meetings and office space. Adjacent to this building would also be a larger meeting venue that could be shared with 2 other community organisations. The services available would certainly meet our needs.

The buildings are in an area known as Keswick Park, bounded on the western side by Surrey Road and on the southern side by Everard Avenue.

The benefits to the VK5 Division of such a move include the availability of higher quality premises in all aspects and a reduction in costs for a headquarters facility. Following a comprehensive report to the November General Meeting the members present voted unanimously towards our continuing negotiations along the lines described.

As I write, we are still in the process of negotiation and discussion with all the other interested parties. I am hopeful of an early outcome that will be to our advantage. We could be in our new location some time in February or March.

This move will require some bodily assistance from members. I hope that all will help in the task to 'move and improve' our situation.

Meanwhile, if you have any queries on any of these matters you can contact me on the telephone number listed in the Adelaide "white pages" directory.

Meetings

The first General Meeting for 1999 will be held on Tuesday 26 January. I would assume that the venue will be the BGB, however, should there be any change from this you will be notified on the weekly news broadcasts.

Thank you

Finally, I, and the Division, thank all volunteers who provided the various services for both members and non-members throughout the year. There are too many to mention in detail, however, the thanks are certainly sincere and heartfelt.

*Best 73 to you from Ian VK5QX
Divisional President.*



"QRM" from the Tasmanian Division

VK7 Notes

With the winding down of divisional activities for the year come the celebrations around our three branches.

Northwest Branch

The Christmas Dinner was held at Ulverstone on the 1st of December with 32 hams and ladies in attendance.

A feature of this night is the presentation of the "Joan Fudge Memorial Award" for outstanding service to the branch during the year. Joan was a much-loved amateur and secretary until cancer claimed her. The well-deserving recipient his year is Bob, VK7MGW.

Our Branch President, David, VK7ZDJ thanked all for their interest and work during the year. The Divisional President, Ron, VK7RN wished all the season's greetings from the State division.

Northern Branch

A fine night ensured a good roll-up at the barbecue at Myrtle Park on the 9th December. The Sterling Heights Vineyard sponsored the event, and this, together with the excellent fire-making of Alf, VK7LAW, contributed to the success of the night.

Southern Branch

It was disappointing that only nine attended the Southern branch breakup barbecue. That did not deter the hams who came from having a very good night.

"Sewing Circle" barbecue

This is always a very good event with hams coming from all over the state to the home of Bill, VK7AAW at Forcett, near Sorell. Those present paid tribute to two Silent Keys, Bob, VK7NBF, and Lloyd, VK7LC, both were part of the Tuesday night circle for many years.

We get good callbacks for our Divisional Broadcasts on 3.57, 7.090, and 14.130 MHz. at 9.30am summer time each Sunday morning. We welcome all from the northern island to this and also to our VK7 Internet site at wia.tasnet.net.au or, alternately as wia.org.au/vk7 - attached to the federal net-site. We are close to the 1000 mark with logged in visitors to this in the 6 months it has been operating.

The Tasmanian Division would like to wish the rest of Australia a very happy and fruitful New Year. This Institute year must be a year of strong growth and renewed commitment by every member to the goals of the W.I.A. to make it a really strong force in the field of Amateur Radio. The Tasmanian Division is pledged to these goals.

Ron Churcher, VK7RN, State President.

ar

REPEATER LINK

Will McGhie

21 Waterloo Cr Lismurdie 6076
VK6UU@VK6BBR will@faroc.com.au

Feedback on 10kHz Channels

November's article of 10kHz channels for repeaters resulted in some feedback, most of which was to say no.

I hope the article was understood, as one comment I received indicated the article may have not been descriptive enough.

Concern at going to lower deviation standards was the query. To go to lower bandwidth is not the intention of the 10kHz proposal but rather to allow the use of more channels. All would remain the same except for the small frequency shift of channels ending in 025 and 075. Use could then be made of the additional channels at separation distances that would not normally cause co-channel interference.

10kHz spacing is overlapping use and hence interference if the channels are within propagation distances. But provided there is sufficient distance between repeaters they would not interfere with one another.

After all we have many repeaters on the same frequency around Australia and they don't interfere as long as they are far enough apart.

Fill up

One point that was made was that the number of 2 metre repeater channels would just see more repeaters, and in the end the number of channels would fill up and we would be right back where we are in some areas of Australia right now, overcrowded.

This is a good point.

In the short term if your repeater is having problems due to pagers above 147MHz and a move to the crowded segment below 147MHz is the only solution, then the availability of a few more repeater channels is an attractive thought.

However in the long term there are only a finite number of repeater systems that can be placed in the 2-metre band and tackling the problem needs some real solutions.

70cm

The solution most often mentioned is the move to 70cm.

We all appear to agree that 70cm is the way to go. But how often does discussion focus

around establishing a new repeater system on 2 metres, with 70cm not even getting a mention. If it is mentioned, the age-old argument arises of not enough operators on the 70cm band to make use of the service, the age-old chicken and egg situation.

70cm repeaters must come first. Perhaps if your repeater system is having problem after problem with interference, a long term plan to change the system from 2 metres to 70cm needs to be discussed.

While on the subject of 70cm repeaters, they are much easier to put on air than 2 metre repeaters.

De-sense is less of a problem on 70cm due to the effective wider separation on 70cm between input and output. Percentage separation on 2 metres (600kHz) is about 0.4% and on 70cm (5MHz) about 1.1%, a considerable reduction in de-sense problems.

Added to this is the greatly reduced size of the duplexer. I often pick up UHF duplexers that operate with 5MHz separation for a cost as little as \$10. Their size is a twentieth of the equivalent 2-metre duplexer.

More Discussion Please

I would like to receive more discussion on the 10kHz proposal.

Input came via FTAC from one division to say 'no way'. I just hope the considered opinion from that division was from a wide number of people and not just one or two. It is so easy to appear to speak for all, or if the idea is not liked by a particular person, to present the concept in a negative way. The old half full or half empty situation.

VK6 HF Net

To stray slightly off the track in regards to repeater subjects for a moment, I find less and less time for repeater projects due to WIA commitments.

VK6 WIA General meetings have been suspended due to lack of attendance. Less than ten members were attending meetings and most of those in attendance were the same people.

At some meetings Councillors outnumbered members.

To replace this limited contact between Council and members at general meetings an



AMATEUR TRANSCIVER RADIO CENTRE

ALINCO AUSTRALIA'S NO 1 ALINCO
FACTORY AUTHORISED
DEALER

SEE US AT THE CENTRAL COAST FIELD DAY,
SUNDAY THE 28TH FEBRUARY AT
WYONG RACECOURSE
HUGE DISPLAY - UNBEATABLE PRICES.

BIGGEST MONTHLY IMPORTER GENUINE
EXPORT MODELS FULL 3 YEAR WARRANTY
ALINCO SPECIALIST

DX-70TH, DR-610E, DX-77E, DJ-G5EY



IC-746, IC-T8A, IC-706MKIIG,
IC-Q7A, IC-207H, IC-821H,
IC-PCR100, IC-R2

CREATE ANTENNA ROTATORS FULL RANGE



NRD-545G NEW RECEIVER,
NRD-345,
JST-245 TRANSCIVER



TS-570SG TM-V7A
TH-G71A VCH1

PHONE (02) 9896 2545

E-mail: atrc@bytelink.com.au

Web Page:

<http://users.bytelink.com.au/atrc>

REPEATER LINK

continues

on air net is being trialed. The net takes place on a two-metre repeater and via a gateway onto 80 metres. Whatever is said on two metres is automatically re-transmitted on to 80 metres and vice versa.

Technically the idea has worked well with seamless operation between the two bands. All amateurs can hear all conversations no matter which band they are using. Net control is from 2 metres.

Input from members and non-members is picking up and Council is gaining some of the thoughts of the members in a wider circle than could be gained from the same numbers attending the general meetings.

The question arises as to whether this attended gateway is legal? With considerable interest from some amateurs in VK6 to have the HF gateway concept legalised, the VK6 WIA 2-metre - 80-metre gateway is an interesting experiment that has given a taste of this type of operation.

I must emphasise that although the gateway is automatic; it is attended by an amateur, (myself). However if the concerted effort to see HF gateways legalised is successful, then this type of experimentation could provide us with another type of amateur communication.

For the moment combining 2-metres and 80-metres on the VK6 WIA net is proving most successful, allowing country members in particular to have direct access to the VK6 Council.

One item that has been discussed on the VK6 net, and in other places as well, is the value of *Amateur Radio* magazine.

Opinions seem to be poles apart. Two areas of opinion are, waste of money, nothing in it worth more than a few minutes of reading; through to, without the magazine there would be no WIA. Your elected WIA representatives have to decide what is the best for your organisation, based in part on such diverse opinion. A difficult task to say the least.

One other point that was made on the net was that the WIA should be doing more important things rather than some of the things it is doing now. Criticism that I'm sure could be applied to almost any organisation.

However, the question is, are members prepared to put in more precise detail in what they believe the WIA should be concentrating on, and in particular help with the preparation of the documentation of these items.

If you have an opinion you would like to see promoted, do some of the keyboard work

and present your ideas to the WIA through your local Council. It is easy to say they should be doing this and that, but detailed thoughts are what are required.

More on the VK6 WIA Nets and their success or failure in the future, and in particular the legalisation of HF Gateways. Agenda and postal motions have been prepared and circulated to formalise the WIA position on HF gateways. Their outcome will be reported in a future article.

The VK6 WIA Council will continue to gauge the usefulness of such nets over a period of time. Minutes are taken of the on air nets which are circulated on packet and the VK6 WIA Web page.

Further off the subject

If I may stray further off the subject of voice repeaters for another moment, the Federal WIA is doing more and more of its communications between office bearers such as Federal Councillors and the Federal Executive, using email.

Much had been said about making the move to email but that progress was slow. However as soon as the Federal Office came on line with an email address, Federal WIA matters quickly took advantage of the fast correspondence. All WIA divisions are on email plus all but one Federal Councillor.

The results so far have been exceptional with all matter of Federal WIA matters being discussed between WIA Office holders. The result of this innovative communications is a quicker and easier response to Federal WIA business.

Also well done to many of the Federal and divisional office holders who carry the cost of their email accounts to the benefit of the WIA and Amateur Radio in general.

"It Costs Too Much"

I have thoughts of a brief article in the future to inform amateurs about the cost of being a WIA office-bearer.

It may surprise you just how much it costs individuals to hold WIA positions. It is not always possible to define these costs so they can be covered by WIA funds. Some Amateurs complain about the cost of being a WIA member while others devote their time and money to hold WIA positions.

As a simple example, to send this article for publication before the use of email cost me a dollar. That adds up to \$12 a year. Now it is emailed, the cost has come down to a local phone call times twelve per year.

Petty costs for sure but the comment "it costs too much to be a member of the WIA" needs further thought, as the costs to many Amateurs who hold WIA positions are considerably higher. They do the work and foot the bill as well.

ar

Repeaters:

New

additions?

deletions?

alterations?

contacts?

Have you
advised both
the ACA and
the WIA?

Annual Index for 1998

Bill Roper VK3BR,
Bill Rice VK3ABP
& Bob Harper VK4KNH

A large number of dedicated Amateurs submitted articles in 1998 for the benefit of all WIA members and, no doubt, for others who read AR gratis.

The range of topics shows the many varied interests of radio amateurs.

It is pleasing to see a large number of technical articles, including experimentation and project building.

If your collection is incomplete, you can call the Federal Office for a back issue, if available, or for a photocopy of that missing article. Details on page 1.

Technical or General articles are always welcome and should be addressed to the Editor c/o WIA Federal Office PO Box 2175 Caulfield Junction Victoria 3161.

A writing guide for *Amateur Radio* can be found on page 52 of this edition of *Amateur Radio* or by sending a stamped, self addressed envelope the Federal Office at the address above.

You may also contact AR via the email address armag@hotkey.net.au.

TITLE	AUTHOR	ISSUE	PAGE
Administration			
ACA Releases Draft New Australian RF Spectrum Plan	WIA News	Nov	05
Amateur Radio Operators and the Olympic Games	WIA News	Nov	03
Amateurs Breath Sigh of Relief as WRC-97 Ends	WIA News	Jan	03
ARRL Suggests Restructure of Ham Radio	WIA News	Oct	04
David Wardlaw VK3ADW for Vice President of the IARU	WIA News	Dec	3
Many Changes at Federal AGM	WIA News	May	03
More Threats of Interference to the HF Spectrum	WIA News	Jul	04
New Production House for "Amateur Radio"	WIA News	Dec	3
Outlook for Amateur Radio - Views Sought	WIA News	Mar	03
WIA ACA Liaison Team in Action	WIA News	Aug	04
WIA Responds to ACA on RF Emission Limit Proposals	WIA News	Feb	07
WIA Revives Submission for LF Band Allocation	WIA News	Feb	06
Antennas, Towers, Lines Etc.			
A J-Pole Antenna for Two Metres	Drew Diamond VK3XU	Nov	10
An LF Antenna Bridge	Lloyd Butler VK5BR	Oct	06
Clothesline Antenna	Technical Abstracts	Oct	15
Coaxial Cable Antenna Joint Weatherproofing	Technical Abstracts	Nov	13
Deltaloop Beam	Technical Abstracts	Mar	12
Device to Adjust a Driven Element	Graeme L Wilson	Apr	23
How Low Can You Go?	Random Radiators	Aug	20
Lew McCoy on Antennas (Book Review)	Evan Jarman VK3ANI	Mar	17
More Out of Thin Air (Book Review)	Gil Sones VK3AUI	Mar	19
PVC Extended Double Zepp	Technical Abstracts	Apr	12
Quads and Their Spreaders	Don Jackson VK3DBB	Apr	24
Quarter Wave Line Matching	Technical Abstracts	Sep	18
S92SS Limited Space Antenna for 160 Metres	Technical Abstracts	May	15
Some Practical Tips on Timber Masts	Drew Diamond VK3XU	Dec	26
Stripline Directional Coupler	Technical Abstracts	Sep	15
Tetrahedral Dipole Antenna	Technical Abstracts	Jan	23
The Clemens Match	Phil Zeid VK6PZ	Jan	14
The Versatile End-Fed Wire	Peter Parker VK1PK	Jun	22
Trap Semi-Vertical	Random Radiators	Jul	18
W6SAI HF Antenna Handbook (Book Review)	Evan Jarman VK3ANI	Mar	19
Awards			
"Amateur Radio" Awards for 1997	Bill Rice VK3ABP	Feb	32
ALARA Award	Technical Abstracts	Nov	26
Amateur Radio Best Contribution Awards		Oct	22
Australian DXCC List	John Kelleher VK3DP	May	25
Award Chasing Not for the Fainthearted!	John Sanders VK2DEJ	Mar	21
Council of Europe (Cup and Award)		Oct	40
DXCC Listings		Aug	30
Prize for Young Outstanding WIAQ Member	WIA News	Sep	03
RFDS Award		Jul	24
Tassie Trout Award		Mar	27
The Six-Twenty Eights Award		Apr	35
The WIA Awards Program	John Kelleher VK3DP	Feb	25
VK1 Award		Dec	7
Winner of the WIA Membership Prize		Jun	21

TITLE	AUTHOR	ISSUE	PAGE
Book Reviews			
Amateur Radio Study Course and Study Guide	Ron Cook VK3AFW	Dec	22
Ham Shacks, Brass Pounders & Rag Chewers	Bill Rice VK3ABP	Sep	25
Lew McCoy on Antennas	Evan Jarman VK3ANI	Mar	17
More Out of Thin Air	Gil Sones VK3AUI	Mar	19
Royal Air Force Beam Benders	Gil Sones VK3AUI	Mar	18
RSGB IOTA Directory & Yearbook 1998/99	Ron Fisher VK3OM	Dec	18
The Novice Operators Theory Handbook	Ron Cook VK3AFW	Oct	24
The Novice Operators Theory Study Program	Ron Cook VK3AFW	Oct	25
W6SAI HF Antenna Handbook	Evan Jarman VK3ANI	Mar	19
WIA Call Book 99	Bill Rice VK3ABP	Oct	23
Computers and Programs			
A Simple CW Practice Oscillator	Steve Page VK6BGN	Oct	20
Advanced Data Management Software (review)	Richard Mumane VK2SKY	Jan	21
Computers, Ugh!	Will McGhie VK6UU	Aug	18
Computers, Ugh! (Part 2)	Will McGhie VK6UU	Sep	19
Easy CW	David A. Pilley VK2AYD	Dec	6
Great Circle Distance and Bearings Program	Richard Atkinson	Aug	23
Contests			
Summer VHF-UHF Field Day (Rules)		Dec	32
1998 Commonwealth Contest Rules		Feb	39
1998 John Moyle Contest Rules		Feb	41
1998 Remembrance Day Contest Opening Address	Governor of WA	Sep	21
ALARA Contest (CW/Phone) Rules		Sep	32
ANARTS RTTY Contest Results 1997		Mar	32
ANARTS WW DX RTTY Contest		May	27
Asia-Pacific Sprint		Jan	39
Australasian Sprints Rules		Jun	33
Commonwealth Contest 1998 Results		Oct	35
Commonwealth Contest Results 1997		Mar	31
Jack Files Memorial Contest Results 1997		Apr	37
Jack Files Memorial Contest Rules		Jun	32
John Moyle Field Day Contest 1998 Results		Oct	35
NZART 80 m Memorial Contest Rules		Jun	33
QRP Day Contest 1998		May	27
Remembrance Day Contest Rules 1998		Jul	27
Results 1998 Australasian Sprints		Dec	31
Results 1998 Novice Contest		Dec	31
Ross Hull Memorial Contest Results 1997/98		May	31
Ross Hull VHF-UHF Contest 1998-1999 Rules		Nov	31
Southside Amateur Radio Society Sprints 1998		Jul	26
Spring VHF-UHF Field Day Rules		Oct	36
VHF/UHF Field Day 1998 Results		Jun	34
VK/ZL/Oceania Contest 1997 Results		Sep	31
VK/ZL/Oceania DX Contest Rules 1998		Aug	26
WIA VK Novice Contest Rules 1998		May	30
Digital Communications			
16 Digit DTMF Decoder	Repeater Link	Oct	18
A Shaft Encoder for a Digital VFO	Keith Gooley VK5OQ	May	06
Amateur Radio on the World Wide Web	Peter Parker VK1PK	Feb	27
DTMF Code Options	Repeater Link	Jun	21
DTMF Decoder	Will McGhie VK6UU	May	18
Easy CW	David A. Pilley VK2AYD	Dec	6
Record Contacts on your PC	Peter Wajngarten VK3OU	Dec	30
Remote Mute for a Voice Repeater	Repeater Link	Mar	14
Equipment Reviews			
Advanced Data Management Software	Richard Mumane VK2SKY	Jan	21
Icom IC-706MkII HF + 50 MHz + 144 MHz All Mode	Ron Fisher VK3OM	Oct	09
Icom IC-746 HF + 6 m + 2 m 100 W Transceiver	Ron Fisher VK3OM	Jun	06
Icom IC-T8A Tri-Band Handheld Transceiver	Paul McMahon VK3DIP	Aug	10
Magellan GPS-2000XL Mk 3 Receiver	Richard Mumane VK2SKY	Nov	07
The Magellan GPS Pioneer	Richard P Mumane VK2SKY	Jul	12
Yaesu FT-8100R (2 m, 70 cm transceiver)	Paul McMahon VK3DIP	Feb	22
Yaesu FT-847 12 Band All Mode Transceiver	Ron Fisher VK3OM	Sep	06
Yaesu VX-1R Miniature Handheld Transceiver	Paul McMahon VK3DIP	Jun	11

TITLE	AUTHOR	ISSUE	PAGE
History			
"Winnie the War Winner"	Reprinted from SIGNALS	Jul	20
50 Years of Mobile Radio Operation	Les Brennan VK4XJ	May	11
50 Years of the Geelong Amateur Radio Club	Dick Highway VK3ABK	Nov	23
A Man of Vision	Dave Hanscomb	Jan	34
A Short History of Electronic Communication	Rex Newsome VK4LR	Apr	19
Big Brother is Watching You - Thank Goodness!	Sam Wright VK6YN	Apr	24
Ham Shacks, Brass Pounders & Rag Chewers (Review)	Bill Rice VK3ABP	Sep	25
Harry Angel VK4HA Silent Key	Al Shawsmith VK4SS	Nov	21
Ron Morris VK3APM (SK)	John L Morris VK2BES	Oct	21
Ross A Hull - VHF Pioneer	John Martin VK3KWA	Jan	26
Royal Air Force Beam Benders (Book Review)	Gil Sones VK3AUI	Mar	18
Samuel Morse	How's DX?	Feb	35
The Father of Youth Radio - Rex Black VK2YA (1912-1997)	Sid Ward VK2SW	Apr	25
Those Were the Days!	John Scougall VK5YY	May	10
Miscellaneous Technical			
A Geomagnetic Storm Detector	John Moen VK2KA	Mar	09
A Simple Sheet-Metal Bender	Drew Diamond VK3XU	Sep	11
A Two-Way Morse Practice Set	Peter Parker VK1PK	Apr	15
Broadcast Station Wave Trap	Technical Abstracts	Jul	16
DTMF Tone frequencies	Technical Abstracts	Aug	17
Low Voltage Alarm	Technical Abstracts	Jun	20
Making Boxes with Ordinary Tools	Drew Diamond VK3XU	May	20
On the Secondary Side	Lloyd Butler VK5BR	Jan	25
One Transistor Frequency Synthesiser	Peter Parker VK1PK	Aug	08
Passive Narrow Band AF LC Filter	Technical Abstracts	Jul	15
PTT Repeater Box	Technical Abstracts	Dec	18
Reverse-a-Probe	Technical Abstracts	Jun	20
RF Speech Clipper	Technical Abstracts	Dec	15
Series Diode Strings	Technical Abstracts	Jan	24
Ten Metres for the Newcomer	Peter Parker VK1PK	Oct	12
The Cube Tamer	Technical Abstracts	Dec	15
The Super VXO Heads South	Peter Parker VK1PK	Apr	31
Three-Chip Electronic Morse Keyer	Drew Diamond VK3XU	Jan	10
Video Low Pass Filter	Technical Abstracts	Aug	16
Yoghurt Container Sound Projector	Peter Parker VK1PK	Oct	22
Operating			
50 Years of Mobile Radio Operation	Les Brennan VK4XJ	May	11
A Letter to Your XYL	Christine Taylor	Nov	18
A Review of VK5MIR Operations	Ian J Hunt VK5QX	Sep	22
A Three Way QSO with Andy Thomas VK5MIR	Ian Hunt VK5QX	Jun	26
Amateur Radio on Public Transport	Peter Parker VK3YE	Dec	19
An Introduction to Fox Hunting	Peter Parker VK1PK	Aug	13
Award Chasing Not for the Fainthearted!	John Sanders VK2DEJ	Mar	21
MIREX Comes to Gormandale	Chris Morley VK3KME	Jul	07
QSLing! Direct, via the Bureau, or What?	Neil Penfold VK6NE	Nov	22
Russian/CIS Prefixes Are Not That Simple	Ken Matchett VK3TL	Jul	22
The 41st Jamboree on the Air (JOTA)	Harvey Lennon	Oct	30
The Radio Came Back!	Dominic Bragge VK2YAK	May	22
Vampire - VK2CCV	Casey Schreuder	Apr	18
What a Weekend!	Christine Taylor VK5CTY	Oct	26
Work-em First, Worry Later	Hank Pruncken VK5JAZ	Dec	21
People			
A Man of Vision	Dave Hanscomb VK6ATE	Jan	34
Harry Angel VK4HA Silent Key	Al Shawsmith VK4SS	Nov	21
HE Major General Michael Jeffery AC MC Governor of WA		Sep	21
Peter Naish WIA Federal President Revealed	David Thompson VK2NH	Aug	03
Pierce Healy VK2APQ	Neil Penfold VK6NE	Mar	
Ron Morris VK3APM (SK)	John L Morris VK2BES	Oct	21
Ross A Hull : VHF Pioneer	John Martin VK3KWA	Jan	26
The Father of Youth Radio - Rex Black VK2YA (1912-1997)	Sid Ward K2SW	Apr	25

TITLE	AUTHOR	ISSUE	PAGE
Places			
Chatham Island - ZL7IR	How's DX?	Jun	35
Czechoslovakia	QSLs from the WIA Collection	May	23
North Korea - P5	How's DX	Sep	35
Rottneest Island - VK6ISL	How's DX?	Jan	43
Rowley Shoals VK9	How's DX?	Nov	32
Propagation			
A Geomagnetic Storm Detector	John Moen VK2KA	Mar	09
Ionospheric Update	Evan Jarman VK3ANI	May	51
Ionospheric Update	Evan Jarman VK3ANI	Nov	51
Ionospheric Update	Evan Jarman VK3ANI	Aug	51
Ionospheric Update	Evan Jarman VK3ANI	Feb	51
Receivers			
A Junk Box Regenerative Receiver	Peter Parker VK1PK	Jun	15
A Six to Two Receiving Converter	Peter Parker VK1PK	Apr	08
An SSB Product Detector for "Boat Anchor" Receivers	Morris Odell VK3DOC	Mar	07
Magellan GPS-2000XL Mk 3 Receiver	Richard Murnane VK2SKY	Nov	07
Simple VHF Receiver	Technical Abstracts	Jun	18
Repeaters and Beacons			
16 Digit DTMF Decoder	Repeater Link	Oct	18
40 m SSB Gateway	Repeater Link	Apr	11
Misbehaving EPIRB	Ron Graham VK4BRG	Mar	16
Remote Mute for a Voice Repeater	Repeater Link	Mar	14
The Gateway	Repeater Link	Jul	39
VHF/UHF Signal Generator	Repeater Link	Jan	17
Test Equipment			
A Dip Oscillator, Crystal Checker and Signal Source	Drew Diamond VK3XU	Apr	04
A Sensitive Field Strength Indicator	Drew Diamond VK3XU	Aug	06
A Sensitive HF Indicating Wavemeter	Drew Diamond VK3XU	Dec	11
An LF Antenna Bridge	Lloyd Butler VK5BR	Oct	06
Audio Oscillator and Function Generator	Paul Clutter VK2SPC	May	08
Build a Cheap RF Capacitance Bridge	Ron Sanders VK2WB	Apr	26
Combined 2 m and 70 cm Signal Source	Technical Abstracts	Nov	13
Power Attenuator	Technical Abstracts	Jul	15
Simple Output Indicator	Technical Abstracts	Sep	16
Simple Transmission Monitor and Interference Sniffer	Drew Diamond VK3XU	Feb	19
Time Domain Reflectometer	Technical Abstracts	Jun	19
VHF-UHF Tuneable Signal Generator Using a 72-74 MHz VFO	Will McGhie VK6UU	Apr	10
VHF/UHF Signal Generator	Repeater Link	Jan	17
Transceivers			
ALIVO Fun Transceiver	Technical Abstracts	Aug	16
FM828 on 29 MHz	Will McGhie VK6UU	Feb	47
Icom IC-706MKII HF + 50 MHz + 144 MHz All Mode	Ron Fisher VK3OM	Oct	09
Icom IC-746 HF + 6 m + 2 m 100 W Transceiver (Review)	Ron Fisher VK3OM	Jun	06
Icom IC-T8A Tri-Band Handheld Transceiver (Review)	Paul McMahon VK3DIP	Aug	10
Sidetone for the "TCF" Transceiver	Bob Kemp VK3CAY	Mar	06
Yaesu FT-847 12 Band All mode transceiver (Review)	Ron Fisher VK3OM	Sep	06
Yaesu VX-1R Miniature Handheld Transceiver (Review)	Paul McMahon VK3DIP	Jun	11
Transmitters			
Fonelist' SSB/CW Transmitter for 80 Metres	Drew Diamond VK3XU	Nov	10
Further Thoughts on the Garran	Peter Parker VK1PK	Mar	20
SSB by the Fourth Method?	Phil Rice VK3BHR	Feb	15
The DSB40 - A 40 Metre DSB Transceiver	Peter Parker VK1PK	Jul	09

The complete index from 1989 to December 1998 is available on disk, in text and ".dbf" format from the Federal Office for \$10

ar

CONTESTS

Ian Godsill VK3DID

Federal Contests Coordinator

25 Monaco Street, Mentone Vic. 3194 vk3did@eudoramail.com

Greetings to all Contestants! My wife and I are in the throes of moving, so as we wish you all a very happy New Year and good contesting, ours will certainly be a busy one.

Contest Calendar 1999

January

2/3 ARRL RTTY Roundup

8-10 Japan International DX CW
(Low Band) (Dec 98)

9/10 Summer VHF/UHF Field Day Contest
(Dec 98)

16/17 HA DX CW Contest

22-24 CQ WW 160 m DX Contest (Dec 98)

30/31 REF (France) CW DX Contest (Dec 98)

30/31 UBA (Belgium) SSB DX Contest

February

13 Asia - Pacific CW Sprint (Jan 99)

13/14 PACC DX Contest (CW/Phone) (Jan 99)

19-21 CQ 160 Metres SSB Contest (Dec 98)

20/21 ARRL DX CW Contest (Jan 99)

27/28 RSGB 7 MHz CW Contest (Jan 99)

27/28 Jock White Memorial Field Day
(CW/Phone) (Jan 99)

27/28 UBA (Belgium) CW DX Contest

27/28 REF (France) SSB DX Contest (Dec 98)

28 High Speed Club CW Contest (Jan 99)

March

6/7 ARRL DX SSB Contest (Jan 99)

13/14 Commonwealth Contest (CW) (Feb 99)

20/21 WIA John Moyle Field Day

20/21 DARC HF SSTV Contest

20/21 Bermuda Contest

20/21 Russian DX Contest (CW/Phone)

27/28 CQ WPX SSB Contest

Thanks this month to :

VK4EMM, VK3APN, OH2KI & JE1CKA

PLEASE NOTE: The Ross Hull Contest will finish on the **11th January 1999.**

Matters Requiring Attention

I must claim space this month to raise some issues, which need discussion.

1. There is a growing trend towards electronic log submission. This is now quite widespread in Europe and America and there are logging programs that do quite a lot of the work for the contester — CT and TR are names that come to mind.

We may not all have these programs, nevertheless many of us use a computer to type our log sheets. Rather than printing and posting, why not save to disk and post, or e-mail?

ASCII seems to be the preferred format and as far as I know, modern computers still can save in text format. Binary files are definitely taboo. Please consider this in 1999 and where possible make use of this form of log submission. To assist this, I would ask all contest managers to be prepared to accept logs on disk and via e-mail.

2. Of great concern worldwide lately is the definition of "Single Operator". Traditionally this is someone who does all the work himself. More recently the use of Packet nets and the Internet have produced a system whereby those connected to these nets can be made aware of potential new contacts. This is called "spotting". If you have ever had a sudden pile-up and just as suddenly it disappears, then you have probably been spotted by someone else.

All this is certainly making good use of modern technology. The problem arises in that this method can be seen as the operator having assistance, therefore (a) he is no longer a single but multi-operator and (b) he may be in breach of working within "the spirit of the contest".

Some managers have created a Single Operator Assisted category, so the traditional Single Operator can still have his time-honoured methods and the modern techno-contester can use his aids. The debate is around (a) are these aids giving that operator an advantage that normal SOs do not have, and (b) is he still a single or multi-operator?

I would certainly appreciate your comments, even though the worldwide community of testers very much

favours the traditional system. Please send any thoughts to me at the WIA Federal Office above, or via e-mail. If sufficient replies are received, I shall publish a digest in March or April.

3. Of similar vein is the issue being canvassed in Europe, viz. the use of CW-to-ASCII Converters. Again the feeling is that the narrow filters can put up signals that may otherwise be difficult or impossible to hear, therefore the operator is receiving assistance and an advantage. The feeling in Region 1 is that these devices are to be outlawed entirely. Again, any comments welcome.

4. There are several well-established VK/ZL contests each year and again I ask for your support of these. The RD is the most readily recognisable, but there are others — field days, Ross Hull VHF, Novice, 160 Metres, VK/ZL/Oceania, all under very capable managers who devote many hours to checking logs, compiling results and organising certificates.

Please aim to support these events. It is a cliché to say, "they are fun", but it is true. Your abilities get tested, your equipment gets a workout in a way that it usually doesn't and I can assure you that the DX stations are delighted to hear VKs and ZLs. Great is the lamenting in the Northern Hemisphere that VKs are "notoriously silent on CW".

Like Amateur Radio in general, no one knows the future of contests: so please, whilst there is time, support your national contests and be an ambassador for our country. (Many of you reading this are testers, so please get your friends involved.)

5. There is an agreement that use of the 80 metres DX Window for contest purposes is not acceptable. I ask all testers in VK to abide by this.

Result SARTG WW RTTY Contest 1998

(Posn\call\cat\score)

92 VK6GOM SOAIBand 259675

Asia - Pacific Sprint

CW: 1230z - 1430z Sat. 13 Feb.

SSB: 1230z - 1430z Sat. 12 Jun.

CW: 1230z - 1430z Sat. 16 Oct.

Object is for stations in the Asia-Pacific region to work as many stations worldwide as possible within two hours.

Bands are 40/20 m only. Suggested frequencies are (CW) 7015-7040 and 14030-14050 and (SSB) 7060-7080 and 14250-14280 kHz.

Category is single operator single tx only.

Output power is limited to 150 w.

Exchange RS(T) serial number and count one point per valid QSO. The called station (usually the CQer) must QSY at least 1 kHz after a CW QSO, or 6 kHz after an SSB QSO. The multiplier is the total number of prefixes, per WPX rules (ie each prefix once only, not once per band).

Final score equals valid QSOs X multiplier.

Post logs to: James Brookes, 26 Jalan Asas, Singapore 678787, postmarked within seven days, or e-mail an ASCII version to jamesb@pacific.net.sg within 72 hours.

Rules and results will be distributed by automated info-server. Send e-mail to: info-contest@ne.nal.go.jp containing #get ap-sprint.rule

ARRL DX Contest

CW: 0000z Sat 2400z Sun 20/21 February.

SSB: 0000z Sat - 2400z Sun 6/7 March

Object is to work as many W/VE amateurs as possible.

Bands 160 - 10 m (no WARC).

Single operator categories are: single band; all band; all band QRP (max 5w o/p), all band low power (max 150 w o/p) and all band unrestricted. Single band entrants who make contacts on other bands should submit logs for checking purposes; spotting nets not permitted. Single Operator Assisted where spotting nets are permitted.

Multi-operator categories are: single tx, two tx and unlimited. In the single and two tx categories, once a transmitter has begun operation on a band, it must remain on that band for at least 10 minutes. Listening time counts as operating time. See QST or <http://www.arrl.org> for more comprehensive rules governing multi-operator entries.

Exchange RS(T) and a three-digit number indicating approximate output power. W/VE stations will send RS(T) and state/province.

Score three points per W/VE QSO.

The **multiplier** is the sum of US states and District of Columbia (DC) (except KH6/KL7), NB (VE1), NS (VE1), PEI (VE1 or VY2), PQ (VE2), ON (VE3), MB (VE4), SK (VE5), AB (VE6), BC (VE7), NWT (VE8), YUK (VY1), NF (VO1) and LAB (VO2) worked to a maximum of 62 per band.

Final score equals total QSO points X multiplier. Entries with more than 500 QSOs must include a crosscheck (dupe) sheet.

Entries must be **postmarked** within 30 days after the last contest, or they will be classed as check logs (no exceptions!).

Mark the envelope CW or Phone and send to ARRL Contest Branch, 225 Main Street, Newington, CT 06111, USA.

ASCII logs on disc are welcome in lieu of a paper log. An official **summary sheet** (or reasonable facsimile) with a signed declaration, is required with all entries. Alternatively, logs can be forwarded via

Internet to <contest@arrl.org> or anonymous ftp to <ftp@arrl.org>. Include your summary sheet file, making sure it contains all pertinent information. Multi-operator entries must list all operators.

Certificates will be awarded to the top scoring stations in each country and category, and plaques to the top worldwide and continental stations.

PACC CW/SSB DX Contest

1200z Sat - 1200z Sun, 13/14 February

Object of this contest is to work as many Dutch stations as possible on 160 - 10 m (no WARC) and no SSB QSOs on 160 m.

Categories are single operator, multi-operator and SWL. Stations may be worked only once per band, regardless of mode, except on 160 m where CW contacts only are eligible.

Exchange RS(T) plus serial number. Dutch stations will send RS(T) plus two-letter province code (DR FL FR GD GR LB NB NH OV UT ZH ZL)

Score one point per Dutch QSO. Contacts must be confirmed with TU, OK or QSL.

Final score equals total QSO points X total Dutch provinces worked from each band (max 72).

Mail logs with summary sheet and declaration by 31 March to: Hans Timmerman PA3EBT, Nieuweweg 21, 4031 MN Ingen, Netherlands.

E-mail logs to <pa3ebt@wxs.nl> Certificates will be awarded to the top-scoring stations in each category and country, with second and third places where justified.

RSGB 7 MHz CW Contest

1500z Sat to 0900z Sun, 27/28 Feb.

Object of this contest is to contact as many British Isles stations as possible on band 40 m CW only. Categories: Single operator; multi-operator single tx; SWL.

Exchange RST plus serial number starting at 001; UK stations will add their county code.

Oceania stations **score** 30 points per QSO and **final score** is total QSO points times the number of UK counties worked.

Include a **summary sheet** showing all standard details, plus a checklist if more than 80 QSOs are made.

Send logs to arrive by 31 March to: RSGB HF Contests Committee, c/o S V Knowles G3UFY, 77 Bensham Manor Road, Thornton Heath, Surrey, CR7 7AF, England. Airmail is recommended, as late logs may be treated as check logs.

Join 18 million Eudora users by signing up for a free

Eudora Web-Mail account at

<http://www.eudoramail.com>

Certificates will be awarded to the leading entrant in each overseas section.

High Speed Club CW Contest

0900 - 1100z and 1500z - 700z

Sunday, 28 February

Sunday, 7 November

Held twice yearly, these contests are organised by the High Speed CW Club.

Bands are 80 - 10 m (no WARC). **Categories** are HSC members; non-members; QRP 5w; and SWL.

Exchange RST + HSC number or serial number.

Score one point per QSO with own continent and three points for DX. Stations may be worked once per band and period. Each DXCC country per band counts as a multiplier. **Final score** equals points X multiplier.

Send logs within six weeks to: Frank Steinke DL8WAA, PO Box 1188, D-56238 Selters, Germany.

Jock White National Field Day

(NZART) (CW/Phone)

0200 -1100z and 1700 -0000z Sat 27 February & 0000 -0200z Sun 28 February

This contest is open to portable ZL stations and also to overseas stations. VKs work ZL field day stations only.

Bands 80 and 40 m.

Sections include: CW; Phone; mixed mode; 80 m only; "natural" power; QRP max 5 w o/p. Cross-mode contacts are not permitted.

Exchange RS(T) plus serial number. ZLs will add their branch number. This contest is divided into 18 one-hour periods, changing over on the hour. Stations can be contacted once per hourly period, per mode, per band. Note that two consecutive QSOs with the same station are not permitted under the following circumstances, unless five minutes have elapsed: (a) when changing modes but staying on same band; (b) at the end of one period and the start of the next.

Score five points per CW QSO and three points per Phone QSO.

Multiply by the total number of branches worked on Phone and CW. Multipliers are counted separately on 80 m and 40 m, and on Phone and CW, ie the same multiplier can be counted up to four times. The **summary sheet** should show all usual details, plus a summary of the QSOs and multipliers per band and mode.

Send logs to: S. White ZL2ST, 19 Rosspoint Street, Johnsonville, Wellington, New Zealand to arrive by 25 March 1999.

Thanks and 73 de Ian VK3DID

ar

AWARDS

John Kelleher VK3DP

Federal Awards Officer

4 Brook Crescent, Box Hill South, Vic 3128 (03) 9889 8393

Another year has passed, with little pleasure for the avid DXer. Sad, isn't it. So the powers to be invented places like Scarborough Reef, Pratas Island, Temotu Province, The Marquesas and Austral Islands.

Southern Sudan was deleted, and Czechoslovakia decided to split in two.

The final outcome of it all is that the total countries has been increased to 331.

I find that I still have only one VK1 in my active files. Why is this so ?

CZECH REPUBLIC

General requirements. Fee for all awards is 10 IRC or US\$5.00. Endorsement fee is 2 IRC or US\$1.00 and indicate number and issue date of basic award. Send cards unless GCR from national level Society has confirmed possession. List for P75P must contain locations of listed stations.

Apply to : Czech Radio Club, Awards Manager, PO Box 69, 113 27 Praha 1, Czech Republic.

S-S

Work and confirm contacts with at least one station located in each of the six continents since January 1st, 1950. All CW, all Phone, all RTTY, and all SSTV. Endorsement stickers for basic certificate are available for 80, 40, 20, 15 and 10 Metres.

P-75-P Worked 75 Zones.

Work and confirm contacts with at least one station located in 50 different ITU Zones since 1st January 1960. Endorsement for 60 or 70 zones. SWL OK.

100-CS Worked 100 Czech Stations.

Work and confirm contacts with at least 100 different OK/OL stations since 1st January, 1993.

Issued for mixed mode, all CW, all Phone, all 160 Metres, all VHF or SWL. Endorsement available for each additional 100 up to 500.

OKDX AWARD

Contact at least 40 different Czech counties during the annual OK/OM DX Contest held every year, during the second week in November.

OMDX AWARD

Contact at least 15 different Slovak counties during the contest as above.

Logs for the last two awards go to the Contest Sponsor, Karel Karmasin, OK2FD Gen Svobody 636, 674 01 Trebic, Czech Republic.

RSGB Series

(In this case, the IARU Region 1 Award).

Contact the required number of stations in countries whose National Societies are members of the Region 1 Division of the IARU. This award may be endorsed for a single mode or band, including 2 or 6 Metres, or for contacts made by satellite. The three classes are :

- Class 1 All countries on the current list.
- Class 2 60 member countries.
- Class 3 40 member countries.

MEMBERS OF IARU REGION 1 ARE :

3A Monaco	EZ Turkmenistan	T9 Bosnia and Herzegovina
3B Maurilius	F France (Including TK)	TA Turkey
3DA Swaziland	G UK (Including GI, GJ, GM, GU & GW)	TF Iceland
4X/Z Israel	HA Hungary	TR Gabon
5B Cyprus	HB9 Switzerland	TU Ivory Coast
5H Tanzania	HB0 Liechtenstein	TZ Mali
5N Nigeria	I Italy (Including IS0)	UR Ukraine
5X Uganda	J2 Djibouti	V5 Namibia
5Z Kenya	JT Mongolia	XT Birkina Fasso
6W Senegal	JY Jordan	YI Iraq
7P Lesotho	LA Norway	YK Syria
7X Algeria	LX Luxembourg	YL Latvia
9A Croatia	LY Lithuania	YO Romania
9G Ghana	LZ Bulgaria	YU Yugoslavia
9H Malta	OD Lebanon	Z2 Zimbabwe
9J Zambia	OE Austria	Z3 Macedonia
9L Sierra Leone	OH Finland (Including OH0 and OJ0)	ZA Albania
A2 Botswana	OK Czech Republic	ZB2 Gibraltar
A4 Oman	OM Slovakia	ZS South Africa.
A7 Qatar	ON Belgium	
A9 Bahrain	OY Faroe Islands	
C3 Andorra	OZ Denmark	
C5 The Gambia	PA Netherlands	
CN Morocco	R Russian Federation	
CT Portugal (including CU and CT3)	S5 Slovenia	
DL Germany	SM Sweden	
EA Spain	SP Poland	
EI Ireland	SU Egypt	
EL Liberia	SV Greece	
ES Estonia	T7 San Marino	
EU/EW Belarus		
EY Tadjikistan		

Fees for this award for non-RSGB members are 9 IRC or US\$6.00.

Apply to :

The Awards Manager,
Fred Hanscombe
Sandholm,
Bridge End Road,
Red Lodge,
Bury St. Edmonds,
Suffolk,
England TP28 8LQ

HF PREDICTIONS

by **Evan Jarman VK3ANI**
34 Alandale Court, Blackburn Vic 3130

Adelaide-Capetown 226
Second 4F5-14 4E0 Short 10155 km

Brisbane-Lima 122
First F 0-5 Short 13056 km

January
1999
T index: 106

These graphs show the predicted diurnal variation of key frequencies for the nominated circuits.

These frequencies as identified in the legend are:-

- Upper Decile (F-layer)
- F-layer Maximum Useable Frequency
- E-layer Maximum Useable Frequency
- Optimum Working Frequency (F-layer)
- Absorption Limiting Frequency (D region)

Shown hourly are the highest frequency amateur bands in ranges between these key frequencies; when useable. The path, propagation mode and Australian terminal bearing are also given for each circuit.

These predictions were made with the Ionospheric Prediction Service program: ASAPS version 4.

Legend

Frequency scale

UD
F-MUF
E-MUF
OWF
ALE
10%-50%
50%-90%
90%-100%

Time scale

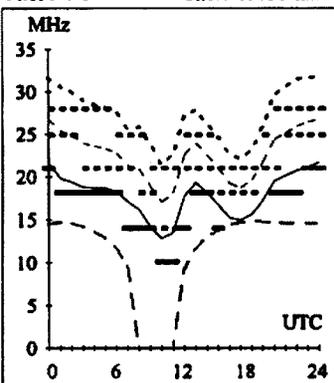
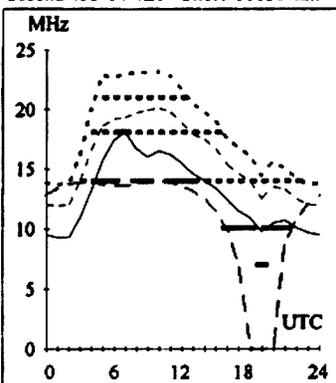

Adelaide-Manila 338
Second 3F10-20 3E1 Short 5813 km

Brisbane-Los Angeles 59
Second 4F3-8 4E0 Short 11564 km

Canberra-Auckland 102
Second 2F21-31 2E6 Short 2300 km

Darwin-Honolulu 65
First 3F3-10 3E0 Short 8635 km

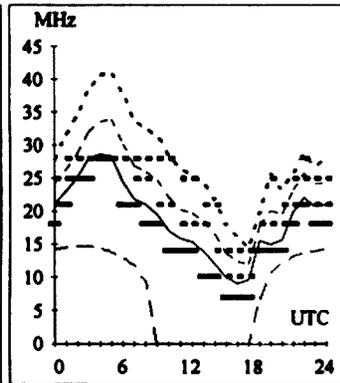
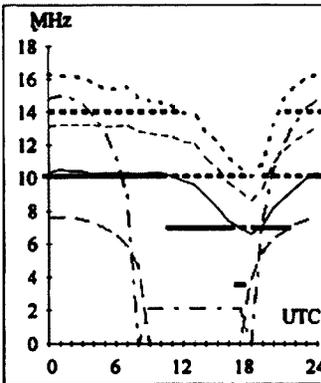
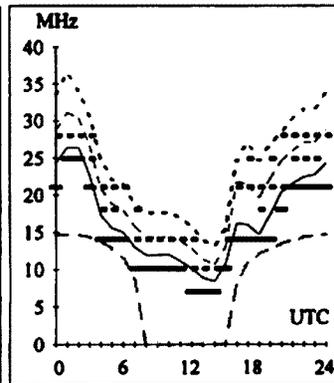
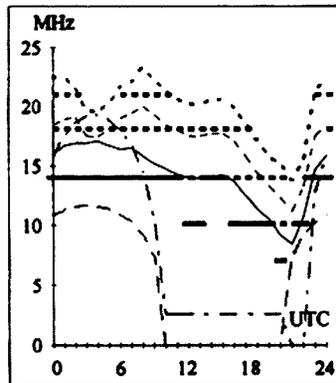

Adelaide-Miami 95
First F 0-5 Short 16175 km

Brisbane-Port Moresby 342
Second 2F23-25 2E7 Short 2090 km

Canberra-New York 68
First F 0-5 Short 16217 km

Darwin-London 145
First F 0-5 Long 26171 km

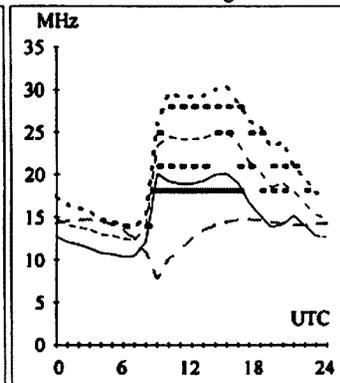
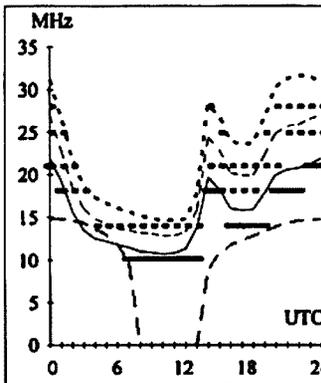
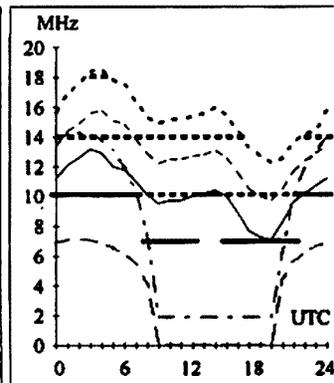
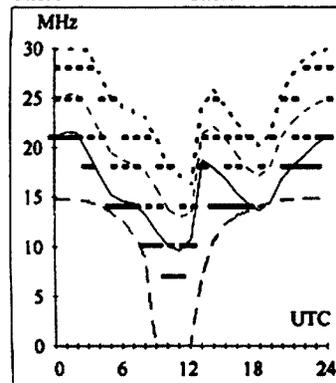

Adelaide-Tel Aviv 291
First F 0-5 Short 13125 km

Brisbane-Pretoria 230
Second 4F3-10 4E0 Short 11655 km

Canberra-Singapore 301
Second 3F9-17 3E0 Short 6212 km

Darwin-London 325
First F 0-5 Short 13853 km

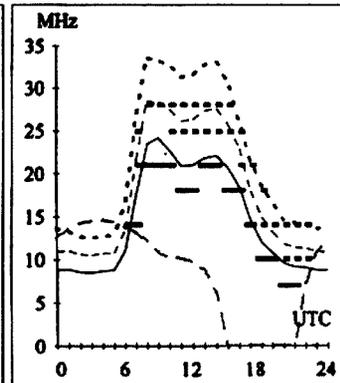
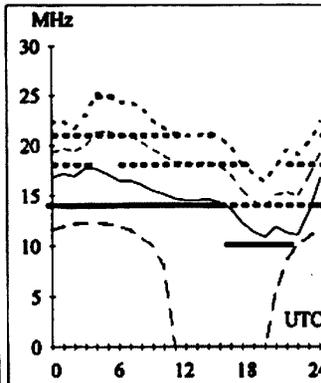
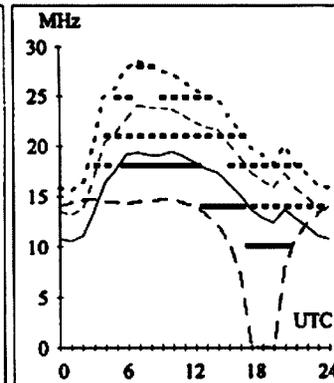
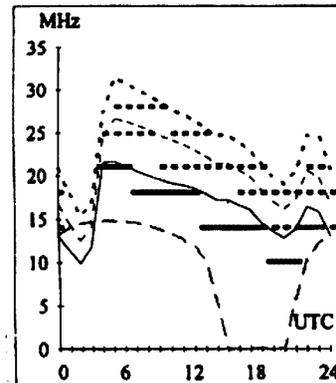

HF PREDICTIONS

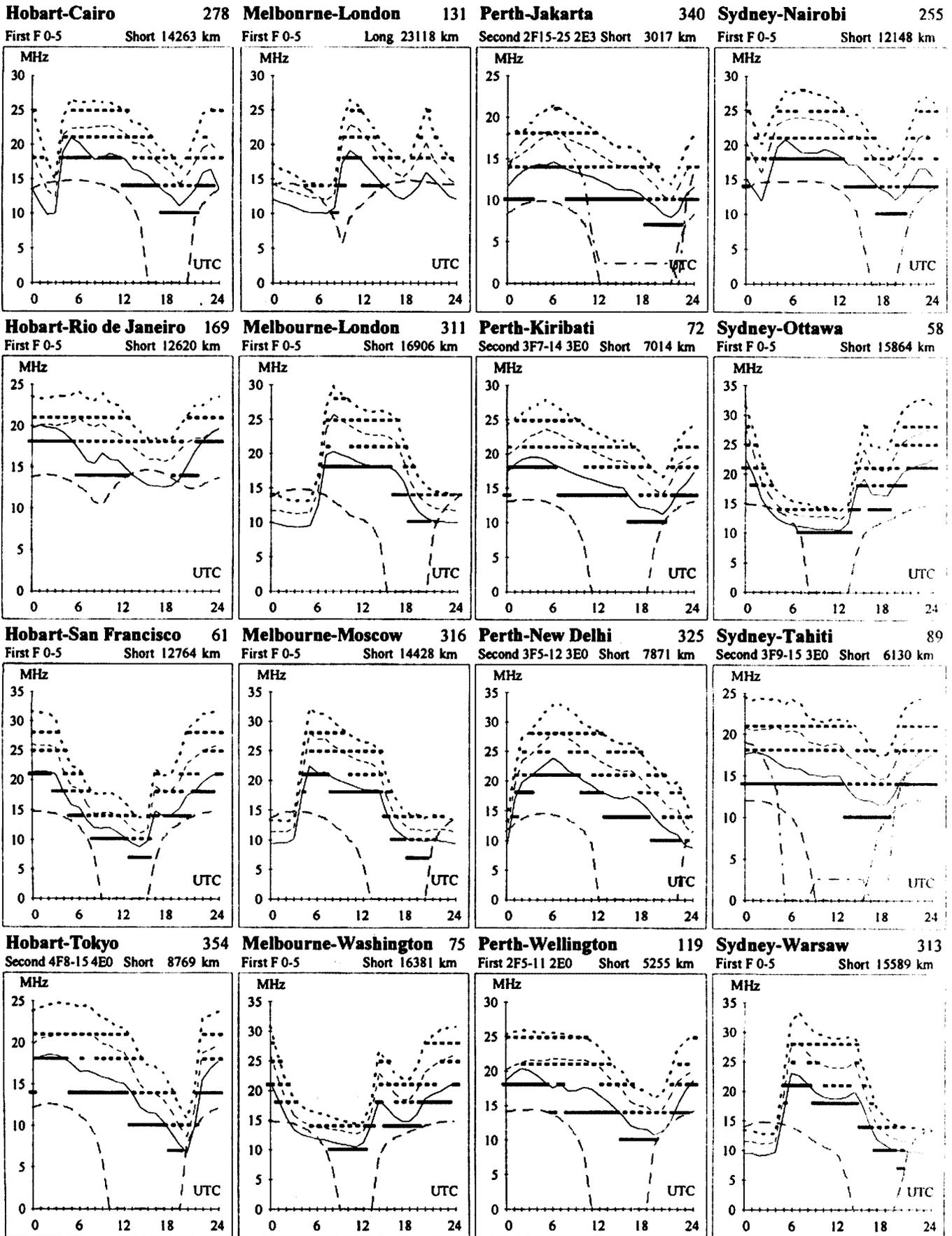

AWARDS

continued

OVER TO YOU

Like a duct over water

As a non-amateur reader of your magazine I noted with interest the report from VK2EI Neil Sandford in November's issue.

I once worked with Neil in Geraldton and would like to say hello. More to the point, I note Neil's work at 10 and 24 GHz. I am currently undertaking a PhD in Engineering at the University of Canberra and the topic of my research is the characterisation of microwave propagation in the evaporation duct over warm tropical oceans.

While that sounds like a mouthful it isn't really.

As most readers will know, atmospheric ducts or layers can trap the RF energy often leading to anomalous propagation, DXing. In the maritime environment these ducts or elevated layers can also cause radar blind spots.

There are recorded instances where another ship was visible to the eye, but

invisible to radar. This is not a welcome event in a crowded, foggy shipping lane or in instances where the unseen object is an anti-ship missile.

I would be very interested to hear from WIA members who are experienced in RF ducting at 10 GHz, over land or sea.

I am particularly looking for records of anomalous propagation in ducts or layers, received signal strengths and any atmospheric readings or observations taken at the time. As the research progresses I would also be happy to share it with WIA members.

If anyone is interested I could write a short article on the planned experimental set-ups to be used at Lucinda in north Queensland and in Darwin.

Andrew Kerans

PO Box 3060

Belconnen ACT 2617

ar

All letters from members will be considered for publication, but should be less than 300 words. The WIA accepts no responsibility for opinions expressed by correspondents

Silent Key

Frank Hill VK2HQ

It is with regret that we announce the death of Frank Talbot Hill, VK2HQ.

Frank became a silent key on Saturday 28th November in Milton Hospital.

Frank was born in Adelaide on January 15 1912. He was educated at Scotch College Adelaide and, on leaving school, studied radio engineering and joined broadcasting station 5AD as an engineer.

He became a licensed amateur in about 1927 and at the outbreak of WWII was called into the RAAF as a radio operator. He rose to the rank of FltLieutenant and saw service in Australia and New Guinea. Whilst in the service he met and married his wife Jean who was a

telegraphist stationed at Brisbane WT Station.

After the war, Frank held a senior position with Hallstroms Pty Ltd, the refrigerator firm, and remained with them until his retirement when he moved to Milton on the south coast of NSW.

He was always very active in Amateur Radio and a great ambassador, encouraging young (and older) people to join our ranks.

He was a foundation member of the Mid South Coast Amateur Radio Club and has been patron of that club for many years. Until his death he played an active role in this club and will be sadly missed.

David VK2CX

ar

Due to space demands, obituaries should be no longer than 200 words

GERMANY

The Eternal Cities Award.

This diploma may be earned by amateurs and SWL's for contacting Cities which were established before the time of Christ.

The requirements are 50 points for Europe and Asia, all others 25.

A city founded 200 years, or two centuries BC = 2 points : 300 years = 3 points etc. All bands and modes. No date limitations. GCR list and fee of DM12 to :

Victor Ganin UU5JFY,
c/o Hermann Warnecke,
Feuerwehrstr. 11, D-28857
Syke-Ristedt, Germany.

The most ancient cities of the world and their award values :

City		Value
Athens	SV	15
Bologna	I	6
Koln	DL	1
Feodosia	UR	6
Jerusalem	4X	2
Lyon	F	1
Malaga	EA	11
Paris	F	1
Rome	I	8
Tunis	3V	10
Eriwan	EK	8
Ankara	TA	7
Barcelona	EA	3
Damascus	YK	11
Geneva	HB	1
Kerch	UR	6
Marseille	F	6
Nicosia	5B	7
Peking	BY	15
Samarkand	UM	4
Tashkent	UM	1
Zaragoza	EA	27
Beirut	OD	17
Belgrade	YU	5
Delhi	VU	10
Istanbul	TA	7
Lisbon	CT	2
Milan	I	5
Piraeus	SV	15
Plovdiv	LZ	4
Sparta	SV	7
Valencia	EA	2

Best Regards

es 73, de VK3DP

ar

HAMADS

- Hamads may be submitted on the form on the reverse side of the Amateur Radio address flysheet. Please use your latest flysheet where possible.
- Please submit separate forms for For Sale and Wanted items, and be sure to include your name, address and telephone number (including STD code) if you do not use the form on the back of the Amateur Radio address flysheet.
- Eight lines (forty words) per issue free to all WIA members, ninth and tenth lines for name and address. Commercial rates apply for non-members.
- Deceased estates Hamads will be published in full, even if the ad is not fully radio equipment.
- WIA policy recommends that the serial number of all equipment offered for sale should be included in the Hamad.
- QTHR means the address is correct in the current WIA Call Book.
- Ordinary Hamads from members who are deemed to be in general electronics retail and wholesale distributive trades should be certified as referring only to private articles not being re-sold for merchandising purposes.
- Commercial advertising (Trade Hamads) are pre-payable at \$25.00 for four lines (twenty words), plus \$2.25 per line (or part thereof), with a minimum charge of \$25.00. Cheques are to be made out to: WIA Hamads.
- Copy should be typed or in block letters, and be received by the deadlines shown on page 1 of each issue of Amateur Radio, at:

Postal: Newsletters Unlimited, 29 Tanner Street, Richmond, 3121

Fax: 03 9428 4242

E-mail: news1@webtime.com.au

FOR SALE NSW

- YAESU FT-890 All mode HF Transceiver 100W 160-10m Allband Rx Brand new condition Never used on Tx demo only on Rx \$1500 No offers. YAESU FT-26 2m handheld txcvr dricell battery pack spk/mic dc power lead VGC \$220 Chris VK2YMW QTHR 02 9487 2764
- Transmitting Valves 3-500 \$200, Q-04 (equiv to 4-400) \$60. Tom, VK2OE (02) 9482 1565 evenings

WANTED NSW

- Drake L7 amplifier, GAP Voyager antenna, HF-6 antenna. Tom, VK2OE 02 9482 1565 evenings
- Old unloved receivers for restoration. I don't mind if they are working or not working parts circuits, love the old valve sets. Used for listening. Heavy old sets very welcome. Will pay \$\$ if necessary. So clean up the shack and I will help you have more room. Come on and give me a hernia! contact John 02 9533 6261 WIAL 21068

FOR SALE SA

- HP7475A Plotter exc condn. A3 size. 6 pen carousel. With serial cable, orig manual and approx 30 spare pens. \$150 ONO. Phone John 08 8226 8084 (W) or 08 8278 1296 (H) S/N 2807V-86242
- Power supply PS 430 Kenwood \$120 Antenna tuning unit AT230 Kenwood \$110 Both units in top condition QTHR 08 9446 1568

WANTED SA

- Multi 800D 2mtr FM transv in any condition, (but not squashed. Hi) Made by Fukuyama (FDK) Circa 1978 08 8346 7042 VK5MX QTHR Callbook

WANTED QLD

- Hy-Gain TH3 MK3 or TH5 Yagi; Heavy duty antenna rotator prefer EMOTATOR, CREATE, KENPRO, TELEX; Kenwood PS50 power supply; Kenwood or Henry linear amplifier HF; John VK4SKY QTHR 0417 410 503 PO Box 1166 Coolangatta QLD 4225
- Kenwood TS 830 S owners and service manual; VFO 230; 6146B Tubes; Any repair or modifications information; Rotator Kenpro, Emotator or similar; Hy Gain TH3 or TH3 VNR Yagi antenna. John VK4SKY QTHR 0417 410 503 PO Box 1166 Coolangatta QLD 4225

FOR SALE TAS

- YAESU FT990 HF Xcvr Gen cov rec built in P/supp deluxe Xcvr \$1795 Inc Boxes etc YAESU SP5 Speaker \$130 Kenwood TS 500S exc cond unmarked boxes inc cw filter \$395. Kenwood MC50 base mic \$90 above all in as new cond. Contact Allen VK7AN 03 6327 1171 Mobile 0417 354 410

FOR SALE VIC

- Kenwood PG-3G 20 A DC noise filter new in box \$30 sm-220 monitoroscope w/BS-8 Panadaptor \$250 Icom IC-730 HF TXXR. & IC901 10/6/2/70cm FM & extras. Soffers for either? Damien VK3RX 03 5427 3121
- Nally tower wind-up tilt over with Kenpro rotator and 6 metre 5 element beam. Buyer to dismantle. VCC \$450-ONO Bob VK3ZRY 03 95784961
- YAESU FT26 HH., charger, manual \$150. Dowkey type 60 relay with ext.dc contacts \$60. Melabs 2-2.5GHZ circulator \$50. Mitsubishi module M57713 \$60. RLC coaxial switch type n connect. 12GHZ \$50. Dick Smith variable power supply 3-15v at 25 amp \$200. Roger VK3XRS 03 5152 1163

- General purpose noise remover and filter model NRF-7 \$75 Alf Chandler VK3LC QTHR
- PWR SUPPLY I.C.-PS.15 in carton with manual, 20 amp, mint cond. \$150. TXCVR YAESU FT-75 B with quick charge D/C adaptor NC_15 \$100. ATU Brand new MFJ-945E in carton etc \$100. PWR SUPPLY Brand new DSE 1 amp multi-volt 3-12 V at 1 amp, fully regulated \$25. MAX VK3GMM 03 5985 2671 all hours.
- YAESU FT757GX HF Xcvr VGC \$550 ONO Dick Smith D-3800 3-15V 25amp DC Power supply EC. \$200 Graeme VK3GPT 5962 6098

WANTED VIC

- YAESU 7-B manual with circuit diagrams. Photocopy OK. Will pay all costs. Graeme VK3GPT 5062 6098
- New YAESU or similar type dual time clock for amateur time zone reference. VK3YJ QTHR 03 9315 9387

MISCELLANEOUS

- The WIA QSL Collection (now Federal) requires QSLs. All types welcome, especially rare DX pictorial cards, special issue. Please contact the Hon Curator, Ken Matchett VK3TL, 4 Sunrise Hill Road, Montrose Vic 3765, tel 03 9728 5350
- If you got your licence before 1973 you are invited to join the Radio Amateurs Old Timers Club. A \$2.50 joining fee plus \$5.00 per year gets you two interesting Journals plus good fellowship. Arthur Evans VK3VQ or Milton Crompton VK3MN can supply application forms. Both are QTHR in any Call Book.

TRADE ADS

- AMIDON FERROMAGNETIC CORES: For all RF applications. Send business size SASE for data/price to RJ & US Imports, PO Box 431, Kiama NSW 2533 (no enquiries at office please ... 14 Boanyo Ave Kiama). Agencies at: Assoc TV Service, Hobart; Truscott's Electronic World, Melbourne and Mildura; Alpha Tango Products, Perth; Haven Electronics, Nowra; and WIA Equipment Supplies, Adelaide.
- WEATHER FAX programs for IBM XT/ATs *** "RADFAXZ" \$35.00, is a high resolution short-wave weather fax, Morse and RTTY receiving program. Suitable for CGA, EGA, VGA and Hercules cards (state which). Needs SSB HF radio and RADFAX decoder. *** "SATFAX" \$45.00, is a NOAA, Meteor and GMS weather satellite picture receiving program. Needs EGA or VGA & WEATHER FAX PC card, + 137 MHz Receiver. *** "MAXISAT" \$75.00 is similar to SATFAX but needs 2 MB of expanded memory (EMS 3.6 or 4.0) and 1024 x 768 SVGA card. All programs are on 5.25" or 3.5" disks (state which) plus documentation, add \$3.00 postage. ONLY from M. Delahunty, 42 Villers St. New Farm QLD 4005. Ph 07 358 2785.



Prevent Pirates

make sure you sell your transmitting equipment to a
licensed
Amateur Operator

WIA Division Directory

The WIA consists of seven autonomous State Divisions. Each member of the WIA is a member of a Division, usually in their residential State or Territory, and each Division looks after amateur radio affairs within its area.

Division	Address	Officers	News Broadcasts	1998 Fees	
VK1 ACT Division GPO Box 600 Canberra ACT 2601	President Secretary Treasurer	Hugh Blemings John Woolner Les Davey	VK1YYZ VK1ET VK1LD	3.570 MHz LSB, 146.950 MHz FM each Sunday evening commencing at 8.00 pm local time. The broadcast text is available on packet, on Internet aus.radio.amateur.misc newsgroup , and on the VK1 Home Page http://www.vk1.wia.ampr.org From VK2WI 1.845, 3.595, 7.146*, 10.125, 14.170, 24.950, 28.320, 29.120, 52.120, 52.525, 144.150, 147.000, 438.525, 1273.500 (* morning only) with relays to some of 18.120, 21.170, 581.750 ATV sound. Many country regions relay on 2 m or 70 cm repeaters. Sunday 1000 and 1930. Highlights included in VK2AWX Newcastle news, Monday 1930 on 3.593 plus 10 m, 2 m, 70 cm, 23 cm. The broadcast text is available on the Internet newsgroup aus.radio.amateur.misc , and on packet radio.	(F) \$72.00 (G) (S) \$88.00 (X) \$44.00
VK2 NSW Division 109 Wigram St Parramatta NSW (PO Box 1066 Parramatta 2124) Phone 02 9689 2417 Freecall 1800 817 644 Fax 02 9633 1525	President Secretary Treasurer Web: http://ozemail.com.au/~vk2wi/ e-mail address: vk2wi@ozemail.com.au Packet BBS: VK2WI on 144.850 MHz	Michael Corbin Eric Fossey Eric Van Da Weyer (Office hours Mon-Fri 11.00-14.00)	VK2YC VK2EFY VK2KUR	VK3BWI broadcasts on the 1st Sunday of the month, starts 10.30 am. Primary frequencies, 3.615 LSB, 7.085 LSB, and FM(R)s VK3RML 146.700, VK3RMM 147.250, VK3RWG 147.225, and 70 cm FM(R)s VK3ROU 438.225, and VK3RMU 438.075. Major news under call VK3WI on Victorian packet BBS and WIA VIC Web Site.	(F) \$89.00 (G) (S) \$58.00 (X) \$41.00
VK3 Victorian Division 40G Victory Boulevard Ashburton VIC 3147 Phone 03 9885 9261 Fax 03 9885 9298	President Secretary Treasurer e-mail address: vk3wi@vnt.com.au Web: http://www.tbsa.com.au/~wivaw/	Jim Linton Barry Wilton Rob Halley (Office hours Tue & Thur 0830-1530)	VK3PC VK3XV VK3NC	1.825 MHz SSB, 3.605 MHz SSB, 7.118 MHz SSB, 14.342 MHz SSB, 21.175 MHz, 28.400 MHz SSB, 29.220 MHz FM, 53.725 MHz FM, 147.000 MHz FM, 438.500 MHz (Brisbane only), and regional VHF/UHF repeaters at 0900 hrs EAST Sunday. Repeated on 3.605 MHz SSB & 147.000 MHz FM at 1930 hrs EAST Monday. Broadcast news in text form on packet under WIAQ@VKNET.	(F) \$74.00 (G) (S) \$61.00 (X) \$46.00
VK4 Queensland Division GPO Box 638 Brisbane QLD 4001 Phone 07 3221 9377	President Secretary Treasurer e-mail: secretary@wiaq.powerup.com.au Web: http://www.wiaq.powerup.com.au	Colin Gladstone Peter Harding Allstair Elick	VK4ACG VK4JPH VK4FTL	1827 kHz AM, 3.550 MHz LSB, 7.095 AM, 14.175 USB, 28.470 USB, 53.100 FM, 147.000 FM Adelaide, 146.700 FM Mid North, 146.800 FM Mildura, 146.825 FM Barossa Valley, 146.900 FM South East, 146.925 FM Central North, 147.825 FM Gawler, 438.425 FM Barossa Valley, 438.475 FM Adelaide North, ATV Ch 35 579.250 Adelaide. (NT) 3.555 USB, 7.065 USB, 10.125 USB, 146.700 FM, 0900 hrs Sunday. 3.585 MHz and 146.675 MHz FM Adelaide, 1930 hrs Monday.	(F) \$75.00 (G) (S) \$61.00 (X) \$47.00
VK5 South Australian Division 34 West Thebarton Rd Thebarton SA 5031 (GPO Box 1234 Adelaide SA 5001) Phone 08 8352 3428 Fax 08 8264 0463	President Secretary Treasurer Web: http://www.vk5wia.ampr.org/	Ian Hunt Graham Wiseman Joe Burford	VK5QX VK5EU VK5UJ	146.700 FM(R), 438.525 FM(R), 29.120 FM at 0930 and 1900 hrs Sundays from Perth, relayed (morning only) on 1.825, 3.560, 3.582 (Busselton), 7.075, 14.116 (North), 14.175 (East), 21.185, 50.150; (morning and evening) 146.900(R) Mt William (Bunbury), 147.00(R) Katanning, 147.200(R) Cataby, 147.250(R) Mt Saddleback (Boddington), and 147.350(R) Busselton; (evening only) 1.865, 3.564 MHz.	(F) \$62.00 (G) (S) \$50.00 (X) \$34.00
VK6 West Australian Division PO Box 10 West Perth WA 6872 Phone 08 9351 8873	President Secretary Treasurer Web: http://www.faroc.com.au/~vk6wia/ e-mail: vk6wia@faroc.com.au	Cliff Bastin Christine Bastin Bruce Hedland-Thomas	VK6LZ VK6ZLZ VK6OO	146.700 MHz FM (VK7RHT) at 0930 hrs Sunday relayed on 147.000 (VK7RAA), 146.725 (VK7RNE), 146.825 (VK7RMD), 3.570, 7.090, 14.130, 52.100, 144.150 (Hobart), repeated Tues 3.590 at 1930 hrs.	(F) \$74.00 (G) (S) \$60.00
VK7 Tasmanian Division 24 Targett Street Scamander TAS 7250 Phone 03 6372 5305	President Secretary Treasurer Web: http://www.wia.tasnet.net e-mail: vk7kpg@hamnet.hotnet.com.au	Ron Churcher Paul Godden John Klop	VK7RN VK7KPG VK7KCC	Membership Grades Full (F) Pension (G) Needy (G) Student (S) Non receipt of AR (X)	Three-year membership available to (F) (G) (X) grades at fee x 3 times.
VK8 Northern Territory (part of the VK5 Division and relays broadcasts from VK5 as shown, received on 14 or 28 MHz). Note: All times are local. All frequencies MHz.					

Advertisers index

Amateur Radio Index on Disk	38	Jaycar Electronics	17
Amateur Transceiver Radio	44	Radio and Communications	32
Andrews Communication Systems	14	Terlin Aerials	IFC, 7
Av-Comm	14	Trade Hamads	55
Dick Smith Electronics	28, 29, IBC	WIA Index on Disc	19
Emona Electronics	0	WIA Defence	2
ICOM	OBC, 4	WIA Call Book	36

Advertise with **Amateur Radio**
Reach the keen users of your product or service

TRADE PRACTICES ACT

It is impossible for us to ensure the advertisements submitted for publication comply with the Trade Practices Act 1974. Therefore, advertisers and advertising agents will appreciate the absolute need for themselves to ensure that the provisions of the Act are complied with strictly.

VICTORIAN CONSUMER AFFAIRS ACT

All advertisers are advised that advertisements containing only a PO Box number as the address cannot be accepted without the addition of the business address of the box-holder or seller of the goods.

FT-847 EARTH STATION



Only one transceiver gives you all-mode operation on the HF, 6m, 2m, and 70cm bands with full satellite capability...

the new Yaesu FT-847 "Earth Station"

Ready for action on SSB, CW, AM, FM and Digital modes, the FT-847's compact size makes it ideal for a variety of portable/mobile applications as well as for serious base station operation. You get a solid 100W output on the HF and 6m bands, 50W output on both 2m and 70cm, dual fan cooling and a rugged diecast chassis. Plus, the ultra-quiet HEMT receive pre-amps on 2m and 70cm contribute to the FT-847's industry best sensitivity figures. Advanced Digital Signal Processing (DSP) circuitry enhances received signal/noise ratios for easier copy of signals under marginal conditions through the use of 16 selectable noise reduction algorithms, while the Bandpass and Auto-notch filters aid the IF based Shift and Noise Blanker circuits in reducing interference on crowded bands.

The FT-847 is ready for satellite operation, with crossband full duplex operation, normal and inverted VFO tracking of the satellite uplink/downlink, as well as 12 special satellite memories with alpha-numeric name tags. Also provided is a low-noise Direct Digital Synthesiser (DDS) that provides tuning steps as small as 0.1Hz, plus there's an adjustable DSP bandpass filter as narrow as 25Hz for exceptional weak-signal CW performance. You can also install optional Collins® mechanical filters in both the transmit and receive chain for enhanced SSB operation, as well as a 500Hz Collins® filter in the receiver side for CW. An RF-style speech processor with adjustable frequency shift voice tailoring is also provided to add punch to your SSB transmissions.

The FT-847 is ready for data modes, with a rear panel Data In/Out socket and a Packet socket for 1200/9600 baud VHF/UHF operation. Other features include extended receiver coverage (37-76, 108-174, and 420-512MHz), a high-speed computer control interface, 10 key keypad for band/frequency entry, and a Shuttle-Jog tuning ring for fast QSY. Also included are encode/decode CTCSS and DCS operation, selectable channelised steps for FM operation, an iambic CW keyer, FM narrow/wide modes for 29MHz use, and a large LCD screen with adjustable backlighting.

Each transceiver is supplied with a hand-mic, DC power lead and a comprehensive instruction manual. Call us for a copy of Yaesu's 6 page colour brochure to learn more about this incredible value "Earth Station" transceiver.

2 YEAR WARRANTY

D 3425

YAESU

\$3250

DICK SMITH
ELECTRONICS

That's where you go!

MORE

GREAT

GEAR

FROM

ICOM



746 A tri-bander packed with power. Powerful and versatile to satisfy all your base station needs, HF + 6m + 2m band coverage, 100 W of output power on all bands, DSP functions standard, large multi-function LCD keeps you totally informed and makes the 746 so easy to use.

207H Switch to two bands for a single band price...

In-dash versatility, VHF/UHF capabilities (one band at a time) via a band switching system, superb clarity on either operating channel, easily detachable front panel, even a connection to a packet modem supporting speeds of up to 9600bps.



Q7A A mini unit with maximum performance. 2m/70cm transceiver/wide band receiver just 8.6 cms high, wide band receive from 30 to 1300 MHz in FM/WFM/AM modes, simple operation with easy band switching, automatic squelch, crystal clear audio.

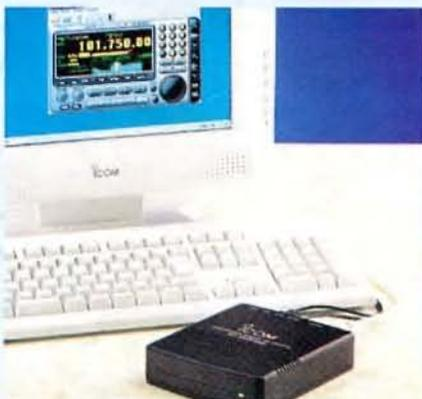

PCR100 Cruise the airwaves with your computer. Turns your PC into a sophisticated 0.5 - 1300 MHz receiver (FM/WFM/AM modes) with plug'n play installation. Multi function control panel, wide frequency coverage, and unlimited memory channels.

R2 Fit the world's airwaves in your shirt pocket. Just 8.6cm high, 0.5 - 1300 MHz frequency range divided into 9 bands plus FM/WFM/AM, auto squelch for consistent signal strength, 400 memory channels, great sound in rugged water resistant construction.

ICOM

Clearly Ahead

2 YR WARRANTY

See your nearest Icom Dealer, call Icom on 1800 338 915, or visit our website at www.icom.net.au



February 1999

Volume 67 No 2

Amateur Radio

Journal of the Wireless Institute of Australia



Full of the latest amateur radio news, information and technical articles, including...

- The John Moyle Field Day Competition
- Inductance Meter for Radio Coils
- HF-MT Dummy Load
- RF Low Pass Filters
- A 160 Metre Band Pass Filter
- The Car Battery as a Low Cost Power Source
- A Telescopic Mast for the Amateur on the Move

Plus *lots of other articles, news and special interest columns.*

QMS - 7

Antenna Coupler System

Quick Mount System
for mobile HF and VHF use



- **QMS-7 offers unsurpassed frequency agility without user intervention**
- **SG-231 Smartuner automatic antenna coupler, SG-307 extended full-range antenna, and weather resistant QMS-7 package**
- **1 to 60 Mhz-continuous-instant tuning while you drive**
- **Rated for use on moving vehicles at up to 75 Miles (120km) per hour**

SG-230 MICROPROCESSOR CONTROLLED ANTENNA COUPLER (1.6-30MHz) 200W Smarttuner

The SG-230 Smartuner automatic antenna coupler can be used within its power rating with any HF Transceiver in range of 1.6-30MHz. Designed for marine, portable and fixed base applications. For antenna types: 23ft marine whip for 1.6 to 30MHz and with 9ft. minimum antenna for 3-30 MHz operation

Number of channels unlimited
Frequency range 1.6-30 MHz
Power rating 200 watts PEP maximum 12 VDC. operation
SWR: Less than 1:1.5
Tune power: 3 watts nominal
Weight: 8Lbs.
Dimensions: 12.5 x 10.5 x 3
Supplied with 9ft. cable for coaxial and DC power.



Terlin
OUTbacker 

PO BOX 1197
Canning Vale W.A. 6155
www.outbacker.com.au
terlin@outbacker.com.au

Ph (08) 9455 4288
Fax (08) 9455 4289



Amateur Radio

Volume 67
Number 2
February 1999

Amateur Radio is published by the Wireless Institute of Australia ACN004 920 745 as its official Journal on the last Friday of each month

Editorial

Editor: Bill Rice* VK3ABP
 Production Manager: Bob Harper VK4KNH
 Snr Technical Editor: Peter Gibson* VK3AZL
 Technical Editors: Evan Jarman* VK3ANI
 Gil Sones* VK3AUI
 Don Graham VK6HK
 Contributing Editors: Ron Fisher* VK3OM
 Don Jackson* VK3DBB
 WIA News Editor: David Thompson VK2NH

*Publications Committee member

Advertising

Mrs June Fox
 WIA Federal Office
 PO Box 2175 CAULFIELD JUNCTION VIC 3161
 Tel: (03) 9528 5962 Fax (03) 9523 8191
 email amag@hotkey.net.au

Amateur Radio Correspondence

All correspondence, contributions and queries about the content should be sent to:

The Editor *Amateur Radio*
 PO Box 2175
 CAULFIELD JUNCTION VIC 3161
 email amag@hotkey.net.au
 Tel: (03) 9528 5962 Fax (03) 9523 8191

Amateur Radio Delivery

All queries regarding delivery should be directed to:

Amateur Radio Federal Office
 PO Box 2175 Caulfield Junction Vic 3161
 Tel: (03) 9528 5962 Fax (03) 9523 8191

Registered Office

10/229 Balaclava Road
 Caulfield North VIC 3161
 Tel: (03) 9528 5962 Fax (03) 9523 8191
 Business hours: 9.30am-3pm weekdays

Editorial & Display Booking Deadlines

February 12/1/99
 March 12/2/99
 April 12/3/99

Hamad & Display Material Deadline

February 22/1/99
 March 19/2/99
 April 19/3/99

Production

Administration, Drafting, Design & Sub-editing
 Shadetree Publishing & Imaging
 PO Box 288 BEERWAH OLD 4519

Pre-press, print and mail management
 Newsletters Unlimited (03) 9428 3458

Printed by Streamline Press, Melbourne (03) 9417 2766

Mailed by IMS, Melbourne (03) 9291 5888

Receipt of Amateur Radio by mail

This issue was delivered to Australia Post on Monday Feb. 7
 If you are a financial member and have not received your copy
 by the 15th of the month please check with your local Post Office
 before contacting the registered office of the WIA

Copyright and Reproduction

The copyright in this magazine, except where specifically noted,
 is held by Wireless Institute of Australia ©WIA 1999.
 Permission to republish articles in any form must be obtained
 in writing from the Institute (other than for purposes of 'fair dealing').
 This permission is usually freely given for information purposes.

The Journal of the Wireless
Institute of Australia

ISSN 0002-8859

Technical

An Inductance Meter for Radio Coils	12
<i>Drew Diamond VK3XU</i>	
160 Metre Bandpass Filter	14
<i>Keith Gooley VK5OQ</i>	
Telescopic Mast for an Amateur on the Move	16
<i>Graham B Jackson VK3GBJ</i>	
RF Low Pass Filters	18
<i>Ron Sanders VK2WV</i>	
HF-MT Dummy Load	20
<i>Ross Fraser VK2KVV</i>	
The CarBattery as a Low Cost Power Source	22
<i>Ian Cowan VK1BG</i>	
Technical Abstracts	26
<i>Gil Sones VK3AUI</i>	

General

John Moyle Field Day Competition	6
<i>Bob Harper VK4KNH</i>	
Rescued by a Rat	11
<i>QNEWS VK4ZZ</i>	

Columns

Advertisers' Index	56	Hamads	54
ALARA	32	HF Predictions	52
AMSAT Australia	33	Ionospheric Update	51
Awards	49	Novice Notes	38
Club News	25	Over To You	36
Contests	44	Pounding Brass	35
WIA Divisions News		Silent Keys	36
VK1 Notes	40	Spotlight on SWLING	37
VK2 Notes	40	VHF/UHF - An Expanding World	30
VK4 Notes	41	WIA Comment	3
VK5 and VK8 Notes	41	WIA News	3
VK6 Notes	43	WIA Division Directory	56
Editor's Comment	2	WIA Federal Directory	2
Education	34		

Our cover this month

Cover Photo by Peter VK5TZX. The photo, depicting the VK5ARC contest station, was taken at Willunga Hill during the VHF/UHF Field Day - 1995

Contributions to Amateur Radio

Amateur Radio is a forum for WIA members' amateur radio experiments, experiences opinions and news. Manuscripts with drawings and or photos are always welcome and will be considered for publication. Articles on disc or email are especially welcome. The WIA cannot be responsible for loss or damage to any material. A pamphlet, How to write for Amateur Radio is available from the Federal Office on receipt of a stamped self-addressed envelope.

Back Issues

Back issues are available directly from the WIA Federal Office (until stocks are exhausted, at \$4.00 each (including postage within Australia) to members.

Photostat copies

When back issues are no longer available, photocopies of articles are available to members at \$2.50 each (plus an additional \$2 for each additional issue in which the article appears).

Disclaimer

The opinions expressed in this publication do not necessarily reflect the official view of the WIA and the WIA cannot be held responsible for incorrect information published..

Amateur Radio Service

A radiocommunication service for the purpose of self-training, intercommunication and technical investigation carried out by amateurs; that is, by duly authorised persons interested in radio technique solely with a personal aim and without pecuniary interest.

Wireless Institute of Australia

The world's first and oldest
National Radio Society
Founded 1910

Representing
The Australian Amateur Radio Service
Member of the
International Amateur Radio Union

Registered Federal Office of the WIA
10/229 Balaclava Road
Caulfield North Vic 3181
Tel: (03) 9528 5962
Fax (03) 9523 8191
http://www.wia.org.au

All mail to
PO Box 2175 Caulfield Junction VIC 3161

Business hours: 9.30am-3pm weekdays

Acting Federal Secretary

Peter Naish VK2BPN

Federal Office staff

June Fox Bookkeeper
Rita Trebilco VK3IF Examinations Officer

Council

President	Peter Naish	VK2BPN
VK1 Federal Councillor	Michael Jenkins	VK1MJ
VK2 Federal Councillor	Michael Corbin	VK2YC
VK3 Federal Councillor	Brenda Edmonds	VK3KT
VK4 Federal Councillor	Ross Marren	VK4AMJ
VK5 Federal Councillor	Jim McLachlan	VK5NB
VK6 Federal Councillor	Will McGhie	VK6UU
VK7 Federal Councillor	Andrew Dixon	VK7GL

Executive

Peter Naish	VK2BPN
Martin Luther	VK5GN
Wally Howse	VK6KZ
Neil Penfold	VK6NE

Federal Coordinators

AMSAT	Graham Ratcliff	VK5AGR
Awards	John Kelleher	VK3DP
Contests	Ian Godsil	VK3DID
Education	Brenda Edmonds	VK3KT
FTAC	John Martin	VK3KWA
Historian	John Edmonds	VK3AFU
IARU	Grant Willis	VK2ZWI
Intruder Watch	Gordon Loveday	VK4KAL
ITU Conference and study group	David Wardlaw	VK3ADW
Public Relations	David Thompson	VK2NH
QSL Manager (VK9, VK0)	Neil Penfold	VK6NE
Videotapes	Don Bland	VK4TVD

ACA Liaison Team

Brenda Edmonds	VK3KT
David Wardlaw	VK3ADW
Peter Naish	VK2BPN

EDITORS COMMENT

Feedback

Positive Feedback — AGAIN!

IN *AMATEUR RADIO* for November, 1988. I wrote an editorial entitled "Positive Feedback". I drew analogies between stock market trading, economic cycles, WIA funding and electronic circuits having gain and feedback.

When the feedback is positive any trend becomes amplified and increases until a limit is reached. At this stage the original trend may reverse and the system proceed as far as it can in the opposite direction.

I was reminded of this by our producer Bob Harper, who described the financial health of the WIA by the feedback analogy, in a note to us the other day. I quote from his description:

"A larger membership brings a larger print run that in turn brings greater advertising revenue. The

circle spirals and it is difficult to control but currently it is heading the wrong way. How can we change any of the above to increase rather than decrease? Ponder on that one a while. Perhaps some fodder for the next editorial Bill"

How can we change the system indeed? I suggested in 1988 that we would oscillate slowly between the two natural limits, in which all Australian amateurs belong to the WIA, or none belong. In this latter extreme the WIA disappears. There are people who have the power to change our direction. At present they are non-members. All they need to do is JOIN! As soon as our print run increases the trend will begin to reverse! Wouldn't that be marvellous?

Bill Rice VK3ABP

Editor

P.S. Thanks for the suggestion, Bob!

ar

Annual awards

Amateur Radio

The WIA Publications Committee at its January 1999 meeting decided the *Amateur Radio* awards for 1998.

They are:-

Technical Award for the best technical article in 1998 was awarded to PHIL RICE VK3BHR for his article *SSB by the Fourth Method* published in February.

Higginbotham Award for service to amateur radio was awarded to STEPHEN PALL VK2PS for his work in providing the monthly *How's DX* column throughout many years.

Both Stephen and Phil, to whom the editor professes not to be related to, will each receive an award cheque for \$100

Radiation Regulation

ASI PROMISED last month, you will find under WIANEWS in this issue of AR a summary of the most significant items that were discussed by the WIA during the meeting with ACA last December.

All these matters have a direct bearing on our activities as radio amateurs but, to my mind, the most important one is the forthcoming regulation concerning Electro-Magnetic Radiation (EMR).

It is expected that from early next year a provision to meet certain levels of performance in regard to harmful radiation will apply to all licensed transmitting devices, including those used by radio amateurs.

At present there is still debate as to what the safe levels are but it appears that recent work performed by the FCC in America will be taken into consideration.

The WIA is working closely with the ACA on your behalf to ensure that any mandatory provisions placed on our licences will be easy to understand and can be readily implemented without undue burden on licensees.

On the subject of WIA Policy in general, perhaps it is timely to remind ourselves that it is the seven WIA State Divisions who, through their Federal Councillors, ultimately determine national Policy.

Such matters are (or should be) the major agenda items at Federal Conventions. With so many topical issues, it is vital therefore that you support your Divisional Council in policy considerations so that WIA Federal can truly represent your interests nationally and internationally.

A strong WIA ultimately results in a secure amateur radio service.

Peter Naish, VK2BPN
WIA Federal President.



ACA Meeting Held in Canberra

An ACA Liaison Committee meeting was held in Canberra on 9 December 1998. A summary of that meeting is reprinted here in AR for your information.

Summary Of Main Issues

(1) 80 metre DX Window

ACA advised that a draft issues paper was in final stages of preparation. ACA wanted a positive outcome but would not be ready before March 1999.

(2) Possible LF Band

ACA were not opposed to the idea of such a new band but could not move at present because there was no provision in the Australian Spectrum Plan. The WIA was asked to use its IARU Region 3 membership and other ITU-related activities to encourage the adoption of LF spectrum for amateur use in this region. Meanwhile the existing arrangement for specific scientific permits would continue.

(3) Continuing usage by amateurs of bands subject to Spectrum Licensing

Much discussion took place on this matter without any significant short-term solution. The WIA was asked to make a submission to the forthcoming review of the Radio-Communications Act in regard to co-usage of Spectrum Licensed bands.

(4) Conversion of certain UHF and SHF bands to Primary usage by amateurs.

The WIA was asked to prepare a list of frequency bands which are presently allocated to amateurs on a secondary

ACA/WIA Meeting

Wednesday 9 December 1998 Level 2, Conference Room, Purple Building, Benjamin Offices

Attendees:

WIA

Peter Naish *President - WIA*
 David Wardlaw *Member - WIA
ACA Liaison Committee*
 Brenda Edmonds *Member - WIA
ACA Liaison Committee*
 Richard Jenkins *Liaison Officer -
WIA ACA Liaison Committee*

Peter Stackpole *Executive Manager
Customer Service Group (CSG)*

Peter Allen *CSG*

Alan Jordan *Compliance & Licensing*

Len Bray *Spectrum Planning*

Ray Wyeth *Compliance & Licensing*

Geoff McMillen *CSG*

Wayne Huxley *CSG*

Geoff Hartwig *Standards*

Ian Hayne *Spectrum Marketing*

Sue Bourke *CSG (minutes)*

ACA

Gill Kempton *(Chairperson)
Manager - Customer Access
Management Team*

basis and which were of most value to amateurs. The primary user would then have to be contacted by WIA as an initial step. ACA would monitor progress.

(5) Examination System

ACA reported that there was no change to the fundamental concept of devolution. However, a discussion paper was being prepared by ACA for release by March 1999. This would seek inputs from the WIA and other interested parties concerning participation in the exam system. The current arrangement with WIA would continue to operate for the time being.

(6) High Power permits

ACA is currently working on a variation clause to the amateur LCD for EME contacts (only). The arrangement would allow high power operation provided it met the new EMR provisions to come into effect next year.

(7) Call-signs not in accordance with established practice

ACA were continuing to abide by the practice of issuing call signs in accordance with the WIA's wishes. However, they acknowledged that there had been cases where this had not happened due to the automatic allocation of call signs by computer. ACA asked WIA to report such anomalies to them.

(8) HF gateways to VHF/UHF repeaters

ACA advised that as a matter of general policy such gateways would not be allowed where this would provide access to HF bands by amateurs not qualified for operation on those bands.

(9) Call book information

Subject only to the WIA entering into a specific arrangement with ACA to publish a list of call signs, names and addresses, the information required by the WIA for production of an annual call book was freely available by purchasing the current CD-ROM of all Australian licensed stations.

(10) EMR provisions for amateur radio stations

This is likely to be the single most important change to amateur radio licences in the foreseeable future. The requirement to meet an EMR standard will apply to all amateur operations from January 2000. The actual requirements are still under discussion but would be modelled on the FCC documents. The WIA will work closely with ACA and also assist them in preparing a plain language statement that amateur licences could readily understand. The impact on amateur radio operations could be significant, especially for those stations using high power outputs in densely populated areas.

(11) The next meeting

The next meeting with ACA of the WIA Liaison Committee is scheduled for 23 April 1999.

Radio Communications Act (1992) Review Discussion Paper Released for Comment.

The paper has been released to stimulate discussion by all interested parties, including the WIA. Comments were to be returned by 8 February 1999.

It was only released just after Christmas so there has been less than a month to react and this has meant quite a lot of work by both Federal Councillors and coordinators in association with the ACA Liaison Committee.

By now the submission will have been lodged by the WIA. Further inputs to the Department of Communications, Information Technology and the Arts (DOCITA) will be provided over coming months.

Sydney 2000 Olympics

Q News tells us that the Sydney Olympic Broadcasting Organisation (SOBO) recently hosted a six-day briefing for more than 220 broadcasters from around the world.

They were shown the Grace Brothers Distribution Centre, adjacent to the Olympic Stadium that will become the largest International Broadcast Centre in Games history. Broadcasters will, together, produce more than 3200 hours of live video.

Morse Code Practice in New South Wales

VK2RCW, long known for continuous CW code transmissions on 3.699 MHz is back in action. Barry VK2AAB of the Hornsby and Districts Amateur Radio Club say that "signal reports from around VK & ZL would be appreciated". The transmission on 80 is a duplicate of the two metre sessions on 145.650 MHz.

Reports should be directed to
*Barry VK2AAB or to the Hornsby & Districts Amateur Radio Club
PO Box 362 Hornsby NSW 2077.*

New Operating Schedule for W1AW

The ARRL Maxim Memorial Station W1AW is now on a new operating schedule that reinstates morning code practice on four weekdays and expands weekday operating hours for visiting hams.

The new schedule reinstates one hour of code practice Tuesdays through Fridays at 9 AM, while discontinuing morning bulletin transmissions. This makes room to expand visitor operating hours on weekdays by three hours. The new visitor hours will be 10 AM until 4 PM, Monday through Friday.

The new schedule eliminates weekend code practice and bulletins, however. The demise of weekend hours also means an end to Saturday W1AW operation by visiting hams. The evening code practice and bulletin schedules remain almost unchanged, except that the final transmission of the day will be a code bulletin at 11 PM Eastern Time. The midnight digital and 12:45 AM voice bulletins will be discontinued. Please note that all time references are for the United States.

The complete new schedule appears in January 1999 *QST*, page 74 and on *ARRLWeb* at <http://www.arrl.org/w1aw.html>. Members may direct questions and comments about the new

schedule to *W1AW*, 225 Main St, Newington, CT 06111; e-mail w1aw@arrl.org.

Via ARRL Newsletter

ITU warns that CDMA-based RTT proposals for IMT-2000 could be excluded from further consideration if IPR stalemate is not resolved by the year-end

Discussions at the meeting of Task Group 8/1 held in Jersey, Channel Islands from 9 to 20 November 1998 indicated that the ITU may only be able to consider RTT technologies for IMT-2000 that are based on TDMA technology if the dispute surrounding Intellectual Property Rights of CDMA proposals is not resolved before the end of this year. “

This is clearly laid out in the procedure for submitting candidate Radio Transmissions Technologies (RTTs) described in an ITU Circular sent out to our membership on 26 May 1998(1)” said Robert Jones, Director of the ITU Radio-Communications Bureau.

The procedure was set out after consultation with over 200 industry experts who met in Geneva earlier in May.

“To conform with the ITU patent policy”, Mr Jones explained, “the holder of any known patent or any pending patent application related to any proposal made to the ITU in the process of international standards-setting must submit a written statement, either waiving his rights or committing to negotiate licenses on a non-discriminatory basis and on reasonable terms and conditions.

“Failure to provide this statement ultimately excludes the proposal from the international standards-setting process” Jones stressed.

The ITU patent policy is basically similar to that of most other standards-setting organisations so the proponents will face similar difficulties elsewhere if these issues are not resolved quickly.

The deadline for the submission of patent statements on IMT-2000 RTTs is set at 31 December 1998 in order to facilitate the consensus building phase of the ITU standards process and avoid

detailed development of standards which would ultimately be blocked from approval by IPR issues.

To date, two of the statements received are upholding IPRs on CDMA-based technology proposals: one by Ericsson on 28 September 1998 and one made by QUALCOMM on 13 October 1998.

The global telecommunications industry is at a critical juncture and the ITU believes that global competition based on IMT-2000 standards will be a key driver for the world wireless market; incompatible standards, sometimes softly referred to as “technology differentiation”, can however only mean bad

CDMA-based RTT proposals for IMT-2000 could be excluded from further consideration if IPR stalemate is not resolved by the year-end

news for consumers through higher costs and lack of inter-operability across regions and around the world.

And this is precisely what would happen if the various TDMA and CDMA RTT proposals submitted to the ITU are not harmonised into a single global standard for 3G. About 80% of today’s digital mobile market is TDMA-based.

A move to multiple 3G standards tied to today’s 2G “footprints” could fragment the 3G marketplace. On the other hand, a global standard based on the best features of the various RTT proposals submitted to the ITU would mean a worldwide competitive platform for all players.

The ITU is concerned that the “virtual holy war” – to take the expression of ATT’s Ken Woo – can well mark the end of a dream: the dream for consumers to have truly “anywhere, anytime” communication across networks, across frontiers, across technologies for personal access to Information Age services.

Given the glittering prize that third generation represents, it is now time to make sure this chance is not wasted and turn the “unfulfilled dream of the 20th century” into reality.

For operators and equipment manufacturers, a lot is riding on the choice of RTT. Incumbent operators have made huge investments in the networks deployed for second-generation systems. They clearly need to make sure that whatever decision is made on 3G, their existing 2G networks will remain interoperable with third generation systems under IMT-2000.

The consensus within Task Group 8/1 where all major industry players are taking an active part - including QUALCOMM and Ericsson – has therefore been to select a *radio interface* for IMT-2000 capable of delivering the full range of 3G services and quality in a global roaming environment, that could also operate with 2G networks through dual or multi-mode sets albeit without all the added functionalities of IMT-2000. In other words, a migration path similar to that experienced when colour television was introduced.

There is a growing consensus from all corners to develop a single global standard for third generation based around the ITU IMT-2000 concept. One of the last main remaining stumbling blocks is that of the IPR.

On the development of key characteristics of the IMT-2000 radio interfaces, the Jersey meeting achieved considerable progress. In particular, the Task Group 8/1 meeting, among other things:

- agreed that all 16 proposals for radio technologies (10 terrestrial and 6 satellite) qualified for the next phase, as well as;
- agreeing on a draft list of potential frequency bands for additional spectrum for IMT-2000. Although some spectrum was identified by the 1992 World Administrative Radio Conference for IMT-2000 and reviewed in 1995, additional spectrum is needed to cope with the increasing amount of broadband and increasingly interactive traffic of third generation systems. This will be addressed at the World Radio Conference in the year 2000.

Via International Telecommunication Union Release ITU/98-34

ar

The John Moyle Field Day Competition

by Bob Harper VK4KNH

Every year in March, Australia is host to the John Moyle Field Day Competition. In essence, normally sane people leave their comfortable homes and well-organised ham shacks for the fly infested, dusty/muddy turmoil of the wild wilderness.

Once there, they erect the best antenna system that a roll of wire can provide, connect their expensive black box radios to an unregulated generator and pull the starter cord.

For the next twenty-four hours they will talk to anybody, anywhere, on as many frequencies as possible, as long as they haven't spoken to them too recently. Then, when totally exhausted, they pack up and go home; it's great!

John Moyle, VK2JU (sk)

Amateur Radio Operator, Engineer, Musician, Journalist, Editor, et.al. John Moyle was certainly an active person. John was born at Malvern in Victoria in 1908 and even at an early age was regarded as an active person.

The then Principal of Scotch College, Dr.W.S.(Bill) Littlejohn, noted in John's testimonial: "The list of offices which he holds in the school shows that he is a lad of high ability and of exceptional energy. — He has earned the thanks of the school for his excellent work as Editor of the 'Scotch Collegian'."

John worked at Radio 3DB in the early 30's and wrote many short stories and technical articles before joining the staff of "Wireless Weekly" in 1932. He began by answering technical queries before becoming the assistant technical editor and then technical editor.

In April 1939 "Wireless Weekly" split into two magazines with John following the more technical "Radio & Hobbies" as the Technical Editor, becoming the Editor a few months later. He held that position until he died in March 1960.

In 1941 he temporarily dropped editorial duties and joined the RAAF where he rose to the rank of Squadron Leader. He was put in charge of all

RAAF RADAR publications that were being written at the Melbourne Headquarters. Some of the publications, training guides and manuals, continued to be used into the 1960s.

John was well regarded in the science of recording, both on disk and briefly on tape as the then new technology emerged. He spent many hours experimenting with valve amplifiers trying to attain the highest standard in high fidelity reproduction. John was a foundation member of the Sydney Recorded Music Society where he was renowned as the man who demonstrated stereo sound, hailed at that time as the finest ever heard in Australia.

In 1948 John and his staff experimented with VHF Mobile Radiotelephone being the first publication in Australia to have "Radio Cars". The same basic system was still in use by the Sydney Sun Newspaper in the 1960s.

Licensed as an Amateur Operator in 1932, John devoted a great deal of time to the WIA, both in the New South Wales Division as their President and the Federal WIA as the VK2 Federal Councillor. He represented amateurs on the 1959 Australian delegation to the then Administrative Radio Conference in Geneva, Switzerland.

As an avid VHF experimenter, John is well remembered by the older serving Amateurs but is perhaps known to the younger among us by the annual John Moyle Field Day Competition. If you have the opportunity this year, please join in with the large number of Australian Amateurs who celebrate the memory of John by partaking in this event.

History

I'm not sure if the John Moyle Field day has been an annual event since 1961, as I think it to be, but it has certainly been around since I began Amateur Radio in the late 70s. Indeed it was one of my first outings with the Ipswich Radio Club and has remained as an annual social event throughout many changes of address since that time.

I have seen some very casual approaches and some others organised with almost military precision. I've been on winning teams and many less successful teams and in every case the



Photo 1: George Embry (was VK4AGE) at VK4WIP Station around 1980

participants have recounted their experiences for many months and even years afterwards. As I recall it, one station was congratulated by many operators one year for the great signal they generated on 160m. It seems that they simply used what they found in the paddock; including an out-of-service MF Radio mast and an extensive groundplane.

Every year you will hear voices that you probably haven't heard since the previous year. You will renew old acquaintances and make many new ones.

Historically it is a weekend where as many of us as possible take to the hills and set up in paddocks, gullies and on hilltops or even on mountaintops. The aim is to be prepared to set up your station in quick time in a strange location and be ready to handle traffic. What better practice is there for handling emergencies such as natural disasters.

Traditionally the station is operated over a twenty-four hour period with all contacts logged and weighted.

The Competition

I don't intend to go into depth on the rules, as they will be in February AR in the Contest Column. You must sit down with your fellow team mates and pick the rules apart yourself. My suggestion is to get a copy of past rules sheets from old February editions of AR and look at what changes there have been over the years.

Search for the results that are generally printed in AR a few months later and look at the scores in the various sections. Is there a section that you feel you could have performed better in than the teams that won?

Do you feel that there is an advantage in hitting a specific section that had few contestants last year? Do you have another advantage such as the perfect VHF position overlooking a large population and some very impressive VHF equipment? Pick your section and prepare specifically for it.

Location and Layout

Location, location, location is the real estate agent's motto. It has to be yours as well. It is no use planning to make camp on a small mountaintop for great VHF coverage if you want to put up a lot of HF gear as well. Similarly a large open salty pan might be great for those HF



Photo 2: Graham Rayner VK4GDR operating 'tailboard portable.'

verticals but too low for any VHF bands.

If VHF is your first choice then work the distance rule. By moving a few kilometres further away from town you can double your score due to the distance multipliers, as long as you can get people on to the simplex frequencies. I am sure there are many for which it would be their first simplex contact, on any frequency!

Remember that many members of your club may not want to travel. There is not much use in the competition committee selecting a prime location only to find that most of the members wouldn't travel that far. You might have to be content with the local park just to get the numbers you require.

If your members intend bringing spouses then make sure that they will be comfortable as well. Again it's hard to concentrate on the bands when you are being reminded that its time to go to Auntie Mary's party.

Housing

Field Day weekends bring out the most ingenious amongst us. While most stations will be operated from within tents, there will also be those that operate from caravans and vehicles. (Care to test run the local SES Communications Van for them?)

These are all valid options but I am not sure whether some of my experiences would be considered as within the spirit of the competition. I have been with stations operated from within park pavilions, public rest areas and from a

tarp stretched from one wall of a public toilet.

The rules allow you to make use of any facilities that you find within the area you have chosen, but the spirit of the competition is to house yourself in something that you brought onto the site yourself.

You will need tents or such to house stations for each band. It may be that you can house many operating positions from the same tent but beware of the noise level, interference between transmitters and spacing for the antennas.

Separate tents may be the best option if you have sufficient operators and assistants.

You should also prepare an area for cooking, eating and perhaps even sleeping, not to mention some form of toilet facility.

When you consider housing you should also look at how many operating tables and chairs you will require.

Tools

I am often fascinated to see the most organised people of commerce and industry finding themselves lost in the bush. Usually they simply forget or rather did not consider the tools they may require. A short list, but one that should suffice would include the following: A basic Electronics, Electrical and Mechanical Toolbox, Soldering Iron/Station, Mattock, Axe, Sledge Hammer and last but most importantly a Shovel!

You should also bring an antenna

launcher and a compass. The antenna launcher and compass will be dealt with later but the shovel is for the antenna bases, digging the latrine, levelling the generator and lifting damper and baked spuds from the fire and filling in the latrine. Be sure to get the order right, right!!

The driest of grounds will be surprisingly water resistant in a sudden downpour, which any John Moyle veteran will tell you is always on the cards. It will flow through your tent and then soak in around your feet, so be prepared to dig a shallow drainage trench around your tent to divert it away. This is where the Mattock comes in handy.

The other tools are generally for insurance, if you have them you probably won't need them! (Murphy et al.)

Portable Station

If we start off the discussion by saying that almost any radio will do, there will be some that want to argue about specific qualities of each brand and model. I simply don't care, unless you want to buy a radio specifically for the competition.

I think that portable operation is best achieved with low voltage equipment. Many modern radios are rated for twelve-volt operation with the added bonus that they will accept a wide variation in that voltage and even overcome fairly high noise levels.

A couple of car batteries or a single, high-capacity truck battery will operate for many hours with few problems. Power can be

Every year you will hear voices that you probably haven't heard since the previous year. You will renew old acquaintances and make many new ones

maintained by charging that battery continuously or by rotating batteries.

Other than that, remember that the more complex a radio is the longer it will take another operator to learn to use it. Simple, common controls are a sign of a good radio for field operations.

Each radio should have an antenna tuner even if it will be operated into a 50-ohm antenna. The tuner provides an added level of filtering to help avoid interference with nearby stations on harmonically related bands.

As an additional precaution, low-pass or band-pass filters may be constructed

and used but be sure that the band of operation is clearly marked on the filter. The small losses due to the filters will be overcome by the hours of interference free (reduced?) operation.

Wherever possible, antennas should be designed for a single band. Broadband antennas such as the G5RV, while a great portable antenna for broadband/multiband operation, are more likely to allow harmonics to be transmitted and received.

On the higher bands, from twenty metres up, beams are the best option. Some might also use a dipole or vertical "sniffer" for searching for the next beam direction or frequency. On lower bands use a mix of horizontal and vertical antennas to help "decouple" them or place dipoles so their lobes are at right angles to each other.

A portable mast can be a length of pipe, an old TV antenna mast or a suitable tree. Rotation is often considered as much more difficult with the tree however!

Pipes and other masts can be supported by guy wires or even rope which has been well inspected and tested. The usual method of rotation is known as the Armstrong method – simply go outside and turn the pipe by hand. Make sure the base is on something solid or it will drill itself into the ground.

Remember to bring plenty of cable, both coaxial cable and antenna wire. Every field day I have attended has required some minor alteration or construction. We even made all of the antennas for one event after realising that the antenna box was three hours drive away. Moral, double-check everything before leaving home – Murphy is watching.

Make sure that you have a good headset, Morse key if you use one, a suitable clock and all of the leads and plug in bits for the radios. Galvanised toolboxes, that are so common now, make

a great "Kit Box" to keep all of the regular bits in.

A tape recorder comes in handy, just let it run on record continuously just in case you miss some detail from a station who no longer answers you.

Use the best lighting that you can manage but test and check any fluorescent lighting in a portable environment before you commit to using it. Inverters can themselves be noisy but often play havoc with radio receivers and transmitters alike. I like the old gas camping lamp myself, and it's adjustable as well.

If you are going to use computers, then again test them with the station in a portable situation operating the radio on all bands before you decide to take them along. If there is a problem, try using ferrite traps on all of the leads entering the computer. The same goes for many modern electronic devices especially including digital clocks.

Personnel

We once sat down with some other operators and made a list of the jobs required on what we considered would be a well-prepared John Moyle Field Day team. Even though only a team with a rich benefactor could support all of the job positions we came up with, most of the following tasks have to be done by somebody.

The Operators

Preferably there should be several operators for each band with some acting as assistants (spotters) to others. We even considered supporting the operators with scribes but for most of our outings we couldn't even support all of the bands.

Power Supply Operator

One soul should have the responsibility of keeping the power supply up to the operators. That might entail fuelling the generators, charging batteries or simply keeping the noise from the generators to a minimum.

Housing/Furnishing Officer

One poor soul to coordinate the supply, delivery and erection of a suitable number of tents, tables and chairs.

Canteen/Catering Officer

Napoleon once wrote, "An army marches on its stomach." and he hadn't even seen

hams on the go. If the operators have to stop to make dinner for themselves then contacts will be lost. Now personally I don't take it that seriously, as a quick look at my stomach will verify, but it is true that the operators can be more effective if well catered for.

Contest Secretary/ Logkeeper

One person must be responsible for knowing the rules inside out and back to front. They should also be responsible for ensuring that all of the paperwork is done and that the logs are checked, copied neatly and sent off in time.

Equipment Manager

A list of equipment must be generated, equipment found and details recorded. Equipment must be tested where necessary, and then transported to the site. As I have said earlier, there is not much glory in finding that a necessary piece of equipment is a three-hour drive away.

First Aid Officer

We have been lucky on many occasions to have a trained Ambulance officer with us who we thankfully didn't need to bother. There will probably be a trained First Aider amongst your crew. Find out who they are and make sure that you have a first aid kit on site.

Publicity Officer

Every organisation today needs to have a good PR officer, -one who can get the local media as well as businesses on side. Perhaps the "Holden Marquee" is available for the weekend and the manager can see an advertising possibility or the local Hiring Firm will work a deal, special weekend rate, on an industrial generator for you.

Certainly it would be of benefit to you to have prospective members come along to help out as free labour, perhaps as the cook. I have had three senior scouts on one outing working their behinds off. I understand that at least one has a callsign now.

Coach/Captain/Strategist

Every team needs a "Gee-up" occasionally. A leader who can stir an extra effort at the right time or one who is in a position to see the whole picture and can perhaps make decisions about strategy. When to turn the beam, change bands, modes or whatever.

Tour Guides!

If you are lucky you might get interested onlookers. They will peer in and wonder what strange people we are. If one person is able to explain what you are up to, what you hope to achieve and what the funny sounds are, you will have promoted AR and removed some of the mystique from the visitors' minds. You might even score some new members. Do you have a banner for your group and could you put up a display board explaining what you do?

Catering

I can remember one event when we ran out of coffee before it got dark. Apparently everybody thought they'd be drinking something from a bottle. On another occasion it turned so cold that we made soup from chopped up sandwiches to keep warm. The moral of the story is to come prepared for any eventuality.

Bring plenty of makings for both hot and cold drinks whether that's coffee, tea, cocoa or cordial. You'll need plenty of plain water and some fire and ice. Oh, and don't forget the milk and sugar.

When it gets cold there's nothing like a hot mug of soup and as well as the Cup-of-soup style, a couple of cans are easy to carry and prepare and you can water it down to suit the numbers. We once made a stew out of an army ration pack using virtually everything in it. It was gratefully received even by the ex-army type who supplied the makings. "You couldn't get food like this in the army" he stated as he chowed down on it.

For cold food; sandwiches, fruit, biscuits and cakes are all well received. Other munchies such as crisps, chocolates and nuts can also provide that much-needed snack.

The main needs of the kitchen are a place to eat, somewhere cold such as an Esky and somewhere to heat things up such as a barbeque or fire.

Promotion

"It's only our recreation, why promote it?" I have heard such comments so many times from so many amateurs. They seem to believe that we should leave everything as it is and all will be well. The truth is that membership numbers in the amateur fraternity are in

Terlin



Antenna & Communications

OUTREACH \$386 inc tax

Bumper bar or tow bar mountable. Only 3.6 metres tall, with a 2.4m mainshaft that breaks down into 2 sections with a 1.2 metre tuning spike. When broken down for storage the Outreach is only 1.2m in length and comes complete with carrybag. Exceptional performance!

10-12-15m are 5/8 wave with all bands centre loaded for peak performance. Compared to any other whip you have used, you'll be amazed.

150 watts PEP and terminates with a standard 3/8 x24 (tpl) base. The Outreach can also be used as a portable antenna system provided sufficient ground plane or counterpoise is used.

Bands 160-80-75-40-30-20-17-15-12-10m.



CUSHCRAFT
COMMUNICATIONS ANTENNAS

Newly appointed
Sole Australian importer
Complete range of antenna in stock
Please call for more details



SGC-230 \$998 inc tax

The SGC-230 Automatic antenna coupler can be used within its' power rating with any HF Transceiver within 1.6 to 30 Mhz.

Designed for marine, portable and fixed base applications.

3-30 Mhz range with 9ft minimum antenna. Number of channels unlimited.

Frequency range:	1.6-30 Mhz
Power rating:	200watts PEP max. 12VDC operation Less than 1:1.5
SWR:	Less than 1:1.5
Tune power:	3 watts nominal
Weight:	3.5kg
Dimensions:	370x300x90mm
Supplied with	9ft. cable for coaxial and DC power.

Ph (08) 9455 4288

Fax (08) 9455 4289

Web: www.outbacker.com.au

Email: terlin@outbacker.com.au

P.O. Box 1197

Canning Vale WA 6155

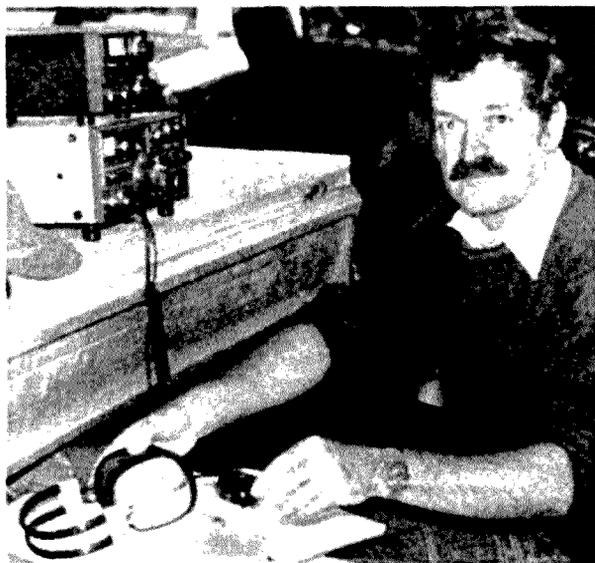

Photo 3: Dave Gay VK4DJG – operating JMFD station at Dalveen around 1990

decline. You can help change that by enjoying your hobby more and introducing it to others.

Every time you do something with your club, look at how you can use that event to promote your club and amateur radio as a whole. The public basically hasn't heard of us. Believe it or not!

Let the papers know what you're doing. They won't react unless you tell them how it would benefit their readers. So tell them that you and your club are entering a national competition that helps amateurs prepare for communications duties during a natural disaster. Give example such as Cyclone Tracy where amateur radio was the first on air after the established communications were flattened. Amateur Radio gave the first communications from Mexico City after the earthquake shut down all of the commercial systems and networks.

Use the **5WH** rule; also known as "**what, where, when, who, how and why**".

Tell them that the competition involves communicating with amateurs all over the world. The competition helps advertise Australia as a tourist destination. If you have previously been successful at winning a section then say so. Show the reporter your certificate and say that you are defending it against strong interstate competition.

Invite the papers/TV/radio to attend, to capture some sounds off air and to take some pictures. If they can't attend then that's fine; offer to take down the story

details they require, get some pictures for them and ask what else they might need.

If it is a local paper they will almost always want photos of people who are either well known or have a lot of relations in the area with clear captions of who is in the photo, what they are doing and who they are talking to. Make it friendly and easy to follow.

Suggest a small piece before the event announcing who you are, what the event is, where and when it is on and why

the public is invited to come and see the action.

After the event, follow up with the photos that you promised. Make sure that they are processed on the next business day and given that same day to the reporter with the details of the event. Most importantly, leave a contact name and number.

If any of the participants attend a local school make sure that they are photographed with mike in hand and then give the story to the school newspaper. That is where you will find tomorrow's hams. While you are at it, provide a copy to any professional or other bodies you belong to for their magazines; Scouts, Institute of Engineers, Teachers Journal etc. Many bodies like to show their members "at play".

Finally make sure that some photographs are given or sent to your local club, the WIA for "Amateur Radio" and your local WIA Divisional News.

Safety

It would be nice to think that our hobby is perfectly safe but in reality there are always risks. As a safety officer I have learned that many people simply ignore the risks and hope that accidents won't happen. I find that the best medicine is to know the risks and take the precautions necessary.

Let's look at the simple risks first and consider what to pack into the first aid box. You were going to take one weren't you?

Bities

You will encounter insects and as such you should take insect repellent, stingoes (or similar) and have some ice handy. Now for the nasty ones -spiders, centipedes and snakes bite when cornered. Have the right bandages on hand and learn what to do if bitten. I won't try to cover it here and there is plenty written about the right treatments. The best plan is know that you are in their territory and avoid them. Do any of your members have an allergy to bee stings and if so how do they react?

The sun will hopefully be out but even if it is not, a day under thin cloud can be just as bad. Take hats and skin factor 15+ lotion with you. Again keep some ice handy in case of heat stroke.

For minor burns, scalds, cuts, abrasions and such have some bandaids, bandages and antiseptic handy. Also keep a stretch bandage for sprains and strains and, you guessed it, have some ice handy. Do you notice that ice is a very practical item?

Masts

Temporary masts may tend to be too temporary. Avoid placing tents within the likely range of any falling mast. Remember that the good old gum tree occasionally sheds huge branches as well. Either could well be silent killers if they drop in your direction. Remember also that masts in the bush can be attractive lightning points. If a major storm builds up you must ensure that you are safe even if it means tossing the cable out of the tent until the storm passes.

Electricity

Generators are fairly safe if used correctly, although I have known of two neighbours who were shocked and killed when trying to move a generator while it was running. Follow the instructions and note the precautions for setting up. Never refuel a generator while it is running. There is too great a risk of sparks from electrical ignition or the exhaust that could ignite the petrol fumes.

RF Burns were quite a risk when I first started doing field days as many antenna tuners were in open boxes or on a fiat board and adjustments were made by moving an alligator clip along the coil. I bet there are still some in common use out there.

Paper Warfare

As the sign in the gents says, "The job isn't finished until the paperwork is done." You will need a log of the contacts made and a summary or cover sheet. Log sheets can be printed up cheaply or made on a friendly photocopier.

It is always better to have more than you need than to run out. You can use one of the computer contest log programs if you trust it but it isn't essential. If possible though have all of the cover sheet and contact details typed into a text file to make the contest manager's job easier.

The cover sheet identifies the team, callsign and equipment used, the operator's names and callsigns that took part and the points claimed for each band.

It should have a statement signed by

a representative of the team stating that both the rules and the spirit of the competition were observed.

A word from experience here, get the cover sheet filled out and signed by the operators on the contest day or be prepared to chase each and every one of them later.

You will also need pens, pencils and other basic stationery including "doodle" paper. Have some clipboards available and other items such as tape and string.

We put together a folder with a collection of "shack-side" data.

In it we included the rules, band plans, Q-codes and the phonetic alphabet, world time zones, AR zones, Australian map and local area map for VHF distances, Maidenhead tables, IPS data from the latest AR magazine, some phrases in

Japanese and a list of club operators that might be attending.

Every year is different, yet every year is a ton of fun. You'll go home tired and perhaps even sore but by simply participating you will have already won. You may have to wait a few months to learn how well you did but you'll be listed there with those who you spoke with, some for the first time, many for the first time in a long time.

I challenge you to go out, find a team and do it. I wish you a lot of luck, lots of contacts and know that you'll have a lot of fun in the process.

Don't forget the camera and notebook – I expect to hear all of the great stories and see some great pictures.

Cheers for now, Bob Harper VK4KNH

Reference – details of John Moyle's life were taken from an obituary published in AR in April 1960 – authors anonymous.

ar

Rescued by a rat

"Amateur Radio to the Rescue once again."

During the QNEWS callbacks on Sunday Morning (24th January) in Townsville, Dave Chandler VK4NN reported that the 2metre **VK4RAT** voice repeater had been put to good use earlier that morning.

VK4NN takes up the story....

We have been enjoying some quite good spells of weather out here at Magnetic Island although the fish aren't biting as well as they should.

Saturday Afternoon whilst at Florence Bay we were overflowed by helicopter RESCUE 521 who advised us that there were some tourists overdue in a hire dinghy.

Being the responsible mariners we are, we agreed to look out for them during the evening whilst we proceeded to anchorage at Jeffries Bay.

At around 5am on Sunday morning we spotted the two tourists on the rocks with their dinghy fully swamped.

Unfortunately the coastline was too

rocky for us to approach so we attempted to raise the local Coast Guard on the Marine HF, with no success.

So we put out an emergency call on the VK4RAT VHF Voice Repeater and were answered nearly straight away by Les Steel VK4ALS (the TARC WICEN Coordinator).

Les knew all the right buttons to press and informed the local police who then attended and got the tourists to safety and medical attention.

We were able to get a line around the swamped dinghy, Dave VK4NN said, and pull it out into open water to prevent it from floating away and becoming a navigation hazard.



We want to pass on our thanks to Les VK4ALS for the fantastic way he responded to our call!"

Gavin Reibelt, QNEWS Townsville re-broadcaster, reported that during the call-backs they were able to confirm this happening with Les VK4ALS who was listening to QNEWS in between scheduling ambulances and medivacs in the Townsville region.

It goes to show that anyone with a radio should 'expect the unexpected'. (ESPECIALLY WHEN TUNED TO "THE RAT" VK4RAT.)

Submitted by QNEWS from TOWNSVILLE VK4ZZ

ar

Test Equipment

An Inductance Meter for Radio Coils

Drew Diamond VK3XU
45 Gatters Road
Wonga Park Vic 3115

For our purposes, the measurement of ordinary values of resistance and capacitance is quite straightforward. Inductance is a bit more involved. Various methods have been detailed in this and other journals in recent years, but the difficulty for many experimenters is in obtaining a sufficient number of accurate inductance "standards" to calibrate a direct-reading meter.

THE MULTI-FUNCTION multimeters with an inductance range generally turn out to be useless for micro and nanoHenry measurement. The intrepid radio worker can apply a dip meter to the job, depending on coil type, but if the coil is enclosed in a can, or otherwise inaccessible, or out of the dipper's range, then we're pretty much stumped.

If the idea of performing a simple calculation is not a bother, and you have access to a calibrated signal source that can output 1 milliwatt or more, then this little gadget may be just the thing. Measuring range is from less than 50 nanohenries to at least 200 microhenries (depending on the generator's output power), which should cover just about

any tuning coil used in the MF, HF, VHF and lower UHF regions. If desired, another simple calculation allows us to make a pretty good estimate of a coil's Q factor.

Circuit

The variable frequency signal from the generator is applied to a 56 ohm terminating resistor, where a 1 pF capacitor couples the voltage thus obtained to the Lx measuring terminals. A 47 pF NPO or silver mica capacitor in combination with strays establishes a "known" of nominally 50 pF at the terminals.

With an unknown inductor connected, the generator is adjusted to the parallel resonant frequency of the 50 pF and coil

combination. Signal voltage will then be at maximum across the terminals. A second 1 pF capacitor couples a sample of the signal voltage to a two-diode detector, thus producing a DC potential across the 100 k sensitivity pot, where an appropriate value is picked off and applied to the op-amp.

A LM-386 is wired here as a DC, or servo amplifier. Circuitry inside the LM-386 sets the gain, and establishes the quiescent (no-signal) DC output at pin 5 to half supply voltage, in this instance +4.5 V. A voltage divider comprised of a 33 k resistor from +9 V, 10 k trim pot and another 33 k to chassis produces a voltage of about +4.5 V at the slider of the trim pot. The 100 microamp meter is connected in what is virtually a bridge arrangement.

Now, the relatively small positive DC detected signal voltage applied to the (+) input of the LM-386 is amplified, causing the DC output at pin 5 to move in a more positive direction, thus unbalancing the bridge and proportionately driving the meter. Current drawn from the 9 V, "transistor" battery is about 5 mA.

Construction

The die-cast box shown measures 122 x 66 x 41 (mm) L x W x H. An ordinary aluminium or plastic box with a metal panel should also serve.

To obtain minimum stray inductance, the "earthy" Lx terminal must connect direct to chassis, with the hot terminal

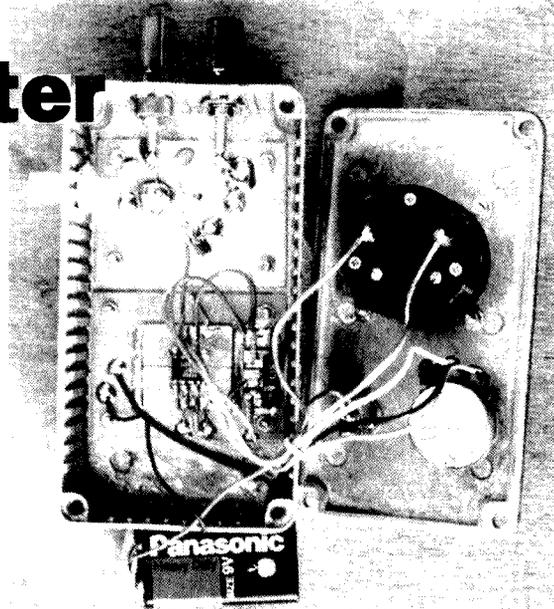

Photo 1: Inside View

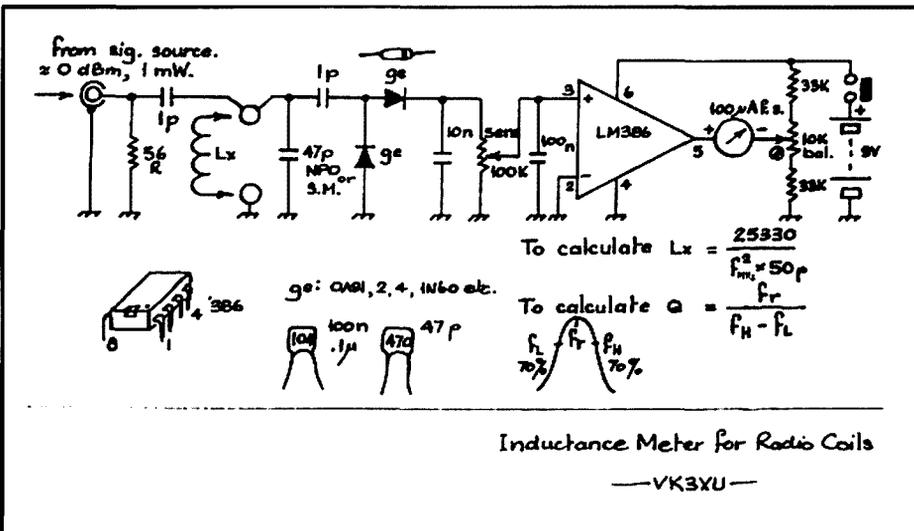

Figure 1

spaced 20 mm from it. The 47 pF capacitor should be soldered between the "hot" Lx terminal and chassis with leads as short as practicable. The 56 ohm resistor, 1 pF capacitors, germanium diodes and 10 nF capacitor should also have reasonably short leads.

A small rectangle of plain printed circuit board may be used to accommodate the components (I used two small boards, but one would be easier). Use direct wiring for all circuit parts between the 56 ohm resistor and 10 n capacitor.

The LM-386 may be mounted "dead-bug", or, preferably, "paddyboard" style (see *Reference 4*). The 10 k balance trim-pot does not need frequent attention, but a small screwdriver adjust hole should be provided in the box.

If you prefer to use a 1 mA meter, substitute 3.3 k resistors for the 33 k ones, and 1 k or 500 R for the 10 k trim-pot.

Operation

Before applying power, check your wiring, paying close attention to polarised components. Set the sensitivity potentiometer to minimum and balance potentiometer to mid travel. With no

signal connected, switch on. Adjust the balance potentiometer for zero deflection on the meter.

Rotation of the sensitivity potentiometer should not cause a significant deflection (you may see one or two needle-widths deflection, however, which is not a problem). Now set the sensitivity potentiometer near maximum.

A typical measuring set-up is pictured. The generator delivers a nominal 1 mW signal, which is applied via 50-ohm coax to the signal input of the meter. Connect your coil to the Lx terminals. Sweep the generator frequency until you see the meter needle flick upwards, then carefully peak the reading. Note the frequency. Inductance in microhenries is calculated by:

If you want to estimate the Q factor of the coil, first obtain a full-scale (100 %) reading as described above. Note the frequency (f_{res}), then alter the frequency upwards until the reading is 70 %, note the frequency (f_{high}), then tune downwards past resonance to 70 % on the low side, and note the frequency (f_{low}). Q factor is estimated by

$$Q = f_{res} / (f_{high} - f_{low})$$

The frequency resolution of the dial must be very good for Q measurement; otherwise, connect a frequency counter to the generator's output.

It would be a good plan to type these formulas onto a card or sticker, and fix it to the bottom of the box for easy reference.

Things get a bit tricky where the coil runs into the hundreds of microhenries and larger. The problem is twofold. Self (or "winding") capacitance of typical coils starts to become significant, and secondly, we find that a fairly large generator signal is required as we get into the millihenries.

A signal generator such as the HP 606 will deliver up to 100 mW, and may allow us to obtain a reading, but the accuracy cannot be relied upon because of the self-capacitance. This can be "swamped" to some extent by connecting an additional (say) 150 pF across the coil, thus making the total resonating capacitance 200 pF.

With a bit of application and practice, radio coils of all kinds can be measured with confidence and reasonable accuracy, from an oscillator coil in a broadcast set, to a hairpin loop for a 432 MHz amplifier.

ar

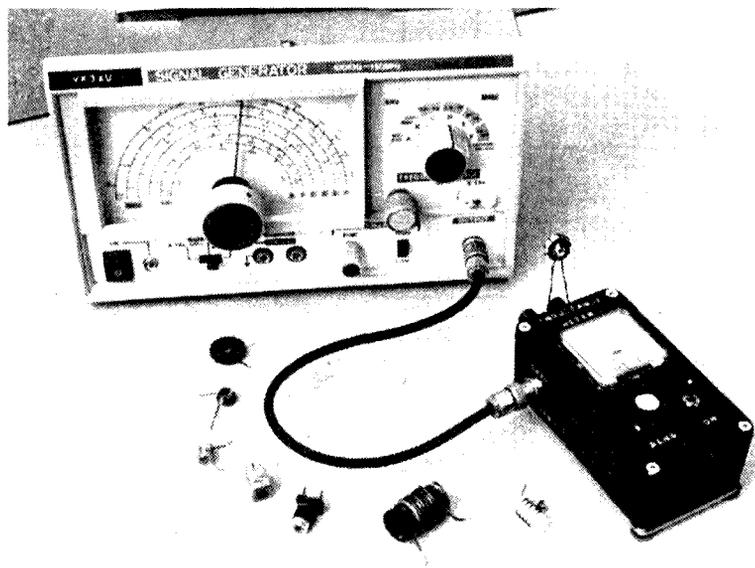

Photo 2: Measuring set-up

References and Further Reading

1. "The G4HUV Inductance Meter" Scott, G4HUV, Rad Com Nov '93.
2. "An RF Inductance Meter" Butler, VK5BR, AR June '97.
3. *Second Thoughts on Radio Theory*, Scroggie, Iliffe Books.
4. "Paddyboard" Circuit Construction; Diamond, Amateur Radio Feb '95.
5. "Little-L" Inductance Meter, Diamond, Amateur Radio Nov '92.
6. "Nano-L" Inductance Meter, Diamond, Amateur Radio May '97.

A 160 Metre Bandpass Filter

Keith Gooley VK5OQ
 Lot 15 Tenafeate Ct
 One Tree Hill SA 5114

If you need a filter for 160 metres to remove interference from AM broadcast signals and other signals above the band, this is it. The response plot shows 60 dB attenuation for broadcast band signals at 1650 kHz and on the high side a similar attenuation is provided at 2.05 MHz and above. The filter can also be scaled to operate on any range of frequencies in the HF and low VHF band provided the same percentage bandwidth is acceptable.

THE FILTER IS a 0.5 dB Chebychev design with a bandwidth of 60 kHz. The 0.5 dB refers to the passband ripple; chosen to give steeper skirts than if the response had zero ripple in the passband. The termination impedances are 50 ohms resistive although the response will not change much if the terminations depart from the design values within reasonable limits.

The response plot was taken from a computer simulation of the filter using the ARRL's Radio Designer software. The actual response of the completed filter followed the simulation remarkably closely.

Construction

The filter should be built in some kind of metal box to achieve the out-of-band rejection afforded by the design. Copper clad fibreglass PCB blank could be used instead. The three coils should be shielded from one another and the shields should be kept away from the coil a distance equal to the coil diameter otherwise the Q of the coil will be degraded. The coils are wound on 25 mm OD PVC tube and if the specified wire is used (25 SWG), the coil Q will be about 190. This will result in the filter having a passband attenuation of about 11 dB rather than the 5 dB shown in the plot. The lower attenuation (5dB) was due to a higher Q value obtained by

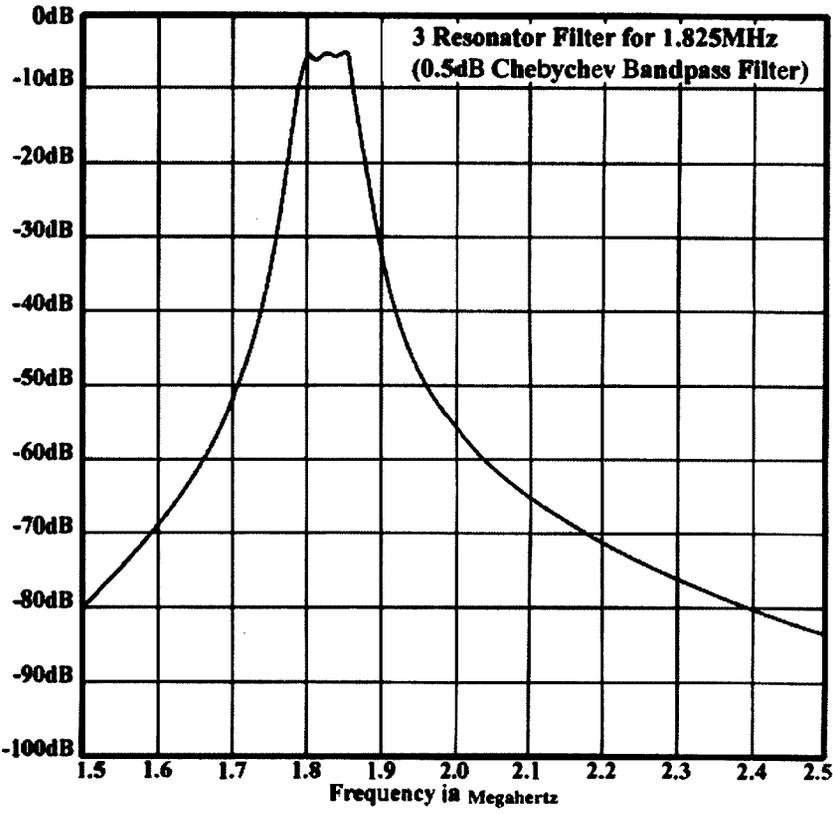

Figure 1. the passband characteristics of the Chebychev fileter as designed

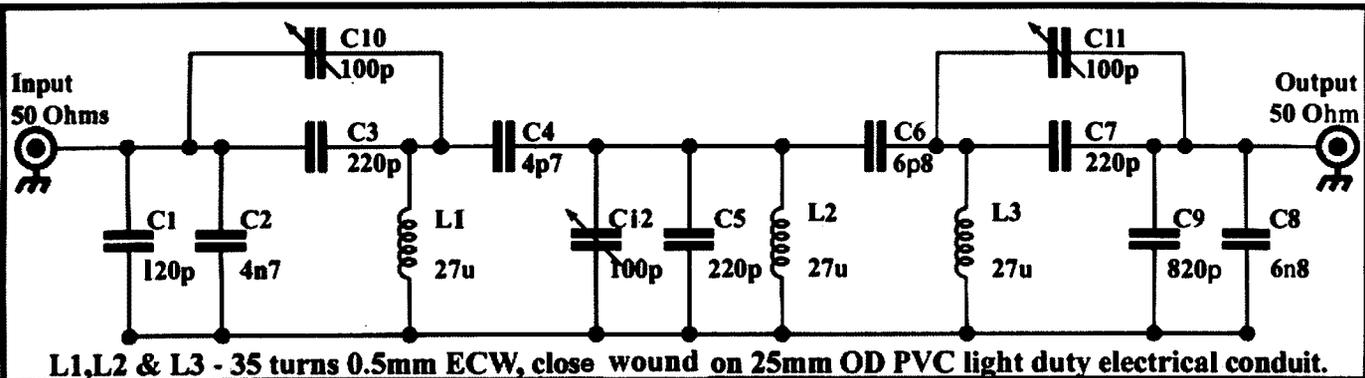

Figure 2. Circuit of the Chebychev filter

using Litz wire instead of the solid enamelled copper.

Litz Wire

For those not familiar with Litz wire, it is a multi-stranded wire with the strands individually insulated. I used 40/44 -(40 strands of 44 gauge wire). All the strands are soldered together at each end of the coil but the fact that they are insulated from each other means that the RF resistance is much lower than a solid wire of the same diameter due to skin effect. The coils wound with this wire had a Q of 300. It was quite a surprise to see the decrease in passband attenuation resulting from the higher Q. So if you can get hold of some Litz wire a better filter will be made.

Capacitors of 220 pF and below should be NPO ceramic or silvered mica (not common these days) while those above this value should be polystyrene or greencaps. Don't use ceramic for these, as they will be too lossy. For the trimmers I used mica compression types but ceramic types could be used as well. Jaycar has recently introduced a 100 pF ceramic trimmer (cat # RV-5722) which would be fine. The commonly available little round ceramic trimmers could be

used although the max capacity of the brown ones is only 50 or 60 pF and the 220 pF components (C3, C5 and C7) may have to be increased to compensate.

Design Values of Capacitors

C1 + C2	4944 pF
C3 + C10	296 pF
C4	5.0 pF
C5 + C12	274 pF
C6	6.8 pF
C7 + C11	289 pF
C8 + C9	7727 pF

Scaling to other frequencies

The design centre frequency of this filter was 1825 kHz. If it is desired to build a filter centred on another frequency f (kHz), multiply the inductance by 1825 and divide by f . Similarly multiply the capacitances by 1825 and divide by f . The bandwidth will be changed in direct proportion to the frequency. That is the new bandwidth will be $60xf/1825$. The bandwidth can be increased by increasing C4 and C6 and vice versa. The overall shape will suffer if this process is taken too far however.

ar

WANTED

A VOLUNTEER TO MANAGE THE WIA CALL BOOK

Duties are —

- to keep the Call Book information up to date
- to add new data as appropriate, and
- to arrange printing for distribution in October each year.

For further details:

Martin Luther VK5GN

AH phone: 08 8524 3440 fax: 08 8524 3836

email: MartinL@AppDes.com.au

ICOM *Clearly Ahead*



"VK3LZ calling!"

More sound information from
your friends at Icom.

EXCITING NEW PRODUCTS
IN THE AIR FOR '99!

Now that we've all well and truly recovered from the Christmas festivities and have effectively kick started the New Year, it's time for us to start spreading the word about the big year ahead for us at Icom.

Following hot on the heels of the extraordinary success of our star products in '98 - the IC-40S, the IC-R2 and the IC-Q7A, our '99 product range is guaranteed to set the air waves on fire!

As we mentioned last month, the new look advertising campaign will feature a broader range of products, with more to tune in to than ever before. No doubt you'll be as excited by the latest word in Icom technology as we are!

We're all looking forward to the next Hamfest at Wyong, New South Wales at the end of the month. Hook up to our web site for more details and don't miss the chance to come along and see, touch and get a feel for all our new goodies. All our dealers will be there demonstrating our exciting new gear - so make sure you're there too!

"...73"

FreeCall 1800 338 915

290 -294 Albert Street
Brunswick, Victoria 3056

Tel : (03) 9387 0666

Fax : (03) 9387 0022

www.icom.net.au

ACN 006 092 575

L. BROWN ADVERTISING AGO

A Telescopic Mast For The Amateur On The Move

Graham B. Jackson
VK3GBJ
Upper Beaconsfield, Vic

Recently my wife and I went on a 10 day field trip into the Pilbara region of Western Australia; I was determined to work HF on the trip, particularly to make contacts with friends back in Melbourne. The biggest problem was how to get that piece of wire to stay up in the air – particularly as the Pilbara is not over endowed with tall trees over which one might sling a wire.

ALSO THERE WAS a tight limit on the gear I could take and whatever I took had to be able to stand a fair bit of knocking around. I would not have the opportunity to even see the expedition vehicles let alone add any fittings to them, prior to the expedition's departure from Karratha.

Single wire antenna

I was striving to put together the smallest portable HF station I could manage. My choice was an ALINCO DX70, an MFJ – 971 ATU and a single wire antenna. Great – but as I said – how to get that piece of wire to stand up. Aluminium tubing, whilst light weight and easy to assemble, suffered from the disadvantage that any rough treatment would dent, bend or buckle the tubing beyond repair.

My mind turned to the possibility of using fibreglass fishing rod blanks. However when I inquired at a supplier of fishing gear, I was told such rod blanks were no longer readily available as it was cheaper to buy an imported rod – complete with all the trimmings – for less than the cost of the pieces needed to assemble a rod yourself. They did have telescopic fishing rods for those who combined bush walking with trout fishing but they were nowhere near long enough – even in the Pilbara I could find trees taller than that.

Playing with a Giant Squid

As I was leaving the purveyor of fishing tackle my eye was taken by a piece of black tubing, which later proved to be only 1120 mm (44 inches) long and 35 mm (slightly over 1 inch) in diameter. It carried a label which announced that it was a "21' GIANT SQUID POLE". This certainly warranted further investigation, and so, with the approval of the aforesaid purveyor of fishing tackle, we proceeded to "have a play".

A surprising pole

The pole turned out to be quite a surprise – it consisted of 7 tubular elements, including the outer case, which easily and smoothly extended out to a pole some 6 metres. (19 ft 6 in) in length. It was surprisingly light – 650 gram (1 lb 7 oz) and surprisingly stiff. This was looking very interesting, particularly as the material of construction was very resilient and would clearly withstand quite a degree of rough handling without buckling, distorting or denting.

Each of the sections was tapered over its length so that as each section was pulled out to its limit the bottom of the section "jammed" in the top of the next section, which then proceeded to extend, and so on until the pole was fully extended. The "jamming" was sufficient to make the mast self-supporting yet easily "un-jammed" when returning the pole to its collapsed state.

With some trepidation I inquired the price and was told \$30.00 – at that point I decided the GIANT SQUID POLE warranted smuggling into the shack for further testing.

Experiments with the pole and a wire some 17 ft long feeding the DX-70 via the ATU gave commendable results on 20 metres, including contacts with UK, Japan, USA. etc. Things were looking good, so the next move was to visit the suppliers of this interesting piece of plastic – Jarvis Walker of fishing rod fame – who manufacture the pole in their factory in Malaysia.

Their Sales Manager – Darren Round – was an interested listener as I told him of what I proposed to do with his GIANT SQUID POLE, however he was reluctant to divulge any details as to the manufacturing process that produced these thin wall tapered tubes. I was advised that Jarvis Walker have been manufacturing

tapered fishing rods for many years and had developed techniques they were not prepared to divulge.

Investigating the tubes

I am still keen to learn how these lovely tapered tubes are made, so if anyone has any bright ideas do let me know! Darren was also not forthcoming on the material of construction, although it is clearly a fibre reinforced product, but I doubt the reinforcing is fibre glass.

I was hoping Darren would be able to provide a small scrap piece of tubing for testing in a microwave oven, but unfortunately no small pieces were available. Why not cut a bit off one section? Well that is not as simple as it sounds. Remember the bottom of each section is so sized that it jams within the top of the next section, whilst the bottom of the outer case section has a closure tightly fitted. Any amputation of a section would render the whole pole useless by causing the jamming of the section to fail.

Portable

The expedition to the Pilbara went well and the pole stood up to the abuse of being thrown in with all the other gear in a 4-wheel drive for 10 days. The method of use was to extend the pole with one end of the wire tied to the tip with a piece of string, and then lash the base of the pole to the bull bar of the 4-wheel drive.

The top section of the pole is flexible like the end of a fishing rod – in fact it is the end of a fishing rod! A piece of cord was tied near the lower end of the wire and this was then tied to the bull bar to maintain some tension on the wire against the spring of the rod tip. The wire antenna was connected to the ATU and worked against the vehicle.

The antenna pole proved highly satisfactory – for those able to add one or two well thought out fittings to their vehicle, using the pole would be made even easier. We tried taking photos showing the pole in use however the proportions made it difficult to come up with anything meaningful. A photo showing the pole extended was taken so far away it lost detail, whilst a close up shows just a length of black tubing.

The only criticism of the pole is that it does not quite make it to the 21' (6.4m) suggested by the label, however 19'6" (5.94m) is pretty good going for such a small light weight mast.

ar

Jaytech 8 Sector Alarm Deal

Save a fortune by buying our ALARM DEAL using the Jaytech 6000 panel. Includes all the components needed to give you a quality basic home alarm system. All you need is a bit of labour & you have a reliable affordable alarm that offers you peace of mind. Cat. LA-5450

INCLUDES	NORMAL PRICE
1 x 8 sector Jaytech panel	\$129.50
2 x Micron pulse count PIRs	\$53.90
1 x mains power supply	\$23.50
2 x reed/magnet switches	\$9.00
1 x siren horn	\$23.95
2 x deterrent stickers	\$4.00
60 m of 4 core alarm cable	\$51.00

Was \$229
February \$199
NORMALLY PAY \$294.85

Valve Socket Assortment

NEW

Each pack will contain 30 valve sockets from 9 pin PCB chassis mount types (over 1/2 t pack contents) to higher pin types. Some packs may even get a 7 pin socket which was common in early battery valve sets. Cat. PS-2065

\$9.95

IEC Double Socket Power Lead

3 pin mains plug to 2 x IEC female plugs. Length 1.85 metres. Ideal to run a computer and monitor from one power point. SAA approved. Cat. PS-4102

\$14.95

FAST NICAD CHARGER & DISCHARGER



Charges AA, AAA, C and D Nicads in 4 hours. See 98 Cat. page 86 for full details. Cat. MB-3500

Was \$69
Only \$49.95

PIR CCD CAMERA

This is a motion activated camera. When the PIR detects someone, the CCD camera is switched on, & the following can be triggered: Alarm output. Terminals are NC, NO and common. 30VDC / 0.5A rated. This NC output will switch a mains lamp up to 500W / 2.5A. Cat. QC-3478



Only \$199

Multi Electronic Tester

Checks AC and DC volts, continuity, transistors and diodes plus more! See 98 Cat. page 29 for full details. Cat. QP-2260

Save \$5.95
Was \$17.95
Feb. \$12

CCD Camera in Case with Infra Red Illumination

NEW

Brand new unit replaces old model which sold for \$169.50. This unit is much smaller, measures only 65(W) x 50(D) and is black in colour. 6 LEDs give the IR illumination which means it can "see in the dark" to some extent. Includes RCA socket for video and 2.1mm DC socket for 12V DC. Great price! Cat. QC-3466

Only \$139

Low Cost DMM

•3.5 Digits •Transistor •Diode •10 Amp •Plug in leads. See 98 Cat. page 20 for full details. Cat. QM-1500

Normally \$19.95
Feb. \$15 Save \$5

2.0uf 250VDC Cap

Our normal price for these is \$2.25 each. We've made a bulk surplus deal, and can offer these at well below normal price. They are white in colour, size 31(L) x 10.5(W) x 20(H)mm. Lead spacing 27mm, lead length 18mm. Cat. RG-5176 Pkt 10 for

\$7.95
\$59

Cat. RG-5177 Pkt 100 for

32V 150W Halogen Swimming Pool Light

Are you sick and tired of paying well over \$30 for a replacement globe for your swimming pool light? We certainly were! So we've done something about it. Attention Pool Shops and bulk users - Contact our Wholesale Dept. for fantastic prices for quantity buys. Cat. SL-2725

\$24.95

VISIT OUR WEB SITE
www.jaycar.com.au

AURA INTERACTOR BODY BLASTERS CUSHION

FEEL THE ACTION

\$200
\$79.95 LESS THAN 1/2 PRICE

FEB \$49.95

We have made a huge distress stock purchase from AURA in USA. We have sold thousands of the Interactor Backpacks, and now can offer a CUSHION VERSION, for a crazy low price. The cushion should sell for well over \$200, but you can grab one - or more, for only \$49.95 each, while stock lasts. **THEY ARE WELL UNDER 1/2 PRICE!** This Interactor Cushion will transform low sounds into movement, so you can actually feel these through your back. Simply place in your lounge chair, or seat, and complete a 3D sound environment for added impact for home theatre, computer games etc. The Interactor Cushion can be used with almost any PC/Mac, home theatre system, CD player or video. Supplied with black cushion (with inbuilt shaker), amplifier module, 240V mains power supply and connecting lead set.

was \$49.95
FEB \$39.95

Cat. XC-1000

BACKPACK

Plug it into computer games, stereos etc, then put the back pack on and feel all the low frequency sounds. See 98 Cat. page 213 for full details.

AURA ADAPTOR CABLE FOR N64 & PLAYSTATION
This pack contains all the leads required to attach the Aura Interactor Backpack to your games console and stereo system. Includes RCA piggyback lead, 3.5mm phone to 2 x RCA adaptor lead, RCA joiners & stereo Hi Fi RCA cable. Total value \$17.40. Cat. XC-1001

\$11.95

JC50 10" Speaker Kit



December for details. Speaker kit & built cabinets. **NEW**

\$869 pair

EMAIL ORDERS
mailorders@jaycar.com.au
EMAIL YOUR ORDERS NOW

Jaycar ELECTRONICS

Jaycar stores located in - Sydney, Melbourne, Brisbane, Adelaide, Hobart, Perth, Canberra, Newcastle, Auckland NZ and Dealers in most country areas. Call Freecall 1800 022 888. Fax (02) 9743 2066. Website: www.jaycar.com.au
Special prices and deals available until February 28th 1999.

RF Low Pass Filters

Ron Sanders VK2WB

Low pass filters are commonly used in amateur equipment to reduce the passage of harmonics. This is particularly true at the output of transmitters, where any radiated harmonics can cause interference and are also illegal if above the legal threshold. There is plenty of information in the various handbooks that cover the theory and application of these filters. The most common low pass filters used at the output of amateur transmitters have equal input and output impedances, eg 50 ohms.

THIS ARTICLE WILL SHOW some practical results obtained from the construction of 3.5MHz low pass filters using readily obtainable components, and having input and output impedances of 50 ohms. Such filters would be used at the output of a home-brew 3.5MHz transmitter, with the aim to reduce the harmonics reaching the antenna system. Commercial transmitters will have equivalent filters built into them so that they comply with regulations.

For transmitters in the HF range the following spurious emission standards generally apply:

- rf power less than 5W at least 30dB below the fundamental
- rf power less than 25W at least 40dB below the fundamental
- rf power more than 25W at least 60dB below the fundamental
- at any rf power spurious emissions must never exceed 50mW

Low pass filters are usually specified as having a number of elements. The elements referred to are the reactive components used to construct the filter, namely the capacitors and inductors. Since the form of the filter is symmetrical it always ends up with either a capacitor

or an inductor at the input and output. The most common form is to use capacitors at the input and output, but some PA stages are unstable if they look into a capacitance and require an inductance at the input to the filter.

Circuits

The simplest and most common filters are called Chebyshev filters and are the type used in this article.

Fig. 1 shows a filter which consists of 3 capacitors and 2 inductors, which adds up to 5 reactive components and is therefore called a 5 element low pass filter. Without going into the theory of the filter it can be seen intuitively that this is a low pass filter because of the capacitors which connect from the signal path to ground. With an increase in input frequency the capacitive reactances will decrease thereby providing lower impedance paths to ground that will reduce the level at the output with respect to the input. As a matter of interest, guess what would happen if the circuit had capacitors and inductors reversed? We would have a high pass filter, but that is not the subject of this article.

Fig. 2 shows a 7 element low pass filter, and Fig. 3 shows a 9 element low pass filter.

Construction

All component values were measured by "amateur" type equipment and are within about 5% of the calculated (theoretical) values which are given in the circuit diagrams. These values were obtained from the ARRL Handbook reference section for Chebyshev low pass filter designs, 50 ohm impedance, C in/out for standard E24 capacitor values.

The components used in the filter determine the stability of the frequency response, so it is important to only use components with low temperature coefficients. The ideal capacitor is a silvered mica type with adequate voltage rating for the application. These are obtainable in 1% tolerance from RS Components, but are not cheap. An alternative is to use polystyrene capacitors which are available from Dick Smith and possibly other suppliers. The required values can be made up from parallel combinations of standard values. Where possible, try to use similar values to make any parallel combination as this will more evenly distribute the rf current flowing in each capacitor, and so reduce any localisation of heat in a single component. For example, it would be best to make up a 1330pF combination from 2 x 470pF and 1 x 390pF, rather than 1 x 1000pF and 1 x 330pF. If you have the facilities to measure the values you can almost eliminate the tolerances in the individual capacitors and come up with a 5% tolerance for the combination. Refer to AR April 98 p26 for a suitable instrument.

The inductors for this particular filter are wound on AMIDON T68-2 toroidal cores, which are available from advertisers at the back of this magazine. Toroidal cores are almost universally used in these filters as they have very little coupling between inductors and are much more compact than air-wound coils. To reduce the coupling to a minimum, it is good practice to position adjacent cores at 90 degrees relative to each other. This is most important where the filter is crowded into a small space. Spread the turns evenly around 270 - 330 degrees circumference of the core and use the heaviest gauge that will comfortably fit in that space in a single layer. Do NOT wind the core so that the winding occupies 360 degrees, as the capacitance

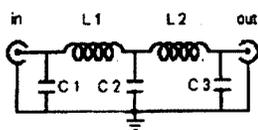

Fig. 1 4MHz 5-element low pass filter

- L1, L2 3.03 uH,
22 turns 24g on
T68-2 core.
- C1, C3 750 pF
- C2 1500 pF

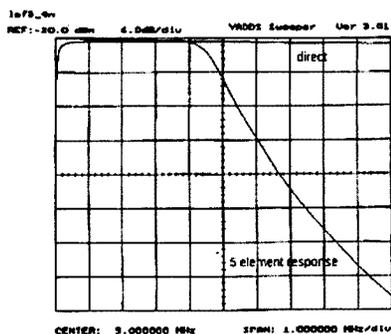

Fig. 1a

between the ends will produce spurious responses that are unpredictable. This warning applies to any toroidal inductor used in rf circuits.

Double-sided pc board makes a very good platform for these filters. The top side is used as a ground plane with circuit connections on the lower side. The filters also lend themselves to a "rats-nest" type of construction on a single sided pc board, with the inductors sitting in line between the input and output and the capacitors connected from the junctions to the ground plane.

Several filters can be built on a single board with suitable switching of the input and output. The input and output impedances match up to RG58 coax and make connections much easier. These filters can be enclosed in a screened box with coax connectors at the input and output.

The construction is quite simple and a filter can easily be made up in an hour or two. The filters shown here were operated at about 50W without noticeable heating of the inductors.

Results

The relative response plots of each filter are shown in Figs. 1a, 2a and 3a and were obtained using the "sweeper" designed by Tibor Becce and featured in *Electronics Australia* over several months in 1996/7.

Note that the response of all plots is almost identical below 4MHz, and shows that there is almost no loss through any of the filters.

Details

1. Fig. 1a shows the response of the 5 element filter shown in Fig. 1. Above 4MHz it falls at about 11dB/MHz, and is better than 24dB below our reference at 7MHz which is the second harmonic of the start of the 80m band at 3.5MHz. This represents an attenuation of at least 250, in other words any 7Mhz content present at the input to the filter will be reduced by a factor of 250. If 1W of 7MHz rf was applied to the input there would be less than 4mW at the output.
2. Fig. 2a shows the response of the 7 element filter shown in Fig. 2.

Above 4MHz it falls at about 18dB/MHz, and is about 40dB down at 7MHz. By adding two more elements to the first filter we have gained about 16dB extra attenuation of the second harmonic of 3.5Mhz. Now 1W of 7Mhz rf at the input would only be about 100 uW at the output.

3. Fig. 3a shows the response of the 9 element filter shown in Fig. 3. Above 4Mhz it falls at about 30dB/MHz, and (by extrapolation of the plot) is about 60dB below our reference at 7MHz. We have now gained another 20dB attenuation at the second harmonic of 3.5MHz. A 1W input at 7MHz would now result in only 1 uW at the output.

Other Frequencies

Similar filters can be made for other HF bands. Details of component values are listed in the ARRL Handbook reference section on filters.

The characteristics and winding information for AMIDON cores is listed in the ARRL Handbook. For the HF amateur bands the following iron powder materials are suitable:

material type (mix)	frequency coverage (MHz)
2	1.8 - 10.5
6	14.0 - 18.5
10	20.0 - 30

For operation at higher rf power a physically larger core should be used. This could be made up of two T68-() cores stacked together which would be adequate for 100 - 150W of rf output.

Conclusions

The choice of the filter type, whether it should have 5, 7 or 9 elements will depend on the particular application.

A transmitter which has only a single ended PA stage will have considerable second harmonic content at the output, and should use at least a 7 element filter to reduce the harmonic radiation. If the transmitter above generates only low power, say less than 25W, a 7 element filter will probably be adequate. A single ended PA that generates more than 25W should use a 9 element filter.

Where a balanced PA stage (push-pull) is used, the second harmonic is reduced by at least 10dB and a 5 element filter may be adequate depending upon the output power.

A 7 element filter is a good choice for most transmitters in the 100 - 200W range.

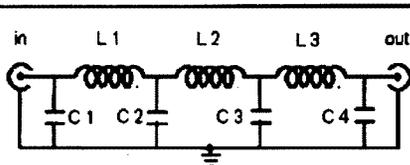

Fig. 2 4MHz 7-element low pass filter

L1, L3	2.86 uH, 21 turns 24g on T68-2 core.
L2	3.26 uH, 23 turns 24g on T68-2 core.
C1, C4	750 pF
C2, C3	1500 pF

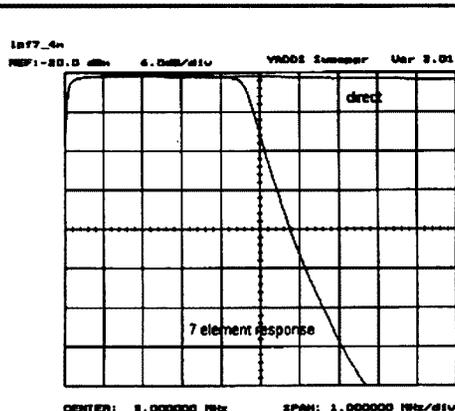

Fig. 2a

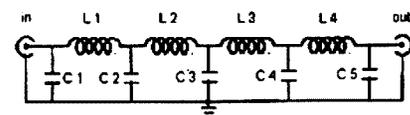

Fig. 3 4MHz 9-element low pass filter

L1, L4	2.86 uH, 21 turns 24g on T68-2 core.
L2, L3	3.26 uH, 23 turns 24g on T68-2 core.
C1, C5	750 pF
C2, C3, C4	1500 pF

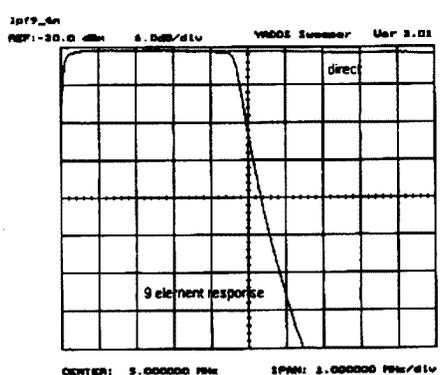

Fig. 3a

*HF-MT Dummy Load

By Ross Fraser VK2KVV

52 Terry Rd
Box Hill NSW 2765

This is a handy piece of test equipment, useful for frequencies from 1.8MHz to 30MHz. It can absorb a modulated carrier power of 200 watts continuous for about 2 minutes (Ref 1), enabling transmitter tuning off-air and so minimising interference to other spectrum users. Its construction is straightforward and it uses readily available parts. It is housed in a Milo tin or similar, and part filled with dry sand which aids in its power dissipation.

A DUMMY LOAD IS an artificial antenna that represents to the output of the transmitter an essentially ideal load. Therefore, the transmitter can be tuned to deliver its output into a correct load. Once the transmitter is tuned, it can be matched to the antenna. Ideally the dummy load will be exactly 50 ohms (the same as the output impedance of the transmitter) and also be able to absorb the power output from the transmitter. A dummy load is especially useful for tuning of a transmitter with valves in the final output stage. This is because a valve based output stage has to be manually tuned into a load. (Solid-state transmitters are generally broad-band amplifiers which are tuned by design and manufacture.)

Construction method

This article is essentially a reproduction of the high-frequency dummy load described by F C Judd (Ref 1). Figures 1, 2 and 3 should give any potential constructors sufficient information for making the dummy load



but I shall also describe my construction method: -

- The dummy load is housed in a Milo tin measuring 122 mm high and 105 mm in diameter. Obviously, any similar container would be suitable.
- Cut two circular plates (90 mm diameter) from other discarded tins (I used old coffee tin lids) and file off rough or sharp edges. It is also a good idea to clean the plate surfaces with a kitchen scourer or steel wool to assist soldering later on.
- Drill or punch holes (about 1 mm diameter) for the resistors in both plates. Lay one plate on top of the other so that the holes match up (refer Fig 3).
- Drill holes in the top plates for the support bolts and also in the centre for the centre conductor to pass through. Also at this stage drill a small hole on the outside of the top plate for the heavy wire leading from R21 (2.2 kohm, 0.25 watt) to the bottom plate of the resistor network assembly. The main reason for using heavy wire at this point is to provide mechanical support for the matrix board assembly. Also drill a hole in the centre of the top plate for the centre conductor to pass through.
- Insert all of the resistors between the top plate and the bottom plate and solder them in. I found that a good method for doing this is first to put the resistors through one plate, bend the resistor lead and solder it to the same plate and then line up the next plate and solder the other side of the resistor to it.
- Once the resistor network assembly

is complete the hard part is done. Solder the heavy wire in place and the centre conductor wire so that it is soldered to the bottom plate and passes through a hole in the centre of the top plate extending above the top plate by about 30 mm.

- Drill holes in the top of the tin lid for the SO239 socket and the socket supporting bolts, the main supporting bolts and the LED.
- Mount the LED, SO239 socket and, using 25 mm spacers, secure the resistor network assembly to the lid.
- Solder the protruding centre conductor wire to the centre conductor of the socket.
- Solder 4 earth straps (I used short lengths of braid from RG-58C/U coax) from the top plate of the resistor network assembly to the underside of the lid. I also soldered link wire from the SO239 bolts to the underside of the lid to ensure satisfactory earthing.
- The next thing to do is the matrix board assembly. See Fig.1 for the wiring diagram. I soldered R22 (5.6 kohm) from the matrix board assembly directly to the top of the lid. The heavy wire from the bottom plate of the resistor network assembly is soldered to one end of R21 (2.2 kohm).
- To complete the assembly I put a piece of stiff cardboard behind the matrix board assembly and using a cable tie secured it to one of the resistor network assembly bolts. This was to ensure that the matrix board assembly didn't accidentally short against one of the spacers and also to keep the matrix board assembly in place.
- The final thing to do is to put the sand into the tin. I used Sydney sand (which has about the same consistency as sugar). I also made certain that it was completely dry by baking it in a cake tin in a conventional oven for 30 to 45 minutes on 200 degrees Celsius. If the sand contains foreign particles it might be a good idea to sift. Once the sand is clean and dry put enough into the tin to fill it half way up the resistor network assembly.

**HF-MT stands for
"High Frequency — Milo Tin"*

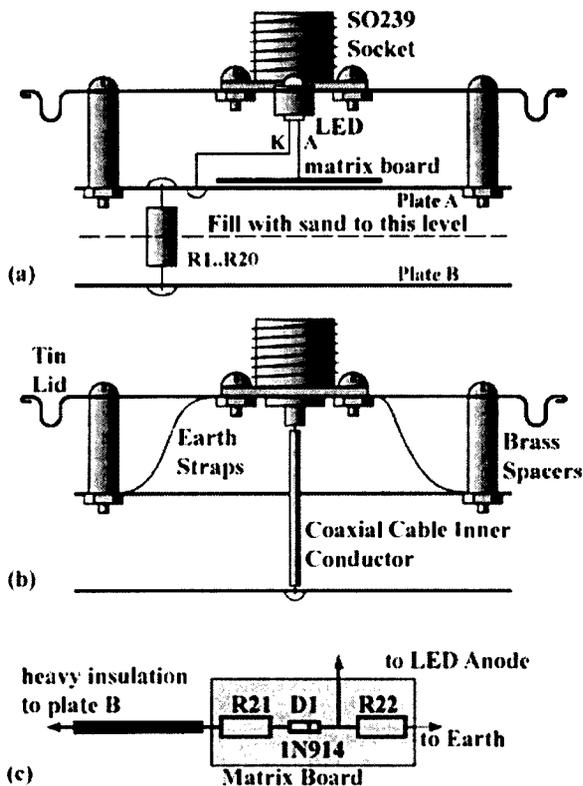

References:

1. F C Judd (G2BCX) RF Dummy Loads Part 1, Practical Wireless, Jan. 1983

Related articles:

1. Drew Diamond (VK3XU) Power Meter/Dummy Load (with notes on PEP), Amateur Radio, April 1993
2. Hank Prunckun (VK5NCA) Build a Simple Dummy Load for Your Shack, Radio and Communications, February 1998
3. F C Judd (G2BCX) RF Dummy Loads Part 2, Practical Wireless, Feb. 1983

Parts:

- 20 x 1 kOhm, 2 watt, 5%, carbon resistor (R1 to R20)
- * I obtained R1 to R20 at RS Components, Phone: (02) 9737 9966
- 1 x 2.2 kOhm, 0.25 watt, 5%, carbon resistor (R21)
- 1 x 5.6 kOhm, 0.25 watt, 5%, carbon resistor (R22)
- 1 x 1N4148 (or 1N914) diode (D1)
- 1 x square SO-239 UHF socket

Miscellaneous: Metal container (122mm x 105mm); 2 x 90mm circular tin plates; 5/32" x 40mm round-head bolts and nuts; 1/8" x 12mm round-head bolts and nuts; 2 x 25mm spacers; matrix board (40mm x 30mm); 1 x 5mm Red LED plus holder; earth straps; stiff cardboard (40mm x 30mm); cable tie.

ar

Support the Advertisers

who support

**Amateur
Radio** magazine

Andrews Communications Systems

(EST. 1976 - ACH 001 968 752)

ALINCO

**AUSTRALIA'S FIRST AUTHORISED
FACTORY DIRECT IMPORTER**

*No 1 & Biggest Importer with one or two
shipments monthly.*

- ★ FULL 3-YEAR FACTORY WARRANTY
- ★ INSTANT REPAIRS ON FRIDAYS

*We Sell Most Brands And Make
Baluns, Verticals, Yagis, P/S.*

ICOM-KENWOOD-JRC-AOR-EMOTATOR-
MJF-DIAMOND-TIMEWAVE-KANTRONICS-
THP-GARMAN-TERLIN-UNIDEN-ETC

*We Urgently Want Good HF, VHF, UHF
Transceivers And Repairs.*

NEW IC-706II & IC-756PRO

**NOW 3-YEAR WARRANTY ON
NEW ICOM SOLD BY US.**

*** OVER 20 YEARS OF SERVICE ***

Call us for unbeatable prices . . .

(02) 9636 9060 or (02) 9688 4301

SHOP 8, 41 BATHURST ST. GREYSTANES,
N.S.W. 2145. FAX (02) 9688 1995



AV-COM
Pty.Ltd.
**SATELLITE TV
EQUIPMENT**

\$7.50
**SATELLITE
RECEIVER**

Ex commercial service
#NEC 1022

- 700-1700 MHz Input
 - 8 Channels
 - Need PLL Audio Demodulator
 - Need Video de-emphasis filter
 - Circuits available
 - High performance UHF Modulator
- Clubs: ask for free sample
(excluding freight)
Max 10 per order

Tel: 02 9949 7417
02 9948 2667

Fax: 02 9949 7095

Internet: <http://www.avcomm.com.au>

The Car Battery As A Low Cost Power Source

Ian Cowan, VK1BG
cowan@effect.net.au

A large amount of radio equipment now available, at least for input power levels up to about 200 watts, is designed for operation from a nominal 12V DC supply. This normally means that the equipment can be expected to operate satisfactorily if the on load supply voltage is between about 11.5 and 15 volts.

With care, the bottom end of this range can be satisfied unaided by the humble car battery, and many operators are opting for this approach to powering their new black boxes. Car batteries are cheap, and can perform this role very satisfactorily, but are subject to mysterious early failures if not treated correctly.

In this article, I want to provide guidance on the use of the car battery so that operators may get the best results available for a given situation.

Structure of the normal lead acid car battery

Not all lead acid batteries are the same; a battery for any particular purpose is an optimised compromise, designed to suit the intended final application. The car battery is no exception to this. The main characteristics of the car battery's design environment are vibration; a frequent, but shallow charge/discharge cycle regime; heavy current discharges for engine cranking; intermittent recharging from a voltage regulated, current limited source; and of course, the user's expectation of endless life!

There are now three broad categories of car battery available to meet these conditions. By taking particular account of the characteristics of each individual type, it is possible to avoid the early failure syndrome sometimes encountered by amateurs.

For our purposes there is no need for a detailed knowledge of the chemical reactions taking place during the charge and discharge cycles. Most will be familiar with the fact that the usual cell is made up as a 5, 7, 9, or more, layer sandwich of plates. Positive and negative plates are interleaved, and there is always one more negative than positive plate - for the simple reason that the negatives are structurally stronger and can therefore help restrain the positives from falling apart.

The active materials of both plates are pressed into lead alloy grids, designed to optimise mechanical strength, conductivity, active material content and retention, and resistance to the hostile sulphuric acid environment. The negative grid in wet cells contains about 6% antimony, the purpose of which is to improve mechanical strength. The active material within the grid is "spongy lead", which is chemically a very pure, but porous, form of the metal. The negative plate usually gives little trouble.

It is at the positive plate that most of the problems in lead acid batteries occur, and it is in the grid structure of this plate that most of the compromises are worked by makers to achieve optimum results for a particular application. Ideally, the positive grid should be made of the purest possible lead, but this ideal is unavailable in a car battery because of the lousy mechanical properties of the pure metal!

Some quite complex alloys have been worked up over the years but the major component (other than lead) of these is either antimony, or occasionally, calcium. Antimony is preferred because it not only strengthens the grid structure, but also improves the battery's load cycling tolerance. The active material at the positive plate is nominally lead oxide, but here too, makers have attempted to defeat the odds by adding small quantities of other materials to achieve particular objectives relating to the intended end use.

Battery failures are usually due to corrosion of the positive grids and support structures or to progressive decay/crumbling of the positive active material.

There are three broad classes of car battery in wide use, and these I will call conventional, low maintenance, and maintenance free.

Conventional battery

The conventional battery (often called heavy duty nowadays) has antimonial positive plate grids, usually with about 6% antimony. They work reasonably well in their intended environment and are quite forgiving of misuse. However, antimonial poisoning of the spongy lead active material at the negative plate is a serious problem.

By an electrolytic reaction, antimony from the positive plate grid is deposited during the charge cycle on to the negative active material. Here it sets up a local reaction with the spongy lead that has the effect of locally discharging the negative, and causing the electrolysis of water from the electrolyte.

The discharging negative calls for more input from the charger, and since this charge current flows also through the positive plate, the positive becomes overcharged and therefore suffers corrosion damage. This battery type is characterised by high water loss, and in fact water use and charge current both rise steadily through the life of the battery, as the antimonial poisoning of the negative plate progresses.

The conventional battery has poor charge retention, and needs regular top up charges to keep it in good condition - not a problem in most cars. Failure occurs at the positive plate when grid corrosion becomes excessive. Fortunately, the poisoning effect is mitigated somewhat by regular cycling between charge and discharge, as this tends to disperse the fine layer of antimony which forms over the active material at the negative plate.

This type of battery is not suited to long term float charging.

Low Maintenance battery

The low maintenance battery arose from experiments to see how low the antimonial content of a car battery could go whilst still maintaining satisfactory mechanical properties. The answer turned out to be about 1.8% so long as some

other additives are also included in the alloy in small quantities. The result has been a battery that still suffers a degree of antimonial poisoning of the negative plate, but has markedly less water and electrical losses than a conventional battery.

It is not quite as rugged as the conventional battery but will give good results in its designed application. Like the conventional battery it needs shallow cycling and discontinuous charging for antimony dispersal. It, too, is unsuited to long term float charging.

Maintenance Free battery

Maintenance free batteries make use of recombination electrolyte (RE) technology in which recombination of hydrogen and oxygen takes place within the cell as the gases are formed, so maintaining the electrolyte level and composition. The electrolyte quantity is limited, and it is either restrained within a microporous separator, or is gelled in silicic acid.

These batteries are provided with oversized negative plates that do not become fully charged, and therefore do not liberate hydrogen. It is here that recombination takes place. Oxygen that forms at the positive plate when it reaches its full charge state readily diffuses through the limited volume of electrolyte to the negative plate where, by a fortuitous set of circumstances, it eventually combines with hydrogen to form water.

The recombination process is readily overloaded, however, and when this happens gassing occurs and the cell dries out and is destroyed. RE batteries use lead calcium type grid alloys (with other additives such as tin) for both grids. This does away with antimonial poisoning of the negative plate and so the battery has very low self-losses, which unlike the antimonial flooded battery remain more or less constant throughout the life of the battery.

Cycle life is typically not as good as for the antimonial battery though the makers attempt to compensate for the loss by the addition of additives to the electrolyte. The RE battery generally has poor tolerance to deep discharges. Of the three car battery types, however, the RE

battery would offer the best performance on continuous float charge provided the charger was well regulated.

Applications

Amateur applications will normally be classified as home, mobile, or portable.

In the shack, the choice of battery type depends mainly on the charging arrangements. If long term "float" charging from a well-regulated charger (ie 13.50 volts DC, +/- 1%, with low ripple) is intended, the maintenance free type is the battery of choice. It is free of the antimony in the positive plate that promotes water loss and positive plate corrosion on long term float.

Deep discharges should of course be avoided, but an occasional burst will do no harm and may even be beneficial to battery life. The maintenance free battery is the least tolerant of the three car battery types to deep discharge, but is the most shack compatible, since there is no chance of acid spillage, nor is gas liberated under normal conditions.

Conventional or low maintenance types may also be used in the shack, but not on float charge. Gentle cycling is best for these. The conventional battery offers the best resistance to deeper discharges. However it is always important to fully recharge as soon as possible after a discharge in the interests of minimising harmful sulphation. The recharged battery should then be allowed to sit in a cool place until next needed. However regular refresher charges (say at two-week intervals) are needed to minimise sulphation.

The mobile application is close to that for which the car battery has been designed, and therefore requires the least intervention by the operator to look after the battery. Because the radio equipment will on occasions be used when the engine is off, the battery will be subjected to deeper than normal discharges and so a conventional battery can be expected to give the best life and reliability. The other types can also be used, of course, but as said above, these have less tolerance to discharge cycling. In any case, battery charge recovery can be slow in a vehicle in a typical suburban environment, and refresher charging is therefore recommended as soon as possible after anything more than a slight discharge. Portable and field day work

usually requires that the battery is the prime source of power for the duration of the exercise, and it is therefore subject to deep discharge. If this is something of a regular occurrence, none of the car battery types will last very long!

The operator would be advised to invest in the more robust semi-traction (or golf buggy) type of battery that is built better to tolerate this type of service, but at higher cost of course. For occasional field excursions, however, the best of the car battery types is clearly the conventional "heavy duty" type. The maintenance free type should be avoided because of its inherent intolerance of deep discharges.

Charging Techniques

The apparent simplicity of the automotive charging system is really quite deceptive. In spite of the low component count, the battery charger built into a car has performance which is difficult to duplicate in a much more complex mains driven unit. It has good voltage regulation, high current capability with inherent current limit, and even thermal compensation. It operates for a few hours only in a normal week, yet car batteries in normal service commonly last 4 years, and sometimes 6, in automotive service. The only drawback is that with this system it takes perhaps 24 hours of continuous operation to restore a 95% charged battery to the fully charged state.

For mobile operation, it is usually sufficient to let the car's generator look after the battery, and therefore forget about it. The exception to this is the case where the battery has been subjected to an extended discharge (say 10 AH or more taken from it). With intermittent engine operation, it could take weeks for full recovery, and the battery is therefore at risk of suffering permanent sulphation damage.

A refresher charge from an external source is useful in this case: A constant current charge of about 500 mA should be continued until the battery terminal voltage reaches about 14.5 volts. (14.0 volts in the case of MF types). 24 hours at this charge rate is typically enough, yet the battery is not at great risk if the operator forgets to take the charge off for a few extra hours.

Shack-bound batteries, and those used for portable operation are best charged from a voltage-regulated, current-limited source. After a discharge, the battery will at first draw a heavy current (held down by the current limit in the charger only) and should remain on charge until the charge current has fallen away to some low, but constant value. It should then be taken off charge and left alone until next needed.

If the idle period is long, the battery should be given refresher charges as if it were in storage - see below. Maintenance free batteries can probably be left continuously floated across the output of a well-regulated charger, but this does not apply to the other two types. Suitable charging voltages are typically 14.0 volts for conventional and low maintenance types, and 13.5 volts for maintenance free types. These voltages should be held to within about 1% when the battery is approaching full charge. Current rating doesn't matter; a larger charger shortens charging time while in the constant current mode, but it takes more than 24 hours anyway to restore the battery to full charge. Beware of chargers which can overcharge a maintenance free battery. If the battery

gasses due to overload of the recombination reaction, the electrolyte will lose water, and with the restricted amount available, this is serious. Permanent, irreversible damage is the result. At least with the wet cell types, water addition is possible, albeit with some difficulty in the case of the low maintenance types.

Battery Storage

The main thing to remember here is that batteries undergo a self-discharge reaction when left on the shelf. This is worst in the conventional type, and is a direct consequence of the high antimony level in the positive plate grid. Such batteries should not be left without refresher charges for more than about 2 weeks at a time, and the 500 mA regime I described above would be suitable.

Alternatively a spell of a day or so on a constant voltage charger would also be effective. Maintenance free batteries should have low self-losses, and could be left on the shelf for a couple of months between refresher charges. Low maintenance batteries, because they contain a little antimony, are somewhere in between the other two in this respect.

Safety

Batteries are dangerous in two main ways.

Burns

The first is that the electrolyte is a corrosive material capable of causing severe burns to unprotected skin, and blindness if it gets into the eyes. It makes sense to wear goggles when handling batteries in any way and to ensure that there is a supply of fresh water nearby to flush away any electrolyte that may escape from a battery. To have a packet of bicarbonate of soda close at hand is also a sensible precaution.

Explosion

Second, batteries can explode with considerable force if ignited. This is due

to the fact that when a battery gasses, as it does when approaching the full-charge state, it produces an optimally explosive mixture of hydrogen and oxygen. A tiny spark is all that is needed to trigger an explosion sufficient to blow the battery apart, spraying electrolyte everywhere. Extreme care is therefore needed to ensure that no spark or naked flame is allowed in the vicinity of a battery on charge, or one that has recently been on charge.

This poses problems when connecting equipment, including the charger itself, to or from the battery. Normal rules concerning the avoidance of accidental short circuits to the terminal posts apply. Further, one must never connect or disconnect an energised charger to the battery, nor connect or disconnect a load circuit which is not isolated from the load.

Chargers should be switched off at the mains first, and then be disconnected from the battery - preferably after a suitable time delay to allow the dissipation of residual hydrogen. Fortunately hydrogen is a highly mobile gas, and it escapes fairly quickly if given the chance. No doubt many untrained people unknowingly owe their eyesight to this fact!

Short circuit

A third, usually less hazardous feature, is the very low internal resistance of the car battery. Anyone who has inadvertently short-circuited the terminals of a healthy car battery will know that a fearsome amount of energy can be liberated in a short time. So care is necessary to avoid inadvertent short circuits.

It is therefore essential that a suitable fuse or circuit breaker is used to ensure safe, rapid isolation of the battery in the event of an electrical fault occurring somewhere downline from the battery. Failure to do this can result in severe damage to equipment wiring, or even fire.

ar



**AMATEUR
TRANSCIVER
RADIO CENTRE**

ALINCO AUSTRALIA'S NO 1 ALINCO
FACTORY AUTHORISED
DEALER

SEE US AT THE CENTRAL COAST FIELD DAY,
SUNDAY THE 28TH FEBRUARY AT
WYONG RACECOURSE
HUGE DISPLAY - UNBEATABLE PRICES.

BIGGEST MONTHLY IMPORTER GENUINE
EXPORT MODELS FULL 3 YEAR WARRANTY
ALINCO SPECIALIST

DX-70TH, DR-610E, DX-77E, DJ-G5EY



IC-746, IC-T8A, IC-706MKIIG,
IC-Q7A, IC-207H, IC-821H,
IC-PCR100, IC-R2

CREATE ANTENNA ROTATORS FULL RANGE



NRD-545G NEW RECEIVER,
NRD-345,
JST-245 TRANSCIVER

KENWOOD TS-570SG TM-V7A
TH-G71A VCH1

PHONE (02) 9896 2545

E-mail: atrc@bytelink.com.au

Web Page:

<http://users.bytelink.com.au/atrc>

**Amateur
Radio Spans the World**



CLUB NEWS

Send your club news and events to Club News

Compiled by Bob Harper
VK4KNH

Central Highlands Amateur Radio Club Of Tasmania

Theyre coming to get you!

Nestled in the foothills of the Australian Alps is the small town of Dargo, a little gem.

It seems that the Tasmanians have chosen this quiet locale as the site of their northern invasion that informed sources predict will occur on Friday the 26th of February 1999.

The plan is to dig in until at least Sunday.

Activities will include general sight seeing, winery visits, four-wheel drive trips, fishing, some radio events and telling lies around the campfire. We also hope to have a couple of trade displays on site so you can check out some of the latest gear.

Being social types we extend an invitation to all amateurs and radio enthusiasts to come and join us.

Activities will be centered on the **Dargo Caravan Park**, owned and operated by Tom and Rosemary Freeman.

Planned call-in frequencies are 3.585, 7.115 and 146.45 using the club call VK7CHT suitably qualified operators being present.

We expect to be monitoring all frequencies from mid morning on the Friday 26th.

So hook up the van or chuck the tent in the boot (don't forget the esky) and come join us.

Sites are available within the park for either tent or van.. Some cabin accommodation is available if you get in early.

For site bookings and general inquiries contact Claureen (VK3LCM) or Dave (VK3JKY) on 03 5977 4439 (AH) or email

TTSSYS@peninsula.hotkey.net.au.

The Great Amateur Radio Funday

THE VERY FIRST Great Amateur Radio Fun Day will be held at the **Daisy Hill Environment Park (QLD) Sunday 21st February 1999 11am**. It's a great place to bring the family.

The social and fun get-together has been organised by Brian VK4BBS. Brian hopes he can be assured of the support of SE Queensland clubs. Not only should you and your fellow members attend but you'll be free to talk to other visitors interested in Radio and Electronics, particularly Radio Amateurs and Shortwave Listeners. There may be some looking for a local radio club in your area to join.

Brian is further requesting support with a small, portable demonstration or activity as an indication of what Radio Clubs and Amateur Radio, particularly yours are all about.

These small demonstrations could include, Portable Packet, ATV, Fox Hunt, Portable RTTY, Mobile HF, Small Potable Antennas, CW Demo, Portable SSTV, 10 and 6m repeater operation etc.

The Southside ARC has indicated that they are prepared to help with the day perhaps a small activity demonstration also. City Of Brisbane will put on a Portable RTTY demo and I have heard that the Brisbane ARC have been discussing support.

Maybe being a member, Brian may

be able to encourage the SEQ Trekking Radio Amateur group to come along and cook some tea and damper for us.

The frequency to monitor for directions is **147.000Mhz**. The day will be a totally BYO and free although a small, gold coin donation would be appreciated from each adult with funds raised going to the Royal Flying Doctor Service.

A couple of competitions are being run, remember they are FUN as that is the whole intent of the day.

Bring along *The Most Unique Working Crystal Set* and *The Most Humorous Working Crystal Set*. Remember they must all be working and be demonstrated to be so. A Gold Coin entry fee, again for the RFDS, applies to each entry. It is hoped that the local FM Community stations and other media will attend during the day. An invite will be made to the RFDS to attend also. The SEQATV group may Videotape the day for replay on the ATV repeater?

If you are from "out of town" you're more than welcome! Bring your handheld. 147.000MHz -the Brisbane VHF Group Repeater will be our liaison channel.

The FUNDAY is in the Koala Park at Daisy Hill Environment Park, at the end of Daisy Hill Rd. Brian VK4BBS needs our support Feb 21, does he have it?

Central Coast Field Day

DON'T MISS Australia's biggest and best exhibition and sale of Radio and Communication equipment at the Central Coast Field Day on Sunday, 28th February 1999 at Wyong Race Course, just one hour north from Sydney.

The country's major electronic equipment traders will be there with field day bargain prices and tonnes of disposals gear will be on offer in the flea market. See many exhibits and displays from

radio and computer clubs and other groups ranging from vintage radio to packet radio and satellite communication. Opposite the Wyong railway station, the gates open 8.30 am wet or fine with undercover displays and trading.

Admission: Adults \$10.00, Seniors and students \$5.00, children under 12 free.

For more details see www.ccarc.org.au or phone (02) 43402500.

TECHNICAL ABSTRACTS

Gil Sones VK3AUI
30 Moore Street
Box Hill South Vic 3128

Auto Antenna Switch for Icom Transceivers

Auto Antenna Switch for Icom Transceivers An automatic antenna switch interface to drive coaxial antenna relays was described in CQ May 1998 by Art Rideout WA6IPD.

The interface uses the band information voltage available from the accessory socket of Icom transceivers and converts it into driving outputs for antenna selection coaxial relays. If a multiband antenna is used then those band outputs are paralleled.

The WARC 18 and 24 MHz bands

require a switch selection. The 10 MHz band was not included but only needs another driver circuit connected to pin 1 of the IC.

The circuit makes use of an LM3914 as a voltage level detector.

The LM3914 drives relay driver PNP transistors type MPS2907 which provide a current drive from 12 volts to drive the antenna selection relays. The circuit of the device is shown in Fig 1.

The relay is just a small 12 Volt relay that provides an auto switch on driven by the transceiver.

The 10 K pot is a scaling adjustment so that only one band at a time is selected. To adjust initially set this to about 4 K that is just under half and then adjust on test.

Magnetic Dial Scales

Temporary non-permanent dial scales were described in the QST Hints and Kinks column of Bob Schetgen KU7G in the October 1998 issue of QST.

The item was called Magnetic Tuner Rings and was from Rick Mintz W1TY. The idea is to use magnetic rubber sheet to provide an additional dial scale on a Tuner.

Magnetic rubber sheet, such as used to make refrigerator magnets, were used to provide a ring around the dial scales

of a Drake MN2000 tuner which has an aluminium panel.

The magnetic material came with a contact type adhesive applied.

This adhesive was removed and a less permanent rubber adhesive was used so as not to permanently affect the panel.

Dots of magnetic material were then used with coloured paper or tape stuck to them to provide movable tuning markers so as to allow quick adjustment on the various bands. The arrangement is shown in Fig 2.

There are local sources of the magnetic rubber material.

One source is business stationery shops. They sell the material for making signs that can be stuck to magnetic boards.

Another cheaper source is to collect them free from the businesses that hand them out.

The auxiliary dial markers should be so arranged so as not to obscure the dial markings on the panel.

If the equipment has a steel panel you can dispense with the ring and just use magnetic dots that can be bought from many sources including retail stores and newsagents.

Using Film Canisters

In March 1998 CQ, George Murphy VE3ERP described the use of 35-mm film canisters in making open wire line and a dipole centre insulator assembly.

While the article was aimed at QRP operation the ideas would be applicable up to a reasonable power level.

A dipole centre insulator assembly made out of an old toothbrush handle and a film canister is shown in Fig 3.

The plastic toothbrush handle acts as the actual centre insulator and the film

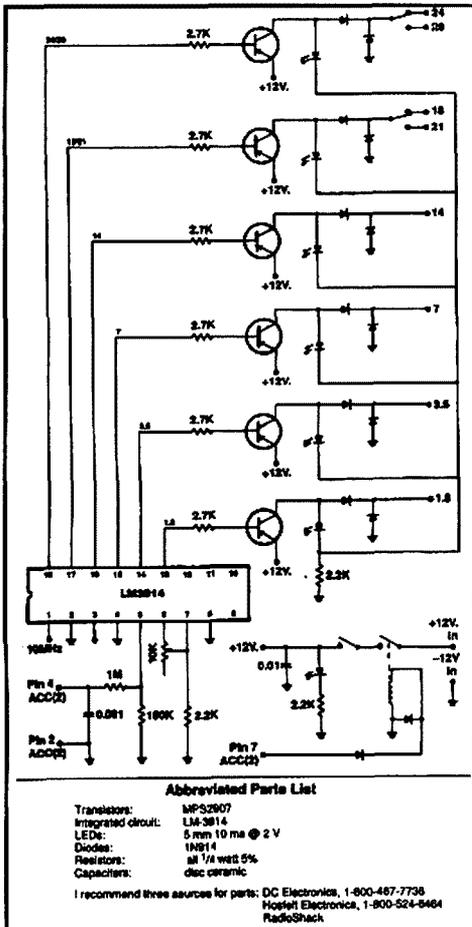

Fig 1. Automatic Antenna Switch

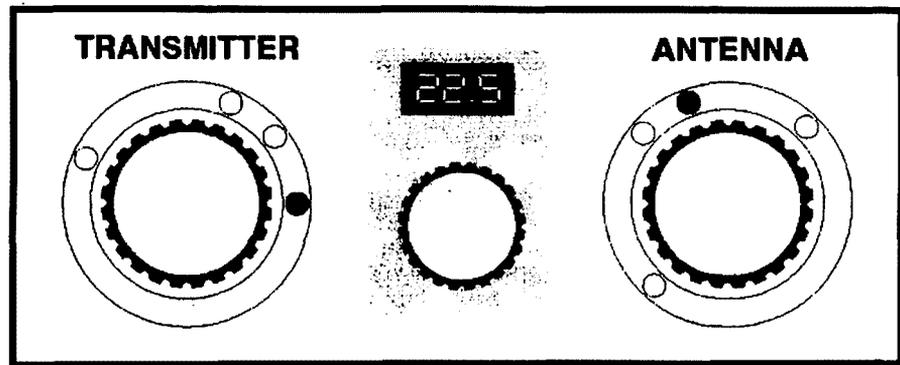

Fig 2. Magnetic Rings and Magnetic Dots record ATU settings.

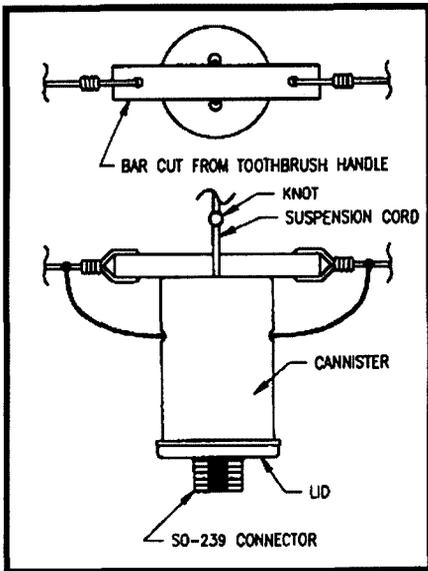

Fig 3. Dipole Centre Insulator using Toothbrush Handle and Film Canister.

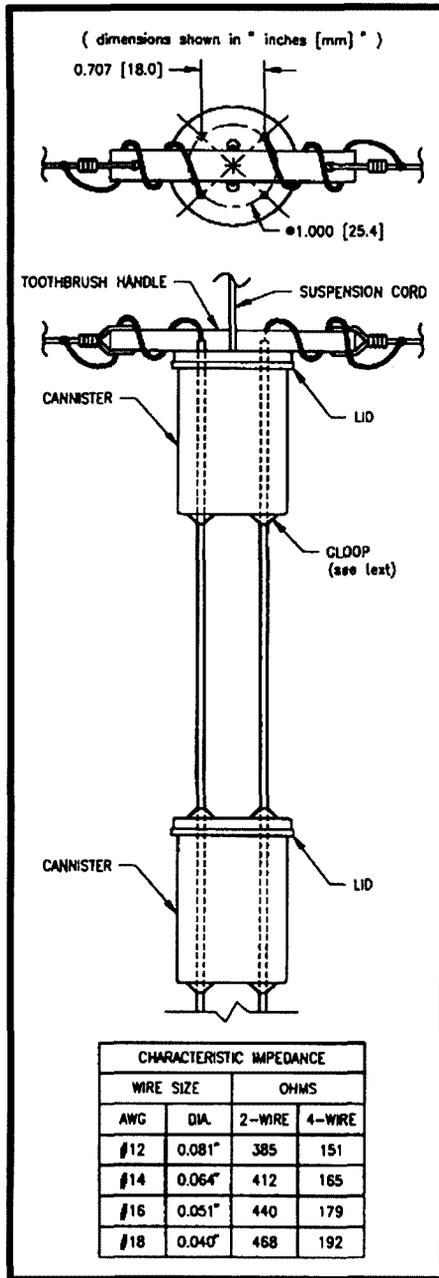

Fig 4. Open Wire Line Using Film Canister Spreaders.

CHARACTERISTIC IMPEDANCE			
WIRE SIZE		OHMS	
AWG	DIA.	2-WIRE	4-WIRE
#12	0.081"	385	151
#14	0.064"	412	165
#16	0.051"	440	179
#18	0.040"	468	192

canister is used to mount the coaxial connector.

Open wire line using film canisters as the spacer insulators is shown in Fig 4.

This application also uses a toothbrush handle as the dipole centre insulator.

George advises using care when making holes in the canisters and the use of an Exacto knife is recommended.

Drills need to be used very carefully, as the material is soft.

An alternative is to burn holes into the canisters with a soldering iron, but not with an expensive one as the plastic is acidic when burnt.

ar

Notice of Annual General Meeting

THE ANNUAL GENERAL MEETING of WIA Federal will be held over the weekend of 1, 2 May, 1999. In accordance with the WIA Federal constitution, the positions of Federal President, Federal Directors, Company Auditor and the various Federal Coordinators are declared vacant at the AGM. The Federal Council will then elect Office bearers for the forthcoming year from those who have been properly nominated.

At the 1998 AGM of WIA Federal, the Federal Council adopted the motion that at future AGMs all nominations for the office bearers must be received by the Company Secretary at the registered address of WIA Federal by no later than 42 days prior to the AGM.

Therefore, I wish to advise that the closing date for such nominations to be made by Divisional Councils is close of business 19 March, 1999. If any WIA member feels that they can help in any way, they should contact their Divisional President or Federal Councillor.

A list of currently established coordinator positions is given below for information

P J Naish
Acting Company Secretary
WIA Federal

List Of Coordinator Positions Within WIA Federal:

- IARU Region III Liaison Officer
- ITU International Regulatory and Radiocommunication Study Group Officer
- ACA Liaison Committee
- Editor
- Publications Committee
- Federal Media Officer
- Chairman Federal Technical Advisory Committee
- Electromagnetic Compatibility coordinator
- AMSAT Coordinator
- Federal Education Coordinator
- Intruder Watch Coordinator
- Federal WICEN Coordinator
- Federal Contest Coordinator
- Federal Awards Manager
- Historian
- QSL Collection Curator
- Videotape Coordinator
- Federal QSL Manager (VK9/VKO QSL Bureau)
- International Travel Host Exchange Coordinator

If your customers are radio Amateurs

This space could be making you money

Advertising in Amateur Radio is an excellent way to get your message directly to precisely people who buy your product.

Call WIA (03) 528 5962

BARGAINS

Get in quick and grab a bargain! These ex-demo Yaesu transceivers may have a few minor marks or scratches, but you'll save a fortune. Two-year warranty applies but stocks are strictly limited.

FT-10R Compact 2m hand-held

A compact 2m hand-held with a unique clam shell design and rear-mounted NiCad battery pack that provides 5W RF output as standard through the use of a MOSFET power amplifier and extensive component miniaturisation. Built to a tough MIL-STD 810 rating for shock and vibration resistance, the FT-10R also uses gasket seals for improved weatherproofing.

Features:

- Tx 144-148MHz, Rx 140-174MHz
- RF output: 5, 2.8, 1, 0.1W,
- Dual watch facility
- Large Omni-Glow display
- High efficiency speaker
- CTCSS encode/decode
- Auto battery save, Tx save and Auto power off,
- 12V DC socket
- Keypad frequency entry
- 99 memories
- Digital Code Squelch
- Size: 62 x 100 x 42mm (WHD)
- Comes with FNB-41, 9.6V 600mA/H NiCad, A16D version keypad, belt-clip and AC charger.

D 3650

8 PIECES ONLY
2 YEAR WARRANTY

\$299
SAVE \$100

FT-51R 2m/70cm hand-held

The FT-51R uses a sculpted case and diecast rear panel for strength, and dual microprocessor control for ease of use. At just 57 x 123 x 26.5mm (W.H.D) including NiCad battery pack, it's comfortable to hold or clip in a pocket. Includes inbuilt "Spectrum Scope", scrolling text help messages, and power-saving MOSFET amplifiers.

Features:

- Tx 144-148, 430-450MHz
- Rx 118-174, 420-470MHz
- 2m RF Output: 2.0, 1.5, 0.5, 0.02W
- 70cm RF Output: 1.5, 0.5, 0.02W
- Twin VFOs per band
- 120 memory channels
- Dual-band & dual in-band receive facilities (VHF/VHF, VHF/UHF, UHF/UHF)
- DTMF Paging and Messaging
- Large illuminated LCD screen
- Auto battery saver, Auto battery off
- CTCSS encode/decode
- Australian version selectable Auto repeater shift
- Includes FNB-31 600mA/H NiCad, belt clip, AC charger, CA-9 charging stand and high efficiency antenna.

\$599
SAVE \$100

8 PIECES ONLY

2 YEAR WARRANTY

Battery packs to suit FT-11R and FT-51R

FBA-14 dry cell case	D 3626	\$19.95	
FNB-35 7.5V 900mA/H NiCad	D 3624	\$59.95	SAVE \$40
FNB-33 4.8V 1200mA/H NiCad	D 3623	\$69.95	SAVE \$30
FNB-38 9.6V 600mA/H NiCad	D 3625	\$79.95	SAVE \$37



FT-290R II 2m all-mode transportable

Covers 144-148MHz and features FM, SSB (USB/LSB), & CW operation with 2.5W or 250mW switchable output power, twin VFOs and 10 memories that store mode and simplex or repeater frequencies. Selectable tuning rates are also provided for SSB/CW and FM (SSB- 25Hz/100Hz/ 2.5kHz and 100kHz; FM-5/10/20kHz and 1MHz). Mode specific features include a noise blanker and clarifier control for SSB/CW, plus a full set of functions for FM repeater operation, making this unit very simple to operate. It comes with a flexible rubber antenna, an FBA-8 battery holder which takes 9 x C size batteries (standard or NiCad) and a hand-held microphone.

D 2875

9 PIECES ONLY
2 YEAR WARRANTY

\$699
SAVE \$200



CD-2 mobile fast charger

A fast NiCad charger and mobile cradle assembly to suit the FT-11R and FT-51R handheld transceivers. Uses a regulated switched-mode charging circuit for cool operation and light weight. Reverts to trickle charging once the battery is fully charged. Includes cigarette lighter lead.

D 3628

20 PIECES ONLY
2 YEAR WARRANTY

\$49.95
WAY BELOW COST!

FL-2025 2m 25W Amp

Turn your FT-290II into a powerful mobile/base transceiver with this bolt-on RF amplifier. Replacing the FBA-8 battery holder on the FT-290II, it boosts transceiver output to 25 watts. Requires 13.8V DC.

D 2863

5 PIECES ONLY

\$199
SAVE \$100



BARGAINS BARGAINS BARGAINS BARGAINS
 BARGAINS BARGAINS BARGAINS BARGAINS
BARGAINS
 BARGAINS BARGAINS BARGAINS BARGAINS
 BARGAINS BARGAINS BARGAINS BARGAINS

MORE EX-DEMO BARGAINS WITH FULL WARRANTIES

Stocks are strictly limited.

Mastercharger 1 Fast Desktop Charger

The Mastercharger 1 is a compact fast charger that operates from 13.5V DC and uses switch-mode technology plus a Philips battery charge monitor I.C. to charge NiCad batteries between 4.8V and 13.2V. Suits Yaesu FT-23, 73, 411, 411e, 26, 415, 815 and 530 handhelds. The charging cradle on each MasterCharger can easily be replaced, allowing for the insertion of a new cradle to suit other transceivers. Requires 12-15V DC at 1.5A, and comes with a fused cigarette lighter cable.
 D 3850

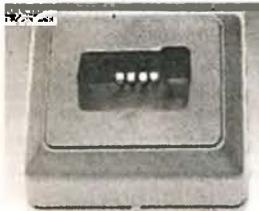

\$49⁹⁵ WAY BELOW COST!

SP-6 Extension Desk Speaker

With 12 different audio filtering selections, this speaker set suits most transceivers and receivers. A selectable high/low pass filter coupled with a large high-sensitivity speaker produces superior audio compared to that of standard transceiver speakers. The SP-6 has two input terminals with front panel selection, and a front panel headphone socket with filtered audio.
 D 3265

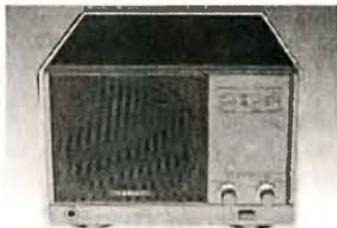

\$199 2 YEAR WARRANTY 12 PIECES ONLY SAVE \$50

ARRL 1999 Amateur handbook

Since 1926, The ARRL Handbook has meant many things to several generations of hams, engineers and technicians.

- To the technically minded it's an unimpeachable reference for data, project ideas and electronics theory.
- To the operator, it's an overview of what hams do and how they do it
- To the newcomer, it's a primer on the modes and equipment hams use and basic theory

The 1999 version is the 76th edition of this book. A must for those who haven't seen the ARRL Handbook recently.

B 2236

OVER 1000 PAGES

\$59⁹⁵

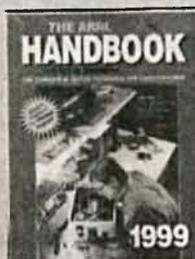

WIA 1999 Amateur Callbook

This is the latest edition of the WIA Call Book. The Call Book has been produced by the WIA for many years to assist all those interested in amateur radio with a wide range of information as well as the listing of the call-signs, names and postal addresses of all radio operators licensed by the Australian Communications Authority.

B 2343

\$16

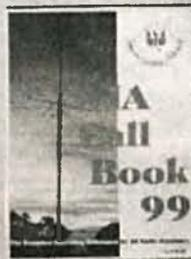

FT-3000M 70W 2m mobile

An amazing 2m mobile transceiver with up to 70W RF output, MIL-STD 810 shock and vibration resistance, wide band receiver coverage (110-180 and 300-520MHz), dual-band or dual in-band receiver facility, 1200/9600 baud Packet socket, and a very large back-lit alphanumeric LCD screen.

The FT-3000M has a total of 81 memories, as well as a Spectrum Scope mode that allows you to view activity above and below the operating frequency, or activity among six programmed memories. A programming menu holds over 50 transceiver settings for easy "set and forget" access, and includes a scrolling text help guide, while twin fans provide optimum cooling during long transmissions for greater component reliability.

The FT-3000M is supplied with a MH-42A6J hand mic, DC power lead, and detailed instruction manual.

D 3700

2 YEAR WARRANTY

\$599

SAVE \$100

YAESU



Specifications:

- Frequency Range: Tx 144-148MHz. Rx 110-180, 300-520, 800-824, 849-869, 894-999MHz
- RF Output: 70, 50, 25, 10W
- Sensitivity (Ham bands): 0.2uV (Main Rx), 0.25uV (Sub Rx).
- Dimensions: 140 x 40 x 180mm (W.H.D)

PHONE FAX AND MAIL ORDERS



PHONE: WITHIN AUSTRALIA: 1300 366 644
 (Local Call Charge)

FAX: (02) 9395 1155 within Australia and
 (+612) 9395 1155 from outside Australia

Visit our web site at
<http://www.dse.com.au>

MAIL: DICK SMITH ELECTRONICS, Direct Link Reply Paid 160, PO Box 321,
 North Ryde NSW 1670 (No Stamp Required)

*Excludes packaging and postage. All major Credit Cards accepted.
 14 Day Money Back Guarantee if NOT completely satisfied. (Software excluded)*

DICK SMITH ELECTRONICS

That's where you go!

*Pricing valid until 28/2/99, then subject to change.

B 3725

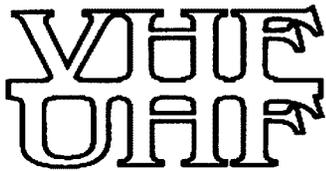

AN EXPANDING WORLD

Eric Jamieson VK5LP PO Box 169 Meningie South Australia 5264

E-mail: vk5lp@ozemail.com.au

Fax: 08 8575 1777

Packet: VK5LP@VK5WI.#ADL.#SA.AUS.OC

All times are UTC

Beacons

V73SIX/b frequency is now 50.014 ...
Tim V73AT.

A note from Geoff GJ4ICD

Accompanying the last Internet Six News, Geoff GJ4ICD said: "Please note that this is the last info that you will receive. I am leaving GJ to take up running SMC Ltd in the UK on 4/1/1999. I will not be active for some time, you will have to log in to the new URL: <http://www.radiosales.demon.co.uk/50dx.html> Thanks to all for the fun/help and friendship during the past years, and the 166 countries on 50 MHz!" [Geoff's new callsign will be G4ICD.]

VK9L report

"Three days with dipole only. Weather horrific, continuous rain and 50-60 knot winds, I was unable to erect the Yagi. No contact on six metres, although a few with JA ops on 28.885 MHz. My apologies to those looking for me, but I can't control the weather. So on my day of departure it was fine! ... Scott VK4JSR.

Gordon VK2ZAB advises that his station is active seven days per week for forty-seven weeks per year. Four weeks in July and one week in March are off.

His schedule is: All Local times, Monday through Friday: Instant response to calls from 0730 until 0900 on 144.100 MHz. Instant QSY to 70 cm, 23 cm or even 6 m. Beam pointed north from 0730 until 0800, south to south west from 0800 until 0900. Frequent CQ calling. After 0900 144.100 MHz is monitored most days until 1630, with beam usually west. Allow a couple of minutes for a response and call again. Once may not be enough during this monitoring period.

Currently, sked with VK2TWR on 432.160 MHz at 1930. Would extend this to include any contacts from 1915 until 2000, but only on 70 cm. Currently on 432.150 MHz at 2045 until about 2115 for sked with VK4AFL and sometimes VK2FZ/4, Mondays and Thursdays only.

Saturday and Sunday: As for weekdays except that 144.200 MHz is prime

frequency from 0730-0915, with the beam from 0900 to 0915 west to north west before reverting to the same routine as weekdays until 1630. There is no operation at night.

Would be pleased to modify the current routine to suit any worthwhile contact attempts, try me.

Steve VK5SFA in PF95ic writes: On 13/12 at 0345: 50.180 VK2BA 589 near Coffs Harbour. Proves that 100 metres of mountain from my QTH in the Adelaide foothills and VK2 doesn't mean a thing on sporadic E! 0415: 50.306 VK6RBU/b 599. No stations worked in VK6. 0425: 50.200 VK4PU 518 - 60 km north of Brisbane. Called me as I was beaming 270 degrees. Swung beam around to 45 degrees and signal 589. 0437: 50.200 VK6KDC 599 - 25 km south of Bridgetown. 0550: 50.306 VK6RBU/b 599. 0555: 50.200 VK6KDC 599.

From Tony VK3CAT: 4-5/12: 2350-0028 TEP opening from Melbourne to JA, call areas 1, 2, 3, 4, 6 and 7 worked. Signals up to 5x9. 4/12: 2250 VK4ABP/b 5x5; 5/12: 0235 VK8RAS/b 5x8.

On two metres worked Jim VK3AEF (Nhill) 29/11 at 0930 and 1930; 30/11 at 1930 and 2/12 at 1930. Signals into Melbourne 4x1 to 5x2. Jim has also worked VK3AFW and VK3AMH. Believe that contacts with VK1MP unsuccessful

Ray VK4BLK sends:

14/12: 0045-0100 XE1KK/b 539 19/12: 0004-0035 XE1KK/b 539 23/12: 0114-0129 FO5DR/b 549 25/12: 2334 W5VWB heard. Did not respond to call. 2359-0257 XE2UZL/b S7, in for three hours 4/12: Bob ZL3TY reported as follows: Many JAs worked between 0022 and 0300 in districts 1,2,4,5,6, almost all on 50.110, also HL5XF. At 0004 Asian TV on 49.750 very strong, also VK TV.

Mike ZL3TIC reported similar conditions: 3/12: 2350 N6XQ 5x8. 4/12: JAs from 0200 to 0336 in districts 1,2,4,5,6 plus HL5XF. Indicators came from strong Asian TV offsets on 49.750 around 0030 to 0300. At 2230 XE1KK/b up to 599 with QSB - in for a half an hour.

Andy Hewitt XE1/G3SVD reports (via

UKSMG News Page) that: On 14/12 best opening on six metres that I have been able to participate in, between 2232 and 2350 I worked ZL3ADT, ZL3TIC, ZL2KT, ZL3NW, ZL2TPY, ZL1ADP, ZL3TLG, ZL4AAA, ZL3TY, VK7IK/7, VK3AKK and XE1/SMOKAK, W5UWB by backscatter. The HC2FG/b beacon audible from 0038 - 0100 when I went QRT.

Repeaters

Steve VK2KFJ, is assembling a list of six metre repeaters, he advises of a ZL repeater! Input 52.570, output 53.750 MHz. Located at Colonial Knob, near Wellington. Would have been operational now except for frequency concerns.

Two metres and above

Russell VK3ZQB: Sporadic E on 2 metres. On 19/12 I worked VK8GF and VK8TM 5x7 0255 UTC. Band open for about 2 hours extending to at least Melbourne where Allan VK3XPD worked both as well. Jeff VK8GF reported were working VK4 prior to the band opening southward.

Gary VK5ZGC at Tarlee, 80 km north of Adelaide reports VK5RSE/b on 144.550 is audible most nights after 2000 hours local time. Locator PF95JR. He says: I am about 200 metres above sea level using an ATN.13 element beam up about 15 metres, fed with LDF5-50 and with a 20 dB pre-amp with an ICOM IC-251A.

The strength varies between nothing and S2 mostly although it has been up around S7. Have heard nil activity on 144.100 MHz. Distance about 415 km.

Gordon VK2ZAB: Lest anyone thinks nothing is happening here, this is an update of activity as the 1998/99 summer season approaches.

1) Daily activity.

Activity every day on the bands, 2 m and above. This is centred on 144.100 MHz Mondays - Fridays and on 144.2 MHz Saturdays/Sundays. Peak is from 2030 until 2200 that is local morning. Some activity occurs at night as well.

2) Propagation events prior to 11/12-13/12:

1a) Early Trans-Tasman Duct

Notice of this extraordinary event seems to have been missed.

It occurred on 1/10, the earliest duct in the season for at least the 20 years of my Sydney experience.

It resulted in 2 m SSB contacts from Sydney stations including myself to ZL2TAL and ZL2VAL both at New Plymouth.

[b] Auroral Scatter

Occurred on 7-8/11, allowing contacts from Sydney stations to VK3 and VK5. Guy VK2KU the main participant here. I worked VK5NC on 2 m SSB.

[c] The Leonids meteor shower on 16-17/11

This was the most spectacular meteor event for VHF propagation in memory. Sydney stations were truly in it even though our location, in the middle of the other large areas of amateur population, meant that the distances from here to those locations was less than optimum. I made contacts on 2 m SSB with VK4TZL, VK2FZ/4, VK3TMP, VK3AFW, VK3TDV, VK3AXH, VK4KZR, VK4JSR, VK4ZBH, VK3TMP/m, VK3XPD, VK4BRG, VK5NY, VK5ACY, VK7XR, VK7JG, and VK4KK.

Guy VK2KU returned from Adelaide and with perfect timing a duct opened to ZL at 2000 (11/12 UTC) and lasted until a violent thunderstorm at 0500 on 13/12.

Worked on 144 MHz: ZL1IU 5x9 many times, ZL2TAL 4x1, ZL2VAL 5x1, ZL3NE/1 5x2 several times, ZL1TBG 5x6 several times. The ZL1s were much stronger than those further south. Other VKs heard beaming/working ZL: VK2BIT, VK2ZAB, VK2TZ, VK2DXE, VK2DVZ, VK3BWT.

Heard on 432 MHz but not worked: ZL3NE, ZL2TAL. Nothing on 1296MHz.

From Gordon VK2ZAB: Sporadic E contact on 2 m SSB was made from Alice Springs to Sydney today 19/12/98.

Contacts between VK8 and VK2 and stations have been heard each way from Alice Springs and Sydney but that is all. No two way contact between the two centres is known to have occurred until now.

Sydney stations were aware of the Sporadic E opening on 6 m and VK2ZAB had been advised by Gary VK4ABW that the Alice Springs 2 m beacon was audible in Townsville. This resulted in many 2 m CQ calls to north and north west by VK2ZAB in Sydney, VK2KU in Springwood and VK2FHN in Blackbutt. The latter had learned via 6 m that Gary VK4ABW had a 2 m contact to Alice Springs.

At about 0430 Adrian VK2FZ/4 advised VK2ZAB by telephone that he had just made 2 m contact with VK8GF in Alice Springs. Adrian had been alerted by Glen VK4TZL who, it is assumed, had also made the VK8 contact.

VK2ZAB returned to the shack; the Alice Springs 2 m beacon was heard at about S2. A few minutes later VK8GF heard in

contact with a VK4. A couple of calls resulted in contact at 0443. Jeff VK8GF was 5/3 and gave VK2ZAB 5/5.

Guy VK2KU disappeared at this time. He telephoned VK2ZAB, returned to his shack and made contact with VK8GF. A few minutes later, Mike VK2FLR made contact with VK8GF also.

There may have been other contacts to VK8 from the Sydney area but these are not known to me as I took the dogs for their walk. [You did, Gordon? ... VK5LP]

From Tony VK3CAT: *On 19/12 at 0520 VK8RAS/b on two metres was 4x1 to 5x4. Slow QSB. VK8RAS/b on six metres 5x2 to 5x5 at the same time.*

Heard VK3AFW and VK3TMP work VK8GF, no signal here at 0530. VK8GF heard here at 0535 with signals from 3x1 peaking to 5x7. Worked VK8GF prior to amplifier failure at 0538 signals 5x5 both ways. The 2 metre beacon peaked here at 5x7 and was audible until 0555. The 6 metre beacon remained at 5x2 to 5x7.

Barry VK3BJM was alerted by Alan VK3XPD on 19/12 that two metres was open to Alice Springs. *"I heard Jeff working David VK3XLD, then Mark VK3TLW, Tony VK3CAT, before I worked him at 0539; Jeff was 5x5 solid to start with, but started to get choppy at the end. I was last Melbourne station to work Jeff. My first Es contact on two metres.*

Alan VK3XPD did a great job to get as many VK3s and VK5s on air so quickly, especially as most of us seemed to be not near the phone at the beginning of the opening.

John VK4FNQ has moved QTH west to a 200-acre block near Charters Towers. So far has only a 1/4-wave vertical on the roof for southern stations, and a 6 element Yagi for six but it is stuck north.

Amateur radio to the rescue

Russell VK3ZQB sent information in relation to a request on 22/12 to help the Water Police locate an electronic position indicating radio beacon (EPIRB). With help from the amateurs in Mount Gambier, the beacon was quickly located.

World microwave records fall

New World distance records at 24 and 47 GHz were set this past September and October, according to accounts in the *RSGB Microwave Newsletter* for October 1998.

JM3KMO, on Mt Norikura on Honshu Island, made a 24 GHz contact with JR3EDZ, on top of Mt Tsurugi on Shikoku Island, in early September. Distance was 402 km, which exceeds the existing 1993

world record of 397 km.

The new 47 GHz mark of 221 km was established on October 3 by F6BVA, operating from Mt Chian (JN33du), and F5CAU, on Mt Aigoual (JN14sc). The weather was wet and foggy with the temperature just above freezing. The previous record of 203 km was set in Italy earlier in 1998. In contrast, the North American record has stood at 105 km for more than ten years.

The previous record on 120 GHz was 0.7 miles set in July 1994 by WA1MBA and WB2BYW. They also hold the 144 GHz record of 2.3 miles. Bob Johnson KF6KVG and Will Jensby W0EOM have been working for the past six months on gear for 120 and 144 GHz. Both systems are based on Hughes harmonic mixers and 9 inch Cassegrain feed dishes.

On 2/10, a one-way contact at a distance of 2.9 miles was made on 144 GHz. Bob could hear Will, but his transmit power was lower, and no two-way was made. The sets were modified for 120 GHz, and on 16/11 a short-range test was made to calibrate the receivers and bore-sight the antennas. Contact was then made at 2.9 miles, exchanging information by slow-speed CW. This was later extended to 3.3 miles (5.3 km).

Russell VK3ZQB wrote on 11/12: *The 1998/1999 microwave season is about to get under way with the arrival of the first significant high pressure cell for the summer. The small cell of 1024 hPa has moved slowly over the southern states and consolidated to give some short distance super refractivity. Contacts on 2 m, 70 cm and 1296 MHz from western Victoria to Melbourne yielded extremely strong signals.*

Allan VK3XPD connected his masthead pre-amp to his HP spectrum analyser and could see the signal received on 1296 from VK3ZQB 300 km away, indicating the strength of signals received. The super refractive layer persisted from 0930 on 8/12 to 0000 on 9/12.

Closure

Next month I should be able to report of the degree of activity during the Summer VHF/UHF Field Day Contest on 9/10 January.

Thoughts for the month:

1. When you want to break bad habits, drop them; and
2. Successful people not only take opportunities, they make them.

73 from
The Voice by the Lake.

ar

ALARA

Christine Taylor VK5CTY ALARA Publicity Officer
16 Fairmont Avenue, Black Forest SA 5035
Packet: VK5CTY@VK5TTY

Change Of Callsign

Meg formerly VK5AOV is now VK5YG. No, it is not so she will be known as the green giraffe. It came about partly because she caused some confusion with her call, while she was caravanning.

It is just as well that Meg did not want to become incognito with a new callsign. Her voice is much too well known!

We have teased her a bit about it, but we'll get used to it. Good Luck to you VK5YG

The Alara Web Page

Webaddress:

<http://crash.tig.com.au/~bishops/alara>

I hope those of you on the Internet have looked for and found the ALARA website.

Designed for us by Peter VK2HCU, Dot VK2DDB's son, it has all sorts of information about ALARA and maybe even a photograph of some of the ladies manning the food stall at the AHARS Buy and Sell, in November. Kim VK5HUS took a digital photo which he sent to Dot for inclusion. Another marvel of communications!

Now That's A Great

Callsign

Whilst in Oslo, Gwen VK3DYL met a 15 yo YL, from Latvia. She has a callsign many YLs would envy - YL1YL. No-one will be likely to forget that one!

New, Special Callsigns To Listen For From G-land

A new Club Callsign has been issued for Bylara, our sister association in the UK. Associated callsigns for England, Wales, Scotland and Jersey are M0BYL, BW0BYL, MM0BYL, and MJ0BYL (there are no authorised operators in GI, GD or GU, at the moment).

These callsigns will be used in YL Nets and when in contact with a YL and can be used for OM contacts for those of you who are seeking YL Awards. Special QSL cards are being designed, so listen for the calls and add to your card collection.

Eyeball Contacts



Last year, when Sally VK4SHE (our previous ALARA column correspondent) was overseas she had eyeballs with two of the YLs she sponsors overseas.

In Worthing, Sussex she met Jackie G7MZI and OM Peter G4LKW. It was with them that Sally and Rex saw the town of Horsham, where they used to live and the

amazing Brighton Pavilion.

At the end of August Sally and Rex met Patsy W7PAT and her OM John W7SIR - note the 'vanity' calls they have. Patsy and John had a full program organised to show visitors the beauty spots of Oregon.

Nothing beats having a local contact to be sure you see everything most worth seeing. As radio amateurs we are very lucky that we can have such local contacts all over the world. I hope we are as good ambassadors to our visitors.

I hope that whenever you hear an interstate callsign on the repeaters or an unusual accent, you answer the call and make the person welcome.

It is very off-putting as to call on a repeater in a strange city and have no response. This happened to us in England.



Tracing Your Family Tree?

Rex has been doing this and it paid off on their travels. Sally and Rex met a number of 'cousins' after having made family tree enquires of them. With one they spent two weeks travelling the Midland canals in a narrow boat. They also joined family gatherings, one in England the other in the US.

They saw places they would otherwise have missed just because one of the cousins could say it was worth seeing.

If you haven't yet started tracing your family tree maybe you should do before you next go overseas.

In Britain I spent time in a local library and now have photographs of streets and houses that my ancestors once occupied. Something to pass down to my children.

YL-Meets

As a last word about the Svalbaad Meet the photo of Gwen VK3DYL dressed in a yellow 'mac' at the helm of the 10-metre sailing yacht "Maken" (meaning Seagull) was used for Gwen's 1998 Christmas cards.

Plans for the ALARAMEET in Brisbane are progressing well and a number of people have indicated they will be there. If you are thinking about it, please let Bev VK4NBC know. You can change your mind but it will help with planning. Some 30 (THIRTY) ZL-YLs have indicated interest!

Initial Announcement

YL2000 Meet in NZ

Date: - 29 Sept - 1 Oct 2000

Diary this now, much more information shortly, or visit the webpage

<http://www.wave.co.nz/pages/osborneg/yl2000.html> or contact

International YL2000
C/o Biny Owen ZL2AZY
550 Kane Street,
Pirongia 2450 NEW ZEALAND
Tel: +64 7 871 9992
Fax: +64 7 871 9190
Email: yl2000@iname.com **ar**



AMSAT AUSTRALIA

Bill Magnusson VK3JT

RMB 1627 Milawa Vic. 3678 Email: vk3jt@amsat.org

Oscars for SEDSAT and PANSAT

National coordinator:

Graham Ratcliff VK5AGR

Email: vk5agr@amsat.org

AMSAT Australia net:

The AMSAT Australia net is held on 80 and 40 metres LSB each Sunday evening. During daylight saving time in South Australia the net is on 7068 kHz +/- QRM with an official start time of 0900 UTC (with early check-ins at 0845 UTC). During the rest of the year, the net is on 3685 kHz +/- QRM with an official start time of 1000 UTC (with early check-ins at 0945 UTC).

AMSAT Australia newsletter and software service:

Graham VK5AGR publishes the newsletter monthly. Subscription is \$30 for Australia, \$35 for New Zealand and \$40 for other countries by AIRMAIL. It is payable to AMSAT Australia addressed as follows:

AMSAT Australia

GPO Box 2141

Adelaide SA 5001

Keplerian Elements.

Current keps are available from the Internet by accessing the AMSAT FTP

'SEDSAT-OSCAR 33' (or simply 'SO-33') and PANSAT-OSCAR-34' (or simply 'PO-34') respectively.

We can expect keps for these satellites to appear under these headings from now on.

SSTV Activity from the MIR Space Station

Live SSTV images have been transmitted from the Russian MIR space station.

I have not heard the signals myself but the quality of pictures uploaded to the digital birds has been quite good. They show scenes of activity on board MIR and some shots taken through windows. In a number of these shots, parts of the MIR superstructure are visible.

SSTV equipment was transported to the spacecraft earlier this year and first appeared on the air around December 11th. Several amateurs reported copying the images on 2-metres, but plans call for the SSTV transmissions to move to a frequency in the 70cm band.

Various stations reported hearing the call ROMIR in CW before the SSTV transmission began.

Evidently neither of the cosmonauts aboard MIR during the current tour of duty is a licensed amateur. This no doubt accounts for the lack of voice activity recently.

SSTV however is another matter.

Being transmit only there should be no regulatory problems associated with this mode or the packet PMS/digipcat. Miles Mann, WF1F who supplied the equipment to the Russians says the system operates in automatic mode and can display a new image every two minutes.

AMSAT Frequency Coordinator, Graham VK5AGR and Miles had reached agreement on 437.975 MHz as a spot for SSTV activity from MIR.

It is expected that a move will be

made to this frequency early in 1999. Packet and SAFEX will be switched off when the SSTV system is in operation.

Full details on how to receive the SSTV transmissions are available on the Internet at <http://www.ultranet.com/~sstv>.

At the time of writing an unofficial schedule of packet on weekdays and SSTV at weekends is reported as being in operation.

The SSTV images transmitted by MIR use the Robot Research 36-second colour format. I'm led to believe that a PC and sound card or "Hamcomm" interface can be used with suitable software to receive these images.

Such software can be downloaded from the above web-site. Unfortunately the popular JVFX software does not support the Robot 36 SSTV mode that is currently in use by the MIR space station.

ISS Amateur Radio Facility News

Former Astronaut Ron Parisse WA4SIR will be remembered for his amateur radio operations from the Space Shuttle.

Many Australian amateurs made contact with Ron during his STS missions. He is now coordinating the amateur radio facility on the evolving International Space Station. Ron reports that the station will proceed in 3 phases.

The first phase will consist of 2-meter and 70cm transceivers and a packet TNC. The hardware is built and is currently undergoing qualification testing.

The second phase will see the introduction of higher power equipment with a digiwalker and configurations for cross band repeater operation.

The third and final phase will see the completion of a re-configurable station through the use of plug-in modules designed to operate on any band from HF through microwave, and be able to operate on any mode.

This station will be commanded from the ground and interfaced to ISS voice and video channels to allow ISS cameras to be used as a source for the SSTV system.

It is planned to have the first phase ready for immediate operation when the first crew occupies the ISS.

Continues over page

SEDSAT and PANSAT become OSCARS.

The tradition continues. Amsat News Service reports that these two satellites have been assigned OSCAR numbers. The OSCAR numbering system has been in operation since OSCAR-1 was launched in 1961.

For a satellite to be granted an OSCAR number three things must happen.

It must achieve orbit, its transmitter must successfully be turned on and finally the people responsible for its design, launch and control must make a request to AMSAT for an OSCAR number.

All these conditions have been met in the cases of SEDSAT and PANSAT and it is now appropriate to refer to the two new amateur satellites as

Brenda M Edmonds, VK3KT WIA Federal Education Co-ordinator, PO Box 445, BLACKBURN VIC 3130

PanSat PO-34 News

PanSat, an American Naval Postgraduate School project, was launched from the shuttle Discovery last year.

Its spread spectrum digital transponders will be available to amateur radio operators in the near future, along with software to utilise this technology.

The PO-34 command station is located in Monterey, California.

If you want to 'bone-up' on spread spectrum transmission and reception before the event, the project Manager, Dan Sakoda, KD6DRA, recommends *The ARRL Spread Spectrum Sourcebook* as a good place to start.

Spread Spectrum technology will be new to most radio amateurs and it will be interesting to see how many take up the challenge.

As yet, the technique has little popularity among the wider amateur radio community.

The advent of a well-supported amateur radio satellite may hasten its acceptance among amateurs. It is widely used in commercial practice these days.

The PANSAT Team does not expect the satellite to be available to the Amateur Radio community for a few months.

If you have internet facilities you can keep up to date on this ground breaking project by visiting the PANSAT web site at: <http://www.sp.nps.navy.mil/pansat/>

ar

NEXT MONTH:

'A Satellite User's Perspective on the Millennium Bug' by Roy WOSL.

How your computer will react to the turn of the century and what steps you can take as an amateur radio satellite user to make the transition as smooth as possible. Don't leave it to chance.

Don't take notice of rumours. Read what one of the gurus has to say about your chances of making it safely into the next century and taking your AMSAT station with you.

The ACA intends to review the devolvement of amateur examinations and possibly make modifications to the present system.

THE ACA HAS notified the WIA that it intends to review the devolvement of amateur examinations and possibly make a number of modifications to the present system.

Naturally the WIA is seriously concerned and is having considerable input into discussions on the matter.

This may be an appropriate time for the WIA also to review the examination situation.

WIA Exam Service has been in operation since 1991. Older readers may remember when examinations were conducted by the Department of Communications and before that by the Postmaster General's Department. During the last 30 years, the only significant changes have been the move from essay-type to multi-choice questions, and the devolvement to external examiners.

The introduction of the Novice and Novice Limited licences have simply added more of the same to the system. The examinations that are required for a Certificate of Proficiency, the number of questions per paper and the pass marks have remained unchanged. The syllabuses have been re-arranged but the content is substantially the same as it was 30 years ago. Does this mean that we have got it right for all time?

The WIA Examinations Committee has revised all the syllabuses and submitted them for ACA approval, but they have been placed on hold until the review of the devolvement is completed. We are concerned that the current syllabuses do not reflect the present state of amateur radio and the advances that have been made in recent decades.

The Committee has also given much thought to the whole system. The amateur scene is vastly different now from what it was in the 1960s. It is time we re-

considered the purpose of the examinations and the status of the Amateur service.

We must accept that very few amateurs now build or service their own equipment, and that only a very small percentage operate over the full range of frequencies and modes permitted.

Some of the points that the Committee has considered include (apart from the perennial question of Morse code): ?

- Why have separate examination papers for the two levels of theory rather than two pass marks on one paper? ?
- Can we include some practical testing of operating procedures? ?
- Why do we still require a 70% pass mark? ?
- Do we still need a Regulations examination?
- Would a declaration of intent to operate within the regulations be sufficient? ?
- Is multi-choice questioning the only way to go? ?
- Are 50 questions really the magic number? ?
- Is WIA Exam Service operating efficiently now that the number of candidates is dropping?

Please note that the above questions are simply items that have been discussed.

At present no decisions have been made or policies finalised. It is expected that the Committee will make recommendations to the Federal Council on the stand it should take.

Individual members may care to consider these items and any others they consider relevant and discuss them at divisional level.

My best wishes to all readers for a productive and satisfying 1999.

ar

POUNDRING BRASS

S P Smith VK2SPS

Peak Street Bateau Bay NSW 2261 (02) 4334 7743

What To Look For In A Paddle

CW OPERATION TO THE beginner must be very confusing with the variety of keys and keying equipment available. If you have never used a semi-auto or a single lever before, by all means start with an "Iambic paddle" and "Keyer".

(*Iambic* refers to the Latin 'poetic foot' or rhythm of di-dah, di-dah and is well named for CW signals.)

1. You have no bad habits to unlearn.
2. Iambic sending is very satisfying.
3. Importantly, it will be fun to use.

There are many iambic paddles available, so choosing the right one can be a very daunting experience, especially for the beginner. Try several models before laying out that hard earned cash. Perhaps you could borrow one to get a feel for iambic keying.

If you can't borrow a paddle and keyer here is some advice and general suggestions of what to look for.

Feel

Try as many models as possible, the feel of paddles varies tremendously. Some paddles are stiff, others feel very sluggish while others have a very light touch. Correct adjustment and personal experience are important in the feel of the paddle. A good paddle should feel smooth and precise during use; you should never feel like you are fighting it.

Weight

The heavier the better. A paddle that is too light will slip and slide during use. If you are a heavy hitter go for a very heavy base. If you have found that perfect paddle and want to purchase it, but feel that it is somewhat under weight this problem can be easily rectified. You can purchase sheet lead from most hardware and plumbing outlets. Fold it over a few times and glue it to the base of your

paddle or Blue Tack® it to the top of your paddle so you can vary the weight to suit.

Or you might blue tack the paddle to the table or use double-sided tape, either method will prevent the paddle from moving during operations.

Adjustability

Contact spacing and tension (ie return force) should both be independently adjustable for each side, but sadly this is lacking in some models. Most paddles allow you to adjust contact spacing and tension, but the range of adjustment varies tremendously.

The ideal paddle will allow contact spacing to be easily adjusted from almost touching to quite wide, about 10mm, and tension to be adjusted from a very light touch to quite heavy. Every operator has that perfect adjustment for their particular fist, one setting you favour might be unsuitable to another operator.

Again experience plays a role here. Once adjusted it should hold until re-adjustment will eventually be required due to normal wear and tear.

A rough guide for contact spacing is to use a standard business card, about 0.2-0.4 mm thick. Place this between the contacts and adjust the contact spacing screw until a snug fit is achieved. You don't want the contacts so narrow that the slightest knock will activate the keyer. You don't want the contacts so far apart that it feels like stirring a pudding bowl. You want to achieve a happy medium.

Another factor to look out for is how the paddle is adjusted and what tools if any are needed. Some paddles require Phillips head screwdrivers while the Bencher Model uses a small Allen key that is stored underneath. The key is more permanent especially if you don't want others to touch it, but if you are portable and misplace the key, no adjustments can be made.

The advantage of having a paddle that adjusts without the need for tools, such as using thumbscrews, is that you can adjust the key anytime, anyplace. Again it's up to the individual which method suits best. Some more expensive overseas models have interchangeable levers and the ability to set the distance between levers so the user can custom tailor the key to suit.

Connections

Basically there are two types of connections 'Binding Posts' and "Soldered". Binding posts with thumbscrews allow you to attach the cable directly to the paddle without soldering. The disadvantage is losing the cable during transport. If a soldered connection fails when portable you need soldering equipment to repair it.

The Bencher Key cable for example is soldered underneath the base to three terminals, earth, a dot connector and a dash connector. A 3-core cable must be used, but avoid the 240-vac type cable.

Appearance

A good paddle will cost you good money. I consider it to be an expensive accessory item in the shack and one that, if looked after well, will outlive the operator. Depending upon personal taste they come in a range of colours, though standard models usually have a black, chrome or gold base, with different coloured finger levers. Some operators paint their own levers to give that personal touch.

Cost

Cost, like quality, varies tremendously. Expect anywhere from \$100 to over \$800 for a custom built paddle from the USA.

Conclusion

I hope this short article has helped you to understand iambic paddles and how much fun this style of operation can be for anybody willing to give it a go.

Next month:

- (1) Detailed look at the "Bencher Paddle" this being the most widely used paddle in Australia.
- (2) The Bencher history, mechanics and adjustments

See you then 73 Steve

ar

Timber masts and plastic guys

re; Article "Some Practical Tips on Timber Radio Masts"

by Drew Diamond, VK3XU, in December 1998.

I note that Drew has had trouble with cockatoos prising off the mast cap. If that is the case then his selection of galvanised wire guys, even if only for sentimental reasons, may have been fortunate.

When community radio station 6NR was established in about 1975, the guys for its transmitting mast were made from one of the synthetic insulating materials then available.

I do not know if it was Kevlar or not, but within about five years the local black cockatoos had damaged the guys so much that it was necessary to replace them with, wait for it, stranded galvanised wire!

By the way, does anyone know how to prevent parrots and cockatoos from damaging coaxial feedline?

Perhaps I should resort to open wire feeders.

Malcolm McDonald.

(Mac VK6MM)

188 Culeenup Road

North Yunderup WA 6208

SILENT KEYS

Kenneth Berkley 'Bud' Pounsett VK4QY 1925-99

IT IS WITH CONSIDERABLE regret that we announce the passing of Ken 'Bud' Pounsett VK4QY on Saturday the 2nd of January, at Caloundra. His well-attended funeral was held Friday, 8th of January in Brisbane.

Bud and his wife Bonnie produced the WIAQ news service for some 12 years during the 70's and 80's with Bud writing the VK4 Notes for AR Journal for a number of years. Whilst a VK2 Amateur he also wrote the monthly feature for AR on SSB when that mode

was in its infancy. An exceptional CW operator, Bud was often heard on 20 metres, known far and wide as "The Amateur Gentleman on air".

Bud was born in 1925 and during WW2 was trained as a wireless operator and later in Canada, as a pilot. He served in the RAAF during WW2, the Korean War and the Malayan uprising, mainly flying Lincoln bombers. He ended his RAAF career as a VIP Flight pilot, where he regularly flew Sir Robert Menzies and other noted personages of the 1950's.

After a distinguished RAAF career, Bud joined the ABC in Canberra and then AWA as a communications expert, ending his chosen second career only three years ago, after many years with the well known local firms of Delsound and Matthews Fire Alarms.

Bud was a kind hearted caring person who gave an immense amount of his time to the community.

He was a Board member of the Brisbane City Mission for many years and a WIAQ Councillor for nearly 20 years.

When Bud saw a need he quietly helped. He instructed many Amateurs; he ran the WIAQ Bookshop and finally in the 1980's he ran the VK4 News Service. He and his devoted wife, Bonnie, were renowned throughout VK4 and the South West Pacific as the voice of the WIAQ for well over a decade. Bud, you were one of nature's gentlemen and your sudden passing has left us saddened.

(Submitted by Guy Minter VK4ZXZ)

D W Boyd VK1NR

DR DERRICK WILDER BOYD, born in Scotland, and educated in Germany in the '20s was active as VK2NR from his shack in Katoomba, NSW, and later, VK1NR in Canberra, ACT.

Before the 1939-45 War, he lived in Africa, where he later served with the Kenya Mounted Rifles. On his discharge, he completed his medical degrees at Cape Town. He married Sani, and emigrated to Katoomba, where he entered general practice with his father, Dr Stanley Boyd.

His daughter Jeanetta and son Michael have both followed their father's profession, but so far have not been bitten by the radio ham bug.

In 1953, Derrick and I met at the Blue Mountains District Anzac Memorial Hospital, Katoomba, and discovered our mutual interest in amateur radio. Derrick determined to obtain his AOC and full licence, which he soon achieved. From then on, he was into home brew radio.

With the keen analytical mind of a diagnostician and his manual dexterity as a general surgeon, he made and used much gear for his working interest. He derived much pleasure from the improvements in radio technology over the years, and his ability to keep abreast of these.

Retirement entailed a move to Canberra, to be closer to Jeanetta and her family. He and Sani were soon settled

in, and he then focussed on mastering HFSSB, which fascinated him.

Neither Derrick nor Sani enjoyed good health recently, but his mind remained as active as ever, lately he was still thinking about astronomy, navigation, the trajectories of explosives, and languages. He was an expert in all of these.

Derrick died peacefully mid year (27/6/98). He leaves the memories of a gentle, caring husband, father and friend. We all miss his courtesy, integrity, freely shared knowledge and hearty belly laugh.

Keith L King VK2ABK, Dave Melbourne VK7NK, Noel Hill VK2JG

SPOTLIGHT ON SWLING

Robin L. Harwood VK7RH

5 Helen Street, Newstead Tasmania 7250 (03) 6344 2324
e-mail: robroy@tassie.net.au

MY HOBBY HAS KEPT ME informed for many years with happenings throughout the world. This was especially true when I accidentally came across a major life and death communications emergency as the Sydney-Hobart yacht race progressed at the end of December.

YOU COULD CONTRAST this with the silent situation ten days earlier when Britain and the US bombed Iraq for four days, after the UN weapons inspectors said that Iraq was not co-operating.

Why the contrast? The normal US military HF communications activities and networks were conspicuously silent before and during the raids. I expect that they did not want to warn the Iraqis they were coming.

Once the raids finished just after commencement of the Moslem holy month of Ramadan, the chatter seemed to pick up again. There was some activity during the period but it was minor and well away from the Persian Gulf region.

So many divergent views on the bombing raids were broadcast. The BBC World Service pre-empted normal programming over the first day to concentrate on this one major story, and also increased their Arabic output on 21825 kHz within hours of the Baghdad raids. Again the American CNN stole the show by telecasting live the initial air raids on Baghdad, as they did seven years previously.

Iraq has no shortwave capability ever since "Desert Storm" in early 1992. There have been attempts to get shortwave going but the recent air raids targeted the telecommunications centres and infrastructure, largely destroying what remained. So the Baghdad regime was largely reliant on their supporters to broadcast messages of support. Also they were relying on western and other media outlets reporting their press conferences.

Ramadan is a very highly emotive period in the Moslem calendar and to have these raids so close to it, severely

antagonised the entire Islamic world. Many commentators saw the raid as a domestic diversion from the impeachment furore in Washington. It was also close to the Christian festival of Christmas, which strongly emphasises Peace and Goodwill to all men.

Just days before this happened we had the American President in Israel and Palestine, trying to speed up the stalled Wye River Treaty. Kol Israel and the VOA extensively covered this. With a general election in Israel expected in April or May, there are going to be plenty of words spoken in the next three months.

This year I was unable to hear many of my regular Christmas Day Broadcasts due to Mother Nature. Christmas night ended with a spectacular sound and light show.

It was an uncomfortably hot and humid day and I was trying to hear the Vatican Radio on 21850 kHz but the static level was far too high. Looking out, I noticed that there were continuous flashes of lightning illuminating the night sky. Naturally I quickly turned everything off and disconnected all my antennas.

These electrical storms heralded a change in the weather. This intensifying system went out into the Tasman Sea where the Sydney-Hobart yacht race fleet really copped it.

The channel of 4483 kHz was extremely busy on the night of December 27 with numerous yachts in difficulties, requesting assistance. Tragically 6 sailors lost their lives and over 50 others were injured. Several yachts were abandoned to the elements, as a huge air/sea rescue operation was launched. Many were winched from the sea by helicopters in atrocious conditions.

The majority of communications in this disaster were on HF, demonstrating that shortwave is far from being redundant. As from the end of January, many maritime stations will be closing their HF C/W stations in favour of satellite communications. Other modes used on HF are also being closed, such as radiotelephone and telex. The historic Dutch Maritime Communications station PCH - Scheveningen Radio closed down at 1515 UTC on December 31 just a week after it's 94th anniversary. The British station, Portishead radio (GKA/GKB) is also closing down on June 30.

There are allocations for HF marine communications being hundreds of kilohertz wide. What is going to replace the HF C/W stations? Judging by what I am hearing, numerous Asian SSB stations usually in Cantonese, Indonesian or Korean are already there.

The American Globe Wireless network will be continuing on HF and are expanding their worldwide coverage by acquiring some of these facilities and operating them remotely from near San Francisco.

Globe uses e-mail and Telex although they have been reducing C/W as demand decreases. Globe is also using an encrypted form of Clover, allowing ships at sea to send e-mail via HF.

While monitoring Sydney Radio on 6507 kHz, during the Sydney-Hobart yacht emergencies, there was an unusual signal around 1300 UTC.

Once the crisis was over I went back. It was on AM yet was distorted and was easier on USB. I initially thought it was an Indo-Chinese marine station with the operator singing the weather reports. At the top of the hour, there was an Interval signal and a Vietnamese announcement. There was a mention of Cao Bang that immediately identified it as a provincial station in the hill regions of Vietnam. The station is using a very unstable transmitter that is never on the same channel for very long. It has been logged by others as high as 6590 and as low as 6390. What I found fascinating is the unusual singsong manner of the speakers, presumably in hill dialects. It is a broadcast station and only on apparently for three hours a day between 1100 and 1400 UTC.

Well that is all for February. 73,
Robin L. Harwood

ar

NOVICE NOTES

Peter Parker VK3YE 12/8 Walnut Street, Carnegie, Vic, 3163
Email: parkerp@alphalink.com.au Novice Notes
Online: <http://www.alphalink.com.au/~parkerp/nonline.htm>

Computers in the amateur shack

Most Australian amateurs own a personal computer. Word processing and games are the most common activities on these. However, a computer can be made to do many useful things around the amateur shack.

THIS IS A BRIEF TOUR of the many ways a computer can support amateur radio activities. Coverage of each item is necessarily brief. However, it is assumed that the reader has access to the Internet and will be able to obtain further information and/or software from the websites listed.

What type of machine?

A 486 or basic Pentium will serve well for most of the functions described here.

Programs are required. Advice on obtaining programs is given later. Accessories such as a printer, modem and (possibly) sound capability add greatly to the computer's usefulness.

Short wave listening

Would you like to sample HF reception without buying a short wave receiver? Or have you ever wondered what the bands sound like from the other end of the earth? If so, why not try one of the several 'web receivers' on the Internet?

A Web receiver is a HF radio receiver remotely controlled by a computer linked to the Internet. You type in the URL and hear an HF receiver through the Internet (providing you have a sound card installed). You can usually adjust the receiver's frequency, the mode of reception and the volume from your own PC.

Web receivers, though fun, are no substitute for your own receiver. Their main drawback is when another person uses it and changes its frequency. Also, it can take several seconds for any user made frequency adjustment to happen.

The short wave listening links section of the Radio Amateurs Canada website (<http://www.rac.ca/swl.htm>) has a section on web receivers.

Morse code

Morse Code can be transmitted and received by computer. All that is needed is the appropriate software and a simple interface unit that can be built at home. The limitation of simple computer Morse decoders is that weak signals can be buried in interference - the human ear will always do better.

See page 6 of December's *Amateur Radio* for an easy-to-build Morse decoder interface.

Morse practise software also exists. This can send text or random groups at a speed specified by the user. Links to webpages containing Morse-related software can be found at URL <http://www.rac.ca/cw.htm>.

Digital modes

Most operators of digital modes such as radio-teletype (RTTY), slow scan television (SSTV) and packet radio use a computer for sending and receiving. This requires a small interface unit between transceiver and computer and some special software (eg Hamcomm for RTTY and Baycom for packet).

The interface can be either easy to build and use only a handful of components (eg a Hamcomm interface unit or a Baycom modem) or an advanced project (eg a packet radio TNC).

Packet radio was covered in Novice Notes for December 1995. However, Amateur Radio has carried few beginner articles on the other digital modes.

The best way to get started on these digital modes is to approach another amateur who already has these modes set up and is able to assist with software and show you circuits of interface units/modems.

Log keeping

It often happens these days. You've just answered a call from a DX station. Without waiting for your transmission, you are called by name and your location and details known.

Impressed, you wonder how your contact can recall your details instantly. It's just a demonstration of a most useful application for computers in amateur radio - an amateur station log and callsign database. Several logging and contesting programs are available. <http://www.zeta.org.au/~richardm/hamlog.html> includes a demonstration copy of Ham Log v3.1, a contesting and logging program developed by Robin Gandevia VK2VN.

Callbooks

If you bought the 1999 WIA Callbook, you can send away for a copy on disk. The latest International callbooks are also available this way. There are some on-line callbooks available on the Internet. To find them, just type 'callbook' into any search engine. Just type in a callsign, and the name and address of the licensee appears.

Some Internet callbooks display extra information (eg an individual's e-mail address, URL or amateur radio interests) or allow you to make corrections. However, my experience is that at least for Australian listings, the free Internet callbooks are not as current as the WIA Callbook. You get what you pay for.

QSL cards

The use of programs to keep records of logs, countries confirmed and QSL cards sent and received was discussed earlier. If you have a good printer and the software you can print QSL cards on your computer.

Some logging programs include a QSL label-printing feature.

Satellite tracking

As often pointed out in the AMSAT Australia column, ownership of a computer is a must if you are interested in amateur satellites. Their main use is to calculate the workable times of the satellite. Computers can also control antenna headings - very useful for satellite operation, as both azimuth and elevation often have to be varied. Information and software can be obtained by joining AMSAT.

Grid squares

Amateur VHF/UHF operators often exchange four or six digit codes indicating their approximate location. These are called Maidenhead locator squares.

The world is divided up into 324 numbered squares based on latitude and longitude. They are easier to exchange on air than long place names.

If you know your latitude and longitude, you can calculate your Maidenhead locator using a program developed by John Martin VK3KWA.

This program also calculates the distance between any two squares and the correct beam heading for each station. To obtain a copy send a 3.5" disk and a stamped addressed envelope to VK3KWA at the address given in the callbook. This simple program will work on any IBM-compatible computer.

Automatic CQ caller

Those with a sound card in their PCs can turn their computer into an automatic CQ caller.

You need a single recording of a 20 second CQ call and a means to repeat it every minute or so. For convenience, an interface box containing input sockets (for the sound input from the computer and the microphone), an audio output socket (to the transceiver's microphone socket) and possibly switching circuitry for the PTT line would be desirable.

Those more

advanced could integrate the CQ caller with other functions such as transceiver control, beam steering and computer logging.

You can then collect detailed statistical information on all aspects of station performance (eg CQ:contact ratios on various bands and various directions, mean difference between signal reports sent and received, and more). A detailed assessment of the strengths and weaknesses of your station is possible with this data, particularly if other DXers your area were also collecting it.

Drawing circuit diagrams

Readers of Repeater Link will know of *Draft Choice*, a program for drawing schematic diagrams. My experience is that such programs are only justified if you do a lot of drawing and/or are willing to invest considerable time in learning them.

An alternative for those with an occasional need to draw circuits is MS Paintbrush. It comes standard in any PC.

Drawing a circuit with MS Paintbrush takes longer than drawing on paper, but the finished result looks professional. All schematics on Novice Notes Online were drawn with MS Paintbrush. The large size of Paintbrush's .BMP files can be reduced by converting them to .GIF files with Image Convert. The diagrams are clear, easy to read but quick to load. Below is a diagram drawn with MS Paintbrush.

Interference

It can be difficult to get computer and radio equipment to operate together harmoniously. Radio transmitters can cause interference to computer systems - when using an automatic CQ caller on 10 metres one day, I heard my recorded voice come through the modem while trying to log on to the Internet. Computers can also interfere with radio and TV equipment and, in extreme cases, make them unusable.

The first step to treating interference is to isolate the source of the problem. For example, does the interference go away when the modem or monitor is turned off? It can be wrong to assume that just because something is switched off, it is incapable of causing interference. I have a Canon BJC210SP printer that interfered with HF reception even when the computer was not being used. The solution was to unplug it from the wall.

Poor quality, badly shielded connecting cables sometimes radiate interference, the computer to monitor cable can be particularly troublesome.

The FCC has a World Wide Web site that includes an electronic copy of the *Interference to Home Electronic Entertainment Equipment Handbook* that discusses sources of interference and possible remedies. The Handbook can be viewed at URL: <http://www.fcc.gov/cib/Publications/tvibook.html>.

Figure 1. An example of a schematic diagram drawn with MS Paintbrush

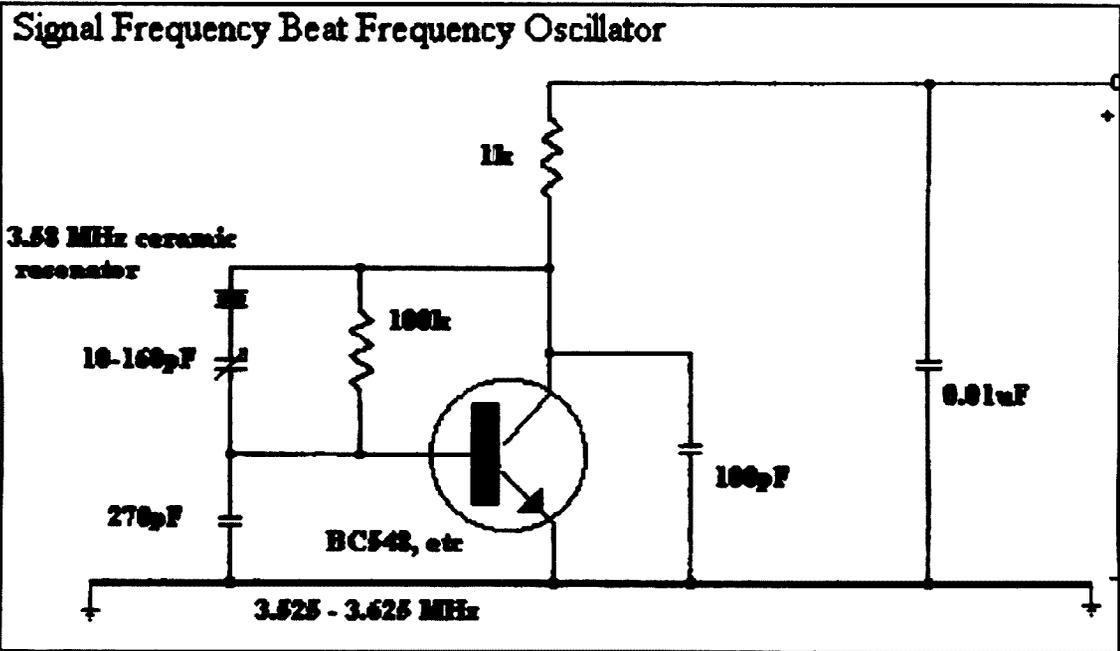



Divisional News

Saturday 6 March 1999. The necessary Nomination Forms will be available mid February - please apply to the office.

During the AGM, the lucky winner of the New Member Prize - the ICOM 706 Mark II valued at about \$2300, kindly donated jointly by Icom Australia and Amateur Transceiver Radio Centre - will be drawn

Should you, therefore, have a friend who is thinking about joining the WIA suggest that now is the time and he/she contact the office for a Membership Application Form. A phone call to (02) 9689 2417 is sufficient - we will send one out by post, or the form may be downloaded from the VK2 Web Page at www.wia.org.au/vk2. To be in the draw completed applications must be received at the office not later than 26 March 1999.

DURAL

As I have stated many times in this column, the upgrade of the Dural site has been a major commitment of the present Council - not only in the improvement of equipment etc. but also in the site itself.

The driveway was surfaced with road base, the exteriors of the buildings were painted, grass is now cut and brush cleared on a regular basis to name just a few of the tasks undertaken.

However, the upkeep is an on-going necessity and our Dural Officer, Vice President Owen Holmwood VK2AEJ, advises that during the New Year Holidays a "Clean up Day" was again undertaken at VK2WI. According to a report given to the author by an independent source, "Dural is looking very good indeed". Thanks Owen and your Dural team.

PARRAMATTA OFFICE

A new supply of books has just been received from the USA and UK, which contains quite a few new titles - that is new titles not new editions - so why not call in and browse through something like 140 titles covering most aspects of our hobby.

By the way, continuing in our endeavours to offer the best possible service to our members we have now installed EFTPOS. This service will also be available at the WIA stand at the Central Coast Field Day at Wyong.

FORWARD BIAS -

VK1 NOTES

Peter Kloppenburg VK1CPK
(02) 6231 1790

Adrian Dudok, the director of the National Capital Rally extended thanks on behalf of the event to the twenty or so operators who provided such invaluable assistance to the event on October 5th.

As a WIA/WICEN event, 18 field and two headquarters operators provided communications for safety and logistics information to the start and end of the events nine stages. Thankfully it was a relatively incident free event despite a very large field of some 93 competitors of which some 20 or so did not finish.

The Brindabella Motorsport Club, the organisers of the event, presented the Division with a donation of \$500 by way of a thankyou for our assistance. As an added bonus, a dinner for two was made available at Blundells Restaurant at the Canberra Parkroyal to be presented to one of the Division's volunteers.

To select the lucky operator, the callsigns of all the participating field personnel were placed in a hat (well it was actually part of an old 5.25" hard drive but that's another story). Fiona McCubbin-Mee, the secretary of the event did the honours and drew the callsign of Derek, VK2DRK from the "hat". Gil, VK1GH and Hugh, VK1YYZ who organised the participation of the field operators also extend their thanks to all who were involved. An enjoyable day was had by all!

Preliminary notice is hereby given about a rally that will take place on 7-8-9 of May 1999.

As some of you may know, the division is in the process of coordinating the erection of the new 18-metre mast at Mt. Ginini. Progress so far: The hole has

been dug. But it took 7 hours with a backhoe to accomplish. The soil contained many boulders and rocks that are notoriously difficult to shift.

Next job will be making formwork for the foundations and pouring the concrete. From the electronic side comes word that the makeshift and temporary 2-metre repeater at Mt Ginini will be removed and replaced with the original one. That unit has now been repaired and refurbished and should give a few more years of good service.

Cheers pkloppen@dynamite.com.au

VK2 NOTES

Eric Fossey VK2EFY
Division Secretary

ANNUAL GENERAL MEETING

When you read this, we will be well into a New Year and fast approaching the period when most Divisions hold their Annual General Meetings. In VK2, as previously advised, the AGM will be held at Amateur Radio House, Parramatta on Saturday 17 April commencing at 11.00 am.

The Annual General Meeting is where you, the members, elect the Council for the coming year - it is for you to decide whom you want to run YOUR Division for the next twelve months.

When you receive your ballot papers etc., please take the time to carefully read the instructions and then mark your choices (9). Return the form in the "reply paid" envelope provided. Don't forget - if you can't attend the meeting personally, please give your proxy vote to a friend who is attending and indicate on the proxy form how you wish him/her to vote on any motion.

Nominations for Council and "Motions on Notice" must be received at the office not later than 12.00 hrs on

VK4 NOTES**Alistair Elrick VK4FTL
WIAQ Treasurer****FUN DAY**

The very first Great Amateur Radio Fun Day will be held at the Daisy Hill Environment Park Sunday 21 February 1999 11am. Enter via Daisy Hill Rd from Winnetts Rd., which runs along side the Pacific Highway at Slacks Creek.

The day starts at 11 AM, so come along and don't forget your Gold coin donation to RFDS.

It's a great place to bring the family.

The Great Amateur Radio Funday is intended as a Social and Fun get together organised by VK4BBS.

Brian hopes he can be assured of the support of your club. Not only should you and your fellow members attend but also you'll be free to talk to those interested in Radio and Electronics particularly Radio Amateurs and Shortwave Listeners who may be looking for a local radio club in your club's area to join.

If attending from "out of town" you're more than welcome!

The Brisbane VHF Group 147.000 MHz repeater will be our liaison channel. Brian is further requesting support with a small, portable demonstration or activity as an indication of what Radio Clubs and Amateur Radio, particularly yours are all about.

These small demonstrations could include, Portable Packet, ATV, Fox Hunt, Portable RTTY, Mobile HF, Small Portable Antennas, CW Demo, Portable SSTV, 10 and 6m repeater operation etc.

The Southside ARC has indicated that they are prepared to help with a small activity demonstration also.

City Of Brisbane will put on a Portable RTTY demo and the Brisbane ARC and Redcliffe have been discussing support.

Being a member, Brian may be able to encourage the SEQ Trekking Radio Amateur group to come along and cook some dampers etc for us.

Brian VK4BBS needs our support on 21 Feb, does he have it?

NETWORK EXTENDS

Thanks to Gordon VK2AGE and David VK2YDN the Mt Nardi node is on air again. They changed the node to an X1J node (RPL440) and it is now operating very well with mail moving to both those stations. VK2 now have TCPIP session facilities through to Brisbane. VK4's QDG congratulates Gordon VK2AGE for his efforts and work in providing this extension to the QDG network. (Info from Nev VK4TX)

WICEN BUNDABERG

News from Bundy's VK4JM who has 17 operators in training, in fact 17 operators about to successfully complete their WICEN training. 12 have joined the local SES Branch...well done!

Rusty is continuing message training on the Bundaberg City repeater Tuesday night. That's 147.800. A good rapport has been established with Bundaberg SES due in no small part to WICEN being involved in the drawing up of the welfare and disaster plan for the City and Burnett region. Sop's are now in place for local WICEN and Community roles.

ROAR**ROTARIANS OF AMATEUR
RADIO**

ROAR ANZO Chairman Dr. David Portley VK4DP (an ex wiaq fed councillor) asks the ROAR group to try 21.403 at 1030UTC Sundays as he links into ROAR RIBI (G-LAND). A reminder, if you're on packet and a Rotarian, drop a packet to ROAR club station VK4WAY @ VK4PKT.

MORSE SOLDIERS ON

FIRST ROCKHAMPTON LIGHT HORSE HISTORICAL REGIMENT has approached Clive VK4ACC the Secretary of the Rockhampton And District Radio Club inc for assistance to learn Morse Code.

Some of them were keen to qualify officially and hope to sit for the 5wpm amateur radio CW test. Clive went along and addressed one of their meetings. They wanted to be as authentic as possible and intend later on to use light and flags (semaphore) as well. They were supplied with CW tapes and will contact Clive for further tuition as required.

WICEN

Currently transmitted on the beacon transmissions of BBS VK4ZZ is a short precis of any information regarding developing low-pressure systems in the Coral and Arafura seas. It is extracted from the Bureau of Meteorology Internet pages for High Seas areas 10 and 11, plus any cyclone information which might come to hand. These transmissions are designed to keep hams in the north informed and to flag any times they might need to source extra information on developing systems. The beacon transmissions go to:

147.6 VK4ZZ > VK4RAT
144.9 VK4ZZ > VK4RAT > VK4RCA
434.2 VK4ZZ > VK4RAT > VK4TUB
> VK3TCD
7.040 VK4ZZ > VK4DO > VK4FC

IPSWICH

The Technical "boffins" out in the West Moreton have just built up the DTMF decoder designed by Will VK6UU for their repeater VK4RKP 146.725 Mt Crosby. Also in the Ipswich clubs newsletter "DOPPLER" comes word on e-mail addresses. If you're looking for a fellow Amateur who might be on the Internet then check out Australia's largest listing of VK URL's and e-mail addresses available on the WWW. If you log on and discover you're NOT shown, submitting your info is as easy as a "double click". VK2NNN Allan is to be commended for the page.

For QNEWS listeners and readers it's simply a matter of clicking the links page on <http://www.wiaq.powerup.com.au>.

VK5/VK8 NOTES**Ian Hunt VK5QX
Division President****ANDY THOMAS AGAIN**

By the time these notes appear we will have enjoyed a very special occasion. Dr Andy Thomas who operated with the callsign of VK5MIR from the Russian Space Station will have presented a lecture, especially for Amateur Radio operators, towards the end of January.

He is at present in Adelaide visiting his parents and friends and in his usual

way also undertaking various commitments in the public arena.

Andy initially wanted to meet and speak with those operators with whom he had made contact whilst on MIR, however, in view of the difficulty of ascertaining just who these were, we decided that the talk should be open to all.

The fact that the weekly Sunday news broadcast has been in recess did not make the task of promulgating information regarding this event any easier.

However, we have been able to spread the word pretty effectively through both the Packet Radio Network and by contacting as many clubs and groups as possible by telephone and e-mail.

As a result of our efforts we have a good idea regarding those who will attend and who did make a voice contact with Andy thus allowing to organise a "private" supper function following the lecture so that Andy's wishes may be met.

Also to take place at this occasion will be the presentation to Andy by the Acting Mayor of the City of West Torrens, Dr Reece Jennings, of the City's highest available Civic Award.

The last person to whom this award was presented was the State Governor, so Andy is certainly in honoured circles.

All of the event is to be video-taped, so we hope to be able to make copies of the tape available so that others unable to be present will also benefit from Andy's kind gesture towards the Amateur Radio operators of Australia.

QSL CARDS FOR VK5MIR CONTACTS

I am surprised at the apparent lack of interest in the special QSL card to be produced to commemorate the VK5MIR 2 metre operation by Andy Thomas.

Despite providing details several months ago I have so far received only around 30 or so requests for the QSL card.

I thought we had made it as simple as it could be requiring only a QSL request and a Self-Addressed Stamped Envelope (SASE). For contacts made outside Australia we need merely the amount of necessary postage costs.

QSL requests can be sent to Ian J. Hunt, VK5QX 8 Dexter Drive Salisbury East, South Australia 5109.

In view of the fact that it is difficult to determine just how many cards will be required I have put off production of the cards to a later date and I will probably in due course announce an actual cut-off date for requests.

This will allow us to have the cards printed without excessive wastage. You may note that the members decided by vote that the VK5 Division would pay for the costs of the QSL card production.

MEMORIAL FOR ALF TRAEGER

The late Alf Traeger held the callsign of VK5AX. He became world famous for his work in connection with the Royal Flying Doctor Service and particularly for his invention of the "pedal radio".

Alf Traeger was brought up in the country area around the town of Balaklava, however, until now there has been nothing in that area to specifically mark the history concerning this well-known pioneer in radio development.

So as to rectify that situation action was taken by several people to have a memorial made which will allow recognition of Alf Traeger's achievements. This effort will come to fruition on Tuesday 26 January, which also happens to be Australia Day.

As part of the Wakefield Regional Council celebration of this National Day the memorial, which will be located in "The Triangle", a park area in the centre of the town of Balaklava, will be unveiled by the Honourable Neil Andrew, Member for Wakefield and Speaker of the House of Representatives. This ceremony will take place at 10.00am.

The memorial takes the form of a plaque and sundial. The plaque will carry on it the insignia of both the Royal Flying Doctor Service and of the Wireless Institute of Australia and includes a reference to both bodies with which Alf was connected.

The members of the VK5 Division moved that provide a donation of \$100 to be made towards production of the memorial. Acknowledgment of this donation has been received from the Wakefield Regional Council.

I have been invited, as Divisional President, to attend both this ceremony as well as an Australia Day Breakfast to be held at the "Balaklava Triangle"

commencing at 8.00am on that day. That will be a busy day for me what with the divisional monthly General Meeting also that same evening.

I would expect that in due course more details and perhaps even photographs from the two events described above would be available for publication.

FEBRUARY GENERAL MEETING

The format for the February General meeting will be somewhat changed from usual.

It is anticipated that for the evening we will be paying a visit to the Australian Broadcasting Corporation radio and television studios located at Collinswood, one of the inner eastern suburbs.

More details regarding this will be presented via the weekly Sunday news broadcasts, which I encourage you to listen to. I also point out that, if you miss the Sunday broadcasts there is a repeat each Monday evening on the 80 metre and 2 metre bands originating from here in Adelaide. Check the WIA Division Directory, page 56 for full details.

DIVISIONAL SECRETARY

I had announced in one of the Sunday broadcasts prior to Christmas the appointment of Merv Millar as Secretary of the Division.

Graham VK5EU had continued as Acting Secretary, however, he had been encountering some difficulties that did not allow him to do, in his opinion, full justice to the position.

Following the passing of Don VK5ADC we had coopted Merv VK5MX to the Divisional Council and he has gradually taken on the full duties of the Secretary position.

It would appear that inadvertently the listing for Secretary in the WIA Division Directory page in the January issue of this magazine was not correctly amended as requested to show this change.

We apologise to both Merv and Graham for this mistake which should now be rectified. We also offer our thanks to them both for their efforts on behalf of the Division and the hobby of Amateur Radio.

BURLEY GRIFFIN BUILDING

The ongoing saga regarding a new headquarters continues and I can see that my guess, in the January issue, of February or March for completion of the move was certainly optimistic.

We have an excellent relationship with the West Torrens Council. However, despite that fact some things take time to come to fruition. I will keep you posted as matters develop on this issue.

NEW CONSTITUTION AND AGM

Finally, I remind you that the Annual General meeting will take place in April.

Adoption of a new constitution will be part of that AGM. There is more in the "Divisional Journal" insert in "Amateur Radio" this month.

The new Constitution is of major importance both for now and also for the future of both our division and our hobby. I ask that you ensure that you take part in both the debate and voting on this matter.

Best 73 to your from Ian VK5QX
Divisional President.

VK6 NOTES

NOTICE: WEST AUSTRALIAN DIVISION AGM FOR 1999

It is hereby notified that the Annual General Meeting of the Wireless Institute of Australia (Western Australian Division Inc.) will be held from 9am on Saturday 24 April 1999 prior to the 2nd Conference of Clubs which will possibly be followed by a BYO BBQ and a car boot sale.

The venue will be the RSL Hall on the corner of Fred Bell Parade and Playfield Street, East Victoria Park. The agenda will be:

1. Consideration of the Council's annual report
2. Consideration of the financial report
3. Consideration of other reports
4. Election of office-bearers (President, Vice President and seven other Councillors)
5. Election of two Auditors
6. Appointment of a Patron
7. General business which has been duly notified.

Notices of Motion for the AGM must

be received by the Secretary not less than 42 days prior to the meeting (ie by 13 March 1999), and must be signed by at least three members.

The Secretary's postal address is: PO Box 10, West Perth WA 6872.

Nominations of candidates for election to Council must be received by the Secretary, in writing, not less than 42 days prior to the meeting (ie by 13 March 1999), with an intimation that the candidate is willing to act.

A candidate may submit a statement, not exceeding 200 words, outlining his or her experience and case for election. Each nomination shall be signed by two members proposing the candidate.

Candidates must possess a current licence.

Any financial member who is entitled to vote may appoint a proxy, who must also be a financial member who is entitled to vote, to speak and vote on his or her behalf. Written notice of such proxy must be received by the Secretary prior to the meeting, and be in the following form:

I (full name), a member of the Institute, hereby appoint (full name), also a member of the Institute, to act for me as my proxy, and in my name do all things which I myself being present could do at the meeting of the Institute held on 24 April 1999.

Signed:

Witness:

Date:

73 for February.

ar

Urunga Convention 1999

THE 2-METRE Pedestrian Fox Hunts at Urunga are well supported as the attached photograph clearly shows.

For fifty years amateurs have been coming to Urunga for their annual convention and the Fox Hunt has become one of their regular attractions.

What is encouraging is the range of contestants, both male and female with ages ranging from the very young to the very experienced!

Sounds like a lot of fun is had by all that attend.

This year is the fiftieth birthday of the convention and as any fifty-year-old would expect, there will be a birthday party in celebration.

The cutting of the cake will take place after dinner at the Ocean View Hotel, Urunga, so come along and

celebrate with the troop at Urunga.

Bring your Fox Hunting gear and test your skills against the locals. (If you are a local then don't let your neighbours down, pride is at stake!)

Urunga claim to have devised many of the fox hunt contests that we currently enjoy so here's their chance to prove it and your chance to join in.

**See you at Urunga,
3rd and 4th April
1999.**

Best 73's Brian Slarke VK2ZCQ

**For more information and
accommodation information
call Brian after 8:00pm on (02)
6655 1115.**



The contestants line up for their chance at the Urunga 1998 Convention

CONTESTS

Ian Godsil VK3DID

Federal Contests Coordinator

56 Nepean Hwy, Aspendale Vic. 3195 vk3did@eudoramail.com

1998 RD Contest Results

Big Win by VK7 Division

Contest Calendar

February - April 1999

February

- 13 Asia-Pacific CW Sprint (Jan 99)
- 13/14 PACC DX Contest (CW/Phone) (Jan 99)
- 19/21 CQ 160 Metres SSB Contest (Dec 98)
- 20/21 ARRL DX CW Contest (Jan 99)
- 27/28 RSGB 7 MHz CW Contest (Jan 99)
- 27/28 Jock White Memorial Field Day (CW/Phone) (Jan 99)
- 27/28 UBA (Belgium) CW DX Contest
- 27/28 REF (France) SSB DX Contest (Dec 98)
- 28 High Speed Club CW Contest (Jan 99)

MARCH

- 6/7 ARRL DX SSB Contest (Jan 99)
- 13/14 Commonwealth Contest (CW) (Feb 99)
- 20/21 WIA John Moyle Field Day (Feb 99)
- 20/21 DARC HF SSTV Contest
- 20/21 Bermuda Contest (Feb 99)
- 20/21 Russian DX Contest (CW/Phone) (Feb 99)
- 27/28 CQ WPX SSB Contest (Feb 99)

APRIL

- 3/4 SP DX Contest (CW/Phone)
- 9/11 JA DX CW Contest (High Band)
- 10/11 International HF Grid Square Contest
- 10/11 EA DX Contest (CW/Phone)
- 17/18 SARTG AMTOR Contest
- 17/18 Holyland DX Contest (CW/Phone)
- 24/25 Helvetia DX Contest (CW/Phone)
- 24/25 SP RTTY Contest

Thanks this month to VK3KWA, VK6APK, RSGB, SM3CER

THE VK7 DIVISION has done it again. Congratulations to all the members of that division who put in the effort to secure the title for 1998. Despite a substantial drop in the HF score, they have increased their lead over their nearest rivals.

The runner up, the VK2 Division was very unlucky not to be the new titleholder. They were the most consistent, registering good improvements in both HF and VHF activity.

One thing that was apparent again this year was the need to clarify or change rule 9 that relates to multi operator stations. It states, in part: 'only one person may operate at any time, ie no multi transmission.'

As we can all appreciate, this rule is impossible to police and I am actually at a loss to explain why the rule even exists.

To me, anything that promotes activity and participation is very much in the spirit of the contest and should be encouraged.

Most contests in the world allow for multi-operator/multi-transmitter entries and I don't see any reason why the RD should be excluded. I will endeavour to have it rectified in the rules for next year.

I received detailed reports of some stations not operating within the spirit of the contest, ie contacting only one station to the exclusion of all others in the contest and simultaneous transmissions by one operator on two or more bands.

I have noted these reports and have carefully scrutinised the affected logs. I have disallowed contacts where this abuse of the rules was apparent and adjusted the scores appropriately.

At my discretion, I did not disqualify these entrants. They are however, ineligible for certificates. I am confident that the situation will not occur again in the future.

Looking at this year's divisional scores and the benchmarks for next year,

it can be seen that the all divisions have an excellent chance of taking out the prize next year.

Divisional Scores

The method used to determine the winning division using 'Benchmarks' and 'Improvement Factors' was published with the rules in Amateur Radio July 1998, starting on page 27.

Readers who wish to do their own calculations are referred to that issue of the magazine.

Table 1 shows the placing of each division along with their overall Improvement Factors.

Table 1: Divisional Ladder

1st	VK7	3.543
2nd	VK2	1.276
3rd	VK5/8	1.043
4th	VK6	0.770
5th	VK4	0.689
6th	VK1	0.511
7th	VK3	0.449

The total scores in both HF and VHF are shown in Table 2.

Table 2: Divisional Scores

Div'n	HF	VHF
VK1	694	44
VK2	5513	95
VK3	2775	3145
VK4	3640	317
VK5/8	3890	1416
VK6	3297	3016
VK7	1331	1215

The above totals were used in the calculation of the Improvement Factors, which determined the winning division. They were also used in the calculation of the Benchmarks to be used for next year's contest.

These Benchmarks, which are shown in Table 3, are the scores that must be surpassed by each division in order to register an improvement. They will be published again with the rules in July 1999.

Table 3: 1999 Benchmarks

Div'n	HF	VHF
VK1	783	206
VK2	4639	79
VK3	4004	9558
VK4	3372	965
VK5/8	3782	1368
VK6	3044	6063
VK7	1778	446

Results ARI International DX Contest 1998 (Call/cat/score)

VK2APK SO-MIX 358110

Results CQ-M International DX Contest 1998 (Posn/Call/Cat/Score)

10 VK2APK SO-MIX 129948

Individual Scores

The individual scores for entrants are listed below. Certificate winners are denoted by an asterisk (*) and the top Australian scores in each section by a hash (#).

This year, for the first time, certificates will be issued to both the top single operator and top multi-operator stations in each division.

VK1

DID	138		
II	104		
RJ	100		
AZR	90		
PH	88		
CW	74		
HF CW		HF Open	
AU	240*	BO	431*
HF Open		ZL	348*
PK	197*	EP	104
VHF Phone		VHF Phone	
DW	26*	IBT	42*
KMA	18	HT	18
		ZL	18
		UAI	17

VK2

HP Phone	
XN	396*
CM	313
DCL	272*
SHA	259
ARJ	266
PB	235
XT	203
CAA	154
AGF	116
VG	107
APP	84
KQ	75
IBT	69
LEE	47
TG	46
ALZ	44
FY	41
IV	38
DDW	36
WI	33
GCE	24
SW	23
HT	18
KCO	15
CF	13
DDB	11

HF CW

KM	296*
OI	210
BHO	206
EL	200
QF	186

VK3

HF Phone	
SAY	301*
IO	300*
AHY	144
CB	121
GH	105
EX	96
JK	65
KQB	58
KTO	52
ABP	50
BWT	50
EST	47
ALD	42
DY	42
DS	40
DVT	36
ATJ	29
BLZ	26
ADW	21
GHA	21
GK	17
AAJ	16
CAM	12

HF CW

APN	242*
SV	164
XB	96
AMD	46
JL	44
VB	44
OZ	28

KS 23

HF OPEN

DID 177*

VHF Phone

GUS	629#
SAA	594*
DBQ	319*
MBD	233
KTO	214
HLP	202
JK	155
XBA	129
AYF	117
GPT	115
GK	114
BGS	67
XJU	50
CAM	50
GH	47
MGZ	34
AJJ	22
4PJ/3	22
XH	20
DID	12

VK4

HF Phone

BAY	205*
EJ	92
BTW	77
JAL	68
JAE	64
ACW	56
PF	55
AWL	45
4PJ/3	35
QF	30
EHT	26
AO	26
DV	25
LUV	22
BSH	20
WJG	16
EV	11
OE	8

HFCW

XA	316*
LV	266
LP	210
XW	186
XY	176
CI	146
COZ	114
RE	54

HF Open

EMM	456*
LT	284
DB	248

GZ 120
ZA 104
AJH 77

VHF Phone

ZBV	129*
EHT	54
ZA	43
OE	31
BAY	29
AO	13
JAE	7
LUV	6
AWL	5

VK5/8

HF Phone

EN	361*
ARC	322*
8DA	237
BWH	229
BQ	228
ZDW	212
EE	169
GRC	112
UE	71
AFZ	55
RK	24
TW	23
KJT	19

HF CW

8HA	218*
XE	204
HO/4	16

HF Open

BRC	641#
ATU	380*
GZ	308
UQ	61

VHF Phone

ARC	484*
BRC	447
AR	202*
GRC	174
KLD	50
KIA	31
BQ	20
KMI	5
TW	3

SWL

JAZ 128*

VK6

HF Phone

SZ	551#
CSW	203*

VX 131
JP 118
DDX 113
ADI 97
CD 95
PM 63
PX 60
PX 60
BIK 57
KG 56
SAR 52
KH 49
AR 44
ER 35
KZ/5 29
YF 25
WU 19
PO 12

HF CW

AFW	208*
VZ	164
AJ	136
WZ	26

HF Open

GW	299*
CF	291
RU	163
JS	112
WT	61
HK	28

VHF Phone

ZDW	342*
ANC	297*
FJA	187
HU	181
SAA	181
SAR	150
JP	133
DS	132
HAQ	132
BDO	130
AR	122
MCB	120
YF	112
AD	94
ZDS	80
RO	75
KG	75
CSW	67
PX	60
TS	60
MIN	57
XH	45
KTN	43

CX 41
BW 24
PO 22
VX 20
WT 20
GA 14

VK7

HF Phone

CK	411*
RN	245
JGD	162
NDO	132
DG	109
JP	52
RM	50
RR	39
KC	28
BM	10

VHF Phone

ZBX	200*
DG	156
FB	151
JGD	129
RR	127
KV	95
EB	75
RM	70
RB	63
KC	37
NDO	37
NGC	28
HJ	26
LS	21

OVERSEAS

ENTRIES

Thanks go out once again to the overseas entrants for their participation and help in making the contest the success it is.

HF Phone

ZL3TX	176*
ZL1AGO	15

HF CW

ZL4GU	278*
ZL1ASZ	158

That's it for another year.
73 and good luck in 1999.
Alek Petkovic, VK6APK
E-Mail vk6apk@eon.net.au

CONTESTS

RUSSIAN DX CONTEST

1200 Sat - 1200z Sun, 20/21 March

Bands: 160 - 10 m (no WARC).

Sections: Single Operator; CW, Phone, Mixed; single or all bands. Modes: CW, SSB. Exchange RS(T) plus serial number starting with 001.

Russian stations will send serial number plus two-letter Oblast code (max 88 + 3 on each band). Score 10 points per Russian QSO, five points for QSOs with stations on another continent, three

points for stations in the same continent and two points with your own country. Continents are as per WAC.

Final score is total QSO points by number of DXCC countries and Russian Oblasts worked on each band. Send logs and summary sheets postmarked by 16 April 1999 to: Contest Committee SRR, PO Box 59, 105122 Moscow, Russia.

Oblast designators are:

AB AD AL AM AO AR BA BO
BR BU CB CK CN CT CU DA
EA EW GA HA HK HM IR IV
JA JN KA KB KC KE KG KI
KJ KK KL KM KN KO KP KR
KS KT KU LO LP MA MD MG
MO MR MU NN NO NS NV
OB OM OR PE PK PM PS
RA RO SA SL ST SM SO SP
SR SV TA TB TL TM TN TO
TU TV UD UL UO VL VG VO
VR YA.

SPRING VHF-UHF FIELD DAY 1998: RESULTS

John Martin VK3KWA,
contest manager

COMMENTS

Some comments and suggestions from the logs:

"I found it harder to work stations on 6 than on 2. The multiplier should be the same for both bands".

"I did not hear anyone on FM".

"A good contest. Should be repeated, possibly a week earlier to avoid clashing with the ALARA contest".

"Early December might be a more reliable time for both weather and propagation".

Other suggestions were that the repeat contact limit should be two hours rather than three; that the duration should be any 24 consecutive hours out of 26; and that 6 metres should be dropped (here we go again)! Any comments on these points would be much appreciated.

THE INAUGURAL Spring Field Day went very well, especially considering that it was announced at very short notice. There were no multi-operator entries, probably for this reason.

Once again VK3 dominated the logs, and again VK6 was conspicuous by its absence.

The logs reveal a number of contacts over 600 km, both on 2 metres and 70 cm. There were also some interstate contacts on 1296 MHz and a total of 18 stations active on this band.

Many of the logs had to be re-scored, in most cases because entrants forgot to claim credit for the grid square they were operating in. Something to remember for next time.

RESULTS

Speaking of remembering, Rod VK2TWR almost forgot to send his log in. It is just as well that he eventually got around to it, because he is the overall winner. Congratulations Rod.

In Section A, Barry VK3BJM came a close second. The winner of Section B was Ralph VK3WRE by a big margin, and Max VK3TMP came first in Section D with an equally big margin.

Congratulations all round, and also to all other entrants for making this inaugural Spring Field Day a success.

SECTION A - PORTABLE, SINGLE OPERATOR, 24 HOURS

Call	Name	Grid	50 MHz	144 MHz	432 MHz	1.2 GHz	2.4 GHz	TOTAL
VK2TWR	R. Collman	QF43	117(8)	832(14)	994(9)	430(2)	-	2373
VK3BJM	B. Miller	QF23	85(6)	940(16)	777(8)	500(3)	-	2302
VK4OE	D. Friend	QG50, QF59	-	-	336(2)	-	429(1)	765
VK2XCI	N. McMillan	QF27	-	536(10)	-	-	-	536

SECTION B - PORTABLE, SINGLE OPERATOR, 6 HOURS

Call	Name	Grid	50 MHz	144 MHz	432 MHz	1.2 GHz	2.4 GHz	TOTAL
VK3WRE	R. Edgar	QF31	88(6)	432(6)	651(6)	770(5)	299(1)	2240
VK3AFW	R. Cook	QF33	80(6)	632(12)	-	-	-	712
VK3KAI	P. Freeman	QF31	-	-	147(1)	220(1)	286(1)	653
VK5ZUC	A. Russell	PF95	21(1)	172(3)	147(1)	-	-	340
VK3YE	P. Parker	QF22	-	280(4)	-	-	-	280

SECTION D - HOME STATION, 24 HOURS

Call	Name	Grid	50 MHz	144 MHz	432 MHz	1.2 GHz	2.4 GHz	TOTAL
VK3TMP	M. Pickering	QF21	35(2)	544(11)	791(9)	330(2)	-	1700
VK7JG	J. Gelston	QE38	36(2)	356(4)	252(2)	220(1)	-	864
VK1WJ	W. Jirgens	QF44	51(3)	252(4)	371(3)	-	-	674
VK3CAT	T. Middleditch	QF22	58(4)	388(6)	-	-	-	446
VK4PJ3	P. Brown	QF22	-	184(3)	-	-	-	184

Numbers in brackets are the numbers of locator squares worked on each band.

CONTESTS

CQ WPX CONTEST

SSB: 0001z Sat - 2400z Sun 27/28 March

CW: 0001z Sat - 2400z Sun 29/30 May

OBJECT IS TO contact as many stations worldwide as possible on bands: HF (no WARC).

Categories: single operator (single or all-band), subdivided according to power (unrestricted, low power max 100 w o/p and QRPP max 5w o/p); multi-operator (single or multi-tx, all bands only). Single operator stations are where one person performs all operating, logging and spotting functions.

Note: single operators may only work for 36 of the 48 hours. Off periods must be at least one hour and clearly marked in the log. No time limits apply to multi-operator stations.

Multi-multi stations must have all txs located within a 500-m diameter circle or within the property limits of the licensee's address, whichever is the greater. All antennae must be physically connected by wires to the station txs and rx's.

Exchange RS(T) plus a three-digit number starting at 001. Continue to four digits if past 999. Multi-tx stations must use separate numbers for each band.

Score three points (20/15/10 m) or six points (160/80/40 m) for contacts with stations on different WAC continents, and one point (20/15/10 m) or two points (160/80/40 m) for contacts with stations within same WAC boundary.

Contacts with stations in same country are permitted for multiplier credit, but have zero point value.

Multiplier is the total number of prefixes worked on all bands) (each prefix counted once only regardless of the number of different bands on which it is worked). Final score is QSO points X multiplier.

Logs must show times in UTC, with breaks clearly marked. Show prefix multipliers first time they are worked.

Logs should be checked for duplicates, correct points and prefix multipliers. Logs must be accompanied by a sorted alphanumeric list of prefix multipliers and a summary sheet showing call, name, address, category, power, scoring information and a signed

declaration that all contest rules and radio regulations were observed.

Send logs by disk. CT's *.bin file or *.all file; N6TR's *.dat file; NA's *.qdf file or *.dbf files are preferred. ASCII file containing all information is acceptable.

Disk files must be in chronological order for single operator and multi-single stations, and chronological order by bands for multi-multi stations.

Please label disks and name your files with the call used (eg VK3DID.BIN or VK3DID.DAT). Disks will be required from top-scoring stations. Logs may also be submitted via e-mail to:

sdb@ag9v.ampr.org or
n8bjq@erinet.com. Logs received via e-mail will be confirmed upon receipt. Send logs no later than 7 May (SSB) or 9 July (CW) above, or to: WPX Contest, 76 N Broadway, Hicksville, NY 11801, USA. Indicate SSB or CW on envelope.

To be eligible for awards, single operator stations must show at least 12 hours operation and multi-operator stations must show at least 24 hours operation.

Single band entries showing points for more than one band will be judged as multi-band unless otherwise specified.

COMMONWEALTH CONTEST 1999 1200z Sat - 1200z Sun, 13/14 March

OBJECT IS TO promote contacts between stations in the Commonwealth and Mandated Territories.

Category: Single Operator only.

Sections: Open (no limit on operating time), and Restricted (operation limited to 12 hours; off periods must be clearly marked and at least one hour each; at least four hours' operation must take place after 0000z on 14 March. Operate in lowest 30 kHz of each band, except when contacting Novice stations operating above 21030 and 28030 kHz.

Exchange RST plus serial number. Any station using a Commonwealth Call Area prefix may be worked, except those within the entrant's own call area. Note that for this contest, the entire UK counts as ONE call area. Score five points per valid QSO, plus a bonus of 20 points for each of the first three contacts with each Commonwealth Call Area, on each band.

A number of Commonwealth Society HQ stations will be active during the contest, and will send 'HQ' after their serial number to identify themselves. Every HQ station counts as an additional call area, and entrants can contact their own HQ station for points and bonuses.

Separate logs and lists of bonuses

are required for each band. Entries must be accompanied by a summary sheet indicating the section entered, and scores claimed on each band. Send logs postmarked by 6 April 1999 to: RSGB HF Contest Committee, c/o S V Knowles, 77 Bensham Manor Road, Thornton Heath, Surrey, CR7 7AF, UK. Awards of the Senior and Junior Rose Bowls will be made to the winners of the Open and Restricted categories respectively, and Certificates of Merit to runners-up.

Commonwealth Call Areas are:

3B6 3B8 3B9 3DA 4S 5B 5H 5N 5W
5X 5Z 6Y 7P 7Q 8P 8Q 8R 9G 9H 9J
9L 9M0 9M2 9M6/8 9V 9Y A2 A3 AP
C2 C5 C6 C9 CY0 CY9 G/GB/GD/GI/
GJ/GM/GU/GW (all one area) h4 J3 J6
J7 J8 P2 S2 S7 T2 T30 T31 T32 T33
TJ V3 (Antigua, Barbuda) V3 (Belize) V4
V5 V8 VE1 VE2 VE3 VE4 VE5 VE6
VE7 VE8 VE9 VK0 (Heard) VK0
(Macquarie) VK1/2/3/4/5/6/7/8 VK9C/L/M/
N/W/X VO1 VO2 VP2E VP2M VP2VVP5
VP8 (Antarctica) VP8 (Falkland) VP8 (S.
Georgia) VP8 (S. Sandwich) VP8 (S.
Shetland) VP8 (S. Orkney) VP9 VQ9 VR6
VU VU4 VU7 VY1 VY2 YJ Z2 ZB2 ZC4
ZD7 ZD8 (Tristan da Cunha) ZD8
(Ascension) ZF ZK1 (N. Cook) ZK1 (S.
Cook) ZK2 ZK3 ZL0/1/2/3/4/7/8/9 ZS1/2/
4/5/6/8 GB5CC (RSGB
HQ) (various other HQ).

Thanks and 73 de Ian VK3DID

1999: 20/21 March,

0100z Sat - 0059z Sunday

OVERVIEW

- The aim is to encourage and provide familiarisation with portable operation and provide training for emergency situations. The rules are therefore designed to encourage field operation.
- The contest takes place on the third full weekend in March each year and runs 0100 UTC Saturday to 0059 UTC Sunday, 1999: 20/21 March.
- Contest is open to all VK, ZL and P2 stations. Other stations are welcome to participate, but can only claim points for contacts with VK, ZL and P2 stations.
- Single operator portable entries shall consist of one choice from each of the following:
 - 24 or six hours
 - Phone, CW or Open mode
 - HF, VHF/UHF, All Band
- Multi-operator portable entries shall be Open Mode and consist of one choice from each of the following: -
 - 24 or six hours.
 - HF, VHF/UHF, All Band.
- Home and SWL entries may be either 24 or six hours, Open-mode, all-band.

SCORING

- Portable HF stations shall score two points per QSO.
- Portable stations shall score the following on 6m: -
 - 0-49 km, 2 points per QSO.
 - 50-99 km, 10 points per QSO.
 - 100-149 km, 20 points per QSO.
 - 150-199 km, 30 points per QSO.
 - 200-499 km, 50 points per QSO.
 - 500 km and greater, 2 points per QSO.
- Portable station shall score the following on 144 MHz and higher:
 - 0-49 km, 2 points per QSO
 - 50-99 km, 10 points per QSO
 - 100-149 km, 20 points per QSO
 - 150 km & greater, 30 points per QSO.
- For each VHF/UHF QSO where more than two points are claimed, both latitude and longitude of the station contacted or other satisfactory proof of distance must be supplied.
- Home stations shall score:
 - Two points per QSO with each portable station
 - One point per QSO with other home stations

LOG SUBMISSION

- Logs must be accompanied by a summary sheet showing: callsign, name, mailing address, section entered, number of contacts, claimed score, location of the station during the contest, equipment used and a signed declaration stating "I hereby

certify that this station was operated in accordance with the rules and spirit of the contest." For multi-operator stations, the names and callsigns of all operators must be listed.

- Logs must be sent by mail no later than 26 April 1999, to: John Moyle Contest Manager, 108 Queensport Road, Murarrie, 4172, Australia. An ASCII copy on 3.5" disk would be helpful. Also logs may be sent by e-mail to: <esr@powerup.com.au> Logs sent by e-mail must include a summary sheet and declaration, but operator's name is acceptable in lieu of a signature.

CERTIFICATES AND TROPHY

- At the discretion of the Contest Manager, certificates will be awarded to the winners of each portable section. Additional certificates may be awarded where operation merits it. Note that entrants in the 24 hours section are ineligible for awards in the six hours section.
- The Australian portable station with the highest CW score will be awarded the President's Cup.

DISQUALIFICATION

- General WIA contest disqualification criteria apply to entries in the contest. Logs that are unintelligible or excessively untidy are also liable to be disqualified.

DEFINITIONS

- A portable station comprises field equipment operating from a power source independent of any permanent facilities. eg batteries, portable generator, solar power, wind power etc.
- Equipment comprising the portable station must be located within an 800-metre diameter circle.
- A single operator station is where one person performs all operating, logging and spotting functions.
- A single operator may only use a callsign of which he/she is the official holder. A single operator may not use a callsign for which he/she is a sponsor except as part of a multi-operator entry.
- A multi-operator station is where more than one person operates, checks for duplicates, keeps the log, engages in spotting, etc.
- A multi-operator station may use only one callsign during the contest.
- A multi-operator station may only use one transmitter or a given band at any one time, regardless of the mode used.
- A multi-operator station must use a separate log for each band.
- A station operated by a club, group or

organisation will be considered to be multi-operator by default.

- None of the portable field equipment may be erected on the site more than 28 hours before the beginning of the contest.
- Single operator stations may receive moderate assistance prior to and during the contest, except for operating, logging and spotting. Massive logistic support by dubs, etc, is totally against the spirit of the contest and may result in disqualification and, at the discretion of the Manager, may be banned from this contest for up to three years.
- Phone includes SSB, AM and FM.
- CW includes CW, RTTY and Packet.
- It is not expected that any other modes will be used in the contest, but if they are they shall be classed as CW.
- All HF amateur bands except WARC may be used. VHF/UHF means all amateur bands above 30 MHz. Note: on 6 m the region below 50.150 MHz has been declared a contest-free zone; contest CQs and exchanges must take place above this frequency. Stations violating this rule will be disqualified.
- Cross-band, cross-mode and contacts made via repeaters are not permitted for contest credit. However, repeaters may be used to arrange a contact on another frequency, providing that a repeater is not used for the actual contact.
- Stations may make repeat contacts and claim full points for each one. For this purpose, the contest is divided into eight consecutive three-hour blocks: 01-0359; 04-0656; 07-0959; 10-1259; 13-1559; 16-1859; 19-2159; 22-0059 UTC. If you work a station at 0359 UTC, a repeat contact may be made after the start of the new block, providing they are not consecutive or are separated by five minutes since the previous valid contact with that station on the same band and mode.
- Exchange RS(T) plus a three-digit serial number commencing at 001 and incrementing by one for each contact.
- Portable stations must indicate that they are portable by sending their callsigns followed by "P", eg 5699003P.
- Multi-operator stations must use a separate log for each band and commence each band with 001.
- Receiving stations must record the exchanges sent by both stations. QSO points will be on the same basis as Home Stations, unless the receiving station is portable.
- For all stations, the period of operation commences with the first contact on any band or mode, and finishes six or 24 hours later. There will be no exceptions to this rule.

AWARDS

John Kelleher VK3DP

Federal Awards Officer

4 Brook Crescent, Box Hill South, Vic 3128 (03) 9889 8393

MUCH HAS BEEN mentioned, and I have had numerous queries about GCR lists.

Firstly, the letters GCR stand for General Certification Rules.

Most of the award sponsors allow a GCR list in lieu of wanting to see your cards; but you need to hold the actual QSL cards as verification of your DXCC contacts.

GCR usually means getting the signatures of two witnesses, who certify that you possess the cards, and that the information on the application is correct.

If the award rules specify Club officials you should make sure that their titles follow their signatures; include the name of the club just to be sure.

Some sponsors (a tiny minority) actually want to see the cards for themselves. - If you want the award, you are going to have to risk the possible loss of your cards. I've never lost any cards in the mail; but then again, I didn't rest easy until they were returned.

QSL Cards

On the subject of QSL cards, here are some handy hints about their design.

- (1) Maximum size of each card should not exceed 3.5 in. (9 cm) X 5.5 in. (14 cm).
- (2) Thickness should be about that of a normal business card.
- (3) Your cards should be reasonably attractive. Pictures are great, but not necessary.
- (4) Your cards should contain all of the QSO data, in a clear and logical format.
- (5) Show the contact time in UTC and please be accurate.
- (6) Finally, and where possible, indicate on your card what awards YOUR card is good for!

Try to ascertain the actual path to adopt to obtain THEIR QSL card, whether direct, or via a manager, or simply via "the bureau".

Booklets are available, (usually free) from your local Post Office, showing the existing Air and surface mail charges to almost anywhere in the world. !

Special Event Station

The NZART Official Station call sign ZL6A will be used for 24 hours on ANZAC day in New Zealand. It will be used on all bands and modes.

Date and times: 24 April 1999 1200 UTC to 25 April 1999 1200 UTC.

QSL cards will be sent on receipt of your QSL card. Send cards via the bureau. Alternately, cards may be sent, with a SAE and one IRC or US\$1.00 (for postal costs only) directly to: Bob Pearce ZL2GJ, 3 Strasbourge Street, and Martinborough 5954 New Zealand.

NZART Guiding Light Award

This is a new award, which requires contacts with stations within 30 km of the

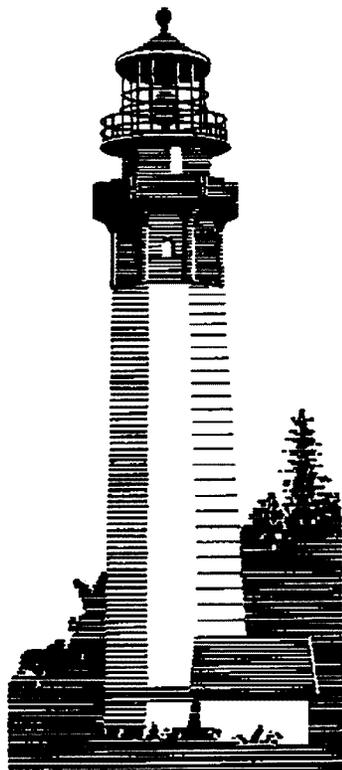

more remote lighthouses and 10-Km of the lighthouses near cities.

Depending on the degree of difficulty each lighthouse has been allocated 1 to 5 points.

A total of 20 points are required for the basic "Mariners" Award, and 50 points for the "Master Mariners" Award.

The lighthouses are:

NORTH ISLAND

	Points	Km
1. Cape Reinga	2	30
2. Cape Brett	1	30
3. Mokohinau	5	30
4. Cuvier Island	3	30
5. Tiritiri Matangi	1	10
6. Bean Rock	1	10
7. East Cape	2	30
8. Portland Island	2	30
9. Castlepoint	2	30
10. Cape Palliser	2	30
11. Baring Head	1	10
12. Pencarrow	1	10
13. Somes Island	1	10
14. Cape Egmont	1	30

SOUTH ISLAND

15. Cape Foulwind	1	30
16. Kahurangi Point	3	30
17. Farewell Spit	2	30
18. Boulder Bank	1	10
19. Stephens Island	5	30
20. The Brothers	2	30
21. Cape Campbell	1	30
22. Godley Head	1	10
23. Akaroa	1	30
24. Moeraki	1	30
25. Taiaroa Heads	1	10
26. Cape Saunders	1	10
27. Nugget Point	2	30
28. Waipapa Point	2	30
29. Dog Island	1	30
30. Centre Island	1	30
31. Puysegur Point	5	30

This Award is open to all amateurs and SWL's.

Eligible contacts for this award must date from 1st November 1998 and after. Fees are A\$5.00 or 5 IRC. Applications and log sheets available from:

NZART Awards Manager ZL3GX
PO Box 1733
Christchurch 8015
New Zealand.

The ZL1FND Far North Avocado Festival Award.

I must apologise due to limited space, I cannot include the information.

DXCC LISTINGS WEF**31ST DECEMBER 1998****Roll of Honour SSB**

1.	VK5MS	330/384
2.	VK5WO	330/363
3.	VK3QI	330/344
4.	VK3DYL	330/336
5.	VK4LC	329/376
6.	VK1ZL	328/334
7.	VK6LK	327/352
8.	VK3AKK	327/338
9.	VK4OH	327/334
10.	VK2FGI	326/332
11.	VK6RU	325/380
12.	VK6HD	325/350
13.	VK5XN	324/345
14.	VK4UA	324/338
15.	VK3AMK	321/340
16.	VK6NE	321/337
17.	VK5EE	321/327
18.	VK3YJ	320/326
19.	VK4AAR	320/324
20.	VK2AVZ	319/330
21.	VK7BC	319/329
22.	VK2DEJ	317/323
23.	VK3CSR	316/325
24.	VK6VS	315/319

SSB - Ordinary List

1.	VK6AJW	312/317
2.	VK6APK	310/315
3.	VK5WV	306/326
4.	VK6PY	306/312
5.	VK3JI	304/319
6.	VK5FV	304/307
7.	VK6RO	302/308
8.	VK3IR	295/298
9.	VK4DP	293/305
10.	VK2WU	291/296
11.	VK4BG	286/302
12.	VK3CYL	282/288
13.	VK4SJ	278/279
14.	VK3DP	264/267
15.	VK3GI	263/267
16.	VK3VQ	259/276
17.	VK5IE	258/261
18.	VK4CY	254/256
19.	VK4LV	250/252
20.	VK3UY	250/252
21.	VK4ICU	249/251
22.	VK6ANC	244/248
23.	VK2PU	243/247
24.	VK3CIM	242/246
25.	VK6YF	238/241
26.	VK7TS	237/238
27.	VK2CKW	234/237
28.	VK6APW	228/229

29.	VK3DS	226/236
30.	VK4BAY	226/229
31.	VK3ETM	226/227
32.	VK3SM	222/242
33.	VK4EJ	219/221
34.	VK5BO	217/222
35.	VK3DD	213/217
36.	VK4XJ	204/216
37.	VK3DVT	201/204
38.	VK3EFT	198/201
39.	VK4AU	189/190
40.	VK6WJH	183/-
41.	VK2HV	177/-
42.	VK4IL	176/-
43.	WA1MKS	171/-
44.	VK6APH	168/169
45.	LU5DSE	161/-
46.	VK4ARB	159/160
47.	VK2NO	157/-
48.	VK4IT	154/155
49.	VK4CHB	152/153
50.	VK4EMS	149/-
51.	VK4DMP	147/148
52.	VK2SPS	141/143
53.	VK3DNC	141/142
54.	VK6LC	139/140
55.	VK2EQ	139/-
56.	VK2GSN	135/-
57.	VK6LG	134/135
58.	VK2LEE	130/132
59.	VK3DQ	127/141
60.	TI2YLL	127/-
61.	YC8EMH	126/127
62.	VK6ABS	126/-
63.	VK4BP	126/-
64.	VK4VIS	124/126
65.	VK3TI	122/125
66.	SM6PRX	121/126
67.	HL4YD	118/119
68.	VK7WD	115/116
69.	VK5GZ	113/115
70.	VK4NJQ	111/115
71.	VK6NV	111/113
72.	JA8XDM	111/-
73.	C21DJ	109/-
74.	JE9EMA	108/-
75.	VK5UO	107/110
76.	HC2HYB	106/107
77.	VK4LW	105/-
78.	JN6MIC	103/104
79.	ZS6IR	102/104
80.	KB2NEK	102/103
81.	C21NJ	102/-
82.	VK2FZR	102/-
83.	VK4JAE	102/-
84.	JH3OHO	101/103
85.	ON4BCM	100/-

Roll of Honour - CW

1.	VK3QI	330/342
2.	VK6HD	323/344
3.	VK5WO	318/344
4.	VK3XB	315/350

Ordinary List - CW

1.	VK3KS	302/330
2.	VK6RU	275/319
3.	VK3JI	271/296
4.	VK3AKK	270/275
5.	VK4LV	252/259
6.	VK2CWS	239/241
7.	VK3DP	237/240
8.	VK7BC	234/243
9.	VK4ICU	231/-
10.	VK3DQ	228/255
11.	VK4DA	226/228
12.	VK3CIM	219/220
13.	VK4DP	205/216
14.	VK6MK	202/204
15.	VK7RO	201/204
16.	VK6PY	190/194
17.	VK5GZ	189/191
18.	VK4CY	187/188
19.	VK6HW	179/182
20.	VK7TS	165/-
21.	VK5UO	164/165
22.	VK5BO	159/184
23.	VK3DNC	154/157
24.	VK4XJ	150/163
25.	WA5VGI	146/148
26.	VK4UA	143/145
27.	VK4AAR	139/141
28.	VK7DQ	137/138
29.	VK2TB	123/125
30.	VK3AGW	119/120
31.	VK4CMY	117/118
32.	SP1AFU	112/113
33.	VK8KV	112/113
34.	VK5BWW	110/111
35.	VK6NV	109/110
36.	OK1FED	109/-
37.	VK2FYM	106/108
38.	VK3DG	102/-
39.	VK8XC	101/103
40.	SM6PRX	101/102

Roll of Honour -**Open**

1.	VK5WO	330/367
2.	VK3QI	330/345
3.	VK4LC	329/376
4.	VK3AKK	327/338
5.	VK7BC	327/336
6.	VK6RU	325/380
7.	VK6HD	325/351
8.	VK4UA	324/340
9.	VK3JA	323/371

10.	VK6AMK	322/341
11.	VK2AVZ	320/330
12.	VK4AAR	320/324
13.	VK3XB	317/347
14.	VK3UY	316/319
15.	VK3JI	315/344

Ordinary List - Open

1.	VK4DP	309/323
2.	VK6PY	308/316
3.	VK6RO	308/314
4.	VK3DP	303/307
5.	VK4DV	301/316
6.	VK4BG	293/312
7.	VK4CY	289/293
8.	VK3CYL	282/288
9.	VK3VQ	274/291
10.	VK4LV	272/279
11.	VK4ICU	271/273
12.	VK3CIM	266/270
13.	VK5BO	264/301
14.	TF5BW	260/264
15.	VK7TS	253/254
16.	VK6ANC	247/250
17.	VK5UO	245/249
18.	VK2CWS	245/247
19.	VK3DQ	241/270
20.	VK6APW	239/240
21.	VK2ETM	238/240
22.	VK4XJ	233/249
23.	VK4DA	227/229
24.	WA5VGI	216/218
25.	VK6MK	209/211
26.	VK2EFT	202/205
27.	VK5GZ	198/200
28.	VK3DNC	185/187
29.	VK2HV	178/-
30.	VK6NV	172/173
31.	VK6APH	171/172
32.	SM6PRX	162/169
33.	VK4CHB	160/162
34.	VK2NO	158/-
35.	VK8XC	150/152
36.	VK4EMS	150/-
37.	VK6LC	142/144
38.	VK4NJQ	133/139
39.	VK4EZ	129/138
40.	YB8GH	127/129
41.	VK3VB	126/128
42.	VK4CMY	120/122
43.	VK7HV	114/117
44.	SP1AFU	114/115
45.	VK2FYM	113/115
46.	VK3OZ	104/105
47.	VK2AJE	100/-

Hoping you have a successful
1999,
best 73 de VK3DP

ar

IONOSPHERIC UPDATE

Evan Jarman VK3ANI 34 Alandale Court Blackburn Victoria 3130

Solar activity

Solar activity during October was mostly at low levels with activity rising to moderate on only two days.

The three flares during the month occurred on these two days and ranged in intensity between class M1.6 and class M2.4.

November solar activity was higher but dipped in the middle of the month.

While the count of flares, class M1 or stronger, was 23, there were none between 12 November and 22 November.

It was due to an active region that declined as it passed round the west limb the reappeared on the east limb around 24 November producing the class X3.3 flare on 28 November.

Ionospheric activity

Ionospheric conditions were generally at low levels throughout the quarter. Depressions followed geomagnetic activity.

The only indication of better than average conditions was mid-October in Darwin where MUFs were enhanced by 40%. In other locations throughout the quarter MUFs could be depressed by up to the same percentage.

Geomagnetic activity

The greatest geomagnetic activity occurred during the first two months of the quarter. On 2-3 October the activity is believed to be due to the a coronal mass ejection associated with the 30 September

class M2.8 flare mentioned in last quarter's *Ionospheric Update*. A coronal hole is believed to be the cause of the activity on 21-22 October. All major variations in geomagnetic activity in November were Coronal Mass Ejection related.

Solar cycle 23 progress

Now shown in the solar cycle graph is the monthly count of flares: class M1 or stronger.

While most of the observations have been during the minimum between solar cycles, there is enough information to show that flare activity is expected to rise with the rise in the sunspot number.

Last year, the greatest number of flares counted was in November but August had some more intense class X flares so was a more active month.

The Ionospheric Prediction Service compares the current flare counts with those of previous solar cycles to get a progress guide on the current solar cycle.

In a commentary published late last year they state that:

"flare production this cycle has been quite modest compared with previous cycles. As we reach the peak of the new solar cycle we can expect months during which there are a great many more flares than in August. Data for previous cycles shows several months in which there were around 90 M class flares (and presumably quite a few X class ones as well). This means that there was an average of 3, M-class flares every day; and probably some days during those months were way above average! So solar cycle 23 is only now starting to kick into action. We can expect much more as the cycle progresses."

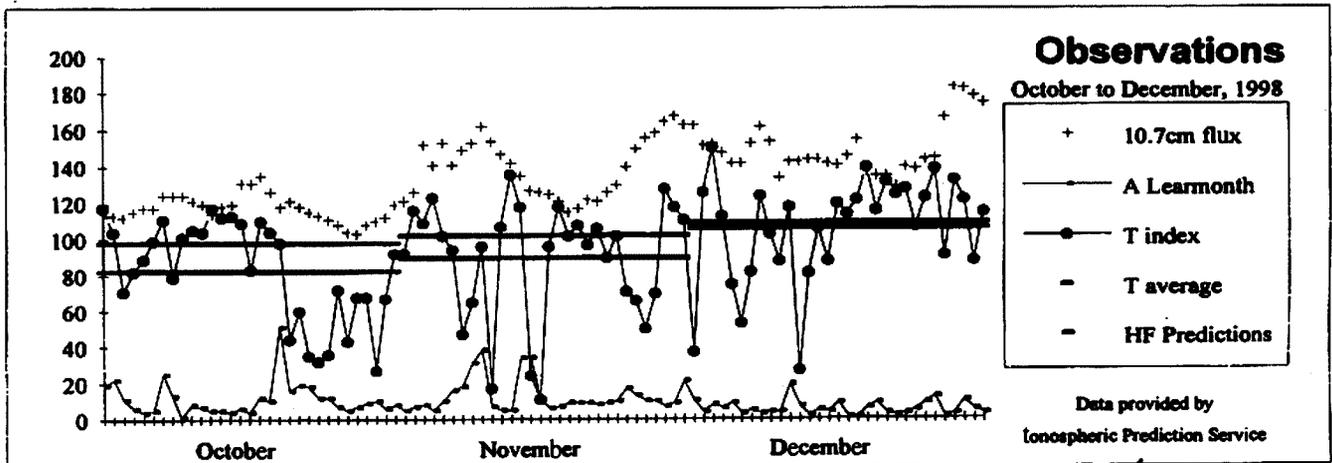
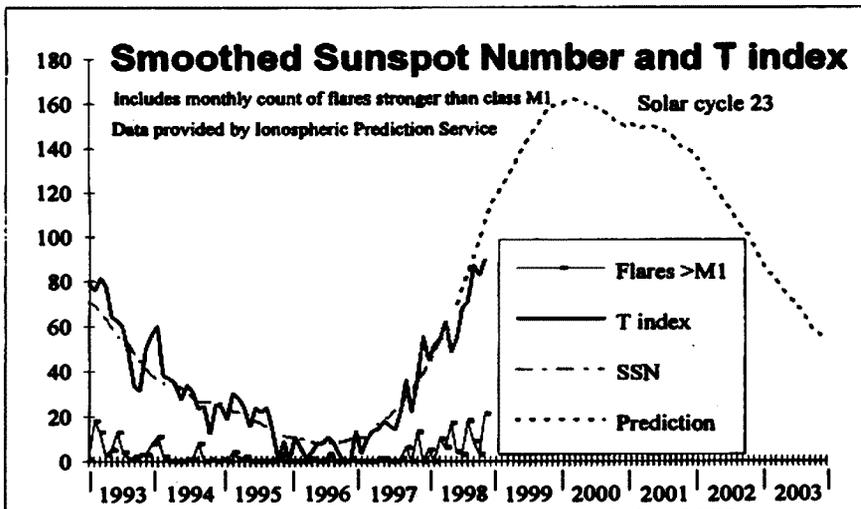

HF PREDICTIONS

by Evan Jarman VK3ANI 34 Alandale Court, Blackburn Vic 3130

Adelaide-London 132
First F 0-5 Long 23755 km

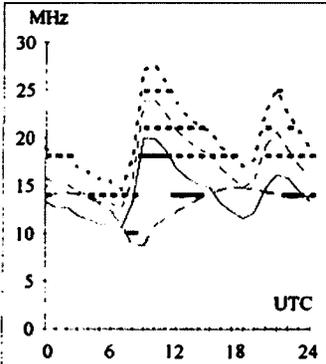

Brisbane-Christchurch 141
Second 2F19-26 2E5 Short 2518 km

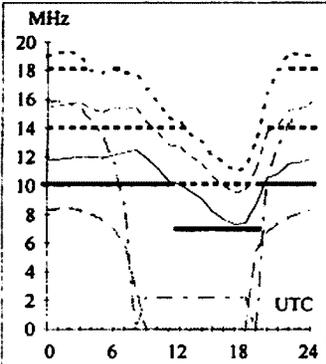

February
1999
T index: 109

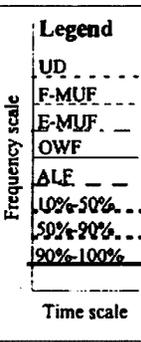

These graphs show the predicted diurnal variation of key frequencies for the nominated circuits. These frequencies as identified in the legend are:-

- Upper Decile (F-layer)
- F-layer Maximum Useable Frequency
- E-layer Maximum Useable Frequency
- Optimum Working Frequency (F-layer)
- Absorption Limiting Frequency (D region)

Shown hourly are the highest frequency amateur bands in ranges between these key frequencies; when useable. The path, propagation mode and Australian terminal bearing are also given for each circuit.

These predictions were made with the Ionospheric Prediction Service program: ASAPS version 4.

Adelaide-London 312
First F 0-5 Short 16269 km

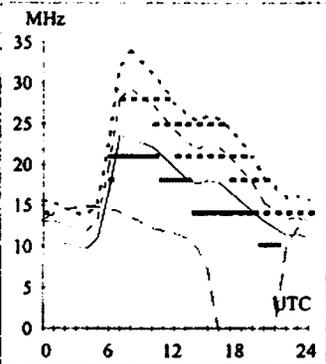

Brisbane-Honolulu 49
Second 3F5-11 3E0 Short 7569 km

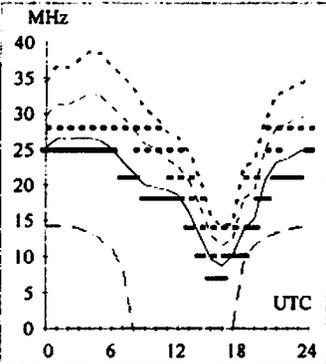

Canberra-Tokyo 352
Second 3F4-10 3E0 Short 7948 km

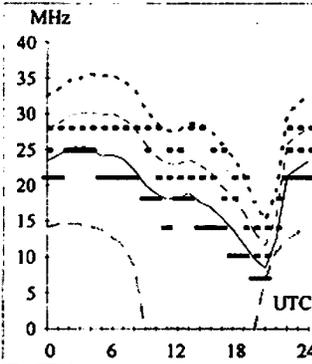

Darwin-Auckland 130
First 2E5-9 2E0 Short 5136 km

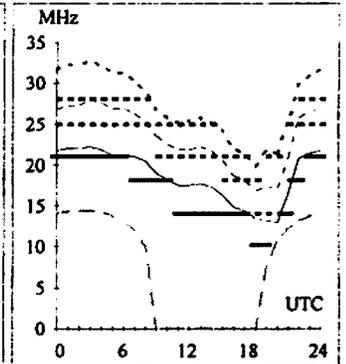

Adelaide-Los Angeles 66
First F 0-5 Short 13159 km

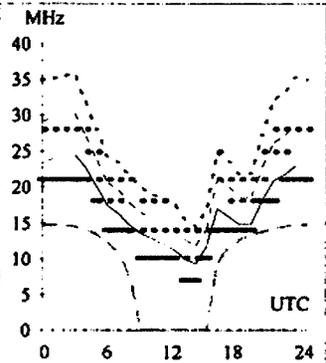

Brisbane-Miami 79
First F 0-5 Short 14761 km

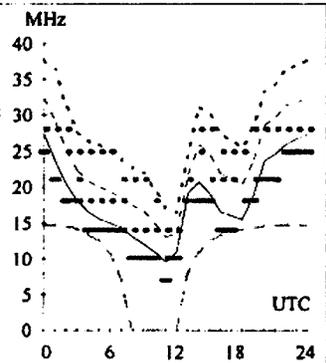

Canberra-Washington 70
First F 0-5 Short 15938 km

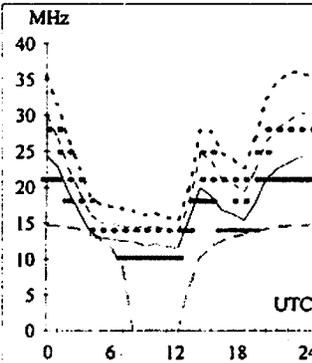

Darwin-New Delhi 309
Second 3F6-13 3E0 Short 7345 km

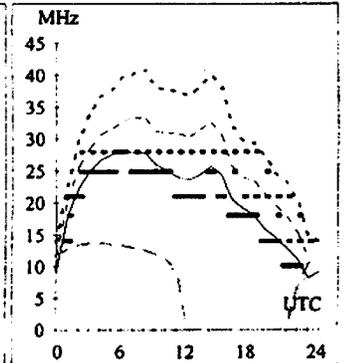

Adelaide-Manila 338
Second 3F10-19 3E1 Short 5813 km

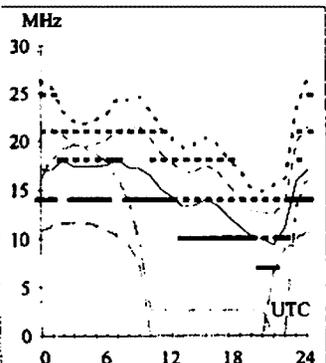

Brisbane-Singapore 293
Second 3F9-16 3E0 Short 6146 km

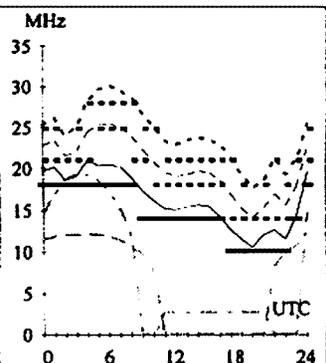

Canberra-Wellington 115
Second 2F21-28 2E6 Short 2342 km

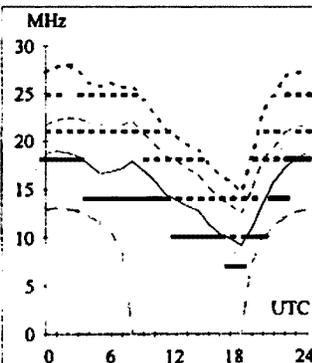

Darwin-Osaka 5
First 2F4-11 2E0 Short 5262 km

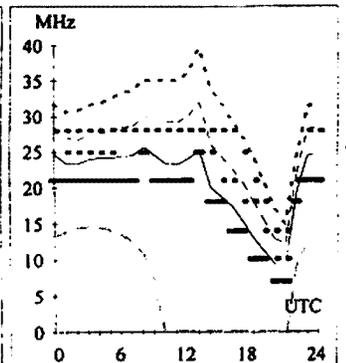

HIP PREDICTIONS

Hobart-Cairo 270 **Melbourne-Achorage** 28 **Perth-Capetown** 237 **Sydney-Barbados** 119

First F 0-5 Short 14263 km First F 0-5 Short 12473 km First 3F3-9 3E0 Short 8704 km First F 0-5 Short 16155 km

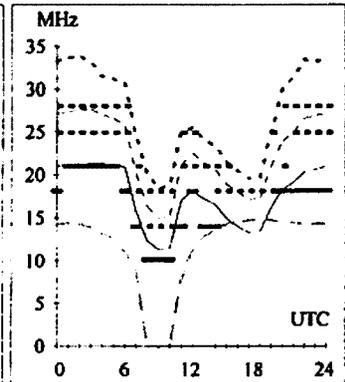
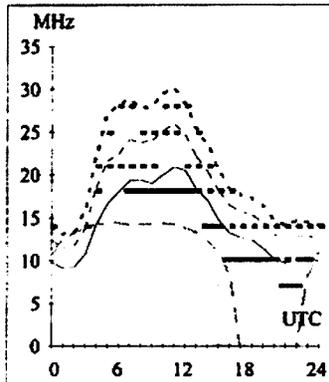
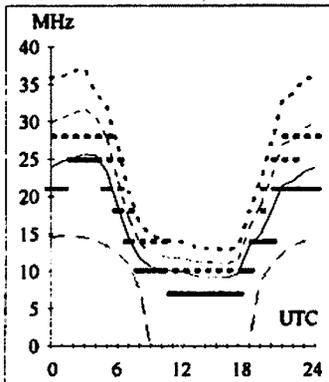
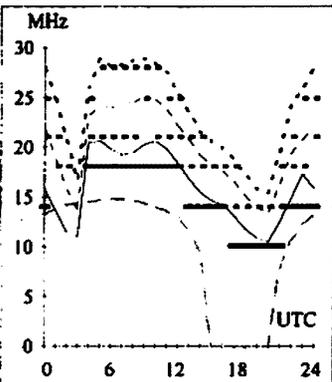

Hobart-Chicago 72 **Melbourne-Jakarta** 303 **Perth-Dakar** 259 **Sydney-London** 139

First F 0-5 Short 15576 km Second 3F12-19 3E2 Short 5214 km First F 0-5 Short 14918 km First F 0-5 Long 23032 km

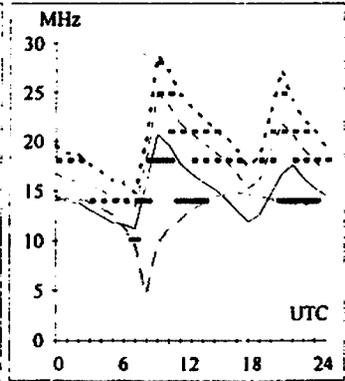
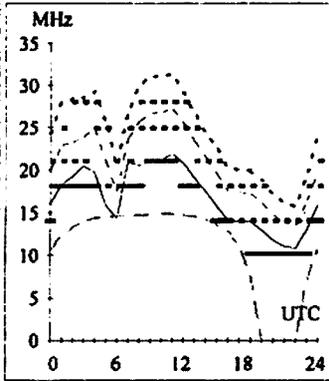
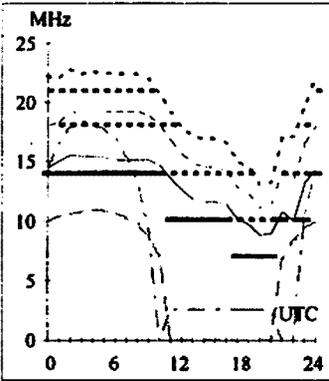
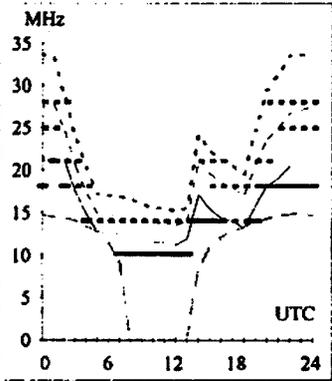

Hobart-Johannesburg 231 **Melbourne-Miami** 94 **Perth-Montevideo** 187 **Sydney-London** 319

Second 4F5-13 4E0 Short 10141 km First F 0-5 Short 15584 km First F 0-5 Short 12536 km First F 0-5 Short 16992 km

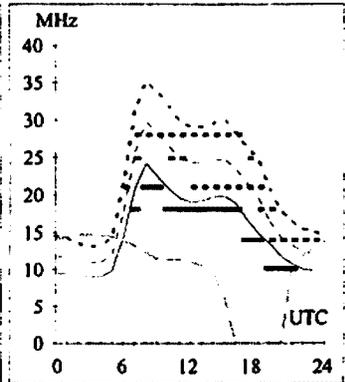
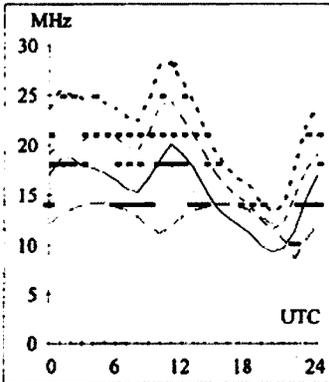
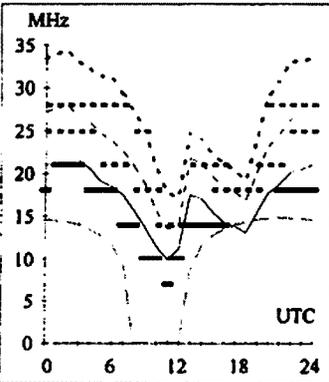
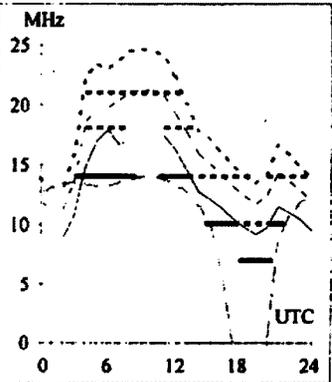

Hobart-Rio de Janeiro 169 **Melbourne-Sofia** 296 **Perth-Tel Aviv** 302 **Sydney-Seoul** 340

First F 0-5 Short 12620 km First F 0-5 Short 15132 km Second 4F4-8 4E0 Short 11091 km First 3F4-9 3E0 Short 8325 km

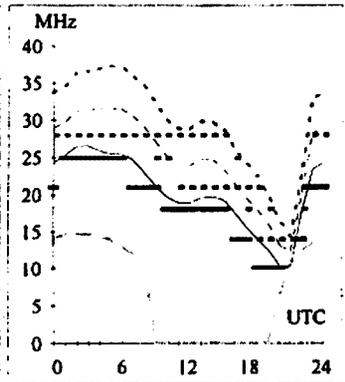
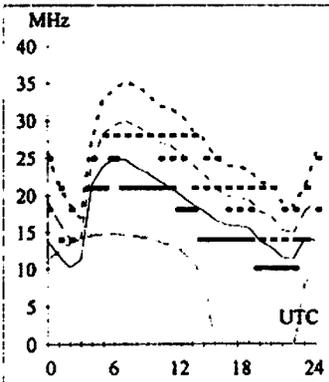
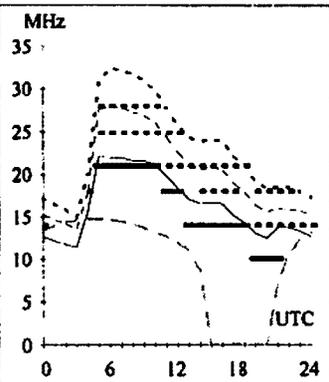
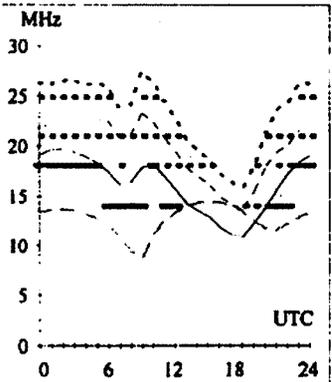

HAMADS

- Hamads may be submitted on the form on the reverse of your current Amateur Radio address flysheet. Please print carefully, especially where case or numerals are critical.
- Please submit separate forms for For Sale and Wanted items, and be sure to include your name, address and telephone number (including STD code) if you do not use the flysheet.
- Eight lines (forty words) per issue free to all WIA members, ninth and tenth lines for name and address. Commercial rates apply for non-members.
- Deceased estates Hamads will be published in full, even if the ad is not fully radio equipment.
- WIA policy recommends that the serial number of all equipment for sale should be included.
- QTHR means the address is correct in the current WIA Call Book.
- Ordinary Hamads from members who are deemed to be in general electronics retail and wholesale distributive trades should be certified as referring only to private articles not being re-sold for merchandising purposes.
- Commercial advertising (Trade Hamads) are pre-payable at \$25.00 for four lines (twenty words), plus \$2.25 per line (or part thereof), with a minimum charge of \$25.00. Cheques are to be made out to: WIA Hamads.
- Copy should be typed or in block letters, and be received by the deadlines shown on page 1 of each issue of Amateur Radio, at:

Postal: Newsletters Unlimited, 29 Tanner Street, Richmond, 3121

Fax: 03 9428 4242 **E-mail:** news1@webtime.com.au

Please only send your Hamad once

Please send Hamads by mail OR fax OR email (much preferred).

Please do not send by more than one method for any one ad or issue, it is confusing.

FOR SALE ACT

● On behalf VK2EWK Kenwood TS130SE TCVR. 2071241. DFC230 104137. Kenwood antenna tuner AT200 950546. YAESU FP107E power supply with speaker. Chimside CS5EE five band vertical antenna. Kenwood MC60 desk mike. \$1150 ONO. Prefer sell complete. Eric VK1EP 02 62496907

FOR SALE NSW

● One Terlin Outbacker mobile antenna, with heavy duty spring base...bought late 1997 for two special outback trips...now surplus to requirements...covers all HF bands (inc 160mx)...is a "split" version...basically as new...cost\$550...sell\$400. Ph. Sid VK2SW QTHR 02 69226082

● ICOM IC-820H 2M/70cm all mode base station/ satellite rig in new condition \$1900. YAESU FT757GXII HF Transceiver \$750 EC. FT-290R11 2M all mode Transceiver and FL2025 matching 25W linear \$650 new! IC202 2M#SSB portable \$150. FT690 6M all mode plus matching FL6010 10W linear \$400. Phone Brad 0412651782 VK2ZBD

● Back issues of Amateur Radio Magazines from 1984 to 1998. Ex condition \$20. you pay post. Ken VK2CWI 0244761 805 Narooma NSW

● AWA Type AT21 Xmitter circa 1942 g/cond complete with h/books power supply and cables. Offers to Alex 0265837095 Villa 3/8 Woods st. Port Macquarie N.S.W 2444. VK2DV New QTH.

● ICOM handhelds 2M IC-2A and IC-02A Both good order and have BP7 batteries in reasonable condition \$100 each. David VK2BDT 02 48215036

● Kenpro KR500 elevation rotator, with controller, mast clamps, brand new unused \$300. YAESU elevation Azimuth controller G-5400B SN 4G010000 Plus elevation and Azimuth rotator assembly cw boom, mast clamps also 2M and 70cm crossed Y antennas, switched polarisation \$1200. Peter VK2APP 0263826086

● YAESU FT-1000 delux HF TX/RX, 200W output s/no OL100242, fitted with BPF unit, CW filter and I update chip. Also included, MD-1C8 Dynamic Base microphone, SP-5 external speaker all manuals and cables. Purchased mid1996 from deceased estate used twice since then. Unit in excellent to mint condition, also service manual for FT-1000 which was purchased separately. Valued at over \$6000, sell for \$5100, ONO. Also, Icom IC-275A, Base station rig AC or DC operation. Excellent condition with all accessories, never used, sell for \$1150. Contact Steve on (H) 02 43347743 or (m) 0419 602 520

● Triband Beam (copy of Tet 14/21/28) dismantled on ground approx 25 kg \$180 or offer.

● Siemens Teleprinter good order give away free Roger VK2AIV QTHR (02) 4234 1431

WANTED NSW.

● Old unloved relics of the valve age, after communication receivers or military equipment. I am quite willing to accept busted or junked sets, or even working sets! Will pay \$\$ if necessary. A monitoring/museum is being set up at Ermington, in Sydney's mid west. A real labour of love.

The heavier the better, no one has given me a hernia yet. Will help clean out the shack, call John (02) 9533 6261 WIA L21068.

● Philips FM-828 E Band 68-88 MHz transceivers for rescue squad. Contact Maurie Camps VK2DCD Box 72 Coleambally NSW 2707 014 438 215

FOR SALE VIC

● Azden 2m mobile plus desk mike for base use. EC Remote, Head SN12089 5-25W \$250. Icom HH 2GAT 20MEM 2 Batteries Speaker Mike. 12 volt adapter charger door mount EC SN30909 \$ 250 Both radios with manuals and schematics. Werner Wulf 5 band vertical ground plane in 2 sections. Never used \$100. CW Key Hi Mould. Model HK708, new \$25. CW Morse Trainer Oscillator \$10. QTHR VK3LPM Ron 53689477

● Wilson 4 element tribander, YAGI 10,15,20m \$250. Tokyo Hy-Power HF Allband 2kw Antenna Coupler, Vernier Drives, \$450. VK3OK 98022541

● Kenwood TS-680S HF & 6metre XCVR. Very good condition. Original box etc \$825. Barlow Wadley XCR-30 All Band Receiver. Very good order. Instr book \$150. Kenwood TS-430S HF XCVR. AM,SSB & CW Filters. Excellent condition \$775. Ron VK3OM. QTHR Ph. 03 59443019

● General purpose noise remover and filter model WRF-7, \$75. Mr A Chandler, VK3LC 55 Jacana Dve Carrum Downs 3201

● Wilson (USA) 4 element Yagi tribander, 10 15 20, metre, works well \$250. Tokyo Hy-Power ATU 2kw PEP \$450. YAESU FC107 ATU \$180. VK3OK 0398022541

● Deceased estate Neil Hatfield VK3PBI All excellent order. Complete mic. manuals orig packing boxes Kenwood station monitor SM220 \$200 TS130V \$350. TS520S \$350 SP100 \$35. AT200 \$125 SP520 \$35 TS680S \$850 YAESU FT26 \$175. FT212RH \$250. Digitor C1509 mic \$35. Nally I3.7M tilt-over self-supporting tower with Archer rotator and 3EL YAGI. Purchaser to dismantle and remove \$500 Harvey VK3AHU QTHR 03 5798 1451.

● Kenwood TS 711 all mode 2mx transceiver. EC. with manual \$600. Kenwood TS50 100W HF transceiver and same sized switched mode power supply. MC 80 desk mic and manuals \$995. KLM KT34A linear loaded 20/15/10 beam. EC with cables \$500. HD EMOTATOR rotator for above beam, with controller & approx 100ft cable. EC \$200. MFJ 815B Delux SWR/PWR meter \$150. WAVETEK Model 3006 100Hz-520MHz professional sig gen \$850. AIRMEC valve type sig gen Type 201A.30kHz-30MHz \$100. GOODWILL Type GOS955 5MHz CRO \$75. Weller solder station WCTPC Brand new. Cost \$195 Sell \$135. 40amp 13.6v very heavy duty regulated power supply \$150. Harold VK3AFQ QTHR Ph 03 95962414

● Tower 46ft three sections, pivots 16ft properly engineered \$950. Kenwood TS 440SAT (8050454) service manual \$1500 Kenwood TS130-V (1033315) with TL-120 linear

(2010130) \$300. P.S. 50 (0100523) \$200. Trio sig. gen SR402 30 MHz (5040171) \$100 LODESTAR LAB.P.S 5A 501671) \$50. LODESTAR 'scope 05 7300A 5MHz (504088) \$100. National SSB TXCVR model RJX1011D (261220 B) Suberb performer, suit newcommer \$300. TEN-TEC dummy load model 209.300W \$20. Noise bridge EMTRON (EN 283) \$40 QTHR Murray VK3ECI (03) 51567789

● **FT290R S/N5G450020** trcvr 2m \$350. Valves 6146B GEC \$50. 12BY7 \$25. 572B \$100. CETRONS many other types of valves 2m vertical "DINGO" \$25. 14el 2m Beam \$55. Linear amp FL2100B S/N 9K340227 \$750. 2m Lin. amp HL35V S/N 470263 VARIAC 1500W \$200. COAX. Harry Lodder VK3AXJ 3 Muir St Mount Waverly (03)98025704 QTHR

● **Datong D-70 Morse Tutor**, in EC; \$175 ONO. 30m LDF4-50A Heliax, fitted with 2 female N connectors; \$250 ONO. Barry, VK3BJM, (03) 9888 0000.

● **Kenwood SSB transceivers TS-520 + TS-520S C/W crystals**. Kenwood 2m transceiver. Type 241A still in box. Palec multimeters assorted electron tubes MFJ antenna switch MFJ 1700B MFJ deluxe versa tuner and freq counter 2m mast + coax, sundry capacitors-resistor antennas. J N Blake VK3DPB 7Josephine st, Oak Park 3046.

WANTED VIC

● **Kenwood TS 790H, ICOM IC 970H or IC 820H**. Please contact Horst VK3GDK QTHR 03 52753293

FOR SALE QLD

● **6METRE FM TRANSCIEVER; TAIT T499**. 25 watts. 100 channel capacity programmed with ALL repeater, simplex & reverse repeater frequencies. CTCSS encoder, Mic, Spkr, cradle, circuits, CH list. GC. \$110. SIGNAL GENERATOR Marconi TF2015. 10MHz to 520MHz. AM/FM. Compact size. 240VAC. GC \$350. MODULATION METER; RACAL DANA 9008M. AM/FM. 8 ranges. AF filters. up to 2000 MHz. 240VAC. GC, \$110. Gary, VK4AR, 07 3353 1695

● **Kenwood TS440SAT, MB-430 Mobile Bracket MC43S scanning hand microphone, DC lead, owners manual, original carton \$1100**. Kenwood TS140S, MC43S, DC lead, owners manual \$850. Kenwood TM241A 50 watts output 2metre FM 118-174 mHz RX, owners manual \$300. All excellent. All items must be sold! John Abbott VK4SKY QTHR 24hrs. 0417 410503

● **Kenwood TS430S HF-xcvr. incl. Service Manual \$730 - ONO Kenwood TS440S HF-xcvr incl Service Manual and built-in AT \$970 ONO Kenwood CW-Crystal Filter YK-88C \$85 ONO Daiwa Automatic Antenna Tuner Model CNA-1001 \$150 ONO Longwire Antenna 80-20Metres \$115 ONO Sansei Mini SWR-meter Model SE-406; 1.8 - 200MHz \$55 ONOVK4ASN Tel 07 3207 2050**

● **Antenna TE-33 YAGI beam 10,15,20 metre \$225**. Microsoft Internet starter kit for Windows \$20. Encyclopaedia Britannica CD '98 Set of 2 CDs \$100. Encyclopaedia Britannica CD '97 \$50. Dick VK4DIC ph. 07 3264 1655

● **4-1000A (etc) valve socket type SK510-S Deluxe air system type imported from USA new unused**. One pair available \$140 pair or will separate \$75 each. Coaxial relay 24 volt "N" connectors DPST precision preamplifier isolation relay new unused \$40. John VK4KK QTHR 07 3269 6647

WANTED QLD

● **Kenwood DG-5 digital display**. Len VK4JZ QTHR (07) 5485 3324

● **AM17 VHF Transmitter ex. DCA Ray VK4BLK QTHR 07 49392284**

● **Hewlett Packard Model 141B Oscilloscope operation and service manuals; Any other info for this model; Any after-market company able to supply manuals for this model**. Geoff VK4ZGF QTHR 0741221368 A/H PO Box 210 Maryborough QLD 4650

● **Any RF bandswitches and squirrel cage blowers that may suit a linear amplifier**. Ron VK4BL QTHR or vk4bl@tpgi.com.au or 07 4055 0230

● **Manual/book for YAESU FT-411E 2metre hand held**. Allan VK4NBZ PO Box 1779 Cairns QLD 4870 (H) 07 40392876

● **Toshiba laptop T3200 for parts or the 1.44 FFD and Manual Allan VK4NBZ (H) 07 40392876**

FOR SALE SA

● **Antenna triband 20-15-10, Model Com-Antenna**. Trapless beam near new. This is a five element beam. See Radio + Communications Dec '98 Price \$320. Linear amp pair 572Bs 400W. Price \$400. Phone Con 08 95745112

● **Power supply PS430 Kenwood \$120**. Antenna tuning unit AT230 Kenwood \$110. Both units in top condition QTHR 08 9446 1568

● **Deceased Estate VK5WQ**. Offers wanted for YAESU FTDX 401 TXCVR with manual and/or valves for same. VK5ZU QTHR

● **YAESU FT920 new 3 months old**. 160m to 6m 100W all mode comes with FM board, AM filter, has DSP, ser no. 7LO9054. \$500 below new price \$2000. Frank VK8FT ph. 08 89832954

● **Comantenna 6M vertical colinear base station antenna**. Excellent condition \$125 ONO David VK5AXW 08 83709569 (AH) 08 8370 1066 (BH)

● **From the estate of the late VK5ADC: ICOM Charger BC30 S/NO 06604 \$25. ICOM IC2E 2 metre hand held transceiver S/NO 10114 \$150. KENWOOD TH26A handheld transceiver S/NO 10201924 \$150. KENWOOD TS680s transceiver S/NO 9031298 C/W mic \$750. KENWOOD SP180 speaker with filters S/NO 0020048 \$40. KENWOOD LF 30 low pass filter 1KW PEP \$30. YAESU FT101E transceiver C/W leads S/NO 8H 351753 \$200. YAESU desk mic YD148 600 OHM/50k \$40. UNIDEN UBC 760XLT 100 channel scanner S/NO 65000294 \$175. KYORITSU SWR meter \$20. OMEGA T**

Systems Noise Bridge S/NO 08202 \$20. KW Electronics KW2000 transceiver S/NO B1180 C/W EXTERNAL PSU. Collector's item - what offers? Contact Betty (08) 8248 2472 or Ian VK5QX (08) 8250 1708

WANTED SA

● **2M/70cm Dual band vertical colinear base station antenna David VK5AXW 08 83709569 (AH) 08 8370 1066 (BH)**

● **915 kHz IFTs or may be padded to 915 kHz - required for modification to BC348 valve receiver - Rob VK5RG QTHR 08 83791889**

FOR SALE TAS

● **YAESU FT990 HF T/ceiver gen. cov. rec. Built in P/supply. Deluxe T/ceiver \$1795 Inc Boxes etc. YAESU SP5 speaker \$130. Kenwood TS520S exc cond unmarked boxes inc CW filter \$395. Kenwood MC50 Base Mic \$90. Above all in as new cond. Contact Allen VK7AN 0363271171 Mobile 0417354410**

● **YAESU FT990 top line HF T/ceiver Auto/A+U P/supply as new. G#coverage Receive YAESU SP5 ext Spkr inc filters ec YAESU Ftone H.F. T/ceiver inc p/supply Gen Cov Receiver EC Daiwa CNW 217 HFATU 160-10 All with boxes manual phones Allen VK7AN 0363271171 0417 354410 QTHR.**

● **YAESU FT50RD hand held 144MHz-70cm xcvr# with FND42 power pack Little used still inwarranty 18 months \$450. Braioner 144mc 70cm vertical GST3 antenna \$195 Neville VK7NC QTHR 03 62251304**

TRADE ADS

● AMIDON FERROMAGNETIC CORES:

For all RF applications. Send business size SASE for data/price to RJ & US Imports, PO Box 431, Kiama NSW 2533 (no enquiries at office please ... 14 Boanyo Ave Kiama). Agencies at: Assoc TV Service, Hobart: Truscotts Electronic World, Melbourne and Mildura: Alpha Tango Products, Perth: Haven Electronics, Nowra: and WIA Equipment Supplies, Adelaide.

● **WEATHER FAX programs for IBM XT/ATs *** "RADFAXZ" \$35.00**, is a high resolution short-wave weather fax, Morse and RTTY receiving program. Suitable for CGA, EGA, VGA and Hercules cards (state which). Needs SSB HF radio and RADFAX decoder. *** "SATFAX" \$45.00, is a NOAA, Meteor and GMS weather satellite picture receiving program. Needs EGA or VGA & WEATHER FAX PC card, + 137 MHz Receiver. *** "MAXISAT" \$75.00 is similar to SATFAX but needs 2 MB of expanded memory (EMS 3.6 or 4.0) and 1024 x 768 SVGA card. All programs are on 5.25" or 3.5" disks (state which) plus documentation, add \$3.00 postage. ONLY from M. Delahunty, 42 Villers St, New Farm QLD 4005. Ph 07 358 2785.

WIA Division Directory

The WIA consists of seven autonomous State Divisions. Each member of the WIA is a member of a Division, usually in their residential State or Territory, and each Division looks after amateur radio affairs within its area.

Division	Address Officers	News Broadcasts	Note: All times are local. All frequencies MHz.	Fees
VK1 ACT Division GPO Box 600 Canberra ACT 2601	President Hugh Blemings Secretary John Woolner Treasurer Les Davey	VK1YYZ VK1ET VK1LD	3.590, 146.950, 438.375, 438.325, 438.225 & 438.025 FM each Sunday from 8.00pm AEST. News text on packet BCAST@VK1BBS, http://www.vk1.wia.ampr.org & aus.radio.amateur.misc.newsgroup . Send items by packet as personal message BCAST@VK1BBS or e-mail to broadcast@vk1.wia.ampr.org.	(F) \$72.00 (G) (S) \$58.00 (X) \$44.00
VK2 NSW Division 109 Wigram St Parramatta NSW (PO Box 1066 Parramatta 2124) Phone 02 9689 2417 Freecall 1800 817 644 Fax 02 9633 1525	President Michael Corbin Secretary Eric Fossey Treasurer Eric Van De Weyer (Office hours Mon-Fri 11.00-14.00) Web: http://ozemail.com.au/~vk2w/ e-mail: vk2w@ozemail.com.au Packet BBS: VK2WI on 144.850 MHz	VK2YC VK2EFY VK2KUR	From VK2WI 1.845, 3.595, 7.146*, 10.125, 14.170, 24.950, 28.320, 29.120, 52.120, 52.525, 144.150, 147.000, 438.525, 1273.500 (* morning only) with relays to some of 18.120, 21.170, 581.750 ATV sound. Many country regions relay on 2 m or 70 cm repeaters. Sunday 1000 and 1930. Highlights included in VK2AWX Newcastle news, Monday 1930 on 3.593 plus 10 m, 2 m, 70 cm, 23 cm. The broadcast text is available on the Internet newsgroup aus.radio.amateur.misc , and on packet radio.	(F) \$69.00 (G) (S) \$66.00 (X) \$41.00
VK3 Victorian Division 40G Victory Boulevard Ashburton VIC 3147 Phone 03 9885 9261 Fax 03 9885 9298	President Jim Linton Secretary Barry Wilton Treasurer Rob Halley (Office hours Tue & Thur 0830-1530) e-mail: vk3wi@rint.com.au Web: http://www.tbsa.com.au/~wivac/	VK3PC VK3XV VK3NC	VK3BWI broadcasts on the 1st Sunday of the month, starts 10.30 am. Primary frequencies, 3.615 LSB, 7.085 LSB, and FM(R)s VK3RML 146.700, VK3RMM 147.250, VK3RWG 147.225, and 70 cm FM(R)s VK3ROU 438.225, and VK3RMU 438.075. Major news under call VK3WI on Victorian packet BBS and WIA VIC Web Site.	(F) \$75.00 (G) (S) \$61.00 (X) \$47.00
VK4 Queensland Division GPO Box 638 Brisbane QLD 4001 Phone 07 3221 9377	President Colin Gladstone Secretary Peter Harding Treasurer Alistair Elrick e-mail: secretary@wiaq.powerup.com.au Web: http://www.wiaq.powerup.com.au	VK4ACG VK4JPH VK4FTL	1.825 MHz SSB, 3.605 MHz SSB, 7.118 MHz SSB, 14.342 MHz SSB, 21.175 MHz, 28.400 MHz SSB, 29.220 MHz FM, 53.725 MHz FM, 147.000 MHz FM, 438.500 MHz (Brisbane only), and regional VHF/UHF repeaters at 0900 hrs EAST Sunday. Repeated on 3.605 MHz SSB & 147.000 MHz FM at 1930 hrs EAST Monday. Broadcast news in text form on packet under WIAQ@VKNET.	(F) \$74.00 (G) (S) \$60.00 (X) \$46.00
VK5 South Australian Division 34 West Thebarton Rd Thebarton SA 5031 (GPO Box 1234 Adelaide SA 5001) Phone 08 8352 3428 Fax 08 8264 0463	President Ian Hunt Secretary Merv Miller Treasurer Joe Burford Web: http://www.vk5wia.ampr.org/	VK5OX VK5MX VK5UJ	1827 kHz AM, 3.550 MHz LSB, 7.095 AM, 14.175 USB, 28.470 USB, 53.100 FM, 147.000 FM Adelaide, 146.700 FM Mid North, 146.800 FM Mildura, 146.825 FM Barossa Valley, 146.900 FM South East, 146.925 FM Central North, 147.825 FM Gawler, 438.425 FM Barossa Valley, 438.475 FM Adelaide North, ATV Ch 35 579.250 Adelaide. (NT) 3.555 USB, 7.065 USB, 10.125 USB, 146.700 FM, 0900 hrs Sunday, 3.585 MHz and 146.675 MHz FM Adelaide, 1930 hrs Monday.	(F) \$75.00 (G) (S) \$61.00 (X) \$47.00
VK6 West Australian Division PO Box 10 West Perth WA 6872 Phone 08 9351 8873	President Cliff Bastin Secretary Christine Bastin Treasurer Bruce Hedland-Thomas Web: http://www.faroc.com.au/~vk6wia/ e-mail: vk6wia@faroc.com.au	VK6LZ VK6ZLZ VK6OO	146.700 FM(R), 438.525 FM(R), 29.120 FM at 0930 and 1900 hrs Sundays from Perth, relayed (morning only) on 1.865, 3.564, 3.582 (Busselton), 7.075, 14.116 (North), 14.175 (East), 21.185, 50.150; (morning and evening) 146.900(R) Mt William (Bunbury), 147.00(R) Katanning, 147.200(R) Cataby, 147.250(R) Mt Saddleback (Boddington), and 147.350(R) Busselton; (evening only) 1.865, 3.564 MHz.	(F) \$62.00 (G) (S) \$50.00 (X) \$34.00
VK7 Tasmanian Division 24 Targett Street Scamander TAS 7250 Phone 03 6372 5305	President Ron Churcher Secretary Paul Godden Treasurer John Klop Web: http://www.wia.tasnet.net e-mail: vk7kpg@hamnet.hotnet.com.au	VK7RN VK7KPG VK7KCC	146.700 MHz FM (VK7RHT) at 0930 hrs Sunday relayed on 147.000 (VK7RAA), 146.725 (VK7RNE), 146.625 (VK7RMD), 3.570, 7.090, 14.130, 52.100, 144.150 (Hobart), repeated Tues 3.590 at 1930 hrs.	(F) \$74.00 (G) (S) \$60.00 (X) \$46.00
VK8 Northern Territory (part of the VK5 Division and relays broadcasts from VK5 as shown, received on 14 or 28 MHz).				

Membership Grades

Full (F) Pension (G) Needy (G) Student (S) Non receipt of AR (X)
Three-year membership available to (F) (G) (X) grades at fee x 3 times.

ADVERTISERS INDEX

Terlin	IFC,9	Av-Com	21
Icom.....	OBC, 15	Amateur Transceiver Radio ...	24
Jaycar	17	Dick Smith	IBC 28,29
Andrews	21		

TRADE PRACTICES ACT

It is impossible for us to ensure that the advertisements submitted for publication comply with the Trade Practices Act 1974. Therefore, advertisers and advertising agents will appreciate the absolute need for themselves to ensure that the provisions of the Act are strictly complied with.

VICTORIAN CONSUMER AFFAIRS ACT

All advertisers are advised that advertisements containing only a PO Box number as the address cannot be accepted without the addition of the business address of the box-holder or seller of the goods.

YAESU VX-IR MICRO DUALBAND HANDHELD TRANSCEIVER

Wide receiver coverage, leading edge features, and Lithium Ion technology, packaged for convenience at a price that will surprise!



VX-IR shown full size

The new VX-IR is one of the world's smallest dualband amateur rigs, sporting a 2m/70cm transceiver with wideband receiver in a case sized just 47 x 81 x 25mm WHD. It has impressive memory and scanning facilities as well as receive coverage of VHF and UHF TV, AM and FM broadcast bands, AM aircraft band and other public service frequencies from 76 to 999 MHz*.

Leading-edge technology from the VX-IR's 500mW MOSFET power amplifiers together with the supplied 3.6V 700mA/H high-capacity Lithium Ion battery will provide many hours of superb local communications. Up to 1W output is available for longer range when external DC power is used. Extensive battery-saving features together with the Li-Ion battery's 2-hour recharge system yields long operating times under real-world conditions.

The VX-IR's extensive memory system provides 291 memory channels, most with Alpha-numeric labelling for easy recognition. A Smart Search™ system allows you to search a portion of a band you define, then loads any active frequencies into 31 special Smart Search™ memories for later inspection (great for finding activity when visiting a new area).

Besides being a fully-featured dual-band amateur transceiver, the VX-IR has extraordinarily wide receiver frequency coverage; you'll also be pleasantly surprised by the great audio on the FM broadcast band. A dual-watch facility is provided – and together with the AM, FM-narrow and FM-wide reception modes – you'll be having fun even when you're not operating on the amateur bands. For selective calling and listening, the VX-IR also includes a CTCSS encoder/decoder and a 104-code Digital Code Squelch (DCS) system as well as a Tone Search facility for both CTCSS and DCS encoded transmissions.

A great range of accessory lines for the VX-IR are available such as speaker/mics, a carry case, as well as a battery holder for 1 x AA alkaline battery which includes an inbuilt voltage step-up converter. Computer programming of the VX-IR is available via the optional ADMS-ID programming kit.

So when Yaesu says "Dick Tracy, we're waiting for your call" you can be sure they have good reason to do so. In fact, call into your Dick Smith Electronics' Hams Shack store for a demo of this fun new rig. Or phone 1300 366 644 for a copy of the Yaesu colour brochure.

D 3665

2 YEAR WARRANTY

\$469

YAESU

BONUS

MH-34 SPKR/MIC (D 2114) valued at \$49.95 **OR**
FNB-52LI Lithium battery (D 3667) valued at \$59.95

PHONE FAX AND MAIL ORDERS

PHONE: WITHIN AUSTRALIA: 1300 366 644
(Local Call Charge)

FAX: (02) 9395 1155 within Australia and
(+612) 9395 1155 from outside Australia

MAIL: DICK SMITH ELECTRONICS, Direct Link Reply Paid 160, PO Box 321,
North Ryde NSW 2113 (No Stamp Required)

Excludes packaging and postage. All major Credit Cards accepted.

14 Day Money Back Guaranteed if NOT completely satisfied. (Software excluded)

direct link

Visit our web site at
<http://www.dse.com.au>

DICK SMITH
ELECTRONICS

That's where you go!

MORE

GREAT

GEAR

FROM

ICOM



746 A tri-bander packed with power. Powerful and versatile to satisfy all your base station needs, HF + 6m + 2m band coverage, 100 W of output power on all bands, DSP functions standard, large multi-function LCD keeps you totally informed and makes the 746 so easy to use.



2071H Switch to two bands for a single band price... In-dash versatility, VHF/UHF capabilities (one band at a time) via a band switching system, superb clarity on either operating channel, easily detachable front panel, even a connection to a packet modem supporting speeds of up to 9600bps.

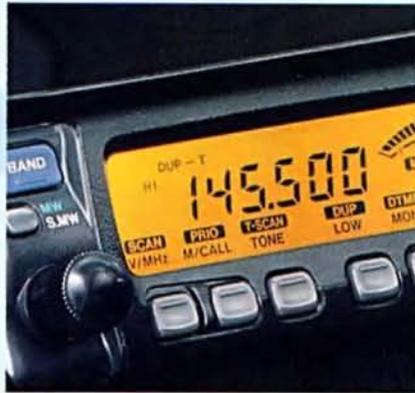

Q7A A mini unit with maximum performance. 2m/70cm transceiver/wide band receiver just 8.6 cms high, wide band receive from 30 to 1300 MHz in FM/WFM/AM modes, simple operation with easy band switching, automatic squelch, crystal clear audio.

PCR100 Cruise the airwaves with your computer. Turns your PC into a sophisticated 0.5 - 1300 MHz receiver (FM/WFM/AM modes) with plug'n play installation. Multi function control panel, wide frequency coverage, and unlimited memory channels.



R2 Fit the world's airwaves in your shirt pocket. Just 8.6cm high, 0.5 - 1300 MHz frequency range divided into 9 bands plus FM/WFM/AM, auto squelch for consistent signal strength, 400 memory channels, great sound in rugged water resistant construction.

ICOM

Clearly Ahead

2 YR WARRANTY

See your nearest Icom Dealer, call Icom on 1800 338 915, or visit our website at www.icom.net.au

March 1999
Volume 67 No 3



Amateur Radio

Journal of the Wireless Institute of Australia



Full of the latest amateur radio news, information and technical articles, including...

- Our Response to RCA Discussion Paper
- Australia Day Honours for VK4s
- Homebrew 813 Linear Amplifier
- Boom Corrections to Element Lengths of Yagis
- Workshop Time
- Pick up SSB on your FM Receiver
- Kerosine Lamps and kHz — 50 years an Amateur
- Preserving our Pictorial History
- Broadband Level Meter, HighPerformance Regenerative Receiver, Soft starting

Plus *lots of other articles, news and special interest columns.*

QMS - 7

Antenna Coupler System

Quick Mount System
for mobile HF and VHF use



SG-230 MICROPROCESSOR CONTROLLED ANTENNA COUPLER (1.6-30MHz) 200W Smarttuner

The SG-230 Smarttuner automatic antenna coupler can be used within its power rating with any HF Transceiver in range of 1.6-30MHz. Designed for marine, portable and fixed base applications. For antenna types: 23ft marine whip for 1.6 to 30MHz and with 9ft. minimum antenna for 3-30 MHz operation

Number of channels unlimited
Frequency range 1.6-30 MHz
Power rating 200 watts PEP maximum 12 VDC. operation
SWR: Less than 1:1.5
Tune power: 3 watts nominal
Weight: 8Lbs.
Dimensions: 12.5 x 10.5 x 3
Supplied with 9ft. cable for coaxial and DC power.

- QMS-7 offers unsurpassed frequency agility without user intervention
- SG-231 Smarttuner automatic antenna coupler, SG-307 extended full-range antenna, and weather resistant QMS-7 package
- 1 to 60 Mhz-continuous-instant tuning while you drive
- Rated for use on moving vehicles at up to 75 Miles (120km) per hour



Terlin
OUTbacker 

PO BOX 1197
Canning Vale W.A. 6155
www.outbacker.com.au
terlin@outbacker.com.au

Ph (08) 9455 4288
Fax (08) 9455 4289



Amateur Radio

Volume 67
Number 3
March 1999

Amateur Radio is published by the Wireless Institute of Australia ACN004 920 745 as its official Journal on the last Friday of each month

Editorial

Editor: Bill Rice* VK3ABP
 Production Manager: Bob Harper VK4KNH
 Snr Technical Editor: Peter Gibson* VK3AZL
 Technical Editors: Evan Jarman* VK3ANI
 Gil Sones* VK3AUI
 Don Graham VK6HK
 Contributing Editors: Ron Fisher* VK3OM
 Don Jackson* VK3DBB
 WIA News Editor: David Thompson VK2NH

*Publications Committee member

Advertising

Mrs June Fox
 WIA Federal Office
 PO Box 2175 CAULFIELD JUNCTION VIC 3161
 Tel: (03) 9528 5962 Fax (03) 9523 8191
 email armag@hotkey.net.au

Amateur Radio Correspondence

All correspondence, contributions and queries about the *content* should be sent to:

The Editor *Amateur Radio*
 PO Box 2175
 CAULFIELD JUNCTION VIC 3161
 email armag@hotkey.net.au
 Tel: (03) 9528 5962 Fax (03) 9523 8191

Amateur Radio Delivery

All queries regarding delivery should be directed to:

Amateur Radio WIA Federal Office
 PO Box 2175 Caulfield Junction Vic 3161
 Tel: (03) 9528 5962 Fax (03) 9523 8191

Registered Office

10/229 Balaclava Road
 Caulfield North VIC 3161
 Tel: (03) 9528 5962 Fax (03) 9523 8191
 Business hours: 9.30am-3pm weekdays

Editorial & Display Booking Deadlines

April	12/3/99
May	16/4/99
June	14/5/99

Hamad & Display Material Deadline

April	19/3/99
May	23/4/99
June	21/5/99

Production

Administration, Drafting, Design & Sub-editing
 Shadetree Publishing & Imaging
 PO Box 288 BEERWAH QLD 4519

Pre-press, print and mail management
 Newsletter Unlimited (03) 9428 3458

Printed by Streamline Press, Melbourne (03) 9417 2766
 Mailed by IMS, Melbourne (03) 9291 5888

Receipt of Amateur Radio by mail

This issue was delivered to Australia Post on Tuesday March 2 If you are a financial member and have not received your copy by the 15th of the month please check with your local Post Office before contacting the registered office of the WIA.

Copyright and Reproduction

The copyright in this magazine, except where specifically noted, is held by Wireless Institute of Australia ©WIA 1999. Permission to republish articles in any form must be obtained in writing from the Institute (other than for purposes of 'fair dealing'). This permission is usually freely given for information purposes.

The Journal of the Wireless Institute of Australia

ISSN 0002-6859

Technical

A Homebrew 813 Linear Amplifier	7
<i>C.J. Bourke VK4YE</i>	
Boom Corrections to Element Lengths of Yagis at 144, 432 & 1296MHz	11
<i>Guy Fletcher VK2KU</i>	
Receive SSB on your FM Receiver	18
<i>Peter Parker VK1PK</i>	
Technical Abstracts	30
<i>Gil Sones VK3AUI</i>	

General

After fifty years — I still remember	21
<i>Eric Jamieson VK5LP</i>	
Beginners Page — Workshop Time	16
<i>Terry Sexton</i>	
Preserving our Pictorial History	25
<i>Will McGhie VK6UU @ VK6BBR</i>	
Radio Amateurs Old Timers Club	47
<i>Allan Dobel VK3AMD</i>	
"The Three Amigos"	6
<i>Bob Harper VK4KNH</i>	

Columns

Advertisers' Index	56	Editor's Comment	2
ALARA	50	Hamads	54
AMSAT Australia	40	HF Predictions	52
ARDF	34	Repeater Link	51
Awards	33	Silent Keys	35, 47, 49
Club News	27	Spotlight on SWLing	43
Contests	48	VHF/UHF - An Expanding World	36
WIA Divisions News		WIA Comment	3
VK2 Notes	44	WIA News	3
VK4 Notes	44	WIA Division Directory	56
VK5 and VK8 Notes	44	WIA Federal Directory	2
VK6 Notes	46		
VK 7 Notes	46		

Our cover this month

Brian Rickeby VK4RX, Guy Minter VK4ZXZ and Bill Sebbens VK4XZ, recipients of the Australia Day Achievement Award for communications work with Caloundra District Rural Fire Brigade.

Contributions to Amateur Radio

Amateur Radio is a forum for WIA members' amateur radio experiments, experiences opinions and news. Manuscripts with drawings and or photos are always welcome and will be considered for publication. Articles on disc or email are especially welcome. The WIA cannot be responsible for loss or damage to any material. A pamphlet, How to write for Amateur Radio is available from the Federal Office on receipt of a stamped self-addressed envelope.

Back Issues

Back issues are available directly from the WIA Federal Office (until stocks are exhausted, at \$4.00 each (including postage within Australia) to members.

Photostat copies

When back issues are no longer available, photocopies of articles are available to members at \$2.50 each (plus an additional \$2 for each additional issue in which the article appears).

Disclaimer

The opinions expressed in this publication do not necessarily reflect the official view of the WIA and the WIA cannot be held responsible for incorrect information published..

Amateur Radio Service

A radiocommunication service for the purpose of self-training, intercommunication and technical investigation carried out by amateurs; that is, by duly authorised persons interested in radio technique solely with a personal aim and without pecuniary interest.

Wireless Institute of Australia

The world's first and oldest
National Radio Society
Founded 1910

Representing
The Australian Amateur Radio Service

Member of the
International Amateur Radio Union

Registered Federal Office of the WIA
10/229 Balaclava Road
Caulfield North Vic 3161
Tel: (03) 9526 5962
Fax (03) 9523 8191
<http://www.wia.org.au>

All mail to
PO Box 2175 Caulfield Junction VIC 3161

Business hours: 9.30am-3pm weekdays

Acting Federal Secretary

Peter Naish VK2BPN

Federal Office staff

June Fox Bookkeeper
Rita Trebilco VK3IF Examinations Officer

Council

President	Peter Naish	VK2BPN
VK1 Federal Councillor	Michael Jenkins	VK1MJ
VK2 Federal Councillor	Michael Corbin	VK2YC
VK3 Federal Councillor	Brenda Edmonds	VK3KT
VK4 Federal Councillor	Ross Marren	VK4AMJ
VK5 Federal Councillor	Jim McLachlan	VK5NB
VK6 Federal Councillor	Will McGhie	VK6UU
VK7 Federal Councillor	Andrew Dixon	VK7GL

Executive

Peter Naish	VK2BPN
Martin Luther	VK5GN
Wally Howse	VK6KZ
Neil Penfold	VK6NE

Federal Coordinators

AMSAT	Graham Ratcliff	VK5AGR
Awards	John Kelleher	VK3DP
Contests	Ian Godsil	VK3DID
Education	Brenda Edmonds	VK3KT
FTAC	John Martin	VK3KWA
Historian	John Edmonds	VK3AFU
IARU	Grant Willis	VK2ZWI
Intruder Watch	Gordon Loveday	VK4KAL
ITU Conference and study group	David Wardlaw	VK3ADW
Public Relations	David Thompson	VK2NH
QSL Manager (VK, VKO)	Neil Penfold	VK6NE
Videotapes	Don Bland	VK4TVD

ACA Liaison Team

Brenda Edmonds	VK3KT
David Wardlaw	VK3ADW
Peter Naish	VK2BPN

EDITORS COMMENT

"...Then there are statistics"

I think it was Lord Kelvin who expressed the philosophy that "knowledge which cannot be expressed in figures is of a very meagre and unsatisfactory kind".

BENJAMIN DISRAELI, on the other hand, said, "There are lies and damned lies. Then there are statistics".

The real truth, as is so often the case, lies somewhere in between. I would like to give you a few statistics which I hope are better than "damned lies". Here they are:

I joined the WIA in 1945 and have been a member ever since, ie for 54 years. I was 18 when I joined, so I am 72 this year. I achieved my AOCPL and licence in 1947, so I have been licensed for 52 years. I have been editor of "Amateur Radio" for almost 15 years. This is the 157th editorial I have written for this magazine. About 20 have been written by others.

Since October 1945 every month has brought a new issue of the magazine, 641 issues to the present day. The first few were rather skimpy with only about 20 pages, but they improved as the number of members increased. By 1980 we had about 80 pages per issue and about 10,000 members. There were nearly 30 different advertisers.

Perhaps we may never again see such a large and healthy WIA. Many who might once have become amateurs have been content with CB or the Internet.

But do they give you all you want?

After a lifetime in the WIA am I going to see it collapse completely?

Maybe, or is this the bottom of the trough?

From here on the only way is up? Let us hope so, and do what we can to help.

Bill Rice VK3ABP Editor



Amateur Radio

Supporting the community



Speaking WIA

FROM TIME TO TIME I am asked to speak to Amateur Radio Clubs about the WIA and its activities at the Federal level. I enjoy this as it gives me direct contact with radio amateurs who otherwise would just be callsigns and names. Many of them are WIA members but a considerable number are not. These meetings are always lively affairs, which I use to sample the mood of the radio fraternity.

I find that there are three types of Club member, namely those who are staunch WIA supporters, those who can see no virtue in being a WIA member and the waverers who need a bit of encouragement to join us.

I direct my presentation to the latter two categories, with the general theme that the WIA is the accepted voice of amateur radio and is working very hard indeed to protect and enhance our operating privileges.

I give concrete examples of what we have achieved together with the long list of tasks still to do. After the meeting I usually find a much more relaxed attitude about the WIA. Hopefully some who were not supporters of our work will now join.

Now, you, the readers of this Journal, are already WIA members so it is expected that you are in the first category.

So, why not help the WIA Councils and myself to encourage those in your local radio club to become members of the WIA.

Listen to their concerns and help them to understand what we are doing to make amateur radio more enjoyable and future-safe. Please, let your WIA Divisional Council know what is happening at club level because it is these local organisations that seem to me to be the current heart of the amateur radio movement.

The clubs and the WIA perform complementary functions and one is not an alternative for the other.

That is how I see it. Let us all be ambassadors for the WIA.

Peter Naish, VK2BPN
WIA Federal President.

The WIA Submits Response to Discussion Paper

As we reported last month, the WIA has lodged a response to the Department of Communications, Information Technology and the Arts (DOCITA) as requested for comment on the *Radio Communications Act (1992) Review Discussion Paper* which was released for comment last year to stimulate discussion by all interested parties, including the WIA.

Executive Summary

The WIA has undertaken a detailed review of the discussion paper produced by the Department of Communications, Information Technology and the Arts. Issues that have an impact on the Amateur Radio Service in Australia have been dealt with this response to that paper.

In general, the WIA feels that the discussion paper has been biased towards large commercial and industry players, to the detriment of smaller non-profit services such as the Amateur Service.

The belief that market forces will be the most efficient regulator appears to be

an underlying theme, which is an approach the WIA disagrees with if it is applied across the board to all services.

The paper also appears a little naive when considering interference management issues. The courts are not an efficient place to solve complex spectrum engineering issues. The WIA believes that the ACA must be charged with the ongoing role of mediating in these matters.

In summary, here are the major points, chapter by chapter, made by the WIA in its response.

Chapter 3 Spectrum Planning

- The WIA believes there is little scope for further relaxing the legislative basis for the Australian Spectrum Plan.
- Increased public consultation on international matters would be a worthwhile move.
- Non-conforming users of spectrum need to have limited rights and be secondary to all other spectrum users. Such usage may provide a benefit for experimental aspects of the Amateur Service.
- Civil action is not seen as a positive or useful path in dealing with

interference, and may have hidden costs to the community that are greater than the current systems.

Chapter 4 Trade, Competition & Access

- Trading in apparatus licences is not seen as viable if the Amateur Service continues to be licensed using this system. This is seen as improving the case for creation of the "Amateur Operator Licence" type.
- Public and community access spectrum should not be made available for private sector management or market forces. Broad guidelines should be set for the ACA in the Act as to what areas could be

allowed to have these management philosophies applied to them.

- Some Spectrum should be declared by the minister through the Act to be “out of bounds” for commercial licensing tools, and instead be left to community and public uses, including amateur radio.
- Spectrum Sharing for the Amateur Service on a secondary basis to spectrum licencees is a method of improving spectrum efficiency while creating negligible if any costs. Moves by ACA to require the Amateur Service to negotiate this access with each individual spectrum licencee are seen as inefficient. Such access should be granted automatically by the ACA to the Amateur Service, considering the unique operational nature of the service.

Chapter 5

Taxes and Charges

- The WIA contends that none of the existing licensing schemes properly suits the nature of the Amateur Service, although the new proposed Class Operator Licence may have some potential, which should be explored further.
- In their place, the WIA offers the proposal for creating the “Amateur Operator Licence” which would address the unique nature of the service. In presenting this option, the administrative and operational requirements of the Amateur Service are outlined.
- Options for reducing the cost of administering the Amateur Service, as a result of the Amateur Operator Licence are presented.

Chapter 6

Licensing

- If distinctions between Apparatus and Spectrum licensing are removed, then the case for creating the Amateur Operator licence type is strengthened.

Chapter 7

Tenure, Compensation and Band Clearance

- The WIA sees the current 5 year licence term as attractive, and may see a longer term as beneficial in reducing costs.

- The only consumable affected by the number of amateur licences is call sign allocation space. Mechanisms for long term conservation of the call sign space are discussed.
- The WIA contends that any forced loss of spectrum to the Amateur Service should be met with increased status and tenure in remaining spectrum, and/or other new bands being made available.
- The quantity and allocation of remaining spectrum needs to take into account the Amateur Service’s international usage of that spectrum (including microwave frequencies) as well as bandwidth requirements to allow the full range of communications experiments to continue to be undertaken.

Chapter 8

Frequency Coordination

- Frequency coordination activities need to be retained by the ACA in at least some form to cater for the needs of non-profit organisations.
- Removal of a subsidised system will dramatically affect the Amateur Repeater and Beacon facilities, which then has a direct impact on the Amateur Service’s abilities to provide effective communications in emergencies and disasters.

Chapter 9

Defence and other public purpose uses for spectrum

- The creation of “out of bounds” spectrum is seen as an efficient way of managing public service spectrum, because it means that any costs potentially incurred through invalidly considering it for other users are avoided.
- Uniform fee exemptions for non-profit services could initially take the form of dropping the spectrum access tax component.
- Further exemptions could then be granted, including a fee free licence in various circumstances (eg non-profit services involved in carrying safety of life traffic)

Chapter 11

Satellites

- The Amateur Satellite Service should not be included in any moves

to change the way satellite services are licensed or charged.

Chapter 14

Operator Proficiency

- The requirement for operator proficiency is mandated by ITU regulations.
- The existing theory examination syllabuses do not currently reflect the desired outcomes, due to inefficiencies in the revision processes being encountered.
- The current examination system is seen as the most workable solution for the Amateur Service.
- Qualifications for the Amateur Service need to cover more than just how to manage interference. There are international ramifications in the syllabus.
- Linking qualifications to the objectives of the Act requires additions to the Act to cover the full objectives of the Amateur Service.
- Maintenance of uniform standards for exam papers and syllabus is a requirement of the Amateur Service. Devolvement of exam paper creation to multiple bodies is likely to generate inefficiencies in handing exam material preparations due to extra administrative overhead required by the ACA in moderating all participating bodies.
- The issuing of certificates of proficiency is an activity that could be the subject of devolution.
- Various alternatives are suggested to the current examination system, and some short comings are given that would need to be addressed and discussed if any of the systems were to be considered for adoption.

Chapter 15

Legislation

- Any move to simplify the objectives statements of the Act need to be carefully considered, and any moves to relax the descriptions of operational and administrative procedures further may cause problems to not-for-profit services.
- The periods required to be allowed for public responses need to be spelt out in the Act, and in particular be preferably set at 90 days, to allow time for services such as the

Amateur Service to consult properly among its members.

- The mandatory requirement for licence address details to be published needs to be reviewed to allow voluntary suppression of these details in public media.
- Enforcement activities must remain under the control of the ACA, as it is a spectrum policing role that does not belong in private industry hands for a number of reasons.

Conclusion

The WIA sees the moves to relax spectrum management controls as being detrimental to all users of the radio spectrum. The continuing push for commercialisation of the radio spectrum and the ongoing belief that financial competition is the best rationing system does not apply to all parts of the radio spectrum. The WIA urges the Department to develop a better understanding of the true value of spectrum users like the Amateur Service to the Australian and international community and encourage greater participation in this activity within Australia.

Recognition of the uniqueness of the Amateur Service in what it allows participants to do is needed. This would lead to the conclusion that all of the current licensing systems fail the Amateur Service in some manner. The merits of creating the "Amateur Operator Licence" type, in addition to apparatus, class and spectrum licensing should be seen as enhancing the community resource that is the Amateur Service. The cost savings possible through definition of this new licence type should also be tangible, as was seen with the various ways that could be considered for reducing administrative contact and hence costs.

The area of operator certification, and in particular the amateur operator certificate of proficiency has scope for improvements in some aspects, but works well in others. Weakening of the requirements for examinations and syllabus would be seen as detrimental to the Amateur Service, although a streamlined system of dealing with the syllabus and examination papers would be a benefit.

Many of the other concerns raised have roots in a belief of the WIA's that the proper management of the spectrum is essential to maintaining the best environment for all spectrum users. The

suggestions in the discussion paper revolving around outsourcing functions such as enforcement ring alarm bells, and should not be implemented. At the very most, they could in some small number of circumstances be put to working parties to explore the full gamut of implications.

The WIA welcomes the opportunity to have had input into the review into the Australian Radiocommunications Act and would like to see discussions continue between the department and the WIA on issues of mutual interest.

Federal President Peter Naish said "The ACA Liaison Committee, and others in conjunction with Grant Willis VK5ZWI, spent many hours putting together the WIA response. This has meant a lot of work by both Federal Councillors and coordinators in association with the ACA Liaison Committee".

If you would like a copy of the submission, send a stamped, self-addressed A4 envelope to the Federal Office.

Italians Stage High Speed CW Contest

The Italian Hams Association, A.R.I IARU member, division of Pordenone in Italy, has organized the third World Championship of High Speed Radiotelegraphy to take place in Pordenone, from April 28th to May 2nd 1999. More than 20 countries have confirmed their participation, with Japan and South Korea included. Invitations have been sent out by mail and email to the entire Region I countries and by E-mail to all the Regions I and II countries.

The email addressed to Australia read "*Even your country keeps up with a strong tradition of good telegraphers (we know it from both pile-up and most importantly contests)*". It is also pointed out in the message, that at the time of the competitions, the 34th National Ham's Exhibition will take place too. It is one of the Europe's greatest exhibitions. A guided visit to Venice has also been organised, so as to give the chance to participants and companions to visit this wonderful city of Pordenone. If you are interested in competing in this event, contact The Organising Committee Secretary, through the email address: mauriziotoc@agemont.it

Story courtesy of Maurizio Toccaceli IV3HRO

DXCC QSL Card Collection

The WIA's Curator of QSLs Ken Matchett VK3TL has put together a unique collection of approximately 330 cards. The collection features one card from every current DXCC country. The cards were obtained from those donated to the WIA from VK2 amateurs through NSW Divisional historian Jo Harris VK2KAA. This album will, be on permanent display at the WIA New South Wales Division headquarters at Amateur Radio House House, Parramatta.

Ham Magazine Cost Cutting

NZART has announced that it is reducing the number of copies of its official publication Break-in from 12 copies a year to six. Organisation sources say the reduction is a move to cut costs of production.

The Disappearing Coastal Morse

As you will now be aware, the last Morse code transmission of Australia's coast radio service took place earlier this year. Through Qnews, we have been blessed with a transcript of Australia's Coast Radio Service, Last Morse Transmission. It reads:

"CQ CQ CQ DE VIM/VIS VIM/VIS/VIT VIM/VIS/VIT=THIS IS THE FINAL MORSE TRANSMISSION FROM THE TELSTRA MARITIME COMMUNICATIONS NETWORK. WE CONCLUDE OUR FINAL CW WATCHKEEPING AFTER 87 YEARS OF CONTINUOUS SERVICE WITH PRIDE AND SADNESS. TELSTRA, THE AUSTRALIAN MARITIME SAFETY AUTHORITY AND THE BUREAU OF METEOROLOGY WISH ALL SEAFARERS FAIR WINDS AND FOLLOWING SEAS. ON BEHALF OF THE COUNTLESS SOULS WHO WOULD HAVE DIED BUT FOR THEM, WE SALUTE ALL WHO HAVE SERVED OUR PROFESSION WITH SKILL AND DEDICATION THROUGH THE YEARS. 73S = 31ST JANUARY 1999 2359UTC + VA

Transcribed off 500kHz at 01FEB1999 0005 to 0011UTC by Gavin Reibelt, former OTC Coast Station Operator CSOCP #N57, GMDSS-OPS #A0310 and received at the Electromagnetic Testing Services Lab, Garbutt, Townsville, QLD. The audio-tape and digitised sound file are held in archives.

"The Three Amigos"

by Bob Harper VK4KNH

Australia Day Honours

for Guy Minter VK4ZXZ, Brian Rickeby VK4RX and Bill Sebbens VK4XZ.

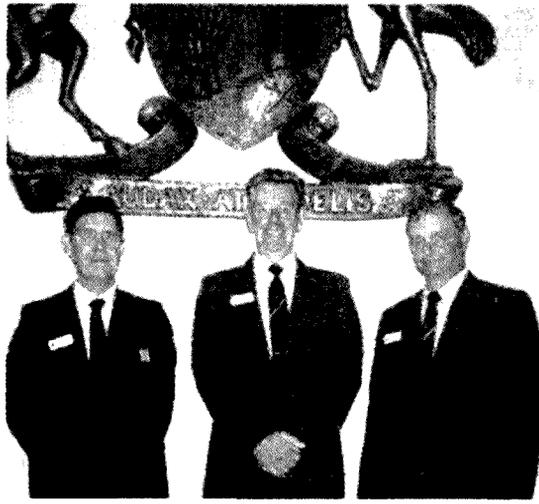

THE WORD WAS OUT under the caveat of "Keep it quiet, but this should interest you!" Three Queensland amateurs were to present themselves to Parliament House on Australia Day for services rendered to the State Rural Fire Brigade Services. To tell the whole story we have to go back nearly five years when this area experienced more than a fair share of widespread bushfires. Volunteer firefighters were out week after week protecting the rural property of their own neighbours.

The bush in this neighbourhood is often rainforest, tall and thick with a canopy that barely loses touch over narrow rugged bush tracks. Retired Maleny amateurs, Guy Minter VK4ZXZ, Brian Rickeby VK4RX and Bill Sebbens VK4XZ became aware that fire brigades were operating without as much as radio backup. "We could not believe that they were fighting fires without proper communications," Guy said. "We had the expertise and the time, so we decided to do something about it."

In the first two years Guy, Brian and Bill not only installed more than thirty-five radios in vehicles but tuned and re-programmed them, and trained the volunteers in their use. They installed the radios at Maleny, Crystal Waters, Conondale, Coochin Creek and Landsborough. As the word went out more and more requests were received.

As other Government Departments upgrade to newer UHF equipment, the older radios, many of which would have been dumped, are salvaged, sorted, repaired as necessary and tuned for the frequency allocation. They are re-programmed and tested before installation. "All up we spend around four hours with them by the time we install the radio and give some training," Guy said.

A complication arose in that the greatly increased number of radios was going to cause congestion on the allocated frequencies. After several band plans had been suggested from government sources the "Three Amigos", as I am told they are known, put together their own plan. No doubt their various amateur radio experiences, which include many collective years on Council, helped not only in the technical aspects of the band plan but in handling the bureaucratic aspects as well. Their band plan with 12.5 kHz channel splits was put forward and accepted with such vigour that it is now adopted statewide.

Since that time they have also performed the same service for the Caboolture Area Rural Fire Brigades

for his VHF/UHF advisory role in QTAC and as WIAQ Councillor for 7 years, and Guy for service to the WIAQ as Treasurer and President, Federal Councillor and IARU Representative. So their individual energy and spirit was well known to Queensland amateurs but the three as a team are unstoppable. One Queensland amateur puts it this way "The sum of the three is far greater than each individual". Look out for the new Queensland Political Party - "The Three Amigos".

Officially their award is the "Australia Day Achievement Award" presented "for outstanding contributions to the development and implementation of the Rural Fire Service's communications network." This heavy and impressive medallion features the Australian continent on one side with a swirling cloud pattern about it. On the reverse side there is an inscription nominating the recipient.

While they would not have received their award without the selfless contribution they have made, it occurred to me that there are many instances of persons making an effort over and above what is generally expected. What is often missing is the recognition for these efforts. Often we simply accept what others are doing on our behalf without understanding the debt owed to those individuals. Think of your own club, community or indeed of the WIA and the Divisional Councils that keep your hobby alive for you. I am sure that these individuals don't expect awards or even gratitude but your appreciation helps and your assistance would be even better.

ar

Retirees help open lines of communication for brigades

THREE Maleny retirees are helping open up the lines of communication for six Caboolture rural fire brigades.

Guy Minter, Brian Rickeby and Bill Sebbens are installing and repairing mobile radios in equipment in the Caboolture area.

Minter, Rickeby and Sebbens, former members of the Maleny Amateur Radio Club, decided to put their experience of working with the brigades' lack of communication equipment and firefighters' need to work with

"We just could not believe they were out fighting fires without proper communication," Minter said.

"We had the expertise and the time, so we decided to do something about it."

Minter and his friends have installed more than 30 radios in the past two years.

"We have put 11 in for Maleny, five for Crystal Waters, and had more when we



A giving team: Brian Rickeby left, Bill Sebbens, on radio, and Guy Minter helping brigades stay in touch.

started them to coordinate us for Landsborough and we have five to put in for Coocoin Creek when they get there. He said every time he looked around there seemed to be more and more radios needing installation.

"What happens is the Government gives them the money but the fire brigades pay some

Sunshine Coast Daily

A Homebrew 813 Linear Amplifier

(Part 1)

C.J. Bourke VK4YE

Lot 16 Waterford-Tamborine Road
Tamborine Village Qld 4270

Introduction

While the usual approach over the past twenty years or so in the design of a linear amplifier is to opt for a triode [or triodes] running class AB₂ in grounded grid configuration, I chose to revamp a design rarely seen these days. This is the once well known G2DAF circuit. It was quite popular with British amateurs, and to a lesser extent, with USA amateurs in the days of rigs with a vacuum tube output stage.

For those not familiar with the configuration, a resistor or resistive network of 100Ω to 300Ω replaces the tuned circuit of a grid fed amplifier. Tetrodes or pentodes are used because they have a very low value of plate to control grid capacitance. Being non-neutralised, stability is achieved by the damping of any feedback signal by the low value of input resistance. This amplifier uses a pair of 813 beam power pentode tubes. Other suitable types like the 4-125, QY3-125 and QB3/300 are discussed later.

The passive grid configuration has a couple of advantages compared to a grounded grid design. The input resistor provides a constant value load for the exciter to work into, and there is no requirement for a filament choke and associated pi-network. Drive levels are modest at around 25 - 30W pep. This means that your rig's output stage can loaf along quite comfortably while the linear amplifier is called upon to do the heavy work.

The passive grid design probably fell from favour with the arrival of the solid state output stage in transceivers. If your rig has a fixed 50Ω output impedance and you attempt to load it up into a 200Ω resistive load, how much power is transferred? Probably so little that you

qualify as a QRP operator! The rig's SWR protection circuit winds back the output so much that it is not possible to get enough signal to drive the amplifier. However, as I discovered, it is possible to overcome this objection by constructing a 1:4 transmission line transformer [of Guanella design] on a short piece of ferrite rod.

Description

The amplifier described in this article works satisfactorily with plate voltages ranging from 1.5kV to 2.5kV and easily exceeds 400W pep output from 160m to 10m. If you are inexperienced with, or hesitant about working with high voltages, forget about tackling this project. There is no such thing as a "slight shock" from a 2.5kV power supply. IT IS LETHAL!

Turning to the circuit in Figure 1, drive is applied through contacts RAI of input relay RA. I have separate input and output switching relays. Relay RB has the antenna changeover function. These two relays pull in together when a relay in your rig closes after the press to talk button is pressed. You must ensure that this relay has a set of contacts that places an earth on the "ground side" of RA. If you are unsure, read your manual. The 1:4 unbalanced to unbalanced [unun] transmission line transformer transforms the 50Ω impedance to 200Ω to match the 200Ω grid resistor, which should be rated at 20W. I used a commercial 200Ω 50W non-inductive

resistor. Surprisingly, 5 x 1kΩ 5W wire wound resistors in parallel gave quite satisfactory results, particularly as they have some inductance.

Drive is sampled and fed through a 0.047μF 630V capacitor to the rectifier-doubler that comprises 12 BAW62 diodes, each shunted by a 220kΩ 0.5W resistor. There are 6 diodes in each leg. A DC voltage proportional to the driving signal is applied to the screen grid of each 813. This method of generating the screen voltage works extremely well. The tubes draw around 40 - 50mA of plate current with no drive, as the screen voltage is zero. With drive, the screen voltage rises quickly to 200V or so. Do make provision to meter the screen current as it is a better indicator of resonance in the tank circuit of tetrode and pentode tubes than the conventional method of dipping the plate current.

A 0.01μF 630V capacitor passes drive to the control grid of the paralleled tubes that are operated in zero bias AB₂ configuration. When driven positive, grid current flows through a 3.3mH RFC [Altronics L 7052] and must be metered with a 100mA FSD meter as it indicates the level of drive from your rig. While separate meters are shown to read I_{sg} and I_g, you may use one meter. A DPDT switch is used in my amplifier. 10Ω 0.5W resistors bridge the position nominally occupied by the meter to complete the circuit when the meter is switched to the other position. See Figure 2 (c) for a circuit of this arrangement.

You will notice that on the circuit diagram in Figure 1, I have a different symbol for earth at the grounded end of the plate and load capacitors. All connections made to this point, like the

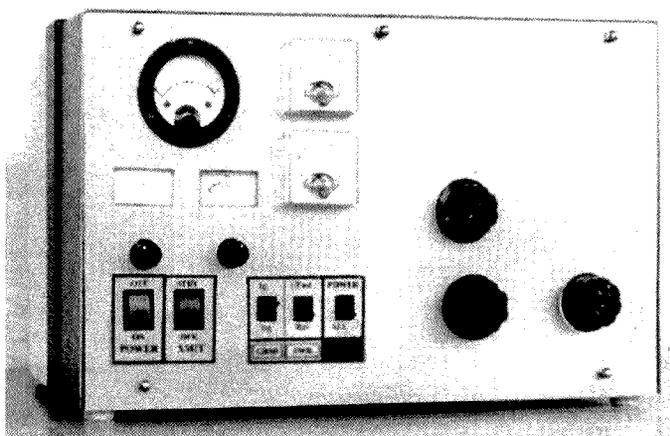

Photo 1. The front panel layout of the linear amplifier.

beam forming plates and the filament and screen bypass capacitors should be connected by 1 cm wide copper strap or brass shim. Because the tubes are not neutralised, it is imperative that a low impedance common ground be available to prevent instability. No trace of errant behaviour has been detected in the two amplifiers made to this design.

The 1mH RFC across the output is a mandatory safety item. Should the 1000pF DC blocking capacitor break down, the high-tension supply will be connected to the antenna system. The choke will shunt the DC to earth and open the 10A fuses in the primary side of the plate transformers. Under no circumstances is this choke to be left out. It comprises at least 100 turns of 0.4mm enamelled wire on a 50mm length of ferrite rod. Apply a layer of insulation tape before and after the winding is done. It does not matter if 2 or 3 layers of wire are used. Antenna changeover relay RB is an Altronics S 4197 job.

Filament Transformer

A 47kΩ 1W resistor connects the centre-tap of the filament transformer to ground. Its purpose is to maintain the tubes at cutoff when the amplifier is in standby mode. The pair of 813s requires a filament supply of 10V at 10A. This transformer is centre-tapped and is not exactly an 'off the shelf' item. You do what I have done - wind your own. You take a discarded microwave transformer, chisel out the high voltage secondary and wind the required number of turns through the window. This is easily done, as the turns ratio is about 1 turn per

volt. You cannot pull laminations apart as they are welded together.

In determining the exact number of turns to use, remove the secondary winding, then wind 10 turns of ordinary insulated hook up wire through the window. Using an accurate AC voltmeter, measure the voltage delivered by this winding. Exercise extreme caution when connecting mains power to these transformers, as terminals tend to be exposed spade types and careless amateurs could easily become silent keys!

Wind on or take off half a turn at a time until 10.0V to 10.5V is measured. Now that the correct number of turns is known, you can take some 2mm lacquered wire and wind the filament winding. It is a good idea before you start the winding process to wrap teflon tape around the core to prevent accidental shorts to frame through nicks on the wire. You must make provision for a centre-tap by winding half the turns, then start again to wind the second half. When it is completed, again check that the voltage produced is between 10.0V and 10.5V. The 813 tubes require 10V±0.5V. The filament transformer must be mounted on the same chassis as the tubes. Use 2mm insulated wire to connect the filament transformer secondary to the tube sockets.

Plate Tank Circuit

The plate tank circuit is a modified pi-network. The plate tuning capacitor is tapped to the centre of the 10m coil to allow a more optimum value of Q to be obtained from 20m through to 10m. The 10/15/20m coils should be wound with 3.6mm copper capillary tubing that is used in pressure gauges,

COIL WINDING DATA for 813 TUBES				
BAND	TURNS	DIAMETER (mm)	LENGTH (mm)	WIRE GAUGE
160m	25 turns	60	40	1.6mm
80m	tap 13 turns			
40m	tap 7 turns			
30m	tap 4 turns			
20m	8.5 turns	40	55	3.6mm capillary tubing
17m	tap 7 turns			
15m	tap 3 turns			
12m	tap 2 turns			
10m	5 turns plate tuning capacitor tapped at 2.5 turns	30	45	3.6mm capillary tubing

but 1.5mm wire can be safely used below 20m. Hobby shops often stock suitable capillary tubing. Try to orientate the 10m coil at right angles to the 15/20m coil to minimise coupling and losses.

For the 160m to 40m coil, which is wound in one continuous winding, the turns should fit tightly against each other. A tapping point can be made by twisting a small loop in the wire, then continue with the winding to the next tapping point. I used 60mm pvc pipe for the coil former.

Split Stator Plate Tuning Capacitor

We need to be careful about ensuring that the minimum capacitance of the plate tuning capacitor is as low as possible. It is not an easy task to find a capacitor that has a maximum capacitance of at least 220pF, so that the 160m band can be tuned, yet have a minimum capacitance of 10pF, to ensure we can tune the higher frequencies and still maintain an acceptable loaded Q.

It is possible to divide the capacitor up into two unequal sections. The first one can have a maximum capacitance of around 50pF while the second contains the balance of the capacitance. A miniature relay [Altronics S 4197] can switch the two sections together for operation on the 80m and 160m bands. Transmitting type tuning capacitors are easily pulled down into stator and rotor plates. The stator plates are usually held together by two long threaded bolts on which plates and spacers alternate. If the stator plates are soldered in position, then it is unlikely you have a tuning capacitor made for high power RF work.

Provided you have the correctly constructed capacitor, remove the rotor assembly.

It is quite easily done by removing

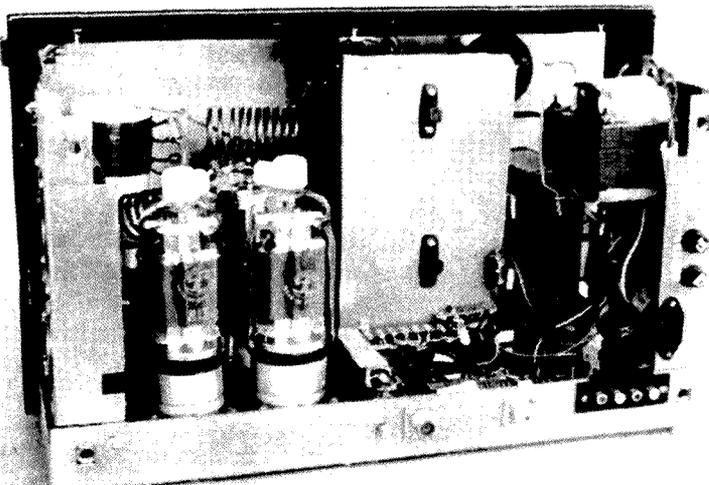

Photo 2. Internal arrangement of the major components.

blocking capacitor is made up of 2 x 2200pF ceramic capacitors in series. Each has a voltage rating of 6kV. In Brisbane, David Hall Electronics sells these - Ph (07)3808 2777.

Optional ALC

The ALC circuit is a fairly standard arrangement. A capacitive voltage divider samples the drive at the input of the unun. The 1N60, or similar germanium diode, is reverse biased at a voltage determined by the setting of the 50kΩ potentiometer which should be mounted on the front panel. ALC operation is very simple. When a sufficiently negative-going peak voltage causes the diode to conduct, the difference voltage is sent back to your rig's ALC input to compress excessively high peaks in the drive signal. If you do not want to include the ALC facility, it can be omitted so long as you are aware of the consequences of over driving a high power linear amplifier. If you are unaware I'm sure your TV watching neighbours will inform you fairly smartly!

Input Circuit

Now that the plate tank circuit has been taken care of, we need to ensure the input side can accept all bands from 160m to 10m. The unun consists of 13 bifilar

wound turns of ordinary hook up wire on an 80mm section of standard ferrite rod. This works as well as any toroid I have experimented with.

Due to the input capacitance of the tubes, the SWR increases to around 1.5:1 at 20m. To maintain a low SWR from 20m to 10m, use slug tuned coils to form a parallel resonant circuit with this capacitance. They are switched in by miniature relays [Altronics S 4160]. For 20 m use 20 turns of 0.4 mm wire on a 6 mm former. The 15m coil consists of 12 turns of 1mm wire on a 6mm former, and the 10m coil consists of 6 turns of 1mm wire stretched to a length of 1cm on a 6mm former. All coils are fitted with an F14 slug.

Once the coils have been fitted, the SWR stays very low and flat across each band because of the low Q due to the swamping effect of the 200Ω resistor. The earth end of R1 should be terminated very close to the braid of the coax bringing the input signal from the contacts of RA1. I have tried to make this obvious on the schematic of the input circuit.

I coupled a 12-position rotary switch wafer to the shaft of the band switch using a switch mechanism from Farnell Electronics. All relays were wired up so that they were switched in according to

the band selected. This is a neater option than having to provide a separate 'input selector' for switching in these relays. The Farnell stock numbers for the switch mechanism and 12-position wafer are 146-033 and 146-034 respectively.

Next Month:

To complete this article next month we will cover the power supply, filtering, metering, mounting and cooling the tubes, testing, alternate tubes, coil winding details, and component suppliers.

Should anyone wish to enquire further about this article, VK4YE, the author can be contacted through:

The Secretary, Southside Amateur Radio Society Incorporated, PO Box 294, Woodridge, QLD, 4114.

Our packet address is VK4WSS@VK4PKT#BNE.QLD.AUS.OC

You may also care to look at our Internet Homepage www.powerup.com.au/~jabba

for a copy of this article plus two QBASIC programs I have written. One calculates pi-network constants, and the other calculates the dimensions of single layer air wound coils.

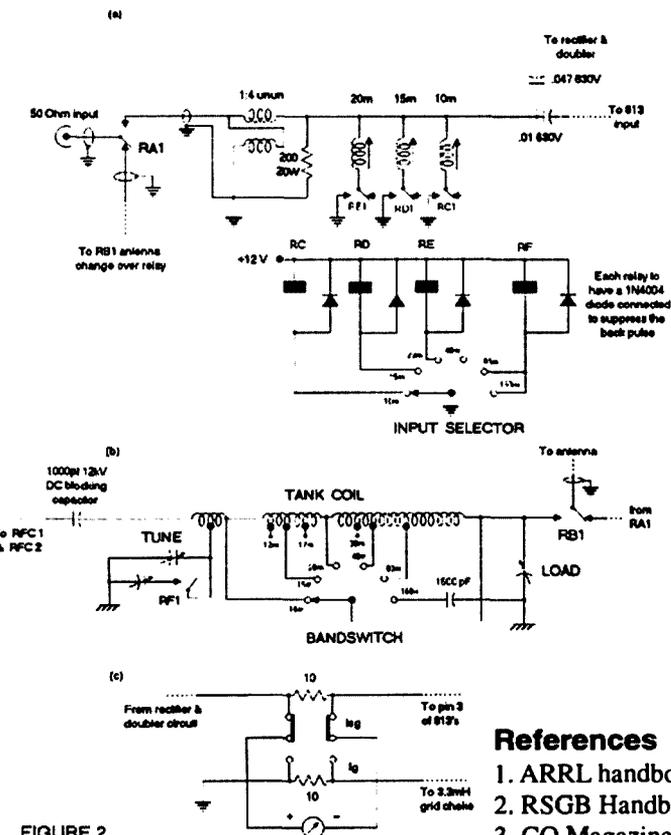

FIGURE 2.

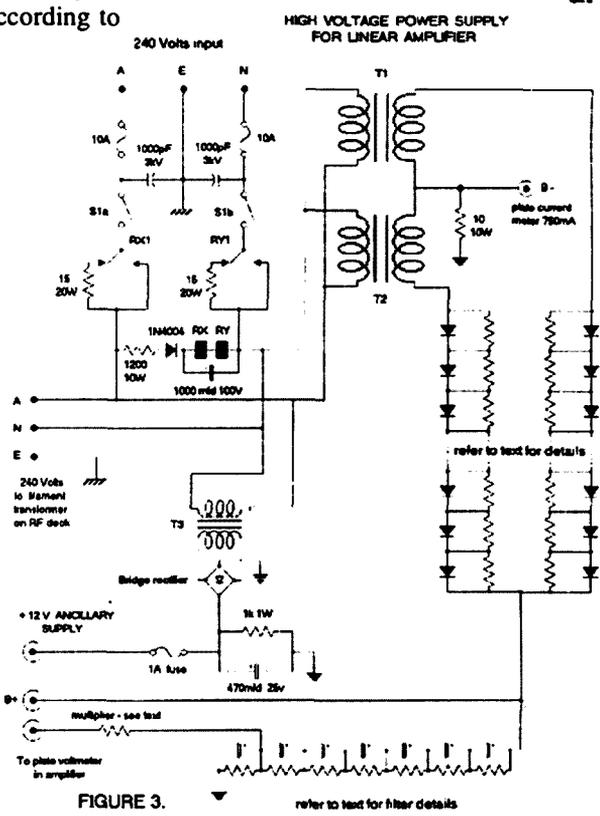

FIGURE 3. refer to text for filter details

References

1. ARRL handbook 1968, p 195 - 198
2. RSGB Handbook, Fourth Edition, Chapter 10.62 - 10.65
3. CQ Magazine, March 1966

Boom Corrections to Element Lengths of Yagis at 144, 432 and 1296MHz

Effect of Boom and Element Diameters

Guy Fletcher VK2KU

12 Sassafras Gully Road, Springwood, NSW 2777.

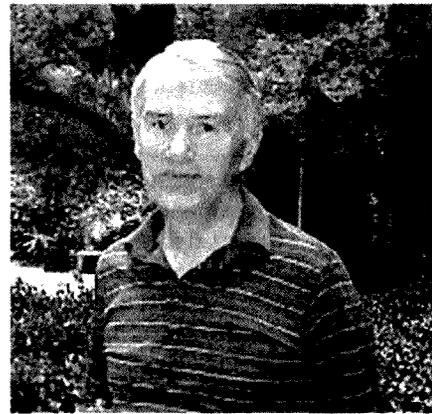

Guy Fletcher VK2KU

This article describes measurements of boom correction factors for yagi elements mounted through the middle of and in good electrical contact with a metal boom.

THE EXPERIMENTS were performed at frequencies of 144.2MHz, 432.2MHz and 1296.2MHz, and extend the range of boom diameters (as a fraction of wavelength) for which data are available up to 0.08λ , as well as exploring the effect of element diameter. The results show clearly that the boom correction depends not only on boom diameter but also on element diameter and element length.

The effect of the boom may be represented by a negative inductive reactance at the centre of the element. A simple empirical formula for this inductance is given, which agrees well with all the experimental data, and enables the prediction of the correction for any combination of boom diameter and element diameter, given in the form of a universal graph.

The observed dependence on element length is intrinsic to the model of boom reactance, and leads to a correction that tapers as the element length reduces. This

may be adequately represented in practice by a simple power law correction to the value for a standard element length of 0.42λ taken from the graph.

The effect of using tapered corrections for the different element lengths (rather than a single fixed correction) has been applied to examples of practical yagis. The difference is negligible at 144MHz and small at 432MHz. However at 1296MHz, where boom diameters may be relatively large, the use of a fixed correction appears to change the performance parameters of the antenna quite significantly.

Background

Boom correction factors are discussed by Günter Hoch DL6WU in the "VHF/UHF Dx Book" (edited by Ian White G3SEK), and other similar references. Günter Hoch's corrections may be represented by a formula due to Ian White:

$$C/B = 25.195 (B/\lambda) - 229(B/\lambda)^2$$

where C is the Correction Factor in mm and B is the Boom Diameter in mm. This formula is not valid at boom diameters greater than 0.055λ , although diameters of up to 16mm (0.071λ) are common at 1296MHz. Ian White's formula is shown in the form of a graph in Figure 1, and includes no dependence on Element Diameter or Element Length. Also the curve is assumed to pass through the origin, though there is no real reason to expect this; C is obviously zero when the Boom Diameter B is zero, but the ratio C/B does not need to be zero to make C zero.

No data seem to be available for larger boom diameters, which is perhaps why some amateurs have remarked on the difficulty of matching antennas correctly at 1296MHz. The experiments to measure boom corrections are in fact quite straightforward, so it was decided to make some simple measurements. The scope of the project expanded rapidly as the unexpected nature of the results appeared.

Theory and Model

The complex voltage reflection coefficient ρ measures the magnitude and relative phase of the ratio of the reflected voltage wave to the forward voltage wave at a load. In these experiments the reflected power P_R and the forward power P_F were measured rather than the voltages:

$$|\rho| = (P_R/P_F)$$

The voltage standing wave ratio σ is related to $|\rho|$ by:

$$\sigma = (1+|\rho|) / (1-|\rho|)$$

Any element of a yagi antenna has energy stored in the fields surrounding it. Near the element centre, where the current is large and the voltage small, the

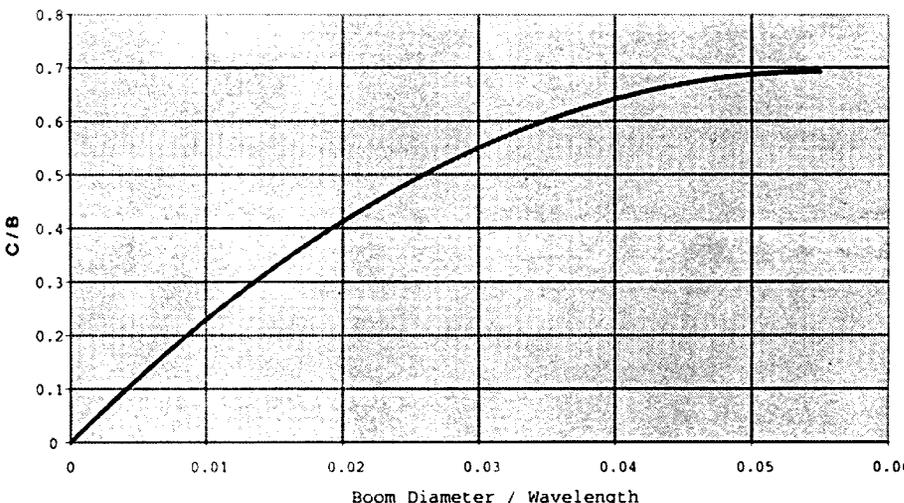

Fig 1. The G3SEK Formula for Boom Correction

dominant field is magnetic. Near the ends, where the current is small and the voltage large, the electric field is dominant. If the element passes through a larger boom at its centre and with which it is in good electrical contact, the skin effect forces the current to flow around the outside of the boom instead of directly along the element surface. This reduces the volume of the magnetic field around the element, and therefore also reduces the stored energy. Since the stored energy is directly proportional to the self-inductance L of the element, the effect of the boom is to contribute a negative inductive reactance ($-j$) to the element impedance Z . This negative inductance contribution will increase in magnitude as the boom diameter increases.

For thicker elements the volume of the magnetic field is reduced anyway, because the field is limited to the region outside the element. Thus there is less field volume for the boom to remove, so the effect of thicker elements will be to reduce the magnitude of the negative inductance contributed by the boom, and hence the boom correction required.

The element-plus-boom can be restored (more or less) to its original electrical effect by lengthening the element at the tips so as to contribute a negative capacitive reactance (ie $+j$) to offset the boom effect; this is the Boom Correction. Brian Beezley K6STI writes in the handbook to his yagi design and analysis program YO6 that elements (of different diameter) are electrically equivalent when the phase angle of the complex self-impedance Z is the same. This is slightly different from simply equating the imaginary components (ie the reactive parts) of Z .

The Experiments

Thirteen experimental measurements were made with the following boom (B) and element (d) diameters, limited by available materials:

144.2MHz:	B=32.0mm	d=4.76mm, 6.35mm
432.2MHz:	B=16.2mm	d=2.40mm, 3.18mm, 4.76mm
	B=20.2mm	d=2.40mm, 3.18mm, 4.76mm, 6.35mm
1296.2MHz:	B=16.2mm	d=1.60mm, 2.40mm, 3.18mm, 4.76mm.

The signal source was a Yaesu transceiver FT736R, delivering a nominal 25W on 144MHz and 432MHz, and 10W on 1296MHz.

Forward and reflected power was

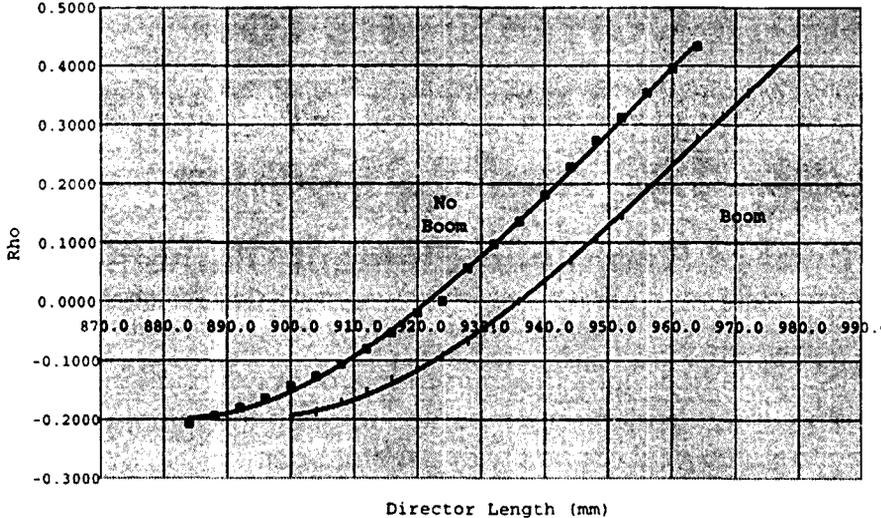

Fig 2. Data for Frequency 144.2MHz, Boom 32.0mm, Element 6.3

measured with a Bird 43 wattmeter, using different plug-in elements for forward and reflected power. Measurement precision for the reflected power was about 0.02W on 144MHz, 0.04W on 432MHz, and 0.01W on 1296MHz. Measurement accuracy is not nearly as good as this, but the experiments consisted essentially of comparing different antennas to obtain the same reflected power, so calibration errors are not really as important as reading precision.

For each frequency and boom diameter, a simple 3-element yagi was designed using the program YO6, and constructed on a dry wood boom (usually rectangular). The feed impedance was around 25Ω, and T-matching was used with a conventional 4:1 balun. In each case the 3 elements were cut to the expected length; then the T-bars and the

length of the driven element (DE) were adjusted for zero reflected power with no metal boom sleeve in place. The metal boom for the director (D1) was an exact sliding fit over the wood boom, and extended about half the distance back towards the DE and a similar distance forwards. Elements were pinned in place with a self-tapping screw, which made no observable difference to any reading, to ensure good electrical contact between element and boom. This arrangement guaranteed that the director D1 could be repeatedly removed and replaced in exactly the same position.

Each antenna was mounted to radiate vertically upwards, so as to avoid ground effects. With the boom sleeve in place and the director cut deliberately long, the forward and reflected powers were recorded for each value of director length

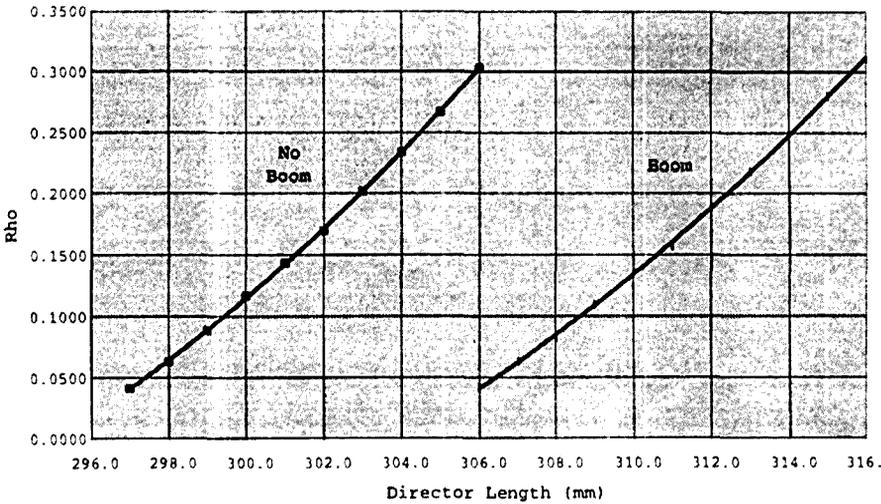

Fig 3. Data for Frequency 432.2MHz, Boom 20.2mm, Element 4.76

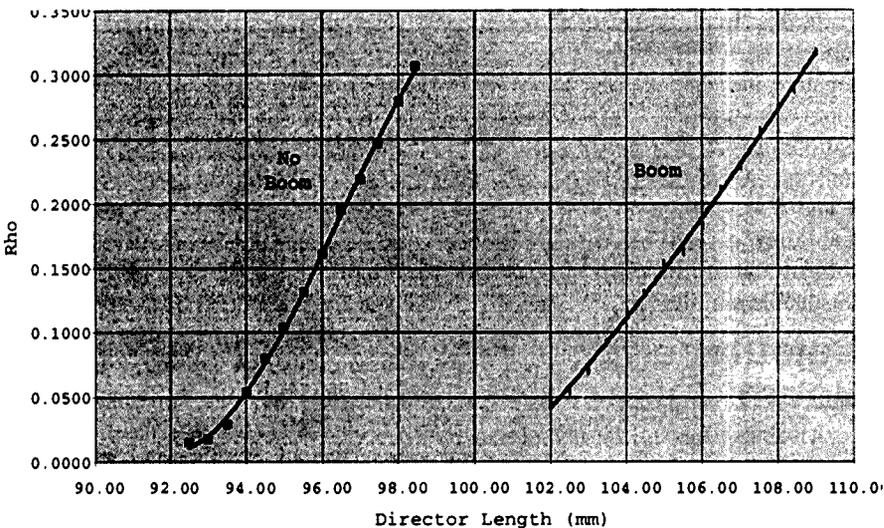

Fig 4. Data for Frequency 1296.2MHz, Boom 16.2mm, Element

(L1). The length was systematically reduced by small increments until the reflected power was near zero; sometimes the measurements were continued well beyond this point. The boom sleeve was then removed and the process repeated over a similar range of reflected powers. The voltage reflection coefficient ρ , equal to the square root of the power reflection coefficient, was plotted against L1. The expectation was that two parallel curves would result, their separation being the desired boom correction. In fact the curves turned out to be not quite parallel!

Element lengths were measured with a steel ruler on 144MHz and 432MHz to a precision of about 0.2 mm, and with dial callipers on 1296MHz to a precision of 0.01mm. These two methods are not really equivalent in that the ruler measures a length averaged by eye over the end faces, whereas the callipers measure between the high points on each end face. However since all measurements in any one experiment were made in a consistent way, the accuracy in the experimental boom correction factors, found from a length difference, should approach twice the appropriate precision above. The smoothness of the raw data curves supports this belief.

The Results of the Experiments

Figures 2-4 are typical of the 13 graphs obtained for Voltage Reflection Coefficient r as a function of director length (L1) with and without a metal boom sleeve. Careful study of these (and the other) graphs shows that the Boom

Correction, measured by the separation of the two curves, decreases slightly as the director length is reduced. This finding is not really very surprising, but is significant because such dependence has not previously been suggested.

From each graph the director lengths with and without the boom sleeve were tabulated at several values of voltage reflection coefficient ρ , usually 0.1, 0.15, 0.2, 0.25 and 0.3, and hence a set of Boom Corrections found. For each of the more than 50 pairs of director lengths, the program YO6 was used to find the complex element impedance Z. The program actually requires a reflector to be present, so this was placed 100m behind the Driven Element, where it would have no discernible effect. The use of a particular program such as YO6 to find element impedance is open to some criticism, and this important point will be discussed below.

The impedances from each pair of director lengths were used to find the negative inductive reactance X contributed by the boom. This is best illustrated by an example. The results from Figure 3 for $\rho = 0.1$ are reproduced in Table 1.

Table 1

Results taken from Figure 3 for $\rho = 0.1$		
	No Boom Sleeve	With Boom Sleeve
Director Length (mm)	299.45	308.60
Impedance Z (Ω)	51.5-35.7j	55.5-20.0j+X

The Boom Correction is here 9.15mm. The X in the column for impedance with the boom sleeve present represents the unknown contribution of the boom to Z. The value of X was found by equating the phase angle ϕ of Z with and without the boom sleeve, so that the two situations are electrically equivalent. This gives $X = -j18.50 \Omega$. Originally the comparison was made by simply equating the imaginary components of Z, but this procedure led to model curves which did not converge in the way actually observed, so the phase angle method was adopted. The values of X found in this way were reasonably consistent over the whole range of ρ and were averaged.

Finally the value of X was used to predict boom corrections over a wider range of element lengths covering the range typical of a long yagi, by reversing the procedure. For the example in Table 1, the calculated Boom Corrections range from 7mm for the shortest director to 12mm for the reflector. This shows clearly the variation of boom corrections to be expected over the length of such a yagi, and the errors introduced by using a fixed boom correction for all elements. A table of such calculated

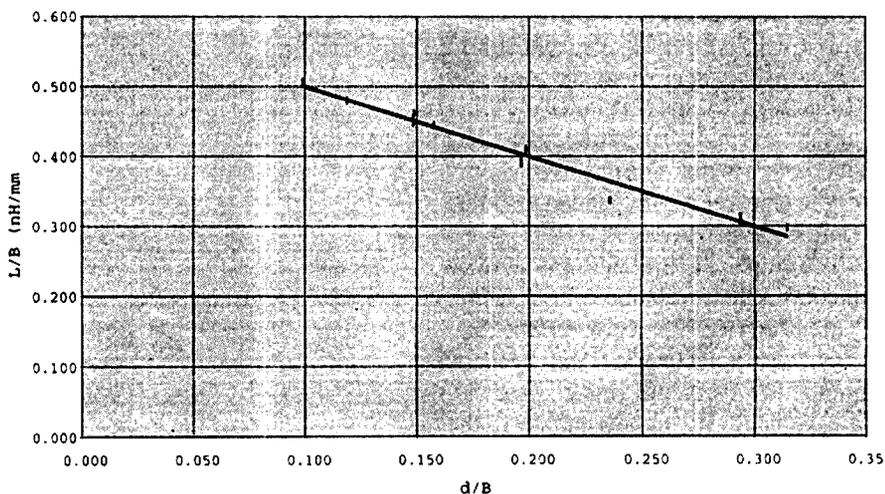

Fig 5. Dependence of Boom Inductance L on B and d

Boom Corrections (which include the experimental values as a subset) was generated for all 13 experiments.

Each of these 13 tables of calculated corrections was plotted against director length LI, and they were all found to fit closely to a simple power law relationship. The optimum value of the power varied slightly across the experiments, but a satisfactory fit for all the data was given by:

$$C = \text{constant} \times (LI)^{1.8},$$

$$\text{or } (C/C_0) = (LI/L_0)^{1.8},$$

where C_0 and L_0 correspond to some standard director length. For various reasons this standard element length was chosen to be 0.42λ , and the final graph presented below corresponds to this standard length.

Effect of Boom and Element Diameters

In spite of trying many different plots it has not proved possible to represent the dependence of the Length Correction (C) on Element Diameter (d) in any simple way. This is not entirely surprising because of the complexity of the effect on element impedance of varying the tip length to compensate for the effect of the boom. It has proved very helpful to break the problem into two separate parts:

1. The effect of the boom on the element impedance. As explained above, this can be represented as a pure negative reactance, the value of which depends also to a lesser effect on the element diameter.
2. The increase in tip length required to compensate for this reactance, so as to restore the original phase to the element impedance.

The negative reactances from the 13 different experiments have been converted to inductance (L), and are plotted in Figure 5 in the form L/B against d/B . The inductance is plotted as a positive quantity for convenience, it being understood that it contributes negatively to Z.

The graph of L/B against d/B shows a remarkable linear relationship:

$$L/B = 0.5994 - 0.999(d/B).$$

Only one point (at 432.2MHz) departs appreciably from the line of best fit. Having due regard to the accuracy of the data, this relationship is most simply expressed as:

$$L = 0.6B - 1.0d.$$

In this simple and elegant expression (Guy's Rule!) L is the value of the negative inductance contributed by the boom-element combination to the element impedance Z. For the values of the constants as presented, L is in nH while B and d are in mm. With this rule, the reactance of any boom and element combination can be predicted with reasonable confidence.

Calculation of Boom Corrections

It is straightforward, but not particularly convenient, to use the inductance value given by Guy's Rule to calculate a value for the boom correction C for any combination of boom diameter, element diameter and element length. This involves using YO6, first to find the complex impedance Z of the uncorrected element length and hence its phase ϕ , and then by a process of trial and error to find a new element length which, when combined with the negative reactance contributed by the boom, has the same phase.

Instead, for the standard element length of 0.42λ , Boom Corrections have been calculated over a wide range of boom diameters (B) and element diameters (d) covering all the sizes likely to be met in practice.

The results may be plotted in the form C/B against B/λ , as in Figure 6, with separate curves for different element diameters. Alternatively C/B may be plotted against d/B , as in Figure 7, with separate curves for different boom diameters. Other possibilities

include using d/λ in place of d/B . Figure 6 may be compared directly with Figure 1, based on the G3SEK formula. The curve shapes in Figure 6 are generally similar to that in Figure 1, but it is apparent that the intercepts on the vertical axis of Figure 6 are well above zero for all values of dB. The curves in Figure 6 also intersect making it hard to use in practice. The reason for these intersecting curves is clearer in Figure 7. In general as the element diameter increases the boom correction factor C/B decreases as expected from the discussion earlier. In the case of thick booms however, the boom correction factor also falls for very thin elements, for which the reactance component is large. This is in fact a consequence of the use of a standard element of fixed length rather than fixed phase. The use of a standard element of fixed length is much easier to deal with in practice, but leads to curves that intersect when boom diameter is used as the horizontal coordinate.

For the practical prediction of boom corrections, Figure 7 is significantly easier to use than Figure 6, because the various curves are well separated and generally less inclined.

Practical Significance of Length-Dependent Boom Corrections

The detailed results described in this article are novel in that they lead to boom correction factors that depend not only on

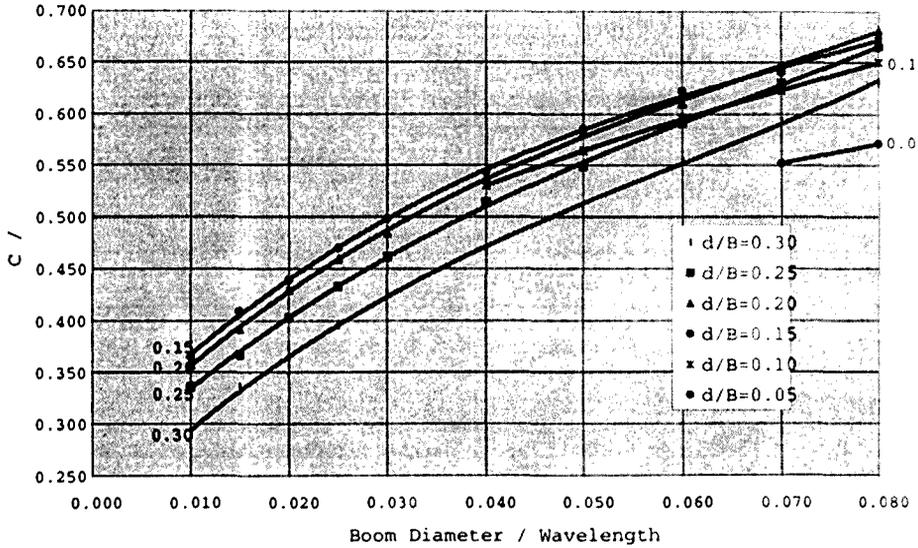

Fig 6. Boom Correction for Elements of Length 0.42 Wavelength d/B values as marked for each curve

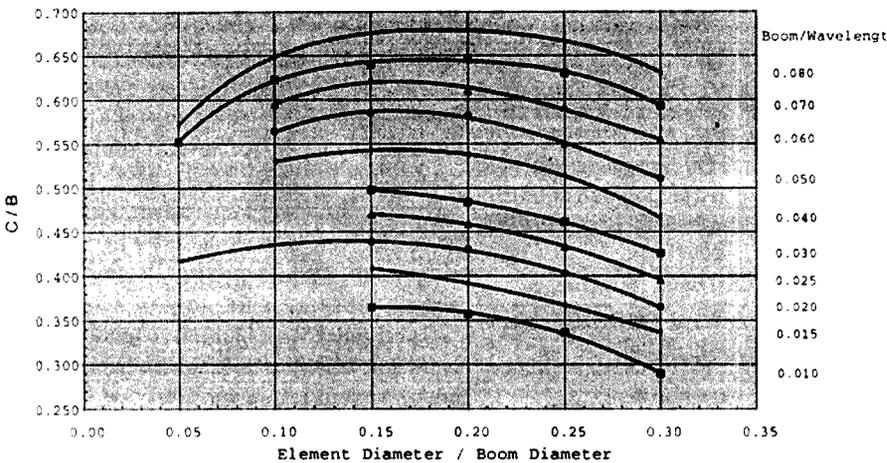

Fig 7. Boom Correction for Elements of Length 0.42 Wavelength. Boom Diameter/Wavelength is marked for each curve.

the boom diameter, but also on element diameter and length. It is reasonable to wonder whether this has any real practical significance when compared with the simpler system of a fixed correction factor at present in use. If the corrections are tapered from larger values for the reflector and longest directors to smaller values for the shorter directors, as suggested, then the effect of using a single fixed correction is to apply a correction which is too small for the longest elements and too big for the shortest ones.

This can easily be simulated in an antenna analysis program such as YO6 by adding the fixed correction to every element and then subtracting the tapered corrections. Such simulations lead to the conclusion that at 144MHz the difference between the two approaches is negligible; this is not at all surprising since the corrections are a small fraction of the element lengths. At 432MHz small differences are apparent but do not appear to be very significant. At 1296MHz however, the fixed and tapered corrections differ by considerably more than acceptable construction tolerances. The predicted antenna properties also differ significantly, with some loss of gain when a fixed correction is used, with major differences apparent in the feed impedance. This is consistent with the matching difficulties previously experienced at 1296MHz by some amateurs.

Several local amateurs have now constructed long yagis for 1296MHz using the VK2KU tapered corrections, and in each case have reported that matching the yagi proved quite straightforward.

Conclusions

The raw data graphs such as Figures 2-4 appear to show unequivocally that boom corrections depend not only on the boom diameter (as a fraction of wavelength), but also on element diameter and element length. The dependence on element diameter may not be much of a surprise, but the dependence on element length appears to be a novel idea that was initially unexpected.

The formula for calculating the negative reactance contributed by the boom-element combination (Guy's Rule) is also new, but it fits the experimental data very well. This rule is the key to calculating boom corrections for any combination of boom and element diameter. It may well be that the use of a different computer program for finding element impedance would lead to somewhat different values for the

negative inductance contributed by the boom, and hence to slightly different constants in the formula. However when the procedure is reversed and the same program is used to find the corrections in other situations, such differences between programs should largely be eliminated. In effect the computer modelling is used to interpolate between boom correction factors which were found directly by experiment. Thus the author believes that the graphical results as presented in Figure 7 are substantially independent of the computer modelling, and represent a close approximation to the truth.

The length dependence of the corrections appears to be best described by a power law of index 1.8, though this value does not seem to be very critical.

The fixed boom corrections at present in use extend up to a boom diameter of 0.055λ . The experiments described in this article extend this range up to 0.070 , and calculations have been carried out up to 0.080λ , thus covering the important range of booms thicker than 12mm at 1296MHz.

Acknowledgments

I would particularly like to thank Gordon McDonald VK2ZAB and Ian White G3SEK for their encouragement and advice. They willingly assisted in a project that threatened to get out of hand, growing rapidly from a planned single measurement at 1296MHz into a comprehensive survey over 3 frequency bands, 3 boom diameters and 5 element diameters.

ar

Appendix - Seven Simple Steps

1. Calculate the wavelength in mm from $\lambda = 299792.5/f$ where f is in MHz. [e.g. $f = 1296.2\text{MHz}$, $\lambda = 231.3\text{mm}$]
2. Choose a boom diameter B and element diameter d , both in mm. [e.g. $B = 16.2\text{mm}$, $d = 3.18\text{mm}$]
3. Calculate the ratios (B/λ) and (d/B) . [$B/\lambda = 0.070$, $d/B = 0.196$]
4. Refer to Figure 7, draw a vertical line corresponding to the value of d/B , and read off the value of C/B from the appropriate curve - interpolate between the curves as necessary. [$C/B = 0.645$]
5. Calculate C (in mm) from C/B by multiplying by B . This is in fact the Boom Correction for an element of length equal to the Standard Length L_0 . [$C_0 = 10.4\text{mm}$]
6. Calculate the Standard Length L_0 from $L_0 = 0.42\lambda$. [$L_0 = 97.1\text{mm}$]
7. Calculate the Correction C for any element of length L from $(C/C_0) = (L/L_0)^{1.8}$. [e.g. for $L = 90.0\text{mm}$, $C = 9.1\text{mm}$]

Beginners Page

Workshop Time

by Terry Sexton

Submitted by Drew Diamond VK3XU from an article he found in the "Journal" of the Melbourne Society of Model & Experimental Engineers.

TIME - where do you get it? You steal it of course! You sneak out when no one is looking and put in a few minutes in your shop. You plan your jobs inside other peoples' time or while you are commuting, walking the dog or under the shower. Stolen fruit is always sweeter!

HOW long does a project take? Minimum time, because you plan the stages, come up with an estimate and stay focussed on the project until it is finished.

We all have our methods. I remember how one of our recently deceased members used to put in a minimum of one hour per day in his shop. When he missed a couple of days, that meant finding three hours shop time at the next session. His 'one hour' was simply a door opener; he always got carried away and lapsed into working overtime anyway.

Now you might reckon that one hour per day would hardly achieve much? Wrong, because 365 hours per year comes to 9, five-day, forty hour working weeks. I reckon that forty five days spent in any decent sort of workshop should yield something worthwhile. The last time that I saw Media Industry figures, they showed that every Australian man woman and child watched 1200 hours of TV per year

(3 hours and 17 minutes per day all year round). We are not average and we don't know anyone in that survey but most of us watch some TV.

That one hour per day in your shop can easily be wasted. Starting new projects before you finish the one you are on; or fiddling about procrastinating while the clock is ticking won't achieve anything for that end of year exhibition night. By staying focussed on the job in hand and avoiding interruptions you can achieve a great deal in a given time.

Equipment

Selection and utilisation are important. Most of us select what we can both afford and justify owning. Very few of us fully utilise the equipment we have.

Some very fine models have been built on primitive equipment, yet there are owners of modern lathes and turret mills who never produce anything at all.

Projects

Selecting just one project from the vast quantity of published designs is a task that many people never come to terms with. Others of course start every published design they come across and never finish anything. I'm very wary when it comes to collecting old restorable items. The temptation is to keep on collecting and neglect the restoration, so you finish up snowed under with junk. Eventually the workshop becomes unusable because you are up to your armpits in stuff that smart people knew was worthless when they got rid of it.

That Aimless Attitude

The ABC recently ran a program on MEN & THEIR SHEDS'. While most of us found it amusing and thought provoking, it did highlight the fact that many 'shed men' are perfectly happy doing nothing worthwhile in their workshops and sheds. All except one chap on that program exhibited a total lack of goals to work toward. That aimless attitude is fine with me as long as there has been no outlay on tools and equipment. We all have a few power tools but once a lathe appears on the scene, serious metal cutting is in order. Installation of a milling machine usually follows and should widen the scope of work being tackled, if not, why not? When you think about it, the addition of some welding gear to that lot improves the potential output of a shop enormously. And what do most owners of such goodies produce? Nothing but second-rate excuses!

According to the armchair brigade, it is supposed to take time, money and willpower to complete a project in the workshop. Take it from me, you can get away without the money and you can steal the time. Given the willpower, dedication and some careful planning, you will complete all sorts of projects in a very short time. The best way to improve your range of skills is to tackle and finish off projects. Don't jump in at the deep end; start off with simple projects. Keep working on your skills and steadily increase the degree of difficulty.

The more challenging a project at the start, the more rewarding it is when finished.

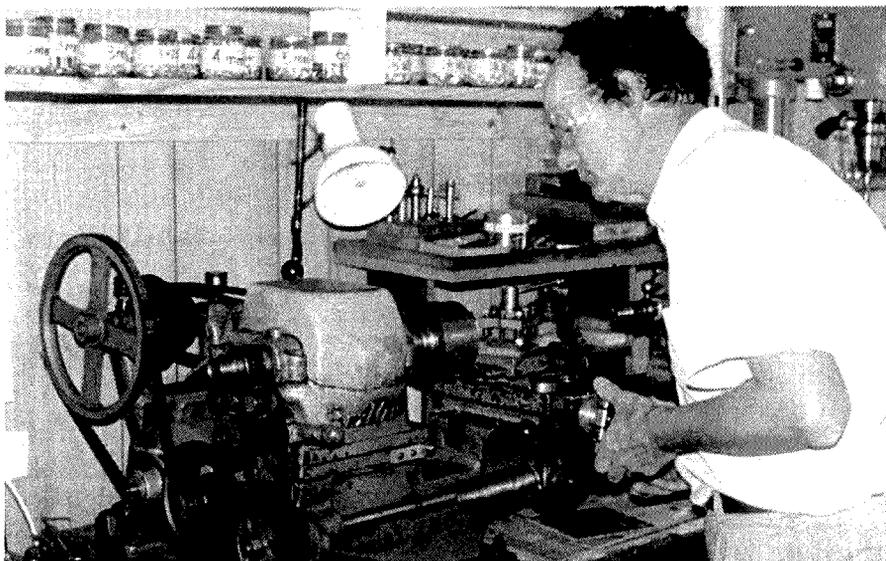

Drew Diamond practising what the article suggests — so that's how he gets so much done

CCD Camera in Case with Infra Red Illumination

Brand new unit replaces old model which sold for \$169.50. This unit is much smaller, measures only 65(W) x 50(D) and is black in colour. 6 LEDs give the IR illumination which means it can "see in the dark" to some extent. Includes RCA socket for video and 2.1mm DC socket for 12V DC. Great price! Cat. QC-3466



Only \$139

2.0uf 250VDC Cap

Our normal price for these is \$2.25 each. We've made a bulk surplus deal, and can offer these at well below normal price. They are white in colour, size 31(L) x 10.5(W) x 20(H)mm. Lead spacing 27mm, lead length 18mm. Cat. RG-5176 Pkt 10 for \$7.95 Cat. RG-5177 Pkt 100 for \$59



Amateur Radio VOX Headset

This headset is designed to suit YAESU, ICOM, STANDARD and ALINCO transceivers. About half the price of other headsets, and they don't even have VOX! This modern communication headset is of the "single ear, over head" type - while its tiny inline controller simply clips to your belt or top pocket. Controller has 2 sensitivity settings & a manual over-ride. Cat. AA-2030



\$49.95

Magnifying Glass Desk Mount

Mains operated, 22W circular fluorescent tube. See Cat. P185 for details.



Cat. QM-3525

WAS \$149.50
Now \$125
Save \$24.50

VISIT OUR WEB SITE
www.jaycar.com.au

Miniature Battery Charger AA Nicad & NIMH

This tiny and convenient charger plugs directly into a power point and will charge 2 or 4 Nicad / NIMH batteries - AA size. A 'charging indicator' LED for each pair shows that the batteries are inserted properly and charging correctly. The time of charging is determined by the small chart supplied. Cat. MB-3530



\$17.95

IEC Double Socket Power Lead

3 pin mains plug to 2 x IEC female plugs. Length 1.85 metres. Ideal to run a computer and monitor from one power point. SAA approved. Cat. PS-4102



\$14.95

AUDIO GENERATOR

See 98 Cat. page 31 for full details. Cat. QT-2300

Normally \$269
Save \$40

March \$229



CCD Video Intercom System

Can you see who's at the door or gate before you open it. As soon as a visitor rings your doorbell, the video monitor turns on automatically. The camera has infra-red LEDs for night illumination, an internal tamper switch (90dB alarm on main panel), and adjustable viewing angle. The camera can be mounted up to 100 metres away from the monitor - cable not included. Main unit even has button for opening the door remotely (electric door strikes avail separately LA-5078/80)

Cat. QC-3410

Only \$439

NEW JAYCAR STORE IN MELBOURNE

OPEN EARLY MARCH

141A

MAROONDAH HIGHWAY RINGWOOD VICTORIA 3134

PHONE: 03 9870 9053
FAX: 03 9870 2598

LCD Handheld CRO

See 98 Cat. P30 for details. Cat. QC-1905

Was \$479
March \$399

SAVE \$80



Dwell Taicho DMM

RPM x1, x10, Dwell angle, Resistance, DC volts, includes holster. Cat. QM-1440

Was \$79.95 March \$59.95
SAVE \$20

8" 24 HOUR WALL CLOCK

Military, airlines, travel agents, ham radio operators and others all still use 24 hour time. Designed with white face with black numbering and quartz timing mechanism. Dia 20cm

Cat. XC-0111

\$19.95



Aluminium Case with Foam Insert Camera / Video Case

This case has a foam insert which has been perforated into 15mm square holes. Simply pull out the squares and form a hole to put your valuable equipment in. Size 450(W) x 320(H) x 145mm(D).



Cat. HB-6356

Was \$69.50
March \$59.50

Save \$10

AURA INTERACTOR

CUSHION VERSION

Cat. XC-1005 **\$49.95**

LESS THAN 1/2 PRICE

BACKPACK VERSION

Cat. XC-1000 **\$39.95**

Save \$200



We have made a huge distress stock purchase from AURA in USA. We have sold thousands of the Interactor Backpacks, and now can offer a CUSHION VERSION, for a crazy low price.

THEY ARE UNDER 1/2 PRICE! This Interactor Cushion will transform low sounds into movement, so you can actually feel these through your back.

Simply place in your lounge chair, or seat, and complete a 3D sound environment for added impact for home theatre, computer games etc.

The Interactor Cushion can be used with almost any PC/Mac, home theatre system, CD player or video. Supplied with black cushion (with inbuilt shaker), amplifier module, 240V mains power supply and connecting lead set.



0-260VAC Variable Autotransformer (Variac) - 500 VA

Used for the control of A.C. voltage & of voltage-dependent parameters such as current, power, temp, light intensity, motor speed... etc. Encased in heavy-duty steel housing it also features on/off switch, output-voltage meter, mains-supply lead and 3-pin power output. A must for testing appliance performance under real (simulated) mains fluctuations. •Rated power: 500 VA (fused) •Input: 240 VAC @ 50 Hz •Output: 0 - 260 VAC@50Hz •165x120x160mm (DxWxH) Cat MP-3080



\$189.50



Jaycar stores located in - Sydney, Melbourne, Brisbane, Adelaide, Hobart, Perth, Canberra, Newcastle, Auckland NZ and Dealers in most country areas. Call Freecall 1800 022 888. Fax (02) 9743 2066. Website: www.jaycar.com.au
Special prices and deals available until end of March 1999.

Receive SSB on your FM Receiver

Peter Parker VK1PK
7/1 Garran Place
Garran ACT 2605
parkerp@pcug.org.au



Photo 1. The VK1PK converter box.

Do you often miss your favourite net or WIA broadcast because you are doing things outside? Would you like to keep in touch with amateur activity when in the garden, next door or fixing the car? Or, do you have problems remembering when your sched begins?

IF SO, THIS PROJECT is for you. It is a simple direct conversion receiver connected to an FM wireless microphone. With it, you can monitor amateur activity on your car radio, stereo system, walkman or any other FM broadcast receiver. You could even use a clock radio set to allow reception of a particular frequency at a particular time.

This unusual project should also appeal to beginners. Most of the circuitry is in a readily-available kit that takes less than 30 minutes to assemble. The remainder of the project consists of two simple modules built on printed circuit boards.

As described, the project tunes the most popular part of the 40 metre SSB segment. However, just two component changes are required to add coverage of a segment of 80 metres.

Circuit Description

The block diagram (Fig 1) shows how it all fits together. The product detector mixes the incoming signal with the second harmonic from the local oscillator. The output from the product detector, which is a low-level audio signal, modulates the wireless microphone. The incoming signal can then be heard on any FM broadcast receiver tuned to the wireless microphone's transmitting frequency. Though the local oscillator could be made into a free-running VFO for full band coverage, a ceramic resonator oscillator was used here for simplicity combined with good frequency stability. Figure 2 shows the schematic diagram for the project.

Construction

The unit comprises three modules. These are:

- Bandpass filter/Product detector
- Local oscillator
- FM wireless microphone (kit)

All modules are assembled on separate printed circuit boards. The wireless microphone kit is supplied with its own PC board. The boards for the other modules are simple to make because only discrete components are used.

Assemble the FM wireless microphone kit as per the instructions supplied. Check that it works, set it to an unused frequency and put it to one side.

Next etch the circuit boards for the Bandpass Filter/Product Detector and Local Oscillator modules. This is done as follows:

1. Cut the two boards to size with a hacksaw or similar.
2. File the edges to remove burrs.
3. Clean the copper surfaces with sandpaper.
4. Cover the parts of the copper that need to be retained with pieces of

PVC insulating tape. Fig 3 shows the etching patterns for both boards.

5. Place the boards in an etching bath. Follow the safety instructions on the etchant's packet or bottle. Do not remove the board until all exposed copper has been removed.
6. Wash the boards in soapy water and remove the tape.
7. Drill holes for all component leads. A 1 mm drill bit can be used.

The component placements for both boards are shown in Fig 4. Conventional PC board mounting is used; ie components are mounted above the board, component leads pass through the holes drilled and are soldered to the copper pads.

Build the local oscillator on the larger board. Check that it works by locating its signal on a receiver that covers 3.5 MHz. Note the frequencies covered when the variable capacitor is adjusted.

A range of 3.510 to 3.590 MHz was obtained in the prototype circuit. This corresponds to a coverage of 7.020 to 7.180 MHz on 40 metres. The bandspread was remarkably linear over this range. Your unit may cover different frequencies - component values, trimmer settings (on the tuning capacitor) and tolerances all affect tuning range. The ceramic resonator used is also a factor - the brown/yellow type sold by Vorlac (and used in the

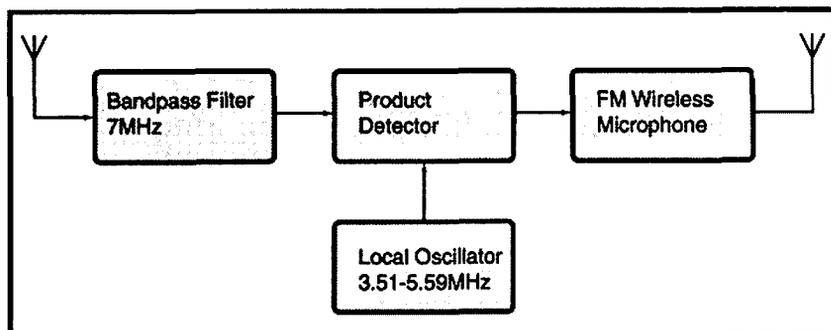

fig 1. The block diagram of the 7MHz SSB to FM Wireless circuit

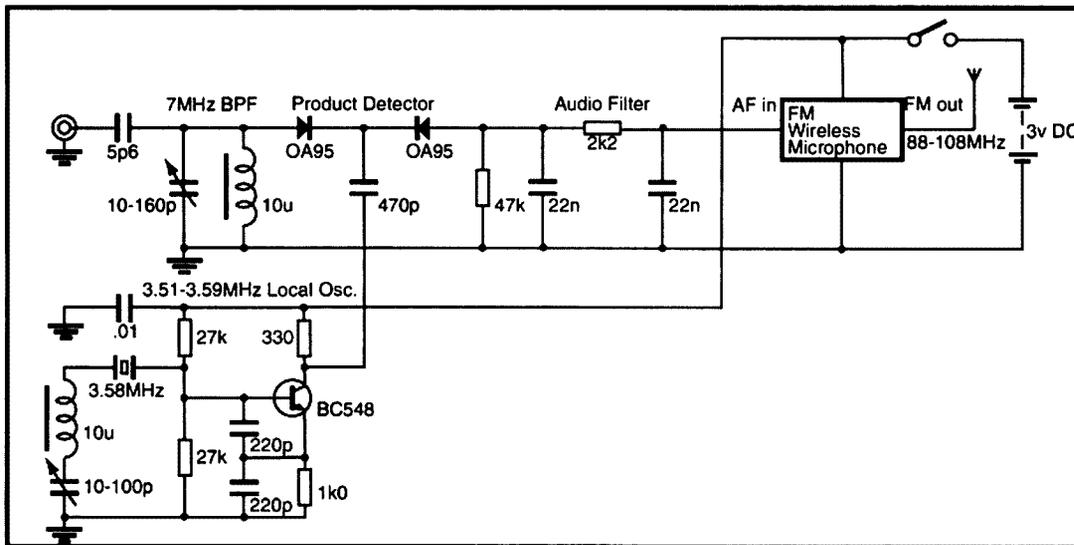

fig 2. The circuit diagram for the converter. Note that all of the local oscillator components are on the large PCB.

printed circuit board material screwed to the inside bottom of the box. Printed circuit board pins were then used as spacers between this board and each of the three circuit boards. Solder both ends of each circuit board pin to assure rigidity and good connections.

The wireless microphone used in the prototype is powered by two N-type cells that are mounted on the kit's circuit board. It was decided to use these to power the local oscillator,

thus eliminating the need for an external supply. Power to the wireless microphone and local oscillator is controlled by a panel-mounted toggle switch. The only other controls on the front panel are the tuning control and the front-end peaking control. Note that some space has been kept for a band switch if it is decided to add 80 metre coverage.

There are only two sockets on the rear panel. These are an SO-239 for the HF receiving antenna and a banana socket for the wireless microphone antenna. This antenna, which is a 75 cm length of wire, is required because of the shielding effect of the case and the need for a noise-free signal at the receiver for best reception.

Adding 80 Metre Coverage

As mentioned before, this circuit can be made to operate on 80 metres. This is done by increasing the antenna coupling capacitor from 5.6 to 47 pF and adding a 100 pF fixed capacitor across the input tuned circuit. If the builder is interested in coverage of both bands, a single DPDT switch is all that is required to switch the extra components in or out.

A shortcoming of this approach is that the frequency coverage on 80 metres is insufficient to cover many popular SSB frequencies (above about 3.590 MHz). This can be remedied by using a free-running local oscillator instead, or making some changes to the ceramic resonator oscillator. A ceramic resonator oscillator covering 3.525-3.625 MHz was described in Reference 2.

tuning capacitor; these particularly affect coverage at the top end of the tuning range.

After the oscillator has been made to cover a satisfactory tuning range, assemble the product detector on the smaller board. Construction should be straightforward. If you have TV or broadcast stations nearby it might be a good idea to use miniature coaxial cable (eg RG-174) between the local oscillator and the product detector to prevent pick-up of VHF/UHF signals. Ensure that the connections to the variable capacitor are correct; this project uses the 160 pF larger section only.

The output of the product detector is wired to the audio input of the wireless microphone. This is done by disconnecting the electret microphone (and the resistor that supplies it with a DC bias) and wiring the output of the product detector to the non-grounded audio input terminal. This connection allows the wireless microphone to transmit the received audio from the product detector.

All boards are mounted in a die cast aluminium case. There are several ways to anchor the circuit boards to the bottom of the box. The author used a large piece of

prototype) can be pulled low in frequency with small capacitance values, but the blue type (as stocked by RS Components) requires higher capacitance values to reach these same frequencies. The use of two ceramic resonators in parallel, though desirable for other reasons (Reference 1), may also affect the frequencies covered.

Component values need to be altered if the tuning range of your unit is not satisfactory. Try reducing the value of the 220 pF capacitors if the frequencies covered are too low. Conversely, increase these values for greater coverage of lower frequencies. Wiring up both gangs of the oscillator variable capacitor in parallel and/or placing a small inductance in series with the ceramic resonator (several μH normally required) are other ways to pull the oscillator's frequency down. Do not overlook the effect of any trimmers on the

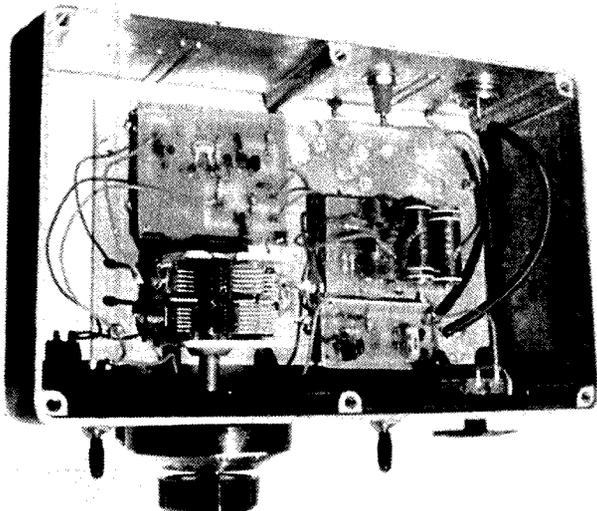

Photo 2. Internal view of the completed Converter

Operation

Place an FM receiver near the unit and tune it to the wireless microphone's frequency. Connect an antenna and peak the front-end tuning capacitor for most noise. It should be possible to tune in signals by adjusting the vernier dial. If the receiver has a graphic equaliser or tone controls, adjust these for best signal clarity. The completed receiver should be sensitive and stable. Selectivity will be inferior to receivers that include a crystal filter for SSB but should still be adequate for reception of local signals.

Obtaining Parts

Most parts should be obtainable from the usual suppliers. The exceptions are the 3.58 MHz ceramic resonator and the local oscillator variable capacitor.

The ceramic resonator used in the prototype was supplied by Vorlac. Resonators are also stocked by RS Components (Cat no 656-170) and the CW Operators' QRP Club. The author has a number of resonators available to readers on receipt of a stamped, self-addressed envelope.

This project uses two variable capacitors. The front-end peaking control is an ordinary plastic dielectric type from an old transistor radio. Use the 160 pF section ('G' and 'A' connections). The local oscillator capacitor can be either a plastic type or an air-spaced unit. The latter usually has the advantage of a longer shaft to which a vernier reduction drive can be coupled. The maximum value is not particularly critical, but it will determine the frequencies that the receiver will tune.

The vernier drive, though not essential, makes the receiver easier to tune. It is available from Dick Smith (Cat No P7170 or P-7172). The FM wireless microphone kit used in the prototype is catalogue number K-5006. A number of similar kits are available. Choose a sensitive unit with a separate microphone amplifier stage to assure sufficient transmitted audio.

All other parts should be readily obtainable from any good electronics store.

References

1. Searle K, Ceramic Resonators on 3.5 MHz, Lo-Key, June 1997, p 24.
2. Parker P, Receive SSB on your Short-wave AM Radio, Amateur Radio, October 1997, p 8.

ar

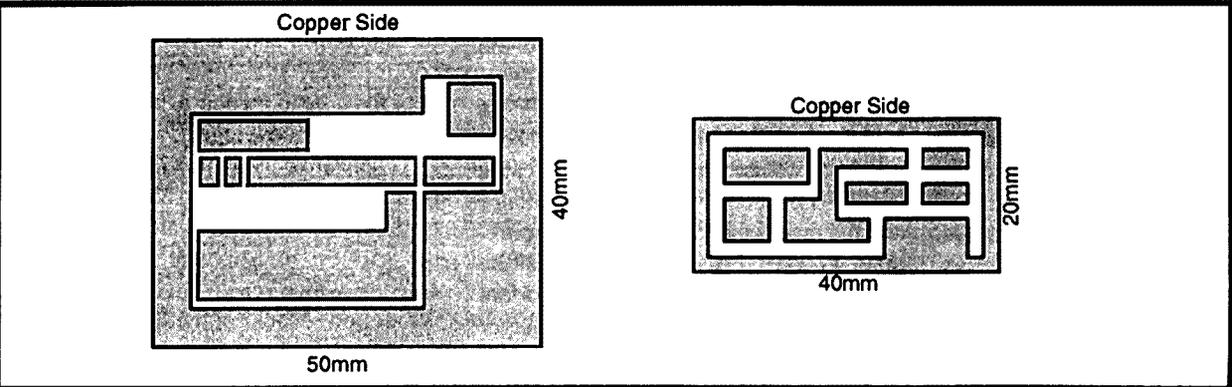

fig 3. Layout of the PCBs - Note that the copper pattern is shown here on the top side of the board.

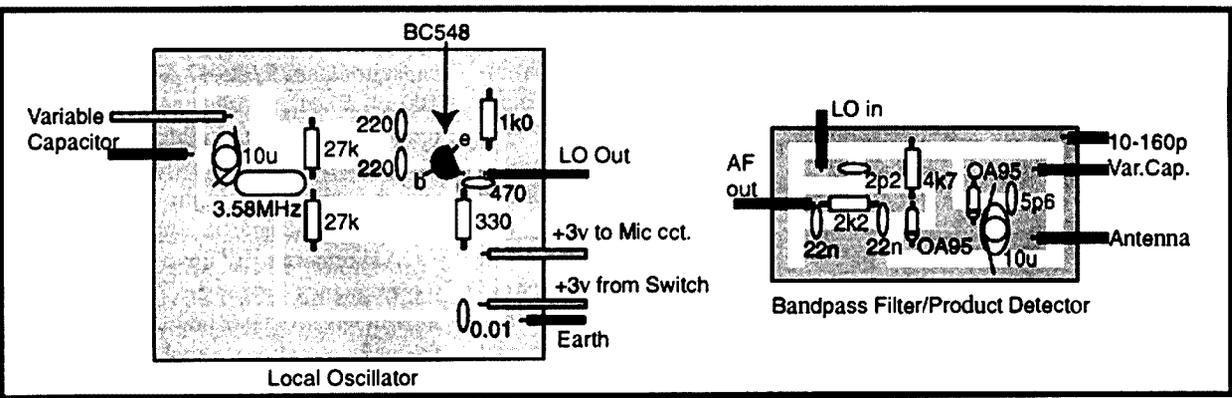

fig 4. Layout of the components on the PCB - Note that the copper pattern is on the bottom side of the board.

After fifty years — I still remember

by Eric Jamieson VK5LP

It was something of a culture shock returning home after four years in the RAAF, to find that in 1946 we were still in the era of kerosene lamps for lighting and using horses for farm work - nothing had changed since I enlisted in 1942. While those living in towns generally were supplied with mains power, their poor cousins living in small provincial towns and on farms were denied that privilege.

MY TIME IN the RAAF had been spent on stations where 240 volt AC power was available, in fact, its provision was taken as a matter of course.

Having spent four years servicing receivers and transmitters in aircraft and on receiving and transmitting stations, I was not about to give it all away and do something else.

During the latter half of 1946, a room/shack was built on the end of the garage, lined with a tar-based material (not malthoid) to prevent moisture condensation dripping from the roof during periods of severe winter frosts, common to the Adelaide Hills. A large window provided much needed light (with a blind for privacy at night) and, the door included a half panel of beaded glass to allow in further daylight. A wooden floor, benches, shelves and a large cupboard all made for a good start.

Now to the equipment

The mandatory multimeter of course, but only at 1000 ohms per volt, all that was available at the time, so some loading of components could be expected and allowances made for the voltage readings obtained. A University brand valve and circuit tester; I still had the pre-war small soldering iron which had been heated by a blowlamp; this would have to do as there were no available alternatives. It was well before the era of Scope irons that could be powered from accumulators.

Lighting at night was a problem. My mother offered me the use of a small Miller lamp that gave a reasonable degree of lighting but it presented some danger

as it could be easily knocked over, especially if caught by a cable. This was placed on a shelf for special occasions, perhaps when entertaining visitors to the shack, but for other times I had to settle for a hurricane lantern! They were never renowned for their light output but at least were safe to use.

For cold weather I had a kerosene heater, for hot days air-conditioning was achieved by opening the window. I was fortunate that a sycamore tree shaded the

For cold weather I had a kerosene heater, for hot days air-conditioning was achieved by opening the window. I was fortunate that a sycamore tree shaded the shack during summer afternoons.

shack during summer afternoons.

To keep initial costs to a minimum I drew extensively on the stocks of ex-military material sold by The Waltham Trading Co in Adelaide. All sizes of resistors, capacitors, valves and sockets, tuning capacitors and other "goodies" were sold cheaply, but the quality was good.

My farm wages were not high — they never are when you work for your father - but were sufficient to sustain me. Prudently, I put aside one pound per week into a Savings Bank Account that paid a

few percent interest. This was my nest egg that gradually grew to the extent that I was finally able to front-up to the counter at Gerard and Goodman Ltd, not far from Waltham's. Here I could purchase more modern components but at a higher price.

In late 1946 I fulfilled a long held ambition. Wait for it! I constructed a battery-operated communications receiver using two-volt valves, powered from an accumulator and three 45-volt heavy-duty B batteries. It consisted of two tuned RF stages, a mixer with separate oscillator, three IF stages at 455 kHz, dual diode valve for detector and delayed AVC, audio driver, phase changer and push-pull output of two watts. In addition there was a stabilised BFO, a noise silencer, 100 kHz marker generator and an S meter.

The dial was similar to the excellent dial used in AR7 receivers, but tuned from 0 to 600 rather than the 0 to 500 of the AR7 dial. It had a very smooth slow motion movement. Frequency read-out was achieved using a series of graphs which I had plotted using a Bendix 221 frequency meter of wartime vintage, plus the 100 kHz calibrator. It was a somewhat cumbersome process but it worked.

There were 15 valves in all and the tuning range was from 550 kHz to 30 MHz in six switched bands. The band switch was 12 inches or 30 cm long as the various RCS coils were mounted end to end, for efficiency and isolation. The IF stages were unique in that back-to-back IF transformers were used between each stage. These were top coupled to give a flat but narrow top bandwidth with steep sides, making the receiver very selective but easy to tune. The receiver performed very well, although the 1C7G mixer was struggling a bit at 30 MHz! It was remarkably stable. A heavy-duty eight-inch speaker was mounted in a separate box.

The receiver was enclosed in a steel cabinet a little larger than the dimensions of an AR7 receiver. This communications

receiver continued in service after the arrival of power, except that the B batteries were replaced by a suitable AC power supply providing about 150 volts. It was finally put aside around 1954 when I purchased the first of several AR7 receivers. Reluctantly, I eventually sold it to a shortwave listener who lived out "in the sticks" somewhere in Western Australia. I often wonder what became of it - surely no other receiver with similar specifications existed anywhere.

Following the construction of this receiver, I used some of my little spare time to repair the battery operated radios on local farms, or the AC radios in the towns. The small charges I levied went into the nest egg. To repair the AC radios I used a 60 watt 240 volt soldering iron. On the farms I placed a small copper-head iron in the kitchen stove or fireplace; often overheating it and necessitating re-tinning of the tip. A block of Sal Ammoniac was very useful as the overheated tip could be pushed into the block, cooling and cleaning the tip ready for the application of tinning solder.

My mode of transport was by motor cycle. I strapped a large kit bag to the rear parcel carrier (which was in the place where a pillion passenger would normally ride). In the bag I carried the multimeter, sundry spare valves, small components, light gauge wire, soldering irons and solder, a torch and tools. All rested on a piece of folded blanket in an effort to protect the equipment from the rough roads I needed to negotiate - we didn't have the luxury of bitumen roads in those days, not in the country anyway.

By word of mouth, it soon became known that I was capable of repairing the district radios, obviating the need to take them to Adelaide. One modification I made to many battery sets was to increase the coupling between the aerial and grid windings of the aerial coil, by adding several extra turns to the earth end of the aerial winding, finishing the extra turns close to the grid winding. At the expense of some selectivity, there was a considerable increase in the performance from 5AD, which satisfied customers. This simple modification brought me many new customers.

As I toured the country, the most common question asked was: "When do you think we will have power?". Of course, I could only guess and my usual reply was that it could be five or six years.

IN 1949 I JOINED my father and uncle to form a deputation to wait on The Premier, Mr (later Sir) Thomas Playford to see if the arrival of power could be accelerated from the four to five years quoted by The Electricity Trust of SA. After all, we were only 25 miles (40 km) from Adelaide. Mr Playford said he "would look into the matter", to the point that we had power by January 1951 instead of 1953. It seemed in this case that the old adage - it's not what you know but who you know - that can achieve results. I am sure it did for our community.

Throughout the years of World War II, I had continued to subscribe to two magazines, "Radio and Hobbies" which today is "Electronics Australia" and The "Australasian Radio World" which

As I toured the country, the most common question asked was: "When do you think we will have power?". Of course, I could only guess and my usual reply was that it could be five or six years

ceased publication in the early 1950s. As each monthly publication arrived, my parents dutifully stacked the magazines separately in my room. On my return there was much reading to keep me occupied.

I did note that in the January 1946 issue of *Australasian Radio World* that Kingsley Radio Pty Ltd in Melbourne (the manufacturers of that popular wartime receiver the AR7), began advertising and describing a new "Ferrotune tuning unit" they had developed. It took the place of the usual ganged tuning capacitor and associated coils. The "Ferrotune" unit allowed for a straight-line tuning dial from end to end over its tuning range of 540 to 1650 KCs (kHz), obviating the crowding effect at the high frequency end of the dial when used with the usual tuning gang. Each revolution of the tuning knob equalled 100 KCs (kHz), each unit being

aligned and tracked during manufacture.

Through 1946 and 1947 a number of articles appeared in the magazine together with circuit diagrams for the three different tuning units they were manufacturing. The KFT1 was for a standard 4-valve receiver using a 6J8G, 6U7G, 6G8G and 6V6G. The KFT2 was for a two valve "Reinartz" type receiver using a 6J7G and a 6V6G, while the KFT3 was a three valve receiver using a 6J8G, EBF35 and a EL3NG. In each case a 5Y3G rectifier was used. The KFT1 tuning unit was also suitable for use with battery operated converter valves such as the 1C7G and 1A7GT, so it was in fact, a very versatile unit.

In addition, Homecrafts Pty Ltd in Melbourne were providing a kit for the three models; the KFT1 sold retail for 12 guineas (£12/12/- or \$25.20), KFT2 for 9 guineas (£9/9/- or \$18.90) and the KFT3 for 10 guineas (£10/10/- or \$21.00).

Each kit came with a pre-drilled and cut cadmium plated chassis, tuning unit with dial and escutcheon, IF transformers

where appropriate and a six inch Kingsley speaker. In addition, suitable polished wooden cabinets were available for each model, complete with speaker grille and only requiring the space for the dial to be cut from the cabinet and three

holes for the controls.

That complex mind of mine kept coming up with the question - why can't I build some special sets that would have immediate local appeal? They could operate from batteries while we waited for the arrival of AC power, then switched over to AC operation at the appropriate time.

From Homecrafts in Melbourne I obtained a kit for the KFT1 model which was AC operated, plus a cabinet. Well protected, it arrived in the post and had an immediate appeal to me. I noted I would need a power transformer, valves and the small bits and pieces, together with the associated wiring, power lead etc.

From Gerard and Goodman Ltd I obtained a Trimax transformer with a 290-volt centre-tapped secondary winding. The rectifier valve was changed from a 5Y3G to a 6X5GT, as its slow warm-up

meant that high voltage was not applied until all valves were drawing current, hence protecting the electrolytic filter capacitors. To know the final cost of such a receiver, I purchased all the required parts from there, arriving at a figure just under £20 or \$40 including the kit. Therefore, I believed that I could retail the AC sets for £40 (\$80), with additional cost for those requiring a six volt vibrator or B batteries.* The 6-volt accumulator became the responsibility of the purchaser.

The final figures were: AC only version £40; AC and vibrator/battery model £52 (\$104), the latter cost also including a special changeover switch to move from AC to vibrator or battery as required. The switch was special in that it required that each mode of operation entered an "off" stage before entering the next mode.

During the early part of 1948, my father installed a 32-volt lighting plant and I was commissioned to wire the house and sheds for lights and power. My shack now had electric light and power for a 32-volt soldering iron. I also constructed a 32-volt inverter that gave me 240 volts AC power, so at last I was able to use 32 volts while I waited for the power.

As I was about to launch into the business of radio construction, I thought it wise to be licensed by the ARTS&P organisation, which covered patent rights to parts used. I think the cost was about £1 (\$2) per unit; for this fee I was supplied with a numbered Decal transfer which was applied to the rear of each chassis as it was completed.

BY MID 1948 I was ready. I had constructed a prototype of each model, so I ran a slide at the local picture theatre with details of the proposed receiver stating that orders would be fulfilled in strict rotation. Each set would be constructed in response to the needs of the customer.

There was an immediate response, especially from the people on the farms. They saw the advantage of a modern set that could continue to be operated on batteries, but switched over to AC when the power arrived. Orders for five multi-function sets were received the next day! I explained that there would be delays because the sets would need to be constructed, but the local people accepted

that situation - they could not buy a similar receiver from any other source, so really I had a cornered market!

There was little demand for the Reinartz set, two only being sold. The same applied to the KFT3. It performed almost as well as the KFT1 but people seemed to be of the opinion that an extra valve was good value. The RF circuitry was the same as the KFT1. The main difference was that one of the diodes of the 6G8G was used to drive the EL3NG. It did this quite well, as the valve only required a negative bias of six volts that allowed it to be driven quite easily in Class A.

In my spare time I could turn out better than one KFT1 set per week. During a fortnight's holiday I averaged close to one set a day, producing a total of 12 sets in that period! The soldering iron and screwdrivers were working overtime.

Realising that it would be difficult to deliver mantle radios using a motor cycle, in 1948 I purchased a 1928 model Morris Cowley buckboard. It was somewhat dated but reliable and served its purpose well. The precious radios travelled to customers beside me on the seat.

For the straight AC models the valves used were 6J8G converter, 6U7G IF amplifier, 6G8G detector, AVC and audio driver, 6V6G audio output and 6X5GT rectifier. The multi-function sets used a 6D8G, 6S7G, 6T7G, 6G6G and 6X5GT respectively. In this model, the four main valves each consumed 0.15 amps heater current and the 6X5GT heater only came on when connected to the AC. The 0.15 amp valves were chosen to keep battery drain to a minimum, while the 6G6G output was an adequate 1-watt. All the valves could be purchased new from the Waltham Trading Co as ex-wartime supplies. They were about one-third the cost of those available from Gerard and Goodman and equal in performance. This assisted in keeping the price reasonable.

The Kingsley KFT1 tuning unit was designed around the 6J8G and an output of 455 KCs (kHz) to which the supplied IF transformers were exactly factory matched, only a tweak being required to compensate for lead length etc. I used the suggested Kingsley circuit that was modern and straightforward.

One change I made was to include a 40 ohm resistor in the negative high tension lead, the resulting voltage drop

Andrews

Communications Systems

1E ST 1 176 - ACN 001 700 7521



**AUSTRALIA'S FIRST AUTHORISED
FACTORY DIRECT IMPORTER**

*No 1 & Biggest Importer with one or two
shipments monthly.*

★ **FULL 3-YEAR FACTORY WARRANTY.**
★ **INSTANT REPAIRS ON FRIDAYS**

**WE SELL MOST BRANDS AND MAKE
BALUNS, VERTICALS, YAGIS, P/S.**

**ICOM-KENWOOD-JRC-AOR-EMOTATOR-
MJF-DIAMOND-TIMEWAVE-KANTRONICS-
THP-GARMAN-TERLIN-UNIDEN-ETC**

**WE URGENTLY WANT GOOD HF, VHF,
UHF TRANSCEIVERS AND REPAIRS.**

NEW IC-706II & IC-756PRO

**NOW 3-YEAR WARRANTY ON
NEW ICOM SOLD BY US.**

*** OVER 20 YEARS OF SERVICE ***

Call us for unbeatable prices...

(02) 9636 9060 or (02) 9688 4301

SHOP 8, 41 BATHURST ST. GREYSTANES.
N.S.W. 2146. FAX (02) 9688 1996



AV-COMM
Pty. Ltd.

**SATELLITE TV
EQUIPMENT**

Established 1981

**Specialising in:
Free to Air Satellite TV**

**CALL OR FAX
FOR FREE INFO PACK.**

198 Condamine Street
Balgowlah 2093 Australia

Tel: 61 2 9949 7417

61 2 9948 2667

Fax: 61 2 9949 7095

Internet: <http://www.avcomm.com.au>

being applied to the AVC line to provide a small delay voltage so that the AVC began working when a certain signal level was reached. This was useful for any country weak signal conditions.

Negative feedback to improve the audio response was provided by a voltage divider across the primary of the output transformer, with the voltage fed back to the plate of the driver stage.

Several special models were created. One customer required more and better audio power, so he received a console model with a 12 inch speaker and push-pull 6A3 triode valves to provide about 7 watts of high fidelity output. The extra valves were accommodated on a sub-chassis that also mounted the larger power transformer. He was quite happy to pay £100 for it to operate from 240 volts AC.

Difficult reception areas were covered by leaving the Ferrotune kits and building separate radios on another chassis that boasted a tuned RF stage in one case, two IF stages as well. In those days 5AD on

1310 kHz was a weak signal in the country. Many people wanted to listen to that station so their needs were satisfied. The larger sets were all dual-wave models using a pre-designed coil assembly made either by Aegis or RCS.

Eventually, for my own use I built another special. This was based on the

- large set which would draw that much power.
- all valves to be enclosed in metal cans - output valves and rectifiers are never screened - they become too hot anyway.
- an indicator light to show that the power was connected - I thought the dial lights were sufficient.

There were several other equally ridiculous requirements. I informed the department that my standard set was adequate for the school, but if they wanted these extras the price of the radio would double to £80. They accepted the standard

During the period a total of 64 radios were constructed and sold. The 65th kit I still have in its original package as it arrived in the post!

KFT1 kit but the output stage was a direct coupled 6A3 valve. To achieve this the power transformer cutout (Chassis opening) was enlarged to accommodate a 385-volt centre-tapped transformer. Despite the small cabinet size the audio quality was noticeably superior to the standard 6V6G. This was assisted by replacing the normal six-inch speaker with a heavy-duty model, there being just sufficient clearance to accommodate the larger magnet. The set remained largely unused until the power arrived.

model!

Installed in 1949 this radio was still working well when the school closed in 1968. During that time it had been used every school day and had required no service. I felt that its faultless performance for nearly 20 years had vindicated my stand on the unnecessary requirements.

A lull in demand occurred around 1950 when immediate demands had been satisfied. Four sets were constructed and placed to one side for eventual sale.

With the arrival of the mains supply in January 1951, production of these receivers ceased in 1952, after I became the local agent for a large range of receivers provided by Philips Electrical Industries.

During the period a total of 64 radios were constructed and sold. The 65th kit I still have in its original package as it arrived in the post! At times I have contemplated constructing it to a working model, but so far time has eluded me. In later years, one of the multi-purpose sets came back to me as a trade-in on a Philips radio, so I have saved this for my own interest. After 50 years, it remains in good working order, with the original valves!

So ended a short but interestingly productive period of my life, details of which are not widely known outside the local community at the time.

ar



**AMATEUR
TRANSCIVER
RADIO CENTRE**

ALINCO AUSTRALIA'S NO 1
ALINCO FACTORY
AUTHORISED DEALER

**MASSIVE NEW YEAR SHIPMENT
JUST LANDED - LATEST ARRIVALS**
DR-M06TH NEW 6M 20W MOBILE
DX-70TH, DR-610E, DJ-G5E, DJ-C5
BIGGEST MONTHLY IMPORTER
FULL 3-YEAR WARRANTY
ALINCO SPECIALIST

ICOM IC-706MKIIG, IC-T81A,
IC-2800H, IC-746, IC-756,
IC-T8A, IC-T7H, IC-Q7A.

ROTATORS - EMOTATOR
105TSX 747SRX

CREATE — RC5A-3 RC5A-2 RC5-1
MFJ-259B - HF/VHF
FREQUENCY ANALYSER

KENWOOD TS-570SG TM-V7A
TH-G71A VC-H1 TH-7DA TM-G707A

JRC NRD-545G, JST-245, NRD-345.

KANTRONICS -
KPC-9612, KPC-3, KAM-98

PHONE (02) 9896 2545
E-mail: atrc@bytelink.com.au
Web Page:
<http://users.bytelink.com.au/atrc>

IN 1949, THROUGH the local school committee, I received an order from the Education Department to supply a radio for use in the school. With the request came a long list of specifications that had to be met. As the design of the standard receiver incorporated many of their requirements, those which were additional I considered unreasonable:

- provision for the use of a long or short aerial - this idea was discarded in the 1930s when tuned-radio-frequency (TRF) and Reinartz type radios disappeared in favour of super-heterodyne receivers.
- provision for use of headphones — why in a school room?
- three year warranty - normal warranty was one year.
- should not draw more than 100 watts from the mains - it would be a

Are you reading *someone else's*

Amateur?
Radio

Call (03) 9528 5962 to
find out how YOU can
receive it every month!

Preserving our Pictorial History

Will McGhie

21 Waterloo Cr Lesmurdie 6076

VK6UU @ VK6BBF

will@faroc.com.au



Our History

For Christmas I bought myself a 35mm slide scanner and have been scanning old photos of family and friends non-stop for a few weeks. The results from even poor faded slides and negatives have been exceptional. This started a thought, "What about amateur radio history in Australia from a photographic point of view?" There must be thousands of photographs in all sorts of formats lying around forgotten and fading away. Not only fading but being lost and misplaced. I know from enquiries about VK6 historical information how quickly people forget who had what last and just what it was that we had anyway.

My thoughts are to scan in as many photographs as possible, that are significant to amateur radio in Australia. It could be a big job if large numbers of photographs are found, but the intention is to tackle the job over a long time. Digitising a few (5?) each week is not a big effort, but at the end of a year some 250 photographs would have been stored for future historians.

How To Do It

I have the equipment to scan all photograph types. Negatives and slides provide the best quality and are the preferred image source. However negatives are usually the first to be lost or discarded and much of what will be found will be photographic prints. The most important part of the process is finding the information about the photograph. There is no point in having a photograph if you don't know what you are looking at, who the people are, or when the photo was taken; so the number one requirement is to gain information about the photograph. This information would be attached to the photograph. If

you have the digital copy you have the information about the photograph right along side it. Programs such as Adobe Photoshop allow the information to be stored as a part of the image file.

What Is History?

So what qualifies an image to become a part of photographic history of amateur radio in Australia? For a start, history is anything that happened prior to today. Historical photographs don't have to be old but just have to tell a small story about amateur radio on a particular day. Photographs of repeater sites, beacon sites, Hamfests, meetings, field days, amateurs of particular note and so on; the list is a long one.

Recently, due to having purchased the slide scanner, I started going through my collection of 35mm slides. Some of them I had completely forgotten about and they included a hundred or more of the construction phase of one of our repeater sites some 17 years ago; Tic Hill near Perth. The repeater site project was a large one that involved perhaps 40 amateurs and friends and family over many months. The slides were a trip down memory lane.

I have included a couple that reproduced well in greyscale. In particular the person wielding the axe was one of the first to strike a blow in clearing the hill top site. His name is Kevin, unsure of his callsign. The amateur on the concrete vibrator is Trevor VK6MS.

Format

What file format should a collection of digitised images take? If this project is worth doing, it does require a good understanding of digital photography and how the end result meets our expectations. Here is some background information for those of you who are new to digital photography.

The image is scanned into a computer like a television image, but can be stored in a number of file formats. Why are there so many different formats if they are just a means of storing the digital image? Some formats were copyright so new program writers developed different file formats. They all basically did the same thing, they just did it differently, like Beta and VHS tape formats. However this is not the complete story, as high quality colour photographs, when converted to a digital file, take up a lot of storage space. To store all the information that can be extracted from a colour 35mm slide the file size would be a hundred megabytes.

Compression

To greatly reduce the size of the resulting file, less information is recorded and the data is compressed. File reductions of a hundred or more are possible on some photographs with little loss of detail. Areas of a photograph that are the same, such as blue sky, don't have to be recorded bit by bit. It can be saved as a block of area of a particular shade of blue. The final size of the file depends on many factors, one of which is the content of the photograph. A photo that is mostly one colour will be much smaller than one with lots of detail.

The most widely used file format for storing compressed photographs is called JPEG, named after the organisation that standardised the format (Joint Photographic Experts Group). On older systems JPEG is often abbreviated further to the file extension (.JPG).

JPG files can be saved in varying degrees of compression. Medium levels of compression give excellent results, with file sizes of between 20k and 200k. The actual file size depends on several factors, such as the number of colours or



greyscale levels, the resolution that the photograph was scanned at, in dots per inch (DPI) and the detail in the photograph.

Another widely used compression format is GIF. GIF is best suited for graphics that contain 256 colours or less, or greyscale. GIF can produce very small file sizes of images with just two colours, black and white. It is therefore popular for graphics on the Internet.

Colour original inserted



A format commonly used for images in the printing industry is the TIFF format. While file sizes are usually much larger than JPEG files the quality of the reproduced image is also much better and there is less degradation of the image in handling –loading, editing and saving. Images should be created and edited in TIFF and finally saved in JPEG for storage.

Why So Many Colours?

In 1801 Sir Thomas Young showed that our eyes have three sets of receivers (known as receptors), Red, Green and Blue that are each capable of recognising minute differences in signal strength. The three colours are known as the primary colours of light. Colour therefore is a combination of these three colours in various strengths. If each colour receptor can recognise a thousand levels of light then the number of colours would be 1000x1000x1000. However, as good as the eye is, it is able to adjust to and recognise images from colours that are nearly correct. Just look at a row of televisions in a retail store and compare the range of colours that we humans are willing to accept as OK.

And The Winner Is...

As you can see, my opinion is that JPG is the format to use. JPEG not only saves colour and greyscale photographs well, but is also the main file form used on the Internet for digital photographic images. A high quality image can be saved onto a computer hard disk or CD-ROM and a lower quality smaller file size saved for distribution via the Internet or floppy disk.

Presentation

There is no purpose in saving our amateur radio photographic history if we can't all gain access to it. My primary interest is to make digital images available for viewing on a computer screen. JPEG images saved onto a CD-ROM can be readily shared and loaded onto Internet sites. Also in reference to presentation, the Internet is by far the best and cheapest way for large numbers of amateurs and others to see the photographic collection on a week by week basis as it grows. However file sizes over about 100k are not a good idea on the Internet as they take much longer to load from the web site.

The solution is to digitise the original at a high resolution and then make a low resolution version available on the Internet. Don't feel left out if you are not on the Internet. The growing collection would be made available by a variety of means such as floppy disk and CD-ROM.

Interested?

What I'm looking for at this stage is expressions of interest. Do photographs about *Amateur Radio* in Australia exist that could represent our history, and are we interested in the project as described? Your comments please.

ar

Support the Advertisers who support

Amateur Radio

magazine

CLUB NEWS

Send your club news and events to Club News

Melbourne Packet Radio Group Inc

YOUR ATTENTION is drawn to the change of meeting nights from the second Monday of the month to the first Thursday of the month at 1930 hours at the Moorabbin and District Radio Club rooms, Turner Road, Highett in Victoria, (Melways 77 J9). All are welcome. Enquiries should be addressed to MPRGi, PO Box 299, St Albans, Vic. 3021 or via packet to MPRGCM@VK3BBS.#MEL.VIC.AUS.OC

During the last couple of months we have prepared a submission to the other clubs in the Melbourne area seeking their financial support for the implementation of our own permanent gateway. Although prepared very close to Christmas we have already gratefully received donations from MDRC, a solid commitment from a second club and individual donations from Gerry, VK3MQ and Matt, VK3JNJ. We will have been in touch with the remaining clubs by the time you read this and hope to get the new facility up and running soon. In the meantime Peter, VK3AVE is still providing a part time service using his own ISP.

In the last couple of weeks work has been carried out on the VK3RPK site at Red Hill. This work was to rectify a transmitter problem on the 144.8 MHz 1200 baud port and to install a new 1200-baud port on 53.025 MHz. There is also a 9600-baud port on 434.2 MHz. Our appreciation for the funding of the 6-metre equipment goes to the members of the Moorabbin and District Radio Club.

Don't forget, the meeting nights have been changed, the March meeting is on Thursday the 4th. 73.



Urunga Convention – the longest running annual convention in Australia

THE EASTER WEEKEND will see Urunga host the 51st convention celebrating the 50th birthday of the event. The convention was started when a passing comment took root and flourished into an annual convention and foxhunt competition. Crieff VK2XO, Peter VK2PA, Col VK2 ASF and Gill VK2SH were crossing a lagoon on an oyster punt, which probably is a great place to think other thoughts, when the suggestion came up. A group of local amateurs all agreed to camp in the DO-ME boat shed for the weekend and enjoy each other's company. So many fellow amateurs turned up that a second boat shed had to be occupied as well.

So what is there to do at the Urunga Convention? Well apart from the socialising, which I must say has been very well recommended to me, they hold an annual foxhunt, even awarding a trophy to the winner, the Jack Gerard Memorial Award. There is a smorgasbord at the Ocean View Hotel in Urunga on Saturday night featuring a display of old gear and home brew equipment. From memory all of my home brew equipment is old gear.

Foxhunt proceedings begin on Saturday at 10:00am with a 7 MHz mobile event. Except for one more 7 MHz event on Sunday, the remainder of the events are on 2 metres. Try your hand at the 7 MHz pedestrian mobile foxhunt. The rules call for transistor radios only for this event and I can't imagine why as I'm sure that nobody uses valve gear pedestrian mobile anyway. Call-in will be on 146.5 MHz simplex. All up it sounds like a great weekend for all. If you have any questions or want to know more about accommodation call Brian Slarke VK2ZCQ after 8:00pm on (02) 6655 1115.

Grand opening

REDCLIFFE RADIO CLUB, arguably SouthEast Queensland's most active, is christening its new clubhouse Saturday, March 13 on the Corner of Klingner Road & MacFarlane Street, Kippa-Ring from 10.00am to whenever. Book an indoor site, bring a table, or sell your excess shack equipment from the boot of your car. This is an excellent opportunity for an informal get-together and a chat. There will be a Sausage Sizzle, a working Radio Shack complete with HF, VHF, UHF, Packet and with a bit of luck ATV (we are still working on that). It should prove to be a great day where you can bring your family and friends. Make a day of it and come to see Redcliffe as well. Tell me if you're coming and we'll reserve a place for you. Phone Kevin - VK4AKI on (07) 3880 1112.

Gold Coast Amateur Radio Society

THE CLUB HAS re-introduced its technical hour, 1 hour before the Friday night meetings. Fire off all those "techo" type questions that have had you stumped! (Now that's an idea worth pinching!) Gold Coast's AGM will be held March 12th, at which ALL positions will be declared vacant and a brand new committee elected.

Hervey Bay

AMATEUR RADIO'S Buy/Sell/Swap Day - April 3 1999. Hervey Bay Amateur Radio Club will host the day at the well equipped club house, Dayman Park, Urangan and invite all Amateurs and Clubs from near and far to participate. A \$4:00 BBQ will cap off the day.

FNNQARGT!

A REMINDER that this years Far North and North Queensland Amateur Radio Get Together will be held at Beachcomber Coconut Village, South Mission Beach, from Friday Afternoon 11th to Monday 14th June 1999. All Welcome!

ar

BARGAINS

Get in quick and grab a bargain! These ex-demo Yaesu transceivers may have a few minor marks or scratches, but you'll save a fortune. Two-year warranty applies but stocks are strictly limited.

FT-51R 2m/70cm hand-held

The FT-51R uses a sculpted case and diecast rear panel for strength, and dual microprocessor control for ease of use. At just 57 x 123 x 26.5mm (W.H.D) including NiCad battery pack, it's comfortable to hold or clip in a pocket. Includes inbuilt "Spectrum Scope", scrolling text help messages, and power-saving MOSFET amplifiers.

Features:

- Tx 144-148, 430-450MHz
- Rx 118-174, 420-470MHz
- 2m RF Output: 2.0, 1.5, 0.5, 0.02W
- 70cm RF Output: 1.5, 0.5, 0.02W
- Twin VFOs per band
- 120 memory channels
- Dual-band & dual in-band receive facilities (VHF/VHF, VHF/UHF, UHF/UHF)
- DTMF Paging and Messaging
- Large illuminated LCD screen
- Auto battery saver, Auto battery off
- CTCSS encode/decode
- Australian version selectable Auto repeater shift
- Includes FNB-31 600mA/H NiCad, belt clip, AC charger, CA-9 charging stand and high efficiency antenna.

\$599
SAVE \$100

LIMITED STOCK

2 YEAR WARRANTY



CD-2 mobile fast charger

A fast NiCad charger and mobile cradle assembly to suit the FT-11R and FT-51R handheld transceivers. Uses a regulated switched-mode charging circuit for cool operation and light weight. Reverts to trickle charging once the battery is fully charged. Includes cigarette lighter lead. D 3628

\$49⁹⁵

WAY BELOW COST!

20 PIECES ONLY
2 YEAR WARRANTY



FL-2025 2m 25W Amp

Turn your FT-290II into a powerful mobile/base transceiver with this bolt-on RF amplifier. Replacing the FBA-8 battery holder on the FT-290RII, it boosts transceiver output to 25 watts. Requires 13.8V DC. D 2863

LAST FEW UNITS

\$199
SAVE \$100



Battery packs to suit FT-11R and FT-51R

FBA-14 dry cell case	D 3626	\$19.95	
FNB-35 7.5V 900mAH NiCad	D 3624	\$59.95	SAVE \$40
FNB-33 4.8V 1200mAH NiCad	D 3623	\$69.95	SAVE \$30
FNB-38 9.6V 600mAH NiCad	D 3625	\$79.95	SAVE \$37



FT-290RII 2m all-mode transportable

Covers 144-148MHz and features FM, SSB (USB/LSB), & CW operation with 2.5W or 250mW switchable output power, twin VFOs and 10 memories that store mode and simplex or repeater frequencies. Selectable tuning rates are also provided for SSB/CW and FM (SSB- 25Hz/100Hz/ 2.5kHz and 100kHz; FM-5/10/20kHz and 1MHz). Mode specific features include a noise blanker and clarifier control for SSB/CW, plus a full set of functions for FM repeater operation, making this unit very simple to operate. It comes with a flexible rubber antenna, an FBA-8 battery holder which takes 9 x C size batteries (standard or NiCad) and a hand-held microphone. D 2875

LIMITED STOCK
2 YEAR WARRANTY

YAESU

\$699
SAVE \$200

Rugged HF 5-Band Trap Vertical Antenna

The rugged 5BTV incorporates Hustler's exclusive trap design (25mm solid fibreglass formers, high tolerance trap covers and low loss windings) for accurate trap resonance with 1kW (PEP) power handling. Wide-band coverage is provided on the 10, 15, 20 and 40m bands (SWR typically 1.15:1 at resonance, <2:1 SWR at band edges) with 80kHz bandwidth typical on 80m at 2:1 SWR. An optional 30m resonator kit can be installed without affecting operation of other bands. High strength aluminium and a 4mm (wall thickness) extra heavy-duty base section guarantee optimum mechanical stability. At just 7.65m, the 5BTV can be ground mounted (with or without radials, although radials are recommended), or it can be mounted in an elevated position with radial system. Unlike other antenna designs, the 5BTV can be fed with any length of 50-ohm coax cable. D 4920

\$449 **HUSTLER**

30m Resonator Kit

Adds 30m coverage to the 5BTV and includes all hardware. D 4921 **\$99.95**

BONUS OFFER! Purchase the 30m-resonator (D 4921) with the 5BTV vertical and pay only half price for the 30m resonator!



BARGAINS

Advanced Data Management Software

An advanced way to program many of the functions of Yaesu handheld and mobile transceivers. Each package consists of an interface that plugs into the serial port of a PC and connects to the transceiver via its microphone socket (for handhelds) or its Packet socket (for mobiles). Also provides easy-to-use 3.5" (inch) PC software with pull down menus that allow for programming and naming of memory channels, selection of output power, CTCSS tones, scan and battery saver operation, plus much more.

ADMS-1D suits FT-10, 11R, 50R/RD, 51R, VX-1R D 3753
 ADMS-2D suits FT-3000M, 8000R, 8500, 8100R D 3759

\$89⁹⁵ ea



LP-1300 Log Periodic Yagi

The Maldol LP-1300 is a Log Periodic Yagi beam antenna designed to provide useful gain across the 100 to 1300MHz range. Ideal for scanner enthusiasts and ham operators needing a directional wideband antenna. Consists of a 17-element Yagi with a special feed system providing low SWR (less than 2.0:1) across the 100-1300MHz range.

Gain: 6.0dBi to 10.0dBi
Boom length: 1.46m
Suitable mast: 28-60mm diameter
Max wind speed: 40m/sec
Max power: 500W
Connector: SO-239
 D 4828

\$269



FT-50RD 2m/70cm Handheld

The Yaesu FT-50RD is an amazingly compact 2m/70cm amateur band handheld transceiver which provides MIL-STD 810 shock and vibration resistance, super wideband receiver coverage, simple menu settings for most functions, and compatibility with the optional Yaesu ADMS-1D software/interface package for PC programming of many functions.

Other features include:

- Tx 144-148MHz, 430 - 450MHz
- Rx 76-200, 300 - 540, 590 - 999MHz (cellular blocked)
- FTT-12 keypad provides Digital Voice Recording, CTCSS/DCS scanning, and CTCSS encode/decode
- 2m/70cm RF output: 2.5, 1.0, 0.1W standard, up to 5W with 9.6V battery or 12V DC socket
- "Omni-glow" LCD screen for easier night-time viewing
- 112 memory channels with 4 character alpha naming
- Dual watch allows monitoring of sub-band activity
- Direct FM modulation for better audio quality

- 5 battery saving systems (includes Rx and Tx Save)
- Comes with FNB-40 slimline 6V 650mA/H Nicad battery pack, flexible 2m/70cm antenna and modified M-9626 AC plugpack adaptor for Nicad charging
 D 3660

YAESU

2 YEAR WARRANTY

\$569

BONUS!

Pay only half-price for a second Nicad pack when purchased with the FT-50RD. Limit one per customer. Applies to FNB-40, 41, 42 only.



FT-8100R 2m/70cm Mobile

The stunning new Yaesu FT-8100R is a state-of-the-art 2m/70cm band mobile transceiver that combines high power and the industry's most versatile memory system with an excellent wideband receiver and solid construction. Its US MIL-STD-810 shock and vibration rating is your assurance of years of reliable operation. Includes hand mic, mounting bracket and fused DC power cord.



Other features include:

- 198 memory channels
- 1200/9600 baud packet socket
- Inbuilt antenna duplexer
- Inbuilt crossband repeater facility
- Dual receive capability (VHF/UHF, VHF/VHF, UHF/UHF)
- Optional removable front panel

Frequency range: Tx 144-148MHz, 430-450MHz
 Rx 110-550MHz, 750-1330MHz (less cellular)
Output power: 2m: 50W, 20W, 5W
 70cm: 35, 20, 5W

2 YEAR WARRANTY

\$949

D 3314

YAESU

PHONE FAX AND MAIL ORDERS

PHONE: WITHIN AUSTRALIA: 1300 366 644
 (Local call charge)

FAX: (02) 9395 1155 within Australia and
 (+612) 9395 1155 from outside Australia

MAIL: DICK SMITH ELECTRONICS, Direct Link Reply Paid 160, PO Box 321,
 North Ryde NSW 1670 (No stamp required)

Excludes packaging and postage. All major credit cards accepted.

14 Day Money Back Guaranteed if NOT completely satisfied. (Software excluded)



Visit our web site at
<http://www.dse.com.au>

DICK SMITH ELECTRONICS

That's where you go!

*Pricing valid until 28/3/99, then subject to change.

High Performance Regenerative Receiver

The regenerative receiver is capable of good performance with a relatively small number of parts.

RECENTLY THERE HAVE been a number of designs for regenerative receivers published in a variety of publications.

In QEX Nov/Dec 1998 Charles Kitchin N1TEV presented an overview of regenerative receivers together with some practical circuits. He presented a high performance shortwave receiver which may be of interest.

The receiver is built in a wooden box so as to minimise loading of the tuned circuit.

The panel may be metal to minimise hand capacity effects or you can use earthed metal plates between a wooden panel and the tuning capacitor frames.

The circuitry components were mounted on a small piece of strip board or you could use a small piece of printed circuit laminate.

Plug-in coils were used and these were of the type familiar to older readers. The formers are available in the USA from a supplier called Antique Wireless Supply. They would appear to be approximately 1 1/4 inch diameter or about 30 mm in diameter and have a valve type base to plug into a 5 pin valve socket.

A reduction drive should be used for the main tuning capacitor and reduction drives may also be convenient for both the fine tune capacitor and the regeneration capacitor. Large knobs are

advisable to give ease of adjustment.

The circuit is shown in Fig 3. The AD745 audio amplifier is used because it provides high gain together with low noise.

A zener diode is used to provide regulated supply voltage to the regenerative detector so as to provide some extra stability of the operating point.

The source of the coil formers was the Antique Wireless Supply PO box 27468 Tempe AZ. The USA phone number is 602 820 5411 and the URL is <http://www.tubesandmore.co>.

This company would appear to be able to supply a range of parts for older style radios.

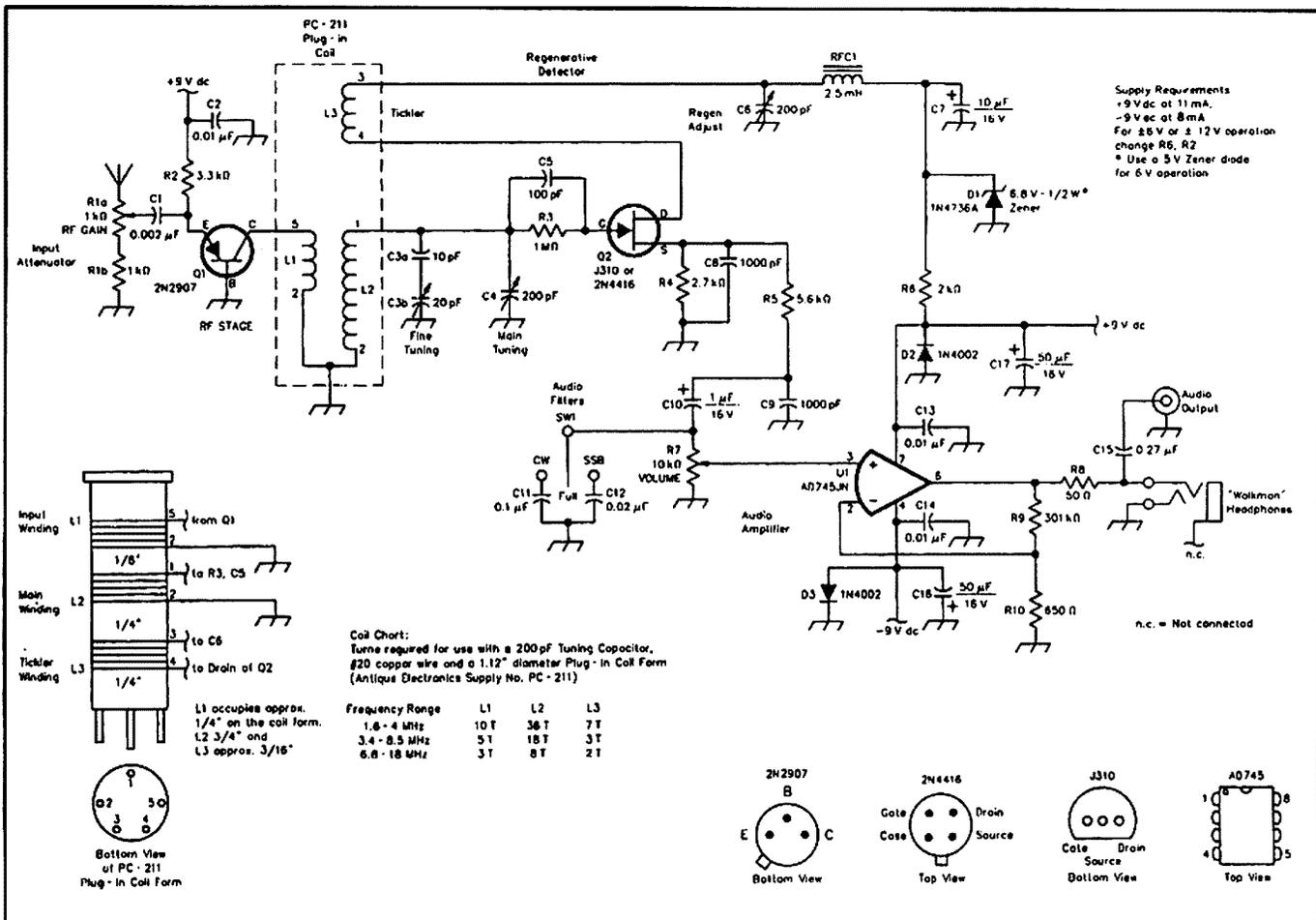

Soft Starting

Soft starting is a way of turning on a mains supply gradually so as to avoid stress on components due to a sudden voltage or current surge.

SOFT STARTING is often incorporated in valve linear amplifiers that may suffer from the sudden application of the full mains voltage at switch on. Some suitable soft start circuits were presented by Ian White G3SEK in his In Practice column in the December 1998 issue of RadCom.

The circuits are shown in Fig 4. Fig 4(a) is a relay delay circuit where the main supply is initially applied through a series resistor to limit the current.

After a time set by the operation of the relay the limiting resistor is shorted out and the full mains supply is applied. However the relay circuit dissipates an appreciable amount of power.

The circuit of Fig 4(b) uses an auxiliary supply to drive the relay timer. This complicates the circuit. By using tapplings on the main transformer the circuit of Fig 4(c) reduces the dissipation in the relay circuit and uses feedback to assist with the delay. R2 should be adjusted on test and 200 ohms at 2 watts is a good starting point.

A further refinement is a fuse or PTC to provide protection in the starting phase of operation.

A PTC is a device which is normally low resistance but will go high resistance if excessive current flows. The PTC will recover when the overload is removed.

PTC devices are sold by a number of suppliers under a variety of trade names.

A simple circuit that uses a NTC device is shown at Fig 4(d). NTC devices are sold by a number of suppliers. An NTC has a high resistance when cold which falls to a low resistance when the device has warmed up to its operating temperature.

They are often used to protect lamp filaments.

Both NTC and PTC devices must be sized to the particular application. The original article suggested both RS Components and Farnell as sources for these components.

Fig 4. Soft Start Circuits.

ar

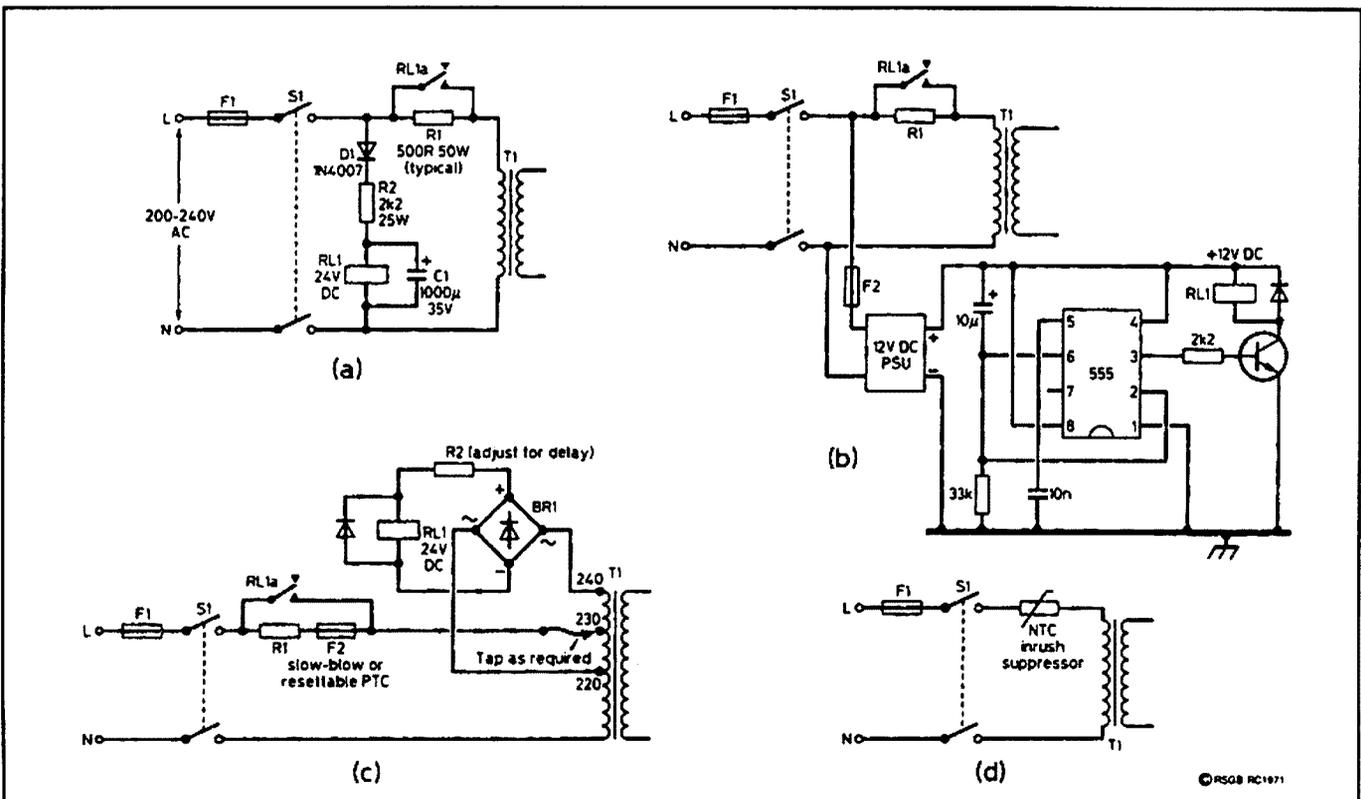

©RSGB RC1971

ERRATUM

Correction to article "Narrowband Voice Transmission" in January 1999 edition of *Amateur Radio*, page 18, 3rd column, lines 6-9: "Output components are removed from the modulator below 600Hz by a low-pass filter". The author Lloyd Butler VK5BR apologises for the description "low-pass". It should read "high-pass".

**Amateur
Radio Spans the World**



AWARDS

John Kelleher VK3DP

Federal Awards Officer

4 Brook Crescent, Box Hill South, Vic 3128 (03) 9889 8393



YU1LW Joca Stojkov, recent recipient of Wavkca, Cert. No 2131

DURING THE WEEK, I received a letter from an interested Amateur requesting information on the number and kind of awards that I can effectively handle. The answer is easy. I have pleasure in processing all those listed as Federal Awards, plus, when requested, some overseas awards. These are WAC and WAS. Awards sponsored by CQ Magazine can be handled by either VK5IE or VK3AKK. New Zealand awards are handled by the NZART Awards Manager ZL3GX at 7 Dellow Place, Christchurch 8002 NZ. All others are dealt with by their respective sponsors or listed Clubs or Managers.

If you have a particular award on which information is required, and I have that information to hand, then I would be pleased to publish your request. Here are some that have been requested.

Worked Republic of India Award.

Issued by the Amateur Radio Society of India for contacting stations in India, the Laccadive Islands, and the Andaman and Nicobar Islands on 1.8 to 28.0 MHz (including WARC bands) on CW, AM, SSB or RTTY since 26th January 1950. A minimum of 100 points is needed. QSO's with mainland India on 1.8 MHz = 3, on 3.5 and 7 MHz = 2, and on 14.0 to 28.0 MHz = 1. Contacts with stations using special prefixes count an additional point. With Laccadive and Andaman the points value is 5 on 1.8 Mhz, 4 on 3.5 and 7.0 MHz, and 3 on other bands. GCR list and 5 IRCs to: -

Awards Manager
Amateur Radio Society of India
40 Ghalib Apts.
Parwana Road
Pitamoura, Delhi 110034 India.

Worked the Equator Award (WTEA) from Indonesia.

Issued for confirmed contacts with stations along the Earth's Equator, in the following countries: C2 HC HC8 HK

KH1/KB6 PR-PY PY0
(P & P Rocks) S9 (Sao Thome) T30 T31 T32 TN TR YB5 YB7 YB8 5X 60 80 90. Swl OK. Three

categories of the award are as follows: -

Class 1- confirmed contacts/ swl with 15 above countries.

Class 2- confirmed contacts/ swl with 12 above countries.

Class 3- confirmed contacts/ swl with 8 above countries.

For all classes, YB5 YB7 and YB8 are mandatory. GCR list and fee of US \$8.00 or 16 IRCs go to: -

Biro Nugraha ORARI Pusat
PO Box 1002
Jakarta 10010 Indonesia.

Worked All Indonesia Award...WAIA

Issued for contact with stations in each of the Indonesian call areas (1 to 0) as follows: -

—DX stations other than those in CQ Zone 28 need two stations in each area.

—DX stations in Zone 28 require three stations in each call area.

Additionally, they need contact with three stations YB YC and YD in the same call area.

Modes or bands may be mixed. SWL OK. Contacts after 7th September 1968. GCR list and \$8US or 16 IRCs to:

Mr. M Maruto YB0TK,
PO Box 6763-JKSRB
Jakarta 12067 Indonesia

Cork Radio Club DX Award.

Make contacts with members of the Cork Radio Club, or EI stations in County Cork. EI/G needs 4, rest of Europe 3, and outside Europe 2 QSOs. Any band, any mode. SWL OK. GCR list and \$4US or 8 IRCs to: -

W. O'Reilly EI8AU
Mount Oval
Rochestown Co. Cork Ireland

Worked EI Counties Award.

Work or hear at least 20 of the following counties after 1st January 1982:

Carlow	Dublin	Laois
Mayo	Sliogo	Wicklow
Cavan	Galway	Leitrim
Meath	Tipperary	
Clare	Kerry	Limerick
Monaghan	Waterford	
Cork	Kildare	Longford
Offaly	Westmeath	
Donegal	Kilkenny	Louth
Roscommon	Wexford	

Look for the rarer Irish counties to be activated each St. Patrick's Day (17th March) by the IRTS. Amateurs with an Irish ancestry can join IRTS as honorary members. SASE to W2ORA for details. GCR list and 10 IRCs to:

IRTS Awards Manager
Box 462
Dublin 9 Ireland

Worked All African Continent Award (Italy)

The Award is a dark coloured plate (15 X 20cm) showing the African continent. Receive confirmations from at least 40 African DX countries since 1st January 1980. SSB CW RTTY or mixed modes on all bands except WARC. SWL OK. Fee is \$US15.00 or 20 IRCs. GCR list and photocopies of both sides of your QSL's. You must include statement that all QSO's were worked from your own QTH and that you followed all applicable rules of your country. Apply to: -

Giuseppe Acquaviva IK7NXX
PO Box 57
Canosa di Puglia BA
I-70053 Italy
73, and best DX
De John, VK3DP.

ARDF

Ron Graham VK4BRG
PO Box 323 Sarina Qld 4737

Emergency beacons or EPIRBs send out a signal that is automatically picked up by commercial aircraft. Each time the pilots return to that frequency, the intrusive signal is heard.

You can imagine the frustration in high places (30,000 feet *and* in Canberra) when an EPIRB goes off accidentally and cannot be found.

Don't ask a policeman, ask a radio amateur

I REFERRED PREVIOUSLY in this column (AR May and Oct '98) to possible amateur operator involvement in helping authorities to locate activated emergency beacons.

Following is a report from Russell, VK3ZQB and Alan, VK3XPD regarding amateur experiences near Portland, Victoria.

Hi Eric,

THIS MIGHT BE of interest for the magazine, as it has hit the local news, generating some good PR for the hobby. The attached news article gives a background to what happened and, to expand on the article, I will tell you how we became involved.

I received a phone call from Mick Owen of the Australian Communications Authority at 0930 UTC, asking if I had the capability to listen to 121.5 MHz. He explained that a Electronic Position Indicating Radio Beacon (EPIRB) had been activated in the Portland region, and the water police were unable to locate it.

This was nearly 12 hours after the initial alert and was only by chance that he contacted me.

Mick received the request from Canberra to track the exact location of the beacon but as he is based in Melbourne, it would be at least a 4 hour drive to get to Portland.

The water police were considering sending the helicopter down with the tracking team but this would also have been very costly. He decided to contact Ian McDonald VK3AXH in Ballarat and Ian suggested that he ring me.

As I was talking to Mick on the phone, Trevor VK5NC called on 2m and I asked Trev if he could monitor 121.5 MHz. He did and heard the EPIRB signal. I briefed Trev on what had happened and he said that they had tracking gear in Mount Gambier that would do the job. Mick said that he would inform the water police that we could do the job and I awaited a phone call from them with the details of what they wanted us to do.

At 0945 UTC Trev VK5NC, Tom VK5EE and Wayne VK5ZX departed Mount Gambier, and I started out from Port Fairy for Portland.

The trip took about 1 hour and we met with Sgt Peter Swiers at Portland where he briefed us on the situation.

Within 10 minutes we had found the beacon and had it turned off. The police were amazed at how fast we found the beacon and wished that they had known that we were available to do the job much earlier in the day.



We agreed that, at some point in the emergency services standard operating procedures, a notation to use the services of the amateur radio operators, especially when the official service is too far away to be of any use, should be included.

Perhaps the WIA should make some recommendation to the emergency authorities to investigate the inclusion of amateurs for tracking purposes.

They could also compile a national register of amateurs who were equipped for tracking and keep the emergency services informed.

It's worth a thought for if this occasion had been more serious, valuable time would have been lost waiting for equipment to arrive to track the beacon. The Mount Gambier boys were called out again at 6.30 am SA time, by the Mount Gambier police to track another EPIRB that had been accidentally set off in the area. Two calls in one night.

Late note: The Mt. Gambier boys have had three call outs since then. Is this the start of something big or perhaps a business opportunity?

Warrnambool Standard
December 21, 1998
Used by permission

ARDF Coordinator

Jack, VK3WWW, has taken up this position in an acting capacity. This is particularly important as it is necessary to have someone to do the necessary organization/liason with regard to the Australian team going to Korea in June.

It is hoped that the WIA will soon appoint Jack, or another suitably qualified person, to a permanent position.

Florida

As I write this in late January, my "spy" in Florida reports the presence of "Melbourne, Australia fox hunters" prowling his State! Reports also indicate that some fox hunting competitions took place.

Maybe each side are having some practice for the International events coming up later this year in both Korea and Oregon?

Fox Hunting versus Amateur Radio Direction Finding (ARDF)

When I started this column I tried to point out that I would use the term ARDF in relationship to all facets of Amateur Radio type fox hunting.

I think some reasons may have been to help promote the newer (but more involved) true ARDF activity and that ARDF was easier to type than "fox hunting and ARDF", or even "fox hunting". (Just lazy at typing!).

I will continue to use the term ARDF, but this may be a good time to discuss a few of the differences between the two. In my opinion fox hunting would apply to all amateur radio direction finding type activities that were not actually genuine ARDF, or a variation of ARDF.

Fox hunting is where it all starts. Probably with something simple .. maybe a handy talkie running on low power as a fox ... maybe using handy talkies as receivers ... even without a directional antenna. I would like to discuss some of these simple receive arrangements in a future column. From that simple, and readily available equipment, a Club or a Group may start to investigate more dedicated equipment. Maybe directional antennas for receiving, maybe a simple dedicated fox transmitter and

so on. They will no doubt find limitations with that simple equipment and this will, hopefully, inspire them to build or obtain better equipment.

As with most interests or hobbies, as one gets more and more serious, one needs better equipment to try and achieve the results that the "experts" achieve. Rules for, and types of, fox hunts may be many and varied.

Starting with something simple would be my advice — rules may be added if and when required. Various types of fox hunts may be tried, pedestrian, mobile or a combination of the two. Lots of possibilities! With luck, eventually the Group will come up with a type of fox hunt that will suit them.

This need not remain permanent, they may continue to try different ideas and adapt those that appeal. Space does not allow a detailed description of ARDF at this time.

Briefly, it involves contestants on foot finding a series of transmitters (foxes) in the minimum time. ARDF is no doubt for the better equipped and more serious. There are International Rules but, in my opinion, there is nothing wrong with a Group developing their own variations to those rules. As I have tried to point out with the more basic fox hunts, the main thing is to develop ideas, rules and variations to suit your Group, to learn something new and to HAVE FUN.



silent key

King Hussein of Jordan JY1

Below is the text of a letter of condolence sent to the Jordanian Ambassador to Australia from the WIA Federal President, Peter Naish:



14 February 1999

The Ambassador
Embassy of Hashemite Kingdom of Jordan
20 Roebuck Street
RED HILL
ACT, 2603.

Dear Sir,

On behalf of the Radio Amateurs of Australia I offer sincere condolences on the recent death of the revered Jordanian radio amateur operator, JY1.

King Hussein endeared himself to amateur radio enthusiasts throughout the world but particularly here in Australia where very many of my fellow "hams" were privileged to speak with him in two-way contacts. His personal touch and great understanding were much appreciated.

Vale, JY1.

Yours sincerely,

Peter Naish
WIA Federal President



radio and Communications

INCORPORATING AMATEUR RADIO ACTION and CB ACTION

Published by
ACP ACTION,
Locked Bag 12,
Oakleigh,
Victoria 3166
(03) 9567 4200

Who's this handsome bloke? Why, it's Arthur Collins, WØCXX, founder of the Collins Radio Company. This month we present a biography of a marvellous achiever in the world of radio, and remember some of his radios. But there's *much* more than that!

Yes, the March R&C is as always full to the brim with great reading for amateur radio operators! Like these...

- **ANTENNAS:** you read the D5 construction story a few months ago but would prefer coax? Done!
- **THE ALF TRAEGER MEMORIAL:** A short story about a tribute to the inventor of the pedal wireless set...
- **ANATOMY OF A HAMFEST:** So what *really* goes into making a successful hamfest? James tells us!
- **SSTV FROM MIR:** We've all heard the voice and packet radio signals from Mir. Now there's SSTV!!
- **MARINE MORSE SENDS ITS LAST...** The safe and gentle sound of CW is gone from the maritime world.
- *As usual, we have our three DX columns and lots more... the best stories and regulars every month!*

Don't miss out — **RADIO and COMMUNICATIONS** is great reading for amateurs!
Check your local newsagent today!

(PS. We also have the biggest collection of radio-oriented Classified adverts in the country. There's lots of them because they work so well. Ask your newsagent to keep a copy for you each month, or ring 1800 25 2515 for subscription details. Hurry — you might miss something!)

VHF AN UHF EXPANDING WORLD

Eric Jamieson VK5LP

PO Box 169 Meningie South Australia 5264

E-mail: vk5lp@ozemail.com.au Fax: (08) 8575 1777

Packet: VK5LP@VK5WI.#ADL.#SA.AUS.OC

All times are UTC

Those One Metre days

Ken Pincott VK3AFJ writes "I was pleased to see the material from Max VK3ATK, in the January issue of AR. It inspired me to go looking for my old logbooks, and it saddened me to see how many old friends have become silent keys.

To add to Max's list, and my logs are nowhere near as neat or complete as his, I can add the following call signs: all VK3s. PO, AAP, ED, TI, AMD, ALY, ZAF, AHN, ZBN, ZDJ, ZDO, ZDU, BU, ZEK and TV. I was not very active during 1956/57, so there could well be others with whom I made no contact.

It has certainly brought back many memories of 288 MHz days, one or two of which are not suitable for publication, but if and when I catch up with the parties concerned, will give them a reminder.

As well as Max, Bert VK3AAF and myself were using 16 element phased arrays. For mobile and portable work I used a 3 element Yagi which I poked through the sunroof of the car. It is to be hoped that other states will be inspired to add their "pioneers" to the list.

Six metres

Steve VK2KFJ forwards these details from Shirow JF6DEA concerning 6m FM activity in Japan. The FM segment is 51.000 to 53.999 MHz in 20 kHz steps. No 6m or 2m FM repeaters - only repeaters on 10m and 70cm and above. The 6m FM calling frequency is 51.000 and most FM is from JA to HL. Shirow has operated the 6m beacon JA6YBR on 50.017 since 1985.

JA beacon changes: JF6DEA advises that the callsign of JA7ZMA on 50.027 has been changed to JE7YNQ. Location and equipment as previously. The beacon also operates on 28.187 MHz.

On 2/2 between 0630 and 1220 the

beacons VK8RAS, VK8VF, VK6RSX, VK4ABP and VK7RAE were heard in Japan by JR2HCB, J11 UHZ and JA1RJU. So it seems signals are still crossing the equator.

Rex VK8RH reports having just returned from a trip to Thursday Island on the top of Cape York. Mike VK8ZMA is working there for a few months and they set up a beacon on 52.200 (carrier frequency listen on 52.199 USB) with the ident of VK8ZMA/b. Power is 5 watts and vertical antenna. He would appreciate any reports.

The Christchurch VHF DX Group 28.228 MHz beacon has changed its callsign from ZL3SIX to ZL3TEN. Power is 10w, antenna halfwave vertical. ... Mike ZL3TIC.

11/01/99 was a good day for 50 MHz: 0105 W5UWB 5x9 into Christchurch 50.105.

0115 WA5UFH 5x7 50.105. Backscatter into ZL3 from ZL2, ZL4, VK2 and VK3. 0120 55.250 and .260 to 5x9 with NTSC frame buzz. No audio on 59.750. Very strong 45.170 and .240 also 57.240,250 and 260.

0230 VK4DO worked ZL9CI on CW, followed by Ron VK4BRG. At 0303 again worked, this time 5x5. Ron could hear ZL9CI working VK2, VK3 and VK7. 0323 Phil VK5AKK worked ZL9CI on 50.110 5x9.

0324 Bernie VK3YTT and Peter VK3KAI worked ZL9CI.

12/01: A wide-coverage report from Mike ZL3TIC:

0005 very strong VKs 46.170,240,57.240,250,260 all 5x9.

0200 ZL9CI 50.110 5x9.

0230 49.750 up to 5x5.

0255 JR2HCB 50.110 5x9.

0400 JF2MBF 50.110 5x9.

0430 49.750 very weak.

0500 VK TV very strong.

0600 JR1RJU 50.130 5x9.

0630 JR6NKZ 50.140 5x9.
0631 JA2IYH 50.110 5x9.
0719 JA4DLP 50.140 5x9.
0730 VK TV 57.240,250,260
69.670,750, 86.250 all 5x9.

0745 FM broadcast band wide open, many Melbourne and Sydney stations 0840 to 1030 6m still wide open, many VKs, mainly VK1,2,3,4.

14/01: from ZL3TIC 2216 Worked ZL1ADP. 2230 Very strong VKs. 2330 XE1KK/b 5x8. 2345 49.750 up to 5x9. 2355 ZL3NW worked N6XQ.

15/01: 0105 W6JKB/5 5x5 50.105. 0130 other weak Ws on 50.110 but too weak to copy. 0135 55.260 NTSC video up to 5x9 but no audio on 59.750. 0200 W6JKB/5 still in on CW.

Jack N6XQ will be active from CP (Bolivia) with 500 watts and a medium sized beam antenna from March 17-29. Six metre operating is included. 28.885 will be used for liaison. ... JA1VOK.

Steve VK2KFJ supplies more information regarding six metre repeaters:

53.550 VK2RAY Albury, still in the planning/construction stage.

53.550 VK3RMH Melbourne, operational.

53.575 VK3RDD Dandenong, operational.

53.675 VK2RMB Sydney North, off air with a receiver fault.

53.675 VK3RAD Melbourne, planning stages.

53.700 VK2RGN Goulburn, now completed and operational.

53.750 VK5RDX Adelaide South, operational.

53.900 VK3RMS Melbourne East, operational.

53.750 - input 52.750 Wellington NZ, under construction.

Two metres

Rob VK3EK/DEM reported good VHF propagation from Bairnsdale across Bass Strait on the night of 3/1. He worked Andrew VK7XR on 144, 432 and 1296 MHz all 5x9. Andrew went mobile with his HT and they worked 5x5 on low power (250 mW) so the band was really open. On Thursday night (4/1) the VK7 144 and 432 MHz beacons were 5x9.

On 6/1: ZL3TY worked VK2ATO 0936 146.550 FM. VK2IJM 1017 144.600 SSB.

New Zealand had a great day on 12/1. Bob ZL3TY reports that 148 MHz

paggers audible 0710 then VK1ZQR worked at 0734 on 144.100 MHz, followed by VK3DUT, VK1VP, VK3TET, VK1MP, VK1ZQR, VK3KEG, VK3BRZ, VK2XVJ, VK2EM, VK2ZAB, VK2KU. Paggers faded out 0900.

Mike ZL3TIC provided the following for 12/1:

0745 148.183 MHz paggers 5x9
0752 VK2NWF 146.5 FM 5x9
0753 VK3DUT 144.1 5x9
0810 VK3SF 146.5 5x9
0811 VK3EK 146.5 5x9
0822 VK3DMW 146.8 Very strong repeater, could be heard on reverse
0823 VK3EK 144.1 5x9
0830 VK2KU 144.1 5x9
0833 VK2ZAB 144.1 5x9
0835 VK2CH 146.5 5x9 also about 15 repeaters all 5x9.

Mike said *This 2m opening would be one of the best in ten years. Quite amazing as this season has been so poor up to now!*

12/1: **Ron VK3AFW**: Rob VK3EK worked ZL3TIC and ZL3ADZ on 146.500 FM followed by ZL3TIC, ZL3AIC, ZL2TAL on 144.1 and ZL2TAL on 432 4x1.

DX on 432 via Es is pretty rare, but not unknown. Andrew VK7XR copied transmissions from Adrian VK2FZ/4, on 432 via Es a year or two back.

Many other VK3 stations heard ZL stations and responded but missed out, partly through QRM, partly the fickle Es footprint and perhaps insufficient ERP. Let's hope it's not another ten years before we get a similar opening again.

Bruce VK2EM advises that on 12/1 at 0800 he was scanning the local repeaters when he heard the Greatlakes repeater key up and a voice say, "This is ZL3TY QS Ying to 144.100 MHz". Switching his FT-290RII to sideband and 144.100 he found Bob ZL3TY working a VK3. He rang Frank VK2XVJ and both worked Bob for a 5x2 both ways, Frank with 100 watts into a Diamond vertical and Bruce with 3 watts into 30 metres of RG-58 coax and a 6 element vertically polarised Yagi. Five minutes later Bruce worked ZL3AIC for a 4x4 to his 5x5 and then the band died.

13/1: **Gordon VK2ZAB** - At about 0140 the VK5 two metre beacon on Mount Lofty was audible in Sydney area. Liaison with John VK5PO on six metres ensured that calls were made on two metres from both ends but no contact was made.

At 0800 ZL3s were heard on 2m. I had 2m SSB contacts running 25 watts pep with ZL3TY in Greymouth and ZL3TIB, ZL3AIC, ZL3TJZ, ZL3TIC, ZL3ADT and ZL3NW all in the Christchurch area. Signals were S5 to S9 both ways. Guy VK2KU worked all these stations plus ZL2VAL in New Plymouth.

The 2m beacon near Wellington was audible in Sydney but no contacts are known to have been made to the Wellington area.

14/1: **Roger VK5NY** - At 2336 worked VK6KDC at Manjimup 5x5 on 2m. Darrel runs a continuous keyer with 18 watts on 432.105, worth noting, I could not hear the keyer.

15/1: **Phil VK5AKK** - Some very short 2m openings between VK5 and VK4. Worked Des VK4DMI at 0310 5x7 on 144.100. At 0344 contacted Adrian VK2FZ/4 on 144.100, gave him 5x3 but did not receive my report back.

15/1: **Eric VK5LP** - On 144.140 from 2328 worked Darrel VK6KDC at Manjimup 5x8, Wally VK6WG 5x5. 16/1: 0949 VK6WG 5x9 on 144 and 432, 5x3 on 1296. 1030 to 1139 - 144: VK3AEF, VK3WRE/p, VK3ZL, VK3TMP, and VK3FIQ. From 2216 VK3XPD, VK3AEF, VK3ATN. All at various signal levels but mostly good signals. On 432 VK3ZL 5x5, VK3AXH 5x9; 1296 VK5NC 5x5.

16/1: **Wally VK6KZ** - At 2157 worked VK5DK in Mount Gambier on 144 and 432 MHz from Perth and VK5AKK in Adelaide on 144 MHz at 4x1 - hard copy.

Mount Gambier beacons on 144.550 and 432.550 strong. Adelaide beacons not audible. No signs of Geelong beacon or any VK3s.

16/1: **Don VK6HK** - VK5RSE/b 144.550 faded out at 0100 here in Wembley Downs in the Northern suburbs of Perth. Wally VK6KZ and Cec VK6AO also copied Trevor VK5NC on CW on 1296 during the opening but no QSO. Nil heard here.

16/1: **Steve VK5SFA** - worked Wally VK6WG on 144.100 MHz at 0250 5x7. Tried 70cm and 23cm ... no go!

16/1: **Phil VK5AKK** - worked VK6WG 2400 on 144.100, 432.100 and 1296.100.

Ron VK3AFW reports that the weekend of 16-17/1 saw good tropo on 2m and above, covering many points east

of Perth, but apparently not getting much further north. A number of VK3s worked various VK6 stations.

Max VK3TMP worked VK6KDC at Manjimup on 2m on Saturday morning 16/1 and Wally VK6WG and also VK6KZ on Sunday morning.

VK3ZL, VK3FIQ and other VK3s also heard working Wally VK6WG on 2m Saturday night. Best contact was Alan VK3XPD to Wally VK6WG on 1296 at 0930. Wally's 10 w was 4x1, Alan's 70 w 5x5 I believe. Congratulations. A few km short of the VK record but a long time since this path was worked on 1296.

Ron's modest log for 14/1 reads.

	1142	VK5DK	5x9
	2106	VK3BMY	5x6-9
16/1:	1026	VK5DK	5x9
	1129	VK6WG	5x7
	1137	VK6WG	5x9
	1207	VK5NY	5x9
	1226	VK5DJ	5x9
	1247	VK5NC	5x9
	2131	VK5NY	5x9
	2145	VK1BG	5x4
	2155	VK7JG	5x9
17/1:	2110	VK7XR	5x9

VK5LP was heard (5x2) working several stations but did not have his beam in my direction while I was listening.

The VK5RSE beacon in Mount Gambier on 2m was very strong for the whole weekend. The VK7RNE beacon was also strong.

Alan VK3AL in South Melbourne shared the excellent tropospheric conditions on 16/1. He was particularly pleased to work Wally VK6WG on 432 MHz for his best DX on that band. His QSO on 2 metres came with signals up to S9. However, tests with VK6WG on 1296 were not successful.

Contacts with Trevor VK5NC and Colin VK5DK, both in Mount Gambier, on 1296 were also very pleasing. He said it was a most exciting evening with very good signals, despite some QSB.

Alan VK3XPD: *On 16/1 at 0930 Wally VK6WG and I gave the current National Record for 23cm a bit of a scare. I was pleased to make it to Wally as he is now nearly 90 years of age and still active.*

I had just completed building a "water-cooled" 2C39 valve amplifier for 23cm. It was delivering about 80-90 watts during tests but the sealed cooling system using distilled water had not been completed so the coolant was normal tap

water in a 4 gallon bucket sitting on a chair - a little risky since the water was "live" at 1300 volts - but only temporarily!

Propagation had been open to VK6 on the mornings of 15-16/1 and several VK3s had worked Darrel VK6KDC at Manjimup but Saturday evening was to be a real propagation "feast".

As the evening progressed and propagation improved, the number of VK3, 5, 6 and 7 stations being heard at my QTH on 2m grew rapidly. There were many VK3 and VK5 contacts on 2m and 70cm into VK6 to Wally at Albany and I believe others. The VK5 boys also worked Wally on 23cm.

Meanwhile, I had been running the 23cm beacon VK3RXX on 1296.530 MHz on the amplifier and beaming west. Trevor VK5NC had commented that the signal was bending his "S" meter from the back of his beam and Joe VK7JG from Launceston also mentioned it was 559 and this was with the beam "side-on" to him in Tassie!

At 0930 Wally VK6WG came on 2m calling CQ and he was 5x9 in Burwood. I responded and suggested he take a look for the VK3RXX 23cm beacon and he played it back to me on 144.150 MHz. A QSO on 1296.150 MHz gave me 5x2 and after a struggle I gave him the disappointing report of 4x1. We had just completed a QSO on 23cm of around 2450 kms - about 3 km short of the current National Record set by Wally with Les VK3ZBJ. Close but not close enough!

Field Day

Alan VK5AR sends a list of his "better contacts" for the field day. He was portable near Kuitpo Forest about 400 meters asl.

0522 144 VK3FIQ 5x5 QF12
0524 144 VK3CY 5x7 QF13
0528 144 VK3AEF 5x5 QF03
0530 432 VK3AEF 3x3 QF03
0623 146 VK5NWH 5x5 PF75
0629 146 VK5KOP 3x3 PF75
0638 439 VK5NWH 5x5 PF75
0642 439 VK5KOP 5x5 PF75
0720 50 VK5XE 5x5 PF96
0722 50 VK6AOM 5x5 OG80
0820 144 VK5NC 5x9 QF02
0837 50 VK4FNQ 5x2 QG39
1014 144 VK3CY 5x9 QF13
1200 432 VK5MC 5x9 QF02
1959 144 VK3WRE 5x8 QF32
2008 144 VK3AEF 5x9 QF03

2011 432 VK3AEF 5x2 QF03
2014 432 VK3WRE 4x1 QF32
2024 144 VK3AXH 5x9 QF12
2025 432 VK3AXH 5x5 QF12
2027 50 VK3AXH 5x5 QF12
2028 50 VK5NC 5x7 QF02
2029 50 VK3WRE 5x3 QF32
2035 50 VK3ATQ 5x2 QF22
2037 144 VK3ATQ 5x3 QF22
2041 144 VK3BJM 4x3 QF33
2048 144 VK3AUU 5x3 QF21
2050 144 VK3XPD 5x5 QF22
2052 144 VK5NC 5x9 QF02
2158 146 VK3SWD 5x9 QF03
2213 144 VK3AL 5x5 QF22
2215 144 VK7JG 5x3 QE38
2221 144 VK3DQW 4x3 QF12
2225 50 VK3DQW 3x3 QF12
2227 144 VK3AFW 5x5 QF22
2240 144 VK3CY 5x9 QF13
2254 144 VK3ATL 5x5 QF21
2259 144 VK3ATN 5x7 QF14
2300 50 VK3ATN 5x7 QF14
2301 50 VK3NA 5x7 QF14
2302 144 VK3NA 5x3 QF14
2309 50 VK3ATL 4x1 QF21

He said, "I believe that there is no advantage in trying to work these stations during the field day. Two contacts in the SAME locator square on 10 GHz nearly doubled the score of 39 (mainly) difficult contacts on 50 MHz. I am going to think seriously whether I will operate in this contest again with the current rules.

Alan VK3XPD reported good weather for the Field Day contest on 8-9/

On the evening of Saturday 9/1, Trevor VK5NC, Colin VK5DK with Tom VK5EE providing "support services", all travelled to a point about 30 km west of Mount Gambier while Alan VK3XPD went to his usual spot at Olinda, about 30 km east of Melbourne.

Also participating on 2.4 GHz (as part of the Field Day) were Ralph VK3WRE and Mark VK3TLW who were "perched" near the summit of Mount Skene about 100 km to the north-east. At 1118 they successfully contacted Alan VK3XPD at 5x2 both ways.

While these 2.4 GHz contacts were being conducted, Trevor VK5NC and David VK3XLD, (part of the Geelong contingent operating at Anglesea under the callsign VK3ATL), were attempting a 5.7 GHz contact over about 300 km. David was a welcome newcomer to 5.7 GHz but with only 5 milliwatts available from his recently completed "No Tune

Transverter"; this QSO was always going to be tough. David did hear Trevor (with his 6 watts) but unfortunately Trevor could not hear David. David will be building an amplifier very soon.

Later, Colin, Trevor and Tom had a series of QSOs with Alan on 3.4, 5.7 and 10 GHz over an "all land" path of some 420 km.

Initial signals at 1200 were marginal with QSB but built up to a peak of 5x9 as the evening passed and the early morning arrived. These series of QSOs were recorded for the Ross Hull Contest between the hours of 1240 and 1352.

David VK5KK reports: *With the slow start to the tropo season, the National Field Day Contest on 9-10/1 was a golden opportunity to test all the microwave gear. In the end I had 50, 144, 432, 3456 and 10,368. I forgot to take the 1296 transverter and 5760 was found to be non-operational. Out of practice! I did however have my new fold-out tripod tower that will hold two 600 mm dishes plus 144, 432 and 1296 MHz antennas. This was a resounding success (ie. it didn't blow over!). The whole arrangement including antennas packs down to fit in the car boot. Everything successfully ran from one 40 Ah 12-volt battery.*

Arrangements had been made to team up with Alan VK5AR who was near Mount Magnificent, about 60 km SE of Adelaide, as part of the exercise. In the SouthEast, VK5DK, VK5EE and VK5NC were taking microwave gear to Mount Graham. At least some one else was going to have gear within earshot, about 350km!

As I arrived around dusk, the first problem was finding Alan VK5AR. My map for the area was a little vague so some mutual DFing was needed. Regardless, I decided to first set up at a spot near Bald Hill that I had noted from previous surveys to be a good location for microwaves to the SouthEast. Contact was made with VK5DK, VK5EE and VK5NC on 3456.2 and 10368.2 MHz with signals up to 5x9 over the 350-km path.

On 10368.2 MHz I also worked Chris VK5MC who had his portable equipment set up just outside his EME shack, again about a 350-km path. Also worked into central VK3 on 144 and 432. The 432 equipment was simply 2.5 watts from an IC402 into a 9-element beam.

After this round of contacts, I packed up and went looking for Alan VK5AR. In

the pitch black it took about 20 minutes to find him, using the 2m handheld with no antenna to DF him! I set up again and worked the SouthEast crew on 10 GHz for a second round. Alan VK5AR also made use of the 10 GHz equipment. All in all an enjoyable outing!

Microwaves

David VK5KK: *Since early January, I have had almost nightly rag chews on 10 GHz with Keith VK5AKM. Both he and I have 10 GHz set up permanently from home so we just turn it on and talk! To add a bit of challenge to the work we use the Torrens Island Power Station as our "reflector", signals are normally 20 dB over the noise via this path, as we are about 35 km apart; direct path signals are substantial.*

With the ability to rotate dishes at both ends, we have been able to measure Doppler shift on various "moving" reflections. As VK5VF/b is well shielded from here and the direct signal is very weak, reflections with Doppler are much stronger. As the Doppler can be up to a few 100 Hz, it has become an interesting study to judge the quality of a duct and locate larger moving fronts or clouds out a few hundred km with a bit of help from a satellite weather map.

The actual results are still a little vague, as we just tune on SSB to work out the frequency difference between the two signals. Some simple maths will give a velocity. As the object is travelling towards you the frequency shift is always to the high side. It is possible to pick times when a high level duct does exist to the west sufficient to carry the signal to/from a cloud mass or ??? well out to sea. As this year has been poor to the west, we just haven't had any really good ducts with which to work!

Alan VK3XPD: *On 30/12/98 at 1230, Russell VK3ZQB at Port Fairy worked on 10 GHz Colin VK5DK and Trevor VK5NC both at Mount Gambier and Chris VK5MC on holidays at Robe. This is a fairly significant series of QSOs because it is not often that four stations are on 10 GHz simultaneously in VK. Signal reports were 5x5, 5x5 and 5x2 respectively.*

In the evening of New Year's Day we noticed propagation building up. The conditions were deemed suitable for 10 GHz so at about 1100 we were all in position. Russell VK3ZQB on the Port

Fairy foreshore, Colin VK5DK and Trevor VK5NC on "the mount" at Mount Gambier, Mark VK3TLW and Ralph VK3WRE the summit of Mount Tassie and Alan VK3XPD at Olinda on the south eastern edge of the Dandenong Ranges.

On 10 GHz, the 150-km path from Russell at Port Fairy to Colin and Trevor at Mount Gambier was open with steady 5x9 signals over this relatively short distance. The 250 km path from Alan at Olinda to Russell at Port Fairy yielded similar signals with rapid QSB (within a matter of seconds) from just above the noise floor to 5x9.

The path from Olinda to Mount Gambier of roughly 400 km was very poor in comparison - signals were hovering around the noise floor. No two-way contacts were achieved.

Meanwhile, over at Mount Tassie disaster had struck when Mark's 10 GHz transverter was found to be very "deaf" so it was packed away for a repair job. Ralph had also brought his recently completed 2.4 GHz transverter and a midnight QSO over roughly 150 km to Olinda yielded a 5x2 report from Alan (not bad for 40 milliwatts into a GridPack) and 5x9 from Ralph. The difference being the 5 watts from Alan's transverter.

Even later that night, Russell VK3ZQB and Roger VK5NY near Mount Wilson in McLaren Vale had a long "rag chew" on 23cm starting at 1230. Signals for this QSO from the home QTHs were a steady 5x8 for most of the time.

Next day in the wee hours of the morning, the phone at Alan's place rang at 2045 (0745 local). It was Trevor again! The 23cm beacon VK3RXX was "in" again at Mount Gambier. At 2100 Alan completed a QSO with Russell on 23cm 5x9 both ways followed almost immediately by QSOs with Colin and Trevor in Mount Gambier, where signal reports were 5x8/5x9 respectively.

As band conditions were so good we went portable again. However by the time we were in place the propagation between Alan at Olinda and Colin west of Mount Gambier had again deteriorated significantly but not before we achieved a QSO on 10 GHz over a distance of some 420 kms. The mediocre reports of 5x1 reflected these poor conditions. This was Colin's first 400 kms plus QSO on 10 GHz. Not unexpectedly, the 10 GHz signals between Russell at Port Fairy and

Mount Gambier were 5x9.

The propagation continued into Sunday evening (3/1) when Alan VK3XPD completed seven 23cm QSOs from 0830 until 1200. Alan worked both Joe VK7JG and Andrew VK7XR in Tasmania and five other stations in the Latrobe Valley region of Victoria. These were Rob VK3EK, Ralph VK3WRE, Peter VK3KAI, Brian VK3BBB (1 watt FM) and Mark VK3TLW at Ralph's QTH.

120 GHz Record

Will Jensby W0EOM has claimed a new 120 GHz distance record of 5.3 km with **Bob Johnson KF6KVG**. The CW contact was completed on November 16 in Redwood City, California. The pair has been working on 120 and 144 GHz rigs based on Hughes harmonic mixers and 9-inch Cassegrain fed dishes. They plan further work in the upper microwave bands. ... **W3EP**

Closure

The peak of Cycle 23 approaches and so does the next equinox. In the light of this the following from **Neville Mattick VK2QF** <vk2qf@winsoft.net.au> who says: So the "SF == < 100" 21:00 indices == 99 13 03.

<http://www.ips.gov.au/papers/richard/ssnpred.html>

April 2000 solar peak, as per above, 1999 equinox to come will yield many interesting chances for station evaluation prior to the peak.

Some interesting data may coincide with this prediction: <http://www.winsoft.net.au/~vk2qf/predictn.htm>

Need I say more? You should be preparing your six-metre equipment in readiness for those countries you missed last cycle and for new stations that have since appeared.

Closing with two thoughts for the month:

1. A psychiatrist is a person who invites you to tell everything and then charges you for listening, and
2. In a democracy, the votes of the vicious and stupid count, but under any other system they might be running the show.

73 from The Voice by the Lake.

AMSAT AUSTRALIA

Bill Magnusson VK3JT
RMB 1627 Milawa Vic. 3678
Email: vk3jt@amsat.org

A Satellite User's Perspective on the Millennium Bug

I will devote this month's column to a very important issue. How will your computer cope with the transition from 1999 to 2000? As satellite users, a great deal of our software is time dependent and this time-critical element is crucial to the enjoyment of our particular facet of amateur radio.

Volumes have been written on this subject over the past few years but this dissertation from a well-known and respected member of the amateur radio satellite fraternity is directed specifically at you, the satellite user.

The article was downloaded from the AMSAT web site and is reprinted here with the permission of the author.

The Year 2000 Transition:

Your PC and AMSAT Software,

by Roy D. Welch, W0SL

Abstract

As we approach the year 2000, there are some items we need to begin to check out in our computers and the software that is running on them. We need to check that date and time sensitive software will function during and after the transition from December 31, 1999 to January 1, 2000.

The PC Most computer software that uses the current date and time gets that information from the PC operating system. The operating system, DOS, Windows, etc., is just software that disappears when the PC is turned off. From where then, does the operating system get this information? At boot time the operating system is loaded and reads the CMOS Real Time Clock (RTC) which remains running on a backup battery when the PC is powered off.

This RTC is hardware in the PC. The CMOS RTC maintains a two digit year value, so the PC BIOS appends these two digits to a pair of stored century digits making the four digit year value that the operating system obtains. The RTC does

not have the century digits and therefore cannot increment them when the year changes from 1999 to 2000. The RTC then just turns over from 99 to 00.

The earlier PC BIOS systems only stored the century value of 19. No one was worried about the year 2000 back then. It was a long way off. Now when the year rolls over from 1999 to 2000 you would logically expect this to cause the programs run in those PCS to think the date is 1900. If the program takes its date input directly from the BIOS, that is what will happen.

However, if the program gets the date from the operating system, it will think the year is 1980. This is because the operating systems that were designed back in 1984 had no need for supplying current dates earlier than the 1980's.

So when the PC boots up with the RTC showing the year 00, the operating system tries to make this 1900, but discovers this is an invalid date and defaults to 1980. How many of you remember booting up one of the older PCs that had a dead ROM backup battery or worse still, no RTC at all? It probably showed the date of April 1, 1980.

Generally, machines that have been manufactured more recently have BIOS systems that have the ability to decide that the century year is either 19 or 20. You might infer that deep in the BIOS there

National co-ordinator:

Graham Ratcliff VK5AGR
Email: vk5agr@amsat.org

AMSAT Australia net:

The AMSAT-Australia net is held on 80 or 40 meters LSB each Sunday evening. During daylight saving time in South Australia the net is on 7068 kHz +/- QRM with an official start time of 0900utc (with early check-ins at 0845utc), during the rest of the year the net is on 3685 kHz +/- QRM with an official start time 1000utc (with early check-ins at 0945utc).

AMSAT Australia newsletter and software service:

The newsletter is published monthly by Graham VK5AGR. Subscription is \$30 for Australia, \$35 for New Zealand and \$40 for other countries by AIRMAIL. It is payable to AMSAT Australia addressed as follows:

AMSAT Australia
GPO Box 2141
Adelaide SA 5001

Keplerian Elements.

Current keps are available from the Internet by accessing the AMSAT FTP site, ftp.amsat.org and following the sub-directories to "KEPS".

must be some decision tree that says if the year digits are between 80 and 99, for example, the century digits are 19 and if they are between 00 and 79 they are 20. This would mean that all would be OK until 2079.

However, this is not the case. In Windows 95 you can set the date to any year from 1980 through 2099. The next time you boot up, the date is remembered, that is if your PC is "Year 2000 (Y2K) compliant."

The Tests

Your PC will be "Y2K compliant" if:

1. The RTC two digit year date is read at boot time and is furnished to the operating system by the BIOS as a four digit year value which will increment from 1999 to 2000 at midnight.
2. Then after rebooting, the correct 2000 date will be furnished to the operating system by the BIOS.
3. The year 2000 will correctly accept February 29, 2000 as a valid date.

The leap year rules say that any year evenly divisible by four shall have an

extra day added, EXCEPT for century years, EXCEPT for century years evenly divisible by four hundred. In other words, the years 1600 and 2000 are leap years since they are evenly divisible by both four and four hundred. However the years 1500, 1700, 1800, 1900 and 2100 which are evenly divisible by four, but not by four hundred, are not leap years. How can you tell if your PC is Y2K compliant? There are three manual tests you can make which will help you determine this.

First, set your system date and time to December 31, 1999 and the time to about two minutes before midnight. Turn your PC off and wait for three or four minutes. Then reboot and check that the system date and time displayed are a few minutes after midnight on January 1, 2000. Secondly, set the date to any date after January 1, 2000, except February 29, 2000. Power down the PC and reboot. Check that the date shown is still the same date you set. Lastly, try to set the system date to February 29, 2000. If any of these tests fail, your PC is not Y2K compliant. If you want to perform a more thorough test, there are software programs available which can perform these tests for you. Also, in some cases, there are software solutions available that can correct for certain types of non-compliance for Y2K. One Internet site to visit for a more complete discussion of this problem and a free test program is <http://www.righttime.com>.

The Software

OK, so lets assume our PCs are Y2K compliant. We ought to be home free, right? Wrong! Our software must also be Y2K compliant. Back when early software was being written, the ability to conserve memory was paramount.

If you could find a way to store data in memory in a compressed way, you did it. It cost more processing time to compress and uncompress the data, but it saved memory. Memory cost more than processing time back then. One of the minor memory savings used was to store year values in two digits rather than four. In other words store 1985 as just 85. After all, everybody knew that the century value was 19 and it would be assumed that way by any software writer. As a result, in many cases, only two digit year values are contained in the data input to date and time sensitive programs.

One example of this is seen in the Keplerian elements data. Remember the Epoch entry? It is in the form YYDDD.xxxxxxxx, where YY is the two-digit year value. The satellite tracking programs written beginning in the middle to late 1980s have had to interface with these two digit year values. In many cases, the orbital calculation algorithms in these programs used the two digit year values throughout. A typical tracking program looks at the Keplerian elements and then calculates forward from the Epoch time in the elements to the current time to determine the current position of the satellite. This means that the year, day and fraction-of-a-day values in the Keplerian elements are the beginning point of the calculations. The current year, day and fraction of a day are the target of the calculations.

The program must determine the exact difference in time from the Keplerian element Epoch time and the current time. This involves mathematical operations on the year, days, hours, minutes, seconds, and fraction of seconds involved. Leap year days and Century days have to be accounted for also. This gets rather messy. So the Epoch times involved are converted to Julian days. Julian day one was January 1, 4713 BC. January 1, 2000 will be Julian day 2,451,545. There are mathematical formulas that let you input two different Gregorian calendar dates and times, with four digit year values, convert them to Julian dates and obtain the difference between the two dates in days and fractions of days. These formulas take into consideration all leap year and century days. This really simplifies things. This difference in time is the input to the orbital calculation algorithms that let us determine the current satellite position from the Keplerian elements. If there are tracking programs still out there, which do not use Julian dates in their calculations; they are in deep trouble. However, even those programs that do use Julian date calculations can still have problems. Remember, that the Julian dates are calculated from Gregorian date inputs that contain a four-digit year value. NASA has said that the Keplerian Element format will remain the same and that the year value will just roll over from 99 to 00 with the transition to the year 2000. When the tracking program looks at the Keplerian elements for a satellite, how then will it

know what century value to use with the two-digit year value in the Epoch date? Somewhere along the calculation train, a decision must be made. One way is to make the assumption, for example, that any Keplerian Epoch year value 78 through 99 has a century value of 19, and any year value 00 through 77 has a century value of 20. Once this has been done, the use of Julian day calculations will safely allow you track a satellite right through midnight December 31, 1999 into January 1, 2000 without a glitch.

Another glitch to look for

In some orbital calculations it is necessary to calculate a value called the Sidereal Time value at January 1, YYYY at 00:00:00.000Z. This value is used throughout that year. Here again, the assumption above must be applied to determine which century should be applied to the two-digit year value. In other orbital calculations, the Julian date difference between the Keplerian Epoch year value and the Julian day value for January 1, 2000 is used. Still, it is necessary to convert the two-digit Epoch year value to a four-digit year value to obtain the Epoch Julian date.

Lastly, a less troublesome problem may arise when the Keplerian Elements are updated. Most tracking programs have a Keplerian update routine that protects against updating the elements for any given satellite with elements that are older than the ones already on file. Imagine what will happen when the first set of new Keplerian elements are issued in 2000. Some Epoch dates will have year values of 00 and some will still have 99. It usually takes one or two issues of Keplerian elements before all the satellites have a year value from the new year. In the case above, those satellites with Epoch year values of 99 will still update OK as long as the complete Epoch date is later than the ones already on file. However, unless some programming has been done to recognise 00 as representing 2000 and 99 as 1999, the 00 Epoch year elements will be rejected as being older than the ones already on file. Some programs may permit updates overwriting existing elements without regard to the Epoch value. This will be the work around for those programs where the normal updates are rejected. Others which are not compliant in this regard may require that

the tracking program Keplerian data base file be deleted completely before each update until the new Keplerian element files contain satellites with all Epoch year values of 00. This will be done automatically in those programs which do not create a Keplerian element data base file and instead, just read in the distributed Keplerian Element file itself.

What has been done?

OK then, just what is the status of our AMSAT distributed tracking programs with respect to Y2K compliance? First, some background. Back in 1985 when I first changed the ORBITS programs from an interpreted Basic program to a compiled Quick Basic program I ran up against this Y2K consideration. I decided at that time I didn't want to hear from a lot of people in fifteen more years, much less pay the postage for replies, etc. So I

many of the software authors as I could find, asking them to make a Y2K compliance check of their programs and let me know what the status of the programs were, and whether or not they would be made compliant or not. My concern was that we should stop offering any programs that were not going to be made compliant. As a result of that inquiry we stopped offering one program. The author said that he did not intend to update it. Then in October 1997, at the AMSAT Symposium in Toronto, Philip Chien KC4YER and I met with Ken Ernandes. We asked him if he could develop a set of test Keplerian elements for December, 1999 and January, 2000 that I could send to the software writers for their use in performing actual tests on their programs. He kindly agreed to do so and in a few weeks I received a TEST2000 zipped package via e-mail which I then sent to

if your PC will make the transition and if not, download a simple program to be run at boot time to see if that fixes the problem.

There are such programs available on some of the Y2K web sites. Check with your PC manufacturer to see if there are ROM BIOS updates or boot time programs available for your PC that will fix the problem. After all is done, if your PC still fails Tests 1 and 2 above, you have the worst possible Y2K scenario. If you have date/time sensitive programs running on that PC, you should consider replacing it. If the PC fails Test 1 and passes Test 2, then at least you can manually set the date after booting it up. If it fails Test 3 however, there is no work around and all dates following February 29, 2000 will show the wrong day of the week. This may or may not be a problem for your particular applications. Once you have run through the tests covered earlier in this paper, checked out your application programs and have satisfied yourself that all is well, then you should not have any further date/time problems, right? Remember; never say never. Those of you with some of the older GPS units, watch it on the evening of August 21, 1999 when the week counter rolls over from week 1023 to week 0. Also, watch out for the year 2038 when the signed long integer variable in the compiler that compiled your program is too small to contain the Julian date values. When this happens, I don't expect to still be around. However, I can look ahead and imagine that those who are, may wake in the middle of the night or look up from their work, depending on where they are, and wonder, "What was that?"

Where do I stand ...? ... I'll be buying a new computer and attempting to upgrade my old 486 so it can run programs other than satellite related ones. But then I've been prepared to do just that for some time now

made the decision to force the user to input the Epoch year in a complete four-digit value separate from the Epoch day. I then tested the program across the 1999/2000 transition boundary and it worked as it should have. I was happy and confident that I would never have to worry with that problem again. Never say never! Time went by and in 1994 I began making inquiries as to what NASA was going to do about the published Keplerian elements. Were they going to change the format of the Epoch day or were they just going to roll the year value over to zero (00)? The answer I received was inconclusive.

"We didn't know yet." At that time I also began making inquiries of a few of the AMSAT software authors as to whether their programs were Y2K compliant. I received some answers saying that it didn't appear so and a few that said yes. One said his program wasn't compliant and didn't expect it would be updated. In June, 1996, I e-mailed as

all the tracking software developers I could think of. Just for the fun of it, I decided to test the ORBITS programs again with the test Keplerian elements. It worked beautifully, tracking right up to midnight on the evening of December 31, 1999 and then into January 1, 2000 without a hitch. Then I tried to update the 1999 elements with the ones having 2000 as the Epoch year. Ugh!!! It refused to update, claiming the elements were older than the ones already in file. Back to the keyboard and compiler again. It had been so long since I had compiled a new version, that I had a problem remembering how to get the compiler set up. I did get the fix in and it is now fully Y2K compliant ... I think. Remember, "Never say never."

Summary

I suggest you visit some of the web sites devoted to the Y2K problem. You can find them by doing a search with your web browser. Run the three simple tests to see

Sources

Pete Woytovech, Senior Programmer Dell BIOS Development, "The Century Rollover and the PC System Date".

RighTime (The RighTime Company, Miami). J. David McLaughlin, Systems Coordinator Simco County Mental Health Education, "Testing Your PC's Hardware Year 2000 Readiness".

Well ... that's the story according to Roy et al. Where do I stand in view of the above? Simple ... I'll be buying a new computer and attempting to upgrade my old 486 so it can run programs other than satellite related ones. But then I've been prepared to do just that for some time now. How did you fare? Good luck!

ar

SPOTLIGHT on SWLING

by Robin L. Harwood VK7RH
5 Helen Street, Newstead Tasmania 7250
(03) 6344 2324
E-mail: robroy@tassie.net.au

“Sparky, it’s time to go”

SUMMER HAS GONE and already Propagation is changing. Daytime signals are becoming increasingly noticeable with the propagation we have experienced on the higher frequencies in the evening hours gradually dropping off. Also the major seasonal alteration is due to take place on Sunday March 28.

This is when most of Europe goes on to Daylight Saving Time, which also coincides with those Australian states reverting to Standard time. Previously there were four set periods roughly corresponding to the seasonal variations but this was reduced to two, being the last Sundays in October and March. However some broadcasters still have opted to keep the four periods.

Final message

“Sparky, it’s time to go” was the final message tapped out in Morse over Melbourne Radio, VIM, on Monday February 1 at 0019 UTC. After 87 years of continuous service to the maritime service in Australian waters, the plug was finally pulled on 600 metres (500 kHz) when this frequency was no longer required to be constantly monitored, either by coast stations or by radio officers at sea. It remained the primary search and distress channel from the very inception of wireless telegraphy at sea until then. It was on this frequency that the Titanic sent out the first SOS signal on the 14th of April 1912, after colliding with an iceberg in the North Atlantic.

Thousands of lives could have been saved if the wireless operator on a nearby American steamer the “SS California” had kept monitoring the channel. Instead he turned off the receiver and went to bed. Following the Titanic disaster, it became mandatory for all ships at sea and for land stations to constantly monitor 500 kHz in case of another emergency.

In 1988, it was decided to introduce a new automated system called GMDSS or

Global Maritime Distress and Safety System. This came into effect last month and the MF service was no longer required, nor was the use of Morse. Also GMDSS has done away with the need of a permanent radio officer on board. All communications are computerised and the use of satellite delivery means that MF and HF are no longer needed. Will the wheel turn full circle? Many think that the bureaucrats have got it all wrong. Satellites are prone to fail due either to mechanical failure or from solar flares. They are also vulnerable to strategic attack by missiles.

The cost of telecommunications via satellite at sea is still fairly expensive. The American Globe wireless company has capitalised on this by acquiring many former HF coast stations and linking them by satellite to their HQ in California. Although VIP Perth radio may have closed their CW operation, the call is continuing with Globe’s SITOR/CLOVER server. I do hear some Globe outlets still using c/w, primarily KFS/KPH in California and A9M in Bahrain.

Yes there still are other stations within the maritime allocations still employing c/w, mainly in China, Taiwan, Korea, Indonesia and Italy. The Japanese have gone. They were an excellent measure of 22 MHz propagation. Although Morse may be fading away, amateurs are still enthusiastically using it and are some intelligence agencies who use it to send traffic in cut numbers. Letters are sent instead of numerals. There is one strong station doing this from the USA on 6785 KHz +/- around 1000 Hrs daily. No call signs are given, just numbers.

What is filling the void are plenty of Asian SSB stations. Because they seem to use vernacular of dialects, identification is almost impossible. I am reliably informed that the traffic often revolves around illegal activities including piracy. I did recently hear an item on the BBC World News that the International Maritime Organisation

(IMO) stated there was a dramatic increase especially in South-east Asian waters. I would not be therefore surprised that they could be using SSB transceivers either modified amateur or redundant marine equipment.

There also seems to be other modes being heard within these allocations. There is one with a whooshing sound, not to be confused with the R7B mode. I think it is some kind of digital mode used by NATO.

When does the twenty first century begin?

Following my comments in the January issue, I received a letter from Ken VK4KF querying my assertion that 21st Century starts on January 2001. He wants to know if it was promulgated as the official date. Well I have consulted the VK7 divisional solicitor and also note that the Commonwealth constitution came into effect on the first day of the 20th Century being January 1, 1901.

Ken maintains that the first number is zero and thus 2000 should be the first year. When I was at school, I was taught that the first number was 1. I am certain that 1/1/2001 is the first day of the 21st century. Legally you are not one until you have your first birthday that is one year after you have been born, unless you were unfortunately born on the 29th February, then you have to wait four years for your first birthday. 2000 is being touted as being the birth of the millennium. This topic has been also hotly debated in the editorial columns of many local papers.

Belgium

You may know that Belgium is linguistically divided into two, French and Flemish (a variant of Dutch). For many years there have been two separate broadcasting organisations catering for each group. The French service discontinued using shortwave several years ago and the Flemish section, which also produces other languages such as English, continued. Now the French section known as the RTBF is back on shortwave but using the Deutsche Telekom facilities as Juelich, Germany. I am hearing them on 9490 around 0530 daily, although after March 28, this will probably alter.

Well that is all for this month. My thanks go to Ken VK4KF, EDXP. Don’t forget that you can contact me at the above address or e-mail me at

robroy@tassie.net.au.

73,
Robin VK7RH



Divisional News

weekends of the 7th and 14th, VK4WAG Maurie did the 80 meter transmission using the internet feed, however it appears no callbacks were forth coming.

Golden Days Of Wireless

Golden Anniversary celebrations are in order for VK4RH, Leigh Hoey of Broadbeach, on Queensland's Gold Coast. Leigh has just "clocked up" 50 years as a licenced operator in our Amateur Service. Well done on this landmark achievement.

WIAQ Annual General Meeting

Keep April 17 free so you may attend and vote in a brand new team for 1999-2000. The venue this year will be the Edwards Room at the Bronco's Leagues Club, Fulcher Rd, Red Hill. The start time as yet to be advised.

Southside AR Society

Warren VK4WH would like to remind members that due to the summer storm season playing havoc with 80m. The 80m Sunday night nets have been moved to 28.430MHz USB. Static and general QRM was noted at 20dB on 3.565Mhz most nights, with most people on the net having difficulty hearing each other. As you will be aware propagation has been quite good on 10m for the past few weeks so the chance of a DX station dropping in is quite possible. Nets are held at 7:30pm QLD time Each Sunday night.

Townsville

FNNQARGG! : A reminder that this years Far North and North Queensland Amateur Radio Get Together will be held at Beachcomber Coconut Village, South Mission Beach, from Friday Afternoon 11th to Monday 14th June 1999. Plenty of time to organise your travel to this idillic spot.

Alistair Elrick VK4FTL
WIAQ Treasurer.

VK5/VK8 Division Notes

Burley Griffin Building - Move of Headquarters

As of writing, mid February, we are awaiting full details of a proposed lease and licence from the City of West Torrens Council for use of the appropriate buildings for our proposed new Headquarters and other meeting facilities. I would expect that by the time this material appears in print we will have received and examined such documents, following which it will have been necessary for a final decision to be made regarding the proposed move.

In the meantime we have gone ahead with

Dural:

More upgrading of equipment etc. is proposed for Dural with Council recently approving expenditure on crystals for new transmitters. A request has also been received by Council from our Dural Engineers, supported by the Dural Officer, that new, low-loss, coax and connectors be purchased to replace some of the older cable. At the recent Council Meeting it was resolved that quotations should be obtained from various suppliers.

'til next time -

Eric Fossey VK2EFY
Division Secretary.

Qnews - VK4 Notes

RMT Awarded AX Day Medallions

A just reward story has surfaced in VK4: - John VK4AFS sniffed out this one on three dedicated volunteer Amateurs. Messrs Bill Sebbens VK4XZ, Guy Minter VK4ZXZ and Brian Rickaby VK4RX were summoned to appear at Queensland's Parliamentary Annex for Australia Day. They have been presented with the Australia Day Medallion by the Minister for Emergency Services, the Honourable Merri Rose MP, *'for outstanding contribution to the development and implementation of the Rural Fire Service's communication network'*.

The RMT gang, (Retired Maleny Trio) submitted a proposed new and improved radio bandplan to the Commissioner for Rural Fire Services. She accepted it, and then Brian, Guy and Bill proceeded to visit all Rural fire Brigades in the area from Noosa to Kingaroy to reprogram their Transceivers to the new bandplan. I might add all this was done on a voluntary basis.

As they said during their acceptance speech, "We consider it's a great way to use our Amateur Radio knowledge for the benefit of the community".

80 Meters Returns

Wayne VK4NWH will recommence the Sunday Morning 80 Metre QNEWS as from the 21st February on 3.605 MHz. The

VK2 Notes

Annual General Meeting:

A reminder that the AGM of the VK2 Division is to be held at Amateur Radio House, Parramatta on Saturday 17 April 1999 commencing at 11.00am.

By the time most of you read this the deadline of 6 March for Council nominations for will have passed and the list of nominees closed. I sincerely hope that more than the required nine have been received and, therefore, an election by ballot will be necessary.

The Annual Report together with the necessary ballot papers, including a brief history of the various candidates, will be forwarded to all members eligible to vote mid March in accordance with our Articles of Association. Under "Motions on Notice" you will see there are a number of amendments to the Articles that have been recommended by the Policy and Strategy Committee and approved by Council. In every case the amendment is of a minor nature and is designed to clarify and reinforce the Article in question. Please, therefore, consider them carefully by comparing the proposed wording against the original.

One very important point - if you cannot attend the AGM please ensure that you appoint a member who will be attending as your proxy. Remember also to give him or her instructions as to how you wish them to vote on your behalf. It is YOUR Division - have your say!!!

New Member Prize:

As previously advised in this column - a draw will be held at the AGM and the lucky new member will win an ICOM 706 MarkII (valued at about \$2300) kindly donated jointly by Icom Australia and Amateur Transceiver Radio Centre of Girraween, NSW. To be eligible to be included in the draw Membership Applications must be received not later than 26 March 1999.

All New Members previously approved will automatically be included in the draw. So why not try once more to persuade that friend to join the Institute - you could be doing both him/her, and the Institute, a big favour - they could win the ICOM and the WIA becomes that little bit stronger at the negotiation tables.

arrangements, as instructed by members at a General Meeting, to pursue the matter as expeditiously as possible. To this end a Planning Application has been submitted which, if approved, will allow us to erect a suitable tower on the site. This action has been taken in view of the fact that such approvals can take some time and the existence of a tower would be a prime requirement prior to any further moves to change the location of VK5WI.

Rest assured that members will be notified as soon as possible, that means probably via the Sunday News broadcast, as to the ongoing developments.

Sunday Broadcasts

We recently saw a need to update the record of arrangements with the Australian Communications Authority (ACA) regarding the provision of a weekly Sunday news "broadcast". A letter was written to the Adelaide office of the ACA and a reply subsequently received.

Space considerations for these notes preclude reproduction of the full text of the ACA letter. In the reply the ACA points out that "the arrangements in place are the result of various decisions made over a number of years and are, thus, the product of history." The letter continues, "I can say that the Australian Communications Authority (ACA) has no intention of changing these at present and is happy for them to continue for the present."

The letter also points out that although the notion of a "broadcast" may seem to be at odds with the Licence Condition Determination, the view is taken that "these may be sanctioned on the grounds that they are intercommunications with members about radiocommunications matters and are thus in accord with the broad definition of Amateur Radio".

The ACA sees no need to alter the present arrangement at this time, including the agreement to allow an equipment disposal section of the broadcast.

In connection with the production and transmission of the weekly broadcast the Divisional Council recently approved a revised set of "guidelines". These were read as part of the broadcast on 7 February and will be available in the Divisional Notes, Packet Radio version for that date. Copies will also be provided to the various affiliated Radio Clubs and other regular contributors to the weekly broadcast.

The Andy Thomas Show

During January I was approached by our own Australian astronaut, Dr Andy Thomas, who had operated as VK5MIR during his mission on the Russian Space Station. Andy was hoping to be able to meet as many as possible

of those Amateur Radio operators who had made contact with him during that event. I explained that we had no real way of determining just who these were, however, an evening was organised where all Amateur Radio operators were invited to hear a talk by Andy on his experiences.

This event took place on 20 January and was possibly the most successful Amateur Radio event ever held in South Australia. We had some difficulty in promulgating details as the weekly Sunday Broadcast was in recess for most of the time leading up to the event, however, a lot of work was done to try and reach as many people as possible. We feel that we did achieve this purpose.

The evening with Andy Thomas was of such significance that I do not believe we can do justice to it in these Divisional notes. I will thus be producing a separate article, with photographs, to deal with it.

QSLING for VK5MIR

Contacts

No provision was made in the USA for any special QSL card for contacts with VK5MIR. It is not surprising that the significance of the operation using this callsign was overlooked by our United States friends. Action has been taken to remedy this situation. Members of the VK5 Division of the WIA saw fit, at a General Meeting to vote for the costs of such a QSL card to be borne by the Division. A suitable card is in the process of being produced.

Those who made voice radio contact with Andy Thomas when he operated as VK5MIR on the Russian Space Station may obtain a commemorative QSL card for such a contact. They should send their own QSL card accompanied by a self addressed stamped envelope (SASE) to Ian Hunt VK5QX at 8 Dexter Drive, Salisbury East, South Australia.

It has been decided that a "cut off" date will be set for receipt of requests for a VK5MIR QSL card. Cards received after that date will not be acknowledged. The "cut off" date will be announced in this magazine and on broadcasts from VK5WI.

The reason for this approach is that we do not have any definitive log for the VK5MIR operation and thus no idea as to how many cards may be required. We also wish to keep costs for the cards to a reasonable minimum.

I would ask that you also spread this information to non-WIA Members where you think that they may have made contact with Andy Thomas as VK5MIR. Again, I emphasise that this applies only to "voice" contacts. Requests for QSLs for Packet Radio contacts with the MIR Space Station should be sent to the USA address provided for R0MIR.

A Memorial For Alf Traeger (VK5AX)

On Australia Day, 26 January, a memorial to the late Alfred Hermann Traeger OBE 1895 - 1980 was unveiled by the Member for Wakefield and Speaker of the House of Representatives, the Hon. Neil Andrew MHR. He was assisted in this task by Mrs Traeger.

This event took place at the town of Balaklava located to the north west of Adelaide. The site of the memorial is a garden area on the southern entrance to the town and adjacent to a school. The memorial is in the form of a sundial with a suitably inscribed plaque fixed to the base. The plaque refers to Alf as having invented the famous "pedal radio" system as used on many outback stations for emergency contact with the Royal Flying Doctor Service. It also mentions that Alf was an Amateur Radio operator and a Member of the Wireless Institute of Australia.

Mr Neil Andrew spoke regarding the history of Alf Traeger and exhibited a sound knowledge of his various exploits. I was invited to speak on behalf of the WIA at the unveiling ceremony. Quite a number of Amateur Radio operators from both the local and city areas were present. I hope to soon be able to provide some suitable photographs in connection with this historic occasion.

Divisional Meetings

The February General Meeting of the Division will have been held by the time this material appears. The evening will have been in the form of a visit to the ABC Radio and Television studios in Adelaide. A report on this visit should appear in the April issue.

The March General Meeting will be held on Tuesday 23 commencing at 7.30pm. Unless other notice is provided the location will be the Burley Griffin Building. Keep tuned to the weekly Sunday broadcast for any additional information. This meeting will feature a presentation by Tony Bell VK5UA on military radio equipment. Tony has a remarkable collection of such items and I am sure that those attending will find the evening very interesting.

Members are reminded of the Annual General Meeting that will be held on Tuesday 27 April where the Divisional Council for the ensuing year will be appointed by the members. Please make a note of this date in your diary and determine to attend this most important evening.

For now I wish you all the best on behalf of the Council and the Division.

73 de
Ian VK5QX
Divisional President

VK6 Notes

Hello to all VK6 members. As I have been away from the column for awhile, I will take this first opportunity to wish you all the very best during 1999, and I hope we can all find the time to enjoy the rapidly improving propagation now being provided by the rising sunspot cycle no. 23. It appears that I have missed out on some good VHF DX too while working offshore, with for example, John VK6AFA, working into Victoria on 2m FM !

2m Beacon

Tom VK6TR, President of the Southern Electronics Group in Albany has advised that the Albany 2mx beacon VK6RTW recommenced operation from his location at King River near Albany on Saturday 30th January 1999. The beacon has a new transmitter operating on 144.564 MHz, (a change of frequency from the old 144.465 MHz). It runs 10W into two yagis; one east and the other north towards Perth.

VK6RTW is also licensed for 50.308 MHz. The transmitter for this frequency is installed, but awaits an antenna at this stage. It is expected to commence operation shortly.

(thanks to Don VK6HK for this item)

VK6RAV working bee

This was held on-site just outside Northam on Sat 23rd Jan, the main purpose of which was to ascertain whether or not a UHF path exists from RAV to RUF in Perth. It is intended to link RAV "on demand", into the existing country / city 2m system, in order to provide better access from the east to broadcasts, WARG weekly nets, and to friends in the city and broader country areas.

A very early start was made by the Perth (and Beverly) contingents, as we all met at the QTH of Jim VK6CA, in Northam, at 07:30 am! As it was a windy day, there was not much enthusiasm for bringing the 90 ft (+/-) tower down and wrestling with guy wires. The suggestion was made that someone should climb the tower instead. After a prolonged silence in which no volunteer stepped forward, someone else recalled my promise, unwisely made in a previous column, that I would climb if no one else would. Accordingly I soon found myself installing the test antenna at about 50 ft, a sobering enough experience on a very gusty day !! The important thing is that it worked, contact was made with Perth via RUF, mission accomplished and we have a path ! Many thanks for the support of all those involved in this project, and a special thanks to those who attended the bee from afar. Attendance this day included; VK6CA, VK6LZ, VK6MT, VK6NT, VK6TRC, VK6ZLZ, VK6BIK.

I understand that RMS Mt. Saddleback was

also the subject of a working bee recently, and that the new 15-element UHF voice link beam was connected up with considerable improvement in signal strength. The beam is at the bottom of the last section. At least 6dB signal improvement was achieved and it may be as much as 9dB.

On Air General Meetings

The recently inaugurated on-air meetings appear to have drawn strong participation with the Tuesday 19/01/99 meeting having 22 participants on VHF, including 7 Councillors, and 2 on 80 m. The purpose of the Net is to overcome lack of member contact since General Meetings of the VK6 division have been discontinued. The call sign is VK6WIA, held on 146.750 MHz Lesmurdie Repeater and an 80 Metre Gateway on 3.564 Mhz controlled by Will VK6UU. Net Controller is Tony VK6TS. Meetings open at 1930 Hours (I believe still every 3rd Tuesday).

VK6TS Tony opened the net and invited participants to raise points of interest for discussion. Subjects discussed included; Net Notes published on Packet, Amateur Radio Study/Courses, WIA run Courses, Examination Costs, Benefits to Non-Members, various licensing fee issues, WARC/International Representation, Submission on AR to 38th Parliament, Response to new AR Magazine Format (generally favourable). The net closed at 2046 hours.

Red Flag item

One of the items discussed above leaves me uneasy about the long-term future and the situation described surely needs our urgent attention. The subject: WIA run Courses.

One participant asked if the WIA had run any courses, this was answered in the affirmative. Some years ago a series of courses had been run very successfully, however in later years it had been almost impossible to find sufficient candidates in spite of heavily subsidising the course and advertising it in the press.

The last WIA courses were held in 1996 and 1997, although a course had also been run privately by VK6JG last year. I'm sure that any letters sent to the Editor on how you think we could address this situation will be well received and will also be of more than passing interest to our Councillors.

January Council Meeting

Some items of interest:

- (1) A letter has been despatched to ACA supporting the Hills Group application for a HF Morse Beacon.
- (2) A letter to Clubs proposing a conference on 24th April is being prepared.

- (3) Proposed motions for the Federal AGM about possible fee increases have been circulated.
- (4) AR Magazine has been advised of changes to Broadcast frequencies.
- (5) Enquiries are being made about the recovery of possible WIA records.
- (6) Bill Bolton, VK6MB had become a Silent Key in the last few days (our deepest sympathy to family and friends).
- (7) Re: coverage of persons climbing towers. The Insurance Broker had confirmed that unqualified but experienced volunteers were conditionally covered by the WIA policies. It was up to the WIA to ensure that volunteers were experienced.
- (8) Attention was drawn to the final Morse transmission from VIP Perth (and other coast stations) on Monday morning 1st February at 0000Z. Harry 6WZ had achieved some publicity on ABC radio about the topic. The final message had been hand sent by an operator who was also a Licensed Amateur. VIP had provided the service for 87 years.
- (9) Callbacks for the Sunday news service had totalled 132 recently.
- (10) The closing date for nominations for Federal positions is the 19th March.

73,
Chris VK6BIK,
chrismor@avon.net.au

"QRM" Tasmanian notes

VK7 notes

Firstly my apologies for those who were waiting with baited breath for the Tasmanian notes in the February edition - they just didn't get there - sorry!.

The February Branch meetings incorporating each branch's annual meeting have come and gone with the loss of some old faces from the executives and some new ones elected.

Southern Branch

Officers elected for the next year are:

PRESIDENT Mike Jenner, VK7FB
Vice PRESIDENT Scott Evans VK7HSE
SECRETARY John Bates VK7RT
TREASURER Harvey Lennon VK7KSM

The names of the other officers will be notified later.

President Mike reported a very satisfactory year but expressed concern on finance. Cost of the repeater maintenance etc. is putting severe stress on the bank account.

Northern Branch

Officers elected for the year are:

PRESIDENT Al Burke VK7AN
Vice-PRESIDENT Geoff Wells VK7ZOO
SECRETARY Tony Simmonds
Ass. SECRETARY Phil Corby VK7ZAX
TREASURER Tim Holloway VK7TIM
QSL MANAGER Frank Beech VK7BC
Wicen/Education/

Examinations Officer Barry Hill VK7BE

In his annual report Al highlighted the excellent co-operation between members resulting in a very good year. Social events on some meeting nights, the Christmas barbecue at Myrtle Park/ the annual get-together at Christine and Paul Godden's, Scamander, plus some fine speakers at regular meetings had held member interest.

He thanked five members who have worked hard braving some stormy and cold weather on Mt Barrow to keep the repeaters on air.

The branch patron and QSL manager, Col Wright, VK7LZ has had to resign and will be sadly missed.

The northern branch has seen a succession of candidates passing and/or upgrading their licences under the eye of Barry Hill, VK7BE. Hopefully lots more to come.

North-west Branch

Our 1998 President David, VK7ZDJ and Secretary John, VK7KCC did not seek renomination. The new Executive is: -

PRESIDENT Al Burke VK7AN
PRESIDENT Bob McCulloch, VK7MGW
Vice PRESIDENT Bob Cropper, VK7BY
TREASURER Terry Ives, VK7ZTI
REPEATER MAINTENANCE

Alan van Dullemen VK7KAN
QSL MANAGER Ken hancock VK7KH

Retiring President David, in his annual report highlighted the very successful Christmas dinner function and the branch barbecue, both held in Ulverstone. He also recorded the problems of repeater maintenance.

Divisional Annual Meeting

This is being held in Burnie this year on March 13th. in association with a Hamfest and the Divisional Annual Dinner. Preparations are well in hand for a very successful day - all we need now is lots of amateurs to turn up!

Reading these notes one may be excused for thinking that all we do here is feed the inner man. Let me assure you that the way our members pull together and work any inner sustenance is richly deserved.

Ron VK7RN
Tasmanian President.
ar

Radio Amateurs Old Timers Club

Our March luncheon will be held at the extensively refurbished Bentleigh Club on Tuesday, march 16.

Lunch will be served at 1.00pm. The cost will be \$25 per head as in previous years. Refreshments during lunch included.

The Club is located in Yawla Street, Bentleigh, Melway map reference 68 — B11.

A very interesting talk will be given by Mr Brian Horman founder of the company Court Recordings and a past President of the American Audio Engineering Society (Australian Division)

Friends of members and members of other clubs are welcome to attend, provided a firm booking is made not later than Thursday March

11 with our Secretary, Arthur Evans VK3VQ, phone 9598 4262.

Members are reminded that subscriptions are now due on April 1 because of the change in our financial year from July/June to April/March. Regretfully subscriptions will now be \$8 per year, or \$15 for two years. Without this change we would have to consider producing only one "OTN" magazine a year and we feel sure members would not want that to happen.

Allan Doble VK3AMD

silent keys

The WIA regrets to announce the recent passing of

W S (Bill) Munn VK2BMX

B Jordan VK2MLL

C (Ian) Beulke VK3BQB

L S (Stan) Dixon VK3 TE

J L (Jack) Bates VK4UR

Jack Bates VK4UR

JACK OBTAINED HIS LICENCE in 1935 and was very active prior to the war.

With a wife and young family to raise, he did not return to the airwaves after the war until 1973.

Over the last 25 years, Jack was very active on the bands mainly on CW. He was particularly pleased to renew many old contacts that he had pre-war, particularly Stateside. Jack's great love was rag chewing with "Yanks" on CW.

He is survived by two close radio friends from his pre-war days, George Gray VK4JP and Charlie Miller VK4QM (ex VK4UU, VK2ADE) who were both instrumental in helping to get him back on the air.

Jack also built new friendships with

younger hams including Sava Magazinovic VK4PN, Greg Lee VK4AML and his nephew Keith Griffin, VK410.

He was particularly pleased recently to renew a pre-war association with Madeline Pugh (nee Mackenzie) VK4YL who gained her licence at 12 years of age on the same day as Jack.

Jack entered many contests. He was a keen DXer and QSLer who believed that the secret of having a good signal lay in the choice of antenna. He also enjoyed going QRP.

Jack is survived by his wife Dorothy VK4NAM, member of ALARA, Ian ex VK4KUR and Ken.

Ken Bates

When you buy from our advertisers...

tell them you saw it in the WIA

**Amateur
Radio magazine**

CONTESTS

Ian Godsil VK3DID,

57 Nepean Highway, Aspendale, 3195

CONTEST CALENDAR MARCH - MAY 1999

- Mar 6/7 ARRL DX SSB Contest (Jan 99)
Mar 13/14 Commonwealth Contest (CW) (Feb 99)
World -Wide Locator Contest (CW/SSB/MIXED)(Mar 99)
Mar 20/21 WIA John Moyle Field Day (Feb 99)
DARC HF SSTV Contest
Bermuda Contest (Feb 98)
Russian DX Contest (CW/Phone) (Feb 99)
Mar 27/28 CQ WPX SSB Contest (Feb 99)
Apr 3/4 SP DX Contest (CW/Phone) (Mar 99)
Apr 9/11 JA DX CW Contest (High Band) (Dec 98)
Apr 10/11 King of Spain DX Contest (CW/Phone)
Apr 17 Australian Postcode Contest (CW/SSB) (Mar 99)
Apr 17/18 Holyland DX Contest (CW/Phone) (Mar 99)
Apr 24/25 Helvetia DX Contest (CW/Phone) (Mar 99)
Apr 24/25 SP RTTY Contest (Mar 99)
May 1/2 ARI International DX Contest (CW/SSB/RITY)
May 8/9 CQ-M International DX Contest (CW/SSB/SSTV)
May 29/30 CQ WW WPX Contest (CW) (Feb 99)

Thanks this month to VK4VW SM3CER

RESULTS OF JACK FILES

CONTEST 1998

from Peter Dawson VK4VW

CW 4 July 1998

(Posn\call\score)

Section A Single Operator Home

- 1 VK4EMM 2680**
 - 2 VK4BAZ 1764*
 - 3 VK3APN 1651*
 - 4 VK4VFX 616
 - 5 VK4BOV 275
 - 6 VK3DID 41
- Phone11 July 1998

Section A Single Operator Home

- 1 VK4AJS 5049**
- 2 VK4VFX 2834*
- 3 VK3KQB 360*
- 4 VK4AO 56

Section B Club Fixed

- 1 VK4QD 7114*

Section C Single Operator

Mobile/Portable

- 1 VK4JAE/7 80*

Section D Club Mobile/Portable

- 1 VK4BAR 7226**

Section E No entrants

Section F SWL

- 1 L40383 1495*

WORLD WIDE LOCATOR CONTEST

13/14 March 0000z Sat. - 2400z Sun

Bands: 160- 10 metres (no WARC). Modes CW, SSB, Mixed.

Categories:

Single Op: (CW, SSB, Mixed, High Pwr, Low Pwr)

1. All bands
2. Single band
3. Any two bands

Multi-ops (CW, SSB, Mixed)

1. Single TX - one signal anytime; 10 minute rule (per band and mode);
2. Two TXs - two signals anytime, but different bands; 10 minute rule (per band and mode)
3. Multi-multi - one signal on each band. Packet allowed for multi-ops.

SWL single op., no packet allowed.

Exchange RS(T) plus WWL (four characters eg QF26).

Score depends on computed distance between centres of locators. Each 100 km = one point on 40/20/15/10 m; two points on 80 m; four points on 160 m.

Multipliers are first two characters of WWL on each band separately regardless of mode. Final Score is total QSO points X total multipliers.

Logs: electronic logs only in ASCII format. It is not necessary to have Computed points/multipliers/final result). Send by e-mail to: ok2fd@contesting.com.> or by mail to Karel Karmasin, Gen. Svodoby 636, 674 1 Trebic, Czech Republic

SP DX CONTEST (CW/PHONE)

1500z Sat - 1500z Sun, 3-4th April

Categories: single operator (single/all band), multi-operator and SWL. Bands are 160 - 10 m (no WARC) and modes are CW and SSB. No mixed Code logs allowed. Send RS(T) plus serial number. SPs will send RS(T) plus a two-letter province code. Score three points per QSO with each Polish station. Final score is total QSO points X number of Polish provinces worked (max 49). In this contest, multipliers are counted once only. SWLs must receive the callsign and number sent by Polish stations, plus the callsign worked. Each SP may be logged only once per band. Send log, summary sheet and multiplier check sheet postmarked by 30 April to: SPDX Contest Committee, Box 320, 00-950 Warsaw, Poland. Disk logs in ASCII format are welcome.

Polish provinces are: - SP1: KO SL SZ; SP2: BY EL GD TO WL; SP3: GO KL KN LE PI PO ZG; SP4: BK LO OL SU; SP5: CI OS PL SE WA; SP6: JG LG OP WB WR; SP7: K9I LD PT RA SI SK TG; SP8: BP CH KS LU PR RZ ZA; SP9: BB CZ KA KR NS TA.

HOLYLAND DX CONTEST (CW/PHONE)

1800z Sat - 1800z Sun, 17/18 April

Object is to work as many Israeli stations as possible. Bands are 160 - 10 m (no WARC) and categories: single and multi-operator multi-bands; SWL. Send RS(T) plus serial number. Israeli stations will send RS(T) plus area code. The same stations may be contacted on both CW and SSB on each band. Score two points per QSO on 160/80/40 and one point on 20/15/10. Final score is total points X total areas, with areas counted separately for each band. SWLs should report Israeli stations only, and include time, callsign, station worked, RS(T) plus area code and points. Send summary sheet and separate logs for each band, postmarked by 28 May 1999 to: Contest Manager, Israel Amateur Radio Club, Box 17600, Tel Aviv, Israel 61176.

HELVETIA DX CW/SSB CONTEST

1300z Sat - 1300z Sun, 24/25 April

Work only Swiss stations, CW on 160 - 10 m and SSB on 80 - 10 m (no WARC). Each station may be worked only once per

band regardless of mode. Score three points per QSO. Multiplier is total number of Swiss cantons worked (max 26 per band). Send log to be received by 11 June to: Niklaus Zinsstag HB9DDZ, Salmendorfli 568, CH-4338 Rheinsulz, Switzerland. Cantons are: - AG AI AR BE BL BS FR GE GL GR JU LU NE NW OW SG SH SO SZ TG TI UR VD VS ZG ZH.

SP DX RTTY CONTEST

1200z Sat - 1200z Sun, 24/25 April

Categories are: - single operator all bands; multi-operator all bands; SWL. Use Baudot mode on bands 80 - 10 m (no WARC) and call CQ SP RVG TEST. Exchange RST plus serial number. Score two points per QSO with own country, five points with other countries in same continent and ten points with other continents. Multipliers are the sum of DXCC countries and Polish provinces (max 49). Send logs postmarked by 25 May to: SPDX RTTY Contest Manager, Box 253, 81-963 Gdynia 1, Poland.

AUSTRALIAN POSTCODE CONTEST

0000z - 2359z Sat 17 April

Aim of this contest is for stations worldwide to work as many different Australian Postcodes as possible. VK/VK contacts are permitted. Contacts made during this contest will be eligible for the "Worked all VK Postcode Award". Bands: 80 - 10 m (no WARC). Modes: SSB and CW. Please note on 3.5 MHz band VKs are not permitted to contest in the DX window (3.8 MHz). Categories: Single operator all bands and SWL. Exchange: a. VK Stations will send RST plus their four-digit postcode. b. DX stations will send RST plus a serial number commencing with 001. Score 2 points per contact within Australia and 10 points per contact between Australia and another country. Countries are as per DXCC/WAE. Multiplier: is the number of different postcodes worked on each band in the relevant mode, with the band totals added together. PLEASE NOTE that repeat contacts on the same band and mode are not permissible, except that VK stations that go mobile to different postcodes can be reworked for the new postcode. Final Score is total QSO points from all bands times the total multiplier. Logs must show the Date, UTC time, band, mode, callsign of station worked, exchange sent and received, new multipliers, and points. Attach a summary

sheet showing: name, address, callsign, section, number of valid QSOs and multipliers on each band, claimed score and a signed declaration that the rules and spirit of the contest were observed. Send logs to the following address postmarked no later than one month after the contest: - Australian Postcode Contest Manager, Oceania DX Group, P O Box 929, GYMPIE, QLD 4570, AUSTRALIA. Logs may be sent by e-mail to: <odxg@keylink.com.au> Logs sent on disk must be standard format as per ARRL. Contest criteria.

Untidy logs may be disqualified. Unmarked duplicates will result in the loss of all points for the QSO as well as the deletion of three contacts following the duplication.

Awards: The overall winner will receive a plaque kindly donated by VK4FW. Certificates will be presented to the station with the highest score in each section in each country as well as runners-up. A special award will also be presented to the highest placed VK novice in each section. Further awards may be made at the discretion of the Contest Manager. Thanks and 73 de Ian VK3DID

HARRY ANGEL MEMORIAL SPRINT

1100 - 1246 UTC, Sunday April 25 1999
This sprint contest which is open to all Amateur Stations and SWLs honours the late Harry Angel VK4HA. Harry who passed away at the age of 106 in 1998 was at the time Australia's oldest living Radio Amateur. Harry served in the Middle East and other areas during the First World War. The Sprint will be

unique, as it will last for 106 minutes, Harry's Age, in place of the customary 60 minutes.

The Object is to make as many QSOs as possible on the 80m band (SWLs hear and log QSOs) during the 106-minute contest period using Phone or CW modes.

Categories are Single operator only. CW, Phone, Mixed (CW & Phone), & SWL. Frequencies are 3500-3700 kHz (CW) and 3535-3700 kHz (phone).

Contacts in the "DX Window" (3.798-3.800) are not permitted.

Exchange RS(T) and a serial number starting at any number between 001 and 999, reverting to 001 if 999 is reached.

Score two points per CW QSO and one point per Phone QSO. You may work a station once only using each mode. Logs must show the time (UTC) callsign worked (or both callsigns for SWLs), mode, RS(T), and serial numbers sent and received for each QSO.

Logs must be accompanied by a summary sheet showing name and date of the contest, category entered, name and callsign of the entrant, station address, equipment used, points claimed and a declaration that the rules and the spirit of the contest were observed.

Send logs to Harry Angel Sprint, PO Box 171, Caboolture QLD 4510 or by email in plain text only to vk4vw@qsl.net to be received no later than Friday 28 May 1999.

Certificates will be awarded to the top three scorers in each section with a perpetual trophy awarded for the top scorer in the CW, Phone & Mixed categories.

ar

silent key

Nim Love VK4JL

NIM LOVE VK4JL passed away this week in Bundaberg.

VK4JL - J.P. (Nim) Love, AOCP Brisbane 1930. Nim started out building crystal sets as a boy. Later he obtained his ticket and joined the Woolloowin Radio Club. Nim installed his station aboard the family yacht "Sweetheart" and conducted many ship-to-shore experiments with Vern Kenna VK4FK.

Radio Inspector Tom Armstrong who monitored every message sent just in case a monetary charge could be levied strictly supervised his activities. Using less than

10 watts input he could work easily into the USA. He served in the AIF as Artillery Commander 2/5th Field regiment in UK, Greece, and the Middle East. ending his time as Lieut-Colonel in New Guinea. Nim was a member of the Royal Queensland Aero Club, a long serving member of the Queensland Boy Scouts Association (decorated in retirement), and member of the Brisbane Rotary Club. He did not renew his licence post WWII but reclaimed his call sign in the 1980's. Farewell Nim.

Peter Brown, John Stevens
Allan Shawsmit

ALARA

**Christine Taylor VK5CTY
ALARA Publicity Officer**

16 Fairmont Avenue, Black Forest SA 5035
Packet: VK5CTY@VK5TTY



Melbourne luncheon: Bron VK3DYL, Mavis VK3KS, myself VK5CTY, Robyn VK2ENX, Jessie VK3VAN Dot VK2DDB and Jean Shaw.

Another Callsign Changed

Dot VK2DDB is now also VK2DB. When she bought the new callbook she discovered there was no entry for VK2DB. Ray Biddle, who had held the callsign for 35 years had relinquished it in May. He had hoped that his daughter would take it over, but as that had not happened, at 85 he had decided not to renew. He is now more interested in radio astronomy than in radio. He was active in ATV and helped build their first repeater in Sydney.

When Dot contacted Ray he was very happy for her to take over the call, and wrote to ACA authorising it. The only problem is that Dot is now *mike shy* about using it. She says it is quite a different feeling to the "Look, I've upgraded" feeling. Anyway, listen out for a familiar voice with a new callsign.

An Evening With Andy Thomas

ALARA was well represented recently at an evening organised by the WIA(SA)Div and the West Torrens Council, in Adelaide. Three of the VK5 girls had spoken to Andy when he was orbiting the Russian spacecraft, MIR, Meg VK5YG (then VK5AOV), Mary VK5AMD, and Lyndell VK5KLO. Also at the meeting were Judy VK5BYL (known to many for her CW practice sessions with those diabolical recipes!), Tina VK5TMC, Bev Tamblin and your correspondent Christine VK5CTY.

It was a fascinating evening. Andy was presented with a regular VK callsign, VK5JAT, and gave the first couple of contacts under the call. So listen for another recognisable voice with a new callsign. The film of life on MIR was interesting as were Andy's answers to our questions. Those who had contacted Andy as VK5MIR were invited to stay back for supper. Everyone agreed he is a remarkable young man, yet he seems to take it all in his stride and considers himself fortunate to have been in the right place at the right time.

News From A New Zealand Girl

Adele ZL1TMD has been a member of ALARA since she was here in Adelaide as a Year 10 Rotary student. She is now in her last year (Honours) of a Technology degree. She is also a part-time computer consultant and active on the Web both within and outside her work.

When Adele first came to Adelaide she was determined to continue her interest in amateur radio while she was here. She first contacted me and we met a number of times. We had a meal with her one night with five or six YLs and a couple of harmonics of similar age to Adele. She comes from a family of amateurs. Dad, Mum and one other daughter have licences.

The New Look ALARA Contest

Marilyn VK3DMS tells me that everyone seems to be happy with the new format. Some girls used the repeat contacts to advantage though conditions were not very good during the day. 80 metres was very good that night, though, and for long enough for a number of contacts to be made at hourly intervals.

Unfortunately the gremlins got into the rules when they were printed in AR so some girls were asked for their membership numbers. This wasn't necessary, of course, and I have to admit that I do not ever remember knowing my membership number. Never mind, gremlins have always been involved in radio, haven't they?

Congratulations to June VK4SJ for her very convincing win. She worked hard and deserves the trophy. Unfortunately there was no winner of the Florence McKenzie Trophy for 1998. We will have to remedy that next time. Now that it is open to all YL CW operators we hope to encourage Morse activity.

Congratulations to Amiee FK8FA, our DX winner. Living in Noumea has its advantages when it comes to contests. It was exciting to receive a log from a YL non-member, Mary WN6HYX, especially as many of her contacts were on CW. We appreciate the OMs who participate, especially the regulars like Len VK3ALD.

We know there was at least one SWL log made, but it wasn't submitted. What a shame. I am sure she was not the only SWL, either. If you listen but don't or can't operate, why not submit an SWL log to some of these contests? The Contest Manager is always delighted to know there are people out there listening.

Some Other Activities

Our Contest Manager and her OM, Geoff VK3ACZ attended a wedding anniversary in

Adelaide recently. They brought some photos of their new house, a kit-home with an all-steel, pre-fabricated frame. One series of photos, taken over a matter of hours show that the main frame was up in a day. By the end of the second day the roof was on and the door and window frames were in place (all this in a temperature of 40° plus).

I don't know how long it will be before we hear Marilyn and Geoff on air. Aerials are not high on the list of priorities at the moment. They will have problems if they try to re-erect the five-element beam they had at Irymple. It would overhang the fences either side of their new block! The antenna farm will probably be associated with long wires starting with an 80-metre dipole.

Only recently out of the camera is a photo taken when I was in Melbourne last year. I timed it so that I could attend the YL luncheon that day, and chose the same day as Dot VK2DDB (then) used her Fly Buy points to visit. In the photo we have Bron VK3DYL, Mavis VK3KS, myself VK5CTY, Robyn VK2ENX, Jessie VK3VAN Dot VK2DDB and Jean Shaw. I understand the name of the venue in Melbourne has changed again but it is still in the same place.

As in Adelaide the VK3 luncheons are on the second Friday of the month. If you are in either city on those days please join us. At the January luncheon in Adelaide Meg VK5YG, Jean VK5TSX and Tina VK5TMC were with me. It is great to have a chat and catch up. The venue for the Adelaide lunches may be changing as the current venue has been redecorated and is now not as much to our liking. Keep your eye on the Newsletter or this column for more information.

When I was asked to give a short talk about ALARA to the AHARS members at our January meeting, I was pleased to be able to take the Florence McKenzie trophy to show. It normally lives in the WIA (SA) divisional headquarters, the Burley Griffin Building, but I had it for the new plaque to be attached. With the new rules for that section of the Contest we had to have a new inscription in place of the old one. The wording was agreed to when Marilyn attended the AHARS Buy and Sell in November.

ar

REPEATER LINK

Will McGhie

21 Waterloo Cr Lesmurdie 6076
VK6UU @ VK6BBR will@faroc.com.au

10 KHz Feedback

Recently an AR article on 10 KHz spacing for repeaters was developed from an original idea by Robert VK2MT. Most feedback said NO to the idea and expanded on this. A detailed, negative response from JOHN MARTIN FTAC is included in this month's column.

I AM IN FAVOUR of the idea for its relative simplicity to implement and that a channel 10 KHz away could be usable, if the distance between the repeaters was great enough. If two repeaters sharing the same frequency but at a respectable distance apart interfere occasionally, then moving them 10 KHz apart should fix, or reduce the problem. However I have no evidence to prove this and changing the band plan to 10 KHz spacing might only cause expense and effort for little or no gain.

After reading John's reply (below) you may wish to provide some thoughts of your own.

FTAC Comment

"IN "AR" you note that feedback on the 10 kHz proposal had been negative, and that you would like to see more discussion.

"I agree, but would like to see a balanced discussion. So far you have only mentioned the minor point that extra channels would fill up. You haven't published any of the important arguments which show the idea won't work.

"You said: *To go to lower bandwidth is not the intention of the 10 KHz proposal, but rather to allow the use of more channels.* But you can't use narrower channels unless you reduce the bandwidth of the stations on them. With overlapping channels the closest spacing achievable is twice the channel width: in this case 20 KHz. Some areas might use the odd channels, and others use the evens, but in no area can you use both. In practice the 10 KHz plan is a 20 KHz plan with the extra complication of unnecessary adjacent channel interference.

"Use could then be made of the additional channels at separation distances that would not normally cause co-channel interference".

The "extra" channels are an illusion. No matter where you are, they are not available in your area, they can only be used somewhere else a few hundred KM away. They are like a mirage that you can never reach!

So what is in the balance sheet?

In favour:

A change from 25 KHz channel spacing to a de facto 20 KHz, which would provide four extra 146 MHz repeater pairs, and four more at 147 MHz.

Against:

1. Frequency changes and costs - including fees for changes to licences - for nearly 100 repeaters on 25/75 frequencies.
2. Plus - not mentioned - 10 KHz frequency changes for many repeaters on 00/50 frequencies as well. If you left a repeater on say 146.750 in an area that used channels such as 700, 720, 740, 760 etc, it would occupy two channels. Totally counterproductive.
3. The licensees of most repeaters would have to agree to change frequency.
4. Major inconvenience those without radios 5 or 10 KHz steps on their radios. A total loss for radios like the IC22S, which could only operate on one or two out of every five consecutive channels in any area.
5. The need to co-ordinate repeater frequencies to avoid co-channel stations *and* also those using the channels 10 kHz to either side.
6. Problems of adjacent channel interference in the transition zones between areas using "odd" and "even" channels.
7. In the overcrowded areas, the 8 extra channels would be filled in next to no time.
8. The problem of simplex channels - either cause more inconvenience by changing their channel spacing as well, or cause confusion by leaving them at 25 kHz steps.

"What more can I say? It is a dead horse. The issue arises because of overcrowding in one part of the country. There are too few vacant channels because the area has too many repeaters. They need a rationalisation plan. If some of the least useful repeaters closed down or moved to 70 cm, their frequencies could be used elsewhere. Not easy to agree on, but far better than expecting the whole country to bail them out with scheme which cannot deliver.

Ho, it seems that I keep dumping wet blankets on you, sorry about that. But I suppose you're used to it by now!

73 John VK3KWA

Dead issue?

Sounds like John not only holds the FTAC title but also puts some effort into it. Perhaps the 10 KHz idea is technically wrong and

should be pronounced dead. Given merely a few more channels they would fill quickly and we would be back where we are now. John's response might tempt Robert VK2MT to comment further.

Thanks, John, for the response. Some praise for John; he has held the FTAC position for many years and has done the very best at all times. One of the few prepared to put in real time to a most demanding job that must take up several hours each week. Sounds easy to organise the odd few band plans but the job requires attention to detail and good record keeping.

VK6RAV Visit

Repeater site VK6RAV Northam had a service visit recently. The repeater, installed some 90 KM ENE of Perth a year ago, had developed intermittent desensing. Desensing is the plague of 2 metre repeaters. In hindsight, 600 KHz spacing would not be chosen, as the 100 dB of isolation required for no desensing is difficult to achieve over long periods of time, but we are stuck with it. 1 MHz would have been a more suitable as some 10 dB less isolation required.

Why was 600 KHz chosen? It was to keep repeater operation contained within 1 MHz of 2-metre band space between 146 and 147 in the USA. 600 KHz allowed for enough repeater channels all within 1 MHz. The numbers of repeaters grew and moved into the 147 to 148 MHz segment but it was too late to change the band plans by then. We are paying for short sighted planning. But to be fair no one could have foreseen the tremendous growth of repeaters in the late 60's and their need for increased band space.

Australia and New Zealand both had 500 KHz spacing originally for a couple of years before changing to 600 KHz spacing.

Back to VK6RAV Northam. The desensing was not found due to its intermittent nature and a further visit is planned. While on site a test was carried out back to VK6RUF, our UHF repeater in Perth, to gauge signal strengths. There are thoughts to link this little used repeater back to Perth. The test indicated enough signal strength for a link and planning is under way.

Insurance

At long last; we received an answer from our insurers on unqualified people (non-riggers) climbing masts.

The answer is that we are covered.

The insurance company accepts that most of us don't hold any climbing qualifications. However the insurance company refer to the climbers as 'experienced'.

This was not defined and we take it to mean have climbed before. So if anyone falls or is injured in any way it can not be on their first climb!

ar

HF PREDICTIONS

by Evan Jarman VK3ANI
34 Alandale Court, Blackburn Vic 3130

Adelaide-Ottawa 58

First F 0-5 Short 16901 km

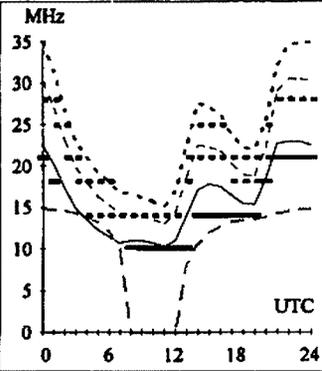

Brisbane-Auckland 123

First 1F7-10 1E0 Short 2289 km

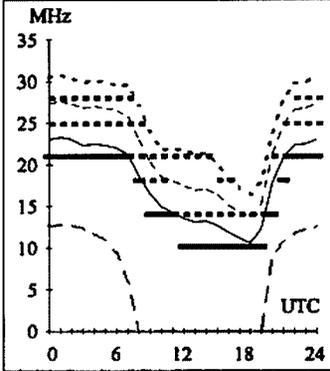

March

1999

T index: 111

Legend

UD - - - - -

F-MUF - - - - -

E-MUF - - - - -

OMF - - - - -

ΔLE - - - - -

100%-50% - - - - -

50%-90% - - - - -

90%-100% - - - - -

Time scale

These graphs show the predicted diurnal variation of key frequencies for the nominated circuits.

These frequencies as identified in the legend are:-

- Upper Decile (F-layer)
- F-layer Maximum Useable Frequency
- E-layer Maximum Useable Frequency
- Optimum Working Frequency (F-layer)
- Absorption Limiting Frequency (D region)

Shown hourly are the highest frequency amateur bands in ranges between these key frequencies; when useable. The path, propagation mode and Australian terminal bearing are also given for each circuit.

These predictions were made with the Ionospheric Prediction Service program: ASAPS version 4.

Adelaide-Singapore 311

Second 3F11-17 3E1 Short 5414 km

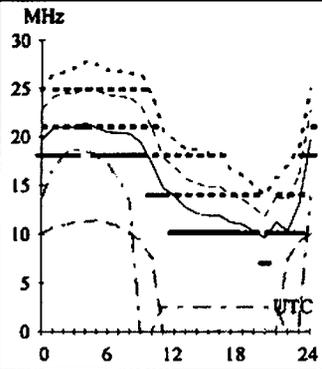

Brisbane-Los Angeles 59

Second 4F3-8 4E0 Short 11563 km

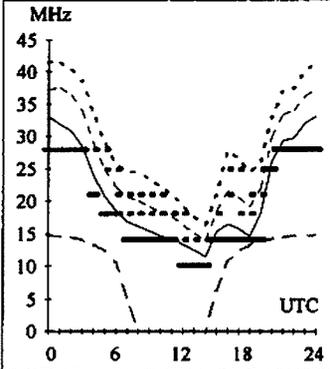

Canberra-London 136

First F 0-5 Long 23042 km

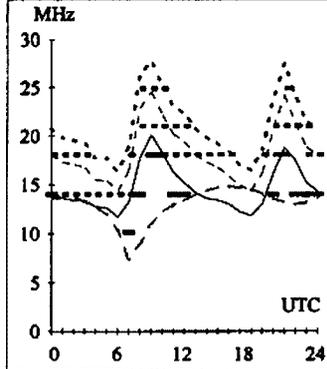

Darwin-Honolulu 65

First 3F3-9 3E0 Short 8636 km

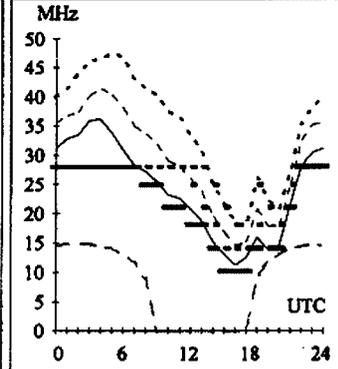

Adelaide-Tel Aviv 291

First F 0-5 Short 13126 km

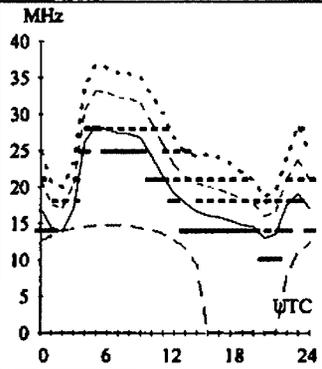

Brisbane-Manila 320

First 2F3-9 2E0 Short 5813 km

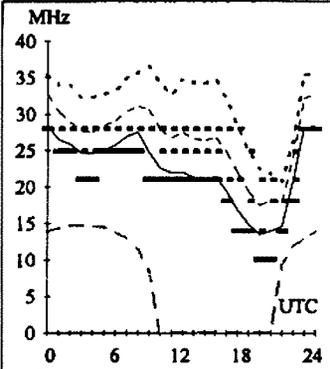

Canberra-London 316

First F 0-5 Short 16982 km

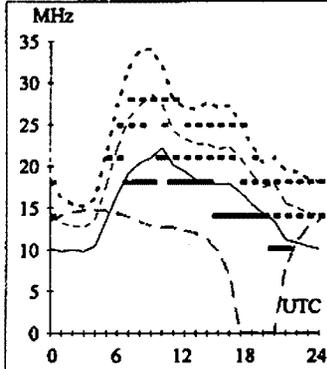

Darwin-Osaka 5

First 2F4-11 2E0 Short 5263 km

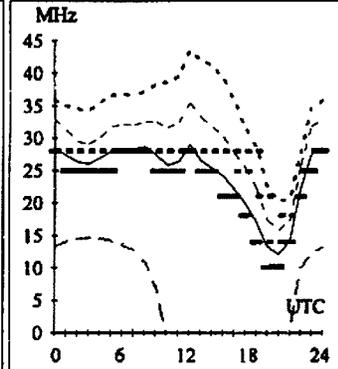

Adelaide-Wellington 114

Second 2F14-19 2E2 Short 3214 km

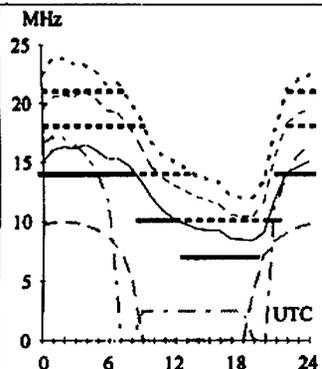

Brisbane-Rome 305

First F 0-5 Short 16108 km

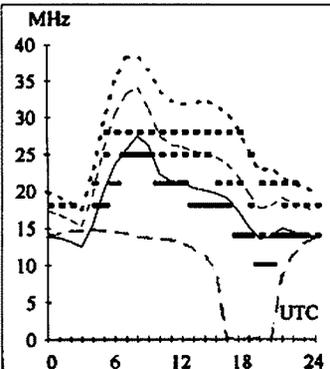

Canberra-Pretoria 231

Second 4F4-8 4E0 Short 10824 km

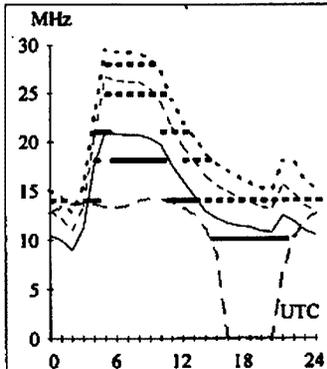

Darwin-Seattle 44

First F 0-5 Short 12283 km

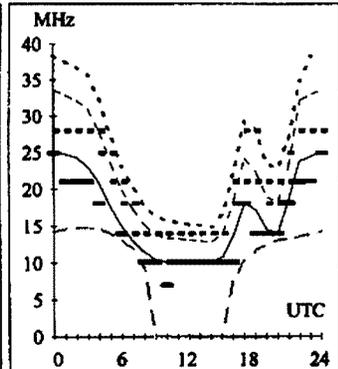

HF PREDICTIONS

Hobart-Cairo 278 **Melbourne-Capetown** 222 **Perth-Johannesburg** 248 **Sydney-Barbados** 119

First F 0-5 Short 14264 km

Second 4F5-9 4E0 Short 10316 km

First 3F4-7 3E0 Short 8315 km

First F 0-5 Short 16155 km

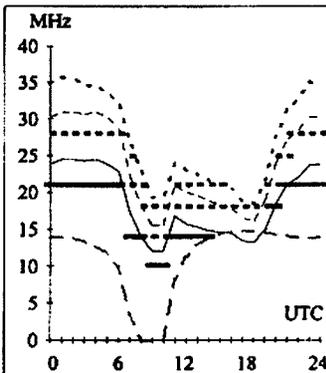
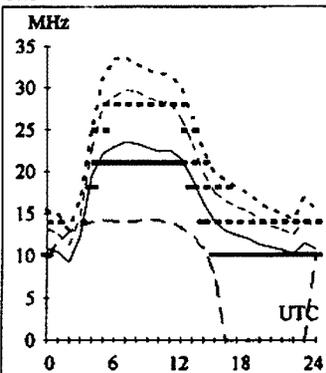
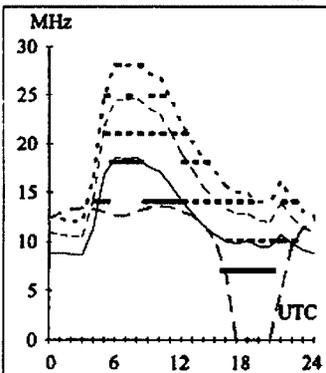
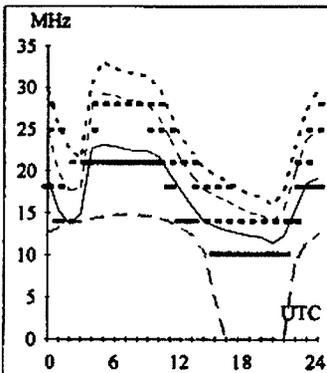

Hobart-Chicago 72 **Melbourne-Moscow** 316

First F 0-5 Short 15576 km

Perth-London 133 **Sydney-Nairobi** 255

First F 0-5 Short 12147 km

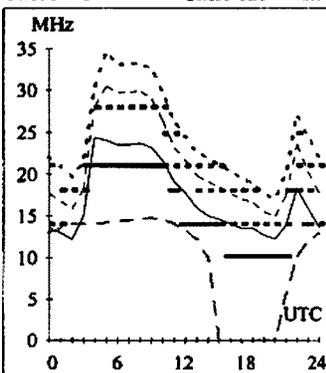
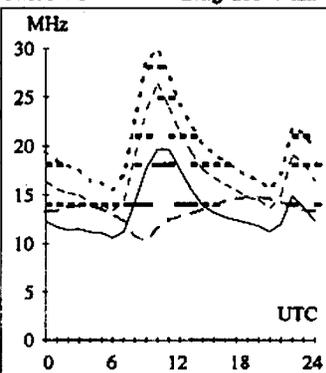
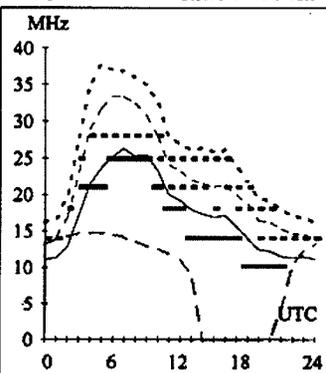
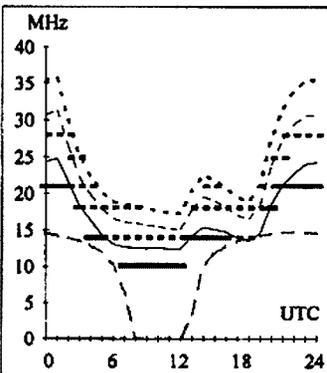

Hobart-Oslo 138 **Melbourne-Ottawa** 63

First F 0-5 Long 23450 km

Perth-London 313 **Sydney-Seoul** 340

First F 0-5 Short 16557 km

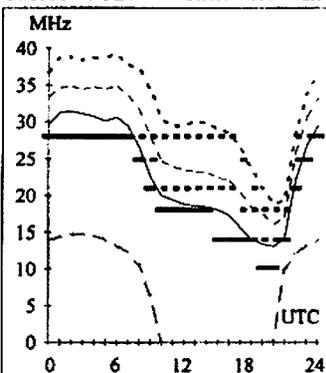
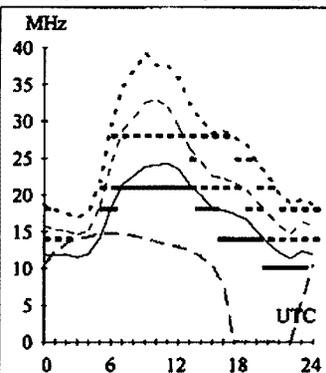
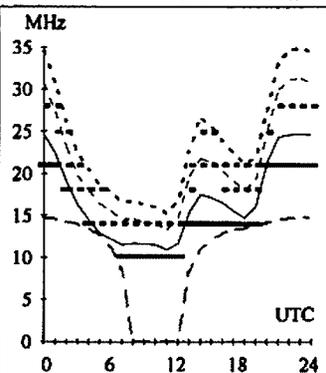
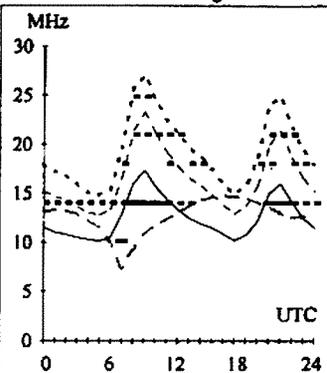

Hobart-Santiago 149 **Melbourne-Tokyo** 356

Second 4F4-7 4E0 Short 10686 km

Perth-Tokyo 20 **Sydney-Vancouver** 45

Second 4F9-14 4E0 Short 8192 km

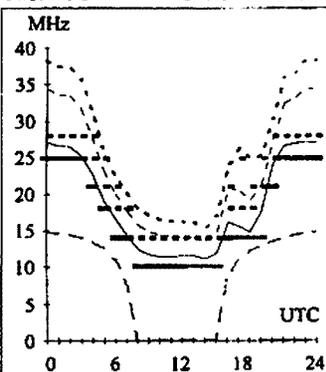
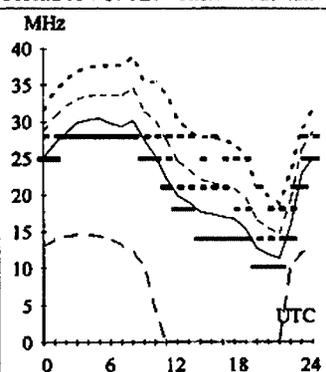
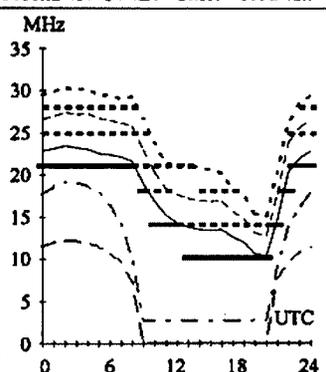
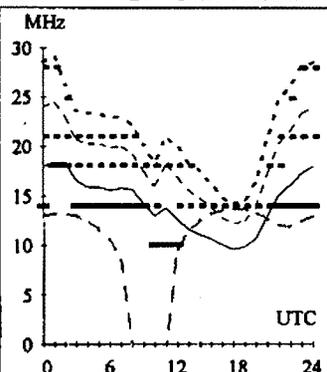

HAMADS

- Hamads may be submitted on the form on the reverse of your current Amateur Radio address flysheet. Please print carefully, especially where case or numerals are critical.
- Please submit separate forms for For Sale and Wanted items, and be sure to include your name, address and telephone number (including STD code) if you do not use the flysheet.
- Eight lines (forty words) per issue free to all WIA members, ninth and tenth lines for name and address. Commercial rates apply for non-members.
- Deceased estates Hamads will be published in full, even if the ad is not fully radio equipment.
- WIA policy recommends that the serial number of all equipment for sale should be included.
- QTHR means the address is correct in the current WIA Call Book.
- Ordinary Hamads from members who are deemed to be in general electronics retail and wholesale distributive trades should be certified as referring only to private articles not being re-sold for merchandising purposes.
- Commercial advertising (Trade Hamads) are pre-payable at \$25.00 for four lines (twenty words), plus \$2.25 per line (or part thereof), with a minimum charge of \$25.00. Cheques are to be made out to: WIA Hamads.
- Copy should be typed or in block letters, and be received by the deadlines shown on page 1 of each issue of Amateur Radio, at:

Postal: Newsletters Unlimited, 29 Tanner Street, Richmond, 3121
Fax: 03 9428 4242 **E-mail:** news1@webtime.com.au

Please only send your Hamad once

Please send Hamads by mail OR fax OR email (much preferred).

Please do not send by more than one method for any one ad or issue, it is confusing.

● **Attention all restricted licence holders.** Do you believe that morse code exams requirement should be amended to five words per minute maximum? Join a campaign for reform. Contact Brian VK2AZW NOW. QTHR.

FOR SALE VK2 NSW

- **YAESU FT-890 all-mode HF Transceiver** 100W 160-10m Allband Rx. Brand new condition, never used on Tx Demo only on Rx \$1500. FM900s 6&2M transceivers both sets \$250. Chris VK2YMW QTHR 02 9487 2764
- **Shack clearance:** Old test equipment (1950's) valve operated, working; Audio generator, 4X 6V6's; Het. frequency meter & RF Osc. Xtal check, VFO, audio modulator, offers? Many pre-war valves, Tx&Rx request needs \$5 ea. WW2 BC221 het. freq. meter mains op. VGC charts and book \$50. WW2 4band aircraft receiver 200-1500 KHz CG46115 GE/US navy, mods for mains supply, working \$80. AWA Audio BFO 0-13 kHz \$40 Oskerblock SWR-Pwr meter SWR200B S/N54039 \$30 Mizuho Preselector SX101 \$30. Stingray Marine MF/HF SSB transceiver 120W 2-4-6 MHz VGC with Wagner ATU \$800 ONO. YAESU FT902DM S/N OM160412 EC but external power pack (original xformer blew) \$300. Yaesu FV101DM S/N IJ 010205 EC \$50. Stingray CB converted 24ch 10M \$80. YAESU 2M FT720RVH S/N 060774 with mount and remote cable EC \$200. Himound key HK707 EC \$25. Keith VK2AXN QTHR 02 9489 0304 keithfreda@msn.com.au
- **70cm. TAIT 555 2** Channel synthesized, tuned, and programmed. Any two channels simplex or repeater \$100 David 02 4821 5036
- **HEATHKIT CW TX HX-1681** with PS-23 supply. Also YAESU FR101 digital receiver. All manuals and in good working order. \$500 the lot. Ray VK2COX QTHR 02 6345 1911

- **YAESU FT212RH2m 45 watt transceiver** \$330. 5/8 Ground Plane Antenna. Marco VK2ARC 02 9774 3492 S/N IM790221
- **Kenwood 820S \$400.** 240/12 volt. Power meter SWR \$20. Telereader \$20. Multi band vertical \$25. Paton VCT. SIGEN VCT EHT probe \$75 for three ONO. PAKET Radio rig 486DX2 computer IC22s PACOMM TNC320 \$450. ONO. VK2AHP QTHR.

FOR SALE VK3 VIC

- **Autek Research CMOS Keyer (U.S.A)** Plus message memory 12V.DC paddle req. \$25. Ramsay 60 MHz Counter inc. 600MHz Prescaler 12V.DC \$25. Reg.PS 13V5A voltmeter, ammeter \$25. BMC. 27cm green screen monitor \$25. All items working order. Andy VK3UJ QTHR 9726 8879
- **Transistor Service Manuals Vols. 1 & 2.** Service details of hundreds of transistor radios. \$20 the pair. Allen VK3SM. QTHR. 03 9386 4406
- **Kenwood TM-2550A 2m FM mobile transceiver** 45 Watts GC boxes etc \$300. Hewlett-Packard signal generator model 680D 10mc to 420mc. Variable attenuator .1 microvolt to 0.5 volt manual GC \$300. ONO Ray VK3RD 03 9726 0222

FOR SALE VK4 QLD

- **Antenna log periodic 16 element AV11C** freq 5 to 30 MHz gain 12 DBi power 5KW. New \$500. Power Klystron 2.4 GHz up to 1.25 kw output 40 DB gain. New \$350. 4CX10 000 socket. New \$300. EIMAC SK806 chimney. New \$25. Coaxial relay 24 volt "N" type changeover (S.P.D.T) New \$50. 6146B tubes (used) O.K. 4 for \$30. Microwave coax 4mm dia copper tube "N" connectors 2 metre lengths \$25 each. Collins

500kHz mechanical and crystal filter. New \$50 each. 07 3269 6647. John VK4KK QTHR

● **FT901DM S/N 8E820429** good condition with hand book and workshop manual. \$500. Plus freight. VK4BMN QTHR 07 4622 4365 or 0418 742 338

FOR SALE VK5 SA

- **Book Collectors:** Radio and Hobbies in Australia Vol.1 No.1 April 1939 VGC. Any offers? Harro VK5HK 08 8323 9622
- **Kenwood TS-130S, AT-130 ATU,** Ext 120 VFO, ML-50 desk mic, mobile bracket, service manual, all other manuals, EC, \$830. 8 element log periodic antenna \$400. Sell complete for \$1100. More for sale. Paul VK5MAP QTHR Ph/ fax 08 8651 2398
- **Kenwood TS50** as new mint condition. Still in box. Hardly used. \$900 SN 50403113 Roger VK5NWE 08 8388 1863

FOR SALE VK6 WA

- **YAESU FT707 HF trans \$450.** YAESU FP707 P.S. \$150. YAESU YD148 desk mic \$30. Antenna HB35C 3EI tribeam \$425. Coax R68 30m \$60. Mast Galv. pipe 12m telescope \$50. The lot \$1000. Colin VK6ZB Ph 08 9725 8680
- **Kenwood VOX4 \$30.** VCI0 For R2000 \$20. DFK7 Rem. Kit \$15. FM board IC740-5 \$10. Final Transistors 2SC2290 pair \$80. MRF 422 pair \$170 ICOM keyer IC735 \$15. ICOM 720A band change relay, new \$40. CODAN tuner 7208 Mk 2 \$50. AR 2001 scanner \$90 MFJ 401B keyer \$15. ICOM SM5 mic \$30. VK6RO Rogers 22 Grace Street Ferndale WA

FOR SALE VK7 TAS

- **ICOM HF all band transceiver IC720A,** plus matching IC-PS20 Power supply, with speaker, hand and desk mikes, handbooks etc. As is \$600 the lot. Retiring Ham relocating. Alan 07 3408 9701
- **YAESU FT990 Deluxe Top of the Range HF T/ciever inc.** Gen. Coverage Receive Auto ATV & P/supply. As new boxes \$1695.00 Yaesu FT900 T/ciever inc. Collins filter Auto ATV 3 months old. Alen VK7AN 03 6327 1171 or 0417-354410. Above must sell inc. Manual Boxes etc.

WANTED VK2 NSW

- **ICOM IC22A circuit diagram.** Note this is the 22 channel Xtal locked model. Copy will do. Cost happily recompensed. Laurie VK2ALV QTHR 02 4229 8820
- **Service manual for Kenwood TS600 6m.** XCVR. Also power supply input ? for same AC or DC OK. Vince VK2VC 02 9713 6655
- **Kenwood TS 870s, GAP V₁** ,na, 3-1000 valves. Tom VK2OE ph. .42 (evenings)
- **Service manual and/or circuit AWA teleradio SS70 30W SSB XCVR.** AWA .nannual No. 62570R. Buy borrow or pay f_r copy. VK2BGP 02 6743 6519 QTHR
- **Kantronic Kanplus Modem.** Doug VK2DDR Ph. 02 9949 3426
- **One inch audio or video tapes** John VK2ZHM (02) 9417 5338

WANTED VK3 VIC

● **Antenna rotator suitable for 20 metre Yagi in good working order.** Evan Phillips VK3BIX Phone (Bus Hrs 03 9687 3371

Operating Manual for YAESU FLDX2000 Linear Amp. Copy. Costs Covered VK3DBZ Phone 03 5367 5820

● **Kenwood TS830S and VFO230.** Must be EC and GWO. Damien VK3RX 03 5427 3121.

● **Circuit and information for TRI520 aircraft radio.** Also seeking No. 11 set chassis. Clem VK3CYD 03 5126 2064
clem@gippstafe.vic.edu.au POBox 285 Newborough 3825

● **Control book for Hygain Ham IV rotator or circuit details for same.** Any details appreciated. VK3FIR QTHR 03 9752 3224

● **Operating manual for YAESU FL DX2000 linear amp.** Copy cost covered. VK3DBZ Ph 03 5367 5820

WANTED VK4 QLD

● **YAESU MUSEN FT107M owners manual or photostat copy OK.** Will pay costs or buy; Rotator Emotator Kenpro Create or Hygain Triband Yagi. John VK4SKY PO Box 116 Coolangatta QLD 4225. Ph 0417 410 503

WANTED VK5 SA

● **YAESU FT-201 Technical or Workshop Manual.** Photocopy OK. Will pay all costs. Contact Mark VK8MA - 08 89831699 evenings. PO Box 228, Howard Springs, NT 0835 or vk8ma@ozemail.com.au

WANTED VK7 TAS

● **Still wanting an MFJ 764 dummy load new or good condition.** Can anyone help me track one down. Tony VK7CAJ. QTHR. P.S. Have MFJ 260c dummy load for swap etc.

WANTED VK8 NT

● **Automatic ATU for Codan 8525 Transceiver.** Peter VK8KZZ QTHR 0418 894404 or Peter.Clee@parkview.com.au

TRADE ADS

● AMIDON FERROMAGNETIC CORES:

For all RF applications. Send business size SASE for data/price to RJ & US Imports, PO Box 431, Kiama NSW 2533 (no enquiries at office please ... 14 Boanyo Ave Kiama). Agencies at: Assoc TV Service, Hobart; Truscotts Electronic World, Melbourne and Mildura; Alpha Tango Products, Perth; Haven Electronics, Nowra; and WIA Equipment Supplies, Adelaide.

● **WEATHER FAX programs for IBM XT/ATs** *** "RADFAXZ" \$35.00, is a high resolution short-wave weather fax, Morse and RTTY receiving program. Suitable for CGA, EGA, VGA and Hercules cards (state which). Needs SSB HF radio and RADFAX decoder. *** "SATFAX" \$45.00, is a NOAA, Meteor and GMS weather satellite picture receiving program. Needs EGA or VGA & WEATHER FAX PC card, + 137 MHz Receiver. *** "MAXISAT" \$75.00 is similar to SATFAX but needs 2 MB of expanded memory (EMS 3.6 or 4.0) and 1024 x 768 SVGA card. All programs are on 5.25" or 3.5" disks (state which) plus documentation, add \$3.00 postage. ONLY from M. Delahunty, 42 Villers St, New Farm QLD 4005. Ph 07 358 2785.

ICOM

Clearly Ahead



"VK3LZ calling!"

More sound information from your friends at Icom

NEW PRODUCT RELEASES CREATE QUITE A STIR.

As recently revealed at the Wyong Hamfest, Icom's newest releases have everyone talking. Dealers and enthusiasts alike have been heaping praise on the latest Icom gear. There's the IC-706MKIIG, the amazing evolution of the legendary 706 featuring 70 cms and increased power output on 2m. The IC-T81A, a remarkably compact quad bander (6m/2m/70cms/23cms).

And the IC-2800H, a totally new approach to dual band mobile (2m/70cms) with a remote head and a 3" multi-function colour LCD screen. Check these new units out at your nearest Icom dealer, you'll soon see what all the excitement is about.

A NEW STAR ON THE HORIZON!

Coming soon, another model that is sure to attract loads of interest too. The IC-R75 receiver offering HF + 6m all mode performance. We've had a sneak preview here at Icom Australia, and we can tell you that this is one special unit.

LOOKING FOR THE LATEST? THEN START SURFING.

Today's world of radio communications is moving so rapidly with changes happening almost every week. To really keep up to date be sure to visit the Icom Australia website regularly. You'll find info on the latest product releases, coming events, plus heaps of other interesting information. It's a great way to keep in touch with what's happening.

"...73"

FreeCall 1800 338 915
290 -294 Albert Street
Brunswick, Victoria 3056
Tel : (03) 9387 0666
Fax : (03) 9387 0022
www.icom.net.au

ACN 006 092 575

11 Brown Ad. 06/93

WANTED

A VOLUNTEER TO MANAGE THE WIA CALL BOOK

Duties are —

- to keep the Call Book information up to date
- to add new data as appropriate, and
- to arrange printing for distribution in October each year.

For further details:

Martin Luther VK5GN

AH phone: 08 8524 3440 fax: 08 8524 3836

email: MartinL@AppDes.com.au

WIA Division Directory

The WIA consists of seven autonomous State Divisions. Each member of the WIA is a member of a Division, usually in their residential State or Territory, and each Division looks after amateur radio affairs within its area.

Division	Address Officers	News Broadcasts	Note: All times are local. All frequencies MHz.	Fees
VK1 ACT Division GPO Box 600 Canberra ACT 2601	President Hugh Blemlings Secretary John Woolner Treasurer Les Davey	VK1YYZ VK1ET VK1LD	3.590, 146.950, 438.375, 438.325, 438.225 & 438.025 FM each Sunday from 8.00pm AEST. News text on packet BCAST@VK1BBS, http://www.vk1.wia.ampr.org & aus.radio.amateur.misc newsgroup. Send items by packet as personal message BCAST@VK1BBS or e-mail to broadcast@vk1.wia.ampr.org.	(F) \$72.00 (G) (S) \$58.00 (X) \$44.00
VK2 NSW Division 109 Wigram St Parramatta NSW (PO Box 1066 Parramatta 2124) Phone 02 9689 2417 Freecall 1800 817 644 Fax 02 9633 1525	President Michael Corbin Secretary Eric Fossey Treasurer Eric Van De Weyer (Office hours Mon-Fri 11.00-14.00) Web: http://ozemail.com.au/~vk2wl/ e-mail: vk2wl@ozemail.com.au Packet BBS: VK2WI on 144.850 MHz	VK2YC VK2EFY VK2KUR	From VK2WI 1.845, 3.595, 7.146*, 10.125, 14.170, 24.950, 28.320, 29.120, 52.120, 52.525, 144.150, 147.000, 438.525, 1273.500 (* morning only) with relays to some of 18.120, 21.170, 581.750 ATV sound. Many country regions relay on 2 m or 70 cm repeaters. Sunday 1000 and 1930. Highlights included in VK2AWX Newcastle news, Monday 1930 on 3.593 plus 10 m, 2 m, 70 cm, 23 cm. The broadcast text is available on the Internet newsgroup aus.radio.amateur.misc , and on packet radio.	(F) \$69.00 (G) (S) \$56.00 (X) \$41.00
VK3 Victorian Division 40G Victory Boulevard Ashburton VIC 3147 Phone 03 9885 9261 Fax 03 9885 9298	President Jim Linton Secretary Barry Wilton Treasurer Rob Hailey (Office hours Tue & Thur 0830-1530) e-mail: vk3wi@rint.com.au Web: http://www.tbsa.com.au/~wivac/	VK3PC VK3XV VK3NC	VK3BWI broadcasts on the 1st Sunday of the month, starts 10.30 am. Primary frequencies, 3.615 LSB, 7.085 LSB, and FM(R)s VK3RML 146.700, VK3RMM 147.250, VK3RWG 147.225, and 70 cm FM(R)s VK3ROU 438.225, and VK3RMU 438.075. Major news under call VK3WI on Victorian packet BBS and WIA VIC Web Site.	(F) \$75.00 (G) (S) \$61.00 (X) \$47.00
VK4 Queensland Division GPO Box 638 Brisbane QLD 4001 Phone 07 3221 9377	President Colin Gladstone Secretary Peter Harding Treasurer Alistair Elrick e-mail: secretary@wiaq.powerup.com.au Web: http://www.wiaq.powerup.com.au	VK4ACG VK4JPH VK4FTL	1.825 MHz SSB, 3.605 MHz SSB, 7.118 MHz SSB, 14.342 MHz SSB, 21.175 MHz FM, 28.400 MHz SSB, 29.220 MHz FM, 53.725 MHz FM, 147.000 MHz FM, 438.500 MHz (Brisbane only), and regional VHF/UHF repeaters at 0900 hrs EAST Sunday. Repeated on 3.605 MHz SSB & 147.000 MHz FM at 1930 hrs EAST Monday. Broadcast news in text form on packet under WIAQ@VKNET.	(F) \$74.00 (G) (S) \$60.00 (X) \$46.00
VK5 South Australian Division 34 West Thebarton Rd Thebarton SA 5031 (GPO Box 1234 Adelaide SA 5001) Phone 08 8352 3428 Fax 08 8264 0463	President Ian Hunt Secretary Merv Miller Treasurer Joe Burford Web: http://www.vk5wia.ampr.org/	VK5QX VK5MX VK5UJ	1827 kHz AM, 3.550 MHz LSB, 7.095 AM, 14.175 USB, 28.470 USB, 53.100 FM, 147.000 FM Adelaide, 146.700 FM Mid North, 146.800 FM Mildura, 146.825 FM Barossa Valley, 146.900 FM South East, 146.925 FM Central North, 147.825 FM Gawler, 438.425 FM Barossa Valley, 438.475 FM Adelaide North, ATV Ch 35 579.250 Adelaide. (NT) 3.555 USB, 7.065 USB, 10.125 USB, 146.700 FM, 0900 hrs Sunday. 3.585 MHz and 146.675 MHz FM Adelaide, 1930 hrs Monday.	(F) \$75.00 (G) (S) \$61.00 (X) \$47.00
VK6 West Australian Division PO Box 10 West Perth WA 6872 Phone 08 9351 8873	President Cliff Bastin Secretary Christine Bastin Treasurer Bruce Hedland-Thomas Web: http://www.faroc.com.au/~vk6wia/ e-mail: vk6wia@faroc.com.au	VK6LZ VK6ZLZ VK6OO	146.700 FM(R), 438.525 FM(R), 29.120 FM at 0930 and 1900 hrs Sundays from Perth, relayed (morning only) on 1.865, 3.564, 3.582 (Busselton), 7.075, 14.116 (North), 14.175 (East), 21.185, 50.150; (morning and evening) 146.900(R) Mt William (Bunbury), 147.00(R) Katanning, 147.200(R) Cataby, 147.250(R) Mt Saddleback (Boddington), and 147.350(R) Busselton; (evening only) 1.865, 3.564 MHz.	(F) \$62.00 (G) (S) \$50.00 (X) \$34.00
VK7 Tasmanian Division 24 Targett Street Scamander TAS 7250 Phone 03 6372 5305	President Ron Churcher Secretary Paul Godden Treasurer John Klop Web: http://www.wia.tasnet.net e-mail: vk7kpg@hamnet.hotnet.com.au	VK7RN VK7KPG VK7KCC	146.700 MHz FM (VK7RHT) at 0930 hrs Sunday relayed on 147.000 (VK7RAA), 146.725 (VK7RNE), 146.625 (VK7RMD), 3.570, 7.090, 14.130, 52.100, 144.150 (Hobart), repeated Tues 3.590 at 1930 hrs.	(F) \$74.00 (G) (S) \$60.00 (X) \$46.00
VK8 Northern Territory (part of the VK5 Division and relays broadcasts from VK5 as shown, received on 14 or 28 MHz).				

Membership Grades
Full (F) Pension (G) Needy (G) Student (S) Non receipt of AR (X)
Three-year membership available to (F) (G) (X) grades at fee x 3 times.

ADVERTISERS INDEX

Terlin	IFC	Av-Com	23
Icom.....	OBC, 55	Amateur Transceiver Radio ...	24
Jaycar	17	Dick Smith	IBC 28,29
Andrews	23		

TRADE PRACTICES ACT

It is impossible for us to ensure that the advertisements submitted for publication comply with the Trade Practices Act 1974. Therefore, advertisers and advertising agents will appreciate the absolute need for themselves to ensure that the provisions of the Act are strictly complied with.

VICTORIAN CONSUMER AFFAIRS ACT

All advertisers are advised that advertisements containing only a PO Box number as the address cannot be accepted without the addition of the business address of the box-holder or seller of the goods.

YAESU VX-1R MICRO DUALBAND HANDHELD TRANSCEIVER

Wide receiver coverage, leading edge features, and Lithium Ion technology, packaged for convenience at a price that will surprise!



VX-1R shown full size

The new VX-1R is one of the world's smallest dualband amateur rigs, sporting a 2m/70cm transceiver with wideband receiver in a case sized just 47 x 81 x 25mm WHD. It has impressive memory and scanning facilities as well as receive coverage of VHF and UHF TV, AM and FM broadcast bands, AM aircraft band and other public service frequencies from 76 to 999 MHz*.

Leading-edge technology from the VX-1R's 500mW MOSFET power amplifiers together with the supplied 3.6V 700mA/H high-capacity Lithium Ion battery will provide many hours of superb local communications. Up to 1W output is available for longer range when external DC power is used. Extensive battery-saving features together with the Li-Ion battery's 2-hour recharge system yields long operating times under real-world conditions.

The VX-1R's extensive memory system provides 291 memory channels, most with Alpha-numeric labelling for easy recognition. A Smart Search™ system allows you to search a portion of a band you define, then loads any active frequencies into 31 special Smart Search™ memories for later inspection (great for finding activity when visiting a new area).

Besides being a fully-featured dual-band amateur transceiver, the VX-1R has extraordinarily wide receiver frequency coverage; you'll also be pleasantly surprised by the great audio on the FM broadcast band. A dual-watch facility is provided – and together with the AM, FM-narrow and FM-wide reception modes – you'll be having fun even when you're not operating on the amateur bands. For selective calling and listening, the VX-1R also includes a CTCSS encoder/decoder and a 104-code Digital Code Squelch (DCS) system as well as a Tone Search facility for both CTCSS and DCS encoded transmissions.

A great range of accessory lines for the VX-1R are available such as speaker/mics, a carry case, as well as a battery holder for 1 x AA alkaline battery which includes an inbuilt voltage step-up converter. Computer programming of the VX-1R is available via the optional ADMS-ID programming kit.

So when Yaesu says "Dick Tracy, we're waiting for your call" you can be sure they have good reason to do so. In fact, call into your Dick Smith Electronics' Hams Shack store for a demo of this fun new rig. Or phone 1300 366 644 for a copy of the Yaesu colour brochure.

D 3665

2 YEAR WARRANTY.

\$469

YAESU

BONUS

MH-34 SPKR/MIC (D 2114) valued at \$49.95 OR

FNB-52LI Lithium battery (D 3667) valued at \$59.95

PHONE FAX AND MAIL ORDERS

PHONE: WITHIN AUSTRALIA: 1300 366 644
(Local Call Charge)

FAX: (02) 9395 1155 within Australia and
(+612) 9395 1155 from outside Australia

MAIL: DICK SMITH ELECTRONICS, Direct Link Reply Paid 160, PO Box 321,
North Ryde NSW 2113 (No Stamp Required)

*Excludes packaging and postage. All major Credit Cards accepted.
14 Day Money Back Guaranteed if NOT completely satisfied. (Software excluded)*



Visit our web site at
<http://www.dse.com.au>



That's where you go!

MORE

GREAT

GEAR

FROM

ICOM



746 *A tri-bander packed with power.* Powerful and versatile to satisfy all your base station needs, HF + 6m + 2m band coverage, 100 W of output power on all bands, DSP functions standard, large multi-function LCD keeps you totally informed and makes the 746 so easy to use.

207H *Switch to two bands for a single band price...* In-dash versatility, VHF/UHF capabilities (one band at a time) via a band switching system, superb clarity on either operating channel, easily detachable front panel, even a connection to a packet modem supporting speeds of up to 9600bps.



Q7A *A mini unit with maximum performance.* 2m/70cm transceiver/wide band receiver just 8.6 cms high, wide band receive from 30 to 1300 MHz in FM/WFM/AM modes, simple operation with easy band switching, automatic squelch, crystal clear audio.

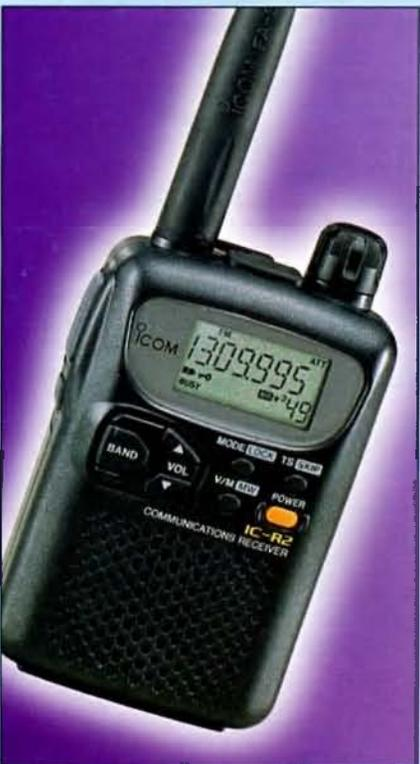

PCR100 *Cruise the airwaves with your computer.* Turns your PC into a sophisticated 0.5 - 1300 MHz receiver (FM/WFM/AM modes) with plug'n play installation. Multi function control panel, wide frequency coverage, and unlimited memory channels.

R2 *Fit the world's airwaves in your shirt pocket.* Just 8.6cm high, 0.5 - 1300 MHz frequency range divided into 9 bands plus FM/WFM/AM, auto squelch for consistent signal strength, 400 memory channels, great sound in rugged water resistant construction.

ICOM

Clearly Ahead

2 YR WARRANTY

See your nearest Icom Dealer, call Icom on 1800 338 915, or visit our website at www.icom.net.au



April 1999
Volume 67 No 4

Amateur Radio

Journal of the Wireless Institute of Australia



Full of the latest amateur radio news, information and technical articles, including...

- Homebrew 813 HF Linear Amplifier – Part 2
- Improvements to Signal Generator Model Q-1312/SG-9200
- Making PCBs with your Computer
- Is the WIA Fading Away?
- 70cm Personal Handhelds – No Licence Required!
- 9U Burundi DXCC Contacts Void!

Plus *lots of other articles, news and special interest columns.*

QMS - 7

Antenna Coupler System

Quick Mount System
for mobile HF and VHF use



- QMS-7 offers unsurpassed frequency agility without user intervention
- SG-231 Smartuner automatic antenna coupler, SG-307 extended full-range antenna, and weather resistant QMS-7 package
- 1 to 60 Mhz-continuous-instant tuning while you drive
- Rated for use on moving vehicles at up to 75 Miles (120km) per hour

SG-230 MICROPROCESSOR CONTROLLED ANTENNA COUPLER (1.6-30MHz) 200W Smarttuner

The SG-230 Smartuner automatic antenna coupler can be used within its power rating with any HF Transceiver in range of 1.6-30MHz. Designed for marine, portable and fixed base applications. For antenna types: 23ft marine whip for 1.6 to 30MHz and with 9ft. minimum antenna for 3-30 MHz operation

Number of channels unlimited
Frequency range 1.6-30 MHz
Power rating 200 watts PEP maximum 12 VDC. operation
SWR: Less than 1:1.5
Tune power: 3 watts nominal
Weight: 8Lbs.
Dimensions: 12.5 x 10.5 x 3
Supplied with 9ft. cable for coaxial and DC power.



Terlin
OUTbacker 

PO BOX 1197
Canning Vale W.A. 6155
www.outbacker.com.au
terlin@outbacker.com.au

Ph (08) 9455 4288
Fax (08) 9455 4289



Amateur Radio

Volume 67
Number 4
April 1999

The Journal of the Wireless
Institute of Australia

ISSN 0002-6859

Amateur Radio is published by the Wireless Institute of Australia ACN004 920 745 as its official Journal on the last Friday of each month

Editorial

Editor:	Bill Rice*	VK3ABP
Production Manager:	Bob Harper	VK4KNH
Snr Technical Editor:	Peter Gibson*	VK3AZL
Technical Editors:	Evan Jarman*	VK3ANI
	Gil Sones*	VK3AUI
	Don Graham	VK6HK
Contributing Editors:	Ron Fisher*	VK3OM
	Don Jackson*	VK3DBB
WIA News Editor:	David Thompson	VK2NH

*Publications Committee member

Advertising

Mrs June Fox
WIA Federal Office
PO Box 2175 CAULFIELD JUNCTION VIC 3161
Tel: (03) 9528 5962 Fax (03) 9523 8191
email armag@hotkey.net.au

Amateur Radio Correspondence

All correspondence, contributions and queries about the **content** should be sent to:

The Editor *Amateur Radio*
PO Box 2175
CAULFIELD JUNCTION VIC 3161
email armag@hotkey.net.au
Tel: (03) 9528 5962 Fax (03) 9523 8191

Amateur Radio Delivery

All queries regarding delivery should be directed to:

Amateur Radio WIA Federal Office
PO Box 2175 Caulfield Junction Vic 3161
Tel: (03) 9528 5962 Fax (03) 9523 8191

Registered Office

10/229 Balaclava Road
Caulfield North VIC 3161
Tel: (03) 9528 5962 Fax (03) 9523 8191
Business hours: 9.30am-3pm weekdays

Editorial & Display Booking Deadlines

May	16/4/99
June	14/5/99
July	11/6/99

Hamad & Display Material Deadline

May	20/4/99
June	21/5/99
July	18/6/99

Production

Administration, Drafting, Design & Sub-editing
Shadetree Publishing & Imaging
PQ Box 288 BEERWAH QLD 4519

Pre-press, print and mail management
Newsletters Unlimited (03) 9428 3458

Printed by Streamline Press, Melbourne (03) 9417 2766

Mailed by IMS, Melbourne (03) 9291 5888

Receipt of Amateur Radio by mail

This issue was delivered to Australia Post on Thursday April 1. If you are a financial member and have not received your copy by the 15th of the month please check with your local Post Office before contacting the registered office of the WIA.

Copyright and Reproduction

The copyright in this magazine, except where specifically noted, is held by Wireless Institute of Australia ©WIA 1999. Permission to republish articles in any form must be obtained in writing from the Institute (other than for purposes of 'fair dealing'). This permission is usually freely given for information purposes.

Technical

Improvements to Signal Generator Model Q-1312/SG-9200	6
<i>Drew Diamond VK3XU</i>	
Make PCBs with your computer	10
<i>Joe Rotenberg VK3BBN</i>	
A Homebrew 813 Linear Amplifier part 2	12
<i>C.J. Bourke VK4YE</i>	
Technical Abstracts	18
<i>Gil Sones VK3AUI</i>	
A note about the DL6WU Yagi	20
<i>Ian Cowan VK1BG</i>	

General

The WIA, is it Fading Away?	8
<i>John Bennett VK3ZA</i>	
You have email	11
<i>Brian Beamish VK4BBS</i>	
Taking photos for <i>Amateur Radio</i>	22
<i>Bob Harper VK4KNH</i>	
Book Review: The RSGB Guide to EMC	23
<i>Bill Rice VK3ABP</i>	
Australian LF Band Gains International Reputation	24
<i>Jim Linton VK3PC</i>	
A Regulator Reflects	24
<i>Rob Gurr VK5RG</i>	
The Need for Morse Code, an FOC viewpoint	25
<i>G3WGV (submitted by David Pilley VK2AYD)</i>	
Kickstarting a radio operator	35
<i>Bob Harper VK4KNH</i>	
Beware Burundi	44

Columns

Advertisers' Index	56	Over to You	30
ALARA	50	Pounding Brass	45
AMSAT Australia	39	QSP News	31
Awards	21	Silent Keys	31
Club News	32	Spotlight on SWLing	40
Contests	48	VHF/UHF - An Expanding World	36
Editor's Comment	2	WIA Comment	3
Education	46	WIA News	3
Hamads	54	WIA Divisions News	41
HF Predictions	52	WIA Federal Statement	5
How's DX	51	WIA Division Directory	56
Novice Notes	34	WIA Federal Directory	2

Our cover this month

Harry Angel VK4HA

Representing those who served Australia in all conflicts.

Contributions to Amateur Radio

Amateur Radio is a forum for WIA members' amateur radio experiments, experiences opinions and news. Manuscripts with drawings and or photos are always welcome and will be considered for publication. Articles on disc or email are especially welcome. The WIA cannot be responsible for loss or damage to any material. A pamphlet, How to write for Amateur Radio is available from the Federal Office on receipt of a stamped self-addressed envelope.

Back Issues

Back issues are available directly from the WIA Federal Office (until stocks are exhausted, at \$4.00 each (including postage within Australia) to members.

Photostat copies

When back issues are no longer available, photocopies of articles are available to members at \$2.50 each (plus an additional \$2 for each additional issue in which the article appears).

Disclaimer

The opinions expressed in this publication do not necessarily reflect the official view of the WIA and the WIA cannot be held responsible for incorrect information published.

Guest Editorial

Technological Changes

The other day I heard a man say "I'm not an Internet man. I don't even own a computer." This caused me to reflect yet again about the myriad of changes that have impinged on us all in the last decade or two.

This man had only 68 years, so he could have entered the computer age, especially as his background was the PMG and later in developing communications at the South Australian rocket testing site in the 1950s and 60s.

With so many changes, it is easy to get out of balance with the past, so the questions arise; one, is anything from the past still relevant and two, are new ideas necessarily better? In short form, I think that we would agree that the answers are yes and no respectively.

Does anyone care about the loss of CW skeds and watches from the Marine Service? How many of you, like me, saw the regular bulletins not only as a service to ships, but wonderful daily opportunities to practice CW reading? I accept that modern satellite communications may give generally better service (with reservations as highlighted by recent yachting rescues). It is only fair that these advances should be utilized.

I do, however, mourn the passing of yet another tried and true service, even if it was for a minority group in the community.

Yet I do not believe that CW will die – there will always be someone in the Amateur Service to keep it alive, even if they use computers to do it!

Ian Godsil VK3DID
Federal Contests Co-Ordinator

NEW WIA MEMBERS

The WIA bids a warm welcome to the following new members who were entered into the WIA Membership Register over the past few months :-

L21159	MR A MCNAMARA	VK2ZJV	MR J E BROWN-SARRE
L21160	MR J D ROBINSON	VK3UQ	MR J HAMILTON
L21161	MR M ASHMAN	VK5PKW	MR K W WHITLOCK
L21162	MR W J BIRTCHELL	VK5ZLT	MR A NANKIVELL
L31546	MR G O'SHEA	VK7DU	MR H M ROGERS
L60397	MR E P GREGORY	VK7NN	MR D A HOPPER
L60411	MR K BRASCHE	VK7ZOB	MR S M BRYANT
VK2 TJE	MR J JAMIESON	VK1VI	MR V C IONESC
VK2AGN	MR A GEESON	VK1YPM	MR P E MCILLREE
VK2BGL	MR S G LEATHEAM	VK3ASI	MR H MICHAEL
VK2CNN	MR G PAK	VK3BBT	MR D TAYLOR
VK2EHF	MR H FEIGE	VK3BMY	MR L J HEARNES
VK2GJM	MR J MOUKATATZAKIS	VK3FKF	MR G GIBBINGS-JOHN
VK2GMB	MR B G MEERS	VK3HAD	MR C WHITEFIELD
VK2IR	MR T HOROZAKIS	VK3MRV	MR R VIGH
VK2KLD	MR L DAVID	VK3QW	MR P ENGELMAN
VK2KYT	MR A W HILDER	VK3XSC	MR P ARNETT
VK2MDT	MR D P TODD	VK5CC	MR C P CARROLL
VK2MSC	MR S D SALMON	VK5KBM	MR E B MACKENZIE
VK2TDW	MR J M REID	VK7VV	MR R R TAYLOR
VK2TPR	MR P R HULL		
VK2TTH	MR A E HAWKINS		
VK2WCR	MR E R MILNE		
VK2WDL	MR W D BRACK		
VK2YME	MR G J PETERS		

I apologise for the delay in publishing these names, unfortunately this was one job that went amiss in the change-over. I trust that with a few more next month we'll be right back in step again.

Bob VK4KNH

Amateur Radio Service

A radiocommunication service for the purpose of self-training, intercommunication and technical investigation carried out by amateurs; that is, by duly authorised persons interested in radio technique solely with a personal aim and without pecuniary interest.

Wireless Institute of Australia

The world's first and oldest
National Radio Society
Founded 1910

Representing
The Australian Amateur Radio Service

Member of the
International Amateur Radio Union

Registered Federal Office of the WIA

10/229 Balacava Road
Caulfield North Vic 3161
Tel: (03) 9528 5962
Fax: (03) 9523 8191
<http://www.wia.org.au>

All mail to
PO Box 2175 Caulfield Junction VIC 3161

Business hours: 9.30am-3pm weekdays

Acting Federal Secretary

Peter Naish VK2BPN

Federal Office staff

June Fox Bookkeeper
Rita Trebilco VK3IF Examinations Officer

Council

President	Peter Naish	VK2BPN
VK1 Federal Councillor	Michael Jenkins	VK1MJ
VK2 Federal Councillor	Michael Corbin	VK2YC
VK3 Federal Councillor	Brenda Edmonds	VK3KT
VK4 Federal Councillor	Ross Marren	VK4AMJ
VK5 Federal Councillor	Jim McLachlan	VK5NB
VK6 Federal Councillor	Will McGhie	VK6UU
VK7 Federal Councillor	Andrew Dixon	VK7GL

Executive

Peter Naish	VK2BPN
Martin Luther	VK5GN
Wally Howse	VK6KZ
Neil Penfold	VK6NE

Federal Coordinators

AMSAT	Graham Ratcliff	VK5AGR
Awards	John Kelleher	VK3DP
Contests	Ian Godsil	VK3DID
Education	Brenda Edmonds	VK3KT
FTAC	John Martin	VK3KWA
Historian	John Edmonds	VK3AFU
JARU	Grant Willis	VK2ZWI
Intruder Watch	Gordon Loveday	VK4KAL
ITU Conference and study group	David Wardlaw	VK3ADW
Public Relations	David Thompson	VK2NH
QSL Manager (VK9, VK0)	Neil Penfold	VK6NE
Videotapes	Don Bland	VK4TVD

ACA Liaison Team

Brenda Edmonds	VK3KT
David Wardlaw	VK3ADW
Peter Naish	VK2BPN



Comment

Federal President, Peter Naish
VK2BPN.

Need for constant vigilance

I MAKE NO APOLOGY for once again highlighting the need for amateur radio operators to be ever vigilant in watching for cases of intrusion into our bands.

An excellent example of this is given elsewhere in this issue of *Amateur Radio* that describes the launch of a non-amateur radio transceiver by a well-known electronics company. Nothing unusual about this except that the device operates in the 70cm band on a narrow frequency segment set aside for class licensees.

There is nothing to prevent this kind of intrusion occurring elsewhere in our bands. The WIA is mindful of this possibility and will continue to represent your point of view to the Australian Government authorities who regulate the spectrum in this country. We can only be fully effective if we have the total support of all radio amateurs. More than ever we need the strongest possible voice to ensure that these authorities are aware of our needs and will respond to them. I'll say it again — the real value in being a member of the WIA comes from the knowledge that you are supporting the team of dedicated volunteers who spend so much of their time working to maintain and improve our operating privileges.

With the rapid improvement in HF band conditions as we move towards another sunspot maximum, it is wonderful to be able to once more work the world with modest equipment.

This is the amateur radio that attracted me all those many years ago with the thrill of talking to stations thousands of miles away (yes miles in those days!) There is still that special feeling of delight when that rare station answers your call. Finally getting through the pile-up a few kHz up from that DX-pedition station after perhaps many attempts is indescribable. I bet you don't get that feeling on the Internet!

Let us hope that we can engender that spark of enthusiasm into some of the younger members of our community and encourage them to join this great hobby of amateur radio

Peter Naish, VK2BPN
WIA Federal President

WIA NEWS

WIA News Prepared, researched and compiled by
David Thompson VK2NH
Federal Public Relations Coordinator.

Program of Future Spectrum Auctions Released

The Australian Communications Authority (ACA) has released its *Program of Future Auctions*.

The Program lists radiofrequency bands likely to be auctioned in Australia in the future, with an indication of the priority and possible applications of each band.

ACA Chairman Tony Shaw said the Program was intended to provide information for current users and potential purchasers of radiofrequency spectrum, and other interested parties, about the bands likely to be considered for spectrum auctions.

"The ACA is keen to provide as much information as possible about when and how spectrum will be allocated.

This Program provides participants in the Australian communications market with an indication of the ACA's thinking about particular bands, and the likely timeframe of future auctions."

Mr Shaw emphasised that the Program does not replace the normal consultation process the ACA undertakes before initiating price-based allocation of any band.

The Program of Future Auctions is based on an ACA discussion paper released in 1998, which set out preliminary views on possible bands for future auction.

This Program reflects comments received in response to the paper, and includes discussion of criteria used by the ACA in deciding whether or not a band should be considered for auction.

The Program is designed to be a three-year rolling program, updated on an annual basis.

The ACA welcomes comments on the bands listed in the Program, other bands that might be considered for future auction, or any relevant matters.

The Program of Future Auctions is available on the ACA website at www.aca.gov.au under Spectrum Auctions.

New Standard to Limit RF Exposure

The Australian Communications Authority (ACA) has introduced a new regulatory framework setting electromagnetic energy exposure limits for the general public from mobile phones and mobile phone base stations. The range of devices covered by the standard will be progressively extended to eventually cover all types of radiocommunications transmitters.

Consumers can rest assured that they have protection from the use of radiocommunications equipment. The exposure limits have been determined in response to considerable community interest in the possible adverse health effects associated with the use of radiocommunications equipment such as mobile phones, the siting of mobile phone base stations, and other installations utilising radio frequencies.

The mandatory standard introduced on 1 February, 1999, includes human exposure limits from the Australian Standard AS/NZS 2772.1(Int):1998. This standard applies to the exposure of people to radiofrequency fields which are produced or radiated, either deliberately or incidentally, by the operation of devices or equipment.

Within the regulatory framework, responsibility for compliance with the mandatory standard will fall on manufacturers or importers of certain devices as well as holders of ACA radiocommunications licences. Responsibility for the compliance of radiocommunications installations (for example, broadcasting transmitters or mobile phone base stations) will rest with the licensee.

The effect of making this mandatory standard under the provisions of the *Radio Communications Act 1992* is such that it will be an offence to knowingly supply, operate or use any radiocommunications transmitter that does not meet the mandatory standard. Manufacturers and importers will be required to demonstrate compliance with the standard, prior to being allowed to place a product on the marketplace. They will need to make a declaration that their product complies with applicable standards, create and maintain a compliance folder of documentation supporting their claim, and label devices. Owners and operators of radio-

communications facilities will also be required to demonstrate compliance with the standard prior to issue or renewal of a radiocommunications licence.

This requirement will be written into the licence. Compliance with the mandatory human exposure standard by manufacturers, importers, and operators of specified devices will be enforced through random audits of compliance documentation by ACA officers as well as through complaint investigations.

Background

The ACA has provided a backgrounder on the *Electromagnetic Radiation Regulatory Regime* which is designed to provide a better understanding of the need for the energy exposure limits Standard. It is reproduced here in relative detail for your information.

In recent years, use of the radiofrequency (RF) spectrum has increased exponentially. Increasing demand for personal mobile communication services, such as handheld radio-telephones (mobile phones) has seen radiocommunications transmitters expand from being used for specialised applications to becoming widely available consumer items.

The telecommunications sector has been largely responsible for this expansion, and as usage of radio communication devices increases, concerns continue as to the long term health consequences of the use of radiocommunications.

All radiocommunications transmitters emit electromagnetic radiation (EMR). Exposure to high levels of RF EMR can result in tissue heating and exposure to excessive levels is known to cause such acute adverse health effects as shocks and burns. These effects are well documented and are known as "thermal effects". However, there is no conclusive evidence that long term exposure to low level RF EMR is associated with adverse health effects such as cancer.

Internationally there is an increasing trend to regulate RF EMR. The United States of America already has some regulations in this area, and the European Union and Japan are currently considering limits for RF EMR.

Until the beginning of 1999 the Australian Communications Authority (ACA) regulated human exposure to EMR from mobile telecommunications devices, including handsets and base stations, under the *Telecommunications Act 1997*.

However, these devices are only a fraction of the total of radiocommunications transmitters in the community, and are not necessarily the devices likely to exceed the limits of human exposure standards. Legislation enacted on 1 July 1997 provided

additional powers to the ACA to mandate standards to protect the health and safety of persons who may be exposed to emissions from radiocommunications transmitters.

To enable implementation of these powers the ACA has consulted both extensively and in depth with its stakeholders to develop a workable regulatory regime to regulate EMR exposure.

At the basis of the ACA standard are the human exposure limits of the Australian standard AS/NZS 2772.1 (Int):1998 together with a methodology for testing the compliance of mobile phone handsets with the Specific Absorption Rate (SAR) limits of the standard.

Implementation of the EMR framework is a phased approach. The ACA is applying the non-occupational exposure limits of the standard first to devices in the following order:

- 1 February 1999—mobile phones and base stations;
- mid-1999—low power radiocommunication transmitters; and
- late-1999—remaining radiocommunications transmitters.

The mechanisms for compliance with the requirements in the mandatory standard apply at point of supply to the market for specified devices and to radiocommunications licences.

Compliance with the mandatory standard is required by manufacturers and importers of devices fitted, or intended to be fitted, with an integral antenna and intended to be used in close proximity to the body. For these devices (for example, mobile and cordless phones) there are two categories of compliance depending on whether the device meets the non-evaluation criterion specified in the standard. If the device requires evaluation, this must be according to the methodology in the standard.

Compliance is also required of operators and users of all transmitters presently licensed under the Radiocommunications Act including telecommunications and broadcasting transmitters.

In general, two categories of compliance apply to licensing conditions depending on an assessment of the likelihood of the transmitter exceeding the limits in the standard. Where testing is required this must be performed in accordance with the standard, otherwise, compliance may be evaluated using appropriate engineering charts and tools.

All compliance requirements are being harmonised with existing ACA regulatory requirements to minimise the regulatory burden on industry.

For more information about the mandatory standard, or to obtain a copy of

the EMR information paper and Fact Sheet, please contact Mr Ian McAlister on (02) 6256 5451.

The ACA will acknowledge all written and electronic communications, including complaints concerning breaches of the EMR regulations, within seven days and report on the progress of investigations.

Enquiries relating to the Health Exposure Standard AS2772.1 (Int): 1998 should be directed to the Standards Association of Australia on telephone (02) 9746 4700.

Amateur Radio Assists in Austrian Avalanche Emergency

Hams in Austria assisted in the wake of the series of avalanches that hit the snow capped Alps. And the nation's communications regulators are asking radio amateurs around the world to keep off two frequencies until further notice.

The two frequencies are 3.685 MHz on 75 metres and 7.085 on 40 metres. According to an Austrian news release, they are being used extensively in relief efforts in the mountains by hams involved in snow disaster relief communications. Austria would therefore like for these two frequencies to be kept clear of all non-avalanche related communications. 24 hours a day, seven days a week — until further notice.

Via Austria Telecommunications Authorities

Sunsat is in Orbit

From Amateur Radio Newline comes the story that after several weeks of frustrating delays, South Africa's SUNSAT Satellite was placed into orbit on February 23rd. A Delta II Missile carried SUNSAT and 2 other spacecraft lifted off from Vandenberg Air Force Base in California

The SUNSAT Satellite was designed and built by engineering students at Stellenbosch University in South Africa. At 132 pounds weight, the spacecraft is the country's first satellite and the first ever built in Africa. It contains Amateur Radio equipment designed to support digital and voice communications. An onboard BBS will allow hams to store and forward files and messages. Meanwhile the satellite parrot system will receive and repeat voice on 2 metres

SUNSAT will take images of South Africa from orbit to monitor agriculture and the environment. The satellite will also collect data to more accurately map the earth's gravity field. Onboard experiments from 2 South African high schools will detect atomic particles and vibrations made by the satellite. SUNSAT is expected to remain in orbit for about 6 years.

World's Most Respected Radio Amateur SK

The man described as the world's most respected radio amateur, King Hussein of Jordan, JY1 died on 7 February 1999 at 63.

The Middle East's longest serving ruler, Jordanian King for 47 years, was a senior statesman in determining world affairs, especially in his troubled region. His son, Abdullah, 37, succeeds him. Hussein had earned a reputation as a catalyst for peace and as a conciliator in the Middle East.

Reportedly King Hussein had been active in recent months from the United States whole being treated for the cancer, which claimed his life. A QSO with JY1, who was a life member of the ARRL, was considered by many hams to be both an honor and a privilege. His elegant QSL card was prized.

ARRL Executive Vice President David Sumner, K1ZZ, has called him "an enthusiastic radio amateur whose support was invaluable to us in obtaining new amateur bands at the 1979 World Administrative Radio Conference." The WARC-79 resulted in Amateur Radio's gaining the 30, 17, and 12-metre bands. That same year, JY1 was featured in the film, "The World of Amateur Radio." Hussein regarded his 1983 contact with Owen Garriott, W5LFL, on board the Space Shuttle Columbia, as a high point in his Amateur Radio activities. He was also was involved in early satellite experiments.

Former US Ambassador to Lebanon and Iran, Armin Meyer, W3ACE, also recalled Hussein in The Washington Post. "JY1 has for decades been promoting peace and good will among quite ordinary people." As Meyer put it: "For the king, ham radio was a different world, a community of diverse people."

All of the Jordanian royal family automatically have Amateur Radio privileges in Jordan. King Hussein's widow—the American-born Queen Noor—is JY1NH. His brother, former Crown Prince Hassan, is JY2HT, his cousin, Prince Raad, JY2RZ, chairs the Royal Jordanian Radio Amateur Society.

Via Jennifer Gagne, N1TDY, ARRL & RSGB



JY1 at his hobby

WIA Federal Statement

By Peter Naish

Class licence operations on the 70-cm band

FOLLOWING CONCERNS RAISED by WIA about a licence-free handheld transceiver that operates on the 70-centimetre band, retail giant Dick Smith Electronics (DSE) has stated it believes the unit won't cause interference to amateur operations.

The 20-channel transceiver sold by DSE is the first and latest in a range of low powered devices permitted under a class licence to operate on part of the 70-cm band — an allocation shared by a number of radio services including the amateur service.

WIA Federal President, Peter Naish VK2BPN, said the first the WIA heard about the transceiver was through a magazine advertisement. It then contacted Chris Ayres of DSE to seek clarification of the matter.

Mr Naish said, "In talking with Chris Ayres I expressed the WIA's surprise that this product had been launched without prior discussion considering the good relations that exist between the WIA and DSE.

"We need to work together to foster our separate but complementary interests in amateur radio and avoid the possibility of damage to those interests.

"I advised Mr Ayres that I could foresee some antipathy towards DSE if the impact of this product's availability in the general market was not properly understood."

DSE has advised the WIA that the transceiver is:

- A product meeting a demand for short haul (intra-building) wireless communications, and an alternative to the very cluttered 40MHz band also used for this purpose under a class licence
- Priced at \$150 to suit the non-commercial and residential market
- A 20-channel hand-held set with 20mW EIRP output power and is spectrally clean with no provision for an external antenna
- Asian made to DSE specifications which include channels in the simplex section of the WIA band plan (433.750-434.250MHz) so as to be clear of the amateur radio service repeater input frequencies

Chris Ayres says that he is very conscious of the WIA's concern but believes the product as sold will not (unless abused) interfere to other services outside the narrow range of frequencies programmed into it.

The WIA has agreed to keep him informed about the WIA's concern and let him know about any substantiated cases of interference to amateur radio services due to this product.

Mr Naish said, "If the ACA had taken note of the WIA's complaints regarding the establishment of a class licence in the 70-cm band, none of this potential for interference would have occurred."

The Amateur Service is a *secondary* user of the band. The Australian Communications Authority (ACA) advised the WIA in 1996 that it would declare a class licence for low powered devices on the band.

The WIA at the time expressed its concerns about the compatibility of low powered devices on the band and in particular those frequencies in the Amateur Repeater sub-band and the Amateur Satellite Service sub-band.

The ACA's declaration of the class licence was seen as a response to pressure from commercial interests wanting to legitimise European products on the Australian market, such as wireless headphones, wireless speakers, and radio controllers such as RF key locks for vehicles.

Mr Naish said the WIA's concerns about the class licence being "open" in terms of types of emission were raised unsuccessfully with the ACA in 1996/97.

Peter Naish said, "The class licence makes no constraint on the type of emission. The only restriction is a limitation in output power.

"It is therefore entirely legal to sell and operate devices for two way communication under this class licence, making it a defacto citizens band.

The class licence allows for 20 mW ERP in a band 433.050-434.790 MHz. Users of equipment are not able to claim protection from interference they may experience from other users of the band which are the Amateur Service, Radiolocation Service and Department of Defence.

First to take advantage of the class licence were devices used for the transmission of data, and radio control devices including RF key locks for vehicles.

Last year 130 imported European cars landed at Elizabeth in SA fitted with 70-cm radio key locks that suffered interference from an Amateur repeater.

IMPROVEMENTS TO SIGNAL GENERATOR MODEL Q-1312/SG-9200

Drew Diamond, VK3XU

45 Gatters Rd
Wonga Park, 3115.

A SIGNAL GENERATOR ENABLES the experimenter to do all sorts of useful tests and measurements. In recent years we have been fortunate by able to buy surplus laboratory-grade sig. gens. at very reasonable cost. They are generally of the "boat-anchor" variety. The beautiful Hewlett Packard model 606(suffix) is a typical example. However, for the worker with limited workshop space, these take up rather a lot of bench area.

You may be thinking about purchasing- or already own, one of the neat little generic "signal generators" of the type sold by Dick Smith, and others, model Q-1312. It has a few limitations (as in most things- you get what you pay for). Nor does it qualify for the illustrious title of "signal generator"- it is simply a signal source. Nevertheless, in the hands of a competent operator, the Q-1312 is capable of doing some serious work.

Let me list a few applications: In receiver work, as a signal source/VFO in transmitter development, as a signal source to drive inductance/capacitance bridge(s), as a source in antenna, feedline and impedance bridge measurements, and as the local oscillator for a "poor man's" spectrum analyser (more on these topics, it is hoped, at a later date).

Briefly, frequency range is from 100 kHz to 150 MHz in six bands. Internal amplitude modulation is fixed at 1 kHz, about 30 % depth, with provision for external AM. The audio signal is also ported to the front panel. A handy crystal check circuit is provided, which may be mixed with the main signal to produce $f_1 \pm f_2$ products. The unmodulated RF output waveform is nicely sinusoidal over the HF range, and the AM envelope has a near "text-book" appearance. Maximum output is specified as "at least 100 mV (my sample gives 220 mV or 1 mW/0 dBm) across 50 ohms- a very appropriate level for a variety of applications. After a reasonable "settling down" period, HF frequency stability is adequate for ordinary tests, even at 28 MHz.

One of the most striking inadequacies is the lack of any fine manual variation of frequency, especially above about 1.8 MHz. I spent hours

on this problem, trying to fit some form of fine control using tuning diodes, varactors and so on, and met with only limited success. The frequency could be made to vary by an appropriately small amount at the high end of each range, only to find that there was little or no variation at the low end (due, probably, to

the very high C:L ratio of the oscillator tank at the low frequency end of each range).

What to do? In the end it was realised that the amateur's need for a fine control is generally felt above about 3 MHz, to perhaps 30 MHz (for sneaking up to, through, and out of crystal filters for instance), which is included in ranges D and E. The oscillator coils are placed around the range switch as shown in Photo 1. A small variation in inductance, rather than capacitance, was thought desirable. Shown is one approach (stop reading now if you cannot bring yourself to drill holes in factory-made equipment). A powdered-iron slug (from an old style IF transformer) with brass spindle is soldered to the metal lug of an IRC potentiometer. (See Photo 2). The slug is arranged so that it can be swung in proximity to the D and E range coils (Photo 1.)

There is room for the pot to be mounted upon the front panel, below the Frequency

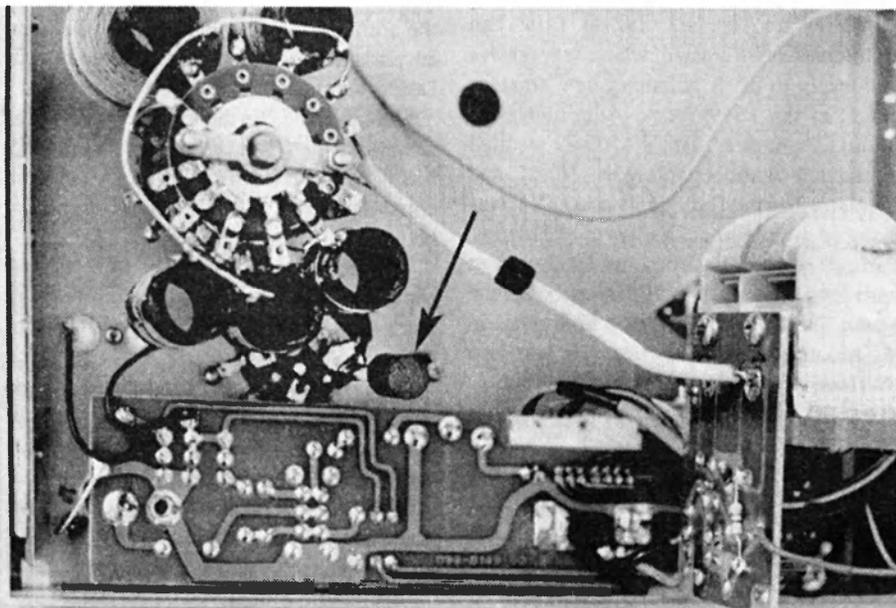

Photo 1 - Pot/slug assembly installed

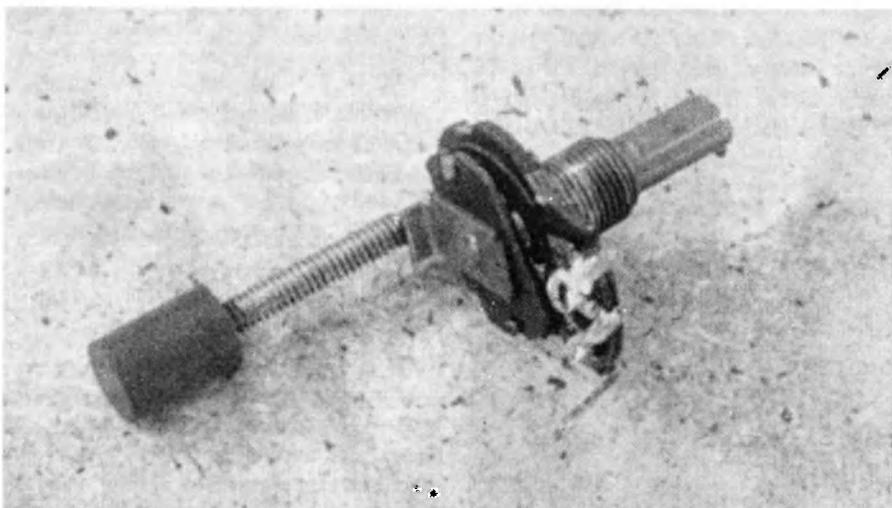

Photo 2 - Potentiometer Mechanism with the Slug attached.

Range switch, and to the left of the crystal socket. See (Photo 3). In order to drill the hole in the panel, firstly, unsolder coils D and E. Don't go straight in with a 3/8" drill, but carefully drill from the front in stages to about 1/4", then hand-ream to 3/8". Mount the modified pot/slug assembly, then replace the two coils. Check that you can obtain a smooth interference-free swing of the slug between the D and E coils and without striking the circuit board. Melt a bead of wax onto the coils where the slug touches each coil to prevent it from actually contacting the windings.

The second modification is less important. Being at the end of a long rural line, my mains voltage varies all over the place- from 210 V to 250 V (seriously). The oscillator section runs from a stabilised supply rail, but the output amplifier is powered from the unregulated +18V rail. Mains voltage variations do show up as frequency variations under some circumstances. There is also a trace of 100 Hz FM. Regulating the +18 V rail significantly improved matters. I used a common and cheap regulator chip type 7805 (nominally +5 V) with external divider resistors set to deliver +18 V.

If you find this improvement necessary; remove the 100R 1/2 W resistor R27, whose holes may now be used for the input and output legs of the regulator chip. The 470R 1/4 or 1/2 W resistor may now be fitted between the floating (C)ommon leg and the left spare hole enclosed in the semi-circle. The 820R 1/4 or 1/2 W resistor may be fitted between the common leg and a spare ground hole, as shown in Photo 4. Double check your component locations, values, and wiring before switch-on. If you have an oscilloscope; check that the '7805 is not oscillating by probing the +18 V rail. If so, fit a 100 nF capacitor between input and Common, and another between(+) and Common of the chip.

Battery operation was considered, but a DC supply requirement of 18 V at about 65 mA makes a heavy demand for ordinary dry cells. For field work, consider a polarised two-pin socket for external battery connection.

The third most obvious deficiency is an inability to reduce the signal to a sufficiently small value to permit microvolt and sub-microvolt receiver sensitivity measurements. Nor is the output level metered. In a future issue I hope to tackle this problem, and also go on to describe some more amateur applications for this versatile test instrument.

Further Reading:

1. Test Equipment for the Radio Amateur, C. Smith, G4FZN. RSGB Publications.
2. Low Cost RF Test Oscillator, J. Rowe, in Electronics Australia, May/June '96.

ar

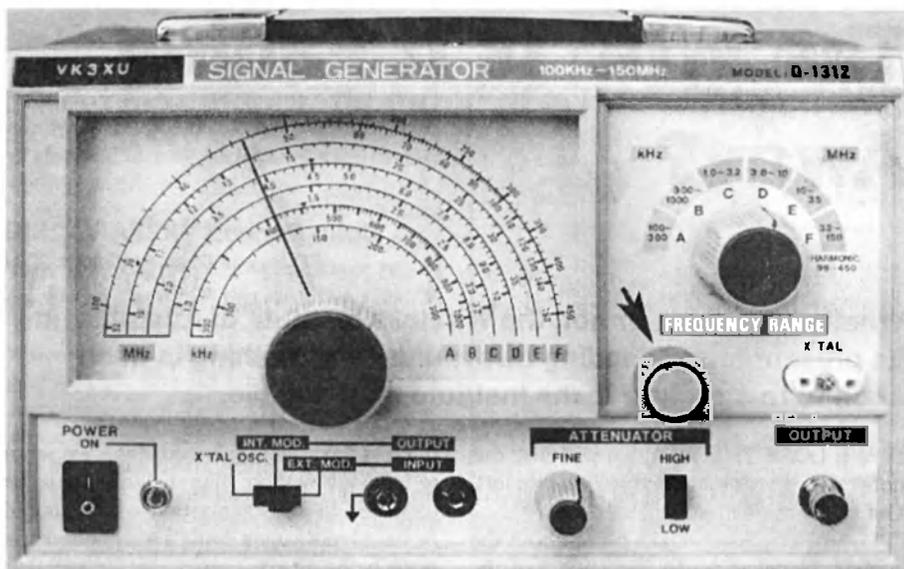

Photo 3 - The Q-1312 with fine frequency control fitted (arrowed).

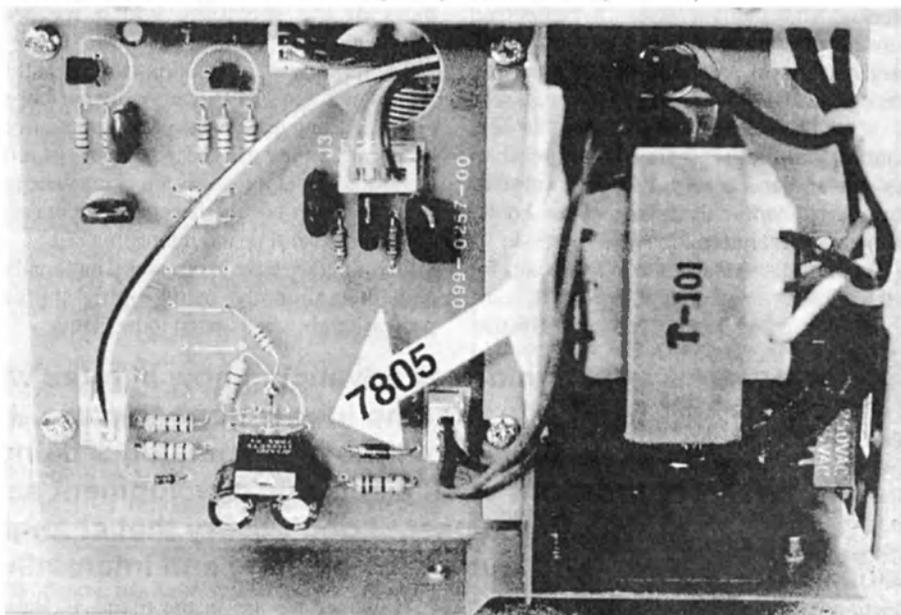

Photo 4 - Placement of 7805 (arrowed).

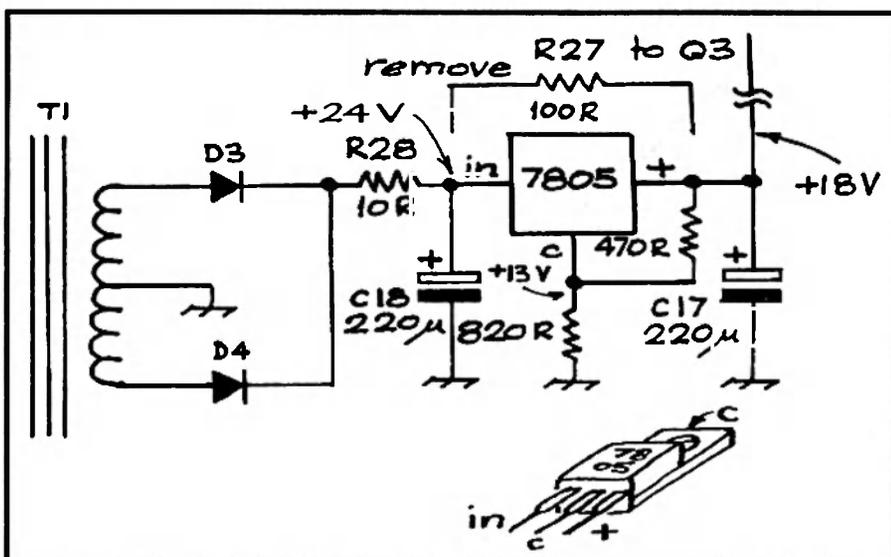

fig 1 - Q-1312 Power Supply Modification

The WIA- Is It Fading Away?

John Bennett VK3ZA/VK2SIG
PO Box 48 Dunkeld Victoria 3294

Whether we like it or not, the Wireless Institute of Australia, in its present form, is fading away; unless something is done soon to re-structure it, the Institute may well die.

IF WE LOSE THE WIA, we will lose our collective voice as amateur radio operators. Our hobby can't afford that loss.

Lots of discussion takes place about the future of amateur radio, the impact of the Internet and loss of amateur spectrum access. Little thought appears to be directed toward preserving the only amateur radio organisation in Australia that is currently recognised by Government.

What is needed urgently is a less cumbersome, less complex, less expensive-to-run and more widely representative Institute to handle the affairs of our hobby nationally and internationally.

As things now stand, the WIA speaks for all Australian amateur radio operators, some 16,000 of us, while only having a fraction of that total number in its membership.

That doesn't mean that 16,000 amateurs are not well served by the WIA. The WIA negotiations with Government are for all amateurs, but the Institute will steadily lose credibility as more and more Hams lose interest in belonging.

The WIA urgently needs restructuring and increasing in strength. The present form is largely lacking in appeal and interest to Amateurs and certainly is not conducive to attracting new members to its ranks.

I first joined the WIA in 1948 and subsequently served on the Divisional Councils of the VK2 and VK3 Divisions. I produced the VK2 weekly broadcast; have been President of the Canberra Radio Society (now the VK1 Division); was a member of the WIA Federal Executive and have written many editorials for "Amateur Radio" magazine over a considerable period. I believe I have sufficient 'feel' for the Institute to make some observations.

The WIA has never, in my experience, been a particularly cohesive organisation. Nevertheless, it is far less cohesive and more factional now than ever before. Most organisations of individuals of common

interest have their primadonnas - we seem to have a few more than would perhaps be expected in an organisation which should be based more upon being a science and less upon being an art.

Today we face more pressures to acquire parts of the spectrum, which we are privileged to use, than at any earlier time.

Technology is advancing now at rates with which most of us can no longer hope to cope. Long gone is the era of innovative amateurs being in the forefront of all electronic development as amateurs were in the past. I don't decry that change: it makes our hobby exciting and interesting.

Certainly we have in our ranks, nationally and internationally, many highly skilled professionals who happen to be Hams.

Technology is advancing now at rates with which most of us can no longer hope to cope. Long gone is the era of innovative amateurs being in the forefront of all electronic development as amateurs were in the past. I don't decry that change: it makes our hobby exciting and interesting.

However we are in the main, as Ham Radio enthusiasts, increasingly 'amateurs' in the whirlwind of technological communications developments. This is the era of the highly skilled professional.

Unfortunately, the WIA is, in many ways, becoming increasingly 'amateurish' rather than 'amateur concerned'.

The very structure of the WIA is archaic and nobody seems prepared to make the move to change it. The bickering within and between the state Divisions and WIA Federal and the all-too-public clashes within the organisation are doing a great disservice to our hobby and to the one organisation in the country that can speak on our cohesive behalf.

It is almost miraculous that the Australian Securities Commission does not yet seem to have been attracted by the inane antics of the WIA in its seeming inability to effectively administer itself as a registered company.

Why do we need the present structure of the WIA? We certainly need our institute as a responsible body to be the voice for our hobby but, with the exception of some present divisional services, the Divisions seem superfluous.

I don't claim to have the solution to the woes of the WIA but I do have great concern for the need for it to continue. I also have a few thoughts which may warrant discussion, consideration and, perhaps, implementation.

Firstly, the structure and role of the WIA should be examined and reported upon by a competent management consultancy, completely outside the WIA. Their charter would be to come up with a viable, simple, economical (bearing in mind our 'hobby status') proposal to restructure the Institute with a single national office—wherever that may be.

Doubtless, the anguished screams of divisional protest will be audible already!

Why should the divisions continue to exist? Given a new national WIA Headquarters, those of their few functions that would still be needed could continue; drawing upon the wonderful band of dedicated volunteers who currently make things work.

Appropriate funding would be made available from HQ as required for such items as repeater licence fees etc.

The Divisions are costly to run and with the possible exception of repeater facilities (particularly in VK3) they provide few benefits for their local membership.

Radio clubs throughout the country provide more service, interest and involvement for their members than does the WIA. The total membership of the about 150 radio clubs and groups in Australia will almost certainly outnumber that of the WIA! The latest published list of radio clubs affiliated with the WIA lists 126 clubs.

How many of their members actually belong to the WIA in their own right? It is very hard to know but a broad general inquiry indicates that many certainly do not.

Most amateurs, who really think they belong to the WIA, are members only of their State Division. The WIA at Federal level is a skeleton whose flesh is made up by the disparate bits and pieces of the seven state divisions, each of which is represented by ONE Divisional Councillor. In reality, the WIA exists in name only as a 'Not-for-profit' public company under Section 383 of the Corporations Law.

Let's restructure the whole sorry mess, which even some Councillors have admitted they are at a loss to understand. Let us have one WIA body, based in Canberra where it can be in close contact with Government and the Australian Communications Authority - probably our greatest collective need.

Dispense with the Divisions and have all clubs and their members as members of the new WIA at cost lower than the present subscription rate,

Scrap "Amateur Radio" magazine. Its production and distribution cost and lack of advertising support scarcely warrant its continuation. By mutual arrangement, buy, say, four pages periodically (perhaps monthly or quarterly) in issues of one or more popular radio magazines. "Radio & Communications" would be a 'must'.

These pages would easily cover the purely WIA matters currently contained in "Amateur Radio". The cost would be considerably less than publishing "AR". Getting the magazine would be at the option of the person buying it. It would also have the impact of putting the amateur radio hobby and the WIA before a larger target audience.

Drop the Divisional broadcasts in their present form. They are often largely repetitive in their content. Co-ordinate all material from all States and clubs throughout Australia and broadcast it from one point only. "WON'T WORK!" ... I hear people say. Oh yes, it will! Having travelled the length and breadth of our wonderful country, over many years while in the Army and after retiring, I've never failed to hear the New South Wales Division broadcast on one or more of the eight High-Frequency outlets they use; even in times of poor propagation.

Add to that their half-dozen VHF and UHF channels and the fact that a lot of country regions relay on 2 metres and 70 cm. Also, the Sunday morning broadcast is repeated that evening.

An approach should be made to the ACA to obtain their views on restructuring the WIA broadcast arrangements to authorise rebroadcasting an appropriate one of the VK2 broadcast frequencies on local repeaters in other States.

If this came about, I would be prepared to start this system by coordinating the broadcast and preparing a tape for use in Sydney each week. I have nearly 50 years' experience in editing, preparing, reading and recording news broadcasts and tapes for local and overseas use.

The WIA is steadily declining in membership and many reasons no doubt account for this - not least among them is the perception that the Institute seems to do

little for people in exchange or their membership fees; other than produce "Amateur Radio" magazine. Not every member is prepared to pay for that; preferring to buy something else or buy nothing at all.

What would you say to \$20.00 per head per year to belong to both your local radio club AND the WIA? A percentage would go to the club and the remainder to the WIA? Wouldn't this concept have much more appeal to the amateur radio enthusiast? The WIA would receive new memberships of those who now belong to clubs but not to a WIA State Division.

The reduced operating costs brought about by disbanding the Divisional structure, ceasing publication of "Amateur Radio" and reduction of travelling costs for WIA 'talk fests' would seem to make a reduced membership fee practicable.

Of course this is based on the membership of clubs remaining at about their present level with a possibly (although not in all cases) increased cost to the club member.

There are of course many other facets of our hobby that require consideration, emphasis and inclusion. Those, which come immediately to mind, include satellites, WICEN, digital technology and spectrum questions.

While not dealing with any of these here, I'm not ignoring their significance. However, the first priority as I see it is to find the right formula for the WIA itself.

The WIA, to use that generic term, is bleeding to death. If it should die, then the chance of replacing it with a cohesive organisation to speak for all amateurs appears slim. The 'look after number one' syndrome has been steadily gnawing away at society and in many ways this has impacted upon the Institute.

The WIA cannot go on the way it is today. If it does, it will do so at its own peril.

The Executive must grasp this unpleasant nettle and overcome the inertia that has plagued the Wireless Institute of Australia for far too long.

As a final point of absolute heresy, perhaps the name should also be changed at the same time. Maybe the words 'wireless' and 'institute' smack of ancient history. Perhaps they are seen by younger generations as outmoded and no longer appropriate; and deter them as being 'fuddy-duddy'.

After all, many organisations, large and small, have changed their names in recent years and we've soon learned to identify them by their new, often shorter and catchy title. Why not the WIA?

How about "*Amateur Radio Australia*"?

ICOM Clearly Ahead



**"VK3LZ
calling!"**

More sound information from
your friends at Icom

**WYONG - THE CHANGING FACE OF
HAMFESTS.**

The Wyong Hamfest was a real eye opener. A record attendance and phenomenal interest shown in all our Icom product particularly our ground breaking new units like the 706MKIIG, the T81A, and the 2800H. Enthusiasts took advantage of the specials and savings offered by our Authorised Dealers in attendance with a high level of sales achieved. It just goes to show that it always pays to look for that 'Authorised Icom Dealer' identity. Units that also proved popular were our 40S CB (also known as the Icom Traveller), and proven performers from our receiver range like the R2 and R10 handhelds. Our Dealers have also reported outstanding 'after show' sales. This indicates to us how Hamfests are changing. In addition to the usual fun hobbyist activities, they have become a showcase of the brightest ideas and technological innovations from the world of radio communications. Remember, a Hamfest is a great environment to see what is new from Icom and to meet up with your Icom Dealer.

STAY INFORMED ON THE WEB.

Speaking of Hamfests, the Icom website is a great way to keep up-to-date with all the upcoming events. If you want to know the exact dates for hamfests in the near future, such as Bendigo and Mount Gambier, visit us soon. Our website is continually updated with all the latest information.

"...73"

FreeCall 1800 338 915
290 -294 Albert Street
Brunswick, Victoria 3056
Tel : (03) 9387 0666
Fax : (03) 9387 0022
www.icom.net.au
ACN 006 092 575

Make PCBs with your computer.

Joe Rotenberg VK3BBN

20/104 The Avenue
Parkville 3052

Introduction

Over the years there have been a number of ways of connecting together electronic components to make circuits.

In the 1920's radios did not have many components. So components were bolted to the chassis and connections were made with heavy wires between screw terminals. Later soldered joints replaced the screws.

A popular method in the 1930s, by which time components had become lighter and more numerous, was the "tag strip" construction method that consisted of rows of terminals with components soldered between them. This was a useful technique for semiskilled workers to assemble radios, as they didn't need to understand the circuit.

By the 1940s, when the gain and top frequency of each stage had risen, tag strip layout was prone to produce oscillations in the circuit and so "point to point" (or "rats nest") wiring became popular. Wires, components and terminals were connected from component to component according to the requirements of the circuit.

This remained the preferred system till the advent of the transistor radio in the 1960s.

From that time, "printed circuit" construction, where the components are soldered onto an etched copper foil pattern on a piece of insulating board became the norm and remains so for practically all electronic equipment to this day.

Unfortunately, however, the early printed circuit design methods were very time consuming.

I remember laying out PCBs as a vacation student at the Weather Bureau in the early 1970s. We had a large piece of plastic sheet fixed to a table to which we attached lengths of black tape for the tracks and washer shaped pads for the connections. Later, this pattern would be photographically reduced and etched on the copper foil. The method was slow and prone to errors, and so it was usual to build a prototype circuit on matrix board first to get the bugs out.

With the advent of the computer all this has changed. Professional PCB drafting

software can automatically lay out a circuit from the circuit diagram.

It is no longer necessary to build a test circuit on a matrix board first; the board is assembled as a PCB straight away and if there are any mistakes, some keystrokes on the circuit diagram fix them immediately and off we go again.

Full Professional software is very expensive and not readily available to the average amateur. "Shareware" software is available but you will have to learn to use it. Fortunately, we can make do with the software that comes with the standard "windows" operating system. The result is, in my opinion, an easy and less time consuming method of constructing circuits. This article describes how to draft a PCB with a computer on a low budget.

What kind of computer do I need?

To make life easy for yourself you need a computer that will run "Windows", so this means at least a "386" machine. Make sure it will take 3-1/2 inch discs and check that it has "Windows". When you turn it on you should get a pretty picture with a sign saying

"Windows". If all you get is "C>" on a black screen then type "win" and press return and see if the picture appears then.

Don't worry about how big a memory it has or how fast it is; if it will run "windows" it's OK for this job.

You need to find a wordprocessor somewhere in the system. This will go by the name of "write", "word", "works" or something of that sort depending on what software has been installed on the computer. If you're not comfortable about finding files and all that kind of computer talk get your grandchildren to show you how it's done!

After you've found the wordprocessor see if you can get it to "insert" a drawing. At this point you should get a screen with some coloured boxes down the bottom and some more boxes on the left side. That is the drawing software, "MS Draw" that you create your drawing with. When you are finished call up "exit" and follow the instructions.

Some hints.

MS Draw enables you to set patterns onto a grid. This is very useful for integrated circuit patterns. However, one problem: the grid is 12 to the inch, whereas integrated circuit legs are 10 to the inch. Not a problem. Use the grid anyway then when you're finished adjust the scaling to 120%. Actually, it's better to draw it double size and then set the scaling to 60%.

I find a line width of "4 point" works best for the connections but power or RF tracks may need to be wider. The pads can be made by drawing a small white circle within a larger black circle and then using "copy", "paste" and "group" to make a complete pad that can be moved around the screen to

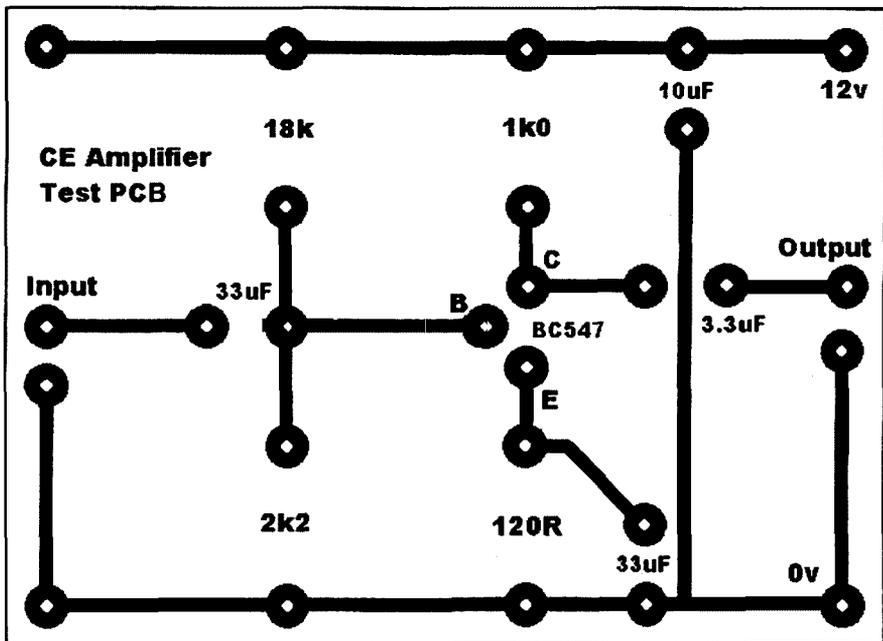

Fig 1 A simple example pattern showing a CE Amplifier demonstration circuit.

the desired location. Use "snap to grid" to fix the spacings.

Once you've got your PCB drawn out on the computer screen, save it on a disk and take it to a printing place, secretarial office or such. For a couple of dollars or less they will make you an overhead transparency of it. Don't forget to say it's black and white, otherwise they will charge you for colour.

Then follow the procedure for making PCB's from a transparency. You can buy all the chemicals from Dick Smith and others and follow the instructions on the bottles.

It's really easy!

An Example

As an example of this procedure I laid out a simple one transistor Common Emitter amplifier which could be used to train Novices.

Start off by drawing a box for the printed circuit outline. Divide the required dimensions by 60% and draw an outline that size on the MS Draw screen.

Then draw up the pads for the transistors and integrated circuits and place them on the board. The pads for the other components follow. After you have made one IC pad pattern, you can copy and paste it and move the copies around until they are in position. Make the connections, (tracks) and then apply the labelling with the text function. Be careful not to over run the tracks or you may create shorts.

I like to lay out the board from the top view, so I needed to flip the finished design to get the copper side. When you are satisfied with the design, scale the drawing to 60% and you're done.

It's as simple as that.

Note that other similar methods have appeared in AR for which references have been included.

Ref:

AR November 93 p17

AR February 94 p13

QST July 93

ar

Do you know of a process, a technical shortcut or a completely new way to achieve an amateur radio result?

Share it with

**Amateur
Radio**

and your fellow amateurs

You Have E-mail

Brian Beamish <brianvk4bbs@msn.com.au>

Subject: Urgent Warning New Virus!

Date: Thursday, 1 April 1999 8:19

VIRUS WARNING!

If you receive an e-mail entitled "Crazy Times" delete it immediately. Do not open it! Apparently this one is pretty nasty. It will not only erase everything on your hard drive, but it will also delete anything on disks within 20 feet of your computer. It demagnetises the stripes on ALL of your credit cards.

It reprograms your ATM access code, messes up the tracking on your VCR and uses sub-space field harmonics to scratch any CD's you attempt to play or use. It will re-calibrate your refrigerator's coolness settings so all your ice cream melts and your milk freezes. It will program your phone autodial to call only your mother-in-law's number.

This virus will mix antifreeze into your fish tank, drink all your beer, will leave dirty socks on the coffee table when you are expecting company and its radioactive emissions will cause your toe jam and bellybutton fuzz (be honest, you have some) to migrate behind your ears.

It will replace your shampoo with Nair and your Nair with Rogaine, all while dating your current boy/girlfriend behind your back and billing their hotel rendezvous to your Visa card.

It will cause you to run with scissors and throw things in a way that is only fun until someone loses an eye. It will give you Dutch Elm Disease and tinea.

It will rewrite your backup files, changing all your active verbs to passive tense and incorporating undetectable misspellings that grossly change the interpretations of key sentences.

If the "Crazy Times" message is opened in a Windows 95 environment, it will leave the toilet seat up and your hair dryer plugged in dangerously close to a full bathtub.

It will not only remove the tags from your mattresses and pillows, but it will also refill your skimmed milk with whole milk and replace all your luncheon meat with Spam.

It will molecularly rearrange your cologne or perfume, causing it to smell like dill pickles. (Remember Brut 33?)

It is insidious and subtle.

It is dangerous and terrifying to behold.

It is also a rather interesting shade of mauve.

(I recently received this from Brian and just had to pass it on
Bob VK4KNH)

A Homebrew 813

Linear Amplifier

(Part 2)

C.J. Bourke VK4YE

Lot 16 Waterford-Tamborine Road
Tamborine Village Qld 4270

High Voltage Supply

The amplifier works quite happily with supply voltages from 1.5 to 2.5kV. The 813 will take 3kV, but you will not find reference to it by the original manufacturer, RCA.

A pair of microwave transformers offers a very convenient means of producing a high voltage supply at minimal cost. Your local rubbish tip/recycling centre ought to have a good supply of dead microwave ovens. Secondary voltages seem to range from 1500V to 2200V. Technically, they are known as saturable reactors. They are designed to regulate their output voltage through the action of a pair of soft iron shunts inserted between the primary and the secondary windings. This feature must be disabled.

To remove these shunts, cut the heavy filament winding [usually 3 or 4 turns] and pull the wire out. With a piece of steel rod about 5mm in diameter, carefully tap out both shunts. Refer to page 16 of the May 1998 issue of Amateur Radio for more information on microwave transformers and removal of the shunts.

You will note that one side of the secondary winding is earthed because the microwave oven uses one transformer in a half-wave rectifier circuit. You must use two similar transformers in a push-pull arrangement to obtain full-wave rectification. They must be phased so that they effectively behave as a single transformer with a centre-tapped secondary. The schematic for this appears in Figure 3.

The phasing is simple. Wire the transformers as per my circuit with the primaries in parallel. This can be done on the bench. Connect a low voltage AC supply, say 6V, to the primaries and measure the total secondary voltage, making sure the framed secondaries are connected together. The total secondary voltage should be twice that of each individual secondary voltage which in turn will be about nine or ten times the primary voltage. Expect to see 100V or more for the total secondary voltage. If the voltage is low, you have the transformers connected in anti-phase. Reverse the connections of one

transformer primary and remeasure. It should now be correctly connected.

I strongly suggest you use a pair of transformers with a secondary rating of around 1800V. This will give a theoretical peak rectified voltage of about 2500V across the filter capacitors. However, the bleeder resistors will pull this down to 2300V or so. If your transformers have a secondary rating of 2200 Vrms, then the peak rectified voltage will exceed 3kV. I recommend you lower the primary voltage through the use of a line-bucking transformer. Figure 4 shows how this is done. As the transformer secondary carries the entire plate transformer primary current, a continuous secondary rating of 2A or 3A should be adequate. The secondary voltage should be at least 30V and ideally be 40 - 50 volts.

I did not bother with a soft-start in the primary circuit for the prototype amplifier. However Figure 3 shows one that has been built and tested. The relays have 24V coils with a SPDT 30A set of contacts. They are available from Altronics [S 4199]. The high voltage rectifier consists of a string of 10 x 1N5408 diodes with voltage sharing resistors. These diodes are rated at 1000V PIV with a forward current of 3A. The resistors are to ensure equalisation of the reverse voltage on the non-conducting cycle. Do not omit them. Each resistor has a value of 470k Ω and is rated at 1W. Use carbon resistors as they can withstand 500V working voltage and up to 1kV peak [according to the manufacturer's data].

Filtering

Next we have the filter capacitors and bleeder network. High voltage electrolytic capacitors are not a cheap item. After a lot of shopping around, the best deal came from Jaycar. They have 100 μ F 400V working electrolytics at \$5.95 for single units. Provided the rms secondary voltage of the plate transformers does not exceed 2kV, 7 electrolytic capacitors of 400 working volts will do. The bleeder resistors will ensure that the rectified output voltage does not rise to the peak value of the secondary voltage.

Last Month

The first part of this article, printed in the March issue of AR contained the description of the circuit, and details on the filament transformer, split stator plate tuning capacitor, band selection, plate choke, the input circuit and the optional ALC. To avoid confusion, figures 1 and 2 if referred to here are in the March issue and figures 3 and 4 are in this issue.

If in doubt, use 8 capacitors in series. Each electrolytic has a 22k Ω 17W voltage sharing resistor across it. Bigger supply companies such as Farnell Electronic Components stock these resistors. Incidentally, it is not worth going beyond 30 μ F of filtering. The dynamic regulation of a power supply for this amplifier is quite adequate even at 12.5 μ F [8 x 100 μ F in series].

Metering

Metering of the high voltage is best done by sampling the voltage across the bottom bleeder resistor. An appropriate multiplier resistor connects to the meter that is scaled to read 3kV or so. You then do not have the full supply voltage connected to a series of multiplier resistors, giving rise to unnecessary component failure risks.

The plate current is metered by inserting a 10 Ω 10W resistor between the "earthly" end of the plate transformer secondaries and earth. This requires you to lift the framed ends and tie them together. The plate current meter is connected across this resistor. While screen current is also included in the meter reading, it is not significant compared to the plate current. Incidentally, I made up scales for all meters by cutting out letters and digits that were printed out by an ink jet printer. They were then pasted on to a sheet of paper at appropriate positions to form a meter scale. The scale was then photocopied, cut to correct size, and finally pasted on to the faceplate of a meter. It was a far neater option than attempting a freehand sketch.

I have found a useful type of high voltage stand off insulator at your local hardware store. The store will sell them as door closers! They are made from tough plastic and can be easily cut, filed and drilled. Several of them have been used in this project.

Mounting of Tubes

The 813 tubes can be mounted upright or horizontally with pins 1 and 6 in the vertical plane. Horizontal mounting has the

advantage that you can build the amplifier into a low profile box perhaps no higher than 175mm. It certainly looks more modern and compatible with solid state rigs.

Cooling of Tubes

While the 813 operates as a natural convection/radiation cooled tube, I would recommend the use of a computer fan to assist cooling.

If the tubes are to be mounted horizontally, the fan can be mounted beneath the tubes blowing air up past them. Consider using a fan to remove heat from the power supply as well.

Testing

Assuming you have thoroughly done preliminary wiring checks, a step by step testing procedure can be implemented.

- The high voltage supply can be tested first. Other transformer primaries must not be wired to the soft-start circuit yet. Initially, connect a 100W light globe in series with the primary of the high-tension transformer, which are then wired to the soft-start circuit. This is to give a reduced primary voltage just in case there is a serious wiring error in the high-tension area. The tubes should be out of their sockets. Switch on the 240V and observe that the soft-start circuit works. A delay of approximately 0.5 seconds will occur before relays RX and RY operate. Note the reading on the high voltage meter. It should be less than the design value due to the presence of the light globe.
- If all seems well, remove the 100W globe from the input and connect the high-tension supply transformers directly to the soft-start circuit. Switch on the 240V and note the reading of the high-tension voltage. It ought to be around the peak value expected for your particular transformer/filter/bleeder combination.
- Disconnect the primary of the high-tension transformers from the soft-start circuit.
- Now connect the ancillary supply to the soft-start circuit. Switch on and check that +12V is available. Check that relays RA and RB operate by inserting a shorting plug or a ground at the 'relay to rig' socket. Leave the ancillary supply permanently connected.
- Connect an SWR /POWER meter between your rig and the input of the amplifier. The output of the amplifier should be terminated in a suitably

rated 50Ω dummy load. This is simply a "straight through" test. Apply low level carrier and observe that the SWR reading is very low. If all is well increase the drive to maximum. The amplifier should have only a minimal effect on the SWR reading in the 'straight through' position.

- Connect the filament supply to the soft-start circuit. Fit the two tubes into their sockets, fit plate connectors and switch on. Measure the filament voltage at the filament transformer and at the tube sockets. Previously you ensured that the filament voltage at the transformer [no load] was between 10.0 and 10.5V. The minimum voltage at the filaments must be 9.5V. The filament supply is to remain permanently connected.
- Now connect the amplifier's relay socket to the rig's relay socket. With minimum drive, check that the input/output relays RA and RB operate when you hit the PTT switch.
- Apply initially no more than 5W of drive. Observe the input SWR reading and adjust the slug in the input-tuning unit for the band you are using. You should be able to get the SWR down to 1:1 for 10m, 15m and 20m [if installed]. Below 20m the SWR will remain quite low.
- You can check that screen voltage is being developed with input power - perhaps 80V to 100V at 5 W of drive.
- Reconnect the B* supply to the soft-start circuit and switch on. If all seems well you are ready for the smoke test.
- Connect your SWR/POWER meter between the amplifier's output and dummy load. If you have a second SWR/POWER meter connect it between the transmitter and the amplifier input. Leave the ALC disconnected for the time being. Set the band switch to the highest frequency band, say 10m, and turn the amplifier on. The plate current [Ip] should be zero. If all is well, set the standby switch to the operate position. The B* voltage should fall a little and Ip should rise to around 50mA.
- Monitoring Ig, rock the plate and tune capacitors through their range. There should be absolutely no hint of meter movement. If there is, you have either a VHF parasitic oscillation or stray feedback from the plate tank circuit to the grid circuit. Parasitic oscillations will have a frequency between 100MHz and 200MHz, while plate to grid feedback will occur in the HF

range. Parasitic oscillations are cured by altering the dimensions of the plate chokes - more/less turns and by the placing of ferrite beads over the control grid and screen grid connections at the tube sockets. HF feedback requires careful shielding so that the plate components do not "see" the input components. Repeat this test for all other bands you have installed.

- Assuming the amplifier is behaving nicely so far, select a mid-range band such as 40m, and un-mesh the load capacitor. Set the tune capacitor to half mesh and apply a couple of watts of drive. Ip should rise a little. Apply enough drive to bring Ip up to 100mA. Adjust the load capacitor until a peak in output power is indicated. Now alternatively adjust the tune and plate capacitors for maximum power output - it will be perhaps 50W or so.
- Check that some Ig is indicated and then monitor Isg. At resonance, Isg is at a maximum value. Check this by rocking the tune capacitor and observing the change in Isg and power output. The dip in Ip at resonance may not be particularly noticeable.
- Increase drive until 250mA of Ip shows. Readjust tune and load capacitors for maximum power output. Again monitor both control grid and screen grid currents. Increase drive further until around 400W rms is indicated at the output. Keep Ip under 500mA. Ig should be around 50mA and Isg about 40mA. Note that this power level of 400W rms is grossly in excess of the allowed 120W CW signal we are permitted to put to air.
- Now repeat the procedure for the other bands. Do not be too concerned if 10m does not show 400W rms with 25W - 30W of drive. Losses will be higher on this band and key down carrier [single-tone] testing is really quite severe on the dynamic regulation of the high-tension supply. Proper two-tone testing will show that the legal limit is easily being achieved on all bands. Furthermore, linearity can also be checked by this method.

Single-tone test data at 14.2MHz indicates the DC power input is 650W and the efficiency works out to be 62%.

SINGLE-TONE TEST DATA FOR 14.20MHz				
Vp	Ip	Ig	Isg	Power Out
2100V	310mA	50mA	40mA	400W rms

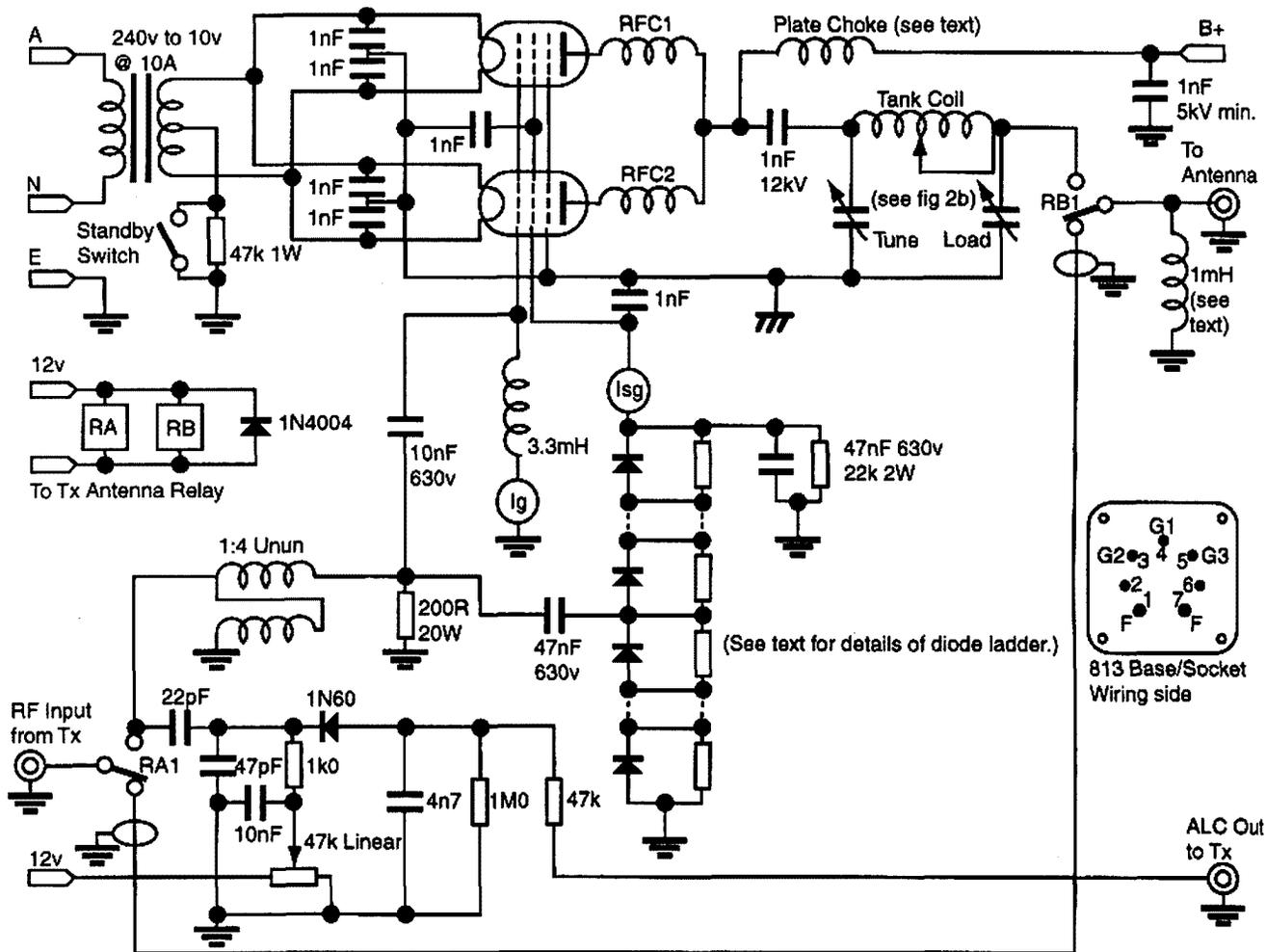

Figure 1

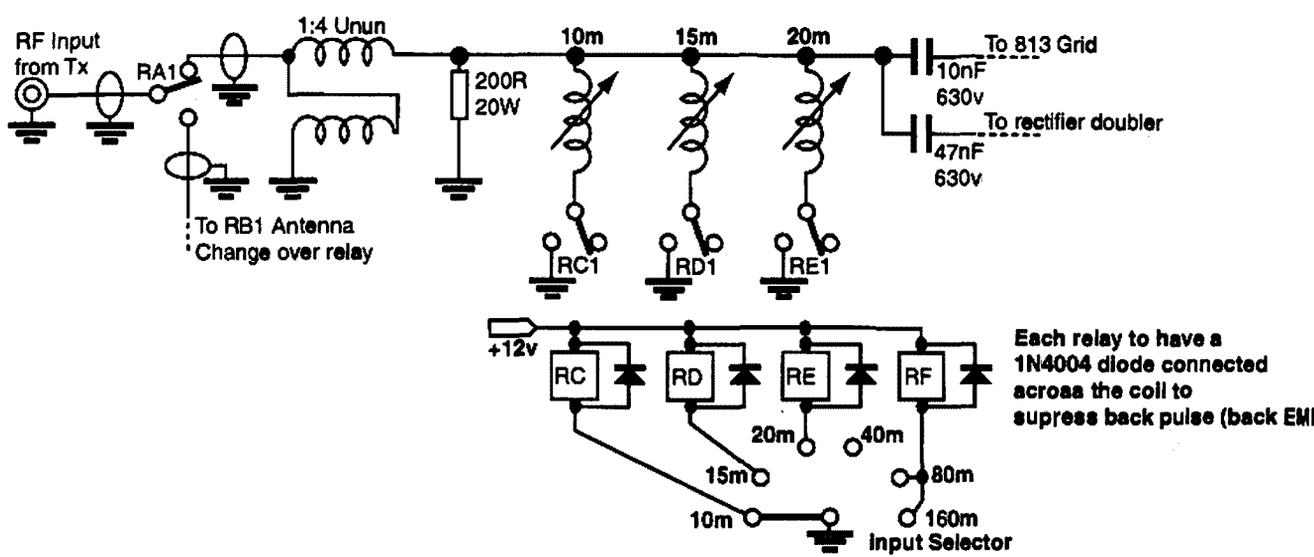

Figure 2a

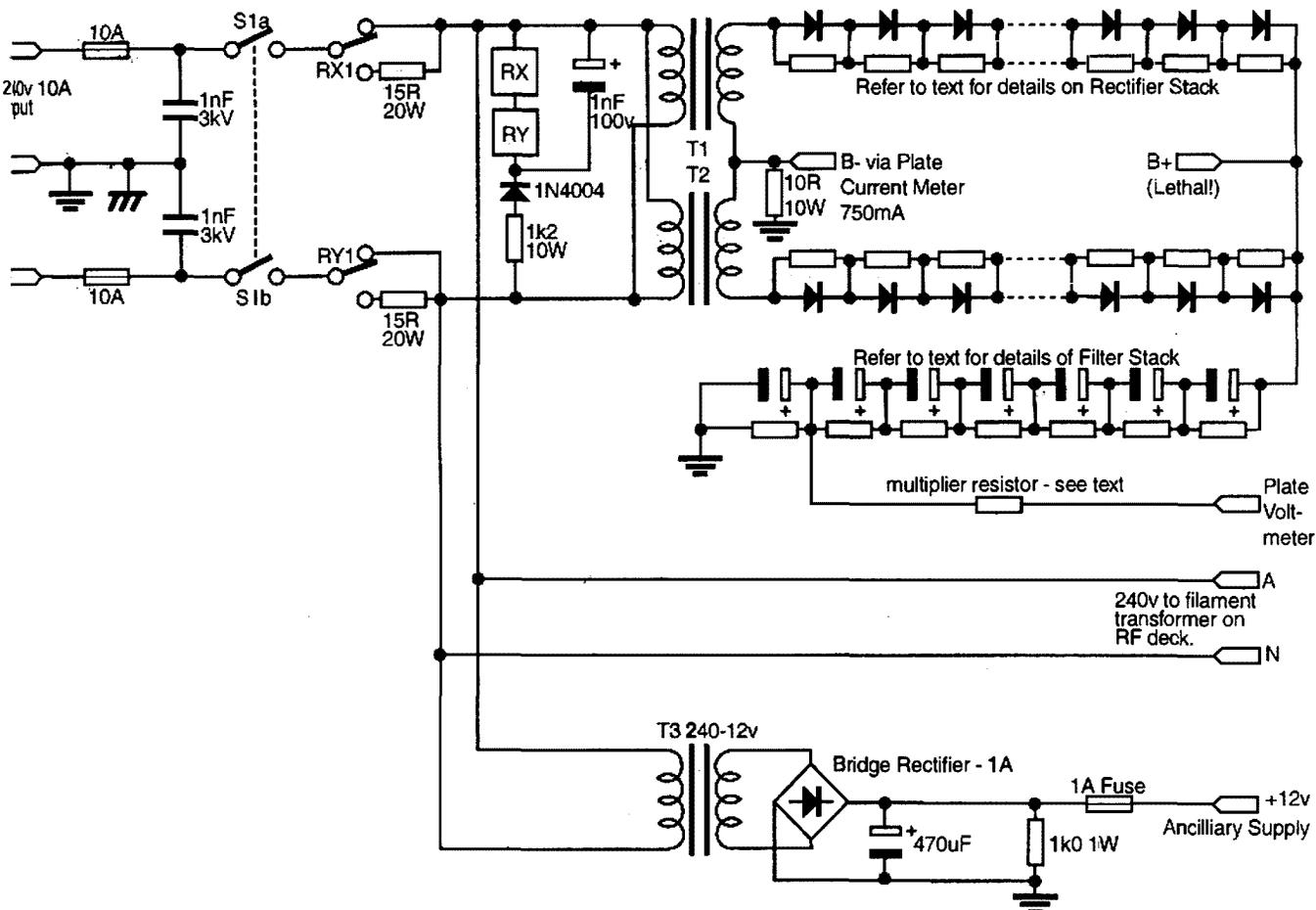

Figure 3 - Power Supply

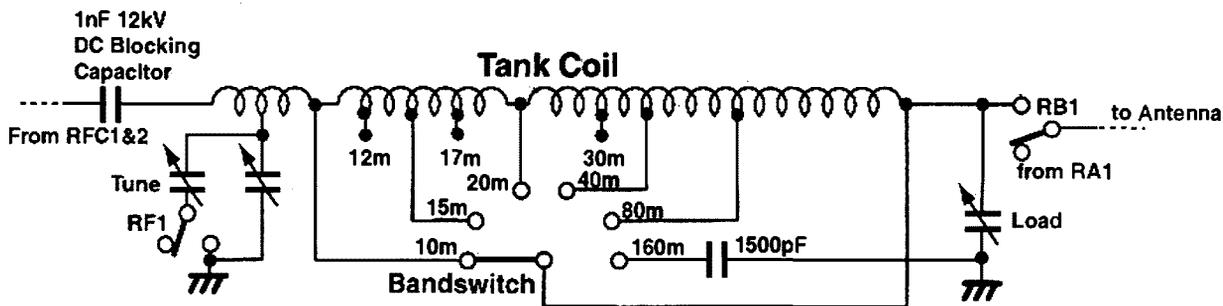

Figure 2b

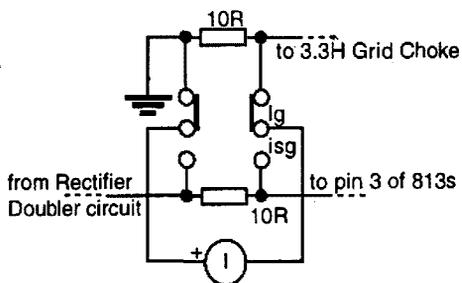

Figure 2c - Meter switch if used.

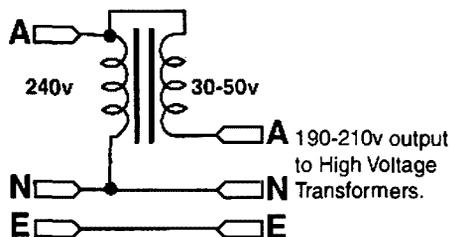

Figure 4 - Line Bucking Circuit



AV-COMM

Pty.Ltd.

SATELLITE TV EQUIPMENT

Established 1981 :-

**Specialising in:
Free to Air Satellite TV**

**CALL OR FAX
FOR FREE INFO PACK.**

198 Condamine Street
Balgowlah 2093 Australia

Tel: 61 2 9949 7417
61 2 9948 2667

Fax: 61 2 9949 7095

Internet: <http://www.avcomm.com.au>

Andrews

Communications Systems

(EST. 1976 - ACN 001 968 752)



ALINGO

**AUSTRALIA'S FIRST AUTHORISED
FACTORY DIRECT IMPORTER**

*No 1 & Biggest Importer with one or two
shipments monthly.*

★ **FULL 3-YEAR FACTORY WARRANTY**
★ **INSTANT REPAIRS ON FRIDAYS**

WE SELL MOST BRANDS AND MAKE
BALUNS, VERTICALS, YAGIS, P/S.

ICOM-KENWOOD-JRC-AOR-EMOTATOR-
MJF-DIAMOND-TIMEWAVE-KANTRONICS-
THP-GARMAN-TERLIN-UNIDEN-ETC

**WE URGENTLY WANT GOOD HF, VHF,
UHF TRANSCEIVERS AND REPAIRS.**

NEW IC-70611 & IC-756PRO

**NOW 3-YEAR WARRANTY ON
NEW ICOM SOLD BY US.**

* **OVER 20 YEARS OF SERVICE***
Call us for unbeatable prices .

(02) 9636 9060 or (02) 9688 4301

SHOP 8 41 BATHURST ST, GREYSTANES,
NSW 2145 FAX (02) 9688 1995

Two-tone Testing

A thorough testing procedure requires access to a two-tone oscillator, oscilloscope and heavy-duty dummy load. Two-tone testing will give a completely different set of readings and power output figures compared to single-tone testing. Under this testing procedure, 200 W mean power indicated on the power meter is equivalent to 400 W pep. Test results giving a mean power output of 200W required a DC input of 515W. Efficiency is just under 40%.

TWO-TONE TEST DATA FOR 14.20MHz				
Vp	Ip	Ig	Isg	Power Out
2100V	245mA	20mA	15mA	400W PEP

Alternate Tubes

The 4-125 tetrode and its derivatives such as the RS1007, QY3-125 and QB3/300 are very suitable for this design. They are physically smaller than the 813, and have a 5V filament drawing 6.5A. All have an ICAS plate dissipation rating of 125W. You will require a paralleled pair plus sockets. The plate connectors, which are the same as for an 811A tube are available from the Electronic Valve and Tube Company. Telephone (03) 9571 1160.

The correct ceramic socket to use is a Johnson type 275. This series of socket also fits the 4-250, 4-400 and 3-500Z transmitting tubes. The QB3/300 tubes and sockets are available from Malcolm McIntosh, 26 Branch Creek Rd, Clear Mountain, QLD 4500. Telephone (07) 3298 5454.

Because the QB3/300 has a much lower plate to filament capacitance of only 3.5pF, I have recalculated the pi-network values. The plate tuning capacitor will still need to be modified as explained previously, but it will connect to the to the start, not the centre of the 10 m coil. I suggest the following coil winding data for the nine MF/HF bands.

COIL WINDING DATA for QB3/300 TUBES				
BAND	TURNS	DIAMETER (mm)	LENGTH (mm)	WIRE GAUGE
160m	26 turns	60	40	1.6mm
80m	tap 14 turns			
40m	tap 7 turns			
30m	tap 4 turns			
20m	8 turns	40	55	3.6mm capillary tubing
17m	tap 5 turns			
15m	tap 4 turns			
12m	tap 2 turns			
10m	6 turns	40	45	3.6mm capillary tubing

There will of course be a modification to the filament supply and connections. I recommend the existing 10V filament transformer be retained, but the centre-tap obviously will not be included. The tubes will have their filaments connected in series as per Figure 5. The total current drawn will be 6.5A.

As the input capacitance is lower than that of the 813, it may be possible to achieve a low SWR on the 20m band without having to switch in an inductor as previously done.

Components and Suppliers

Many parts are readily available at the usual electronic component retailers. Some, such as RF chokes, can be fabricated. Hamfests and amateur radio clubs are useful sources of supply as are the advertisements in AR magazine, and Radio and Communications magazine. The following businesses and individuals are worth contacting -

1. Strictly Ham Pty Ltd (03) 9729 7656 - secured much of Daycom's stock of tubes and MFJ products. Plate tuning capacitor, 813 tubes and sockets.
2. Peter Hadgraft (07) 3397 3751 - 813 tubes.
3. The QRP Club (08) 8295 8112 - Load capacitors, 200W 50W non-inductive resistors [availability varies].

Conclusion

While the home brewer can assemble this project for around \$300, I am aware that second hand commercial linear amplifiers are available for around \$600-700 that will serve well. Many licensees prefer to go down that path. This article is presented for those of us who get a buzz out of pursuing the 'self-training and technical investigation' aspect of our hobby. It would make a great club project because it will allow those with expertise to share it with fellow operators who have not been exposed to vacuum tube technology and/or the construction of high power amplifiers.

Should anyone wish to enquire further , the author, VK4YE, can be contacted through:

The Secretary, Southside
Amateur Radio Society
Incorporated, PO Box 294,
Woodridge, QLD, 4114.

Our packet address is
VK4WSS@VK4PKT.
#BNE.QLD.AUS.OC

You may also care to look at our Internet Homepage
www.powerup.com.au/v-jabba
for a copy of this article plus two QBASIC programs I have written. One calculates pi-network constants, and the other

calculates the dimensions of single layer air wound coils.

References

1. ARRL handbook 1968, p 195 - 198
2. RSGB Handbook, Fourth Edition, Chapter 10.62 - 10.65
3. CQ Magazine, March 1966

1999 268 PAGE

FULL COLOUR **Jaycar** ELECTRONICS

CATALOGUE NOW OUT

Call into any Jaycar store
and pick up a copy for only
\$2, or fill out the coupon
and post it with payment.



HUNDREDS OF NEW & INTERESTING PRODUCTS

Alarms

Computer

Plug/Sockets

Speakers

TV Antennas

Batteries

General

PICs

Switches

Wire & Cable

Books

Hardware

Resistors

Telephone

Boxes/Racks

Heatsinks

Semi's

Test Equip

Capacitors

Kits & Modules

Service Aids

Tools

CCD's

Microphones

Soldering

Transformers

Jaycar
ELECTRONICS

HEAD OFFICE: 8 Leeds Street,
Rhodes, New South Wales, 2138.
Ph: (02) 9743 5222
Fax (02) 9743 2066
Website: www.jaycar.com.au

SYDNEY - CITY 129 York St. (02) 9267 1614
PARRAMATTA 355 Church St. (02) 9683 3377
PENRITH 199 High St. (02) 4721 8337
BANKSTOWN 363 Hume Hwy. (02) 9709 2822
GORE HILL 188 Pacific Hwy. (02) 9439 4799
RHODES 8 Leeds St. (02) 9743 5222
CANBERRA 121 Wollongong St. Fyshwick. (02) 6239 1801
NEWCASTLE 990 Hunter St. (02) 4965 3799
HOBART 140 Campbell St. (03) 6231 5877
ADELAIDE SA 191-195 Wright St. (08) 8231 7355

PERTH WA 326 Newcastle St. Northbridge.
(08) 9328 8252
BURANDA QLD 144 Logan Rd. (07) 3393 0777
ASPLEY QLD 1322 Gympie Rd. (07) 3863 0099
MELBOURNE CITY 2, 45 A'Beckett St. (03) 9663 2030
COBURG VIC 266 Sydney Rd. (03) 9384 1811
RINGWOOD VIC 141A Maroondah Hwy. (03) 9870 9053
SPRINGVALE VIC 887-889 Springvale Rd
Mulgrave. (03) 9547 1022
NEW ZEALAND 14A Gillies Ave. New Market
Auckland. (09) 529 9916

I've enclosed \$2 so please rush me my copy
of the fabulous 1999 268 page Jaycar
Electronics catalogue.

Send to:
Jaycar Electronics, P.O. Box 185
Concord NSW 2137. Fax (02) 9743 2066
AR APRIL 99

Name: _____

Address: _____

Suburb: _____ State: _____

Postcode: _____ Phone: _____

TECHNICAL ABSTRACTS

Gil Sones VK3AUI
30 Moore Street
Box Hill South Vic 3128

TV Locked Frequency Standard

In the United Kingdom some TV networks are locked to a standard frequency. This is available via the synchronising signals transmitted as part of the signal. The standard used may be quite good. In an article in *Rad Com* Jan 1999 a Caesium standard was mentioned. Lesser standards are often used but these may better than the sort of standards normally available to amateurs. In Australia a variety of standards are in use.

The article, by Dave McQue G4NJU

described a circuit which locked a 10 MHz oscillator to the synchronising signal from a TV set or VCR used as a receiver. The signal was obtained from the SCART socket on the TV or VCR. The circuit described had been derived from a design originally published in *CQ TV* and had been modified. The circuit is shown in Fig 1. IC1 is a sync separator integrated circuit which separates the sync pulses from the composite video input signal. IC2a is a 40-microsecond monostable used to mask the

half sync pulses in the output of IC1. The 15625 kHz output of IC2a is divided by 2 in IC2b to give a 7812.5 Hz output that is 1 MHz divided by 128. IC3 functions as a phase detector with outputs to the phase meter and to lock the local 10 MHz crystal. IC4 provides the 10 MHz crystal oscillator and some buffers. IC5 and IC6 is the divider chain. Outputs of 1 MHz, 100 kHz and 100 Hz are provided. The meter used was a 100-0-100 microamp type but other centre zero types can be used. R6 is adjusted initially before connection to IC3 to give FSD when connected to the 5-Volt rail. R6 is then connected to pin 6 of IC3. To set up the circuit VC1 is adjusted to give centre zero on the meter with the switch in the set position. Then VC1 is touched up to give the slowest meter movement in the Lock position. The 10 MHz oscillator is then locked to whatever standard the TV network is using. At switch on the meter needle will oscillate and then settle as lock is achieved.

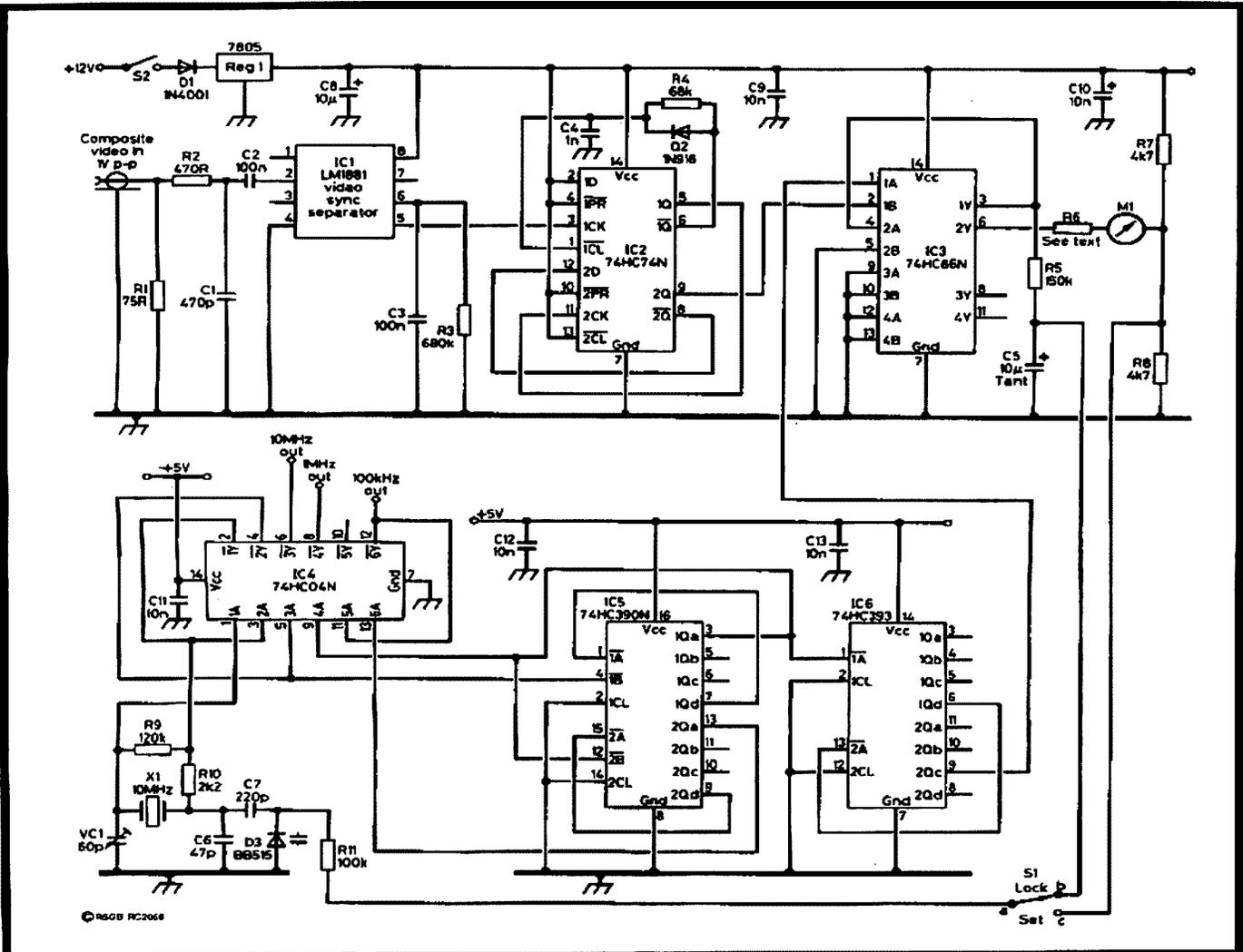

Fig 1. TV Locked Frequency Standard

A NOTE ABOUT THE DL6WU YAGI

Ian Cowan VK1BG,
13 Mainoru Place
Hawker, ACT, 2614.
cowan@effect.net.au

My trusty 13 element DL6WU was built and erected about 10 years ago. It replaced a smaller beam that was based on the NBS design data.

A few days before I put up the new wonder beam, I received a letter from Gordon McDonald (VK2ZAB), in which he put forward a then new theory concerning the influence of the last director on the front to back performance of a Yagi antenna.

Gordon explained that the wave travelling down the director string effectively encounters a discontinuity when it arrives at the last director, and as a result some of the energy is reflected back along the director string towards the driven element.

Whether the returning wave is in or out of phase with the wave being delivered by the driven element has a significant influence on the front to back performance.

This of course depends upon the distance between the last director and the driven element.

Gordon said that 13 elements were not a good choice in a DL6WU antenna, and that 14 elements should be much better.

While Gordon's letter was of interest, my new pride and joy had already been completed, so I decided to leave it alone.

Besides, a poor front to back ratio wasn't going to matter much in my mode of operation, and it could even be an advantage to be able to hear what the Sydney stations were up to while my beam was on Melbourne.

In the event, my memory tells me that the front to back ratio came out at about 18dB, which in the scheme of things was not too flash.

This was in accordance with Gordon's prediction, but maybe that was due to a crook reflector element rather than to good theory.

Well things have changed somewhat since then!

There is now a lot more activity from Sydney, and in addition there has been the arrival on the scene of Reg, VK1MP. He lives only a few km away to the North East.

He has a very big signal which my poor Rx has difficulty rejecting even when our two stations are working 50 kHz apart, and with my beam to the South West, and hence back on to Reg. I gather from Reg that my signal did not do his system any good either.

On an impulse, and still mindful of Gordon's theory, I checked my aluminium stockpile to see if I could find enough to provide some extra boom length, and a 12th director.

A few dB improvement to the front to back ratio might be worth having, though my experience with such things led me not to expect too much.

At risk to life and limb, the new element was fitted to the old antenna in situ, -not a recommended practice in normal conditions.

Well, it turned out that the theory was good.

While I have not been able to make decent measurements as yet (we don't have a beacon in Canberra any more) it is clear that there has been a profound change in the front to back ratio.

Reg and I now both chase VK3's with minimal mutual interference at 50 kHz separation, and the Sydney stations are much weaker off the back of the beam.

An extra small bonus is that the SWR has improved to near perfect. It was never really an issue, but now it is pretty hard to see any reverse power at all.

All this suggests to me that the 14-element DL6WU configuration makes a very effective antenna for a medium level two-metre station.

The exercise provided a rather neat demonstration of coincidence between theory and practice that I ultimately found to be quite satisfying.

The RF clipping approach is an interesting technique that has been used a number of times. It is more complex than an audio clipper but is capable of better performance.

I would like to thank Lloyd for bringing this error to my attention.



**AMATEUR
TRANSCEIVER
RADIO CENTRE**

ALINCO

AUSTRALIA'S NO 1
ALINCO FACTORY
AUTHORISED DEALER

MASSIVE NEW YEAR SHIPMENT JUST

LANDED - LATEST ARRIVALS

DR-M06TH NEW 6M 20W MOBILE

DX-70TH, DR-610E, DJ-G5E, DJ-C5

BIGGEST MONTHLY IMPORTER

FULL 3-YEAR WARRANTY

ALINCO SPECIALIST

ICOM

IC-706MKIIG, IC-T81A,
IC-2800H, IC-746, IC-756,
IC-T8A, IC-R75, IC-Q7A.

ROTATORS - EMOTATOR -

105TSX 747SRX

CREATE --- RC5A-3 RC5A-2 RC5-1

MFJ-259B - HF/VHF

FREQUENCY ANALYSER

KENWOOD TS-570SG TM-V7A

TH-G71A VC-H1 TH-D7A TM-G707A

JRC NRD-545G, JST-245, NRD-345.

KANTRONICS -

KPC-9612, KPC-3, KAM-98, KAM PLUS

PHONE (02) 9896 2545

E-mail: atrc@bytelink.com.au

Web Page:

<http://users.bytelink.com.au/atrc>

WANTED A volunteer to manage the WIA Advertising

Duties are:

- **Assist the Federal Office in servicing existing advertisers.**
- **seek out new Companies and/or individuals to advertise in Amateur Radio and the Call Book.**

For Further Details

Martin Luther VK5GN

AH phone 08 8524 3440

Fax 08 8524 3836

email MartinL@AppDes.com.au

**TECHNICAL
ABSTRACTS** continued

sidebands and the acceptance band of the ceramic filter.

So the harmonic distortion is removed but not the intermodulation distortion.

Lloyd also referred to his article in AR August 1997 which dealt with Inter-modulation Performance and Measurement of Inter-modulation Components.

ar

AWARDS

John Kelleher VK3DP

Federal Awards Officer

4 Brook Crescent, Box Hill South, Vic 3128 (03) 9889 8393

Just when I had formed my own opinion about new DXCC countries, somebody got the bright idea of increasing the active countries (entities) to read 332.

Of course, I have yet to see documentation in the affirmative. What it means to me, is that I will now have to add E44 - Palestine, to over 400 files that I presently manage! Why is it, that I still have only one VK1 in those aforementioned files?

PNG - The Bird of Paradise Award

Contact P29 stations after 16th September 1975. Oceania stations need 7 contacts in at least 5 provinces; others must contact 5 in at least 3 provinces. GCR list and 10 IRC's - Or the equivalent to: - Awards Committee

P.O. Box 204 Port Moresby Papua New Guinea

The provinces include: - Capital District, East Sepik, Milne Bay, Southern Highlands, Central Enga, Morobe, West New Britain, Chimbu Gulf, New Ireland, Western East New Britain, Madang, Northern Western Highlands, Eastern Highlands, Manus, Northern Solomons, West Sepik.

Panama International Award

Available to any licensed Amateur who has received QSL cards from each of the HP call areas 1 through 9 after 1st January 1978. Up to three required call areas may be substituted for by any of the Panamanian Club stations - for example HP1LR through HP9LR. Non-members of the Panamanian ARL must submit the returnable cards. Provide list, cards if required, and a fee of US\$3.00 or 6 IRC's to: -

LPR-HP Bureau

P.O. Box 175 Panama 9A Republic of Panama

Solomon Islands - 4 from 44 Award

Work or hear at least four (4) land based, (not /MM) Solomon Islands stations after 7th July 1978. Band or mode endorsements are available on request. GCR list and fee of US\$2.00 to: -

The Awards Manager

SIRS, Box 418 Honiara Solomon Islands.

Romanian Amateur Radio Federation Series

General requirements: All awards may be endorsed for different modes or bands. SWL OK.

Contacts since 23rd August 1949. GCR list and US\$3.00 fee for each award. Apply to: -

Romanian Amateur Radio Federation

P.O. Box 22-50 R-71100 Bucharest Romania

Bucaresti Award.

Work 10 different YO3 stations. The Jubiliar Bucaresti award is issued for working only 5 different YO3 stations annually between 20th August and 30th October, as during this period there are various activities celebrating the National day of Romania. Application for this special version of the award must be mailed before 31st December of the same year. All YO3 stations located in Bucharest City use the YO3 prefix.

Romania Award

Work at least 30 different YO stations each in a different YO county. The capital city of Bucharest must be included. All 8 YO districts (2 to 9) must be represented. The list is: -

AB Alba YO5	HD Hunedoara YO2
AR Arad YO2	HD Hunedoara YO2
AG Arges YO7	IL Ialomitza YO9
BC Bacau YO8	IS Iasi YO8
BH Bihor YO5	MM Maramures YO5
BN Bistrita-Nasaud YO5	MH Mehedinti YO5
BT Botosani YO8	MS Mures YO6
BR Braila YO4	NT Neamt YO8
BV Brasov YO6	OT Olt YO7
BZ Buzau YO9	PH Prahova YO9
CL Calasari YO9	SJ Salaj YO5
CS Caras-Severin YO2	SM Satu Mare YO5
CJ Cluj YO5	SB Sibiu YO6
CT Constanta YO4	SV Suceava YO8
CV Covasna YO6	TR Teleorman YO9
DB Dimbovita YO9	TM Timis YO2
DJ Dolj YO7	TL Tulcea YO4
GL Galati YO4	VS Vaslui YO8
GJ Gorj YO7	VL Vilcea YO7
GR Giurgiu YO9	VR Vrancea YO4
HR Harghita YO6	

South Africa - The All Africa Award

Contact 34 different AREAS in Africa. One contact with areas 1 to 9 is mandatory, plus any 25 additional ones from the list below. Land stations only, no islands around Africa. Contacts may be with past or present prefixes, but not both. The

AREAS are:

ZS1 South Africa
ZS2 South Africa
ZS3/V51 Namibia
ZS4 South Africa
ZS5 South Africa
ZS6 South Africa
A2 Botswana
3D6 Swaziland
ZS8/7P8 Lesotho
H5 Bophutatswana

S8 Transkei
7X Algeria
D2 Angola
ST Sudan
9Q5 Zaire
9U5 Burundi
9X5 Rwanda
6O/T5 Somalia
TJ Cameroons
SU Egypt
ET3 Ethiopia

TL8 Cent. African Republic
TN8 Congo
TR8 Gabon
TT8 Chad
CN Morocco
FL8/J2 Djibouti
TU Ivory Coast
TY Benin
TZ Mali
XT2 Birkina Fasso
5T5 Mauritania
6W Senegal
5U7 Niger
3X Guinea
3C Equatorial Guinea
ZD6/C5 The Gambia
ZD4/9G1 Ghana

9L1 Sierra Leone
ZE/J2 Zimbabwe
EA9/S0 Ceuta/Melilla,
Western Sahara
5H3 Tanzania
3V8 Tunisia
5V4 Togo
5X5 Uganda.

5Z4 Kenya
EL/5L Liberia
5A Libya
C8/9 Mozambique
ZD2/5N2 Nigeria
9J2 Zambia
7Q7 Malawi
J52 Guinea-Bissau

SARL Series : General requirements : GCR rules apply. Award fee is US\$4.00 10 IRC's or 2 Rand. Apply:

Awards Manager
South African Radio League
P.O. Box 807
Houghton 2041
South Africa

Taking Photos for Amateur Radio

Bob Harper VK4KNH
PO Box 288 Beerwah 4519
Bobharper@bigpond.com

SINCE I HAVE BEEN managing AR I have had a few occasions when photographs had to be rejected as they were unfortunately not technically printable. I would like to see many more photos in the magazine and as such thought I might have a few words about taking photos for AR.

Although the photos within the magazine will be in Black and White there is no need to buy special film for the job. Use ordinary colour film and have it processed in a normal Minilab then just send one copy of the prints to the WIA Federal address. Prints should be covered with plain paper and have a piece of cardboard enclosed to reduce the chances of having them folded. You should write the words "Photos - Do not fold" on the envelope on both sides.

All photos should have a caption describing what it depicts, who is in the photo, who took it and when it was taken etc. This can be written on a piece of sticky label that is then stuck to the back of the photo. Otherwise the photos should be numbered and a separate caption sheet written out. Please make sure I know who sent them in and how to return them.

That was the easy part; now for the photographs themselves. Taking photos today should be fairly easy with cameras doing most of the thinking for you. In fact they do so much of the work that we often just point and shoot and don't even think what we are shooting. It is only when the photos are printed that the mistakes become obvious.

Here are some general rules to help take better photos:

People

Remember that we want those who know the subject to recognise them. So avoid grand poses and simply try to have the person smile. They don't have to be staring goo-goo eyes at the camera either; they may well be working DX into a microphone or exercising their fist on a key in which case they wouldn't normally be looking at the camera - would they? Try to get them as natural as possible.

When cropping people, there are a few places to cut them off that work and many others that don't. How many of you know

somebody that always cuts off either feet or heads? The rule I was taught was to cut a limb about a third from the top. So a "head and shoulders" shot for example has about a third of each arm in it. Sounds right doesn't it? If you cropped at the waist and sent it in I would probably crop it as head and shoulders anyway. Similarly, you don't see photos cropped at the knees or ankles unless it is a mistake. For our purposes most photos would be head and shoulders anyway.

Be considerate. Taking photos that the person will hate you for will probably not be good for you, the subject or the magazine.

Groups

Gather them in. Better to have a shot of five people shoulder to shoulder than five small faces and a lot of open space around them. It is also a good idea to have the subjects all look at the same point - "look here" or "look at Charlie over there" but not all looking in different directions.

You might not want to say cheese but let them know when the photo is going to be taken - "Everybody ready - Now". That way you'll have fewer photos of closed eyes or sneezes.

Backgrounds

Photographers always choose a bland background when they want the person to stand out. If you are photographing a person receiving an award then try to have them stand against a plain wall or plain curtains. Outside you might choose an outside wall, plain foliage or shoot against the sky. If you have a lens that you can adjust, (ie a camera not a snapshot special) use a large aperture and adjust the speed to suit. Then stand the person away from any background and hopefully the background will be out of focus anyway.

Indoors

Use a flash and if possible bounce it off of the ceiling as long as it isn't a strong colour.

Have people stand away from the walls to avoid strong shadows around their heads. Otherwise they tend to look like mug shots or drivers licence photos.

Outdoors

It helps to use a flash here as well if you cannot choose the best place and angle for the shot. If you can though, have the sun at your back (a little to one side or the other won't hurt.) and if it is in the subjects eyes, let them look down until you are ready then say "Look up - Cheese" and take it. That way the subjects aren't all squinting at you.

If the light is too strong and sharp, in the middle of the day for example, look for a shadow or go indoors. Avoid shooting people against bright backgrounds unless you want a silhouette. Essentially, if in doubt, use the flash.

Another point, particularly when shooting outdoors, is to avoid traps such as telephone poles that appear to sprout out of heads, wires coming out of ears etc. It even happens to professional wedding photographers occasionally. But you won't see the proofs of that.

Finally as far as people photos are concerned, if they are doing something, then the photo should show that. Why take a photo of an Amateur sitting beside a radio? Would you take a photo of a footballer standing beside the goal posts or would it be better to show him taking a high mark?

Equipment and Projects

When equipment is to be reviewed, the supplier can often access photos shot specifically for that purpose and they prefer their own expensive photos which no doubt show the best side of their equipment. This is simply because they paid a professional photographer to spend hours getting the best lighting and angles.

The two most important items here are lighting and focus. If your camera can't focus up close then take it back to where it can focus. A smaller image in the frame may still be sharper when enlarged, than an out-of-focus image. It may be an advantage to get back and use a telephoto lens if you have one. The perspective probably looks more natural anyway.

Lighting doesn't need to be expensive, as the equipment is quite happy to sit still while you shoot it. You don't even need a flash. Use desk lamps, fluoro lights, floodlights or whatever and just experiment with them until you get the light right. You can take very good photos on a bright sunny day by using ordinary white paper to reflect sunlight into the darker areas and diffuse the Sun's rays into a softer light. I use a cheap windscreen sun shield as a reflector in many of my outdoor photos.

Another item that may be of concern is the background material. Black cloth, especially felt is great for lighter items but too dark for "Black Box" items that we Amateurs love to make. Use a light blue cloth with no pattern

and lay it so there are a few "waves" but not folds in the cloth. One common method is to use table and a large box as a backing with the cloth laid over it so there is a curve from the vertical to horizontal surfaces and there is no corner to be seen.

The main aim is to make the equipment the only item of interest in the photo. One other item may be included as a reference to the size of the equipment. Commonly this would be a coin, pencil, matchbox or other common item that every reader should recognise.

If the front panel is important due to the control layout or whatever then take a separate photo of the panel, square on. Then take a photo of the whole item in perspective view – ie so that three sides can be seen. That gives the reader an idea of the shape and depth of your project.

When you need to show the innards of the project try to find the best angle for showing as much detail as possible. Set up the lighting to avoid shadows even if it means using three lights. If you need to point out a particular component or position then there are several methods possible. One is to use small paper arrows perhaps labelled or numbered and placed to point to the item of concern. Another is to use string or wool passing around the item and held taut outside of the camera view. But the best is to take two shots – one for the actual image and the other to draw your arrows onto.

I will then put neat arrows with labels on the photos digitally just like in the textbooks. Your job is a clear, well-focused and well-lit photograph.

If the front panel isn't as neat as you would like it – just take the best shot you can. I may be able to add a classy front panel with neat lettering afterwards – as long as I know what the controls should be called.

Antennas and Hardware

Antennas are difficult to photograph effectively due to widespread narrow elements. I suspect that beams could be shot on a dark night by opening the lens on a "Bulb" setting and shooting multiple flashes at the tower and elements.

It would make an interesting front cover if somebody wants to experiment and has a suitable camera especially as you might get star tracks in the background.

For construction projects on antennas, treat the important points such as brackets and connections similarly to equipment photos discussed above.

Aluminium is difficult to photograph without careful lighting but one trick that I have seen used in textbooks is to use a felt pen on all of the edges.

Black coaxial cable will often show up as thick black lines but a quick polish up may make them show up in 3D again.

Photos or Diagrams?

Thin wires strung between trees are almost always impossible to see, so send a diagram instead. Likewise, a photo of the top of a PCB will look nice but a diagram will show much more, if the sizes are accurate. A well-drawn diagram often explains your story better than a photo and with less trouble.

Events and Scenes

There are photo opportunities often forgotten. We Amateurs often attend rallies, fun-runs and other sporting events, put on displays in shopping malls, assist fundraising for charities, respond to emergencies, participate in State Emergency Services, Rural Fire Services and many other activities where Amateur Radio is on show. But we never seem to take photos to show we were there. Was an amateur in the Sydney to Hobart Yacht Race? I'll be amazed if there wasn't. Photograph an event that you attend as it shows Amateur Radio involvement.

If your club goes on an excursion, take a photo of the attendees with a landmark prominent in the shot. Why go to the Opera House and get a photo with some harbour vaguely behind you? Seek opportunities for personal shots and for promotion of AR as a part of the community.

Remember: film is cheap and photos last a very long time – take some history with you.

ar

Book Review:

The RSGB Guide to EMC

Author: Robin Page-Jones G3JWI

Reviewed by Bill Rice VK3ABP

ISBN: 1 872309 48 8, 208 pages

Our copy Direct from RSGB UK

Recommended Retail Price £18.75

As I'm sure you all know, EMC stands for Electro-Magnetic Compatibility, which is a sort of shorthand for "ability of electronic equipment to perform normally in the presence of other electronic equipment while it is also performing normally."

In other words, it covers far more than the presence or lack of interference between systems, but also the whole range of technology by which such interference can be minimised or preferably, eliminated.

This book is probably the most comprehensive volume so far published on the ramifications of EMC; and of course its origin

guarantees that it tackles the subject from an amateur radio viewpoint.

As many of us know from unhappy experience there is great scope for inadequate compatibility between amateur transmitters and nearby television receivers.

But a whole armoury exist of techniques to minimise this and similar problems. Such techniques are the subject of this book.

Related topics which are also covered are interference to and by computers, and there is even an appendix on the subject of lightning. I would go so far as to say that no senior amateur can afford to be without this book.

It should be compulsory reading.

ar

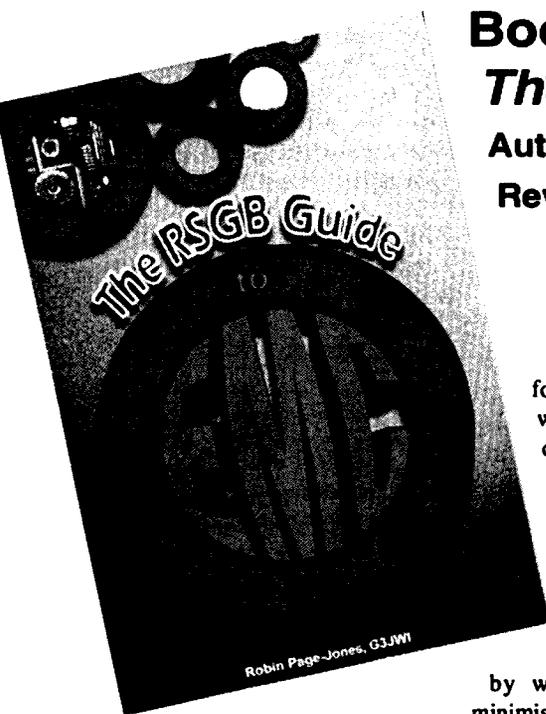

Australian LF Band Gains International Reputation

By Jim Linton VK3PC

Articles on a long wave propagation by John Adcock VK3ACA which appeared in *Amateur Radio* June-September 1991 is now attracting interest worldwide.

The Long Wave Club of America (LWCA), whose members experiment in the LF spectrum below the AM broadcast band, has endorsed the articles as a seminal text on propagation.

The articles have frequently been quoted in other mediums. The full text and diagrams are now on the Internet after permission was granted by the WIA to the LWCA.

The series was by Australian LF pioneer, John VK3ACA, who, with others, ventured on to LF in the 1980s after taking out experimental licences. His pioneering was first documented in "Experimental Stations on 196kHz" in AR magazine, July 1984.

At about the same time it became WIA policy to seek an LF allocation for VK radio amateurs. The issue was last raised at the

WIA-ACA liaison meeting in December, 1998, and efforts are continuing to secure an allocation.

John VK3ACA's four-part series article on LF propagation in 1991 attracted little local attention at the time, but it is now the "must read" text for LowFERS (experimenters on long wave) in various countries.

In that series John said, "As far as I know no attempt has been made before to explain LF propagation in concise terms with the average interested reader in mind, and to point out where it differs from HF propagation. "It is therefore hoped that this article will become a basic reference for amateur radio on the subject of LF propagation."

LWCA recognition will give the text a much wider audience, and it acknowledges the LF experimentation done in Australia.

Lyle Koehler KOLR of the LWVCA told John VK3ACA, "I have had a copy of your article for several years, during which I have

often wished it could be made available to other LowFERS in the US. There has been a lot of discussion about propagation among some of my LowFER friends. Your article is now 'public' and is headlined on the Internet at <http://users.aol.com/lwcanews>, the LWCA web page and will be a very useful reference."

Lyle also reports that there has been "a flurry of experiments" using binary phase-shift keying (BPSK) by LowFERS in the US ahead of moves for amateur access to LF bands.

The American Radio Relay League asked in 1998 that the Federal Communications Commission create two low-frequency Amateur Radio bands at 136kHz and 160kHz.

The 136kHz band, a spot allocation only 2.1kHz wide, falls within the European conference of Postal and Telecommunications Administrations (CEPT) band plan.

If the ARRL gets that band it will open the way for trans-Atlantic, and trans-Pacific propagation experiments.

The second band being sought is a 30kHz segment from 160 to 190kHz.

Europe and New Zealand already have LF band allocations, and it has been WIA policy for a decade or so for such an allocation to be available in Australia.

ar

A Regulator Reflects

Rob Gurr VK5RG

35 Grandview Ave.
Urrbrae SA 5064

For many years Rob Gurr was employed in many roles by the government bodies that regulate our hobby and was a keen amateur operator in his own right.

I have now held my Amateur Licence for 50 years and worked in telecommunications for most of those.

In reflecting on the evolution of the hobby over those years, I appreciate most the many friendships I have made, some close and personal, with many others made at Radio Clubs, Conventions and the WIA meetings.

All have contributed to my enjoyment of the hobby. I am certainly pleased that various "optional" grades of licence were introduced over the years, starting firstly with the "Limited", followed by the "Novice" and lately with the "Novice Restricted".

From these, new Amateurs have emerged, making major contributions to all aspects of technology, operating techniques and journalism, that may have otherwise been lost to us, if the earlier conditions of licensing had continued.

I have been able to assist newcomers

obtain qualifications and construction skills, as well as help them sort out the dry joints, etc. when their equipment failed to meet their expectations.

Most of the designs I passed on came from the many publications in my library, and some were my own initiative.

In earlier years, no one ever complained when a circuit that he had published, was modified and used in a successful project.

Not so these days when many items, for example, software used in *Amateur Radio*, has a plea from the developer to send him some money to help pay for his time spent developing it.

I think that if we had asked for similar payment for the ideas we published in these years, we would have outpriced our hobby to all but the very rich.

I continue to give talks and lectures to Radio Clubs and Learned Societies, and have never felt the need to be recompensed,

for my preparation time and transport expenses to attend.

I hope this "pay me for my hobby" attitude does not hinder our radio hobby too much, in the future.

Apart from my participation in Amateur Radio, I was lucky enough to spend a career in the administration of Radio-communications Legislation mainly in Australia, with a few years in Papua New Guinea.

The changes over the 50 years in the Amateur Radio legislation, are minor compared to those the Marine and Land Mobile Services experienced.

Few Amateurs are aware of the many other services that use the Radio Frequency Spectrum, and the agonies they also endure to get their justifiable needs met from this scarce resource.

I participated in the clearance of Double Sideband High Frequency Services and the coincident introduction of Single Sideband, as well as the rearrangement of VHF Land Mobile bands to make more VHF TV Channels available.

Then there was the unsuccessful attempt to put our FM Broadcasters on UHF, at a time the only available receivers were from overseas and were on the International 88 to 108 MHz Band.

Facing up to the public with their logical

continues next page

criticism of this policy wasn't all that much fun! Thank goodness we eventually got it right.

Also of course we had to interesting days of CB Radio pirates.

What a spin off to Amateur Radio, when hundreds of licensed CBers found there was life beyond this service, and became Hams. I enjoyed coaching those interested, and many remain close friends today, even though we had some bad times in our earlier relationships.

The changes that held my continuing interest were those in the Maritime Marine Service, where the term FGMDSS became a daily conversation piece. The "Future Global Maritime Distress and Safety Service" of the early 80s has now become the GMDSS.

Direct printing Radioteletype from the bridges of Merchantmen on the high seas, 406MHz Beacons that float away from a sinking ship, giving locations from the last known Gyro Compass reading, to aid orbiting Satellites in the location of the survivors.

It was during the development and introduction of these techniques that I became a little cynical about the need for Morse Code in the Amateur Service. We no longer needed to train Morse operators, in the Marine Safety Service, whilst many highly competent persons not able to face the Morse tests in the Amateur Service, were giving up, and being lost to our hobby.

In the area of my work, high level Public Service Administrators, without any concept of Morse Code, were heading the pressure on ship owners to comply with the FGMDSS.

At the same time these same officials were giving no relief to the Amateur Service's cry for some consideration, even though it was obvious there would very soon be no need for Morse!

The Radio Frequency administrators still require Morse for our Service?

Do they really need it, or is it in our hands to be more realistic about these matters? I have often sent Baudot and ASCII at 10 words per minute for testing...I hope I am never asked to copy that down in my own handwriting!

What would be the use unless all my amateur contacts could do the same thing.

Don't blame me, I left the real world of Regulation 11 years ago, and it feels good on the other side of the counter.

What a hobby, one of the best in the world. Let's keep it that way. 73

Rob Gurr has also operated under the callsigns VK2ARQ VK1RG (Macquarie 1) VK9RO and VK8RO

ar

The Need for Morse Code

Another Viewpoint

By G3WGV

Submitted for discussion by David Pilley VK2AYD.

The following is a copy of the submission made by the First Class CW Operators' Club to the RSGB dated August 1998.

Introduction

Authorities throughout the world, notably UK, USA and Canada at this time, are considering the basis of licensing for the Amateur Radio service.

Key issues include the matter of Morse code as a requirement for access to the HF bands and the more general considerations of access standards and licence classes.

The RSGB has a primary influence on Radio Amateurs' relationship with the Radio-communications Agency and has requested input to the debate from Radio Amateurs and Radio Amateur organisations.

The First Class CW Operators' Club (FOC) is a British club with members throughout the world. Many of its 500 members are UK licence holders.

FOC is an activity club dedicated to excellence in Morse code operating on the Amateur bands. Membership requirements are stringent and the world-wide membership is limited to 500.

FOC respectfully makes the following submission for consideration.

The role of CW

Morse code (CW) has a distinguished history which predates radio communication by several decades.

It remains an efficient and cost effective means of communication, especially for Radio Amateurs who in many parts of the world operate on limited budgets and with poor access to modern technology.

Historically a knowledge of CW has also been perceived as a reasonable pre-requisite for access to the HF bands.

These are thus two separate issues here, namely USE and PREREQUISITE, that should be considered independently.

CW as a means of communication

FOC proposes that CW is a valid means of communication today and in the future.

Although CW has been largely (not totally) replaced by other means of communication in the commercial world,

this in no way compromises its validity as a means of AMATEUR communications. Consider:

1. At virtually any time of the day or night, a scan across the Amateur bands reveals as many, if not more stations using CW as are to be found on any mode. CW Contests, for example, continue to attract increasing participation and standards continue to rise;
2. Generally, the extremes of behaviour (eg bad pile-up discipline, foul language etc.) are far less evident on CW than on speech modes;
3. There is plenty of empirical evidence that CW operators ENJOY their hobby more and put more back into the Amateur radio service;
4. CW is bandwidth efficient and can be sent and received with simple equipment.
5. There are many occasions where CW is the optimal mode and sometimes the only mode that will work. Consider aurora, moon-bounce and QRP activity;
6. The art of good CW is a genuine skill that sets its exponents apart from the norm and validates the concept of self training, an important part of the *raison d'être* of Amateur Radio. The argument that CW is no longer prevalent in the commercial sector is thus irrelevant and should be discontinued. CW is relevant to Amateur Radio and has an important place now and into the future.

CW as an access prerequisite

If CW is a valid means of Amateur communication, then is it also a reasonable access prerequisite for HF operation?

FOC considers that it is but one of the range of expressions of capability which might be tested as part of the licencing requirement. Thus:

1. A CW test in isolation is not rational: why not an English elocution test for SSB or a typing test for data modes? The requirement dates back to a period

when these other modes were not common-place. Had they been, then no doubt the then licensing authorities would have specified a need for related tests;

2. The CW test, as it stands, in no way prepares the candidate for CW operation on the air. Very little CW is sent at 12 wpm these days and even less is sent on a straight key. The test is thus something of an anachronism as it stands;
3. Yet the test does have validity in that it requires some commitment from the examinee to meet its requirements and as such imposes a **QUALITY ASSURANCE** process on those who wish to operate on HF. It can be seen then that the CW test is useful as one of a range of access qualifications but that its standard is inadequate given the present-day use of CW on air.

Regulating access to the bands

It is clear that CW has been part of an access regulating process. Some factions argue strenuously that it is no longer a valid regulator and in principle, FOC has sympathy with this view. However, it is not acceptable to remove the requirement without considering what might replace it.

FOC considers that the standards required for general access to the HF bands must NOT be lowered further. The following reasons are advanced for this assertion:

1. Radio equipment is increasingly hard for the home enthusiast to maintain. The self training that used to occur from home maintenance is therefore not readily available and other ways must be found to ensure the knowledge is extant;
2. The general level of competence displayed on the bands today is much lower than in generations past. This is despite the hobby becoming far more complex in the meantime. A further competence reduction will compromise the standing of Amateur Radio service and contribute to its decline;
3. There is a tendency towards **INSTANT GRATIFICATION** expressed as an unwillingness to work for something that is worthwhile. Yet something that is achieved without effort will tend to have little perceived value and therefore not worthy of protection. Amateur Radio should be perceived as a worthy goal which justifies the effort required to attain it;
4. Radio communication and technology skills are what differentiate Amateur

Radio from unregulated services such as CB. De-skilling Amateur Radio will ultimately remove that differentiation, with inevitable consequences.

Replacing/supplementing Morse Code

FOC considers that competence in Morse is and will remain a core requirement for active proponents of the hobby.

However it is also recognised that there are many other competencies equally important, most of which are not tested in any way whatsoever under the present licensing regime.

Morse code should therefore be considered one of a set of tests that might be imposed for a given class of licence.

It might even be that some level of choice may be exercised by the examinee. There might be six (say) components to a given test, of which Morse is one. Candidates are required to pass at least four of these but have a choice regarding which four they attempt.

Examples of components that might be in such a test regime include:

- Morse code
- Construction skills
- HF operating skills
- VHF operating skills
- Contesting
- Digital modes
- Special communications (moon-bounce, aurora, etc.)
- Antenna technology
- Propagation
- Safety in the shack

Morse stands its ground as a pre-eminent communications mode and does not require an obligatory test to reinforce its status.

It should take its place amongst a family of competence tests that collectively demonstrate the capability of the individual to be a Radio Amateur and to maintain the status of the service.

Maintaining standards

From the above, it is concluded that there is a clear case for maintaining standards and that this is, in large part achieved by access controls.

FOC considers that there is a strong case for **ENHANCING** the standards in Amateur Radio and this raises the concept of a range of licensing levels. This might also be called **INCENTIVE LICENSING** and it is a practice that has existed in other countries, notably the USA for many years.

It is interesting to reflect that the highest class of licence available in the UK is barely the equivalent to the USA General Class, the third in a five level licensing system.

Although there has in recent years been a two tier system in the UK (Novice and Full)

and differentiation between HF and VHF articulated by the need for Morse, this hardly constitutes an incentive licensing system.

Licence class proposals

FOC proposes a three level licensing structure with the middle class broadly similar in standard to the present Class-A licence.

HIGHER OR EXTRA CLASS

FOC considers that there is an excellent case for classes of licence beyond Amateur "A" which keen exponents of the hobby might pursue in return for enhanced facilities.

Golden opportunities to introduce this were missed with, inter alia, the awarding of 6m and the WARC bands. another opportunity is clearly afforded by the long overdue need to bring UK power levels into line with Europe. The UK "Extra Class" could be the way such a move could be palatable to the Authorities.

This class should carry with it a CW capability requirement that is consistent with standards on the bands today; probably about 20 wpm as a minimum. The class could also confer privileges such as exclusive access to desirable portions of the bands.

GENERAL CLASS

The present A-class licence represents a bare minimum in terms of knowledge required vs. benefits conferred. It is clearly preposterous to suggest that this represents too high a level for aspirants to achieve.

One need only consider the vast number of people, this author included, who were able to pass the much harder written test of 30+ years ago at the tender age of 15.

We are by common consent a better educated nation than we were 30 years ago so what possible logic can there be in **REDUCING** standards? CW might be one of the optional modules for this class of licence in the manner discussed above.

NOVICE LICENCE

Finally, a case does exist for an entry class licence to act as a "taster" for those who are unsure whether their interest will mature.

In the past this would have been via an **APPRENTICESHIP** as a Short Wave Listener. Regrettably this seems no longer to happen, with all too obvious effects on our bands today.

The novice licence scheme introduced some years ago seems to provide a fair basis and should have a place in a new scheme. There is scope for improvement to the class but that is outside the scope of this paper.

HF/VHF DIFFERENTIATION

There seems little point in perpetuating this class distinction which has, since its inception, been divisive.

If we accept the provision that CW is no longer the sole prerequisite for access to the

continues over

HF bands then the need for HF/VHF differentiation disappears. The same arguments, presented above, for higher levels of demonstrated competence apply equally to VHF.

It might be argued that VHF is technically more challenging and that even CW has an important place at VHF by virtue of its pre-eminence in aurora and moon-bounce activity.

FOC therefore proposes that there should be no HF/VHF differentiation from a licence requirements perspective.

TRANSITION

An awkward problem to be resolved is transition from existing Radio Amateurs into a new licensing class structure.

As a general principle, it is proposed that retrospective legislation is inappropriate and that therefore it is not feasible to annex privileges from those that already enjoy them.

Thus, if spectrum segmentation by class were adopted, the current Class-A licensee would have to be offered the highest class licence in the new structure, simply to keep what he already has. Similarly, should the new licensing regime contain limitations on the use of frequencies above 30MHz, current Class-B licensees would have to be offered the licence class that did not carry such limitations.

Conversely, if the only differentiator between classes were to be privileges not yet conferred, such as higher power, then the transition process is simplified and existing licensees would become General Class licensees with the option to upgrade. This simpler proposition is perhaps more palatable.

New licensees, or those seeking greater privileges to those currently held would be obliged to satisfy the criteria associated with the enhanced privileges desired.

Band planning

Over the years, the CW segments of virtually all Amateur bands have been eroded by the emergence of new modes and in some cases by encroachment from existing modes.

Broadly this has been accommodated by the CW fraternity because of the inherent spectral efficiency of CW together with improving selectivity in equipment.

If CW is dropped as a licence requirement, it opens up the prospect of greater use of the HF spectrum and by definition these new users would be using modes other than CW.

A strong case can be made for keeping and perhaps even reinforcing band plans. It might be that compulsory band planning would be required to offset the inevitable tendency for the relatively inefficient voice modes to usurp CW spectrum. Some bands may require a review of sub-band edges. There is no doubt that the CW segment could be reduced on some, notably 28MHz.

This may give an opportunity to define a class of licence specifically using that recovered spectrum. But the 10.1 MHz band would have to be strenuously protected from encroachment of wide band modes, including SSB.

Assuring the future of Amateur Radio

FOC asserts that the future of Amateur radio is not aided by the remorseless reduction of standards that seems so prevalent in other walks of society today.

Yes, Amateur Radio has to appeal to people of all age groups (not just the young) in order to survive but it is a myth that licence requirements are a barrier to that appeal.

Amateur Radio will survive by remaining a worthwhile pastime which requires commitment and offers a lot in return. This is the route to long term participation.

Reduction in standards may see a short term influx, but is unlikely to result in sustained long-term interest. Easy come, easy go.

There are other very real barriers to the growth of the hobby. The Society would be well advised to focus on matters such as

- RAE is operation. It is preposterous that one can only sit the RAE twice a year and that the results take months to arrive. It is also outrageously expensive. These factors create a real obstacle to the aspiring Radio Amateur at a time when commitment is unclear. Contrast this with the Americans test system which is superior in every way;
- The tendency for people to live in ever smaller properties, combined with ever more onerous and expensive planning permission issues. This is a real barrier to HF operation in particular.
- The illogical urge to compare Amateur Radio with, for example, the Internet and computers. They are totally different and in many regards complementary. Amateur Radio uniquely provides a way to communicate without needing to use (and pay for) someone else's infrastructure. Amateur Radio's "Internet" is a natural phenomenon: the ionosphere;
- The service element of Amateur Radio. Certainly we live in a country where natural disasters are, thankfully, very rare and a good infrastructure generally exists. Amateur Radio has nevertheless shown its capabilities in recent years in disasters such as Lockerbie and has provided a basis for a productive career in electronics and telecommunications;
- The way Amateur Radio is marketed to and perceived by the general populace.

FOC position and recommendations

This paper has sought to discuss the general issues relating to Morse code and expand into areas such as licensing and the place Amateur Radio should occupy.

Summary

1. CW is and will remain a valid mode for Amateur Radio use, both because of its useful characteristics and for its pure enjoyment;
2. CW can no longer be considered uniquely appropriate as an access control to the HF bands;
3. CW should be one part, possibly optional amongst a group, of access controls;
4. The standard of access requirements must not be diluted and could usefully be increased to take account of the greater technical complexity of today's Amateur Radio;
5. There is scope and pressure for a higher class of licence than the present A-licence;
6. There is scope for a higher speed CW test as part of the proposed higher class licence requirements.
7. Transition between the current licensing regime and the new structure should be done on the basis of no loss of privileges for those presently holding licenses. Those wishing to upgrade or obtain a new licence do so by obtaining the appropriate qualifications.
8. There is scope for simplification of the process by which licenses are granted, in particular by reforming the way the RAE is operated;
9. The issue of commitment to the hobby will not be satisfactorily resolved in the longer term by reducing the competence levels required for a licence;
10. There are socio-economic issues that prejudice the continued wellbeing of Amateur Radio, including population pressures on housing and open space;
11. Poor marketing of Amateur Radio has it being perceived as a "Greek pastime" with no account taken of its considerable contribution to society and industry;
12. We must stop drawing comparisons between Amateur Radio and computer/the Internet.

Do you have some thoughts on this point of view?

Do you agree or disagree?

The editor would love to have your comment.

FOR ALL YOUR COMMUNICATIONS NEEDS

2m 30W RF Power Amplifier

Ideal for use at home or in the car.

It works with inputs from 0.5 to 5W, and produces up to 30W output with just 3W input. A switchable 12dB gain low noise GaAs FET receiver pre-amp is included for use in quiet RF areas. The amplifier includes a large heatsink, fused DC power lead, SO-239 input/output connectors and simple LED metering for DC supply voltage and relative RF output power. Frequency range 144-148MHz FM only, but can be modified for SSB use. Requires 13.8V DC at 6A max. Size: 125 x 48 x 147mm (WDH) including protrusions. D 2515

\$129⁹⁵



3-15V 25A Heavy Duty Power Supply

This solidly built benchtop power supply provides current of up to 25 amps ICAS at 15V, 20 amp continuous at 13.8V and lower current at lower voltages. It has front panel metering plus high current banana-style and low-current output connections. An internal heatsink and thermally switched fan provides cooling without protrusions in the metal case. Specially modified for more reliable, long-term operation, it uses a rugged 50 amp bridge rectifier & trifilar transformer. Also provided is extensive overload protection through dissipation limiting circuitry for the pass transistors, a 30 amp instantaneous current limit, AC mains circuit breaker, a transformer thermal fuse & fused auxiliary secondary winding. D 3800

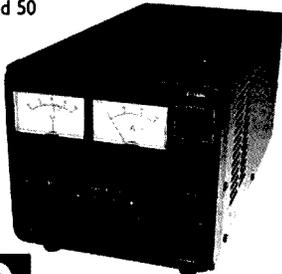

\$299

Great Value!

Rugged HF 5-Band Trap Vertical Antenna

The rugged 5BTV incorporates Hustler's exclusive trap design (25mm solid fibreglass formers, high tolerance trap covers and low loss windings) for accurate trap resonance with 1kW (PEP) power handling. Wide-band coverage is provided on the 10, 15, 20 and 40m bands (SWR typically 1.15:1 at resonance, <2:1 SWR at band edges) with 80kHz bandwidth typical on 80m at 2:1 SWR. An optional 30m resonator kit can be installed without affecting operation of other bands. High strength aluminium and a 4mm (wall thickness) extra heavy-duty base section guarantee optimum mechanical stability. At just 7.65m, the 5BTV can be ground mounted (with or without radials, although radials are recommended), or it can be mounted in an elevated position with radial system. Unlike other antenna designs, the 5BTV can be fed with any length of 50-ohm coax cable. D 4920

\$449

HUSTLER

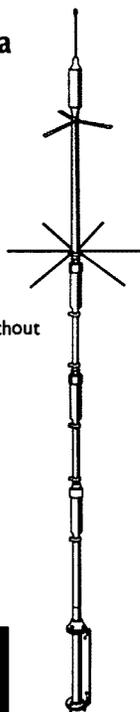

30m Resonator Kit

Adds 30m coverage to the 5BTV and includes all hardware.

D 4921 **\$99.95**

BONUS OFFER! Purchase the 30m resonator (D 4921) with the 5BTV vertical and pay only half price for the 30m resonator!

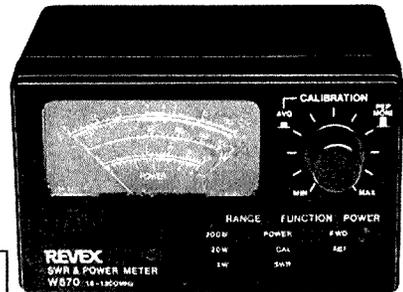

\$299^{ea}



Revex W570 HF/VHF/UHF SWR/PWR Meter

Top of the line performance! The W570 provides switchable 1.6-160, 400-525, 700-1100 and 1240-1300MHz coverage, with measurement of 3 power levels (5,20,200W) and SWR. External UHF sensor uses N-type sockets with remote mounting for easier cable connection to the meter. Measures 120 x 80 x 155mm. D1377

Yupiteru MVT-9000EU Deluxe Scanner

The Yupiteru MVT-9000EU is an amazing new Japanese handheld scanner that provides wide 531kHz to 2039MHz frequency coverage, a large and informative backlit LCD screen and excellent sound quality. All-mode reception capabilities are provided, (FM, W-FM, AM and SSB modes) plus there are 18 selectable step rates between 50Hz and 125kHz to allow the best tuning choice for the signals being listened to. For easy storage of popular frequencies the MVT-9000EU provides 1000 memory channels (20 banks of 50 channels each) which can store frequency, frequency step, reception mode as well as the Attenuator setting. Selected memory banks can be scanned to check on activity at a rate of up to 30 channels per second. Search operation is provided across 20 bands with 500 Search Pass memories provided to "lock-out" unwanted frequencies for more efficient Search operation.

Other features include:

- In-built ferrite rod for AM broadcast band reception
- A Band Scope function allows checking of adjacent channel activity, with two selectable Scope bandwidths. Using the Marker mode you can substitute the centre frequency with a moveable marker, so you can see the frequency and hear the audio of specific adjacent signals
- 10 priority channels
- 50 Autowrite memories to store active frequencies during Search operation
- Title editing for Band, Bank and Channel name is provided

Complete with NiCad batteries, AC plugpack charger, car cigarette lighter lead, antenna, carry strap and belt-clip.

D 2797

YUPITERU \$999

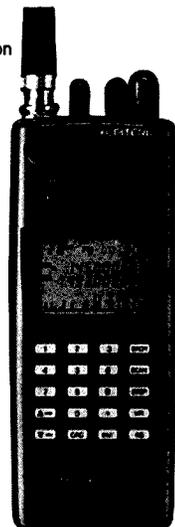

FOR ALL YOUR COMMUNICATIONS NEEDS

Advanced Data Management Software

An advanced way to program many of the functions of Yaesu handheld and mobile transceivers. Each package consists of an interface that plugs into the serial port of a PC and connects to the transceiver via its microphone socket (for handhelds) or its Packet socket (for mobiles). Also provides easy-to-use 3.5" (inch) PC software with pull down menus that allow for programming and naming of memory channels, selection of output power, CTCSS tones, scan and battery saver operation, plus much more.

ADMS-ID suits FT-10, 11R, 50R/RD, 51R, VX-1R D 3753

ADMS-2D suits FT-3000M, 8000R, 8500, 8100R D 3759

\$89⁹⁵ea

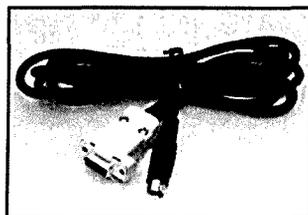

LP-1300 Log Periodic Yagi

The Maldol LP-1300 is a Log Periodic Yagi beam antenna designed to provide useful gain across the 100 to 1300MHz range. Ideal for scanner enthusiasts and ham operators needing a directional wideband antenna. Consists of a 17-element Yagi with a special feed system providing low SWR (less than 2.0:1) across the 100-1300MHz range.

Gain: 6.0dBi to 10.0dBi
Boom length: 1.46m
Suitable mast: 28-60mm diameter

Max wind speed: 40m/sec
Max power: 500W
Connector: SO-239
 D 4828

\$269

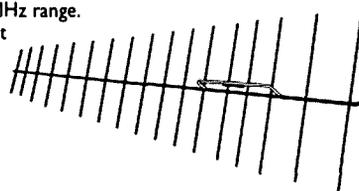

FT-50RD 2m/70cm Handheld

The Yaesu FT-50RD is an amazingly compact 2m/70cm amateur band handheld transceiver which provides MIL-STD 810 shock and vibration resistance, super wideband receiver coverage, simple menu settings for most functions, and compatibility with the optional Yaesu ADMS-ID software/interface package for PC programming of many functions.

Other features include:

- Tx 144-148MHz, 430 - 450MHz
- Rx 76-200, 300 - 540, 590 - 999MHz (cellular blocked)
- FTT-12 keypad provides Digital Voice Recording, CTCSS/DCS scanning, and CTCSS encode/decode
- 2m/70cm RF output: 2.5, 1.0, 0.1W standard, up to 5W with 9.6V battery or 12V DC socket
- "Omni-glow" LCD screen for easier night-time viewing
- 112 memory channels with 4 character alpha naming
- Dual watch allows monitoring of sub-band activity
- Direct FM modulation for better audio quality

- 5 battery saving systems (includes Rx and Tx Save)
- Comes with FNB-40 slimline 6V 650mA/H Nicad battery pack, flexible 2m/70cm antenna and modified M-9626 AC plugpack adaptor for Nicad charging D 3660

YAESU BONUS!

2 YEAR WARRANTY

\$569

Pay only half-price for a second Nicad pack when purchased with the FT-50RD. Limit one per customer. Applies to FNB-40, 41, 42 only.



FT-8100R 2m/70cm Mobile

The stunning new Yaesu FT-8100R is a state-of-the-art 2m/70cm band mobile transceiver that combines high power and the industry's most versatile memory system with an excellent wideband receiver and solid construction. Its US MIL-STD-810 shock and vibration rating is your assurance of years of reliable operation. Includes hand mic, mounting bracket and fused DC power cord.

Other features include:

- 198 memory channels
- 1200/9600 baud packet socket
- Inbuilt antenna duplexer
- Inbuilt crossband repeater facility
- Dual receive capability (VHF/UHF, VHF/VHF, UHF/UHF)
- Optional removable front panel

Frequency range: Tx 144-148MHz, 430-450MHz
 Rx 110-550MHz, 750-1330MHz (less cellular)

Output power: 2m: 50, 20, 5W
 70cm: 35, 20, 5W

2 YEAR WARRANTY

\$949

D 3314

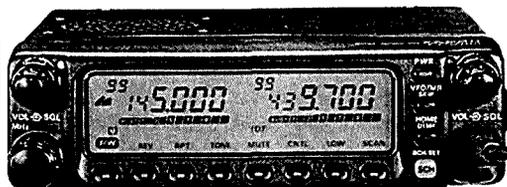

YAESU

PHONE FAX AND MAIL ORDERS

PHONE: WITHIN AUSTRALIA: 1300 366 644
 (Local call charge)

FAX: (02) 9395 1155 within Australia and
 (+612) 9395 1155 from outside Australia

MAIL: DICK SMITH ELECTRONICS, Direct Link Reply Paid 160, PO Box 321,
 North Ryde NSW 1670 (No stamp required)

Excludes packaging and postage. All major credit cards accepted.

14 Day Money Back Guaranteed if NOT completely satisfied. (Software excluded)



Visit our web site at
<http://www.dse.com.au>



That's where you go!

*Pricing valid until 30/4/99, then subject to change.

OVER TO YOU

Membership

I've been prompted to write this letter by the negative vibes I keep getting every time I read AR magazine — members more members.

First I'll try to explain, I'm 50 years old, a mechanic by trade and a CBer for more than twenty years. A CBer you say; but haven't you people obtained many VKs from CB ranks? (I'll be there shortly).

In Carnarvon there are four VKs in town. Only one was really willing to help me to get my VK.

One in four, is that the norm?

Derek—VK6DSL has been of invaluable assistance—I have his OK to print his name.

I received an FT1000MP for Christmas, a very nice radio — Derek comes over and we work the world—beautiful.

One day, I'll be able to work it on my own. In all fairness, the WIA people and Rex in Exmouth, were also extremely helpful in my quest to obtain my VK.

If you people wish to recruit more members, I feel some attitudes may have to change. After all, we all have a common interest.

More promotions in the country would certainly help — Try finding an examiner in Carnarvon! Communications are so vital in the bush—especially WA. We have been known to drive 200 km for a beer!

I've joined the WIA as a member; the more the merrier and I'll think we'll all be better off. If you can't beat them, join them!

In closing, may I wish everyone in the WIA and all the radio enthusiasts, all the best for '99 from Carnarvon.

PS Keep printing AR, one of the few direct contacts we have!

Kon Brasche L60411

P O Box 170
Carnarvon 6701
(CB WAA556)

More on Coax vs Cockies

Referring to your article on cockatoos chewing up coax cable.

In my experience, they only go for the highest parts, near the antenna.

If a length of garden hose is slipped over the last few metres of coax, they are no longer interested. Even if your cockies are hungrier, it gives them something to chew on before they do any damage.

Dave Gibbons VK1GD

PO Box 3 Hawker
ACT, 2614 Australia
Darogi@pcug.org.au
vk1gd@vk1bbs.act.aus.oc

Goodbye — Hello

We have our VK5 Division AGM in April and after that I will no longer be the Divisional President.

The VK5 Division constitution states that you cannot be President for more than 2 consecutive years. (Very wise)

It is thus quite likely that someone else will be writing the VK5 Notes in future.

I have enjoyed doing so for the last 2 years although with the many other tasks I have taken on as President I could do with a rest.

I will not necessarily be taking a back seat, however, in many ways I will not be so bound to be as "diplomatic" as a President needs to be. (You can read whatever you wish into that statement. Hi.)

I wish to express my thanks to Bill Rice VK3ABP.

I also ask that it be conveyed to Bill Roper VK3BR, June Fox and the Federal Office staff, for the cooperation shown to me both as a Divisional President and also as a correspondent to "Amateur Radio" magazine.

At the same time I wish to acknowledge the work of all the members of the Magazine Committee without which we would not have such a good publication.

When one considers the amount of effort provided on a voluntary basis we can only be grateful for such people dedicated to helping in this way.

My best wishes to all concerned.

Ian J. Hunt

e-mail: ianh@picknowl.com.au
Packet Radio:
VK5QX@VK5LZ.#ADL.#SA.AUS.OC
Tel: +61 8 8250 1708

(Farewell Ian — Editor and his staff)

Exams Comment

With reference to the "Education Notes" by Brenda VK3KT on page 34 of the February issue of *Amateur Radio* may I offer some input to the examination debate?

1. Examination venues should be reasonably accessible to the candidates.
2. The Morse code may have to be dropped as a trade for on-air operating procedures as part of the Regulations examination.
Yes, it's a touchy subject but we must face it!
Certainly the standard of many operators coming on to the Novice frequencies leaves much to be desired.
3. A pass mark of less than 70% would not be a fair indicator of a student's ability to understand the subject.
4. The suggestion of using one theory paper with two marking levels would cause much dissension.
5. Multi-choice questions cover a wider range of a subject than is possible with a "written exam".
6. There are possibilities for only two classes of licence, but that's something for discussion after the changes already mentioned are ironed out.

Max Morris VK3GMM

"Erehwon"
60-62 Observation Drive
Rye Victoria 3941

Do you have a point of view about some thing you have read in *Amateur Radio*?

Or about the hobby itself.

Or perhaps some news about people connected with amateur radio.

Share it with us and your fellow amateurs.

These are your pages.

The Editor *Amateur Radio*
PO Box 2175
CAULFIELD JUNCTION VIC 3161
email armag@hotkey.net.au
Tel: (03) 9528 5962
Fax (03) 9523 8191

Deadlines: by about the 15th of month prior

SPECIAL

FIVE for the Price of THREE

— Well Almost!

There still seems to be a lack of awareness about the cost of renewing the station licence for \$168 for 5 years.

This compares more than favourably with five times the yearly renewal fee of \$50. (ie \$250!)

So next time your licence renewal arrives from the ACA, consider the savings you could make.

73 Neil Penfold VK6NE

Silent Keys

Ross VK6DA

On 22 June 1998, amateur radio lost one of its most respected voices that of Ross Greenaway VK6DA.

Born in 1926 Ross lived all of his life in Leederville

In 1944 and 18 he joined the RAAF and served as a radar technician until 1946.

With this sort of technical training it wasn't surprising that Ross discovered amateur radio.

He was first licensed in 1963 and began a long association with the WIA, culminating in two terms as State president 1975 and 1978. He was a keen member of WICEN and served terms as an intruder watch officer and Morse practice officer

He also published a VK6 newsletter *The Bulletin*.

As an enthusiastic supporter of the Guides and Scouts Associations, JOTA was always an annual highlight. The RD contest was another favourite.

His contributions to amateur radio were rewarded in 1979 with life membership of the WIA. A proud moment for Ross.

Upon retirement in 1987, Ross turned his attention to the travellers and realised that a large number of VK amateurs did not have access to the established 20m net.

Never a person to sit back and wait for others, he started a daily net on 15m. It is a tribute to him that, 10 years after its inception, the 21.105 net is as strong as ever.

To Ross, amateur radio was not only interesting but fun. He could never resist the opportunity to crack a joke, usually at his own expense.

No tribute to Ross can exclude his wife June. She shared and encouraged his love of amateur radio.

There was always tea on offer at the VK6DH QTH.

Finally, though the key may be silent, for those of us lucky enough to have known him well, the memories will remain.

He hasn't really gone QRT, just QSY.
Vale Ross

J Baxendale VK6 JD

VK3 Mike November

The sudden death of Milton Crompton on Sunday, January 3rd, 1999 was a shock to all who knew and admired him.

Milton was multi-skilled and expert in each field he worked in and a perfectionist in all the equipment he made, from a lathe and a honeycomb coil-winding machine to a great variety of electronic equipment.

First licensed just before World War 2 he obtained both an amateur licence and a broadcast operator's licence. He liked changing jobs and disciplines. He first worked in radio manufacture, then service. Through the war he taught Radio Theory and Laboratory Practice at R.M.I.T. in Melbourne. Then he spent a period working on electronics at the Defence Research Laboratories.

He became a Senior Engineer at the Rola Company, famous for loud speakers and tape recorders. He worked as Maintenance Engineer for an Audio and Video agency. His last job was in Cinematography at the Victorian Film Laboratories.

Somewhere in all this was a period he spent in England studying Television before its introduction here in Australia.

Somewhere else in this series of changes there were two periods each for a few years when he owned shops selling and servicing radio and television equipment. As VK3MN he kept morning and afternoon 40 metre skeds. He was one of the amateurs involved in maintaining essential contact with Government Authorities during the Darwin Cyclone disaster. He was an early member of the Moorabbin and District Radio Club and served an early term as President.

In later years - in conjunction with his long time friend, Doug Richards VK3CCY, he raised a lot of money for the Club by clearing out the radio equipment of deceased members on behalf of the families concerned.

He was one of a small group of members of the Moorabbin Radio Club who revitalized VK3AOM at the Science Museum of Victoria when the VK3 Division of the WIA moved their Sunday broadcast to Lyndhurst.

Milton became part of our ROATC broadcast team a few years ago and a member of our committee about two years ago. He is survived by his wife Rita, his son Barry, his daughter Pam and her husband and children.

A large group of amateur operators attended Milton's funeral on Thursday 7th January 1999.

Rest easy Milton OM.

Allen Doble VK3AMD

For the Radio Amateurs Old Timers Club of Australia

QSP NEWS

QSLING FOR VK5MIR VOICE CONTACTS

Provision has been made for a special QSL card for contacts with VK5MIR that was the occasion of

"THE FIRST USE OF AN AUSTRALIAN RADIO CALLSIGN FROM SPACE".

Members of the VK5 Division of the WIA saw fit, at a General Meeting, to vote for the costs of such a QSL card to be borne by the Division. A suitable card is being produced.

Those who made voice radio contact with Andy Thomas, operating as VK5MIR on the Russian Space Station, may obtain a commemorative QSL card for the contact.

Simply send your own QSL card accompanied by a self addressed stamped envelope (SASE) to

Ian Hunt VK5QX
8 Dexter Drive,
Salisbury East,
South Australia.
5109

It has been decided that a "cut off" date will be set for receipt of requests for a VK5MIR QSL card. Cards received after that date would not be acknowledged.

The "cut off" date is 31 MAY 1999

Requests for the QSL card must be postmarked no later than this date. Any received beyond this postage date will not necessarily be acknowledged.

The reason for this approach is that we do not have any definitive log for the VK5MIR operation and thus no idea as to how many cards may be required.

We also wish to keep costs for the cards to a reasonable minimum.

I would ask that you also spread this information to non-WIA Members where you think that they may have made contact with Andy Thomas as VK5MIR.

Again, I emphasise that this applies only to "voice" contacts.

Requests for QSLs for Packet Radio contacts with the MIR Space Station should be sent to the USA address provided for R0MIR.

Ian J. HUNT VK5QX

Amateur Radio

reporting on technique and opinion in the world of Amateur Radio

CLUB NEWS

Blue Mountains Amateur Radio Club Inc

PO Box 54 Springwood NSW 2777

The club is alive and well and continuing to grow both in member numbers and in club activities.

At the 1998 Christmas Party and Homebrew competition, the club instigated the "Rex Black Memorial Trophy," in remembrance of service to the hobby by Rex. This year it was awarded to Kevin Purves VK2MNU, for his outstanding commitment as the club magazine Editor.

Over the coming year, the club will be involved in the following activities: -

- * Participation in the John Moyle Field Day Competition, 24 hour, open mode section, using the Club Callsign VK2HZ Portable.
- * Co-sponsoring of the NSW VHF DX Group VHF FM DX Competition, to be held on Sunday 18th April 1999 from 0200-0600Z.
- * Club Fox Hunts on Friday evenings, as well as daytime Fox Hunts, open to all comers.
- * Installation of the new 2m repeater transceiver, replacing the original radio that suffered a fatal attack of final transistor failure. The site will soon include a 70cm repeater.

The Club web page, which is getting better all the time, can be found at <http://www.mis.net.au/leatheam/bmarc>

On the page is information about the Club, a membership application form, Philips FM900 articles, repeater photographs and information, links to other sites, a Ham Radio search engine and much more.

The Club holds weekly nets on 80m (3.543 MHz LSB) on Tuesday evenings at 8:00pm local time and 2m (147.050+) on Wednesday evenings at 8.00pm local time.

**Send your club
news and events
to Club News**

The Shepparton and District Amateur Radio Club Annual Hamfest

Will be held on Sunday September 12th 1999 at the Shepparton Youth Club Hall behind the High Street Safeway complex as in 1998.

Tables approx 2 metres for hire at \$10 each. Doors open to sellers from 7am - buyers from 10am.

Booking and payment would be appreciated early as tables not occupied by 9am or not paid in advance will be reallocated.

C/O the Secretary
SDARC
PO Box 692
Shepparton 3630

HF NET Commences again

Well, daylight saving is over at last and that means that the

Moorabbin HF Monday Night Net returns to the airwaves.

The frequency will be 3.567 MHz commencing at 8pm (1000 UTC).

As usual the now very popular VHF net will still commence at 7.30pm (0930 UTC). So if you live in country Victoria or even interstate, you can now talk directly with the club on HF.

MDRC

BARCfest 1999

**The Brisbane Amateur Radio
Club BARCfest this year will
be held on**

Saturday May 8th,

at

**Kelvin Grove High School
Auditorium, Victoria Park
Road, Kelvin Grove.**

Opening at 9am.

**For early bookings ring
VK4KDP on 32884911 or
post to: - PO Box 3007 Darra
Qld.**

The WIA's Victorian Foxhunting Championships

The WIA's Victorian Foxhunting Championships will this year be held on

Saturday 8th May.

The location this year will be in the

Doveton area

The day will be split into an afternoon and evening session with dinner in between.

The events will get under way at 1pm so those who want to pick up a bargain at the Moorabbin hamvention can still do so.

The afternoon's events will include all the usual bands with the evening session starting at 8pm so those teams who only have 2m and 70cm gear can participate as well.

Supper and prizes will be around 10:30pm in the Dingley Village area.

For further details contact Mark Diggins on AH 03 9558 2959.

**If you have some club
news to share.**

**Or an event to publicise.
this is the place.**

The

CLUB NEWS

pages are your pages.

Send your information to

The Editor *Amateur Radio*

PO Box 2175

**CAULFIELD JUNCTION
VIC 3161**

email armag@hotkey.net.au

Fax (03) 9523 8191

MOORABBIN & DISTRICT RADIO CLUB INC

HAMFEST

The date for the Moorabbin Hamfest this year will be **Saturday May 8th, commencing at 10 am.** The venue is the **Brentwood Secondary College, Watsons Road, Glen Waverly.**

As in previous years there will be lots of second hand gear for sale as well new equipment of course.

Refreshments and snacks will be available during the day at reasonable prices.

There is something new for the event this year, a crystal set competition. Full details are shown further down.

So why not have a go at something different. Most of us have had a dabble at a crystal set at least sometime or another while exploring the world of radio.

If you are considering having a shack clearance, well, why not book a table.

Contact the coordinator Wally Hunt VK3JWH on (03) 9318 0197 or mobile 0419 356 263.

COMPETITION & CONTEST

Are you looking for something different to do, bored with the same old usual things to do, well have look at the rules for the Crystal Set competition for this years Hamfest or Radio on Rails, on Sunday April 11th.

Rules and information are shown below. You never know. You could be a winner.

INTERNET HOME PAGE

The club Internet home page is still developing and has recently had some changes made to it.

As well as the latest news about the club there is also many links to other sites with a very wide range of radio related topics.

So point your browser to mdrc.org.au Comments and suggestions on the content are always welcome and should be forwarded to Paul Girling VK3ALE by just clicking on the link provided.

PACKET GATEWAY CLUB CONTACT

Enquiries about the Moorabbin & district Radio Club Inc., can be forwarded to P O Box 58, Highett, 3190, or through the club home page on the Internet.

Denis Babore VK3BGS

Publicity Officer

MDRC Even Greater Crystal Set Competition — Rules

1. The competition will be held during the MDRC Hamfest on Saturday May 8 at the Brentwood Secondary College, Glen Waverley.
2. Entries must be submitted by 11am. The underside or rear of sets should be marked with the entrant's name and callsign. No entry fee is payable.
3. Entries that contain any active amplifying devices such as valves, transistors, ICs, etc or be connected to any external power source will not be eligible for certificates or prizes.
4. Entries should cover the AM broadcast band.
5. A basic aerial and earth system will be provided at the Hamfest site. The judges will use a small, fixed-gain audio amplifier with an input impedance of approximately 30 k ohms to assess the performance of each set. Either a locally generated modulated signal or local broadcast stations will be used by the judges for this test.
6. Certificates will be awarded for :
 - Best overall performance
 - Most authentic
 - Smallest
 - Most selective
 - Most novel
7. The Club may award small prizes to winning entrants.
8. Results will be announced on the day, at the next MDRC general meeting, in the APC Newsletter and in *Amateur Radio* magazine.

MDRC Radio on Rails Contest - Rules

Object: To make contact with operators on board trains and trams around Melbourne.

Date: Sunday, April 11

Time: 9am - 1pm

Band: FM voice segments of two metres only

Mode: FM

Sections:

- A. Transmitting Mobile (in train or tram, also includes waiting at railway stations or tram stops)
- B. Transmitting Home (includes operators at home or in a car)
- C. Listening Mobile (in train or tram, also includes waiting at railway stations or tram stops)
- D. Listening Home (includes listeners at home or in a car)

Contacts: Train or tram mobile stations may work (or hear) any station for points. Home station entrants may work (or hear) train or tram mobile stations only for points.

Repeat contacts: Repeat contacts are valid for scoring purposes provided at least one hour has elapsed between them.

Use of repeaters: Contacts on repeaters count for scoring purposes.

Exchange: Train or tram mobile stations give their nearest railway station, tram route number or tram stop location (if waiting). Home stations give their suburb. No serial numbers are required.

Eyeball contacts: Stations in Sections A and C may claim extra points for 'eyeball contacts', which is defined as one where participants can shake hands with one another on a train, tram, and railway station or tram stop. Pre-arrangement of eyeball contacts before the contest start time is not allowed. However, eyeball contacts may be arranged during the contest period on two metres FM only. Unlike with radio contacts, entrants cannot claim extra points for repeat eyeball contacts with the same person. Amateurs or SWLs not active in the contest cannot be claimed as eyeball contacts.

Scoring: Score 1 point per station worked (or heard). Total score is the number of stations worked (or heard) plus the number of valid eyeball contacts made.

Logs: Logs should show time, frequency, callsign and exchanges for each contact. Eyeball contacts should also be logged. Train or tram mobile entrants should staple their used Met ticket to their log. Where this is not practical (eg ticket remains current after the contest), a signed photocopy of the ticket will be accepted in lieu.

Logs should be posted to *Radio on Rails*, MDRC, PO Box 58, Highett, Vic. 3190. Logs should be received by 30th April 1999.

Certificates: These will be awarded to the first three placegetters in each section. Other entrants will receive participation certificates.

Results: Results will be announced in the MDRC's newsletter and AR magazine.

ar

NOVICE NOTES

Peter Parker VK3YE

12/8 Walnut Street, Carnegie, Vic 3163

Email: parkerp@alphalink.com.au

Novice Notes Online: <http://www.alphalink.com.au/~parkerp/nonline.htm>

Please note that this is Peter's correct address.

I think that I will never see an antenna hidden in a tree

Where it is not possible to erect stand-alone masts, trees are good ways of concealing and supporting antennas and masts.

Some people will tell you that an antenna in the clear is better than one surrounded by foliage. This may be true, but either antenna is better than none at all! The use of a tree can provide height that is impossible by other means.



Wire antenna through trees

The end-fed wire antenna shown in the picture is about 12 metres long. (Again – the wire has been drawn in.) It extends to the top of the tree and is almost perfectly vertical. Because the tree is not tall enough to support the full length, the top part of the wire is bent toward itself forming an acute angle at the top of the tree. A small pea-sized lead sinker is attached to the free end to keep the antenna wire taut. Choose green or black covered insulated wire to reduce visibility.

Though this antenna is shorter than the fence-mounted wire described above, its height makes it more effective on bands above 7 MHz than the longer antenna.

Trees can also be used to conceal antennas other than end-fed wires. For example, a fixed-position two-element quad with wire elements for six or ten metres can provide an effective gain antenna that does not attract attention. Alternatively, a single-element quad loop fed with open wire feed lines can cover several bands if you have an antenna-coupling unit.

Do fence me in

Though it may not be very apparent in the picture below, you are actually looking at a HF antenna that has been used on most HF bands between 15 and 160 metres.

The antenna consists of an end-fed wire 40 metres long as described in *Novice Notes* June 1998.

Most of the wire is threaded through the slats of a wooden fence approximately 1.6 metres tall. Thin enamelled copper wire was used. (It was so well hidden a black line has been drawn over it to show the location.)

The antenna's main advantage is its multiband capability. It is also unlikely to be noticed by neighbours, spouses or landlords.

Because of its low height, the antenna has poor low-angle radiation.

This makes the antenna quite effective for local operation (up to 1000 km) but poor for longer distances. Nevertheless, the author has worked Japan on 15 metres CW with two watts on this antenna, so DX is still possible if conditions are good.

Low profile amateur radio

Be on air without your neighbours knowing

Though antennas are things of great beauty to radio enthusiasts, people who are not interested in radio often think otherwise. However antennas are necessary for all types of on-air amateur activity.

Many amateurs live in dwellings where, for various reasons, it is important to keep a low profile. This may mean running only moderate power to reduce interference risks, refraining from erecting tall masts stacked with beams, and finding inconspicuous ways to bring antenna feed lines inside. Too many amateurs when faced with these difficulties either go off the air entirely or transmit only from their vehicle.

However, most of the problems mentioned above can be resolved. It is possible to enjoy amateur radio without neighbours or landlords knowing. And, given the current high sunspot activity and good HF radio conditions, now is the ideal time to establish your own low-profile amateur radio station.

This month we provide pictorial examples of low-visibility outdoor HF antenna systems and suggest ways that they can be concealed.

"Hidden" Long Wire

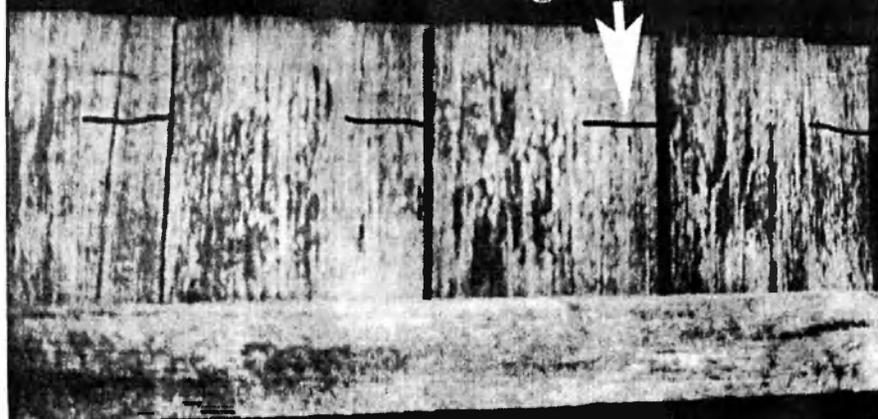

Wire antenna in fence (almost invisible)

The balcony scene brought to earth

Balcony rails can appear attractive as ground systems because of their sometimes-considerable length.

However, their use is fraught with dangers. The author's only attempt to use one was greeted by a barrage of carrier signals heard while tuning across eighty metres. These carriers were harmonics of local AM broadcast stations.

The harmonics originate not from the station transmitters themselves, but from bad connections in the riveted aluminium balcony rail. The metal oxide surfaces act like diodes causing harmonics to be generated.

Using such a rail as part of an earth system would be unwise - it would almost certainly generate TV interference (even though your transmitter is clean and you have a low pass filter) and blow the cover off your 'covert' transmitting activities.

If you do use a balcony rail (or other metal structure) as an earth, make sure connections are good before proceeding. If this is not possible, find an alternative earth for your antenna system.

The standard handbooks stress the importance of having a station earth with short and stout connections to the equipment. However, this is almost impossible to arrange for amateur shacks that are several storeys up. Alternatives include the use of the plumbing system (if there are copper pipes available) and radials a quarter wavelength long on the bands of interest.

Staking your claim to the earth

A typical earth stake consists of a copper jacketed steel earth rod, 12mm diameter and 1200mm long. Mine was only 600 mm long - an earlier attempt at driving a longer stake into the ground was not successful as it struck a rock and one did not wish to draw attention by continuing to hammer the stake any deeper. The stake must reach the damp underearth where a ground resistance of around an ohm is achievable.

Use a stainless steel clamp to attach the wire to the copper. Alternatively, if you have access to a large soldering iron or butane-powered torch, solder the connection instead. In some industrial installations the connections are brazed together or silver soldered.

Ideally one would use a thick conductor such as coaxial cable braid (leaving the outer jacket on) for the lead from the earth to the station. If appearances are a problem, other types of wire could be used.

In my installation, green and yellow insulated electrical earth wire was used to

make the earth system appear as part of the home electrical system.

The simple ground stake as described above will not be sufficient for good performance with some types of antennas. In such cases, connecting radials to the earth stake will dramatically improve performance. A small number of elevated radials is better than a larger number of buried radials. However, elevated radials are unsightly, and the experimenter may have to be satisfied with running a few radials along the surface of the ground.

A thin wire running along the ground can be almost invisible. This is especially the case if care is taken to choose the colour of the insulation to match the colour of the ground.

A single 10 metre long radial was run from the earth stake as an experiment on 40 metres. Improvements in the strength of the transmitted signal ranged from nothing to 3 to 4 s-points in some directions.

If the radial is run down the side of a building or laneway it can go unnoticed. Some types of coaxial cable look like plastic irrigation tubing, so it may be possible to run the radial beside a flowerbed without it attracting attention.

One major difficulty is getting the feed line in. Gaps under doors can be small, and windows (especially those fitted with fysicscreens) do not always offer a solution.

Some people get around the problem by drilling small holes near the comers of doors or windows. These can be filled in if you move out.

Open wire feeder is usually easier to get inside than coaxial cable, particularly if you do not have metal-framed windows.

In my installation a homemade open wire feed line was passed through an open front window. Security is not compromised as the window can still be closed and locked with the feed line in place. The use of white wire (rather than black) would have improved the visual appeal of the installation.

Open wire feed line is less lossy than coaxial cable. It also allows multiband operation with simple dipole and loop-type antennas if you have an antenna coupling unit.

The attempt to do the same with coaxial cable would lead to quite high losses as a result of the extreme impedance mismatches that would occur.

Conclusion

The above comments, have, I hope, given several ideas for the amateur wishing to establish a low-profile amateur station. With recent improvements to propagation conditions, there will never be a better time to set up a station than right now!

Kick Started Radio Operator

Bob Harper VK4KNH

PO Box 288 Beerwah 4519

Bobharper@bigpond.com

I WAS WORKING on an old valve BC radio today and received a tickle from one of the capacitors - the first one in a long time, and I got to thinking of some of the many occasions when this had happened in the past.

Most are not worth relating and I am sure that most of you have had similar experiences. But one story is worth at least one more airing. Especially as it didn't happen to me.

I made a friend, Peter, some time back. Peter is one of those guys that always has a story, due in part to his world wide travelling and in part to having been selected for a tour of Vietnam to use his technical skills.

At one time he was on a seismological survey vessel for an American company as one of their on-board techs and radio operators.

The story, as he told it, was that the main ship HF transmitter would occasionally go intermittent as a result of salt induced corrosion in the PA valve sockets.

The rig had a hinged cover panel that, when opened, would disconnect the three kilovolts from the finals for safety. The operators knew this and trusted it a little too much. They would open the door, wriggle the finals to make contact again and close the door. Operation usually returned to normal - for a time at least.

One time when this problem arose Peter, always his congenial self, volunteered to fix the problem so the duty operator didn't have to get up from his key position. Peter opened the door, grabbed the hot valve to wriggle it and it grabbed him.

Apparently the microswitch on the door failed to operate and Peter copped the 3kv up his left arm, across his chest and down his right arm to the offending door. Needless to say he went down fast and hit the floor hard.

Almost immediately a small crowd of ship's crew gathered around him but it was a small Chinese man, the ships cook, that administered the resuscitation by standing on Peters chest and kicking him with his heel.

Wherever the process was learned didn't matter for Peter was saved and lived to tell many other stories. But he always finishes this story with the comment that he believes that he is *the only Australian radio operator ever kick-started by a Chinese cook.*

I believe that he is still in Hong Kong but have lost contact with him. So if you hear a tall ginger haired guy nearing fifty, perhaps sporting a beard, telling this story somewhere, give him the address above and tell him to say g'day.

ar

ar



AN EXPANDING WORLD

Eric Jamieson VK5LP

PO Box 169 Meningie South Australia 5264
E-mail: vk5lp@ozemail.net.au Fax: (08) 8575 1777
Packet: VK5LP@VK5WI.#ADL.#SA.AUS.OC

All times are UTC

F2 indicators

With the emergence of increased F2 activity, the following stations are useful pointers to a rising MUF. Keep a copy by your transceiver.

- 35.574 Pager system believed to be from California
- 35.639 VOA harmonic believed to be from Hawaii
- 40.679 Local pager Australia wide FMn low power
- 40.695 Meteor Data Inc M/S burst system Alaska
- 40.749 Local pager Australia wide FMn low power
- 42.999 TEP Asia 43.649 Philippines M/S system 20 kW
- 43.579 Pager system believed to be from California
- 43.849 TEP Asia believed to be radio link system
- 47.749. 3 Asian or Middle East video unknown source
- 48.000-49.000 Asian radio telephone repeater
- 48.239 EU Asian and Middle East video
- 48.249 EU Asian and Middle East video
- 48.259 EU Asian and Middle East video
- 49.500 49.900 Asian cordless telephones
- 49.639 Alaskan DARN radar
- 49.739 EU Asian and Middle East video
- 49.749 EU Asian and Middle East video
- 49.7499 Khabarovsk Video outlet 67 kW
- 49.759 EU Asian and Middle East video
- 50.100 Worldwide CW DX only calling frequency
- 50.110 Worldwide SSB\CW DX only calling frequency
- 50.125 American Primary local calling frequency
- 50.200 Australian Primary local calling frequency
- 55.2498 - Pago Pago Alava American Samoa 67.5 kW NTSC
- 55.250+/- US, Mexico, Canada and NZ CH 2 video

Details courtesy of Neville VK2QF and the two Steves KL7FZ and VK3SIX.

Beacons

Rex VK8RH reports: *Returned from a trip to Thursday Island on the top of Cape York. Mike VK8ZMA is working there for a few months and we set up a beacon on 52.200 (carrier frequency listen on 52.199 USB) with the ident of VK8ZMA/b. Power is 5 watts and vertical antenna. Would appreciate any reports.*

Six metres

February was busy with activities which point towards the appearance of long distance contacts via F2 being around the corner. There is so much to report, repeating day after day, that it is impossible to give a blow-by-blow description of events.

Almost every day during February, signals were heard between 35 and 50 MHz from Asia, in a general area north of Australia. Signals have been prominent into VK4, VK2 and VK3 in particular, and to ZL. Steve VK3SIX supplies the bulk of reports, supported by information from ZL and the JA 50 MHz Cluster.

Loggings usually commence from around 2300 and extend through to 0300, although there have been days when the reception of signals continues through to 0700. Then there may be a lull of an hour or two after which the evening reception commences, and signals are heard to 1200 and beyond.

Other out-of-band signals are found between 55 and 60 MHz and usually comprise sound channels of various TV stations, from New Zealand, American Samoa and other places.

Then there are the multitude of TEP contacts between VK, ZL and JA, in addition to these, the JAs have the advantage of being able to work a number of other countries situated around them, including HL, VR2, V73, KH6, 9M2, P29, W and XE. Noted also is that as of 3/3 KH4/IV3NVN (Midway) was still being worked, mainly by JAs.

VK to VK and VK to ZL contacts have been common, plus the continuing availability of VK beacon signals, with VK8RAS/b at Alice Springs featuring prominently. From the VK5 viewpoint VK4BRG/b and VK4RGG/b are heard on a regular basis. It surprises me the number of contacts between ZL and JA, they appear

almost as easy to achieve as between VK and JA. In addition, ZL has reached the US and Mexico.

V73AT seems to be in a prime spot judging by the stations worked, with JA and KH6 high on the list.

So it is all looking very good for some exciting happenings during April. Nev VK2QF says: The 27 day rotation will see activity around the 8 to 14 March and the classic equinoxial period 28 March until the 15 April.

Following are a sample of the signals heard or worked in VK or ZL:

- 42.500 Los Angeles police FM
- 43.650 Burst transmitter, Philippines
- 43.850 FM radio telephone link
- 45.2500 ZL TV 46.261 VK2 TV video
- 49.7499 UA0 TV video
- 50.062 KH6HME/b 50.110 KH7R
- 50.110 V73AT
- 50.110 WA5LIG/6
- 50.125 NK7J SSB heard
- 50.750 ZL2 TV FM
- 55.2396 ZL1 TV video

Stations heard working JAs: VKs 1VP, 2BA, 2BUE, 2DN, 2FC, 2FHN, 2QF, 2YO, 3AMK, 3SIX, 4ABP, 4ABW, 4APG, 4BIT, 4BLK, 4BRG, 4DB, 4DMI, 4DUG, 4GPS, 4ID, 4JH, 4KHQ, 4KJL, 4KK, 4LR, 4PU, 4VV, 4WTN, 4YPM, 5BC, 5GN and others. ZLs 2AGI, 2TPY and 3TIC.

JA - all districts worked except JA5. (Strange, no JA5s). Many JA8s at 8000+ km. JAs into some part of VK almost every day during February and continuing into March.

- Other interesting contacts:
- 15/2: 0220 XE1/SM0KAK to LW5DX; XE2UZL/b, XE1KK and WA5LIG/6 into ZL. 15/2: 0230 VK3SIX to JA8QX SSB via F2, distance 9000+ km.
 - 15/2: 0335 JR2HCB to HL1 and HL5.
 - 17/2: 0623 JA1RJU to 9M2JKL 559.
 - 20/2: 0130 7J1AEJ/7 worked VK0YQS/9 Lord Howe Is.
 - 20/2: 0555 VK4KK to JOISKU (3 watts) 5x9+.
 - 20/2: 1137 V73AT to VR2XMT 5x7.
 - 20/2: 2305 ZL3NW heard XE2UZL/b, 2313 worked N6XQ SSB.
 - 21/1: 1142 JH0BQX to P29PL; 1251 JM1IGJ to P29KFS and P29PL.
 - 21/1: 0144 XE1/SM0KAK to LU9MA 5x7.
 - 27/2: 0046 XE1/SM0KAK to PY5CC 5x5, HC5X, also many LUs.

E-mail address change

Please note that my e-mail address is now changed to <vk5lp@lm.net.au>. This allows me to have local call access fees instead of STD charges.

02/3: VK2QF reports many US utilities between 35 and 42 MHz.
 03/3: 0200 VK2QF to HL5XF. (HL5XF reported LW4BHN* and PP5HOT).
 03/3: 0248 JR2HCB heard LW4HBN 5x5.
 03/3: 0400 49.751 Russian TV, weak to VK3SIX.
 08/3: 1506 4S7YSG to YC1EHR SSB.
 08/3: 1535 VR2ZGK to 4S7YSG SSB.
 08/3: 1600 9M2NK to VQ9DX CW heard.
 08/3: 1717 4S7YSG to A61AH SSB.
 08/3: 2130 P29KFS to BG7OH 5x9.
 08/3: 1200 P29KFS heard V63CV 5x6.

* Neville **VK2QF** advises the HL5XF/LW4BHN contact as being near antipodean, "which augers well for VK/ZLs to see some good propagation when it stretches sideways a bit!"

Also of note is the appearance of 4S7YSG from Sri Lanka. I think the last time a station appeared from there was in 1982! ... VK5LP.

Thanks to Waiwai Ham Life, Japan 50 MHz Cluster, VK3SIX, VK2QF and ZL3TIC for various excerpts from their news information. Also to the VK-VHF Reflector and Pacific Rim DX Reflector.

Peter **VK3KAI** reports that he worked Doug VK0YQS/9 Lord Howe Island 50.120 MHz at 1205-1230 on 1/3. Ralph VK3WRE joined in the contact, only running a vertical. Doug was peaking S9+20. *I could hear Doug (weak) working VK3XLD and VK3BRZ as the propagation shifted after 1230. Doug is expecting a VK9 call to be issued soon, and will be on LHI for two years.*

Ron **VK4BRG** reports that on 3/3 he worked at 0159 NH6YK Hawaii, 0240 KH4/IV3NVN Midway, who was working JAs at the time. 0507 V73AT. General JA openings most days.

From Wally **VK4DO** via **VK4ZZ**: On 6/3 between 0150-0230 XE2UZL beacon was heard by Wally VK4DO QG49 and Ron VK4BRG QG48 at S1-2 with medium QSB. Other signals identified at the same time were VK4KK and VK4ABW on backscatter. The beacon appeared again very weak on 7/3 from 0500-0510.

A hint of things to come ...

Information from **VK8MS** states that he worked a station signing A61AH on 7/3 at 1120. Believed located at Dubai in the United Arab Emirates in the Persian Gulf region. Name Almur and running an IC706 into dipole antenna. A second QSO at 1145 was better at 5x9 on 50.145.

Also, intelligence gathered shows we finally have the frequency of the Trade Centre high power CH3 outlet - it is 55.3205

MHz. Also strong into Darwin on 7/3 the South Asian offset on 48.2396 plus other strong signals. ... Steve VK3SIX.

Geminids Meteors

Adrian **VK2FZ/4** in Grid QG63kf sent details of his activities during the Geminids meteor showers on 12-13 December 1998. Although now somewhat dated it is still relevant information for future research purposes.

Adrian monitored the Geelong beacon VK3RGL on 144.530 MHz in QF22. The beacon runs 8 watts to a 7 (?) element yagi and is 1494 km distant. All dates and times UTC with any local dates and times in brackets.

My 1997 log reads - Geminids best 12/12/97 1500-1900 (13/12 0100-0500 EAST). Peak 1600-1700 but longer burns later 1830-1900.

For 1998 I began monitoring VK3RGL on 9/12 and noted quite a few 5 second bursts around 1830 (10/12 0430). I planned to be on over the weekend 11-12/12 between 1700-1900 (12-13/12 0300-0500) calling on 144.200 MHz SSB whenever a good burst occurred. I was on both mornings but longer bursts were few. I heard Ron VK3AFW work Glen VK4TZL between 1830-1900 with a couple of reasonable 5 second bursts around 1830-1835. I worked no one.

I was disappointed thinking that Sunday morning local was the peak. I did not plan to rise on 13/12 (Monday morning local) but was awakened by loud long (10 second) bursts around 1630 (0230). There were many good 5-10 second bursts between 1630-1700.

14/12 (Tuesday local) again awakened by loud bursts at 1630. Clocked VK3RGL/b from 1700 (0300) onwards. I called with no reply on each of the bursts listed. Many shorter bursts of about one second and pings not logged. 1724 (05/3) means at 1724 there was a 5 second burst of maximum signal strength S3.

1701(05/2), 1710(05/2), 1713(03/3), 1714(03/3), 1716(03/8), 1718(03/3), 1723(10/9), 1723(05/5), 1724(05/3), 1725(01/8), 1729(10/9), 1730 (10/3), 1733(03/3), 1735(10/3), 1736(15/9), 1736(10/7), 1737(05/3), 1737(05/9), 1738(05/3), 1738(10/9), 1744(01/3), 1747(03/3), 1750 (03/8), 1752(10/9), 1753(05/3), 1755(05/3), 1804(05/3), 1810(05/9), 1813(02/3), 1820(05/8), virtually nil until 1843 (05/5) Mount Gambier, 1930(07/7) Geelong, 1932(10/7) Geelong. All called with no result.

15/12/98: Wednesday morning local, bad QRN with thunderstorms - no serious clocking.

It is my view that the Geminids 1998 for

this Melbourne - Brisbane path peaked 13-14/12 between 1600 and 1800 (14-15/12 0200-0400 EAST). It is not surprising that no one is operating at these times! My thanks to the Geelong VHF Group for maintenance of a truly superb meteor scatter beacon.

I think the November Field Day is a great idea, and if it is scheduled as close as possible to the Leonids meteors, 16-17-18-19/11 even better, but please make the exchange required as short as possible - trying to swap a five digit serial number and a grid square is too much. How about a three digit number consisting of a signal report (RS) and a single digit (0-9) QSO number - start with 590 say and after 599 is reached revert to 590 again. Grid squares can be worked out later and need not be part of the exchange. Your thoughts please.

Grid Square Standings at 22/12/1998 by Guy VK2KU

144 MHz

VK2ZAB	Gordon	56
VK3CY	Des	45 (+3 EME)
VK2KU	Guy	42
VK3CAT	Tony	23
VK3BJM	Barry	17
VK6KZ	Wally	17
VK6KZ/p	Wally	16
VK2TZ	Dale	14

432 MHz

VK2ZAB	Gordon	30
VK3CY	Des	23
VK2KU	Guy	11
VK6KZ	Wally	10
VK3BJM	Barry	8
VK6KZ/p	Wally	8
VK2TZ	Dale	3

1296 MHz

VK2ZAB	Gordon	8
VK6KZ/p	Wally	5
VK6KZ	Wally	4
VK2KU	Guy	3
VK2TZ	Dale	1

Additional rule inadvertently omitted: Contacts made via active satellite or repeater, do not count. Cross-band contacts should not be counted either.

Additions, updates and requests for the guidelines to Guy VK2KU, guy@mpce.mq.edu.au, or by mail (QTHR 99).

Two metres and above

Rick **VK6XLR** Geraldton made contact with Bill VK6AS Esperance at 2356 1/3 on 144.120 MHz 5x5 both ways and up to 5x7. Distance 900 km over land.

Ron **VK3AFW** report: The poor tropo weather has made DX very rare on two metres and above and no Es opening to VK4 has occurred this year, so that's probably one reason why there's not a lot of reports about.

I continue to work Andrew VK7XR on

144.080 MHz in the mornings on CW, although now I am restricted to 30 watts we don't make it two-ways all the time. I also work Ian VK1BG via aircraft enhancement most Sunday mornings on 144.250 MHz. On 20/2 I managed a QSO on 144.200 MHz with Chris VK1DO, using CW from here.

Des VK3CY at Wedderburn, is progressing with a 4 bay EME array. On 28/2 he worked W5UN on 144.028 MHz using one yagi only.

Russell VK3ZQB writes: *Conditions have been very poor. The only glimmer of hope was a brief 5x5 opening to VK6AS on 11/2 at 1327. Just prior to that contact Col VK5DK worked VK6KDC 5x5. I could not hear VK6KDC.*

On 12/2 I worked Bill VK6AS again with 5x9 signals. Nothing further west was heard and the opening may have been associated with a front that was moving through.

On the 22/2 there was a super refractive duct existing between Mount Gambier and Port Fairy. Col VK5DK heard me on 144 and 1296 at 5x9+. I turned my 1296 antenna toward Melbourne to see what Allan VK3XPDs beacon was like, and Col could hear me 5x9 on 1296 off the back of my yagi. I had a contact with Allan on 1296 5x5 but the duct was not as good as toward the west.

Col set up his 10 GHz gear outside his shack door and I did the same. We did not expect to make a contact as both stations were looking into trees and houses. Surprisingly, Col heard my signal at 5x3 when pointing toward me and 5x5 when he pointed south and received a reflection from the Mount, an indication of the strength of the duct.

Wally VK6KZ reports: *During the National VHF/UHF Field Day on 9/1, Terry Grammer VK6TRG operated portable on all bands to 5760 MHz, Alan Woods VK6ZWZ/p worked from 50 to 5760 MHz except for 3456 MHz, Bruce Douglas VK6BMD/p 50 to 2403 MHz, Al Edgar VK6ZAY from 50 to 1296 MHz from home and then went portable on 10 GHz and Wally Howse VK6KZ/p worked on all bands from 50 to 10368 MHz. Four locators were activated by the latter.*

At 2157 on 15/1 phones ran hot with Daryl Church VK6KDC in Manjimup alerting Bob Blinco VK6KRC in Perth who then rang Don Graham VK6HK who rang Wally Howse VK6KZ who rang ... and so on. All this was for an opening to Mount Gambier on 144, 432 and 1296 MHz. Worked from Perth on 144 and 432 were Col Hutchesson VK5DK and Trevor Niven VK5NC in Mount Gambier. John Drew VK5DJ, Phil Helbig VK5AKK and Roger Bowman VK5NY were worked on 144 MHz. 1296 MHz was a little frustrating with Cec Andrews VK6AO being heard by Col VK5DK, and VK5NC being heard by Cec and by VK6KZ but no two-way

contacts made.

VK3VSW in Colac was heard by VK6KZ via the VK6RMS repeater and then direct on 146.325 MHz at 4x1 but no contact was made. Lee VK6AL in Perth did work VK3VSW.

Next morning at 2250 VK6KZ worked Max Pickering VK3TMP and VK5DK on 144 MHz. Others in Perth alerted by phone had no success.

From 18-21/1, Wally VK6KZ operated portable from Torbay. For the first time in 20 years his prognosis of good conditions failed and no signals were heard from the east across the Bight despite a promising high in the Bight. Upper level disturbances were blamed for the poor conditions. The only plus from the trip was working Don VK6HK on 144 MHz from three locators new to Don including the rare OF94. Certainly the long east-west path has been most frustrating this year.

Bill Hockley VK6AS reappeared on 144 MHz with his new 8 bays of 10 metre boom long yagis on 14/2 and daily contacts continue.

A welcome addition to the early morning skeds on 144 MHz SSB is Rick Kowalewski VK6XLR who has moved from Exmouth to Geraldton. On 28/2 Rick was 5x9+ on 144 and 5x7 on 50 MHz (tropo) in Perth when he worked VK6KZ at 0945. The following (WA) morning at 2200 a number of contacts were made among David Lloyd VK6AOM at Buntine, Bill VK6AS in Esperance, Wally VK6WG in Albany, Rick VK6XLR in Geraldton, Wally VK6KZ, Glen Hufner VK6IQ, Cec VK6AO and Don VK6HK.

On 1/3 at 2350 Rick VK6XLR worked Bill VK6AS over a 888 km land path on 144 MHz. The next morning at about the same time Wally VK6WG worked Rick VK6XLR over a land path again, of 757 km.

Al VK6ZAY has had his first contact on 24 GHz SSB with Wally VK6KZ over a 1000 wavelength path with time preventing a longer distance trial. Al designed his own circuitry constructs of all the necessary PCBs with stick-on copper tape on to the teflon board. His design is ingenious with a double conversion system on transmit and receive.

Starting with an IC202 on 144 MHz he generates SSB at about 3 GHz and this 3.3 GHz SSB is then mixed again with a further multiple of the oscillator chain at about 21 GHz to produce the 24 GHz signal. A MGF1302 is used as an active mixer and provided the output for the tests (1000 wavelengths = approx 10 metres). A separate MGF1302 mixer is used on receive. An SMA relay is used to switch the antenna. The actual feed is a shepherd's crook-shaped-waveguide (made from a corrugated wall tube - formerly a water pipe!) with an open end into a 600 mm dish.

Provision has been made for amplifiers for both transmit and receive.

Alan VK3XPD says that there has been nothing heard from the west since early January when (among other things) he had his first 23 cm contact to Wally Green VK6WG. The present weather pattern continuing, gives little prospect for any improvement for now.

It seems strange that ...

Adrian VK2FZ/4 from Maleny asks that amateurs be alerted to a set of circumstances which have occurred near his location, about which he has written to the Queensland Technical Advisory Council.

It seems that a few months ago Adrian began receiving severe interference on the International EME Frequency Segment of the 432 MHz band, 432.000-432.100 MHz, in fact, the interference continues at least to 434.000 MHz.

Seemingly the interference emanates from an ATV repeater; output frequency 426.250 MHz (video) and 431.750 MHz (sound). At present it has output 24 hours a day and has ruined all Adrian's operation on 432 MHz.

His concerns are:

1. Why is a repeater transmitting continually? One would expect it to transmit when triggered and have time-out control.

2. The Band Plan recommends that 426 MHz be the repeater input, not output as is now the case.

3. He finds the operation of the repeater particularly objectionable as it is a case of amateurs interfering with amateurs on a continuing basis and not in accordance with the spirit of the Amateur Code.

This is in these notes as a warning to others who may find themselves being led into a similar situation. But I query why 426 MHz is being used as the output frequency.

Closure

By the time you read these columns, you will be noting whether this equinox is living up to the various projections that it should produce six metre F2 contacts over long distances, or whether frustrations will set in with reception of signals in the 35 to 45 MHz area and not far beyond.

Those working the higher bands will have observed any enhanced conditions on the east-west path, which has been poor this year. It seems good conditions were confined to the east coast, with particular emphasis on the range of conditions presented to Gordon VK2ZAB in his palace at Berowra Heights.

Closing with two thoughts for the month:

1. People who give up smoking usually substitute something for it - like bragging.

2. The best safety device in a car is a rear-vision mirror with a policeman in it.

73 from The Voice by the Lake.

ar

AMSAT AUSTRALIA

Bill Magnusson VK3JT
RMB 1627 Milawa Vic. 3678
Email: vk3jt@amsat.org

National co-ordinator:

Graham Ratcliff VK5AGR
Email: vk5agr@amsat.org

AMSAT Australia net:

The AMSAT-Australia net is held on 80 or 40 meters LSB each Sunday evening. During daylight saving time in South Australia the net is on 7068 kHz +/- QRM with an official start time of 0900utc (with early check-ins at 0845utc), during the rest of the year the net is on 3685 kHz +/- QRM with an official start time 1000utc (with early check-ins at 0945utc).

AMSAT Australia newsletter and software service:

The newsletter is published monthly by Graham VK5AGR. Subscription is \$30 for Australia, \$35 for New Zealand and \$40 for other countries by AIRMAIL. It is payable to AMSAT Australia addressed as follows:

AMSAT Australia
GPO Box 2141
Adelaide SA 5001

Keplerian Elements.

Current keps are available from the Internet by accessing the AMSAT FTP site, ftp.amsat.org and following the sub-directories to "KEPS".

Status of the new batch of Amateur Radio Satellites

There has been somewhat of a flurry of activity in satellite launches recently. Unfortunately they have not all met with complete success.

Here is a summary of the situation at the time of writing.

PanSat PO-34 (USA).

This satellite is still in commissioning and it is expected to be another couple of months before it will be opened for general use.

It was developed by the Naval Postgraduate School and its spread-spectrum digital transponders will be available to amateur radio operators in the near future along with software to utilise this technology. Its command station is in Monterey, California.

SunSat SO-35 (South Africa)

This new satellite is scheduled for release for general use about the time you will read this. SunSat was launched February 23, 1999.

continues next page

Out of this world use for Velcro

It was reported by ARRL recently that the first set of amateur radio equipment to be "installed" on the International Space Station would be held in place with, of all things, Velcro.

Industrial strength Velcro has long been used for keeping tools and small pieces of equipment in place in the zero gravity environment of MIR and the Space Shuttle. It is planned to eventually install the amateur radio gear in a large rack in the crew's recreation module.

TMSAT-1 TO-31 (Thailand and University of Surrey)

This satellite is working very well. The downlink signal on 436.925 MHz 9600 baud FSK is proving to be very popular among the digital imagery fraternity.

TO-31's earth pointing cameras have been capturing some spectacular pictures. The raw images rival the NOAAs for clarity. The resolution is such that each full image is almost a megabyte long and can take some time to download.

Thumbnail images accompany the main image files so the quality of the main image can be assessed before downloading.

The uplink on 145.925 MHz is switched off at present.

Eventually it is hoped to switch on the alternative 38k4 baud downlink to allow much faster downloading of large image files. A new version of ProcMail (V2.00G) has been released by G7UPN. This software permits the processing of the very large image files from TO-31.

TechSat-1B GO-32 (Israel).

Downlink 435.325 MHz.

Its HDLC telemetry is framed so a TNC in KISS mode can be used for decoding.

The TechSat-1B micro-satellite was successfully launched from the Russian Baikonur Cosmodrome on July 10, 1998. It does not have a continuous beacon.

It transmits a 3-second, 9600-baud burst every 30 seconds. The satellite is still undergoing commissioning.

KO-23 Situation

I was a bit premature a few months ago with my hope that KO-23 would give us good operating conditions over the holiday period. Murphy struck with a partial battery failure. The satellite had still not been returned to service at the time of writing. Monitoring over the past week or two has revealed that KO-23 is sometimes transmitting an unmodulated carrier. The signal strength is below normal but strong enough to detect data if it was present. KO-23's shut down has meant that KO-25 and to some extent UO-22 have carried more than the usual amount of digital traffic over the last few months.

The last data from KO-23 received at this station was on January 17 1999.

SSTV on MIR

I've never been involved in the SSTV scene so I do not have any decoders for the signal being broadcast from MIR on weekends. I have listened however and the signal is strong and appears to be well modulated with no discernible noise.

Good signals like that should mean good pictures. I have viewed the pictures on the Internet and also those uploaded to the digital birds and they are mostly very good quality. I wonder is anyone in VK actively downloading the pictures. They are in Robot 36 format and I'm told that the JVfax SSTV package will not handle them.

SedSat-1 SO-33.

Downlink 437.910 MHz FM 9600 Baud FSK.

This satellite suffered problems with the command receivers right from the start. It is not currently available for uplink transmissions and recovery efforts have not been successful.

SedSat-1, signifying Students for the Exploration and Development of Space Satellite number one, was successfully launched and placed in orbit on October 24 1998.

SedSat-1 was also designed as an imaging satellite but much of the equipment has not been activated due to telecommand problems.

SPOTLIGHT ON SWING

by Robin L. Harwood VK7RH

5 Helen Street, Newstead Tasmania 7250

(03) 6344 2324

E-mail: robroy@tassie.net.au

Well, Time is really flying so quickly with a quarter of the second last year of the 20th Century already gone.

So far, we have seen the demise of Morse code together with the closure of some HF maritime communications stations throughout the World.

The BBC World Service has announced that they have closed some language sections, as they are no longer viable.

One of these was German, which first started in 1938 just prior to the Second World War. After 61 years, it was decided not to broadcast either in German or Czech any longer.

Other language services were cut back including Russian. I also believe some Asian languages were either axed or reduced. These changes took effect on the 28th of March.

The BBC World Service also decided to introduce two streams of English programming, with a news and current affairs stream over short wave and other programming being fed either through local FM affiliates or via the Internet in Audio formats.

I believe as well that the BBC is going to try and have the World Service available on FM in major capital cities and regions throughout the Globe via local affiliates. Of course, programming will be increasingly commercially oriented and global.

I personally think that the BBC World Service has gone downhill. It no longer has the character or authority it previously had when it was the Voice of the United Kingdom.

Radio Australia recently increased the hours of its Indonesian service. Matt Francis in Canberra informed me that Radio Australia as from Monday March 8th introduced an afternoon service, with a new half-hour broadcast at 0800-0830 (1500 local time in Indonesia) on 17,750 and 15,415.

It will provide news updates and information additional to the existing 2130-0000 morning broadcast (on 11,695 and 15,415). All broadcasts are from the 100 kW transmitters in Shepparton, Victoria.

The additional service will be available on Radio Australia's Indonesian Language web site that includes news bulletins in text and audio as well as information programs.

RA says its strategy of rebroadcasting some programs via local FM stations in cities is proving successful.

Of course, there has been recent turmoil within Indonesia leading up to the presidential elections in June. Also the former Portuguese colony, of East Timor may be leaving Indonesia. With recent clashes on Ambon and at Aceh, the need for updated Indonesian news bulletins is paramount.

Matthew also informed me through the Electronic DX Post (EDXP #116) that American religious broadcaster KTWR which is located on Guam will introduce a new service in Tok Pisin ('Pidgin') for Papua. This is the lingua franca of Papua-Nuigini and some nearby Pacific Island nations.

It commenced from the 29th March and will only be weekdays from 0930-1000

UTC on 15330 kHz. This will make KTWR only the second international broadcaster to use this language (in addition to Radio Australia).

Incidentally Radio Budapest is no longer using 25,700 kHz to Australia. This leaves the 11 metre broadcasting allocation surprisingly without any regular stations. Hungary is now using 21560 and 21745 to Australia, in Hungarian at 1000-1100 UTC (1100-1200 Sundays). I well remember hearing a powerful BBC signal on 25650 kHz in the early seventies. I think they were aiming for Africa.

The only other consistent signal was the French yet they too have dropped using it. I think they were using it primarily as a feeder to Francophone nations in Africa as well as broadcasting to remote French islands in the Atlantic and Indian Oceans.

Surprisingly there are some broadcast signals on both 25 and 26 MHz. These are on narrow band FM and are feeders for American radio and television stations.

These are for the benefit of remote OB's such as aerial traffic reports or live news feeds or broadcasts. They are low powered and over 40 stations are currently active.

One I have heard often is in Florida on 25950 kHz with a sports format. They are best observed here around 2230 hours which is in our local morning and when it is Sunset there in Florida. These feeders are licensed by the FCC and are classed as utility stations.

Iceland is another difficult catch. They have short broadcasts primarily for fishermen in the Atlantic Ocean. They use SSB.

The latest sked I have is on 13685 and 15575 kHz and from 1855-1930 on 5055 7735 9725 kHz, 1410-1440 & 1935-2010 on 11402 and 13860 kHz or from 2300-2335 on 9275 and 11402 kHz.

The choice of frequencies well out of the normal broadcasting allocations makes it easier to hear Iceland.

Well that is all for April. Until next time the best of 73,

ar

AMSAT continued

SunSat stands for Stellenbosch University Satellite and takes its name from the South African University whose students constructed the payload.

The SunSat package includes 1200 and 9600 baud digital store-and-forward capability and a voice 'parrot' repeater system that will be used primarily for educational demonstrations.

The satellite has two VHF and two UHF transmit-receive systems. As I write this column news broadcasts indicate that the commissioning of this new bird is going very well.

Close-but-no-cigar

APRSat nearly made it to launch but was scuttled at the last minute by a paper work hitch.

It was to go into a geo-stationary transfer orbit along with a test mass on a new launch system.

Its orbit would have been highly elliptical around the equator, much like the ill-fated Arsenne satellite of some years ago but with a much lower perigee.

It may still get into orbit if a suitable launch can be organised.

On the Horizon

VOXSAT-1 will not be a free flying satellite like most of the OSCARs.

It will reside as an instrument package within a large Russian satellite in the manner of AO-21 and many of the RS series.

It will have a cross band FM repeater and other goodies aimed at the modest amateur station.

It is scheduled for launch "sometime in 1999" so stay tuned for more information as it comes to hand.

ar



Divisional News

Forward Bias

VK1 Notes

Peter Kloppenburg VK1CPK

This issue of AR contains a combination of March and April commentary for the Canberra members.

A room full of trash and treasures for the radio amateur is a sight to behold. So it was on the twenty-fifth of January when the VK1 Division held its first of the regular T&T sales of the year.

As was to be expected, there were many amateurs with interesting gear for sale. I saw boxes full of resistors, big and small. There were all types of capacitors, fixed and variable, transistors, and ultra miniature valves of the microwave type, many types of multiple connectors and coaxial cables, including Heliax.

Then there were the transceivers for VHF and UHF and even a splendid looking HF Collins KWM-2A with Power supply.

Committee members were well represented. They answered questions, and had yarns with hams and buyers alike. The QSL manager handed out cards, and the membership officer was busy signing up new members of the Division. Speaking of QSL cards, the management of the VK1 Division QSL bureau has now been split into two. Mike VK1MJ now handles only outgoing QSLs and Tex VK1TX handles the incoming.

Mike says that in the near future - before the February general meeting - a large shipment of QSLs will be sent away. Mike has also decided to relinquish his position as Federal Councillor. He wants to concentrate more on the technical aspects of amateur radio, rather than the administrative ones. The new Federal Councillor is Glenn Dunstan VK1XX. We wish Glenn good luck and thank him for his preparedness to take up the position.

Gilbert Hughes reports that work at the site of Mt Ginini is progressing well. After the framework for the antenna mast foundation was prepared, concrete was poured. Mounting bolts for the antenna base are in situ and as soon as the concrete has set, the first 6 metres of mast will be mounted on the base. In the meantime, work

has started assembling the antennas, stays, and other bits and pieces.

From the US comes word that the Federal Communications Commission (FCC) has issued an Experimental Radio Service licence to the ARRL to permit two-way tests in the vicinity of 5 MHz, the most likely site of the next amateur HF band. The licence, bearing the callsign WA2XSY, was issued January 8. A group of 15 current amateurs in various parts of the US and the Caribbean will conduct experimental, two-way RTTY and SSB transmissions within the band 5.100 to 5.450 MHz. To avoid interfering with existing services, the participants will confine their operations to the least-populated 50-kHz segment. The licence is good for two years, and allows up to 200 Watts ERP.

The Annual General Meeting was held on February 22nd 1999 at the Griffin Civic Centre. After the various reports for 1998 had been delivered, the 1998 committee stood down. The returning Officer, John Woolner, then took the chair and proceeded with the election of office bearers for 1999. The following officers were elected: Gilbert Hughes VK1GH - President; John Woolner VK1ET - Secretary; Leslie Davey VK1LD - Treasurer; Simon Trotter VK1AUS - WICEN liaison; Peter Kloppenburg VK1CPK - 'Forward Bias' writer. Other committee members elected were Philip Longworth VK1ZPL - technical support; Tex Ihasz VK1TX - joint QSL manager. The support group includes: Hugh Blemings VK1YYZ - Membership Officer; Mike Jenkins VK1MJ - joint QSL manager; Glenn Dunstan VK1XX - Federal Councillor.

FLASH:

A new 6 metre FM repeater has been activated in Goulburn. Its callsign is VK2RGN. The repeater's receive frequency is 52.7 MHz and its transmit frequency is 53.7 MHz. My guess is that the repeater should be operable from the Canberra region, although I have not been able to activate it myself from Kambah. The new divisional committee is concerning itself at present with coming to grips with actions, issues, and decisions that were

made and started by previous committees. Progress is being made about the state of affairs of the theory and Morse classes, assets that were acquired over the last two years, and locating and putting into operation the 40 ft mobile mast for VHF use for WICEN and other remote operations. Other enquiries are on going in regard to the division's commitments made by it in the past. The mailout that was started on the first of March already has had some limited success. Five new members have signed up and the Federal Office of the WIA is currently processing their applications. Our new Federal Councillor, Glenn Dunstan, will be attending the Federal Conference on 1-2 May 1999. The VK1 Division organises two meetings every month. The divisional committee meets on the second Monday of the month at one of the member's homes. The general meetings are held on the fourth Monday of the month. The next general meeting will be on the 26th of April in room 1, Griffin Civic Centre, Canberra City.

Flash-flash:

Committee member Simon Trotter VK1AUS has got himself a job in Queensland. He resigned at the last committee meeting. Philip Longworth VK1ZPL has taken over his position as WICEN liaison and coordinator.

pkloppen@dynamite.com.au

VK2 NOTES

Eric Fossey VK2EFY

The main activity over the past few weeks has been preparation for the Annual General Meeting at Amateur Radio House on Saturday 17 April 1999.

A fair amount of work and co-ordination is involved. A full financial and stock audit has to be conducted together with auditors reports, plus the collation and printing of the Annual Report and the necessary voting documents for the Election of Councillors and Motions on Notice. All this activity has to be co-ordinated to ensure that everything is in readiness for posting to members in accordance with our Articles of Association (Constitution).

By the time you read this you will have received all the necessary documents and, hopefully, will have voted where necessary.

One important reminder! If you cannot attend the AGM personally - please ensure that you have given your Proxy to someone who will attend and **make sure that your Proxy is directed as to how you wish to vote by recording your YES/NO on the back of the form.**

If you wish your proxy to use his/her

judgement on your behalf you may leave the reverse of the form blank.

The New Member Prize will be drawn and, if the winner is in the audience, will be presented at the Annual General Meeting. So, all you new members, come along and take part in the Annual General Meeting of YOUR organisation. Meet the Council for a chat over a cup of coffee or a cool drink. These are the people who will be working for you during the next year and it is important that you should be aware of their views etc just as much as they should be aware of yours.

The NSW VHF-DX Group, in association with the Blue Mountains ARC will hold a new FM Contest on Sunday 18 April 1999 (the day after the AGM) between the hours of 1200 -1600 hrs EST (0200 - 0600Z) on VHF and UHF Simplex.

Briefly the rules are as follows - but for full information interested members should log-on to either the Blue Mountains ARC Web page (www.mis.net.au/leatheam/bmarc/) direct or via the link provided, for your convenience, on the WIA VK2 Web Page.

The contest is limited to FM telephony mode in the following frequencies: -

146.000-148.000MHz: 433.000 - 435.000MHz & 438.000 - 440.000MHz.

Recognised simplex channels must be used for all contacts.

National voice calling frequencies may be used for contest exchanges, but no station may participate in more than 2 consecutive contest exchanges on a single channel, except after a delay of at least 1 minute to allow other stations to use the channel.

Entry is in one of 2 sections:

Section 1 - Novice or Novice Limited (All members of this group must hold Novice Licence)

Section 2 - All other operators.

Power is limited to 50 watts, or the normal maximum output of the equipment in use if greater than 50 watts. Separate power amplifiers with a rated output greater than 50 watts may not be used.

Scoring is 1 point for each contact with multipliers of - 2 if distance exceeds 50kms, 3 if exceeding 100kms, 4 if exceeding 150kms and 5 if exceeding 200 kms. The contest is divided into 2 parts 0200 - 0400Z and 0400 - 0600Z - contestants may work stations on both 2m & 70cm once in each two-hour period for scoring points.

Interested operators (VK2 stations operating within NSW only) are urged to read the full rules on the Internet, or the copy of sent by the office to all Affiliated Clubs.

Bye for now,

Eric Fossey VK2EFY
Division Secretary.

VK3 Notes —

By Jim Linton VK3PC

WIA Victoria AGM

A formal notice of the annual general meeting to be held on Wednesday, May 26th will be sent to members. The notice will also include annual reports.

The venue will be the same as previous years - the St Michael's hall, corner of Victory Boulevard and High Street, Ashburton.

Come along and meet with the WIA Victoria councillors and your fellow members, and after the formal corporate business of the night is conducted, and presentations made, enjoy the social gathering afterwards.

ACA gets tough

Spectrum anarchy has reared its head again - this time with persistent illegal activity on the HF channels used by Royal Flying Doctor Service (RFDS) and Australian National Four Wheel Drive Radio Network.

The ACA has advised WIA Victoria that it believes converted amateur radio transceivers are being used on these frequencies.

Sources say that among the first offenders in a crack down will be a number of radio amateurs who have been identified initially by their voice and operating styles.

They are receiving either a knock on the door by a radio inspector who has the power to seize equipment, or a Regulatory Infringement Warning in the mail.

WIA Victoria Education

A new "EDUCATION ON-LINE" section has been added to the WIA Victoria web site. It has been initiated in response to difficulties being faced by prospective radio amateurs studying to sit the regulations exam.

WIA Victoria believes that the syllabus information available so far for candidates and class instructors has not been particularly user friendly.

The regulations have also changed enormously in recent years resulting in a complete revision of examination papers.

The new WIA Victoria EDUCATION ON-LINE presents some essential information in an easy to use format, plus a trial regulations exam.

Events in Victoria

The Midland Amateur Radio Club 1999 Convention will be on Sunday, 11 April at the Eaglehawk Town Hall. Doors open to the public at 10am. For more information contact Doug Fairbairn VK3DJY 03 5442 4450 or Alan Williams VK3TTY 03 5443 4750.

The Moorabbin and District Amateur Radio Club Hamfest is Saturday, May 8 at the Brentwood Secondary College, Glen

Waverley. The club is also celebrating the 50th anniversary this year of its formation.

And in Spring the Shepparton and District Amateur Radio Club Hamfest is Sunday September 12 at the Shepparton Youth Club Hall behind the High Street Safeway complex

VK4 Notes

Qnews

Alistair Elrick VK4FTL

WIAQ President

Col Gladstone VK4ACG reports on the WIAQ - ACA Liaison meeting held recently in Brisbane. The first item of note is that the ACA phone numbers in the Brisbane office will change from the start of business on the 22 March the main switchboard number will be PH 3247 7111 - FAX 3247 7100.

Items on the agenda included, pirated 40-metre calls, ABA TV Channel 35 "drophrough", advertising on Amateur Radio and delayed renewal notices.

There have been some complaints from members that they had not received their licence renewals until a few days before they were due.

This has been caused by the delay in signing the changes in fee structure where the changes for the New Year are normally announced on the 1st December each year. The latest date for implementation of the new structure is the 22 March. Late in April there will be a change in the way you can pay your licence, when there will be a locked bag system where you will be able to pay at a bank. Later in the year it is proposed that it will be possible to pay with the B-pay system.

There were reports of some Amateurs receiving a large number of QSL cards for contacts they have not made. Obviously someone else has been using his or her callsign. If you have had a similar problem let us know so that we can take it up with the ACA. They also had complaints that some people have been using Flying Doctor and other land mobile frequencies and are anxious to catch the pirates.

Advertising on Amateur Radio has at last received a decision on its legality and the ACA has given it the thumbs down, this applies to all forms of transmission including Packet.

Ron VK4BRG has been making investigations re DGPS in Australia.

The Australian Maritime Safety Authority (AMSA) has a series of web pages describing their system in the 285 to 325 kHz band.

Essentially, this system seems compatible with the US Coast Guard system that is

better known, and easily found, on the WWW. The big advantage of this system, which will no doubt appeal, is that it is free to users. Also, its 10-metre accuracy plus its early "warnings" of outages.

The complete Barrier Reef is covered by 4 stations with more projected. Also covered, by a single station each, are the areas around Sydney, Melbourne and Karratha (WA). A map showing the coverage is on their web page, but as to be expected, due to the 300 kHz frequency used, is not very extensive.

Jim Rixby, bix@san.rr.com describes a DGPS receiver he built. VK4BRG is, more or less, following Jim's design. The receiver, outputs data in SC104 data format that is fed to a "differential ready" GPS (which, I think, most modern GPS's are).

Ron, VK4BRG.

We thank Ken VK4KD Editor of the Gold Coasts newsletter for advising QNEWS of SUNFEST the Ham Radio Day put on each 2 years by the SUNSHINE COAST CLUB. Nambour Showgrounds venue again, but a little earlier this year, August 28.

For all those travelling to the area later in the year, this is reported from the Far North about the FNNQARGG! A reminder that this years Far North and North Queensland Amateur Radio Get Together will be held at Beachcomber Coconut Village, South Mission Beach, from Friday afternoon 11th to Monday 14th June 1999.

Also, the North Queensland Amateur Radio Convention. Planning has started on this year's convention. Stay tuned for further info!

Members of the Australian Ladies Amateur Radio Association are looking forward to the ALARAMEET held, this time around, in Brisbane. Bev VK4NBC has been keeping their members informed and says it's coming together quite nicely and it looks like they'll all have a very good time. This usually turns into an international ham meet of some note, already this year Flo KU7F looks like attending.

Why not "pop up" on the ALARA NET Monday nights, 3.580 MHz 1000UTC.

Bev, VK4NBC again is the coordinator for ALARAMEET 1999 in Brisbane this September and for further info Bev's phone number is 3359 0109, also on e-mail to vk4bgc@bigpond.com.

Qnews broadcasts can be listened to or copied from a number of sources. On the Internet in RealAudio and text, <http://www.wiaq.powerup.com.au> and the news in text is in 3 pages, Current week, Previous Month and Two months ago.

RF transmissions across the Country on

your favourite repeater, call in and check availability, eg Townsville and Perth have several news broadcasts. On MW 2300hrs Saturdays (9am Sunday Aest) 1.825. On HF 2300hrs Saturdays (9am Sunday Aest) 3.605, 7.118, 10.135, 14.341.9, 21.175, 28.400, all SSB and 29.66FM. A rebroadcast is conducted Mondays 7:30pm Aest 3.605 and the Deja vu edition, that is news originally aired 1 week previously is retransmitted Sunday evenings at 1/4 to 7 on 3605 and Brisbane's 147.000 MHz repeater.

Societies and Club newsletter Editors can obtain an e-mail feed prior to the actual broadcast date, e-mail qnews@powerup.com.au

Cheers, Alistair VK4FTL

VK5 Notes

Ian Hunt VK5QX

VK5 Divisional President

IT'S APRIL AGAIN

The significance of this "headline" is twofold. It is the month when we normally hold the Divisional Annual General Meeting (AGM) and also, in accordance with the requirements of the constitution, marks the end of my two-year term as President of the VK5 Division.

I look back on this period with mixed feelings. I would like to have seen more general activity within the Division as well as a larger increase in membership.

Whilst some achievements may not be particularly of note, I do feel that your Council has demonstrated very clearly the principle of consultation and consensus where it comes to members having a say in the running of an organisation.

This principle applies as the basis of action in many areas of our community ranging from Federal Government down to small local clubs and societies and is a time proven method of operation sometimes being seen as "democracy" in action.

The AGM will be held at the Burley Griffin Building on Tuesday 27 April commencing at 7.30pm.

At this meeting it is necessary that we advise of arrangements for the forthcoming year. We will also be in a position to consider the contents of the amended version of the proposed new constitution and, if approved by the members, be able to proceed with motions to allow it to be adopted for future use.

It is thus very important that as many members as possible attend this most

important meeting.

With my "release" from the position of President I will be continuing on Council for another 12 months as "immediate Past President". This proviso of the constitution is intended to ensure some form of continuity. I will also be able to continue to take an interest in the wellbeing of our Division and provide some help to whoever is selected as the incoming President and members of Council.

For the last 2 years, indicated above, I have provided the monthly notes for "Amateur Radio" magazine.

I hope that these have been of interest to you and that I have been able to convey somewhat of the activities of the Division as well as provide an inkling of various ideas that apply to the running of such an organisation as ours.

I assume, as a result of the changes to be made, that this will be my last of this series of notes for the magazine.

Undoubtedly this will be a relief for the Editor who will not have to deal with the ~~problem of running his blue pencil through much of the material provided in an effort~~ to fit the more important parts into the ~~space~~ allowed. He has been very patient with me and, ~~know~~, at times has allowed me some latitude ~~in this respect~~. (*Too much is always better to edit than too little, Ian!* Ed)

BURLEY GRIFFIN BUILDING - MOVE OF HEADQUARTERS

As well as the end of the period of my Presidency we approach the finalisation of an era where the Divisional Headquarters was located at the heritage listed Burley Griffin Building.

Our legal people are currently finalising some suggested changes to the lease document and it should not be too long before we are installed in the new location at 47 Surrey Road, Keswick within the boundaries of Keswick Park.

I feel that a new era now begins and I look forward with an optimistic frame of mind to great advances in the running of our Division and the conditions under which the hobby of Amateur Radio operates.

The one thing I see as of paramount importance is that we must have a strong and effective representation of our hobby to the various authorities.

BUILDING BRIDGES

I am very happy to be able to say that our relations with the elected Council members of the City of West Torrens as well as with the various officers employed by the council are excellent.

From a situation of seeming confrontation existing when I became President we now find that the City Council, including the employed officers, seem eager to assist us

in whatever ways they can. Their cooperation has been making it easier to deal with the many routine but necessary items encountered in connection with our proposed move.

Much of this seems to have resulted from the amalgamation of two City Councils and the fact that some reorganisation had to occur. However, it is interesting to note that in quite a few instances we are still dealing with the same people who were involved with the previous City Council.

Several elected Council members, and particularly the newly elected Mayor, Dr Reece Jennings, have indicated their appreciation of the WIA as a responsible organisation and a good tenant and assured us of their continued support.

I trust that we can find more ways to show our value as a community minded organisation and in doing so justify the faith shown in us.

THE FUTURE

I hope that it will be seen that the VK5 Division is in good shape and in a position to continue its role as a representative body for the benefit of the members and for the hobby of Amateur Radio as a whole.

There is no doubt in my mind that it is very important that we continue to play an effective role particularly in Federal matters.

May I make a final comment regarding such things by quoting from a letter I recently sent to all WIA State Presidents, Federal Directors and Federal Councillors.

“ I ask that you give some “considered” thought to the issues which face the WIA as a “National” body and also as the major representative group on behalf of Amateur Radio in Australia.

The issues are such that we need, more than ever, open and honest action designed to benefit the hobby as a whole and clear recognition that selfish individual and sectional interests must be subjugated to our main needs.”

My best wishes to you all. 73 from Ian VK5QX.

QRM

VK 7 Notes

Ron Churcher VK7RN

State President.

After all the hype of the Annual meetings of our three branches they all are settling down to what looks like a good year for the Tasmanian Division.

We now have our Divisional Annual Meetings on the 20th March - a report will have to wait until the May issue. This is being held at Bumie under the sponsorship of the Northwest branch. Voting forms have been distributed by our efficient Secretary Paul, VK7KPG, for the eight positions on the State Council. It has been very pleasing to see that there is so much interest this year with a very good list of excellent candidates. Looking down it, it's a pity we can't have the lot!

One disappointing thing, however, is the fact that our Secretary, Paul, and our Treasurer John, VK7KCC, are both not re-nominating for personal reasons. We have been very fortunate this year to have had them in these positions doing a very efficient job and we will miss them on Council. Thank you very sincerely, chaps, for your help.

We are pleased to welcome to Tasmania 3A2LU, John, a previous resident of Monaco who now holds the call VK7LU. We win some - lose some - we are saddened by the death of Bruno Fritsche, VK7BFF, recently. Bruno had one time been Northern Branch Secretary.

All the communications for Rally Tasmania, held in early March, were handled by the Northwest branch members with the assistance of some very welcome southerners.

Two of our members, VK7XR, Andrew, and VK7KY, Max, were the first on the scene of the horrific accident with two of the competitors killed instantly when their car left the road and ploughed into a tree. It was not a nice situation for these two hams.

The southern branch is involved with Targa Tasmania later in the year.

Cheers for now from Ron VK7RN.

ar

DXCC Status of 9U Burundi Contacts

OVER THE YEARS since 1994, the DXCC Desk has received several pieces of documentation for operations from 9U, Burundi. This documentation was accompanied by licence copies, complete with stamps and signatures. However, the DXCC Desk has heard rumours that these documents were in fact forgeries, and not authentic documents.

Due to the fact that the operators were still inside the country, and that we did not want to take action that could possibly cause them physical harm, and we knew we would be able to purge these contacts from DXCC records if this was found to be true, cards were accepted until we had the opportunity to investigate after the operators left the country.

The situation came to a head earlier than we expected. The Director General of ONATEL, the communications authorities in Burundi, contacted us by fax inquiring as to whether we had seen licences from Burundi. After several faxes back and forth, they informed us that the licences were forgeries.

The signature on the document was that of an official who had not been in that position for some time. The operators were saved from any real punishment other than being expelled from the country, and the entire incident is under investigation by their employer.

Since that time, the DXCC Desk has been rejecting cards for those operations concerned.

As soon as it is possible for the DXCC computer program to do so, all contacts from those operations will be purged from the DXCC database. We expect that will happen before March, 1999. This affects all operations since 1994 using a 9U prefix.

The submission of forged documentation is a clear violation of DXCC Section 1, Basic Rule 7, and also Rule 12 (a).

ar

Amateur Radio

Supporting the community

POUNDRING BRASS

S P Smith
9 Peak Street
Bateau Bay NSW 2261
02 4334 7743

I HAVE RECEIVED a number of requests from readers in relation to the American made "Bencher Paddles" currently sold in Australia.

Rather than corresponding to each of you individually, the information is in this month's column.

Bugs were all the rage for operators who sought to send at speeds greater than could be achieved with the simple hand key.

The 1950s was the decade of the bugs' demise.

These mechanical marvels were soon to be replaced by the paddle and electronic keyer circuits which were to revolutionise code sending speeds.

Keys of the time had a pivoted shaft held in bearings. Early paddle designs copied the vertical bug mechanical mechanism which was quite complex to adjust and took some time to master.

Joseph A Hills W8FYO from Ohio was to revolutionise paddle design.

His radical design was a single paddle mounted on a ring which rested on two bearings which could be pivoted from side to side. The ring was pulled onto the two bearings by means of a spring. He called his design the "FYO Single Lever Paddle."

Hal Communication Corp changed Hill's design by splitting the ring in two halves, each half fitted with a lever. This design was on the market for only two years, 1975 - 76.

Other manufacturers followed suit, Teletek in 1975 and Bencher in 1977. Hamco incorporated magnetic tensioning into their dual lever models, the "Carson and Scotia" in 1978.

Vibroplex bought out Hamco and redesigned the Scotia model and called it the "Blue Racer".

Today only Vibroplex with two models and Bencher with several models keep Joseph A Hill "FYO" design alive.

With this article I will only concentrate on the Bencher range.

Bencher paddles are offered in two types: the Iambic BY series which consists of four models BY-1 to BY-4 and the non-Iambic ST series, again consisting of four models.

We will look at the BY dual lever range of paddles. The mechanism is mounted on a solid steel base, 10cm X 9.4cm, the total weight of the paddle being 1.25kg. Four

finished options are available:

BY-1 Black base with chrome mechanism

BY-2 All chrome base and mechanism

BY-3 Black base with gold plated mechanism

BY-4 Deluxe model being completely gold-plated.

Key adjustments

Keyer lever tension adjustment is achieved by varying the length of a small 17mm screw attached to spring on each of the split rings. The lightest touch, or minimum tension is achieved with these screws all the way in. I measured the lever tension at 52g. To increase the tension turn the screw anticlockwise fully out the lever tension measured 152g.

Next adjust the contact gap. The contact gap is individually adjusted to each lever by the position of a 20mm long contact screw which is fixed to a split vertical post.

The contact screw is held in place by a small 8mm Allen screw which, when tightened, draws in the top section of the split vertical post together and prevents the contact screw from moving.

The maximum amount of horizontal movement of the contact screw is about 4mm, being flush with the split vertical post (maximum gap) to contacting the contact on the contact paddle bracket (no gap).

A good rule is to adjust the contact gap to about 1 - 1.5mm, approximately the thickness of a business card.

Contact points are solid silver with a gold plating requiring little or no cleaning under normal operating conditions.

After some months the contacts should be inspected and cleaned if necessary. Run a small business card through the contacts a number of times until clean.

Under no circumstances use wet/dry paper, sand paper or file as this will remove the protective coating from the contacts.

Some points to look for:

When I first purchased my BY-1 model, I found that the split vertical post had moved somewhat and that the contact screw face was not in line with the contact paddle bracket.

To rectify this, I loosened the split vertical post screw underneath the base and moved the split vertical post either right or left until the contacts were aligned then retightened the screw (an easy adjustment).

Another problem encountered is similar to the one I just mentioned, except the contacts don't line up and are not flush with one another when the contact screw is adjusted all the way in (no gap).

Even moving the split vertical post small amounts left and right cannot rectify this problem.

The contact paddle bracket must be bent to correct this error, but take care when bending that no damage to the rest of the mechanism happens. Use long nose pliers for this adjustment — one to hold the contact paddle bracket steady and other to do the bending.

Adjustment should be checked every so often depending on how often you use the paddle. Springs should be replaced every few years.

If you don't do much paddle operating remove the tension off the springs.

It only takes a few moments to adjust your paddle and get on air. I know some operators that apply Loktite to all screws. This permanently sets the paddle. (I don't recommend this to beginners).

If you have any further questions please contact me.

See you next month.

Steve Smith VK2SPS
ar

**If you have a product
or service to sell
and amateur radio operators
are your target market then
the pages of**

Amateur Radio

could be just the spot.

**Even if your product or
service is not radio
orientated, if the profile of the
readership is close to your
client base profile, you should
consider this niche market.**

**Call
Mrs June Fox
Tel: (03) 9528 5962
in the first instance**

EDUCATION

Brenda M Edmonds, VK3KT
PO Box 445, BLACKBURN 3130

There still seems to be some confusion regarding the resource material required for the Regulations examination. This material is no longer published in the brochures RIB 70, 71 and 72. Instead, all is available on the ACA Web pages and should be downloaded from there. If you do not have access to the Internet and World Wide Web, you can obtain the material from the local ACA State Office.

You will need the following publications:

Amateur Examinations (this one is not examinable)

Amateur Licence Information Paper

Amateur Operating Procedures

Radiocommunications Licence

Conditions (Amateur Licence)

Determination

Amateurs Visiting Australia.

(There are also minor bits such as definitions from other papers and the ACA considers that every amateur should have a copy of the Radio-communications Act!).

This unfortunately adds up to a fair pile of paper (about 80 pages), which is very off-putting for a newcomer to the hobby.

The size of the pile explains why the WIA Federal Office can no longer send out free copies of the information to those who enquire.

Another potential problem is that the ACA retains the right to modify the content of the publications as necessary.

So if you have an early copy of some of the papers, it may pay to check it against the current copy. At least they are putting a "Last edited" date on most of the papers.

The "Amateur Examinations" paper

above contains the syllabuses for both levels of Theory and for the Regulations examination.

These syllabuses are still the subject of negotiations between the WIA and the ACA, but current examination papers are based on them. This is the first time that an official Regulations syllabus has been published.

Items included that have not previously been considered as examinable refer to some of the ITU Radio Regulations that pertain to amateur operations and the use of amateur bands in national emergencies.

It is interesting to note that the importance of the sections on Emergency Procedures has been down-graded by the ACA.

This reflects the extensive development of other communications networks such as mobile phones, global positioning systems, and satellites.

The *Radiocommunications Act 1992* is currently under review. The WIA has presented a submission to the Department of Communications, Information Technology and the Arts in response to a circulated discussion paper.

Members will be kept informed of developments.

On Examinations

The curriculum and examination system for the Amateur Radio service has been of great interest to me for some time. I have taught many classes over the past twenty years or so, many as a full time TAFE Teacher. I have therefore looked at the syllabus in some depth, especially the CW side, and believe that there are several improvements that could or should be made. I personally see no need for a CW test at all. The CW test as it is, is an invalid test for the skills supposedly being graded. For more on this point later.

I have had what I believe to be a great deal of experience in writing and assessing examination instruments and in measuring their effectiveness for electronics subjects.

In answer to some of your committees thoughts/points:

(a) Two examination papers are required, as there are two syllabi. It is not practical to create one test instrument that addresses two different syllabi. Many professional institutions have tried and as far as I am aware none have found success. It may be possible however to make one syllabus that addresses the different competencies required in such a manner that a test can be offered with

Bob Harper VK4KNH

Dip. T. (TAFE), B.Tech.(Eng.)

two parts: - the main part relevant to the competencies of both levels and an appended part that addresses the higher level only. But should there be two levels at all? That is another question.

- (b) Practical testing requires far greater resources than the WIA would be prepared to supply and guarantee. It also requires greater levels of expertise in the examiner. It is very difficult to ensure that the test is not completed or assisted inadvertently by the examiner and indeed candidates could well complain that others received more assistance that they did; - a can of worms and smelly ones at that.
- (c) The educational reasons for the 70% pass mark are valid but would take a lot of space to explain and should now be increased to 80% in line with Australian Competency Based Assessment guidelines. The test questions must, as a matter of course, be reviewed to reflect such a change. Has any assessment been done on the assessment materials as yet; I assume not or at least not by education professionals.

- (d) Consider as an option to practical tests, a learner's permit; particularly in the case of CW. The candidate would be required to pass a Theory, Regulations and Operation Procedures test. They would then be issued with a temporary licence for twelve months during which time they are required to log a number of local and DX stations on SSB and CW and to receive QSL reports from each. When the required number have been received they would be submitted to a divisional committee for approval and, providing that no adverse reports of on-air behaviour are received, the candidate is granted privileges commensurate with the theory and practical levels.
- (e) The regulations test is today more important than the theory test. There are so many black-box operators out there! Look on it as a driver's road rules test. That does not imply however that the current test is valid. There have been many doubtful questions over the years and many with more than one answer. Personally I would make the regulations an open book test with each candidate given a set time to answer a series of questions directly from the regulations book (Pamphlet?).

- (f) A "declaration of intent" to comply with the regs, as suggested, assumes that the operator has (a) seen the regs, (b) read them, (c) understands them and (d) accepts them. Signing your licence application already suggests that and it still cannot guarantee that the operator knows anything about them. There must be a regs exam.

Multi-choice questions are hard to generate but easy to mark. That is why they are used so often where non-experts undertake the task of marking. Eg drivers licence tests. Well-written questions require experts with knowledge of testing theory as well as content theory.

You have not experienced any serious questioning of your procedures as yet but the wording of a single question could result in court challenges if a candidate has the money to spend. In CBT there should be one answer that is clearly correct and three (or more) that are clearly not correct. "More correct than the others" is very difficult to prove legally.

A bank of questions is the way to go and, if well written, can be freely given

out to candidates for study purposes. (Old time teachers choke on that concept.)

- (g) Whether 50 questions are appropriate or not depends on the body of material to be tested and the depth of knowledge required. On the one hand I could see 50 Novice level questions followed by 50 full grade questions still not satisfying a syllabus. I expect however that a test of 100 questions, comprising of 50 general, 25 advanced and 25 regulations could be designed to cover the syllabus content adequately.

The structure of Amateur Radio is now quite complex with too many levels of variation. I would pursue a simplification to two levels with possible endorsements for CW proficiency etc. A general level based around "Novice" level skills and privileges and an advanced level based on "Full Call" skills and privileges. Operation on HF should be available to all amateurs but perhaps with an endorsement for those with recognised CW skills. CW endorsement based on the learners permit system outlined above would allow those operators access to the CW only portions of the bands.

CW is indeed a part of our heritage, but one

that should not hang like a noose around our necks. If CW is to survive it can only survive as a nostalgic means of communication practiced by loving historians. You cannot force people to like it or accept it and will not attract members who do not agree with your politics. CW has no further place in commercial ventures and it will be the downfall of the Amateur Radio Service if it remains as a requirement for what is now, essentially, a hobby licence.

I hope I have not crossed swords with anybody on the issues above but I understand that some run on emotions rather than logic. If so, it was not my intention to provoke.

I did, several years ago, go over the syllabi and write the content into the Qld TAFE CBT format. I will search out a copy, which I assume is archived somewhere in my materials, and send it to Brenda as it contains matters on CBT, competencies to be achieved, assessment, format of the tests etc. It was never submitted, which was a shame. Qld. TAFE no longer recognises any Amateur Radio courses other than perhaps adult hobby classes. If submitted and accepted at the time, they may have been accepted Australia wide by the other TAFE systems.

Now we would have to pay for such a basic privilege.

Radio and Communications

Incorporating AMATEUR RADIO ACTION and CB ACTION

Published by
ACP ACTION

Locked Bag 12
Oakleigh
Victoria 3166
(03) 9567 4200

The amateur bands have faced pressure over the years, but the latest arrival on our bands is different. We take several pages in our April issue to fully examine the impact of LIPDs on the 70cm band — radios which anybody can use on our band, with no licence required at all.

Do not miss this! Meanwhile, at left is a mini quad with attitude! Build it!

April's R&C is vital reading for all Australian amateur radio operators! Don't miss any of these great stories...

- HF ANTENNAS: Steve Ireland, VK6VZ, describes a compact quad which really pulls in the rare DX...
- THE PHASE-LOCKED LOOP: Ron Bertrand, VK2DQ looks at the PLL, and explains it fully but clearly.
- A 22-GALLON ANTENNA: A construction story with a difference ... you start with a 44-gallon drum!!
- HOW TO CONQUER THE MORSE CODE: It is possible for almost anyone, reports Greg Towells, VK2RQ
- A SIMPLE 6M OMNI ANTENNA: Like so many other designs, you start with a CB base station ...
- As usual, we have our three DX columns, mods and lots more ... the best stories and regulars every month!

Don't miss out — RADIO and COMMUNICATIONS is great reading for amateurs!

Check your local newsagent today!

(PS. We also have the biggest collection of radio-oriented Classified adverts in the country. There's lots of them because they work so well. Ask your newsagent to keep a copy for you each month, or ring 1800 25 2515 for subscription details. Hurry — you might miss something!)

CONTESTS

Ian Godsill VK3DID,
57 Nepean Highway, Aspendale, 3195

Apr 3/4	SP DX Contest	(CW/Phone)	(Mar 99)
Apr 9/11	JA DX CW Contest	(High Band)	(Dec 98)
Apr 10/11	King of Spain DX Contest	(CW/Phone)	
Apr 17	Australian Postcode Contest	(CW/SSB)	(Mar 99)
Apr 17/18	Holyland DX Contest	(CW/Phone)	(Mar 99)
Apr 24/25	Helvetia DX Contest	(CW/Phone)	(Mar 99)
Apr 24/25	SP RTTY Contest		(Mar 99)
May 1/2	ARI International DX Contest	(CW/SSB/RTTY)	(Apr 99)
May 8/9	CQ-M International DX Contest	(CW/SSB/SSTV)	(Apr 99)
May 15/16	Sangster Shield NZART	(CW)	(Apr 99)
May 29/30	CQ WW WPX Contest	(CW)	(Feb 99)
Jun 5/6	IARU region 1 Field Day	(CW)	
Jun 6	Portugal Day Contest	(SSB)	
Jun 12	QRP Day Contest	(CW)	(Apr 99)
Jun 12	Asia-Pacific Sprint	(SSB)	(Jan 99)
Jun 12/13	ANARTS RTTY Contest		
Jun 12/13	South America WW Contest	(CW)	
Jun 19/20	VK Novice Contest	(CW/Phone)	
Jun 19/20	All Asia DX Contest	(CW)	
Jun 26/27	ARRL Field Day		
Jun 26/27	Marconi Memorial Contest	(CW)	

Results ALARA Contest November 1998

From Marilyn VK3DMS

CALL	NAME	SCORE	AWARD
VK4SJ	June	641	Top score overall, top phone, top VK YL, top VK4 member
FK8FA	Aimee	318	Top DX YL, top Pac. Is. memb.
VK3DYL	Gwen	276	Check log
WN6HYX	May	210(96 CW)	Top DX YL CW, top US non-memb.
VK5CTY	Christine	180	Top VK5 member
VK3AGC	Judy	163(8 CW)	Top VK3 memb.
VK4VR	Val	161	
VK6DE	Bev	150	Top VK6 member
ZL1WA	Alma	149	Top ZL member
VK5YG	Meg	145	
VK4AOE	Margaret	113	
ZL1ALK	Celia	108	
VK3DMS	Marilyn	105	Check log
VK3DYF	Bron	99	
VK5BMT	Maria	88	
ZL3AHT	Sue	76	
VK2DDB	Dot	65	Top VK2 member
VK3DVT	Valda	63	
VK3MGZ	John	50	Top VK OM
ZL1BIZ	Elva	50	
VK5AIM	Steve	35	
VK3ALD	Len	20	
VK3DID	Ian	10	
VK8A/4V	Alan	5	

Everyone seems happy with the change of rules for repeat contacts.

Conditions were poor during the day, but the 80-metre band at night was reasonable.

It was very disappointing that only one VK girl made CW contacts, even though Mavis VK3KS, Ivor VK3XB and Ian VK3DID were calling throughout the day. Come on girls - give it a go next year. Let's keep the spirit of VK2FV alive into the new century!

Congratulations to June VK4SJ, Aimee FK8FA and the OMs who are always there to give us points, and especially to Len VK3ALD. 73 de Marilyn VK3DMS.

Harry Angel Memorial Sprint

1100z - 1246z Sun 25 April, 1999

This is a new Contest to remember VK's oldest licensed operator, Harry Angel. Please note the time length of the Contest - 106 minutes, Harry's age when he died last year. It is open to all appropriately qualified HF operators.

Object is to make as many contacts as possible on the 80 metre band, using modes CW and SSB.

Greetings to all contesters.

I hope that the year has settled down well for you all and that you are preparing for our VK/ZL contest season.

In January I raised several issues with you for consideration, principally the issue of the definition of Single Operator.

I would like to report that three replies were received and I thank those operators for their concern.

In the light of these the feeling is that we should try to be uniform as much as possible with Regions 1 and 2.

Single Operator means just that - no assistance of any type. However, I felt that there would be no objection to the inclusion of a Single Operator Assisted category for those who can handle spotting nets and other modern aids.

There were no specific comments on electronic log submission; however, I ask all Contest Managers in VK to give serious consideration to accepting results via disks and e-mail as much as possible.

Yes I know that some of you are, as I am, in the middle age group and not so familiar

with computers.

BUT

Windows and its offshoots can be learned. I had a dreadful time last year when I took on this job, but I am determined not to let it beat me! I feel that we must remember that a great many genuinely interested contesters use computers as an integral part of shack operations. How easy can it be to just send the data from the machine to the Manager?

Does anyone have any logging programs specifically for VK/ZL contests? If so, please let me know.

Finally, may I draw your attention to a new Sprint Contest to mark the life of the late Harry Angel VK4HA? Details below. Please give this your special support, even if you are not a regular contesteer, so that the inaugural event can be really successful.

Thanks this month to VK4VW SM3CER VK3DMS VK2ZI VK3ABP ZL3KR

73 de Ian VK3DID

Categories: Single Operator (CW, Phone, Mixed) and SWL.

Frequencies: CW: 3500 - 3700 kHz, Phone: 3535 - 3700 kHz. Contacts in DX window not permitted. Exchange RS(T) and serial number; revert to 001 if 999 reached.

Score two points per CW QSO and one point per Phone QSO.

Stations may be worked once only per mode.

Logs must show time UTC, callsign worked (both callsigns for SWLs), mode, RS(T), serial numbers sent and received for each QSO.

Send summary sheet showing name and date of Contest, name and callsign of entrant, category entered, address, equipment used, points claimed and a signed declaration that the rules and spirit of the Contest were observed.

Send logs to

Harry Angel Sprint,
PO Box 171, Caboolture,
Queensland, 4510

by Friday, 28 May 1999.

Logs may also be sent by e-mail to:

<vk4vw@qsl.net>

Sangster Shield NZART

0800z - 1100z Sat 15 May/Sun 16 May

Object is to contact as many ZLs as possible. All power levels permitted, but serious competitors for the Sangster Shield must not exceed five watts o/p.

Band: 80 m.

Category: Single Operator.

Mode: CW only.

Repeat contacts may be made each half-hour, with at least five minutes between repeats with the same station.

Exchange RST plus serial number beginning at 001. ZLs will send RST, branch number and power (eg 569/11/04).

Score 10 points for VK QRP to ZL QRP; five points for VK QRP to ZL QRO; five points for VK QRO to ZL QRP.

Final score is total QSO points X number of branches worked.

Send logs showing QSO details, points claimed, name and address of operator and power level to

Alan Hughes ZL3KR,

4 Exton Street,

Christchurch 8005, NZ,

before 17 June, 1999.

CQ-M DX Contest

2100z - 2100z Sat 8 May - Sun 9 May

Bands: all HF bands and satellites (no WARC).

Modes: CW; SSB; SSTV.

Categories: Single operator single band CW only, SSB only, Mixed, satellites, SSTV. S/O multi-band CW, SSB, Mixed, satellites, QRP, SSTV. Multi-operator: multi-band, single tx, mixed, SSTV. SWL: multi-band, mixed.

Exchange RS(T/V) and serial number beginning at 001.

Score one point with own P-150-C country; three points for QSO with another continent. SWLs score one point for log of one station; three points for complete QSO.

Multipliers: each country in P-150-C list counts as a multiplier once only per band. SWLs have no multipliers.

Final score is total QSO points X sum of all multipliers. Various awards will be available.

Send logs by mail to:

CQ-M Contest Committee,
Krenkel Central Radio Club of Russia,
PO Box 88

Moscow Russia, by 1 July.

Logs may be sent by e-mail as ASCII text to: <cqm99@mai.ru>. For details of P-150-C list see http://www.mai.ru/~crc/crc_e/award/r150s_e.htm

QRP Day Contest Rules

0700z - 1200z Sat 12 June 1999

Open to all CW operators, the object is to work as many stations as possible.

Category: Single Operator only.

Sections: (i) VK, ZL, P29 (ii) outside the above call areas.

Mode: CW only.

Bands: all HF bands (no WARC).

Exchange: RST plus serial number beginning at 001 and incrementing by one for each contact. Repeat contacts on same band: In order to make greater use of available band space and time, repeat contacts with the same station will be allowed with a minimum of two (2) hours between contacts.

Scoring: the object is to score as many points as possible in your section.

Stations within VK/ZL/P29 score

VK/ZL/P29 contacts 1 point

Outside VK/ZL/P29 3 points

Stations outside VK/ZL/P29 score

VK/ZL/P29 contacts 3 points

Outside VK/ZL/P29 1 point

All contacts made with an homebrew transmitter or transceiver score double points.

Final Score is the sum of the total QSO points. Except for the use of homebrew equipment (see above), no multipliers apply.

Certificates:

(i) the first three place getters in each section.

(ii) the top scorer on each band (if the entrant is not already a placegetter).

General: any station claiming to operate QRP MUST NOT exceed a maximum of five watts carrier to the antenna and should add /QRP after its callsign.

Logs showing contacts and points claimed, together with a full description of equipment used, should be sent to: -

Ron Everingham VK4EV,

30 Hunter Street,

Everton Park,

Queensland, 4053

No later than 10 July 1999.

ARI International DX Contest

2000z Sat 1 May - 2000z Sun 2 May

Object of this contest is for anyone to work anyone else.

Bands: all HF bands (no WARC). 10 minutes rule applies.

Modes: CW, SSB, RTTY & Mixed.

Categories: Single operator CW, SSB, RTTY or Mixed; Multi-operator single tx mixed; SWL single operator mixed; SWL.

Exchange RS(T) and serial number beginning at 001. Italian stations will send RS(T) plus a two-letter province code. Multipliers are each Italian province (103) plus each DXCC country (except I and IS0).

Count each multiplier once only per band. QSOs with own country count as multipliers.

Score 0 points for QSOs with own country, three points for QSOs with stations on different continents, 10 points for QSOs with Italian stations. Stations may be contacted once on each band on each mode.

Final score is total QSO points X total multipliers. SWLs must log both callsigns. Separate logs for each band must show all QSO data.

Send logs with summary sheet showing times UTC, callsign, names and addresses of all operators and signed declaration to:

ARI Contest Manager,

PO Box 1-27043

BRONI (PV) Italy.

Logs may also be sent by disk in N6TR, K1EA, EI5DI and ASCII formats or in ASCII (or attached files) by e-mail to: <ari@contesting.com>. Various awards will be issued.

ar

ALARA

Christine Taylor VK5CTY
ALARA Publicity Officer

16 Fairmont Avenue, Black Forest SA 5035
Packet: VK5CTY@VK5TTY

WeatherReports

Often the first round of the ALARA Monday Nets (on 3.80 +/- at 1000Z Daylight Saving periods, 1030Z non-Daylight Saving period) is a weather report from round the country.

As we regularly have girls from VK3, VK4 and VK5 we get quite a picture of the wide variation in weather across this vast continent. Recently, the heavy rains in Queensland have been causing concern.

We know this is their Wet Season, but this is ridiculous. One night June VK4SJ told us there was water over her patio for the first time since they had lived in that house in Caloundra, and shortly after that Bev VK4NBC had to cut her session short so she could deal with the water seeping under the window!

We were pleased when Mary VK5AMD reassured us that her daughter in Maryborough was quite safe. Her house is on high ground. We did have a giggle when we heard that the husband of the house in Maryborough had come home from buying a bottle of milk to report that it was expected that the main street would be flooded that night.

"Did you bring an extra bottle of milk, then?" he was asked. "I didn't even think of it," was the reply. Oh well, there was plenty of powdered milk in the pantry, but fresh milk would have been nice.

New houses

Many of you know June VK4SJ and Doug VK4BP and know that they are building another house.

They were not able to get through the floods to the house - June said that on that day there was a raging river where there isn't even a stream normally - but a neighbour rang to assure them that the new house was well above danger level. June and Doug are now in the new house. There are no aerials up yet, but the E-mail service is just as good there as it was in Caloundra. Further reports as they come to hand.

In Mildura, where it has been dry all the time except just before grape harvest time (though that doesn't worry Marilyn VK3DMS and Geoff VK3ACZ any more) the new house is becoming habitable. Paint is going on and furniture is arriving. It will

soon be time for House-warming parties! However, there was the story of the hurried placing of a bucket under the drain hole of the sink recently. The plumbing is not yet in place but the kitchen sink is. The dishes were being washed in a basin and stacked on the draining board - from where the water was running into the sink. Hence the rapid grab for a bucket.

No aerials are expected for a while but the phone works well for now.

News from Gwen

After much difficulty I managed to read a message from Gwen VK3DYL. (Our packet system has been misbehaving for some time, mostly because of transceivers slightly off tune, I suspect, but is going again via a C64 system).

Gwen had a lovely visit from Bev ZL1OS and OM Geoff, recently. They spent some time talking about YL conventions past, present and future. Bev is running the web page for the New Zealand International YL Meet in the year 2000. The address is: <http://www.wave.co.nz/pages/osborneg/waropge.html>

Gwen reminded me that, while the name of the venue for the YL luncheons in VK3 has changed, the place has not. The Vista Cafe is now the Melba Cafe but it is still at 215 Little Collins Street, attached to the Victoria Hotel.

The YLs start drinking cappuccino at about 10:30am but lunch is not ordered till noon. They continue with the coffee till they have to leave to catch trains and trams.

All interstate and overseas visitors are welcome to join them on the SECOND FRIDAY of the month. Please try to fit your visits to Melbourne around those Fridays. I do so, whenever I can. QSOs are fun, but 'eyeballs' are also fun.

See you there maybe on the 9th April, 14th May or 11th June. Please note, on the same day of the month the VK5 YLs also meet. Currently we meet at noon at the North Terrace entrance to the Myer Centre and we eat in the London Tavern (just to the left of the bottom of the escalator).

We also encourage all visitors to join us; the cappuccino is just as good in Adelaide as it is in Melbourne.

Good publicity for AmateurRadio

Mary VK5AMD was asked to talk about amateur radio, to the Bordertown Rotary Club. She kept them well enough entertained that they didn't ring the bell for her to stop.

Mary has been interested in radio since her father showed her a radio and named the components, when she was very small.

She listened very carefully but couldn't understand why something with so many wires in it could possibly be called a 'wireless'. Haven't we all wondered that, too?

Mary had featured in the Border News last year when she had a contact with Andy Thomas, on MIR. The Rotarians were very interested to hear all the details about that event and about Mary's meeting with Andy in Adelaide a couple of months ago.

When Mary spoke of ALARA the listeners were amazed to hear how many ladies have taken up amateur radio.

Mary can speak with authority of the benefits of amateur radio for ladies in the country, in particular.

Mary has a radio in 'listening mode' all the time on 144.500MHz and is well known to many amateurs who regularly travel the road between Melbourne and Adelaide.

I am sure the Rotarians know much more about our hobby now than they did.

Letter from Jasmin G4KFP

Jasmin was sponsored in for many years by Austine VK3YL so is well known to many YLs and OMs, too, from on air contacts.

She and her OM Bill G4IOD have had the misfortune to be both made redundant twice in four years! Jasmin now runs a Bed and Breakfast in Cleckheaton, Yorkshire, assisted by Bill when he has time from his two part-time jobs.

They do plan to have their camper up and running in September, though, when they intend to be in Cornwall to see the eclipse. That should be a major event, but a chaotic one on the narrow Cornish roads.

Jasmin says her sister, who lived down there fully expects the place to grind to a complete halt before, during and after the eclipse.

I was lucky enough to see the total eclipse a number of years ago at Tantanoola. (If we had gone on to Mount Gambier the cloud would have obscured it for us, as it did for the thousands gathered there). We saw it all in a break in the clouds.

Amazing! The difference between a partial and a total eclipse is totally surprising.

Up to 98% coverage and you need to use a pinhole camera to view it safely, so little is the loss of light.

At totality there is no argument. It is dark! If you have the chance to be in Cornwall in September, do not hesitate! I'd love to be there, too, but I hope to be at the ALARAMEET, instead.

ALARAMEET News

Many caravan route plans have been made, bookings of plane tickets, and cabin and motel rooms are happening. To date it is expected that there will be about 60 there, but we are not sure how many from ZL land will appear.

We hear they have made a bulk booking, but we don't know how large the bulk is going to be.

If you haven't made your arrangements yet, do think about it. We have a marvellous time, meeting each other again after three years, new faces and old, familiar ones.

The dates of the actual meet are October 2, 3 and 4, but many will meet informally on Friday evening for dinner and quite a number will stay on for a couple of days to enjoy the extra trips Bev has planned.

For more information contact Bev VK4NBC or read the details in the ALARA Newsletter. There was an official application form in the January Newsletter. That has a list of some of the activities. Look for the form and make your plans.

ANNUAL GENERAL MEETING

Don't forget the AGM on the 4th Monday of May the 24th, on the usual frequency at 1030Z. We enjoy the long list of calls that night. Contrary to many organisations, our AGM is the best Net of the year.

If you would like to come onto the committee but hesitate to put yourself forward, please do send a nomination form to our Secretary, Tina VK5TMC. She will easily find counter signers for your form.

It is not onerous to be on the committee but it is fun. You feel you are giving something back to your hobby and helping YLs at the same time.

We always need new blood, please bleed for us.

Do you have an amateur radio story or photo with a YL point of view?

(Or even a funny tale about, or gently against an OM, who are often good sources).

Share it with

Amateur Radio

by getting it to Christine VK5CTY

How's DX

Quo Vadis DX?

FOR 18 DAYS OF OPERATION on Cocos Keeling and Christmas Islands Erwin, HB9QR and myself, VK6CTL/HB9TL, were confronted as VK9CTL-VK9XTL and VK9CQR-VK9XQR with the mindset of nowadays DX-screamers.

We made about 750 QSOs per day and learned to handle the new dual watch technics, an ingenious invention in hand of seasoned operators. Whenever we contacted a station, immediately and mercilessly the European horde of two-character-beakers jumped in on him in the middle of his reply. The QRM mounted to an inferno.

Five or 10 kHz up the band the same thing happened again. Even on CW the horde jumped exactly 5 up, producing a solid 50 Hertz tone, against which there are no filters, even in the most modern equipment.

The result was a constant tuning for possible readable signals, which slowed down the rate of QSOs. "Spread out" seems to be unknown to these appliance operators.

On SSB, especially Latin speaking Europeans, demonstrated extreme difficulties in understanding the expression "FULL CALL" or "complete call" or "entire call".

On recent DX-peditions like H40AA, 3B7RF and timely with our DX-pedition BQ9P, various DX-operators still work like this: ...Alfa-Delta, your 59. Next ...Kilo-Alfa-Delta, your 59, your prefix please. Then ...Indigo-Zulu-Three-Kilo-Alfa-Delta, thank you. Next QSO again: ...Tango-Mike, your 59. It takes these operators two, mostly three goes for a contact. What efficient communication!

These DX-operators have cultivated this DX hungry bunch of the "Two-Character-Communication-Society" (how do you like my new concatenation?).

Full-Call-Communication, which licensing authority requests, seems to be no longer the courtesy even toward the DX-operator who makes these desired QSOs possible. These DX-mongers sit at ease at their Kilowatt station with multi-element beams crying for hours their two character tune ...Alfa-Delta ...Alfa-Delta ...ALFA-DELTA and expect the poor DX operator to waste voice power and time on them by taking multiple goes to get his complete call.

In the age of computer logs I certainly need first the complete call, in the worst case the prefix in order to enter the suffix afterwards. But with the two ending characters I absolutely don't know what to do on my computer. To communicate

efficiently I requested "FULL CALL" which sped up my operation very much and economised my voice power.

The caller only gets a report from me when he is correct in the log. I was told that my way of operation is stupid and dated.

Look at the recent H40AA DX-pedition. They exclusively gave 59 reports and that was also what is preprinted on their QSL.

That makes log keeping easier and who is interested in a report nowadays anyway. Why give an old fashioned 59 report anyway if the remark "you are in the log" would do. You may check the Internet if you are in doubt of being in the log. It seems without the Internet no major DX-pedition is up to date any more. But either way, better work them twice per band for security. I have deleted all second contacts per band, only the first receive a QSL. Try not to be the ham that gets his QSL back with the remark "not in log at this date and time".

Quo Vadis Amateur Radio?

As President of the Swiss USKA some 20 years ago, I could point to a great future for ham radio.

It was the time we got the use of the WARC bands, satellite communication was getting more momentum and reciprocal licensing opened new opportunities for relays and travel.

But now? If the IARU and its member societies do not quickly find solutions to adapt to new trends and the challenges of the Internet our future looks dim. Will we only react when we find out that our numbers are dwindling?

Why should a youngster of today learn CW, rules, regulation and band usage for an amateur licence exam, be restricted by zoning laws for the erection of antennas, face the neighbours because of BCI, TVI, interference to their Fax, video and telephone, be hampered by new regulation of radiation, hear the bedlam of DX-hungry monsters with their Two-Character-Communication and the closed societies on repeaters?

The new generation have already found QRM-free communication, at any time to anywhere with no government limitations, on the Internet. The challenge is on now.

Act quickly before the Dear Old Man (dr om) is lost in time and forgotten already at the start of next century.

See you with the young on the Internet where unrestricted communication is possible.

ar

Jacob C Laib VK6CTL

U12/929 Wellington Street

West Perth WA 6005

Ph & Fax: 08 9322 2672

HF PREDICTIONS

by Evan Jarman VK3ANI
34 Alandale Court, Blackburn Vic 3130

These graphs show the predicted diurnal variation of key frequencies for the nominated circuits.

- These frequencies as identified in the legend are:-
- Upper Decile (F-layer)
 - F-layer Maximum Useable Frequency
 - E-layer Maximum Useable Frequency
 - Optimum Working Frequency (F-layer)
 - Absorption Limiting Frequency (D region)

Shown hourly are the highest frequency amateur bands in ranges between these key frequencies; when useable. The path, propagation mode and Australian terminal bearing are also given for each circuit.

These predictions were made with the Ionospheric Prediction Service program: ASAPS version 4.

April
1999
Index: 113

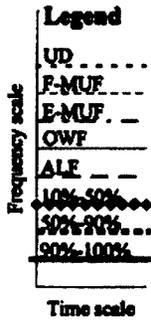

Adelaide-Moscow 318
First F 0-5 Short 13807 km

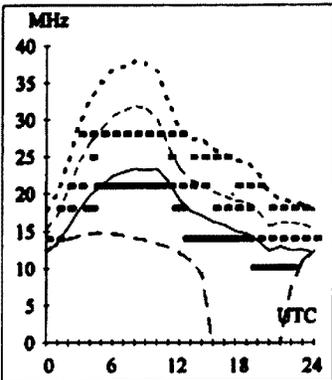

Brisbane-Berlin 321
First F 0-5 Short 15678 km

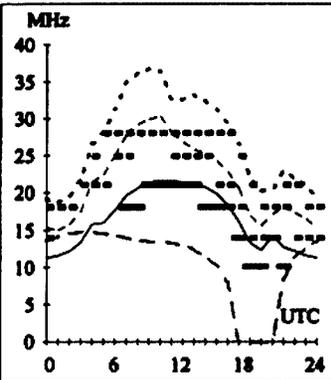

Adelaide-Osaka 257
Second 3F5-11 3E0 Short 7746 km

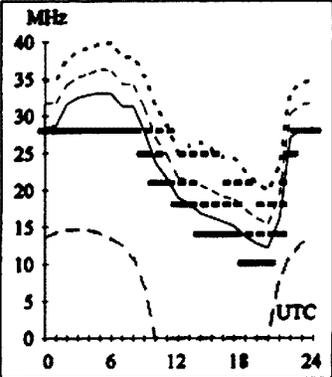

Brisbane-Johannesburg 229
Second 4F3-5 4E0 Short 11632 km

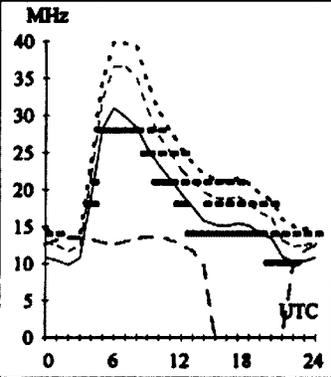

Canberra-Ankara 102
First 1F7-9 1E0 Short 2300 km

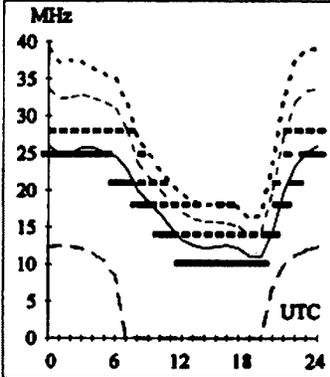

Darwin-London 145
First F 0-5 Long 26171 km

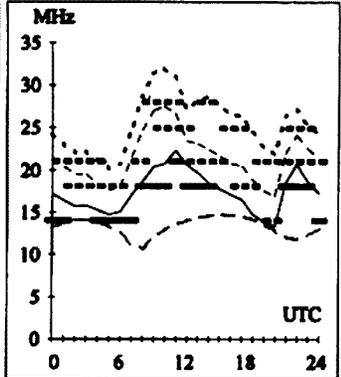

Adelaide-Pretoria 238
Second 4F5-8 4E0 Short 10064 km

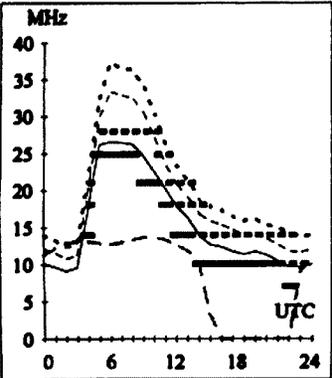

Brisbane-Noumea 70
Second 2F33-39 2E1 Short 1472 km

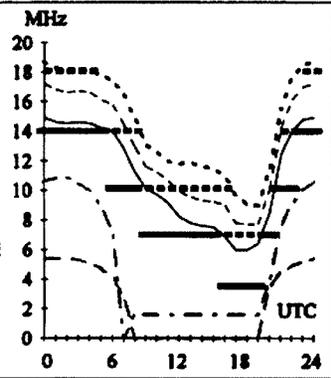

Canberra-Manila 327
First 2F2-7 2E0 Short 6286 km

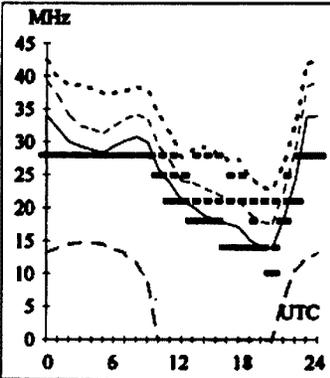

Darwin-London 325
First F 0-5 Short 13553 km

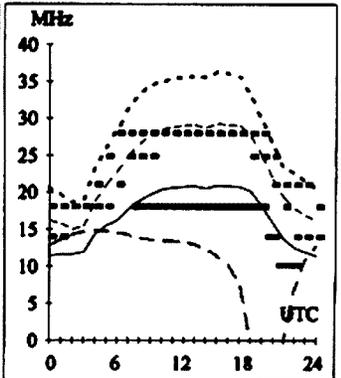

Adelaide-Seattle 51
First F 0-5 Short 13413 km

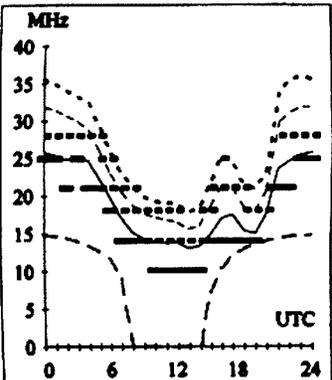

Brisbane-Singapore 293
First 2F2-6 2E0 Short 6147 km

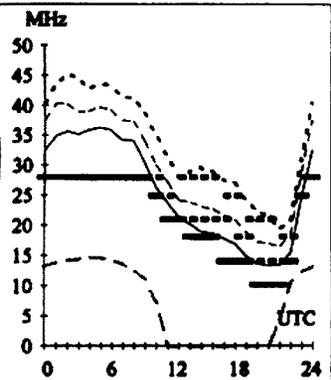

Canberra-Cape Town 219
Second 4F4-7 4E0 Short 10778 km

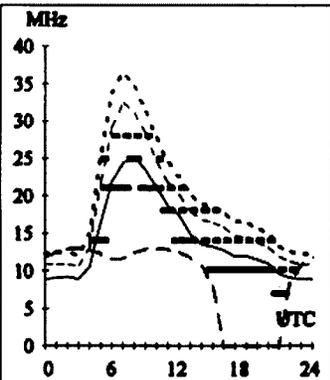

Darwin-Riyadh 295
Second 4F5-14 4E0 Short 10000 km

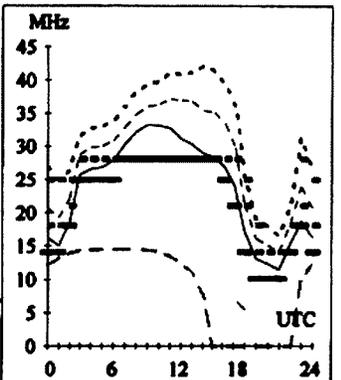

HF PREDICTIONS

Hobart-Dakar 209

First F 0-5 Short 16555 km

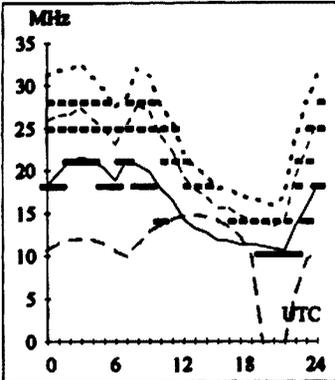

Melbourne-Bangkok 312

Second 3F6-12 3E0 Short 7372 km

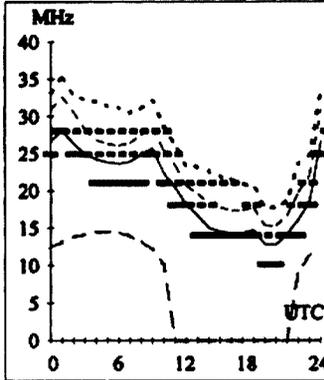

Perth-Harare 257

First 3F3-6 3E0 Short 8496 km

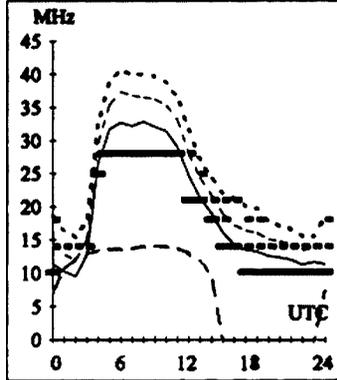

Sydney-Miami 86

First F 0-5 Short 15026 km

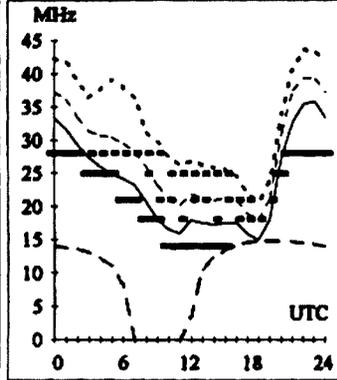

Hobart-Lima 133

First F 0-5 Short 12421 km

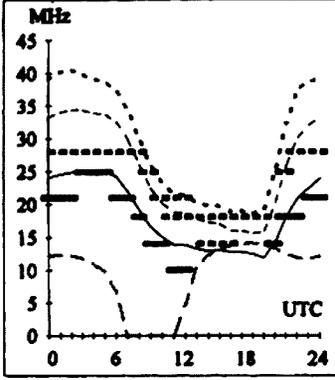

Melbourne-London 131

First F 0-5 Long 23118 km

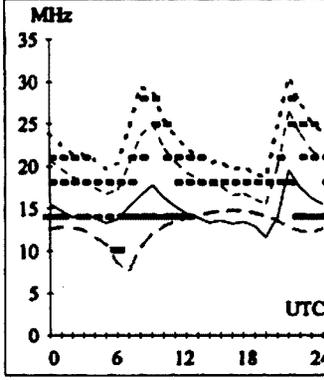

Perth-Maldives 303

Second 3F9-15 3E0 Short 5979 km

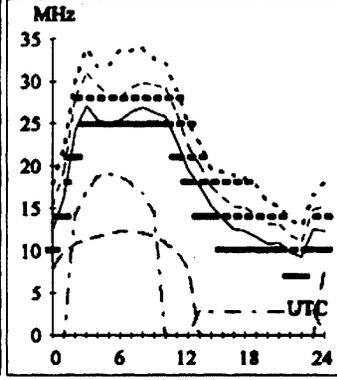

Sydney-New Delhi 302

Second 4F5-11 4E0 Short 10418 km

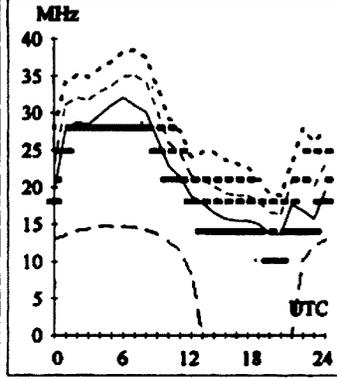

Hobart-New York 80

First F 0-5 Short 16609 km

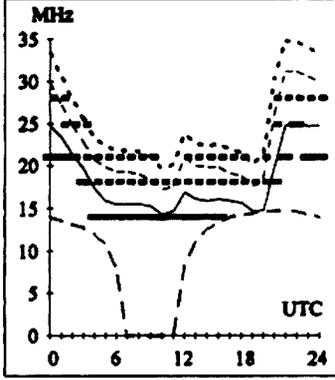

Melbourne-London 311

First F 0-5 Short 16906 km

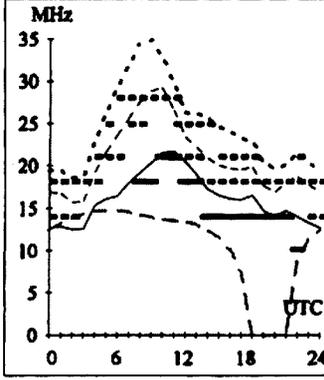

Perth-Rome 303

First F 0-5 Short 13340 km

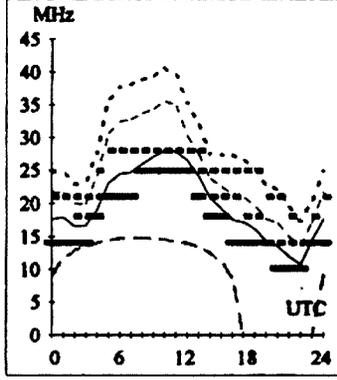

Sydney-Rio de Janeiro 164

First F 0-5 Short 13519 km

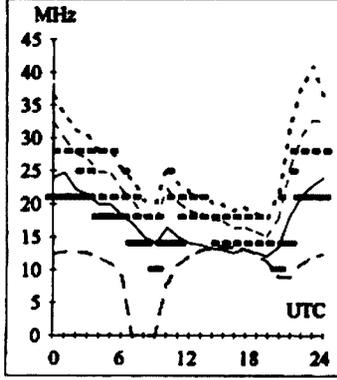

Hobart-Seoul 344

Second 4F7-13 4E0 Short 9175 km

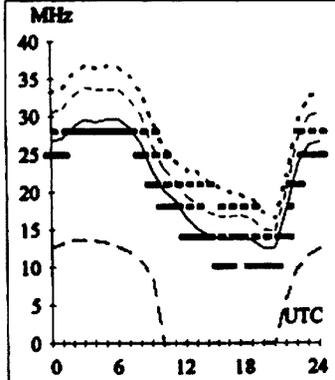

Melbourne-Lusaka 241

Second 4F4-6 4E0 Short 11153 km

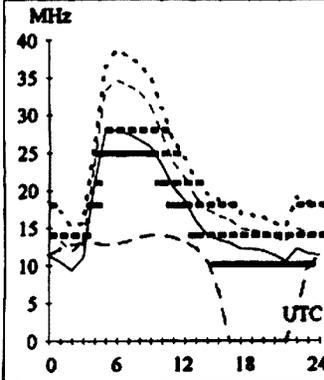

Perth-Vancouver 50

First F 0-5 Short 14823 km

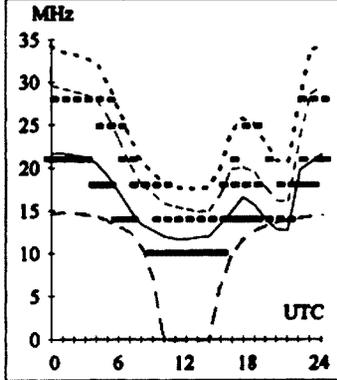

Sydney-Tokyo 350

Second 3F5-11 3E0 Short 7825 km

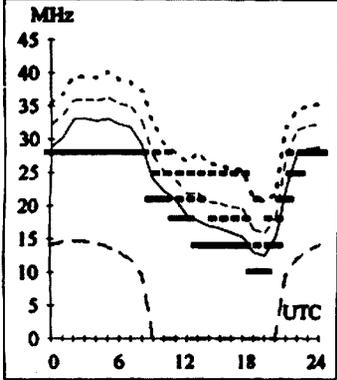

HAMADS

- Hamads may be submitted on the form on the reverse of your current Amateur Radio address flysheet. Please print carefully, especially where case or numerals are critical.
- Please submit separate forms for For Sale and Wanted items, and be sure to include your name, address and telephone number (including STD code) if you do not use the flysheet.
- Eight lines (forty words) per issue free to all WIA members, ninth and tenth lines for name and address. Commercial rates apply for non-members.
- Deceased estates Hamads will be published in full, even if the ad is not fully radio equipment.
- WIA policy recommends that the serial number of all equipment for sale should be included.
- QTHR means the address is correct in the current WIA Call Book.
- Ordinary Hamads from members who are deemed to be in general electronics retail and wholesale distributive trades should be certified as referring only to private articles not being re-sold for merchandising purposes.
- Commercial advertising (Trade Hamads) are pre-payable at \$25.00 for four lines (twenty words), plus \$2.25 per line (or part thereof), with a minimum charge of \$25.00. Cheques are to be made out to: WIA Hamads.
- Copy should be typed or in block letters, and be received by the deadlines shown on page 1 of each issue of Amateur Radio, at:

Postal: Newsletters Unlimited, 29 Tanner Street, Richmond, 3121

Fax: 03 9428 4242 **E-mail:** newsl@webtime.com.au

Please only send your Hamad once

Please send Hamads by mail OR fax OR email (much preferred).

Please do not send by more than one method for any one ad or issue, it is confusing.

FOR SALE NSW

ICOM desk mic. SM20 as new in box \$190 s/n 011597 Philips FM900 2metre XCVR 99chan G.C with ex speaker and circuit \$95 John VK2CCC Ph 02 4984 9770

Kenwood TS-680S 100W HF + 6M excellent condition. Mounting Bracket manual, cartons \$890 ONO. CEC 4CH comms recorder. CMS 10441 ex-navy german made military standard cassette recorder \$200 Les VK2KLD QTHR 02 4297 2737 OR 0419 295 371

Philips FM92 Enhanced Software. Added functions and many scanning options. Single button Anti Repeater. Full details: www.digitalgraphics.com.au/fm900pg.html Digital Graphics P/L 02 9888 3105 PO Box 281 North Ryde NSW 1670

Estate late John Gray VK2BGJ. HF Transceiver Kenwood 430S sn 3050570 Tech. Manual \$700. Kenwood AT-200 Antenna Tuner \$100. Welz SWR Meter \$100. Kenwood Communications Receiver R-1000 \$150. MFJ-1278 Multi-mode data modem \$150. YAESU FT-709 UHF Handheld \$150. YAESU dynamic desk mike YD-844 \$80. Tony VK2BOA 02 4943 8981

YAESU FT990 HF transceiver auto ATV 12/240v op manual deskmike handmike extspkr. 500/250Hz CW filters FM board. Digital memory unit. Terminal mode controller pakratt PK232MBX. Antenna vertical 6band trap hustler. Hamlog. Books. Some test equipment. All for \$1800-QTHR VK2DEB 02 9744 2601 GEORGE.

FOR SALE VIC

TS 680 HF & 6m. Good Cond \$1000. TW4100 2m-70cm good cond \$650. John VK3BIL 03 5756 2149 email vk3bil@netc.net.au

Manuals/Schematics for YAESU etc. FRDX-400rx, FL2000 Linear, FT-DX100/150 tx.rtx, FT-200 (copy), w/FT220 Schematic, FT-101B, FT-75, KYOKUTO FM-2025 A/E, DRAKE SSR-1rx, Schematic for Barlow Wadley XR 800C. \$35 the lot posted. Otherwise recycled. VK3IZ QTHR 03 5156 2053 email: jupeter@net-tech.com.au

Linear Amp; Components. 2X Eddystone split stator 220 pf, 2X heavy duty ceramic switches 6pos. 2pole, Bifilar Fil Choke, Plate Choke, 2 x National Slow Motion Dials, Filter Capacitors Bosch (new), 2 x 10 mfd. 5KV. Bleeder Resistor 2x100k w.w. 180watt. Job Lot, No Separations \$120 O.B.O.

Fluke Digital Multimeter 8810A W/Service Manual. G.C. \$80. VK3IZ QTHR 03 5156 2053 email: jupeter@net-tech.com.au

YAESU FT200 HF XCVR. GC genuine 100W PEP 80-15m, a bit less on 10m. S/N 3G 338381. Spare PA tubes (used OK.) Black case, \$285. B40D general coverage rcvr. ex-navy circa 1950 650kHz-30MHz 15 tubes, excellent working order, weighs 100lbs \$175 ONO. Graham VK3BKG QTHR ph 03 9781 1650 a.h. 03 9669 4167 bus

YAESU FT980 HF t/ciever mint condition no mods, incls mike, h/book access in orig. carton. Rob VK3JE 02 6027 1077 \$1475-

ICOM 738Inbuilt ATU. Dual ant. connectors. 100 tunable memories plus many more features. Little used, original packaging, operators manual. As new condition. \$1480 Ser. 03084. John VK3CJA 03 5866 2551

Kenwood TS450 S. Inbuilt ATU. Program Scan all bands. Original packaging. Operators manual. Excellent condition \$1200. Ser. 30714183. John VK3CJA 03 5866 2551

YAESU FT-736R 2M/70cm all-mode xcvr in mint cond, 20 months old. Incl int. pwr supply, full satellite facilities, data in/out etc. Will accept two additional band modules and ATV option. \$1900. Len VK3BMY 03 5862 3116.

Amateur Radio magazines 1980 to 1995. Ring to arrange pickup. Max VK3VI. Ph 03 5147 1763

Kenwood TS 50-S. Brand new unused. Original packaging and operators manual. Ser. 00142 \$1240 ono. Lic amateurs only. John VK3CJA. 03 5866 2551

FOR SALE QLD

Kenwood R820 RX excellent notch filters, I.F. shift, V.B.T. selectivity ETC digital readout. Matches TS820 V.G.C Offers to VK4KHQ QTHR

YAESU FRG8800 HF RX. 150kHz - 30MHz continuous. Band scan, memory scan and select scanning, AM, FM, CW, SSB V.G.C. Offers to VK4KHQ QTHR

Kenwood TS520S in mint condition \$400. DG5 display \$100. SP520 spkr \$30. Matching external VFO \$90. Will negotiate. Chris VK4YE

ICOM HF all band txcvr IC720A plus matching ICPS20 power supply with speaker hand and desk mikes, handbooks etc AS IS \$600 the lot. VK4CKF QTHR Alan 07 3408 9701 Alan Vugler 1 Cutter Court Bribie Island QLD 4507

Kenwood TS680S \$850. MFJ-1278 multimode controller \$350. Yaesu FT101E (110v model) \$120. Kenwood SM220 station monitor \$220. Peter VK4APG. (07)3264 3851. <mailto:pjgarden@gil.com.au

2 Emtron TE-33 3 element tri-bander & 1:1 balun both new May 98 Kenpro KR-400RC rotator, controller & control cable \$600. Yaesu FT-920 HF/6m transceiver S/N 7L090498 new nov 98 auto atu, DSP, CW & Voice keyer as new \$1900. Peter VK4VW 0754958724 vk4vw@qsl.net

Timewave DSP-9 digi signal processor with PSU PC \$150 ONO sell or swap. Paul VK4DJ 07 4778 6031

Are Hamads cost effective?

I'll say.

They cost nothing and get great results.

Wavemeter class C GWO AC & DC PSUs \$150. Comd xmr BC459A 7-9 MHz C/W valves xtal \$50. BC348 recr C/W valves no PSU original needs checking \$80. Hitachi 8tr t/recorder deck several prerec tapes GWO \$30. B2 (suitcase set) PSU spare recs set manual \$50. John VK4NZ QTHR 07 5446 1458

Kenwood KSC-1 Desk top chargers 12.6v 1.2amp easily adapted for various connection \$4 each. Peter VK4NJQ 07 3351 6374

FOR SALE SA

ICOM IC738 S/N 2456 HF Transceiver fitted with automatic antenna tuner, excellent condition, manual, in original packaging. \$1800. John VK5HJ 08 8535 4278

Large professionally built all valve AM transmitter built in CRO separate BFO with own power supply 130 watts output transmitter modulator & power supply all built in shielded frame. Ideal for senior enthusiasts. VK5ZLC QTHR 08 8294 6906

ICOM IC-281H 2M FM mobile transceiver 50 watts serial #16044 complete with antenna \$475 ONO. Noel VK5NL QTHR 08 8842 2502 OR 8842 3486

FOR SALE TAS

YAESU FT900 HF t/ciever inc. gen. cov. Reciever Collins Filter auto ATU. Boxes, manuals, new, 3 1/2 months old not used. Offers please. ICOM EX106 FM unit suit IC551. New in box. Offers. Pakratt Com. Serial RS232 Conn & Cartridge Software. Suit Commodore C64 & 128 Suitable PK232 Allen VK7AN 0417 354 410 OR 03 6327 1171

WANTED NSW

One only heliax connector type 45AW or 45AN. Prefer 45 AN new or used. QTHR VK2AS Art 9416 7784

Wanted!!! VHF Converter for Kenwood R-2000 Comms Rcvr.

ANY SENSIBLE PRICE paid + shipping from ANYWHERE!

Michael VK2XMD PO Box 158 Lawson NSW 2783 Australia.

Wanted Hernia! Old, pre-loved receivers, working or not. Junked sets. The bigger the better! Will pay dollars if needed. I will help clean the shack. Mad SWL and historian. Will personally collect in Sydney area and will bring the broom! Call John 02 9533 6261 WIA L21068

ph +61 247 591 421 or 0414 591 421
md@pnc.com.aumeter.

AMPEX reel to reel tape recorder 2-30 MHz plug in module for bird through line watt meter Ray VK2FW 02 6365 3410 mornings. QTHR

WANTED VIC

Kenwood VFO-230, SP-230, MC355 GC + GWO. Damien VK3RX 03 5427 3121

Collins 30S-1 amp. Any condition considered. Ph. Lindsay after 6pm 03 9509 8423 VK3CML

FT101 second mixer box required. Max VK3VI Ph 03 5147 1763

WANTED QLD

Two(2) "T" band Philips 828 T/cvrs unmodified and working order. Price to Gordon VK4KAL QTHR 07 4985 4168

30 Pin 4 MEG SIMMS RAM. Allan VK4NBZ 07-4039 2876

Spectrum analyzer software for IBM P.C. or details. Also PC-to-JRC, NRD525 RX interface. VK4KHQ QTHR

YAESU FIF232C CAT interface and software for FRG8800 RX. VK4KHQ QTHR

WANTED WA

Power transformer for YAESU YO-901 Multiscope or an unservicable unit with good transformer. Bob VK6ABS QTHR 08 9075 4136

WANTED TAS

HP8444A tracking generator for the HP 141T Spectrum analyzer system. Any condition. Trevor VK7TB 9 Norfolk St Perth 7300 Tasmania. Phone 03 6398 2118. Fax 03 6398 1629.

TRADE ADS

● **AMIDON FERROMAGNETIC CORES:** For all RF applications. Send business size SASE for data/price to RJ & US Imports, PO Box 431, Kiama NSW 2533 (no enquiries at office please ... 14 Boanyo Ave Kiama).

www.cyberelectric.net.au/~rjandusimports
Agencies at: Assoc TV Service, Hobart; Truscotts Electronic World, Melbourne and Mildura; Alpha Tango Products, Perth; Haven Electronics, Nowra.

● **WEATHER FAX programs** for IBM XT/ATs *** "RADFAXZ" \$35.00, is a high resolution short-wave weather fax. Morse and RTTY receiving program. Suitable for CGA, EGA, VGA and Hercules cards (state which). Needs SSB HF radio and RADFAX decoder. *** "SATFAX" \$45.00, is a NOAA, Meteor and GMS weather satellite picture receiving program. Needs EGA or VGA & WEATHER FAX PC card. + 137 MHz Receiver. *** "MAXISAT" \$75.00 is similar to SATFAX but needs 2 MB of expanded memory (EMS 3.6 or 4.0) and 1024 x 768 SVGA card. All programs are on 5.25" or 3.5" disks (state which) plus documentation, add \$3.00 postage. ONLY from M. Delahunty, 42 Villers St. New Farm QLD 4005. Ph 07 358 2785.

The Amateur Radio Cover Photo Quest



Amateur Radio magazine has an Amateur Radio related photograph on the front cover of each edition. And we need some!

CURRENTLY THE STOCKS are running low and almost all that we have are either a man up an antenna mast or a sunset with a silhouette of an antenna system.

So, if you can give us a photo that we use we will give you a present in return, probably a full colour reproduction of your cover.

So please get out that camera and start shooting.

Cheers for now, Bob Harper VK4KNH.

Short Conditions

1. The photographs must have an Amateur Radio interest such as famous/prominent amateurs, equipment (especially Home Brew), or events such as hamfests and competitions, Jota, etc.
2. You must own the rights to the photograph and be prepared to allow Amateur Radio Magazine the right to publish the photograph. Attach a piece of paper stating: "I, [your name], the copyright owner of this photograph, grant Amateur Radio Magazine the right to publish this photograph at any time and in any manner they see fit." Then sign and date the statement.
3. All photographs should be captioned with the following information: who took the photo, where and when it was taken, what the subject is and who is depicted in it.
4. The photograph must be a colour print at least 3" by 5". Photographs should be clear, well focused and with good contrast. Avoid background clutter.
5. All photographs will remain the property of the WIA and will be kept as the beginning of a photographic collection.
6. Photographs will be assessed on their content, quality and appeal. The selection will be based on publication needs and not necessarily on technical merit. The publication committee, Editor and Production Manager will have the final say on the selection.
7. Photographs should be sent to Bob Harper, PO Box 288, Beerwah 4519 and the envelopes should have a stiff insert and be marked with the words "Photographs - DO NOT FOLD"

WIA Division Directory

The WIA consists of seven autonomous State Divisions. Each member of the WIA is a member of a Division, usually in their residential State or Territory, and each Division looks after amateur radio affairs within its area.

Division	Address	Officers	News Broadcasts	Note: All times are local. All frequencies MHz.	Fees
VK1 ACT Division GPO Box 600 Canberra ACT 2601		President Hugh Blemings Secretary John Woolner Treasurer Les Davey	VK1YYZ VK1ET VK1LD	3,590, 146.950, 438.375, 438.325, 438.225 & 438.025 FM each Sunday from 8.00pm AEST. News text on packet BCAST@VK1BBS, http://www.vk1.wia.ampr.org & aus.radio.amateur.misc newsgroup. Send items by packet as personal message BCAST@VK1BBS or e-mail to broadcast@vk1.wia.ampr.org .	(F) \$72.00 (G) (S) \$58.00 (X) \$44.00
VK2 NSW Division 109 Wigram St Parramatta NSW (PO Box 1066 Parramatta 2124) Phone 02 9689 2417 Freecall 1800 817 644 Fax 02 9633 1525		President Michael Corbin Secretary Eric Fossey Treasurer Eric Van De Weyer (Office hours Mon-Fri 11.00-14.00)	VK2YC VK2EFY VK2KUR	From VK2WI 1.845, 3.595, 7.146*, 10.125, 14.170, 24.950, 28.320, 29.120, 52.120, 52.525, 144.150, 147.000, 438.525, 1273.500 (* morning only) with relays to some of 18.120, 21.170, 581.750 ATV sound. Many country regions relay on 2 m or 70 cm repeaters. Sunday 1000 and 1930. Highlights included in VK2AWX Newcastle news, Monday 1930 on 3.593 plus 10 m, 2 m, 70 cm, 23 cm. The broadcast text is available on the Internet newsgroup aus.radio.amateur.misc , and on packet radio.	(F) \$69.00 (G) (S) \$56.00 (X) \$41.00
VK3 Victorian Division 40G Victory Boulevard Ashburton VIC 3147 Phone 03 9885 9261 Fax 03 9885 9298		President Jim Linton Secretary Barry Wilton Treasurer Rob Hailey (Office hours Tue & Thur 0830-1530) e-mail: vk3wi@rint.com.au Web: http://www.tbsa.com.au/~wivavic/	VK3PC VK3XV VK3NC	VK3BWI broadcasts on the 1st Sunday of the month, starts 10.30 am. Primary frequencies, 3.615 LSB, 7.085 LSB, and FM(R)s VK3RML 146.700, VK3RMM 147.250, VK3RWG 147.225, and 70 cm FM(R)s VK3ROU 438.225, and VK3RMU 438.075. Major news under call VK3WI on Victorian packet BBS and WIA VIC Web Site.	(F) \$75.00 (G) (S) \$61.00 (X) \$47.00
VK4 Queensland Division GPO Box 638 Brisbane QLD 4001 Phone 07 3221 9377		President Colin Gladstone Secretary Peter Harding Treasurer Alistair Elrick e-mail: secretary@wiaq.powerup.com.au Web: http://www.wiaq.powerup.com.au	VK4ACG VK4JPH VK4FTL	1.825 MHz SSB, 3.605 MHz SSB, 7.118 MHz SSB, 14.342 MHz SSB, 21.175 MHz, 28.400 MHz SSB, 29.220 MHz FM, 53.725 MHz FM, 147.000 MHz FM, 438.500 MHz (Brisbane only), and regional VHF/UHF repeaters at 0900 hrs EAST Sunday. Repeated on 3.605 MHz SSB & 147.000 MHz FM at 1930 hrs EAST Monday. Broadcast news in text form on packet under WIAQ@VKNET.	(F) \$74.00 (G) (S) \$60.00 (X) \$46.00
VK5 South Australian Division 34 West Thebarton Rd Thebarton SA 5031 (GPO Box 1234 Adelaide SA 5001) Phone 08 8352 3428 Fax 08 8264 0463		President Ian Hunt Secretary Merv Millar Treasurer Joe Burford Web: http://www.vk5wia.ampr.org/	VK5QX VK5MX VK5UJ	1827 kHz AM, 3.550 MHz LSB, 7.095 AM, 14.175 USB, 28.470 USB, 53.100 FM, 147.000 FM Adelaide, 146.700 FM Mid North, 146.800 FM Mildura, 146.825 FM Barossa Valley, 146.900 FM South East, 146.925 FM Central North, 147.825 FM Gawler, 438.425 FM Barossa Valley, 438.475 FM Adelaide North, ATV Ch 35 579.250 Adelaide. (NT) 3.555 USB, 7.065 USB, 10.125 USB, 146.700 FM, 0900 hrs Sunday, 3.585 MHz and 146.675 MHz FM Adelaide, 1930 hrs Monday.	(F) \$75.00 (G) (S) \$61.00 (X) \$47.00
VK6 West Australian Division PO Box 10 West Perth WA 6872 Phone 08 9351 8873		President Cliff Bastin Secretary Christine Bastin Treasurer Bruce Hedland-Thomas Web: http://www.faroc.com.au/~vk6wia/ e-mail: vk6wia@faroc.com.au	VK6LZ VK6ZLZ VK6OO	146.700 FM(R), 438.525 FM(R), 29.120 FM at 0930 and 1900 hrs Sundays from Perth, relayed (morning only) on 1.865, 3.564, 3.582 (Busselton), 7.075, 14.116 (North), 14.175 (East), 21.185, 50.150; (morning and evening) 146.900(R) Mt William (Bunbury), 147.00(R) Katanning, 147.200(R) Cataby, 147.250(R) Mt Saddleback (Boddington), and 147.350(R) Busselton; (evening only) 1.865, 3.564 MHz.	(F) \$62.00 (G) (S) \$50.00 (X) \$34.00
VK7 Tasmanian Division 24 Targett Street Scamander TAS 7250 Phone 03 6372 5305		President Ron Churcher Secretary Paul Godden Treasurer John Klop Web: http://www.wia.tasnet.net e-mail: vk7kpg@hamnet.hotnet.com.au	VK7RN VK7KPN VK7KCC	146.700 MHz FM (VK7RHT) at 0930 hrs Sunday relayed on 147.000 (VK7RAA), 146.725 (VK7RNE), 146.625 (VK7RMD), 3.570, 7.090, 14.130, 52.100, 144.150 (Hobart), repeated Tues 3.590 at 1930 hrs.	(F) \$74.00 (G) (S) \$60.00 (X) \$46.00
VK8 Northern Territory (part of the VK5 Division and relays broadcasts from VK5 as shown, received on 14 or 28 MHz).					

Membership Grades

Full (F) Pension (G) Needy (G) Student (S) Non receipt of AR (X)
Three-year membership available to (F) (G) (X) grades at fee x 3 times.

ADVERTISERS INDEX

Terlin	IFC	Av-Com	16
Icom.....	OBC, 55	Amateur Transceiver Radio ...	20
Jaycar	17	Dick Smith	IBC 28,29
Andrews	16		

TRADE PRACTICES ACT

It is impossible for us to ensure that the advertisements submitted for publication comply with the Trade Practices Act 1974. Therefore, advertisers and advertising agents will appreciate the absolute need for themselves to ensure that the provisions of the Act are strictly complied with.

VICTORIAN CONSUMER AFFAIRS ACT

All advertisers are advised that advertisements containing only a PO Box number as the address cannot be accepted without the addition of the business address of the box-holder or seller of the goods.

YAESU'S DONE IT AGAIN



FT-920 HF/6m Transceiver With DSP

Now there's no excuse for not taking advantage of the latest advances in Digital Signal Processing, transceiver design plus the fun of 6m operation. The stunning new Yaesu FT-920 is a high performance HF/6m multi-mode base station transceiver that provides 100W PEP output on the 160-6m bands, incredible front-end performance based on the FT-1000MP design, and a huge array of features that make it a pleasure to use.

At first glance Yaesu's renowned Omni-Glow LCD screen is obvious, and its wide-angle view provides a wealth of information about the transceiver's operating status with multi-function metering, dual frequency displays and an Enhanced Tuning scale for DSP bandwidth, CW tuning, FM discriminator and more. Inside, the FT-920 is built around a rugged diecast unibody chassis which provides excellent heatsinking for the low distortion dual MRF255 160-6m FET power amplifier.

For more comfortable operating when weaker signals are present Yaesu's engineers dedicated themselves to enhancement of real-world signal to noise ratios, and after thousands of hours of design and testing have produced an industry-leading 33.3MIPS (millions of instructions per second) processing speed DSP in the FT-920 that provides a two-parameter noise reduction system with 32 steps of front panel adjustment. This amazing system also provides dual control DSP passband tuning, DSP auto-notch filter, an amazing new transmit Digital Speech Processor, DSP mic equalisation, fast acting DSP VOX circuitry as well as a Contest-ready Digital Voice Recorder!

Other features include an all-band (160-6m) auto antenna tuner which also provides greater receiver band-pass protection, Direct Digital Synthesis for clean local oscillators, selectable frequency-optimised receiver front-end pre-amps, and a Shuttle Jog tuning ring for fast QSY.

A Dual Watch receive system allows you to check for band openings, especially handy when monitoring 6m. Also provided are SSB/CW/FM operation (AM with optional filter), 127 memories with alphanumeric labelling, IF shift and IF noise blanker to fight interference, plus an extensive menu system for selecting most "set and forget" functions. The FT-920 is supplied with an MH-31B8 hand mic, DC power lead and comprehensive instruction manual.

D 3420

Why not call for a copy of the Yaesu 6 page FT-920 colour brochure to learn more about this efficient transceiver that's without peer in its price class.

YAESU

\$2695

2 YEAR WARRANTY



That's where you go!

MORE

GREAT

GEAR

FROM

ICOM

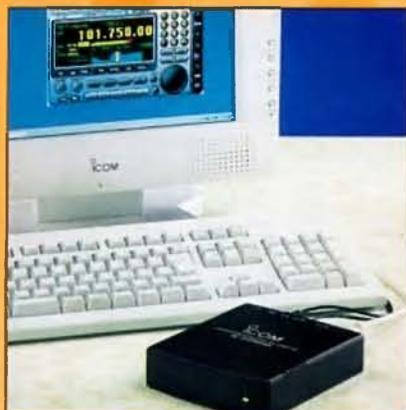

PCR100 Cruise the air waves with your computer. Turns your PC into a high performance 0.5 - 1300 MHz receiver (FM/WFM/AM modes) with plug'n play installation. Multi function control panel, wide frequency coverage, and unlimited memory channels.

R2 Fit the world's airwaves in your shirt pocket. Just 8.6cm high, wide 0.5 - 1300 MHz frequency range divided into 9 bands plus FM/WFM/AM, 400 memory channels, great sound in rugged water resistant construction.

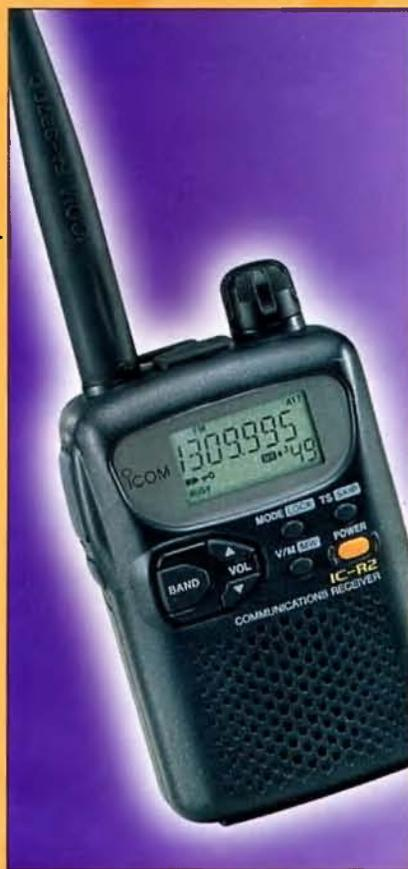

2800H A totally new approach to dual band mobile.

Powerful performance on 2m and 70cm bands, remote control capability, and a first for mobile rigs...a multi-function colour LCD screen! All your information is right in front of you in colourful 3D-like characters and icons.



T81A A remarkably compact quad bander.

Superb clarity on the 6m, 2m, 70cms and 23cm bands. It's water resistant, with tone squelch and pocket beep functions standard, plus you can change volume and bands even quicker with the 'joy-stick' style multi-function switch.

706MKIIG The amazing evolution of the legendary 706.

Frequency coverage is expanded to the 70 cm band and output power is increased for the 2m band. You get base station performance and features in a mobile rig-sized package.



ICOM

Clearly Ahead

2 YR WARRANTY

See your nearest Icom Dealer, call Icom on 1800 338 915, or visit our website at www.icom.net.au



May 1999
Volume 67 No 5

Amateur Radio

Journal of the Wireless Institute of Australia

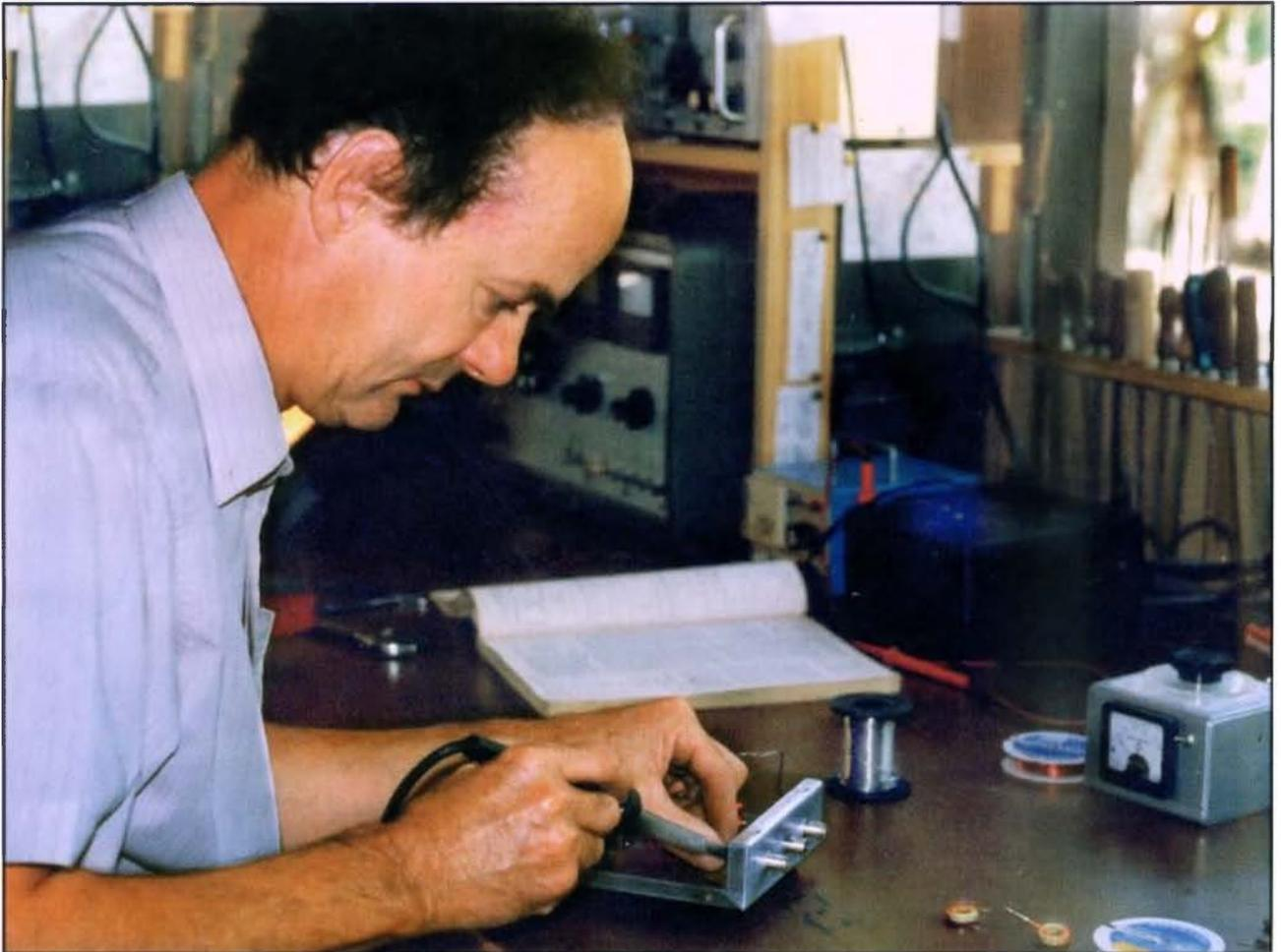

Full of the latest amateur radio news, information and technical articles, including...

- ★ **APRS in the 1998 Sun-Herald City to Surf Race**
- ★ **Twin Meter SWR Bridge**
- ★ **CTCSS Tone Decoder**
- ★ **The Tower of Strength**
- ★ **LIPD Devices in Australia**
- ★ **Radio Reminiscences**

Plus *lots of other articles, news and special interest columns.*

QMS - 7

Antenna Coupler System

Quick Mount System
for mobile HF and VHF use



SG-230 MICROPROCESSOR CONTROLLED ANTENNA COUPLER (1.6-30MHz) 200W Smarttuner

The SG-230 Smarttuner automatic antenna coupler can be used within its power rating with any HF Transceiver in range of 1.6-30MHz. Designed for marine, portable and fixed base applications. For antenna types: 23ft marine whip for 1.6 to 30MHz and with 9ft. minimum antenna for 3-30 MHz operation

Number of channels unlimited
Frequency range 1.6-30 MHz
Power rating 200 watts PEP maximum 12 VDC. operation
SWR: Less than 1:1.5
Tune power: 3 watts nominal
Weight: 8Lbs.
Dimensions: 12.5 x 10.5 x 3
Supplied with 9ft. cable for coaxial and DC power.

- QMS-7 offers unsurpassed frequency agility without user intervention
- SG-231 Smarttuner automatic antenna coupler, SG-307 extended full-range antenna, and weather resistant QMS-7 package
- 1 to 60 Mhz-continuous-instant tuning while you drive
- Rated for use on moving vehicles at up to 75 Miles (120km) per hour



Terlin
OUTbacker

PO BOX 1197
Canning Vale W.A. 6155
www.outbacker.com.au
terlin@outbacker.com.au

Ph (08) 9455 4288
Fax (08) 9455 4289

Amateur Radio

Volume 67
Number 5
May 1999

The Journal of the Wireless
Institute of Australia

ISSN 0002-6859

Amateur Radio is published by the Wireless Institute of Australia ACN004 920 745 as its official Journal on the last Friday of each month

Editorial

Editor: Bill Rice* VK3ABP
Production Manager: Bob Harper VK4KNH
Snr Technical Editor: Peter Gibson* VK3AZL
Technical Editors: Evan Jarman* VK3ANI
Gil Sones* VK3AUI
Contributing Editors: Ron Fisher* VK3OM
Don Jackson* VK3DBB
WIA News Editor: David Thompson VK2NH

*Publications Committee member

Advertising

Mrs June Fox, WIA Federal Office
PO Box 2175 CAULFIELD JUNCTION VIC 3161
Tel: (03) 9528 5962 Fax (03) 9523 8191
email armag@hotmail.net.au

Hamads

"Hamads" Newsletters Unlimited
29 Tanner Street, Richmond VIC 3121
Fax: (03) 9428 4242
e-mail: news1@webtime.com.au

Amateur Radio Correspondence

All correspondence, contributions and queries about the *content* should be sent to:

The Editor **Amateur Radio**
PO Box 2175, CAULFIELD JUNCTION VIC 3161
email armag@hotmail.net.au
Tel: (03) 9528 5962 Fax (03) 9523 8191

Amateur Radio Delivery

All queries regarding delivery should be directed to:

Amateur Radio WIA Federal Office
PO Box 2175 Caulfield Junction Vic 3161
Tel: (03) 9528 5962 Fax (03) 9523 8191

Registered Office

10/229 Balaclava Road
Caulfield North VIC 3161
Tel: (03) 9528 5962 Fax (03) 9523 8191
Business hours: 9.30am-3pm weekdays

Editorial & Display Booking Deadlines

June 14/5/99
July 11/6/99
August 11/7/99

Hamad & Display Material Deadline

June 21/5/99
July 18/6/99
August 21/7/99

Production

Administration, Drafting, Design & Sub-editing
Shadtree Publishing & Imaging
PO Box 288 BEERWAH QLD 4519

Pre-press, print and mail management
Newsletters Unlimited (03) 9428 3458

Printed by Streamline Press, Melbourne (03) 9417 2766

Mailed by IMS, Melbourne (03) 9291 5888

Receipt of Amateur Radio by mail

This issue was delivered to Australia Post on Wednesday May 5. If you are a financial member and have not received your copy by the 15th of the month please check with your local Post Office before contacting the registered office of the WIA.

Copyright and Reproduction

The copyright in this magazine, except where specifically noted, is held by Wireless Institute of Australia ©WIA 1999. Permission to republish articles in any form must be obtained in writing from the Institute (other than for purposes of 'fair dealing'). This permission is usually freely given for information purposes.

Technical

A Twin meter SWR Bridge 21
Drew Diamond VK3XU

CTSS Tone Detector 24
Warren Stirling VK3KSW

Technical Abstracts 30
Gil Sones VK3AUI

General

Is It Fate? 11
Alan Shawsmith VK4SS

A Tower of Strength 12
Kevin Peacock VK4VKD

Amateur Radio on the Web 14
Bob Harper VK4KNH

APRS Enters Sun-Herald City to Surf 18
Darryl Smith VK2TDS

Radio Reminiscences The Tasmanian Search for ET 20
Jim Davis VK4KNH

The Impossible QSO 20
Alan Shawsmith VK4SS

Greek Call Sign 38

Columns

Advertisers' Index 52

ALARA 10 HF Predictions 52

AMSAT Australia 36 Intruder Watch 50

ARDF 40 Ionospheric Update 51

Awards 16 New Members 2

Club News 8 Pounding Brass 33

Column 73 34 Repeater Link 41

Contests 46 Silent Key 50

WIA Divisions News Spotlight on SWLING 35

VK1 Notes 6 VHF/UHF - An Expanding World 42

VK4 Notes 6 WIA Comment 3

VK7 Notes 7 WIA News 3

Editor's Comment 2 WIA Division Directory 56

Hamads 54 WIA Federal Directory 2

Our cover this month

Drew Diamond VK3XU

hard at work on yet another project to share with fellow amateurs.

Contributions to Amateur Radio

Amateur Radio is a forum for WIA members' amateur radio experiments, experiences opinions and news. Manuscripts with drawings and or photos are always welcome and will be considered for publication. Articles on disc or email are especially welcome. The WIA cannot be responsible for loss or damage to any material. A pamphlet, How to write for Amateur Radio is available from the Federal Office on receipt of a stamped self-addressed envelope.

Back Issues

Back issues are available directly from the WIA Federal Office (until stocks are exhausted, at \$4.00 each (including postage within Australia) to members.

Photostat copies

When back issues are no longer available, photocopies of articles are available to members at \$2.50 each (plus an additional \$2 for each additional issue in which the article appears).

Disclaimer

The opinions expressed in this publication do not necessarily reflect the official view of the WIA and the WIA cannot be held responsible for incorrect information published.

Amateur Radio Service

A radiocommunication service for the purpose of self-training, intercommunication and technical investigation carried out by amateurs; that is, by duly authorised persons interested in radio technique solely with a personal aim and without pecuniary interest.

Wireless Institute of Australia

The world's first and oldest
National Radio Society
Founded 1910

Representing
The Australian Amateur Radio Service

Member of the
International Amateur Radio Union

Registered Federal Office of the WIA

10/229 Balaclava Road
Caulfield North Vic 3161
Tel: (03) 9528 5962
Fax (03) 9523 8191
<http://www.wia.org.au>

All mail to
PO Box 2175 Caulfield Junction VIC 3161

Business hours: 9.30am-3pm weekdays

Acting Federal Secretary

Peter Naish VK2BPN

Federal Office staff

June Fox Bookkeeper
Rita Trebilco VK3IF Examinations Officer

Council

President	Peter Naish	VK2BPN
VK1 Federal Councillor	Michael Jenkins	VK1MJ
VK2 Federal Councillor	Michael Corbin	VK2YC
VK3 Federal Councillor	Brenda Edmonds	VK3KT
VK4 Federal Councillor	Ross Marren	VK4AMJ
VK5 Federal Councillor	John McLachlan	VK5NB
VK6 Federal Councillor	Will McGhie	VK6UU
VK7 Federal Councillor	Andrew Dixon	VK7GL

Executive

Peter Naish	VK2BPN
Martin Luther	VK5GN
Wally Howse	VK6KZ
Neil Penfold	VK6NE

Federal Coordinators

AMSAT	Graham Ratcliff	VK5AGR
Awards	John Kelleher	VK3DP
Contests	Ian Godsill	VK3DID
Education	Brenda Edmonds	VK3KT
FTAC	John Manin	VK3KWA
Historian	John Edmonds	VK3AFU
JARU	Grant Willis	VK22WI
Intruder Watch	Gordon Loveday	VK4KAL
ITU Conference and study group	David Wardlaw	VK3ADW
Public Relations	David Thompson	VK2NH
QSL Manager (VK6, VK0)	Neil Penfold	VK6NE
Videotapes	Don Bland	VK4TVD

ACA Liaison Team

Brenda Edmonds	VK3KT
David Wardlaw	VK3ADW
Peter Naish	VK2BPN

EDITORS COMMENT

Hamads

One of the most popular services provided by this magazine is the page or two of members' advertisements placed just inside the back cover.

Up to eight lines per issue can be inserted free, with two more free lines for the address details. Forms are provided on the back of the "fly sheet" address label included with each AR for you to write out your Hamad in neat block capitals, or use a typewriter (if there are any left in this computer age!).

Some months ago I was asked by our then Production Manager Bill Roper VK3BR to mention in an editorial some of the difficulties he had from time to time in dealing with the Hamads. Time galloped on, Bill ceased to be Production Manager, and several months elapsed before the topic could be "resurrected".

So here we are: the facts and factors of Hamads.

Most of the ads are from the two most populous states, NSW and Victoria. I guess that's no surprise. The actual numbers "ebb and flow" somewhat. We had 40 last month. A minimum of perhaps 20 up to a maximum approaching 100 probably covers all cases.

These days many arrive by fax and e-mail as well as by post. No matter how they come they have to be read and keyed in. Sometimes we have problems reading them. That's the reason for wanting block capitals or typing. Abbreviations and punctuation are areas where confusion can arise. If you are in doubt check in a few back issues and see what abbreviations are popular.

Handwritten faxes are often quite difficult to read. The best method is e-mail direct to our typesetters (Newsletters Unlimited). They have the task of putting the ads all together so that your hapless Editor can check them, or delegate the task to someone else as time permits.

So there it is. We look forward to your next Hamad!

73 Bill Rice VK3ABP Editor

Note: Hamads sent by e-mail to news1@webtime.com.au arrive quicker and are entered electronically, exactly as you write them. If you do not have e-mail do not worry, any form is OK, but legibility is important.

NEW WIA MEMBERS

The WIA bids a warm welcome to the following new members who were entered into the WIA Membership Register during the month of MARCH

L21163	MR M GRIFFIN	VK2XEG	MR A R HOOD
L21164	MR G G PEARCE	VK2ZJS	MR J DRINKWATER
L21165	MR D W WINCKLE	VK3ET	MR J A CLARK
L21166	MR P M PASCOE	VK3TFG	MR F W GREGORY
L21167	MR G C HILL	VK5GX	MR P M SPINKS
L50747	MR G BANGETER	VK5HS	MR I SMITH
L50748	MR L J CHAPMAN	VK5TTL	MR L J MAY
L50749	MR L J MORRIS	VK6KLN	MR L A NORTH
L50750	MR A G ROBINSON	VK6NKT	MR G L GARRATT
L50751	MR A IANNELLA	VK7HJD	MR J D DABNER
VK1HAG	MR S AMMOSCATO	VK7HSE	MR S V EVANS
VK1JA	MR J A HEWSON	VK8JJ	MR J J LAMBERT
VK1WR	MR J W RAWLINGS		
VK1ZQR	MR R C QUICK		
VK2CRC	MR R J COLEMAN		
VK2DHI	DR H P H IVENS		
VK2HCF	MR C FORKIN		
VK2KNR	MR N E RUSSELL		

The WIA regrets to announce the recent passing of:-
B G POWELL VK2AIZ
V (FRANK) WALLER VK2EHY
LA CHAPPELL VK7LC



**Federal President, Peter Naish
VK2BPN.**

Busy time for WIA

This is a particularly busy time of the year for the WIA.

It is in autumn that many of the WIA State Divisions hold their Annual General Meetings and elect their Councils and Officers for the year ahead.

On these occasions the members have the opportunity to voice their opinions on how they see the WIA performing. Hopefully some new ideas on future policy will emerge for incorporation into the log of issues that are continually pursued by the WIA Federal Council.

In May, we have the Annual Convention of the WIA Federal Council where national and international matters are reviewed and progressed to provide a national policy for implementation with the ACA and IARU.

The WIA Federal ACA Liaison Committee is continuing its dialogue with the ACA in Canberra. Recent matters which have been prominent include the entry into the 70 cm band of a variety of Low-Interference-Potential Devices (LIPD's) under a class licence scheme established a few years ago by the ACA (then the SMA).

Unfortunately for some amateur radio users, these LIPD's have become a source of great concern and annoyance with a number of recent cases of interference to amateur radio repeaters alleged to be due to such devices. Your liaison committee is continuing to seek ways of overcoming this threat to our long established repeater stations.

The long-awaited report from ACA on the possible extension of the 80 metre DX window has now arrived. It contains some positive options for the amateur radio usage of the DX window and is being reviewed by the Liaison team

Recently, the WIA met with representatives of DOCITA (Department of Communications, Information Technology and the Arts) in Canberra to provide additional support to our recent submission on the review of the Radio-Communications Act.

This proved to be a very fruitful meeting with the Department's representatives gaining a first hand knowledge of the desires and concerns of the Amateur Radio Service in Australia. They showed considerable interest in the WIA's submission and promised to continue the association with us.

It seems that in this life very little comes free!

The continual pursuit of better representation for amateur radio enthusiasts is no exception. Again, I must commend the many volunteers who spend long hours devoting their spare time to working to resolve the many issues that worry us. Please give them the support they deserve.

We can all confidently answer our critics by saying that the WIA is very much "doing something about it" but it does take time to achieve some of our goals.

Peter Naish, VK2BPN
WIA Federal President.

WIA NEWS

WIA News Prepared, researched and compiled by
David Thompson VK2NH
Federal Public Relations Coordinator.

Mobile Telephone Jammers Prohibited

The Australian Communications Authority (ACA) has declared mobile telephone jammers to be prohibited devices under the *Radiocommunications Act 1992* (the Act).

The prohibition makes it an offence to operate or supply, or possess for the purpose of operation or supply, such a device. The ACA's decision was made following public consultation, and is the first time the ACA has prohibited the use of a device under the Act.

The declaration describes the prohibited device as 'a device designed to operate within the frequency bands 870-960 MHz or 825-845 MHz and to interfere with radio-communications or disrupt or disturb radio-communications'. These bands are used primarily for mobile telephone services.

The ACA is prepared to take action, including prosecution, if necessary, against any person operating or supplying a jammer, or possessing a jammer for the purpose of operation or supply, that is likely to affect these frequency bands. Penalties include substantial fines and imprisonment.

The ACA's spectrum management responsibilities are to facilitate access to the radiofrequency spectrum for all forms of radio-communications, including those used to provide public mobile telecommunications services.

ACA now Reporting on Telecommunications Y2K Readiness

The Australian Communications Authority (ACA) has released its *Telecommunications Performance Monitoring Bulletin* for the December 1998 quarter.

The bulletin reports on carrier performance in the fixed and mobile phone networks, and, for the first time, includes a report on the Y2K readiness of the telecommunications industry. The ACA will provide regular reports on this issue leading up to 1 January 2000 and during 2000.

The state of Y2K readiness has significant potential to affect network integrity, the quality of service of the carriers and consumer satisfaction. A high level of awareness exists within the industry regarding the Y2K issue.

The ACA will expand the format of future Y2K reporting to include access to emergency services and effects on customer equipment.

A copy of the Telecommunications Performance Monitoring Bulletin, can be obtained from the ACA by calling (03) 9963 6968.

New Phone Number for WICEN New South Wales

WICEN (NSW) is reported to have a new digital telephone. David Horsfall VK2KFU tells us the number is 0408-397-217.

APRS

If you are interested in APRS, there is a mailing list for Australian participants, according to Darryl Smith VK2TDS. For details, send an e-mail message to VK2TDS@ozemail.com.au

To see APRS working on the Internet, just look at the URL <http://www.aprs.net>

Sun Powered

WIA News has recently been told about Bill May VK2WHM out Weetalibah way, which is in the Central West of New South Wales, (in fact seven miles the other side of the black side of the black stump).

It seems that Bill has an interesting solar power setup for his amateur gear.

About 10 years ago he made up a bank of cells that track the sun. Bill says that tracking is about 40% more efficient than not tracking.

Among the advanced state of the art equipment he uses is the complete rear axle with differential of a car and a record player motor plus of course the electronics and simple sensing for tracking.

Thanks to NSW Councillor Ken Westerman VK2AGW who says we could make quite an article out of Bill's ingenuity.

Staff Changes at the ARRL.

David Patton, W9QA, will join the ARRL staff April 26 as Special Assistant to Executive Vice President Dave Sumner K1ZZ.

Dave is a former editor of the *National Contest Journal*. He holds a Bachelor's and Master's Degrees in Geography from Western Illinois University.

Via ARRL

International Space Station Commander is a Ham

The expedition commander of the first International Space Station crew is now a ham radio operator.

U.S. astronaut William G. "Shep" Shepherd, was issued the call sign KD5GSL. This after passing a Technician class exam.

Once it is habitable, Shepherd will join Russian cosmonauts Yuri Gidzenko and Sergei Krikalev on board the ISS.

Via ARRL

FCC Says Reciprocal Permits Now Paperless

The FCC is advising applicants for reciprocal operating permits that an application is no longer required.

Under new ULS rules that took effect February 12, the FCC Form 610A has passed into history.

The new rules also will pave the way for US hams to more easily operate in most of Europe.

The FCC is expected to issue a Public Notice in the near future that will spell out the details.

"Alien" visitors to the US holding an amateur licence issued by their home country may operate in the US without submitting any FCC paperwork—provided that a reciprocal operating agreement is in effect between the two countries.

The only documentation required is proof of citizenship and an Amateur Radio licence issued by the country of citizenship.

These arrangements are similar to longstanding arrangements between the US and Canada.

The new rules move the US a step closer to participation in the licensing arrangements of CEPT, the European Conference of Postal and Telecommunications Administrations.

The US State Department applied for US participation in 1997, and the request was approved in early 1998.

Completion of the final steps to make this a reality is understood to be imminent. These steps include formal US notification to the European Radio-communications Office that it is prepared to carry out its responsibilities under CEPT Recommendation T/R 61-01, and the issuance of a *Public Notice* in English, French and German.

Under the CEPT arrangements, a US Technician licensee will be recognized as holding the equivalent of a CEPT Class 2 (VHF-only) licence.

Holder of Tech Plus through Extra tickets will have the full HF and VHF privileges of a CEPT Class 1 license. Novice licensees will not be eligible.

Additionally, the ARRL has informed the US State Department that it plans to go forward in April with arrangements to issue International Amateur Radio Permits to US hams in accordance with the CITEL Amateur Convention, signed by several countries in the Americas.

The League has offered its services to issue IARPs to US hams. An IARP is not a licence, but it certifies the existence of a licence.

The new rules will not change the procedures for US hams wishing to operate overseas in countries that are not CEPT members or CITEL Amateur Convention signatories.

**Got some news
that you think
would interest
members?
talk to the editor**

Low Powered Devices in the band 433.05 to 434.79 MHz

Provided by ACA

Introduction

The authorised operation of low powered devices in the radio frequency band 433.05 to 434.79 MHz is supported through the Australian Communications Authority's (ACA) class licence for low interference potential devices (LIPDs).

Specifically, item 17 of the schedule to that class licence provides for the operation of all transmitters in this band up to a maximum equivalent isotropically radiated power (EIRP) of 25 mW. This is one of many relatively small bands established throughout the radiofrequency spectrum at operating frequencies ranging from a few kilohertz to many tens of gigahertz that support the licensed use of a wide range of LIPDs which provide benefit to the Australian community.

This summary explains the considerations that led to the introduction of this provision in the class licence.

Need for the LIPD allocation

The ACA has statutory responsibilities under the Radiocommunications Act which essentially relate to maximising the public benefit in the use of a national resource. In exercising this spectrum management function on behalf of all of the Australian people, the ACA tries to accommodate the needs of all groups of users. Where there are competing demands for access to particular parts of the spectrum, the ACA tries to take a balanced approach in weighing up these demands. In making these sorts of decisions, the ACA will typically consider:

- domestic and international spectrum allocations;
- likely demand;
- public benefit;
- international regulatory arrangements;
- interference potential and effects on incumbents.

The band 433.05 MHz to 434.79 MHz is shared by Amateur Radio, low-powered applications and the radiolocation service. The radiolocation service is the only primary service in this band. Other services operating in this band must not cause harmful interference to the primary service, and are not afforded protection should they receive harmful interference from that primary service.

Amateur applications in the 433.05 MHz to 434.79 MHz band (1.74 MHz bandwidth) include FM repeaters and FM

simplex services. Amateur services operate on a secondary basis over the wider band 420 to 450 MHz (30 MHz bandwidth) and in a number of other bands throughout the radiofrequency spectrum. That is, the segment allocated for LIPDs overlaps just 6% of the 30 MHz bandwidth used by amateurs in this band.

Arrangements to support low powered devices in the 434 MHz band came into to the LIPDs class licence in June 1997 to support a growing demand for such applications sourced mainly from Europe, part of International Tele-communication Union (ITU) Region 1. In many countries in that Region, the band 433.05 to 434.79 MHz has a long-standing designation for industrial, scientific and medical (ISM) applications¹. ISM applications use radiofrequency energy for their function but are not radio-communications devices (eg, microwave ovens).

A significant international manufacturing trend is to develop communications devices to operate at low power and on an uncoordinated basis in ISM bands. Radiocommunications devices operating in designated ISM bands do so on the internationally established basis that they must accept any interference they may receive from ISM applications. Products have been developed for ISM bands that are common world-wide and in other bands adopted in major regions for ISM. As a consequence of the European adoption of the 434 MHz band for ISM, manufacturers have developed a range of low powered radiocommunications products for that band.

From a review of international regulatory arrangements it was clear that European countries, and the United States of America to a lesser extent, supported the operation of low powered devices in the band 433.05 to 434.79 MHz. Whilst Australia is in ITU Region 3 geographically, we are continually approached by customers, importers, manufacturers, retailers, etc to support products that are designed in other countries and not necessarily in accordance with Region 3 spectrum arrangements. In Australia by 1996/97 there was a strong and increasing demand to operate European based low powered applications designed to operate in the 434 MHz band.

The ACA decided that it was in the public interest to facilitate the operation of these devices in Australia. ACA believes that this benefit significantly outweighs the relatively small loss suffered by amateur users.

A factor in that decision was a concern that, being prevalent in many other countries, the devices would be imported anyway, as happened in the case of the 900 MHz band which is used widely in Region 2 for these sorts of devices.

Feasibility for continued Amateur operations

The band chosen for LIPD operation was aimed to achieve commonality with international developments. The associated power cap of 25 mW was set at a level that balanced the identified needs against the overall utility of the band for uncoordinated LIPD operations (a few countries allow up to 500 mW transmitters in this band for such operations). The class licence specifies the essential technical conditions and does not specify the type of application for this band. The regulatory approach chosen is deliberately intended to minimise the need for unique Australian products and so maximise the public benefit.

Having made the basic decision to develop a class licence, studies assessed the potential for continued operation of amateur services in the segment. It is recognised that interference from LIPDs is possible in some circumstances and is probably more likely in heavily populated areas, but there is still a lot of potential for amateurs to continue to use the segment if they wish.

ACA officers are liaising with the WIA on this issue. One aspect discussed is what interference mitigation steps might be taken.

The ACA encourages the amateur community to review the technical viability of its repeater network in its current configuration (the European repeater configuration is unlike Australia's and is less susceptible to LIPD interference). The ACA would expect that, given the very nature of the amateur hobby itself, and the associated technical skills held by amateur enthusiasts, they would be much better placed than most users to identify which repeaters may be more susceptible to interference and take protective measures.

Summary

The ACA believes that development of the class licence to support LIPDs is clearly in the public interest. Further, the ACA believes that the conditions of the class licence are appropriate and should not be changed or further restricted in the types of applications allowed.

The total loss to the amateur community is relatively small. The ACA would encourage the amateur community to make realistic assessments of the likely levels of interference. If the levels of interference or operational constraints are judged to be too high, the ACA would encourage the amateurs to consider ways to modify the repeaters to build-in better immunity.

End Note: Australia is part of ITU Region 3. The band 433.05 to 434.79 MHz is not a designated ISM band in Australia.

ar

ICOM Clearly Ahead



"VK3LZ calling!"

More sound information from your friends at Icom

AN AMATEUR RADIO RESURGENCE?

There are strong indications that amateur radio is going through a real resurgence.

The recent Wyong Hamfest had a record attendance with significant sales of the latest units. Two smaller events also set records of their own recently. They were the Eastern and Mountain Districts Radio Club White Elephant Day on March 14, and the Burnie Hamfest on March 20. In addition to traditional swap meet activities, these events saw extraordinary sales of equipment from CBs to the most sophisticated base units.

At Icom we have just ended our financial year and our sales have increased significantly across the board, from marine radios, land mobiles, and airband, to CB and amateur rigs.

It would seem radio sales and usage in Australia have never been healthier!

MAKE OUR WEBSITE YOUR INFORMATION SOURCE

The Icom website has become a valuable information source for amateur radio enthusiasts across the country. If you haven't visited, make sure you drop by soon on www.icom.net.au

DATES TO REMEMBER

Moorabbin Hamfest ~ Saturday May 8

Mount Gambier Hamfest ~ Sunday June 13

Icom Day at Amateur Transceiver Radio Centre, Sydney ~ Saturday June 19

"...73"

FreeCall 1800 338 915
290 -294 Albert Street
Brunswick, Victoria 3056

Tel : (03) 9387 0666

Fax : (03) 9387 0022

www.icom.net.au

ACN 006 092 575

Alistair Elrick QTC Editor

As I write this, it is just 2 days before the WIAQ Annual General Meeting and brings to a close the 1998-1999 Council year.

It has been personally both rewarding and frustrating to come to grips with the needs of running the Division, since I became involved in July last year as Treasurer.

I believe it is a little better in some aspects from what I started with 10 months ago, but recent experiences tell me it could always have been better again.

I see some very good positives for VK4, both within the WIAQ itself and in the Club scene. The QSL Bureau and Bookshop/ Disposals have been very successfully run by their respective managers Laurie VK4BLE and John VK4AFS and provide both good service and viable financial returns to members.

Several clubs have raised their profiles within the amateur community and with the public, which is commendable as well as necessary to maintain a vibrant hobby for us all to enjoy.

Notable among the public profile opportunities is Redcliffe Club being offered space in the upper level of the Kippa-Ring Shopping Village to put on Saturday displays.

The club is looking for a volunteer to set up and supervise an active display of packet, VHF and whatever else may grab the attention of prospective amateur radio operators. They will need volunteers to actually run the display on a roster basis, so all interested persons can contact the club to add to the work force or the display range. So roll up all club reps and promote your particular aspect of AR.

Caboolture Club will have been on the road and on the air with club callsign VK4QD on April 24 from Kilcoy.

The club was asked to put on a demonstration and display of Amateur Radio during the Kilcoy Show, highlighting its communication and emergency value to the community. Sounds like a good opportunity for other clubs to do the same, so volunteer if you are not asked. Promotional brochures are available from your divisional office.

Congratulations to WIAQ Regional Representative Neil VK4NF for clocking up 12 issues of Dalby Clubs Packet news bulletin, MiniNews. Yep it's survived for one whole year!

If you're in the area west of Toowoomba give some serious thought to supporting Dalby club. To contact the club write to The Secretary at 15 Bunya St Dalby 4405 or

Divisional News



location, and the hunters use radios with directional antennas to locate the transmitter. It is not only a lot of fun, but you learn your way around the ACT as well.

An added benefit is that the hunters get experience handling their equipment while on the run in the open field.

The hilly terrain in the ACT imposes certain restrictions on propagation paths.

To overcome these restrictions, knowledge of the local area is essential and knowing where the roads and tracks are is critical to being the first to find the fox.

The other type of communications exercises is in the provision of support to field events such as a boat race, a car rally, or a two-day medal walk.

In these events voice communications between the organisers, marshals, and relay stations are essential for success.

The benefit to WICEN volunteers is similar to the ones obtained during fox hunts, but also includes learning net operating discipline, and how to accurately relay voice messages.

The VK1 Division is always keen to attract new WICEN volunteers, and to train as many of them as possible in case the really big event occurs.

You can use your communications equipment for the benefit of the ACT community by joining WICEN and learning to become an efficient operator.

Contact Phil Longworth, VK1ZPL, who is the WICEN coordinator for the ACT.

The next general meeting of the VK1 Division is on May 24, in room Nr.1, Griffin Civic Centre, Canberra City.

Forward Bias

VK1 Notes

Peter Kloppenburg VK1CPK

I hope that AR arrived in your letterbox before the Solar Boat Race on Saturday, May 1, or the FAI Rally on May 7, 8, or 9.

If it did, then here are some details about these events.

Frequencies in use are: 146.900 MHz and 438.525 MHz.

These frequencies are supported by backup frequencies on: 146.950 MHz and 438.375 MHz. Phil Longworth, VK1ZPL, is the coordinator for both events, and can be contacted as follows:

Email: plongw@mpx.com.au.

Packet: VK1ZPL@VK1BBS,

Phone: 6216 8995, AH 6241 5797,

Mobile: 0416 216 003, FAX: 6216 8988.

Mike Walkington, VK1KCK, is the communicator deployment officer for the FAI Rally. WICEN volunteers should contact him in the first instance.

You can reach him via email on: mikew@netspeed.com.au or by home phone on: 02 6291 2552.

The above mentioned events are being supported by WICEN (Wireless Institute Civil Emergency Network).

As the name says, the network becomes activated when a civil emergency occurs anywhere in the community and communications must be established.

This could include the use of mobile or portable VHF and UHF equipment, repeaters, HF point-to-point, and satellite links. Luckily for us, no civil emergency has occurred here yet.

It could happen though! To prepare WICEN volunteers for such an emergency, the VK1 Division organises communications support exercises.

One type of exercise is fox hunting.

This is where a small VHF transmitter (the fox) is hidden somewhere in an unusual

VK4NF @ VK4YH and by phone (07) 4662 4950.

Clive VK4ACC, Secretary of the RADAR Club (Rockhampton and District) reports the following office bearer positions were keenly snapped up at their recent AGM!

President Don VK4BY, Vice President Doug VK4DUG, Treasurer Nev VK4KNB, Secretary Clive VK4ACC, Assistant Sec. Incorporation. Lyle VK4ALD

The RADAR Club congratulates the persons responsible for the new and improved WIAQ Council minutes. Also a reminder that the Clairview Amateur Radio get together half way between Rocky and Mackay is on May Day weekend. (2nd May).

Someone within the RADAR Club will have been especially looking forward to the April meeting. Peter VK4VW as WIAQ contest manager, should have visited at the Frenchville Sports Club to present John VK4AJS with his trophy for the Jack Files Contest. Well done John.

Sunshine Coast Club; Ron VK4GZ was awarded the Ken Wilford CW Trophy at the April general meeting of SCARC.

The trophy is awarded annually, for the best cumulative score in contests using CW. As well, Ian VK4KIJ is the new Secretary of the club. He replaces Geoff VK4KEL who acted as temporary secretary until enough pressure could be applied to Ian.

(Must be something about running BBS's that qualify one as Club Secretary!)

Sunshine Coast's Repeater Group is in the last stages of siting a new repeater at Tewantin. This repeater will enhance repeater coverage to the north of Noosa, hopefully as far as Rainbow Beach and will be an asset to travellers as well as club members. More news on the repeater and frequencies as it comes to hand.

FNNQARG

This years Far North and North Queensland Amateur Radio Get Together will be held at Beachcomber Coconut Village, South Mission Beach, from Friday Afternoon 11th to Monday 14th June 1999.

You must attend the Far North and North Queensland Amateur Radio Get-together! (FNNQARG!) (FNNQARG - the sound the cassowary makes as it tries to swallow your hand-held!)

Obtain further information from:

Pat VK4MUY phone 07-4772 5760
packet VK4MUY @ 4RAT.
#NQ.QLD.AUS.OC

Bob VK4WJ phone 07-4779 7869 email
Robert.Mann @ jcu.edu.au

Gavin VK4ZZ phone 07-4779 1161
packet VK4ZZ @ VK4ZZ.
#NQ.QLD.AUS.OC

email vk4zz @ ultra.net.au

Last but not least, it is farewell to our

Federal Councillor Ross Marren VK4AMJ, who has pulled the pin after many years of service in that and other positions within the WIAQ. Ross has strived to maintain an even keel in some often rough waters.

We will strive to continue the high standard of devotion you have shown to the interests of the members of this Division. Thanks Ross from all on council and Queensland in general.

Enjoy your well earned 'retirement'.

Cheers, Alistair VK4FTL

QRM.

VK7 Notes

Our Annual Divisional Meeting and HamFest, held at Burnie on the 17 March was a howling success with a large number of Tasmanian Amateurs attending.

Business was brisk in the pre-loved stalls and also the Commercial exhibits with good results reported.

Many of the demonstrations ranging from packet, Internet to video conferencing kept the interest of the crowd.

The Annual meeting went smoothly, yours truly is the State President again (my last year) and Tony Bedelph VK7AX, is our new State Secretary.

His address is

5 Kywong Cresc,
Ulverstone, 7315.

Phone number (I hope?)- (03) 6425 2923. A list of all our other officers has been sent to each other division.

The annual dinner at night saw David, VK7ZDJ win the Icom R2 receiver kindly donated by the Tasmanian ICOM agents Marcom-Watson in Launceston. This firm has been a great friend of amateur radio in this State.

Members of our Southern branch in Hobart are having great fun with a weekly fox-hunt. A different "fox" each week ensures that some of the hides are real "stinkers" but the interesting part is the fact that each week seems to see different winners.

Novice and full-call classes start on 26 April in the South - run by VK7SW, Steve.

If anyone is visiting Flinders Island make sure you include a visit to our resident member Peter Blundstone, VK7ZPB. You would be welcomed.

Following the resignation of our Federal Councillor, Andrew, VK7GL, we have elected a worthy successor in the person of our Hon. Solicitor, Phil Corby, VK7ZAX. Phil's legal expertise could often be very welcome.

Cheers for now from Ron, VK7RN, Tasmanian President.

Andrews

Communications Systems

(EST.1976 - ACN 001 968 752)

ALINGO

**AUSTRALIA'S FIRST AUTHORISED
FACTORY DIRECT IMPORTER**

**No 1 & Biggest Importer with one or two
shipments monthly.**

**FULL 3-YEAR FACTORY WARRANTY
INSTANT REPAIRS ON FRIDAYS**

**WE SELL MOST BRANDS AND MAKE
BALUNS, VERTICALS, YAGIS, P/S.
ICOM-KENWOOD-JRC-AOR-EMOTATOR-
MJF-DIAMOND-TIMEWAVE-KANTRONICS**

**-THP-JARMAN-TERLIN-UNIDEN-ETC
WE URGENTLY WANT GOOD HF, VHF.**

**HUGE RANGE OF ELECTRONICS
NEW IC-706IIG & IC-756PRO
NOW 3-YEAR WARRANTY ON
NEW ICOM SOLD BY US.**

*** OVER 20 YEARS OF SERVICE *
Call us for unbeatable prices ...**

(02) 9636 9060 or (02) 9688 4301

SHOP 8, 41 BATHURST ST, GREYSTANES,
N.S.W. 2145. FAX (02) 9688 1995



AV-COMM

Pty.Ltd

SATELLITE TV EQUIPMENT

- Established 1981 -

Specialising in: Free to Air Satellite TV

**CALL OR FAX
FOR FREE INFO PACK.**

198 Condamine Street
Balgowlah 2093 Australia

Tel: 61 2 9949 7417
61 2 9948 2667

Fax: 61 2 9949 7095

Internet: <http://www.avcomm.com.au>

ar

CLUB NEWS

Send all of your Club News and Coming Events items to
Club News, Amateur Radio
PO Box 2175 Caulfield Junction
VIC 3161

Port Macquarie Field Day

Field days seem to have become something of an institution over time and the fact that they have continued for so many years as important events in the amateur radio calendar says much about their popularity.

The Oxley Region Amateur Radio Club plans to hold its annual Field Day over the Queen's Birthday weekend, June 12th and 13th.

As in previous years, the venue will be right on the waterfront at the Sea Scouts' hall in Buller Street, Port Macquarie, NSW.

The program will start around 10.00am on Saturday and provides for 2m mobile and pedestrian foxhunts as well as a wide range of other activities for the whole family.

New amateur gear will be on display, supplied by both local and city dealers and it is significant that much of this current equipment embodies real state-of-the-art technology.

In addition and perhaps by contrast, a table will be provided for the sale of pre-loved gear, where a bargain or two can always be expected.

Sausage sizzles are planned for both days with drinks, tea and coffee also being available on site.

Since the Queen's Birthday is a holiday weekend and Port Macquarie is a very popular holiday venue, it is important to book early for both motel and caravan sites to avoid disappointment.

We look forward to enjoying the company of visiting amateurs who plan on spending the weekend with us in Port..

Alan Nutt VK2GD

Publicity Officer

For Oxley Region Amateur Radio Club

20 Amaroo Parade

Port Macquarie NSW 2444

Oxley Region Amateur Radio Club
Annual Field Day
Queen's Birthday weekend,
June 12th and 13th.

SCARC John Moyle Report

"The usual crew of adventurers arrived at the Sunday Creek fire tower around 11am. Conditions not too bad - a little drizzle - grass a little high, no problem - Out with the trusty brush cutter.

Then "Daddy daddy, look at the pretty worm. Why is my boot full of water?" That's not water; it's blood. AAAGH! LEECHES.

Not one, not one hundred but serious numbers of the horrible little fellows, all determined to suck the goodness from SCARC leaving broken men and dried out husks littering the land.

A quick council of war resulted in some of the most unscientific suggestions for the removal of leeches, liberally apply rum "internally" seemed the most popular followed closely by an old favourite; put salt on their tails.

The VHF-UHF group quickly stole a march on the low-banders, by the simple expedient of erecting 1/4 wave verticals fed by 10 cm(?) Helix cable all over the fire tower.

"Get enough metal in the air and you can't go wrong" seemed to be the philosophy. It must have worked, since it caused close encounters with confused airforce F-111's all night.

Meanwhile, back at leech central, the lowfers were stumbling around trying to raise an 80m dipole. William Tell, aka Max VK4TXL, was spot on with the bow. Unfortunately the forest had the audacity to have grown 10m since last year. The conversation went something like:- "It went up ok last time", "do you think we could just bend that 10m wattle a little to the left?", short silence, "maybe we could hang it on that big radar reflector", horrified whimper, "you mean the big shiny thing on top of the hill?"

Eventually, antennas in the air, sleeping gear sorted, meals of monumental to indifferent quality cooked and eaten, thoughts turned to the social aspects of the hobby. "We should have a few drinks with those fellows camped under the radar

reflector", "OK, but remember an early night is a very good thing". Gods don't destroy fools, they handle the job themselves.

10.30 pm local time, Sunday Creek fire tower. Altitude 7,000m (or there-about) Max, who has trekked Tibet, climbed K2 without oxygen or shoes and survived last year's John Moyle, wisely decides to go to bed. The rest of the crew, unaware of the danger, continue walking (sort of), trekking AND socialising.

11.15 pm local time. The first insidious symptoms of altitude sickness appear. Members of the club, normally the most sober of men, begin sharing strange recipes. Dark and stormy-rum and ginger beer ala what turns out to be the drink the ROCKY boys and girls will discover when they ride the tilt train to Bundy (TILT APTLY NAMED!) Tor Ro Red, toxic-metho and tomato sauce. Private school special — Stones Green Ginger wine and gin.

Time passes. The trek staggers on.

11.30 pm local time. The drinks become doubles; then multiples, then who measures?

Some members of the group begin, probably for the first time, to get in touch with the sensitive side of their natures. Ribald comments erupt from the terminal yobbo's in the group.

11.45 pm local time. The sensitive and the insensitive alike are becoming incoherent. Sitting like a rock in this turmoil is Wayne

If you have some club news to share.

Or an event to publicise. this is the place.

The
Amateur Radio

pages are your pages. Send your information to

**The Editor Amateur Radio
PO Box 2175**

**CAULFIELD JUNCTION
VIC 3161**

email amag@hotkey.net.au

Fax (03) 9523 8191

SWC. The man is immune to alcohol having spent his formative years growing cane on the slopes of Bli Bli.

11.47 pm local time. The first casualty. A member of the club, who shall remain nameless, succumbs to altitude sickness in a bad way, he is helped to the base camp by two of his less capable mates.

12.00 pm very local time. The rest of the group, sobered by the tragedy, conserve their energy and eventually make it to the summit.

Early next morning the whole camp was saddened to find the blood stained clothes of Max outside his tent. "Taken by leeches" was the only possible conclusion.

One of the V.H.F chaps remembered hearing the faint cry, DI DI DIT DI DI DI DIT DI DIT DAAAA-a-a-h some time in the night but had not thought to investigate. Pity he hadn't remembered SOS.

Now - what were we here for?

The contest was a little slow compared to previous years and the lowfers were handicapped by a lack of operators but in general it was an experience "not to be missed".

Would we do it again? Well, Maybe; Probably; - Ask us next year.

By Dave VK4TDL, President SCARC. (I told you it was a social event. Bob VK4KNH)Brisbane Amateur Radio Clubs

"BARCFest99"

BARCFest99 will be held on Saturday 8th May at Kelvin Grove High School auditorium commencing at 9.00 am.

For tables and display space bookings phone Dave 3288 4911 or write to BARCFest99 Co-ordinator PO Box 3007 Darra Qld. If your club wishes to participate in this event by means of a display or disposals table, please let Dave Prince know a.s.a.p. so that a table registration form can be sent.

Dave Prince VK4KDP
BARCFEST '99 Co-ordinator
davprin@gil.com.au

Special Interest Groups— Radio Scouting

JOTA v JOTI

Bayside District Amateur Radio Society at Brisbane experienced problems with JOTA last year.

After contacting the Scout Association of Australia we have received from the Branch Commissioner, Ian Lightbody a reply which

more than suggests Baysides experiences were felt elsewhere, particularly in the Brisbane VK4 area.

In part Scouts Australia reply points out 3 problems with last years JOTA.

1 JOTI, Jamboree On The Internet is more accessible and reliable a form of communication than Amateur Radio. It has detracted a little from JOTA.

2 JOTA QUALITY, in some areas JOTA has been poorly run, to the detriment of the activity. Some hams just let Scouts look on similarly some Scout Groups have not treated radio operators well.

3 FINDING OPERATORS, numbers of willing hams seem to dwindle each year.

It's frustrating to see Karingal campsite set up with keen Amateurs and few Scouts.

Whereas at Baden-Powell Park, Samford (the state radio station) hundreds of Scouts, their own radio gear, but few operators. At times they closed operations due to a lack of Amateurs.

Ian concludes with an offer to convene a forum with keen JOTA people from across Brisbane!(QNEWS)

ar

Club Secretaries please note

Your Club Events happening in June, July, August and September would benefit by exposure in these pages

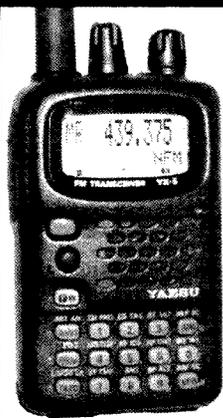

Radio and Communications

Incorporating AMATEUR RADIO ACTION and CB ACTION

Edited by
**Chris Edmondson,
VK3CE**
Box 1 Yarra Road,
Wonga Park
Victoria 3115
(03) 9873 1777

At left is one quite remarkable hand-held transceiver. In fact, some would argue it's a scanner which talks. It covers almost everything from broadcast and shortwave up to a Gig! And it transmits on six, two and 70. We review the new **Yaesu VX-5R** for you this month. But that's not all...!

May's R&C is simply jammed with value for you! Here's just a selection of the great stories lined up and ready...

- SPECTRUM FOCUS: Welcome Roger Harrison, VK2ZRH, as he untangles the regulatory web. Are we safe?
- SWATCH BEATNIK: A happy story of how amateur radio operators could beat a commercial giant...
- THE PHILIPS FM900 SERIES: A somewhat belated review, but a review nonetheless. Have you got one?
- CHOOSING COAXIAL CABLE: A great yarn — written for us by a man who designs coax for a living...
- SIX METRES ON THE MOVE: Get it while it's hot! The six metre band is jumping. Grab the DX while you can!
- As usual, we have our three DX columns, mods and lots more... the best stories and regulars every month!

Don't miss out — **RADIO and COMMUNICATIONS** is great reading for amateurs!

Check your local newsagent today!

(PS. We also have the biggest collection of radio-oriented Classified adverts in the country. There's lots of them because they work so well. Ask your newsagent to keep a copy for you each month, or ring 1800 25 2515 for subscription details. Hurry — you might miss something!)

vicce

ALARA

**Christine Taylor VK5CTY
ALARA Publicity Officer**

16 Fairmont Avenue, Black Forest SA 5035
Packet: VK5CTY@VK5TTY

ALARA ANNUAL GENERAL MEETING

Please don't forget that the fourth Monday in May is our AGM.

We meet on air on 80 metres. At 1030 Zulu on 3.85 MHz +/-.

Make this year another one to remember. We always have a good roll-up for our AGM and it is lovely to hear all those callsigns we don't hear so often, as well as to hear the more regular ones.

A Special Crystal Set

The photos show (outside and inside) a crystal set entered by Dot VK2DB in the recent Crystal Set Competition run by the HADARC. You must admit it is different! It did work and was awarded the prize for the most amusing.

Dot didn't do the soldering for the crystal set - OM John VK2ZOI didn't trust her to!

However, she followed up the crystal set with a doorbell she made entirely herself (her two younger sons were very surprised to see Mum wielding a soldering iron, but it was 'old hat' to her elder sons, they used to see Mum soldering quite often, when they were younger).

The doorbell works but its external appearance is yet to be determined. It may end up looking like a volcano, or maybe a grandfather clock, or maybe a giraffe. The jury is still out. You will be kept informed.

More New Callsigns

One callsign that will be unfamiliar to us all at the AGM is VK3WX.

Robyn VK3ENX will be using her new callsign by then.

Robyn used to visit Bill's shack when she was just a little girl. When he died, recently, his daughter rang Robyn and offered her the use of the callsign.

She was honoured though she was sorry to hear that her original mentor had become SK.

A callsign heard on the 222 Nct recently is a very new and hard-won call. Mai, previously VK5KYL, now VK5AM, has taken over a year and more than six attempts to make the upgrade.

It wasn't that she didn't know the code, she was just too nervous to write it down. Congratulations Mai, hope we hear you on a Monday night, sometime, too.

Some New (and new/Old) Callsigns Heard on Monday nights

It has been great to hear Elwyn VK2DLT back on the Monday Nets. Elwyn used to be a regular participant but due to other commitments has been missing for some years. Now she has more time we hear her quite frequently.

Now that daylight saving is over we are able to hear the VK6 girls much more easily. It has been good to have Poppy VK6YL, in particular, back with us again.

A completely new callsign heard several times recently is Nina VK2IEZ. Nina is only new to us. She is DL2GRC, back home in Germany and has also held the callsign 7J3AUS.

Nina was recruited into ALARA by Dot VK2DB, at the Gosford Field Day, which appears to have again been a very successful meeting.

Dot had Nancy Karas (who also helped her husband - never by nagging? - to enter a crystal set in the HADARC competition

mentioned above) to help with the ALARA table and had visits from Val VK4VR and Ann VK4ANN.

She also enrolled Frances VK3HLF whom we hope to hear on the Monday Net when she upgrades.

DON'T FORGET JOTA AND JOTI 1

YOU ARE ALL INVOLVED

JOTA and JOTI will be here on the third weekend in October, but it is not too soon to be planning your participation.

Both the Scout and Guide groups and the amateurs need to have some preparation.

If you are involved with a Guide or Scout Group get them thinking about October, now. If your group already has an active radio group why not encourage them to take part in some of the Contests that allow Club participation? Remember VK5GGA has won the club section of the ALARA Contest twice.

I am sure Sharon Pariossien (the new coordinator in VK5) would like some competition. The ALARA contest is not the only one to welcome clubs. Look for this section in the Contest Rules.

It is excellent practice for the boys and girls in preparation for JOTA.

All it needs is the use of your HF gear for a weekend, either at home or in their meeting hall

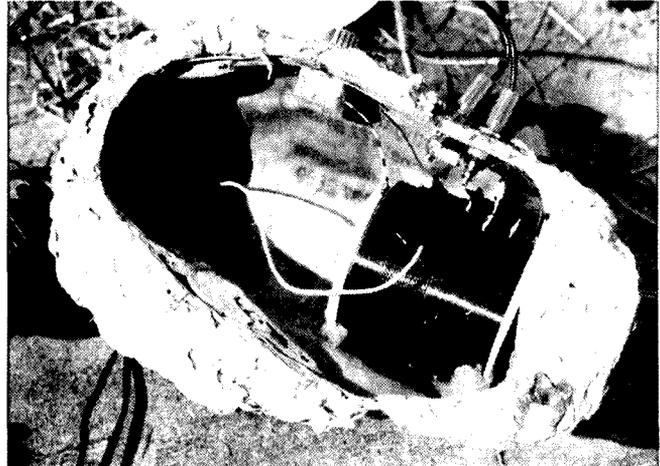
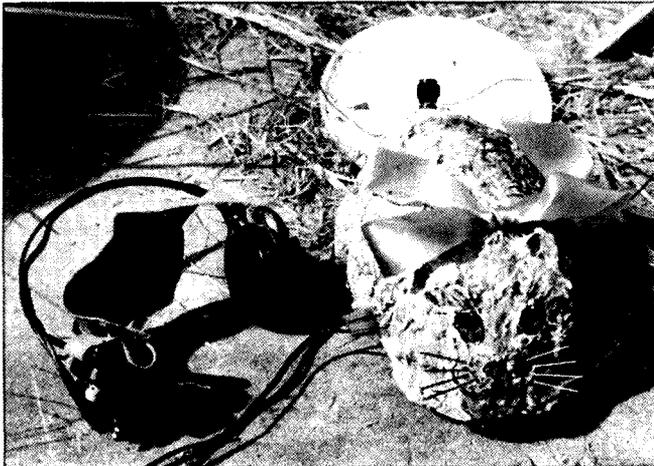

Is It Fate?

Or is it chance that flings the dice of survival across the board of each man's destiny??



Alan Shawsmith VK4SS

35 Whynot Street, West End Brisbane 4001

ONE CANNOT ACTIVELY spend a full lifetime in AR (in my case 64 years) without becoming involved in some way in a whole series of unexpected events.

A few that come to mind are; the big N.Z. 'Quake 1930's'; L.D.E.'s (twice); the Danny Weil VP2VP Sea Drama; The Lady Elliott Lighthouse problem; the 'LA BALSAM' Raft Affair; the atomic bomb tests on Eniwetok Atoll 1948; the Brisbane Floods 1974 and the Solomon Islands Cyclone to mention a few.

My role in the Solomon Islands Cyclone was small in that only the life of one young girl was at stake but the brief affair was so bizarre and dicey it is worth repeating.

In autumn 1939 a cyclone in the Coral Sea was lashing the Solomon Islands. Nearly 2000 miles to the South, at dusk in Brisbane I was in my bedroom getting dressed for a date with my then girlfriend.

I was late and in a hurry, yet for some reason decided to have a quick listen to my little 30 watt rig — a small capricious act that was to help save a young girl's life.

QRN heaped upon more QRN that crashed into my eardrums. Not one signal was audible. Only a fool would call CQ into that I told myself and got up, leaving the receiver running.

I was pulling on my socks, when a faint signal became audible. Did I catch the word *BRISBANE*? I poured all my

concentration into the headphones. There it was again "CQ CQ CQ BRISBANE URGENT DE VR4HR".

The morse was so weak I sat and waited for some other local to reply — but there was no one. It started up again, but weaker. I replied and was gratified to hear ROGER ROGER CFM. He then went straight into the text sending QRS and QSZ. 'SEVERE CYCLONE DAMAGE. ISOLATED. DAUGHTER DYING FEVER. MUST HAVE (certain type of) DRUG. URGENT URGENT. PHONE BRISBANE (Phone number given).

I stared in utter disbelief at the phone number. There must be an error. I replied with PSE RPT PHONE NO? He did so, but the signal was now getting weaker — fast.

Again, I went back 'PSE RPT?' Only a fading sound reached my straining ears, then silence except for the crashing QRN.

I stared again at the phone number. No; it couldn't be; not in a city like this. Was it a hoax? — a thought I quickly dismissed.

If I had copied wrongly then all was lost, but I could easily check. The number WAS THAT OF MY GIRLFRIEND.

I dialed her and the freakish truth was quickly revealed. She lived at her boss's house as part of the family, which had a son on the Solomon Islands. They assured me that the drug would be sent by charter plane at the first flight clearance and from New Guinea if possible, as it was quicker,

and would I continue to keep listening for HENRY, VR4HR.

News came later that the drug had arrived and VR4HR's daughter was improving.

I never heard him on air again, but did 'eyeball' in Brisbane, just prior to WW2 and prior to enlisting. Over a couple of beers Henry recounted to me the devastation wrought by the wind and rain on that terrible night when his daughter lay delirious and comatose, cut off from all medical aid.

He told me:-

"After the telephone went dead and all the power generators supplying the plantation failed, I turned desperately to a little 5 watt homebrewed rig, discarded in a cupboard because its batteries needed replacing.

"They were re-connected and to my surprise the rig worked. I had to use a rough rundown wire antenna belonging to the MW Broadcast Set. I called about half a dozen times and was about to quit in despair as the rig's output was failing, when I heard your reply".

The rest is simply a small episode in the long history of rescues by Amateur Radio.

We parted, promising to 'eyeball' as soon as the WW2 enemy had been 'put down'.

The rendezvous was never to be.

VR4HR's dice of survival was flung once more across his board of destiny, but this time fate or chance chose to look the other way.

ar

ALARA continues

A VERY BUSY LADY FROM VK3

Each year the District of Heywood chooses a Citizen of the Year.

This year, 1999, the honour has been given to Joy Savill.

Joy is Secretary of the Hamilton and District Radio Club a task that she combines with her long time interest in Guiding.

She holds a Victorian State appointment as Guide Radio Activities Co-ordinator.

In this capacity she is responsible for coordinating information for all Victorian Guides to enable them to take part in JOTA

(Jamboree on the air) or JOTI (Jamboree on the Internet) on the third weekend in October.

After the event Joy collates all the reports from the participating guide groups for the National Radio Coordinator.

During her time as District Guide Leader the local Guides won an Australia wide prize of \$2000 (the Dettol Service Challenge).

The Prize was used to furnish the Respite Room at the Fitzroy Lodge retirement village.

Their project was a Recycling survey they performed in association with the Heywood Shire Council.

Joy's involvement in the local district no doubt influenced the choice of activity but

it must have meant a great deal of hard work and time from many young people.

Winning the prize and the use to which it was put will be remembered for many years to come.

These activities are only a few of the many in which Joy is involved.

Others included 7 years working for Meals on Wheels, serving as Secretary for several tourist oriented organisations in the Heywood area, and a number of Carer groups as well as being active in Art and Craft groups.

She is also the Western Border Towards 2000 representative.

Our congratulations to you Joy, Heywood's Citizen of the Year.

ar

A Tower of Strength

(THE VK4VKD ONE MAN TOWER REVISITED)

Kevin Peacock VK4VKD

PO Box 1013

Browns Plains QLD 4118

Home page <http://www.powerup.com.au/~vk4vkd>

IN 1985 I DECIDED TO DESIGN and build an antenna tower. I chose this course of action, rather than going with one of the existing designs as a result of being involved in helping friends, and their friends, put towers up on their properties. Some of the hurdles that had to be overcome and some of the "near misses" that came about during those efforts left a large scope for improvement.

Transport was usually the first problem encountered. Some structures were rather unwieldy large towers that had possibly been windmill towers. Others were long telescopic crank-up and tilt-over types.

All had one common characteristic. They weren't easy to get into position and once there required the services of a crane or an army of helpers to get the blasted things up.

I wouldn't have contemplated putting some of them at my own house, as they were unsightly. Some I considered simply unsafe both in design and construction.

Thousands of ideas were considered.

Some aspects of existing structures were thought to be practical and with a few small improvements were useable.

I had sketches of design ideas everywhere. Every scrap of paper seemed to have an idea scribbled on it and I found that even though something looked great on paper it wouldn't always work in practice. That's par for the course; by rejecting the inferior designs we finally come to a product that is worth all of the blood and sweat to construct and erect. So was born the "one man tower".

I made my prototype and wrote a small article that was published in October 1986.

Then came the biggest shock of my life. Even though I was staggered by the construction costs, I was absolutely overwhelmed by the response to that article.

The letters just poured in, thousands of people had read the article and wanted one of these towers. There were letters from every corner of VK, ZL, Japan, USA and various Pacific Islands.

I realised that I was expending a considerable amount of money on photocopying plans and posting them to people. Some had included return postage, but sadly many had not.

To make matters worse I now received phone calls at all hours from people with their plans but unsure about various aspects of construction etc. This became an incredible burden. I was working a full-time job and in my spare time was making towers for people unable to build their own.

I didn't want my hobby to become a burden so the tower making came to an halt and I carried on with my life, turning a deaf ear to requests to "Please build me a tower".

The years have mellowed me and, being semi-retired, I have yielded to the prompting of friends to don the welding helmet and "Knock up a few towers". "What the heck, I thought," I need something to do when it's no good for fishing or there's no propagation." I had a look at my present circumstances. Things have progressed in regard to technology, computers, and video cameras. All things combined, today it is so much better than 13 years ago, so I decided to build a tower and make a video of the whole procedure. That way, if anyone wanted to make a tower, all they needed to do was to buy a tape.

E-mail and the Internet would save a fortune in postage. I thought, all things considered, a lot more information can be put on video and e-mail would be a lot better than having the phone ringing day and night. So I put my head down and my

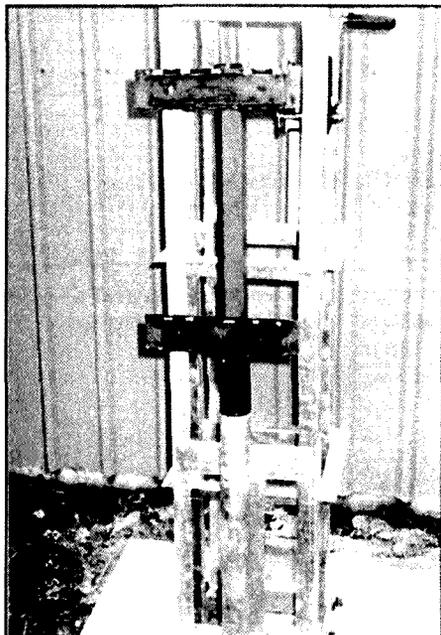

Photo 1 The first section is positioned and bolted to the base. The winch and slide-carriage are fitted and the "self erecting jig" is mounted to the carriage.

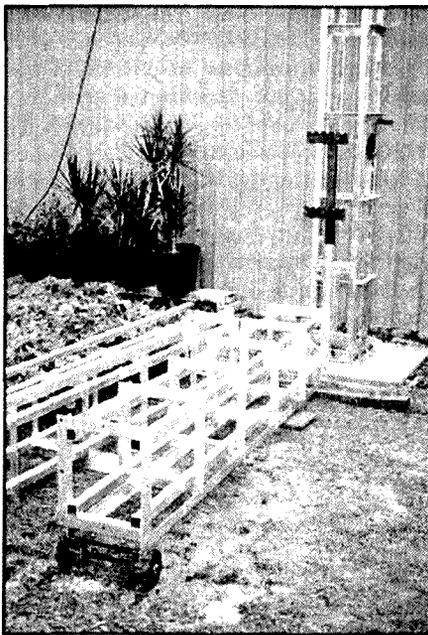

Photo 2 Sections are brought into position. Note the dolly wheels clamped to the section. This makes moving the sections a breeze.

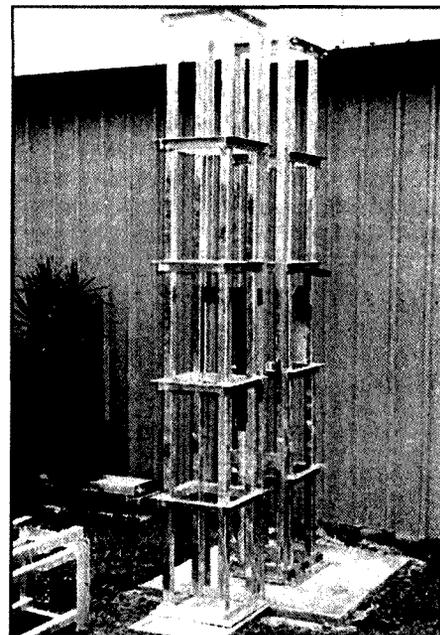

Photo 3 Each section is stood up and clamped to the jig.

other end up and started building the "One Man Tower" again.

The "One Man Tower" has benefited by the advances in metallurgy that have taken place over the interim period between the prototype and the current version.

The new version, Mark III if you like, makes full use of new steel grades like "Dual Grade" (TM). This is a 350/450MPa grade that gives the strength of 450MPa grade with the weldability of 350MPa. The result is a stronger structure with the same weight and dimensions as with the lower grade steel.

When costs are counted this improves the dollar value. I was surprised to find the parity level between now and 1985 shows that the increases in steel prices haven't been as sharp as a lot of other commodities.

Other changes included reducing the modules to 2.5 metres in length giving a better handling and shipping package. Some Municipalities allow towers not exceeding 10 metres to be installed without a permit (be warned, that may have changed by the time this article is published). The 4 x 2.5 metre sections fill the bill nicely.

The slide carriage and self erection jig have had major design improvements and are much more compact and user friendly.

The set-up that you see in the photos tips the scales at 45kg and has no bearing on the overall wind loading of the tower.

The design allows the antenna to be lowered to ground level very quickly thereby removing the loading from the top of the tower during severe storms.

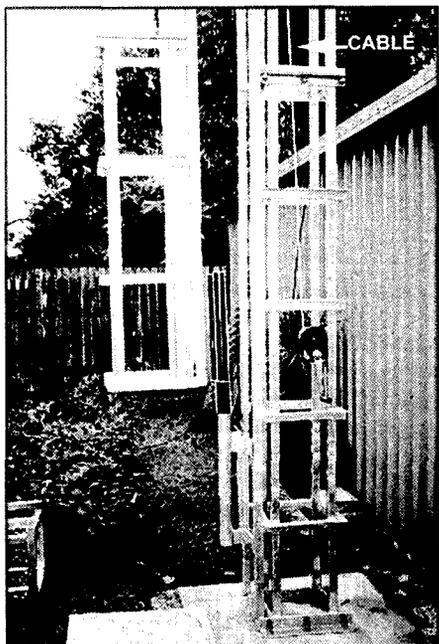

Photo 4 The builder operates the winch to raise each section into position.

Wind Loading

The 2.5 metre modules are each subjected to 99.5kg of horizontal force at 160kph-wind velocity. Bringing the slide carriage and antenna down to ground level reduces wind forces on the tower and reduces the tipping moment of the tower. A total height of 17.5m (including antenna) is reducible to 10m in a few moments, with the antenna at ground level. So you can see the benefit of the design for safety in bad weather.

Gone are the risks associated with climbing up to make adjustments to antennas, or changing antenna arrays, and you don't require a tennis court size area to tilt the structure over.

As I said earlier, I have a VHS video available for \$30 (inc postage and handling within Australia) showing the jigs used to construct the modules and how easily the tower is erected by one person.

You can contact me by e-mail or write to me at address under the title. If you do not have facilities to make a tower for yourself, I could be tempted to make one for you.

**For more information
or
to purchase the video contact**

Kevin Peacock VK4VKD
PO Box 1013
Browns Plains QLD 4118
Home page
<http://www.powerup.com.au/~vk4vkd>

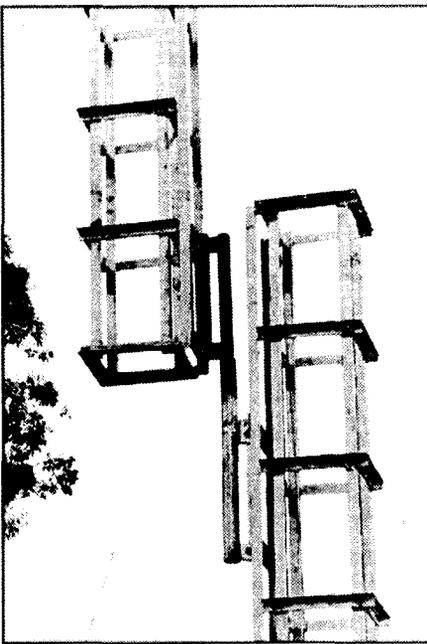

Photo 5 Almost into position. There is no great effort as the sections weigh a mere 65kg and the winch has a mechanical advantage of 3:1.

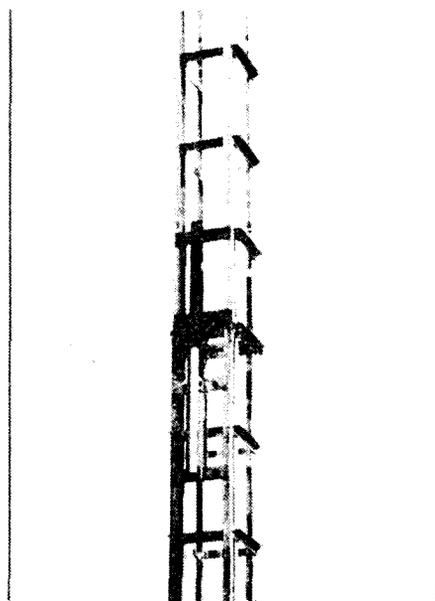

Photo 6 As each section reaches its final height, it is simply turned 180° and bolted onto the previous section.

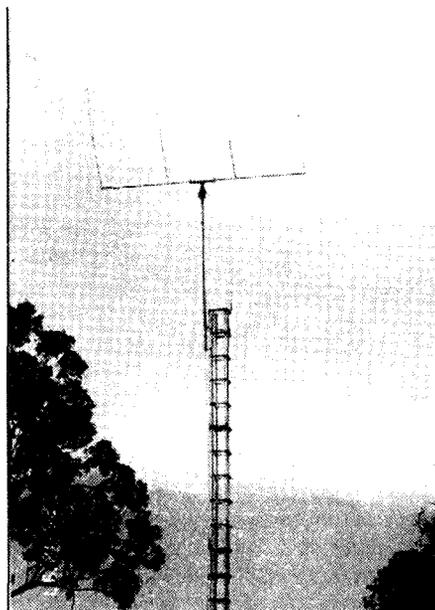

Photo 7. The tower, with a 4 element Delta Loop, stands 17.5m to the top of the antenna but has a tower height of just 12.5m.

Safety Note:

Towers of substantial height and/or weight should be designed by a qualified engineer and may require Local Authority approval before erection begins. Consult your local authority for the appropriate regulations.

Your Insurance Policy may not cover damages or injury resulting from failure of a tower or falling from a tower. Again, consult your Insurance broker for advice.

Amateur Radio on the Web

If you are in the market for a new piece of equipment then the web is the first place to look.

By Bob Harper VK4KNH
PO Box 288 Beerwah 4519
bobharper@bigpond.com

WHEN YOU THINK of how many Amateurs there are in the world and of course how many businesses feed on the hobby, it should come as no surprise to learn that there are a great many internet sites devoted to Amateur Radio.

If the amateur is in the market for a new piece of equipment then the web is, in my

opinion, the first place to look. You will find out what the latest equipment is and what the specifications are without having to tell the salesperson "I'm just looking."

Be aware though that many of the sites are in the US and the same models may not become available here for some time (if at all). You can browse sources of components that are rare here in Australia and even join

Surplus Equipment Sites that will email you if your particular item has just become available, eg marine CW keys!

I don't intend printing the web site contents here but thought that members might appreciate a few Internet addresses to set them off.

Note that the order is 'as found' rather than any preferential order.

http://www.tentec.com	TenTec transceiver range, upgrades and software.	http://www.aesham.com	A large range of AR products for selection online.
http://www.icom.com	Full range current & new releases.	http://www.glenmartin.com	Towers of almost all types including a trailer mounted telescopic tower!
http://www.icom.net.au	Australian Icom site.	http://www.mouser.com	Extensive product range - download their catalog, all 23Mb of it!
http://www.icomamerica.com	US Icom site.	http://www.allcorp.com	Another AR supplier with an extensive range.
http://www.icom.co.jp	Icom Japan.	http://www.rfparts.com	Worth a visit. Extensive range parts, users & service manuals, silver mica caps, doorknob caps, metal case mica, chip caps, large and small air gap tuning/trim caps, tubes, bases and chimneys. RF home brewers should visit but wear a bib.
http://www.outbacker.com.au	Terlin Antennas, see AR ad.	http://www.emsci.com	This is very impressive electromagnetic design software. Hobby and prof. versions available. ie Design your own antennas.
http://www.maha-comm.com	Replacement Batteries for HTs.	http://www.hamstation.com	New and used ham gear.
http://www.arf.com/	A very extensive site. Check out the bookshop!	http://www.connectsystems.com	Various types of repeater controllers.
http://www.ari.com/catalog/	Online manuals and updates. Subscribe to their e-mail newsletter.	http://www.prodintl.com	A wide range of test equipment from various manufacturers.
http://www.alinco.com	ADI manufacture H/helds for 6m, 2m and 70cm as well as commercial sets.	http://www.iacantennas.com/	"Home of the Double Bazooka" I didn't read it but it looked interesting.
http://www.adi-radio.com	Ameritron Linear Amplifiers, Parts and Manuals	http://www.radioera.com	The history of radio! Books, manuals and schematics on early radio & programs. Early test equipment schematics on as well!
http://www.ameritron.com	News, products and more. Good site worth a look.	http://www.randl.com	One of the many AR stores on web
http://www.yaesu.com	Plenty of repeater bits - exciters, front ends, etc.	http://www.wb2jkj.org	WB2JKJ is a School radio club in New York. Look in and consider a similar setup with your local high school.
http://www.hamtronics.com	Electronic kits.	http://www.com-spec.com	A range of CTCSS decoders, telemetry equip. & auto-Morse identifiers.
http://www.vecronics.com	Security products - NOT our own Australian Altronics.	http://www.qth.com/prolog	An amateur radio logging program with a downloadable demo.
http://www.altronics.com	Full catalog: can be printed off	http://www2.wcoil.com/~fairadio	Surplus military and industrial equipment inc. test gear, books etc.
http://www.mfjenterprises.com	Lots of goodies. SWL and QRP equipment, books and CDs.	http://www.cablexperts.com	Anything to do with cable including 300/450 Ohm Ladder line.
http://www.universal-radio.com	From tubes to GPS Rx; Collins parts. A hamfest on the web.	http://www.hosenose.com	A little confused on this one but I note the Amateur Radio Callbook.
http://www.surplussales.com	All sorts of communications filters.	http://www.rust.net/~hires	Kits & bits for Collins gear, peak reading conversions for power meters.
http://www.k-comfilters.com	Buy and sell all manner of radios from antique to new.	http://www.seintl.com	A range of EMF radiation monitors including a pocket device to warn when your RF is getting you!
http://www.associatedradio.com	Test equipment. Sams range of books.		
http://www.elenco.com/cs_sales	Repeater controllers inc. ATV controllers.		
http://home1.gte.net/k4lk/mcc	A range of antennas and amplifiers.		
http://www.mirageamp.com	Radio Modems including Baycom.		
http://www.tigertronics.com	Factor digital communications. Factor II modem, photos and data.		
http://www.scs-ptc.com	DSP products. Digital noise reduction systems.		
http://www.jps.com	A large range of AR products with an online catalog.		
http://www.lentinicom.com	ATV down converters and UHF components inc. mica trimmers.		

http://qth.com/wx9x	WX9X do QSL cards by the thousand.	http://www.vibroplex.com	The CW Bug maker older than Amateur Radio. All current products as well as assembly drawings and adjustment notes.
http://www.davisrf.com	Davis sell mostly cable and cable accessories.	http://www.texasbugcatcher.com	Mobile antenna systems.
http://www.juns.com	A ham store carrying a fairly standard range of products.	http://www.optoelectronics.com	A range of frequency counters inc. tiny handheld units.
http://www.hamstick.com	Hamstick sell a large range of antennas, many types & makes.	http://www.hamradio.com	Yet another AR supplier with a large range of product on an online catalog.
http://members.aol.com/viconqsl	These guys print your photographs as QSL cards in various styles. They also make business cards that they call "Eyeball" cards.	http://www.halcomm.com	Halcomm produce a range of digital communications equip. Packet?
http://www.radioworks.com	A range of wire antennas including the "Carolina Window"	http://www.svetlana.com	Svetlana have been producing valve/tube products in St. Petersburg, for 100 years. Products now available in the west.
http://www.torontosurplus.com	Inc. Harrier Jump Jets !	http://www.coaxial.com	Coaxial produce a range of transmission line test equipment but the smallest connection size I saw was for 7/8" Heliac!
http://www.icc107.com	A Components supply house inc. 150 Ohm headset speakers.	http://www.synctime.com	A clock of interest to any ham; it automatically sets itself and keeps in adjustment, to the second, via WWVB. They make wrist watches that never need setting. They can't be set!
http://www.ameritech.net/users/hamsure/hamsure.html	Amateur Radio Insurance.	http://www.elecdist.com	A range of test equipment including AOR and Daiwa.
http://www.cq2k.com	The site for a "different" Morse Code training system.	http://www.caig.com	Caig produce environmentally friendly chemical products such as contact cleaners as well as a range of plastic welding products.
http://www.phillips-tech.com	Not to be confused with "PHILIPS", they sell RF equipment sales.	http://www.palstarinc.com	You will find a range of antenna tuners/matchers, power meters, dummy loads, roller inductors and air gap tuning capacitors.
http://www.erols.com/pvander	Amateur radio logging program (for Windows) inc. demo version.	http://www.gapantenna.com	I like their motto "No Traps Here". A variety of vertical antennas that have no traps and therefore have lower losses. "More antenna, less resistor."
http://www.oro.net/~w9gr/	They sell DSP products but include a great number of Amateur Radio links (to other Web sites).	http://www.minicircuits.com	They will have to change their name to Microcircuits or even Nanocircuits. A wide range of RF components from attenuators to amplifiers, from mixers to splitters/combiners. Check it out.
http://www.peetbros.com	Weather monitoring equipment including Home Met. Stations.	http://www.zeta.org.au/richardm/	I e-mail Richard occasionally but didn't know much about him until I visited his site. Drop in and find out what he likes. Has links to other Australian sites and keeps AR materials online for Australian Amateurs to see.
http://www.qth.com/cweasy	An interesting concept -learn CW by hypnosis. That's why I'm still technician class -I fall asleep half way through the test.	http://www.effect.net.au/waldis	Another amateur personality willing to tell all about his life and hobbies. Good friendly reading and you can book a QSO if you wish.
http://www.thewireman.com	That he is; cable and accessories including dipole centre insulators.	http://www.eudoramail.com	Many amateurs don't have the web at home. But they can have an email address. Eudoramail (and others) offer free e-mail addresses you can use from shared computers at work, local libraries and schools.
http://www.primenet.com/~bmyers	He has a nice range of vertical antennas.		
http://www.rossdist.com	Another AR shop but with a range of AR links to other sites.		
http://www.wassociates.com	They supply replacement battery packs for a wide range of equipment including HTs.		
http://www.teletec-usa.com	This site is advertised but the opening message was "Access Forbidden"!		
http://www.burghardt-amateur.com	They have been selling to amateurs since 1937. Nice to see traditional businesses on the web.		
http://www.kachina-az.com	A very nice looking HF transceiver with no front panel. You connect it to your PC. I have requested more information, which may form the basis of an article for AR in the future.		
http://www.bencher.com	The CW key manufacturer, who also make photographic equipment.		
http://www.warregregoire.com	Headsets for Aviation as well as AR and general use.		
http://www.kenwood.net	The Kenwood showroom where you'll find current as well as new products. ftp://ftp.kenwood.net Kenwood file & software directory.		
http://www.cushcraft.com	Antenna people with a downloadable catalog, nice gallery of pictures and stories on their antennas around the world; in fact from pole to pole.		
http://www.kantronics.com	Kantronics supply a range of AR as well as "Wireless" Modems for various digital modes.		

Now I trust that I won't be blamed for keeping people from working DX and I know that there are many more sites of interest to Amateurs out there.

I have even found a lot of local ones since originally writing this. Maybe there is sufficient interest for a permanent column on World-Wide Radio Web Sites!

If there are any volunteers to write it, please contact me? Shadetree Publishing - Bob Harper (07) 5494 0471.

AWARDS

John Kelleher VK3DP

Federal Awards Officer
4 Brook Crescent, Box Hill South, Vic 3128
(03) 9889 8393

Conditions seem to be slowly improving.

I have noticed that some days we enjoy really terrific propagation, followed by two or three days of medium to relatively poor conditions. Again followed by a day or so of top conditions.

LAST WEEK I ENJOYED 59 SIGNALS both ways into USA and Europe. So, it seems we have periods of short and long skip. To take advantage of such conditions, show some interest in Contests coming up this month. On May 8-9 we have the CQ-M International Contest utilising CW/SSB and SSTV.

May 29/30 is the ever-popular CQ WW WPX Contest (CW version). In fact, have a go at any contest that is going.

Philippines DU-PX Award

Provide evidence of having contact with 15 different Philippine prefixes. SWL OK. No time, band, or mode limitations. GCR list and fee of US\$5.00 or 10 IRCs to :-

Robin U Go DU9RG

P.O. Box 125

Cotabato City Philippines.

Scotland - Worked All Scottish Regions (WASR)

Contact one station in each of the Scottish Regions. Borders (BDS) Central (CTR) Dumfries and Galloway (DGL) Fife (FFE) Grampain (GRN) Highland or Islands (HLD) Lothian (LTH) Strathclyde (SCD) and Tayside (TYS).

Contacts since 1st May 1975. SWL OK. A QSO with GM3BSQ may be used to substitute for one region. GCR list and a fee of US\$2.00 or 10 IRCs to :-

Sutherland GM4BKV

Aberdeen ARS

Greenfern Road.

Mastrick, Aberdeen

Scotland AB2 6TP.

Sri Lanka Work 10 Sri Lanka Award.

Work 10 4S7 Stations. No time, band or mode restrictions. GCR list and 10 IRCs or equivalent to:-

Secretary Radio Society of Sri Lanka

P.O. Box 907

Colombo

Sri Lanka.

Sweden Worked All Sweden Award (WASA)

Contact Swedish counties (laens) and call sign districts as follows:-

Class	Europeans need	All others need.
HF		
3	All laens on 2 bands	All districts 0 to 7
2	All laens on 3 bands	All laens
1	All laens on 4 bands	All laens on 2 bands.
Shield	All laens on 5 bands	All laens on 5 bands.

Stickers available for 2 x CW, 2 x Phone, and 2 x Rtty. The fee for each diploma is SEK 30, 10 IRCs or US\$5.00. The Swedish Laens are :

- A : Stockholm City
- B : Stockholms
- C : Uppsala
- D : Sodermanlands
- E : Ostergotlands
- F : Jonkopings
- G : Kronobergs
- H : Kalmar
- I : Gotlands
- K : Blekinge
- L : Kristianstads
- M : Malmohaus
- N : Hallands
- O : Goteborgs and Bohus
- P : Alvsborgs
- R : Skaraborgs
- S : Varmlands
- T : Orebro
- U : Vastmanlands
- W : Kopparbergs
- X : Gavleborgs
- Y : Vasternorrlands
- Z : Jamtlands
- AC : Vasterbottens
- BD : Norrbottens

Heard All Sweden Award (HASA)

Available under the same conditions as WASA, but for SWL's only. No shields will be awarded.

Switzerland The Helvetia Award

Confirm contact with all 26 Cantons and half-cantons since 1st January 1979.

This is a beautiful multi-coloured award showing the flags of each canton on its border.

Issued in four categories :

- (1) Phone,cw or mixed
- (2) All cw
- (3) Rtty
- (4) Sstv.

Separate awards for HF and any single VHF/UHF/Microwave bands. Cards must be sent together with QSO information to the sponsor.

The award is free, but sufficient IRCs must be sent to cover the cost of returning your cards. The HF manager is:-
Kurt Bindschedler HB9MX
Strahleggweg 28,
8400 Winterthur
Switzerland.

Manager for VHF/UHF is
Rudolf W Heuberger HB9PQX
Buchserstrass 7
CH-5034 Suhr Switzerland.

Now follows a list of Swiss Cantons.

- AG : Aargau
- AI : Appenzell inner Rhoden
- AR : Appenzell outer Rhoden
- BE : Berne
- BL : Basle Country
- BS : Basle City
- FR : Fribourg
- GE : Geneva
- GL : Glaris
- GR : Grisons
- JU : Jura
- LU : Lucerne
- NE : Neuchatel
- NW : Nidwalden
- OW : Obwalden
- SG : St. Gall
- SH : Schaffhausen
- SO : Solothurn
- SZ : Schwyz
- TG : Thurgau
- TI : Ticino
- UR : Uri
- VD : Vaud
- VS : Valais
- ZG : Zug
- ZH : Zurich

Good hunting,
best 73 de John, VK3DP

ar

1999 268 PAGE

FULL COLOUR **Jaycar** ELECTRONICS

CATALOGUE NOW OUT

**Call into any Jaycar store
and pick up a copy for only
\$2, or fill out the coupon
and post it with payment.**

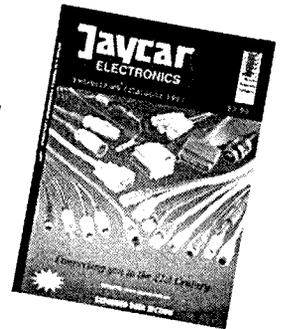

HUNDREDS OF NEW & INTERESTING PRODUCTS

Alarms

Computer

Plug/Sockets

Speakers

TV Antennas

Batteries

General

PICs

Switches

Wire & Cable

Books

Hardware

Resistors

Telephone

Boxes/Racks

Heatsinks

Semi's

Test Equip

Capacitors

Kits & Modules

Service Aids

Tools

CCD's

Microphones

Soldering

Transformers



HEAD OFFICE: 8 Leeds Street.
Rhodes, New South Wales. 2138.
Ph: (02) 9743 5222
Fax (02) 9743 2066
Website: www.jaycar.com.au

SYDNEY - CITY 129 York St. (02) 9267 1614
PARRAMATTA 355 Church St. (02) 9683 3377
PENRITH 199 High St. (02) 4721 8337
BANKSTOWN 363 Hume Hwy. (02) 9709 2822
GORE HILL 188 Pacific Hwy. (02) 9439 4799
RHODES 8 Leeds St. (02) 9743 5222
CANBERRA 121 Wollongong St. Fyshwick. (02) 6239 1801
NEWCASTLE 990 Hunter St. (02) 4965 3799
HOBART 140 Campbell St. (03) 6231 5877
ADELAIDE SA 191-195 Wright St. (08) 8231 7355

PERTH WA 326 Newcastle St. Northbridge.
(08) 9328 8252
BURANDA QLD 144 Logan Rd. (07) 3393 0777
ASPLEY QLD 1322 Gympie Rd. (07) 3863 0099
MELBOURNE CITY 2, 45 A'Beckett St. (03) 9663 2030
COBURG VIC 266 Sydney Rd. (03) 9384 1811
RINGWOOD VIC 141A Maroondah Hwy. (03) 9870 9053
SPRINGVALE VIC 887-889 Springvale Rd
Mulgrave. (03) 9547 1022
NEW ZEALAND 14A Gillies Ave. New Market
Auckland. (09) 529 9916

For the participating dealer nearest you - call (02) 9743 5222 or fill in the form below.

I've enclosed \$2 so please rush me my copy
of the fabulous 1999 268 page Jaycar
Electronics catalogue.

Send to:
Jaycar Electronics, P.O. Box 185
Concord NSW 2137. Fax (02) 9743 2066
AR APRIL 99

Name: _____

Address: _____

Suburb: _____ State: _____

Postcode: _____ Phone: _____

APRS Enters the 1998 Sun Herald City to Surf Race

Darryl Smith, VK2TDS
Vk2tds@ozemail.com.au

COMING HOME ONE SUNDAY afternoon, I found a curious message on my answering machine.

Kevin Dawson, VK2CKD had left a cryptic message about the Sydney City to Surf Run mentioning something about going in it. On returning the call I was told that we had just got permission to use APRS in the race, placing a 'tracker' on the lead vehicle. What I did not expect was that by that time next week the race would be over?

With fear and trepidation I told the WICEN team that I was prepared. After all I presented talks on APRS to about 15 groups over the previous 6 months. How could I not be ready?

Recently I had been preparing, hoping an event such as this would come up. I had been putting the equipment I would need together. I had enough equipment to be able to track two vehicles, set up a repeater and be able to monitor the signal on my Laptop. (The equipment I used is listed in the box).

In any events of this type there was no guarantee of any external power, everything had to run from battery power.

I also needed maps for the area. This was both easier and harder than it sounds. Maps are available from public domain sources, but needed to be digitised and calibrated for use. Luckily I had already done some work with AutoCad Lite and Visual Basic, allowing me to simply get the maps out.

On race day, I was up early for the drive into Sydney, in much better weather than when Sydney had a 1 in 100 year storm.

When people were assigned to stations, APRS was left out and I had to scrounge for personnel. Thankfully, Michael Roll, a newer unlicensed member of the Waverly Club was prepared to help me. He would travel with my mobile transmitter in the start vehicle to simply turn it off if anything went wrong. Michael was given a UHF scanner and mobile phone for contact. (For those wondering if this is legal, the answer is yes. The station had no controls other than an external power switch. Clearly comes under the definition of an unattended packet station, even if it is mobile!)

On the way to dropping him at the start, we dropped the digi-peater at the repeater site, a water tower in Vaucluse. Not wanting

to see how the people setting up were going to lift the car battery for the repeater up the ladders I left them to it.

Then Mike and I went to the Start Line where the lead vehicle was stationed. Once we got there the driver knew nothing about us or our equipment. Some quick talking got the equipment loaded onto the 4-wheel drive. That was after telling them how APRS got into the Atlanta Olympic Games.

I dropped off Mike then went to the finish line to set up the receiver. There were a few hassles here. The first was attempting to get the TNC to receive any packets. This was solved by juggling the modular connections on the radio and the TNC. The other problem was a bit harder to fix – attaching the antenna to the equipment shed. Duct tape to the rescue.

I was set up, the race had just started – but I was not getting packets. I heard them through the repeater but was not decoding them. The packets were mainly the heading data rather than position data from the GPS. This made all the transmissions for the first half of the race useless.

At the time I thought there was a problem but it was actually working as designed. Basically I was not experienced enough neither with the program nor with APRS.

I was only sending packets every minute. A more appropriate timing would have been 10-20 seconds. I'll do this in future.

Although there was little to show because of the update times, the organisers were impressed with the concept. The idea of being able to have an icon move across the screen automatically with the runner is a great idea for this type of event.

Next year we might even have live coverage on to the Internet, and maybe even have the image broadcast on TV. **ar**

Darryl Smith is a 27 year old Electrical Engineer with Pacific Power working in IT and drawing management. He received his licence in 1993 after becoming interested in Packet Radio. Since then he had built 3 complete TNCs from bare boards, designed and built a 4 port TNC, implemented software for it under Linux and presented the design at the 1997 ARRL/TAPR digital

TRACKER IN THE START VEHICLE

The tracker in the start vehicle consisted of a 25 Watt Yaesu FT-230R 2M transmitter, Tiny-2 TNC updated EPROMs, a mag mount Garmin GPS-30PC GPS, a mag mount 2m antenna and 7AH gel-cell batteries. The transmitter, TNC and one battery were in a Laptop bag. The other two batteries were in an old UPS case.

Digipeater

The digipeater consisted of an old PK-88 with pre-APRS and pre-GPS EPROMs, a 2 channel Motorola 2m 25 W radio and a car battery. The antenna was a 1/4 wave vertical made from RG-213 co-ax inside a 16mm conduit.

Receiver

The receiver consisted of a Kenwood TM-251 mobile, receiving only, a PicoPacket TNC, 25A power supply with 1.2AH of gel cells, connected to a NEC Laptop (colour, 100MHz 586). The antenna was the same design as the digipeater.

APRS in the 1996 Atlanta Olympics

APRS was used at 1996 Atlanta Olympics during the marathon and cycling races to track the competitors – or the TV cameras near the competitors. APRS was never intended for use on TV. It was just there to assist with camera and helicopter positioning. However, when the TV producers saw the results, they started using it rather than attempting to read street signs from the video camera footage.

What is APRS?

APRS is technology for tracking objects such as cars and people using 1200 bps packet radio. It works by broadcasting information received from Global Positioning System (GPS) receivers to stations nearby. Wide Area Digipeaters then broadcast the information even wider.

Stations receiving the information with the APRS software have the locations of the object automatically appear on screen. Digital maps allow users to see what the area around the station is like.

The latest in APRS is the Mic-Encoder or MIC-E. It compresses the APRS position report into a packet that is only 200-300 mSec long, and broadcasts this at the end of an over on voice repeaters. Find more information on APRS use on the Internet.

<http://www.aprs.org> <http://www.aprs.net>

<http://www.tapr.org>

<http://www.ozemail.com.au/~vk2tds>

The last site contains information on APRS in Australia and also details on the Australian APRS Internet mailing list.

You may also get more information by contacting Darryl Smith, VK2TDS through his email address –

VK2TDS@ozemail.com.au

communications conference in Baltimore, MD.

Darryl is now actively promoting APRS as a technology to save amateur radio in the Internet age. He is also on the WIA Sydney 2000 committee.

He may be contacted by email at VK2TDS@ozemail.com.au or via post at PO Box 169, INGLEBURN, NSW, 2565.

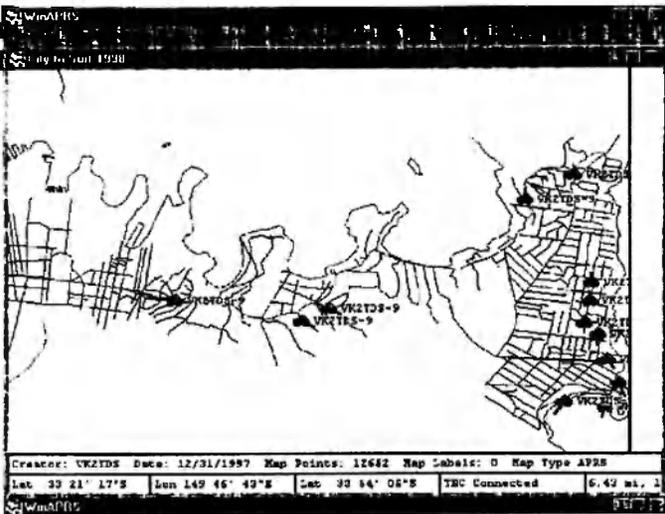

Fig. 1: Screen shot of WinAPRS showing the position of the car at various places in the race.

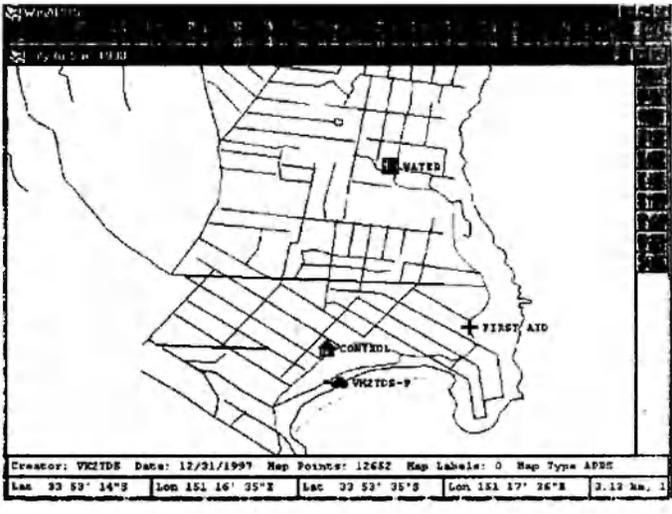

Fig. 4: The end of the race showing the location of the operations centre, water and first - aid stations.

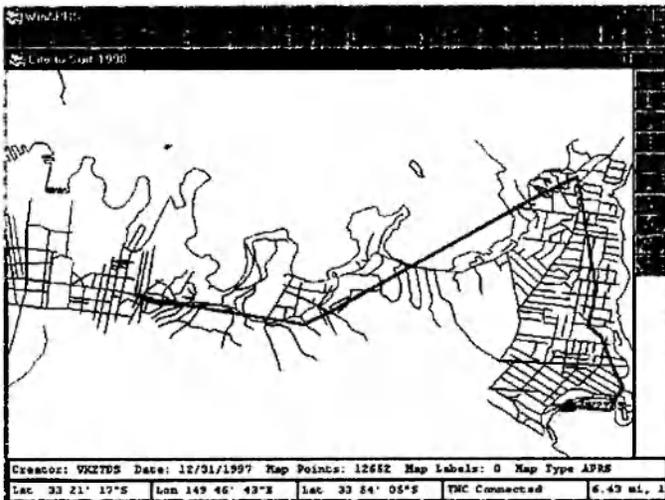

Fig. 2 : Screen shot of WinAPRS showing the TRACK of the lead car with only the last icon shown. Course is interpolated between position reports.

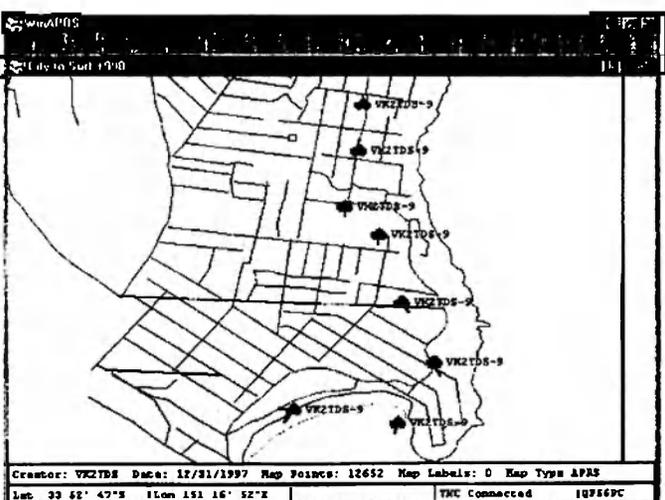
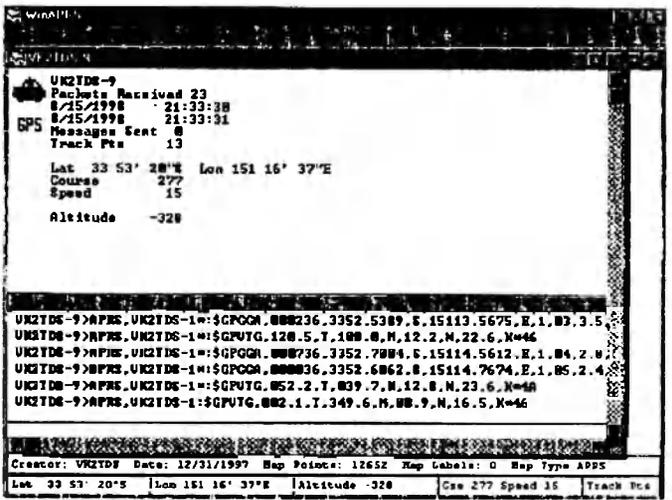

Fig.3: Close up of the end of the race with a large number of position reports. Each icon is 1 minute apart.



The Author in at the finish

Radio Reminiscences

Australia/US

search for ETs

Jim Davis VK7OW
ALARA Publicity Officer
15 James Street
Latrobe Tasmania 7307

DR GROTE REBER BUILT THE FIRST PARABOLIC Dish in USA. at Wheaton, Illinois. in 1935. This dish is preserved in a museum in Ill.

Dr Reber was a brilliant Electronics Engineer (and Radio Amateur) and during WW2 spent some time in the NRL (Naval Research Lab) in Washington DC dealing with Radar.

About 20 years ago, he left the USA to find a suitable location to set up a huge antenna system to listen to signals from Outer Space on around 1.5 MHz. A location in Hawaii proved to be unsuitable, so he finally came to Tasmania where he found an ideal site in the Midlands sheep country. He leased 400 acres on a sheep station that was virtually surrounded by hills, like a huge saucer.

There he set up his huge Antenna system that consisted of 120 phased dipoles on 80 foot poles- obtained from a nearby forest. His Radio Shack was situated in the center of this property, and the antennas radiated in all directions like the spokes on a wheel.

Dr Reber had a platform mounted on a tractor driven by an assistant. From time to time, he would adjust the Transmission lines to coincide with the rotation of the earth.

The signals were recorded on an ink recorder. The recorded rolls were checked and the information was collated at Dr Reber's home in the Midland town of Bothwell. From time to time, this information was sent to USA.

Some years ago, I was contacted by an old NRL friend in Washington State. He said he had a friend going to visit their mutual friend, Dr Reber, and could he stay with us during his visit. He told me not to be deceived by this person's appearance - his name was William E Howe and he "Was a very cluey gentleman"!

Eventually, Bill Howe arrived and introduced himself. Next day, we drove to Bothwell to meet with Dr Reber (whom I had met previously) and I will never forget this meeting. We had lunch at the old stone, convict-built Bothwell Hotel, and the feeling I had sitting opposite perhaps the two most important people in their field in America, was almost indescribable.

Dr Reber designed and built a solar powered house at Bothwell. The whole front is covered with Solar Panels and the heat

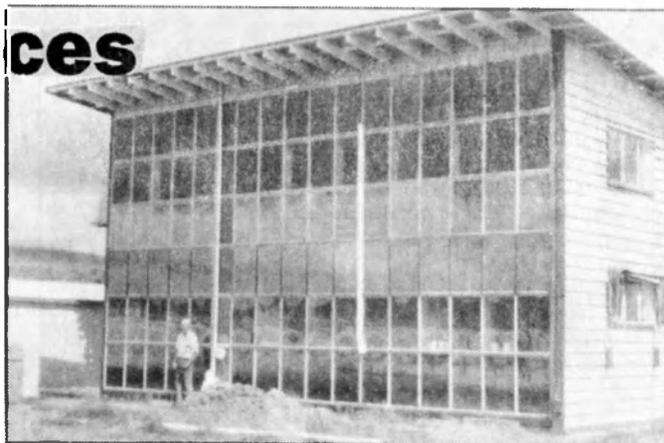

Dr Reber's solar house at Bothwell



The author, left, in the presence of two giants of radio research, Dr Grote Reber and WE Howe.

generated is ducted underground to heat up many tons of specially selected round rocks. Besides supplying hot water, this underground heat can be ducted to various rooms in the house from a central control panel.

About 5 or 6 years ago, Dr Reber concluded his experiments, and the whole antenna system was dismantled.

I will always regret that I did not accept Dr Reber's invitation to "Bring a radio down and hook it up to my array"!

These Dipoles actually disappear from sight; they were so long. (Some years ago I acquired a tape recording of an address by Grote Reber, to the Tasmanian Division of the WIA on "Radio-Astronomy". It is available to any one who may be interested. Bill Rice - ED)

ar



Dr Reber's giant antenna at Midland Tasmania

A Twin-meter SWR Bridge

An afternoon's work getting a new antenna's feed-point to closely match the characteristic impedance (Z_0) of the coax feed-line may be seen as time well spent

Drew Diamond, VK3XU
45 Gatters Road
Wonga Park, 3115.

ONE OF THE MEASUREMENTS of keen interest to us is that of SWR in the coaxial cable link between shack and antenna, or rig and ASTU.

In low loss cable, the generally accepted maximum SWR for a permanent installation on HF is about 2:1, but human nature makes most of us aim for as low a figure as can reasonably be achieved.

Moreover, for correct operation, solid-state PA transmitters should source a low SWR load.

So, an afternoon's work getting a new antenna's feed-point to closely match the characteristic impedance (Z_0) of the coax feed-line may be seen as time well spent, or a complete waste of effort- depending upon your point of view.

The most common Z_0 for coax cable inter-connections in radio work is 50 Ohms. An ordinary commercial SWR meter may require anything up to about 50 W power flow (or 1 A current) to give meaningful readings at 1.8 MHz.

Therefore antenna experiments must be done at that power level. At 28 MHz we may need only 3 or 4 W to operate the same meter.

That's the annoying thing about the strip-line coupler type meter. It has poor sensitivity at the low end of HF, rising to quite good sensitivity at the high end.

Another popular bridge arrangement- the current transformer type offers reasonably constant sensitivity across HF and into the lower VHF region, and improved sensitivity.

After experimenting with numerous published circuits, the following pattern is offered. It is easy to make and adjust, and no fancy test equipment is required.

Frequency range is from less than 1.8 MHz to at least 50 MHz (but not 144 MHz).

Full-scale forward readings are obtained at power flow levels less than 1 W, but the bridge may be safely used at 120 W, so it should be of interest to QRP and QRO operators alike.

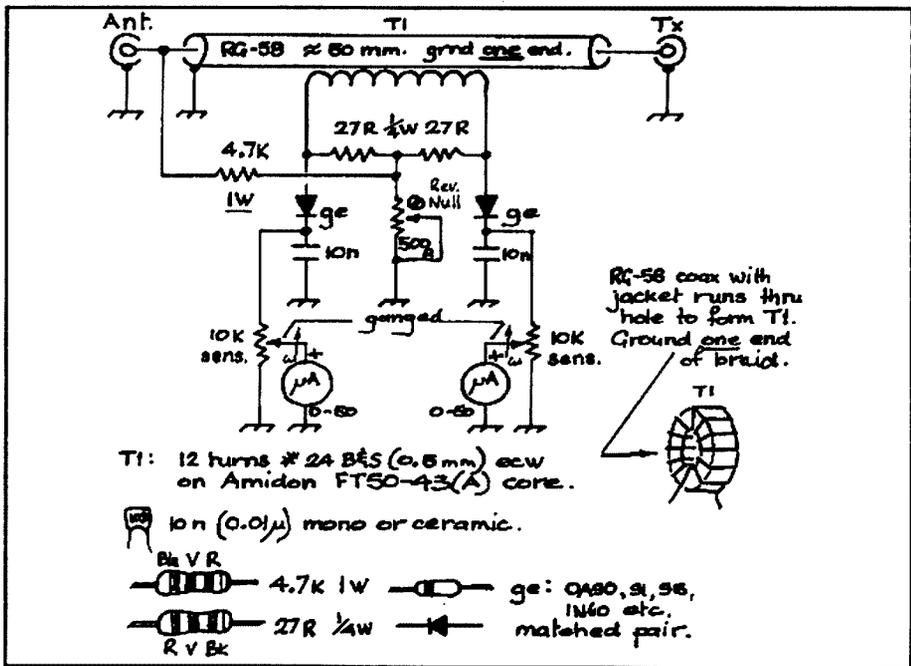

Figure 1

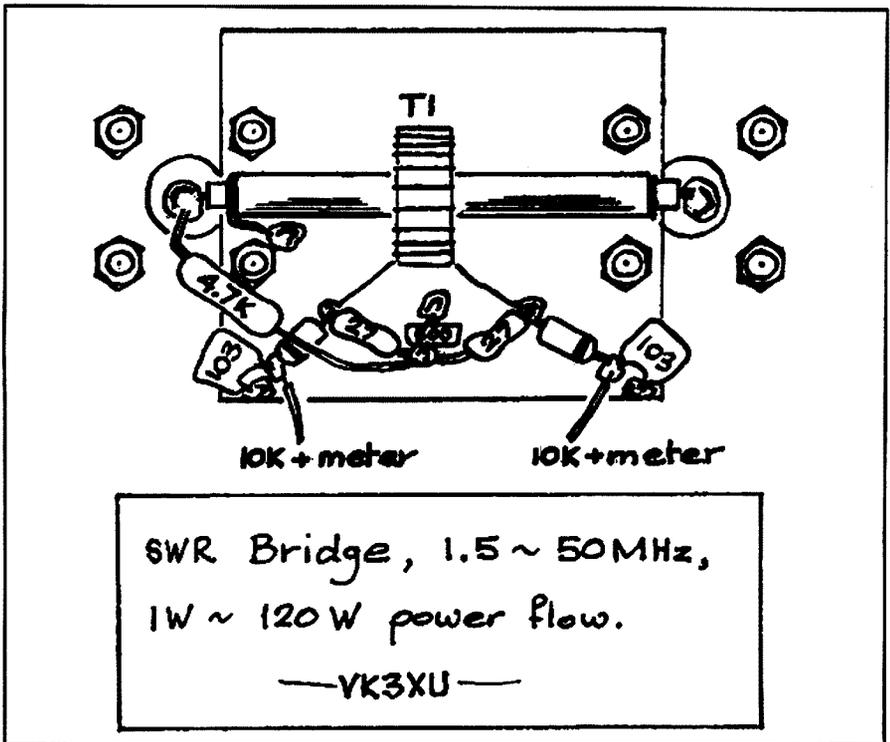

Figure 2

Circuit

The configuration is closely based upon those shown in References 1 and 2, but with modifications to suit prevailing parts availability.

When electromagnetic energy is flowing between the TX and ANT connectors, an RF magnetic field is set up around the short RG-58 line, where the relative strength of this magnetic component is sensed by current transformer T1.

The relative strength of the electric component of the field is sampled by the voltage divider formed by the 4.7 K resistor and 500 Ohm trimpot.

If the ANT connector is terminated in a non-reactive 50 Ohm impedance, the voltage established at the junction of the two 27 Ohm load resistors will aid the signal voltage induced into the secondary winding of T1 at one end and exactly cancel that at the other.

If the terminating impedance deviates from 50 Ohms non-reactive, exact cancellation will not occur, and the degree of "mis-match" will be detected.

For the curious, Ref. 3 has an excellent in-depth description, complete with design formulas.

Germanium diodes provide best affordable sensitivity as detector elements.

The DC signals thus obtained are displayed by two 50 (or 100) microamp meters, one reads relative forward power, and is set by the 10 K sens. pot for full-scale, and the other meter reads relative reflected power.

Construction

The bridge pictured in Photo 1 is housed in a Horwood type 34/6/DS aluminium box, which measures 75 x 100 x 150 mm.

Naturally, a box of smaller or larger dimensions would serve. The bridge could also be built into your ASTU, if desired.

My drawing attempts to show the layout for the RF parts of the instrument.

Note that the braid of the RG-58 coax is grounded at one end only and thus forms an electrostatic screen between primary (line) and secondary of T1. By the way, in this context, ground means "chassis"- not necessarily earth ground.

Wind 12 evenly spaced turns of #24 B&S enamelled copper wire onto an Amidon FT50-43 (A) toroidal core.

You should find that the coax jacket is now a snug fit through the hole of the core.

The distance between the connectors is not especially critical; about 50 mm is recommended. Use connectors of your choice.

A rectangle of plain printed circuit board is fitted under the connector mounting nut(s) as depicted in Photo 2.

The direct "ugly" wiring method is employed.

Tags and other devices will only add stray inductance and capacitance, and possibly spoil the upper frequency range and/or SWR 1:1 null.

Diode, resistor and capacitor leads should be as short as reasonably practicable.

For the diodes and capacitors, leave sufficient lead length for you to apply long-nose pliers as heat sink when soldering these parts.

Buy or obtain a number of diodes (they're cheap enough), sort through them and select

a pair which has lowest identical forward resistance on your multimeter's X1 Ohms range.

Also check that their reverse resistance is very high, typically in the Meg-Ohms.

Whilst you've got the multimeter out, it would also be a good plan to check the resistance of your dual-gang 10 K pot.

Rotate the pot to about half travel (for an "A" taper) and check that each gang has identical, or at least very similar resistance readings of typically 5 K between middle and outside tags.

Photo 3 shows the wiring away to the dual-gang pot and meters, which is not critical, as these carry DC only.

If QRP operation is not planned, the meters may be of a less sensitive type, such as identical 500 microamp, or 1 mA for QRO.

If your bridge will only ever be used for QRP work, the 4.7 K resistor may be an ordinary 1/4 W type. However, at the QRO 100 or 120 W power level, the 4.7 K must be a 1 or 2 W, preferably metal film.

Operation

The circuit deliberately does not show which meter reads FWD and which is REV, because these depend on the relative phasing of the toroid winding.

It's simpler in the long run if we "discover" which is which, so leave any labelling off your connectors until later.

Make up a 50 Ohm termination. Photo 4 shows two possible methods, which yield a satisfactorily low SWR.

One is a "thru" termination with BNCs, and the other is an end termination using a PL-259. Solder on two 100 Ohm 2W metal film resistors- short leads (not wire wound- as I have to remind you!).

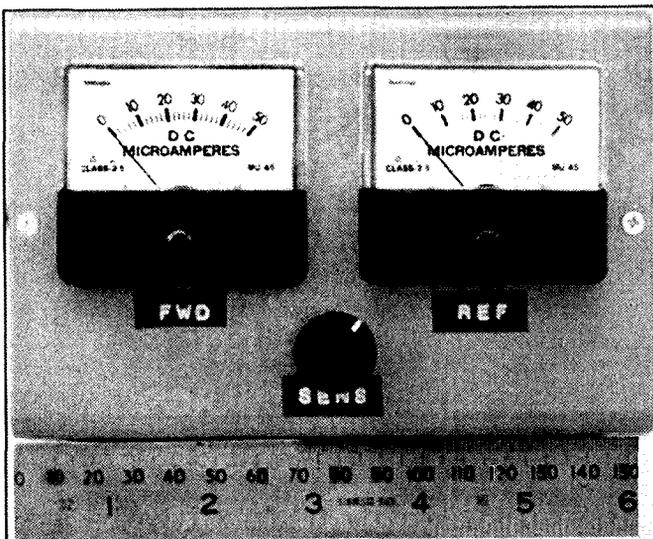

Photo 1

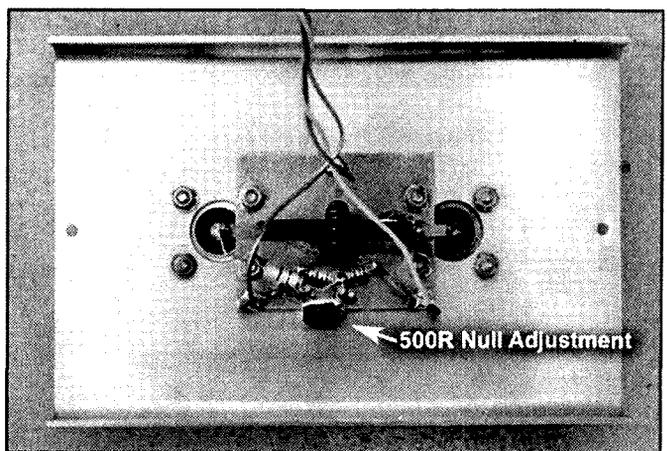

Photo 2

We can apply twice the resistor's rated power in short bursts, say 8 or 10 W, but 4 W allows us to twiddle indefinitely, so crank the transmit power down accordingly.

You may already have some other terminating device which has a very low SWR- but use it only if you know that it is less than about 1.05:1 at 28 MHz.

Link a 50 Ohm coax cable between the (nominal) TX connector and your transmitter's output, and connect the 50 Ohm load to the (nominal) ANT connector of the bridge.

Adjust the 500 Ohm trimpot to about half travel and similar for the sensitivity pot.

Apply some CW power at mid HF, say 14 MHz. One meter will read a high value, the other low. Maintain the sens pot for a full-scale reading on the higher one.

Now carefully adjust the 500 Ohm trimpot for a null on the low reading meter that should go to zero if your termination is very good.

The most sensitive display of REV readings will be had if you go for a null on the REV meter which corresponds with the downward trend on the FWD meter.

This sounds tricky, but when you do it

you'll see what I mean.

If the resulting orientation of the connectors turns out not to suit your set up; swap over the meter connections, or, if you have used a Horwood box like mine, simply turn the back panel through 180 degrees.

The SWR 2:1 mark may be easily found by connecting two 50 Ohm terminations in parallel to make 25 Ohms. Typically SWR 2:1 will lie at 20% of full-scale on the REV meter, and SWR 1.5:1 lies at 10%.

During actual on-air operation, the bridge may be left in-line. The insertion of the bridge causes no measurable loss, or harmonic generation.

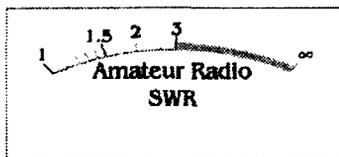

Do you know of a process, a technical shortcut or a completely new way to achieve an amateur radio result?

Share it with

Amateur Radio

and your fellow amateurs

ar

References

1. *Radio Communication Handbook - 6th edition, RSGB, pp 15.30 - 15.31.*
2. *Test Equipment for the Radio Amateur, C. Smith G4FZH, RSGB, pp 56-58.*
3. *HF Antenna Collection, E. David G4LQI (Ed.), RSGB, pp 211-213.*

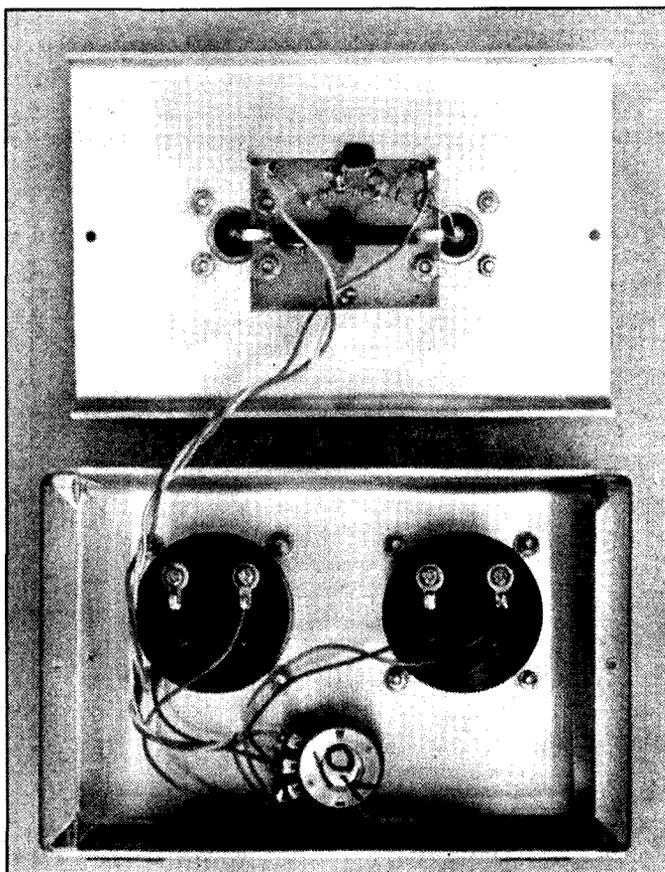

Photo 3

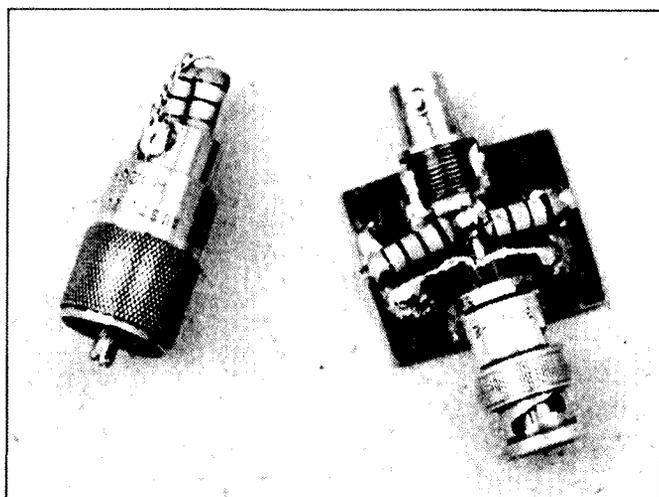

Photo 4

CTCSS Tone Detector

Warren Stirling VK3KSW
 Ph (Bus) (03) 9879 7100
 E-mail warrens@blackboxoz.com.au

This circuit came about because I wanted to be able to detect which of the repeaters I use were transmitting CTCSS tones. Being unable to program any of my rigs to scan for CTCSS tones, I decided to build a unit to do what I wanted, and this is the unit that resulted.

CONTINUOUS TONE CODED SQUELCH SYSTEM, (CTCSS) is a method used to keep a radio receiver muted.

When a tone with a particular frequency is detected in the received signal, the mute opens or a control function is implemented; eg keying up a link transmitter. The 2m repeater VK3RAG will also key up the 6m repeater VK3RTN when a CTCSS tone is detected, so that the received 2m signal is transmitted on both 2 and 6m.

Some repeaters cannot be keyed up at all until a signal with the correct CTCSS tone is received. This is usually for interference reasons. A nearby transmitter may open the mute of a repeater receiver even though it is on a different frequency.

The selected CTCSS tone must be included with the transmitted uplink signal but should not interfere with the audio

signal. Most audio stages in modern transmitter and receiver pass an audio signal in the range 300Hz to 3.4kHz.

The CTCSS tones are in the range 67Hz to 250Hz (below the radio's audio signal range) which is why they are also called subtones (sub audible tones). They are injected into the transmitted signal after the normal audio stages and are recovered from the receiver just after the discriminator and before audio filtering.

Overview

The only control on the described unit is a front panel reset button.

When the unit is powered up, it begins searching for a valid CTCSS tone in the sampled audio. The unit starts with the 250.3 Hz CTCSS tone and scans down to the 67.0 Hz CTCSS tone and will continue to scan until either the unit is switched off or a valid CTCSS tone is detected.

In the latter case the scan stops and a number representing the applied tone is displayed on the two 7 segment displays.

The detected CTCSS tone is also generated by the unit. This facility was included as the CTCSS chip used also has a tone generator function. A preset pot is located on the CTCSS board to adjust the level of the generated CTCSS tone but adjustment is only required if the encode function is implemented.

Specifications

Audio input level: - minimum 150mV direct from discriminator

Dc: 10 - 15V dc @ 58mA max

CTCSS: detects and can generate all 38 CTCSS tones.

CTCSS tone generator output level is adjustable

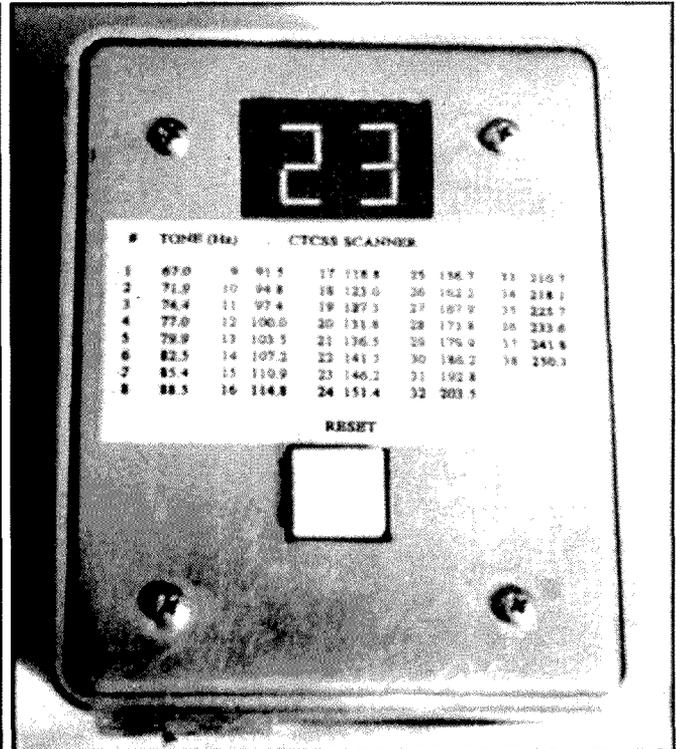
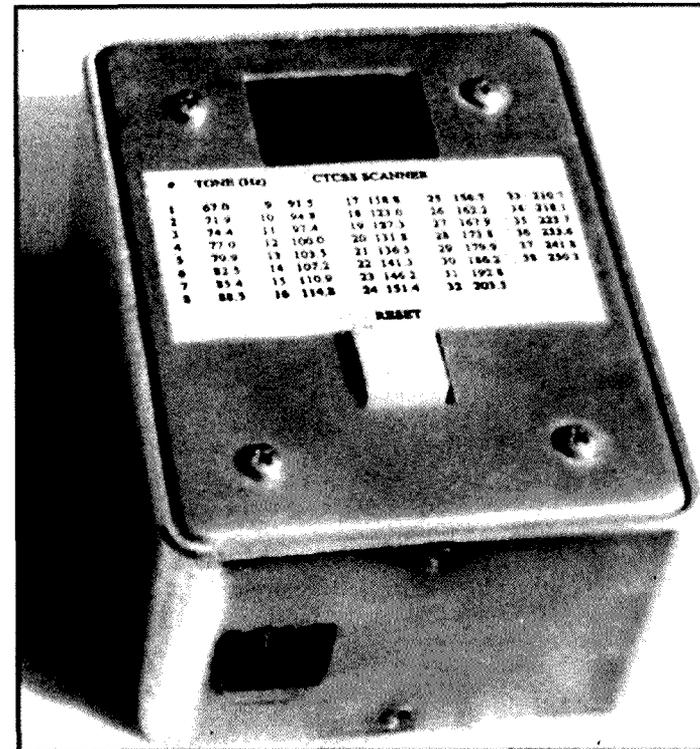

Operation

On power up, the unit will begin scanning for a valid CTCSS tone taking approximately 16 seconds to check all of the 38 valid CTCSS tones.

The LED decimal point of the left display will light when the scan is running and will flicker as each CTCSS tone frequency is checked.

If no tone is detected the circuit will keep scanning. When a valid tone is detected the scanner stops and a display number in the range 1 to 38 indicates which of the tones was detected.

At this time the decimal point led will go out indicating that the scan has stopped. The unit will also generate a CTCSS tone of the same frequency as the tone that was detected.

This audio signal can be fed to a transmitter after the audio amplifier and emphasis circuitry. Thus a CTCSS tone can be relayed from repeater to repeater via links.

The cycle can be restarted by interrupting the power or by pressing the reset button. The reset button can also restart the cycle at any time during the scan.

NOTE: due to the slow scan time, which

is a limitation of the FX335, demodulated audio must be applied for a continuous 16 seconds so that all possible CTCSS tones can be checked.

Circuit overview

The prototype scanner consists of three boards: -

- A **display board** that has the two seven segment displays, their drivers and the reset switch;
- the **CTCSS encode/decode board** that has the FX335 CTCSS chip and audio buffers;
- the **control board** that has the control EPROM, counter, flip flops and monostables which run the unit.

The display and CTCSS boards were removed from other equipment and have been modified from their original specifications.

Only the control board has been designed and built from scratch.

Brian, VK3TRS has designed PC boards for the control and display sections making the project easier to build.

The CTCSS board remains separate so that any CTCSS board using the FX335 chip can be adapted for use.

The control and display boards can be used with CTCSS boards other than the Plessey unit used in the prototype by reprogramming the control EPROM.

The only requirements are that the tone select inputs are of the parallel type and not the serial type and that the CTCSS board has a tone select output which goes active low when a tone is detected. You can't use an Icom UT-40 board for example, as it is a serial type.

The CTCSS board from a Philips FM900 series radio would be ok, as long as it is the encode/decode board (FX335 chip) and not the encode-only board (FX315 chip).

Alternatively, any board using the FX335 chip would be suitable.

Technical Description:

CONTROL BOARD

On power up R3 & C6 provide a low going reset pulse which is applied to the reset input of U7, a 555 in monostable mode, and to one of U5A's inputs. U5A, a 4093 NAND schmitt trigger, shapes and inverts the low going reset pulse and applies the inverted pulse to the reset input of U3, a 4024 counter and to the set input of U4B, a 4013 D type flip flop.

Setting U4B will enable clock oscillator

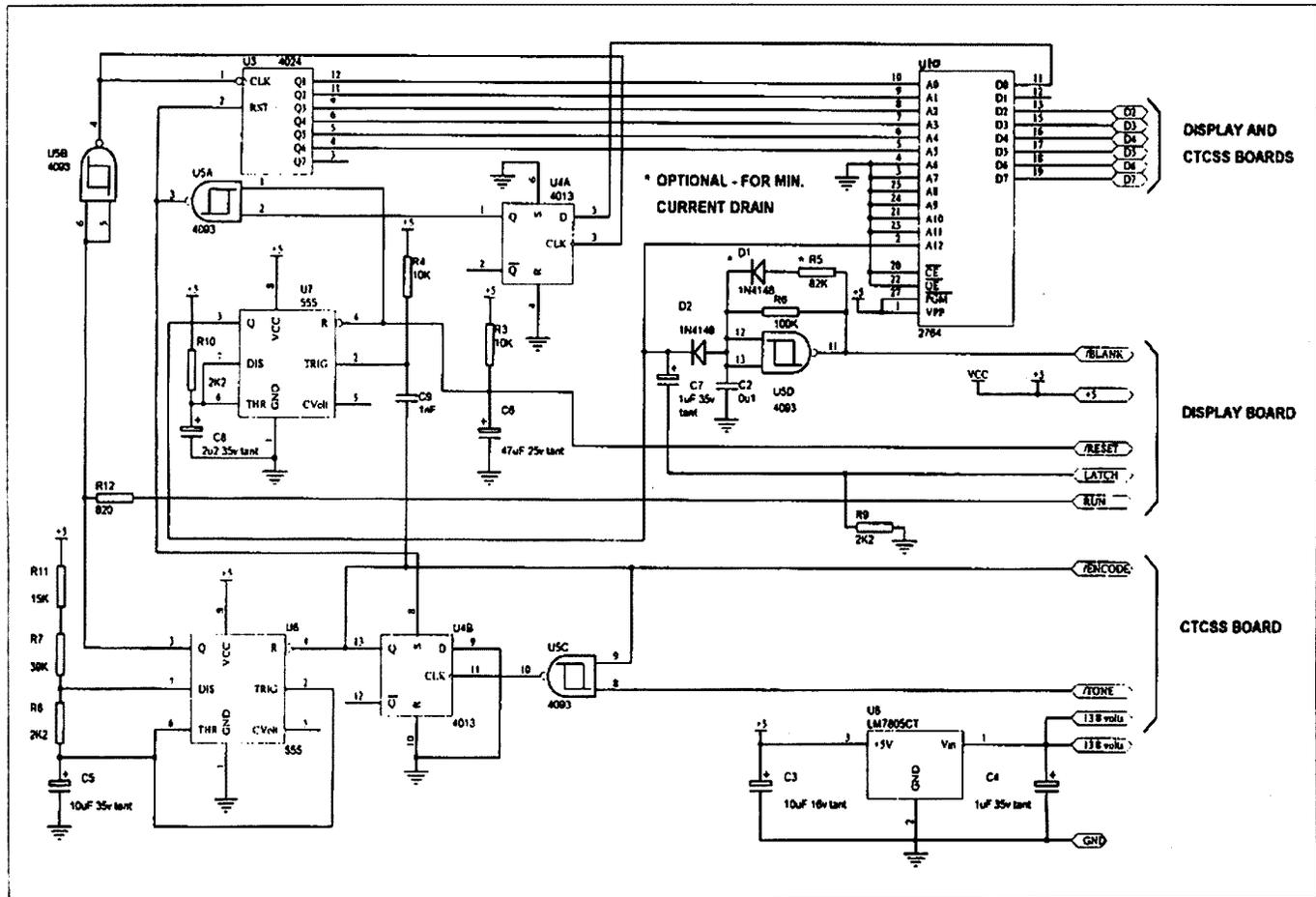

Tone detected

When a valid CTCSS tone is detected U1, the FX335 chip, brings its tone detect output low.

The 1 to 0 transition of this output is inverted by U5C and the inverted edge clocks U4B, resetting it and latching the state of the tone detect line.

This stops U6 by bringing its enable input low via U4B's Q output and also disables U4B's clock input via U5C's second input, preventing any further transitions of the tone detect line from clocking U4B.

Bringing U4B's Q output low also enables the encode half of U1, generating a CTCSS tone of the same frequency as the tone detected.

The 1 to 0 transition of U4B's Q output triggers monostable U7 via C9 and R4 which convert the transition to a negative going pulse, ensuring that U7 is reliably triggered.

The sequence of events triggered by U7's output going high is as follows: - U7's output drives the A12 line of U10 high for 5ms (the monostable timing period, as set by C8 and R10), changing the data presented by U10 from CTCSS data to display data.

The display data is stable for several milliseconds before it is latched into U8 and U9 because the 1 to 0 transition required to latch the data into the display drivers comes from C7 and R9 which generate a pulse slightly shorter than 5ms (approx 3ms).

These two timing pulses (3ms and 5ms) have a fixed relationship as they are triggered at the same time - when the 5ms pulse ends U10's A12 line goes low (its' initial state), again presenting CTCSS data to U1.

Note: data from U10 is sent to both U8 & U9 (the display drivers) and to U1. While the scan is running the displays are blanked so the data presented to U8 and U9 is irrelevant.

When the EPROM data is changed to display data, U1's tone detect output will go high as it responds to the data change as if a different tone had been selected.

When this happens, the tone presented to U1's audio input will no longer match the tone selected.

For this reason the state of the tone detect line is latched by U4B at the moment when a valid tone is detected and its clock input, which is driven by the tone detect line, is disabled immediately afterwards by U5C.

U4B can only be reset by a power off/on sequence or by pressing the reset button.

The circuit is powered by a U8, a 5v regulator that is locally bypassed by C4, a 1uF capacitor, on the input and C3, a 10uF capacitor, on the output.

FX335 CTCSS Board

This board is a standard Plessey CTCSS board (assembly 630/1/42733), which has been modified for this application.

Components Q1, Q2, Q3, R8, R9, R11, R13, 1D2 - 6D2, 1D3 - 6D3 (Plessey component designations) have been removed and the circuitry around the MC1458 audio input buffer has been changed to give a gain of about 2.

The input drive level is thus reduced from the 360mV (approx) required by the FX335 to around 150mV from the receiver.

Demodulated audio is fed via C14 to U3B, the MC1458 audio input buffer, via a filter network consisting of R9 and C16.

The buffer output drives the audio input of U1, the fx335 CTCSS encode/decode chip via C25, which is required for dc blocking.

U1 uses a switched capacitor filter to detect CTCSS tones in the range 67 to 250.3Hz, taking approximately 250mS from the time the tone is applied to give a valid tone detect indication by bringing the tone detect output (pin 12) low.

If no tone or a tone with a frequency other than that set by the 6 tone select inputs is applied then the tone detect output remains high.

The data outputs D2 - D7 from U10 drive U1's tone select lines and change to the next tone in the scan sequence every 260mS.

As U1 has a maximum lock time of 250mS a delay of 10ms is automatically included to allow the select inputs to settle.

When a valid tone is detected pin 12 (tone detect) of U1 goes low, stopping counter U3 on the control board (which drives the tone select inputs via U10).

The CTCSS board has an on board 5v regulator that has been retained to prevent digital noise from the logic and display boards from interfering with the essentially analogue CTCSS circuit.

The input voltage for this regulator is paralleled with the input of the control boards 5v regulator (U8) and is locally bypassed by a 150nF capacitor on the input and a 10uF capacitor, on the output.

Display Board

The board mounts two 4511 BCD decoder/drivers, U8 & U9 and their associated latch input inverter transistor Q1, display current limit resistor packs RN1 & 2, the two 7 segment displays LHS1 & RHS1, and SW1, the reset switch which is accessible from the front panel.

The displays are blanked by U7 on the control board that controls U5D, the oscillator that drives the 4511's blanking line.

Driving the 4511's blanking line from an oscillator substantially reduces display current as the displays are pulsed on and off, rather than being on continuously.

The display current can be reduced further by including the (optional) diode and resistor across R6. In either case a red filter (to make the lit segments more easily visible) is required.

The displays become active only when the scan stops after detecting a valid CTCSS tone. The BCD inputs of the 4511's are driven by the D2-D7 outputs of the EPROM (U10) on the control board.

The decimal point led for the left hand display is driven by the output of U6 on the control board (oscillator clock signal) to provide a visual indication that the scan is running.

The display board derives its power from U8, the 5v regulator on the control board, and is locally bypassed by C15, a 0.1uF capacitor.

Notes

The display and control circuit boards are available from Brian VK2TRS.

They are based on the circuits as drawn but have not been built and tested.

Pre-programmed control EPROMs are available from:

Warren VK3XSW, BH 03 9879 7100 or E-mail to warren@blackboxoz.com.au

Acknowledgements

I would like to acknowledge the input of Brian, VK2TRS, for turning my hand drawn circuits into something legible, his input on the circuit design and for designing the display and control board PCBs to simplify the project.

Thanks also to Roger, VK3BKR, for the use of the test equipment.

ar

**Signals sound
better on gear
that you have
built yourself**

BARGAINS

Get in quick and grab a bargain! These ex-demo Yaesu transceivers may have a few minor marks or scratches, but you'll save a fortune. Warranty applies but stocks are strictly limited.

FT-51R 2m/70cm hand-held

The FT-51R uses a sculpted case and diecast rear panel for strength, and dual microprocessor control for ease of use. At just 57 x 123 x 26.5mm (W.H.D) including NiCad battery pack, it's comfortable to hold or clip in a pocket. Includes inbuilt "Spectrum Scope", scrolling text help messages, and power-saving MOSFET amplifiers.

Features:

- Tx 144-148, 430-450MHz
- Rx 118-174, 420-470MHz
- 2m RF Output: 2.0, 1.5, 0.5, 0.02W
- 70cm RF Output: 1.5, 0.5, 0.02W
- Twin VFOs per band
- 120 memory channels
- Dual-band & dual in-band receive facilities (VHF/VHF, VHF/UHF, UHF/UHF)
- DTMF Paging and Messaging
- Large illuminated LCD screen
- Auto battery saver, Auto battery off
- CTCSS encode/decode
- Australian version selectable Auto repeater shift
- Includes FNB-31 600mA/H NiCad, belt clip, AC charger, CA-9 charging stand and high efficiency antenna.

\$599
SAVE \$100

LAST FEW UNITS

2 YEAR WARRANTY

D 3622



CD-2 mobile fast charger

A fast NiCad charger and mobile cradle assembly to suit the FT-11R and FT-51R handheld transceivers. Uses a regulated switched-mode charging circuit for cool operation and light weight. Reverts to trickle charging once the battery is fully charged. Includes cigarette lighter lead.

D 3628

\$49⁹⁵

WAY BELOW COST!

10 PIECES ONLY
2 YEAR WARRANTY

FL-2025 2m 25W Amp

Turn your FT-290II into a powerful mobile/base transceiver with this bolt-on RF amplifier. Replacing the FBA-8 battery holder on the FT-290RII, it boosts transceiver output to 25 watts. Requires 13.8V DC.

D 2863

LAST FEW UNITS

\$199
SAVE \$100

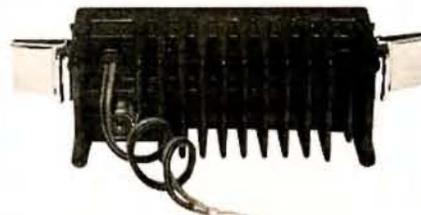

Battery packs to suit FT-11R and FT-51R

FBA-14 dry cell case	D 3626	\$19.95	
FNB-35 7.5V 900mAH NiCad	D 3624	\$59.95	SAVE \$40
FNB-33 4.8V 1200mAH NiCad	D 3623	\$69.95	SAVE \$30
FNB-38 9.6V 600mAH NiCad	D 3625	\$79.95	SAVE \$37



FT-290RII 2m all-mode transportable

Covers 144-148MHz and features FM, SSB (USB/LSB), & CW operation with 2.5W or 250mW switchable output power, twin VFOs and 10 memories that store mode and simplex or repeater frequencies. Selectable tuning rates are also provided for SSB/CW and FM (SSB- 25Hz/100Hz/ 2.5kHz and 100kHz; FM-5/10/20kHz and 1MHz). Mode specific features include a noise blanker and clarifier control for SSB/CW, plus a full set of functions for FM repeater operation, making this unit very simple to operate. It comes with a flexible rubber antenna, an FBA-8 battery holder which takes 9 x C size batteries (standard or NiCad) and a hand-held microphone.

D 2875

\$699
SAVE \$200

LAST 3 UNITS
2 YEAR WARRANTY

Rugged HF 5-Band Trap Vertical Antenna

The rugged 5BTV incorporates Hustler's exclusive trap design (25mm solid fibreglass formers, high tolerance trap covers and low loss windings) for accurate trap resonance with 1kW (PEP) power handling. Wide-band coverage is provided on the 10, 15, 20 and 40m bands (SWR typically 1.15:1 at resonance, <2:1 SWR at band edges) with 80kHz bandwidth typical on 80m at 2:1 SWR. An optional 30m resonator kit can be installed without affecting operation of other bands. High strength aluminium and a 4mm (wall thickness) extra heavy-duty base section guarantee optimum mechanical stability. At just 7.65m, the 5BTV can be ground mounted (with or without radials, although radials are recommended), or it can be mounted in an elevated position with a radial system. Unlike other antenna designs, the 5BTV can be fed with any length of 50-ohm coax cable.

D 4920

\$449 **HUSTLER**

30m Resonator Kit

Adds 30m coverage to the 5BTV and includes all hardware.

D 4921 **\$99.95**

BONUS OFFER! Purchase the 30m-resonator (D 4921) with the 5BTV vertical and pay only half price for the 30m resonator!



BARGAINS

3-15V 25A Heavy Duty Power Supply

This solidly built benchtop supply provides current of up to 25 amps ICAS at 15V, 20 amp continuous at 13.8V and lower current at lower voltages. It has front panel metering plus high current banana-style and low-current output connections. An internal heatsink and thermally switched fan provides cooling without protrusions in the metal case. Specially modified for more reliable long-term operation, it uses a rugged 50 amp bridge rectifier and trifilar wound transformer. Also provided is extensive overload protection through dissipation limiting circuitry for the pass transistors, a 30 amp instantaneous current limit, AC mains circuit breaker, a transformer thermal fuse and fused auxiliary secondary winding.

D 3800

\$299
GREAT VALUE!



\$185

VHF/UHF Power/SWR Meter

A high-quality SWR/power meter suitable for Amateur, UHF CB and commercial applications. Durable Japanese construction assures you of maximum reliability. With an all-metal case, large meter display, 140-525MHz coverage with less than 0.3dB insertion loss, and 4W, 20W and 200W power scales. Revex model W540.

D 1370

FT-50RD 2m/70cm Handheld

The Yaesu FT-50RD is an amazingly compact 2m/70cm amateur band handheld transceiver which provides MIL-STD 810 shock and vibration resistance, super wideband receiver coverage, simple menu settings for most functions, and compatibility with the optional Yaesu ADMS-1D software/interface package for PC programming of many functions.

Other features include:

- Tx 144-148MHz, 430 - 450MHz
- Rx 76-200, 300 - 540, 590 - 999MHz (cellular blocked)
- F1 F-12 keypad provides Digital Voice Recording, CTCSS/DCS scanning, and CTCSS encode/decode
- 2m/70cm RF output: 2.5, 1.0, 0.1W standard; up to 5W with 9.6V battery or 12V DC socket
- "Omni-glow" LCD screen for easier night-time viewing
- 112 memory channels with 4 character alpha naming
- Dual watch allows monitoring of sub-band activity
- Direct FM modulation for better audio quality

- 5 battery saving systems (includes Rx and Tx Save)
- Comes with FNB-40 slimline 6V 650mA/H Nicad battery pack, flexible 2m/70cm antenna and modified M-9626 AC plugpack adaptor for Nicad charging
- D 3660

2 YEAR WARRANTY

\$569

BONUS!

Pay only half-price for a second Nicad pack when purchased with the FT-50RD. Limit one per customer. Applies to FNB-40, 41, 42 only.



FT-8100R 2m/70cm Mobile

The stunning new Yaesu FT-8100R is a state-of-the-art 2m/70cm band mobile transceiver that combines high power and the industry's most versatile memory system with an excellent wideband receiver and solid construction. Its US MIL-STD-810 shock and vibration rating is your assurance of years of reliable operation. Includes hand mic, mounting bracket and fused DC power cord.

Other features include:

- 198 memory channels
- 1200/9600 baud packet socket
- Inbuilt antenna duplexer
- Inbuilt crossband repeater facility
- Dual receive capability (VHF/UHF, VHF/VHF, UHF/UHF)
- Optional removable front panel

Frequency range: Tx 144-148MHz, 430-450MHz
Rx 110-550MHz, 750-1330MHz (less cellular)

Output power: 2m: 50W, 20W, 5W
70cm: 35, 20, 5W

2 YEAR WARRANTY

\$949

D 3314



PHONE FAX AND MAIL ORDERS

PHONE: WITHIN AUSTRALIA: 1300 366 644
(Local call charge)

FAX: (02) 9395 1155 within Australia and
(+612) 9395 1155 from outside Australia

MAIL: DICK SMITH ELECTRONICS, Direct Link Reply Paid 160, PO Box 321,
North Ryde NSW 1670 (No stamp required)

Excludes packaging and postage. All major credit cards accepted.

14 Day Money Back Guaranteed if NOT completely satisfied. (Software excluded)



Visit our web site at
<http://www.dse.com.au>

DICK SMITH
ELECTRONICS

That's where you go!

*Pricing valid until 31/5/99, then subject to change.

TECHNICAL ABSTRACTS

Gil Sones VK3AUI
30 Moore Street
Box Hill South Vic 3128

Compact Mobile Tuner

An antenna tuner designed to extend the operating bandwidth of resonant mobile antennas was described by Patrick Wintheiser WOOPW in QEX Jan/Feb 1999.

The design is based on the work of Ulrich Rohde as described in QST Dec 1974.

The idea is to transform the 50 Ohm coaxial impedance to a lower value and then use an L match tuner. This gets over some difficulties that might be experienced with the L match.

In this design the L match has been modified slightly by the addition of a series output capacitor added to the basic L match.

The author includes a bypass facility for use where the basic SWR is below 1.5:1. The author points out that this avoids extra loss that might occur in such a situation.

The transceiver has no need for the use of a tuner in such a situation.

The tuner circuit is given in Fig 1. The capacitors C1 and C2 are 20-400 pF units and broadcast types could be pressed into service.

Note that C2 is hot to RF and the shaft and mounting should be insulated.

The bandswitch as shown has one less tap than those given in the coil data and you should use a switch suitable for the number

of taps that you use.

T1 is a 4:1 balun. It is wound on an FT114-43 or larger ferrite toroid using RG174 coax. The winding is 12 turns and the output end of the inner conductor is connected to the input end of the outer conductor and this is the centre tap point.

The centre conductor is the primary and the outer conductor is the secondary winding. The two windings are series connected and act as an auto-transformer.

L1 is 22 turns of #14 enamelled copper wire wound on a T-130-6 or larger powdered iron toroid core. L2 is an 8.5 turn winding of #14 bare copper wire about 1.5 inches long on a 1.25 inch OD former.

A plastic 35mm film canister was used for the form. L2 is tapped at 1 turn for 40 metres, 4 turns for 30 metres, 6 turns for 20

metres and at the top or 8.5 turns for 17-10 metres.

Obviously the wiring supplies the inductance for 17-10 metres.

Patrick also described an output current meter that he found useful for tuning up. This is shown in Fig 2.

The transformer T2 is wound on a T-37-2 powdered iron toroid core.

The one turn primary is formed by passing the wire from the output through the centre of the toroid.

The secondary winding is 20 turns of #28 enamelled wire.

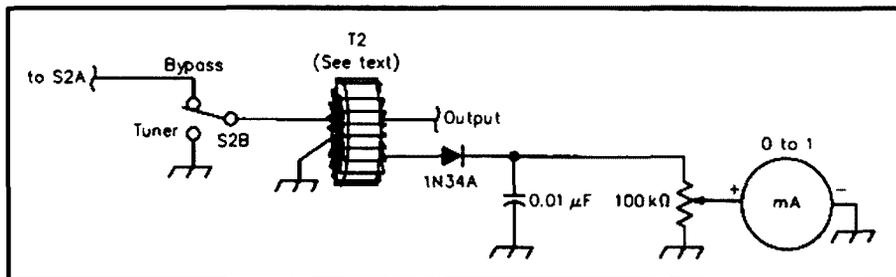

Fig 2. Output Current Meter.

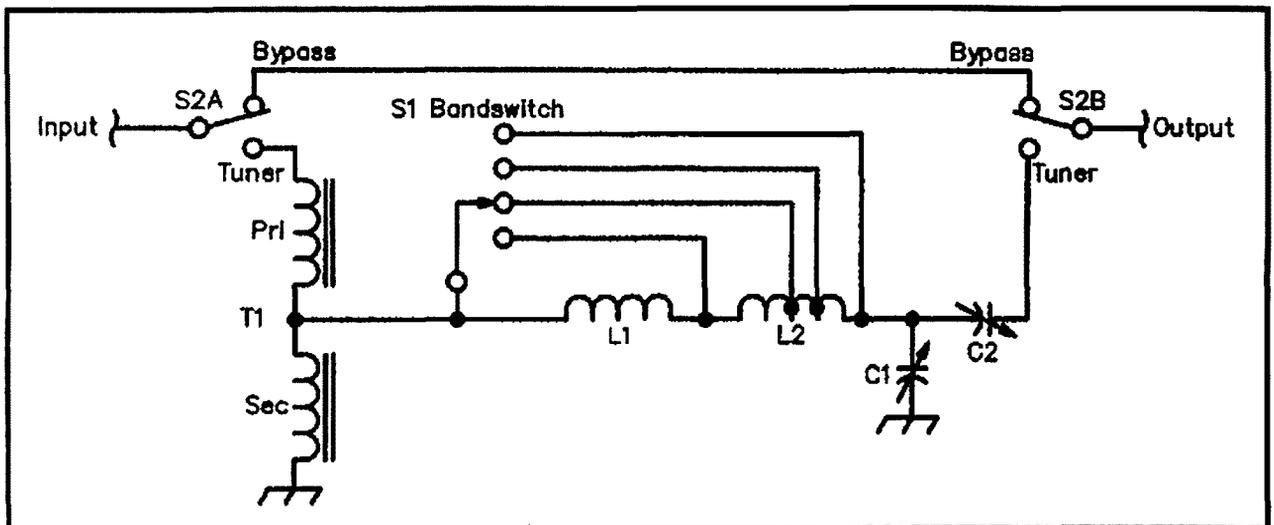

Fig 1. Compact Mobile Tuner.

Touch Sensitive Key

A circuit for construction of a touch sensitive key appeared in Rad Com March 1999. The author was Geoffrey Walsh GM4FH. The key uses a high impedance input with the circuit being made when the operator touches a touch pad.

This allows considerable variety of touch pads and avoids the need for precise mechanical construction.

The touch pads used were brass buttons glued onto plastic tap washers that were in turn glued to the keyer case.

Contact with the metal case provided one side of the electrical circuit and the operator's finger touching the button completed the circuit.

The currents involved were minute and the voltage was only 9 Volts.

One circuit for a straight key is shown in Fig 3.

The Op Amp has a high input impedance and is easily keyed by the small current that flows when the button input is earthed by the operator's finger.

For an iambic keyer two such circuits are required and the CA3240 twin version of the Op Amp could be used.

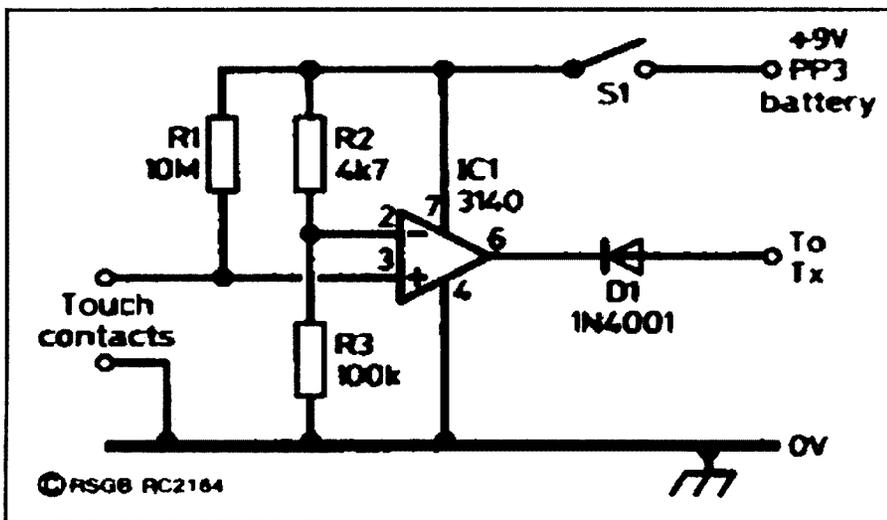

Fig 3. Touch Contact Keying Circuit.

A more complex circuit, which allows a piezo buzzer to be used for sidetone, is shown in Fig 4.

The circuits shown are only suitable for use with solid state radios.

To use them with valve radios either a keying relay output would need to be provided or a suitable high voltage solid state keying output stage would need to be provided.

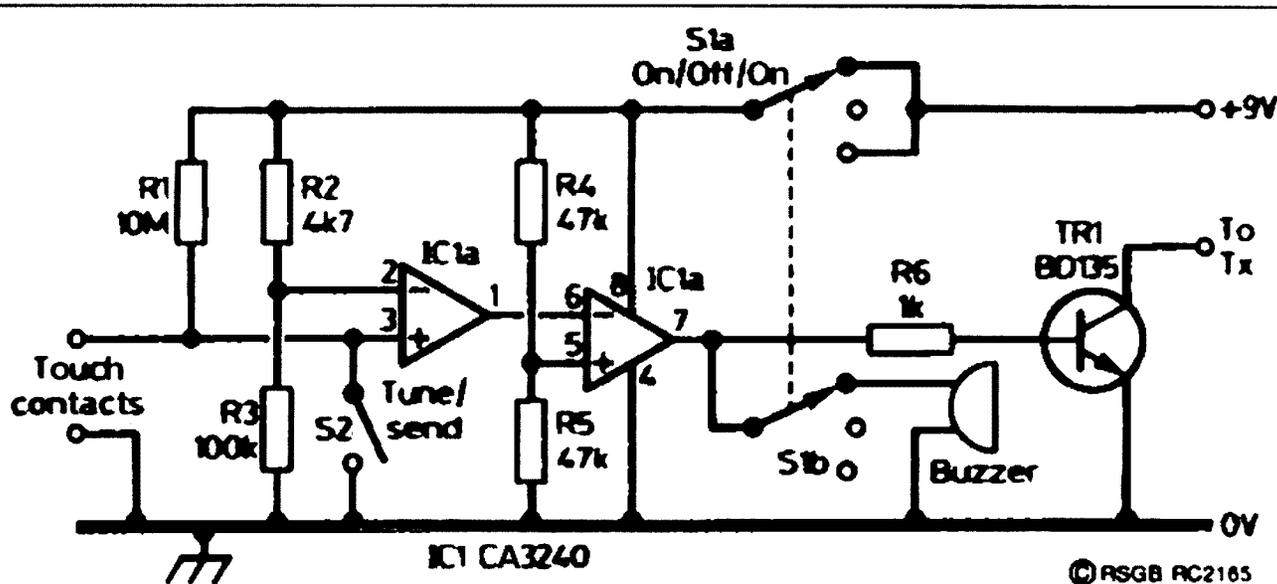

Fig 4. Touch Contact Keying Circuit with Sidetone Option.

Have you seen an article that may be of interest to the avid readers of Technical Abstracts.

Send a copy to our Technical Abstracts coordinator Gil Sones for assessment and possible inclusion in

Amateur Radio

Ceramic 7 MHz Preselector Filter.

An interesting preselector filter for the 7MHz band appeared in the Eurotek column of Erwin David G4LQI in the March 1999 issue of *Rad Com*.

The item originally appeared in *Old Man* October 1998 and the authors were Max HB9AFR and Markus Zimmermann HB9JNH.

In Europe the 7 MHz band suffers from the close proximity of several high power broadcasters.

The strong signals tend to swamp weaker signals which amateurs are trying to listen to. While a modern front-end helps, some additional help from a front-end filter is very useful.

The authors found that Murata make a 7.02 MHz ceramic filter which has the type number SFE 7.02 MHz.

However it is not readily available in small quantities. They obtained some and tried them out as front-end filters with some success.

The filters require matching transformers for use in a 50 Ohm system,

as they are 300 Ohm devices. A single section filter is shown in Fig 5

The matching transformers were wound on Amidon FT37-77 ferrite rings. The winding was 28 turns of 0.28 mm enamelled copper wire tapped at 10 turns from the earthy end. The optimum value of the coupling capacitors is 100 pF.

A two section unit was also tried and is shown in Fig 6. The capacitors C3 and C4 were 390 pF.

The response curve of the filter is shown in Fig 7. The single section has an insertion loss of 4.5 dB and the two section unit has an insertion loss of 7 dB.

Supply of the filters is a problem. Markus had a small supply and may still be willing to supply interested amateurs.

Payment in US dollar notes only, as banking small amounts is expensive. The cost plus postage for a single section is \$US 12 and for a two section \$US 15. Postage was given as \$US 3 but could well be somewhat more for delivery to Australia. Check first.

His address is Markus Zimmermann, Toenler 2, CH-9548 Matzingen. His Email is 100724.2637@compuserv.com. This information is provided only to help track down the parts and you should exercise caution.

However it is only a small amount of money if you really want to try the circuit.

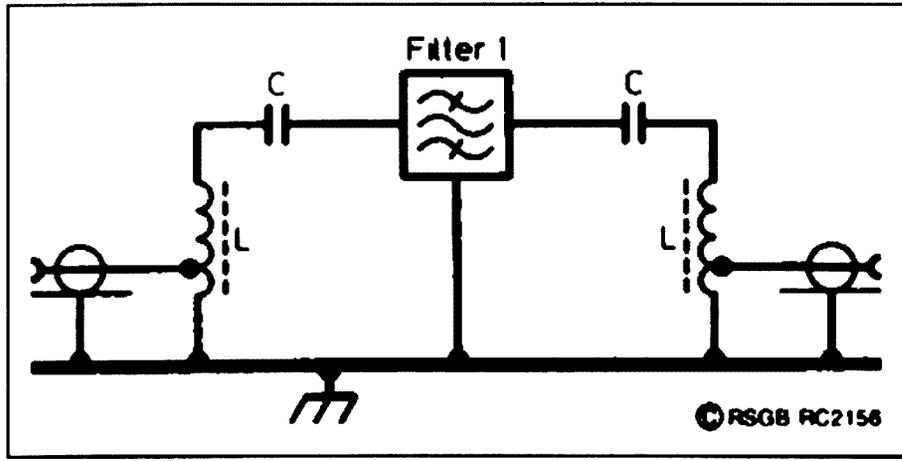

Fig 5. Single Section 7MHz Bandpass Filter.

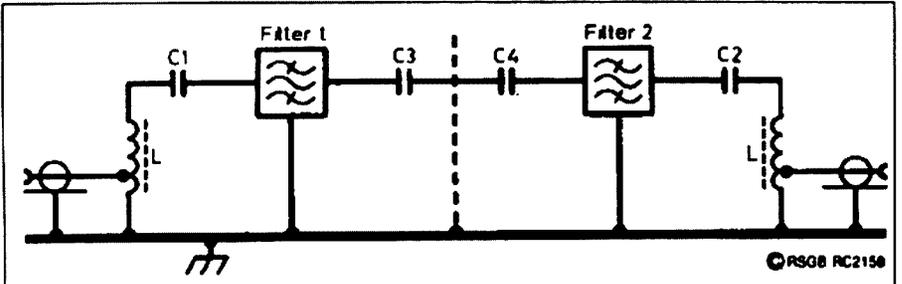

Fig 6. Two Section 7MHz Bandpass Filter.

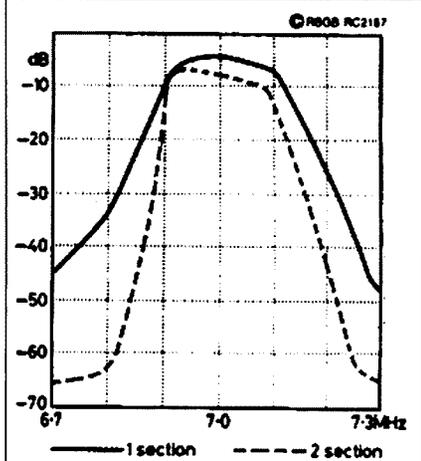

Fig 7. Attenuation Plots of Filters

Looking for an Olde Valve?
or a new Valve?

AMATEUR RADIO - AUDIO - INDUSTRIAL AND VINTAGE RADIO plus electrolytics, sockets and books

BUYING - SELLING - TRADING Australasia's biggest selection

Send a SSAE DL Envelope for your free catalogue

ELECTRONIC VALVE and TUBE COMPANY
PO Box 381 Chadstone Centre VIC 3148
Tel: (03) 9571 1160 Fax: (03) 9505 6209
Mob: 0417 143 167
E-mail: evalco@mira.net

POUNDRING BRASS

S P Smith
9 Peak Street
Bateau Bay NSW 2261
02 4334 7743

Here is a simple QRP transmitter that can be made in an evening. The only tuning is in adjusting the oscillator/transmitter section for the purest sounding note. The builder should get hours of fun building and using this simple 80 metre transmitter. The all up cost of building the transmitter was just under \$20.00 and would be considerably less if you have most of the components on hand.

Circuit Description

T1 forms the load for Q1, the inductor for the tank circuit and the output coupling transformer. C1 and C2 form a capacitive voltage divider to limit the amount of feedback in the oscillator loop to a loop gain of one.

C3, the tuning control is adjusted to obtain the clearest CW signal. D1 helps to reduce harmonics in the output waveform. C7 smooths any ripple on the supply and shapes the keying waveform. C4 shunts any RF on the DC line to ground.

If not powered by a portable battery, a small line choke or ferrite bead on the supply from the key would help avoid

modulating the signal with noise.

R1 delivers just over 1mA to the base of Q1, a 5 watt NPN RF transistor, which can handle a very high SWR when operated at 12 volts or less. C5, C6 and L1 provide a low pass filter to limit any harmonics before they reach the antenna.

Construction

The only trouble I experienced was in the winding of T2 (Toroidal transformer). After a few practice runs I was more confident in winding toroids.

Remember to scrape back the protective

enamel before soldering, it is also a good idea to code the ends for easy identification with a little liquid paper or coloured tubing. Even insulation from hookup wire can be used.

The layout is not critical other than keeping component leads short. Normal construction practices are required. You can wire the circuit on Versa Strip Boards which is similar to the old English Veroboard or printed stripboards.

I used a blank printed circuit board as a ground connection and glued 1 cm x 1 cm insulated copper board to this which acts like a bridge where a number of components can be attached to a central point.

However you decide to make yours, keep it neat and tidy. This will help if you have any problems later.

Alignment

- (1) Set a multimeter to the highest mA range and connect it in series with the 12 volt line.
- (2) Attach a dummy load (two 100 Ohm resistors in parallel) and insert the required crystal.
- (3) Connect to the supply, 9 - 13.8 volts.
- (4) With a receiver, tune around the crystal frequency until a tone is heard. If none is found and 250 to 450 mA of current is being drawn on your meter, adjust C3 until the crystal begins to oscillate.
- (5) Switch off the power and remove the multimeter.

Now connect your händkey.

Power up once more and send a series of "dits". Again adjust C3 for the best sounding CW note.

Once you'r e happy with this, disconnect the dummy load and connect your antenna.

With a little time and effort you can get a QRP signal on air and actually communicate via something you have made for yourself.

Perhaps you could make it a club challenge to gain the best results from such units.

With a smaller transistor such as the BC549 and a 270k resistor for R1, this circuit could be used as a simple practice oscillator.

When coupled to a short piece of wire as an antenna, this practice set up shouldn't annoy anybody.

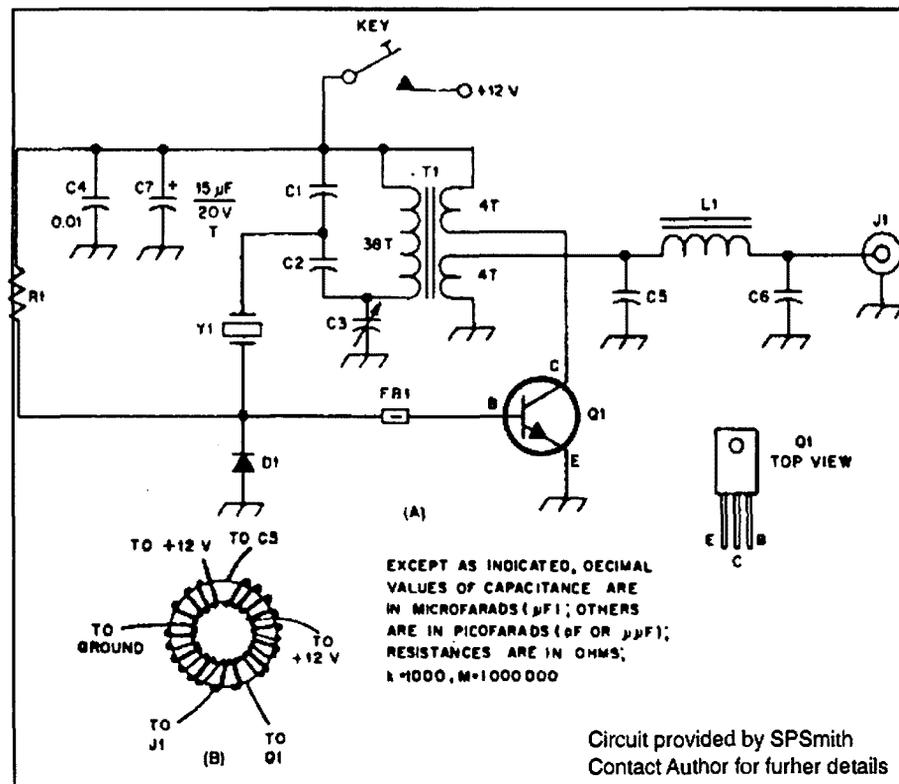

Component list overleaf

The Impossible QSO

Alan Shawsmith VK4SS

35 Whynot Street, West End Brisbane 4001

TI9C. Ebon Atoll 11.2.65.

Opr Don Miller, WP9WNV.

Propagation to East VK, poor to impossible. Activity from this spot, classified as a new country, would be sure to raise a wall to wall, sky-hi 'pile-up'.

And who better to set such a scene in action than DX'er extraordinaire, the man whose ears had the aural sensitivity of a cat, - W9WNV.

I checked out my chances; at best they were bleak. My beam was down being repaired. All I could muster was 90 watts into L.W. up 35'.

Solar activity was at rock bottom between cycles 19 and 20. Smoothed number 10-20. This meant no propagation above 20 metres and high local QRN on the lower bands due to storms. 'W' QRM.

No matter what band TI9C chose to use a 1000 59 Stateside signals would pound into his ears, as Ebon Atoll on the Cormorant Reef was only 1 DX 'hop' away to the S.E. (Split frequency working was used in 1965).

On my way to the car to go to work, my feet decided to make a right angle turn into the Radio Shack. I had already been listening before breakfast for TI9C without success. I switched on the all-valve transceiver, which had a 30 second delay before it came to life, and a 15 minute drift before settling down.

To my surprise a sound similar to a swarm of maddened bees came weakly audible rising and falling in its crescendo, - and then

suddenly there was TI9C at about S4. Weak, woolly with an echo and working Ws at S9s.

I could tell by the sound of his signal that he wouldn't last, so I simply stretched out my hand to the 'bug' key and sent my call once. Imagine my shock when back he came VK4SS 229. This I immediately confirmed with his RST 559.

It was acknowledged and without a pause Don, W9WNV carried on disposing of the wall to wall Ws, 2 at a time, all at S9.

Less than 2 minutes later the sig of TI9C suddenly fell over the edge of propagation at that frequency and he was gone. I had been in the shack less than 3 minutes and had not touched the transceiver.

Only then did I think to check the band. It was 20 metre. Which direction was the beam? I remembered there was none.

The sun was almost 50 degrees to the horizon and at this latitude, up for three and a half hours, and the band had been dead for almost as long.

Was the circuit LP, SP or over one of the poles? I would never know.

I left for work walking on cloud 9 and feeling like a poker player who'd been dealt a royal flush when the stakes were high.

After 64 years Dxing and more than 100,000 QSO's later TI9C is one of my few most cherished QSL's. **ar**

Do you have a favourite QSO story?

Share it with us

Good luck, speak to you on air 73

Stephen Smith VK2SPS

POUNDRING BRASS continues

COMPONENTS (80 metre operation)

J1		Antenna Socket
C1	0.001 uF	Silver mica capacitor
C2	100 pF	Silver mica capacitor
C3	80-600 pF	Mica compression trimmer or equiv
C5, C6	820pF	Disk ceramic capacitors
L1	T-37-2	Core, 24 turns of No 26 enamel wire
T1	T 50-2	(Toroidal Transformer) wound with No 26 enamel wire. Primary, 38 turns Secondary, 4 turns each.
RF C1	Ferrite Bead	FB 43-101 or equiv
D1	1N914	Silicon diode
Q1		NPN RF low power transistor such as 2SC1306 from an old CB
R1		10K 1/4 watt resistor (for very low power use 270k and a BC549 for Q1)
Y2	3.58MHz?	80m Fundamental cut crystal

ar

COLUMN 73

With John Aarsse VK4QA

The March 1999 edition of "Electron" the official journal of VERON, the Amateur Organisation in the Netherlands contains some very disturbing news.

An interesting, but damaging, proposal by a member of the European Union Parliament, a Mr Gianni Tamino, seeks to limit the maximum allowable electric field strength to 1 V/m. He proposes this to guard the European population against possible harmful effects from non-ionising radiation.

Non-Ionising Radiation is an electromagnetic radiation the frequency of which is too low to be able to ionise an atom. This covers the whole radio spectrum, thus also the amateur radio frequencies.

Compared to ionising radiation such as Roentgen and gamma radiations, the non-ionisation type is relatively safe and innocent. About the only proven effects on the human body are currents and some heating effects. Above 100 kHz this is fairly important, especially at GHz frequencies. A microwave oven is an example of this heating effect.

A number of countries have rules requiring owners of radio transmitters to minimise or even prevent the risks of possible dangerous radiation to the general populace, specifically the electromagnetic radiation from the transmitters.

So, where do the European Amateurs stand? If they have to adhere to Mr Tamino's proposals, on shaky ground. A computer model has shown that, to achieve these proposals, the amateurs will have to operate with an effective radiated power as low as 10 Watts! A bit low to work worthwhile DX, especially in competition with stations from other countries where these rules do not apply.

Mr Tamino represents the Italian Green Party in the European Parliament and he is now charged by that institution to write a final report.

Needless to say that everybody associated with anything that radiates electro-magnetic energy, is awaiting this report with a bated breath.

Lets hope that his Australian colleagues don't try the same thing here although something similar was recently tried here in Maleny, Queensland with a cellular phone tower.

They lost to more influential powers - this time!

73 for now, VK4QA

ar

SPOTLIGHT ON SWLING

by Robin L. Harwood VK7RH

5 Helen Street, Newstead Tasmania 7250 (03)
6344 2324 E-mail: robroy@tassie.net.au

When hostilities commenced in the Balkans, an immediate radio war broke out over short wave.

JUST A FORTNIGHT BEFORE Easter, the situation in the Balkans, which was rapidly deteriorating, sharply escalated when NATO commenced to bomb Yugoslavia, after the failure of peace talks in Rambouillet, France.

When hostilities commenced, an immediate radio war broke out over short wave. Yugoslavia immediately expelled foreign media from the disputed province of Kosovo.

This was quickly followed by restrictions on what they could report from Yugoslavia. Also what independent media remained within Serbia was quickly silenced. The famous B92 FM station which was the voice of the Serbian opposition just a few years ago, was yanked off the air and was reduced to sending out bulletins over the Internet with text or live audio.

This too came to an abrupt end with most ISP's within Serbia being placed under government control and censorship.

Just after the NATO air offensive commenced, a huge tidal wave of refugees were emptied out of Kosovo, apparently at the instigation of the Serbian military and paramilitary troops. As I write this, just under a million refugees had escaped into neighboring countries such as Macedonia, Albania and the semi-autonomous Yugoslav province of Montenegro. As a result, NATO further escalated the air offensive.

Listeners in Europe are in a better position to monitor developments in this crisis than we are here in the Southern Hemisphere.

Although much of the activity is on UHF or via military satellite, some HF activity has been noted, especially with air reinforcements being heard over the North Atlantic on civilian air traffic control circuits. The huge B52 and B1 Stealth bombers have been heard going through civil air controllers in the UK and Europe.

The major US military HF channel of 11175 kHz was briefly jammed at the commencement of the Air offensive with unknown operators speaking in heavily accented English with frequent expletives. It is believed however that these were

civilians, pro-Serb and in Western Europe.

Those in Serbia with satellite television, I should expect, will have their gear confiscated. The domestic media is tightly controlled and the Internet has also been placed under further restriction. It now appears increasingly likely that this crisis will be prolonged with the war of words continuing, primarily over short wave.

If you are interested in following developments, here are some frequencies of Balkan nations broadcasting in English.

Croatia: Hvarski Radio, Croatia from Zagreb. This broadcast ironically comes via senders in Juelich, Germany. There is a short 5-minute English news bulletin just at the commencement of their Croatian programming at 0500, 0600, 0700, 0800 UTC. The announcer is usually an Australian Croatian. The frequency is 13820 kHz.

Albania: This poor nation has been receiving the brunt of the Kosovo refugees. Radio Tirana was easily to hear in the 60's and 70's when they were broadcasting over amateur allocations, particularly on 14320 kHz but now they are infrequently heard. The latest schedule I have is at 0145-0200 UTC on 6115 kHz and 7160 kHz repeated at 0230 to 0300.

From 1915-1930 UTC it is on 7180 and 9510 kHz. At 2130-2200 UTC it is on 7160, and 9635 kHz, the latter beamed to Australasia.

Yugoslavia: This is being heard here at 0430 UTC on 9580 kHz broadcasting to the American west coast in English with some flutter. Their senders are in the Serbian enclave of Bosnia-Herzegovina.

Their transmissions to Australia arc curiously at 1900 UTC, that is 5 am here locally. They are on 7230 till 1930. However the transmission to Europe would be better at 2100-2130 UTC on 6100 and 6185 kHz.

Bulgaria: I am hearing the German service very clearly at 0500 UTC on 12000 kHz and usually after the English service to North America.

Greece: 9425 and 9375 kHz are regulars here in the mid to late afternoons from Athens. The broadcasts are in Greek but

there is sometimes a ten-minute English news bulletin at the end of the transmissions.

Turkey: Try 17705 or 21735 kHz. The latter is a relay of the domestic service in Turkish and is extremely strong here from 0400 UTC until 1200 UTC.

17705 used to have English to North America and Asia at 0300 UTC yet I haven't heard it of late.

The BBC World Service is perhaps the best for balanced coverage of continuing developments. There has been an increase of news and current affairs of late from London. Here are the latest channels for the World Service to Australia up until the 30th of October.

5975	2000-2200
7145	0600-0800
9660	2200-2300 **
9740	1100-1600; 1800-2200
11765	0900-1100
11955	0500-0900; 2200-2400
12080	2200-2300 **
15360	0700-0915.

** via Brandon (QLD) to PNG and the SW Pacific

Although not targeted to Australia, I hear the transmissions to South Asia on 17790 from 0030 till 0200 UTC. When it commences, it is subject to multipath echoes yet it is quite acceptable after 0100. I presume it is from the Kranji site in Singapore.

I have seen a press release announcing the sale this month of the National Transmission Authority (NTA) to a UK consortium which handles the Independent Broadcasting Authority's radio and television senders in Great Britain. Senator Alston mentioned a price of about 630 million dollars for all the domestic senders of radio and television and including the Shepparton, Brandon and Darwin HF broadcasting sites of Radio Australia. I wonder if Darwin will be reactivated and now that it is privatized, be available in a similar manner to Merlin and Deutsche Telekom, which now carry programming on a commercial basis.

Incidentally Merlin Network One is extremely strong on 13720 kHz from 0600 till 0900, beamed to Australia. This is a commercial British station with frequent advertisements of British businesses. I do not know where they are broadcasting from but I have seen that it is from the UK. Remember Merlin was a management buyout of the BBC external senders and is a commercial operation. Well that is all for this month. Keep your ears open because there is still plenty to hear over short wave!

73,

Robin L. Harwood VK7RH

ar

AMSAT AUSTRALIA

Bill Magnusson VK3JT
RMB 1627 Milawa Vic. 3678
Email: vk3jt@amsat.org

Earth-imaging with Amateur Radio Satellites.

UoSat-1, UoSat-Oscar-9, UO-9 was built at the University of Surrey, England and launched in October 1981. Oscar-9 was an educational satellite. It was aimed squarely at physics classroom instruction.

It was widely used at University, College and Secondary School level. In addition to many data acquisition devices designed to allow further study in the lab and classroom, UO-9 carried on board a device that was at that time virtually unknown in the wider community. CCD cameras were in the realm of the guru in 1981.

No world-wide standards had been developed as they are today. Even the ATV and amateur SSTV adherents were still using Vidicon type technology. Nowadays CCDs are available from every discount electrical store in the form of cheap hand held video cameras. They are used on the world's greatest astronomical telescopes.

They have revolutionised the way we take pictures. UO-9 did not carry a transponder or repeater as we have come to expect of amateur satellites today. In fact it was a scientific satellite rather than a true amateur satellite. It did however, courtesy of Dr Martin Sweeting G3IOR, have a downlink transmitter and beacon in the 2 metre amateur band and image data was transmitted as part of the telemetry downstream.

Come to think of it ... much of the digital satellite work we enjoy today came about because of Martin and his dual roles as head of the then embryonic Satellite Engineering section of the Electrical Engineering department at Surrey ... and active radio amateur.

This new imaging capability was all very advanced technology at the time and it caught the general amateur fraternity on the hop. It was still in the experimental stage in commercial satellite practice. Virtually no-one had the ability to work with this type of data and the pictures were largely a mystery.

One or two of my friends actually wrote their own software to allow picture acquisition using the simple CP/M

computers of the day like Sinclairs, BBC Acorns and MicroBees. These were the days before hard drives became available for storage. Monochrome screens were the order of the day.

The pictures were printed out on heat sensitive paper using early thermal printers. How things have changed. An amateur radio satellite would not seem complete these days without earth-imaging capability and many amateur radio shacks have fast modern computers as part of the normal day to day equipment on the bench. So what then is this earth-imaging business all about?

First, a quick look at the NOAAs.

Although they are not the only commercial earth-imaging satellites by a long way, the NOAAs are the most widely known among the amateur community. Many amateurs regularly collect weather images from them as they pass over each day. The acronym NOAA stands for National Oceanic and Atmospheric Administration.

One of NOAA's responsibilities is the provision of cloud images to aid in weather forecasting. There are lots of special purpose commercial earth-imaging satellites like LandSat, SeaSat, SPOT, GMS etc. etc. They all have a prime purpose. Land usage detail, sea surface temperature and height etc. They require specialised receiving and decoding equipment and the really useful images ... well; you have to pay for them!

They are after all in the business of earth-imaging. The NOAAs have a "free-to-air" low-resolution downlink and it's this that most amateurs would receive and decode. The pictures have a resolution of about 4 km per pixel and this is enough to give excellent cloud pictures (their primary purpose) and quite good ground detail. Surprisingly you can sometimes even pick out the warm trails left by high flying jet aircraft if the atmospheric conditions are just right.

The APT transmissions as these are known, take place just above 137 MHz. This limits the transmitted bandwidth and

National co-ordinator:

Graham Ratcliff VK5AGR
Email: vk5agr@amsat.org

AMSAT Australia net:

The AMSAT-Australia net is held on 80 or 40 meters LSB each Sunday evening. During daylight saving time in South Australia the net is on 7068 kHz +/- QRM with an official start time of 0900utc (with early check-ins at 0845utc), during the rest of the year the net is on 3685 kHz +/- QRM with an official start time 1000utc (with early check-ins at 0945utc).

AMSAT Australia newsletter and software service:

The newsletter is published monthly by Graham VK5AGR. Subscription is \$30 for Australia, \$35 for New Zealand and \$40 for other countries by AIRMAIL. It is payable to AMSAT Australia addressed as follows:

AMSAT Australia
GPO Box 2141
Adelaide SA 5001

Keplerian Elements.

Current keps are available from the Internet by accessing the AMSAT FTP site, ftp.amsat.org and following the sub-directories to "KEPS".

therefore the resolution of the images. The images are transmitted as a two channel pair, each taken in a particular part of the light spectrum, usually visible light centred around yellow and near-infra-red light during the daylight hours and two different wavelengths of infra-red at night.

The NOAAs also have a "free-to-air" high resolution transmission on 1.707 GHz. Because of the greater bandwidth allowable on this frequency, a resolution of about 1 km per pixel is attainable.

They transmit 5 separate image channels plus telemetry, which is a huge amount of information to process and display. As always there is a price to pay and the down side is that this amount of information, possibly over 80 megabytes per pass, dictates the capabilities of the computer required for its subsequent decoding, image manipulation and display.

An older 386 with 16 or 32 MBytes of RAM would be struggling to cope with files of this size, and subsequent storage or archiving would be out of the question. Fortunately modern Pentium type computers with multi-gigabyte hard drives and hundreds of megabytes of RAM are becoming more common place nowadays. These machines are ideal for this type of work and make it look easy.

So, what about amateur radio satellite imaging?

As I hinted in the opening paragraph, Amateur radio satellite imaging has been around for a long time. It had become more refined over the years and the current batch of satellites can produce excellent pictures of the Earth from low-earth orbit, ie. 500-1000 km. P3D will be able to give us spectacular views of Earth from 40 000+ km away. I haven't studied the projected orbit from an astronomical point of view but wouldn't it be great to see an image of the Earth from P3D with the Moon in the background?

Amateur radio satellite imaging differs from the NOAA system in one fundamental way. The imaging device on the NOAAs could not be described as a "camera" as such. It consists (very basically) of a rotating prism, a lens system including light path splitters and a series of optical sensors that collect the data at different light wavelengths.

It does not "take a snapshot" in the way a normal camera does. The system is on all the time. The rotation of the prism scans across the Earth at right angles to the path of the satellite's orbit. On each rotation of the prism, one line of the picture is built up. The motion of the satellite ensures that the next rotation scans over a new bit of the Earth below. The "picture" is being produced line by line as the satellite orbits the Earth.

After processing it is transmitted as a continuous stream of data in real time. As the NOAA passes over your location you can see the picture being built up one line at a time as it goes over. In fact you can see precisely where the satellite is as each line is transmitted. (Despite what your tracking program might say, hi). This is not how the CCD cameras on the amateur radio satellites operate. They work much more like a normal snapshot camera. They are commanded to take a picture in the same way you would with a digital snapshot camera.

The image file is stored in RAM and processed, usually into a compressed file for transmission as part of the downlink broadcast data stream. Once again, you don't get something for nothing. Just as the frequency in use limits the possible bandwidth, the bandwidth ultimately determines the maximum image file size that can be handled by the entire system. This is one reason why the early amateur radio satellite imaging systems had rather poor resolution.

The latest in the line of amateur radio earth-imaging satellites is TO-31. It has

broken new ground in that it has a high resolution, multi-spectral CCD camera system on board. Multi-spectral means that it takes pictures not only in visible light but also in a number of infrared portions of the spectrum. These images are combined in varying proportions to produce a multitude of effects in the final image. Just like the high-resolution NOAA images.

File sizes can be large and compression invariably results in some loss of resolution. The University of Surrey has developed a compression technique that minimises the losses. The images are transmitted at the moment as compressed files of about 700+kilobytes.

This results in reasonable compromise between download times at 9600 baud and picture resolution. The situation will improve markedly when the 38k4 baud downlink is activated some time in the future. It is hoped that this download rate will be fast enough to allow the image files to be broadcast in uncompressed form permitting the full resolution to be seen in the final image.

The current system of compressed files is giving images which can better the NOAAs free to air APT pictures and occasionally rival the high resolution HRPT images. There are exciting prospects ahead in the field of amateur radio earth-imaging.

The commercial decoding and image manipulation software is closely guarded by the commercial companies. We are fortunate to have devoted programmers like Colin Hurst VK5HI. Colin has been active in the field of imaging software development since the very early days of amateur radio satellite imaging. His latest effort has swept all others away to become the 'industry standard' for amateur radio satellite image processing. Called "CCD Display 97", it is a 32 bit, Windows9x program and caters specifically for the picture formats which have become standard on the amateur radio satellites which carry imaging equipment today. Colin has done a remarkable job to continually update this software from his first DOS versions that served us so well in the early days of satellite imaging.

Current amateur radio satellites with earth-imaging capability.

Although launched in 1984, UoSat-2, Oscar-11 is still fully operational. This in itself is something of a record. Bravo Martin and company. Just think of how many devices you have on your workbench which have been CONSTANTLY switched on and operating for over 15 years! - with barely a

hitch. The CCD camera on UO-11 is rarely turned on these days because the command team has other more pressing work to do.

WeberSat, WO-18 has suffered from progressively worse OBC problems and is currently not working. Its CCD camera provided some excellent images in its early days. The three 9600 baud digital birds, UO-22, KO-23 and KO-25 carry CCD cameras that are turned on from time to time and the images are included in the download directories. Tmsat-1, TO-31 is the current flagship of the imaging fleet. New images are added to the directory once or twice a week. Many spectacular images have been obtained using the high resolution, multi-spectral cameras.

Entry level image capture using simple AR equipment?

So, how much of this is still in the realm of the guru and how easy is it to get going with simpler equipment? Well ... don't bother to read any further if you are expecting to do this type of work with 1950s valve technology or an FM box, ground plane antenna and packet TNC.

I'd be misleading you if I said you could. Unlike Mr Spock in "Star Trek" who managed to get a time warp machine going with valves from old radios when they were marooned in the 1920s, I'm afraid you won't get off the ground.

You will need a capable modern computer with lots of RAM and a capacious hard drive. You will need to have tracking antennas or at least a high gain steerable system unless you live in a super-quiet location on a hilltop and you can produce an efficient all-sky antenna.

You will need sensitive 2 metre and 70cm receivers preferably with mast-head pre-amps. Then there's the demodulator and of course you will need the appropriate software for manipulation of the images after capture. But if you already have a shack equipped to cope with the current batch of digital satellites then imaging is almost the next logical step and it can be an immensely satisfying activity.

If you have a well equipped, high speed, multi-mode packet station and a good high gain antenna system you are well on the way. There are Internet web sites which archive amateur radio satellite images. I'm loath to put their URLs in print as they come and go like the wind. The best bet would be to start out at the AMSAT web site, www.amsat.org and follow the links from there. Who knows, you may be imbued with the 'esprit de corps' and perhaps even give this earth-imaging caper a go yourself.

Greek Call Sign



The prefix SV, allocated to Greece, has its origins even before World War 1. The Bureau International de L'Union Telegraphique of Berne had allocated in 1913 the prefix block SVA-SZZ to Greek ships and land-based stations.

Early radio experimenters frequently used such prefixes for their own despite the fact that many operated without a licence. Years later when laws were passed to permit radio experimentation many of these old prefixes were adopted into the new field of licensed radio experimentation. The SV allocation to Greece remained unmodified as did Belgium (ON), Chile (CO), Denmark (OZ), Japan (J) and several others. But many of the old prefixes were never used, such as those of England (B), British Columbia (CAA-CMZ), Brazil (EPA-EZZ) and Sweden (SA).

It is interesting to note that some of the old prefixes, although unused by amateurs for 80 years, have been recently 'resurrected'. Thus we have today the new allocations of M (England), OT (Belgium), LH (Norway) and CR (Portugal). When on 1 February 1927 the IARU (International Amateur Radio Union) allocated 'intermediated' prefixes, the precursors of modern day prefixes to various countries, Greece received the intermediate EY, the letter E standing for Europe and the Y being an individual country allocation. (Australia at the same time received OA,

and New Zealand the intermediate OZ, the letter O standing for Oceania). These facts would seem to indicate that there could well have been experimental radio activity from Greece during this period. It is interesting to read the following extract about Greece in the October 1936 edition of QST: "Like Italy, the Government does not licence amateurs. Unlike Italy, however, it is less energetic in their suppression. Consequently the few amateurs who are now, after these many years, first putting Greece on the map, operate only more or less under cover."

SV1KE

This QSL is the earliest Greek QSL held by the National QSL Collection and is dated 22 November 1936. The operator was C. Tavaniotis of Athens. On the reverse side of another pre-war QSL, SV1RX, (dated 27 December 1937), this name appears as the QSL Manager for Greece. The SV prefix was many years the only prefix used, although there was some activity by British servicemen and officials belonging to AMFOGE (Allied Mission for the observation of Greek elections) during

the troubled early post-war period. These stations used the call-sign XAAP, XACP. (The WIA Collection holds the QSL XABU sent during this stormy period from the island of Rhodes). Mr Tavaniotis must have been a man of some exception. In the April 1939 issue of QST we read that the issue of licences was not likely, the apparent reason being the general censorship of the press in Greece, and then "SV1KE holds the only licence but cooperates with Government agencies".

SV0VOA

Greek SV prefixes reflect the various geographical regions of Greece. Prefixes SV1, 2, 3, 4, 6 and 8 represent the Greek mainland whilst prefixes SV5 represent the Dodecanese and SV9 Crete. (The zero prefix is a special allocation, the QSL shown celebrating the 50th anniversary of the Voice of America station in Greece). The prefixes used by Greek radio amateurs have become quite varied since the 1970s.

Prefix SZ zero has been used since 1970 for competitions such as the Chess Olympiad and the CQWW WPX contests. It is interesting to note that the prefix SZ was one of two call-signs allocated to ships and land-based stations before World War I, but was never used by radio amateurs until comparatively recently. Greek amateurs were allowed to use the prefix SW to celebrate in 1985 the 2300 years of Thessaloniki, and the special prefix SW zero was used to celebrate the 1980 Summer Olympics. In 1978 the ITU allocated an entirely new prefix to Greece and its adjacent islands. This was J4A-J4Z, and it has been used several times, especially for special events (J42TIF, 50th Thessaloniki International Fair), J41JG (WPX contest) J40AN and J41NA (1982 European Athletic Championships).

QRA C. TAVANIOTIS, 17 BUCHAREST ST. ATHENS-GREECE

TO RADIO **V K 5 Z X**

CONFIRMING OUR QSO OF AT ON

November 22nd 1936
14.25 G.M.T.
14 MC.

UR SLS QSA 5 ORK 5 QSB TO 9x TONE 9x
MOD MOD ORM ORN CONDITIONS Good

SV1KE

REP

XMTR 6LG ecc-801 Bfr-2'800s PP INPUT 200 WATTS
MODULATION RCVR Browning f35

REMARKS Mni tnx fr fb QSO ob ea hpe ouagn.

PSE QSL DIRECT TNX
MNI TNX FR QSL OM

73 ES BEST DX FRM
C. Tavaniotis OP.

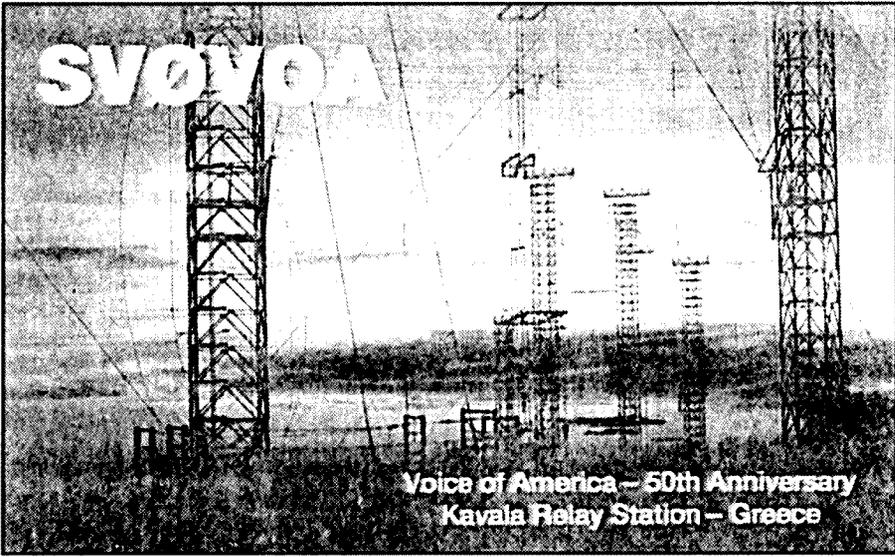

Ivor VK3XB
 Ray VK3JI
 Heinz WIA L. 40370
 Also thanks to the relatives and friends of the following SKs:
 Ken Stevens VK5QW. Courtesy of John VK5FOX
 Gavin Douglas VK3YK. Courtesy of Geoff VK3CNX
 Syd Keighley VK3DSP
 Ken Elkington VK2CBI. Courtesy of David VK2IX
 ("Willing" your QSL collection to the WIA or your local club will help preserve our history. Think how many historically significant QSL cards have been lost through having nobody to pass them to, or passing them to an uninterested party.)

SX1RAAG

This QSL bearing yet another kind of prefix and dated 30 April 1988 celebrated the 30th anniversary of the Radio Amateurs Association of Greece (RAAG).
 On the reverse side of the card a short history of radio activity from Greece is given, together with the fact that the formation of a radio club was deemed impossible in those early years due to political problems.

The EEP on the front of the QSL stands for Enosi Elinon Radioerasitechnon, the official Greek amateur radio society, bearing in mind that the letter R is written as a P in the Greek language.

There seems to be little new under the sun, for despite being a new prefix, the SX prefix was used as early as 1936 but of course not officially on the amateur bands. In the May 1936 edition of the magazine Radio we: "Charlie Myers, W3SI worked

SX3A in Greece on 7mc. QRA is Direction Services Radiotelegraphiques de la Marine, Athens, Greece". In the October 1936 edition of QST mention is made of the same station. It was reported as a Government-owned marine experimental station with 250-500w output, wavelengths between 15 and 90 metres being used and the operator working hams on 20m. The wheel has turned full circle even after sixty years.

THANKS

The Federal body of the WIA would like to express its thanks to the following for their kind donation of QSL cards towards the collection:

- 'Snow' VK3MR
- Ken VK3WM courtesy of Herb VK3JO
- Steve VK2PS
- Jo VK2KAA
- Peter VK3XK courtesy of Geoff VK3CNX
- Lindsay VK5GZ



AMATEUR TRANSCEIVER RADIO CENTRE
 NO 1 FACTORY DIRECT IMPORTER
 AUTHORISED DEALER

ALINCO
 AUSTRALIA'S FIRST ARRIVALS
 NEW DJ-5E 6w, 144/432MHz
 DR-M06TH 6M MOBILE
 DX-70TH, DR-610E, DJ-G5EY, DX-77E
MASSIVE MONTHLY IMPORTS
 3-YEAR WARRANTY
ALINCO SPECIALIST

ICOM IC-706MKIIG, IC-T81A, IC-2800H, IC-746, IC-756-Pro, IC-T8A, IC-R75, IC-Q7A.

ROTATORS - EMOTATOR -
 105TSX 747SRX
CREATE --- RC5A-3 RC5A-2 RC5-1
MFJ-259B - HF/VHF
 FREQUENCY ANALYSER
KENWOOD TS-570SG TM-V7A TH-G71A VC-H1 TH-D7A TM-G707A
JRC NRD-545G, JST-245, NRD-345.
KANTRONICS -
 KPC-9612, KPC-3, KAM-98, KAM PLUS

PHONE (02) 9896 2545
 E-mail: atrc@bytelink.com.au
 Web Page:
<http://users.bytelink.com.au/atrc>



SX 1 RAAG

Radio Amateur Association of Greece



On the occasion of 30th anniversary of RAAG for the 2-way contact made with the

ARS SWL AX4AIX

If you have a QSL card with a story and we can borrow a copy it would make a great illustrated yarn for

Amateur Radio

ARDF

Ron Graham VK4BRG

PO Box 323
Sarina Qld 4737

from the above there emerges a common thread, the ARDF converter. This device, described below, is also often described as an "attenuator". But this description, although describing the actual effect, is somewhat misleading. These devices seem reasonably popular in the US, but not so here in Australia. Hopefully, in a later column, some circuits and construction details will be described.

Some comments on "body shielding" and using a metal tube to attenuate signals will also be covered in a future column. These techniques seem more popular in the US, so I have gained some information from that source.

ARDF CONVERTERS

These devices actually shift the input frequency by a pre-determined amount.

Thus the "lack of shielding" problem is overcome as the HT is actually tuned to a frequency removed from the fox frequency. They consist of an oscillator, the frequency of which determines the offset, and a mixer stage. The output of the oscillator stage is varied by an external control.

This control varies the oscillator injection into the mixer stage and thus forms an attenuator control. So this attenuator function allow one to operate the HT's FM receiver below the limiting level and takes the place of an RF gain control which is missing from the HT.

SERG (Mt. GAMBIER) EVENT.

The South East Radio Group, VK5SR, will be sponsoring the 1999 Annual convention and Foxhunting Championships on 12-13th June 1999 (Queens Birthday Weekend) at Mt. Gambier. The venue will be the A&H HALL, Pick Avenue, Mount Gambia as on previous years.

As a joint initiative with SARC Adelaide, a

** NEW NOVICE FOXHUNT EVENT **

is planned to encourage new interest in this aspect of the hobby. It is realised that the complexity of many current foxhunting stations almost precludes participation by newcomers to ARDF.

For safety reasons all participants for the night Fox-Hunting events this year will be required to be contactable throughout the event via the local 2m repeater. Participants must organise a separate transceiver for this purpose before commencing the hunt.

Full details of the foxhunt schedule will be posted at the SERG Internet site:- <http://www.seol.net.au/serg>

Talk in to convention will be via VK5RMG repeater 146.900 MHz. Further details from the Convention Coordinator, Wayne, VK5ZX. e-mail vk5zx@seol.net.au Packet vk5zx@vk5sr. Phone/fax (08) 8725 4335

ar

In the column this month we discuss some aspects of simple receiver arrangements that could be suitable for ARDF.

Obviously, if we can utilise an inexpensive or existing receiver more people are in a position to try ARDF. Then, if they find some aspects of ARDF of interest they can possibly upgrade to a more elaborate receiver.

The receiving device that falls into the above category, provided you have one of course, is the handy talkie (HT).

Another common device that should not be overlooked, and whose capabilities parallel the HT, is the portable scanner.

Pros and Cons of HT'S

Advantages:

- good sensitivity - this is an advantage in that weak signals, such as at the start of a hunt, may be heard.
- Phase Locked Loop (PLL) tuning - which gives the advantage of stable, fixed tuning with an excellent frequency readout.
- tunes the whole band (due to the PLL tuning) - not always achievable with some ARDF receiver designs.
- may include an S meter - handy, particularly as with FM, the meter can indicate changes in signal strength that are not discernible by ear.

Disadvantages:

- FM - this problem is caused by the inherent FM receiver design, in that one or more stages of (normally) the IF strip are operated as limiters. These stages are driven to saturation primarily to remove any AM modulation. This means that any changes of signal strength, which need to be observed as a basic requirement of direction finding, are masked by this limiting action.
- no inherent directivity - due to the simple vertical antenna.
- poor shielding - the problem here is that as one gets closer to the source of the signal and that signal gets stronger, it tends to enter the HT's input circuitry directly. Thus, as the signal is

not passing via the optionally added beam antenna, that antenna's directional properties cannot be utilised - fairly basic requirement for direction finding!

- no RF gain control.

OVERCOMING THESE DISADVANTAGES.

In respect to:

- the limiting problem may be overcome by operating the receiver with weak input signals and thus below where the limiting action takes place.

For practical purposes, this means reducing the input signal until it appears noisy in the receiver output. This may be achieved by:

- inherent directivity can be improved by:
 - tuning the receiver off centre until the signal is sufficiently noisy.
 - Using an adjustable attenuator between the antenna and radio.
 - inserting the HT in a metal tube.
 - Using an ARDF converter.

Lack of directivity is simply overcome by:

- using a directional antenna.
- body shielding using existing HT antenna.
- the poor shielding problem may be overcome by:
 - using an ARDF converter.
 - adding shielding (possibly aluminium foil) around the radio.

This could be "messy" and facilities have to be made to operate the radio through the shielding. d) the lack of a RF gain control tends to be overcome by a number of the above.

Anything that is capable of reducing the signal input to the receiver is actually acting as a RF gain control. I have seen RF attenuators fitted between the beam and the radio, but this is only effective if the radio is shielded well enough to prevent direct signal entry into its input circuitry. As previously mentioned, the modern plastic cased HT's are not well shielded.

So we notice that a number of the disadvantages of using the HT receiver for ARDF can be largely overcome. Also,

REPEATER LINK

Will McGhie

21 Waterloo Crescent
Lesmurdie 6076
VK6UU@VK6BBR
will@faroc.com.au

More on Repeater channels

I received this comment from Steve VK2KFJ a couple of months back and it makes for interesting reading in relation to the 10 kHz spacing idea on 2 metres.

Steve travels a lot and his experiences of the lack of activity on our repeater networks, queries why we appear to have an overcrowding situation and need more 2 metre repeater channels.

Steve VK2KFJ says...

I read your article on 10kHz spacing for 2 metres and had to laugh. I live in Sydney with the largest population and large neighbours in Wollongong, Gosford and Newcastle.

Sydney has a bucket load of 2m repeaters, plus 70cm repeaters.

Unfortunately, most of these spend 95% of the 24 hour day in complete silence.

I am a computer support technician and travel interstate a lot by car and plane. I have visited all capital cities (except Darwin) for work, and I take my handheld interstate.

In the car I have 6m/2m/70cm as I travel NSW and Canberra, so I get a lot of time to scan.

Over the last decade I have seen a dramatic decline in repeater usage, not just Sydney, but NSW country and interstate.

Having travelled to the USA, I can totally understand why the USA has closer spacing due to their population, plus they live right next door to Canada and Mexico.

For us, to try and squeeze more 2 metre repeater channels in, while we don't use what we have now, does not make sense.

I would love to have several million dollars, to install equipment on every hill 60 kms apart and link them together.

Then I could drive up and down any major highway and still be in reach of a repeater; but if I call CQ, do you think I

have a greater chance of working someone?

With that several million dollars, I could better spend it on a heap of satellite phones and hand them out to my friends, it will work anywhere I go in the world.

So, you can see why I have E mailed you before, about trying to do things like linking our 2m, 70cm, 6m and 10m together, just to create some more activity.

In the previous summer I remember 6m being open. My 6m FM set was scanning the 6m repeaters, and one day a VK7 called on a VK4 repeater; I answered him.

We had a chat, and when we ended our contact he called again, expecting someone from VK4 (it was a Brisbane 6m repeater, linked to their 70cm repeater) to answer.

This was 5pm and not a single response. I went looking around and found 2 repeaters in VK4 and one in VK5 and VK3, all on 6m and all at full scale.

I called on each over an hour with not a single contact, only the VK7 amateur again.

A couple of months later, I was on the Gold Coast and called on the 70cm repeater and received no replies.

I eventually found amateurs on their 2m repeater and asked "do they monitor the linked 6m/70cm system?"

"No" was the reply, "we all stay on 2 metres."

So why go to the bother of linking the 6m and 70cm repeaters together?

The NSW Division of WIA is now generating a project of installing 70cm repeaters into country NSW and linking them altogether.

This was when we thought we might lose 70cm for the Olympics and the future. Even though we won't lose the 70cm band, it did make people think about getting some use on it.

Instead, the commercial spectrum developers just see a deep null on their spectrum analysers between 420 - 450 MHz.

Our club is going to start relaying our divisional broadcast through our local repeaters, starting with 70cm.

70cm is our least used repeater, out of 6, 2 & 70. If everything goes fine, we may introduce 6m into the relay, so it may then be 6 & 70 getting some use, once we sort out our Novice filter problem.

We will start by linking our 6 & 70 repeaters together, then the 10m simplex (once it's finished).

My choice was to tie the four of them together permanently and be done with it, but some people in our club prefer to have one of our 4 repeaters left as standalone, which is a shame, as it is our 2m repeater that is regularly used.

So, if someone is pressuring to get extra 2m repeater channels, I would like to know where they are, as I have been to Melbourne last month, Canberra, Brisbane and the Gold Coast during the last 12 months.

I didn't see any significant activity in any of those capital cities, as I said earlier.

Most 2m repeaters in these places mentioned were quiet 90% of daylight hours and 70cm repeaters 97% of the time. The same applies for the FM simplex frequencies as well.

We have four 70cm repeaters here linked permanently, Wollongong, Goulburn, Mittagong and Mt Ginini (ACT).

A 5th one is due on the NSW South coast in the future. It was busy when first setup, but now much quieter, as the enthusiasm dampens. Ideally as you can see, we need more 70cm repeaters pressed into action and linked, plus a few 6m repeaters as well.

"Get off two metres and onto 70cm" are my thoughts..

Activity in VK6

Thanks Steve for your thoughts.

The lack of activity is mirrored in VK6 on our repeater networks.

Linking repeaters does increase the activity for a while and then interest tapers off.

Amateurs seem to be divided into two camps when it comes to linking repeaters.

One camp thinks it is a good idea and the other camp sees it as an intrusion onto their local repeater from afar.

I find this second opinion strange as it is not unusual to hear comment from amateurs on repeaters complaining about the lack of activity. However as soon as linking is suggested, caution is expressed, as this would see a type of activity that may not be suitable on their local repeater.

A strange point of view as the increased activity is fellow amateurs. Some users I believe want their repeater to be just that, their own "private telephone" to one or two close amateur friends.

Time

Finding time to put this article together every month is difficult.

Much time had to be found to rebuild one of my computers after lightning damage following a very severe storm. Switching on resulted in difficulty loading Windows, with error messages about the C drive.

Further investigation uncovered there was something seriously wrong with the computer. Time to save onto floppy a few un-backed files.

The floppy drive did not work! As time went on I discovered not much did work. Devices discovered to be faulty were the sound card, floppy drive, C:\ drive more or less, mouse, Com 2, printer port and printer!

Luckily most of my files were on the D drive with the operating system and programs on the C drive. I just hoped the D drive was still working.

The computer was delivered to a repair shop and the house insurance picked up the bill. When I received the computer back the D drive was undamaged and little was lost except time. More time was required to reload all the programs and drivers for printers and scanners etc. At times a very frustrating experience.

I could go on about the frustration I have with computers and the strange way they behave but I will save that for another time.

Historical Photographs

Progress is being made towards digitising amateur radio historical photographs.

A few have been received and can be seen on the Internet. A link can be found from the VK6 home page at: <http://www.faroc.com.au/~vk6wia> or go direct to the page at: <http://www.omen.net.au/~vk6wia>.

I have been in contact with our local VK6 WIA historian and the Federal WIA historian and considerable interest was shown with promises of photographs.

I look forward to you also going through your photographs and digging out a few.

ar

VHF AN UHF EXPANDING WORLD

Eric Jamieson VK5LP

PO Box 169 Meningie South Australia 5264

E-mail: vk5lp@ozemail.net.au Fax: (08) 8575 1777

Packet: VK5LP@VK5WI.#ADL.#SA.AUS.OC

All times are UTC

New 2400 MHz Record

A contact between Doug Friend VK4OE/p and Adrian Pollock VK2FZ/4 has broken the VK2 state record for 2.4 GHz set by VK2ZAC and VK2BDN in 1973.

This contact also breaks the previous VK4 State record set by Doug and Adrian in January 1996.

Adrian was operating from Maleny and Doug portable near Ben Lomond in northern NSW on 15/11/98, distance 374.7 km.

Also, re the national 1296 MHz record: The original distance calculating software has been replaced by a more accurate program, and all records set before the changeover have been recalculated.

The 1296 MHz record distance (VK6WG - VK3ZBJ) has been corrected to 2455.1 km.

This correction didn't make it into the last Call Book but it will be in all future lists. ... John VK3KWA.

Six metres

Ian VK5XE reports: *On 21/3 I worked 13 JAs on six metres CW. All were from JA7 and 8 areas.*

Also heard were 7JJs, and a KH7 talking to a JA8 on SSB. Rig is IC 736 with 100 watts and using my HF log periodic (7el) through the auto tuner in the rig.

Wally VK4DO - 9/3: 2213 XE2UZL/b 4x5; 10/3: 1022 V63CV Rosrae Island 5x9; 11/3: 0430 XE2UZL/b 5x1, 0447 XE3RCM/b 4x1. The two KH6 beacons came in at the same time.

"I have been trying for a long time to work out the actual location of the Chinese TV on 49.750 and am now convinced it is from Harbin in North China.

On 11/3 I was receiving one predominant TV picture from China which came over the weaker one, and by zero beating on the IC 7100 (USB and LSB) came to the conclusion it was on 49.750 MHz.

On 12/3 at 0950 the sound channel on 56.250 was at good strength, with two

announcers, male and female, talking in Chinese.

At the time the 49.750 video was S9+.

Here at Strathdickie QG49hq, 50.110 is a minefield; when the band is open it is full of VK2s, VK3s, JAs, KH6s plus VK and Chinese TV crud.

The number of stations staying there for long periods working JA after JA on CW is beyond belief.

However, I have noticed many JAs calling on 50.110 and saying they will be listening on 50.160, which seems a good idea.

The main problem is that there are so many JAs calling that despite saying you are calling east to the US, they persist in calling you."

John VK4KK from Brisbane made a number of interesting contacts.

On 10/3 at 2225 W1LP/mm in EK94; 19/3 0730 KH7U, NH6YK, KH7L; 20/3 2148 HP2CWB; 27/3 0330 T33RD (CW and SSB) and 2/4 0335 V63AO 5x9.

Many contacts to JAs and HL5 also available.

The W1LP/mm contact is interesting as EK94 is off the West Coast of Nicaragua and a considerable distance.

A mass of information is appearing on the **JA 50 MHz cluster**, too numerous for a blow-by-blow description.

However, what follows is a representative sample.

From 9/3 to 15/3 the JAs worked V63CP, 3D2TC, V73AT, P29NB, 5W1SA, VK1-8, ZL1-4, KH7R, VR2UW, VR2YRC, VR2LC, VR2UP, VR2RS, VR2BG, DU1/JA1HBC, VR2JK, VR2PM, V63AO, BG7OH, VR2BA, VR2XRW, VR2ZGD, VR2LX, VR2XTM, 9M2TO, DU1EGA, HL5HF, VQ9DX, YC1MH, DU1SAN, 9M6GY, 9M6CT, 9M2XA.

JAs heard: 9M-TV, V63CV, V63SC,

E-mail address change

Please note that my e-mail address is now changed to vk5lp@lm.net.au. This allows me to have local call access fees instead of STD charges.

V73SIX/b, VK4ABP/b, VK4ABW, VK4RIK/b, VK4TZL, VK5VF/b, VK6AOM, VK6JJ, VK6RBU/b, VK6RO, VK6RPH/b, VK6RSX/b, VK7RAE/b, VK8RAS/b, VK8VF/b, XE2UZL/b, ZL3TY.

Other contacts of interest were 9M2NK and VR2LC to VQ9QM; KH7R to P29KFS; V73AT to KH7R, P29KFS; ZL2KT heard XE1KK/b; HL5XF to VK2QF and VK3s AMK, AWY, XQ, OT; ZL3TIC to VK1VP, VK0YQS/9, W5OZI, W1LP/mm; VR2LC to 5W1SA; HL1LTC to VK3SIX; JAs to KH2/JF2VNV; YC0UVO to 9M6GY; VK8AH to 9M6CT, 9M2JK, A61AH; VR2LC, VR2IL to 9M6GY and 9M2JKL; LU5WW to WP4O; VK8MS to KH7L; KH7L to HC2FG;

JAs were worked by VK6AOM, VK6ACY, VK3SIX, VK6RO, VK2QF, VK3ZYS, VK1VP, VK7BE, VK4BRG, VK3TMP, VK7GUN, VK2FHN, VK3AMK (also by RTTY), VK2FA, VK5AYD, VK3DQJ, VK4BLK, VK2FLI, VK4DMI, VK4IBW, VK0YQS/9, VK2DN, VK9NQ, VK9NM, VK6JJ, VK4GPS, VK4JH, VK4WDM,

Neville VK2QF said: *"That 11/3 presented a classic six metre morning in South East VK. US indicators to 40 MHz by sunrise, W1LP/mm in grid EK94 off the coast of Nicaragua (bound for Panama on an oil tanker!) was heard working ZLs at 2130.*

First two-way here at QF47pf was 2153 to Clint W1LP/mm, he was still audible at 2350. XE1KK/b audible from 2152 to 2333. Mass sporadic E has enhanced this propagation with the ZL video audible here overnight.

WP4O was heard at very low level around 2215, a 15,800 km path! Masses of VK beacons and of course QRM from Es to Es local contacts around 50.110 (yawn)...

Australian Military Liaison on 50.100 FMn, possibly North Queensland, 0055 to 0140.

This is legitimate; do not interfere with this operation.

At 0300, strong R1, and JA dogpile on 50.110 to VK3s. HL5XF 5x9 into southeast VK at 0305, it just goes on, can only get better!

Sunday 21/3 also a good day.

Solid TEP opening to Japan 0230 to 0430, all call areas, 50 QSOs, nothing under RST 559.

Emerging morning F2 to Central America with regular indicators to 40 MHz and beacons on 50 MHz. Interesting period ahead.

22/3: Another solid TEP opening to Japan 0150 to 0430, Hokkaido initially then south

to JA1, 2, 4 and 5 call areas, 39 QSOs, nothing under 559.

HL5XF (Jin) worked 0405. V73SIX beacon in on scatter from 0243 to 0340. Masses of northern R1 video.

31/3: HL5XF, J——JD1 Marcos Id, JR6QWW Ryuku Id, JD1BIA Ogasawara Id, BV2PU Taipei and JR6GU plus Okinawa beacon JR6YAG from 0757 to 1050 15 to 320 degrees, CW signal strength. This event is significant from the perspective of 32 degrees south lat. and the events that unfolded.

Due to a solid E's cloud access to the northern Class II TE zone was available.

With E's it can and mostly is a barrier to extended propagation by acting as either a shield or deflection to useless locations for a desired path.

Tonight (31/3) was just the opposite at 32 degrees south, the crucial element.

Okinawa beacon (6946 km) in from 0757 to 1010 up to S9; this is a rare latitude from this location.

I know it may not be significant in the north but it is at this location.

Many locals were rag chewing about the band on .120 and .140 and were commenting that other signals were unusually strong, giving a clue that broad scatter was about from the E layer.

From here northern VK4 beacons and operators were very strong early in the session; normally this is a sign that no real DX will be made.

The design error in that theory is that the Okinawa beacon was audible to a large number of VK2s judging by their comments.

In other words, the E's was conducting the signal to the "Super F mode TEP". Other indicators and longer haul to mainland Japan were down, in fact only a small number of mainlanders were worked.

Video offsets: The usual R1s around 49.750 (Chinese) but on 48.2604, 48.2505 and 48.2396 bearing around 275 degrees weak but consistent. At 1310 48.2600, 48.2498, 48.2500 and 48.2395 back in at 310 degrees.

To summarise for those who are bored:

The opening for any of the above contacts lasted from 3 minutes to less than 10, the window of opportunity is extremely small, and no-one can afford to dither with a QSO for the benefit of others!

Okinawa 6946 km, Ogasawara Id 6484 km, Marcus Id 6330 km, Taipei 7077 km. 20 years wait to work Marcus Id! Roll on Cycle 23."

A message from Peter Scutt G3IBI to Steve VK3SIX, reports that he has just

returned to UK from A6 and spent two days with Almur A61AH.

The local band 1 TV transmitter is on 48.248 MHz running 200 kW 24 hours a day. Audio is on 53.748 WFM.

Almur has already worked into the Pacific area during his morning/midday time.

T33RD Banaba was worked by all and sundry from 0300 on 26/3. T33RD is the first new DXCC country into VK East Coast this cycle.

QSL OK1RD, Jaroslav Semotam; Borova 155; ZC-251 01 Ricany; Czech Republic.

Steve Stephens VK4KHQ says that nothing has changed at his shack, the six-element Yagi awaits conversion from 52 to 50 MHz in the meantime, he uses a 1/4 wave vertical and about 10 watts of SSB. On-air times are usually limited to 10 am to 3 pm local.

With this set-up he rarely works anyone from June to September! This year he has included contacts with VK9NS, YJ8UU, joined in JA dogpiles, worked all VK States and heard the V73SIX beacon. In March a two-way RTTY contact with Norm VK3DUT.

Rob VK3EK reports from his mountain at Bairnsdale that he worked HL5XF 5x4 at 0600 on 11/3. On 12/3 at 1031 50.110 was open to JA so with a CQ call and QSY to 50.125 and 45 minutes later, he had worked 7 call areas and 37 stations.

ZL on 144 and 432 MHz: 12/1: At 0830 on 146.5 FM Ian VK3ST and Rob VK3EK worked Mike ZL3TIC and Ross ZL3ADT also 5x9 on FM.

Conditions then changed so that the two ZLs were S5 and Mark ZL3AIC 5x3, all on SSB.

The propagation then moved north from Christchurch to Ray ZL2TAL 5x2 and Alan ZL2VAL 5x7 RF70 at New Plymouth. On 432.160 Ray ZL2TAL was 4x1, distance 2,309 km.

Norm VK3DUT now resides at Johnsonville QF32VE in the Gippsland area.

His neighbours are Rob VK3EK (VK3DEM) north of Bairnsdale and Warren VK3BWT at Mallacoota.

Norm has an estate of about 3.5 hectares and may eventually grow an antenna farm!

At present he runs 100 watts on six metres to a 4 element Yagi, two metres 100 watts to a bay of 4x5 Yagis and on 70 cm 15 watts to a bay of 4x11 Yagi.

On 8/11 he shared in the auroral contacts and on 18/11 the meteor contacts, these to VK2BA, VK2DN, VK2TWR, VK3WN, VK3BWT, VK4APG, VK4IC, VK4KK,

VK2FZ/4, VK5ZDS and VK7JG. A good representative coverage.

In December aside from the many Es contacts, Norm contacted T12KD 5x2 at 0120 on 12/12 and heard V31PC weakly, at 0405 NH6YK 5x9, 0415 KH7R 5x5, 0425 KH6WV 5x9, many ZLs, VK9NS and FK8CI for several hours.

On that magic day of 19/12 ZLs, VK1,2,4,5,7,8. During a contact with Jeff VK8GF at 1020, Jeff said he had had 14 hours of two metre propagation that day! For the remainder of the month many Es contacts, ZLs and JAs.

On 3/1/99 Norm worked 56 JAs between 0432 and 0527 in all districts except 8, with most reports 5x9 or better.

On 12/1 he worked ten ZLs on two metres between 0735 and 0810, many at 5x9. On 15/1 ZL9CI 5x2 at 0825.

February was comparatively quiet with openings to VK4 and ZLs. JAs on 14/2 and 25/2.

March was more active.

JAs on 6/3, 10/3 and HL5XF at 0550.

On 12/3 from 0638 to 1119 Norm worked 72 JAs in all districts except JA8, also VK9NQ at 0735. 13/3 0245 to 0444 he worked 45 JAs in areas 1-5 and 7-0. JA dogpiles appeared again at 0640 and 1232.

More JAs on 20/3 from 0350. On 21/3 Norm reported Ray ZL2KT having worked N7CW and several W6s and W7s around 2330. 27/3 0343-0400 T33RD heard working VK2s.

Beacon news

Don VK6HK regrets to advise that the beacon installation at VK6RSX near Exmouth WA was disabled by Cyclone Vance on Monday 22/3/99.

The beacons (50.306 and 144.576 MHz) will be off air indefinitely.

Cyclone Vance was a Category 5 Cyclone with winds in excess of 250 km/hour and of intensity greater than Cyclone Tracy that wiped out Darwin in 1974.

Severe damage was done to the towns of Exmouth and Onslow.

Don also advises that a message from Bob VK6BE indicates that the VK6RTW 50 MHz beacon on 50.308 MHz is operational.

The beacon runs 10 watts to a sloping dipole. Operation is continuous.

The licensee of VK6RTW is the Southern Electronics Group in Albany. VK6RTW is also operational on 144.564 MHz with beams directed east and north from a 10 watt transmitter.

Gridsquare Standings at 18 March 1999

144MHz

VK2ZAB Gordon 56
VK3BRZ Chas 55
VK2DVZ Ross 52
VK3CY Des 45 (+3 EME)
VK2KU Guy 44
VK2FLR Mike 42 (+68 EME)
VK3EK Rob 37
VK3BDL Mike 31
VK3CAT Tony 28
VK3BJM Barry 21
VK6KZ Wally 17
VK6KZ/p Wally 16
VK2TZ Dale 16
VK3HZ/2 David 1
VK3HZ/8 David 1

432MHz

VK2ZAB Gordon 33
VK3BRZ Chas 32
VK3CY Des 23
VK3EK Rob 18
VK2DVZ Ross 17
VK3BDL Mike 15
VK2KU Guy 14
VK6KZ Wally 10
VK3BJM Barry 10
VK6KZ/p Wally 8
VK3HZ David 5
VK2TZ Dale 4
VK3HZ/2 David 2
VK3HZ/8 David 1

1296MHz

VK3EK Rob 11
VK2ZAB Gordon 10
VK2DVZ Ross 9
VK6KZ/p Wally 5
VK6K2 Wally 4
VK3BRZ Chas 4
VK2KU Guy 4
VK3BDL Mike 3
VK2TZ Dale 1
VK3HZ/2 David 1
VK3BJM Barry 1

Additions, updates and requests for the guidelines to **Guy VK2KU**, <guy@mpce.mq.edu.au>, or by mail (QTHR 99).

It is interesting to note that a change of placings has occurred on 1296 MHz since the December 1998 listing.

The other two bands look interesting too. Jockeying for positions is always a worthwhile exercise!

New technology

Clarry Castle VK5KL sent a hand-written letter (rare these days) with news.

However, before adding the news, it may interest readers to know that Clarry's letter was given the distinction of probably being the first letter ever, for publication in AR, which was entered into a computer using a new technology called "Voice Direct".

I dictated the written word into a microphone attached to appropriate software.

My words appeared as text on the monitor with about 75% accuracy.

As the computer has not so far been "trained" to accept electronic and technical terms I consider 75% reasonable accuracy. After its training course, which takes some time, I expect the accuracy rate to rise to at least 90% which is faster than I can type as the words are read at a rate of about 160 words per minute.

I hope to make more use of this medium as the computer becomes better trained to understand my voice!

Clarry said: *I was late getting on 50 MHz this season; I was checking my gear last September and accidentally put a 12 volt lead that had the voltage reversed on to my transverter.*

After the smoke cleared, all transistors were blown plus the Tantalum capacitors, with a few other capacitors and resistors damaged.

It was after Christmas by the time I got all working. Heard one or two VKs and I did QSO ZL9CI.

Heard no JA openings until 21/3 while looking for any stations in the John Moyle Field Day, when up came JF5NTT/7. I QSOd him at 0240 but did not hear any other JAs or beacons.

Was a little disappointed that there were not more openings. [Plenty of activity before Christmas, Clarry ... VK5LP].

Some days the Alice Springs beacon was strong but no other signals.

Been mainly getting my ATV gear on 426/576 MHz working and producing a satisfactory signal and colour picture.

News from all over

Ted Collins G4UPS advises that 25 February 1999 was the tenth anniversary of the first ever six metre QSOs with VS6 and JA from the UK.

Apart from the VS6 and JAs from 0855 the band was open later to ZS3 (now V5), ZS6, J52US and 5N0.

Ted says: *"It really does look as if the present solar cycle is going to peak on the 11th year.*

Incidentally, on 26 February 1989 the

band opened again to JA, JA6, ZS6, ZS3, JS2US, and from 1535 the band opened "across the pond" to W3JO/W2CNS and W8 land!"

Ted continues to maintain his daily morning skeds with G3CCH over the 350 km tropo path and says that contacts have been particularly good over the past few months. "

On 28 February 1999 we celebrated our 4000th six metre QSO - I wonder if this is a record over this distance?"

[Whether it is a record or not, it is a good effort as Ted runs 25 watts to a five element beam, not very high. ... VK5LP].

Restrictions on use of 420 MHz band

Amateurs will have received a withdrawal notice from the Australian Communications Authority.

The notice advises of the withdrawal from use by amateurs within a 150 km radius of the Homebush Olympic Stadium, of the spectrum 421 to 422 MHz and 424 to 432 MHz until 31/12/2000.

The only comment I wish to make is to say it was a pleasant surprise to receive a letter from a Government authority or agency, outlining certain changes to existing procedures, without the accompaniment of a threatening paragraph outlining (usually) huge fines for failure to comply.

In this case the ACA has made a conciliatory approach, albeit definite, that portions of the band have been withdrawn from use by affected amateurs.

For those operating high power around 432 MHz the ACA has invited amateurs to check that they do not interfere with the SORN operations.

Again, I see this as a sensible approach to gain cooperation from those involved. Thank you ACA.

A listener reports

I was pleasantly surprised to receive during February a DX radio listener's extensive log covering the VHF bands.

It came from David Vitek of Parkholme, an Adelaide suburb.

All reception is via an Icom R7000 and a five element 50 MHz beam!

David has no interest in transmitting but is an avid listener, and keeps reception logs covering FM and TV transmissions, six metres, beacons, VHF 30 to 150 MHz, 10 metres, shortwave stations, harmonics and HF stations in general.

I am truly amazed at the loggings he has amassed.

I always knew there were many signals

between 30 and 150 MHz, but it is not until you see a well documented listing that you realise their sheer numbers.

I have spoken directly to David and he understands that it is difficult to include much of what he hears in these columns.

However, with the recent arrival of another massive listing, I think there are readers who would be interested in a sample of what can be heard on VHF. I have selected one day from each group.

The MUF must have been very high on 19/12/98 when 66 stations were logged in the commercial FM band.

Areas heard included Cairns, Townsville, Rockhampton, Airlie Beach, Mackay, Toowoomba, Mount Isa, Alice Springs, Perth, Northam, Albany, Bunbury, Launceston, Devonport, Burnie, St Marys, Hobart, Cootamundra, Sydney, plus a host of lesser known localities, particularly in Queensland.

Frequencies ranged from 88.7 to 107.75 MHz.

In addition, 15 TV stations were logged including three from New Zealand. On 50 MHz there were 8 amateur beacons and 16 VKs plus P29PL.

On 11/3/99: TV: RTQ0 51.670 MHz, ABSQ1 62.76, NENO 51.761, ABMNO 45.24/25/26, 49.750/7465/749/7526/7564/7573; 57.750 China C2, 57.7488 C2, 48.2394 E2 Malaysia, 48.260/250/2396. FM: 88.7 MHz 4ABCFM Nambour, 93.3 4SBS Brisbane.

Amateur: 11 JAs in JA1,2,3 and 9 between 0314 and 0402, VK4JH, VK4ABW, VK2DN, VK2FHN, VK2YO, VK4AFL. Beacons: VK8RAS, VK6RPH, VK4ABP, VK4RGG, VK2RHV, JA2IGY, JG1ZGW.

In total, from 18/12/98 to mid March, the MUF supported signals from 88 to 108 MHz on 19 occasions, plus the odd Channel 5A on 143.750 MHz.

Do you have a point of view about some thing you have read in Amateur Radio?

Or about the hobby itself.

Or perhaps some news about people connected with amateur radio.

Share it with us and your fellow amateurs.

These are your pages.

The Editor *Amateur Radio*
PO Box 2175
CAULFIELD JUNCTION VIC 3161
email armag@hotkey.nat.au

Tel: (03) 9528 5962

Fax (03) 9523 8191

Deadlines: by about the 15th of month prior

All very interesting: I just wish I could give readers a full print-out.

Barry Miller VK3BJM asks: "In order to assist me plan a few field trips, I'm interested in getting some feedback from the grid square hunters as to what squares they may want to add to the "worked" list. Bands immediately available to my plans are 2m and 70cm. 23cm under way.

At the moment grid squares I plan to set up in are those within VK3, and some of those into VK5 and VK2. But all reasonable requests will be considered. I believe QF04 and QF05 may be my first target, tentatively for around 29/30/31-5-1999." E-mail to BMiller@vnpbtrom.telstra.com.au or address letters to 250 Elgar Road, Box Hill South, Victoria, 3128.

Closure

A mixed bag this month. I have done the best I could with it. In lieu of the usual two thoughts for the month, read the following.

David VK5KK said: Here is a piece written by a frustrated engineer in a private company James Antonacci wrote:

Engineers vs Managers

A group of managers were to measure the height of a flagpole. They take their clipboards, calculators, ladders and tape measures to the pole. Half an hour later they're still falling off the ladders, dropping the tape measures and most of their paper has blown away - the whole thing is a shambles.

An engineer sees what they're trying to do, walks over, pulls the flagpole out of the ground, lays it flat, measures it from end to end, gives the measurement to one of the managers, stands the pole back up and walks away.

After the engineer has gone, one manager turns to another and laughs. "Isn't that just like an engineer, we're looking for the height and he gives us the length."

73 from The Voice by the Lake
ar

In a similar mood:-

Three engineering students were travelling home from Uni one afternoon when the car engine stopped.

They sat still for a moment before the mechanical engineer suggested they dismantle and reassemble the engine.

The electrical engineer was wiser and suggested they simply needed to overhaul the ignition system.

But the wisest of all was the computer engineer who suggested they turn everything off, all get out and wait ten seconds; then try restarting it.

Bob VK4KNH.

CONTESTS

Ian Godsil VK3DID,
57 Nepean Highway, Aspendale, 3195

The Contesting Editorial

**Thanks this month to SM3CER
VK4WSS JARL SP DX CLUB
ZL2BIL**

A few weeks ago I heard a comment from a VKDX station that the Americans told him that they "were putting up their big antennas for the Contest".

Now that we in VK are approaching our busy time for contesting, does that comment apply to us, or are we complacent enough to make do with what we have?

Contesting can be great fun and very rewarding, but without some serious effort to achieve our best, then we shall not find the rewards that we think we should have.

I urge all serious contesters to check your antenna system thoroughly, as well as your shack equipment, so that everything is in top condition.

Two points on which I ask for your full co-operation are: - to be sure that you read all current details of Contests, and ensure that you send your logs to the correct address as provided in the details.

There have been many instances of logs being sent to past Managers, which means that there is a strong possibility that the logs will be too late or not received at all for the current year.

For those of you with Internet access, I commend to you the page operated by John Loftus VK4EMM, one of our best-known contesters in VK.

His monthly Report is always interesting and full of good hints for contesters of all levels. John's URL is

<http://www.uq.edu.au/radiosport/>

Good contesting and 73 de Ian VK3DID

Results SPDX Contest 1998

(call/cat/score)
VK3CRP MOMB 1827
(VK3s EST, XJZ)
VK2AR SO14CW 1350

**YOU HAVE TO
BE IN IT TO
WIN IT**

Greetings to all contesters.

The List

May 1/2	ARI International DX Contest	(CW/SSB/RTTY)	(Apr 99)
May 8/9	CQ-M International DX Contest	(CW/SSB/SSTV)	(Apr 99)
May 15/16	Sangster Shield NZART	(CW)	(Apr 99)
May 29/30	CQ WW WPX Contest	(CW)	(Feb 99)
Jun 5/6	IARU Region 1 Field Day	(CW)	
Jun 6	Portugal Day Contest	(SSB)	
Jun 12	QRP Day Contest	(CW)	(Apr 99)
Jun 12	Asia-Pacific Sprint	(SSB)	(Jan 99)
Jun 12/13	TOEC WW Gridf Contest		
Jun 12/13	ANARTS RTTY Contest		(May 99)
Jun 12/13	South America WW Contest	(CW)	
Jun 19/20	VK Novice Contest	(CW/Phone)	(May 99)
Jun 19/20	All Asia DX Contest	(CW)	(May 99)
Jun 26/27	ARRL Field Day		(May 99)
Jun 26/27	Marconi Memorial Contest	(CW)	(May 99)
Jul 1	Canada Day Contest	(CW/Phone)	(Jun 99)
Jul 3	Jack Files Contest	(CW)	(May 99)
Jul 3	Australasian Sprint	(CW)	(Jun 99)
Jul 3	NZART Memorial Contest	(CW/Phone)	(Jun 99)
Jul 10	Australasian Sprint	(Phone)	(Jun 99)
Jul 10	Jack Files Contest (Phone)		(May 99)
Jul 10/11	IARU HF World Championship	(CW/SSB)	(Jun 99)
Jul 10/11	Internet 6 Metres DX Contest	(CW/SSB)	
Jul 17	Pacific 160 Metres Contest		(May 99)
Jul 17/18	SEANET CW Contest		(Jun 99)
Jul 18	Colombian Independence Contest (CW/SSB/RTTY)		(Jun 99)
Jul 23	ACORNZ 'ZIP' Contest (Phone)		(Jun 99)
Jul 24	Waitakere Sprint (Phone)		(Jun 99)
Jul 24/25	Russian RTTY WW Contest		
Jul 24/25	RSGB IOTA Contest (CW/SSB)		(Jun 99)
Jul 30	ACORNZ 'ZIP' Contest (CW)		(Jun 99)
Jul 31	SARS Sprint Contest (SSB)		(Jun 99)
Jul 31	Waitakere Sprint (CW)		(Jun 99)

Summer VHF-UHF Field Day 1999:

John Martin VK3KWA, contest manager
 The Summer Field Day was well supported again this year, although it is disappointing that there were no logs from VK2.

There was only one log from VK6, but it has taken the prize.

Results

The winner this year is Wally Howse VK6KZ, who took out equipment for eight different bands and operated it from four locations.

That is a lot of packing and unpacking. And speaking of which, the top score in section B went to Peter Freeman VK3KAI, who activated three grid squares on four bands and also found time over the weekend to enter the home station section as well.

There were only two multi-operator entrants this time.

The Geelong Amateur Radio Club has done it yet again, but VK5AR was not far behind. And in Section D, Des Clarke VK3CY has taken first place again.

Congratulations to those who won their sections, and to all entrants. It was good to see some new callsigns in the list this year.

I hope you had a good time and I look forward to seeing your logs again next time.

Comments

Looking at the logs for the last few years, it is clear that the growth area is the 6-hour section.

It is ideal if you don't have portable

beams or can't get away for the 24 hours. You can still get a good score by going mobile and spending time at several different locations.

The rules have stayed much the same for some years, but I feel that it is time for some adjustments to the band multipliers.

The aim of the scoring is to provide reasonably equal scoring potential for all bands.

If the band multipliers are too steep they can make it very hard for people who do not have microwave gear.

That seems to be happening now, so I feel that some trimming of the band multipliers is in order.

As usual I would be grateful for any comments or suggestions.

RESULTS

Call	Name	Grid	50	144	432	1.2	2.4	3.4	5.7	10	TOTAL
			MHz	MHz	MHz	GHz	GHz	GHz	GHz	GHz	

SECTION A - PORTABLE, SINGLE OPERATOR, 24 HOURS

VK6KZ	W. Howse	OF77,78,87,88	89	412	742	970	1053	1200	1024	1216	6706
VK3EK	R. Ashlin	QF31,32,42	99	840	1001	1060	819	1008	-	1008	5835
VK3WRE	R. Edgar	QF32	207	1264	1540	1200	273	-	-	-	4484
VK5NC	T. Niven	QF02	59	700	399	580	-	512	336	544	3130
VK3BJM	B. Miller	QF33	73	968	952	720	-	-	-	-	2713
VK4OE	D. Friend	QG61	-	316	259	-	299	-	-	352	1226

SECTION B - PORTABLE, SINGLE OPERATOR, 6 HOURS

VK3KAI	P. Freeman	QF21,30,31	85	496	539	210	-	-	-	-	1330
VK5UE	C. Low	PF95	39	180	301	-	-	-	-	-	520
VK5AIM	S. Mahony	PF95	39	180	294	-	-	-	-	-	513
VK4LP	J. Lemura	QG62	-	458	-	-	-	-	-	-	458
VK3YE	P. Parker	QF22	-	272	-	-	-	-	-	-	272
VK4EV	R. Everingham	QG62	-	192	-	-	-	-	-	-	192

SECTION C - PORTABLE, MULTI OPERATOR, 24 HOURS

VK3ATL	GARC (1)	QF21	78	992	1169	990	-	-	-	-	3229
VK5AR	(2)	PF94	196	964	924	490	-	-	-	352	2926

SECTION D - HOME STATION, 24 HOURS

VK3CY	D. Clarke	QF13	-	832	595	-	-	-	-	-	1427
VK3KAI	P. Freeman	QF31	57	232	392	230	-	-	-	-	911
VK3CAT	T. Middleditch	QF22	82	708	-	-	-	-	-	-	790
VK5LP	E. Jamieson	PF94	47	232	231	220	-	-	-	-	730

(1) Geelong Amateur Radio Club: J. Barrand VK3DFL, C. Gnaccarini VK3BRZ, D. Learmonth VK3XLD, L. Sim VK3ZLS, M. Trickett VK3ASQ.

(2) A. Raftery VK5AR, A. Russell VK5ZUC.

Marconi Memorial Contest (CW)

**1400z Sat 26 June
to 1400z Sun 27 June**

Not a popular contest in VK but worth a mention.

Object is to work as many stations as possible.

Bands all HF (no WARC).

Mode CW only.

Categories Single Operator low power (100 w max. o/p); S/O QRP (max 5 w o/p); Multi-operator.

Exchange RST plus serial number beginning at 001. 10 minute rule applies.

Multiplier is each DXCC country once per band.

Final score is total QSO points X total multipliers

Separate logs for each band.

Summary sheet for each band showing all details, description of station and signed declaration.

Send logs by mail to:

ARI sez. di Fano.

PO Box 35, I-61032 Fano (PS), Italy

by 26 July.

Logs in ASCII format on disk acceptable.

Various awards are available.

All Asian DX Contest

Bands all HF bands (no WARC).
Categories Single Operator single band; single operator multi-band; multi-operator multi-band.

Call on CW CQAA; on Phone CQ Asia.

Exchange for OMs RS(T) us two digits of your age; for YLs RS(T) plus 00. Cross-band contacts not allowed, nor multi-signals for S/O category.

Score three points for QSOs on 160 metres; two points for 80 metres and one point for other bands.

Multipliers will be Asian prefixes worked on each band. Note: JD1 Ogasawara (Bonin and Volcano) Islands are Asia and JD1 Minami-tori Shima (Marcus) Islands are Oceania.

Final score is total QSO points X total multipliers.

Logs should be on separate sheets for each band with full details.

Summary sheet should include your DXCC country, call, category, multipliers (clearly marked by countries or Asian prefixes first time worked each band) and points by band, total score, signed declaration.

Send logs to

All Asian DX Contest,

PO Box 377, Tokyo Central, Japan,

by 29 July (CW) or 29 October (Phone).

Mark CW or Phone on envelope.

ARRL Field Day

**1800z Sat 26 June
to 2100z Sun 27 June**

Again, this is not a popular contest in VK. Details available on Internet or from me.

Pacific 160 Metres Contest

0700z - 2330z Sat 17 July

Object is for P2, ZL and VK stations to make as many contacts as possible on band 160 metres (suggested frequencies 1825 - 1850 kHz). DX stations are encouraged to participate, but may only work P2, ZL and VK.

Categories: Single operator; SWL.
Modes: CW, Phone. (See special notes below).

Exchange RST plus serial number beginning at 001.

Score one point for QSO with own call area; two points for other call areas in ZL and VK; three points for Pacific Islands (ZK1, VK9); five points for areas outside P2, ZL, VK.

Multiplier is number of VK and ZL call areas worked, plus OTHER DXCC countries worked.

Final score is total QSO points X total multiplier.

Certificates will be awarded to top-scoring stations in each section, in each call area of ZL and VK, and in each DXCC country.

Send log with full details, signed summary sheet and any comments to: Ian Godsil VK3DID, 57 Nepean Highway, Aspendale, 3195, Australia, by 13 August 1999. Logs on 3.5 inch disk in ASCII format gladly accepted, or by e-mail to: <vk3did@eudoramail.com>

Special Notes: (i) to avoid QRM between modes, stations are asked to operate in 15-minute blocks as follows: CW on the hour and hour+30; SSB on hour+15 and hour+45; (ii) please listen carefully for DX, as many American stations will be trying for us, also JA, DU and YB.

ANARTS WW RTTY Contest

**0000z Sat 12 June
to 2400z Sun 13 June**

Not more than 30 hours of operating is permitted for Single Operator stations. Non-operating periods can be taken at any time during the contest. Multi-operator stations may operate the entire contest period.

A summary of operating times is required with each single operator log.

BANDS: Use Amateur bands 80/40/20/15/10 metres.

MODES: All digital modes are

permitted (RTTY, AMTOR, FEC, PKT, FACTOR).

NOTE: No satellite operation is permitted.

CATEGORIES: (A) SINGLE OPERATOR (One transmitter)

(B) MULTI-OPERATOR (One transmitter)

(C) S.W.Ls

EXCHANGE: to consist of RST, Time (UTC), and (CQ) Zone.

SCORING: For each band - Use the "Exchange Points Table (Marked 1994)" to obtain QSO Points for each QSO. Any contact with VK2SG earns double the table points for that QSO. Count Countries/Multis worked (see definition).

Total all bands used to obtain (1) Total QSO Points.

(2) Total Countries/Multis.

World stations calculate "VK BONUS" which is 100 points for each VK worked on 14MHz; 200 points for each VK worked on 21 MHz; 300 points for each VK worked on 28 MHz; 400 points for each VK worked on 7 MHz and 500 points for each VK worked on 3.5 MHz.

CLAIMED SCORE for WORLD STATIONS is calculated by multiplying (1) TOTAL QSO POINTS BY (2) TOTAL CNTRY/MULTIS, then THAT TOTAL by (3) the NUMBER OF CONTINENTS WORKED DURING THE CONTEST. (Note that each continent counts once only to a maximum of 6). To the total obtained ADD the "VK BONUS" to show GRAND TOTAL CLAIMED SCORE...

Example for World Station: 720 points from zone chart (1) X 29 cntry/multis (2) X 5 continents (3) = 104,400 points, plus (+) 6 VK stations worked on 14MHz (that is 600 points) giving a grand total of 105,000 points.

CLAIMED SCORE for AUSTRALIAN STATIONS (VK1-VK8) is calculated by multiplying (1) TOTAL QSO POINTS by (2) TOTAL CNTRY/MULTIS and then that total by (3) the NUMBER OF CONTINENTS WORKED during the contest with a maximum of six as stated above. This calculation gives the GRAND TOTAL CLAIMED SCORE.

In all cases, a station may only be worked once per band, but may be worked on other bands for QSO points and multipliers.

COUNTRIES/MULTIS: Are counted as per ARRL DXCC list of countries, EXCEPT THAT Australia (Areas 1- 8), Canada, Japan, and U.S.A. mainland do not count as separate countries. HOWEVER, each call area VK1 - VK8, and each call area in Canada, Japan, and mainland U.S.A. DOES COUNT AS A SEPARATE MULTIPLIER.

Contact with one's own country/multi

does count for QSO points but does NOT COUNT AS A MULTIPLIER. (Remember that call areas VK1-VK8, and call areas in Canada, Japan, and U.S.A. mainland are multis).

LOGS: Logs must show in this order:

1. DATE 2. TIME (UTC) 3. CALLSIGN OF STATION WORKED/HEARD. 4. MESSAGE INFORMATION SENT/RECEIVED (RST/TIME/ZONE) 5. POINTS CLAIMED.

SUMMARY REPORT: Summary sheet must show: Callsign of station, name and address of operator, bands used (a separate log is required for each band), the points claimed for each band, the number of countries worked on each band, the number of continents worked and details of VK BONUS calculations for World Stations.

A summary of the calculations made to obtain the GRAND TOTAL CLAIMED SCORE as per the "Scoring" instruction will assist checking.

The general certification regarding compliance with Rules and the signatures and call signs of operator(s) are also required. Multi-operator logs must contain signatures and callsign of each operator. Single-op logs must show summary of operating times. Dupe sheets will be appreciated for any band log over 75 QSOs. **AWARDS:** Plaques will be awarded to first in World in each Classification.

Certificates will be given to 1st to 5th places in the World, and to 1st to 3rd places in each of six continents, and to 1st to 3rd in each country/- multiplier, in each Classification. The judge's decisions will be final and no correspondence will be entered into.

We reserve the right to list multiple awards on any Certificate and/or vary the numbers of awards given without notice.

Logs become the property of ANARTS.

CLOSING DATE: Logs must be received by the Contest Manager, ANARTS, PO Box 93, TOONGABBIE, NSW, 2146, Australia, by 1 September 1999.

Logs may be sent by e-mail before 25 August to: <vk3did@eudoramail.com> who will forward them.

Jack Files Memorial Contest 1999

from Peter VK4VW

CW: Saturday 3 July 1999

Phone: Saturday 10 July 1999.

Both contests run 0800 to 1400 UTC.

This contest, sponsored by the Wireless Institute of Australia, Queensland Division, honours the late Jack Files, a long serving VK4 WIA Councillor. The Object is for Amateurs to work as many VK4 cities, towns and shires as possible (SWLs to hear and log), to encourage portable/mobile

activity from the less populated VK4 shires and towns, and to serve as a warm-up for the RD contest.

Categories:

- a) Single operator home;
- b) Club fixed;
- c) Single operator mobile/portable;
- d) Club mobile/portable;
- e) Stations outside VK;
- f) Short wave listeners;

In this contest only single operators are permitted to have a log-keeper. Club stations can use multiple transmitters, provided there is only one station on each band at any one time.

Bands 160, 80, and 40m only. The contest is in **six one hour periods** for the purpose of duplicate contacts, ie 0800-0859, 0900-0959, 1000-1059 and so on. You may rework a station at any time provided they are not consecutive QSOs and the station has not already been worked during that one-hour period.

Contacts with stations in other contests are valid, as are contacts with DX stations, and those with VK6 are encouraged. Contacts on the 80m DX window are not permitted. Cross-band contacts are not permitted.

SWL entrants are to include the calls and serial numbers of both stations received, and may not log more than five consecutively from any one station in each one-hour period.

Exchange RS(T) followed by a serial number incremented by one for each QSO, continuing when changing bands. Vks will send RS(T), serial number and a two-letter Shire Code. Multi-transmitter stations should use a separate log sheet for each band.

Score one point per QSO for all non-VK6 stations and two points for VK6 stations. Each VK4 shire/town code per band counts as a multiplier, as does each prefix per band. To stimulate portable/mobile activity, portable/mobile entrants can also claim one multiplier per band for each VK4 shire/town/city they operate from. The **final score** equals total points multiplied by total multipliers.

Definitions: A mobile/portable station is one which uses a portable power source ie: car battery, solar or portable generator power and a temporary antenna system.

Logs: attach a summary sheet showing the name, postal address and callsign of the entrant, section entered, operator names and calls, station location, equipment used, points claimed, and a declaration that the rules and spirit of the contest were observed.

Send logs to Jack Files Contest, WIAQ, GPO Box 638, Brisbane 4001, by Wednesday 1 September 1999 to be eligible.

1999 WIA Novice Contest 0800z Sat - 0800z Sun 19/20 June

from Dave Myers VK2RD

Object is to encourage amateur operation in VK, ZL and P2, and to promote contacts with Novice and Club stations. Only VK, ZL and P2 stations are eligible to compete, and stations in the same call area may contact each other for contest credit.

All operation must be confined to the Novice frequencies in 10, 15 and 80 m bands. No cross-band operation permitted.

Categories: Single Operator; Club; SWL. **Sections:** CW, Phone.

Call: CW "CQ N"; Phone "CQ Novice Contest"; Club "CQ Novice Contest Club Station" followed by callsign. **Exchange RS(T)** and serial number commencing at 001 and incrementing by one for each contact. Stations may be contacted twice per band, providing at least 12 hours have passed since the previous contact.

SWLs may log up to 10 sequential contacts made by a station, and must then log at least five other stations before logging the previous station again. The five stations so logged need be a minimum of one contact only.

Score two points for contacts with Full Call stations; five points for Novice/Combined stations and 10 points for Club stations. SWLs score two points for Novice-to-Full, Full-to-Full; five points Novice-to-Novice; 10 points for Club.

Logs headed "VK Novice Contest 1999" must show: date; time UTC; band; mode; station contacted; exchanges; total claimed score for each page at bottom. A **summary sheet** should show: callsign; name; mailing address; category; section; number of valid contacts, claimed score; signed declaration; signature of operator or, in the case for Club station, a responsible officer.

Entrants may submit only one log per mode. Logs for entries where an entrant uses more than one callsign whilst operating in the contest will not be accepted.

Mail logs to: Novice Contest Manager, Westlakes ARC, PO Box 1, Teralba NSW 2284, by 16 July 1999. Logs may be e-mailed to: <vk3did@eudoramail.com> for forwarding.

Awards: Clive Burns Memorial Trophy for Novice with highest CW score, and Keith Howard VK2AKX Trophy for Novice with highest Phone score. (These are perpetual trophies held at Federal Office, a plaque is sent to the winners.) Certificates will be awarded to top-scoring Novice in each call area; top-scoring station in each section; any entrant where meritorious operation has been carried out. Certificates at the discretion of the Contest Manager.

Thanks and 73 de Ian VK3DID **ar**

INTRUDER WATCH

Silent Key

Bill Ashley VK6GA

Born at Crewe (UK) May 12th 1919 he left the UK with his parents at the age of six weeks, arriving in Australia at age of six months.

His first job in his teens was as radio apprentice and errand boy with Perth branch of Ray Allsop's firm Harringtons. He donned the uniform and spent his war years (WWII) in the Army Signals Corp.

At war's end Bill took a rehabilitation course emerging as a male nurse serving at Heathcote Mental Hospital where he met his future wife, Joy.

A family joke about this was inevitable – the punch line being that Joy too was a nurse and not a patient.

His career then took him to DCA for several years as a Radio Operator.

Bill next took a roving commission as career guidance officer with the WA Dept. of Education visiting high schools in both the city and country.

Just as retirement beckoned (or threatened) Bill allowed himself to be talked into a part-time job with the Dept. of Army.

His Amateur Radio hobby began with his first CW QSO in early 1938 with his new Full-Call ticket.

From then on, whether in professional or amateur life, he was never far away from key, microphone or mill.

Perhaps not a high profile Amateur but a good citizen, loving husband and father and a loyal supporter of the WIA. Bill died quietly at home, March 3rd 1999.

Submitted by Harry Atkinson VK6WZ

ar

WIA/IARUMS Summary

March 1999

Freq	Date	Utc	Em	Details
3.557	2203	1045	A1A	L9CC CIS
3.560	2303	1245	A3E	R.Korea, news in English
7.098**	2503	2330	A3E	B/C Indonesia
14.211**	0303	0533	F1B	UjVFT 850 hz, 112 bds
14.250	2103	1149	N0N	UjCAR, weak/LoMod on fundam'tal
14.250	2203	0940	A3E	N.Korea, H5/2.8MHz.
28.215	0203	0530	A3	EUjBC, Comm. stn. Thailand
28.650**	2003	2210	A3E	R.Habana. H3/995 MHz, ID ok.Cuba

** Primary Intrusions.

Don't let this small summary "fool" you that we are on top of the intrusions - far from it. The IWS still needs New Blood to replace the sometimes elderly observers. Without their continued support Mr Average Amateur would be hard put to find a spot to operate.

Don't kid yourself that the bands will always be available.

WE ALL HAVE TO WORK for the removal of those not entitled to them. Whether it be on 70cm or 160m.

Federal Co-ord, Gordon Loveday VK4KAL.

KEEP 1426.5 kHz under observation.

Please be alert and watch for the return of the 3 channel multiplex signal against which we mounted a combined action last year.

In the past this station has operated from March/April to October/November and if we have been unsuccessful in our attempt to have the transmission moved out of our exclusive band it is due to reappear shortly.

If you hear this signal please advise me by Phone/Fax 07-4985-4168 or Packet Radio VK4KAL @ VK4JEM.

If indeed he does reappear, the Region 1 co-ordinator will try once more to stop the intrusion.

With the co-operation of as many regional societies as possible in obtaining further official complaints we will end this long standing contravention of the Radio Regulations.

(The basic info for this was taken from Region 1 M.S. Newsletter for March 1999)

The most persistent intruders of the month of March, World Wide: Frequency only; 7.000 7.030 7.080 7.085 7.098 14.150 28.000 29.7MHz.

The main RSGB States Russian 36.5bd, 500 hz data signal, Dly on 28.049.5 KHz, appears now on 28.050.5 KHz.

Keep an ear open for this in VK.

And an intruder of another colour

Marketing Junk Technology – the Final Frontier?

How Swatch Hijacked an Amateur Satellite for Commercial Purposes

At first, I thought it had to be a belated April Fool's joke: a Swiss manufacturer planning to broadcast commercial messages on the Amateur Radio two metre satellite band. But no, it was true. Swatch's web site (www.swatch.com) boasted the company's plans to do just that.

It wasn't obvious at first, however. Nowhere on the site was Amateur Radio mentioned directly, but one of the less accessible pages noted that the satellite would transmit its messages "into space" on a frequency in the range 145.800 and 146.00 MHz. Sound familiar? It's the 2m Amateur satellite band.

The company was soliciting messages from Internet visitors, which would be uploaded to the satellite for transmission. Messages could be in the form of a digitised sound file, or a text message. The one proviso was that the message include the word, "BEAT".

Swatch .Beat: What it is and Why it's Technically Inferior

What's so special about the word, "beat", you might ask. It's the name of Swatch's proposed Internet time standard. The idea is that there are no time zones on Internet, and a time-zone independent means of specifying the time should exist.

(Apparently, nobody at Swatch has ever heard of Universal Coordinated Time!)

Swatch proposes that time be specified in "beats", where a beat is 1/1000th of a day. Not satisfied with the prime meridian at Greenwich, Swatch also specifies that "beat" time be referenced to Biel, Switzerland, the location of Swatch Group headquarters. And only Swatch watches will keep beat time.

More next month but checkout:

The full story can be found on the Swatch Protest site, at <http://rob.carlson.org/swatch-protest/>

ar

IONOSPHERIC UPDATE

by Evan Jarman VK3ANI
34 Alandale Court, Blackburn Vic 3130

Solar activity

Solar activity has been at relatively low levels this quarter. The monthly sunspot number for January was 62.4 where the predicted value for the smoothed sunspot number was just over 100.

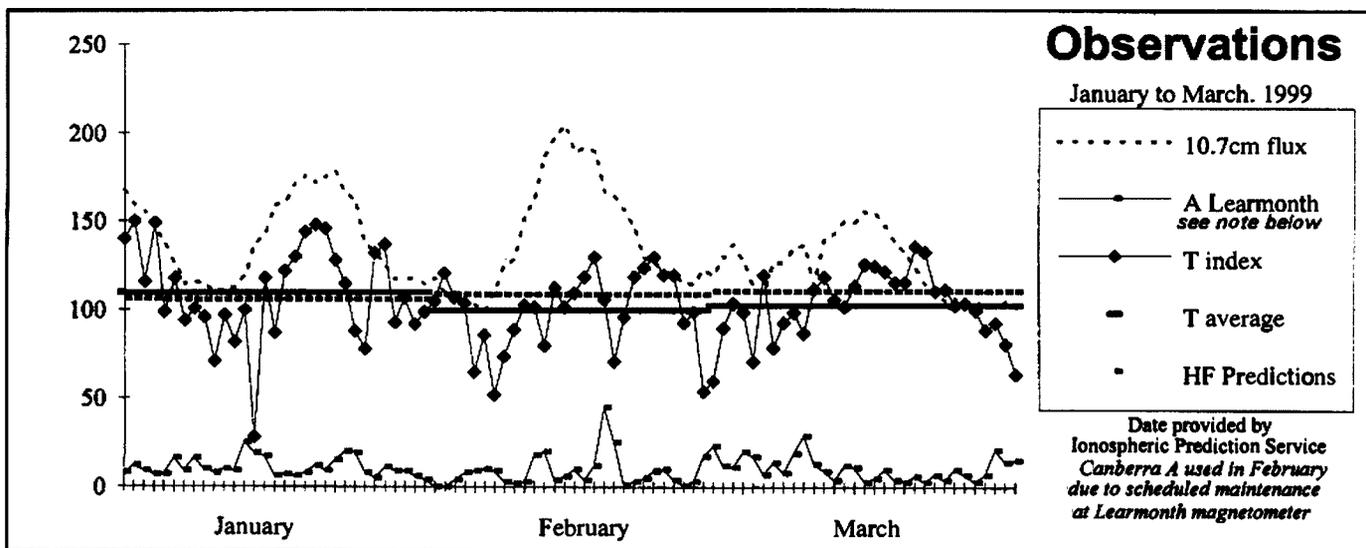
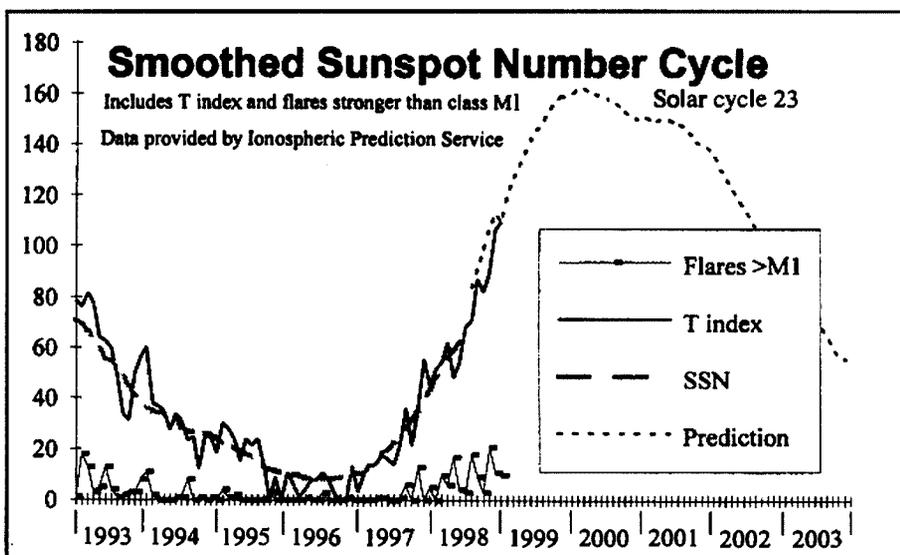

The latest figure for the smoothed sunspot number is 69.7 and is for September 1998. Smoothed sunspot numbers are, by nature, always six months behind. They are an average of the twelve monthly sunspot numbers closest to the time that the smoothed sunspot number refers to.

The twelve month's figures are for the six months in the future and the six months in the past. So any smoothed sunspot number must be at least six months old or it is using a prediction as part of the calculations.

The solar cycle graph shows the smoothed sunspot number (SSN) trending away from the predicted path, and the trend is not good. Hopefully the T index, which is more recent data and does make an attempt to return to the prediction, indicates that this may be momentary. Only time will tell.

In January, activity was low in the first half of the month and rose to moderate levels in the latter half. High activity was observed on 20 January due to a class M5.2 flare at 2004UTC. It occurred behind the

eastern limb of the observable solar disc. It is believed to be part of SEC region 8446 which rotated round onto observable disc the next day. Most activity at the time was associated with another region SEC 8440 which did not rotate onto the observable disc until 7 February.

In February, activity was lower than expected. There was mild activity between 12-16 February due to various isolated low level M class flares as SEC region 8440 decayed.

Activity was high on 28 February due to a class M6.6/2B flare at 1639UTC

In March activity was low but was increasing at the end of the month. The reason was not known when the publishing deadline came; it should be in next quarter's update.

Ionospheric activity

There were three periods of depressed MUFs during the quarter.

In January they occurred on days 14 and

25. Both were due to increasing geomagnetic activity on the previous days.

A widespread depression in regional MUFs was observed on 18-19 February in association with geomagnetic storm activity.

Geomagnetic activity

The more significant disturbances during the quarter occurred in the first two months. Activity on the last day of March was unresolved by publication deadline.

These events were:

6 January is believed to be CME related with a long duration class C flare on 3 January.

13-14 January is believed to be related to the filament that disappeared on 11 January

18-19 February which was the most significant disturbance. It followed a class M3 flare on 16 February. A severe storm was observed following the sudden impulse.

ar

HF PREDICTIONS

by Evan Jarman VK3ANI
34 Alandale Court, Blackburn Vic 3130

Adelaide-Auckland 104
Second 2F13-16 2E2 Short 3240 km

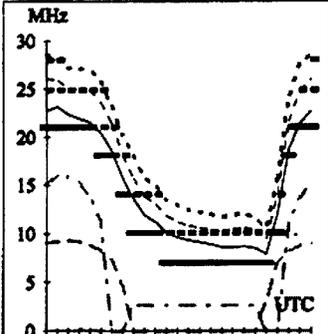

Brisbane-London 147
First F 0-5 Long 23498 km

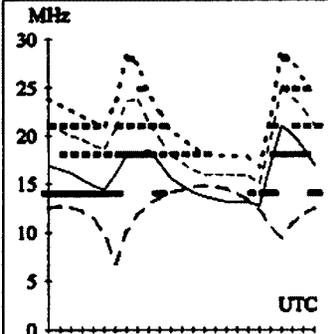

May
1999
T index: 120

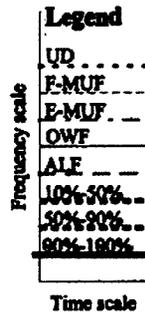

These graphs show the predicted diurnal variation of key frequencies for the nominated circuits. These frequencies as identified in the legend are:

- Upper Decile (F-layer)
- F-layer Maximum Useable Frequency
- E-layer Maximum Useable Frequency
- Optimum Working Frequency (F-layer)
- Absorption Limiting Frequency (D region)

Shown hourly are the highest frequency amateur bands in ranges between these key frequencies; when useable. The path, propagation mode and Australian terminal bearing are also given for each circuit.

These predictions were made with the Ionospheric Prediction Service program: ASAPS version 4.

Adelaide-Cairo 288
First F 0-5 Short 13332 km

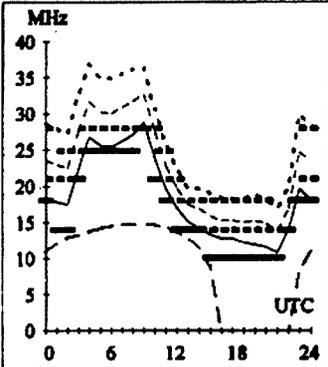

Brisbane-London 327
First F 0-5 Short 16526 km

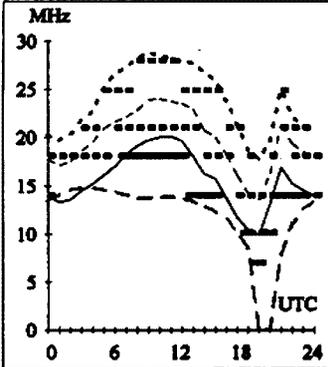

Canberra-Los Angeles 62
First F 0-5 Short 12309 km

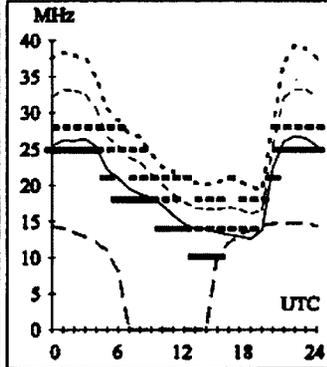

Darwin-Manila 340
Second 2F13-25 2E2 Short 3195 km

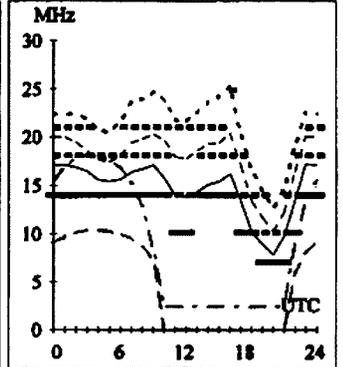

Adelaide-Dakar 233
First F 0-5 Short 16725 km

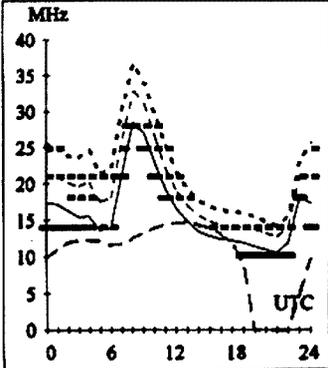

Brisbane-Ottawa 52
First F 0-5 Short 15306 km

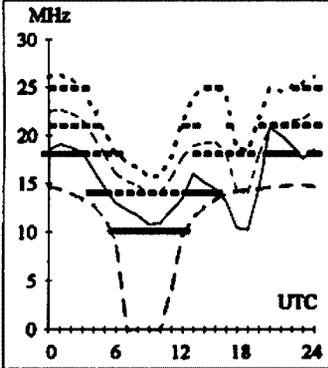

Canberra-Moscow 317
First F 0-5 Short 14481 km

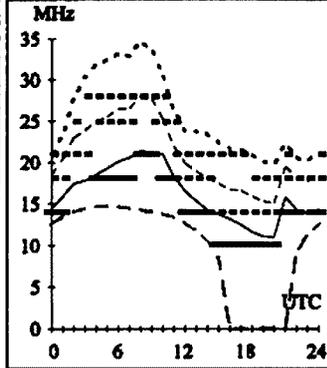

Darwin-Santiago 157
First F 0-5 Short 14421 km

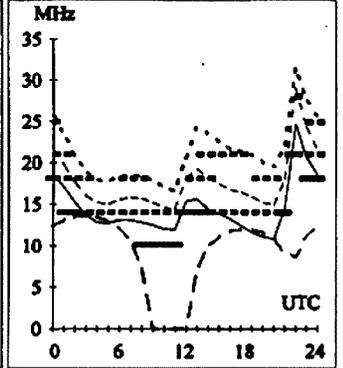

Adelaide-New York 67
First F 0-5 Short 17092 km

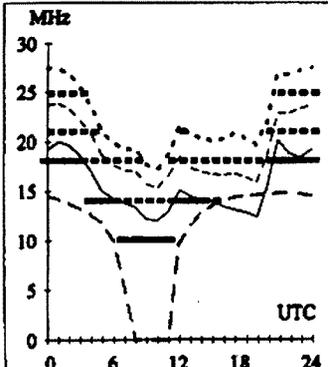

Brisbane-Tokyo 348
Second 3F6-12 3E0 Short 7159 km

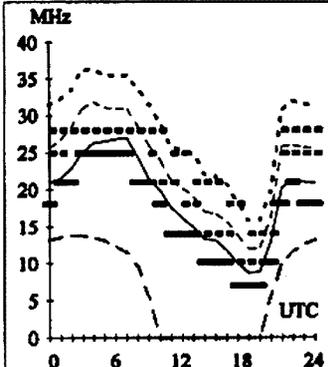

Canberra-New Delhi 303
Second 4F5-10 4E0 Short 10348 km

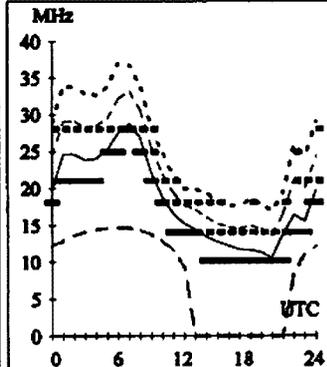

Darwin-Seoul 356
First 2F4-9 2E0 Short 5576 km

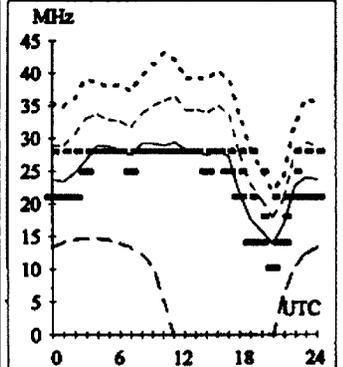

HF PREDICTIONS

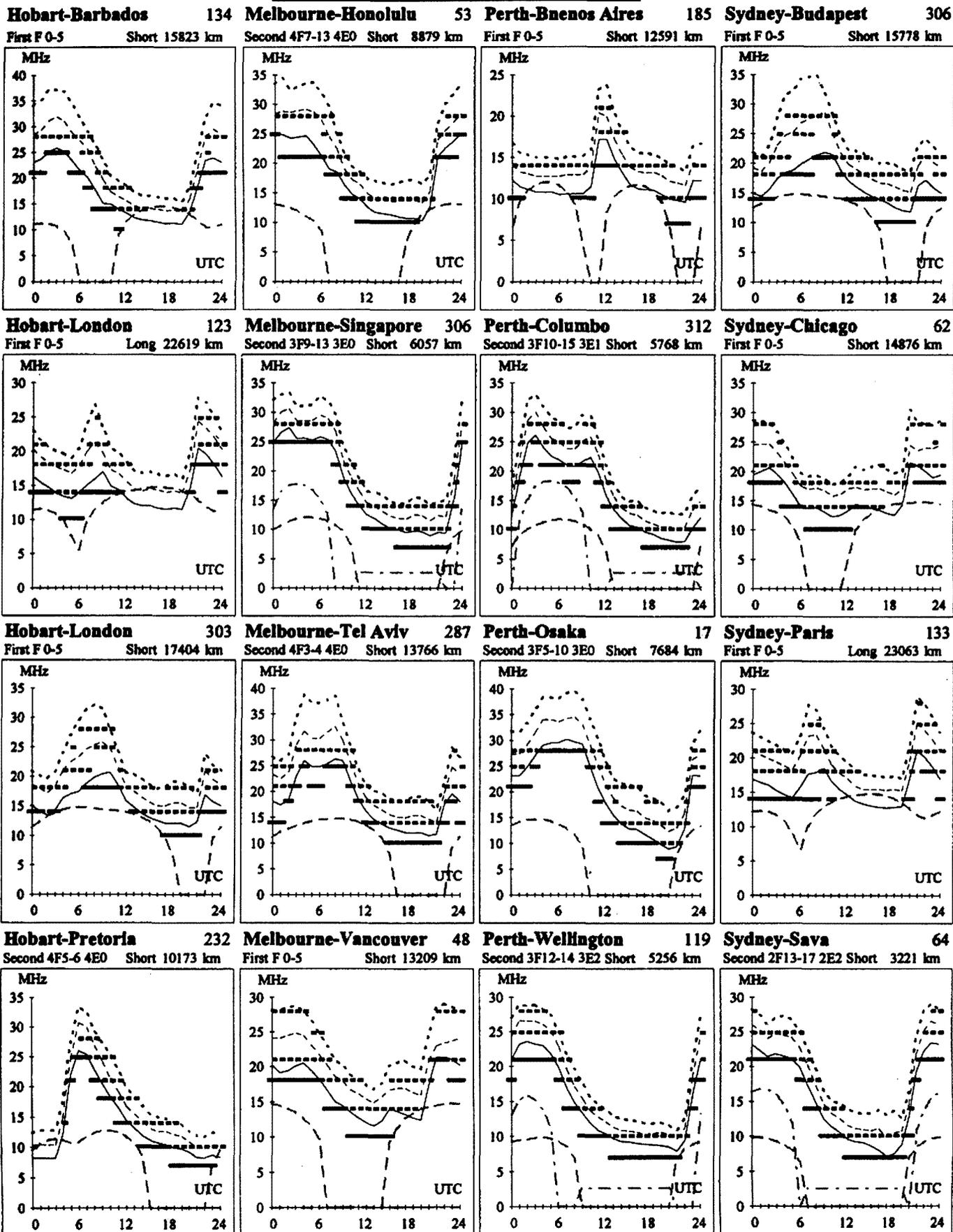

HAMADS

- Hamads may be submitted on the form on the reverse of your current Amateur Radio address flysheet. Please print carefully, especially where case or numerals are critical.
- Please submit separate forms for For Sale and Wanted items, and be sure to include your name, address and telephone number (including STD code) if you do not use the flysheet.
- Eight lines (forty words) per issue free to all WIA members, ninth and tenth lines for name and address. Commercial rates apply for non-members.
- Deceased estates Hamads will be published in full, even if the ad is not fully radio equipment.
- WIA policy recommends that the serial number of all equipment for sale should be included.
- QTHR means the address is correct in the current WIA Call Book.
- Ordinary Hamads from members who are deemed to be in general electronics retail and wholesale distributive trades should be certified as referring only to private articles not being re-sold for merchandising purposes.
- Commercial advertising (Trade Hamads) are pre-payable at \$25.00 for four lines (twenty words), plus \$2.25 per line (or part thereof), with a minimum charge of \$25.00. Cheques are to be made out to: WIA Hamads.
- Copy should be typed or in block letters, and be received by the deadlines shown on page 1 of each issue of Amateur Radio, at:

Postal: Newsletters Unlimited, 29 Tanner Street, Richmond, 3121
 Fax: 03 9428 4242 E-mail: news1@webtime.com.au

Please only send your Hamad once

Please send Hamads by mail OR fax OR email (much preferred).

Please do not send by more than one method for any one ad or issue, it is confusing.

FOR SALE ACT

- **Motorola MCX100** set for 2 meter amateur bands \$75 ONO ED VK1N8H
 Phone / Fax 02 6251 2312
 email gudruned@telstra.easymail.com.au

FOR SALE NSW

- **YAESU FT7** as new YAESU FT7 original condition in carton. manual SN. 090175 VK2COB Cobber phone 026382 3843
- **YAESU FT212 RH** 2 Metre transceiver 45W 140-148 MHz unused in box cost \$569 sell \$360
- TENTEC OMNI D HF** transceiver excellent condition \$450 Jeremy VK2FLE QTHR 02 6366 8410
- **Estate late Bill Munn VK2BMX**
- ICOM IC 736 HF/6M 100W 101 MEM S2100 MFJ969 Versatune S380, Tandy PRO2005 scanner 25-520M 760-1300M 400 Mem S400 Kenwood R5000 Receiver S500, Alinco DJ-X1 Miniature Scanner 100K-1200M 100 mem S400**

Bearcat BC590XLT Scanner 29-512M 100 Mem S350 Bearcat UBC 9000XLT 25-1300M 500 Mem S400 Yaesu FT26 2 metre miniature H/ held transceiver S400 Realistic HTX-100 10 Metre Transceiver S300, Kenwood TR7800 2M transceiver S300, President HR2510 10 meter T/ciever S300 Digitor D2838 Receiver S100

Sn's available, call Tony VK2BOA 02 4943 8981 fax 02 4920 6893 aob@hunterlink.net.au

- **YAESU FT209 RH 2M Xcvr** handheld 140-150MHz- 5watts output case instr. book VGC \$190 Peter VK2BPO QTHR 02 9713 1831

- **BACK** Issues of Amateur Radio Action magazines good condition from 1980 through to 1991 S20 Ken VK2CWI QTHR 02 4476 1805

- **ARON** dual trace oscilloscope 20 meg \$350
Leader LIM -870A Impedance meter \$50:
Leader TR Dip Meter LDM-815 \$50: (pair couple together) **Disposals SCR S22** including manual \$25: **ATR2B TRCV S20: BC221** Freq meter \$20: Over 300 assorted valves and data books Quantity **ARRL hand books VK2AHP QTH 02 9746 6858**

- **Barlow Wardley XCR-30** Communication receiver AM-SSB, instruction manual batteries plus 240V-12V Power Pac \$160: **Realistic Pro 2000 UHF Scanner S110, MJF Versa Tuner 11 ATU model MFJ 941E** made in USA unused \$220 QTHR Les VK2AXZ 02 4954 0893

● Deceased Estate VK2AQF

TS820S, VFO820, TS930S, TS120V, FT726R, FL110, FL2100B, SPARE 572B's, FC902 ATU FTV650 FT290R IC502 SM220 Monitor:OFFERS Luke VK2KYQ 01861 5898 or 02 9521 6403

- **TECH GRIDDIP** meter EC in box 440KC to 280Mc \$55 John VK2CCC 02 4984 9770

FOR SALE VIC

- **YAESU FTS17A** Tone Squelch Unit CTCSS encoder /decoder F/TS suit FT26 \$55 VK3VNB QTHR 03 5335 8426

- **Plessey 6M MTR8000 36Ch** with Freq list and book 40Watt output power Greg VK3ZKV 018309099

- **For sale from the estate of the late Norm Edie VK3UP**

YAESU FT101Z transceiver with YD 148 600/50K ohms dual impedance mic-\$450: **YAESU FL2100B** linear with spare 572B tube - \$800 **YAESU FC902 500W** 3 range antenna tuner with inbuilt SWR meter - \$200 or **All three of the above for \$1300**

YAESU FRG7 full coverage HF receiver - \$300
VIKING 50 ohm 100W 30 MHz low pass (anti TVI) filter - \$30 Phone Harold VK3AFQ - QTHR - (03) 9596 2414 anytime

● SHACK CLEARANCE

"**RADCOM**" (the house magazine of the RSGB).All issues 1981 to 1998.\$10 per year or offer. Prefer not to separate: **GOODWILL 5 MHz** single beam CRO with spare mains Transformer - \$75: **MFJ 815B 500W** peak reading cross needle SWR/Wattmeter. 1.8-60MHz.-\$150
1 KW H/B antenna tuning unit with in line dual needle SWR meter \$150 **MFJ 114** giant LED 12/ 24 hour clock.Brand new.Never used. - \$60 **IBM Voice Type 3** speech translator (speech to screen) never used. - \$30. **AIRMEC 201A 10KHz** to 30MHz signal generator with spare set of tubes - \$75: **HP professional 12 step** (10dB per step) attenuator.Good to UHF. \$100 **GRUNDIG** grid dip oscillator. 1.7-250 MHz.GC. - \$150: **LEADER LMV10** audio millivoltmeter. Good to 1.0 MHz - \$75 **LEADER LAG 120A** audio generator. Sine and square wave to 1.0MHz - \$50Harold VK3AFQ - QTHR - (03)9596 2414

- **YAESU FT-747GX** Gen.CO.V. Xcvr unmarked condition \$690. **Heathkit HW 2036 2M FM** Xcvr with matching HWA 2036 Power supply GC \$120 Alan VK3AMT 03 09789 9106

- **Antenna Log Periodic Yagi.** 7 element 'Coman' built, 3 yrs old. Range is 13-30MHz, in VG condition. All aluminium & SS high quality fittings. Packed up & ready to assemble. \$300. David VK3NDS 03 97396213 AH or email <mailto:dsimp@tbsa.com.au>:dsimp@tbsa.com.au. Will consider trade for tribander.

- **Icom VHF/UHF twins:** IC271H 2m All-mode 100W and IC471H 70cm All-mode 70W base station units. Both in very good condition. \$800 each ONO. Peter VK3KAI QTHR 0409 388 044

FOR SALE QLD

- **KENWOOD TS520S** Transceiver in excellent appearance and working order comes with matching externalVFO \$450 negotiable Chris VK4YE

- **Self standing mast 8 metres 500x400mm steel GC DAIWA antenna rotor model DR7500** with DC7001 round controller (#B11031) GC: **SCALAR TRIBAND Yagi SC33DX 8dB gain VSWR less than 1.5:1 boom 4.32mtrs** with 50 ohm cable instruction manual GC the lot for removal \$500 VK4CK QTHR 07 3371 2135

- **YAESU FT7B** \$350 just serviced: **YAESU 101E** \$250 Good condition: **ICOM IC2A** \$100 H/Held charger: **Kenwood TS 520S** \$400 Just serviced: **ICOM IC551** \$300 No FM GC: **Linear 6Mt** \$100 **85Watt HF 5 Band Trap** \$120Vertical **VK4DLT** 0413 114953

- **YAESU FT 726 6,2,70** all mode with sat option **YM-48 DTMF** Mic ful w/shop manual \$950: **YAESU FL-2100z** HF linear amp \$550: **ALINCO DR-119 2m. wideRX** \$250: **YAESU YD-148** desk mic \$50: **Hansen JM 45 VTVM** \$90 John VK4AJS

Are Hamads cost effective?

I'll say.

They cost nothing and get great results.

07 4939 5724 or 0419 640 229

● **Emtron TE-33** 3 element tri-bander & 1:1 balun both new May 98 **Kenpro KR-400RC** rotator, controller & control cable \$600. **Yaesu FT-920** HF/6m transceiver S/N 7L090498 new nov 98 auto atu, DSP, CW & Voice keyer as new \$1900. Peter VK4VW 0754958724 <mailto:vk4vw@qsl.net>vk4vw@qsl.net

● **813 TUBES BRAND NEW** still in boxes Suit Linear project Alan VK4SS 07 3844 6526 (before 10am please).

FOR SALE SA

New 486DX 250 CD-ROM sound card no monitor \$100.00 Andrew VK5XX 08 8381 7195

FOR SALE TASMANIA

● **Kenwood TS520S** transceiver Serial number 840585 complete with Kenwood desk microphone, type **MC50** with instruction book and spare pair of 6146 tubes **VK7ARM** 03 62 570 400

● **YAESU FT900** HF T/ciever includes general coverage receiver, Collins filter Auto A.T.U. new boxes manuals. What offers? **YAESU SP6** Ext speaker built in filters new in box suit **FT990**, **FT900**, **FT 1000** etc \$150 **VK7AN** Allen 03 6327 1171, 0417 354410

WANTED NSW

● **Info** on **UNIDEN SMU300H** Tx/Rx John Toland **VK2KX** 02 6621 2933

● **Old valve Comms receivers** working or 'dead' Monitoring station being built up. Even junker sets or parts will pay \$ if necessary. big heavy sets welcome so clean out the shed and give me a call. John L21068 (02) 9533 6261.

● **80m resonator** and capacity hat for **18AVT** trapped vertical. Jeff **VK2BYY** **QTHR** (02)43411704

WANTED VICTORIA

● **Instruction manual** for **YAESU FC107** Antenna Tuner Would greatly appreciate a copy to buy or borrow to photocopy. Bill Jamieson **VK3HX** phone (03) 9807 9172 **QTHR**

● **Technical operators manual** for **Racal VHF/UHF** Calibrator Model 9054. Can be used as a frequency calibrator and deviation meter. Will pay any costs for copies and postage. Used by the East Gippsland Amateur Radio Club for repeater systems. Bob **VK3ZAN**. Ph 03 51567654 or Paket **VK3ZAN@VK3ST.vic.aus.oc** or Email **bobprille@net-tech.com.au**

WANTED OLD

● **ANTENNA ROTATOR** Heavy duty emotator. Create, Kenpro, **HF YAGI** Hygain **TH5.6** or **7 CUSHCRAFT TELREX**. **LINEAR POWER AMPLIFIER** HF Henry, TenTec, Titan, Drake, **L4B Kenwood TL922**. **TOWER**: winch up or self supporting heavy duty. John **VK4SKY** PO Box 1166 Coolangatta QLD 4225. 0417 410 503.

● **FM 92 Low band** (Local Mounting) converted to 52 Mhz or not Price and condition. Manual (or copy) for **AWA** Audio ultrasonic test set old type-no model no-marked **MTS A210** Costs refunded **Gwen VK4CB** **QTHR** (07) 3202 7137.

● **MANUAL YAESU FT411E** Allan **VK4NBZ** 07 4039 2876

WANTED SA

● **2mb SVGA video card** (16-bit bus). Hank. **VK5JAZ**. tele (08) 8272-7435; e-mail **vk5jaz@slezak.mtx.net** or packet **vk5jaz@vk5wi.#adl.#sa.aus.oc**

● **Audio output transformer** for **HMV TV 'V'** series stamped part no 905 0621 or 805-0621 **VK5ZT** Ratcliff Box 26 Two Wells SA 5501

WANTED TAS

● **YL1060** Dual VHF Tetrode valve for Acitron transceiver. David Slowan **VK7MS** 72 David Street East Devonport 7310 03 6427 7423

South East Radio Group

Mount Gambier Annual Convention and Fox-Hunt

Championships 1999

12th & 13th June

(Queens Birthday weekend)

A&H Hall, Pick Avenue, Mount Gambier

For further details of Foxhunt schedule etc. including

****NEW NOVICE FOXHUNT EVENT****

access **SERG** home page at:-

<http://www.seol.net.au/serg>.

For table bookings or of other information contact **Wayne VK5ZX**:-

e-mail **vk5zx@seol.net.au**,

packet **vk5zx@vk5sr** or phone (08) 87 254335.

TRADE ADS

● **AMIDON FERROMAGNETIC CORES**:

For all RF applications. Send business size **SASE** for data/price to **RJ & US Imports**, PO Box 431, **Kiama NSW 2533** (no enquiries at office please ... 14 Boanyo Ave Kiama).

www.cyberelectric.net.au/~rjandusimports

Agencies at: **Assoc TV Service**, Hobart; **Truscotts Electronic World**, Melbourne and **Mildura**; **Alpha Tango Products**, Perth; **Haven Electronics**, Nowra. (aug)

● **WEATHER FAX** programs for **IBM XT/ATs** *** **"RADFAXZ"** \$35.00, is a high resolution short-wave weather fax, Morse and **RTTY** receiving program. Suitable for **CGA**, **EGA**, **VGA** and **Hercules** cards (state which). Needs **SSB** HF radio and **RADFAX** decoder. *** **"SATFAX"** \$45.00, is a NOAA, Meteor and **GMS** weather satellite picture receiving program. Needs **EGA** or **VGA** & **WEATHER FAX** PC card, + 137 MHz Receiver. *** **"MAXISAT"** \$75.00 is similar to **SATFAX** but needs 2 MB of expanded memory (**EMS 3.6** or **4.0**) and **1024 x 768 SVGA** card. All programs are on 5.25" or 3.5" disks (state which) plus documentation, add \$3.00 postage. **ONLY** from **M. Delahunty**, 42 Villers St. New Farm QLD 4005. Ph 07 358 2785.

The Amateur Radio Cover Photo Quest



Amateur Radio magazine has an Amateur Radio related photograph on the front cover of each edition. And we need some!

CURRENTLY THE STOCKS are running low and almost all that we have are either a man up an antenna mast or a sunset with a silhouette of an antenna system.

So, if you can give us a photo that we use we will give you a present in return, probably a full colour reproduction of your cover.

So please get out that camera and start shooting.

Cheers for now, **Bob Harper VK4KNH**.

Short Conditions

1. The photographs must have an Amateur Radio interest such as famous/prominent amateurs, equipment (especially Home Brew), or events such as hamlests and competitions, Jota, etc
2. You must own the rights to the photograph and be prepared to allow Amateur Radio Magazine the right to publish the photograph. Attach a piece of paper stating: "I, [your name], the copyright owner of this photograph, grant Amateur Radio Magazine the right to publish this photograph at any time and in any manner they see fit." Then sign and date the statement.
3. All photographs should be captioned with the following information: who took the photo, where and when it was taken, what the subject is and who is depicted in it.
4. The photograph must be a colour print at least 3" by 5". Photographs should be clear, well focused and with good contrast. Avoid background clutter.
5. All photographs will remain the property of the WIA and will be kept as the beginning of a photographic collection.
6. Photographs will be assessed on their content, quality and appeal. The selection will be based on publication needs and not necessarily on technical merit. The publication committee, Editor and Production Manager will have the final say on the selection..
7. Photographs should be sent to **Bob Harper**, PO Box 288, Beerwah 4519 and the envelopes should have a stiff insert and be marked with the words "Photographs - DO NOT FOLD"

WIA Division Directory

The WIA consists of seven autonomous State Divisions. Each member of the WIA is a member of a Division, usually in their residential State or Territory, and each Division looks after amateur radio affairs within its area.

Division	Address Officers	News Broadcasts	Note: All times are local. All frequencies MHz.	Fees
VK1 ACT Division GPO Box 600 Canberra ACT 2601	President Hugh Blemings Secretary John Woolner Treasurer Les Davey	VK1YYZ VK1IET VK1ILD	3.590, 146.950, 438.375, 438.325, 438.225 & 438.025 FM each Sunday from 8.00pm AEST. News text on packet BCAST@VK1BBS, http://www.vk1.wia.ampr.org & aus.radio.amateur.misc newsgroup. Send items by packet as personal message BCAST@VK1BBS or e-mail to broadcast@vk1.wia.ampr.org.	(F) \$72.00 (G) (S) \$58.00 (X) \$44.00
VK2 NSW Division 109 Wigram St Parramatta NSW (PO Box 1066 Parramatta 2124) Phone 02 9689 2417 Freecall 1800 817 644 Fax 02 9633 1525	President Michael Corbin Secretary Eric Fossey Treasurer Eric Van De Weyer (Office hours Mon-Fri 11.00-14.00) Web: http://ozemail.com.au/~vk2w/ e-mail: vk2wi@ozemail.com.au Packet BBS: VK2WI on 144.850 MHz	VK2Y2C VK2EFY VK2KUR	From VK2WI 1.845, 3.595, 7.146*, 10.125, 14.170, 24.950, 28.320, 29.120, 52.120, 52.525, 144.150, 147.000, 438.525, 1273.500 (* morning only) with relays to some of 18.120, 21.170, 581.750 ATV sound. Many country regions relay on 2 m or 70 cm repeaters. Sunday 1000 and 1930. Highlights included in VK2AWX Newcastle news, Monday 1930 on 3.593 plus 10 m, 2 m, 70 cm, 23 cm. The broadcast text is available on the Internet newsgroup aus.radio.amateur.misc , and on packet radio.	(F) \$69.00 (G) (S) \$56.00 (X) \$41.00
VK3 Victorian Division 40G Victory Boulevard Ashburton VIC 3147 Phone 03 9885 9261 Fax 03 9885 9298	President Jim Linton Secretary Barry Wilton Treasurer Rob Hailey (Office hours Tue & Thur 0830-1530) e-mail: vk3wi@iint.com.au Web: http://www.tbsa.com.au/~wivaw/	VK3PC VK3XV VK3NC	VK3BW broadcasts on the 1st Sunday of the month, starts 10.30 am. Primary frequencies, 3.615 LSB, 7.085 LSB, and FM(R)s VK3RML 146.700, VK3RMM 147.250, VK3RWG 147.225, and 70 cm FM(R)s VK3ROU 438.225, and VK3RMU 438.075. Major news under call VK3WI on Victorian packet BBS and WIA VIC Web Site.	(F) \$75.00 (G) (S) \$61.00 (X) \$47.00
VK4 Queensland Division GPO Box 638 Brisbane QLD 4001 Phone 07 3221 9377	President Colin Gladstone Secretary Peter Harding Treasurer Alistair Elrick e-mail: secretary@wiaq.powerup.com.au Web: http://www.wiaq.powerup.com.au	VK4ACG VK4JPH VK4FTL	1.825 MHz SSB, 3.605 MHz SSB, 7.118 MHz SSB, 10.135 MHz SSB, 14.342 MHz SSB, 21.175 MHz, 28.400 MHz SSB, 29.220 MHz FM, 53.725 MHz FM, 147.000 MHz FM, 438.500 MHz (Brisbane only), and regional VHF/UHF repeaters at 0900 hrs EAST Sunday. Repeated on 3.605 MHz SSB & 147.000 MHz FM at 1930 hrs EAST Monday. Broadcast news in text form on packet under WIAQ@VKNET.	(F) \$74.00 (G) (S) \$60.00 (X) \$46.00
VK5 South Australian Division 34 West Thebarton Rd Thebarton SA 5031 (GPO Box 1234 Adelaide SA 5001) Phone 08 8352 3428 Fax 08 8264 0463	President Ian Hunt Secretary Merv Millar Treasurer Joe Burford Web: http://www.vk5wia.ampr.org/	VK5QX VK5MX VK5UJ	1827 kHz AM, 3.550 MHz LSB, 7.095 AM, 14.175 USB, 28.470 USB, 53.100 FM, 147.000 FM Adelaide, 146.700 FM Mid North, 146.800 FM Mildura, 146.825 FM Barossa Valley, 146.900 FM South East, 146.925 FM Central North, 147.825 FM Gawler, 438.425 FM Barossa Valley, 438.475 FM Adelaide North, ATV Ch 35 579.250 Adelaide. (NT) 3.555 USB, 7.065 USB, 10.125 USB, 146.700 FM, 0900 hrs Sunday, 3.585 MHz and 146.675 MHz FM Adelaide, 1930 hrs Monday.	(F) \$75.00 (G) (S) \$61.00 (X) \$47.00
VK6 West Australian Division PO Box 10 West Perth WA 6872 Phone 08 9351 8873	President Cliff Bastin Secretary Christine Bastin Treasurer Bruce Hedland-Thomas Web: http://www.faroc.com.au/~vk6wia/ e-mail: vk6wia@faroc.com.au	VK6LZ VK6ZLZ VK6OO	146.700 FM(R), 438.525 FM(R), 29.120 FM at 0930 and 1900 hrs Sundays from Perth, relayed (morning only) on 1.865, 3.564, 3.582 (Busselton), 7.075, 14.116 (North), 14.175 (East), 21.185, 50.150; (morning and evening) 146.900(R) Mt William (Bunbury), 147.00(R) Katanning, 147.200(R) Cataby, 147.250(R) Mt Saddleback (Boddington), and 147.350(R) Busselton; (evening only) 1.865, 3.564 MHz.	(F) \$62.00 (G) (S) \$50.00 (X) \$34.00
VK7 Tasmanian Division 24 Targett Street Scamander TAS 7250 Phone 03 6372 5305	President Ron Churcher Secretary Paul Godden Treasurer John Klop Web: http://www.wia.tasnet.net e-mail: vk7kpg@hamnet.hotnet.com.au	VK7RN VK7KPG VK7KCC	146.700 MHz FM (VK7RHT) at 0930 hrs Sunday relayed on 147.000 (VK7RAA), 146.725 (VK7RNE), 146.625 (VK7RMD), 3.570, 7.090, 14.130, 52.100, 144.150 (Hobart), repeated Tues 3.590 at 1930 hrs.	(F) \$74.00 (G) (S) \$60.00 (X) \$46.00
VK8 Northern Territory (part of the VK5 Division and relays broadcasts from VK5 as shown, received on 14 or 28 MHz).				

Membership Grades

Full (F) Pension (G) Needy (G) Student (S) Non receipt of AR (X)
Three-year membership available to (F) (G) (X) grades at fee x 3 times.

ADVERTISERS INDEX

Terlin	IFC	Rad-Com	9
Icom.....	OBC, 5	Amateur Transceiver Radio ...	39
Jaycar	17	Dick Smith	IBC 28,29
Andrews	7	Electronic Valve and Tube....	32

TRADE PRACTICES ACT

It is impossible for us to ensure that the advertisements submitted for publication comply with the Trade Practices Act 1974. Therefore, advertisers and advertising agents will appreciate the absolute need for themselves to ensure that the provisions of the Act are strictly complied with.

VICTORIAN CONSUMER AFFAIRS ACT

All advertisers are advised that advertisements containing only a PO Box number as the address cannot be accepted without the addition of the business address of the box-holder or seller of the goods.

YAESU'S DONE IT AGAIN



FT-920 HF/6m Transceiver With DSP

Now there's no excuse for not taking advantage of the latest advances in Digital Signal Processing, transceiver design plus the fun of 6m operation. The stunning new Yaesu FT-920 is a high performance HF/6m multi-mode base station transceiver that provides 100W PEP output on the 160-6m bands, incredible front-end performance based on the FT-1000MP design, and a huge array of features that make it a pleasure to use.

At first glance Yaesu's renowned Omni-Glow LCD screen is obvious, and its wide-angle view provides a wealth of information about the transceiver's operating status with multi-function metering, dual frequency displays and an Enhanced Tuning scale for DSP bandwidth, CW tuning, FM discriminator and more. Inside, the FT-920 is built around a rugged diecast unibody chassis which provides excellent heatsinking for the low distortion dual MRF255 160-6m FET power amplifier.

For more comfortable operating when weaker signals are present Yaesu's engineers dedicated themselves to enhancement of real-world signal to noise ratios, and after thousands of hours of design and testing have produced an industry-leading 33.3MIPS (millions of instructions per second) processing speed DSP in the FT-920 that provides a two-parameter noise reduction system with 32 steps of front panel adjustment. This amazing system also provides dual control DSP passband tuning, DSP auto-notch filter, an amazing new transmit Digital Speech Processor, DSP mic equalisation, fast acting DSP VOX circuitry as well as a Contest-ready Digital Voice Recorder!

Other features include an all-band (160-6m) auto antenna tuner which also provides greater receiver band-pass protection, Direct Digital Synthesis for clean local oscillators, selectable frequency-optimised receiver front-end pre-amps, and a Shuttle Jog tuning ring for fast QSX.

A Dual Watch receive system allows you to check for band openings, especially handy when monitoring 6m. Also provided are SSB/CW/FM operation (AM with optional filter), 127 memories with alphanumeric labelling, IF shift and IF noise blanker to fight interference, plus an extensive menu system for selecting most "set and forget" functions. The FT-920 is supplied with an MH-31B8 hand mic, DC power lead and comprehensive instruction manual.
D 3420

Why not call for a copy of the Yaesu 6 page FT-920 colour brochure to learn more about this efficient transceiver that's without peer in its price class.

YAESU

\$2695

2 YEAR WARRANTY

DICK SMITH
ELECTRONICS

That's where you go!

MORE

GREAT

GEAR

FROM

ICOM

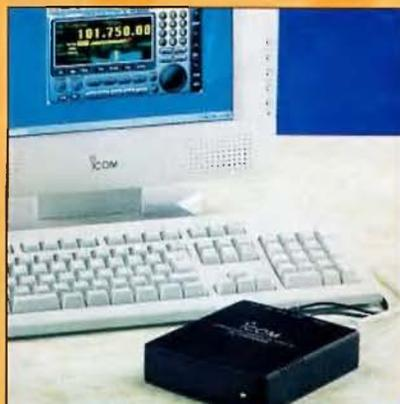

PCR100 Cruise the air waves with your computer. Turns your PC into a high performance 0.5 - 1300 MHz receiver (FM/WFM/AM modes) with plug'n play installation. Multi function control panel, wide frequency coverage, and unlimited memory channels.

R2 Fit the world's airwaves in your shirt pocket. Just 8.6cm high, wide 0.5 - 1300 MHz frequency range divided into 9 bands plus FM/WFM/AM, 400 memory channels, great sound in rugged water resistant construction.

2800H A totally new approach to dual band mobile.

Powerful performance on 2m and 70cm bands, remote control capability, and a first for mobile rigs...a multi-function colour LCD screen! All your information is right in front of you in colourful 3D-like characters and icons.

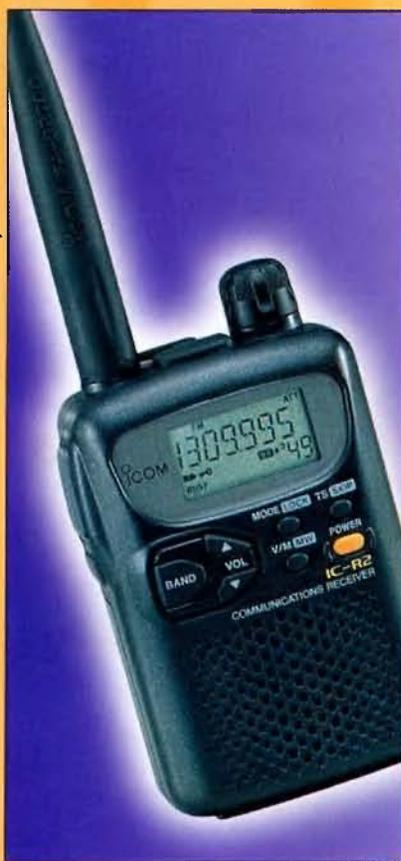
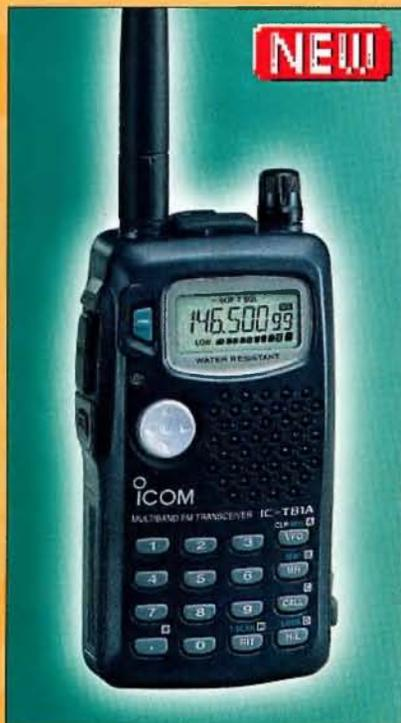

T81A A remarkably compact quad bander. Superb clarity on the 6m, 2m, 70cms and 23cm bands. It's water resistant, with tone squelch and pocket beep functions standard, plus you can change volume and bands even quicker with the 'joy-stick' style multi-function switch.

706MKIIG The amazing evolution of the legendary 706. Frequency coverage is expanded to the 70 cm band and output power is increased for the 2m band. You get base station performance and features in a mobile rig-sized package.



ICOM
Clearly Ahead

2 YR WARRANTY

See your nearest Icom Dealer, call Icom on 1800 338 915, or visit our website at www.icom.net.au



June 1999
Volume 67 No 6

Amateur Radio

Journal of the Wireless Institute of Australia



Full of the latest amateur radio news, information and technical articles, including...

- ★ First Results from the AGM
- ★ Update on LIPDs
- ★ An Automatic Beam Pointer
- ★ General Purpose Amplifier/Mike Tester/Power Supply
- ★ A Complex Impedance Analyser—Review
- ★ Morse Code — Signing Off

Plus *lots of other articles, news and special interest columns.*



CUSHCRAFT

COMMUNICATIONS ANTENNAS

The R7000 is a 10 through to 40 metre, no ground radial antenna that is expandable to include the excitement of 80 metres. It includes the best features of its predecessor the R5 and R7 plus many more. R7000 means excellent performance, easy installation and use, slim silhouette and high reliability.

- Expandable to 80 m - Transforms your R7000 into an R7000+ with R80 kit (trap, tubing, guy & counterpoise wire)
- Reliable - New trap design is stable in all conditions
- Easy installation - For typical use, tuning is not needed
- Automatic Band changing - To any band from 10 through to 40m (80m with R80 kit)
- Slim silhouette - Gain favour of family and neighbours with the slim, smooth profile of our new trap design

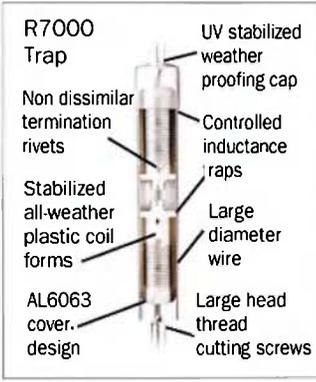
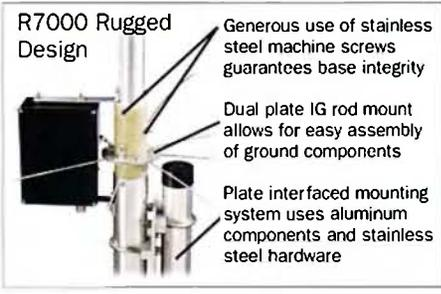

Freq.....	28, 24, 21, 18, 14, 10 & 7MHz
Gain.....	3dBi
Power rating.....	1.5W(PEP)
Mast Size.....	1 3/4" - 2 1/8" dia.
Weight.....	18lbs
Price.....	\$1129.00 INC.TAX

R80 Add-on kit

80 metres can be easily added to the R7000 with the R80 kit. The kit includes a 40 metre trap, tubing, 80 metre loading coil, UV stable 400 lb. test guy rope and three 20 foot counterpoise wires that attach to your guy points. The R80 counterpoise wires were designed with state-of-the-art anti resonators to ensure top performance on all bands.

\$368.00 INC.TAX

HF TO GO

SG-2020 HF Transceiver (20WATTS - 1.8-30MHZ)

Model.....	SG-2020 Synthesised single sideband radiotelephone
Power Output.....	20 watts PEP - USB, LSB, CW
Memories.....	20 Simplex or semi duplex
Voltage.....	12VDC
Speaker.....	Internal 5 watt
Microphone.....	Dynamic fist microphone
Dimensions.....	70H x 150W x 190L
Approx Weight.....	1.1 kg
Price.....	\$1730 Inc tax

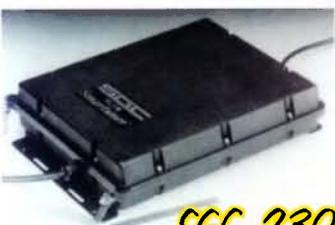

SGC-230

\$950.00 INC. Free delivery Aust. wide

Frequency range:	1.6-30 Mhz
Power rating:	200watts PEP max. 12VDC operation
SW:	Less than 1:1.5
Tune power:	3 watts nominal
Weight:	3.5kg
Dimensions:	370x300x90mm
Supplied with	9ft.cable for coaxial and DC power



The SGC-230 Automatic antenna coupler can be used within its' power rating with any HF Transceiver within 1.6 to 30 Mhz. Designed for marine, portable and fixed base applications. 3-30 Mhz range with 9ft minimum antenna. Number of channels unlimited.

Terlin OUTbacker

Antenna & Communications

PO Box 1197 Canning Vale WA
11 Mc Elligott Crt Canning Vale

Ph: (08) 9455 4288
Fax: (08) 9455 4289

www.outbacker.com.au
email terlin@outbacker.com.au

Amateur Radio

Volume 67
Number 6
June 1999

Amateur Radio is published by the Wireless Institute of Australia ACN004 920 745 as its official Journal on the first Friday of each month

Editorial

Editor: Bill Rice* VK3ABP
Production Manager: Bob Harper VK4KNH
Snr Technical Editor: Peter Gibson* VK3AZL
Technical Editors: Evan Jarman* VK3ANI
Gil Sones* VK3AUI
Contributing Editors: Ron Fisher* VK3OM
Don Jackson* VK3DBB
WIA News Editor: David Thompson VK2NH

*Publications Committee member

Advertising

Mrs June Fox, WIA Federal Office
PO Box 2175 CAULFIELD JUNCTION VIC 3161
Tel: (03) 9528 5962 Fax (03) 9523 8191
email armag@hotmail.net.au

Hamads

"Hamads" Newsletters Unlimited
29 Tanner Street, Richmond VIC 3121
Fax: (03) 9428 4242
e-mail: news1@webtime.com.au

Amateur Radio Correspondence

All correspondence, contributions and queries about the **content** should be sent to:

The Editor **Amateur Radio**
PO Box 2175, CAULFIELD JUNCTION VIC 3161
email armag@hotmail.net.au
Tel: (03) 9528 5962 Fax (03) 9523 8191

Amateur Radio Delivery

All queries regarding delivery should be directed to:

Amateur Radio WIA Federal Office
PO Box 2175 Caulfield Junction Vic 3161
Tel: (03) 9528 5962 Fax (03) 9523 8191

Registered Office

10/229 Balaclava Road
Caulfield North VIC 3161
Tel: (03) 9528 5962 Fax (03) 9523 8191
Business hours: 9.30am-3pm weekdays

Editorial & Display Booking Deadlines

June 14/5/99
July 11/6/99
August 11/7/99

Hamad & Display Material Deadline

June 21/5/99
July 18/6/99
August 21/7/99

Production

Administration, Drafting, Design & Sub-editing
Shadetree Publishing & Imaging
PO Box 288 BEERWAH QLD 4519

Pre-press, print and mail management
Newsletters Unlimited (03) 9428 3458

Printed by Streamline Press, Melbourne (03) 9417 2766

Mailed by IMS, Melbourne (03) 9291 5888

Receipt of Amateur Radio by mail

This issue was delivered to Australia Post on Friday June 4. If you are a financial member and have not received your copy by the 15th of the month please check with your local Post Office before contacting the registered office of the WIA.

Copyright and Reproduction

The copyright in this magazine, except where specifically noted, is held by Wireless Institute of Australia ©WIA 1999. Permission to republish articles in any form must be obtained in writing from the Institute (other than for purposes of 'fair dealing'). This permission is usually freely given for information purposes.

The Journal of the Wireless
Institute of Australia

ISSN 0002-6859

General

The 1999 WIA AGM	4
<i>Ian Hunt VK5QX</i>	
LIPDs	7
<i>Peter Naish Federal President</i>	
Why 50 Ohms	10
<i>Bob Harper VK4KNH</i>	
Andy Thomas VK5MIR —South Australia's Cosmonaut	15
<i>Christine Taylor VK5CTY</i>	
Signing off — Technology replaces Morse Code	18
<i>Annette Codispoti</i>	
New Clubhouse for Redcliffe	19
<i>Kevin Jones VK4AKI</i>	
Special Event Planning for Amateur Radio	48
<i>Bob Harper VK4KNH</i>	

Technical

An Automatic Beam Pointer	20
<i>Barry White VK2AAB</i>	
General Purpose Amplifier/MikeTester/Power Supply	23
<i>Drew Diamond VK3XU</i>	
A HF Complex Impedance Analyser	26
<i>Ralph Holland VK1BRH</i>	
Technical Abstracts	33
<i>Gil Sones VK3AUI</i>	

Columns

Advertisers' Index	56	Intruder Watch	40
ALARA	11	Novice Notes	31
AMSAT Australia	39	Over to You	13
Awards	43	Pounding Brass	42
Club News	9	Repeater Link	41
Contests	44	Silent Keys	22, 55
WIA Division News		Spotlight on SWLing	47
VK1 Notes	8	VHF/UHF - An Expanding World	36
VK 7 Notes	8	What's New	30
Editor's Comment	2	WIA Comment	3
Education	14	WIA News	3
Hamads	54	WIA Division Directory	56
HF Predictions	52	WIA Federal Directory	2

Our cover this month

Some of your representatives at the 1999 Annual General Meeting

Contributions to Amateur Radio

Amateur Radio is a forum for WIA members' amateur radio experiments, experiences opinions and news. Manuscripts with drawings and/or photos are always welcome and will be considered for publication. Articles on disc or email are especially welcome. The WIA cannot be responsible for loss or damage to any material. A pamphlet, How to write for Amateur Radio is available from the Federal Office on receipt of a stamped self-addressed envelope.

Back Issues

Back issues are available directly from the WIA Federal Office (until stocks are exhausted, at \$4.00 each (including postage within Australia) to members.

Photostat copies

When back issues are no longer available, photocopies of articles are available to members at \$2.50 each (plus an additional \$2 for each additional issue in which the article appears).

Disclaimer

The opinions expressed in this publication do not necessarily reflect the official view of the WIA and the WIA cannot be held responsible for incorrect information published.

Amateur Radio Service

A radiocommunication service for the purpose of self-training, intercommunication and technical investigation carried out by amateurs; that is, by duly authorised persons interested in radio technique solely with a personal aim and without pecuniary interest.

Wireless Institute of Australia

The world's first and oldest
National Radio Society
Founded 1910

Representing
The Australian Amateur Radio Service

Member of the
International Amateur Radio Union

Registered Federal Office of the WIA
10/229 Balaclava Road
Caulfield North Vic 3161
Tel: (03) 9528 5962 Fax (03) 9523 8191
<http://www.wia.org.au>

All mail to
PO Box 2175 Caulfield Junction VIC 3161

Business hours: 9.30am-3pm weekdays

Acting Federal Secretary

Peter Naish VK2BPN

Federal Office staff

June Fox Bookkeeper
Rita Trebilco VK3IF Examinations Officer

Council

President	Peter Naish	VK2BPN
VK1 Federal Councillor	Glenn Dunstan	VK1XX
VK2 Federal Councillor	Michael Corbin	VK2YC
VK3 Federal Councillor	Brenda Edmonds	VK3KT
VK4 Federal Councillor	Ross Marren	VK4AMJ
VK5 Federal Councillor	Ian Hunt	VK5QX
VK6 Federal Councillor	Will McGhie	VK6JU
VK7 Federal Councillor	Phil Corby	VK7ZAX

Executive

Peter Naish	VK2BPN
Tony Farrow	VK2TJF
John Loftus	VK4EMM
Wally Howse	VK6KZ

Federal Coordinators

AMSAT	Graham Ratcliff	VK5AGR
ARDF	Jack Bramham	VK3WWW
Awards	John Kelleher	VK3DP
Contests	Ian Godsil	VK3DID
Education	Brenda Edmonds	VK3KT
FTAC	John Martin	VK3KWA
Historian	John Edmonds	VK3AFU
IARU	Grant Willis	VK2ZWI
Intruder Watch	Gordon Loveday	VK4KAL
ITU Conference and study group	David Wardlaw	VK3ADW
Public Relations	David Thompson	VK2NH
QSL Manager (VK9, VK0)	Neil Penfold	VK6NE
Videotapes	Don Bland	VK4TVD

ACA Liaison Team

Peter Naish	VK2BPN
Glenn Dunstan	VK1XX
Michael Corbin	VK2YC
Wally Howse	VK6KZ
Canberra Liaison Officer	
Richard Jenkins	VK1RJ

EDITORS COMMENT

Acronyms

A letter arrived some months ago from Sid Ward VK2SW of Wagga Wagga. He wrote the address using two Waggas, so in deference to his preference and, I believe, most of his fellow residents, I have done so. I guess the duplication is for the same reason as nouns are duplicated in the Indonesian/Malay language, to indicate a plural. In the NSW case it also indicates a number more than two, I believe, and actually means "many crows" in the aboriginal language of the area.

But Sid's letter was not about two Waggas. It was about the WIA news article on page 5 of our February 1999 issue. The article was from an ITU news release (number 34 for 1998) and discussed international negotiations to standardise world communication systems. Sid's problem (and mine too) was "what do all those letter groups mean?". He has been unable to find anyone who does fully understand the article! I have to admit that when I proof read the page it was less than crystal clear to me too! But I assumed that most experts, more knowledgeable than I, would know what was meant by CDMA, RTT and their like. Their meanings should have been listed at the beginning of the article, but they were not in the original and so could not be listed.

Let me have some guesses. IMT is "International Mobile Telephone": RTT (defined in the third paragraph) is "Radio Transmission Technology": IPR (mentioned in paragraph two) is "Intellectual Property Rights": TDMA once meant "Time Division Multiple Access" and experts assure me that it still does. 2G and 3G means "second generation" and "third generation", and CDMA is "Code Division Multiple Access".

I hope all this has helped some of you translate the article.

Bill Rice VK3ABP Editor

1999 FEDERAL CONVENTION ELECTED OFFICE BEARERS

EXECUTIVE

President
Peter Naish VK2BPN

Directors
Tony Farrow VK2TJF
Wally Howse VK6KZ
John Loftus VK4EMM

OTHER OFFICE BEARERS

IARU Region III Liaison Officer
Grant Willis VK5ZWI

ITU International Regulatory & Radiocommunication Study Officer
David Wardlaw VK3ADW

ACA Liaison Committee
Michael Corbin VK2YC
Glenn Dunstan VK1XX
Wally Howse VK6KZ

Editor, "Amateur Radio"
Bill Rice VK3ABP

Publications Committee
Ron Fisher VK3OM
Peter Gibson VK3AZL
Evan Jarman VK3ANI
Gil Sones VK3AUI
Don Jackson VK3DDB.

Chairman, Federal Technical Advisory Committee
John Martin VK3KWA

Federal Education Coordinator
Brenda Edmonds VK3KT

Intruder Watch Coordinator
Gordon Loveday VK4KAL

Federal Contest Coordinator
Ian Godsil VK3DID

Federal Awards Manager
John Kelleher VK3DP

Historian
John Edmonds VK3AFU/ATG

VK9/VK0 QSL Bureau
Neil Penfold VK6NE

International Travel Host
John Miller VK3DJM

Federal Web Page
Richard Murnane VK2SKY

Auditor
Harmon Partners

VACANT POSITIONS

The following positions are vacant. Persons interested in filling these positions or nominating others should do so through their Division as soon as possible.

Federal Media Liaison Officer
Electromagnetic Compatibility Coordinator
AMSAT Coordinator
Federal WICEN Coordinator
QSL Collection Curator
Videotape Coordinator



Comment

Federal President, Peter Naish
VK2BPN.

FROM THE PRESIDENT

The Annual Convention and AGM of WIA Federal was held in Sydney over the weekend May 1/2 1999. It was attended by the Federal Councillors from each of the State Divisions, the Federal Executive and a number of other representatives of the Divisions.

As usual, it was a very busy meeting with many items for discussion and resolution. I am pleased to report that we made considerable progress in an atmosphere that was both constructive and cordial. It seems that we are now indeed working as a national team with the potential to solve the many issues ahead of us. A full report on the meeting is being prepared for publication in the next issue of this journal.

One of the most important functions of the WIA is the liaison with the ACA. We are respected and recognised as the voice of the radio amateur in Australia and have a close working relationship with the ACA. Under my chairmanship the WIA/ACA Liaison Committee is working hard to achieve results which will satisfy the majority of amateurs. There is a great amount of talent at our disposal, which is just as well considering the breadth and depth of the subjects currently under consideration. These range throughout the radio spectrum from possible VLF bands to the high gigahertz regions, plus the many licensing and examination matters that are fundamental to our operations.

I intend that our work with the ACA will be a major activity for the WIA this year. It is an area that can achieve results to benefit all Australian radio amateurs no matter what their particular interests may be.

We must not overlook the international scene, however. There are plans in the next year or so for the ITU to review the International Amateur Service Regulations which form the basis of the amateur radio service world-wide. Apart from preparing to represent the amateur radio service at these ITU meetings, the IARU, in which you are represented by the WIA, is tackling many international issues as diverse as illegal operations on ten metres, revised allocations for forty metres, encryption of amateur transmissions, promotion of QRP operations, support of amateur activity in emerging nations, educational projects involving amateur radio and many, many other facets of our hobby. I propose to ask our WIA coordinators who are responsible for these areas to provide regular "plain language" reports on these activities so that everyone can understand what is happening in the international arena.

WIA NEWS

WIA News, Assembled by
Bob Harper VK4KNH

Items have been supplied to me by
Graeme Kemp VK4BB from his QNews Bulletins

David Thompson VK2NH -Federal Public Relations Coordinator, is not available for this edition as he is currently recovering from major surgery. I don't know enough about his surgery to report to AR but I understand he is comfortable and eager to get on with life. I am sure that all Amateurs and SWLs wish him a speedy recovery and look forward to receiving his WIA News again soon. (Bob VK4KNH)

Brighter Future for Australian Digital TV

The Australian Broadcasting Authority's draft digital channel plan for digital TV services was released Wednesday 5th May. ABA's proposal will allow greater diversity of services and new industries to be created via the broadcast services band in the VHF and UHF spectrum.

The ABA proposes allocating only a main 7 MHz digital segment to each of the five existing broadcasters in the major population centres. Spectrum for the translator channels will be allocated in a phased approach once the ABA is satisfied the best technical information is available.

The announcement clears the way for Australia's existing broadcasters to quickly introduce digital transmissions. The broadcast television industry has debated and won the right to introduce high definition television (HDTV) on 1st January 2001. (News Limited 2 Molt Street, Surry Hills)

THE DRUM...from P29

Our reporter is Rick P29KFS who currently is in Cairns Base Hospital after a helicopter crash in the rugged PNG Highlands. QNEWS is unable to obtain any information on his condition, but our thoughts and prayers go out to all involved.

What's happening in the world of Amateur Radio in P29? In a QNEWS EXCLUSIVE Rick P29KFS picks up the story.

"We have made some efforts here to popularise AR but there has really been a disappointing response. When Jim Smith was here, in the mid 1970's there were many amateurs associated with Telikom, ELCOM and DCA, although most were expatriates.

When these government departments were "localised" a large percentage of the technical types left. In Telikom, quite a significant number of PNG nationals gained their amateur licenses, but did not become active. For many years there were about 40 amateurs in Port Moresby and most of the PNG Amateur Radio Society members and executive came from here. As numbers thinned, the membership became more and more from people on the outstations where radio was part of their life. Now, a lot more amateurs live out of town and Port Moresby has few active people.

As the PNGARS activity waned, a few active VHF'ers and myself started the Port Moresby VHF Club, an informal group that operated about 20 years ago and was responsible for building and finally establishing the Mt Albert Edward voice repeater in 1983. This lasted until 1986 - without any maintenance at all and has now been resurrected as a packet Digipeater due to the low traffic it had on voice.

P29RAE still runs 100% of the time and often displays several VK4 check-ins when we get a chance to look at it.

Unfortunately, the radio in use is a simple MFJ data radio which is both low powered and low in receive sensitivity, so not really conducive to VK4 DX. However we are working on getting some FM828's set up on 144.9 so that this site will really offer a digital gateway into PNG.

Further penetration of PNG will be possible when we place another Digipeater on one of the commercial sites in Lae (my company operates these), as this can talk to Mt Albert Edward quite well.

We already have a digi in the Eastern Highlands (where Norm is) and so VK4's could digi all the way to Goroka when ducting opens the path between Queensland and PNG's south coast."

(Rick P29KFS)

ar

The 1999 WIA AGM

Comments by Federal Councillor
Ian Hunt VK5QX
Photographs Ron Churcher VK7RN

There are so many facets of activity within the WIA that can be addressed and one of these is certainly the make up and composition of the Federal body.

I have been a member of the WIA for over 45 years and in that time I have seen changes take place regarding its operations. In some facets it seems that there has not been much change at all. One aspect that has changed little is that we still have a body made up of seven separate states. It is this that I would like to examine and comment on.

I think that firstly we need to agree on one basic thing. That it is essential that we have some form of representation of the Amateur Radio operators of this country to the various authorities, local, state, national, international and also in some of these areas to other Amateur Radio organisations and societies.

The first groupings refer mainly to government and inter-government instrumentalities and the latter to such as individual radio clubs, other specific national societies such as the ARRL, RSGB and NZART and to the IARU.

To be able to do all this requires a fair amount of effort and a requirement for suitable personnel to carry out the necessary work. It is not always easy to find the people needed and there is always a need for volunteers to help in such as the various coordinator tasks.

I think that firstly we need to agree on one basic thing.

That it is essential that we have some form of representation of the Amateur Radio operators of this country to the various authorities, local, state, national, international and also in some of these areas to other Amateur Radio organisations and societies.

The make up of the WIA seems to have some organisational flaws, however, despite these there are people who try as best they can to provide the needed services to the Amateur Radio operators of Australia.

From time to time these representatives meet, such as at the recent Annual Federal Convention held in Sydney on 1st and 2nd of this month, and by way of telephone conferences from time to time. They also keep in touch by telephone, e-mail and through the postal system.

One would expect that in this day and age communications would be easy, however, we do not live in a model world nor are people perfect in their make-up.

You must expect some problems will be encountered but despite this the people concerned do their best to further the cause of Amateur Radio.

For many years I have been making a point that ALL office bearers in any positions within the WIA, be it at Divisional or Federal level, should always keep in mind the fact that decisions they make can have effects on ALL Amateur Radio operators, WIA members and non-members alike.

Such decisions can also have ramifications on a local basis through to national and international areas.

Thus you can see the necessity for people to act responsibly wherever they hold office. The 1999 Federal Convention the Federal

WIA Directors



Peter Naish VK2BPN, Federal President



Wally Howse VK6KZ, Director

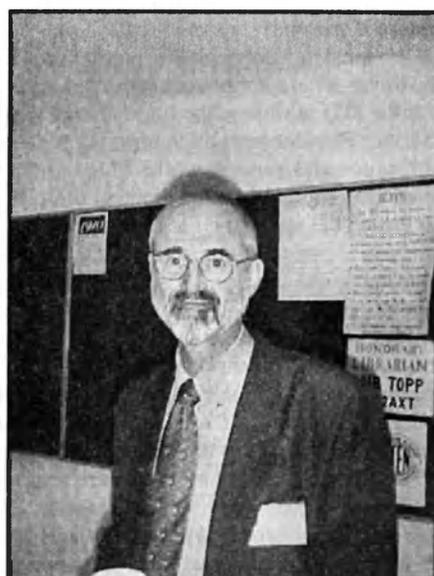

Tony Farrow VK2TJF, Director

The 1999 WIA AGM

Council elected the President and Directors of the WIA for yet another year.

The retiring **Federal President Peter Naish VK2BPN** was the only nomination for the position of President, thus he was elected unopposed.

My opinion is that any Federal President needs at least two years in the position to allow him to make any worthwhile contribution to the workings and direction of the organisation.

There were three Director positions left to fill with four candidates.

Those nominated were two Directors from the previous year namely Wally Howse VK6KZ and Neil Penfold VK6NE. Other candidates were Tony Farrow VK2TJF and John Loftus VK4EMM.

Each of the candidates provided a brief statement to the Council regarding their background and qualifications as well as their ideas and aims for Amateur Radio should they be elected.

Election of the Directors is done by means of an exhaustive ballot meaning that each has to obtain a majority from within the Council to achieve election. The result of this was that Tony VK2TJF, John VK4EMM and Wally VK6KZ were elected.

I am sure that each of these people has the best interests of the WIA and Amateur Radio as a whole in mind as they take up their tasks and adopt the various portfolios to be assigned to them.

There is no doubt in my mind that they do have an important role to play when looking towards the future of Amateur Radio in this country. I do not particularly envy their task.

The nomination by the South Australian Division of John Loftus, a member of the VK4 Division, shows a non-parochial approach and I believe that herein lies the crux of a forward-looking approach. VK5 see it as a virtual necessity that we have the very best people at the higher levels of administration of the WIA.

We have looked wherever we can to locate and identify such people, and this is not easy. People of this calibre are usually very busy with other time consuming management tasks as part of their daily livelihood.

Last year's nomination by VK5 of a member from VK3, whilst not immediately successful, restored the time honoured approach that any Division can nominate any suitable candidate.

It is also interesting to look at the "mix" of Directors from at least two different points of view, their location and their capabilities.

Several arguments can be made regarding location.

I do not know which may be the most important, however, I can see that a spread of Directors from around the country will

provide a perception of a wider spread of opinion and a greater likelihood of variety of contact with Amateur Radio operators and people in general.

Alternatively a case could possibly be made that a group of Directors in close proximity, i.e. all in one state or even city, may provide a more efficient team. You might also argue that with today's modern communications capabilities such should not be so.

It may also seem to some that a change of Directors over a period is advisable, and I do lean towards this idea with the proviso that such changes should be gradual and allow for some continuity of service in the positions.

On the matter of capabilities it seems obvious to me that bringing together a team of people, each with different skills and experience, provides a greater potential for success in any organisation.

So, let us look briefly at our current situation.

We have as a Federal President a person who has already completed a year in that position.

I have almost no doubt that Peter VK2BPN would agree that he has learned from his experience so far and I have no hesitation in believing that this experience

continues over

Not Quite an Eyeball Contact

But these photographs from the AGM do put faces to the VK voices and contributors to AR



Brenda Edmonds VK3KT and Jim Linton VK3PC



John Loftus VK4EMM, Director

The 1999 WIA AGM

will stand the WIA in good stead for the new year of office.

Wally VK6KZ is in a somewhat similar

position and retention of him in a Director's position helps with that need for continuity that I have referred to.

Tony VK2TJF comes to the task with some management experience, a qualification undoubtedly of value.

Putting faces to the voices, — some well known call signs caught in the lens



Phil Corby VK7ZAX and Ron Churcher VK7RN



Christine Bastin VK6ZLZ, Cliff Bastin VK6LZ and Will McGhie VK6UU



Eric Van De Weyer VK2KUR and Barry White VK2AB



Ian Hunt VK5QX and David Box VK5OV



Michael Corbin VK2YC and Eric Fossey VK2EFY

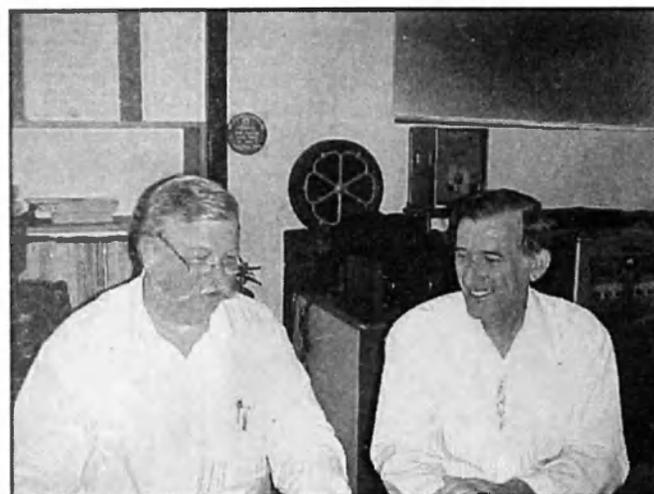

Martin Luther VK5GN and Neil Penfold VK6NE

The 1999 WIA AGM

however his stronger points are that he is skilled in areas of education and development within an academic background and almost certainly with a good understanding of the youth of today.

John VK4EMM fits into a somewhat different category with his strong points being a wide variety of experiences in business management at high level, promotion of company image and sales on a national basis and a detailed understanding of modern business practices.

With John as a nominee of the South Australian Division you would not be too surprised to learn that during the period leading up to the Federal Convention, I had made enquiries regarding him from a number of sources.

I also had a series of discussions with him by both telephone and e-mail. I had, naturally enough, spoken with officials from the VK4 Division regarding his possible nomination.

So, by now you will have at least some understanding of the "why, how and wherefore" of John VK4EMM having been nominated for a Federal position by the VK5 Division.

Maybe just by the way, another good reason, in my opinion, for choosing John is that he is without any doubt a very active Amateur Radio operator. One of my confidants described him as, energetic, capable, single minded, successful - a Victorian Open golf champion and a Chess Master. Need I say more?

ar

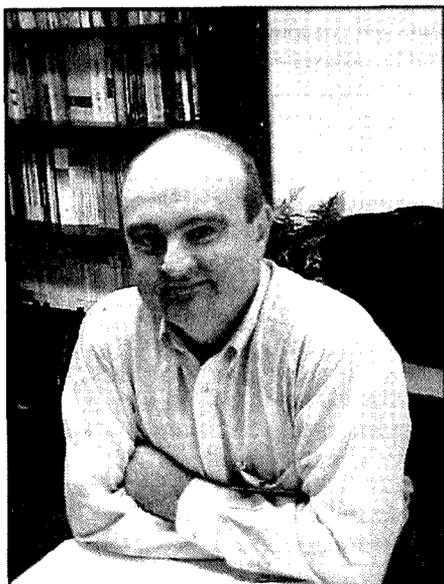

Glen Dunstan VK1XX.

LIPDs

Report On Status Of WIA Actions

WIA is continuing to pursue an acceptable outcome to the concern expressed by many radio amateurs that Low Interference Potential Devices (LIPDs) do/may cause interference to amateur activities.

A particular case is the Class Licence established by the ACA, which allows LIPDs to operate in a portion of the amateur 70cm. Band.

The 70cm Class Licence is intended to provide spectrum for very low power, short range, low duty cycle devices which use wireless technology to interface with parent equipment.

Typical of these are the keys used to operate car doors and remote control of machinery. There is no suggestion that two-way voice communication was envisaged when this Class Licence was originally established some years ago.

A very great number of LIPDs which meet the requirements of ACA's Class Licence are now operating in the 70 cm band. The majority of these are extremely low power data devices fulfilling functions as originally envisaged.

It would therefore be unrealistic to expect ACA to consider any change that would prevent them from being used. Their potential to cause problems to the amateur radio service is very low, hence LIPD.

A much more serious problem is the recent appearance of two-way hand-held voice communication units. These meet the requirements of the Class Licence in its current form, but certainly seem to be outside the original intentions for this Licence.

A defacto Citizens Band could eventuate with major consequences for the amateur usage of this portion of the band. Many of our 70 cm repeaters have their input frequencies in or adjacent to the Class licence segment.

Apart from unwanted interference to our repeaters, the possibility of them unwittingly retransmitting Class Licence voice messages to another part of our band should worry both the ACA and us.

While accepting that there is little hope of removing the Class Licence facility from the 70 cm. band, the WIA is continuing to challenge the arrangement whereby voice transmissions are allowed under that Licence.

This appears to be a more sensible approach considering that precedents do

exist in other Class Licence bands for specific modes of transmission to be banned.

Be assured that the WIA is taking very seriously the matter of intrusions into our bands. The LIPD matter is only one of several threats to our operations. The concerns of all radio amateurs are well understood and the WIA is best placed to progress them with the ACA and other authorities.

There has been a lot of ill-informed comment making the rounds of the packet network and similar channels, much of which was aimed at the WIA with a view to hurting the WIA.

The complex issues surrounding LIPDs can be difficult to grasp, and naturally individuals are concerned when they hear or read various claims about these devices.

Do you wonder how many radio amateurs filled in proforma complaints to the ACA and have since had second thoughts after being acquainted with the facts? The ACA appears unimpressed by these proforma letters.

The WIA has and will continue to issue factual information bulletins on LIPDs to help keep everyone up to date.

Any WIA member who after reading this article has unanswered concerns about LIPDs is advised to contact the Federal Councillor via their WIA Division, who is in close contact with the WIA/ACA Liaison Committee.

You will be kept informed of progress on all matters regarding LIPDs via further reports in "Amateur Radio" or on Divisional Broadcasts.

**Keep a strong
voice that will be
heard**

**Join the WIA - the
only organisation
representing
Amateurs to the
ACA.**



DIVISIONAL NOTES

Forward Bias

VK1 Notes

Peter Kloppenburg VK1CPK

"CQ, CQ, CQ, ALL VK AMATEURS."

Would you be interested in a beautiful award certificate?

Well then, keep on reading. It should not take much effort to qualify for the VK1 award.

It depends on the state or territory you live in, but a minimum of 10 points would be enough to get you a basic award. That is not difficult, is it?

It is even less difficult when you realise that there are more than 400 licensed amateurs in the Australian Capital Territory (ACT). One of these is Ted Ihasz, VK1TX. Ted is a very active ham on the bands, and has recently become the award manager for the ACT.

One sure way of getting into contact with him, and with other hams in the ACT, is during callbacks after the weekly divisional broadcast each Sunday from 8.00 p.m. Australian Eastern Standard Time (AEST). Frequencies in use at that time are: 3.590, 146.950, 438.375, 438.325, 438.225, and 438.025 Mhz.

The VK1 Award is issued by the WIA ACT Division upon receipt of a correctly presented application to any licensed amateur operator or short wave listener.

The certificate displays one of Canberra's most distinctive landmarks, the Telecom Tower, situated on Black Mountain in the heart of Australia's Capital City.

The tower is depicted in light blue on a white background with award information in black lettering.

The information required is a log extract showing date and time in UTC, mode, callsign of the VK1 station worked and ciphers exchanged. Short wave listeners should include the station worked by the VK1 station being claimed.

Each VK1 callsign worked, counts as one point. Each callsign may only be claimed once. The change of status to mobile, portable etc, is not allowed as a separate valid contact. Contact via terrestrial repeater systems are not valid contacts towards the award.

Following are the award requirements:

HF within VK (Excluding VK9 & VK0)

Basic award 20 points
Bronze upgrade 50 points
Silver upgrade 75 points
Gold upgrade 100 points
HF outside VK (Includes VK9 & VK0)
Basic award 10 points
silver upgrade 25 points
Gold upgrade 50 points
VHF and higher frequencies requirements are the same as "HF outside VK" for all areas.

Cost of the basic award is AUS\$3.00 or 5 IRC's. Each upgrade costs AUS\$1.00 or 2 IRC's

In an attempt to assist stations qualifying for the award, a VK1 Award Net operates each Sunday evening on 3.570 Mhz immediately following the VK1 Divisional broadcast. This net generally commences at about 8.30 p.m. AEST. Applications for the award should be addressed to: The Award Manager, GPO Box 600, Canberra, ACT 2601, Australia.

Now for something different. At the last WIA Federal AGM that was held in Sydney, a number of decisions were made. It was decided that Richard Jenkins, VK1RJ, will become the local liaison and coordinator for the ACA liaison team. Good on you, Dick. The next general meeting of the VK1 Division is on June 28, in room Nr. 1, Griffin Civic Centre, Canberra City. Cheers to all.

"QRM" Tasmanian division notes for June Issue.

It was pleasing to see how well out new Divisional Councillor, Phil Corby, grasped the baton and ran with it at the Federal Council meetings in Sydney early last month. I think his training as a lawyer had a bit to do with it but he's got a pretty level head on him as well!!

We feel those meetings went better than we thought they might, a lot of the success due to our President Peter Naish's chairmanship. Thanks, Peter from the Tassy devils.

Our Southern branch members have been very enthusiastic about their weekly fox-hunts. It's been interesting to note that practically every week a different ham wins. They must ALL be geniuses.

NEW WIA MEMBERS

The WIA bids a warm welcome to the following new members who were entered into the WIA Membership Register during the month of May

	MR D GRATTON
L21089	MR T J LEEDER
L21090	MR G F WILSON
L60412	MR E C S KWAN
VK1CG	MR G J CASHION
VK1HF	MR H E FINNEMORE
VK2BYN	MR R G CLARKE
VK2DFU	MR H S COOKE
VK2GLN	MR S FABER
VK2HDA	MR W J CROSSLAND
VK2INZ	MS C C REITHMULLER
VK2IOA	MR H REITHMULLER
VK2IOO	MR J M ROBINSON
VK2JPM	MR J P MAIZELS
VK2NBW	MR K J LONG
VK2TEK	MR E V EMMANUEL
VK2TJM	MR J J MEEKINGS
VK2TUB	MR P BAIRD
VK2XDW	MR D WILLIAMS
VK2XMR	MR M J RAMPLIN
VK2XTJ	MR T SANNUTO
VK2XVS	MR V STAFFORD
VK2XYI	MR S D RICHARDSON
VK2ZJW	MR A J WALKER
VK3JDO	MR D CANNING
VK3OT	MR S R GREGORY
VK3YNG	MR B ACKERLY
VK3ZYS	MR S BARBER
VK6PD	MR P D CROSS
ZL1MRX	MR J FULLER

The north-west branch has changed its meeting night to the first Wednesday each month to alleviate attendance problems for our Secretary, Tony Bedelph, and Treasurer Terry Ives.

A good program of activities has been scheduled for the next few months starting this month with a ladies' do in recognition of their help with the Annual Hamfest in March.

The Northern branch is very alive and well again with a lot of activities coming up for future reports.

For some time we've been asked for a Morse session on our repeaters. The southern branch has started one on VK7RHT and the northern repeater VK7RAA is linked to it. We are hopeful of a lot more upgrades in the future

Cheers for now

Ron VK7RN VK7 State President.

CLUB NEWS

Port Macquarie Field Day

Field days seem to have become something of an institution over time and the fact that they have continued for so many years as important events in the amateur radio calendar says much about their popularity.

The Oxley Region Amateur Radio Club plans to hold its annual Field Day over the Queen's Birthday weekend, June 12th and 13th. As in previous years, the venue will be right on the waterfront at the Sea Scouts' hall in Buller Street, Port Macquarie, NSW. The program will start around 10.00am on Saturday and provides for 2m mobile and pedestrian foxhunts as well as a wide range of other activities for the whole family.

New amateur gear will be on display, supplied by both local and city dealers and it is significant that much of this current equipment embodies real state-of-the-art technology. In addition and perhaps by contrast, a table will be provided for the sale of pre-loved gear, where a bargain or two can always be expected.

Sausage sizzles are planned for both days with drinks, tea and coffee also being available on site.

Since Queen's Birthday is a holiday weekend and Port Macquarie is a very popular holiday venue, it is important to book early for both motel and caravan sites to avoid disappointment. We look forward to enjoying the company of visiting amateurs who plan on spending the weekend with us in Port.

Alan Nutt VK2GD

Publicity Officer

For Oxley Region Amateur Radio Club

20 Amaroo Parade

Port Macquarie NSW 2444

Redcliffe & District Radio Club advise...

Morse tutorials are on again on 3535 kHz at 7.30pm EST most days of the week - the Redcliffe Radio Club transmits on Tuesdays and Thursdays with readback and callback.

Continuous Morse is now on 3.699 24 hours a day, seven days a week. There is no readback with this transmission.

Sunshine Coast Sunfest

The Ham Radio Day put on each 2 years by the Sunshine Coast Club is to be held at Nambour Showgrounds August 28th. SARC are at present negotiating a reduced rate for weekend cabins at one of the local resorts. Maybe some "out of towners" might like to stay for the sights of the Sunshine coast and a little local hospitality.

Table and display space bookings to Angus (07) 5443 2074 or write to SUNFEST Coordinator 285 Main Rd Maroochydore. 4558.

Tables are available at \$15 per table and as space is at a premium SARC are asking for firm bookings by 31st July.

The Sunshine Coast club runs a 2-Metre net every Sunday at 8.30pm. The net, dubbed the "tech net" by one VK4KEL, is devoted to technical problems or topics. All are welcome. Call in on 146.850 Sunday evening to avoid sleeping in front of the "Movie of the Week".

The Shepparton and District Amateur Radio Club annual Hamfest

Will be held on Sunday 12th September 1999 at the Shepparton Youth Club Hall behind the Safeway complex as in 1998.

Early bird gets the worm - further information from

The Secretary

PO Box 692

Shepparton 3630

Moorabbin & District Radio Club Inc. Hamfest

The annual Moorabbin Hamfest was held on Saturday May 8th, at the Brentwood Secondary College in Glen Waverley and was very well attended, with approximately 400 people going through the doors. There were over 55 individuals or groups occupying a total of 80 tables.

The committee wishes to thank those who attended and helped to make this yet another successful Hamfest for the club.

Even Greater Crystal Set Competition

This inaugural competition at the Moorabbin Hamfest attracted several entries. The range of designs used was quite varied from the very simple to elaborate. The standard of construction and performance from each entry was very good. Although I think the judges had quite a fun time in trying to determine who should win what prize and eventually came up with the following results: -

- Ray Rutledge VK3ZQ for the most selective receiver
- Keith McCarthy VK3JNB for the most sensitive receiver
- Ian Johnstone VK3SH whose receiver was judged the most authentic
- Ian Simpson VK3XIS for the most novel receiver
- The best overall entry was awarded to Ray VK3ZQ.

Congratulations go to the above winners.

Denis Babore VK3BGS

Publicity Officer MDRC

Crystal Set Competitions

Is it time for a national competition?

There has been an increase in interest in crystal-set competitions in recent months and it appears that although the recent events were mainly the domain of hams, the opportunity exists for some marketing of AR.

If every club in the country held such a competition, with a category, (or several) for school aged contestants, then that might raise some interest in radio, amongst the next generation.

If the incentive included representing their town or school in a regional competition, then state and finally national competitions, do you suppose that the students might become interested?

The event would be best set to a schedule which would be given to Science teachers Australia Wide.

Local hams might avail themselves to help potential contestants, to measure the performance of entries and to give a general presentation of what radio is all about and Amateur Radio specifically as a hobby. Venues would be at High Schools or perhaps Radio Clubrooms for most competitions.

Initially there are no travel costs for school/town competitions but regional competition would entail at least a car ride. State events could certainly involve travel expenses.

The National competition might attract sponsorship but the state level may prove to

be more difficult and entail higher costs due to more participants.

One method to reduce costs would be to choose from the regional finalists a set number of entries whose performance figures suggested a chance of winning at state level.

Local clubs might raise sufficient funds to assist parents in travel expenses. Various school science organisations may assist in setting up sponsorship.

The one remaining requirement is a standard set of rules defining types of components allowed, maximum size, construction standards, measurement standards and appropriate weighting of the individual measurements. Categories also need to be standardised and suitable prizes sought.

What do you think? Would you be prepared to supply your time to organise events, assist contestants, judge results and chase sponsorship? Give it some thought. Ask your members at the next club meeting. 73, Bob VK4KNH

Amateurs in the News

FROM THE WEIRD AND WONDERFUL FILE
On the local Central Queensland television news recently one of RADAR club members, Leon VK4KLL was seen on screen installing a new 18 tonne 1.5 megawatt "TRANSISTOR"!
This is what the news anchor called it any way.

Actually it was a 66kv to 22kv transformer! Leon is an asset manager with Capricornia Electricity and it was being installed to increase reliability in the area.

(Clive VK4ACC) RADAR is the Rockhampton And District Amateur Radio club.

If you have some club news to share. Or an event to publicise. This is the place.

The
**Amateur
Radio**

**pages are your pages.
Send your information to**

The Editor Amateur Radio

PO Box 2175

CAULFIELD JUNCTION VIC 3161

email armag@hotkey.net.au

Fax (03) 9523 8191

Why 50 Ohms?

Bob Harper VK4KNH
PO Box 288 Beerwah 4519

Is 50 ohms some kind of physical standard?

Today we all accept that 50 ohms is the impedance of coaxial cable used in Amateur Radio.

TVs however, use 75ohm coax exclusively (now that 300 ohm ribbon is almost gone) and I have also known 75 ohm TV cable to be used as transmitting cable as well. Indeed the matching harness used to combine two antennas often uses two 3/4 wavelengths of 75 ohm cable connected via a "T" piece to 50 ohm cable. We'll explain why another day.

I have worked on computer networks connected by 95 ohm cable. In fact I worked on one particularly unreliable network, that had been added to on several occasions. On investigation we found that it had a mixture of 50 ohm, 75 ohm and 95 ohm cable -the main cause of their unreliability.

This all begs the question of why those values were chosen in the first place. If there is an optimal value then surely there would be only one; wouldn't there?

Before delving into answers to that question we need to recall how "impedance" of a cable is established. The transmission line is nothing more than two lengths of conductor separated by an insulator. Being conductors also qualifies the lines as Inductors while being separated by an insulator qualifies the line as a capacitor. The dimensions of the conductors and insulators determine the ratio of inductance to iapacitance, which determines the impedance.

The formula is:

$$Z_0 = \frac{1}{\sqrt{\epsilon}} \frac{L}{C}$$
$$= \frac{138.16}{\sqrt{\epsilon}} \times \log_{10} \left(\frac{D}{d} \right)$$

where Z_0 = characteristic impedance, D = bore of the outer conductor, d = diameter of the inner conductor and ϵ = the dielectric constant of the insulator which for air is one and about 2.3 for polyethylene.

Let us return to the question of why there isn't just one best characteristic impedance.

A cable may have one of several designed uses. It may be required to carry an optimum power, have the lowest possible losses, withstand the highest possible voltage levels or simply have to connect to an existing piece of equipment.

Remember that for lowest losses the cable

must match the impedance of the equipment used.

All of these factors occur at a particular ratio of outer to inner dimensions and, as often happens in the real world, each occurs with different dimensions.

Maximum power carrying capacity occurs at a ratio of 1.65:1, which makes the impedance 30 ohms, but with high attenuation losses.

The optimum dimension to avoid voltage breakdown is 2.7:1 or an impedance of 60 ohms. This would be useful not only where high plate voltages are used but also where occasional mismatches result in high voltage nodes. Such cable has apparently been used but I haven't seen or heard of any.

The minimum attenuation occurs at a diameter ratio of 3.6:1, which gives an impedance of 77 ohms. This is why receiving equipment such as TV and FM radios often use 75 ohm cable.

It can be easily seen that although maximum power carrying capacity is desirable, it is incompatible with lowest losses and highest voltage handling characteristics. There is also one other factor that came into play historically. The cables used at the time that these factors were learned were all air-cored and generally of large diameters meant for high power/performance commercial use.

The general plan was to work on 77 ohms and make the cables large enough to handle the power. At higher frequencies, power was simply not available anyway and therefore low attenuation was considered far more important. The connectors were by now standardising and using another dimension ratio was becoming less likely.

The next changes came about with the use of materials such as polyethylene as an insulator. With a dielectric constant of about 2.3 it changed the impedance of a 77 ohm cable to 51 ohms. That is to say that with the same dimensions but using polyethylene as the insulator the impedance changed to 51 ohms. ($Z_0 = 77 / 2.3 = 51 \text{ W}$)

This was acceptable because the connectors didn't need to be changed. The resulting cable now has good attenuation, power handling and voltage handling characteristics.

I wish to thank RF Components Pty Ltd, 21 Hill Rd, Birrong 2143 for the inspiration for this article.

ar

ALARA

Christine Taylor VK5CTY

ALARA Publicity Officer
16 Fairmont Avenue, Black Forest SA 5035
Packet: VK5CTY@VK5TTY

In VK5 the regular luncheons at the London tavern (second Friday in the month) had three extra attendees in April, even though the City was particularly busy that day because of the Adelaide 500. My daughter was over from Melbourne with her two little boys.

We are considering a change of venue as changes to the decor has spoiled the atmosphere, but no decision has been made. If you are coming to Adelaide around the second Friday please contact Jean VK5TSX the State Rep for up-to-date information.

If you are in Melbourne around the same time of the month you will be very welcome at the VK3 gathering at the Vista Cafe in Little Collins Street. Bron VK3DYF is their State Rep.

In Perth ALARA meet on the fourth Friday at the Park Hotel in North Perth. Contact Poppy VK6YF for more details. Other states? Let me know!

The Alarameet In Brisbane

Plans are well in hand for the gathering on October 2nd and 3rd. Contact Bev VK4NBC for an application form if you think you could be in Brisbane for that weekend.

We usually have an informal dinner on the Friday evening with registration on the Saturday morning. In the afternoon there will be a sightseeing bus tour to Southbank returning in time for the dinner that evening. On Sunday we will have a river cruise and an evening city lights tour.

Proceedings wind up on the Monday morning after which there is an optional tour to the St Helena Island convict settlement.

It is great fun to meet all the YLs we talk to and be able to put faces to voices. I found

Some Mini Alarameets?

For the John Moyle Memorial Field Day this year Adelaide Hills Amateur Radio Society, AHARS, ran a station on the 5TY/CTY scrub block up near Swah Reach.

With Jean VK5TSX and Tina VK5TMC and myself as part of the operating crew we had a mini ALARAMEET of our own. With 12 of us to feed the YLs were mostly on kitchen duty but as one of the photos shows we did have a turn at the microphone as well.

Over the Easter break the same venue saw another group of YLs when Meg VK5AOV, Marilyn VK3DMS and Jenny VK5ANW (with assorted OMs) joined me for another thoroughly enjoyable mini ALARAMEET

At the Gosford Field Day, Dot VK2DB and Nancy Karas 'manned' a table shared by the Hornsby Club and ALARA.

The ALARA web page was displayed on the computer. They were delighted to meet up with Val VK4VR, Anne VK4ANN and Fran VK2HLF and to enrol Nina VK2INZ (she also holds DL2DRC at home in Germany).

I hope some of you caught up with Dot on April 24th when she helped to man an International Marconi day station VK2IMD on 10 metres. If not this year, look for her again next year.



Tina VK5TMC, Christine VK5CTY and Jean VK5TSX operating 40m on John Moyle Weekend.

There was an interesting item in the *YLRL Harmonics* magazine that came across my desk this month.

Just as Australia is about to run the last Miss Australia Contest, I have discovered that SCARA, the Southern Counties Amateur Radio Association, runs a radio room at the Convention Hall in Atlantic City for the Miss America contestants.

In the US amateur radio operators have always been allowed to handle third party traffic so one part of the radio room activity is dispatch and receipt of "Pageantograms".

Each of the contestants is supplied with some of these to send out to friends and family. In return they are sent greetings and good wishes from all around through their National Traffic System.

The contestants seem to enjoy the break from their other activities and are often willing to pose with the operators and to share all the little stories of their particular experience so the operators are very much part of the occasion.

Over the years the regular operators have become friendly with many of the Pageant Hostesses who accompany the contestants for the whole of the contest period as these ladies act as hostesses year after year.

The callsign used by the station is K2BR and will be on air from Monday 13th September to Saturday 18th September 1999. Usually there are several positions operating simultaneously, one on CW and one or two on SSB, in the 80, 40, 20, 15 and 10-metre bands.

The QSL cards have a photo of the newly crowned Miss America on them. You might like to add it to your collection. The QSL address is SCARA PO Box 121, Linwood, NJ08221. They also have a website at <http://www.cisi.net/k2br>.

Last year a crew from CNN was a frequent visitor to the station (it was a totally unfamiliar means of communication to them!) and eventually the station had a 15 second segment in the news.

They chose the time when there was an all YL group operating, Toni N2CYL, Jan KJ4N, Anne KB2CIZ and Gean KN2HX1. Toni is one of the coordinators of the special event station each year.



Jean VK5TSX, Christine VK5CTY and Tina VK5TMC at the Barbeque.

it just as much fun at the Adelaide ALARAMEET when, as I still had a Limited licence, I had not talked to the interstaters before -at all.

When I passed my Morse I had a mental picture to go with the voices I contacted. Attending my fifth MEET will be a case of renewing many friendships and hopefully making many new ones.

Most of the YLs will be members of ALARA but we welcome all YLs (and their OMs) who are in the ALARAMEET City. We have had several such "extras" before. Please think seriously about joining us.

If you are coming and have already sent in your application form and didn't include your \$15 Registration fee, Bev would like to have those before the end of June as she can put the deposits on the various tours etc.

As well as her address and phone number QTH/R in the Callbook, Bev has an email address for contact at vk4bgc@bigpond.com

Looking Ahead

It is not too early to be planning to go to the International YL 2000 in New Zealand, either.

The venue is Hamilton just over an hour's drive South from Auckland.

The date is Saturday Sept 30th and Sunday October 1st. So far there have been Registrations of interest from Germany, Norway, Svaalbard, and Italy as well as from Australia, the USA and Japan, so it looks very exciting.

The organisers are Carol ZL2VQ, Cathy ZL2ADK, Bev ZL1OS, Jill ZL2DBO and Biny ZL2AZY.

They have a Website at <http://www.wave.co.nz/pages/osborne/y12000.html> and an address c/- Biny ZL2AZY, 550 Kane Street, Pirogia 2450, NEW ZEALAND

ar



Maria VK5BMT, Tina VK5TMC, Greta Tapps (my daughter) with Mathew on her lap and Raymond beside her, Christine VK5CTY, Meg VK5YG and Jean VK5TSX at the VK5 ALARA luncheon.

ICOM Clearly Ahead



"VK3LZ calling!"

More sound information from your friends at Icom

ANOTHER ICOM BREAKTHROUGH

The brilliant ideas keep coming from Icom! The latest unit to come into Australia is the IC-R75 and reaction from both dealers and customers has been overwhelming.

It offers outstanding HF + 6m all mode performance with DSP capabilities, synchronous AM detection, front mounted speaker, internal clock with on/off sleep timer, 99 memories and more. Make sure you see the amazing IC-R75 for yourself soon.

BIG EVENTS PROVE IC-R2'S CAPABILITIES

Another recent release, the IC-R2, has literally taken the market by storm. And the recent spate of big events like the Formula 1 Grand Prix, Bathurst, the Motorcycle Grand Prix, and the Avalon Air Show, has seen IC-R2 owners tuning into all the activity on the air waves. Reports have been that the IC-R2's performance has been nothing short of phenomenal.

THE INFORMATION KEEPS COMING ON OUR WEBSITE

Radio enthusiasts across the country are finding the Icom website a fantastic source of information. We are making sure the site is updated regularly so be sure to drop by soon on www.icom.net.au

DATES TO REMEMBER

Mount Gambier Hamfest
Queen's Birthday weekend - June 13
Icom Day at Amateur Transceiver Radio Centre,
Sydney - Saturday June 19

"...73"

FreeCall 1800 338 915
290 -294 Albert Street
Brunswick, Victoria 3056
Tel : (03) 9387 0666
Fax : (03) 9387 0022
www.icom.net.au

ACN 006 092 575

LL Brown Adv-7234

OVER TO YOU

Lest We Forget.

I watched the Martin Place Sydney Anzac dawn service with considerable interest (and emotion). It was not until the lesser organisations began laying their wreaths that I realised, where is the WIA?

In all my 53+ years since discharge from WW2 and attending Dawn Services in various cities. I cannot recall a contribution from the WIA.

From WW1 to the recent Gulf War it's a safe bet to say that some amateur, or amateur-to-be or paid up SWL has been 'involved' in communications in some way. It is on this one day, 25th April, we pay (or should pay) our respects to all those of our fraternity who enlisted and served in the half dozen areas of conflict this century.

We are not glorifying war. That's man's greatest obscenity. We are paying our respects to courage, integrity and mateship. The final virtues that can be stopped from no man.

I hope my observations are wrong but if not, how about it WIA? Do better and remove shame. Lay a wreath - Lest We Forget.

Alan Shawsmith VK4SS

1st Aust L of C Signals, Nth Command
Dutch 19th Air Transport Squadron
WIA member 65 Years

Do you have a point of view
about some thing you have
read in Amateur Radio?

Or about the hobby itself.

Or perhaps some news about
people connected with
amateur radio.

Share it with us and your
fellow amateurs.

These are your pages.

The Editor *Amateur Radio*
PO Box 2175
CAULFIELD JUNCTION VIC
3161

email armag@hotkey.net.au

Tel: (03) 9528 5962

Fax (03) 9523 8191

Deadlines: by about the 15th of
month prior

Fading Away?

'The WIA, is it Fading Away' (AR April 1999) by John Bennett presents views on a range of matters, but I regret, they are views which are unlikely to lead anywhere!

There is an entrenched view about the present structure and organisation of the WIA, and since the majority holds the view, it is a waste of time trying to redesign the WIA organisation. There is too much vested interest and divisional rights involved to allow change. We cannot redesign the WIA as if we had a clean slate.

However, within the existing structure there are a number of steps that might be taken with benefit.

1. The strongest link between the WIA and Hams is through the members and that includes the clubs and groups. Most clubs and groups are members of the WIA. Although there is good communication between the WIA and individual Hams, there is little communication directed at the clubs. One rarely hears a statement directed to the club being read or discussed at club meetings so step 1 is to increase the strength of linkage between the WIA and the clubs. Promote the clubs with publicity material to help attract new members, organise national publicity about Ham radio emphasising the role of clubs and groups. Work with and through the clubs to increase the proportion of Hams who are WIA members. The clubs and groups are the basics of a strong WIA.
2. Develop benefits for membership not only through the magazine and contacts with the world of Ham Radio but look for monetary advantages through organising discounts for WIA members with Dick Smith, Altronics, Jaycar, and all AR advertisers etc. This will have a double benefit in making those store managers aware that amateur radio exists and is using their store. Other discounts are available for corporate groups such as the WIA and we should actively seek out such benefits.
3. Improve the WIA publication record. There are many interesting articles and suggestions in AR. Why not collect the best and publish them under the auspices of the WIA? A good idea in 1980 is probably a good idea in 1999 but has probably been forgotten. For instances the RSGB has several publications

which are collections of articles that have appeared in the magazine. The RSGB has shown what can be done.

So, there are 3 steps that I think will strengthen the WIA. They don't require a lot of work and they would improve the performance in a positive way. And they don't require re-organisation and they improve the communications between us Hams.

Ken Fuller VK4KF

PO Box 396

Wynnum Central 4178

Queensland

More Fading Away

May I begin by congratulating you for publishing the extremely interesting article by Mr John Bennett VK3 ZA/VK2SIG, "The WIA, Is It Fading Away". The short answer is "yes it is", as it is currently constituted. This is a very important question, and should be addressed by the WIA at Federal level and within the various Divisions.

Amateur radio is a wonderful hobby and in order to survive in the 21st century, we very urgently need new members to carry on the hobby.

The reformation of the WIA as proposed by Mr Bennett is, I believe, the only way to go. The present system of a Federal body and seven state autonomous divisions is reminiscent of the 1920's.

If we are to survive we must sweep aside all the bureaucratic parochialism of the past. Modern technology and the availability of good quality commercially-made equipment plus the multi-choice examinations system has decisively downgraded the hobby. Never the less it is a wonderful hobby and we must keep it alive and well.

Sooner rather than later I believe the phasing out of CW at commercial level will prove to be a disaster of great magnitude. What we must do immediately is to "take off the kid gloves" and get political for the protection of our bands and frequencies. The gentlemanly discussions with the ACA are very pleasant but they are a facade.

The ACA is an arm of government who implement government instructions, and the present Federal Government cannot be trusted under any circumstances! To adopt a stance of political neutrality would be and is very naive indeed.

In conclusion, I hope the WIA as a whole will transform itself into the model proposed by Mr Bennett. In the meantime I am working on getting on to CW.

Michael Gell VK5ZLC

3/18 Brighton Road

Glenelg SA 5045

Brenda M Edmonds, VK3KT
PO Box 445, BLACKBURN 3130

WIA Logo Origin



I was recently asked what was the origin and significance of the various components of the WIA logo. The map and scroll at the bottom are self-evident but what about the wings and lightning bolt with roundel in the middle? Doug VK4DUG

Reply:- According to the WIA Book Volume 1, the logo dates from a little before 1922 as Keith Ballantyne VK3AKB related that he received a badge of that design when he joined in 1922.

A version was used in an October 1939 edition of AR that was without Tasmania but Tassy was restored in mid-1947. The Wings and Lightning motif are said to have derived from an Army Wireless Unit of WWI and later formed a part of the RAAF Wireless Reserve emblem authorised in 1935. The oldest known WIA badges date from the 1909-1911 era in Victoria. All included the "Lightning" motif.

Alan Shawsmith VK4SS, in his book *Halcyon Days*, includes a facsimile of a 1929 edition of QTC. QTC is recognised as the oldest magazine published in Australia and indeed in the then British Empire, devoted purely to Amateur Radio.

On the cover is a logo similar to the current WIA logo except with horizontal wings and the letters QTC across the Australian map. Tasmania was included which is, as one would expect of the founding editor, Leo Feenaughty OA4LJ later VK4LJ. QTC ceased production when AR was first produced, to avoid detrimental competition between the two. -

Bob VK4KNH

It has been brought to my notice that some candidates and invigilators have queried some of the questions on various examination papers.

This is to be expected where an attempt is made to examine a large group of candidates of widely differing backgrounds using a limited range of examination materials.

It is very difficult to write questions that mean the same to (say) an experienced electrical engineer as to a high school student studying an arts course. This is because the more experienced candidate will be aware of a much wider range of situations, which increases the chance of one of the alternatives being considered correct because "it could happen under these specific circumstances".

Those of us who have spent considerable time trying to write multi-choice questions are aware of these possibilities, and have tried to cover all aspects of the course with questions which have one answer which is definitely correct and three which are definitely not correct. The level of "not-correctness" is of course variable. We have tried to avoid asking students to select the "most correct" answer. If some of those have crept in, there will be a clear difference between the right answer and the next.

However, there is in all the papers an overall authority to approve and permit the questions. All the papers are individually approved by the ACA, formerly the SMA, before being used. There have at times been extensive arguments between the ACA and the Examination Committee about the wording of specific questions, modifications have been discussed and questions edited as necessary when necessary.

The ACA considers each question on its own, and in relation to the other questions on the paper, to ensure a balance on the paper and an overall standard between papers are maintained.

We have not as yet received further notification from the ACA about their intent to review the whole examination devolvement scene. Until we do, the WIA Exam Service will continue to administer the examination system for the whole of Australia.

ar

Reference "What use would you be...", page 8 of the January 1999 issue by VK6KCH.

I can assure VK6 KCH that WICEN (VIC) Inc, is well and truly ready for activation at any time in the event of communication breakdown.

We have a team of fully trained and accredited members, associated with each police division and working in conjunction with all disaster combat organisations, eg Red Cross, SES, Ambulance, Fire Brigade, etc.

Our members are continuously trained and carry out regular field exercises in various areas. Radio data thus obtained is evaluated, written up, and filed for future reference. Thus we are aware of what type of equipment we require for each part of our district to enable an immediate response to any emergency call.

We can only be activated on a call for assistance from the Chief Inspector of the particular police district, or in the event of evacuation procedures, by the Red Cross, with whom we have set up a packet radio system, to send all details direct to their state headquarters. (NRIS).

In my own division, we have an immediate strike team. To date they have managed to be on site at a disaster situation, within a 30 km radius, within forty five minutes of receiving a call for assistance. This is then followed up by an assessment of the situation by the RCO who then activates as many members as required to handle an ongoing situation, either from his own division if possible, or after notifying the State Coordinator, from other areas.

We in Victoria are held in high regard by the police and in many areas have WICEN aeriels set up on police complexes with permanent hook-up points in the disaster control room.

We also have a representative attend local government disaster plan meetings, and members available to speak to various organisations, and groups about the role of W.I.C.E.N. in the community.

Our members are trained to be totally independent of outside requirements, eg. power for at least 24 hours, during which time independent sources can be marshalled.

Yes VK6KCH. Victoria is ready for emergencies, has been tried in the field, and found able to cope, and is continually looking for ways to effect improvements to the system. Yours in Service,

James L Tobias JP VK3MMD
49 Bentons Road
Mornington. 3931 Victoria

This is an individual comment and does not necessarily represent the views of WICEN (Vic) Inc.

SPECIAL
FIVE for the Price of THREE
- Well Almost!
You can renew your station licence for \$168 for 5 years. This compares more than favourably with five times the yearly renewal fee of \$50. (ie \$250!)
So next time your licence renewal arrives from the ACA, consider the savings you could make.
73 Neil Penfold VK6NE

Andy Thomas VK5MIR - South Australia's Cosmonaut

Christine Taylor VK5CTY

16 Fairmont Avenue, Black Forest SA 5035

On Jan 20th I joined a large group of amateurs at the West Torrens Council Chambers to hear Dr Andy Thomas speak about his experience on the MIR Space Station during 1998. When the WIA(SA) approached the acting-mayor, Mr Reece Jennings to hire a venue for this lecture the Council was delighted and undertook all the preparations.

They also chose the occasion to present Dr Thomas with their Civic Award in recognition of his achievements.

In the foyer I spotted several amateurs from Renmark and the Riverland, from Bordertown and Mt. Gambier and from Victor Harbour and Murray Bridge as well as many from the city and suburbs of Adelaide.

We are very proud of the fact that Dr Thomas was born and raised in Adelaide and that he obtained his first degree at Adelaide University.

It was no surprise that he was the featured speaker on December 28th, when South Australia celebrates our founding fathers as Proclamation Day. That he had found time from his family to speak to us was our pleasure and privilege.

One amateur who had played an especially large part in the communications between MIR and earth was Tony VK5ZAI. Tony had been able to arrange a phone patch so that Andy was able to talk directly to his father. They had tried several other options unsuccessfully but the phone patch worked well. It must have been very special for Andy and his father to hear each other's voices.

Tony also told me that it was Andy's father's 75th birthday on 19th January. I wonder how long it is since they have been together for a birthday? Some years, I suspect. Many thousands of miles separate South Australia and Florida.

The official meeting was opened by Ian VK5QX, President of the WIA(SA) Division. Ian had arranged for a Russian, Oleg, to welcome Andy in Russian because

it was a Russian Space Station. Oleg is a high-speed telegraphy competition winner. He sent at 50 wpm for 20 minutes with only THREE errors. WOW!

Ian spoke of obtaining the special callsign of VK5MIR for Andy to use during the mission and of some of the South Australia groups (non-amateur) who had also participated via radio, in the mission.

These included the SA Symphony Orchestra, where Andy's picture and voice were part of one performance, live. The opening of a performance at Moonta by the Metropolitan Male Choir, both arranged by Ian himself, and the opening of a night of Go-Kart Racing at Kadina through the effort of VK5ZIB.

Andy also spoke directly to one group of Operation Flinders Foundation, a young offenders rehabilitation program. This is a police run organisation, and as a permanent record of that event they had two photographs for Andy to sign that evening in the West Torrens Council Chambers. These will no doubt have pride of place from now on.

Then Ian VK5QX presented Andy with membership of the WIA (the oldest amateur radio society in the world!), and a new Australian callsign. He is now VK5JAT. To make sure that Andy was comfortable with this new callsign he then had two contacts on air. The first one was with Linden VK5TTL, an 11-year-old, and a second with Darren VK5PJR, a young handicapped amateur. Subsequently

the two lads had the thrill of shaking hands with Dr Thomas.

When Andy Thomas spoke to us he told us how after he had flown on the Space Shuttle, *Endeavour*, he heard that they were looking for an astronaut to spend some time on MIR. He thought it sounded interesting so he volunteered to go to Russia and train for such a mission.

He spent a year in Russia, learning the language and learning about the Russian rockets and their space station. At the end of that time he had to sit for and pass a number of exams on the technical details - in Russian! Then he spent another six months actually training for the mission.

At this point we watched a NASA film showing the launch and landing procedures with film inside and from MIR and the US Shuttle vehicles. It was interesting to see and learn about the timing of an actual launch.

Once the crew is all on board and strapped into their seats - lying on their backs - you can hear and almost feel the main engines start two minutes before launch time. These are followed by the solid fuel engines and you have lift off. At this time twelve tons of fuel is being burnt per second!

Two minutes into the flight the solid fuel engines are ejected to return to Earth for re-use. Eight minutes later you are in orbit. After that only bursts of the engines are used to alter the attitude and direct the shuttle correctly towards its rendezvous with MIR.

The two days between launch and



Andy VK5MIR with Meg VK5YG formerly VK5AOV

docking are used for scientific experiments as well as preparation for the actual meeting of the two spacecraft. We were thrilled to watch this all happen from the first sighting of MIR to the lining up of the mating surfaces.

Once Columbia had docked successfully the seals were clamped and the space between the two craft made into an airlock. Despite this all the astronauts were dressed in space suits during the docking manoeuvres. Only when the airlock had been tested were any of the hatches opened. Then the two crews greeted each other with joy.

For the two cosmonauts these were the first new people they had seen for four or five months. For Andy this was the beginning of his 22-week stay aboard MIR. In fact there was an exchange of the Russian cosmonauts carried up to MIR on a Soyuz rocket, shortly after Andy's arrival as there was again a short time after he left the craft. Each astronaut spends about the same length of time in space.

Some of the features of the living in zero gravity were interesting. You sleep in a sleeping bag tethered in space but you don't need a pillow. Your head just lies in the correct position.

Cleaning your teeth must be done very carefully so that no droplets escape. You could easily breath in any droplets. Similarly, no whiskers can be allowed to float away when you shave. Andy also claimed that every day in space was a 'bad hair day'. Your shampoo is the no rinse variety but with no gravity to keep it flat your hair just stands on end.

The MIR (meaning either Peace or World) spacecraft has two side modules called Parada, meaning Nature, about 2 metres across on either side of the central area. One of these was where Andy mostly lived and worked.

Each day any new instructions would come in by radio signal and a schedule of experiments would be conducted. The experiments were mostly either biochemical, concerned with cancer research or melting and/or mixing of material in the special conditions of zero gravity.

All the meals were eaten together in the central section of MIR. The food was all freeze-dried and Andy thought it flavoursome though not all astronauts agree. Most often videos were watched while the meals were being eaten which explained the smiles and far-away looks on the faces filmed as they sat around the table!

All the cosmonauts exercised on treadmills and with other apparatus so as to minimise some of the effects of zero gravity on the body.

Andy claims to have run right across

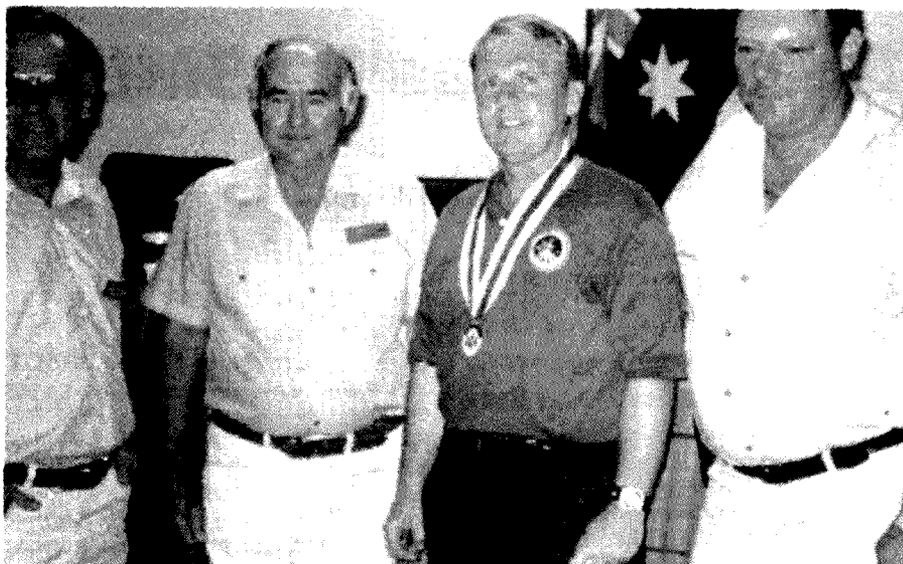

Tony VK5ZAI, Doug VK5GA, Andy VK5MIR (now VK5JAT) and Ivan VK5 HS

Australia on his treadmill. They constantly tested themselves and each other to add data to the scientific studies of space effects and to keep themselves as fit as possible.

During Andy's time on MIR the second two cosmonauts made several space walks to repair the solar panels that were damaged when the unmanned supply vessel made an awkward docking, and to replace a rocket engine at the end of a long tower-like arm.

There are a number of small motors on the main body of MIR used for small adjustments.

These can be refuelled in situ but the

questions with patience and humour. We learned his opinion of the Russian versus the American space technology and that some of the stories of him having difficulties in adjusting to Earth's gravity after his return were exaggerated.

At the end of the lecture Andy kindly signed all the beautiful brochures provided by the West Torrens Council. I am sure they will be treasured mementos for those there that night.

The amateurs who had had contacts with Andy on MIR were invited to stay for supper with the Council members when they had an extra opportunity to speak to Andy and a chance to obtain personal photographs of the occasion.

Meg VK5YG was delighted that Andy remembered their conversation as clearly as she did even though it was nine months since they spoke. He wanted to know whether or not the mouth of

the Murray had actually closed last winter. When they spoke it was in danger of just that.

Mary VK5AMD found that Andy had also remembered her telling him that she had had a handheld tuned to his frequency, lying beside her bed night after night before she actually made the contact. I suspect that was an experience shared by a number of amateurs who made contact in the night hours.

In all, during his 20-week stay on the MIR space station, Andy saw 16 sunrises and sunsets each day, did 2250 orbits of the Earth and travelled over 56 million miles (nearly 90 million kilometres). Even so, he impressed us all with his modesty and the pleasure he felt in sharing his extraordinary experiences with us.

Andy saw 16 sunrises and sunsets each day, did 2250 orbits of the Earth and travelled over 56 million miles (nearly 90 million kilometres).

rocket engine at the end of the tower had to be detached and replaced with a new one brought up with the latest supplies. To achieve this the space walkers had to first build a platform around the tower so they would have a stable base to work on the engine. This all required a number of space walks, but was eventually completed successfully.

To repair the solar panels they had to build and attach a brace to stop the panel moving out of the sun and possibly damaging other parts of the craft if it moved erratically. All these tasks have to be practiced and all tools have to be tethered to your person but be free enough to be used as required.

After the film Andy answered all our



Amazing Amplifier Bargain!!!

This must be the bargain of the year! This is the amp module as used in the Aura Interactor Body Blaster. Ideal for experimenters! The main amplifier is 21WRMS into 4 ohm, mono class B output design. The preamp has filters and switches to give sound effects control. Freq Resp is practically DC to 3khz as required by the Interactor. As this is designed primarily to amplify kicks, explosions and crashes into the Interactor Shaker, it is not a "Hi Fi" unit, but as a cheap amp at your next party - who would know the difference. Get weird and wonderful sounds using the music/games filter and controls in the preamp of this unit. In the games position the preamp filter divides the input frequency by half to give more "whoomp" to those thumps, explosions and crashes. Use two of these for a stereo setup and power from a 120/12 AC at 1.25A transformer or use our Cat MM2005 120/12 transformer @ \$26.50 which will handle two with ease at full volume. Housed in a nifty case with the following: •Input socket - 3.5mm mono from your music/instrument source •Power socket - 3 pin din socket, for 120/12VAC from your power supply •Output socket, RCA direct to 4 ohm •Music / game switch •Normal/A/B switch •Filter control •Power/volume/on-off control/power LED/amp output clipping indicator. A really low cost way to build yourself an experimental stereo amplifier setup with amazing sound divider and distortion effects. Case size 200(L) x 100(W) x 55(H)mm. Cat. XC-1006

NEW '99

ONLY \$5 EA

Wireless Audio & Video Transmitter/Receiver

WATCH CABLE TV ALL OVER THE HOUSE! The transmitter can transmit the audio & video signals from a VCR, TV set, LD, Sat receiver... to the distant receiver, which is connected to another TV or VCR. You can also use the transmitter and receiver to send the picture from a camcorder or CCD camera to a TV. Range up to 100m (line of sight). Cat. AR-1800



CCD CAMERA COMPATIBLE

SEE 99 CAT PAGE 221 FOR FULL SPECIFICATIONS

\$299.50

Laser Module

Includes laser diode mounted on a PCB with a battery spring and on/off switch. Simply connect 3 x 1.5V batteries -1mw output. Cat. ST-3115

\$13.95

Vacuum Fluorescent Display Bargain

Brand new display designed basically for an oven timer. It can easily, however, be used as a custom clock display. Vacuum Fluorescent displays are very attractive & this one - in green - is as well. 4 digits are 14.5mm high. Each segment of each digit is separately addressable as is the AM annunciator. •98W x 34H x 8Dmm (including pinouts, etc). •Factory data is included. Cat. ZD-1875



ONLY \$10ea.

1000MAH AA NI-MH Batteries Save \$\$\$

NIPPLE
Cat. SB-2455
NORMALLY \$4.25
BUY 4 ONLY \$5.50ea.
BUY 10 ONLY \$3.00ea.
SOLDER TAG
Cat. SB-2457
NORMALLY \$4.50
BUY 4 ONLY \$3.75ea.
BUY 10 ONLY \$3.25ea.

Low Cost 3.5 Digit, Digital Panel Meter Sellout

Common Features: •200mV full scale input sensitivity •Single 9V DC operation •Decimal point selectable •Auto polarity indication •Guaranteed zero reading for 9V input •High input impedance > 100Mohm

LCD Panel Meter
Cat. QP-5550
was \$22.95ea
NOW \$14.95
save \$8.00

LED Panel Meter
Cat. QP-5560
was \$27.95ea
NOW \$16.95
save \$11.00



70 Watt 12VDC to 230VAC Mini Size Inverter

See 99 Cat. Page 105 for full details. Cat. MI-5034



NOW \$79.95

Sensational Pot Pack with free Bonus!

This is not an ordinary pot pack. A pack like this only comes along occasionally. Why? Because many of the pots are not just ordinary pots. They are US made rheostat quality, UK/Aust. made attenuator quality, etc. Many are Japanese made. The balance are high quality standard grade. There are sealed, PC mount, solder tag types. 99% are bushing mount. Nuts are supplied (but not all). Styles include ganged (dual/triple), concentric, switched, tapped log and linear. Brands include Clarostat, Allen-Bradley & Morganite. Some of these pots cost \$10 each when originally purchased. Each pack contains 33 pots. Most of the packs are identical. **Bonus!** Included in each pack is a FREE pack of 30 brand new industrial grade cermet single and multitrn trim pots in 2 different styles (both PC mount) & 10 resistance values! These parts generally cost over \$2 each! There is over \$200 value in this pack. Quantities limited only 120 packs available. Cat. RP-3900



Only \$24.95

Pre-built Mini Modules Now Available

See 99 Cat. P22-25 for full details

Cat. AA-0255 Twin Lead Acid Battery Charger \$17.95
Cat. AA-0285 Electric Fence \$39.95
Cat. AA-0258 12V Solar Battery Charger Regulator \$24.95
Cat. AA-0325 Twilight Switch for 240V \$27.95
Cat. AA-0290 IR Spotlight for CCD Camera \$45.00
Cat. AA-0270 IR Remote Control Tester \$17.95
Cat. AA-0295 Electronic Barking Dog \$27.95
Cat. AA-0319 12V Halogen Light Dimmer \$39.95
Cat. AA-0310 3 Channel Light Chaser \$39.95

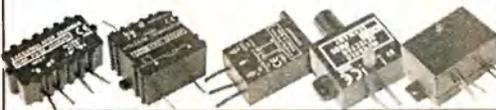

Metal Case Pinhole Camera Sale!!!

Cat. QC-3471
was \$145
NOW \$109
was \$129



EMAIL ORDERS
mailorders@jaycar.com.au
EMAIL YOUR ORDERS NOW

COMPUTER MICROPHONE HEADSET

was \$19.95 then \$14.95
NOW \$9.00
Cat. AA-2028



Signing off ● — ● — ●

Latest technology replaces Morse Code

by **Annette Codispoti,**

Assistant Editor of "THE INSTITUTE"

Newspaper of the Institute of Electrical and Electronic Engineers
April, 1999 Volume 23 Number 4

After over 150 years of faithful service, Morse code has quietly retired from its role as a consistent and dependable rescuer of ships in distress. After all these years and many advances in communications technology, Morse code is just now being replaced by something better.

The transition began in 1979 with an international effort to improve maritime distress and safety communications. The International Maritime Organisation, a United Nations agency, called for the development of the Global Maritime Distress and Safety System (GMDSS).

The new system, according to the U.S. Coast Guard, is based on a combination of satellite and terrestrial radio services and has changed international distress communications from being primarily ship-to-ship based to ship-to-shore based. All ships subject to the new regulations had to fit all GMDSS equipment by 1 Feb. 1999.

"The introduction of satellites was indeed the turning point," said Joseph Hersey, chief, Spectrum Management Division of the U.S. Coast Guard, and an IEEE member.

"Morse telegraphy remained functional for so long for a number of reasons. It is reliable, it is simple, it works and it can operate at a lower signal-to-noise ration

than practically any other radio system," said Hersey.

But as good as it was, there is always room for improvement. "Some elements of the GMDSS, such as satellite communications, emergency position indicating radio beacons and marine safety broadcasts, have proven themselves over the last 10 years," said Hersey. In 1997 this system saved more than 540 lives in the U.S. alone. "In many of these cases, the EPIRB alert, generated when the buoy automatically deployed from a fast-sinking vessel, was the only alert received. Morse code would have been insufficient in most of these cases," said Hersey. "Had the GMDSS and elements such as satellite EPIRBs been around earlier, ships like the *Edmund Fitzgerald*, which sank suddenly with all hands (Nov. 1975), without warning in Lake Superior, might possibly have been saved."

Not everyone is happy with the new system, especially the radio officers, said Hersey. Under the old regulations every ship had at least one radio officer to manage the telecommunications. With GMDSS this person is no longer necessary. While the Coast Guard does not have accurate figures on false alarm rates for GMDSS systems at this time, they are generally high and they do not know exactly why. One reason may be the lack of training for those using the equipment said Hersey.

Amateurs Hanging On

Ken Botterbrodt (K2WB) is the president of the South Jersey Radio Association in Haddonfield, N.J., the oldest continuously operating amateur radio club in the United States. While he agrees Morse code may be obsolete for the IMO's purposes, it's still a big part of a hobby that he and other amateur radio operators enjoy. "It becomes like music. You recognize the sound," he said.

Learning Morse code is like learning a second language, according to Botterbrodt, and he feels people are becoming less interested. "This is an important mode and I hate to see it die," he said. There are currently five classes of FCC licenses for radio operators and one does not require learning Morse code.

Amateurs like Botterbrodt enjoy the contact with other operators and the knowledge they gain from their hobby. One of the advantages to using Morse code, and perhaps the reason it lasted this long, he said, is that it can work with a very weak signal. It's also easier to communicate in Morse code with someone in another country when accents get in the way.

Morse and Vail

It was January 1838 when Samuel Morse, a painter turned inventor and a widower with two children, successfully demonstrated his telegraph machine at Speedwell Iron Works in Morristown, N.J., USA. Several days later, at the very first public demonstration of the telegraph in Morristown, the machine foreshadowed the connection between transportation and communication systems with a message "Railroad cars just arrived, 345 passengers."

Morse and his associates were pioneers in the practical use of electricity. Just as significant as the technical aspects of his machine was the code itself. Today at Historic Speedwell in Morristown (www.speedwell.org) visitors can learn about the events leading to the development of the first electro-magnetic telegraph and the story behind its inventor and his partner, Alfred Vail, as it is written in a book "At Speedwell in the Nineteenth Century" by Cam Cavanaugh, Barbara Hoskins and Frances D. Pigeon.

Over the years the Morse and Vail families disputed who was the true inventor of the telegraph and Morse code. It all started with an agreement between Morse and Vail in 1837. Vail convinced his family, proprietors of the Speedwell Iron Works, to financially support Morse and help him



Samuel FB Morse



Alfred Vail

Continues over

New Clubhouse for Redcliffe

Kevin Jones VK4AKI
Vice President
Redcliffe and Districts Radio Club Inc.

Jota weekend 1998 the Redcliffe and Districts Radio Club officially moved into the Kippa-Ring Guides Hall on a long term, exclusive use basis. A lease was signed to January 2000 and renewable yearly till further notice with an unwritten understanding that if the Guides decide to sell the premises, which is highly unlikely, we will have first option.

The hall was obtained by placing a "Letter to the Editor" in a local newspaper asking about suitable digs. The Guide Group happened to be looking for a means

of paying the rates and electricity. The Group has merged with Clontarf Guides and doesn't use the hall any more, due to falling numbers probably brought about by the same social reasons that plague most clubs.

Since moving in we have fitted out the radio room, erected a mast with antennas for HF, VHF and UHF but we must stress that the electronics which makes it work has been designed for portability and is not left on the premises for security reasons.

The new premises has allowed us to expand our operations to have a meeting

every Monday night, with two project nights, one packet night, an ATV night and a social evening when a fifth Monday appears. Friday nights take in the AOCP and NAOCP classes on an alternating basis. The Club also makes good use of the facility by operating the WIAQ QSL Bureau every Monday night. Sorting takes place every Wednesday.

Since moving to the new premises our membership has grown to seventy four and we are having an aggressive advertising campaign that is gaining us one or two new members a week.

We've come a long way since the seventies, when we started in a hall in Cornelius Street Clontarf, moved to the Education Centre in Henzell Street then to the Deception Bay High School, all of which we shared with other users so couldn't put down roots. We've finally made it.

ar

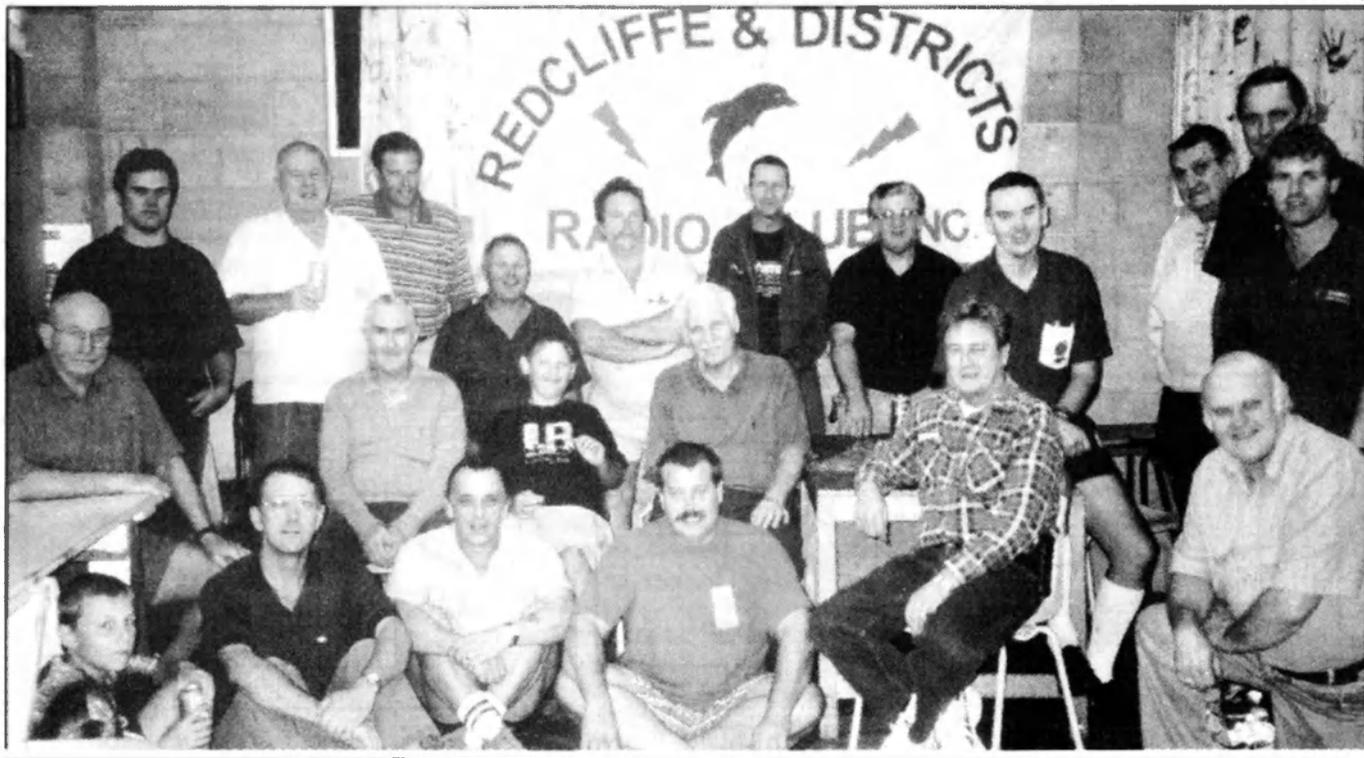

SIGNING OFF CONTINUED

build his machine. Vail recognized the potential in Morse's work where others, even Morse's own brothers, did not. Morse would receive the patent, and all related patents while Vail would receive one-fourth of the U.S. rights.

In the book, supporters of Vail turn to letters written by Vail, Morse, their colleagues and family members as evidence of Vail's contributions. The book even suggests that it was Vail who replaced Morse's numbered dictionary code with an alphabet code employing dots and dashes.

"Alfred had made the telegraph practical," it states.

After the first public demonstration of the telegraph, Vail stayed behind in Morristown making revisions to the machine. Morse went to Europe seeking patents and financial backers. He was not successful in Europe, but in 1840 he received the U.S. patent.

In 1844 construction of the first telegraph line from Washington D.C. to Baltimore was completed. At this time many improvements had been made. Almost all of the machine was replaced or revised by the time the telegraph was in public use, and Morse continued to receive most of the credit.

Despite the uncertainties, Vail and Morse remained friendly in the years that followed. When others filed lawsuits against Morse over telegraph patents, Vail always stood by him. Their families, on the other hand, were not as friendly. The book states that in 1911 "someone—a grandson, it is believed—engraved on Alfred's monument at St. Peter's Church, Morristown, these words 'Inventor of the telegraphic dot and dash alphabet.'"

AR wishes to thank Annette and the IEEE for permission to reprint this article.

ar

An Automatic Beam Pointer

Barry White VK2AAB
 28 Redgrave Road
 Normanhurst NSW 2076

OVER THE LAST YEAR I HAVE been operating an FBB Factor forwarding station, mainly on 20 metres.

However most of the stations I forward to are in directions that are all around the compass. As forwarding takes place every hour it became a considerable burden to have to change the beam heading. I could have just used a dipole but as three of the forwarding stations are overseas it was not desirable to rely on a dipole. The building of an automatic means of turning the beam was undertaken.

The FBB software provides for the execution of a separate program that can be called from the forwarding file of the connected station.

The FBB software places the callsign of a connecting station as a parameter for the called program.

The program that I wrote is called ROTATOR and is written in QuickBasic.

The hardware uses a kit sold by Dick Smith Electronics catalogue number K2805.

This kit is a parallel port input and output board. I included some of the suggested programming into both versions of my program. The first version read the DC voltage from the arm of the potentiometer, calculated the direction of rotation needed and then energised the appropriate relay.

This was repeated until the beam reached the desired position. This version worked very satisfactorily although it had a major disadvantage in that it halted the FBB program while the beam moved to the desired position.

The second version uses two op amps that are driven by the difference between an

- 0278
- 4.9
- VK2AGE, 005
- VK3WZ, 200
- VK4FIL, 355
- VK5ATB, 270
- VK6TN, 270
- G0SPO, 315
- DK0MUN, 315
- ON0BEL, 315
- VE7KGW, 45
- G*, 315
- DF*, 315
- DK*, 315
- DL*, 315
- DU*, 350
- I*, 315
- F*, 315
- K*, 45
- N*, 45
- W*, 45
- ZL*, 98
- ZZZZZZ

Figure 2 - (Follows this line)
 Bearing Table Example - Save as Rotator.INI

Text continues page 22

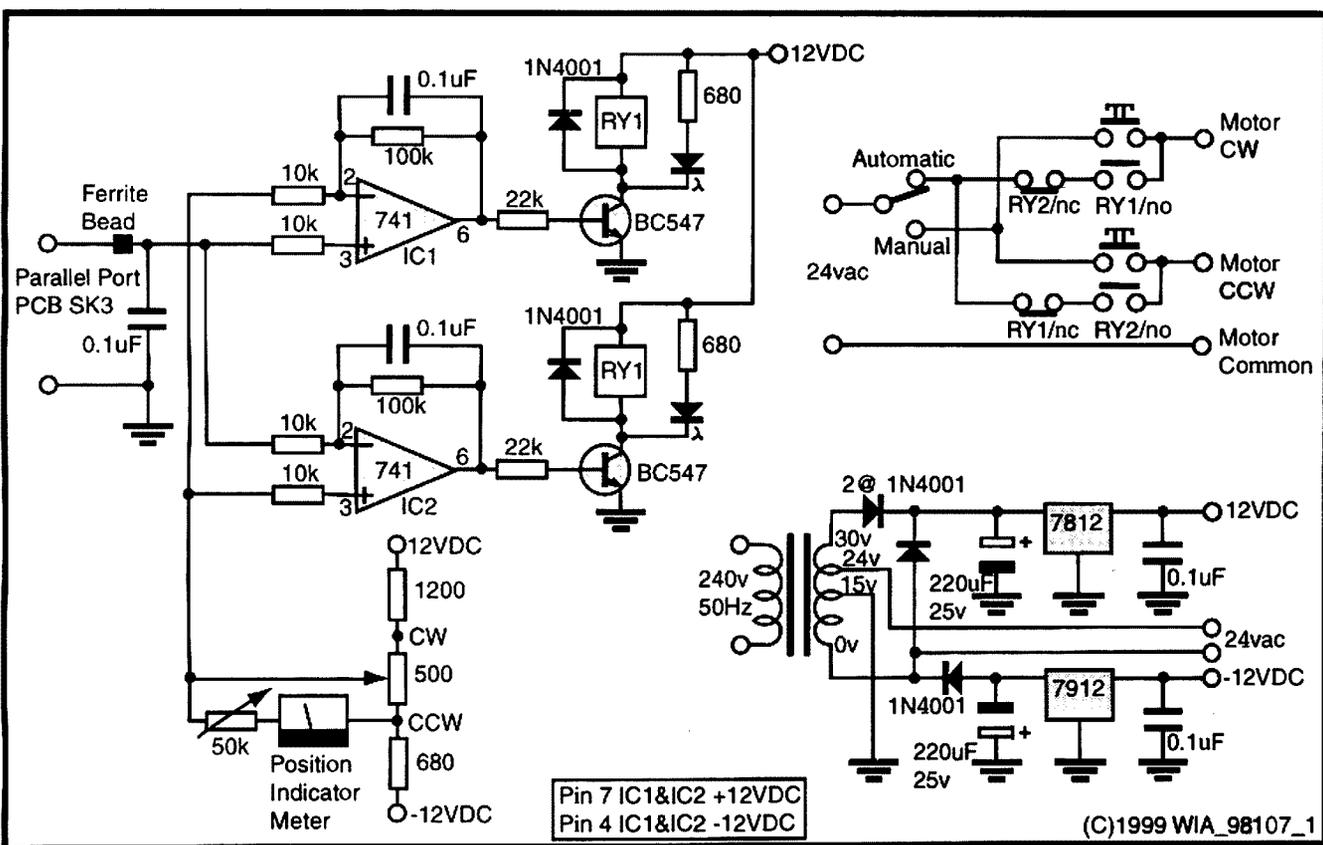

Pin 7 IC1&IC2 +12VDC
 Pin 4 IC1&IC2 -12VDC

(C)1999 WIA_98107_1

Figure 1 Circuit diagram of the Rotator Driver Circuit.

Listing 1 - BASIC program for Rotator.EXE

```

REM PARALLEL PORT IN/OUT CONTROLLER
REM THIS VERSION SETS DC VOLTAGE OUT FOR
COMPARISON WITH POT ARM
REM FSD 4.9 VOLTS MAXIMUM CLOCKWISE
FOR ROTOR
REM Initialisation file may use either callsigns or degrees
SETUP:
  PT$ = COMMAND$
  DIM DIRNUM%(100)
  GOSUB TURNON
  IF PT$ < "A" THEN DIRNUM%(0) = VAL(PT$): I =
0: GOSUB WIO: END
  GOSUB TABLE
REM INPUT "Callsign "; PT$
  GOSUB GETCALL
  END

```

This routine sets up the callsign & prefix table of bearings

```

TABLE: DIM CALL$(100)
  OPEN "ROTATOR.INI" FOR INPUT AS #1
  LINE INPUT #1, PTR$
  LINE INPUT #1, FSD$
LDIT: FOR L = 1 TO 99
  IF EOF(1) THEN GOTO BEAR
PTLST: ' SETUP CALLSIGN & PREFIX TABLE
  INPUT #1, CALL$(L), DIRNUM%(L)
  IF EOF(1) THEN GOTO BEAR
  REM DIRNUM(L) = VAL(DIRECTION$(L))
  IF DIRNUM%(L) > 360 OR DIRNUM%(L) < 0
THEN PRINT "ERROR LINE "; L
DLST: NEXT L
  RETURN

```

This part of the routine is for testing. To be removed

```

BEAR: CLOSE
  CALL$(L) = "ZZZZZ"
REM FOR I = 1 TO L
  REM PRINT CALL$(I), DIRNUM%(I)
  REM NEXT I
  FSD = VAL(FSD$)
  RETURN

```

GETCALL: This routine picks up the requested callsign's bearing

```

  FOR I = 1 TO L
  FOR K = 1 TO LEN(PT$)
  IF MID$(CALL$(I), K, 1) = "" THEN GOTO WIO
  IF MID$(CALL$(I), K, 1) <> MID$(PT$, K, 1) THEN
GOTO GC1
  NEXT K
  GOTO WIO
GC1: NEXT I
  PRINT "CALL OR PREFIX NOT FOUND"
  RETURN

```

```

WIO:
  IF DIRNUM%(I) > 180 THEN V = (DIRNUM%(I) -
180) * .0136
  IF DIRNUM%(I) <= 180 THEN V = (DIRNUM%(I)
* .0136) + 2.45
  PRINT V
  GOSUB VSET
  RETURN

```

```

TURNON:
  ' DEFINE THE PRINTER PORT BASE ADDRESS
& TURN BOARD ON

```

```

  REM PTR$ = "&H" + PTR$
  REM BASE0 = VAL(PTR$)
  REM PRINT "BASE0="; BASE0
  ' SWITCH POWER ON
  BASE0 = &H378
  DIM V(12)

```

```

  OUT BASE0, &HA0
  RETURN

```

```

SETDIR: ' This routine sets the output voltage
  ' ENTER THE DAC NUMBER AND THE
VOLTAGE

```

```

  INPUT "ENTER THE NUMBER OF THE
ANALOG OUTPUT TO BE SET0/1"; N
  IF N < 0 OR N > 1 THEN GOTO SETDIR
  INPUT "ENTER O/P VOLTAGE 0 TO 5"; W

```

```

  V = W
VSET: IF V > 4.98 THEN
  V = 4.98
ELSEIF V < 0 THEN
  V = 0
END IF
  V = CINT(V * 51.2)
  D0 = -V * (N = 0)
  D1 = -V * (N = 1)

```

```

  ' SEND 8 CLOCK PULSES & DIGITAL O/P DATA
  FOR BIT = 1 TO 8
  OUT BASE0, &H82
  OUT BASE0, &H80
  NEXT BIT

```

```

  ' SECOND 8 CLOCK PULSES & DAC1 DATA
  FOR BIT = 9 TO 16
  B = 16 - BIT
  BYTE = ((D1 AND 2 ^ B) / 2 ^ B) OR &H80
  OUT BASE0, BYTE
  OUT BASE0, BYTE OR 2
  OUT BASE0, BYTE
  NEXT BIT

```

```

  ' SEND THIRD 8 CLOCKS & DAC0 DATA
  FOR BIT = 17 TO 24
  B = 24 - BIT
  BYTE = ((D0 AND 2 ^ B) / 2 ^ B) OR &H80
  OUT BASE0, BYTE
  OUT BASE0, BYTE OR 2
  OUT BASE0, BYTE
  NEXT BIT

```

```

  IF N = 0 THEN
  ' LOAD DAC0 LATCH
  OUT BASE0, &H84
  OUT BASE0, &H80
ELSEIF N = 1 THEN
  ' LOAD DAC1 LATCH

```

```

  OUT BASE0, &H88
  OUT BASE0, &H80
  END IF
  ' ENABLE ALL LATCHED OUT PUTS
  OUT BASE0 + 2, 11
  RETURN

```

```

REM THIS ROUTINE IS FOR READING ADC
INPUTS

```

```

READIT: ' DEFINE PRINTER PORT
  BASE0 = &H378
  REM DIM V(12)
  ' POWER ON & DESELECT
  OUT BASE0, &HA0
  CLS

```

```

RD: LOCATE 1, 1
  INPUT "WHICH INPUT 0-11 "; NI
  IF NI < 0 OR NI > 11 GOTO RD
  VI(NI) = 0
  CYCLE = 0

```

```

CYCLESTART:
  CYCLE = CYCLE + 1
  OUT BASE0, &H80 ' SELECT TO IC 4
  VI = VI OR (INP(BASE0 + 1) AND &H10) * &H8

```

```

  ' READ BIT 7
  ' SEND INPUT ADDRESS MSB & READ DATA
  FOR CLK = 1 TO 4
  ' ADDRESS = &H80 + &H40 * (NI AND 2 ^ (4 -
CLK)) / 2 ^ (4 - CLK)
  VI = VI OR (INP(BASE0 + 1) AND &H10) * (2 ^ (8
- CLK)) / &H10
  OUT BASE0, ADDRESS
  OUT BASE0, ADDRESS OR &H2
  OUT BASE0, ADDRESS AND &HF0
  NEXT CLK

```

```

  ' SAMPLE AND HOLD
  FOR CLK = 5 TO 8
  VI = VI OR (INP(BASE0 + 1) AND &H10) * (2 ^ (8
- CLK)) / &H10

```

```

  OUT BASE0, &H82
  OUT BASE0, &H80
  NEXT CLK
  ' CHIP Deselect
  OUT BASE0, &HA0
  DO WHILE TEST = 0

```

```

  TEST = INP(BASE0 + 1) AND &H40
  LOOP

```

```

  IF CYCLE = 1 THEN
  VI = 0
  GOTO CYCLESTART
ELSEIF CYCLE = 2 THEN
  VI(NI) = VI

```

```

  END IF
  CLS
  LOCATE 2, 1
  IF NI < 10 THEN PRINT "VI("; NI; ")="; CINT(VI(NI) *
100 / 51.2) / 100; " "
  IF NI = 10 THEN PRINT "VI("; NI; ")="; V(NI) / 10
  IF NI = 11 THEN PRINT "VI("; NI; ")="; VI(NI)
  RETURN

```

analogue output from the parallel port board and the voltage from the arm of the rotator potentiometer.

By using this method the program is called only for about 1/4 a second as needed to read the bearing table, calculate the needed output voltage and set the analogue output of the parallel board to the desired bearing.

The program takes the callsign of the station, looks up a table of callsigns or prefixes and finds the bearing.

When FBB is initiating the call to another station, the bearing can be used instead of a callsign. This can be important, as the bearing may be different depending on time of day and the use of long and short paths.

The first entry in the table gives the printer port and the second is the voltage for full-scale output at the fully clockwise position of the rotator.

As every rotator indicator I have seen has the end stops at south the program assumes that both zero and maximum output voltages are south.

One of the two op-amps gives a high output depending on whether the rotator has to go CW or CCW to drive the potentiometer arm to the same voltage as the parallel board output.

The op-amp circuit is shown in figure 1. LEDs are used to indicator the direction of rotation. Figure 2 is an example of the bearing table. Listing 1 is the QuickBasic program.

I have a problem with my control box in that when the voltage difference comes close together both relays may energise or still receive some drive from the op-amps.

This is caused by my use of unshielded cable between the rotator and the shack. If I was doing a new installation I would use three core shielded and sheathed cable.

When the circuit is in balance there is 50 cycle hum on the op-amp inputs. The motor

contacts of the relays are fed through the normally closed contacts of the opposite relay so that the rotator is not driven if both relays are energised.

There is a second effect of this hum in that there is a dead band of about 10 degrees in which the beam may come to rest. However as my TH3 is nowhere near as sharp as 10 degrees it does not matter.

The parallel port board has a maximum on its analogue output of 4.95 volts.

Because of this the rotator pot should go from 0 volt at the CCW end to 5 volt at the clockwise end. If the rotator pot is not 500 ohm then the resistors in series with the pot will need to be adjusted to give that range.

The first entry in the bearing table is the fully clockwise voltage output from the rotator potentiometer.

A meter is used as an indicator of the beam position.

Two push buttons are used to give manual control from the front panel. A switch disconnects the relays and enables the push buttons.

The transformer used is from Dick Smith Electronics and is catalogue number M1991.

If you use this transformer note that you cannot earth the motor leads anywhere due to the same windings being used to provide the + & - 12 volt supply.

The relays used are also from DSE and are catalogue P 8012.

Vero board was used for the op-amps, power supplies and relays.

Setting up the program and hardware is quite straightforward.

Put the auto/man switch into manual and rotate the beam to the CCW south position. The voltage on the arm of the pot should be 0 volts, or very close to that.

Each degree is .014 volts so a small error is of no great consequence. Then rotate the

beam to its clockwise stop and the arm of the pot should be near 5 volt.

If the reading is greater than 4.98 you will have to adjust the resistors each side of the potentiometer as you will not be able to reach due south.

If you have less than 4.98 and send it to 180 degrees the rotator will lean on its stop and keep power on the motor.

As an aside, some years ago a book fell onto my rotator control box switch and sent the beam around to the stop and burnt out the motor.

I then fitted stop switches inside the rotator housing. This is quite a straightforward modification to a KR400 rotator.

However it is necessary to shift the starting capacitor up into the rotator. It fits quite nicely. It is an easy job to rewind the motor.

Enter the reading you get from the clockwise position into the second line of the ROTATOR.INI file. This will set into the program the bearing voltage for due south.

To call the program give the command "ROTATOR 95" and this will send the beam to 95 degrees. If the beam goes the wrong way reverse the connections to the motor.

For FBB sysops enter into your forward files "X ROTATOR <callsign>" or "X ROTATOR 010". You also need to insert the line "XC ROTATOR <callsign>" or bearing in the forward file. This last line will operate when the other station connects to you.

If it is being used other than in FBB give the DOS command ROTATOR 270 for the beam to go the west.

At present the program only handles the rotator but I am now extending it to enable the switching of antennae by using the addressable bits output to drive relays.

ar

Silent key

John Purssell VK2AIN

John Purssell, VK2AIN, became a silent key suddenly on the 12th of March 1999 aged 84 years. First licensed 62 years ago; he joined the Institute as soon as he got his licence.

A quiet unassuming man, he was active on the bands right up to the day of his passing.

A number of radio amateurs owe their licences to his quiet insistence that they learn, and one in particular vows that he owes his life to the fact that as a radio operator in World War II he was able to avoid capture and the forced marches of the POW's.

John, VK2AIN will be sadly missed.

Advised by Barry Purssell (his son).

The WIA regrets to announce the recent passing of:-

J. R. PURSSELL VK2AIN

R. W. G. CHALMERS VK3ARO

F. S. G. (Stan) CUNDY VK3NVR

R. J. ANSON VK3PRJ

V. (KEITH) SCOTT VK3SS

L. KOLK VK3ZLK

L.S. (SAMUEL) DRAKEFORD VK4EKK

M. C. BOLTON VK6MB

See also page 55

General Purpose Amplifier/Mike Tester/ Power Supply

Drew Diamond, VK3XU

45 Gatters Rd
Wonga Park, 3115.

It seems that almost daily I hear on-air exchanges which go something like this; "Bill, I'm going to plug in another mike. I want you to tell me how it sounds...(pause)...Now this is mike number one..."

And occasionally it's like this; "I'm sorry Tom, your signal is breaking up. Sounds like you've got a crook mike..." Rather than rely on (perhaps inaccurate, or misleading) reports from other stations, it would be much better, and handier, if communication microphones could be checked right there in your own shack.

One of my most regular correspondents, Max VK2ARZ, in his various activities, has often had need to test and repair radio mikes, and has made several mike testers. His most recent device was extended to provide so many handy facilities that he has called it his "Topsy Tester". Drawing largely from his experience and suggestions, I have cobbled up the following outfit, which finds use as;

- a general-purpose audio amplifier (for signal tracing, receiver work, etc.),
- microphone tester with PTT checker (but not carbon mikes),
- headphones tester,
- stand-alone speaker,
- +12 Vdc 1 Amp power supply,
- +5 Vdc 1 Amp power supply (optional),
- continuity tester (optional).

For ease of duplication, I have used an ordinary LM-386 audio IC as amplifier. The N-4 version of this chip, at an input signal level of 6 mV can supply about 150 mW undistorted output power into 8 ohms. Electrical frequency response (at 6 dB down) is from about 100 Hz to well over 10 kHz, which, when applied to a decent speaker, is adequate for just about all those routine service jobs around the shack.

Construction

Once again I've cheated a bit, and used a rather nice metal box obtained at a recent hamfest. It measures 180 x 120 x 155 mm WDH. You could probably squeeze your model into something smaller, but, if the device is going to provide full advantage, then a reasonably sized and rated speaker should be included.

Most of the components, including '386 chip and rectifier bridge are mounted upon a piece of plain printed circuit board measuring 80 x 80 mm.

The '386 is fitted into a wire wrap socket, which in turn is mounted paddyboard (Ref. 2) fashion to the main board.

Layout is not especially critical, and any other wiring method that you prefer should be satisfactory, but remember that input

circuitry should be well isolated from output wiring, the speaker and output connectors are on t'other side of the sub-chassis depicted in Photo 2. Note also the screened wire used for the input connections.

The power transformer, generic type 2155, may be mounted in the box towards the rear, and the three leads of the secondary (15 V centre-tapped, or 7.5-0-7.5) brought up to the circuit board "sub-chassis" as shown. The 7812 and 7805 regulator chips must be mounted upon the chassis (or sub-chassis) to provide heatsinking.

As there are multitudinous pin-outs and connector types, the connections for the mike socket must be left to you. For my own model I have taken the easy way out, and provided, in addition to plain terminals and BNC connector, a tip-ring-sleeve phone style socket.

Shown is an adaptor to provide conversion to the common 4-pin mike style. An ordinary 35 mm film canister is drilled at one end to take a phone plug- wires soldered on, then part filled with auto body filler (or similar epoxy). The 4-pin mike socket is fitted into the lid, wires soldered on, then, when the epoxy has set, snapped together.

I've been a bit lazy (and stingy) with this project, and not installed a mains on/off switch, as I have found that in practice they are rather redundant.

However, if you wish to have one, use a DPDT type (that is; switch both line and neutral of the mains). Operationally, it is a



Photo 1 The Amplifier/Power supply with adaptor module for four pin microphone.

good plan to use an IEC style 3-pin mains socket and cord, which is tidy and permits easier storage.

Adequately cover all exposed mains connections to prevent accidental contact, and include a 250 mA fuse in the line/active side.

The continuity test is optional, although with the PTT LED already installed, it is only a matter of fitting an extra pair of terminals or banana sockets to take your existing multimeter leads.

Operation

Before switching on, check all wiring, component locations and their polarity where applicable (no bangs please!).

Upon switch-on the LEDs for the +12 and +5 Volt supplies should glow. You may hear a faint hum or buzz from the speaker. Turn the gain to maximum, then touch a screwdriver blade to the input terminal.

You should hear a loud hum or buzz, indicating that the amp is working. Some typical voltages are shown on the circuit to aid in any necessary trouble-shooting.

Plug in a suitable mike. Adjust gain as necessary.

Your voice should emanate reasonably loud and quite undistorted. Operate the PTT button on the mike (if fitted). The PTT LED should glow. Fortuitously, because the PTT ground shares the mike ground, any intermittent connections in the PTT circuit will be heard as a crackle in the speaker.

So, when testing a mike, always remember to give the cord, particularly where it enters the connector and hand-piece, a gentle pull and a wriggle to show up any faults in these. In comparative mike testing, you may have to use headphones to get a more accurate idea of how your voice actually sounds "on-air".

The rest is pretty well self explanatory. If you have installed the +5 V supply, remember that the maximum total current drain is one amp.

So, if you have a load on the 12 V supply which draws 500 mA, then you can only take 500 mA from the 5 V supply.

By plugging into the speaker phone socket, wired as shown, the amp. is cut off, making the speaker available as a stand-alone load for other devices.

References:

1. Correspondence with Max Riley, VK2ARZ.
2. "Paddyboard" Circuit Construction; D. Diamond, *Amateur Radio* Feb. '95.
3. National Semiconductor *Linear Databook*.
4. Bench Amplifier; R. Evans, *Electronics Australia*, Apr. '88.

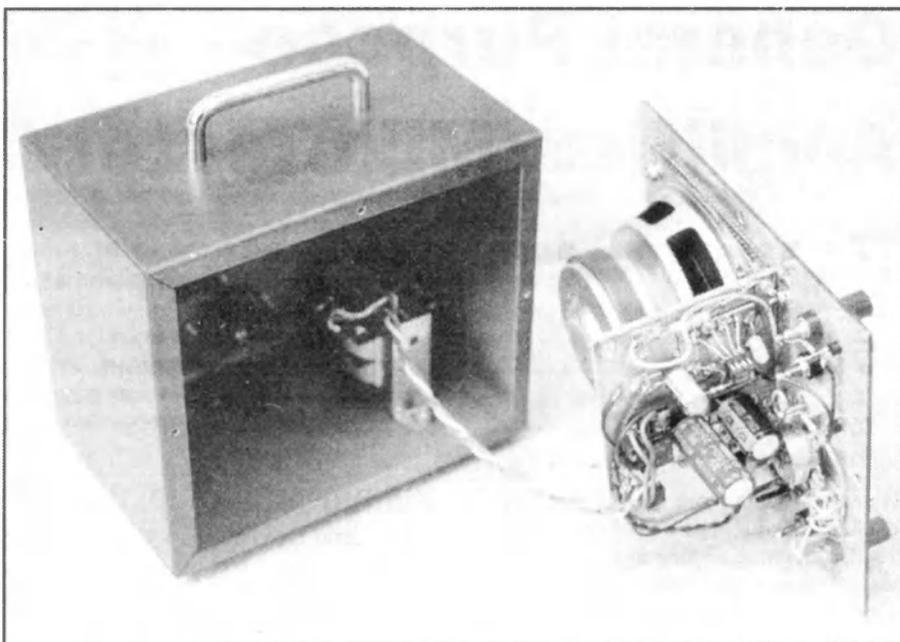

Photo 2 Inside the box showing transformer placement behind the Speaker

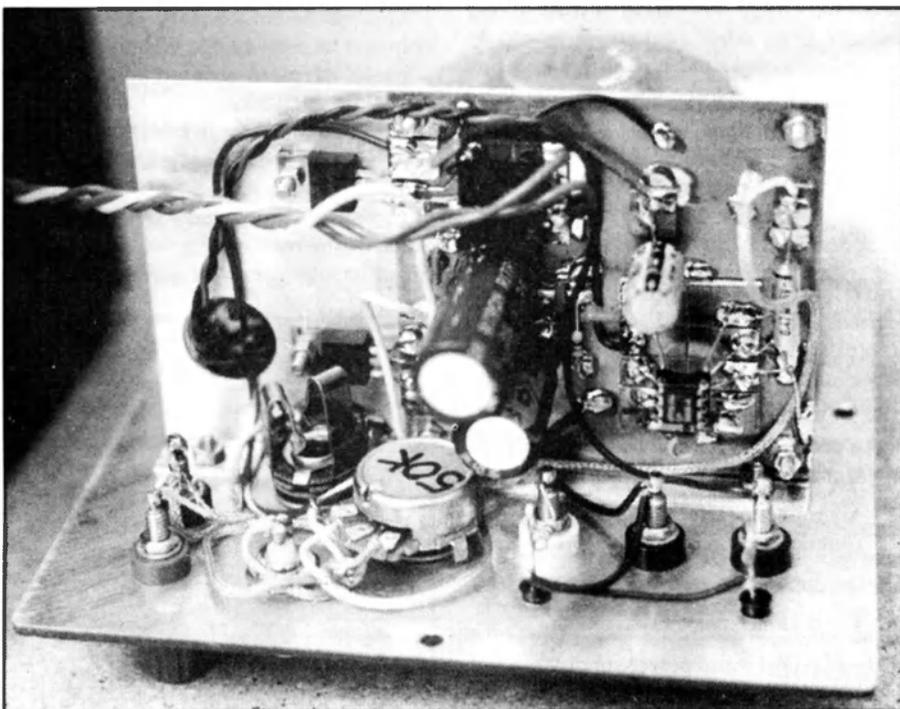

Photo 3 Construction of the electronics - paddy board style

Amateur Radio

Do you have a pet project.
Share it with us
Discuss it with

Bob VK4KNH
Bill VK3ABP

Fig.1 Circuit diagram of the General Purpose Amplifier/Mike Tester and Power Supply

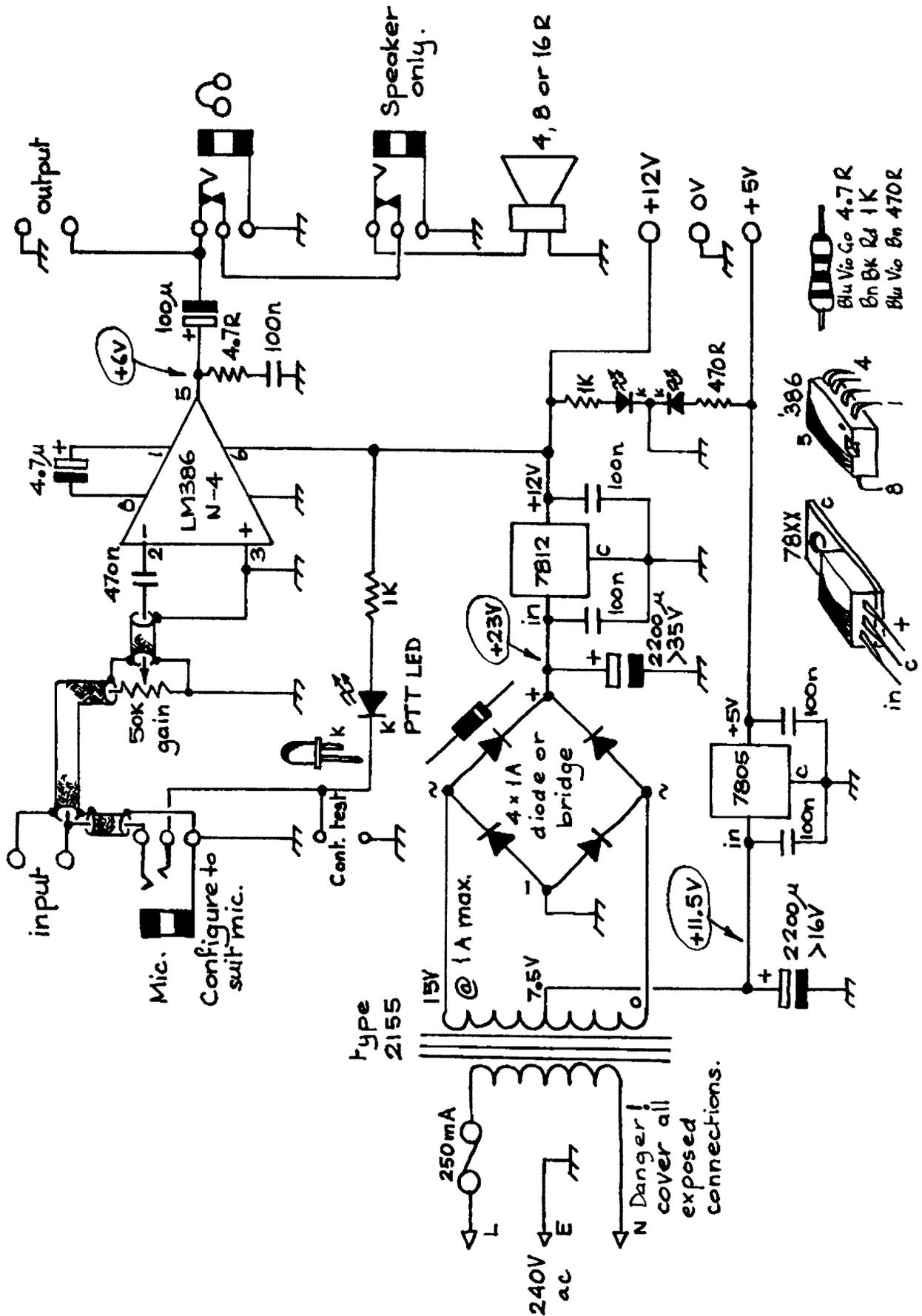

A HF Complex Impedance Analyser.

Ralph Holland VK1BRH
8 Hardy Place Kambah ACT 2902

Introduction

I recently saw a new Complex Impedance Analyser advertised on the web and was impressed by its features. The unit is called the CIA-HF (part number 5012-5000) built by AEA, a division of Tempo Research Corporation, Vista California.

The CIA-HF is microprocessor controlled, contains a DDS synthesiser (400kHz to 54MHz accurate to 200Hz) with a low power impedance bridge (1000 to 0 ohms 2.5 digits or ± 0.1 ohms), an LCD graphical display, keypad and computer interface. The unit is completed by an instruction manual that describes all operations, how to construct simple RF accessories, how to perform measurements such as check coax for shorts, open-circuits and power-loss and how to wire the external computer interface.

The unit is powered by 8 AA batteries (not included) and is connected to the RF load devices via an SO-239. External power can be applied via a jack and the computer interface is provided by a 3.5mm stereo audio socket.

The CIA-HF is housed in a robust grey plastic case and is provided with a flexible adjustable stand.

A photograph of the CIA-HF has been provided in Figure 1 and the manufacturer's specifications are listed in Table 1 and scale factors in Table 2.

Figure 1 shows the Impedance display in expert mode connected to my 80m fan-dipole, which is fed via a voltage-mode balun and open-wire line of some 15m length. The display has been set to the centre frequency of 7.0MHz with 1MHz per division.

The 80m resonance is indicated as a little low, being 3.0MHz, but at 3.5MHz the impedance is closer to 50 ohms. At 7.0MHz the impedance is indicated as 9.7 ohms, zero reactance – so I guess I may turn the balun around and alter the antenna somewhat!

Incidentally, this fan dipole has useful resonances at 10.MHz, 14MHz, 24MHz and 29MHz – that was why I constructed it. It is an excellent performer on 14MHz and the balun is switchable from 1:1 to 4:1 to cope with the variation in the feed-point impedance.

Operation

The CIA-HF is very simple to drive and is a versatile instrument that can be employed to measure antenna impedances, SWR, baluns, coaxial stubs and can also be used to locate shorts or open circuits in coaxial transmission lines.

It has two fundamental modes. The regular mode -for basic antenna impedance and SWR, and the expert mode -that offers many additional features.

The CIA-HF keypad is a membrane pad with five function keys, a numeric pad and the special keys marked: on/off, width, freq, enter and exam/plot. The width and freq keys are divided between up and down functions as marked by the arrows (See figure 1.)

The centre frequency (F_c) can be entered via the numeric keypad and adjusted up or down by the freq key. The width key is used to increment or decrement the frequency display divisions, which are offered in: 1MHz, 500kHz, 200kHz, 100kHz, 50kHz, 20kHz, 10kHz and 0kHz per division. The 0kHz per division is used to provide an audible SWR indication at the centre frequency so you don't have to look at the display to adjust an antenna – a useful feature!

- F1 provides access to the set-up menu, which contains numerous options and a battery voltage indicator, which can be used to check the internal and external power supply.
- F2 toggles a graphics display grid overlay to help line-up values with the scale indicated on the right-hand-side.
- F3 chooses various display items – called data blocks.
- F4 changes the display scale on the right-hand-side.
- F5 permits selection of different graphical displays.

In the regular mode F5 toggles between the graphical display of SWR or Z while F3 toggles between three basic data sub-displays rendered below the graph and indicating:

- the Z, R, X and phase of the load at the centre frequency (F_c)

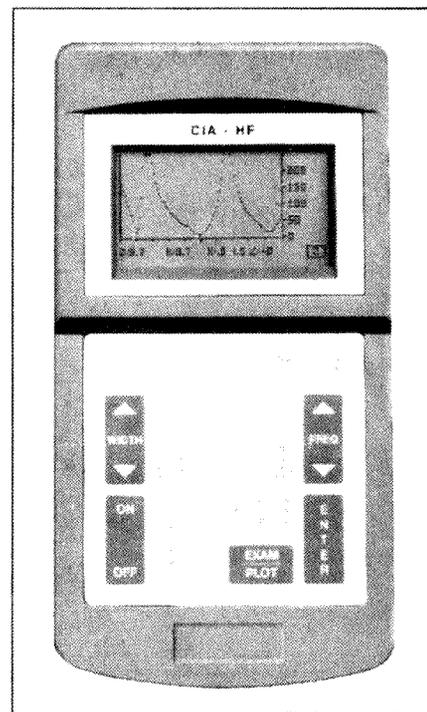

Figure 1. CIA-HF displaying 80m fan dipole, $F_c=7.0\text{MHz}$, $W=1\text{MHz} / .\text{Division}$.

- the SWR and return loss (RL) at F_c
- the display horizontal interval (W) and F_c .

In the expert mode F5 chooses the graphical displays:

- SWR
- Z
- X
- R
- Vector (V) display of phase angle (left capacitive and right inductive, vertical bar real).
- Data which contains numeric values for F_c , R, SWR, X, RL, Z, BW2.dB, phase, Q, C and L.

While in the expert mode F3 toggles the sub-display through:

- W and F_c
- SWR and RL
- Z, R, X and phase
- Inductance and Capacitance at f_c
- 2dB Bandwidth and Q
- 2:1BW
- 3:1 BW
- 1.5:1 BW
- Min SWR search enunciated at some frequency.
- Normalised Z (as R +/- J) referred to 50 ohms.

- Lower frequency, centre frequency (Fc) and upper frequency
- Fc +/- range
- Fc, Velocity Factor and Feet to short or open circuit.

Specifications

Table 1 contains the manufacturer's specifications, while table 2 illustrates the display scales provided by F4 in the various modes.

Uses

This is an invaluable piece of equipment because it provides a portable hand-held accurate impedance bridge with an internal, agile and accurate signal source.

The synthesiser can be programmed to span 400kHz to 54MHz in steps of 1KHz – which is adequate for most RF measurements from the Broadcast band right across the HF spectrum and up to 54MHz.

When I measured a home-made dummy load it indicated 50.3 – 49.3 ohms between 1 - 54MHz – proving that the unit would extend to the 6m band.

The unit may be used in place of the following equipment:

- SWR meter
- Lower power signal source (when set to 0kHz).
- Lower power ATU tuning.
- Coaxial Velocity Factor meter.
- L, R, C meter
- Impedance bridge (R, X, phase)
- Time domain reflectometer (for determining coaxial shorts and open circuits).
- Transmission stub resonator – both _ and half-wave.

I intend to use mine for antenna and other RF research.

Computer Interface

This unit can be driven and sampled via the computer interface using a simple set of commands that have been included in the instruction manual.

I was informed, during my correspondence with two representatives from AEA (both Amateur Radio Operators), that software has just been developed for the computer interface. I am not sure of its availability, but the prototype software executes on an IBM compatible PC running Microsoft Windows.

The connection of the CIA-HF to a computer would be a worthwhile extension to this instrument being a very useful combination that would provide laboratory-grade data capture with the capability to

perform data reduction and display. For example the unit could be used to sweep for areas of interest and then the resolution could be programmed to 1kHz steps to resolve fine details.

As the command-set is so simple I am looking at developing my own software suite to drive this useful instrument so I can carry on with research – yet another project!

I highly recommend this item of equipment if your budget is capable – contact the representative provided below in the footnote.

AEA is a division of Tempo Research, the web address is

<http://www.aea-wireless.com>.

The CIA-HF may be purchased from the local dealer:

Ham Radio World

<http://www.hamradio.com.au>.

Telephone (07) 5464 3954, fax (07) 54643963.

Contact

Ralph Holland, 8 Hardy Place, Kambah 2902. <mailto:vk1brh@dynamite.com.au>

<http://www2.dynamite.com.au/vk1brh>

ar

Table 1. Specifications:

Item	Spec
Frequency range	0.4 to 54MHz
Resolution	Increments of 1KHz
Accuracy	± 200 Hz
Display width	0 to 10MHz
Harmonics and spurious output	< -30 dB
SWR Impedance	50 ohms
SWR range	20:1
Impedance and Resistance ranges	0 to 100, 0 to 250, 0 to 1000 ohms
Return Loss range	-1 to -40 dB
Phase angle	-90 to +90 degrees
Q Factor range	1 to 1000 (defined as 2:1 BW/Fc)
Measurement speed	1.2 seconds per sweep
Antenna connector	SO-239
Output power	<5mW into 50 ohms
DC voltmeter	2.5 digits ±10%, 25 volts max.
Power requirements	8 AA cells, 12 to 16 VDC @ < 150mA
Size	110W x 57H x 216L (inc connector) (4.3"W x 2.25"H x 8.5"L)
Weight	740gms (1bl 10oz) (including batteries)

Table 2 includes the various scales where provided by F4

Item	Scale 1	Scale 2	Scale 3
SWR	18:1 to 1:1	6:1 to 1:1	2.8 to 1:1
Z (ohms)	1000 to 0	250 to 0	100 to 0
X (absolute ohms)	1000 to 0	250 to 0	100 to 0
R (ohms)	1000 to 0	250 to 0	100 to 0

FOR ALL YOUR COMMUNICATIONS NEEDS



\$299

Revex W570 HF/VHF/UHF SWR/PWR Meter

Top of the line performance! The W570 provides switchable 1.6-160, 400-525, 700-1100 and 1240-1300MHz coverage, with measurement of 3 power levels (5,20,200W) and SWR. The external UHF sensor uses N-type sockets with remote mounting for easier cable connection to the meter. Measures 120 x 80 x 155mm.
D1377

Rugged HF 5-Band Trap Vertical Antenna

The rugged 5BTV incorporates Hustler's exclusive trap design (25mm solid fibreglass formers, high tolerance trap covers and low loss windings) for accurate trap resonance with 1kW (PEP) power handling.

Wide-band coverage is provided on the 10, 15, 20 and 40m bands (SWR typically 1.15:1 at resonance, <2:1 SWR at band edges) with 80kHz bandwidth typical on 80m at 2:1 SWR. An optional 30m resonator kit can be installed without affecting operation of other bands. High strength aluminium and a 4mm (wall thickness) extra heavy-duty base section guarantee optimum mechanical stability.

At just 7.65m, the 5BTV can be ground mounted (with or without radials, although radials are recommended), or it can be mounted in an elevated position with radial system. Unlike other antenna designs, the 5BTV can be fed with any length of 50-ohm coax cable.

D 4920

\$449



30m Resonator Kit

Adds 30m coverage to the 5BTV and includes all hardware.
D 4921 **\$99.95**

BONUS OFFER! Purchase the 30m-resonator (D 4921) with the 5BTV vertical and pay only half price for the 30m resonator!



3-15V 25A Heavy Duty Power Supply

This solidly built benchtop power supply provides current of up to 25 amps ICAS at 15V, 20 amp continuous at 13.8V and lower current at lower voltages. It has front panel metering plus high current banana-style and low-current output connections. An internal heatsink and thermally switched fan provides cooling without protrusions in the metal case. Specially modified for more reliable long-term operation, it uses a rugged 50 amp bridge rectifier & trifilar transformer. Also provided is extensive overload protection through dissipation limiting circuitry for the pass transistors, a 30 amp instantaneous current limit, AC mains circuit breaker, a transformer thermal fuse & fused auxiliary secondary winding.
D 3800

\$299

Great Value!



Yaesu FT-1000MP Deluxe HF All Mode Transceiver

Yaesu has created a new 100W HF masterpiece using proven design techniques and a major new technology to the amateur marketplace: Enhanced Digital Signal Processing (EDSP). Teamed up with Direct Digital Synthesis, an outstanding receiver section featuring a high intercept front-end and a variety of IF filters (including a Collins Mechanical Filter), the FT-1000MP's exclusive EDSP facilities provide an impressive array of IF-based noise-reduction and interference reduction filters for enhanced receiver performance. Yaesu's IF-based EDSP system provides 4 random noise-reduction protocols, audio enhancement with 4 equalisation programs for Tx and 3 for Rx, and an automatic notch filter which eliminates multiple interfering carriers. A comprehensive menu system allows you to easily hear the effect of various EDSP settings, so you can choose the best selection for your operating conditions. Front panel selectable EDSP filter contours also aid QRM rejection, providing improved signal-to-noise ratios and razor sharp selectivity. The FT-1000MP also features selectable receiver front-ends, an in-built AC power supply and auto antenna tuner, 2 main antenna sockets, selectable tuning steps as small as 0.625Hz, dual-mode noise blankers, 13.8V DC socket, 500Hz and 6kHz IF crystal filters, an RS-232 computer interface and an MH-31B8 hand microphone. With so many features in this new transceiver, why not ask for a copy of the 12-page FT-1000MP colour brochure or 46-page Technical overview for more detailed information.
D 3400

2 year warranty

\$4450



FOR ALL YOUR COMMUNICATIONS NEEDS

Advanced Data Management Software

An advanced way to program many of the functions of Yaesu handheld and mobile transceivers. Each package consists of an interface that plugs into the serial port of a PC and connects to the transceiver via its microphone socket (for handhelds) or its Packet socket (for mobiles). Also provides easy-to-use 3.5"(inch) PC software with pull down menus that allow for programming and naming of memory channels, selection of output power, CTCSS tones, scan and battery saver operation, plus much more.

ADMS-1D suits FT-10, 11R, 50R/RD, 51R, VX-1R D 3753
 ADMS-2D suits FT-3000M, 8000R, 8500, 8100R D 3759

\$89⁹⁵ea

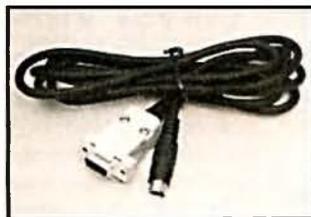

LP-1300 Log Periodic Yagi

The Maldol LP-1300 is a Log Periodic Yagi beam antenna designed to provide useful gain across the 100 to 1300MHz range. Ideal for scanner enthusiasts and ham operators needing a directional wideband antenna. Consists of a 17-element Yagi with a special feed system providing low SWR (less than 2.0:1) across the 100-1300MHz range.

Gain: 6.0dBi to 10.0dBi Max wind speed: 40m/sec
 Boom length: 1.46m Max power: 500W
 Suitable mast: 28-60mm diameter Connector: SO-239
 D 4828

\$269

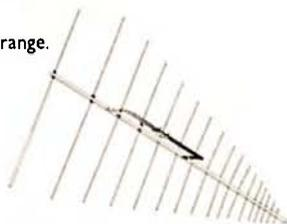

FT-50RD 2m/70cm Handheld

The Yaesu FT-50RD is an amazingly compact 2m/70cm amateur band handheld transceiver which provides MIL-STD 810 shock and vibration resistance, super wideband receiver coverage, simple menu settings for most functions, and compatibility with the optional Yaesu ADMS-ID software/interface package for PC programming of many functions.

Other features include:

- Tx 144-148MHz, 430 - 450MHz
- Rx 76-200, 300 - 540, 590 - 999MHz (cellular blocked)
- FTT-12 keypad provides Digital Voice Recording, CTCSS/DCS scanning, and CTCSS encode/decode
- 2m/70cm RF output: 2.5, 1.0, 0.1W standard, up to 5W with 9.6V battery or 12V DC socket
- "Omni-glow" LCD screen for easier night-time viewing
- 112 memory channels with 4 character alpha naming
- Dual watch allows monitoring of sub-band activity
- Direct FM modulation for better audio quality
- 5 battery saving systems (includes Rx and Tx Save)

- Comes with FNB-40 slimline 6V 650mA/H Nicad battery pack, flexible 2m/70cm antenna and modified M-9626 AC plugpack adaptor for Nicad charging
 D 3660

2 YEAR WARRANTY

\$569

BONUS!

Pay only half-price for a second Nicad pack when purchased with the FT-50RD. Limit one per customer. Applies to FNB-40, 41, 42 only.



FT-8100R 2m/70cm Mobile

The new Yaesu FT-8100R is a state-of-the-art 2m/70cm band mobile transceiver that combines high power and the industry's most versatile memory system with an excellent wideband receiver and solid construction. Its US MIL-STD-810 shock and vibration rating is your assurance of years of reliable operation. Includes hand mic, mounting bracket and fused DC power cord.



Other features include:

- 198 memory channels
- 1200/9600 baud packet socket
- Inbuilt antenna duplexer
- Inbuilt crossband repeater facility
- Dual receive capability (VHF/UHF, VHF/VHF, UHF/UHF)
- Optional removable front panel

Frequency range: Tx 144-148MHz, 430-450MHz
 Rx 110-550MHz, 750-1330MHz (less cellular)
 Output power: 2m: 50, 20, 5W
 70cm: 35, 20, 5W

2 YEAR WARRANTY

\$949*

D 3314

PHONE FAX AND MAIL ORDERS

PHONE: WITHIN AUSTRALIA: 1300 366 644
 (Local call charge)

FAX: (02) 9395 1155 within Australia and
 (+612) 9395 1155 from outside Australia

MAIL: DICK SMITH ELECTRONICS, Direct Link, Reply Paid 160,
 PO Box 321, North Ryde NSW 1670 (No stamp required)

Excludes packaging and postage. All major credit cards accepted.

14 Day Money Back Guaranteed if NOT completely satisfied. (Software excluded)



Visit our web site at
<http://www.dse.com.au>



That's where you go!

*Pricing valid until 30/6/99, then may be subject to change.

A 139-B 3928 DPS

What's New

Two new Alinco products

Doug Wynn, Sales Manager (US)310-618-8616

New DJ-V5T VHF+UHF HT with Wide Receive

Alinco USA is adding to its product line the DJ-V5T, a compact Handy-Talkie (HT) Transceiver designed to operate on the Two Meter (144~148 MHz) and 70 cm (420~450 MHz) bands.

The new HT features alphanumeric display, up to 5 watts power output, 200 memories, an expanded receive capability offering coverage from 76~999.995 MHz (cellular blocked), narrow and wide FM receive modes and CTCSS encode and decode.

The DJ-V5T represents a major step forward in transceiver technology by Alinco. The new HT is powerful, compact and offers a large number of features popular with Amateur Radio operators.

Some additional features include four scan modes, five programmable scan banks, automatic internal temperature protection, cable cloning, SMA antenna connector, 13.8 Vdc direct input, four different European tone bursts, autodial memories, input voltage display with over voltage warning, MARS/CAP capability and more.

The new DJ-V5T has already achieved FCC type approval.

"The DJ-V5T is a very affordable full-featured dual-band radio," said Doug Wynn, KB6YZD, sales manager for Alinco. *"When one compares the price and features to transceivers of just a few years ago, the value is incredible."*

The DJ-V5T is expected to be available at Alinco dealers in early May.

Alinco's MSRP has been announced at US\$315 for the version with a 2 watt output battery and US\$345 for the 5 watt battery model (DJ-V5TH).

Wynn added that individual dealers often set the "street price" of Alinco radios lower than the MSRP.

**DON'T FORGET TO CHECK WITH
"AR" ADVERTISERS FOR LOCAL
AVAILABILITY AND OTHER
EQUIPMENT IN THEIR RANGES.**

Alinco introduces new 2 Meter HT DJ-195T

(With Mozzie repellent)

Alinco USA is planning to release a new Two-Meter HT, the DJ-195T, a newly designed handheld transceiver designed to operate on Amateur Radio's most popular (144~148 MHz) band.

The new HT features alphanumeric display, up to 5 watts power output, 40 memories, receiver coverage from 130~174 MHz, CTCSS encode and decode, Digital Code Squelch (DCS), autodialer memories and more.

Some of the more unique features of the DJ-195T include a theft alarm that when activated, sounds when the unit is removed from an external power source, such as in a mobile environment.

Alinco has also included an experimental "mosquito repel" feature that may keep the annoying insects away from the vicinity of the radio through the emission of an electronic tone. *"It's a feature we added just for fun,"* said Mr. Nakata. *"The mosquito repel feature could make the DJ-195T the first radio capable of de-bugging a Field Day operating position,"* he added with a smile.

Doug Wynn, Sales Manager for Alinco USA, said the features included in the DJ-195T reflect input gathered directly from Amateur Radio operators. *"We're pleased that hams at shows and those who send written comments have taken the time to share their thoughts on what should be included in a transceiver."* Additional DJ-195T features include standard high-output (5 watts) battery, 13.8 VDC direct input, cable cloning, BNC antenna connector, European tone bursts, autodial memories, MARS/CAP capability and more.

The DJ-195T is expected to be available at US Alinco dealers shortly after FCC type approval is granted. Pricing on the DJ-195T has not yet been announced but Wynn says it will be "very competitive" in the marketplace.

The DJ-V5T should be available in the US mid May and the DJ-195T will be available sometime in mid June. To view these products, please visit the Alinco website at www.alinco.com

Thank you for your interest in Alinco products.

Andrews

Communications Systems
(EST. 1976 - ACN 001 968 752)

ALINCO

AUSTRALIA'S FIRST AUTHORISED
FACTORY DIRECT IMPORTER

No 1 & Biggest Importer with one or two
absolutely massive shipments monthly.

**FULL 3-YEAR FACTORY WARRANTY
INSTANT REPAIRS ON FRIDAYS**

WE SELL MOST BRANDS AND MAKE
BALUNS, VERTICALS, YAGIS, P/S.
ICOM-KENWOOD-JRC-AOR-EMOTATOR-
M/JF-DIAMOND-TIMEWAVE-KANTRONICS
-THP - GARMIN - TERLIN - UNIDEN -ETC

WE URGENTLY WANT GOOD HF, VHF.

**HUGE RANGE OF ELECTRONICS
NEW IC-706IIG & IC-756PRO**

**NOW 3-YEAR WARRANTY ON
NEW ICOM SOLD BY US.**

* OVER 20 YEARS OF SERVICE *

**Big Icom Day
Saturday June 19th**

(02) 9636 9060 or (02) 9688 4301

SHOP 8, 41 BATHURST ST. GREYSTANES.

N.S.W. 2145. FAX (02) 9688 1995



AMATEUR TRANSCIVER RADIO CENTRE

NO 1 FACTORY DIRECT
IMPORTER AUTHORISED
DEALER

ALINCO

AUSTRALIA'S FIRST ARRIVALS

NEW DJ-5E 6w, 144/432MHz

DR-M06TH 6M MOBILE

DX-701H, DR-610E, DJ-G5EY, DX-77E

MASSIVE MONTHLY IMPORTS

3-YEAR WARRANTY

ALINCO SPECIALIST

ICOM

IC-706MKIIG, IC-T81A,
IC-2800H, IC-746, IC-756-Pro
IC-T8A, IC-R75, IC-Q7A.

KENWOOD

TS-570SG TM-V7A
TH-G71A VC-HI TH-D7A TM-G707A

JRC

NRD-545G, JST-245, NRD-345.

KANTRONICS

KPC-9612, KPC-3, KAM-98, KAM PLUS

HUGE ICOM OPEN DAY SALE SATURDAY 19TH JUNE

PHONE (02) 9896 2545

E-mail: atrc@bytelink.com.au

Web Page:

<http://users.bytelink.com.au/atrc>

NOVICE NOTES

Peter Parker VK3YE

12/8 Walnut Street, Carnegie, Vic 3163

Email: parkerp@alphalink.com.au

Novice Notes Online: <http://www.alphalink.com.au/~parkerp/nonline.htm>

Please note that this is Peter's correct address.

but signals will usually be marginal with two watts unless you use a small yagi or quad antenna.

Sydney

Sydney's AMP Tower (formerly known as Centrepoint Tower) has a public observation deck 305 metres above street level. Open each day until 10:30pm (11:30pm Saturdays), full admission costs \$10.00, pensioners and children pay much less.

Equipment

The equipment used need not be any different from that used from any other spot with no mains power. The only thing to watch is the strength of your transceiver's front-end - you are just hundreds of metres from high-power pager transmitters and your receiver will need to withstand the onslaught of kilowatts of RF in the area. I find the all-mode Yaesu FT290R MK1, not the most sensitive of radios, to be a good transceiver to use in high-RF areas. Directional antennas and/or horizontal polarisation can also assist in keeping pagers out of your receiver.

Other equipment you should take is a callbook with a current repeater and beacon list, pen, paper, and sufficient battery capacity to last your expected time aloft. Where the building is darkened at night, a small torch to read the callbook and any notes you write is handy. Earphones that don't make you look like a Martian are also desirable to prevent others from hearing your contacts.

Antennas

This is a question of how much attention you wish to draw to yourself. A small hand-held yagi or quad would obviously be ideal, but has a visual impact that cannot be ignored in a small space. There is also the risk of detuning by adding the odd eye ball along the way if the ends of your elements are rigid and pointed. The author has taken a small yagi on two occasions. In both cases it was not used because of its visibility and the number of people present.

A quarter wavelength whip for two metres and a 5/8 wavelength whip on 70 centimetres are not too conspicuous and are suggested as a sensible compromise between antenna gain and visibility.

Horizontal antennas are harder to arrange. I always tilt the vertical antenna on the transceiver when using a vertical antenna. Serious SSB operators should consider building a halo for the purpose.

Batteries

Having taken the trouble of travelling to the operating spot (and paid to get in), you will

Operating from tall buildings

Introduction

A few amateurs are lucky enough to live in good locations and always seem to have the best VHF/UHF signals. They can always hear people you can't and hit repeaters you've never heard of.

How would you like to be one of the biggest signals in your city for a day, or even a couple of hours? Well you can, just by taking your equipment to a good spot. At a good location you can compensate for your 30 watt VHF/UHF power limit and restricted antennas. For a short time you'll get out as well as the "big guns".

A great place to go is the top of a tall building in the city. Here are some tips on how to go 'skyscraper portable' and successfully work the VHF/UHF bands.

Places

Some cities have tall buildings with public viewing platforms. Others have viewing platforms that only open on special occasions. There are also cities that have a viewing structure other than an office building fairly close to the CBD.

Even where your city has no buildings with public viewing platforms, do not discount the possibility of gaining access to the roof of a tall building. This would be a great project for your club for next year's John Moyle Field Day.

The following is a listing of some operating spots available in major Australian cities. Source information came from personal observation, other amateurs, state tourism centres and building staff.

Adelaide

Adelaide lacks the tall buildings found in other capital cities. However the Adelaide Hills are fairly close to the city and offer good opportunities for VHF DX.

Brisbane

The Queensland Government Travel Centre advised there are no tall city buildings with

public viewing decks. There are though several restaurants with reasonable prominence. The cost of the contacts is of course much higher! Mount Cootha, home to the city's television towers, has a grand public lookout overlooking the city.

Canberra

Canberra also has no really tall city buildings. The nearby Telstra Tower includes a public observation deck that provides good views from Black Mountain. The city is surrounded by hills that offer good opportunities for microwave enthusiasts and VHF/UHF DXers. Because of the lack of local VHF/UHF FM activity, SSB operation on Saturday and Sunday mornings is likely to provide the best opportunities for long-distance contacts.

Melbourne

The Rialto Tower allows public access to its 55th floor for \$7.50. A good take-off exists in all directions. The tower is open until 10:00pm (11:00pm Fridays and Saturdays). Reasonable food is available from the cafe near the viewing deck.

Though not nearly as high as the Rialto, Tony VK3JED has had good results from the Westgate Bridge while operating mobile on various frequencies between 144 and 1300 MHz. The main problem here is that the operating time is limited to about two minutes (depending on traffic conditions). Other sites that Tony says are worthwhile include Glen Waverley (alongside the Police Academy), Bundoora, just north of LaTrobe University, and Doncaster Shoppingtown (in the top level car park).

Perth

The Western Australian Tourism Centre advised that Perth has no buildings which have observation decks that are regularly open to members of the public. However, good views are available from the top of the DNA spiral look-out in Kings Park. South-West repeaters are accessible from this site,

want to be able to operate as long as you possibly can. This means taking your handheld's biggest battery pack, perhaps with a fully-charged spare for good measure. A 12 volt 6 to 7 amp-hour sealed lead acid battery will provide reliable operation for hours at a time, especially if you indulge in long ragchews between contest contacts. Operating time can also be extended by selecting the low power setting on your transceiver - 1 watt is plenty for most metropolitan-wide contacts, and quite long distances can be spanned with just a few milliwatts of transmit power.

Attitude of building staff

Provided you use modest antennas, refrain from shouting into microphones and flooding the building with FM receiver hiss, staff will generally be courteous and tolerant of your transmitting activities.

It's not a good idea to stay in the same spot for a long time - you may be considered a security risk and may be asked to show the contents of your bag. Moving at least every 5-10 minutes also lets other people enjoy your view and allows you to try for contacts or repeaters in other directions.

Getting contacts

To get a worthwhile number of contacts, you will need to generate activity yourself.

If you are operating from a large city, it should be easy to work people throughout the metropolitan area and beyond with a few watts. Don't assume that contacts will come easily simply by calling CQ on 146.500 MHz just because the Callbook lists it as the FM simplex calling frequency. You can have the world's biggest signal on 146.500 MHz but sometimes not get an answer.

The reason for this is that Australian hamdom is best understood as being a large number of disparate tribes, each inhabiting their own simplex frequencies or repeaters. The best way to make more contacts is to tune around the obscure simplex frequencies in the week prior to your expedition and find out who uses which frequencies. Then put out calls on these frequencies as well as the recognised calling channels when you're portable. Also do not neglect that some country repeaters will be workable from your lofty position. Your transceiver's repeater reverse facilities can be used to determine if you could attempt simplex operation with stations you work.

Another way to get more contacts is to generate awareness of what you are doing and when you will do it. This may include mentioning it at radio club meetings, putting a message on the aus.radio.amateur.misc Internet newsgroup, mentioning it on the VK-VHF-DX reflector and placing a bulletin on packet radio. It's not every day

that local amateurs can work their city's tallest building, and you will find that your activities will generate interest among local hams, which means more contacts for you.

Contests

Contests with a VHF section are excellent times to go portable from a tall building. This is because they bring out people that are seldom on air at other times.

There are huge variations in contest activity between capital cities. For example, in Perth there is not much interest in the Spring and Summer VHF/UHF Field Days, but the Remembrance Day contest brings dozens of normally inactive operators to the VHF/UHF bands. In contrast, station logs confirm that VHF/UHF RD contest activity is almost unknown in Sydney, despite that city's larger population. Like Perth, Melbourne also enjoys high RD contest activity on VHF. The other cities fall in between these extremes. The Remembrance Day contest is held each August - this year's is scheduled for the weekend of August 14-15. It's the best opportunity you'll get to work many stations in a short time from a high place on the VHF and UHF bands. The RD rules will appear in the July or August *Amateur Radio*.

Many amateurs don't like contests or say that they have 'been there, done that' and will not submit a log. However, it's usually possible to wring numbers out of these people, and get points that others miss. You can work these people by calling them on 'their' simplex frequencies (found out pre-contest). Your publicity should emphasise that your activity is a rare chance for stations to 'work the city's tallest building' only casually mentioning that you are there as part of a contest operation. If you are a lot of people's first contact (ie many 599001 numbers in your log) you know that you have been successful in generating this type of activity for yourself. With any luck the stations you work this year will be more active in the contest next year.

Conclusion

I have operated portable from Melbourne's Rialto Tower during the last three Australian VHF/UHF contests. Distances approaching 150 kilometres have been spanned with 2.5 watts FM to a simple whip antenna. Operating from tall buildings is a great way to exploit the capabilities of your equipment to the maximum and make contacts not possible from your home station.

Novice Notes Online:

<http://www.alphalink.com.au/~parkerp/nonline.htm>



Melbourne's Rialto Tower - one of Australia's top spots for transmitting.

Novice Notes Feedback File

Two items of correspondence, both on aspects of antenna system grounding, have recently been received from readers.

In response to April's column on low profile antennas, Allan VK4FBB advised that there was a good article on grounds and earth wires in the April 1991 issue of *73 Amateur Radio Today*.

Allan said that the article contains full instructions on an RF ground that really works and can be used up to four floors above ground. Old magazines frequently turn up at hamfests and junk sales, and you may be lucky.

A reader who wishes to remain anonymous has been plagued with a problem in his mobile station for nearly a year. The equipment used was a Codan 9323 and auto tune antenna. The fault showed as jittery audio and towards the end as jittery transmit as well when he was mobile. However everything worked properly when the vehicle was stationary.

The problem stumped various two-way experts that were asked about it. Because the fault had got worse, my correspondent decided to check the connections all again. The problem turned out to be that the earth braid on the coaxial cable was intermittent at the antenna end.

He wonders how many others have fallen foul of the same simple yet bewildering fault. Even after more than 30 years playing radio, earning a living from it and all, he still fell for the trick.

ar

TECHNICAL ABSTRACTS

Gil Sones VK3AUI

30 Moore Street
Box Hill South Vic 3128

RF Current Probe

A simple relative reading RF current probe was described in QST February 1999 by Steve L Sparks N5SV. The probe uses a

adjust the sensitivity control to obtain a suitable reading. You can then observe relative RF currents. This can be handy for adjusting radials or looking for current in

leads. You can resonate a ground lead or see how RFI reduction measures affect the current in shack cables. You can also see if all radials are working and carrying their share of the RF current.

Mini Sky Needle

Rick Littlefield K1BQT described a simple way of mounting and rotating a small mast in *Communications Quarterly*, Fall 1998 in the Tech Notes column of Peter Bertini K1ZJH.

The mast used was a push up TV mast from Radio Shack that looks similar to those available locally.

The rotator used was an Alliance HD-73 which would have equivalents available locally.

The whole setup was mounted on the wall at the side of a house.

The setup is shown in Fig 2. The rotator was bottom mounted onto a shelf bracket arrangement fastened to the side wall of a house.

The load and the sideways torque component should be spread out if possible. In a timber house it would be best to fasten to the studs, as the skin may not be substantial enough.

The thrust bearing used was located higher up the wall near the eaves and once again the loading from the mounting should be spread.

The thrust bearing used was an aluminium casting obtained from a marine chandler that was designed for fastening two-inch pipe to a dock. There may well be similar fittings available locally or you could make a steel bracket without too much trouble.

The author used the mast ungued but except for brief periods with only a small VHF antenna this cannot be recommended. The TV push-up masts are really only stable with a full set of guys when extended.

Many have had the experience of what can happen when things go awry during erection. However they are useful when used within their capabilities.

The mast and mounting assembly should be carefully checked and aligned as any binding or misalignment is very undesirable.

You may be able to test alignment of the mountings by trial assembly on a plank prior to fastening mountings to the wall.

I have seen a similar assembly used by a unit dweller that used a wooden frame that was attached to the wall in such a way that it could be removed without leaving marks.

The mast and rotator should be earthed for a measure of lightning protection. This

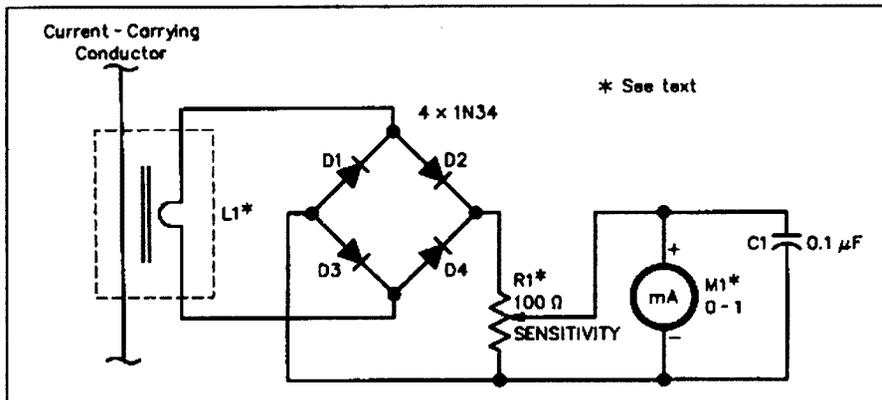

Fig 1. RF Current Probe diagram

snap-on Ferrite choke for the coupler and has good sensitivity that can be improved if necessary by using a more sensitive meter.

The probe circuit is very simple and the only specialised part is the snap-on ferrite choke core.

The one used was obtained from Radio Shack, known locally as Tandy. The ferrite choke may well be available locally from Tandy. Dick Smith, Jaycar and possibly other shops stock alternative chokes. The Radio Shack part no. was RS 275-105.

The winding on the current transformer is one turn of number 14 wire lengthwise through the snap on ferrite choke core.

The bridge rectifier uses germanium diodes. Silicon diodes should not be substituted as their forward voltage is about twice that of germanium. The diodes were also obtained from Radio Shack and there are various local suppliers of 1N34 germanium diodes.

The circuit is shown in Fig 1. A note on the sensitivity potentiometer refers to the author using a 10-turn pot so as to make adjustment easier.

The ferrite choke was glued to the top of the metal enclosure used to house the device. The 0.1 μ F capacitor was a disc ceramic.

To use the device simply snap the ferrite core around the conductor carrying RF and

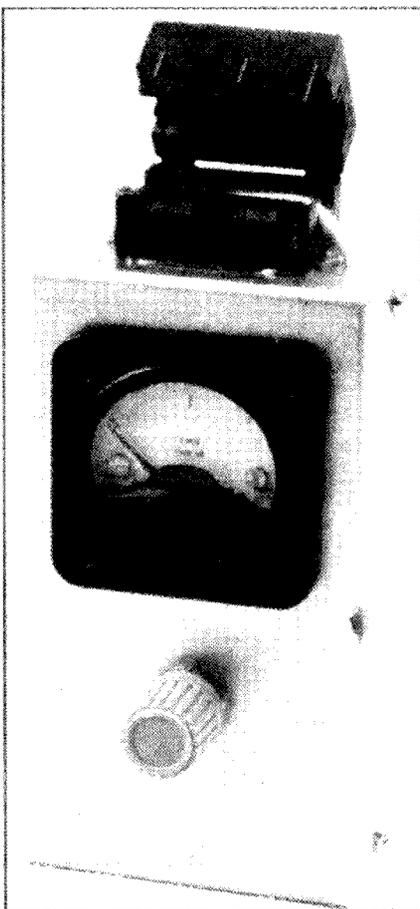

Fig 1b. The RF Current Probe

Continued on page 34

will help divert any stray currents from the shack and is a wise precaution.

The sky needle reference is to a rather larger construction of a base mounted free

standing mast that was rotated from the base. These were available in the USA and made a very elegant antenna support.

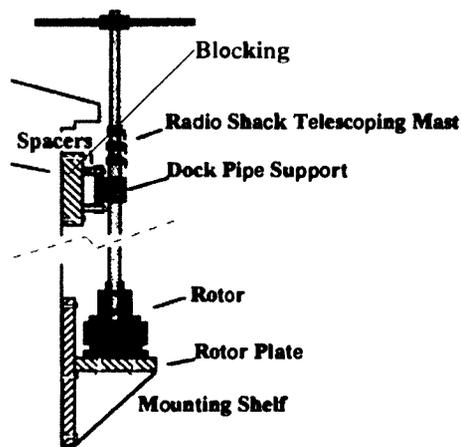

Fig 2 Wall mounted Antenna Support with Bottom Rotator

Second Harmonic Optimised Low Pass Filter.

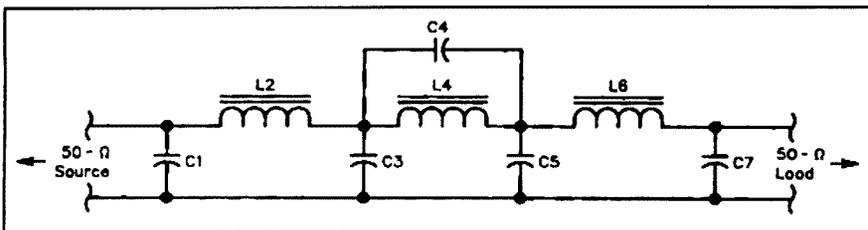

Fig 3. Modified Low Pass Design.

A low pass filter using a modified Chebyshev configuration designed to provide improved second harmonic rejection together with good return loss performance in the passband was described in *QST February 1999*.

The author was Ed Wetherhold W3NQN. A software program from Jim Tonne WB6BLD at Trinity Software was used in the design.

The filter is shown in Fig 3.

Values for various bands are shown in table 1.

The 1 MHz values allow you to scale values for any band of your choice.

The basic idea is to place an additional capacitor across L4 to increase the attenuation of the second harmonic.

A computer plot of the performance of a standard Chebyshev design is shown in Fig 4 using the Elsie computer program.

A similar computer plot of the modified design of Fig 3 is shown in Fig 5.

The Elsie program is available from Trinity Software 7801 Rice Dr., Rowlett, Tx, 75088.

The author describes the filter as a Chebyshev with Added Zero or CWAZ design.

ar

Table 1

CWAZ 50-Ω Low-Pass Filters

Designed for second-harmonic attenuation in amateur bands below 30 MHz.

Band Frequency (m) (MHz)	C1,7 (pF)	C3,5 (pF)	C4 (pF)	L2,6 (μH)	L4 (μH)	F4 (MHz)
Start — 1.00	2986	4556	680.1	9.377	8.516	2.091
160 1.80	1659 1450 + 220 1500 + 150	2531 2100 + 470 2200 + 330	378 330 + 47	5.21	4.73	3.76 3.78
80 3.50	853 470 + 390	1302 1150 + 150 1200 + 100	194 150 + 47	2.68	2.43	7.32 7.27
40 7.00	427 330 + 100	651 330 + 330	97.2 100	1.34	1.22	14.6 14.4
30 10.1	296 150 + 150	451 470	67.3 68	0.928	0.843	21.1 21.0
20 14.0	213 220	325 330	48.6 47	0.670	0.608	29.3 29.8
17 18.068	165 82 + 82	252 100 + 150	37.6 39	0.519	0.471	37.6 37.1
15 21.0	142 150	217 220	32.4 33	0.447	0.406	43.9 43.5
12 24.89	120 120	183 180	27.3 27	0.377	0.342	52.0 52.4
10 28.0	107 100	163 82 + 82	24.3 27	0.335	0.304	56.5 55.6

NOTE:

The CWAZ low-pass filters are designed for a single amateur band to provide more than 50 dB attenuation to the second harmonic of the fundamental frequency and to the higher harmonics. All component values for any particular band are calculated by dividing the 1-MHz values in the first row (included for reference only) by the start frequency of the selected band. The upper capacitor values in each row show the calculated design values obtained by dividing the 1-MHz capacitor values by the amateur-band start frequency in megahertz. The lower standard-capacitor values are suggested as a convenient way to realize the design values. The middle capacitor values in the 160- and 80-meter-band designs are suggested values when the high-value capacitors (greater than 1000 pF) are on the low side of their tolerance range. The design F4 frequency (see upper value in the F4 column) is calculated by multiplying the 1-MHz F4 value by the start frequency of the band. The lower number in the F4 column is the F4 frequency based on the suggested lower capacitor value and the listed L4 value.

**Amateur
Radio**
Technically
Tops

Second Harmonic Optimised Low Pass Filter — Plots

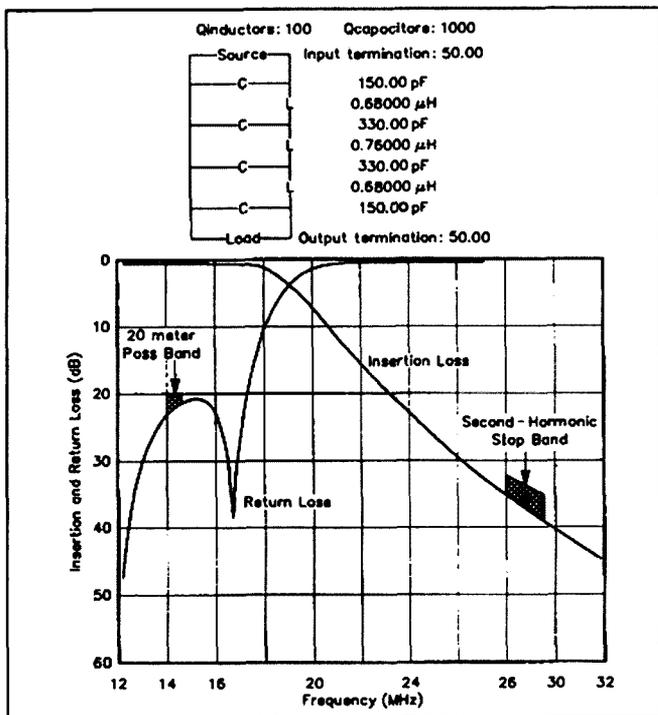

Fig 4. Elsie Plot of Seventh Order Chebyshev Design.

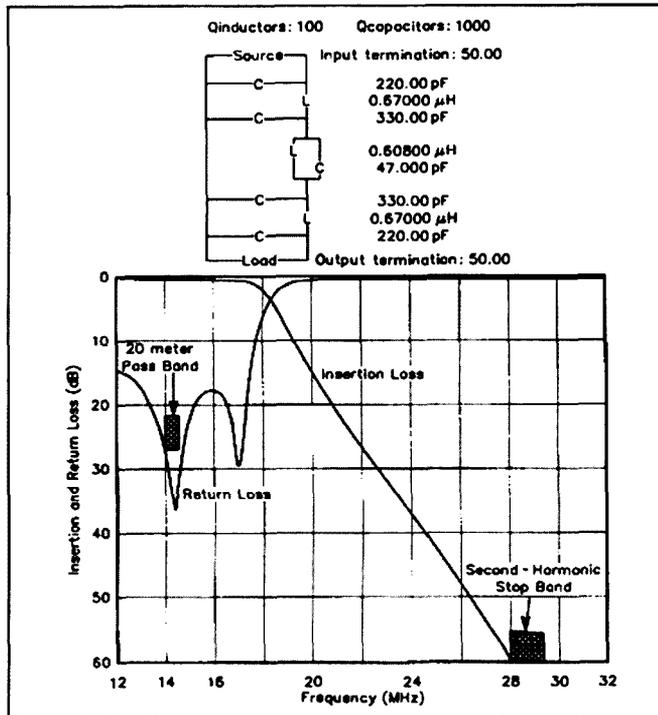

Fig 5. Elsie Plot of Modified Design.



Radio and Communications

Incorporating AMATEUR RADIO ACTION and CB ACTION

Edited by
**Chris Edmondson,
VK3CE**

Box 1 Yarra Road,
Wonga Park,
Victoria 3115
(03) 9722 9666

This handy-looking collection of equipment is overhead, aboard the Mir space station. Okay, so how did it *get* there? We asked one of the men who made it possible, and the story is well worth reading. Another story well worth a good look is our review of the third generation of the great Icom mobile, the IC-706MkIIIG. This is one giant-killing radiol

June's R&C is just jammed with great amateur radio columns and stories. Don't miss any of those...

- BONUS DICK SMITH ELECTRONICS catalogue. 260 pages stuffed with great products and data, *free!*
- HOW TO BE A QSL MANAGER: Jack Haden, VK2GJH, explains everything that's involved in the job.
- THE DXCC PROGRAM: Jim Smith, VK9NS, tackles this one in a multi-part series. This month, the intro.
- TUNING QUAD ANTENNAS: There must be a knack to it... and Steve Ireland, VK6VZ, has that knack!
- ICOM IC-706MKIIIG REVIEW: What a weird name! But what a nice, compact radio. Our full review...
- As usual, we have our three DX columns, mods and lots more... the best stories and regulars every month!

Don't miss out — **RADIO and COMMUNICATIONS** is great reading for amateurs!
Check your local newsagent today!

(PS. We also have the biggest collection of radio-oriented Classified adverts in the country. There's lots of them because they work so well. Ask your newsagent to keep a copy for you each month. Hurry — you might miss something!)

v3ce

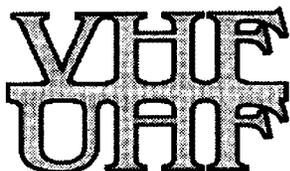

AN EXPANDING WORLD

Eric Jamieson VK5LP

PO Box 169 Meningie South Australia 5264

E-mail: vk5lp@ozemail.net.au Fax: (08) 8575 1777

Packet: VK5LP@VK5WI.#ADL.#SA.AUS.OC

All times are UTC

narrow band segment of 70 cm with 20 mW ERP equipment used for the transmission of data, RF keylocks for vehicles, radio control devices for models and similar activities.

There have been many comments on the Macquarie Reflector for several weeks but little since the ACAs posting of their comments.

I don't propose adding anything in these columns other than to bring the matter to your attention. No doubt AR will carry such information in a separate form. For me to go into the matter fully will probably mean unnecessary duplication, but I am concerned that the use of LIPDs is more likely to escalate than reduce.

Microwave news

David Burger VK2CZ is currently working on equipment to operate on 24.192.1 GHz. He says: *It is of DB6NT origin, but a more flexible design than he publishes in his catalog. Presently I have a 300 mm dish and that will grow to a 900 mm dish in a month. The overall performance is a receive NF of 1.6 dB (measured) and a power output of 85 mW CW (measured). Modes supported are FM/SSB/CW This has been fully operational since 2/99. (Tests courtesy of ATI Microwave, Peter Choquenot).*

I'm waiting for a couple of others here in Sydney to get up to speed, and the UK ham in Chatswood to bring his gear back to VK. The 24.192.1 GHz international calling frequency (!) appears not to be used in VK where 24.048.1GHz is favoured.

Walter Howse VK6KZ writes: *I note David Burger's comments re the use of 24.192 GHz and am excited by his designation of an INTERNATIONAL calling frequency - oh, if it could be such from VK!*

Up to the present, the narrowband activities on 24 GHz have been focused on 24.048 GHz. As one of the two pioneers of narrow-band (together with Neil Sandford VK6BHT - now VK2EI) we chose the 24.048 part of the spectrum as it is consistent with the Australian band plan and has the benefit of overlapping the satellite service. It is the likely future direction of the Europeans.

Currently stations with narrow-band gear on the 24.048 GHz portion of the spectrum include VK2EI, VK2ALU (under construction), VK3XPD, VK3ZQB, VK5NC, VK5KK, VK6ZAY and VK6KZ. It is highly likely that further stations planning activity in VK6, VK5 and VK3 will choose 24.048 GHz.

Of course the potential for long haul contacts interstate is limited but those contemplating building (or buying) gear for

stations except for VK2AQJ and myself, as the VK1 call for Canberra had not been issued at that time.

This activity is perhaps brought into perspective when we realise that this was in the days before the launch of TV in Australia. It was not until a year later that the first satellite, Sputnik 1, was launched, and while watching it go over, little did I think that I would some day be using satellites for Ham Radio and making contacts through a manned Space Station, MIR.

Technology has certainly changed the hobby. I am presently playing with SSTV to receive pictures from MIR, but I do not believe I will ever have as great a thrill as listening to those first squeaky signals travelling the whole length of my workbench on the One Metre Band!

Thanks Eric for raising the topic and I trust the foregoing may fill in a bit more info into what were fun times with simple gear. I enjoy your column.

Another 47 GHz Record for the French

The *RSGB Microwave Newsletter* for February reported that **F6BVA** and **F5CAU** extended their 47 GHz world record to 268 km on 26/12/98. F6BVA operated from Tour de Batere (JN12gm) at 1400 metres elevation, while F5CAU set up on the 1500 metre Mt. Ventoux (JN14pd). The air temperature was just above freezing. ... **W3EP** and **QST**.

Class Licences on 70 cm

I draw readers attention to the WIA Federal Statement by **Peter Najsh VK2APN** on page 5 of April AR, regarding Class Licence operations on the 70 cm band. There is also the ACA response to be found on the Victorian WIA Web site at <www.tbsa.com.au/~wiavic>.

All makes interesting reading. It certainly seems we will be sharing a portion of the

One Metre days

This letter from **George Adams VK2WEL** arrived some time ago, but pressure of space has prevented me from using it. It adds another saga to those daunting one metre days. Thank you George. ... **VK5LP**.

I have read with great interest your recent articles in AR re the One Metre Band and does it sure bring back some great memories!

In the early 1950's I lived at Queanbeyan and in September 1955 I gained my "Z" call VK2ZBT, and set about building my first transmitter from the details of the 288 MHz design in "Radio & Hobbies". Each piece of gear was built on the chassis from an old broadcast receiver. The tubes were 7193s for the transmitters, and 955s for the Super-regenerative receivers, and folded dipoles for the antennas. I later built a 16 element beam.

I know how Marconi must have felt when he first had success, because when I completed my gear, I did not have anybody locally with One Metre gear with which to test it. I made a set of Lecher Lines to set the transmit frequency, and then fiddled with the receiver until the great moment arrived when I could transmit my voice from one end of my work bench to the other!

I made a second receiver and passed it to Bud Pounsett, then VK2AQJ, VK4QY until recently when he passed away. He was the only other ham living in Queanbeyan at the time. Bud lived about a mile away, and it was sheer delight when he could hear me 5x8. This, my first real contact, was on 19/12/55.

With the National Field Day set for February 1956 some fellow members of the Canberra Radio Society (now the VK1 Division of the WIA), got to work and built One Metre gear. My log for the day shows Stan VK2ASB, Bud VK2AQJ, Ted VK2AOP, VK2AIL, VK2ZBS and Ron VK2PM as having been worked. VK2ASB was mobile. We did very well in the Field Day with the multiplier from the One Metre contacts. Note that these were all Canberra

24 GHz should think carefully about the choice of operating frequency. After all, most of those with 24.048 GHz gear have track records for travelling interstate for portable operations. (Got to get contacts somehow!)

Six metres

Neville Mattick VK2QF posted the following autumn equinox Seasonal Summary from 01/02/1999 to 30/04/1999 on the Web site <<http://www.winsoft.net.au/~vk2qf/summary.htm>>.

QSO Total: 281

QSO Totals by DXCC:

Japan 256 Australia 4 Marshall Is 2
Ogasawara Is 1 Marcus Is 1 Banaba 2
Mexico 2 Belau 1 Taiwan 1 New
Zealand 2 Korea 7 Caribbean Sea 2
CW = 259 (92%) SSB = 22 (8%)

Seasonal Performance:

The season reflects the early pre-peak stages of a solar cycle ascent. Classic of this at 32.75 degrees South are brief East-West longitudinal aligned pipes. An example of this would be W1LP/MM in the Caribbean Sea off the East Coast of Nicaragua and the regular reports of the Mexican beacons. Best DX on this mode was hearing traces of unworkable signals from WP4O > 15000km. Other contacts on the local F2 were infrequent, notably T3 and T8. As yet this mode of straight propagation (non "super F") did not extend much more than 15 degrees West of North so far this cycle.

Only two workable sporadic E events can be recalled, one to New Zealand and the second to North Queensland. The Sporadic E event on the evening (March 31 0800-1100z) unusually linked to Super F mode TEP with second departure from North Queensland. It was this opening that resulted in 5 countries (Japan-JR6 etc) worked in that period all in the difficult region 24 degrees North. Significant in that contacts from this location are uncommon to 32 degrees South along with a brief combination of modes and high levels of focussing leads to a narrow window of opportunity per contact.

Standard TEP modes I and II were quite predictable and especially the openings of 20/3, 21/3, 22/3, 10/4 and 11/4/1999. During these openings video signals from West China and Russia were common. In the classic window of 0700-1100z numerous transmitters were heard on many days from Malaysia, the Middle East and Europe (esp 48.239.6 JN39).

Summary:

Simply an outstanding season for an average VK2 station and operator in a poor location, given the current point on the solar graph. Two new countries worked and a

good spread of contacts from East to North. Activity levels especially on TEP to Japan were good and general operating decorum was high. A pro-active approach to DX was taken by trying to be available in most openings. ... VK2QF.

Mike ZL2TIC reports that Saturday 17/4 was an interesting period. A summary follows:

1930 35 MHz pagers 5/9+.

2230 Utility stations from North America/Mexico to over 40 MHz.

0010 Very strong Asian stations up to 40 MHz, including strong repeaters on 39.550,575,585 and 975; all sounded like some sort of taxi service. 35.200 to 35.270 broadband FM tone with very strong signals? Never heard this before.

0200 Asian signals 30-45 MHz strong and many of them.

0300 Strong Aurora beaming south 45.250,260; 55.240,250,260 all 5x9. 0330 ZL3SIX/B 50.040 5x9 via Au.

0400 49.750 with many weak offsets, with what sounded like meteor pings.

0430 48.240 5x5 with QSB.

0530 46.170 TV 5x8.

0730 49.750+/- building up to 5x9, also 30 MHz to 47 MHz+ strong Asian Utility stations.

0800 Strong JA opening lasting half an hour, many worked.

John VK3ATQ advises that the morning six meter scheds are alive and well. He says: *Just to remind you of the format, we usually start off at 7 am (2100) on all weekday mornings (no weekends). The frequency we start on is 50.130 MHz and the stations active are David VK3ANP (Wangaratta), Warren VK3BWT (Mallacoota), Eddie VK1VP (Cberra), Jack VK3AJK (Lakes Entrance), John VK3BQS (Sale), Joe VK7JG (Launceston), Andrew VK7XR (Devonport), Bob VK7JR (King Island) and David VK3XDR (Hallam). Steve VK3OT (Hamilton) comes on every couple of weeks to stretch the legs of the far eastern ops like Warren and John! The VK7 stations are usually to be found on 50.135 MHz from 2115 through to 2135.*

The scheds are necessarily short, as most ops are off to work shortly after. Some of us hook up on 3.650 MHz after the six-meter activity and compare notes.

It is interesting to see how our group members have slowly improved their stations over the past few years. David VK3ANP has built a W1JR designed 8 element Yagi (35 foot boom) and his station capability has increased remarkably. Joe VK7JG has also made some antenna changes and his station has a big signal into Melbourne. Mike VK1KCK has acquired a new FT650 rig (which most use) and will be on air in the next month or so. We all

now reliably work out to the 450-500 km range each morning. Comparisons with two meters seems to verify the theoretical path loss equations ie six meters is 8 to 10 dB better unless some form of enhancement is present.

1999 SMIRK Contest

A long time friend of mine, Bill Tynan W3XO, Vice President of the Six Metre International Radio Klub (SMIRK) has asked me to advise you of the 1999 Contest. He also sends greetings to VHFers in Australia.

As there are quite a number of members in VK and others may be interested, the details are as follows.

The SMIRK QSO Party, sponsored by the Six Meter International Radio Klub will be held from 0000Z June 19, 1999 through 2400Z June 20, 1999. Contacts must be on six metres only, voice and/or CW. No contacts involving another band for one side of the contact count.

One need not be a SMIRK member to take part. Logs must be postmarked no later than 1 August, 1999 and sent to Pat Rose W5OZI, PO Box 393, Junction, Texas 76849, USA.

No contacts between stations in the 48 contiguous U.S. states and lower tier Canada (VE1 through VE7) are allowed between 50.100 and 50.150. Only contacts with and between stations outside of these areas may take place in this band segment.

All contacts must be made by a single operator. There is no multi-operator category in this contest.

Exchange is callsign, SMIRK number if the station worked has one, and grid.

Partial contacts in which one of the above pieces of information is missing, do not count.

All contacts must be made via natural propagation. No contacts using repeaters or any man made device for relaying transmissions are allowed.

All participants must observe the rules governing Amateur Radio operation in the participant's country.

Scoring is as follows:

Count 1 point for each completed contact. If station worked provides a SMIRK number, multiply by 2. Final score is contact points times grids worked. New log forms are available from W5OZI at the above address, or on the SMIRK Web site at <http://www.smirk.org/>.

Continued on page 38

E-mail address change

Please note that my e-mail address is now changed to <vk5lp@lm.net.au>. This allows me to have local call access fees instead of STD charges.

Certificates will be issued to the highest scoring participant submitting a valid log, in each ARRL Section, the Maritime Provinces and each of the remaining Canadian provinces and each other DXCC country. If different from the above, a certificate will also be awarded to the highest scoring SMIRK member from each of these areas submitting a valid log. To be valid, logs must include this above location information.

For the purpose of this contest, a SMIRK member is anyone who has ever been issued a SMIRK number, whether or not he or she has paid dues in recent years.

Of course, all 6-meter operators are encouraged to join SMIRK or renew. Renewals may be obtained by sending \$6 to the above address, noting the SMIRK number. Anyone not a member may join by sending a list of six SMIRK members worked on 6 meters, along with \$6 to the above address.

An attempt will be made to issue a SMIRK number to each new member applying in time to fully participate in this year's SMIRK QSO Party.

SMIRK members as well as non-SMIRK members are invited to take part in this fun event. Why not give it a try? ... W3XO.

Beacons

Chas VK3BRZ says there still appears to be some uncertainty about the VK3RGL 2m beacon, so here are the definitive technical details:

Location: Mt. Anakie QF22DC, approx. 300m asl.

Power: 15W divided equally between two antennas

Frequency: Unkeyed carrier: 144.530MHz

Keying: FSK, with mark freq. shifted up approx. 700Hz.

Antenna: Two 4-element horizontally polarised yagis (see below)

Ident sequence: de VK3RGL VK3RGL QF22DC VK3RGL VK3RGL QF22DC followed by 20 seconds of unkeyed carrier.

The entire sequence is sent within 60 seconds.

Antenna System Details:

The antennas are two 4-element yagis designed using "Yagi Analyzer". Forward gain of each is 8 dBd and the 3 dB beamwidth is 50 degrees. The 10 dB beamwidth is 84 degrees.

The "west" yagi is pointed on a bearing of ~293 degrees.

To visualise this, think of a line from Geelong to where the VK6 border crosses the south coast of Australia. The 3 dB extremities go through Port Augusta and a few hundred km south of Albany. Adelaide and Esperance are both just 2 dB down on the main lobe, or, to put it another way, 6 dB up on the old omni antenna. The 0 dB extremities pass through Darwin (I'm an optimist!) and somewhere in the southern ocean (Heard Is.?).

The North-East antenna is on a bearing of ~35 degrees.

Its main lobe is directed at where the VK2-VK4 border reaches the coast. The 3 dB beamwidth lies towards Lord Howe Island and a little south of Mackay. The 0 dB points go through Cape Howe (Vic.) and Cooktown (QLD).

Modifications to FT-736R

Chris Hill VK6KCH sent the following that may interest users of the FT-736R on six metres.

Around 1988/89, I was using a Kenwood TS-680, which allowed me to listen for the various TV transmissions etc on 48 and 49 MHz, using these signals as an indicator of possible 6m openings into JA etc.

When I upgraded to a Yaesu FT-736R, the one major deficiency was that it wouldn't receive below 50.000 MHz. How frustrating!

I recently found some interesting information at <<http://www.qsl.net/k70n/mods/yaesu/yaesu.htm#FT-736>>.

Based on the information credited to G0HEG and G0TVL, here is how I can now receive from 49.3 MHz to 54MHz.

1. Set VFO B to 53.999 MHz.
2. Set VFO A to 50.000 MHz.
3. Enable the +RPT (hit F, +RPT).
4. Change repeater offset to 01.999 (hit F, BAND, 01999, ENT).
5. Press REV.

6. Press UP MHz key. Should now see 49.000 MHz.

7. Store in PMS, by hitting F, PMS.

This sets the PMS frequency range to be 49.000 to 53.999 MHz. By pressing PMS, you can now freely tune across that range. My VCO falls out of lock below 49.3 MHz. I still use the normal VFO mode for general operations. It is also possible to save a 49 MHz frequency into a memory from PMS, using the VFO>M button.

The full procedure given on the above web site didn't work for me; it seeks to enable display of 00.000.0 to 999.999.9 MHz! Of course, the hardware of the radio won't match that!

I accept no responsibility for any possible side-effects, and people shouldn't transmit out of band. ... Chris VK6KCH.

Listener news

David Vitek of Parkholme SA, sends further loggings, mainly from the spectrum just below 50 MHz.

David says that conditions have been quiet on six metres with the flux stuck! Ten metres if often available. Most days during April the Asian MUF sat around 39 to 41 MHz. Since then the evening/night TEP has disappeared.

The video around 48.240+ and 49.750+ was logged on 15 days. On 5 days there were no signals at all, not even 10 metres. Video signals were frequent around 0300 but also turned up around 0800-0900.

Some of the exotic 10 metre signals have included areas VU3, 9H1, SV3, ZD8, TX8, DF0, 3B9, Z21, 9J2, JT2, ZS6, T70A, 4Z0, LU5, HK6, HR1, AP2, 5B4. It appears these signals can appear at any time of the day or evening.

I suppose the moral is - if you are disillusioned with six metres, have a look on ten metres - it will help to fill your day!

Closure

Since the equinox band conditions have certainly died on six metres. Mid winter may see the occasional Es opening, but I suggest we will need to wait at least until August before there will be much change. September and October will be worth watching for a return of F2, and November may even see the path open to Europe.

Closing with two thoughts for the month:

1. When all is said and done, it's the politicians who say it, and the tax-payers who do it; and
2. Pretensions are a source of pain, and the happy time of life begins as soon as we give them up.

73 from The Voice by the Lake.

ar

Amateur Radio

reporting on technique and opinion in the world of Amateur Radio

AMSAT AUSTRALIA

Bill Magnusson VK3JT
RMB 1627 Milawa Vic. 3678
Email: vk3jt@amsat.org

National co-ordinator:
Graham Ratcliff VK5AGR
Email: vk5agr@amsat.org

AMSAT Australia net:

The AMSAT-Australia net is held on 80 or 40 meters LSB (Lower Side Band) each Sunday evening (except over the Christmas/New Year period). During the winter months in South Australia (end of March until the end of October) the net is on 3.685 MHz +/- QRM with an official start time 1000utc with early check-ins at 0945utc. During the summer months when daylight saving is in operation in South Australia (end of October until end of March) the net is on 7.068 MHz +/- QRM with an official start time of 0900utc with early check-ins at 0845utc. The times and frequencies have been chosen as the best compromise for an Australia-wide net taking into consideration seasonal propagation changes and the various state summer time variations.

AMSAT Australia newsletter and software service:

The newsletter is published monthly by Graham VK5AGR. Subscription is \$30 for Australia, \$35 for New Zealand and \$40 for other countries by AIRMAIL. It is payable to AMSAT Australia addressed as follows:

AMSAT Australia
GPO Box 2141
Adelaide SA 5001

Keplerian Elements.

Current keps are available from the Internet by accessing the AMSAT FTP site, ftp.amsat.org and following the sub-directories to "KEPS".

Satellite signals and the forthcoming sunspot maximum.

The time is right and the charts tell us that we should expect better HF propagation conditions over the next few years.

What has this to do with satellite operation? Well ... satellites orbit ABOVE the atmosphere. They have to. No satellite could be accelerated to orbital velocity inside the atmosphere. It would burn up. So most orbits are 1000 km or more in altitude.

Even at this height there is a tiny amount of residual 'stuff' out there. The atmosphere doesn't just abruptly stop at a specified height but rather tapers off gradually. Out at geostationary orbit the residual 'stuff' can be ignored for all but the most rigorous

payloads with up to a rather surprising 10 meter image resolution. It will feature digital store-and-forward communications in both the VHF and UHF band segments.

Mode L/S voice transponders will also be supported. The satellite is a departure from the 'normal' UoSAT spaceframe in that it is considerably larger and carries a propulsion system.

The imaging system comprises a panchromatic imager and a multispectral imager along with a wide-angle colour camera. The S-band downlink can run at speeds up to 1 mega-baud per second for downloading imaging data. The mode L/S frequencies are selectable via ground station command.

It is expected that the L/S payload will consume quite a lot of power, which means the transponder will not run continuously but will be subject to on/off times following a published schedule.

"All you ever wanted to know about Amateur Radio Satellites but were too afraid to ask".

The President of AMSAT-ZL, Jeff Garrett ZL1BIV has produced a CD containing just about every conceivable piece of data and shareware that is available on the subject of Amateur Radio Satellites.

His "AMSAT-ZL Satellite Compendium 1999" is a veritable mine of information. Jeff has done a remarkable job in archiving a host of relevant information and shareware programs relating to amateur radio satellites.

This is a CD that should find its way into the shack of every amateur seriously interested in amateur radio satellites. The information is contained in some 47 directories and sub-directories. There are tracking programs, Satgen bulletins, Y2k information, images, articles by well as known authors, URLs, equipment mods. I won't try to list them all.

The CD can be ordered from AMSAT-Australia at Box 2141, Adelaide S.A. 5001. It represents great value at \$30 for Newsletter subscribers and \$40 for non-subscribers.

This price includes packaging and air-mail postage. A very valuable reference source.

Correction to last month's column.

In the May column I incorrectly quoted Martin Sweeting's callsign. His correct call is G3YJO. My apologies go to Martin. Somehow I had Pat's callsign in my mind as I was typing and it escaped my scrutiny in several proof-readings.

"Surrey University raises the bar ... again".

Sure enough ... as soon as you commit something to print, it's either superseded or updated!

Following right along from last month's epistle on satellite imaging it was announced from Surrey University that the new UoSAT-12 had been launched. Because of his time-line, Graham was able to include this announcement in the AMSAT-Australia newsletter but we missed out on inclusion in the May column by just a couple of days. We can however now enjoy the benefit of more detail than was available at that early stage.

At the time of writing this month's column the satellite is well and truly up and running. So far its launching and commissioning have gone exactly to plan. It is transmitting 9600 baud FSK telemetry framed in a VLSI format using a downlink frequency of 437.400 MHz. The transponders and digital uplinks are not yet available for general use.

It has been granted an "OSCAR" number and can now be referred to as UoSAT-Oscar-36 or UO-36 for short. For those with Internet capability, the UoS team has produced a specific home-page for this new bird. You can follow all the very latest developments at <http://www.sstl.co.uk/>.

UO-36 is the latest satellite in a long string which have come from the University of Surrey. I made specific reference to a number of them in last month's column. Details of all these satellites are available on the above web site.

The amateur radio package on board UO-36 was built by the University's UoSAT team as a research satellite along the lines of UO-9, UO-11, UO-14, UO-15 and UO-22. UO-36 carries a number of imaging

Continued on page 40

studies. It's this 'tapering off' that gives us the ionosphere. The ionosphere is the ionised, rarefied upper region of the atmosphere so therefore satellites orbit outside it. Signals from the satellite to you and from you to the satellite must pass through the ionosphere. There's no way around it and by nature they try to do so in a straight line.

Whilst all the text books will tell you that the ionosphere affects HF propagation, all serious VHF/UHF DXers know that nearly all long distance work depends on ionospheric or tropospheric refraction of some sort. There will be times then, when signals from orbiting satellites will encounter a barrier on their way from the satellite to your receiving station (and vice versa).

Many of these anomalies will be of very short duration. Some will be hard to detect when using SSB mode. The digital birds and the NOAA weather satellites afford a good opportunity to study the effects of such conditions as both transmit a continuous data stream which gives a steady "S" meter signal.

Over the past few weeks I have been swapping notes with friends in Melbourne and elsewhere, looking for evidence of such anomalies. On several occasions we have noticed that signals can drop to zero for periods of several seconds and sometimes longer. These periods are interspersed with what at times may be dozens or hundreds of shorter 'drop-outs' lasting for perhaps only a few milliseconds. You can pick some of these up by "S" meter fluctuations on the digital birds but they are all, no matter how short duration, displayed as short black lines on the NOAA pictures.

The disturbances seem to occur mainly when the satellite elevation is close to the horizon, perhaps below 10 degrees elevation. Often they are confined to a short period of time, perhaps only a minute or so. There is rarely any such interference at high elevations. In Victoria we are at a latitude that puts us roughly midway between the auroral belt around Antarctica and the tropics where sporadic "E" is prevalent. This may account for the timing of the interference at low elevations. I'd like to hear from someone further afield as to the timing, or indeed the existence of this effect. It's something we will have to learn to accommodate as the sunspot cycle moves towards and through the maximum.

Next Month: The twice-yearly summary of Amateur Radio satellites, their operational status and frequencies.

ar

INTRUDER WATCH

IARUMS Notes

Gordon Loveday VK4KAL

Freepost Nr 4, Rubyvale, Qld 4702,
VK4KAL@VK4UN-1, Tel 07 4985 4168

International Amateur Radio Union Monitoring Service

Researching for the Annual Report brought to light quite a few failings in the reporting method.

Whether this applies in other countries, I do not know, possibly the coordinators there are sometimes at "their wit's end" to simplify the process?

For starters in VK, it appears that observers in this country no longer either have the time or inclination to "go out" and look for the intruders, but have offending frequencies, "dished out" to them!

Ok that's fine by me, I have a large database at the present holding about 340 offenders. From this it will be no problem holding a few of the worst intruders, maybe a bit more time will be needed, but what is time to a busy person?

But in making this time available, at MY END, I expect some of the 18,000 odd amateurs in VK to give a few minutes of theirs. Preferably from each call area.

Once again, if no log sheet is available, I will accept ordinary paper, provided it has the following info recorded:

- Freq,
- UTC,
- Date,
- Mode,
- Call sign if heard,
- Bearing if possible,
- Antenna in use at your end,
- S Meter and remember to put your own call sign in.

I intend to have a good look at the present log sheet, simplification is long overdue.

So for "starters " the frequencies of interest at present are: 3.560 around 1200z, 7.098/1600z, 14.250/0900z+ these are all A3E mode. What do you hear, tell me? 14.056, 14.064 & 14.091 MHz are A1A in the 1100>1300 time slot. Some info has been heard, but of no sense at present, much more copy is needed.

Intruder Watch is NOT a waste of operating time, world wide we have had many successes over the years.

VK observers over the years have had a major input to those successes, so let's keep our end up.

Thank You.
Gordon VK4KAL F.I.W.C.

WIA/IARUMS Summary for May 1999

Federal co-ord, Gordon Loveday VK4KAL, Rubyvale 4702

FREQ	DATE	UTC	EMM	DETAILS
3.560	0504	1200	A3E	R.Korea, news in English
7.098**	3004	1605	A3E	B/C Indonesia, Jakarta ??
10.1285	2304	0528	F1B	UiVFT, Ui PRINTER
14.002	1504	0650	F1B	UiVFT, plus FAX
14.006	2004	1035	F1B	UiVFT, Multi ch Printer
14.056	2604	1120	A1A	Uicw, 4 fig tfc non amat net
14.064	1804	1150	A1A	ID, "TW5Z" Linked to above freq
14.091	1204	1324>	A1A	3 rd freq of above, also 4 figs
14.1855	0904	0726>	F7B	UiMUX, ? pps Pulse
14.211**	1504	1643	F1B	UiVFT, 850 hz, 112bds
14.249	2004	0550	N0N	UiCarr, weak,+ lo modulation
14.250	2004	0940	A3E	R.N/Korea, H5 of 2.85 ? Birdie??
18.075	2204	1048	A3E	UiBC, non amateur net.
28.650	1904	2300	A3E	R.Habana, Cuba, H3 / 9550, ID ok.

** Primary Frequencies for Australian Observers.

REPEATER LINK

Will McGhie VK6UU

21 Waterloo Cr Lesmurdie 6076

will@faroc.com.au

vk6uu@vk6bbr

Repeaters on the Internet

In a past article in Repeater Link I described a system whereby amateur repeaters could be accessed by amateurs in a two-way link via the Internet.

This meant that amateurs could talk into distant repeaters that are set up for Internet access, from their computers.

The system required software control of the Internet linked repeaters and software for the users, plus a verification process to make sure that those using the system on the Internet are amateurs.

A number of amateurs in Australia have copied a variation of the system using their radio equipment and Internet connection to connect Australian repeaters to the World Wide Web.

This is a clever and inventive use of technology demonstrating one of our fundamental amateur goals, to be progressive.

ACA Query

However it probably is not legal, and the brief experiment conducted in VK6 soon disappeared.

Now comes a disturbing variation on the regulation side.

A VK4 amateur, Art VK4GO, was providing a one way only Internet connection between some local amateur repeaters and the Internet.

The one way is important to note, as only amateur activity was broadcast onto the Internet and not traffic from the Internet onto the local repeaters. In effect users of the Internet could listen to amateur activity but could not talk back.

What a great publicity boost this provides for amateur radio in these days of declining interest and numbers in amateur radio.

Trying to do the right thing, the ACA was

contacted in order to verify the legality of the setup. Their reply was, "it is not legal" and the system was shut down. There were two reasons given by the ACA. The first being that "amateurs cannot be re-transmitted without their consent" and the second one "connection to the telephone network is not allowed."

Putting aside the two reasons given by the ACA, an interesting point arises, could a non-amateur broadcast the amateur repeaters onto the Internet?

My belief is that a non-amateur could, and in fact the Internet is full of broadcasts such as police departments radio systems and all sorts of other forms of live broadcasts.

This could be an example of where an amateur qualification is a disadvantage. Your non-amateur spouse for example, could broadcast an amateur repeater onto the Internet but not you. The two reasons given by the ACA are long standing regulations and a brief look at both makes for interesting discussion.

Consent

The first "no re-transmission without consent" surely must relate to re-transmission onto another radio frequency and not the Internet.

In this instance I think the ACA are simply wrong. If you follow this silly direction for example, is putting a loud speaker in your garden for you and your neighbour to listen to amateur radio contacts illegal?

Having the volume up too loud in the mobile could also be illegal, or putting the telephone handset too close to your amateur receiver. The list could be a long one.

Telephone Network

The second regulation, "no connection to the telephone network" is a long-standing regulation that Australian amateurs have had to accept. This regulation was modified a few years back to allow phone patch and I assume we still are allowed phone patch.

However as soon as the word "repeater" appears, any connection to the telephone network is not allowed. As I understand it I can use a phone patch connection on my VHF 2 metre radio but not on a repeater channel. Explain that one to me if you can.

This situation aside however, applying this regulation to connecting a repeater via a computer to the Internet is a limitation we can do without.

Particularly as the traffic is one way only and as far as I can see non amateurs can do it, so why the limitation on the person who has the amateur qualification?

To Be Discussed

This situation is to be discussed by the WIA Liaison team at the next WIA/ACA meeting, and by the time you read this there may be an answer that allows amateurs the same right as non-amateurs.

Finding Time

Since I have taken on the Federal Councillor role for VK6, I have had little time for amateur radio, and as a consequence writing this column.

The column has become more difficult to write and limited, due to a lack of experimenting in amateur radio, and in particular repeaters. Federal council business takes up an average of one hour a day.

Added to this a renewed interest in canoeing and lightning damage to one of my computers that took a couple of weeks to sort out. Time is difficult to find for real amateur radio.

By the way the lightning damage probably came via my sound card. It was connected to my 2 metre radio to record the VK6 WIA news onto my computer so I could load it onto the VK6 WIA home page.

I had left the radio connected to the computer and discovered that when I switched it on the hard drive, floppy disk drive, sound card, mouse, com port one and two, printer port, and printer did not work.

I'm now a bit more cautious about leaving computers connected to the outside world. Luckily my household insurance picked up the repair bill but the time wasted was not compensated.

POUNDRING BRASS

S P Smith
9 Peak Street
Bateau Bay NSW 2261
02 4334 7743

Males over 20 years of age
Senior Females over 40 years of age
Senior Males over 46 years of age

Individual competitors and teams can also take part in the competitions. A team consists of up to 12 persons.

Championships Programme:

1. Reception of letter, figure and mixed messages with PARIS100 initial speed
2. Transmission of letter, figure and mixed messages.
3. Radio Amateur practising test (RPT).

Technical:

The reception messages last during one minute. The message of transmission shall fulfil as fast as possible during one minute each. Straight and Electronic keys are allowed to transmit the messages.

The messages in test 1 and 2 shall be received and transmitted in 5 character groups. The RPT consists of the RUFZ and PED computer programs with given conditions.

It is not compulsory to attend in all tests, for example, one can attend the RPT only.

Classification of Awards:

The summarised result in reception, the summarised results in transmission and RPT will be awarded separately.

Both individual participants and teams will be classified. This is only a short guide of the official rules.

The above as I mentioned earlier is an extract of the letter I received from Oleg Bezzoubov UA4FBP. It may be too short a time frame to organise something for the current HST in Italy, but certainly not for the next event.

I feel the possibilities for this type of contest are endless, with Oleg sharing his skills and experience with us, perhaps we could hold an all Australian contest, with each state selecting their best operators to represent Australia in the next HST Championships.

I am in the process of writing to each president of the WIA to discuss this matter. In the meantime if any one is interested in the HST please contact Oleg who assures me he will only be too pleased to answer all questions and assist in anyway.

Oleg Bezzoubov
2/4 Melville Grove
Hectorville
Adelaide
SA 5073
(T) 088337 3793

E-MAIL oleg-bezz@hotmail.com
See you all next month regards
Steve Smith

In March this year, Ian Hunt, a past president of the South Australia Division spoke to me about the next HST (High Speed Telegraphy) Champion-ships being held in Italy. He informed me that Oleg Bezzoubov, UA4FBP had recently migrated to Australia with his family and had taken up residency in Adelaide, South Australia.

Ian said that Oleg has been European and World champion on many occasions and would like to represent Australia and submit a team for a future HST.

Several days later I received a letter from Oleg in which he explained a little of his back ground, repeated champion and prize winner of World and European HST championships.

And what does it take to win such competitions?

In one competition Oleg sent for twenty minutes at 50wpm with only **three** errors.
How good is that!!!!

In 1996 he was awarded the highest sport title – “Honoured Master of Sport”, by the Government Council of Russia. He has also represented Radio Amateur Society of Russia in WRG IRAU. Oleg said he would be happy to share his skills and experience with those interested in HST. It is too late to participate in the current HST championships, but perhaps in future events.

An extract from Oleg's letters.

HST – High Speed Telegraphy

HST is an Amateur Radio activity, recognised by the IARU, pursued by telegraphy enthusiasts who are ready to develop their skills in this area.

There are national and international championships in which competitors can participate. In the past HST competitions took part mainly in Eastern European countries, but recently it has gone through some positive changes that will hopefully promote popularity all over the world.

The competition consists of three main tests:- the traditional transmitting and receiving of 5 – character groups and the

radio amateur practising test (RPT). RPT consists of two programs.

The RUFZ, which is a ‘callsign receiving’ program, where the task is to receive callsigns and type them back to the computer. The other one is PED, ‘the pile up trainer’, which is a contest and pile up simulator. Both are popular among HAMs.

HST is not only a competition for high skilled CW Ham's, but its programs can promote young people to become radio amateurs. Traditional tests can help in preparing for CW exams. RUFZ is a good program to develop CW skills in young people.

Getting new higher scores in RUFZ can be very exciting to beginners ensuring that they progress gradually. PED produces a typical contest situation, so it is a good device to practice for the real contest in the bands. A popular HST can be an important means to preserve the Morse Code in the future.

Past HST Events:

European Championships;

1983	Moscow	Soviet Union
1989	Hanover	Germany
1991	Neerpelt	Belgium

World Championships;

1995	Siofok	Hungary
1997	Sofia	Bulgaria

Hungary organised the first IARU Championships attended by competitors from 15 countries from 3 continents. The championships are organised every two years with the next one held in Italy in 1999.

This activity is unknown in many countries yet, but where ever there are CW enthusiasts there are potential competitors. If you are one of them, come and join us.

Extract of The “IARU HST Championships Rules”

Categories;

Junior females	under	20 years of age
Junior males	under	20 years of age
Females	over	20 years of age

AWARDS

John Kelleher VK3DP

Federal Awards Officer

4 Brook Crescent, Box Hill South, Vic 3128 (03) 9889 8393

Not very often do I receive kindly words for the effort, however small, that is required for handling this column, and more importantly, the ever-growing DXCC listings.

In the past two weeks three letters have appeared on my desk thanking me profusely for my effort, which not only brought a smile to my usually furrowed countenance, but which caused me to consider much more effort.

Of late, I am recovering from the effects of a stroke, which was not severe, but slowed me down somewhat. Also, as a consequence, I am running very late with answers to correspondence. Now, on with some awards.

SWEDEN - Worked Scandinavian RTTY Award.

Issued for 2-way RTTY contacts with Scandinavian stations. DX countries require 8 contacts for General Class, 15 contacts for Bronze Class, 25 contacts for Silver Class and 50 contacts for Gold Class.

The General Class must be obtained first before Bronze, Silver or Gold. All bands may be used. GCR list is permissible. For the Gold class, it is necessary to have contact with the following prefixes: LA SM OH TF OX OY and OZ.

A photocopy of the 7 cards is needed when applying for the Gold. Fees: General-10 IRCs, Bronze 6 IRCs, Silver 6 and Gold 6. GCR list to: -

Bo. V Ohlsson SM4CMG,
Skulsta 1258,
710 41 Fellingsbro,
Sweden.

TAIWAN - Chinese Taipei ARL Awards Program.

General requirements: GCR or photocopies accepted. All contacts must be with land-based stations. All contacts must have been from the same QTH. Fee for each award is US\$5.00 or 10 IRCs. Apply to: -

CTARTL Award Manager
P.O. Box 73
Taipei Taiwan.

Worked Chinese Prefixes

Contact different Chinese prefixes: BA BT BO BV BZ 3H to 3U. No repeater contacts but Satellite is OK. Available for all CW, SSB or Mixed modes. All bands. Basic award=20 prefixes, Class B = 30, Class A = 40.

Worked All Taiwan Districts

Contact an amateur station located in each of the ten (10) call areas (1 through 0) of Taiwan. No band or mode restriction, however repeaters cannot be used.

10000 Award

Contact with amateurs in towns with different 3-digit postal codes in Taiwan. The codes must be added to at least 10000. Each code may be used one time only. All bands and modes, but no repeater.

THAILAND - The Siam Award.

Contact 10 HS stations. No time limit. SWL OK. GCR and 10 IRCs or equivalent for surface mail 15 IRCs for airmail to: -

Hans D Hollstein HS1BG
Awards Manager
86/1 Sukhumvit soi 23
Bangkok 10110 Thailand.

VANUATU - Vanuato Amateur Radio Society Award.

CONTACT 6 DIFFERENT YJ8 STATIONS WHO ARE MEMBERS OF THE VANUATO AMATEUR RADIO SOCIETY SINCE 30th July 1980. Contacts may be CW, SSB or Rtty. Two contacts with the same YJ8 station will be accepted if they are made on different days, bands or modes. Endorsements for all one mode, band, or additional stations worked. GCR list and US\$2.00 or 10 IRCs to: -

Awards Manager, VARS
P.O. Box 665
Port Vila
Vanuatu.

USA - Worked Central America Award

Work each of the countries of Central America :- HP HR TG TI YN YS and V3. No band / mode or time restrictions. GCR list and US\$2.00 to: -

Thomas T Hoke K5ODZ (ex HC1TH)
4805 Willowbend Blvd.
Houston TX 77035

USA - Dear Mabel Award

For OM operators who wish to acknowledge the kind heart, willing hands and patient understanding of their XYL. She may not always understand what is right, or what went wrong or what just short-circuited in your pile of radio gear, but it's important to her OM, so it's important to her. OM's may nominate their XYL for this award. Send her first and last name plus your callsign. A beautiful 8 x 11 certificate plus a letter explaining just how she earned this award will be sent to the deserving XYL. Fee is US\$4.00. Apply to: -

Florida Skip Magazine
P.O. Box 501
Miami Springs
FL 33266

I hope that you find something of interest in this list of awards. Best of luck and best regards.
73 de VK3DP



AV-COMM
Pty.Ltd

**SATELLITE TV
EQUIPMENT**
:- Established 1981 :-

**Specialising in:
Free to Air Satellite TV**

**GALL OR FAX
FOR FREE INFO PACK.**

198 Condamine Street
Balgowlah 2093 Australia

Tel: 61 2 9949 7417
61 2 9948 2667
Fax: 61 2 9949 7095

Internet: <http://www.avcomm.com.au>

CONTESTS

Ian Godsill VK3DID,
57 Nepean Highway, Aspendale, 3195



Greetings to all contesters.

Jun 5/6	IARU Region 1 Field Day	(CW)	
Jun 12	Portugal Day Contest	(SSB)	
Jun 12	QRP Day Contest	(CW)	(Apr 99)
Jun 12	Asia-Pacific Sprint	(SSB)	(Jan 99)
Jun 12/13	TOEC WW Grid Contest	(SSB)	
Jun 12/13	ANARTS RTTY Contest	(May 99)	
Jun 12/13	South American WW Contest	(CW)	
Jun 19	Merv Stinson Memorial Sprint	(CW/SSB)	(Jun 99)
Jun 19/20	VK Novice Contest	(CW/Phone)	(May 99)
Jun 19/20	All Asia DX Contest	(CW)	(May 99)
Jun 26/27	ARRL Field Day		(May 99)
Jun 26/27	Marconi Memorial Contest	(CW)	(May 99)
Jul 1	Canada Day Contest	(CW/Phone)	(Jun 99)
Jul 3	Jack Files Contest	(CW)	(May 99)
Jul 3	Australasian Sprint	(CW)	(Jun 99)
Jul 3	NZART Memorial Contest	(CW/Phone)	(Jun 99)
Jul 10	Australasian Sprint	(SSB)	(Jun 99)
Jul 10	Jack Files Contest	(SSB)	(May 99)
Jul 10/11	IARU HF World Championship	(CW/SSB)	(Jun 99)
Jul 10/11	Internet 6 Metres DX Contest	(CW/SSB)	
Jul 17	Pacific 160 Metres Contest		(May 99)
Jul 17/18	SEANET CW Contest		(Jun 99)
Jul 18	Colombian Independence Contest	(CW/SSB/RTTY)	(Jun 99)
Jul 23	ACORNZ 'Zip' Contest	(Phone)	(Jun 99)
Jul 24	Waitakere Sprint	(Phone)	(Jun 99)
Jul 24/25	Russian RTTY WW Contest		
Jul 24/25	RSGB IOTA Contest	(CW/SSB)	(Jun 99)
Jul 30	ACORNZ 'Zip' Contest	(CW)	(Jun 99)
Jul 31	SARS Sprint Contest	(SSB)	(Jun 99)
Jul 31	Waitakere Sprint	(CW)	(Jun 99)
Aug 1	YO DX Contest	(CW/SSB)	
Aug 7	SARS Sprint Contest	(CW)	(Jun 99)
Aug 7/8	Worked All Europe DX Contest	(CW)	
Aug 14/15	Keymen's Club of Japan Contest	(CW)	
Aug 14/15	RD Contest	(CW/SSB)	
Aug 21/22	SEANET SSB Contest		(Jun 99)
Aug 28/29	SCC RTTY Championship		
Aug 28/29	TOEC WW Grid Contest	(CW)	

Thanks this month to ZL2BIL SARS AHARC NZART VK4YZ

For the first time recently I was asked to adjudicate on a problem relating to a log submitted in a contest earlier in the year. Both the Contest Manager and I tried to be fair to the entrant, but the situation highlighted some facets that I found difficult to accept would happen, eg. working out-of-band-plan (FM in SSB segment); wrong use of calling frequencies; not having copy of the rules.

As we are about to enter our busy period in VK/ZL contesting, I ask all contesters to be sure that they have the rules and that they follow all the requests made therein, especially about where to send their completed log. There are quite a few contesters who think that a log should go to the same place every year. NOT SO!

In the case of VHF-UHF contests, I particularly ask that the rule of not using DX Calling Frequencies for contest calling, let alone exchanges, be strictly adhered to. Whilst we want you to participate and enjoy your contest, nevertheless we also expect that adherence to the published rules will be a part of that challenge.

If someone you know is a non-member of the WIA and would like to participate in a contest, please give him my address and I shall gladly send him a copy of the rules, rather than have errors in his log. As in community law, ignorance of the rules is no excuse.

My personal thanks go to those who took the trouble to participate in the Harry Angel Contest on ANZAC Day. I thought it went well, with good representation from most States on both CW and Phone. Thanks all.

73 from Ian VK3DID

Canada Day Contest

0000-2359z Thursday, July 1

This contest, which runs on July 1 each year to celebrate Canada's confederation, will take place this year on a Thursday.

Bands: 160-2m, CW & Phone. Suggested **frequencies:** (CW) 25kHz up from band edge and (SSB) 1850, 3775, 7075, 7225, 14175, 21250 and 28500 kHz. Check for CW activity on the half-hour. Note there are to be no CW QSOs in the Phone sub-bands and vice-versa. Any station can work any other once per band and mode. **Exchange:** RS(T) and serial number; Canadians will send RS(T) and province/territory. **Score** 10 points for Canadian QSOs including VE0 and 2 points for others. Canadians with RAC suffixes are worth 20 points.

Multiplier is Canadian provinces and territories (max 12), counted once per band and mode: VE1/CY9/CY09(NS); VE2/

VA2(QC,QU or PQ); VE3/VA3(ON); VE4(MB); VE5(SK); VE6(AB); VE7(BC); VE8(NWT); VE9(NB); VO1/VO2(NF); Yukon (YU or YT); VY2(PEI).

Final score equals points X multiplier. **Send** your log & summary sheet by July 31 to: RAC, 720 Belfast Road #217, Ottawa ON K1G 0Z5, Canada.

Australasian Sprints

The Adelaide Hills Amateur Radio Club is pleased to announce the fourteenth annual Australasian Sprints to be held on 3 July (CW) and 10 July 1999 (Phone), between 1100-1159z.

Both these contests, on **80 metres**, are open to all appropriately licensed amateurs in VK, ZL and P2 call areas using a single call sign. Contacts with any VK, ZL or P2 station during the contest may be counted, but a station may be claimed only once. A section is provided for SWLs.

Certificates will be awarded to highest scorers in each call area; overall winners; the highest scoring Novice operator in CW contest only, provided that this entrant is not entitled to another award for the CW Sprint; and to highest scoring SWL log in each call area.

Frequencies: CW 3.500-3.700MHz Phone 3.535-3.700 MHz. **Call** CQ Sprint/CQ Test/CQ Contest. **Exchange** serial number starting between 001 and 999, reverting to 001 when 999 is reached. RS(T) is optional but may be required for any other concurrent contest.

Logs must show time (UTC); callsign of station worked (both stations for SWLs), serial numbers given and received.

Summary sheet should show name and date of Sprint; callsign; name and address of operator; total number of contacts claimed and a statement that the operator has abided by the rules and spirit of the contest. Multi-operator club callsigns must list the callsigns and names of all operators. Any special conditions (mobile, QRP, etc) should be mentioned in the statement, along with any comments.

Send to AHARS Contest Manager, PO Box 401, Blackwood, SA, 5051.

Logs may be sent by packet to: VK5AFO@VK5WI.#ADL.#SA.AUS.OC or by e-mail to: cavidj@picknowl.com.au by 13 August, 1999.

IARU HF Championship

1200z Sat. to 1200z Sun 10-11 July
Bands: 160-10m (no WARC).

Categories: Single Operator, CW only, phone only, mixed; Multi-operator single transmitter mixed mode only. Multi-operator stations must remain on a band for

at least 10 minutes at a time (exception: IARU member society HQ stations may operate simultaneously on more than one band with one transmitter on each band/mode, providing only one HQ callsign per band is used).

Exchange RS(T) and ITU zone(P2=51,VK4/8=55,VK6=58 and VK1/2/3/5/7=59). HQ stations will send RS(T) and official society abbreviation.

Score one point for QSOs within own zone or with an HQ station; three points for QSOs with a different zone in own continent; five points for QSOs with different continents.

Multiplier is total ITU zones plus IARU HQ stations worked on each band.

Final score is total QSO points from all bands X sum of multipliers from each band.

Include a dupe sheet for 500+ QSOs.

Send logs postmarked by 7 August to: IARU HQ, Box 310905, Newington, CT 06131-0905, USA. Official forms and an ITU zone/prefix/continent map can be obtained from the same address on receipt of a large SASE with two IRCs or equivalent.

Certificates to the top scorers in each category, in each state, ITU zone and DXCC country. Also, stations with 250+ QSOs or 50+ multipliers will receive achievement awards.

NZART 80m Memorial Contest

0800-1400z Saturday 3 July

VKs are invited to join ZLs in this annual contest to commemorate amateurs lost in World War II. It is open to **single operator** stations on **80 m**, fixed and mobile.

The contest has six operating periods, each of one hour, from 0800-1400z. A station may be contacted **TWICE** during each operating period (once on phone & once on CW), providing that such contacts are not consecutive.

Exchange RS(T) plus serial number commencing at any number between 001 & 300 for the first contact. On phone **score** 15 points for the first QSO with a scoring area, 14 points for the second QSO with that area, descending to one point for the 15th & subsequent QSOs with that area. The same scoring system is used with CW, except that QSO points remain at five for the 11th & subsequent QSO with that scoring area. Scoring areas are ZL & VK prefixes/areas & DXCC countries. The rules for SWL entrants are similar, except that the callsigns of the stations heard & being worked must be given and only the cipher of the station heard is required.

Send logs & summary sheets ASAP to: Memorial Contest, PO Box 20 332,

Auckland 7,NZ. Nominate the category entered (Open; Phone; CW; Beginner's CW; QRP; Homemade SSB), & include a points summary showing the number of QSOs & points for each VK/ZL call area worked. Certificates will be awarded to the top three scoring VKs.

Colombian Independence Day Contest

0000-2400z Saturday 17 July

This is a worldwide contest, **bands** 80-10m (no WARC).

Modes: Phone; CW; (not mixed).

Categories: Single Operator (single all band), and multi-operator (single & multi-transmitter).

Exchange RS(T) plus serial number.

Score five points per HK QSO; three points per QSO with stations in another country; one point per QSO with stations in same country; and 10 points for QSOs with official HK HQ stations.

Multiplier is the total countries, including HK plus HK call areas, worked on each band. "HK" includes all Colombian prefixes.

Final score is total QSO points from all bands X sum of multipliers from all bands. At least 2% of QSOs must be with HK and 10% with stations outside your own country.

Send logs postmarked by 26 August to: Colombian Independence Day Contest, Apartado 584, Santafe de Bogota, Colombia.

Waitakere 80m Sprint

Phone: 1000-1100z Saturday 24 July

CW: 1000-1100z Saturday 31 July

This 80m-sprint contest is open to all ZL & VK amateurs. In fairness to other amateurs, it is requested that no linear amplifiers be used in this contest. Call "CQ Sprint" and **exchange** serial numbers commencing at 001 and incrementing by one for each contact. RS(T) is not required.

Logs must show stations worked, with serial numbers sent & received. Attach a **summary** sheet & send log to: Sprint Contest Manager ZL1BVK, 14 Takapu Street, Henderson, Auckland 1208, NZ, to arrive by 1 September. Alternatively, logs may be sent via packet, using three columns only with no commas or other delimiters, to: ZL1BVK@ZL1AB. **Certificates** will be awarded to the overall winner; the best score in each ZL call area & the three best VK scores.

'Zip' 80m Contest

Phone: 0800-0900z Friday 23 July

CW: 0800-0900z Friday 30 July

Instituted last year, this is contest for low

power enthusiasts from ACORNZ, and all VK amateurs are invited to join in, irrespective of power levels.

Call "CQ Zip" and use frequencies 3560 - 3620 kHz (Phone) or 3530 (centre)(CW). Exchange RS(T) plus serial number.

Score one point for QRP to QRO ZL; five points for QRP to QRO DX; five points for QRP to QRP ZL & 15 points for QRP to QRP DX. The reverse applies to DX stations. "DX" is any station outside ZL. No multipliers. Honour system applies. Sign/QRP if using up to 5 watts CW or 10 watts Phone.

Send logs showing mode; date; time; station worked; RS(T); points claimed per contact and total points to: Bill Cox ZL2BIL, 5A Konini Grove, Raumati Beach 6450, NZ, by 13 August 1999. Please contact Bill for information about ACORNZ.

RSGB Islands on the Air Contest

1200z Sat-1200z Sun 24-25 July

This contest is intended to promote contacts between qualifying IOTA island groups and the rest of the world and to encourage expeditions to IOTA islands. Sections are: IOTA Island Stations (ie those with an IOTA reference); World & SWL. You can enter as CW only, SSB only, or mixed mode. Single operator stations can enter as unlimited (no time limit), or limited (12 hours max, with off periods at least 60 minutes long and marked in the log).

Use 80-10 m, avoiding 3.56-3.60, 3.65-3.70, 14.06-14.125 and 14.30-14.35 MHz.

Exchange RS(T) plus serial number, plus IOTA reference number if applicable. Stations can be contacted on both Phone and CW on each band. Use the same serial numbering system for both modes.

Score 15 points per QSO with an IOTA station (including UK); five points for stations in another DXCC country; and two points per QSO with one's own country or IOTA reference.

The multiplier equals the total IOTA references per mode per and, added together.

The final score equals total QSO points X total multiplier.

For each band (but not each mode), submit a separate log, multiplier list and dupe sheet. Send your log and summary sheet to: RSGB IOTA Contest, PO Box 9, Potters Bar, Herts EN6 3RH, postmarked no later than 26 August. A comprehensive range of awards is offered to the leading stations in each category, section & continent.

Southside Amateur Radio Society Sprints 1999

SSB: Sat 31 July CW: Sat 7 August

Chosen to coincide with the Waitakere Sprint, the object is to contact as many P2,

ZL and VK stations as possible. Bands: 10, 15 and 80 metres. Times: 0000z - 0200z on 10 and 15 m; 1000 - 1100z on 80 m.

Exchange serial number only starting at 001. Stations may be contacted once per hourly block, provided that such contacts are not consecutive, or that at least five minutes have elapsed between contacts.

Score three points on 10 m; two points on 15 m; one point on 80 m. QSOs with VK Novice/Limited stations become multipliers.

Final score is total QSO points times total VK Novice/Limited multipliers.

Logs should show all details of date, times UTC, callsign, exchanges, points claimed. Separate logs for each mode, please.

Summary sheets should show callsign; name and address; mode; claimed scores and signed declaration.

Send logs by mail to: SARS Contest Manager, PO Box 294, Woodridge 4114, Queensland; by packet in ASCII format to: VK4WSS@VK4PKT.#BNE.QLD.AUS.OC; by e-mail to: <jabba@powerup.com.au>

Certificates to first three place-getters in each mode and special certificate for combined modes.

SEANET Contest

0000z - 2400z CW: Sat 17 - Sun 18 July Phone: Sat 21 - Sun 22 August

Object is for stations outside SEANET region to work as many SEANET stations as possible.

Bands: 160 - 10 metres (no WARC).

Categories: Single operator all bands; single operator single band; multi-operator single transmitter.

Exchange:RS(T) plus serial number.

Score one point for each QSO. QSOs in own SEANET country count for country credit only.

Multiplier is total number of SEANET countries X three.

Final score is total multiplier X total QSO points.

Send logs by 31 October to: SEANET Contest Manager, Eshee Pazak 9M2FK, PO Box 13, 10700 Penang, Malaysia.

SEANET countries: A4/5/6/7/9 BV BY DU EP HL HS JA JD1 JY KH2

P29 S2 S79 VK VQ9 VS6 VU V8 XU XV XW XX9 YB ZK ZL ZL9 3B6/8/9 4S7 4X 8Q7 9K2 9M2/6 9N 9V

The Merv Stinson Memorial Sprint

from Charlie Strong VK4YZ 1000z - 1000z Sat 19 June

The Merv Stinson Memorial Sprint will

be held in June each year and run by Redcliffe & Districts Radio Club. This contest is held to remember the assistance and effort Merv gave to help many people in gaining their Certificates of Proficiency and the Redcliffe & Districts Radio Club during club activities such as contesting the John Moyle Field Day.

Purpose of the contest is to aid people in attaining proficiency in procedures, fine tuning of equipment and introducing people to the sport of contesting.

This contest is one of three sprint contests over a three-month period. It is hoped that contestants entering all three sprints could enhance and improve their contesting skills and equipment over this period.

Due to the short period of the contest, any person investing one hour on a Saturday night can be competitive and has a chance of winning.

Object of the contest is to contact (or log QSOs if an SWL) as many stations as possible in the one-hour period without duplication using SSB or CW. Any contact between Australian, New Zealand, Papua New Guinea and surrounding countries on the 80 Metre band is valid.

This contest is open to all licensed amateur stations and short wave listeners. Groups are allowed but must only use one callsign and transmitter.

The contest period is from 1000z to 1100z on Saturday, 19 June 1999. This is the same weekend as the VK Novice Contest, therefore extracts from Novice Contest Logs between 1000z and 1100z will be accepted as logs for the Merv Stinson memorial Sprint.

Exchange RS(T) + serial number.

Log must show for each contact the time UTC, callsign (or callsigns for SWL) contacted, exchange sent and received.

A log must have a cover sheet containing name, address, callsign, date of contest, total number of points claimed and a statement that the operator/s abided by the rules and spirit of the contest.

Any comments should also be included.

Send logs to: Contest Manager, Redcliffe & Districts Radio Club, PO Box 20 Woody Point, Qld 4019 by Friday 9 July 1999.

The Contest Managers decision is final and can disqualify any entry that is in violation of the rules and spirit of the contest or has an excessive number of duplicate contacts claimed as valid contacts.

Certificates will be awarded to the highest score over-all and in each of the Australian call areas and to the highest scores in New Zealand, Papua New Guinea and all other countries combined for both SWL and station logs

ar

SPOTLIGHT on SWLING

by Robin L. Harwood VK7RH
5 Helen Street, Newstead Tasmania 7250
(03) 6344 2324
E-mail: robroy@tassie.net.au

Kosovo Crisis Continues

The Kosovo Crisis continues and the war of words has been fierce between the protagonists.

NATO has been targeting both studios and transmitters of the Serbian media. The external senders of Radio Yugoslavia are not in Serbia but in the Serbian enclave of Bosnia-Herzegovina.

They haven't been targeted but the links to the site within Serbia were hit and some days they are not there. Belgrade is supposed to be on 9580 in English at 0430 UTC, beamed to the West Coast of North America and Europe.

To this area, they are on at the highly unusual time of 1900 UTC on 7230. That is 5 am locally in the eastern states and two hours earlier in the west. I think, somehow, that there would be few listeners at those times.

Naturally international broadcasters have introduced extra transmissions directed to the Balkans. The large forced exodus of hundreds of thousands of refugees from Kosovo has separated many families and friends throughout the area and unable to keep in touch.

Contact programs have been introduced over some stations and over the domestic Albanian networks.

Short wave has been vital in this region as the Internet has been turned off or heavily censored within Serbia. Satellite television is only available to a select few.

The domestic television has been bombed

which has seen many relying on short wave to get additional information on the crisis. The refugees sadly have nothing.

Perhaps a few may have small multiband radios, but my information is that anything of value was taken from them by the Serbians.

The VOA has also been carrying live the daily NATO media Briefings in Brussels. These are at 1300 UTC. The BBC World Service has been giving extensive coverage with background to the conflict and ongoing developments.

They have also had phone-in programming allowing people within the region to voice their comments to the World.

I personally have found the VOA "News Now" format disappointing, as it seems to be unbalanced and they are heavily pro-American.

One would also conclude from listening to the VOA, that NATO is primarily made up of Americans.

The truth is that there are 18 other nations and not all are involved in the Kosovo crisis.

Another interesting station in this region is the Croatian Radio in Zagreb. They are on 13720 kHz via the Juelich Senders in Germany at 0700 and have extended their English news bulletins.

They focus primarily on Croatian news and the NATO campaign, which is right on their doorstep, yet very little seems to be mentioned on Kosovo and the refugees.

Internet Audio software

I have installed a new software program called "Vtuner" by Real Networks. This is "tuner" which allows you to find the various Real Audio sites on the Web.

There are over 2,000 different sites you can download. Most use Real Audio although there are other Streaming Audio players about, such as Windows Media Player and Spinner.

However the Real Player has unofficially become the default standard. Most of the Players are free yet upgrades are not. "Vtuner" costs about \$US 14.95 and only works with the G2 Player by Real Audio. The Windows Media Player uses a different method but is said to be compatible in some areas. To get "Vtuner" go to the Real Audio home page.

The other format of streaming audio is MPEG 3. A lot has been written about this format which is primarily a music format.

Unlike Real Audio files, which cannot be saved to the HDD, files in the format of MPEG 3 can and there are several MPEG players available including a detachable player which can play these files away from the computer.

Internet List for ordinary short-wave listeners

There is an Internet List specifically on short-wave programming.

As you may be aware, there are several lists for Dxers and amateurs. Yet the majority of people listening over shortwave are not necessarily interested in these, a list catering for their needs has recently been started.

For further details go to the following weblink:

<http://www.topica.com>.

It is a moderated list and discussions about Dxing and amateur related topics are catered for in other lists and forums.

Well, that is all for this month. Until next time, the very best of listening and 73.

Robin L. Harwood VK7RH

ar

Amateur Radio

Supporting
the
community

Special Event Planning for Amateur Radio (or any organisation)

Bob Harper VK4KNH
PO Box 288 Beerwah 4519
Bobharper@bigpond.com

'Failing to plan is planning to fail' is a common saying.

It's especially true when you are using volunteers and your own free time to put on an event

Here's how to add that professional touch to your special, occasional effort

AMATEUR RADIO HAS VERY few special events compared with some other organisations.

Many seem to retain members purely as a result of running events for their members to attend, -there being no other apparent purpose for some of these organisations to exist. It appears then that there is much to be gained by organising gatherings for your current and prospective members.

The few HamFests that are held each year, (or perhaps every second year!) are usually successful perhaps because they are so far apart from each other, -both in time and location. Each successful event has one common factor; they are well planned.

I cannot stress how important that is; -well planned events generally work. A maxim favoured by NASA puts it simply as: *"Plan the work and work the plan."*

The not so successful events may well have had many hours put into the planning but may still have been poorly planned.

I am sure that we have all been to meetings where every possible thought was aired and considered yet when it is all over the only decision made was on the date of the next meeting. Every thing else was put off or had insufficient data to allow a decision to be made. The too hard basket got more from the meeting than anybody else did.

I haven't planned an Amateur Radio event for many years now but have been involved in the planning of many other events.

The basic team effort required is the same. I urge you to make it a team effort, and to involve members, delegate responsibility and monitor the proceedings.

If something does go wrong, you will be in a better position to look back and isolate the cause. Please remember to identify a cause rather than place blame. It doesn't matter who stuffed up but it is important to know how to avoid stuffing up next time.

What follows are some comments and ideas collected from many sources,

including AR, 73 Magazine, CQ Magazine, various club newsletters, Scouting and TAFE publications.

Many are the result of notes taken by myself from comments made by others at various meetings. I hope that you find at least some of interest and, more importantly, of value in planning your next event.

The Shopping List Approach

I think that the best idea is for a group of interested people to get together, appoint a scribe, and go through this list.

Hopefully you will find other topics to add to the list, which is great. My only request is that you forward any extra points to me so I can update my list and, of course, share it with others.

Concept

What is the Aim and Objectives of the event??

You must answer this one !!!

What are you trying to achieve?

Who are you trying to please??

- Is it a HamFest? What is a HamFest? What does the term mean to your organisation?
- Is it a Social? -eyeball party, picnic, BBQ, etc.
- Is it a Working Bee?

And most importantly, how will you reward those who give freely of their

precious time? Perhaps every working bee should eventually turn into a social.

- Is it your AGM? Assuming that the average member attends meetings then they will probably attend the AGM. Yes? Well maybe but to be sure it would be wise to add some carrots to the stew. Again the social side becomes important.

How about a Swap and Sell, Garage Sale or Ham Radio Flea Market.

They are all essentially the same idea with different names.

Why not look for other names for a change? Try a US style TailGate Sale or a Hot Rod/Drag Racer style Swap Meet? *"You wanna see what I've got in my boot mate!?"*

How about a Ham Radio Convention, AR-EXPO, Technical Seminar, Antenna Compendium or an AR Field Day?

Invite the distributors to your club for a Product Launch?

Is it too late to have a clubhouse Opening? Or a re-opening?

Name

Include your club's name or other suitable identification.

Eg. Gold Coast HamFest, Hamboree, Gympie GoldFest, Sunshine Coast SunFest, BARCFest, Townsville Amateur Radio Convention.

Rockhampton Radio Ball, Lismore SummerFest (SpringFest etc), Sydney Swap Meet, Redcliffe Radio Bazaar, etc. Ham Luncheon!! -Sounds like a sausage.

Outline

Write a paragraph about what you intend to do.

Don't try to stretch this into a report. Stick to the main details that you will give for initial advertising to traders etc.

Some people call this a Mission Statement. A statement that expresses what you want to achieve.

A maxim favoured by NASA puts it simply as:

"Plan the work and work the plan."



The desired result of your effort : a well attended event that literally stops the traffic

Nominate

Select a team and appoint people to jobs. Be specific and record their names! The whole club may be involved but NAME at least the following:

- The Event Co-ordinator, Treasurer,
- Secretary, PR Officer,
- Clubs Liaison Officer,

Other Organisers for Individual Tasks - eg. Home Brew Organiser.

Add more jobs/members as required.

Meeting Procedures

Use proper meeting procedures including: -

- Proper Agenda,
- Action Sheets,
- Meeting Dates,
- Places and Times.

Draw up a TimeLine and set Way Points. (Deadlines).

Include a Post Mortem Meeting to decide on future improvements and plans.

Time and Place

Choose a suitable date noting:

- Other events,
- distances travelled by attendees.

Always choose a second date in case you lose the first choice.

Choosing a Location

- Space - Indoors and Outdoors
- Extra coverings where required - eg. Tents, Tarps etc.
- Look for parking options, proximity to Transport etc.
- Consider the need for and quality of the following facilities - Toilets, Kitchen, Stage, PA System etc.
- Other interests - near shopping centre, park, playground, beach etc.

Personalities and Positions

Who will chair the event?

Who will open the event?

Who might be encouraged to speak?

Who will close the event?

Who will be the spokesperson/contact prior to the event?

Advertising and Publicising

(They are different! You pay for advertising - publicise as much as you can.)

Get to know at least one local reporter on each paper, radio station and TV channel that serves your area.

Initial Advertising

Notices given early: - Pre-Planner Announcement to Traders, Magazines etc.

Call for Technical Papers,

Call for Expressions of interest from other clubs and organisations that may put on a display.

Call for Early Bookings (as a measure of interest.)

Main Advertising

Advertise Traders, Events, Displays, Competitions, Lectures, Date, Times, Place, Transport etc.

Final Advertising

Local and Media Advertising to gain support from community and community based media. Remember a story on the event is publicity and is often better than advertising.

Forms of advertising

Use all the forms available:-

- Word of Mouth - Best and most

**Early to bed,
Early to rise
Work like Hell
and Advertise**

convincing - peer pressure. This is also cheap.

- Club Newsletters, Q-News (Sunday Broadcasts), QTC (Divisional Newsletter), AR, et.al.
- Local Paper, Community Paper, Community Radio.
- Paket, ATV, Club Newsletters of other clubs.
- E-mail lists, Web sites etc.
- Create a team Tee-Shirt and/or Cap for the organisers - a simple gesture to advertise, gain member enthusiasm and form the organisational "cliche". (Some may disagree on principle, but watch it work.)

Assistance with Advertising Costs

Think who else may benefit by the influx of people and hit them for advertising assistance.

The Local Tourism/Commerce Board - Show how your event will promote the locality and they may help with printing a pamphlet with your information but including places of general interest to your visitors.

You may be able to arrange discounted entry to local sites based on a registration at your event.

Accommodations - seek special rates or offer "free" advertising if the hotel/motel pays to print the flyers.

What types of event memorabilia could you sell -Tee-shirts, Caps, Patches, Pins, and Mugs? Remember that to over-order could drain any profit from the exercise. One way to avoid losses is to make sure that memorabilia can be sold off later or at the next event, by not specifically dating the item.

Pre-Registration

Pre-registration allows the organisers to gauge how many people might be attending and to make better planning decisions.

So how can you make people pre-register? Why would *you* pre-register? What benefit would you expect? Would

you expect faster entry by flashing your pre-registered card? Would you expect free entry to some other event or part of the event?

You, the organiser need to decide on whether it is an advantage for you to take pre-registrations and what you can offer to encourage pre-registration.

Pre-registration may be included as a part of booking for the event dinner - or accomodation and meal bookings as a kind of package deal.

Travel

How can you help people get to your event?

Should you offer pick-up from the train/airport to the site? Perhaps there is a member with a people mover, who may be prepared to help. But beware of charging for the service, as you would be setting yourself up as an illegal taxi service.

Could you find enough attendees for an organised bus trip from other major centres to your event? Eg a bus trip for Brisbane Hams to the Sunshine Coast Sunfest?

Bookings

Set the various fees early - Table Space, Attendees, Trade Displays, cut from food stalls etc.

Allocate Space and Location on a Room Plan. If you aren't given one then have one drawn by a member. Send out the room plan with both the invitation and the acceptance letter. Best if you can have a few early bookings already on there to encourage confidence.

Catering

What numbers are expected? This can be a very difficult question. Perhaps an estimate could be made based on past or similar experiences.

Ultimately you have to make a decision based on what risk you are prepared to carry and what plans you can devise to either dispose of excess produce or source for excess requirements during the event.

A word with your suppliers may help, as they would have already worked the problem through with other groups.

Butchers may keep extra meat on hand for you and members may be lined up to buy excess at your purchase prices or better.



Catering to the right number is the trick

Providers - Club Wives and Supporters? Local School Canteen Ladies, Rotary, Lions, Apex etc. Commercial Interests?

Drinks - What is available? How will you keep it cold (or Hot)? Is it worth getting into licensed sales?

Stall Holders Lunch - provide a simple delivery service for those that cannot leave their stall. Let them know beforehand so they will use the service.

Provide enough tables and chairs for eating and provide some well-marked bins.

Tables and Chairs for Stalls - based on bookings. Party Hire places provide tables but also try the local Scouts and Guides.

Child-minding - Provide for the children by organising some of the following - Playground, Face-painting, Videos, Indoor and Open Games and Competitions.

Wrap up BBQ for stallholders and organisers? Here is an opportunity to collect all of the comments on how to improve it next year.



All sorts of fox hunts require planning

Choosing Side-events and Displays

There will always be a main objective and some side -events. The following suggestions will not work at every event but a selection will be appropriate to almost any event. The secret is in the balance. You need to provide an interest for every "character" there.

Swap and Sell - under whatever name you choose.

Auction - preferably an auction of donated goods but perhaps on a commission basis. Use an experienced auctioneer if you can, as they can encourage pockets to open wider than anyone else.

Crystal Set Competition - This is a great way to encourage beginners to understand the properties and needs of a good receiver. There are many possible variations but prizes could be given for appearance, engineering standard, sensitivity, selectivity and audio quality.

Trade Displays - Equipment, Supplies, Maintenance, Magazines, Training, Services and Bookshops.

Technical Lectures and Presentations - Either select a theme, or make a program of lectures spanning the whole day with popular lectures repeated to allow more people to attend. Avoid programming lectures during the opening or other speeches.

Slide Show - make it either impressive or funny. Use captions to otherwise standard photos eg [Flash of Lightning] "Bob finally got the DX contact he was after."

Use a "comedy act" to open and get attention - every club has one but make sure it's presentable and avoid personal references.

Fox Hunt - in any of the many variations. Avoid events that require a large investment in specialised equipment.

QSL Boards - members own and a display collection. Have a prize for the oldest, rarest, most appealing etc QSLs brought and displayed at the event.

QSL Shoot - Cover a notice board with cards from attendees -first in best dressed so to speak. Cards must not overlap. At an appropriate time, select and blindfold a suitable person to throw a dart at the board, which will presumably, hit only one card. The card owner receives a prize.

QSL in/out Bureau -with the co-operation of the club QSL Manager.

WIA/Divisional Stand - Membership, Suggestions, Reports, Bookshop Etc.

Club Stands - Club membership, history, achievements etc.

SIGs - Special Interest Groups - displays by ATV, SSTV, QDG, VHF, WICEN, Competitions, DX etc.

Demonstrations - show hams what happens, how it works, sounds or looks and let them try it.

Specific Construction Competition - eg the best made 2m J-pole, best homemade CW Key etc.

Ham exams in a quiet area or outside of normal hours (before or after).

Arts, Crafts, Plants, et.al. for the "non-participating partners"

Public Relations Stall - let those non-amateurs in on what is happening, what the club/AR has done and who for.

Timetable - what Day/S, TIME/s

You need to promote the following times and perhaps add other times that are important to your event.

Open to Traders/Stall Owners

Open to Attendees

Closing Times

Shut up times - When all must be out.

Opening and Closing Ceremonies

Lectures

Competitions

Prize Presentations

Insurance

We now live in a time where people are likely to sue for minor injuries or losses. You need to consider these insurance needs and perhaps talk with an insurance broker. Consider the following.

Public Liability.

Property Loss - Theft from Traders stalls.

"Rained Out" Insurance.

Decorations

How many times have you gone to an event in a hall where the dominating feature was the echo? Dress it up as if it were your clubhouse. Make it look lived in or make it inviting. People don't stay long where they're not welcome.

Use Banners denoting special areas and groups, the ATV stall, the entrance, food hall, toilets etc.

Hang light items from the ceiling where space and attachment points exist - Banners, Streamers, Flags, Beam Antennas etc.

Use good old US style bunting, flags and streamers. Hang a string of tee-shirts from previous events.

Use display boards and room dividers to break up and define areas, reduce noise and visual pollution. A salesman wouldn't try to sell their product with an opposition product in clear view behind him. Contain the person's view to the display.

Use Australian and City/State flags behind the speakers, or banners with the event name or from advertisers and sponsors.

Encouragements

QSL Board - prize for best presented card, rarest card etc.

Prize for club with most members in attendance.

Door Prize for lucky ticket number etc. Home Brew Competition Judged by a prominent Engineer, Radio Inspector etc.

Best Restored "Old Radio", Valve Radio, Ham Radio, Test Equipment etc.

Best QRP set, Antenna, etc.

Prize for best Construction or Technical Article presented at event. Publish papers afterwards by pre-subscription.

Prize for best AR Art, Photo etc.

CW - Speed and Accuracy Tests.

Security

Have a member patrol outside and quiet areas. It would not be the first time that car thieves have attended a "social" event.

Communications

List the following on all communications for the event. Remember to list all contact numbers for before the event as well as during the event. Make a list of numbers for all the organisers especially their mobile numbers, as some communications may need to be private during the event.

Phone Contacts, Fax Contacts, email/web Contacts

Radio Net times and frequencies, Repeater Call-in on approach for directions. (HF as well in some cases)

Contact List for Police, Fire, Ambulance, Hall Owner, Electrician, Plumber etc for emergency contacts.

Parking

Allow sufficient space and organise the parking so space is not wasted. People will spread out to fill whatever space see making late arrivals harder to cater for.

Security - note the comment above.

Cleanup

Organise members and others to clean up or be prepared to pay for others to do it for you. (It may be cheaper than you think!)

Finally

The organisers are often the last people to enjoy an event. They are so busy that they see nothing, miss everything, miss out on the freebees, don't get fed, and once underway, can't wait for the event to end.

If possible arrange for every organiser to be relieved at various times during the day so that they too can enjoy their creation.

Every organiser should have a notepad to record the items they now know they should have done another way. If not they will have the same déjà-vu experience next year.

Every minute spend working out the problems beforehand will make the day run smoother and the event more enjoyable.

I hope your event is so fantastic that you'll be proud to relate your experiences in this magazine for others to learn from.

ar

HF PREDICTIONS

by Evan Jarman VK3ANI
34 Alandale Court, Blackburn Vic 3130

Adelaide-Anchorage 30
First F 0-5 Short 12466 km

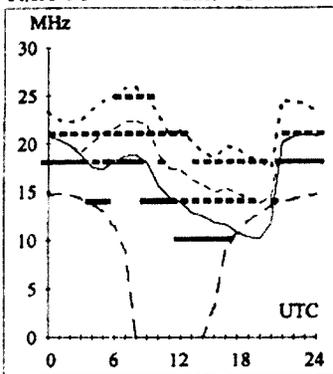

Brisbane-Berne 315
First F 0-5 Short 16321 km

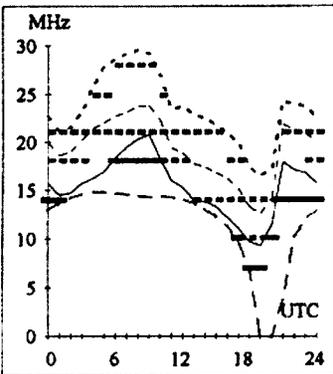

June 1999
T index: 116

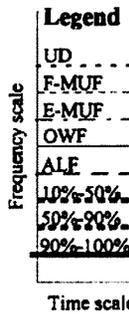

These graphs show the predicted diurnal variation of key frequencies for the nominated circuits. These frequencies as identified in the legend are:-

- Upper Decile (F-layer)
- F-layer Maximum Useable Frequency
- E-layer Maximum Useable Frequency
- Optimum Working Frequency (F-layer)
- Absorption Limiting Frequency (D region)

Shown hourly are the highest frequency amateur bands in ranges between these key frequencies; when useable. The path, propagation mode and Australian terminal bearing are also given for each circuit.

These predictions were made with the Ionospheric Prediction Service program: ASAPS version 4.

Adelaide-Dakar 233
First F 0-5 Short 16724 km

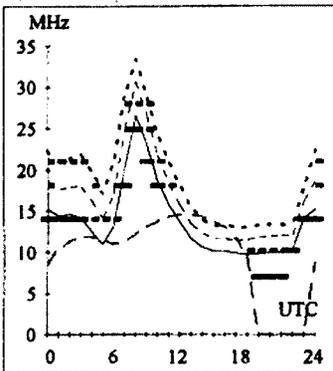

Brisbane-Los Angeles 59
Second 4F3-8 4E0 Short 11564 km

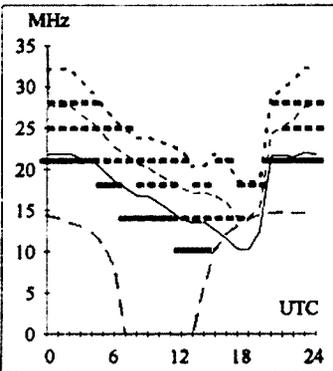

Canberra-London 316
First F 0-5 Long 16982 km

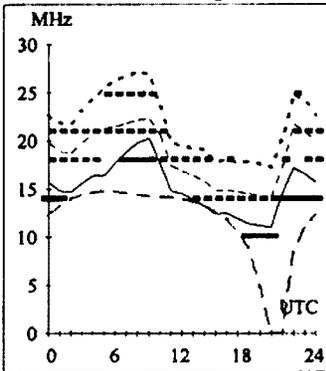

Darwin-Capetown 231
Second 4F3-5 4E0 Short 11221 km

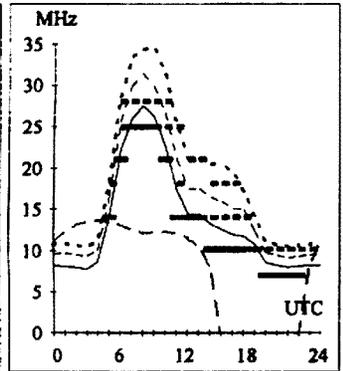

Adelaide-Ottawa 58
First F 0-5 Short 16901 km

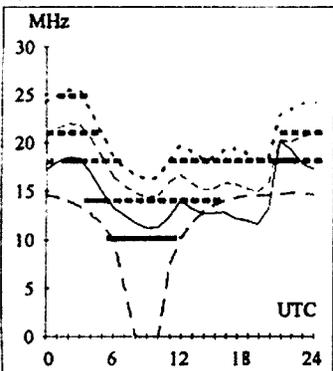

Brisbane-Osaka 344
Second 3F6-12 3E0 Short 7149 km

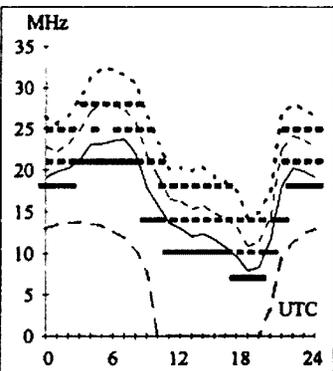

Canberra-London 136
First F 0-5 Short 23042 km

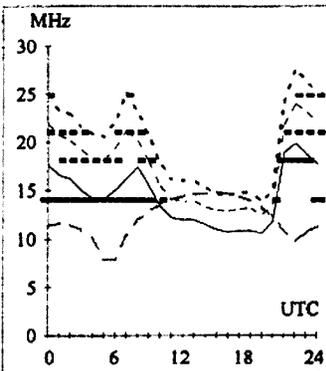

Darwin-Tokyo 10
First 2F4-10 2E0 Short 5436 km

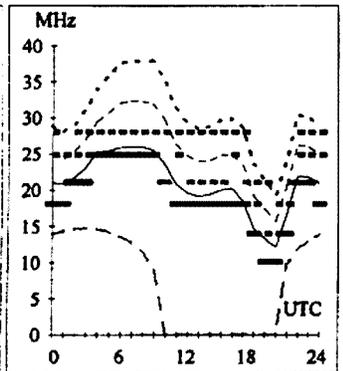

Adelaide-Stockholm 142
First F 0-5 Long 25030 km

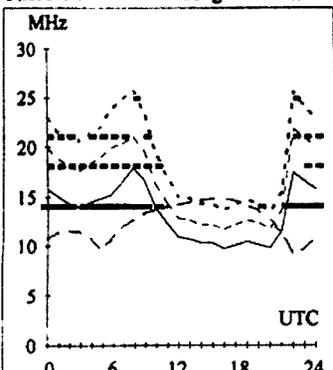

Brisbane-Singapore 293
Second 3F9-12 3E0 Short 6147 km

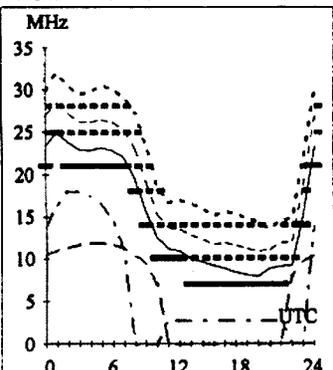

Canberra-Washington 70
First F 0-5 Short 15938 km

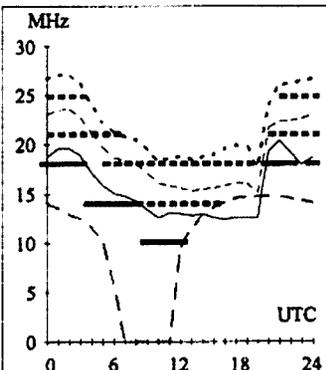

Darwin-Vancouver 42
First F 0-5 Short 12212 km

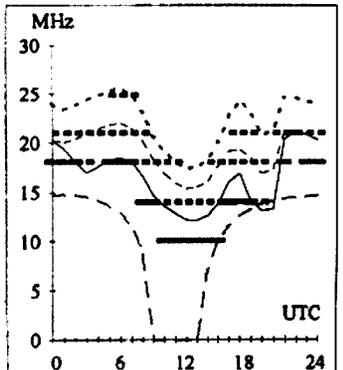

HAMADS

- Hamads may be submitted on the form on the reverse of your current Amateur Radio address flysheet. Please print carefully, especially where case or numerals are critical.
- Please submit separate forms for For Sale and Wanted items, and be sure to include your name, address and telephone number (including STD code) if you do not use the flysheet.
- Eight lines (forty words) per issue free to all WIA members, ninth and tenth lines for name and address. Commercial rates apply for non-members.
- Deceased estates Hamads will be published in full, even if the ad is not fully radio equipment.
- WIA policy recommends that the serial number of all equipment for sale should be included.
- QTHR means the address is correct in the current WIA Call Book.
- Ordinary Hamads from members who are deemed to be in general electronics retail and wholesale distributive trades should be certified as referring only to private articles not being re-sold for merchandising purposes.
- Commercial advertising (Trade Hamads) are pre-payable at \$25.00 for four lines (twenty words), plus \$2.25 per line (or part thereof), with a minimum charge of \$25.00. Cheques are to be made out to: WIA Hamads.
- Copy should be typed or in block letters, and be received by the deadlines shown on page 1 of each issue of Amateur Radio, at:

Postal: Newsletters Unlimited, 29 Tanner Street, Richmond, 3121

Fax: 03 9428 4242 E-mail: newsl@webtime.com.au

Please only send your Hamad once

Please send Hamads by mail OR fax OR email (much preferred).

Please do not send by more than one method for any one ad or issue, it is confusing.

FOR SALE ACT

- **HALLICRAFTERS SR-150** Fixed/Mobile Transceiver. 80 through to 10 metres with transformer manuals spare valves. Good condition. reasonable offers considered. Ed VK1NBH 02 6251 2312 email gudruned@telstra.easymail.com.au

FOR SALE NSW

- **YAESU FT 209 RH** - 2M xcvr handheld - 140-150 MHz - 5 Watts output case instruction book- VGC - \$ 190.- PETER VK2BPO - QTHR - PH. 02 9713 1831
- **ICOM 740 SS HF** Txcvr with WARC Bands integral PS also use mobile Top line features 2 VFO's etc Excel. performer sn 0286806n \$550. optional ATU with meter \$100 Email vktwoclb@zed.org or phone Les 02-9997-110

- **LIVERPOOL AUCTION** Sat. 10th July scout camp Cambridge Ave, Glenfield. Sellers in 1000 hrs, buyers in 1100hrs. Auction commences 1200hrs. Sausage sizzle, cool drinks, tea and coffee. Enquiries to Garry VK2TSR 02 9631 9005. Submitted by G.Barker Hon. Sec. LADARC. P.O. box 690 Liverpool 02 9631 9005.

FOR SALE VIC

- **KENWOOD TM-742A** Dual-band 50W FM XCVR has 2M/70CM fitted and space and front panel controls for optional 10/6M-23cm third band. Had home use only, mint condition \$750 LenVK3BMY 5862 3116 QTHR
- **YAESU FT-736R** 2M/70CM All-Mode XCVR in mint condition 20 months old. inc. int. power supply, full satellite facilities data in/out etc. Will accept two additional band modules and ATV option. Best offer over \$1600. Len VK3BMY (03 5862 3116 QTHR

- **ROTATOR H.A.M III** heavy duty inc. transformer manual ex. con. \$365. Rotator SSS King type 303 medium duty inc. box, brand new. \$250. I.C.45A 70cm tranceiver, manual and cradle ex. con. \$180 ono. I.C02N/I.C.02A/AT tranceiver inc. external speaker, mic, manual 137/153 MHz \$90. Kenwood TS-50S as new inc.manual c. diagram \$ 1200ono.

Harry VK3AXT QTHR 98025704

- **KENWOOD h-held TR2600A** 2mtr txcvr, .3-3w. c/case, headset, chrg-stand, SN5022246 \$75. ono. IC28A/E 2mtr trxcvr 5-25w, extended RX range, SN14889 \$300-ono. Both ex-cond, full doc's & circuits. Ryobi Drill Press HBD6MA 1/3 hp 600-2500 rpm ex cond. SN1294003 \$80-ono. Ryobi Drill-Driver HB10AR 180 rpm, chuck, sockets, bits, variable clutch, \$40.

Keith VK3AFI QTHR 03 52213658

- **ICOM IC281H**. 50W Tx on VHF and Rx only UHF, full cross band operation. Still in its carton, unused S/No. 20010. Geoff VK3GV QTHR. \$400. (03)9560 3773 or valentin@hotkey.net.au

- **ICOM'S IC751 HF** c/w workshop manual and orig packaging and instruction manuals \$1200 ONO. David VK3DPM QTHR (03)9598 1015

- **COMPLETE PACKET RADIO** station with C64 Diskdrive, 1541 DigiCom Modem B&W Monitor Printer 803 DigiCom Program instructions \$50 ONO VK3CHN QTHR 03 9744 2064

- **ANTENNA YAGI 3 EL Hy-Gain 14MHz** mono, wide spaced, g.c. Stan VK3SE 53 322 340 QTHR \$100.

- **YAESU FT-107M HF** Transceiver with matching FV-107 external VFO and hand held microphone. WARC bands and DMS option. Manual and Parts list. \$700.00 Tony VK3TZ 03 9887 2917.

FOR SALE OLD

- **AR magazines** August 1964 to date \$150.
- **QST magazines** January 1953 to date \$450.
- Bill VK4QF QTHR 07 3870 8785 e-mail bilvk4qf@gil.com.au

- **TS-820 CW** Crystal filter Model YG-88C sell or swap. Paul VK4DJ 07 4778 6031

- **Yaesu FT707S** transceiver (low power) FT707 Antenna tuner, Transwest power supply, DX-302 Communication Receiver 10KHz to 30 MHz. All equipment in very good working order and appearance with manuals the lot for \$420 Henry VK4VCD 079 4992 1386.

- **Tetrode 8122** with socket, 400w to 500MHz \$95. 12BY7A \$15. All New. Ray VK4BLK (07) 49392284

- **YAESU FT767GX** desk mic \$1500, KENWOOD 5205 & desk mike \$350, SIGGEN MARCONI TF2015 10-520MHz AM/FM \$50, SIGGEN BK2050 100K-30MHz \$50, BWD CRO 539 \$200, ant couplers LAC895 & LPM 885 \$100, ATU'S \$100, antennas \$275, KEY \$75, coax \$100, gas fuses \$100. \$2900 OR \$2500 THE LOT ANDY VK4CT 0414372 895.

FOR SALE SA

- **VKS POWERMASTER**. 14amp cont.25amp inter.\$120. Hy-gain TH3JR \$130. Commander 400 Rotator. \$150. Deluxe Versa Tuner MFJ-949E. \$140. Advance R.F.Sig. Generator B4 100kHz-80 MHz \$70. Sola Power Conditioner. \$50. Telegrip Scope S51E. \$20. QTHR VK5MZ Bill. 08 8536 3391. bilandot@chariot.net.au

- **HAM RADIO Rig Kenwood TS520** - \$ 250. Antenna: Vertical multiband (7, 14, 21, 28 MHz) VS6KR - \$ 40. Nick Burrows. Phone 08 8294 2039. Email: nickburr@esc.net.au

FOR SALE WA

- **ICOM BP4** dry-cell battery pack. Allows IC-2A, IC-40 etc handheld to be powered from 6 AA cells. \$15 ono. Chris VK6KCH. 08 9354 8416. Email vk6kch@amsat.org

FOR SALE TAS

- **YAESU FT101E HF** transceiver, s/n 7M301513, operator and workshop manuals, also service extension cards \$200. Homebrew ATU 100w \$50. Yaesu FRG7700 HF receiver s/n 31260513 with manual, excellent condition \$250. Lloyd VK7LP 03 6269 6317 e-mail lloydpen@southcom.com.au

- **SCANNERS: JIL SX200 25-550 Mk2/am/ fm** as new boxes books power supply. What offers? AOR 2001 25-550MHz AM/FM Exc condition Boxes Books. What offers?

Allen VK7AN 03 6327 1171 0417354410

**When sending Hamads by email,
which is the much preferred
method, please use upper and
lower case characters as you
would in normal text.**

WANTED NSW

• **BIG OLD VALVE** communications receivers, military or commercial, unloved, dusty, junked. Wanted for monitoring set up. Also parts, books, manuals, magazines from the past. all gratefully accepted. So give me a hernia and give me a call. L WIA 21068. Call John 02 9533 6261 or e-mail to dxer@fl.net.au

• **BACK ISSUES** of QEX, will pay fair price. Also pre 1992 issues of Electronics and Wireless World. Tel. 02 9411 4442 e-mail georgg@acay.com.au VK2KGG QTHR

• **SEVERAL 866 OR 866A** Mercury Vapour Rectifiers. Ben 02 4457 3220 or PO box 570 Ulladulla 2539 VK2AJE

• **LIGHT DUTY CROWN** brand rotator automatic model car24 complete or control box only. Grahame Foster, 17 Tumut st Dudley, N.S.W. 2290 L20747 Ph. 02 4944 8484

• **YAESU FTV-700** transverter, with 6m and 2m modules. Raul, VK2TPJ 02 9618 2910a/h

WANTED VIC

• 3 1/2 inch diskette for "PAKRAT FOR WINDOWS" will buy hire or loan Roc Kirby VK3AKH 03 9331 6316 QTHR

• **PHOTOCOPY** of Owners Manual for Yaesu FT-757GX HF transceiver. I already have the Technical Supplement, but no owner's manual came with my rig. Please contact before sending. I only want one copy, and we can determine costs. I suggest Melbourne Hams only need respond.

Alan VK3JAJ, 98782263, 69 Koonung Rd, Blackburn Nth Vic 3130 or email: ajudson@vnpbanpl.telstra.com.au

WANTED QLD

• **ICOM- 560 6metre** all mode transceiver, price condition. OR SWAP for ICOM- 245 2 metre all mode transceiver. VGC. Gwen, VK4CB 07 3202 7137

• **PHOTOCOPY** of handbook and circuit diagram for Kenpro KR500A elevation rotator. VK4ZGF Ph 07 4122 1368 QTHR

• **TEN TEC** Crystal filter Model 282 or 285 for 580 Delta. Paul VK4DJ 07 4778 6031

WANTED SA

• **HIDAKA DENKI** Triband Yagi tuning instruction manual wanted will pay photostats, expenses. VK5ARL John QTHR 08 8255-0617.

• **YAESU FL7000** HF Linear amplifier. Price and details to Gary on 0419815479 or AH. 08-83966706

WANTED WA

• **USERS MANUAL** or service manual for Kenwood TS-430S HF transceiver. To buy or borrow. Chris VK6KCH. 08 9354 8416. Email vk6kch@amsat.org

• **ICOM AT500** Antenna Tuning Unit. Lionel VK6LA (08) 9592 4771

WANTED TAS

• **ANARC-3** or Anarc-49 VHF transmitter. ANY CONDITION. Trevor Briggs VK7TB (Norfolk st, Perth, 7300 Tasmania Ph 03 6398 2118 Fax 03 6398 1629

South East Radio Group

Mount Gambler Annual Convention and Fox-Hunt

Championships 1999

12th & 13th June

(Queens Birthday weekend)

A&H Hall, Pick Avenue, Mount Gambier
For further details of Foxhunt schedule etc. including

****NEW NOVICE FOXHUNT EVENT****
access SERG home page at:-
<http://www.seol.net.au/serg>.

For table bookings or of other information contact Wayne VK5ZX:-

e-mail vk5zx@seol.net.au,
packet vk5zx@vk5sr or phone (08) 87 254335.

MISCELLANEOUS

• The Federal WIA QSL Collection requires QSLs. All types welcome especially rareDX pictorial cards, special issue. Please contact the Hon. Curator, Ken Matchett VK3TL, 4 Sunrise Hill Road, Montrose VIC 3765 (03) 9728 5350

• If you got your licence before 1974 you are invited to join the **Radio Amateurs Old Timers Club**. A \$2.50 joining fee plus \$5.00 per year gets you two interesting Journals plus good fellowship

TRADE ADS

• **AMIDON FERROMAGNETIC CORES:**

For all RF applications. Send business size SASE for data/price to RJ & US Imports, PO Box 431, Kiama NSW 2533 (no enquiries at office please ... 14 Boanyo Ave Kiama).

www.cyberelectric.net.au/~rjandusimports

Agencies at: Assoc TV Service, Hobart; Truscotts Electronic World, Melbourne and Mildura; Alpha Tango Products, Perth; Haven Electronics, Nowra.

• **WEATHER FAX** programs for IBM XT/ ATs ***"RADFAXZ" \$35.00, is a high resolution short-wave weather fax, Morse and RTTY receiving program. Suitable for CGA, EGA, VGA and Hercules cards (state which). Needs SSB HF radio and RADFAX decoder. *** "SATFAX" \$45.00, is a NOAA, Meteor and GMS weather satellite picture receiving program. Needs EGA or VGA & WEATHER FAX PC card, + 137 MHz Receiver. *** "MAXISAT" \$75.00 is similar to SATFAX but needs 2 MB of expanded memory (EMS 3.6 or 4.0) and 1024 x 768 SVGA card. All programs are on 5.25" or 3.5" disks (state which) plus documentation, add \$3.00 postage. ONLY from M. Delahunty, 42 Villers St, New Farm QLD 4005. Ph 07 358 2785.

Silent Keys

Robert John Marlow, VK6PJ

I am very sorry to report that Bob Marlow, VK6PJ, passed away on 5 November 1998 in Perth after losing his battle with cancer.

After nearly 12 months of study, Bob and I attained our full call licences and commenced transmitting in 1991. It was not long before we became known as 'Bob Up' and 'Bob Down' in some parts of the world as we were neighbours in Geraldton (by coincidence) and lived up or down the road from one another.

Bob always sought opportunities to help others learn amateur radio and operated the Geraldton Senior High School station, VK6AGN, for sometime to generate interest among the students. He threw his home open to scouts camped on his 3 acre property for the JOTA weekend. We became accredited examiners to make it easier for Geraldton folk to obtain licences.

Bob visited his native New Zealand recently to farewell his family there. He made maximum use of his 2-metre radio and spoke highly of their repeater network.

73's to Bob from all his friends. Condolences to Sandy who gave him so much care and love.

Bob Hollingshead VK6KI

L S Drakeford VK4EKK

Samuel Louis Drakeford VK4EKK, ex VS6EK passed away at his home in Runaway Bay, 14 April 1999.

Drake, as he was known on the air, was born in Shanghai China on 14 June 1907.

He was educated at Kings College London and graduated with a Bachelor of Engineering Degree. He was to be posted to China with the Shell Oil Company in charge of the first oil and fuel storage.

Drake operated on amateur radio in China call XU8LD. During WWII he was interned in the International Compound Shanghai.

Drake and wife Ailuen moved to Hong Kong on retirement, where he became known world wide with the call VS6EK. His wife Ailuen passed away 18 Feb 1986. After his wife's death Drake visited Australia and stayed with my wife and I for several months before purchasing his home at Runaway Bay.

Drake and I visited Beijing and Shanghai in 1996 and the Fredrichshafen Hamfest in 1994. Drake continued to be active on all modes up till 1998.

May he rest in peace.

Bill Hempel VK4LC.

Do a Mandrake

Turn your excess gear into cash for new 'toys'. The magic word is

HAMAD!!!!

WIA Division Directory

The WIA consists of seven autonomous State Divisions. Each member of the WIA is a member of a Division, usually in their residential State or Territory, and each Division looks after amateur radio affairs within its area.

Division	Address Officers	News Broadcasts	Note: All times are local. All frequencies MHz.	Fees
VK1 ACT Division GPO Box 600 Canberra ACT 2601	President Gilbert Hughes Secretary John Woolner Treasurer Les Davey	VK1Gh VK1ET VK1LD	3.590, 146.950, 438.375, 438.325, 438.225 & 438.025 FM each Sunday from 8.00pm AEST. News text on packet BCAST@VK1BBS, http://www.vk1.wia.ampr.org & aus.radio.amateur.misc newsgroup. Send items by packet as personal message BCAST@VK1BBS or e-mail to broadcast@vk1.wia.ampr.org.	(F) \$72.00 (G) (S) \$58.00 (X) \$44.00
VK2 NSW Division 109 Wigram St Parramatta NSW (PO Box 1066 Parramatta 2124) Phone 02 9689 2417 Freecall 1800 817 644 Fax 02 9633 1525	President Michael Corbin Secretary Eric Fossey Treasurer Eric Van De Weyer (Office hours Mon-Fri 11.00-14.00) Web: http://ozemail.com.au/~vk2w/ e-mail: vk2wi@ozemail.com.au Packet BBS: VK2WI on 144.850 MHz	VK2YC VK2EFY VK2KUR	From VK2WI 1.845, 3.595, 7.146*, 10.125, 14.170, 24.950, 28.320, 29.120, 52.120, 52.525, 144.150, 147.000, 438.525, 1273.500 (* morning only) with relays to some of 18.120, 21.170, 581.750 ATV sound. Many country regions relay on 2 m or 70 cm repeaters. Sunday 1000 and 1930. Highlights included in VK2AWX Newcastle news, Monday 1930 on 3.593 plus 10 m, 2 m, 70 cm, 23 cm. The broadcast text is available on the Internet newsgroup aus.radio.amateur.misc , and on packet radio.	(F) \$69.00 (G) (S) \$56.00 (X) \$41.00
VK3 Victorian Division 40G Victory Boulevard Ashburton VIC 3147 Phone 03 9885 9261 Fax 03 9885 9298	President Jim Linton Secretary Barry Wilton Treasurer Rob Hailey (Office hours Tue & Thur 0830-1530) e-mail: vk3wi@rint.com.au Web: http://www.tbsa.com.au/~wia/vic/	VK3PC VK3XV VK3NC VK3XV	VK3BWI broadcasts on the 1st and 3rd Sunday of the month, starts 10.30 am. Primary frequencies, 3.615 LSB, 7.085 LSB, and FM(R)s VK3RML 146.700, VK3RMM 147.250, VK3RWG 147.225, and 70 cm FM(R)s VK3ROU 438.225, and VK3RMU 438.075 and repeated at 8pm on 3.615USB. Major news under call VK3WI on Victorian packet BBS and WIA VIC Web Site.	(F) \$75.00 (G) (S) \$61.00 (X) \$47.00
VK4 Queensland Division GPO Box 638 Brisbane QLD 4001 Phone 07 3221 9377	President Colin Gladstone Secretary Peter Harding Treasurer Alistair Elrick e-mail: secretary@wiaq.powerup.com.au Web: http://www.wiaq.powerup.com.au	VK4ACG VK4JPH VK4FTL	1.825 MHz SSB, 3.605 MHz SSB, 7.118 MHz SSB, 14.342 MHz SSB, 21.175 MHz, 28.400 MHz SSB, 29.220 MHz FM, 53.725 MHz FM, 147.000 MHz FM, 438.500 MHz (Brisbane only), and regional VHF/UHF repeaters at 0900 hrs EAST Sunday. Repeated on 3.605 MHz SSB & 147.000 MHz FM at 1930 hrs EAST Monday. Broadcast news in text form on packet under WIAQ@VKNET.	(F) \$74.00 (G) (S) \$60.00 (X) \$46.00
VK5 South Australian Division 34 West Thebarton Rd Thebarton SA 5031 (GPO Box 1234 Adelaide SA 5001) Phone 08 8352 3428 Fax 08 8264 0463	President Ian Hunt Secretary Mervyn Millar Treasurer Joe Burford Web: http://www.vk5wia.ampr.org/	VK5QX VK5MX VK5UJ	1827 kHz AM, 3.550 MHz LSB, 7.095 AM, 14.175 USB, 28.470 USB, 53.100 FM, 147.000 FM Adelaide, 146.700 FM Mid North, 146.800 FM Mildura, 146.825 FM Barossa Valley, 146.900 FM South East, 146.925 FM Central North, 147.825 FM Gawler, 438.425 FM Barossa Valley, 438.475 FM Adelaide North, ATV Ch 35 579.250 Adelaide. (NT) 3.555 USB, 7.065 USB, 10.125 USB, 146.700 FM, 0900 hrs Sunday. 3.585 MHz and 146.675 MHz FM Adelaide, 1930 hrs Monday.	(F) \$75.00 (G) (S) \$61.00 (X) \$47.00
VK6 West Australian Division PO Box 10 West Perth WA 6872 Phone 08 9351 8873	President Cliff Bastin Secretary Christine Bastin Treasurer Bruce Hedland-Thomas Web: http://www.faroc.com.au/~vk6wia/ e-mail: vk6wia@faroc.com.au	VK6LZ VK6ZLZ VK6OO	146.700 FM(R), 438.525 FM(R), 29.120 FM at 0930 and 1900 hrs Sundays from Perth, relayed (morning only) on 1.865, 3.564, 3.582 (Busselton), 7.075, 14.116 (North), 14.175 (East), 21.185, 50.150; (morning and evening) 146.900(R) Mt William (Bunbury), 147.000(R) Katanning, 147.200(R) Cataby, 147.250(R) Mt Saddleback (Boddington), and 147.350(R) Busselton; (evening only) 1.865, 3.564 MHz.	(F) \$62.00 (G) (S) \$50.00 (X) \$34.00
VK7 Tasmanian Division 24 Targett Street Scamander TAS 7250 Phone 03 6372 5305	President Ron Churcher Secretary Paul Godden Treasurer John Kiop Web: http://www.wia.tasnet.net e-mail: vk7kpg@hamnet.hotnet.com.au	VK7RN VK7KPG VK7KCC	146.700 MHz FM (VK7RHT) at 0930 hrs Sunday relayed on 147.000 (VK7RAA), 146.725 (VK7RNE), 146.625 (VK7RMD), 3.570, 7.090, 14.130, 52.100, 144.150 (Hobart), repeated Tues 3.590 at 1930 hrs.	(F) \$74.00 (G) (S) \$60.00 (X) \$46.00
VK8 Northern Territory (part of the VK5 Division and relays broadcasts from VK5 as shown, received on 14 or 28 MHz).				

Membership Grades

Full (F) Pension (G) Needy (G) Student (S) Non receipt of AR (X)
Three-year membership available to (F) (G) (X) grades at fee x 3 times.

ADVERTISERS INDEX

Cushcraft	IFC	Av-Com	43
Icom	OBC, 12	Amateur Transceiver Radio ...	30
Jaycar	17	Dick Smith	IBC 28,29
Andrews	30		

TRADE PRACTICES ACT

It is impossible for us to ensure that the advertisements submitted for publication comply with the Trade Practices Act 1974. Therefore, advertisers and advertising agents will appreciate the absolute need for themselves to ensure that the provisions of the Act are strictly complied with.

VICTORIAN CONSUMER AFFAIRS ACT

All advertisers are advised that advertisements containing only a PO Box number as the address cannot be accepted without the addition of the business address of the box-holder or seller of the goods.

▶ YAESU'S DONE IT AGAIN



Yaesu FT-100 Ultra-compact HF/6m/2m/70cm Mobile

WHAT AMAZING VALUE!

Now you can enjoy the fun of operating on all bands from 160m to 70cm, either at home or in your car, and at a fantastic Yaesu price.

The new Yaesu FT-100 features HF/6m/2m/70cm transmitter coverage with 100W RF output on HF and 6m, 50W on 2m and 20W on 70cm, plus you can easily mount the detachable front panel using an optional lead (YSK-100) for more convenient mobile installations. Powerful interference fighting features such as a DSP based Bandpass filter, Notch filter and Noise reduction together with an IF based Shift control, all aid reception quality during tough conditions. A Speech Processor and VOX facility are provided for SSB users and an internal Electronic keyer is provided for CW operation. Also included are Dual VFOs, built-in CTCSS encode, 300 memory channels, all-mode operation (SSB, CW, AM, FM, AFSK, Packet 1200/9600bps), 100kHz-970MHz receiver (cellular locked-out), and options for additional AM and CW IF filters.

The FT-100 is supplied with an MH-42B6JS hand mic, DC power lead and comprehensive instructions.

D 3285

YSK-100 remote front panel lead \$155

D 3286

YAESU

Included as standard:

- Digital Signal Processing on both transmit and receive
- Effective IF noise blanker
- Electronic CW keyer with 50 character message memory
- Spectrum Scope function
- Massive receiver coverage (100kHz – 970MHz, less cellular)

\$2750

DICK SMITH
ELECTRONICS

That's where you go!

MORE

GREAT

DEAL

FROM

ICOM



PCR100 Cruise the air waves with your computer. Turns your PC into a high performance 0.5 - 1300 MHz receiver (FM/WFM/AM modes) with plug'n play installation. Multi function control panel, wide frequency coverage, and unlimited memory channels.

R2 Fit the world's airwaves in your R2 shirt pocket. Just 8.6cm high, wide 0.5 - 1300 MHz frequency range divided into 9 bands plus FM/WFM/AM, 400 memory channels, great sound in rugged water resistant construction.

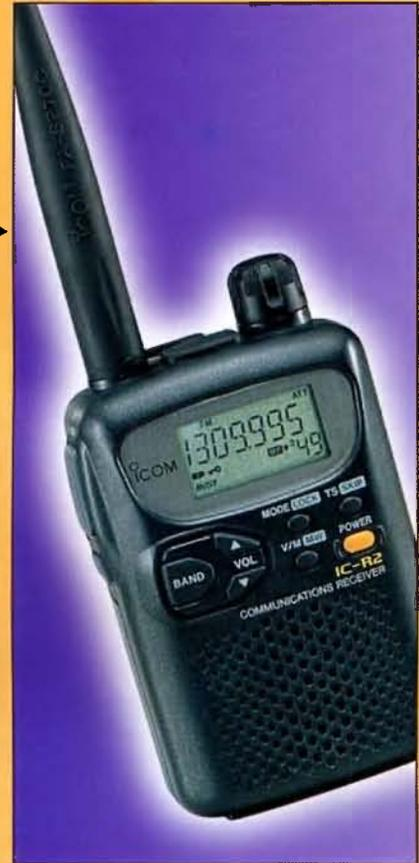

2800H A totally new approach to dual band mobile.

Powerful performance on 2m and 70cm bands, remote control capability, and a first for mobile rigs...a multi-function colour LCD screen! All your information is right in front of you in colourful 3D-like characters and icons.



706MKIIG The amazing evolution of the legendary 706. Frequency coverage is expanded to the 70 cm band and output power is increased for the 2m band. You get base station performance and features in a mobile rig-sized package.



T81A A remarkably compact quad bander. Superb clarity on the 6m, 2m, 70cms and 23cm bands. It's water resistant, with tone squelch and pocket beep functions standard, plus you can change volume and bands even quicker with the 'joy-stick' style multi-function switch.



ICOM

Clearly Ahead

2 YR WARRANTY

See your nearest Icom Dealer, call Icom on 1800 338 915, or visit our website at www.icom.net.au



July 1999
Volume 67 No 7

Amateur Radio

Journal of the Wireless Institute of Australia



Full of the latest amateur radio news, information and technical articles, including...

- ✱ An L&T-Match Design Chart
- ✱ An RF Resistance Bridge
- ✱ The Classic Adelaide Car Rally
- ✱ The WIA Federal Video Tape Library
- ✱ Not all is 'old that Glitters
- ✱ A Microphone Impedance Pre-Amp

Plus *lots of other articles, news and special interest columns.*

COMMUNICATIONS BONANZA!

Uniden UHF CB RADIO

BONUS ANTENNA, BASE & LEAD

SAVE \$100

\$218 TAX EX

Uniden UH077 40 CHANNEL UHF CB

BONUS ANTENNA, BASE & LEAD

\$249 TAX EX

GME Electrophone TX3000 40 CHANNEL UHF CB

BONUS ANTENNA, BASE & LEAD

\$299 TAX EX

Uniden UH088 UHF CB RADIO

BONUS ANTENNA, BASE & LEAD

\$279 TAX EX

Uniden UH045 UHF CB RADIO

\$169 TAX EX

Uniden UH053 UHF 2 WAY CB HANDHELD

BONUS CASE

\$199 TAX EX

Uniden UH054/A UHF 2 WAY CB WATERPROOF

\$279 TAX EX

Uniden UH054/L UHF 2 WAY CB HANDHELD

\$249 TAX EX

LEXMARK HAND HELD

\$239 TAX EX

UHF CB

\$259 TAX EX

Uniden UH057 HANDHELD UHF CB

\$369 TAX EX

GME Electrophone TX6000 PORTABLE UHF TRANSCEIVER

\$399 TAX EX

GME Electrophone TX4200 UHF TRANSCEIVER

BONUS ANTENNA, BASE & LEAD

\$359 TAX EX

Uniden UH100 40 CHANNEL UHF CB

BONUS ANTENNA, BASE & LEAD

\$299 TAX EX

GME Electrophone TX4000R REMOTE MOUNTING UHF TRANSCEIVER

\$489 TAX EX

GME Electrophone TX830 CB RADIO

GREAT VALUE!

\$139 TAX EX

GME Electrophone GLOBAL POSITIONING SYSTEM WITH ELECTRONIC MAPPING

NEW MODEL

\$659 TAX EX

GME Electrophone GPS12XL HANDHELD GPS RECEIVER

BONUS CASE

\$499 TAX EX

GME Electrophone GPS38 HANDHELD GPS RECEIVER

SAVE \$20

\$299 TAX EX

SUBHOLINE 10 CHANNEL CORDLESS PHONE

RRP \$129

\$88

Omni DIGITAL CORDLESS PHONE

UP TO 1 KM RANGE

SAVE \$50

\$199

MULTI HANDSET CORDLESS PHONE + DIGITAL ANSWERING MACHINE + DDPLEX SPEAKER PHONE

BONUS HANDSET & CHARGER VALUE 100

\$299

HIGH RESOLUTION SCANNER

RRP \$169

\$138

600X600 DPI

Canon PLAIN PAPER BUBBLE JET FAX MACHINE

\$529

LEXMARK COLOUR JET PRINTER

RRP \$169

\$128

Canon COLOUR BUBBLE JET PRINTER

RRP \$199

\$159

ALCATEL ONE TOUCH

(view) ONE LOW RATE APPLIES FOR ALL CALLS

PLUS FREE EXTENDED WARRANTY FREE CARRY POUCH

\$29[#]

SATELLITE PHONES EX-RENTAL

MINI-SAT WORLD PHONE

- *Fits in a brief case
- *The phone you can use anywhere
- *Not restricted by networks

LIMITED STOCK!

SAVE UP TO \$2000

Brisbane Car sound

A Division of Strathfield Group

MAIL ORDER

PHONE: (07) 4639 1455
FAX: (07) 4639 2018

#To new and approved Customers. The minimum package cost for Customers who remain connected for 24 continuous months is Alcatel View S454 (Includes \$65 connection fee and 24 months access fees on Value 10) plus call charges. +For a limited time to analogue customers who take up a new digital service in the same name. While Stocks last. Not available with other Telstra MobileNet offers. Limit 3 per customer (except in SA). No trade sales. ID required. Ask us for further details. Some pictures used for illustration purposes only. Limited stocks available.



BCS6517

Amateur Radio

Volume 67
Number 7
July 1999

Amateur Radio is published by the Wireless Institute of Australia ACN004 920 745 as its official Journal on the first Friday of each month

Editorial

Editor: Bill Rice* VK3ABP
Production Manager: Bob Harper VK4KNH
Snr Technical Editor: Peter Gibson* VK3AZL
Technical Editors: Evan Jarman* VK3ANI
Gil Sones* VK3AUI
Contributing Editors: Ron Fisher* VK3OM
Don Jackson* VK3DBB
WIA News Editor: David Thompson VK2NH

*Publications Committee member

Advertising

Mrs June Fox, WIA Federal Office
PO Box 2175 CAULFIELD JUNCTION VIC 3161
Tel: (03) 9528 5962 Fax (03) 9523 8191
email armag@hotmail.net.au

Hamads

"Hamads" Newsletters Unlimited
29 Tanner Street, Richmond VIC 3121
Fax: (03) 9428 4242
e-mail: newsi@webtime.com.au

Amateur Radio Correspondence

All correspondence, contributions and queries about the **content** should be sent to:

The Editor **Amateur Radio**
PO Box 2175, CAULFIELD JUNCTION VIC 3161
email armag@hotmail.net.au
Tel: (03) 9528 5962 Fax (03) 9523 8191

Amateur Radio Delivery

All queries regarding delivery should be directed to:

Amateur Radio WIA Federal Office
PO Box 2175 Caulfield Junction Vic 3161
Tel: (03) 9528 5962 Fax (03) 9523 8191

Registered Office

10/229 Balaclava Road
Caulfield North VIC 3161
Tel: (03) 9528 5962 Fax (03) 9523 8191
Business hours: 9.30am-3pm weekdays

Editorial & Display Booking Deadlines

August	11/7/99
September	13/8/99
October	10/9/99

Hamad & Display Material Deadline

August	21/7/99
September	20/8/99
October	17/9/99

Production

Administration, Drafting, Design & Sub-editing
Shadetree Publishing & Imaging
PO Box 288 BEERWAH QLD 4519

Pre-press, print and mail management
Newsletters Unlimited (03) 9428 3458

Printed by Streamline Press, Melbourne (03) 9417 2766

Mailed by IMS, Melbourne (03) 9291 5888

Receipt of Amateur Radio by mail

This issue was delivered to Australia Post on Wednesday July 7 if you are a financial member and have not received your copy by the 15th of the month please check with your local Post Office before contacting the registered office of the WIA.

Copyright and Reproduction

The copyright in this magazine, except where specifically noted, is held by Wireless Institute of Australia ©WIA 1999. Permission to republish articles in any form must be obtained in writing from the Institute (other than for purposes of 'fair dealing'). This permission is usually freely given for information purposes.

The Journal of the Wireless
Institute of Australia

ISSN 0002-6859

General

The Classic Adelaide Car Rally	12
<i>Christine Taylor VK5CTY</i>	
On Video — WIA Federal Videotape Library	39
<i>Don Bland VK4TYD</i>	
Monitoring Station of Yesteryear	51
<i>John Wright L21068</i>	

Technical

All is not old that glitters	15
<i>Mike Krochmal, VK3KRO</i>	
An L&T-Match Design Chart	17
<i>Graham Thornton VK3IY</i>	
An RF Resistance Bridge	24
<i>Drew Diamond VK3XU</i>	
Mike Impedance Matcher	30
<i>Bob Harper VK4KNH</i>	
Technical Abstracts	32
<i>Gil Sones VK3AUI</i>	

Columns

Advertisers' Index	56	HF Predictions	52
ALARA	10	New Members	2
AMSAT Australia	42	Over to You	11
ARDF	45	Pounding Brass	46
Awards	48	Repeater Link	44
Club News	9	Silent Keys	38
Contests	49	Spotlight on SWLing	50
WIA Division News		Try This	47
VK3 Notes	6	VHF/UHF - An Expanding World	35
VK4 Notes	7	WIA Comment	3
VK6 Notes	7	WIA News	3
Editor's Comment	2	WIA Division Directory	56
Hamads	54	WIA Federal Directory	2

Our cover this month

"Snow DF"

Partaking in a DF hunt at Mt Buller were Graham VK3KOA, Mark VK3JMD, Jack VK3WWW, Craig VK3CRA (SK 29/5/98) and Paul Bilston SWL.

Photo by Jack Bramham VK3WWW 1995.

Contributions to Amateur Radio

Amateur Radio is a forum for WIA members' amateur radio experiments, experiences opinions and news. Manuscripts with drawings and or photos are always welcome and will be considered for publication. Articles on disc or email are especially welcome. The WIA cannot be responsible for loss or damage to any material. A pamphlet, How to write for Amateur Radio is available from the Federal Office on receipt of a stamped self-addressed envelope.

Back Issues

Back Issues are available directly from the WIA Federal Office (until stocks are exhausted, at \$4.00 each (including postage within Australia) to members.

Photostat copies

When back issues are no longer available, photocopies of articles are available to members at \$2.50 each (plus an additional \$2 for each additional issue in which the article appears).

Disclaimer

The opinions expressed in this publication do not necessarily reflect the official view of the WIA and the WIA cannot be held responsible for incorrect information published.

Amateur Radio Service

A radiocommunication service for the purpose of self-training, intercommunication and technical investigation carried out by amateurs; that is, by duly authorised persons interested in radio technique solely with a personal aim and without pecuniary interest.

Wireless Institute of Australia

The world's first and oldest
National Radio Society
Founded 1910

Representing
The Australian Amateur Radio Service

Member of the
International Amateur Radio Union

Registered Federal Office of the WIA
10/229 Balaclava Road
Caulfield North Vic 3161
Tel: (03) 9528 5962 Fax (03) 9523 8191
<http://www.wia.org.au>

All mail to
PO Box 2175 Caulfield Junction VIC 3161

Business hours: 9.30am-3pm weekdays

Acting Federal Secretary

Peter Nalsh VK2BPN

Federal Office staff

June Fox Bookkeeper
Rita Trebilco VK3IF Examinations Officer

Council

President	Peter Nalsh	VK2BPN
VK1 Federal Councillor	Glenn Ounstan	VK1XX
VK2 Federal Councillor	Michael Corbin	VK2YC
VK3 Federal Councillor	Brenda Edmonds	VK3KT
VK4 Federal Councillor	Ross Marren	VK4AMJ
VK5 Federal Councillor	Ian Hunt	VK5QX
VK6 Federal Councillor	Will McGhie	VK6JU
VK7 Federal Councillor	Phil Corby	VK7ZAX

Executive

Peter Nalsh	VK2BPN
Tony Farrow	VK2TJF
John Loftus	VK4EMM
Wally Howse	VK6KZ

Federal Coordinators

AMSAT	Graham Ratcliff	VK5AGR
ARDF	Jack Bramham	VK3WWW
Awards	John Kelleher	VK3DP
Contests	Ian Godsil	VK3DID
Education	Brenda Edmonds	VK3KT
FTAC	John Martin	VK3KWA
Historian	John Edmonds	VK3AFU
IARU	Grant Willis	VK2ZWI
Intruder Watch	Gordon Loveday	VK4KAL
ITU Conference and study group	David Wardlaw	VK3ADW
Public Relations	David Thompson	VK2NH
OSL Manager (VK9, VK0)	Neil Penfold	VK6NE
Videotapes	Don Bland	VK4TVD

ACA Liaison Team

Peter Nalsh	VK2BPN
Glenn Dunstan	VK1XX
Michael Corbin	VK2YC
Wally Howse	VK6KZ
Canberra Liaison Officer	
Richard Jenkins	VK1RJ

EDITORS COMMENT

Buzzwords

LAST MONTH'S COMMENT was going to be entitled "Acronyms and Buzzwords", but as it worked out there was enough on acronyms alone to fill the space.

So now to buzzwords.

Meaning what? For the purpose of this editorial I would define a buzzword as a technical term having at least two meanings. One may have been part of the language for centuries. The other, usually the technical meaning, has come into widespread popular use only recently.

Three not so recent examples came into being just on 100 years ago with the advent of motor vehicles. The words "clutch", "choke", and "throttle" had singular and rather violent meanings once. Not now! In those days "broadcasting" referred to a method of

distributing seed on a farm. But the real trigger for the buzzword business has been computers! From the moment you "boot" your PC and chase your "mouse" over the mat you are "supporting" a "host" of buzzwords. A "hacker" may have planted a "virus" on your "floppy" so "debugging" is necessary. "Default" and "execute" have meanings never known before the 1970's. You don't obtain things, you "source" them. Not to use a noun as a verb is a "big ask", isn't it?

Hopefully? No, preferably "in hope" I guess I have now scored enough "hits" to "exit the program"; and without one mention of amateur radio. Not to say it's without buzzwords, but let's leave them until another time.

Bill Rice VK3ABP
Editor

NEW MEMBERS

The WIA bids a warm welcome to the following new members who were recently entered into the WIA Membership Register.

L31547 Mr Y U K Hang D. Tse	VK4IL Mrs EJ White
VK2DPZ Mr W J Minogue	VK4FAE Mr C Alexander
VK2GPL Mr L J Mcilree	VK4FRF Mr R Frost
VK3AXL Mr B J Neumann	VK4XD Mr PD Love
VK3BIX Mr A E Phillips	VK4NH Mr MGN Hoare
VK3BVW Mr R J Wagner	VK4ZXZ Mr G Minter
VK3TEN Mr G Pearce	VK4FNA Mr Nigel Andrews
VK3XIJ Mr I J Hocking	VK4SM Mr David Soundry
VK3ZJH Mr J Longayroux	VK4GBW Mr Gordon
VK4BO Mr Frank Fisher	L41018 Mr DA Middlebrook
VK4DLT Mr Donald Tunes	L41019 Mr Cj Roberts
VK4DMI Mr D W Shephard	L41016 Mr Dennis Bauer
VK4QD Caboolture Radio Club	L41017 Mr Glenn Wood
VK4SOA Mr So Abrahams	L41020 Ms J H Mancy
VK4VKZ Mr DJ Cantwell	L41021 Mr M Donohoe
VK4YKE Mr NL Doak	L41022 Mr Roy Harris
VK4ZJ Mr RJ Webb	L41023 Mr Tom Deridder
VK4ZKR Mr KS Read	VK5AGX Mr V V Noble
VK4GRM Mr Gregory Mews	VK6HAO Mr P J Larkin
VK4SGW Mr Stephen Watson	VK6VAS Mr V Vasic
VK4KIY Mr N Wright	VK7US Mr S Anderson
VK4BX Mr J White	VK7WM Mr W J Melville

New Executive up and running

THE FEDERAL EXECUTIVE of the WIA, which was elected at the Annual Convention in May, is now well into the various tasks that need immediate attention. The two new Directors have rapidly found their feet and are contributing significantly to the work of running the Federal company.

As promised, the liaison with ACA is a high priority item. There are many matters that currently concern amateur radio operators in Australia and many of these were the subject of discussions with ACA in June. I intend to highlight the results of these in a forthcoming issue of this Journal.

On the international scene, the meeting of IARU Region 3 in Darwin in August 2000 will be an important forum to prepare the amateur radio service for World Radio Conventions scheduled to be held during the next two years. The Darwin Amateur Radio Club is hosting the meeting on behalf of the WIA. More information on this important event will be provided to you as the date approaches but already delegates from throughout Region 3 (most of Asia and the Pacific region countries) plus IARU members from Regions 1 and 2 and IARU headquarters are making their plans to attend.

A few weeks ago I was privileged to be invited to attend the Annual Conference of our sister organisation in New Zealand, NZART. This was held in Christchurch and attended by nearly 300 NZART members. Many of the issues that were raised during this conference were similar to those that are concerning the WIA. It was refreshing to be able to swap ideas on how the NZART and WIA could work together to improve the amateur radio service in our countries. I found a genuine desire to work as a team particularly in regard to international matters where a consolidated front from this part of the world will help to ensure that our voices are heard in international forums which are dominated by the large European and North American representatives.

Peter Naish, VK2BPN
WIA Federal President.

WIA News Prepared, researched and compiled by
Assembled by Bob Harper VK4KNH
(Sources noted where known.)

WWII RAAF Site Memorial

5 Fighter Sector - Darwin

WERE YOU STATIONED at 5 Fighter Sector at Berrimah near Darwin in WWII? The wartime site of 5 Fighter Sector Headquarters, RAAF, near Darwin has been recently rediscovered (5 Fighter now known as 105). The site has been prepared by the Heritage Branch of the Northern Territory Government and will be dedicated

on Friday 13 August 1999. The organisers hope that many ex-servicemen, particularly those from the RAAF, and more particularly any who served there will be able to attend. Enquires should be directed to Graham Calley, telephone 0419 300 822

(Murray VK5ZQ/vk5 news/vk4afs)

VK-News by E-mail

VK2WI News is now available by email subscription.

To subscribe to this free service, simply send an email message to: vk2news-subscribe@onelist.com

QNEWS from VK4 Division is also "on line". Send an email request as above to: QNEWS-subscribe@onelist.com.

Other divisions may be available from this site in the future so keep reading AR for details. (VK2SKY/VK4BB)

3.4 GHz Up for Auction

Parts of the microwave spectrum now allocated to the Amateur Service are planned to be auctioned this year.

A report in the June 1999 issue of Connections, the bulletin of the Australian Communications Authority, advised that the Authority is proposing a re-allocation of frequencies in the 3.410 to 3.600 gigahertz range across Australia.

Segments 3.4425 to 3.4750 and 3.5425 to 3.5750 GHz would be affected by the re-allocation. This part of the spectrum is sought after by commercial interests for Wireless Local Loop services.

A price-based allocation of licences was supported because these frequencies are considered to be commercially desirable.

Page 58 of the WIA Callbook mentions that amateurs have secondary access to 3.3 to 3.6 GHz. Radio-location is the primary

user of this segment. The frequencies to be auctioned are in the middle of this amateur secondary band. (APCNews)

Note that your membership helps the WIA to fight to retain your privileges.

Gold Coast To Host International Meeting For WRC 2000

The ACA and the Department of Communications, Information Technology and the Arts will co-host the Asia Pacific Telecommunity (APT) Preparatory Meeting for the World Radiocommunication Conference 2000 (WRC 2000).

The meeting will be held from 4-8 October 1999, at the Gold Coast International Hotel, Surfers Paradise, Queensland.

Over 100 delegates from more than 29 countries within the Asia-Pacific region are expected to attend.

More information about the meeting is provided on the ACA's website:

<http://www.aca.gov.au/committee/international/apg2000-3.htm>

Kosovan News from BBC

You may have heard the VK7 Division on their news service, called for volunteers to help set up a radio monitoring service for the Kosovan refugees in Tasmania.

Now from the UK a group of radio amateurs and social workers are monitoring

Continued on page 4

the Beeb helping Kosovan refugees, living temporarily in the UK.

Twice a weekday, BBC World Service puts out a 15-minute short wave broadcast in Albanian. These special programs go out at 11.15 hours BST 13,745 kHz, 15,415 kHz and 17,670 kHz. They are transmitted again at 14.30 hours BST on 11,680 kHz, 13,670 kHz and 15,115kHz.

Now for usVK's. If there is a group of refugees living near your home, you may find that their social workers would appreciate receiving a recording of one of these transmissions. Maybe even something our Listed Listeners could become involved in!

VK/ZL Moved Left Of Centre

APRS buffs, bushwalkers, sailors etc soon could be finding themselves lost as Australia moves its longitude and latitude grid.

Ours is currently worked out differently to the rest of the world. From Jan 1st 2000 all our mapping services will have completed the change to bring us in step with "over yonder!"

Remember that GPS already has an error margin factored in, with our change of some 200 metres where you're sitting right now could be up to 1/2 a kilometre from where you think you are! Are you confused?

Sue Buzer, president of the Mapping Sciences Institute of Australia says "the change could easily cause confusion!"

(Rodney Chester/Courier Mail)

Beacons/Repeater Callbook Details

John VK3KWA says he's begun the update of the beacon, repeater and packet BBS directory for the 1999 - 2000 Call Book. Any additions or corrections to the list would be much appreciated.

The information needed for packet systems is:

- Callsign, location and service area.
- Type of system: one or more of:
B BBS D digipeater G gateway N node R Rose switch S Satgate W wormhole.
- Frequencies, and baud rates for each frequency.
- And, if possible, ERP, height of station above sea level, and name of sponsor (if it is a club or group).
- You can also add other information which can be put in a footnote.

Information by mail to WIA (Callbook), PO Box 2175, Caulfield Junction Vic 3161.

Speaking Of Beacons

The VK4RTL beacon has been heard in VK3. The beacon on 28.270 MHz is operating under test from the QTH of Les VK4ALS. APC News confirmed the operation and said it was heard quite strongly in Melbourne recently. Reception reports are still invited and can be sent to VK4ALS.

WIA Callbook for 2000

Have you checked that your details on your licence renewal are correct? If not they will be listed in the callbook as they appear on the ACA database. Please advise the ACA of any changes ASAP.

The contents will soon be gathered for the next callbook. If you have any suggestions for content that should be included please forward your ideas by mail to WIA (Callbook), PO Box 2175, Caulfield Junction Vic 3161.

Anything To Declare?

The ACA has added a new fact sheet "bringing communications equipment into Australia" to its website.

The fact sheet provides general information about how to properly and legally use any communication equipment brought in from overseas.

Communications equipment purchased overseas generally needs to be tested to see if it meets Australian regulatory requirements, and this process can be costly and time consuming.

Anyone thinking of bringing such equipment into Australia should check these requirements first. The sheet provides some general information for visiting amateur radio operators and about the operation of other radio-communications equipment.

The fact sheet is on the ACA website at: <http://www.aca.gov.au/consumer/fsheets/index.htm>

(aca connections)

Off To A "Rocky" Start

VK4YOL Jason and VK3TJN Bruce along with the Australian ARDF team have landed in Korea for the amateur radio direction finding championships, however the trip was not without drama.

When Bruce arrived in Sydney, he realised he had left his passport at home. Fortunately another ARDF participant, Jack VK3WWW, a locksmith by trade, was still in Melbourne and was able to retrieve Bruce's passport from his home!

Later on Bruce found that some antenna elements had been left in his brother's car.

Again these were rescued just in time for the flight to Korea. We hope to have more news on how the Australian team goes in Korea and perhaps the full story in AR soon.

(VK3TJN/apcnews)

ACA News

Roger Smith, formerly Senior Executive Manager Planning and Standards at the ACA, has recently taken up a position at the International Telecommunication Union (ITU) in Geneva, Switzerland as Head of the Space Services Department in the Radio-communication Bureau of the ITU. This Department is responsible for managing International Treaty obligations for the notification, coordination and registration of all national and international satellite systems.

In the past, Roger's responsibilities at the ACA included international radio-communication matters, and he represented Australia at ITU Conferences, meetings and working groups, including chairing the ITU World Radio-communication Conference (WRC-97) in Geneva. Mr Smith has been active in international communications work over many years.

(Connections)

WICEN

Ray Sweatman VK4KV, President of Brisbane area WICEN believed VK4 to be the only place in the world where competitors' scores are flashed to Rally HQ by packet radio. The scoring program was written by Brian Mennis VK4XS.

After QNEWS broadcast that story, Peter VK2ETK in Orange and Editor of that club's magazine contacted QNews to say:-

"Can't possibly let that one go by without firstly, a correction and secondly, a reminder of a piece of ham radio history.

I hope VK4KV does not mind being corrected on his reported belief. Blue Mountains Region of WICEN (NSW) is just one of several VK2 groups regularly using packet radio for these purposes. This is from the Orange Radio club, one of VK's more progressive clubs."

"The reminder about a bit of amateur radio history concerns the very early use of packet radio for just that purpose! The Qantastic 2-Day Motorcycle Trials were run in various forests around Orange NSW in from 1975 to 78.

Local hams used 2m FM, plus some HF, in all of those, with the 1977 and 1978 events also using a sort of packet, slowly chirping competitors' scores (hardly "flashing" in those days), from

Field Control to HQ. The software was written the hard way, just about at the machine-language level, by Kim Stevens VK2ICP (then 2ASY) and Wally Watkins VK4DO (then VK2DEW)."

"While Orange mightn't have been the first, we were very early off the mark, before networks of nodes and digis existed. There's been talk of re-introducing packet and trying ATV for future suitable events in Orange.

The ease of operation, the speed, accuracy and overall success of packet radio is far better now with much improved hardware and software, compared to what our Orange guys did, let it be known, almost a quarter of a century ago."

Amateur Radio Is At The Crossroad

"Amateur Radio is at the cross roads!" says SARRL President Hans Potgieter.

"Taking the low road is easy, we just let things slide and allow fate to take control of our destiny", he said.

"The high road will not be an easy road. There are many obstacles on the way. Many of us that believe that the ITU and SATRA will protect our frequencies, that the American FCC will keep the small satellite industry at bay and all is well. How foolish can we be to believe that?"

"The warnings from Robert Jones, Director of the ITU Radio-communications Bureau and the Chairperson of the ITU Council, Lindall Shope Mafole can not be taken lightly.

Automated receivers connected via satellite and the Internet are monitoring the amateur bands for spectrum occupation and content of communication. Would you put your weight behind the Amateur lobby based on what those studies reveal? I somehow doubt it.

We are back to the old argument, unite by joining the SARRL (WIA here). Joining the SARRL is not a question of who you like or dislike on Council, it is a question of survival, survival of the Amateur frequency allocation and the service," President Hans said.

Contest Time

To celebrate the 25th anniversary of the Ontario DX Association listeners of international short-wave, medium-wave, FM, scanning and Amateur Radio are invited to write an essay on "Radio in my life".

Tell ODXA about the importance of radio to you, how it has contributed to your life, why you love radio... share your emotions

and passions with other radio listeners around the world in 1000 words.

ODXA say ALL essays will be published in a booklet to be available at Radio Fest 99, September 24-25th in Oakville, Canada and all entrants will receive a complimentary copy of the booklet. Copies will also be made available to other radio clubs, publications and international radio stations, as chosen by the Ontario DX Association.

Essays must be received no later than September 1, 1999.

E-mail to: dxontario@compuserve.com

Mail to: Ontario DX Association, P.O. Box 161, Station A, Willowdale, Ontario M2N 5S8, Canada.

Arthur C Clark and Y2K

AMSAT member 2001 has a lot to say about Y2K. Arthur C Clarke, author of "2001: A Space Odyssey," and AMSAT member 2001 feels so strongly about people calling next year a new millennium that he issued a public statement to correct them.

According to Clarke, because the Western calendar starts with Year 1, and not Year Zero, the 21st Century and the Third Millennium do not begin until January 1, 2001.

He says that while some people have great difficulty in grasping this concept, there is a very simple analogy to explain it. He asks if the numbers on your grocer's scale were to begin at 1 instead of 0, would you be happy when he claimed he'd sold you 10 kg of tea?

Clarke says that the same is true regarding what is and is not the real Y-2-K. He says that we will have had only 99 years of this century by January 1, 2000. We will all have to wait until December 31, 2000 for the full hundred.

(Y2K Science Watch/newsline)

ar

Are you a doer
or just a reader?

today!
project
Amateur
Radio
an
Build

Andrews
Communications Systems
(EST. 1976 - ACN 001 968 752)



ALINCO

AUSTRALIA'S FIRST AUTHORISED
FACTORY DIRECT IMPORTER

No1 & Biggest Importer with one or two
absolutely massive shipments monthly.

FULL 3-YEAR FACTORY WARRANTY
INSTANT REPAIRS ON FRIDAYS

WE SELL MOST BRANDS AND MAKE
BALUNS, VERTICALS, YAGIS, P/S.
ICOM-KENWOOD-JRC-AOR-EMOTATOR-
MJF-DIAMOND-TIMEWAVE-KANTRONICS
-THP - GARMIN - TERLIN - UNIDEN -ETC
DX-1600 HF LINEARS FROM \$ 3,799

HUGE RANGE OF ELECTRONICS

NEW IC-706IIG & IC-756PRO

NOW 3-YEAR WARRANTY ON
NEW ICOM SOLD BY US.

* OVER 20 YEARS OF SERVICE *
WE WANT HF SSB TRANSCEIVERS
& LINEAR AMPLIFIERS

(02) 9636 9060 or (02)
9688 4301

SHOP 8, 41 BATHURST ST. GREYSTANES.

N.S.W. 2145. FAX (02) 9688 1995

Looking for an Olde Valve?

or a new Valve ?



AMATEUR RADIO - AUDIO -
INDUSTRIAL AND VINTAGE RADIO
plus electrolytics, sockets and books

BUYING - SELLING - TRADING
Australasia's biggest selection

Send a SSAE DL Envelope
for your free catalogue

ELECTRONIC VALVE
and
TUBE COMPANY

PO Box 381 Chadstone Contra VIC 3148

Tel: (03) 9571 1160 Fax: (03) 9505 6209

Mob: 0417 143 167

E-mail avstco@mira.net



Divisional News

Divisional Notes for July 1999 contain some material that was unfortunately left out of the June edition. The problem has, hopefully, been corrected and it is not expected to happen again. I apologise for this failure and encourage all divisions to use this facility to reach their members. One division has told me that AR reaches more members than any means other than a direct mail-out. How would your division compare?

WIA Victoria News (for June, 1999)

By Jim Linton VK3PC

The WIA Federal Convention

The annual general meeting of WIA Federal was held in Sydney, or more precisely, Parramatta, on the first weekend in May. The delegates for VK3 were our Federal Councillor, Brenda Edmonds VK3KT and the Alternate Councillor, myself Jim Linton VK3PC. The first matter raised by the VK2 delegate was the eligibility of WIA Queensland to participate in the convention.

The VK2 delegate, Michael Corbin VK2YC, argued that under the articles of association, a member division of WIA Federal had to be financial to participate in the Federal Convention. VK4 was not a financial affiliate of the federal body.

VK3 agreed, and seconded VK2's motion that VK4 be excluded from the meeting. The motion was passed and VK4 was excluded from participating, however a subsequent motion permitted the VK4 delegates to remain and observe the proceedings, which they did. VK4 remains a member of the WIA, and the complex issue of membership dues is being worked through to find a solution.

In today's report to WIA members I will mention a number of agenda items of interest.

Two motions concerned Morse code licence qualifications. VK5 proposed that the Morse code test speed be 5-words per minute for the AOCP standard, while in a second motion VK6 called for Morse code to be removed as a licence requirement.

These motions were not carried. VK3 argued that any WIA policy on Morse code should reflect the wishes of the members of the WIA Divisions – and that another survey

needed to be held. During debate it was also pointed out that the issue of Morse code is currently being considered as part of the international review of Amateur Radio qualifications being undertaken by the International Amateur Radio Union.

VK5 in another motion proposed that individual radio amateurs be permitted to openly advertise equipment on the air – the motion also failed. VK5 also proposed increasing the size of the Novice CW segments so they could more easily communicate with full call licensees. The motion failed.

During the conference there was considerable discussion on the operation of the WIA ACA Liaison Team. The delegates universally agreed that this important WIA activity needs more publicity so everyone can learn about the progress, or lack of progress that is being achieved regarding issues under consideration.

The WIA Federal Council also increased the federal component of WIA membership fees – these cover two areas, International representation, and a so-called catch-up for Pensioner G-Grade members for the cost of AR magazine.

In relation to the increase for the G-Grade members, your VK3 delegates did not vote in favour of this impost, and registered a protest about the proposed fee rise. The fee increase first suggested more than a year ago was aimed at standardising the cost of AR magazine to all members receiving the publication. WIA Victoria is now seeking to convince the other Divisions that the fee rise is not justified because of the cost savings in the production of AR magazine under its new production contract.

The Convention also decided that the Year 2000 IARU region 3 conference will be held in Darwin – previously Queensland's Gold Coast has been considered as the venue. The conference

will be coordinated by the Darwin Amateur Radio Club team that has run two successful SEANET conferences.

The delegates chose some new blood for the WIA Federal Board of Directors – with the Federal President, Peter Naish VK2BPN being re-elected along with Wally House VK6KZ, and the new directors are John Loftus VK4EMM and Tony Farrow VK2TJF.

In other major appointments, Bill Rice VK3ABP continues as AR magazine editor headed to set a new record in the editor's chair. There is already some interest expressed by a couple of aspirants in the editorship...when Bill retires.

Gordon Loveday VK4KAL the Federal Intruder Watch Coordinator was also nominated as the IARU Region 3 Coordinator.

Jack Bramham VK3WWW was appointed the WIA ARDF National Coordinator.

Amateur licence fees - no change

A review of all licence fees set by the Australian Communications Authority has not increased the fees of amateur licences. A new scale of fees effective from the 10th of May listed all categories of amateur licence at \$50.

Although the ACA has made changes to the Spectrum Access Tax, Spectrum Management Charge, and Licence Issue or Renewal Charge - the total sum still adds up equal to the fees set last year. While amateurs have escaped a licence fee rise, that has not been the case for all types of radio-communication licences issues by the ACA.

It does seem that the ACA has accepted the arguments put to it by the WIA against higher licence fees for amateur stations.

International Telecommunication Day

To mark International Telecommunications Day, Monday 17 May, the commemorative call sign AX3ITU was put to air. The occasion celebrated the 134th birthday of the world regulator of telegraph, telephone, radio and satellite communications, the International Telecommunication Union. On May 17 each year is it traditional to hear amateur special event stations denoted by their ITU call sign suffix.

Among them was AX3ITU, assigned to WIA Victoria and enthusiastically activated by a team of five members of its affiliate, the Eastern and Mountain District Radio Club who made 310 contacts.

Further discussions on proposed new Amateur Operator Licence

The WIA is still lobbying for the uniqueness of amateur radio to be recognised by the establishment of a new type of licence. The basis of its argument is that the current types of licence available under the Radio-communications Act - Apparatus Licence, Spectrum Licence, and Class Licence - are not suitable for the nature of amateur radio.

The WIA believes that radio amateurs don't fit into those types of licence because they are qualified by examination, do not require type-approved equipment, and are frequency agile within amateur bands.

The Department of Communications, Information Technology and the Arts (DOCTA) is seriously considering this matter as it reviews the Radio-communications Act.

There is clear indication by the nature of follow-up contact between DOCTA and the WIA, that the Department appreciates the logic and merits of the WIA's submission on the issue.

Upcoming events calendar

Gippsland Technical Conference

The 2nd annual GTC will be held on July 10-11. This conference looks at the specialised communication techniques, operating methods and propagation applicable to the VHF, UHF and Microwave spectrum. It will be held at Churchill about 170km east of Melbourne. For more information contact Peter Freeman VK3KAI 03 5122 6416.

Shepparton and District Amateur Radio Club Hamfest

Sunday September 12 at the Shepparton Youth Club Hall behind the High Street Safeway complex. Traders begin setting up at 7am with the doors opening to buyers at 10am.

Jamboree On The Air - JOTA

Saturday 16 Sunday 17 October, the annual Jamboree On The Air which began in 1958 will involve more than 400,000 scouts and guides around the world "getting together" via amateur radio.

Qnews - VK4 Notes

by Alistair Elrick VK4FTL

WIAQ Councillor and QTC Editor

I must apologise for the non-appearance of this column last month; a glitch in procedures led me to believe it had been forwarded for inclusion, when it had not.

It has been stated by several attendees of the Federal AGM, that the atmosphere was friendly and positive, this despite the

exclusion of the VK4 Federal Representative from voting. This came about due to the frustration of many people on the extended debate and inconclusive records of the facts of the matter. Throughout this, all parties did what they believed to be correct by what evidence they had before them. But looking back many would have done it all differently. The conclusion is in sight and we can then, each and every one, turn our energies to the more important matter of ensuring the survival of the Amateur Radio hobby. This can come from raising the profile of AR in the public arena.

The increased activity of many clubs in VK4 bodes well for increasing the interest in Amateur Radio. The increase in 'local' activity makes Amateur Radio more visible to people who may see the hobby as an interesting and enjoyable challenge.

I listened recently to a conversation on a local repeater between a long time Novice licence holder and a recent CB convert (now a Novice). Both determinedly looking at the upgrade to Full Call as a challenge. They are going to attend classes at one of those clubs with a recently increased profile. There must be more candidates out there to attract into the hobby, so get out into the public arena and promote that club image.

Upcoming events which fall into this category are the North Queensland Amateur Radio Convention on from Friday 24th to Sunday 26th of September at the James Cook University Townsville. John VK4MAV is the contact for this one on (07) 4789 1796 or by packet to VK4MAV @ VK4RAT.#NQ.QLD.AUS.OC.

The Central Highland Amateur Radio Club have their annual 'get together' at Lake Maraboon (Fairbairn Dam) near Emerald on the weekend of 4 - 5th of September. Accommodation can be booked for you at the Maraboon Holiday Resort, so contact Gordon VK4KAL on 07 4982 3677 or fax 07 4982 1932 or by mail to PO Box 761 Emerald 4720.

John VK4AFS called for June to be 'Someone Month'. That is, there are many jobs to be done by 'someone'. So even if you can't take part in the Council or WIAQ activities full-time, then part time is still OK. Volunteer no matter who you are or what your particular talent is. You can always help somebody, get to know fellow amateurs and see what they are doing for the amateur community in your area. Any month can be a 'Someone Month' and your help will be appreciated. Contact the office on (07) 3221 9377.

Recent WICEN activities for a car rally in the forests to the north of Brisbane in the Sunshine Coast Hinterland, brought forth the usual favoured conditions for camping, rain, rain and more rain. It was also a bit

cool and windy by all reports. Nevertheless, the activity was a success and once again proved that Amateurs are a hardy lot and I am sure the event tested the resolve and the equipment of those dedicated volunteers who participated. Well done to all.

Moving to Queensland's Sunshine Coast? If you're a Ham make sure you bring your chequebook. Current Caloundra City Council fees for antenna installations seem higher than the tower itself! How about \$300 as a "development fee", \$180 to "advertise" the development and \$20 for a council sign. No this is NOT for a "monster tower" just an 11 metre Nally. (Wonder what Doug and June did with the 2.7 metres cut from the stock standard Nally?)

Bayside AR Society President, Jim VK4WJG 'fossicked' through the callbook and came up with around 100 names and addresses of Hams in their club area! A letter of invitation to attend a club meeting has been planned, club members are "oiling their chains" in readiness for a bicycle letterbox drop shortly! Listen in to QNEWS Mondays at 7 PM, followed by callbacks and the Clubs' popular net on the 2-metre repeater at Alexandra Hills, 146.875, or HF net Wednesday 7:30pm on 3.567 MHz, an easy one to remember. 3-5-6-7.

Commencing Sunday July 11 the Redcliffe Club will be opening on the second Sunday of each month from 9.00 AM to 3.00 PM for a Family and Radio Shack day. The equipment will be fired up and Redcliffe will be on air on HF, VHF and Packet etc. The WIAQ QSL Bureau will be open for business and so will the grounds for impromptu cricket, football or whatever. And how's this! If you live a long way away, but would like to come, you can camp in the Clubhouse. Refreshments will be on sale or you can bring your own BBQ/picnic lunch! The day will be an open day for everybody and you don't even have to be a member. So bring along your family and friends, with your children being most welcome.

VK6 Notes

Chris Lowe VK6BIK

Unfortunately last month I overlooked reporting on the Divisional AGM, one of the more significant events on the VK6 calendar! However, I will summarise both the AGM and the latest Council meeting this month, since there were several interesting matters arising, and not all members have access to packet or the Internet.

Continued on page 8

ROCOM COMPONENTS

**SURPLUS ELECTRONIC
COMPONENTS AT
CHEAP CHEAP PRICES**

INCLUDING:

-  Integrated Circuits
-  LCD Displays
-  Transistors
-  Diodes
-  LEDs
-  Books
-  Connectors
-  Switches
-  Transformers
-  Fans
-  Relays
-  Speakers
-  Terminals
-  Resistors
-  Buzzers
-  Leads
-  Knobs
-  Heatsinks
-  Hardware
-  Capacitors
-  Batteries
-  Motors
-  Computer Accs.
-  Fuses
-  Triacs
-  Potentiometers

**FOR A FREE MONTHLY
MAILER PLEASE
CONTACT US**

Store Address: 56 Renver Road, Clayton, Victoria 3168

Postal Address: Bag 620 Clayton South, Victoria 3169

Phone: (03) 9543 7877 Fax: (03) 9543 4871

Website: <http://www.rocom.com.au>

Email: sales@rocom.com.au

Continued from page 7

Divisional AGM

This was held on 24/4 at the RSL Centre in E.Vic Pk. After the President's annual report, the Treasurer advised that the balance sheet returned a small loss of \$80.25 for the year if interest from investments were taken into account.

The Intruder Watch report again referred to the very large number of intruders now evident in 28 and 7 MHz from Asia. The bottom end of 7MHz was "a disaster". More reporters were always welcome, reports being received from only two sources this year.

WICEN monthly meetings are now held at scout headquarters, but as the venue is up for sale, another forced move may be imminent. Weekly nets on 80 and 2 metres are well patronised. Only two community events, The City to Surf Fun Run and Rally Australia, were serviced this year. The demand for WICEN services for these events had declined with the advent of the Cellphone service.

The Broadcast officer reported that NewsWest averaged 100-150 callback reports each week. The current format is to be retained, but suggestions for change are always welcome. NewsWest is available as audio on the Internet via the VK6 Home Page. The Membership officer reported a disappointing steady fall in membership numbers, despite a number of new recruits. The average age of members is increasing.

The Federal Councillor briefly discussed the coming Federal AGM, outlining several topical issues to be raised. Patron: the Governor of Western Australia has agreed to continue as Patron while he remains in office. **Council:** As only eight nominations were received for nine vacancies, a ballot was not required. The following were therefore declared elected: Cliff Bastin VK6LZ (President), Councillors as follows; Dave Wallace VK6IW, Neil Penfold VK6NE, Tony Savory VK6TS, Will McGhie VK6UU, Keith Bainbridge VK6XH, Christine Bastin VK6ZLZ, Don Graham VK6HK. Eddie 6ZSE was accepted as Councillor to fill the casual vacancy.

Minutes of Council Meeting 1st June

The matter of the RAOTC request for action towards achieving a pensioner discount on licence fees was discussed. Some years ago an earlier Government had concluded that because AR was not in the category of an essential service, a discount was not in accord with policy. It was suggested that contact with the State Government Office of Seniors Interests might produce some useful advice on the likelihood of success today.

Tony VK6TS reported on a meeting held at Wireless Hill attended by Phil VK6AD and Terry VK6ZLT with representatives of the Melville City Council. The City is keen in having a working AR exhibit set up at the Museum. There is a large quantity of historic equipment in storage, which will be the subject of another meeting to assess. The old residence might become available for AR purposes. There is also a large quantity of historic photographs, QSL cards etc. Tony considered that such a project represented a good opportunity for favourable publicity and will follow the matter up. (*Very interesting - I don't know the full detail of this, but it sounds like it has the potential to end the search for "permanent" premises for AR in WA, while at the same time providing a win-win situation for all parties.*)

Two new members, Ebbie Lucas VK6DJ and Harry Butler VK6BSW, were welcomed to the Division. The Federal Directors have advised that there will be some increases in fees commencing 1st January 2000. The rises are due to IARU levy in 2000 and in 2001, and an International levy for 2000 only. (*I'm sure it will be possible to obtain more details from Councillors at the on-air meetings.*)

Broadcast: Tony VK6TS advised that the 29 MHz FM outlet had been attracting callbacks from Eastern VK. Volunteers are being sought to fill the position of Education Officer. The possible extension of the 80m DX window was again discussed. This is likely to become the major topic in one of the on-air meets soon. Will VK6UU advised that the Home Page has now been moved to the new provider (Omen). He also suggested that a telephone number be included as a reporting point for the monthly WIANET as a service to people unable to call in on air. Cliff VK6LZ and Christine VK6ZLZ agreed to the use of the Secretary's telephone (9351 8873) for this purpose.

A proposed new repeater site obtained by WARG in Victoria Park, will probably be developed to improve 70cm coverage in the City area. It was advised that there had been some complaints about poor WIA news coverage via the 6700 repeater in the Northern suburbs, and suggested that people should try the 6100 VK6WIA input signal, which is originated from a favourably elevated site in Doubleview.

A motion was passed to nominate Neil VK6NE for the G.A. Taylor medal, for meritorious Service to AR.

The meeting closed at 2250 hrs (*lucky we don't have to pay our councillors penalty rates !*).

**73 for now, Chris VK6BIK
(chrismor@avon.net.au)**

ar

CLUB NEWS

Club net Frequencies & Times. -

Tuesday Night's 7:30PM.
146.725MHz -Neg Offset VK4RKP Mt Crosby.
3.585MHz +- QRM.

Notice to all clubs

AR will gladly post your event details but we ask that a few simple guidelines be followed:

- Use a club letterhead or email address where possible.
- Supply contact details in case your notice needs any clarification. A name and phone number or email address should always be supplied.
- Keep the details that you want published separate from the covering letter, eg a separate page or identified paragraphs.
- Place all the details that you want published in one section including a contact name and number.
- Try to make the details interesting to all the readers -not just in house stuff please.
- Always start with a title for your piece or the club name. Remember that there may be other clubs with the same initials and there are several towns that appear in more than one state.
- Always finish with the name and callsign of the writer.
- Most importantly always date your submission and tell us when you require it to be printed.

Help us to help you.

Riverland Radio Club AGM

At the Annual General Meeting of the Riverland Radio Club, the following members were elected to the committee.

President Ray Hutchison VK5ZAI, Vice President Adrian Reimann VK5AJR, Secretary/Treasurer Doug Tamblyn VK5GA, Committee Neil Francis VK5ANF, David Wilson VK5NAP, Ivan Smith VK5HS and Malcolm Gardener VK5UBT.

Check out the Riverland Radio Club details on the Murray Pioneer Home page at <http://www.riverland.net.au>.

The North Queensland Amateur Radio Convention is on!

Friday evening September 24th to Sunday afternoon September 26th at the James Cook University, Townsville

If further info is required, please contact the convention coordinator, John VK4MAV packet VK4MAV@VK4RAT.#NQ.QLD.AUS.OC or phone (07) 4789 1796. All visitors are welcome to the tropical North. (VK4ZZ)

Sunshine Coast Sunfest

The Sunshine Coast Amateur Radio Club will be holding their bi-annual event this year on the 28th of August at the Nambour Showgrounds. Table and display space bookings to Angus (07) 5443 2074 or write to the SUNFEST Coordinator, 285 Main Rd Maroochydore. 4558. Tables are available at \$15 per table and as space is at a premium SARC are asking for firm bookings by 31st July.

Ipswich and District Radio Club

The Ipswich Radio Clubs new 2 metre to 80 metre linked cross band repeater system is working just fine.

The President of Ipswich and District Club, Ken Page VK4AKP says "it's proving a boon in encouraging more of the clubs amateurs to take part in the net. VK2AB mobile near Canberra praised our efforts of making the 2m net more interesting and accessible. VK2AB reported that he could hear all of our members linked from the 2m repeater. He was so impressed with our efforts that he said he would love to join in again if he was mobile next week!"

Riverina Field Day

The Wagga Amateur Radio Club presents the Riverina Field Day on the 7th & 8th of August 1999. The Riverina Field Day is held annually and is held alternately in Albury and Wagga Wagga. As the 1998 Field Day was hosted by the Albury Club in 1998, it is Wagga's turn in 1999.

The Field Day is a get together for Radio Amateurs and enthusiasts with a dinner on the Saturday evening and the field day proper on the Sunday being held at the Koorringal High School Gymnasium. There will be trade displays of new and used equipment, lectures on radio related topics, private trading tables for disposal of equipment, talk-in and hidden transmitter hunts.

Details of the program, dinner, available accommodation and map of the location of Koorringal High School are available on the club's web page at <http://hamgate.wts.com.au>. Alternatively contact may be made with John Eyles VK2YW on Phone (02) 69265471 H or (02) 69332363 BH or via E-mail to jevles@csu.edu.au.

The North-East Radio Group NAOCP Classes

NERG will again be holding classes for the NAOCP, commencing early August and running on Tuesday nights for approximately 11 weeks followed by a trial exam. The exam proper will be held a few weeks later at a time convenient to candidates and examiners.

Printed notes on various topics and Morse tuition is included in course fees which are once again only \$100. For further information please contact Stephen Warrillow on 9436 7273, at PO Box 416, Rosanna VIC 3084 or at swarrillow@hotmail.com

Get your News in to AR for next month's edition.

ar

TARC Welcomes Brisbane Visitor

TARC welcomed Jason Morris VK4YOL to their Monday night meeting when he visited Townsville in April this year. Jason is participating in the Region 3 ARDF Championships in South Korea as this is being written (June). Although Jason was there on other business, TARC turned the tables on him donating \$100 toward his costs. President Don VK4MC is pictured handing over the cheque to an embarrassed Jason.

Hopefully Jason will return with a big Jason type smile, perhaps a trophy, a few photos and a lot of stories that he will hopefully share with us all.



ALARA

Christine Taylor VK5CTY
ALARA Publicity Officer

16 Fairmont Avenue, Black Forest SA 5035
Packet: VK5CTY@VK5TTY

Annual General Meeting

As usual our Annual General Meeting on the 4th Monday in May was very well 'attended' with 15 callsigns recorded. We welcome all new members on to the committee and wish those who have 'changed hats', Good Luck in the new positions. Thanks to those committee members leaving us this year. We were fortunate this time to be able to fill all the positions that were vacated and even to have offers from other willing to serve. Thanks. We will remember you another time when we need you.

Two Silent Keys

As Publicity Officer, I am always sorry to have to tell you of our SKs, and unfortunately there are two of them this month. Raedie Fowler and Ivor VK3XB. Both of these people were part of the earliest days of ALARA. Raedie was almost a foundation member and Ivor was an enormous support to Mavis VK3KS, our Life Member, in everything.

These two messages were sent to me by Bron VK3DYF. I print them as she wrote them. She knew both people well.

"I regret having to advise the passing of Raedie Fowler on 27th April last after a short illness. Raedie was the XYL of Ray, VK3BHL(SK), who supported her involvement in LARA (as it then was) from when she joined in 1976.

Although Raedie never attained her licence, she was an enthusiastic supporter of our Association and she held the position of Vice-President of LARA, November 1978 to July 1980, when she became Acting President at a time of problems within LARA.

When ALARA celebrated its 10th birthday in July 1985, Raedie helped Bron VK3NTD (now VK3DYF) the VK3 State Rep, to organise a party at the Moorabbin Radio Club rooms where her OM Ray was a member. She was also one of the organising group for the surprise party given to Mavis, VK3KS, to celebrate her 50 years on air.

From 1987 to 1994 inclusive, the VK3 girls held each ALARA birthday party at Raedie's Glen Waverley QTH where

Raedie and Ray were excellent hosts. Later, monthly lunches, including the birthday celebrations, were held at a cafe in the city and Raedie attended until she was no longer able to travel into town.

VK3 girls, in particular, will miss her. The sympathy of all ALARA members is offered to Raedie's children and grandchildren.

Vale Raedie.

Bron VK3DYF, VK3 State Rep."

-and-

"ALARA regrets advising that Ivor VK3 XB, the OM of Mavis VK3KS, became a Silent Key on 22nd May last.

The term 'silent key' is very apt when applied to Ivor, as using Morse code was a great part of his amateur radio operation. Ivor attained his licence in 1934 and, through the number of organisations he belonged to, became well known and respected throughout the world.

Many of our members will be aware of the support Ivor gave ALARA right from its inception. He entered all our Annual Contests, giving out most welcome points in both SSB and CW. On the nights when Mavis was to be Net Controller, Ivor always occupied the frequency early with anyone who wanted to talk, till it was time for Mavis to take over. He was very proud of Mavis' involvement in amateur radio in general and in ALARA's aim to encourage women's interest and active participation in amateur radio.

Bron's personal comment: Ivor was always the courteous gentleman even when my sending of Morse code was 'badly spaced'. He will be missed.

Our condolences go to Mavis VK3KS, ALARA Life Member.

Gwen VK3DYL and Bron VK3DYF on behalf of all ALARA members."

ALARA At The Hamfest Of The M&DRC

This year ALARA was officially represented at the Moorabbin and District Radio Club Hamfest by Pat VK3OZ, Gwen VK3DYL and Jean Shaw (our Awards Custodian). They had copies of the ALARA Award and the certificates issued for section

winners in the ALARA Contest as well as photographs of our gatherings and information about us in general.

How many people only stopped because they heard the catch phrase "This is the only stall where you don't have to spend money" I don't know, but I do know that all who stopped were interested to hear about us and to have a chat. The sponsorship scheme whereby we extend the hand of friendship across the world to other YL groups was well illustrated by the badges and magazines we had on show.

Both Pat and Jean have been to ALARA lunches held in Adelaide as they both have/had families here. Pat tells me that she will no longer have that excuse to visit Adelaide as her son and family have now moved across the border. This is VK5's loss and VK3's gain.

Thanks for the note, Pat, enjoy having your family closer.

Some VK5 News

Many of you know Maria VK5BMT and her OM Keith VK5MT, through the Travellers' Net so you may be interested to know what they are doing now. They have sold the caravans and bought a boat. They both enjoy "messaging about in boats" so that is what they do.

They used to do a lot of fishing, too, but not any longer. Recently they had a marvellous day. They went out for a trip and when they stopped to enjoy the peace and quiet they threw a line over the side just for fun. The line was hardly in the water when there was a fish on it, and another, and another. By the time the fish stopped biting a couple of hours later, they had hauled in nine dozen lovely mullet. When they caught the first fish they were alone on the water, by the time they left there were boats all around them - none of whom were doing as well as Maria and Keith.

Tired but happy they headed for home to clean and fillet the fish. Each meal of fish will remind them of that gorgeous day all over again.

Maria has a daughter in Melbourne and another one overseas with whom she has regular contact through email. I can remember when she first told us about her efforts with a computer. Now she is an expert, and loves it!

Deb VK5JT is busy planning two new projects. She is learning about ATV and intends to celebrate ALARA's birthday with a broadcast, in about July, about us. Then, in October, she is getting married again. She will wed Udo VK5KAZ who is currently active in VK5 ATV circles. We wish them both well.

ar

OVER TO YOU

Not My Cards!

Recently I have received a few QSL cards to my call sign, VK4DA, for QSOs I have never made. Perhaps this resulted from QRM etc. Knowing how most DXers look forward to the QSL card, I list below the cards in the hope that the owners may recognise them (from their logs) and contact me either by phone or post. I will gladly post the card on to them.

VU-0020 CW 21MHz Feb 24th 1998.

6K98WCX CW 21MHz Oct 8th 1998.

JA0TJV SSB 14MHz Feb 22nd 1998.

Addressed to Wally

KP4ER SSB 14MHz April 22nd 1999.

Addressed to Peter.

My phone number is (07) 4152 5045

L Hawkins VK4DA

15 Coomber Street

Bundaberg Q 4670

Band Plans

Band Plan. What a good idea. The first essential is to compose a set of guidelines to "ensure that all modes have their fair share of spectrum space" and "They should take the popularity of each mode into account". Further "The aim must be to think ahead". Recognising that this is a voluntary or "Gentlemen's agreement", we should have regard to the amateur's code. "He keeps his station abreast of science" and "kindly assistance co-operation and consideration for the interests of others".

With these ideas in mind let us look at the Band Plan.

160m all the way through to 12m CW the whole band.

10m CW more than half the band.

6m CW more than half the band.

2m CW Nearly half the band and where is the slow Morse transmission? Smack on 144.950 MHz, the frequency specifically allocated for space communication ONLY!

80m Even with the first 35 kHz exclusive to CW where is the continuous slow Morse transmission -of course on 3.699 with total disregard for other modes.

The Band Plan idea is great but it seems to have fallen into the hands of a selfish special interest group, who prefer obsolete technology.

Brian Weiley VK2AZW
13 Bourne Blvd
Nelson Bay 2315
(02) 4984 2419

Five Year Licence

I note with interest the item from VK6NE, re the 5 year AR licence renewal fee for \$168. (April AR P30)

I have just renewed my unrestricted AR licence in Brisbane for 5 years at a cost of \$214. ACA here says that is the cost. End of Story. (I tried last year for a five year licence and was told they were not available)

I have heard licence renewal costs vary according to population density and spectrum demand. Does this mean that a 5-year licence would be dearer in Sydney or Melbourne?

I would expect the cost of AR licences to be standard across the continent. Has anyone any ideas why this is so?

George Down VK4XY
PO Box 90
Petrie Q 4502

Morse No More?

The Editor of the newspaper, the "Midland Echo", having a large circulation in several suburbs of Perth, very kindly publishes many of my "Letters to the Editor".

The recent demise of the Morse Code, as a means of much communication, prompted my thoughts to inform members of the public of the occasion, through this particular channel, and the letter below appeared in a recent issue of the "Echo", to the satisfaction of not only many of the local Hams, but I also received interested comments from friends and other people. It was welcome publicity for our hobby.

The Passing of an Old Friend

At midnight last Sunday, January 31st. Mr Samuel Morse's Code, "invented" about one hundred and fifty years ago, ceased, world wide, for use in communication purposes and the event was marked by many a moving final Morse transmission, the messages ending in "QRT", meaning "end of transmission, station closing down".

Countless thousands of lives have been saved, by land, by sea and in aviation, by this simple and reliable method of "di di di dahs" and few do not know the code for "International Distress" SOS, appropriately. "Save Our Souls".

Modern Information Technology, with its orbiting satellites, has not, however totally usurped the delightful rhythms and harmony of this simple carrier of intelligence, as it will be used to ensure the safe operation of many navigation beacons to assist air navigation etc.

It will also live on in the activities of Radio Amateurs, who delight in achieving the necessary skills in operating the code, for the continuation of their world-wide friendships established over many years past.

To the memory of Samuel Morse, we "Hams" offer grateful thanks for enriching our hobby and our lives.

Hang up our morse key?? Never!!

Sam Wright VK6YN
19 John Street
Gooseberry Hill 6076

Send your letters to
Over to You
PO Box 2175, Caulfield Junction Vic 3161
email armag@hotkey.net.au
Fax (03) 9523 8191

SNIPPITS

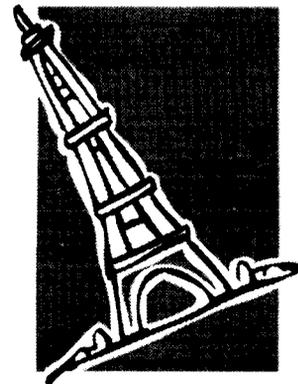

In 1909 the Eiffel Tower was destined for demolition but was saved by the fact that it supported a radio antenna that was considered vitally important to French telecommunications.

The Classic Adelaide Rally

Christine Taylor VK5CTY

16 Fairmont Avenue, Black Forest SA 5035

The communications for the two Classic Adelaide rallies have been provided by the local amateurs as members (many temporarily only) of WICEN. I was one of these operators and I have to say - I had a ball. For me it was an entirely new experience and an opportunity to see some really beautiful cars at close hand.

THE RALLY IS RUN over four days through the beautiful Adelaide Hills on some winding and very hilly roads, starting and ending each day at the Hilton Hotel in the heart of the city. It is from the Hilton that rally headquarters is operated. As communications operators we had to pass all the messages necessary between headquarters and the rally organisers, wherever they were. The safety and the efficient running of the rally depended on us.

There are two parts to each day's rallying. There are a number of special stages comprising closed roads sections where the rally cars were permitted to drive much faster than usual and a number of open sections joining these closed roads where the drivers must obey all the normal road rules. They can and have been booked for speeding just like anyone else.

To facilitate the radio traffic a number of dedicated repeaters and translators were sited on the top of particular hills. The translators accepted signal on 2 metres and transmitted them on 70cm. For a few locations the normal amateur repeaters were used, but in general very little disruption was caused to normal radio traffic. The chart of radio channels to be used for one of the four days is included as an example of the activities.

There were 33 special stages in the 1998 rally. To control and record the car movements as many as 10 marshals were used. They officially closed the roads by tying yellow tape across all side roads and farm gateways and they manned timing and recording tables at the start and finish of the stage. There were four or five police cars



Photo 1 The classic 300 SLS Mercedes Benz escaped the museum for a weekend out. (These were also known as the "gull wing" series, I wonder why?)

and/or motorcycles at each stage and there was an ambulance and an emergency fire unit (identifies as the FIV or first intervention vehicle) on duty at the start of each stage. Emergency vehicles can only enter a stage to deal with an emergency after the stage has been officially stopped, and they can only enter it from the start direction so there is no chance of vehicles meeting head on.

Also at each stage there were at least five amateur operators. There were two at each of the start and finish each with their own radio equipment on the required frequency. This year there was also a radio car with just about all possible frequencies available especially equipped to follow the FIV into the stage in the event of an accident to relay messages direct from the scene. These were the cars we hoped would never be needed.

An international car rally uses a large number of people just to make it run efficiently. Overseas visitors had nothing but praise for the way the Classic Adelaide was run.

As a radio operator, when you reached your particular stage you signed in then set yourself up at either the start or finish and established communications with headquarters. If there are problems you may need to move several times or change frequencies etc till a satisfactory path is found. Then you wait for the road to be closed and the cars to arrive.

For 1998 my OM, Geoff VK5TY and I were at the start of Stage 2, on Sedan Hill, on the edge of the famous Barossa Valley.

In 1997 we were at the finish of the same stage. This is one of the more difficult places for communication back to the city. In 1997 a satisfactory channel was only achieved after a third amateur drove his 4x4 up to the top of the hill from which to act as a relay. In 1998 we started off with a clear path but by the time the rally reached us we had problems.

During 1998 WICEN had made some special checks to check whether the upgrade in power to VK5RBV, the Barossa repeater, would solve the problem. When we set up at about 10.30 we could talk to the Hilton through RBV but unfortunately, by the time of the first car's had started the channel had disappeared because the propagation had changed!! In the event all traffic from the start and the finish of the Sedan Hill stage was relayed through a third vehicle located about a kilometre beyond the finish line, at the highest point on the hill. There must be a lot of metal in the minerals of Sedan Hill to make it such an efficient radio shield !!

We were at Macclesfield at the finish of stage 13 in 1997 and again at the finish of stage 12 near Yankallilla in 1998. These towns are both on the Southern side of the Adelaide Hills and each had its particular communication problem though. From Macclesfield we simply could not use the translator we should have used so we had to change to VK5RSV repeater.

At all times local amateurs, not themselves involved in providing communications for the rally, were most cooperative about the rally use of the

repeaters for which we and WICEN were very grateful. Not one complaint was heard.

At Yankallila the operators at both ends of the stage were experiencing some intermittent interference until one of the roving WICEN people went up to the site of the translator and turned the squelch up to the maximum. The interference was caused by intermodulation frequencies from the local pager systems appearing on the translator frequency.

Personally I found operating through a translator (in and out on the same frequency) very strange because while we could hear messages for other stations being sent from the headquarters we could not hear the signals from those stations. We are all so used to using repeaters where we hear both the input and output signals it seemed odd to hear only one part of the conversation.

The safety procedures of rallying are very strict. Before any competitive car enters a closed stage several official cars will have checked the safety of the stage. Before each of these official cars leaves the start its crew must hold a sheet of paper of the right colour as permission to go. When it arrives at the finish this sheet of paper is given to the marshal. The marshal passes the paper to the radio vehicle. We send a message to the rally headquarters eg., "Stage 2 is condition Blue" or "Stage 2 is Condition Green" etc.

When the road is legally closed the road is said to be Condition yellow. When the cars were about to enter the stage it is Condition Blue. While they are in the stage and competing, the stage is Green. In the event of an incident the radio operator would be the one to tell headquarters about it so they could declare the stage RED. This can only be done this way because it is an official situation. The marshals on the spot



Photo 3 A rare and beautiful Jowet Jupiter in WWII Spitfire colour scheme!

report through our radio channel whenever there is an incident during the rally but all decisions are taken by those at headquarters.

Our task was primarily to pass on any messages given to us by the marshals and to pass to the marshals any messages sent out from the Hilton. As communicators the only messages we initiated were to establish a path and to send lists of the numbers of the cars (in groups of five) to headquarters, as they passed either the start or the finish of the stage. In the headquarters room they made sure everyone was accounted for before the stage was opened to normal traffic.

In the event of a mechanical breakdown or accident the driver or navigator of the car is required to signal to the next car to come past them either that they are alright or that

they need assistance. This car then passes this information to the marshal at the finish of the stage. We pass it to headquarters and they decide what, if any action will be taken. On stage 12 in 1998 I had to pass a message that there was oil on the road 900 metres before the finish of the stage. Headquarters passed this information back to the start of the stage so the marshals could warn succeeding drivers about the oil. This chain of messages is standard procedure for rallies around the world. It means that everyone involved does it the same way and knows how it is done.

Rallies like the Classic Adelaide are divided into three sections. There is a group of Touring cars which follow the same route as the rally cars but simply follow one behind the other without competing. There are the Parade cars which lead the racing sections and are timed over them but are not competing for awards. These include the rare and irreplaceable or the incredibly expensive cars such as the Mercedes Benz 300SL, the Jaguar XKSS and the 'C' type Jaguar. Then there are the actual rally cars that are timed to the second over the closed stages. They are competing for a number of awards including the overall fastest time. All the cars drive, untimed, on the open roads (where they must obey all the normal traffic rules) to the next closed stage.

For the closed sections the cars are sent off from the start at one-minute intervals. They may travel as fast as the conditions will allow and they are not restricted to only the left side of the road. They may use the whole road if that will save them a fraction of a second on a corner. Particular places



Photo 2 Another Classic - the Austin Healey sports car.

Continued on page 14

WHERE TO SEE THE CARS TODAY

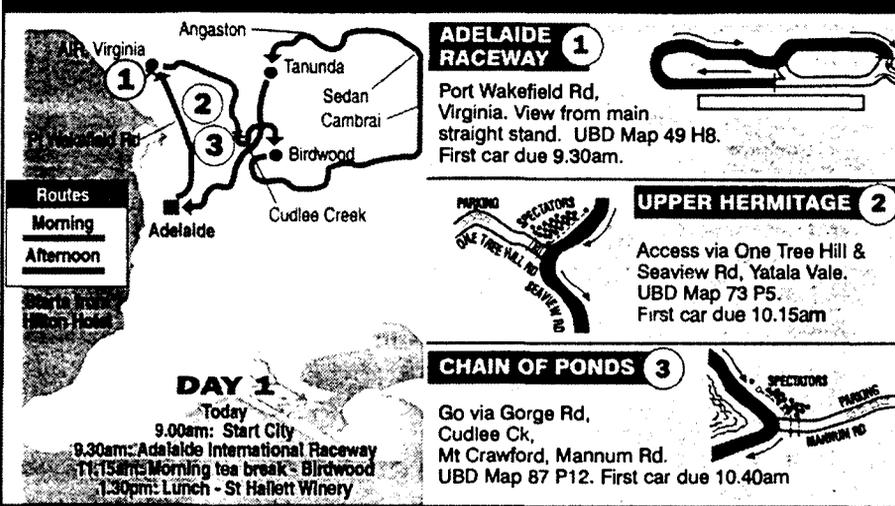

Fig 1 The planned route for Day 1.

Continued from page 13

are set up and designated as safe viewing spots for spectators but local people also sit out behind the farm fences to enjoy the sight of these special cars whizzing by.

With prime positions at the start or finish of the closed stages the amateurs had an excellent opportunity to see cars that are unique. In 1998 Mercedes brought out to Adelaide a 300 SLS model. For the first Classic Adelaide it was the Gull-winged Mercedes, the only one of this type still running. It normally lives in the Mercedes Museum. In the 1998 rally we saw two C Type Jaguars and an XKSS model, the previous year it was a Le Mans winning D type. This has a special fairing behind the drivers' head to improve the streamlining. There were Porsches, Ferraris, a Hispano-Suiza Alfonso, Bentleys, a Lotus, a couple of Alfa Romeos and so many other very special cars, each one lovingly prepared for this event. Many of the amateurs took the opportunity to take photographs that they will treasure for years to come.

WICEN (SA) should be congratulated for the professional way they prepared us for our task. We were all asked to attend a briefing at which everything was explained very clearly. We were given practice in message handling and the use of WICEN message forms (many of us were not at all experienced in the correct procedure as we were only temporary members of WICEN)

We were each presented with a very professionally produced booklet that showed ALL the special stages and ALL the frequency plans, not only the ones concerned with our stages. These booklets were the envy of some of the rally officials as they often had no idea what was happening in the rest of the rally.

For the whole four days of the rally they had roving operators able to cover all contingencies. In 1997 one of the cars

moving translators from hilltop to hilltop suffered major problems but someone else was available and able to recover the translator and get it to its position in time. In the case of the pager interference, there was someone free to fix the problem. The same efficiency was reported by all operators.

In 1997 WICEN (SA) had to borrow some translators from WICEN(Vic) but by 1998 they had developed enough of their own translators or found alternative paths for our transmission that they did not need to borrow. I know from personal experience that for several weeks before the rally, cars were on the road testing communication paths. I cannot speak too highly of the work done by the small group of dedicated WICEN members.

The world of rallying is foreign to me normally, though I read about it and see it on television. To be part of the Classic Adelaide with something to do that contributed to it and to be able to use my amateur radio skills as part of WICEN was something not to be missed. I hope I can play a part again next year and for as long as the event continues to be run. I enjoyed every moment of it!!

I sincerely suggest that you offer your assistance to WICEN whenever you get the opportunity. You will gain both personally and in your technical skills.

ar

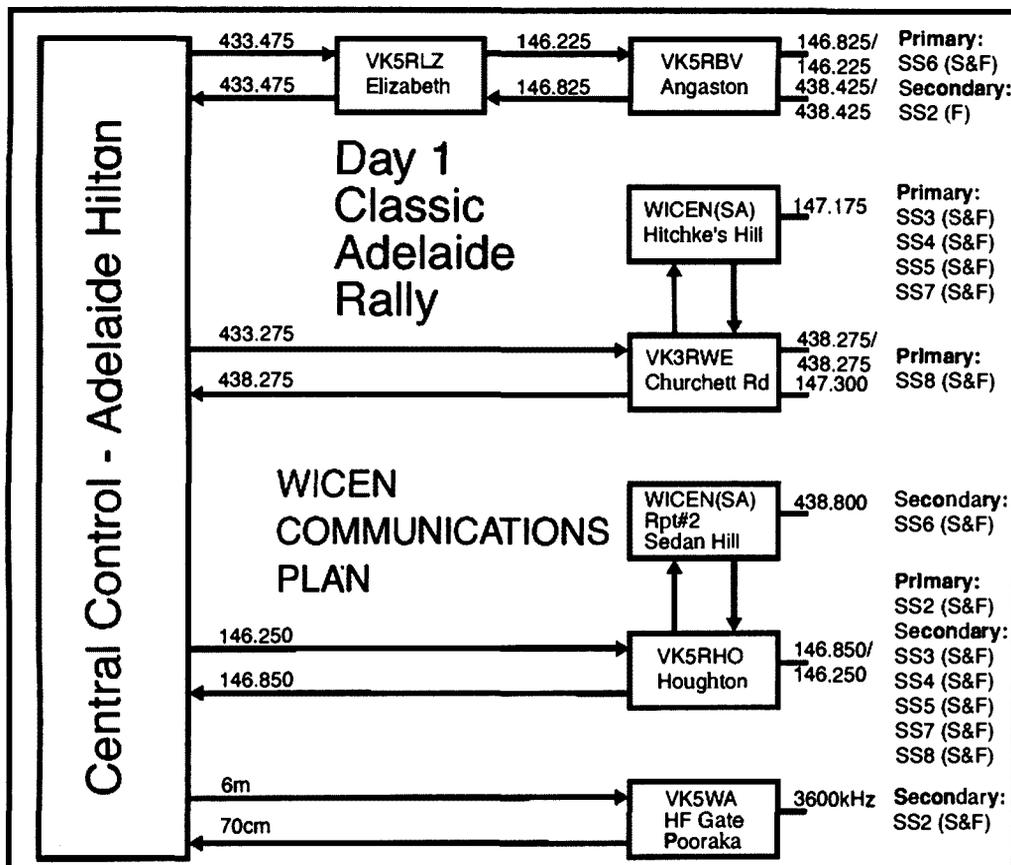

Fig 2 The radio plan for the our communications.

All Is Not Old That Glitters

(A Capacity to Deceive)

By Mike Krochmal, VK3KRO

PO Box 112 Ormond Vic 3204

WHILE RECENTLY RESTORING a "venerable boat-anchor", I found a rather large and ugly hole in its chassis where there once had stood a mighty electrolytic (50 + 50 μ F / 350 V, screw-base) in its aluminium can. In its place, elsewhere on the chassis, were a couple of huge, ugly blue pigtail electrolytics of doubtful but modern provenance, mounted in turn on a large chunk of phenolic board bolted into the side of the chassis. They looked about as appropriate as a pair of gumboots on a ballerina. Also, for all their size, they were a bit on the wimpy side, being only 24 μ F (albeit having a 500 V rating).

I have no objections to the discreet replacement of some of the more horrible components in these old rigs (such as 20% resistors, way out of even that wide

tolerance range, and paper capacitors long past their "use-by" date) with modern-day equivalent components. However, I do take umbrage at the rather crass, yet commonly employed, solution that had been applied by the previous owner of this rig. Multiple electrolytics of the type originally used here are now a bit difficult to obtain. Even if one is lucky enough to find one, its current condition and expected remaining service life are matters of some concern. Thus it became my intention to apply a "stealth" solution to the current quandary, by manufacturing my own electrolytic with the looks of the old and the performance of the new (a sort of wolf in sheep's clothing).

By a stroke of luck, and through the kind offices of my good friend Brian, VK3WYN, I was able to obtain the empty case of a similarly-sized electrolytic which had long since passed on to that big be-Jouled place in the sky where all old capacitors eventually go. It had already been carefully disembowelled by a previous operator (would you call that a Faradectomy?). It consisted merely of a topless carcass with a retainer nut underneath. It also had a fairly prominent dent in one side. (A good friend, by the way, is someone willing to part with the last electrolytic capacitor in his/her junkbox).

The first step was to roll out the dent, which was achieved by judicious application of the end of a ball-peen hammer. Fortunately, the dent was right near the top end, where the hammer was able to reach. The next step was to remove the

accumulated grime of several generations from the outside of the capacitor case. Here I got a bit gung-ho: I used a Scotch-Brite™ plastic scouring pad. That sure got rid of some nasty-looking spots on the case, but produced a shine which was bright enough to allow me to check out the acne on my cheeks - a bit out of place in a piece of time-worn vintage equipment. Fortunately, it was at about this time that I remembered a great tip about how to finish aluminium panels, which I had once read in an old ARRL "Radio Amateur's Handbook" (5th Edition, 1929). I quote from Page 63: "The panel can be given a pleasing finish by stripping it in a strong solution of washing soda. When removed from the solution the 'aluminum' will have a clean matt surface which can be preserved, after the panel has been well washed in clean water, by giving it a thin coat of Duco lacquer". No problem here, apart from the fact that those guys never did learn how to spell aluminium and the fact that presumably any good-quality clear lacquer would do in place of Duco lacquer. Washing soda is sold in supermarkets as Electric Soda. (Washing soda, for those of you who, like me, fell asleep in chemistry classes, is sodium carbonate. It also goes by the name of Natron, that magical substance used by Egyptian embalmers of old to preserve the mummies). Don't confuse washing soda with caustic soda or soda bicarbonate. Either of these should work just as well, but caustic soda is a bit more dangerous to handle and dispose of.

I duly trotted off to the laundry and, while the XYL was out, made up a good strong solution of washing soda in water, in an old plastic tub. (Don't try this in one of those stylish new ceramic kitchen sinks, if that's what you've got - might lead to major marital unpleasantness). I went outside to do the pickling (of the capacitor can, not me - there wasn't a bottle in sight!), making sure I avoided breathing in any nasty vapours, splashing it on my best clothing, or leaving it around for the neighbour's cat to imbibe. The lye bath dressed up the outside of the electrolytic beautifully. (Actually, mother always told me to have nothing to do with nasty lyes, or my nose would grow. I didn't, but it did, anyway.)

Back to the electrolytic. The next step was to give the outside a coat of clear lacquer, to avoid unsightly fingerprints further down the track. Now the fun part - compared to the two original capacitors in the can, providing 2 x 50 μ F at 350 V rating, which would have occupied the entire volume of the 3.4 cm diameter, 10.5 cm high can (a volume on the order of 95 cc), the two separate slightly more modern 24 μ F / 500



Photo 1 The raw materials: - an old electrolytic casing, film canister cap, two new electrolytics, heatshrink tubing, and a 150 mm ruler for size comparison.

Continued on page 16



AV-COMM

Pty.Ltd

SATELLITE TV EQUIPMENT

-: Established 1981 :-

Specialising in: Free to Air Satellite TV

CALL OR FAX FOR FREE INFO PACK.

198 Condamine Street
Balgowlah 2093 Australia

Tel: 61 2 9949 7417
61 2 9948 2667

Fax: 61 2 9949 7095

Internet: <http://www.avcomm.com.au>



AMATEUR TRANSCIVER RADIO CENTRE

ALINCO NO 1 FACTORY DIRECT
IMPORTER
AUTHORISED DEALER
MASSIVE MONTHLY STOCKIST
LATEST ARRIVALS

NEW DJ-V5E 6w VHF/UHF

DR-M06T 6m, DR-610E, DJ-G5EY,

ANTENNA TUNERS, POWER SUPPLIES,

BIGGEST DISCOUNTS ON BULK

PURCHASES OF ALINCO AMATEUR

RADIOS & ACCESSORIES.

FULL 3-YEAR FACTORY BACKED

WARRANTY

ALINCO SPECIALIST



IC-706MKIIG, IC-T81A,
IC-2800H, IC-746, IC-756-Pro,
IC-T8A, IC-R75, IC-Q7A

KENWOOD TS-570SG TM-V7A
TH-G71A VC-H1 TH-D7A TM-G707A

JRC NRD-545G, JST-245, NRD-345.

KANTRONICS -

KPC-9612, KPC-3, KAM-98, KAM PLUS

PHONE (02) 9896 2545

E-mail: atrc@bytelink.com.au

Web Page:

<http://users.bytelink.com.au/atrc>

Continued from page 15

V capacitors, which I was about to give the heave-ho, were roughly 2.5 cm in diameter with a length of about 5 cm (thus having a total volume of about 50 cc). The two capacitors I was about to squeeze into the can were each rated at 47 μ F at 350 V, and measured a mere 1.6 cm in diameter, with a 3.3 cm length and thus a total volume of about 13 cc! It is instructive to consider what this all means in terms of how the march of technology is reflected in the two parameters of charge density and energy density:

Total Capacitance (μ F)	Voltage rating (V)	Volume (cc)	Charge stored $Q = C \times V$ (Coulombs)	Energy stored $W = \frac{1}{2} C \times V^2$ (Joule)	Charge density=Q /Volume	Energy density = W/Volume
Old : 100	350	95	35,000	6,125,000	368	64,474
48	500	50	24,000	6,000,000	480	120,000
New : 94	350	13	32,900	5,757,500	2,531	442,885

Table 1 : Old vs. new capacitor technology

Just goes to show how far we've come since the bad old days, mainly through improvements in dielectric materials.

But I digress. To give the two capacitors a semblance of mechanical stability, I decided to enclose them in heatshrink tubing. I then wired them up with three long trailing wires (common ground lead, two active leads), encased them in another layer of heatshrink tubing and some electrical insulating tape for good measure, and then placed the whole assembly in the can, with the connecting wires coming out of the bottom. The cap of a 35 mm film canister made a perfect top cap, and before fitting this I filled the entire can with neutral cure (very important point!) silicone roofing glue.

I had considered also enclosing a little note in this "time capsule", along the lines of "Fooled You!", in the event that a future adventurer might be silly enough to explore the inside of the can, but in the end discretion prevailed, as I thought that this unkind sentiment might result in the untimely demise of one of my descendants, being the consequence of an act of vengeance by the explorer. The intended function of the silicone glue, by the way, was partly for added electrical insulation, partly to stop things rattling around inside the can, and of course as a fun element for the future adventurer.

Next, I used a word processor to type up an appropriate label to indicate the capacitance value and voltage rating and (cheating only slightly), the now defunct manufacturer of the boat-anchor. I transferred this label on to an overhead transparency film on a photocopier, then

reversed the transparency and re-copied it. This gave me a transparency with the lettering protected on the inside. I happened to have a dead valve with a transfer of the company's logo on it, which I floated off in water and transferred this on to the can to complete the deception. The CIA would have been proud of me. Finally, I wrapped the overhead transparency film around the can (over the logo transfer) and used a fine strip of sticky-tape to hold the transparency on to the can. Voila!

So there it is. Skulduggery in one easy lesson. The purist reader will no doubt cringe and take me to task, in a future "Over

To You" column, on why I did not reconstruct the capacitor from first principles, using foil and boracic/boric acid. My reply is contained in my email signature: "Life's Too Short!". I hope that the above is useful to the less purist portion of the radio amateur and shortwave listener community.

ar



Photo 2 The finished product just prior to mounting on the boat-anchor chassis.

An L&T-Match Design Chart

Graham Thornton VK3IY
 17 Britannia Creek Rd,
 Wesburn Victoria 3799
 graham@scservnet.com

Direct calculation of component values for an L-Match with series reactance input is a tedious process, involving awkward series to parallel conversions, and equally awkward parallel reactance combinations. The chart presented here eliminates these difficulties by working directly with series impedances.

A school compass is all that is necessary to derive the component values. Further, the chart provides information from which insertion loss and capacitor voltage can be found graphically.

The chart did not arise by any designed intention; it came about by pure serendipity. While searching for the reason for 'holes' in the Z-Match response (Ref 1), a plot was made for a given shunt inductance to see what load impedance combinations could be made to look like a 50 ohm resistance in series with a reactance.

Very much to this author's surprise, the result turned out to be a perfect circle when plotted on the load resistance/reactance plane.

Don't be discouraged by the apparent complexity of the chart. It may bear a superficial similarity to a Smith chart, but such a resemblance is illusory. This chart uses rectangular co-ordinates. It should be regarded as a pragmatic tool that provides the answers we want very simply. If we attempted to use a Smith chart for this application, the loci of interest would be elliptical and of little practical value.

The Series Reactance L-Match

A brief recap may be appropriate on the action of this matching circuit. The shunt element converts the impedance of the load into a required value of resistance (eg 50 ohms) and some value of reactance. The reactance of this converted impedance is then resonated by the addition of a series reactance of equal value but opposite

sign. The series element and the combined impedance of the load and the shunt reactance form a tuned circuit with a total impedance of 50 ohms resistive. (Or such resistive load as is required.)

The Chart

The chart is presented in two ranges (Figures 1 & 2) in order to cover the expected values. The two axis of the charts are the Series Load Resistance (Horizontal), and the Series Load Reactance (Vertical).

The circles represent the reactance of the series element in the network. All points on the circumference of one of these circles have a constant value of equivalent parallel

Continued on page 19

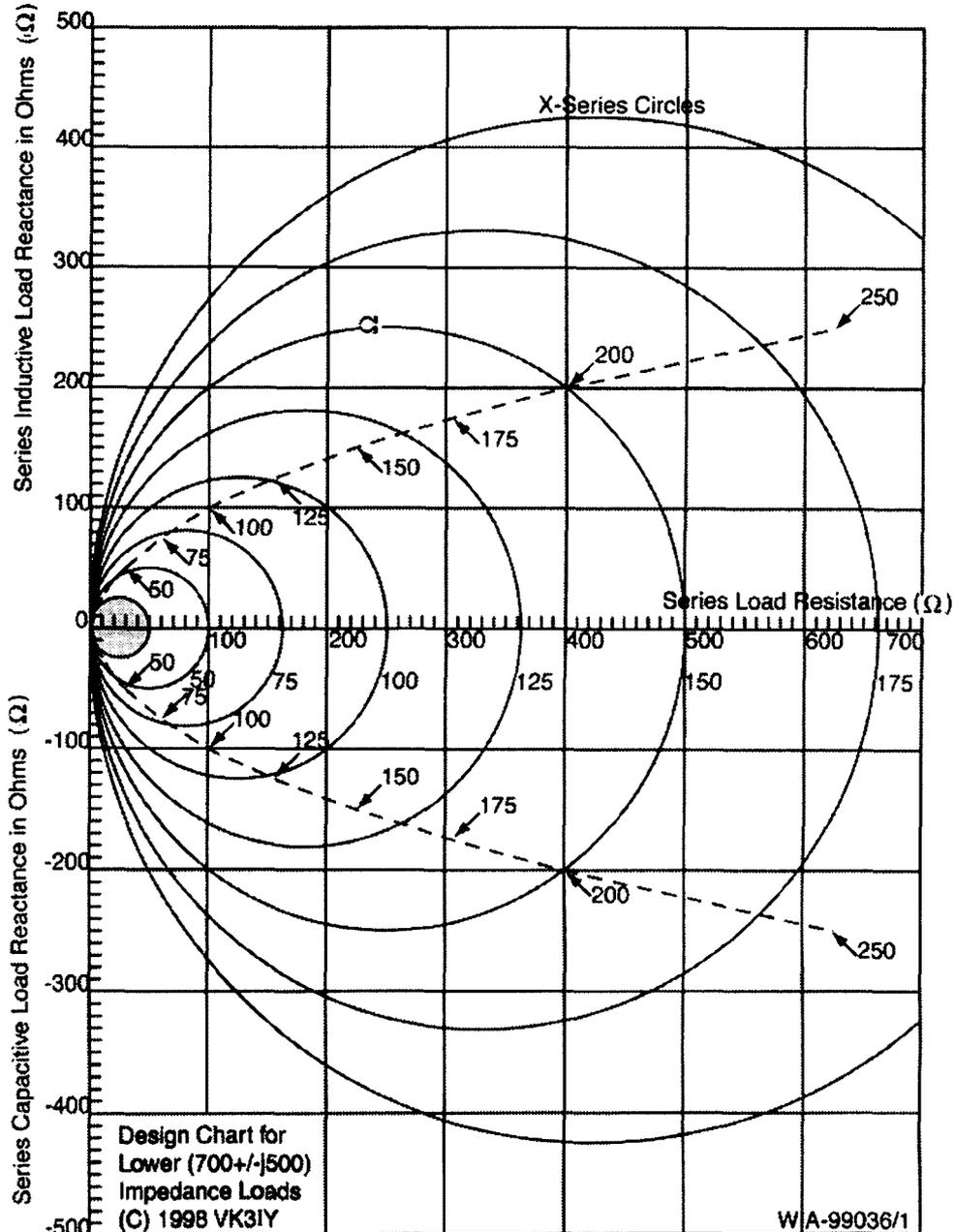

Fig 1. Design Chart for Lower Impedance Loads

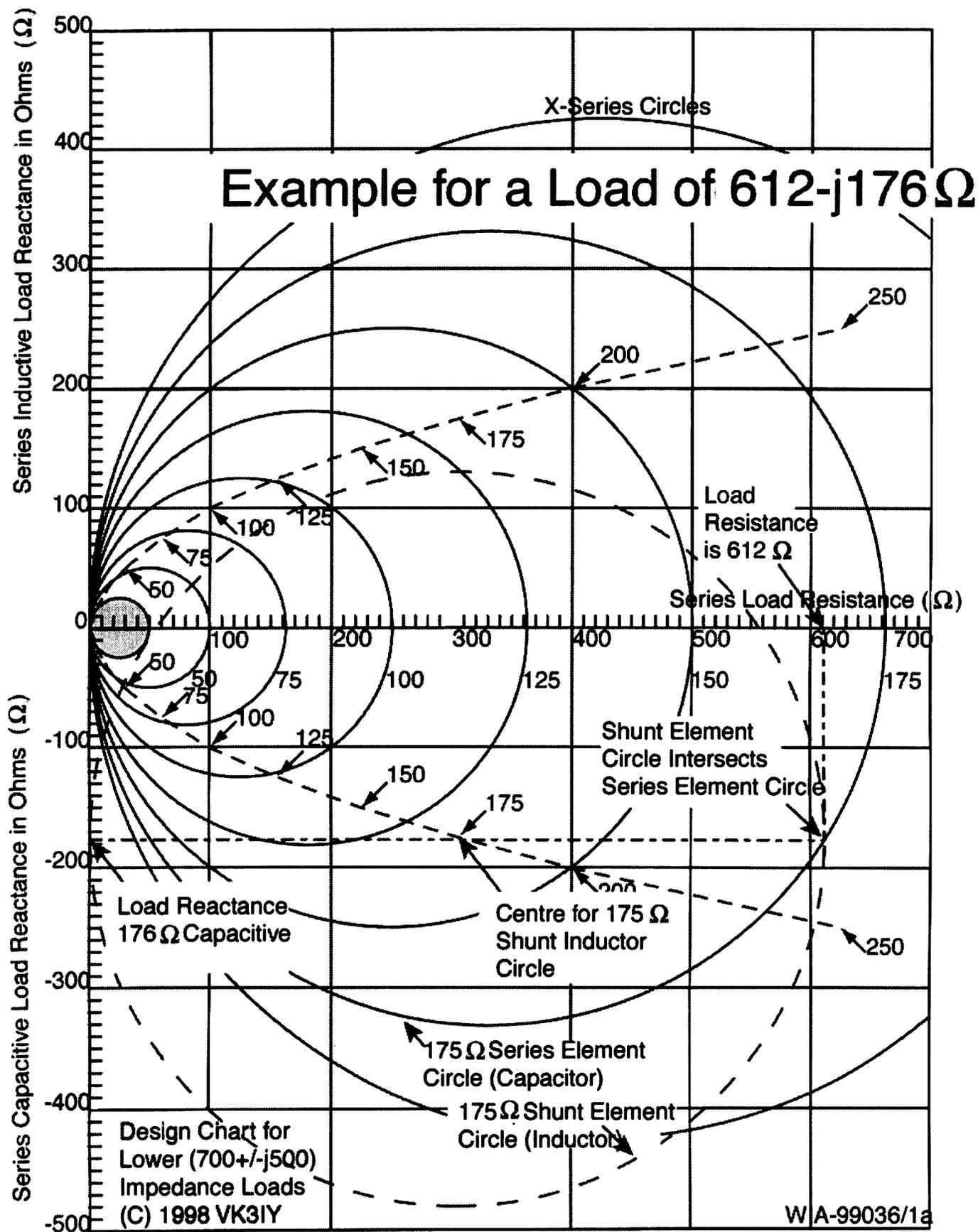

Fig 1a. Example of chart used to match a $612-j176$ ohm Load to 50 ohms

load resistance, the value of which is found at the intersection with the resistance axis. The parallel resistance can also be calculated as $(X_{\text{series}}^2/50) + 50$ ohms.

The smallest circle in Fig 1 is shown shaded as it represents the limiting case where the series element is a short circuit, and the equivalent parallel resistance is 50 ohms. Any point on or inside this circle cannot be dealt with by a series input reactance L-Match. To solve this problem, add a small reactance of either sign in series with the output (ie creating a T-Match). As can be seen from the chart, the simple L-Match can cope with a wide range of load impedances.

Note that the centre of each circle is on the resistance axis and is tangential to the reactance axis.

The shunt element has a unique circle also, whose radius depends on its reactance. However, the centres of such circles are located off the resistance axis along the dashed line.

Thus each series circle can intersect with a shunt circle, and the point of intersection represents the load impedance read from the horizontal and vertical axis, for which the combination will result in 50 ohms.

To avoid cluttering the chart, only the centres of the shunt circles are shown.

Using the Chart

Let us first look at a set of values that are already chosen. Figure 1a is a copy of figure 1 except that a dashed circle is shown for a shunt inductance of 175 ohms. The intersection of the 175 ohm shunt reactance circle and the 175 ohm series reactance circle will resonate to 50 ohms, a load with a resistance of 612 ohms and a reactance of 176 ohms capacitive (612-j176). Note that there is second intersection for a load of about 10-j80.

Intersections with series circles give the conjugates of this variable reactance, and thus a pure resistance of 50 ohms. (The shunt element alone provides resistance transformation; the series element merely gives resonance.)

A similar result would apply for any other shunt circles that might be drawn. These circles are always tangent to the reactance axis. Note that shunt inductors always have their centres below the resistance axis and capacitive shunts always have their centres above the resistance axis. (Either system may confer some advantage in component values, efficiency or bandwidth.)

Note: Some may experience difficulty interpolating between series element

circles. To help with this, a graph is provided so that any circle drawn experimentally may have its series reactance read directly. See Figure 4.

For a known load impedance

Plot the load impedance point on the chart.

If the load point lies on one of the series circles given, then record that as the series element reactance. If not, we need to draw an arc for ourselves. Make a light line from the load point to the origin. Midway along this line, draw a light line at right angles to cross the series load resistance line. Where it does is the centre for the series circle. Draw an arc cutting the resistance axis. This will give you the parallel equivalent resistance of the load. Reference to Figure 4 will give the value of series reactance required.

Find the shunt reactance value. You need to find a point along the dashed shunt centres line where you can place the point of the compass to just reach the load reactance line and just pass through the load point. Trial and error seems to be the easiest method here. We need to know the final position of the compass point on this line. The load reactance scale may be used directly for interpolation, though the sign must be reversed.

For known element reactance

Place the compass point along the shunt centres line for the value of the shunt reactance, interpolating as necessary.

Adjust the radius of the compass so that the pencil point just reaches the load reactance axis.

Draw an arc that passes through the known series reactance circle. The point where the compass intersects the series element circle gives the load impedance that will look like a pure 50 ohm resistance at the network input. (There is no point in drawing the entire circle.)

If the series reactance circle is not already on the chart, use Figure 4 to find the equivalent parallel resistance of the load. The value obtained is twice the radius of the series circle, so use half that value as the centre and radius.

The T-Match

The T-Match contains an extra element in series with the load. This is very easily accommodated. Add the inserted reactance to that of the load (algebraically). ie move the load point vertically on the chart.

The L-Match has a unique pair of elements for each load impedance

combination. If the output reactor is variable, we have an infinite variety of component combinations which will give a 1:1 SWR at the transmitter when using a T-Match. Which of these settings is best?

There is one invariable rule: the setting with the least input reactance will be the most efficient. (You can understand this from the chart. The smaller the series reactance, the lower the equivalent parallel resistance, and thus the higher the efficiency.) Similarly, the efficiency will be greatest when the load reactance is smallest.

So, for efficiency, you should always move towards the resistance axis on the chart. ie the sign of the inserted reactance should be opposite to that of the load. (If the input reactance passes through a minimum as we adjust output reactance, then the minimum represents complete load reactance compensation - ideal for efficiency.) Happily, the condition of maximum efficiency also represents the minimum voltage across the network capacitor, and the widest bandwidth.

Efficiency & Insertion Loss

The efficiency is different under the two options of shunt or series inductor. At first sight, this may appear puzzling. However, it becomes clear if we bear in mind that the current through the inductor is different in each case. The treatment given here assumes that all the loss is due to the resistance inherent in the inductor; ie the capacitor is loss free.

The series inductor is the simpler case, so let's take that first. Part of the total 50 ohms series resistance is due to the coil. Figure 5 shows insertion loss for three different values of coil Q, depending on the reactance of the coil obtained from the chart.

In the shunt inductor case, efficiency is dependent on the ratio of R_p to coil reactance; it is necessary to work out this ratio for yourself. Figure 6 will then give the insertion loss for three different values of coil Q.

For a given installation, it is probably worth looking at both options, in case there is some advantage of one system over the other. Given practical values for antenna impedances, and achievable coil Qs, it is difficult to get an insertion loss greater than 1 dB. However, if running a kilowatt, this represents a loss of 200 W, which would be a problem to avoid excessive temperature rise.

Table I shows the heat produced as a percentage of power applied to the network, for given values of insertion loss.

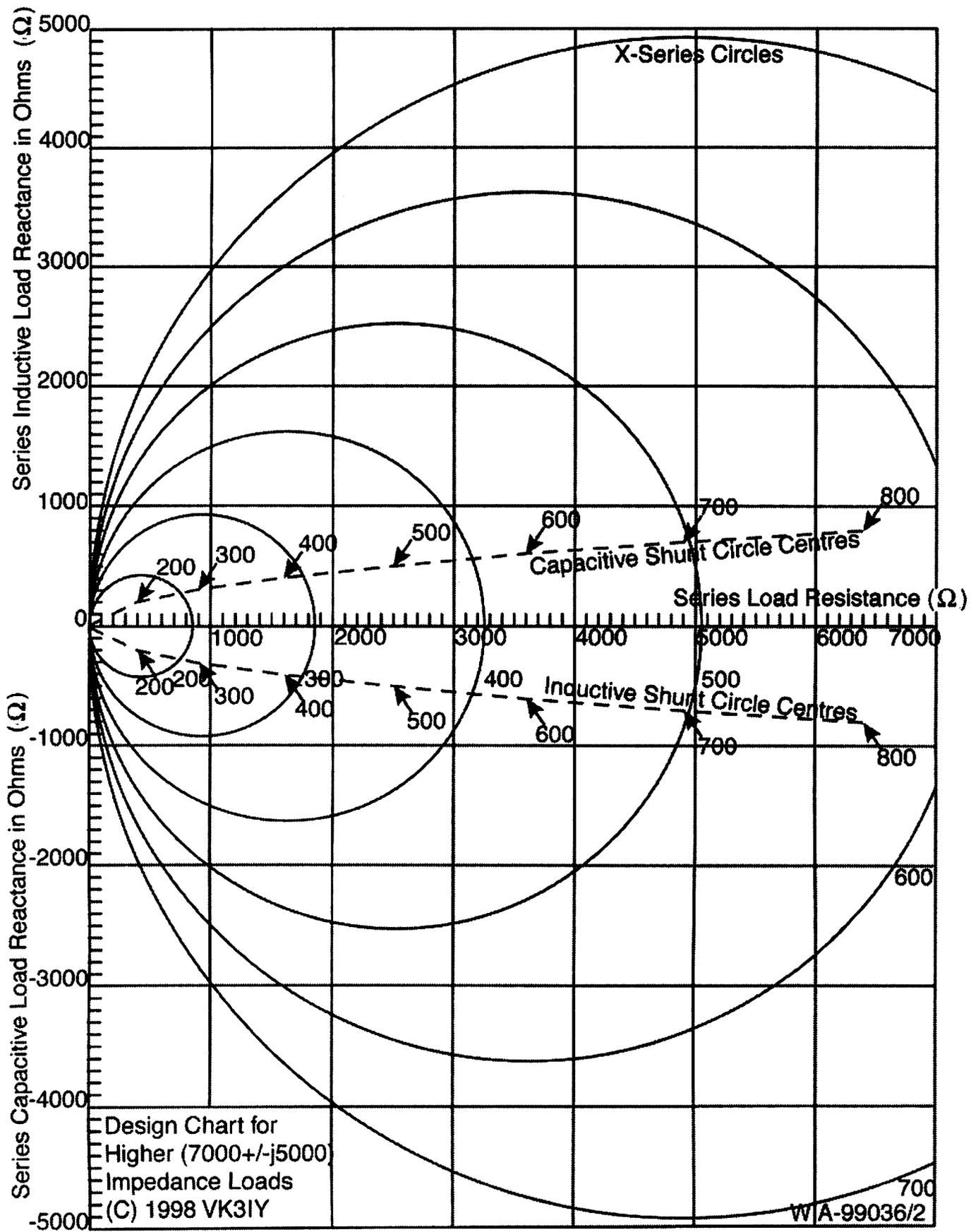

Fig 2. Design Chart for Higher Impedance Loads

Insertion Loss (- dB)	Power Loss (%)	Insertion Loss (- dB)	Power Loss (%)
.05	1	.8	17
.1	2	.85	18
.15	3	.9	19
.2	4	.95	20
.25	6	1.0	21
.3	7	1.05	21.5
.35	8	1.1	22
.4	9	1.15	23
.45	10	1.2	24
.5	11	1.25	25
.55	12	1.3	26
.6	13	1.35	27
.65	14	1.4	28
.7	15	1.45	28
.75	16	1.5	29

Table 1. Percentage of power lost as heat for a given insertion loss.

Capacitor Voltage

The value of peak voltage across the capacitor may be obtained from Figure 7, having read off the value of equivalent parallel resistance from the chart. Above about 300 ohms, the voltage is the same regardless of the position of the capacitor in the network.

Balanced Loads

The L (or T-Match) is essentially an unbalanced system. One side of the generator (the rig) is earthed. Perhaps the simplest and most effective way out of this problem, is to use a one to one toroidal balun between the rig and the ATU, floating everything else above earth. This will be fine if the current distribution of the antenna system is fixed by its own geometry. (eg dipole open ends.) However, with any sort of closed loop antenna, the imbalance in the ATU will upset the works and give unbalanced feeder currents.

With series capacitor input and still using an input balun, the capacitive reactance can be split into two halves, one in each leg. These capacitors can be adjusted for line balance, as well as SWR seen by the rig.

Another solution is to use a T-Match with a 1:4 balun before the compensating reactance. Since baluns do not like reactive loads, the load should be adjusted to be (or be close to) a pure resistance. A shunt compensating reactance is more appropriate here.

Continued on page 22

Mathematical Matters

This section is optional reading only. It is included for completeness, and to assist those who would like to produce their own chart on graph paper. If, as I did, you need a bit of revision about the elementary algebra of a circle, here goes:

The equation for a circle:

$$(x - a)^2 + (y - b)^2 = r^2$$

The empirical equation for the shunt reactance circles is given by:

$$\left(R_s - \frac{X_{Shunt}^2}{100}\right)^2 + (X_s + X_{Shunt})^2 = \left(\frac{X_{Shunt}^2}{100}\right)^2$$

The above was obtained by 'inspired guesswork'. Attempts to derive it by analysis have so far proved futile. A random test of some 17 intersections gave component values which were within one or two percent of the calculated ones. The possibility of this result being obtained by chance is remote indeed! If you would like to test your skill in manipulation of algebra, have a go yourself by all means!

The equation for the series reactance circles (by analysis) is:

$$X_s^2 + \left[R_s - \left(\frac{X_{Series}^2}{100} + 25\right)\right]^2 = \left[\frac{X_{Series}^2}{100} + 25\right]^2$$

The relationship between requisite series reactance of the network and equivalent parallel resistance of the load is:

$$X_{Series} = \sqrt{50(R_p - 50)} \quad (\Omega)$$

The efficiency with series inductor is: $\eta = \frac{50 - \frac{X_{Series}}{Q_u}}{50}$

The efficiency with shunt inductor is: $\eta = \frac{1}{\frac{R_p}{Q_u X_{Shunt}} + 1}$

In both cases: **Insertion loss** = $10 \log_{10} \eta$ (dB)

The peak voltage across the L-Network capacitor is:

$$E_{Max} \approx \sqrt{2PR_p} \quad (V)$$

Care would be needed that sufficient turns were provided in the transformer to ensure that the primary inductance is swamped by any likely value of reflected resistance.

Equivalent Parallel Load Reactance

This can be obtained from the chart as follows: centre the compass at a suitable point on the reactance axis and draw a semi circle such that it is tangent to the resistance axis and passes through the load impedance point. Where this semi circle cuts the reactance axis is the equivalent parallel load reactance. (If the intersection is off the chart, simply double the radius as found on the reactance axis.) Shunting the exact opposite of this across the load gives reactance compensation.

Conclusion

A simple graphical technique has been described which enables component values

and other parameters of an L or T network to be easily obtained. It should be noted that the chart is only appropriate for a 50 ohm system.

Previously published work (Ref 2) gave graphical techniques to achieve the same end. In time, I must confess I found the treatment difficult to follow. I hope this material will make amends for past indiscretions!

The insertion loss curves reveal that the worst case loss for an L-network is of the order of one decibel. From the viewpoint of signal strength, there is little to be gained by improving this with a T-Match. With higher powers, and consequent dissipation problems, a T-Match, properly adjusted, can make a significant difference. The trick would appear to be to try an L-Match first; if the coil does not get unduly hot or the capacitor doesn't arc over, then leave things be. QRPers need not consider a T-Match, except from the viewpoint of bandwidth. The advantage of high Q inductors when using high power is obvious from the loss curves.

The low impedance output L-Match has not been considered here; a simple technique has been given to overcome this deficiency.

The chart may be used in reverse to determine the complex load impedance. If an SWR of one can be found experimentally with an L-Match, and its constants estimated (or, better still, measured) this will provide sufficient information to find load resistance and reactance.

Just why the loci are circular, is a philosophical question that I can only leave you to ponder for yourself.

References

1. The Z-Match and its Matching Load Range - An Inherent Dropout with Certain Capacitive Loads. Lloyd Butler VK5BR & Graham Thornton VK3IY, Amateur Radio March 1997 p 21.
2. An L of a Network Part 2. Graham Thornton VK3IY, Amateur Radio April 1995

ar

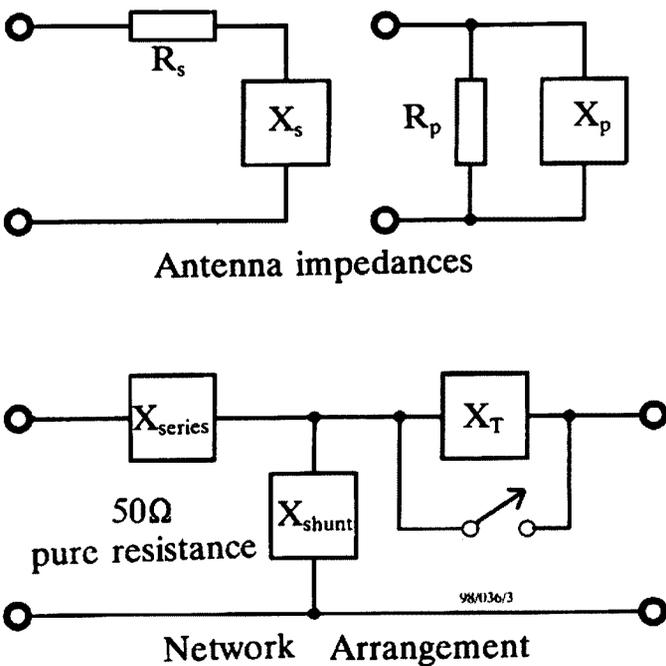

Fig 3. Network Schematics with definition of terms.

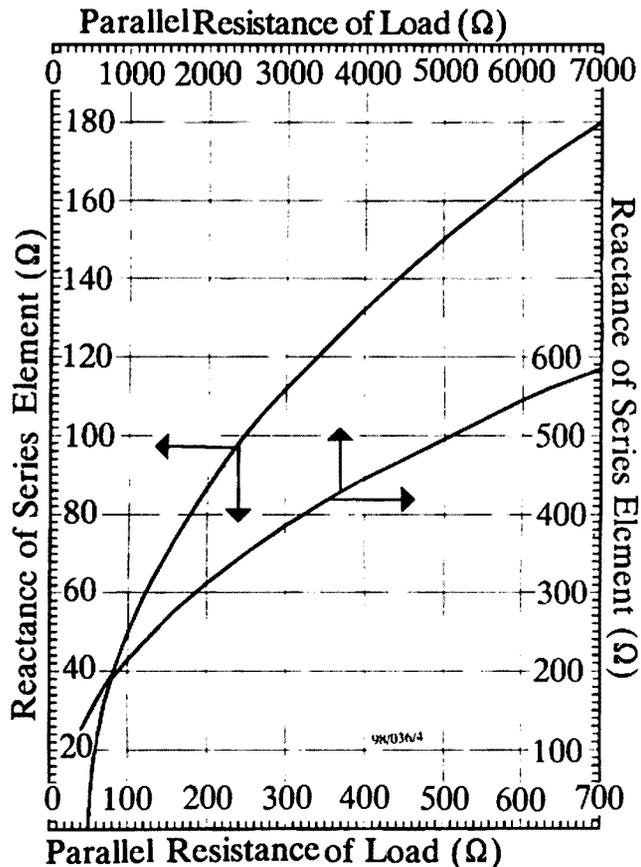

Fig 4. Interpolation curves to give accurate values of X_{series} for given value of R_p .

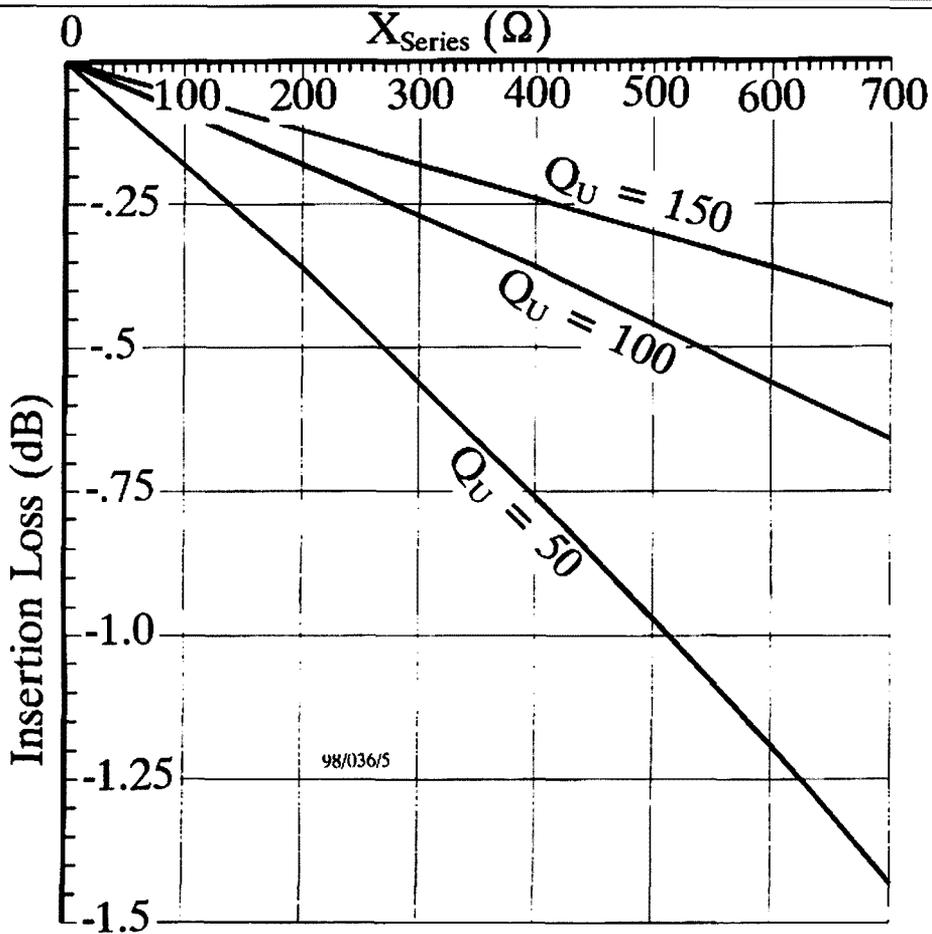

Fig 5. Insertion loss with series inductor

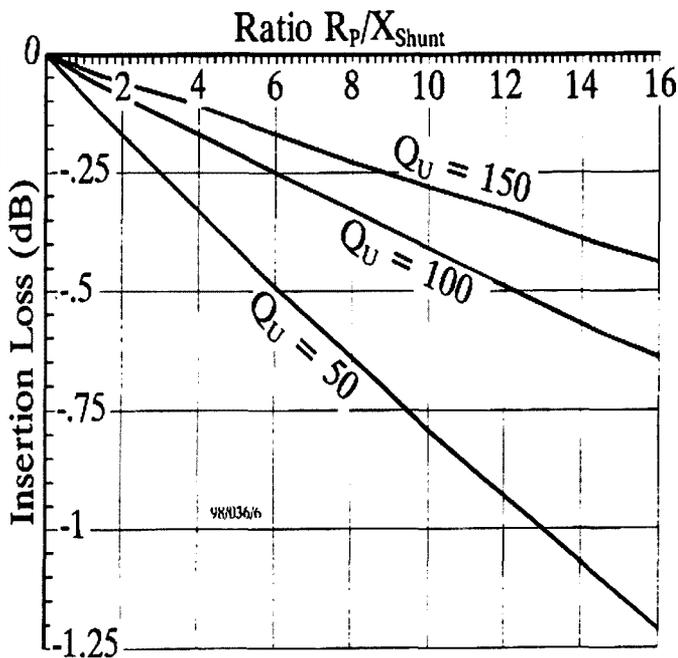

Fig 6. Insertion loss with shunt inductor

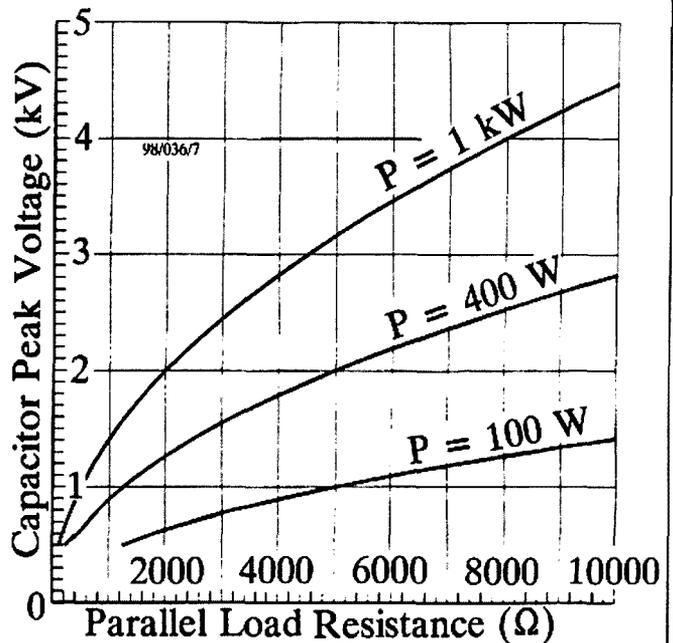

Fig 7. Peak capacitor voltage for a given R_p

An RF Resistance Bridge

Drew Diamond, VK3XU
45 Gatters Rd
Wonga Park, 3115

A desire to have the best antenna that our circumstances will permit seems always to be with us. The amateur without at least a few items of test equipment, who must rely on educated guesswork and signal reports to find out how a new antenna is working (or not working)- may be enjoying the job, but is nevertheless rather handicapped.

THE MOST POPULAR all-round tool for antenna work is the SWR meter, or bridge. With it, we can see if an antenna and feedline is an acceptable match to the transmitter's output amplifier. In a coax fed system, a reading of perhaps 1.5 or 2.0 at the station end would make most of us seek out the problem. Such a reading could be caused by one, or a combination of several things. But an SWR meter can only tell us that there is a significant mismatch-somewhere between the meter, and space.

Furthermore, the device may require anything from 1 W to 50 W to obtain a meaningful reading.

That's where the noise-bridge is so handy. Quite accurate RF impedance measurements may be taken at various points in a system with little or no radiation occurring. The noise bridge is an amateur invention, a successful "lateral thinking" approach, where a broadband noise is applied as signal, and the station receiver is used as tuneable detector in a bridge measurement

(rather than the traditional laboratory method, which employs a modulated signal generator and straight detector).

Much has been written about the noise-bridge in amateur publications, but nearly all of them continue to use a noise generator as signal source, and a receiver as detector. But now the cost of modulated signal generators has fallen so that one may reasonably be added to our equipment armoury. By using a tone-modulated RF signal from a generator, rather than noise, we eliminate the need for a sensitive receiver as detector. A simple diode and audio amplifier has sufficient sensitivity to detect a 1 mW signal, and allow adjustment for null in RF impedance measurements. Also, the human ear is a wonderful instrument in radio tests. When making adjustments, it is much easier for us to listen for a null in an audio tone than it is for noise (see Ref 3).

Taking this idea as starting point, bridges that measure both resistive (R) and reactive (X) component of an impedance ($R \pm jX$), and bridges which measure just the R component were constructed and applied to measurement problems. Now, it must be said that an ability to quantify both R and X components of an impedance is very useful. However, it was found (and has been observed elsewhere, see Ref 2) that inclusion of X measurement significantly complicates the construction, calibration and use of the bridge, whereas, in amateur work, a bridge which measures only the R component may be usefully applied to most measurement problems. We amateurs can generally get around the lack of an X arm because of the fact that we are aiming at one goal; we want an antenna that presents a matched resistive load, and by reasonable assumption, works most effectively. And this condition is satisfied when the antenna is resonant and matched to the transmission line, whose impedance (usually 50 ohms) the radio is designed to work into. To us, the value of the X component is generally of academic interest only, because, whatever the outcome, it must be eliminated, or reduced to as low a value as reasonably possible. A variation in the generator's frequency allows us to determine whether the antenna is too long, or too short.

An RF resistance bridge may be used to find, with reasonable accuracy;

- the resistance of an antenna feed-point, at resonance,
- velocity factor of RF cables,
- characteristic impedance of RF cables,
- the value of RF input resistance of amplifiers and other devices,
- settings for antenna couplers whilst putting less than 1 mW to air, and

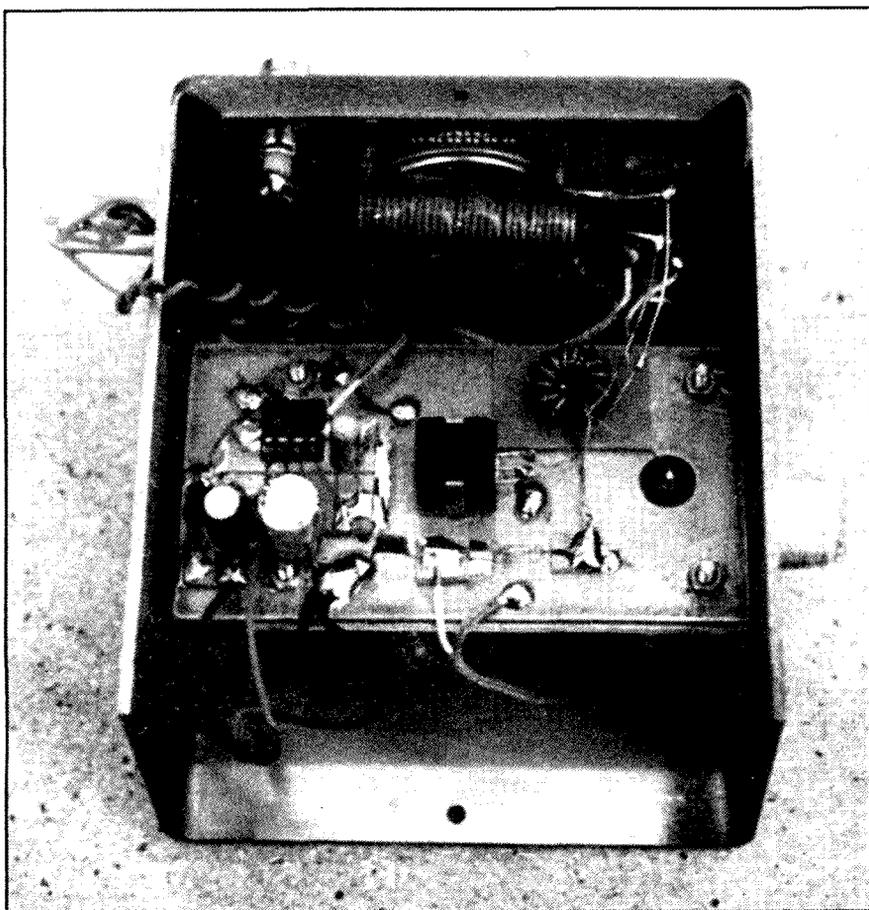

Photo 1 The internal layout.

- the value of microhenry inductors and pF capacitors.

Circuit

The circuit configuration is based upon the popular transformer-ratio-arm bridge, where the three identical windings of T2 are connected in trifilar form as shown in the schematic. Two windings are connected in series to create a tightly-coupled source with a neutral wire formed by the centre tap (ct). The signal voltage available at top and bottom windings are therefore identical in value, and opposite in phase. A diode detector is connected between neutral and chassis ground.

An AM tone-modulated RF signal of about 1 mW power level is applied, via balun T1, to the primary winding of T2. The balun is necessary to preserve capacitive balance between the ends of the secondary winding and ground. The bridge will be "in balance" when the value of the variable resistor is adjusted to exactly equal the resistance applied to the "unknown" connector. Under balanced condition, there will be no signal for detection at the neutral point. However, when either the unknown or dial resistances differ, balance is disturbed, and a signal is created whose amplitude is proportional to the degree of imbalance. The detected audio tone, via a 10 K sensitivity potentiometer, is presented to a conventional LM386 audio amplifier and miniature speaker.

Operationally, if the impedance connected at unknown is in the 0 to 220 ohm range, and predominantly resistive, an audible "null" is produced when the dial resistance is adjusted to match that at Unknown. Should there be some reactance present, the null will be less pronounced. The generator may be varied in frequency together with the R dial to obtain a deeper null. More under "Operation" below.

Construction

The prototype is housed in a Horwood aluminium box type 34/4/D, which measures 100 x 100 x 75 mm. Naturally, a home-made metal box of similar dimensions will do. Except for balun T1, all components are accommodated "ugly" style upon a plain circuit board measuring 50 x 95 mm. Use reasonably short connections, especially the bridge wiring. The LM386 is fitted into a wire-wrap socket, which in turn is mounted "paddyboard" fashion upon the main board. The circuit board is fixed with four 3 mm screws to a right-angle aluminium bracket, and the whole assembly is then

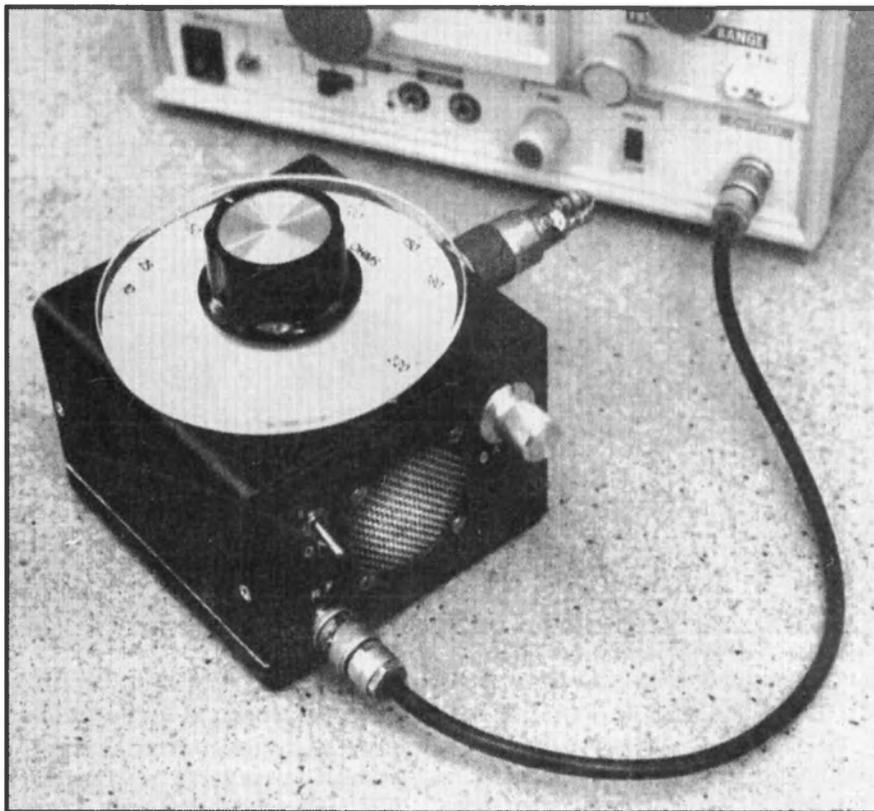

Photo 2 Generator and Bridge set.

mounted onto the box by means of the four coax socket retaining screws. A hole in the board allows connection of the unknown coax inner pin.

Balun T1 is very similar to that described previously in Ref 5. By using 18 B&S enamelled copper (EC) wire, the device is self-supporting, which simplifies construction, and avoids having to use pads or tags at the T2 end (which may cause imbalance). Wind 9 turns (total 27) trifilar onto a 50 mm length of ordinary loopstick rod. Winding starts are the dotted numbers (1. 2. 3.). Note that the start of winding 1 is connected to the end of winding 1, and the end of winding 3 is connected to start

winding 2. The balun assembly should then be encased in epoxy cement.

Bridge transformer T2 has 11 loops of 24 B&S EC wire trifilar wound upon an Amidon FT50-43 core. Make sure the wires are not scratched during winding. Remove about 20 mm enamel from each wire. Using your multimeter on ohms, identify the individual windings. Now connect the start of one winding to the end of another to form the centre tap. The remaining "free" winding is the left-hand primary side shown in the circuit. Super-glue T2 onto a small square of phenolic (or similar), which in turn is cemented to the main board as shown in Photo 1.

Continued on page 26

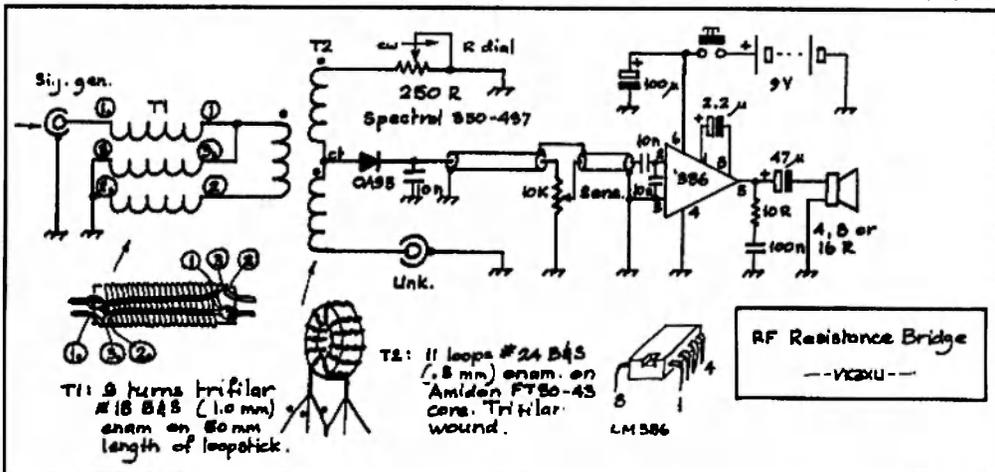

Fig 1 The circuit Diagram

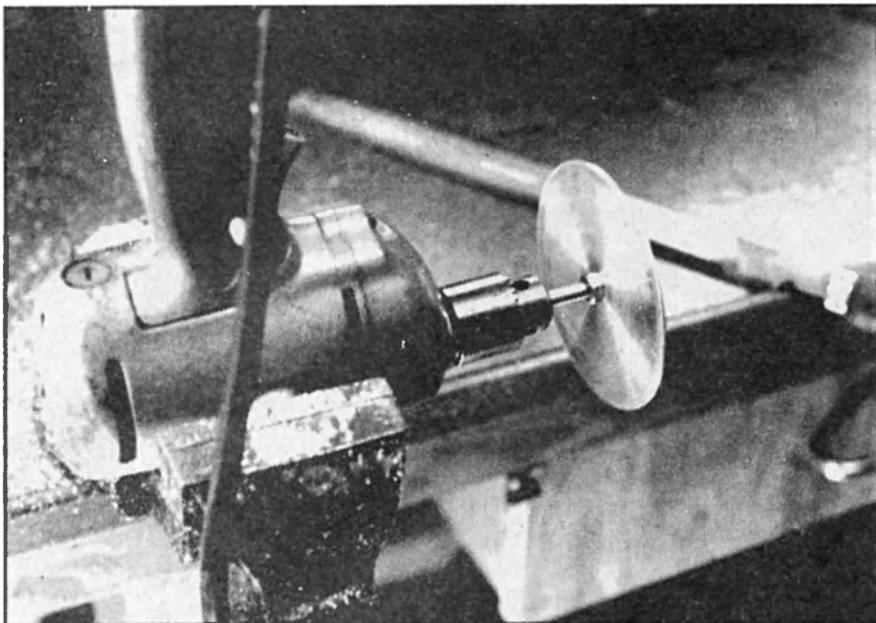

Photo 2 Smoothing the disk edges on a poor man's lathe.

Continued from page 25

To obtain good resistance resolution, the dial must be as large as can reasonably be managed. Mine is a white undercoat spray-painted aluminium disc measuring 100 mm diameter, thus taking the full width of the box. The 250R carbon pot is mounted centrally upon the main board assembly, with an extension shaft attached. The perspex cursor is affixed to the back of a suitable knob as shown in Photo 2. The dial disc components may be produced in the chuck of an ordinary electric drill. Compass, then cut out your aluminium and perspex discs using a rod-saw or similar. Drill a 1/4" hole dead centre of each. Take a 1/4" Whitworth bolt, about 2" long, and cut off the head. Fix the disc in this "chucking piece" using a pair of nuts and washers. Mount the drill in your bench vice as shown in Photo 3. Carefully apply a flat file to the outer edge of the rotating disc to obtain a smooth round finish.

The BNC socket connector for signal generator, on/off switch, miniature speaker and detector gain pot may be mounted upon one side panel as shown.

There is room for the 9 V "transistor" battery inside the box. Mine is mounted upon the bottom detachable panel with phenolic spacers. Or your battery may be fixed to a clip external to the box, depending on operational preference.

Calibration

Before applying power, go over your wiring and component polarities again and confirm that all is correct. Switch on. Full clockwise rotation of the gain pot should produce just a soft hiss. You will need an HF signal "generator" which can deliver about 1 mW, and

has internal AM, such as the Q-1312. Connect the generator output to the RF connector of the bridge using a short coax cable.

Obtain a set of 1/4 W, 1 or 2% resistors of 10R, 100R (X4, to make 50, 100 and 25 ohms), 120R, 150R (X2, to make 150 and 75 ohms), 180R and 220R. Suggested calibration points are 10, 25, 50, 75, 100, 120, 150, 180 and 220 ohms. Starting with the most popular impedance; 50 ohms, take two 100R resistors and solder them into a PL-259 (or whatever you prefer) plug using short leads. Set the generator to mid HF, say 14 MHz at about 1 mW (maximum level on the Q-1312). Switch the internal AM on. You will hear a tone. Carefully adjust the resistance dial for a null, which should be deep and quite sharp. With a pencil, mark this 50 ohm calibration point. Do the same for all other desired calibration points between 0 and 220 ohms. The null at the high end will not be as sharp as those obtained at the low end.

With all calibration points marked, remove the knob/cursor and apply calibrations to the dial disc using rub-on numbers or similar.

Operation

The bridge finds primary application in antenna work. If physically possible, the feed-point of the antenna is connected to directly to Unknown. Sweep the R dial around the nominal impedance whilst listening for a null. Also adjust the generator frequency for deepest null, then read off the resistance and resonant frequency. Let's suppose we want a ground plane with four sloping radials to be resonant at 14.1 MHz and present 50 ohms, but we read 40 ohms and 14.0 MHz. It's too long. Shorten each

element a bit and measure frequency again. We could raise the impedance a little by increasing the angle of radial slope, and measure again. Check for inter-action between variables.

It's easy with a ground plane, because we can generally get at the feed point. What do we do with a more remote feed point? "Use an electrical half-wave (or multiple thereof) of low-loss coax feed-line" blithely say the radio handbooks. Hmmm. To do that we need to know the velocity factor (v) of the cable so that we can be sure of the electrical length. If the velocity factor is known then:

Electrical 1/2 wavelength in metres =
v multiplied by (150 divided by f
MHz).

For example, the coax maker gives v as 0.66, and we want 1/2 wave at 14.1 MHz,

then; length = 0.66 X (150 divided by 14.1), which gives 7.02 m.

Before we go cutting up lengths of precious cable, we can measure the (v) of a sample. Connect one end of a sample length (say 6 m) of cable to "Unknown". Short circuit the far end (perhaps with an alligator clip). Set the R dial near zero (because zero ohms will be reflected over exactly 1/2 wavelength). Sweep the generator down from 30 MHz looking for the lowest frequency that produces a good null. Note the frequency. Calculate;

Velocity factor = (length m multiplied by f MHz) divided by 150.

For example: a 6 m sample length of coax has lowest null at exactly 16.5 MHz, then;

v = (6 X 16.5) divided by 150, which gives 0.66.

Let's say at a hamfest you buy, at bargain price, a mystery coil of coax cable. The person who sold it to you "thinks" it is 50 ohm, but no one is sure. How to measure the characteristic impedance (Zo)? If it is very long, cut off a 3 or 4 metre sample length. Connect one end to "Unknown" using a suitable plug. Solder a miniature 220 ohm carbon trimpot, between one side and slider, to the far end. Set the generator to about 30 MHz. Repeatedly adjust both generator frequency and trimpot until the detected tone is constant (no dips or nulls), regardless of frequency. Now disconnect the coax from Unknown, and measure the trimpot's resistance with your multimeter. The value of the trimpot's resistance will equal the Zo of your cable. The same method may be used to find the Zo of any reasonable length of cable, both coax and twisted pair.

To find the value of an unknown microhenry coil; connect the coil IN

SERIES with a (say) 100 pF mica capacitor across the Unknown connector. Set the R dial to about 10 ohms. Vary the generator frequency and R dial until best null is obtained. Note the frequency. The value of the coil, in microhenries (μH) may be calculated:

$$L(\mu\text{H}) = 25330 \text{ divided by } (f(\text{MHz}) \text{ squared} \times 100(\text{pF})).$$

Similarly, when frequency and inductance are known;

$$C(\text{pF}) = 25330 \text{ divided by } (f(\text{MHz}) \text{ squared} \times L(\mu\text{H})).$$

To adjust an ASTU (or antenna coupler); replace the usual radio coax connection with Unknown of the bridge. Set the R dial to your coax impedance (typically 50 ohms). Set the generator to the required frequency. Now carefully adjust the ASTU, listening for a deep null in tone, then note the settings for each band of interest.

When working with large antennas, you may hear broadcast stations mixed with the tone (the detector acting as an un-tuned crystal set). Simply ignore the babble and concentrate on the tone, which may be nulled in the normal way.

Parts

The 250R carbon pot (carbonised plastic track- or "Cermet"), Spectrol P/N 350-497, is known to be available from Farnell (02 9645 8888). The same type is also available from Rockby Electronics (03 9562 8559), where the Cat. number is RB51X250R. Cost is about \$6. See Hamads for Amidon core retailers. Dick Smiths, Jaycar and Truscotts have loopsick rod material for the balun (shorten by grinding a groove around the circumference then snap, as you would break a stick). The remaining parts are available from the usual electronics suppliers.

References and Further Reading:

1. "The Antenna Noise Bridge", Hart, W5QJR, QST, Dec. '67.
2. "A Review of Antenna Noise Bridges", Slutskin, VK3SK, AR, Mar, Apr. May '81.
3. "A Few Tips On the Design of the Noise Bridge"; Butler, VK5BR, AR Feb. '90.
4. "Another Tip For Using the Noise Bridge"; Butler, VK5BR, AR Dec. '94.
5. "A Home-brew HF Balun", Diamond, AR, Oct '97.
6. Test Equipment for the Radio Amateur, Smith, G4FZH, RSGB Publications.
7. Radio Communication Handbook, 6th Edition, RSGB Publications.



EDITOR "Amateur Radio"

Mr Bill Rice has indicated his intention to retire towards the end of 1999.

Applications are invited for the position of Editor for "Amateur Radio"

The Editor will be appointed by Federal Council to be the Chairman of the Publications Committee. The Publications Committee is responsible for the publication of all WIA publications, subject to the direction of the Council and Executive. The Editor shall ensure that editorial policy of all publications is, in general, in accord with the policy of the WIA.

Applicants are expected to

- have a commitment to maintain and improve the quality of the present "Amateur Radio" magazine and other publications of the WIA
- be skilled in editorial and technical writing matters
- meet the regular deadlines involved in the timely production of a monthly magazine
- work with volunteers both on a one-to-one basis and in a Committee
- be available through email, phone and fax
- be licensed amateur radio operators and members of the WIA.

The Publications Committee is based in Melbourne and applicants outside of this area should not be deterred by this but need to advise on how they would work with this arrangement.

A small honorarium is provided to the Editor.

Applications should be forwarded to the Federal Office by 23 August 1999 addressed to Dr W J Howse, Director.

Enquires about the position can be made to him by phone and fax through the Federal Office or by email to armag@hotkey.net.au

FOR ALL YOUR COMMUNICATIONS NEEDS

Get in quick and grab a bargain! These ex-demo Yaesu transceivers may have a few minor marks or scratches, but you'll save a fortune. Warranty applies but stocks are strictly limited.

FT-51R 2m/70cm hand-held

The FT-51R uses a sculpted case and diecast rear panel for strength, and dual microprocessor control for ease of use. At just 57 x 123 x 26.5mm (W.H.D) including NiCad battery pack, it's comfortable to hold or clip in a pocket. Includes inbuilt "Spectrum Scope", scrolling text help messages, and power-saving MOSFET amplifiers.

Features:

- Tx 144-148, 430-450MHz
- Rx 118-174, 420-470MHz
- 2m RF Output: 2.0, 1.5, 0.5, 0.02W
- 70cm RF Output: 1.5, 0.5, 0.02W
- Twin VFOs per band
- 120 memory channels
- Dual-band & dual in-band receive facilities (VHF/VHF, VHF/UHF, UHF/UHF)
- DTMF Paging and Messaging
- Large illuminated LCD screen
- Auto battery saver, Auto battery off
- CTCSS encode/decode
- Australian version selectable Auto repeater shift
- Includes FNB-31 600mA/H NiCad, belt clip, AC charger, CA-9 charging stand and high efficiency antenna.

\$599
BELOW COST

3 UNITS ONLY

2 YEAR WARRANTY D 3622



CD-2 mobile fast charger

A fast NiCad charger and mobile cradle assembly to suit the FT-11R and FT-51R handheld transceivers. Uses a regulated switched-mode charging circuit for cool operation and light weight. Reverts to trickle charging once the battery is fully charged. Includes cigarette lighter lead. D 3628

\$39⁹⁵

WAY BELOW COST!

10 PIECES ONLY
2 YEAR WARRANTY



FL-2025 2m 25W Amp

Turn your FT-290II into a powerful mobile/base transceiver with this bolt-on RF amplifier. Replacing the FBA-8 battery holder on the FT-290RII, it boosts transceiver output to 25 watts. Requires 13.8V DC. D 2863

LAST FEW UNITS

\$199
SAVE \$100



Battery packs to suit FT-11R and FT-51R

FBA-14 dry cell case	D 3626	\$19.95	SAVE \$40
FNB-35 7.5V 900mAH NiCad	D 3624	\$59.95	SAVE \$30
FNB-33 4.8V 1200mAH NiCad	D 3623	\$69.95	SAVE \$37



FT-290RII 2m all-mode transportable

Covers 144-148MHz and features FM, SSB (USB/LSB), & CW operation with 2.5W or 250mW switchable output power, twin VFOs and 10 memories that store mode and simplex or repeater frequencies. Selectable tuning rates are also provided for SSB/CW and FM (SSB- 25Hz/100Hz/ 2.5kHz and 100kHz; FM-5/10/20kHz and 1MHz). Mode specific features include a noise blanker and clarifier control for SSB/CW, plus a full set of functions for FM repeater operation, making this unit very simple to operate. It comes with a flexible rubber antenna, an FBA-8 battery holder which takes 9 x C size batteries (standard or NiCad) and a hand-held microphone. D 2875

\$699

2 UNITS ONLY
2 YEAR WARRANTY

SAVE \$200

YAESU

SP-6 Extension Desk Speaker

With 12 different audio filtering selections, this speaker set suits most transceivers and receivers. A selectable high/low pass filter coupled with a large high-sensitivity speaker produces superior audio compared to that of standard transceiver speakers. The SP-6 has two input terminals with front panel selection, and a front panel headphone socket with filtered audio. D 3265



2 YEAR WARRANTY
3 PIECES ONLY

\$169
SAVE \$80

Mastercharger I Fast Desktop Charger

The Mastercharger I is a compact fast charger that operates from 13.5V DC and uses switch-mode technology plus a Philips battery charge monitor I.C. to charge NiCad batteries between 4.8V and 13.2V. Suits Yaesu FT-23, 73, 411, 411e, 26, 415, 815 and 530 handhelds. The charging cradle on each MasterCharger can easily be replaced, allowing for the insertion of a new cradle to suit other transceivers. Requires 12-15V DC at 1.5A, and comes with a fused cigarette lighter cable. D 3850



\$39⁹⁵ **WAY BELOW COST!**

FOR ALL YOUR COMMUNICATIONS NEEDS

3-15V 25A Heavy Duty Power Supply

This solidly built benchtop power supply provides current of up to 25 amps ICAS at 15V, 20 amp continuous at 13.8V and lower current at lower voltages. It has front panel metering plus high current banana-style and low-current output connections. An internal heatsink and thermally switched fan provides cooling without protrusions in the metal case. Specially modified for more reliable long-term operation, it uses a rugged 50 amp bridge rectifier & trifilar transformer. Also provided is extensive overload protection through dissipation limiting circuitry for the pass transistors, a 30 amp instantaneous current limit, AC mains circuit breaker, a transformer thermal fuse & fused auxiliary secondary winding.
D 3800

\$299
GREAT VALUE!



Yaesu FT-100 HF/6m/2m/70cm Mobile

What amazing value! Now you can enjoy the fun of operating on all bands from 160m to 70cm, either at home or in your car. The new Yaesu FT-100 features HF/6m/2m/70cm transmitter coverage, with 100W PEP RF output on HF and 6m, 50W on 2m and 20W on 70cm, plus you can easily mount the detachable front panel using an optional lead for more convenient mobile installations. Powerful interference fighting features, such as a DSP based Bandpass filter, Notch filter and Noise reduction, together with an IF based Shift control, all aid reception quality during tough conditions. A speech processor and VOX are provided for SSB users and an internal electronic keyer is provided for CW operation. Also included are dual VFOs, built-in CTCSS encode, 300 memory channels, all-mode operation (SSB, CW, AM, FM, AFSK, Packet (1200/9600bps), 100kHz - 970MHz receiver (cellular locked-out) and options for additional AM and CW IF filters. The FT-100 is supplied with an MH-42B6JS hand mic, DC power lead and comprehensive instructions.
D3285

2 year warranty

YSK-100 Separation Kit D 3286 \$155



STOCKS DUE
MID JULY



YAESU \$2750

Yaesu FT-1000MP Deluxe HF All Mode Transceiver

Yaesu has created a new 100W HF masterpiece using proven design techniques and a major new technology to the amateur marketplace: Enhanced Digital Signal Processing (EDSP). Teamed up with Direct Digital Synthesis, an outstanding receiver section featuring a high intercept front-end and a variety of IF filters (including a Collins Mechanical Filter), the FT-1000MP's exclusive EDSP facilities provide an impressive array of IF-based noise-reduction and interference reduction filters for enhanced receiver performance. Yaesu's IF-based EDSP system provides 4 random noise-reduction protocols, audio enhancement with 4 equalisation programs for Tx and 3 for Rx, and an automatic notch filter which eliminates multiple interfering carriers. A comprehensive menu system allows you to easily hear the effect of various EDSP settings, so you can choose the best selection for your operating conditions. Front panel selectable EDSP filter contours also aid QRM rejection, providing improved signal-to-noise ratios and razor sharp selectivity. The FT-1000MP also features selectable receiver front-ends, an in-built AC power supply and auto antenna tuner, 2 main antenna sockets, selectable tuning steps as small as 0.625Hz, dual-mode noise blankers, 13.8V DC socket, 500Hz and 6kHz IF crystal filters, an RS-232 computer interface and an MH-31B8 hand microphone. With so many features in this new transceiver, why not ask for a copy of the 12-page FT-1000MP colour brochure or 46-page Technical overview for more detailed information.
D 3400

2 year warranty

\$4450

YAESU



PHONE FAX AND MAIL ORDERS

PHONE: WITHIN AUSTRALIA: 1300 366 644
(Local call charge)

FAX: (02) 9395 1155 within Australia and
(+612) 9395 1155 from outside Australia

MAIL: DICK SMITH ELECTRONICS, Direct Link, Reply Paid 160,
PO Box 321, North Ryde NSW 1670 (No stamp required)

Excludes packaging and postage. All major credit cards accepted.

14 Day Money Back Guaranteed if NOT completely satisfied. (Software excluded)



Visit our web site at
<http://www.dse.com.au>

DICK SMITH
ELECTRONICS

That's where you go!

Mike Impedance

Matcher

Bob Harper VK4KNH

PO Box 288

Beerwah 4519

Bobharper@bigpond.com

Recently I had a request from a non-amateur to convert his CB microphone to 50 k-ohms. We can but guess what he was going to do with it. I fixed his problem then considered that as radio microphones are usually either 600 ohms or 50 k-ohms that I should make a pre-amplifier with a dual impedance input and variable gain from 1 to 10. Although this could be the first stage in a speech processor, I haven't followed that path here.

The circuit is a simple, single-supply op-amp circuit with variable gain and a high/low impedance switch on the input. I personally believe that Amateur Radio should be a learning experience and as such will describe the purpose of every component used. That must be the ex-teacher coming out in me.

Active Component Choice

Referring to Figure 1, the Op-amp chosen is a TL071, FET input, low noise type, which has a high input impedance. An LM741, or other op-amp could be used with reasonable results but the one chosen is well suited to the task, readily available and cheap at around \$2.00 from most outlets.

Power

Power is connected to the op-amp at pin 7 and pin 4 is the ground connection. C3 filters out audio frequency ripple that may appear on the power supply either from external sources or generated within the op-amp. The signal simply passes to ground via C3 resulting in almost no ripple on the supply rail.

Op-amp signals should be biased midway between the rail voltages and that is why they are usually fed with a dual power supply of something like +/-9V. When there is only a single supply rail the input pins should be biased at a voltage midway between the supply and ground. The two 100 k-ohm resistors, R3 and R4, do just that in this circuit.

You will also have noticed the R5/C2 combination. This is another filter to prevent any audio ripple still remaining on the power supply from reaching R3 and R4 and thus being amplified.

Input Circuit

There are three circuits for the input that can be chosen by the switch. The first input, switch position one, is a direct input allowing for an input impedance of 50 k-ohms, which is set by the value of R3 in parallel with R4. We could match the input to another impedance by using suitable resistors for R3 and R4.

Note that I refer to R3 and R4 as being in parallel only as far as the audio signal is concerned. The impedance of any power supply capacitor would be almost zero at audio frequencies, thus R3 and R4 appear to the audio signals to be in parallel. (C2 would be about 50 ohms at 300 Hz.)

The second input, switch position 2, is around 600 ohms set by switching R1 across the microphone input. R1 is in parallel with R3 and R4 making the input impedance a little under 620 ohms.

The third input, switch position 3, is provided for the electret microphone element. Electrets require a small current through them to operate. Generally this is less than 0.5 mA. At a rail voltage of 12 volts the resistor required is 12/0.0005 or 60 k-ohms. A 68 k-ohm value should be sufficient.

The capacitor C1 is calculated to have little effect on the circuit at the lowest frequency. In this case the current that will flow in the capacitor will be very small and even 1 k-ohm would be a low resistance. The impedance of a 1uF capacitor would be around 500 ohm at 300 Hz falling to around 50 ohms at 3 kHz. This generally considered acceptable but could be increased to 10uF if better performance with a 600 ohm microphone is required. The reactances would then be reduced by a factor of ten.

Feedback Circuit

An op-amp has two inputs; an inverting input, (often pin 2) and a non-inverting input, (often pin 3). You can simply think of these as for negative feedback and positive feedback respectively. Note that in this circuit, there is no feedback between the output on pin 6 and the input on pin 3; ie there is no positive feedback.

Pin 2 however is connected to pin 6 via the 100 k-ohm potentiometer, VR1. At DC and very low frequencies C4 is essentially an open circuit. The op-amp draws so little current that pin 2 is effectively connected directly to pin 6 and the DC feedback is 100%. This means a gain of one, which is fine for us, as we didn't want any gain at DC anyway.

At audio frequencies the impedance of C4 will be very low, 53 ohms at 300 Hz, and falling as frequency increases. The feedback will depend on the resistance ratio on each side of the wiper of VR1. At minimum with the wiper closer to the output of the op-amp, the gain will be one. With VR1 at full resistance of 100 k-ohms, the gain will be $100k/10k = 10$.

Output Circuit

The output circuit simply consists of a 1k-ohm resistor, R6, that restricts the loading on the op-amp to 12 mA at 12 volts, and a capacitor, C5, that prevents any DC voltages from passing between the amplifier and the radio. The impedance of C5 will be just 53 ohms at 300 Hz.

Construction

As with any project that will operate within a radio shack or near radio energy (in EM Fields), the circuit must be well shielded and be well bypassed. Keep the lead lengths short. If this circuit is constructed in a suitable metal enclosure using standard shielded audio cable, there should be no problems. It can be made on strip-board, vero-board, perf-board, a home etched PCB or dead bug style with success.

One sample has been made on a piece of strip-board about ten holes square. It was placed inside the head of a desk mike after the original transistor circuit was found to be dead. Keep the input and output circuits apart however as the high impedance allows the thing to pick up some quite small signals. Resistors can be 1/8th watt up and capacitors can be either electrolytic or tantalum. It would also run from a single 9 volt transistor battery although I haven't calculated or measured the current draw. It should be no more than 10 mA at a guess and could be around 2.5 mA.

Testing

Always check your connections and polarities especially the IC and the electrolytics. Connect the 12 volt supply and measure the voltage to ground from pins 2, 3 and 6. They should all be around six volts but more importantly, they should all be the same. If not, turn it off

immediately and check your connections again. Connect a microphone to the input and a speaker on the output and gently blow into the mike. You should hear your breath on the speaker. Don't expect a high noise level, the speaker is only 8 ohms attached to a 1 k-ohm resistor.

If all tests out OK, then you have your microphone impedance matcher/pre-amplifier. Get some on air reports and avoid overdriving the radio. Above all else, do it yourself, learn a little and have fun.

ar

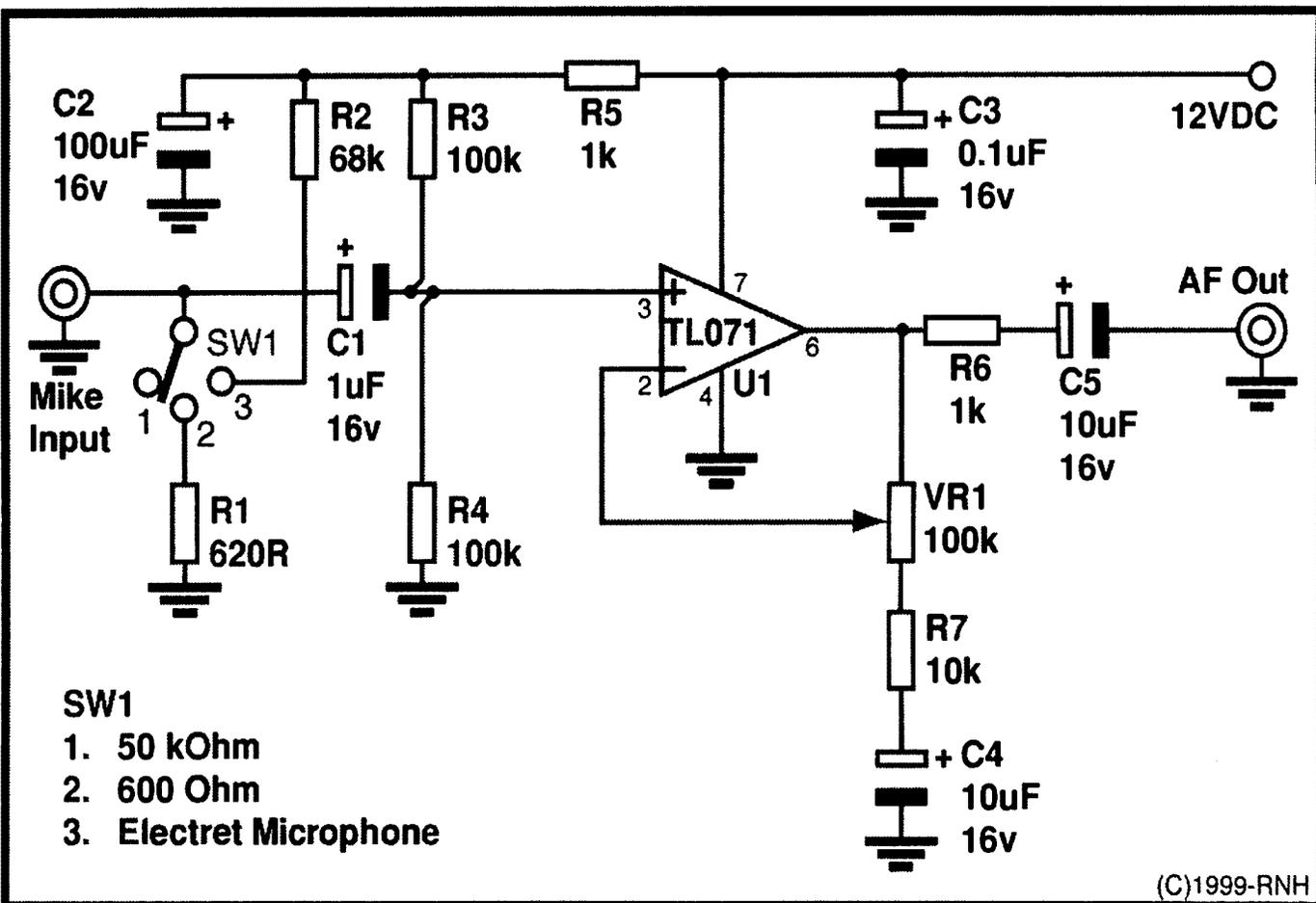
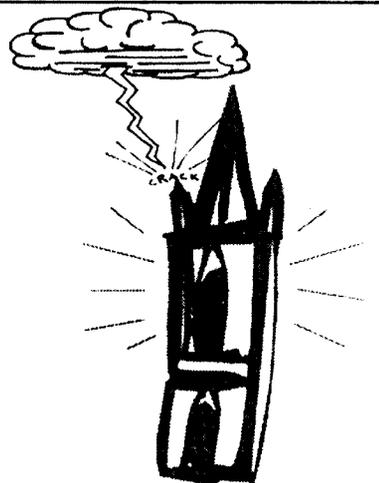

Figure 1

SNIPPETS

Peals of thunder



In the middle-ages it was common practice to ring peals of church bells to disperse the thunder from approaching storms.

It was not until 1786 that the practice ceased after the Parliament of Paris enforced an edict forbidding the practice.

It was noted by that parliament that 103 bell ringers had been killed in just thirty-three years.

A British army edict of the same period forbid the storage of gunpowder in bell towers due to almost 400 reported lightning strikes on bell towers.

Gunpowder stored in the bell tower in an Italian village was hit by lightning, resulting an explosion that flattened 190 houses.

TECHNICAL ABSTRACTS

Gil Sones VK3AUI
30 Moore Street
Box Hill South Vic 3128

End Fed Antenna

Amateurs often use the end fed antenna when it is difficult to use one of the more usual antennas. It is often somewhat difficult to obtain good performance with random length end fed wires. An article appeared in Communications Quarterly Spring 1998 that was a reprint of an original article in RadCom September 1994 titled "Taming the End Fed Antenna". The author was the late Alan Chester G3CCB who explained how to tailor the end fed wire to give multiband performance.

The key to understanding the performance and feeding of the antenna is shown in Fig 1. This impedance characteristic is repeated as the wire operates at higher harmonics. The end fire directivity becomes more prominent as the ratio of wavelengths to wire length increases.

The Earth also plays an important role in the end fed antenna. A stake may be convenient for a portable operation but it is not very efficient. For a fixed location the Earth stake should only be used as a safety Earth. A counterpoise or an array of quarter wave ground radials would be better. Use at least one quarter wave radial for each band

of operation. They can be run on the ground preferably in a straight line but around corners if necessary.

Avoid half wave points when matching as the impedance is quite high and changes very rapidly with slight changes in frequency that can make matching and changing frequencies tedious. It is best to use wire lengths that are at least an eighth wave longer or shorter than half wavelengths or multiple half-wave lengths. Matching will be easier and may often be accomplished by the addition of a series L or C element and an impedance matching transformer.

A chart showing antenna wire lengths with unsuitable lengths indicated by bars are shown in Fig 2. The chart may be used to select suitable wire lengths for the combination of bands and space available. This chart is simply an application of Fig 1. The end effect is not included in Fig 2 and lengths will require some trimming when first setting up. The chart does give a good starting point however. Using the chart the author selected three typical wire lengths and provided tuning and matching data in Table 1.

Fig 3 shows a simplified layout for a typical application. An isolator is placed between the matching transformer and the transceiver cable to isolate the radio from the antenna system. This avoids having the shack hot with RF. The transceiver can be some distance from the feed point but the matching should be close to the wire end. Avoid coupling RF onto other cables by using snap on Ferrite chokes on those cables. This can be a greater problem when the transceiver is closer to the feedpoint.

The impedance at the feedpoint is matched to the coax and the radio by the use of a multi-tapped toroidal matching transformer. Several have been described in recent years and they are also available commercially.

Similarly the isolator can be a simple choke formed by making several turns of the coax through a ferrite core or you could use a commercially produced unit.

The wire is in the region of a half wave multiple on 10 metres for all of the three examples given. The answer is to use a tuned circuit to match the wire on 10 metres. The author used a 25 pF variable capacitor across a four turn centre tapped coil made in 18 gauge wire on a T130-6 powdered iron core. See Fig 3.

By referring to Table 1 it can be seen that the 15 metre wire can be tuned on all but the 160 m and 15 m bands with only capacitive tuning. If a second 10 metre wire length is used the 15 m band can also be tuned by capacitor and therefore avoid tunable inductances.

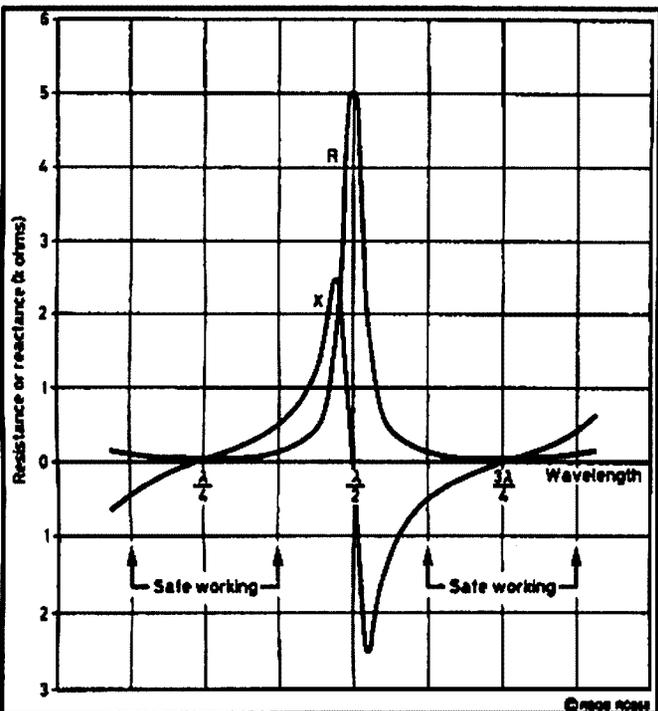

Fig 1. Impedance characteristics of End Fed Wires.

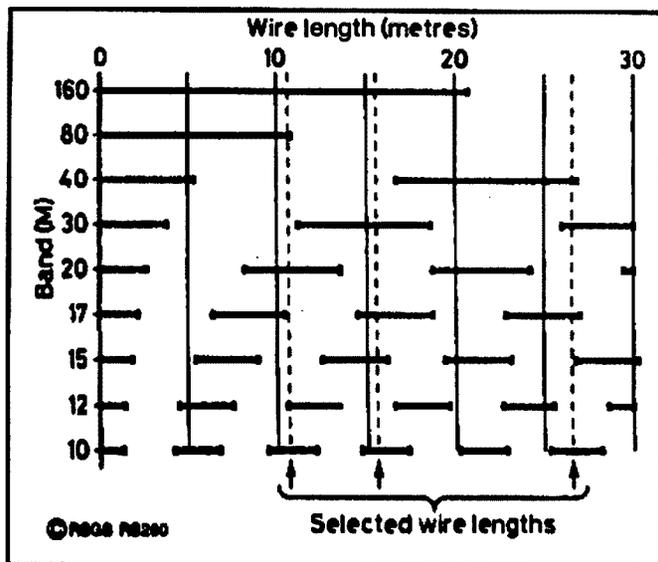

Fig 2. Wire lengths suitable to End Fed Wires. Black Bars are no go.

An Inductive Variometer

A Variometer may be used as the variable inductance in an antenna tuning circuit instead the more usual Tapped Inductor or Roller Inductor. This approach was described in the January 1999 CQ Ham Radio by 7K3GRX. The tuner was used to match a short whip and a counterpoise of three short radials on the 7 MHz band. The variometer used provided an inductance in the range from 16 to 34.7 μH .

Two concentric coils are used with 8 turns of 1.2 mm copper winding wire on each. The inner coil is wound on a 100-mm diameter perspex former while the outer is wound on a 150-mm diameter perspex former. The coils are each spaced over 30mm length with a gap in the middle of each coil to allow a 6 mm diameter plastic shaft to fit through. Brass or Aluminium rod or tube could also be used.

The inner coil is rotated perpendicular to its axis through 180 degrees. Therefore the inner coil changes from being wound in the same direction to the outer coil when the inductance is greatest to being wound in the opposite direction to the outer coil when the inductance is least.

The inductance of the individual coils are 15.6 μH for the larger coil and 8.9 μH for the smaller coil but taking the mutual inductance into account the inductance changes almost linearly from 34.7 μH with both coils "in line" to 16 μH "in opposition".

The coils and the inductance plot are shown in figure 4 and the tuner is shown in figure 5. The input isolator consists of 13 turns of thin coax wound on a small toroid. This isolates the RF from the outer of the coax, which might result when short counterpoise are used. The setup of transceiver and antenna are shown in figure 6.

The tuner uses a combination of fixed and variable capacitors with the variable inductance, variometer, in an L Match configuration.

Screwdriver Antenna

RadCom of February 1999 contained an article with the intriguing title of The Screwdriver Rapid QRV Antenna. The article was translated and edited by Erwin David G4LQI from the original that appeared in Electron by Dr Louis Stuyt PA3BTN and Hans Spits PD0NCF. The article described the use of a tunable whip antenna design from Don K Johnson W6AAQ. The screwdriver mentioned in the title comes from the use at one stage of an electric screwdriver as the drive for the remote adjusting system.

The adjustable whip system is commercially available and is possibly available in Australia from Ray Naughton VK3ATN at ATN Antennas at Birchip in Victoria. The article used a system built by the

Continued on page 34

Tuning and Matching Data

Band (meters)	Tune	Match (ohms)	Notes
25.60-meter wire			
160	32-10 μH	50	Various ground planes
80	150 pF	112	
40	6 μH	112	Near series resonance
30	50 pF	200	
20	>100 pF	112	
17	2 μH	200	
15	25 pF	450	Near series resonance
12	>50 pF	112	
10	1 $\mu\text{H}/25 \text{ pF}$	800	Parallel resonance (see text)
15-meter wire			
80	14-10 μH	25-50	Near series resonance
40	100 pF	50	
20	>50 pF	112	Near series resonance
17	25 pF	450	
15	4 μH	450	
12	>50 pF	450	
10	1 $\mu\text{H}/25 \text{ pF}$	800	Parallel resonance (see text)
10-meter wire			
80	20-14 μH	25-50	Near series resonance
40	>100 pF	50	
30	50 pF	200	Near series resonance
17	2 μH	112	
15	>50 pF	200	
12	25 pF	450	
10	1 $\mu\text{H}/25 \text{ pF}$	800	Parallel resonance (see text)

Table 1. Tuning and Matching Data for three example wire lengths.

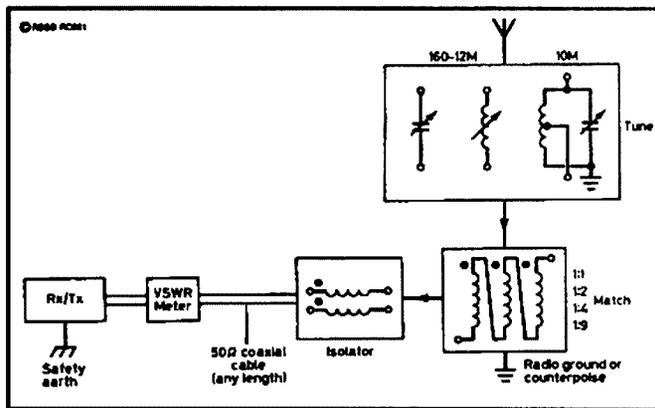

Fig 3. Layout of antenna to transceiver matching components.

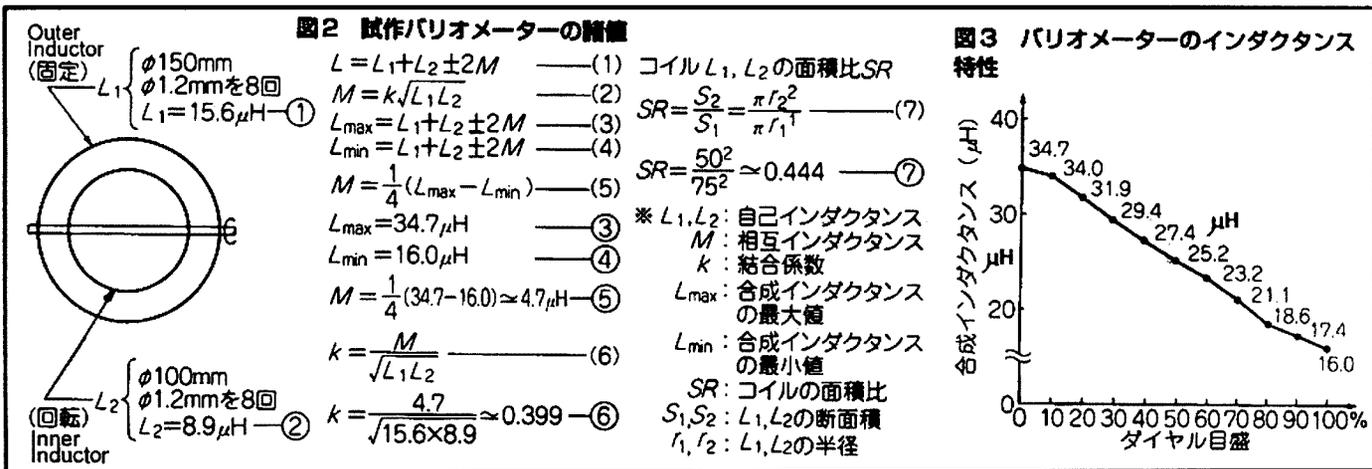
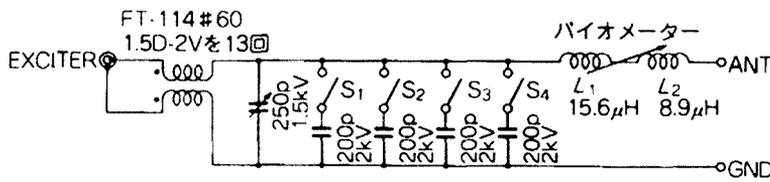

Fig 4. Variometer

図4 アンテナ・チューナー (AT) の回路



FT-114 #60	1	トロイダル・コア (FT-114 #60)	1
1.5D-2Vを13回	1	1.5D-2V	少々
200pF	10m	M型レセブタクル	1
1.5kV	少々	陸軍型ターミナル	2
S1, S2, S3, S4	1	つまみ	1
L1 15.6μH	1	ケース	1
L2 8.9μH	1	プラスチック・ネジ (ビス, ナット)	少々
ANT			
GND			

Fig 5. Antenna Tuner

図5 チューニング試験の
ブロック・ダイヤグラム

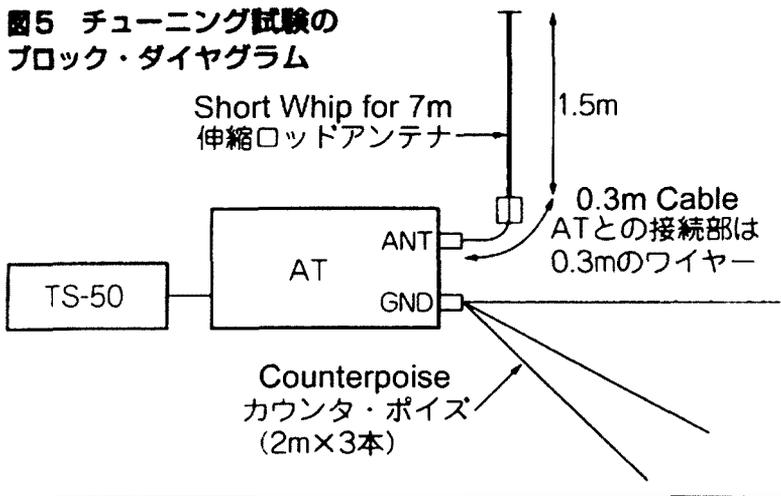

Fig 6. Transceiver - Antenna match layout

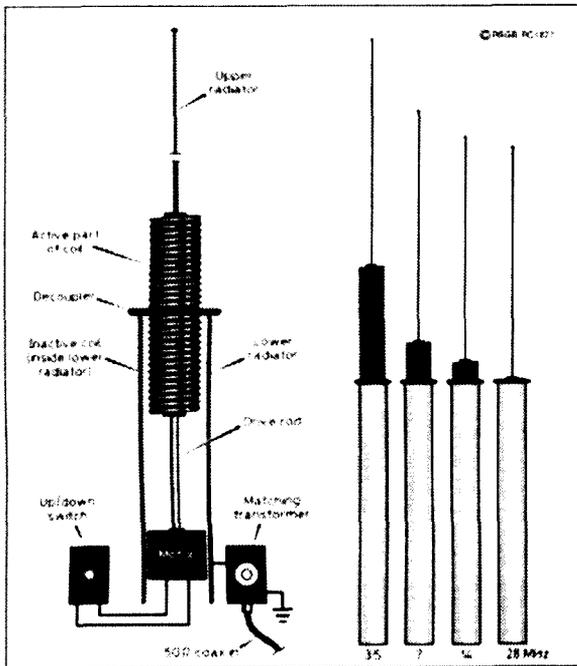

Fig 7. W6AAQ's DK3 continuously tunable 3.5 - 29 MHz mobile Antenna

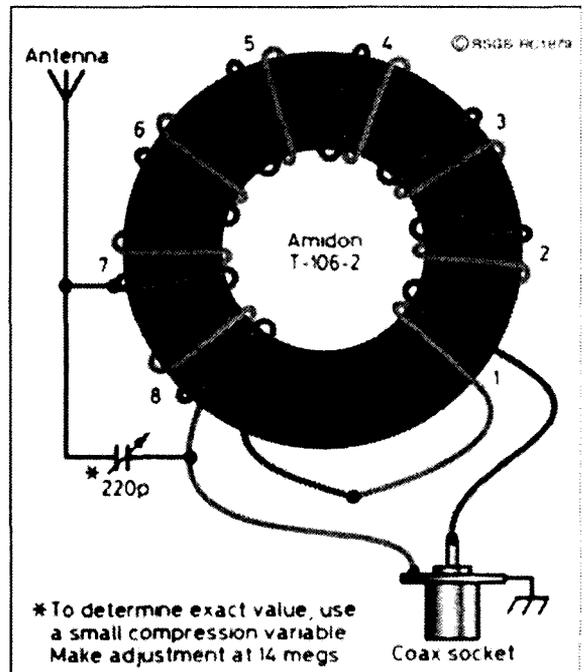

Fig 8. W6AAQ's 3.5 - 30 MHz impedance transformer for the DK3 antenna. The capacitor is only significant above 10 MHz.

Continued from page 33

authors but this course of action should only be attempted by those with a reasonable machine shop and the skill to use it.

The whip is shown in Fig 7. The coil is housed within the lower tubular section of the whip and is driven up through the top of the lower section through a ring of finger stock. Thus the lower section of the coil is shorted out and shielded. Only the top exposed section of the coil is active. RF is loaded into the lower section via a toroidal transformer shown in Fig 8. The capacitor is used for compensation on higher bands. The coil provides a centre loading to the lower housing and upper whip. In the article various lengths and types of whip ranging from a telescopic whip to a 10 mm aluminium rod with an optional top hat - for formal occasions no doubt!

The whip assembly was made to mount on the base of a fold up clothesline. The antenna was used with a counterpoise made up of sixty radials each 2.5 metres long. These were arranged into four groups of fifteen with their outer ends stapled to hinged wooden battens that fold into a "W" shape for storage.

The radials are all connected at the batten ends and also at two places between the battens and the centre. The centre is made from a frypan with a hole cut in the centre to fit over the antenna base. The frypan serves as the antenna earth connection.

Illustrations and text regarding this project are on the RSGB web site at www.rsgb.org/news/radcom/screw.htm.

ar

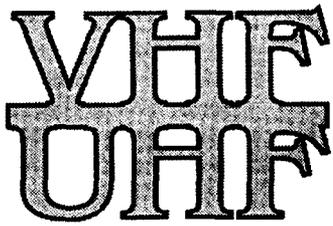

AN EXPANDING WORLD

Eric Jamieson VK5LP

PO Box 169 Meningie South Australia 5264
E-mail: vk5lp@lm.net.au Fax: 08 8575 1777
Packet: VK5LP@VK5WI.#ADL.#SA.AUS.OC

All times are UTC

Paul Lieb, KH6HME- VHF/UHF Pioneer

So little occurred on the bands this month that I looked like being left with a large space. Fortunately, when Emil W3EP sent me his July *QST* notes for *The World Above 50 MHz*, his lead article mentioned Paul Lieb KH6HME. Paul holds one half of all US records from 144 MHz to 5.7 GHz, with those from 432 MHz to 5.7 GHz as World Terrestrial Records - a great achievement.

With permission to reprint granted by **Emil Pocock W3EP** of *The World Above 50 MHz* in *QST* (July 1999 issue) and by the editor of *QST* **Mark Wilson K1RO**, the following should make interesting reading. It has not been placed in italics.

The Dayton Hamvention honoured **Paul Lieb, KH6HME**, on May 15 with its Special Achievement Award for his "pioneering and record-setting work in tropospheric ducting and VHF, UHF and microwave communications." He is best known for the many hundreds of contacts he has made from Hawaii to the mainland of North America on 144 MHz through 5.7 GHz over the past twenty years. As a consequence of his activities, Paul has been on one end of world tropospheric ducting distance records on eight different bands at 144 MHz and higher and made the initial Hawaii-to-North America contacts on six of them. So how did Paul Lieb get started on this pioneering work in the world above 50 MHz?

Young Radio Experimenter

Paul grew up in Anaheim, California, the son of an electrical contractor and sold RCA radios during the 1920s, when it was the newest rage. Five-year old Paul built a crystal receiving set and was delighted to pick up nearby KFI from Los Angeles. By the time he was ten years old in 1937, Paul had added a tuned circuit that allowed him to explore the adjacent amateur band at 160 meters. There he heard his first amateur radio station, W6DYG, operated by his

neighbour Clarence Keilor. Paul became an occasional visitor to the W6DYG shack and eventually made his radio debut by speaking into the station microphone.

Paul's first transmitter, an unlicensed single no 27 tube RF oscillator built from a radio handbook design, could be heard a short distance away on the broadcast band.

About the time the war broke out, Paul bought a used 5-tube receiver for \$4.25 from Western Auto with earnings of 15c an hour mowing lawns and a newspaper route. With driver's license in hand when he turned 14, Paul expanded his newspaper delivery into a 250-subscriber autoroute. Paul also repaired radio during the war years, learning mostly by reading and tinkering on his own. He graduated from Anaheim High School in 1945.

Paul continued experimenting with radios and served in the Air Force during the Korean War. He hoped to get electronics training, but a captain commandeered him as a personal clerk, based on Paul's typing, and made sure he was promoted to master sergeant by the time he was mustered out two years later. Soon afterward, Paul lived in St Louis, where he passed the exams for the new Novice and Technician class licenses. In 1953, Paul received his first call - W0NRI.

K6IZT and the Heady Years of VHF

Back in Anaheim a year later, Paul became K6IZT and was immediately thrown into the exploding world of VHF. His first rigs were modulated oscillators and super-regenerative receivers, the easiest way to get started on the VHF and UHF bands during the 1940s and early 1950s. Those unstable wide-band rigs with their radiating receivers soon gave way to converted military gear, which was especially abundant on the surplus markets in Southern California. No piece of equipment was more popular for getting on two meters than the SCR-522 set, which could put out a few watts of crystal controlled AM or CW.

Paul was soon on the air with his own converted SCR-522 rig. He operated almost exclusively from a portable location at Huntington Beach, with Yagis installed on an abandoned oil well derrick. Paul constructed coaxial feed line using 1/2-inch pipe and 1/4-inch tubing pipe to reach the top, later replaced with FAA surplus RG-17U. He could make regular contacts 125 miles north to Bakersfield. Paul also built a 100 watt 9913 tube amplifier and was on 432 MHz with a tripler strip. He operated the VHF contests and sometimes W6WSQ joined him at the beachfront shack.

Paul was one of the founders of the San Bernardino Microwave Society in 1955, and he also knew John Chambers, W6NLZ, before John began his famous series of experiments with Tommy Thomas, KH6UK, that led to the first Hawaii-to-California contact on 144 MHz in 1957. KH6UK and W6NLZ duplicated their feat on 220 MHz two years later, but they did not pursue the work at any higher frequencies. Paul remembered those experiments, but it was many years later before he picked up where they had left off. Paul is now the custodian of the two-meter equipment W6NLZ used to make the historic first trans-Pacific contact.

Mauna Loa

Paul's move to Hawaii came later, as a result of his work for an electrical contractor. In 1967, his employer sent him to Hawaii to fulfil a contract. Paul liked what he saw and decided to move there two years later. He finally traded in his California call for KH6HME by 1979, about the same time he put the first of a series of VHF and UHF beacons on the air from Hawaii.

Paul had been looking for a likely high spot for beacons that could be beamed toward California. By chance, he found a television relay station on the eastern side of Mauna Loa, at about 8,200 feet. The peak soars to 13,680 feet, but the relay site seemed ideal. There was a short tower and a small shack, it had electricity, and there was a dirt road (later paved) at least that far. After a few phone calls and gentle persuasion, he got permission to install a low-power 432 MHz beacon at the relay site in April 1979. Over the years, his relations with the owners remained cordial, no doubt smoothed by the occasional electrical work Paul undertook.

Paul did not have to wait long for results. In mid-July, Louis Anciaux, WB6NMT, heard the 432 MHz signal from his San Diego home and alerted Paul on the telephone. Louis waited an agonising several hours before Paul drove up the slopes of Mauna Loa to his new beacon and operating location. Then with relative ease,

Continued on page 36

the pair completed a historic 432 MHz contact on July 18, the first ever on that band to span the 2,530 miles between Hawaii and the mainland. That made three bands on which trans-Pacific contact had been made. Could the trans-Pacific duct support such extraordinary paths on even higher frequencies?

That became Paul's quest. The next year, he put up a beacon on 1296 MHz, but four years passed before he made a mainland contact on that band, this time with Chip Angle, N6CA. Chip soon provided Paul with complete home-brew stations on the microwave bands. Each in turn has yielded historic trans-Pacific contacts. Indeed, N6CA went on to make initial contacts with KH6HME on all the remaining bands through 5.7 GHz. (See Table)

In 1981, Paul put up his third beacon from Mauna Loa on 144 MHz. Over the following years, this has become the most popular and often heard of the group. A telephone call from a mainland operator with news that the beacon was being heard on the West Coast sent Paul on the two or three-hour drive up the mountain. On countless occasions, Paul took food and water for stays that sometimes stretched into days. He typically worked all comers on 144 MHz so long as conditions lasted. Sometimes he has switched over to two-meter FM simplex to provide even more operators the chance to make an unusual contact across thousands of miles of ocean. Paul has even worked stations using nothing more than a hand-held rig.

KH6HME has never run more than 100 watts on any band to make trans-Pacific ducting contacts. All the antennas are fixed on California. On 144 MHz, Paul has found just 60 watts to two 7-element Yagis are quite sufficient for the 2,500-mile contacts. He has a single 5-element Yagi on 222 MHz with similar power. The station on 432 MHz

runs 100 watts into two 22-element Yagis. There is an 18-element loop Yagi for 902 MHz. On 1296 MHz, Paul gets 10 watts from a 2C39 amplifier and uses four 25-element loop Yagis stacked vertically. The 2.3, 5.7, and 10 GHz stations all run just a few watts and share a 4-foot dish. The KH6HME (BK29go) 144.170 and 432.075 MHz beacons runs continuously using the same equipment.

The distances spanned on the two more popular bands have crept upward as 2-meter stations as far north as Washington State and south into Baja California made it to Hawaii. Jack Henry, N6XQ, has been among the most active in operating from portable locations along the Baja coast, but he has nearly run out of useable coastline. The single longest contact is currently 4,333 km, made on 144 MHz, but there is good reason to believe this distance can be exceeded on several bands with contacts into British Columbia or further south along

40 meters for regular contacts with friends back in California and for chatting among the islands. He is also the second recorded member of the Hawaii QRP Club. Paul often gets on 50 MHz from his home station, which is closer to sea level, and has provided countless six-meter operators with their 49th or 50th state. His 50.061 MHz beacon has been heard around the world.

There are the further challenges on the trans-Pacific path. Paul has equipment for 10 GHz and turns on the 10 GHz beacon when he is on Mauna Loa, hoping that someone on the mainland will hear. So far, no one has, but that seems to be only a matter of time. Distances on some of the higher bands will certainly be extended as a natural consequence of greater activity. Perhaps Paul can interest some Mexican stations or someone will make an optimally timed trip to the Mexican coast just for the fun of making a 5,000 km trans-Pacific contact.

More importantly, Paul has motivated a

Table - Notable Hawaii to Mainland North America Contacts on 144 MHz through 5.7 GHz via tropospheric Ducting

First Contact		Current Distance Record			
MHz	Date	Stations	Date	Stations	Km
144	1957 July 8	KH6UK-W6NLZ	1995 July 1	KH6HME-W7FI	4,333
222	1959 June 22	KH6UK-W6NLZ	1989 July 15	KH6HME-XE2/N6XQ	4,142
432	1979 July 18	KH6HME-WB6NMT	1989 July 15	KH6HME-XE2/N6XQ	4,142
903	1993 Aug 23	KH6HME-N6CA	1994 July 13	KH6HME-N6XQ	4,061
1296	1984 June 24	KH6HME-N6CA	1989 July 15	KH6HME-XE2/N6XQ	4,142
2304	1994 July 11	KH6HME-N6CA	1994 July 14	KH6HME-N6CA	3,973
3456	1991 July 28	KH6HME-N6CA	1991 July 28	KH6HME-N6CA	3,973
5760	1991 July 29	KH6HME N6CA	1991 July 29	KH6HME-N6CA	3,973

the coast of Mexico. There seems little chance that distances can be extended very far inland, because the duct gets backed up against the coastal mountains.

What Else?

Paul is best known for his trans-Pacific VHF through microwave operating, but has other interests. For many years, Paul got on

whole generation of VHF and UHF experimenters. Operators throughout the US, Europe, Australia, and other places have sought to emulate and even exceed Paul's accomplishments. His pioneering work has inspired the current offer of the Brendan Cups for the first transatlantic contact on 144 MHz. If nothing else, Paul has given countless hams a great thrill of

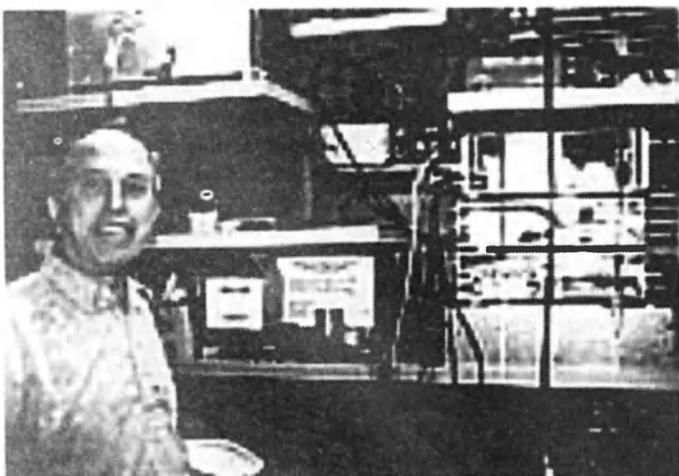

KH6HME Paul Lieb



That tower on Mauna Loa
Pics courtesy of KH6HME website

working across the Pacific, because he has been willing to spend a day or two on a lonely mountain just for the fun of giving out contacts and spending time chatting with each new operator he worked. Many have thrilled to hear Paul's "Aloha from Hawaii" spanning the Pacific on VHP.

For more information and additional photographs from the KH6HME station on Mauna Loa, point your web browser to www.hiloweb.com/kh6hme. If you want to read more about the possibilities of long-distance VHF and UHF ducting, see my article in March 1996 *QST*, "Transoceanic Ducting at VHF and Above." ... **W3EP**.

Africa and the Indian Ocean

Eric Van Offelen, who operates as EL2VO during his periodic business trips to Liberia, logged 130 contacts on six metres from February 13 to April 1, including 10 European, 2 North African, and 2 South American countries.

Several other unusual African and Indian Ocean stations were active during April. 5U7DG (Niger) worked Spain, Greece, and perhaps other countries in southern Europe, and provided SV1DH with country number 163. From the Indian Ocean, 3B9R (Rodriguez Island) worked into Europe as far north as Belgium and Germany during the first week of the month.

Japanese stations in several call areas also found 3B9R on at least two days. Okinawans (JR6) logged 8Q7QQ (Maldives) on April 18 and 4S7SE (Sri Lanka) worked Japan on the 5th.

Europe and the Eastern Mediterranean

Southern Europeans continued to work into Africa on many days in April, but the more interesting contacts came from stations in the eastern Mediterranean. Israelis 4Z5JA and 4X1IF, along with 5B4AGN (Cyprus), worked Argentina and Brazil early in the month. 5B4AGN also worked JR6BU on April 3, for the first Cyprus-Japan contacts of the current cycle.

The Pacific

East-west paths across the Pacific continued to open during April. In addition to A35RK and 3D2TC, H4000 (Temotu) created a good deal of excitement on April 19, when he worked JA call areas 1 through 6. BV2DP (Taiwan) logged an impressive list of stations on 6 metres during April, including YB0ARA/9, P29PL, A61AH, T88WX, VQ9CV, 9M2NK, and KH0XX.

Microwaves

Brian Justin, WA1ZMS, claimed a new 75 GHz North American distance record of 34 km for a contact made with K2AD on April 5 in Virginia. The pair generated a few milliwatts from a transmitter chain built with the help of University of Virginia grad students. They began with 12 GHz California Microwave phase-locked loop oscillators, tripled to 37 GHz, and then doubled with GaAs diode mixers. Antennas were 1-foot dishes.

The CW signals were just in and out of the noise. Brian calculated the total oxygen and water vapour absorption at about 0.24 dB per kilometre, or about 8 dB for the entire path. A drier day could have reduced atmospheric losses by a few dB, but Brian soon hopes to improve total system performance with a better receive system and try again. The listed world record is well over 100 km, made in 1995 by a Swiss and German team. ... Thanks to Emil W3EP and QST.

King Island

Rob VK3EK/DEM operated on 144 MHz from King Island in Bass Strait from 29/4 to 3/5. He used 160 watts to Bob Jordan's 10 element Yagi and worked the following: VK3ATQ 5x2, VK3TMP 5x2, VK3AUU 5x2, VK3KAI 5x1, VK3XLD 5x1, VK3XRS/p 5x1, VK3CAT 5x1, VK3BJM 5x1, VK3CY 4x1, VK3ZKH 5x1, VK3DUT 5x1, VK3AFW 5x2, VK3BRZ 5x3, VK3ZLS 4x1, VK5NC 5x2.

Propagation to the NE and SE was very poor. Tried to work VK3BWT at Mallacoota, but no luck or anyone from the north. Better time of the year and some propagation needed. In all, 15 stations worked in the time I had, which was really a golfing trip until a radio (1C706 and linear) was planted in my wife Maxine's bag. The crayfish was good though!

New Zealand

Mike ZL3TIC reported reasonable band conditions in ZL as follows:

20/05/99

0200 46.240 VK video 5x9+
0420 VK2GJH 50.160 5x7
0430 VK2FHN 50.110 5x3
0500 49.750 5x1, lots of offsets

21/05/99

0300 46.170 VK video 5x9
0430 46.240 VK video 5x9 in up to 0930
2300 46.170 and 46.240 5x9 on backscatter beaming US!

22/05/99

0000 46.170 and 46.240 direct path
0056 VK4WQ 50.140 5x1
0102 VK4KK 50.150 5x7
0105 VK4BLK 50.150 5x3

0110 VK4PU 50.150 5x8
0130 XE1KK/b 5x1 with QSB in for half an hour
0230 VK2DN heard 5x9
0100 to 0400 49.750 in the main, offsets were: 49.7478, 49.7500 and 49.7460 0515
46.170 still 5x9+
Steve VK3SIX reports a little winter Es and F2

20/5/99

ZL3SIX beacon from 0400 to 0800. ZL3NE/?1 and ZL2AGI worked. 48.250 +/- offsets from 300 degrees S/E Asia in from 0600 to after 0800.

21/5/99

VK4BRG/b VK4RGG/b and VK4s on Es.

22/5/99

0600 to 1000 49.7469/7479/7500/7502 in for a long time.

VK2GJH reports he will operate as C21JH from 4/7 for two weeks.

Guy Fletcher VK2KU

<guy@ics.mq.edu.au> reports:

GUIDELINES for the GRIDSQUARE LEAGUE TABLE

1. Submit number of grid squares claimed as worked on 144, 432, and 1296 MHz. No details of actual squares/stations required.
2. Starting date for contacts: 1st January 1990 (as for WIA Awards).
3. No distinction between modes (CW, SSB, FM etc.) - a square is a square.
4. EME claims to be listed separately.
5. Contacts via repeater or active satellite should not be counted.
6. Cross-band contacts should not be counted (on either band).
7. Except as allowed by Rule 8, all squares claimed must be worked from locations within a single limited "region", within a circle of radius 50 km.
8. A gridsquare may also be claimed by a "reverse contact" from that square to any station in your home square.
9. Entry is open to any VK, not just subscribers to the VK-VHF Reflector.
10. The Table of Standings will be posted on the VK-VHF Reflector roughly every 3 months, and may be reprinted from there in *Amateur Radio* and *Radio and Communications* magazines.
11. Updates to me at any time by email/mail (QTHR 1999).

Comments

If you move house to a new "region", you have to start again, though your old score still stands of course.

Continued on page 38

The intention of Rules 7 and 8 is to encourage portable operation (up to 100 km from home, or from a rare gridsquare) to overcome the limitations of a home QTH, but not to an extent which confers an unreasonable advantage. If you regularly go portable to a different "region", you can keep a separate tally for the /p operation.

There is no minimum number of squares to start - you don't need to have 50 squares on 2m! Please enter at any level so that we may all enjoy watching the growth of your tally.

No correspondence will be entered into by myself regarding the veracity of people's claims. If you want more details from someone, please email them privately and not through the Reflector. Dire punishment for transgressors!

Year 2000 Expedition

Neville VK2QF sends a little more on his plans for a Year 2000 DXpedition. He says: *Thanks go to all for the interest and wide ranging support with constructive comment by email.*

As there is a clear preference for Nauru I am looking at that option and with help from seasoned Dx'er Jack VK2GJH perhaps an operation maybe worthwhile given his operations there and probably one or two local C21s soon! More later.

Ron Cook VK3AFW advises: *Good news for those who missed out on last years fantastic meteor scatter contacts during the Leonids. The following is from the current posting of "Spacenews".*

Leonids No Big Worry: *The heavy storm of Leonid meteors expected in November 1999 should not be a major concern for satellite operators, experts said at a conference last month. While the peak of the storm is forecast to be up to four times the rate of the 1998 storm, it will still be far below the extremely heavy rates seen in the last Leonids storm in 1966. The 33-year cycle of heavy Leonids storms had caused concern that satellites could be damaged by the flux of small meteors, but no satellites were damaged in the 1998 storm.*

Four times the peak of 1998? I've got to see that!

Ted Collins G4UPS reports that Romy VU2GTE (India) appeared on 28.885 MHz SSB several times during April and reported that he would look into applying for a six-metre permit. He could receive on six metres. Also, Sergio AP2WAP (Pakistan) was calling the six-metre net on 28.885 on 16/4 at 0826 using SSB and 5x7. May be two new countries for VK?

Apart from his sked contacts with G3CCH and SM7AED, Ted reports few contacts on six metres for April. On 29/4 he worked IK8DYD 5x9 and heard the 7Q7SIX beacon 559.

Listener's Log

David Vitek's log for 27/4 to 28/5 indicates a considerable falling off in the reception of VHF signals. Much of his time was spent on 10 metres where even there conditions were not always favourable.

Two of his best days were 13/5 and 21/5.

On 13/5 he logged by Es between 1050 and 1253: RTQ0 51.67A, ABMN0 51.74A, ABSQ2 62.760, STQ2, ABCN1, NEN0, and ZLTV on 45.23960 and 45.2640 5x3. The MUF went higher - at 1127 4SBS Brisbane 93.3 MHz, ABCFM Nambour 88.7, then VK4ABP/b 539. The K Index was 5.

On 21/5: From 0400 to 0708 - ABMN0 51.740A, RTQ0, ABCN1, ZLTV 45.260 etc 5x4; 52 MHz: VK2RSY/b, VK2RHV/b; 50 MHz VK4WTN, VK4BLK; 48.250 0605 5x5, 9MTV 48.23960 5x6. So it seems something is usually to be found.

Closure

The next few weeks may see the usual winter Es for 50 MHz, but the current weather pattern across the southern areas is not conducive to ducting across The Bight to enhance conditions for the higher bands - the highs are situated too far from the ocean. Ah well! There will be good times again one day!

Closing with two thoughts for the month:

1. If it weren't for the last minute, a lot of things wouldn't get done, and
2. A real friend is someone who takes a winter holiday on a sun-drenched beach and doesn't send a card.

73 from The Voice by the Lake.

ar

SILENT KEY

It is with sadness that I advise of the death of long time member Mr Lyell Woolnough, VK2GW, late of Gordon, at the age of 93. He passed away in Hornsby Hospital on 27th May 1999 after a short illness.

Born 10th March 1906, the son of a professor of Geology, his interest in radio started when accompanying his father on an expedition into Central Australia in 1922.

In order to keep nightly skeds with VIA Adelaide Radio an army communications unit under Lieutenant Bowen was included. Two trucks containing a spark transmitter, receiver and generator were used to convey the equipment.

Lyell was tutored by Lieutenant Bowen and obtained his certificate in 1923 at the age of 17.

After graduating in mechanical and electrical engineering he first worked in the electrical branch of the Railways. On retirement he held the position of Superintendent of the then White Bay power station.

During the 1950's he held various honorary positions with the WIA including that of vice president.

Most of his equipment was home brew or modified disposal types. He favoured CW and gained several awards.

Last year he was awarded a certificate commemorating 75 years as a WIA member.

In recent years although maintaining his interest he was content to tune the bands and reflect on his past achievements.

Submitted by Dudley Reynolds VK2ANW

The WIA regrets to announce the recent passing of:-

- G M PERCIVAL VK1GM**
- L M LE BRETON VK2AKT**
- D HUNZIKER VK2BHD**
- W L WOOLNOUGH VK2GW**
- J KRAMREITER VK3DCJ**
- J K COSGRIFF VK3WM**
- (Ivor) Stafford VK3XB**

<http://www.wia.org.au>

check out the WIA webpage today!

WIA Federal Videotape Library

Don Bland VK4TVD

WIA Video Coordinator:

16 Concorde St., Oxford Park, QLD 4053

Now every radio club can provide its members with quality technical lectures on subjects covering the whole range of Amateur Radio activities by taking advantage of the WIA Federal Videotape Library. You'll find this a boon particularly if yours is a country club that often has difficulty obtaining a variety of expert lecturers for its regular meetings. (Individual Amateurs and Librarians should take note of the duplication fees at the end of this article.)

For radio clubs affiliated with the WIA it's inexpensive and easy. Here's how it works. For those titles that the WIA has placed in the public domain, all you have to do is supply the WIA Video Coordinator with...

- a list of requested titles,
- a blank video cassette,
- a "VCR" Postpak,
- and enclose your address and stamps for return postage.

The program is then free for your use in the support of amateur radio in your area, including duplication and transmission over Amateur Television if you wish. Those programs that are copyright are indicated by the © symbol and are available only ON LOAN. To obtain any Loan Item supply the WIA Video Coordinator (address below) with...

- your requested title,
- information about your preferred VCR format,
- enclose your address and stamps for postage to you,
- and a statement signed by a responsible member of your club that "I undertake that while (program title) is assigned to me, I will not allow it to be copied or transmitted by any means whatsoever, and that I will return the same promptly after showing".

Note: the WIA does not hold a licence from the copyright owners of certain titles; therefore no loan or copy service is available for those so marked; they are held for WIA Archive purposes only.

The present "preferred VCR format" is Standard Play VHS. For estimation of postage, a 3 hour VHS cassette measures

200x100x30 mm and weighs 350 gm.

New Air-Mail Postal Regulations. To avoid disappointment by lack of arrival of late-minute requests, this important change in Postal Regulations should be allowed for by Club Activity Organisers. All packages sent by Airmail MUST now carry a declaration sticker certifying that the contents are not dangerous or prohibited. For items weighing less than 500 gm (i.e. one VHS cassette) pink stickers are obtainable from any Post Office. Items weighing more than 500 gm can only be posted at an official Australia Post Office and a complete declaration of contents must be made. Any item not carrying the correct sticker will not be transported by air, regardless of whether the correct value of stamps for Air Mail have been affixed.

A note to individual amateurs. From the inception of the WIA Federal Video Service cassettes were freely available to all comers. However, in order to stem the rising tide of requests for copies of programs from individual amateurs (some of whom asked for over 10 hours of programs at a time) there is now a duplication fee (payable in advance) of \$2 per hour or part thereof to individuals. Isolated or disadvantaged individual amateurs will however continue to receive free concession.

A note to librarians. A number of educational institutions have already availed themselves of the WIA technical lecture tapes. A duplication fee of \$10 per hour or part thereof is payable in advance by all institutions not affiliated to the WIA.

A note regarding cassette quality. The WIA Videotape Coordinator reserves the right to refuse to copy onto inferior quality video tape. Video dubbing is a real-time,

one-at-a-time operation and in the past low quality tape has been the cause of many lost hours due to clogged heads, etc. Libel laws prevent publication of a list of manufacturers of suspect tape, however, most of the well known brand names are acceptable; in particular use only those tapes bearing the official "VHS" logo.

Finally a note to all radio clubs. No new titles have been added to the library during the last 12 months. Has your club video taped any interesting lectures that would be of interest to other amateurs? If so, please contact me at the address below so that I can arrange for a suitable copy to add to the library.

For up to date titles and information visit the WIA Website - <http://www.wia.org.au/>

WIA Videotape Program Title Listing

Notes:

"©" = Copyright; no copy service

"**" = Optically converted to PAL from NTSC by WB2LLB; noticeable flicker

"w" = available ONLY to Radio Clubs Affiliated with the WIA as per agreement with OTC

"o" = program now out of date

Standard Format: "VHS" Standard Play

Entries are given as Title - Description - Note

Amateur Radio - Historic Interest

Wireless Telegraphy (circa 1910, 10 min.) Archive material courtesy David Wardlaw VK3ADW ©

Amateur Radio - TV Pilot (1968, 30 min.) Archive material courtesy TEN channel 10 ©

Opening of Burley Griffen Building (1977, 45 min.) Archive material

ATV in Australia - made for British ATV Club (1978, 30 min.) Archive material

ATV in United Kingdom - reply from BATC (1978, 30 min.) Archive material

ATV in Australia 1980/81 - made for BATC (1980, 60 min.) Clips from ATV Groups in VKs 2,3,4,5 & 7

History of ATV in South Australia (1980, 30 min.) Archive material, still building

ATV in United Kingdom 1978/81 (1981, 30 min.) Remake of their previous effort

Continued on page 40

CQ ATV DX International (1983, 60 min.) ATV in USA and Europe o*

High Definition TV Tutorial (1983, 60 min.) A look at what is to come in Broadcast TV

ATV Hamfest, York Pennsylvania (Sept. '83, 6 hrs.) Various ATV technical lectures from USA

Opening of Amateur Radio House - NSW HQ (1983, 102 min.) Archive material

ATV in Victoria (1984, 54 min.) Courtesy of "The Roadshow Gang"

Keynote speeches by Fed Pres. David Wardlaw & State DOC Manager John Milton (1985, 135 min.) From WIA 75th Anniversary Seminar

Heard Island DXpedition (1986, 60 min.) Raw Unedited; from 1986 VK2 Seminar

Amateur Radio - Promotional

The Ham's Wide World (1969, 27 min.) Superseded by "The World of Amateur Radio" o

This is Amateur Radio (1970, 15 min.) Pitched at teenagers

Moving Up to Amateur Radio (1975, 11 min.) Pitched at CBers

7J1RL DXpedition (1976, 60 min.) General Amateur Radio interest; LOAN ONLY ©

This Week has 7 Days looks into Amateur Radio (1978, 25 min.) Pitched at teens; includes some ARRL footage.

The World of Amateur Radio (1978, 26 min.) Superseded by The New World of Amateur Radio o

Amateur Radio - The National Resource of Every Nation (1979, 6 min.) Encapsulates AR; good for public exhibitions

Amateur Radio - The National Resource of Every Nation (1979, 60 min.) Continuously running version available ON LOAN

The New World of Amateur Radio (1988, 28 min.) Supersedes The World of Amateur Radio

Antennas

G6CJ's Aerial Circus (1977, 90 min.) The Definitive Antenna Lecture; LOAN ONLY ©

Wire Antennas (1978, 40 min.) Antennas for HF and Antenna Tuners

Loaded Wire Antennas (1980, 50 min.) Using Inductive and Capacity loaded Antennas

Antennas and Directivity (1985, 73 min.) Lecture given to a group of Radio Amateurs w

Antenna Rotator Systems (1986, 50 min.) Servicing the several different types

Broadband Antennas (1986, 62 min.) Includes terminated antennas

Amateur Television - Activity

ATV Item from UK (via Doug VK6ER, 1984) Unedited clips

Hello from America! Made for British ATV Club (1988, 100 min.) Clips from ATV Groups in the USA

VK5 ATV Call-in (1990) Made for VK4XRL who had recently visited

Amateur Television - General Interest

Low Definition Television (1983, 25 min.) Re-creation of TV as transmitted by Baird.

Model Aeronautical Mobile ATV (1983, 6 min.) ATV camera & TX mounted in a model aeroplane.

VK5RCN - Australia's first wind powered ATV repeater (1983, 61 min.) Tour of VK5RCN by Barry Bryant (silent key).

Australian TV History - The Untold Story (1988, 56 min.) Lecture to Radio Amateurs Old Timers Club.

Australian TV History - Part 2 (1988, 49 min.) Technical slides not used in the above.

The Development of the TV Test Card (1988, 43 min.) Made for BATC by the BBC Training Dept.

TV for Amateurs (1990, 19 min.) Excellent introduction to ATV

The first nation-wide ATV AUSSAT TV (1990, 2 hrs.) Noisy off-satellite but interesting.

Amateur Television - Technical

The Signal to Noise Story (1982, 45 min.) Superseded by UHF Preamplifiers (below). o

UHF Preamplifiers (1983, 45 min.) Explanation and demo. of low noise preamps.

Getting Started in Amateur Television (1983, 55 min.) How to set up an ATV station

Testing ATV Transmitters (1983, 50 min.) How to correctly measure ATV systems

Computers

Demo. of VK5RTVs Micro-Computer Controller #1 (1979, 10 min.) First μ -Computer controlled repeater in VK.

Understanding Micro-Processors (1980, 60 min.) A somewhat dated technical description. o

An ATV Ham shack Micro-Computer (1981, 10 min.) Describes now unavailable microcomputer kit. o

Getting Started in Amateur Micro-Computers (1983, 33 min.) Demo of hard & software for Amateur Radio.

Data Transmission

Getting Started in Amateur RTTY (1983, 85 min.) RTTY using teleprinters and Micro-Computers.

Amateur Packet Radio (1984, 60 min.) Theory and Demonstration.

Packet Radio Lecture by Jim Swetlikoe (1984) From WIA Seminar

Packet Radio - 10 months on (1985, 65 min.) Raw unedited; from 75th anniversary. VK2 Seminar.

X25 Protocols and Packet Switching (1986, 47 min.) Lecture given to a group of Radio Amateurs. w

Amateur Satellites and Packet Radio (1989, 130 min.)

Microwave Techniques

Introducing Microwaves (1988, 74 min.) Des Clift gives a "Nuts & Bolts" expert technical lecture

Propagation

Getting Started in Understanding the Ionosphere (1983, 50 min.) How the Ionosphere aids HF communication

Moonbounce EME lecture by Lyle Patison (1984) From WIA Seminar

VHF Signal Enhancement by Aircraft (1986, 70 min.) Raw Unedited; from 1986 VK2 Seminar

HF DX Seminar with Iris & Lloyd Colvin (1990, 74 min.)

Satellites

Getting Started in Amateur Satellites (1983, 60 min.) Superseded - see below o

An Introduction to Amateur Satellites, Pt 1 (1984, 60 min.) An overview of Amateur Satellite working o

Micro-Computer Aids to Satellite Tracking, Pt 2 (1984, 30 min.) Programs for tracking & decoding telemetry o

Using Phase III Amateur Satellites (1984, 90 min.) History, construction & use of high orbit satellites.

The Amsat Oscar Phase 3 Story (1985, 80 min.) Dr. Kari Meinzer "The Father of Oscar" includes film of launch.

Antennas for Satellites (1986, 75 min.) Raw Unedited; from Dr Trevor Bird's 1986 VK2 Seminar

Amateur Satellite Service - What it has to offer (1989, 190 min.)

Amateur Ground Control - What is involved (1989, 130 min.)

Space - General Interest

Apollo 13 Disaster (1980, 90 min.) Australian tracking procedure saved Apollo 13

SSTV Pictures from Space - Voyager (1983, 15 min.) SSTV pix converted from Saturn fly past o

AUSSAT - Australia's Domestic Communications Satellite (1984, 62 min.) Technical description of services offered

Amateur Radio's Newest Frontier (1985, 26 min.) Amateur Radio in Space; General PR.

Working W5LFL in orbit from VKIORR (1986, 23 min.) Raw Unedited actuality footage

Miscellaneous

An Auxiliary Battery Charger (1981, 30 min.) Charging a second mobile battery

Lecture - Winning Foxhunts (1981, 45 min.) How to do it from one who has!

Getting Started in Amateur Construction (1983, 50 min.) Mechanical hints for novice constructors

The Communications Consequences of Nuclear War (1983, 60 min.) Why your gear may not survive even if you do!

The Far Eastern Broadcasting Company (1984, 60 min.) How a Short Wave Broadcaster operates

The Australian "Over the Horizon Radar" (1984, 60 min.) How the "Australian Woodpecker" works

What to Expect when the RI Calls! (1984, 34 min.) by Geoff Caner - a Dept of Communications Field Officer

A Future Shock - Lecture by Roger Harrison (1984) From WIA Seminar

Radio Comm. Act - Lecture by Colin Oliver (1984) From WIA Seminar

Doppler Direction Finding for Foxhunters (1985, 43 min.) Raw unedited; from 75th anniversary VK2 Seminar

Fitting BNC Connectors (1985, 7 min.) Correct Assembly of Crimp type BNC plugs w

Handling Static Sensitive PCBs (1986, 6 min.) Improving reliability of Printed Circuits. w

Extra License Grades (1986, 70 min.) Raw Unedited; from 1986 VK2 Seminar

Thick Film Modules (1988, 45 min.) Description of modules available from VK5 WIA

Quartz Crystals (1988, 106 min.) Clem Tilbrook gives a "Nuts & Bolts" expert technical lecture

How to survive in a Dog Pile (1989, 148 min.)

Making friends on DX (1990, 28 min.)



radio and Communications

Incorporating AMATEUR RADIO ACTION and CB ACTION

Edited by
**Chris Edmondson,
VK3CEJ4**
PO Box 123,
Eagle Heights,
Queensland 4271
ph (07) 5545 0666
fax (07) 5545 0622

Well, here's something a lot of people have waited quite a while to see. It is, of course, the exciting all-new Yaesu FT-100 multi-mode multi-band transceiver. It covers all bands from 160 metres to 70cm, with 300+ memories, and offers DSP as standard. Read all about it! And read about the *History of Radio* too.

July's R&C packs a few surprises and loads of great amateur radio columns and stories. Like these...

- 1999 DAYTON HAMVENTION REPORT: Our man was there with his trusty camera. What a place!
- A RETIRED RI LOOKS BACK... Could these stories be real? Read this lot and decide for yourself...
- THE HISTORY OF RADIO. A truly fascinating multi-part series which puts it in chronological order.
- BUILD THE MOXON RECTANGLE: Les Moxon, G6XN has another design, and VK3BCY describes it.
- REVIEW: YAESU FT-100 'FIELD COMMANDER'. There's not much this radio doesn't do! So is it small?
- As usual, we have our DX columns, mods and lots more... the best stories and regulars every month!

Don't miss out — **RADIO and COMMUNICATIONS** is great reading for amateurs!
Check your local newsagent today!

(P.S. We also have the biggest collection of radio-oriented Classified adverts in the country. There's lots of them because they work so well. Ask your newsagent to keep a copy for you each month. Hurry — you might miss something!)

vk3ce

AMSAT AUSTRALIA

Bill Magnusson VK3JT
RMB 1627 Milawa Vic. 3678
Email: vk3jt@amsat.org

National coordinator:
Graham Ratcliff VK5AGR
Email: vk5agr@amsat.org

AMSAT Australia net:

The AMSAT-Australia net is held on 80 or 40 metres LSB (Lower Side Band) each Sunday evening (except over the Christmas/New Year period). During the winter months in South Australia (end of March until the end of October) the net is on 3.685 MHz +/- QRM with an official start time 1000utc with early check-ins at 0945utc. During the summer months when daylight saving is in operation in South Australia (end of October until end of March) the net is on 7.068 MHz +/- QRM with an official start time of 0900utc with early check-ins at 0845utc. The times and frequencies have been chosen as the best compromise for an Australia-wide net taking into consideration seasonal propagation changes and the various state summer time variations.

AMSAT Australia newsletter and software service:

The newsletter is published monthly by Graham VK5AGR. Subscription is \$30 for Australia, \$35 for New Zealand and \$40 for other countries by AIRMAIL. It is payable to AMSAT Australia addressed as follows:

AMSAT Australia
GPO Box 2141
Adelaide SA 5001

Keplerian Elements.

Current keps are available from the Internet by accessing the AMSAT FTP site, ftp.amsat.org and following the sub-directories to "KEPS".

Good News for High Speed Downloads

The imaging capabilities of UoSAT Oscar-36 are truly remarkable. Pictures have been published recently from the high-resolution camera. They show ground detail previously thought unattainable in such a satellite. The 10-metre resolution camera clearly shows up streets and individual properties. As if that's not enough, the images are multi-spectral. Such images can be overlaid showing up differences between types of vegetation and even soil type variations. Prior to UO-36 this sort of performance was strictly in the realm of the sophisticated commercial imaging satellites.

Of course there's a price to pay for this performance. The image files are large to say the least. At 'normal' baud rates the download times from the satellite would be excessive. UO-36 has transmitters capable of 38.4k and much higher baud rates. The catch is that the receiving apparatus needed to accommodate the greater bandwidths involved has up to now, been difficult to

construct. News is to hand of a simple circuit board addition to one of the usual amateur transceivers that allows it to be used to achieve this happy state of affairs. The modem will need a small work-over too but this is simple by comparison. I hope to be able to report more on this development next month. Listen in to the Amsat net on Sunday nights for the latest news on this exciting project. In the meantime the controllers at Surrey University are bringing the high-speed downlinks on line. Speeds of up to one megabaud are available on UO-36 and may become commonplace in the future.

Six-monthly Amateur Radio Satellite Update

Here is a short-form list showing the current status of the operational amateur radio satellites. For a complete listing showing all transponder modes and frequencies for all amateur radio satellites, past or present, operational or defunct, visit the AMSAT World Wide Web site. The complete list is far too exhaustive to print here.

RS-13

Uplink 21.260 MHz to 21.300 MHz CW/SSB
Uplink 145.960 MHz to 146.000 MHz CW/SSB
Downlink 29.460 MHz to 29.500 MHz CW/SSB
Downlink 145.960 to 146.000 MHz CW/SSB
Beacon 29.504 MHz

Last reported in mode K, the RS-12/13 satellite has seen many recent changes in operation. Modes K, T, KT and simultaneous RS-13 operation have all been reported. No mode-switching schedule has been forthcoming from the controllers. I have had no recent reports of RS-12 being in operation.

RS-15

Uplink 145.858 to 145.898 MHz CW/SSB
Downlink 29.354 to 29.394 MHz CW/SSB
Beacon 29.352 MHz (intermittent)

Semi-operational, mode A, using a 2-meter uplink and a 10-meter downlink.

AO-10

Uplink 435.030 to 435.180 MHz CW/LSB
Downlink 145.975 to 145.825 MHz CW/USB

Beacon 145.810 MHz (unmodulated carrier)

Operational but no longer under ground station control. AO-10 is locked into 70-cm uplink and 2-meter downlink (mode B) operation. Within these constraints AO-10 continues to function well but is subject to periodic deep QSB. This can be partially eliminated by switching antenna polarisation. Strong signals have been heard even at apogee. I have checked AO-10 around apogee and found the transponder to be quite useful. Good return signals with 20 watts uplink power. You have to play with the antenna polarisation to get best results. When closer in around perigee, the signal throughput is every bit as good as it was in the early days of AO-10 operation. Well worth a look at present.

AO-27

Uplink 145.850 MHz FM
Downlink 436.792 MHz FM
Operational, mode J.

Still listed as operational. Please let me know if you hear anything from this satellite. I have had no reports of it being heard in our area.

FO-20

Uplink 145.900 to 146.00 MHz CW/LSB
Downlink 435.80 to 435.90 MHz CW/USB
Operational. FO-20 is in mode JA continuously.

FO-29

Voice/CW Mode JA

Uplink 145.900 to 146.00 MHz CW/LSB

Downlink 435.80 to 435.90 MHz CW/USB

Digital Mode JD

Uplink 145.850 145.870 145.910 MHz FM

Downlink 435.910 MHz FM 9600 baud BPSK

JAS-1 appears to be in mode JA (voice mode) continuously. No further news on mode switching difficulties.

KO-25

Uplink 145.980 MHz FM 9600 Baud FSK

Downlink 436.50 MHz FM

Operational. This satellite is carrying the major part of the digital traffic load since KO-23 went silent in January 1999.

UO-22

Uplink 145.900 or 145.975 MHz FM 9600 Baud FSK

Downlink 435.120 MHz FM

Operational. Carrying the packet radio satgate load as well as lots of day to day personal traffic.

UO-11

Downlink 145.825 MHz FM, 1200 Baud AFSK

Beacon 2401.500 MHz

Operational. The mode-S beacon is on, transmitting an unmodulated carrier. Telemetry indicates that it is only delivering half power. This beacon is a useful test source for those testing mode-S converters prior to the launch of P3D. The 435.025 MHz beacon has been off for some time.

AO-16

Uplink 145.90/145.92/145.94/145.86 MHz FM 1200 bps Manchester FSK

Downlink 437.0513 MHz SSB, 1200 bps RC-BPSK 1200 Baud PSK

Beacon 2401.1428 MHz

Operating normally. Has anyone heard this beacon? I occasionally get requests for information on weak signal sources for checking mode S equipment. I have had no reports of the 2401 MHz beacon being heard in VK/ZL.

LO-19

Uplink 145.84/145.86/145.88/145.90 MHz FM 1200 bps Manchester FSK

Downlink 437.125 MHz SSB 1200 bps RC-BPSK

Currently semi-operational. Downlink and telemetry only.

IO-26

Uplink 145.875/145.900/145.925/145.950 MHz FM 1200 Baud PSK

Downlink 435.822 MHz SSB

Semi-operational. Telemetry downlink only.

TO-31

Uplink 145.925 MHz 9600 baud FSK

Downlink 436.925 MHz 9600 baud FSK

Operational and very active with mainly digital image files being uploaded almost daily.

GO-32

Downlink 435.325/435.225 MHz

Undergoing commissioning. The satellite is transmitting HDLC telemetry framed so a TNC in KISS mode will decode it. There is no continuous beacon. A 9600-baud burst is transmitted every 30 seconds for a continuous 3 seconds in length, currently on 435.225 MHz. Telemetry display software is available from the internet. Still no word on when this satellite will assume full operations.

UO-36

Uplink and downlink frequencies have not yet been established.

The satellite is not currently available for general uplink transmissions. UO-36 has been transmitting 9600-baud FSK telemetry framed in a VLSI format using a downlink frequency of 437.400 MHz. Commissioning of the high speed downlinks is continuing and spectacular pictures are being received in Europe by suitably equipped stations which have a shared footprint with Surrey University.

The Following Satellites Are Non-operational At This Time:

KO-23

KO-23 went silent in January this year. The last packets I received were on 17th January. Control stations report damage to one of the batteries. It is occasionally heard in test mode with a strong carrier and idling modulation.

RS-16

No good news at all. All attempts to revive this satellite have failed. The 435 MHz beacon is still reported as operational.

DO-17

No news. It appears that no further attempts have been made to get DO-17 back.

WO-18

Downlink 437.104 MHz SSB 1200 Baud PSK AX.25

No further news on status or rescue attempts.

ICOM Clearly Ahead



"VK3LZ calling!"

More sound information from your friends at Icom.

ICOM BOOSTS DEFENCE COMMUNICATIONS FOR US ARMY

Every amateur radio enthusiast knows Icom's reputation for quality and durability. Well, just to confirm that reputation, comes the news that Icom has won a significant defence contract for the U.S. Army. For the first time since WWII, they have chosen a non-American supplier for hand held radio equipment for the US Defence Forces. 22,000 Icom IC-F3S units are now in service as part of a special forces communications system known as the 'Soldier Intercom'.

Testing was conducted against leading American radios, but for performance, durability, and ease of use the Icom units won the battle convincingly. It's reassuring to know that the Icom amateur equipment you buy is built to the same high quality as radios used by soldiers in the field.

HAMFESTS PROVING MORE POPULAR THAN EVER.

Closer to home, we've noticed significant attendance increases at the various Hamfests around the country. If you have never been to one, or haven't attended one in recent years, be sure to get along soon. They are a great way to meet fellow radio enthusiasts and check out all the latest gear. Look out for your friends from Icom while you're there.

DATES TO REMEMBER

Wagga Wagga Hamfest August 7 and 8
Shepparton Hamfest September 12

"...73"

FreeCall 1800 338 915
290 -294 Albert Street
Brunswick, Victoria 3056
Tel : (03) 9387 0666
Fax : (03) 9387 0022
www.icom.net.au

ACN 006 092 575

REPEATER LINK

Will McGhie VK6UU

21 Waterloo Cr Lesmurdie 6076

VK6UU@VK6BBR

will2@omen.net.au

(08) 9291 7165

Change of E-mail

After a number of problems with my ISP (Internet Service Provider) I have moved my Internet account, and as a consequence my E-mail address has changed to that given above.

We should do something

I started this column 10 years ago in the hope that it would, among other things, provide a focus for voice repeater managers and builders to improve regulations that are applied to this aspect of our hobby.

I have mixed feelings about any success that I have been able to achieve. Perhaps few believe the regulations that apply to voice repeaters need any changes.

However I have received feedback over the years supporting my opinion that fundamental changes are needed. Discussion from time to time with users of voice repeaters shows a general lack of understanding by some amateurs, of the many regulations that limit voice repeater experimentation. Comments like "Why don't we do such and such?" receive a response; "Because the existing regulations don't allow it." This is then often followed by "We should do something about it." Therein lies the problem; who are we?

The assumption that someone or some group are busy working away at changing voice regulation changes, on the assumption that they need changing, is a fallacy. The infrastructure exists to some degree via the WIA but the WIA needs input. Not just, "We want to be able to do such and such", but a detailed submission that the WIA can use as an argument in order to bring about change. I'm talking about a fundamental change, not just being allowed to link 4 rather than 3 repeaters, but prove that such restrictions should not exist in the first place. Organised representation.

What I'm pressing for is a better stronger representation for voice repeater builders and managers. If we want a stronger voice

we need to become organised. At the moment what little effort is being expended is fragmented and very much on a State by State basis. One State is allowed to do something that may be denied in another State.

First I have to find out whether there is sufficient interest to expand this part of our hobby. Do we want as few regulations as possible? Do we want general concept regulations rather than detailed nit picking regulations? If we do want a fundamental change in the approach that is applied to voice repeater regulation, then we have to do the work, and most important become organised.

What does it mean to become organised? I believe that we first need to find out who we are and how many we are. We can, via Packet Radio and E-mail, gather together a list of interested voice repeater builders and managers. Once we are communicating effectively together we will have strength of numbers and a variety of ideas that we can then pursue.

One of the best ways to be in touch is via a News group on the Internet. This allows all to participate and for all to see what is being said. Packet radio and other input can be fed into the Internet news group as well.

Step One

Step one is to gauge interest, so in an effort to do just that I look for your thoughts. Contact me via e-mail, packet or phone at the addresses/numbers given above

If there is sufficient interest shown, we set up a national organisation to lobby for less bureaucracy and simplified regulations to be applied to voice repeaters in Australia.

A Name

A name provides an important part of any organisation. Perhaps the "National Voice Repeater Association" or "Repeater Association National" (RAN). The name needs to be easy to say along with a catchy abbreviation and reflect the organisation. I look forward to your input.

If you happen to think that what we have at the moment is as it should be, then please by all means let me know. There is no point in spending time on an idea if it has little support.

29MHz FM

With the Sun spot activity predicted to peak in January 2000, 29MHz is alive and kicking. Unfortunately most of the kick is from the wall to wall pirate activity on the entire band. When the pirate activity gets up to the level we have now, the fight is almost lost, but at least we are the legal users of this exclusive Amateur band.

Log intruders and send in your intruder logs. For the next few years during daylight hours the 29MHz FM band allows Australia wide contact every day. Yes that is right, every day. Monitoring of the Melbourne 29MHz repeater in Perth has shown, as soon as the Sun comes up so does the repeater.

Experimentation has also shown that it is simple to link the Melbourne repeater onto one of our local 2 metre repeaters in Perth. This then allows easy hand held or mobile to mobile contact across the continent. It is a pity that voice repeater regulations prohibit this innovative use of amateur technology.

A simple change of one word in the voice repeater regulations would allow this type of activity. Legal activity on a band flooded with pirate activity. The change is in the sentence "no linking below 50MHz". Change the 50MHz to 29MHz, and fun could be had talking on FM across the country, from the ease and comfort of your mobile or hand held on 2 metres or 70 centimetres via 29MHz FM.

What is disappointing is that with changes like this taking several years if successful, we could miss this exciting propagation used in this innovative way, and have to wait until the next Sun spot high. Will we have a 29MHz band that is of any use at all to us by then?

There is a submission to lobby for just that simple change and it hopefully will be part of the next WIA/ACA liaison meeting to be held in July. I will keep you informed.

Amateur Radio

— another
membership service
from your WIA.

ARDF

Ron Graham VK4BRG

PO Box 323
Sarina Qld 4737

IN THE LAST COLUMN we covered some aspects regarding the use of simple receivers for ARDF. In retrospect, the description of handy talkies and portable scanners (which were the main devices discussed) as "simple receivers" is somewhat misleading. Commonly owned or available may have been a better description!

Mention was also made of some simple ARDF techniques. These will now be discussed in greater detail.

Body Shielding

This technique takes advantage of the human body attenuating the received signal, and we are talking about VHF and UHF frequencies. The largest mass of the human body is, in general, the abdominal area. So the receiver/antenna combination is held tightly against the abdomen and one turns through 360 degrees and looks for the minimal signal, which, with the bulk of the human body attenuating the signal, is from one's rear.

Interestingly enough, while typing this, another "blow by blow" description of the technique came to hand. I quote: "place handy talkie vertically in left hand with front panel towards abdomen, hold tightly against abdomen, rotate yourself for minimum signal, look rearward over left shoulder, this is the direction to the transmitter". Further explanation revealed that "looking rearward over left shoulder" means the direction is 45 degrees from one's rear towards the left.

Obviously various techniques (and no doubt, variables) exist and one would be advised to conduct some tests prior to any serious events. Possibly one's abdominal mass and its geometry affect results. An investigation of these matters could make an interesting subject for some prospective PhD candidate!

Attenuators

Reference has already been made to the limiting action when using FM receivers. Unless the receiver is fitted with an S-meter it is somewhere between difficult and impossible to tell any change in signal

strength when this limiting action is taking place. The answer here is to use some sort of attenuator between the antenna and receiver. The amount of attenuation needed is adjusted to keep the signal noisy and then it is possible to judge the signal strength by ear.

The attenuator can take various forms. These may be used, either singly or in combination:

- i) a supply of various BNC to BNC attenuators that are fitted between the receiver and antenna. The antenna may be removed completely with very strong signals.
- ii) detuning the signal.
- iii) use of a device similar to the ARDF converter.
- iv) use the metal tube type attenuator (waveguide beyond cutoff).

Waveguide Beyond Cutoff

This latter device falls in the simple category and consists of a metal tube of sufficient diameter to allow the receiver and antenna to be inserted therein. The theory of operation is that this tube, at the frequencies involved, acts as a "waveguide beyond cutoff". Thus, a variable attenuator is formed with the amount of attenuation depending on how far the receiver/antenna combination is inserted into the metal tube. In practical use, the tube is held vertically and the receiver/antenna combination lowered into it by the carry strap or the carry strap extended with a piece of cord.

The above technique, together with body shielding offers the simplest and lowest cost way into direction finding, provided one already owns a suitable handy talkie or scanner. Also, keep in mind, as the frequency of operation is only limited by what is the receiver is capable of tuning, the technique may be used outside the amateur band. Examples could be an annoying pager, locked-on transmitters, interference problems etc.

The disadvantage against more sophisticated equipment, as I see it, is there

are more variables involved and the results may be somewhat inconclusive. However, with practice, I believe some people have become quite proficient using these simple techniques. One could also say, that under some circumstances (like not having any other equipment available or having had other equipment fail) these techniques could mean the difference between continuing on and hopefully finding the transmitting device.

Conclusion

The above covers, what I consider, to be simple direction finding techniques. They are something with which I have had only limited experience. A lot of the information had been obtained from general reading on the subject plus input from others. Any further contributions to this column on this subject could be included at a later date. I think it is important to keep investigating these simple, low cost techniques so that various people may easily and economically try ARDF, or indeed, any form of hidden transmitting hunting.

Further reference has been made to the "ARDF converter", often called an attenuator or ultimate attenuator. Hopefully, we can discuss this device further in the next column.

Korea

This Region 3 ARDF event takes place in mid June. (I write this column in May for the July issue). Travelling to Korea to participate are Bruce Paterson VK3TJN, Jack Bramham VK3WWW, Jason Morris VK4YOL, Bryan Ackerly VK3YNG and Adam Scammell VK3HDF. We wish that all went well for them and look forward to reading a report on the event in AR magazine.

SNIPPITS

Going Ohm

Ohm's law was derived when George Simon Ohm started to test various bits of materials for their opposition to current flow.

He discovered that by subjecting the materials to various known voltages and plotting the voltage against the measured current, the resulting graph was a straight line that passed through zero.

As any person trained in mathematics would know, he recognised this as a direct linear relationship.

We know this to be Ohm's Law. "In any fixed resistance, the current flow is proportional to the applied voltage."

POUNDRING BRASS

Steve P Smith
7 Mitala Road
Newport NSW 2106
02 4334 7743

AS PROMISED a number of book reviews will appear in coming issues. This issue I will introduce you to a number of selected CW related poems I have accumulated over the years. Some of you should be very familiar with these others not so. The first poem I believe to be an "Australian Classic", "Coming Round The Bend" which is probably better known as "CRTB" written by Frank Spruhan, known by his contemporaries affectionately as "SPRU". Spru was one of those Telegraph legends one hears about while "Pounding Brass". In the 1960's a collection of his works was published, Spru put many of his thoughts about the Telegraph service into verse, "CRTB" is one such poem.

Spru who became a silent key in 1965 rested in the Jiliby cemetery in an unmarked grave up until November 1988, when the Sydney based Morsecodeian Fraternity decided "Spru" deserved something better, they arranged to place an inscribed headstone on his grave, something Spru would have been very proud of.

Coming Round the Bend

I well remember Charlie Teede,
who used to work the races;
No need, indeed, to ask for speed,
He'd pace it with the pacers.
Lord help the man who broke him once
or questioned his "creations";
On him a flood of scorn was turned,
the atmosphere with brimstone burned,
and pitman green with envy squirmed,
at his abbreviations.

"Te field got wl awa to ti & as ty settld
dwn
Te Shicer 1st t bk te li ws flwd bi Jo
Brown.

In close proxim ws Tired Tim, Tn cme
Arbtatn,
Bhnd te bunch ws Cntr Lunch, Gd luck
and Hi Taxatn.
Ty whizzed along (and so did Charles)
Tthout te least cessatn.

Crtb te topwt jumped & got on trms wi
Shicr,

Wo tn & tre hs bundl dumped Wh labld
him a twicer,"

I scrambled after Charlie like a trailer
round a bend,
Then gave OK-but queried "CRTB" u
send.

Now what is that in aid of? Enlarge a bit
my friend."

The sounder nearly hit the roof
as Charlie scorched the line.

"U ort t b on te rabtproof Or up at
Doodlekine.

Chasin poddies rnd t yd Shd b ur chf
pastime.

T nk u cndt wrk tt out It nrly mks me sik.
Ani ole gin or rousabt Cd write it wi a stik.

Fanci a man wo calls hmslf A tgst askg
tt!

A record O S vacuum is located neath ur
hat.

D'u want it in oils bi Lambert? Or carved
on a marbl Stone?

Ole "Winja" Mortill cd tke it & ud nvr hr
a moan;

Not spelt out li Ive dun fr u By cut dwn t
te bone.

"WI I mst sa its te bst dspla of ignrce Ive
hrd,

O all te sqrts in W A Ur crtnli te "bird"
& ani Hrsh remks Ive mist Ty all cn b
inferd

"CRTB"-its Known bi rote, Wt wd u ha
me snd?

Its cmg rnd Te bnd-u goat.

Coming round the bend!

By Frank Spruhan

The following poems from the 1900's era:

That Station

Of all the stations I have worked,
This station is the best.

A 'Haunt' for all the lazy boys
And those who need a rest.

Hard at work at six o'clock,
Off come coats and vests,
You carry in a pile of wood
To smoke away the pests.

These pests are mainly different bugs,
(The skeeters are the worst)
And on the war-path all the time
For naught but blood they thirst.

With head phones on at even bells
You shoot some N-I-Ls.
The spiders get so thick just then
You pray for shrapnel shells.

At eight o'clock the 'Larm is set,
To wake you up for lunch;
You dim the glim and pull the shades
And roll up in a bunch.

At one o'clock you Q-R-U
And set the clock for four;
To get that M-S-G report,
The P&O waits for.

At four o'clock your work is done,
Youv'e got that M-S-G;
So nap till six then doctor up
That log artistically.

By D. Phectiff Inslater
Wireless Age, Nov 1915.

Also Appeared M.M.36 October 1994 (Issue)

Ode to Wireless Operator

When the air is fine and balmy and the
ether's free and clear
and the sigs come in like thunder with a
biff that jars the ears.

Then the PBO* is happy and he wears a
sunny smile
and doesn't curse the traffic that keeps
coming all the while.

But when the X's come on steady with a
sizzly frizzly roar
and the sigs die down to nothing then the
common Op gets sore

and the language that he uses melts the
contacts off his key,
burns the "Bradfield" to a cinder leaves
the aerial hanging free,
and the Old Recording Angel wears a
stern and saddened look
as he logs the bad Op's language in the
big Recording Book.

*(PBO=Poor Bloody Operator)

By Harry Pearson
Sable Island 1905

Also appeared M M 24 1992 issue

Infatuation

O mystic fascination
O fate idealised
I'm but a mass of molecules
Reversely polarised.

I am vanquished by sorcery
No amulet can cure
For love you are the magnet
And I the armature.

The more I circle round you
Love's current stronger grows
Till leaping forth from heart to heart
Love's arc electronic glows.

Against the ardor of that flame
Insurance won't insure
For, Love, you are the magnet
And I the armature.

The messages un-numbered
Of fond endearment fly
At once, in all directions
The wireless they outvie.

A throbbing heart is at the key
Its dots and dashes sure
For, Love, you are the magnet
And I the armature.

I dwell within your field of force
In that blest region where
Your strength is to the distance
Inversely as the square.

No influence external
Can me from you allure
For, Love, you are the magnet
And I the armature.

At last we'll cling together
Apart no more to roam
With hearts attuned harmonic
We'll sing of Ohm, sweet Ohm.

One circuit never broken
While life and love endure
Forever you the magnet
And I the armature.

**By Park Benjamin
Wireless Age, 1915**

Also appeared M M 33 April 1994 issue.
And finally a short one from the "Air
Signallers" of World War Two:

I wish to thank those who recognised the circuit used in the May AR column. The photocopy that I worked from was unfortunately without any indication of the source. It was however identified as the Modified Cubic-Incher designed originally by Dennis Monticelli AE6C and later modified by Greg Bonaguide WA1VUG. It appeared in several editions of the ARRL Handbook, page 30-41 of the 1990 Handbook for example, where Q1 is suggested to be an MRF472.

As many of you could sympathise with, I have quite a collection of loose sheets and cannot always, or easily, identify the source.

The Air Signallers' Prayers

'In days of old
when W/Ops were bold
and sidebands not invented
the word would pass by sounding brass
and all were well contented

AMEN'

According to John Hall G3KVA

Appeared in Radcom, August 1994

I hope you enjoyed the poems as much as I did.
See you all next issue.

Steve VK2SPS

ar

Try This

Easy "Experimental Circuit" Board Manufacture

Graeme L Wilson

26 Dollis Way
Kingsley WA 6026

AFTER USING all of the common commercial and home-brew types of circuit boards over the years, I decided to make my own using a simple home-brewed tool and copper plated boards.

My tool was made from an old 5 BA tube or box spanner 10mm in diameter with a wall thickness of approximately 1mm and 120mm long. You could also use a similar length of 6 to 10mm steel tubing.

Cut off the hexagon end section, back to where it was still circular, and file 8 teeth on the end with a small triangular file. One way is to cut diagonally across the tube with a junior hack saw or modellers saw then divide the remaining sectors in half and then all sectors in half again.

File each tooth into a saw tooth shape. Remember to note which direction the drill

turns. To harden the teeth, heat them to a cherry-red and plunge them into clean, cold water. For mild steel you can heat it to a yellow colour (straw) and dip just the cutting end into ordinary sugar until it cools.

Then heat it again to a cherry red and chill in water as before. That will carbonise the surface of the mild steel and make it harder.

Lay out a grid of pencilled lines approximately 12mm apart on the copper clad board. Mount the tool in a

bench drill and set the stops to a depth just enough to cut through the copper layer. Use a drill vice or clamp a piece of wood to the drill table as a guide and adjust it to line up with the first grid line. Now make sure that the PCB is flat against the table and hard up against the guide, and line up the first hole.

Hold the PCB firmly and drill the first ring. If the board "wants" to move, stop and check that the teeth are level with each other. One longer than the rest will cause the board to want to oscillate like an orbital sander.

So far a 200mm x 100mm board has lasted over a year, 5 projects and half the board still remains for future circuits. The continuous ground-plane makes component placement easy and you build your project then cut it off to size without waste.

ar

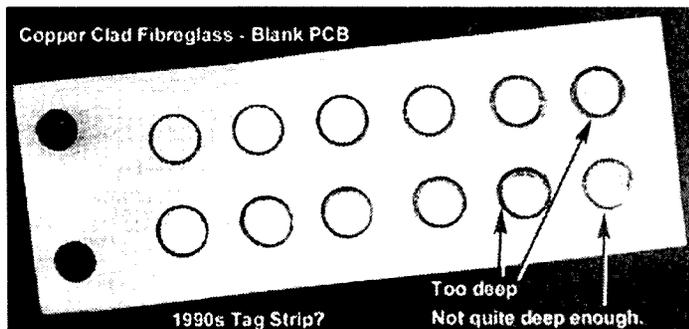

Photo 1 A sample piece of PCB cut with an 8mm ms tube. (The two holes were already in the PCB.)

AWARDS

John Kelleher VK3DP

Federal Awards Officer

4 Brook Crescent, Box Hill South, Vic 3128 (03) 9889 8393

Recently, I received information which I feel should be passed on to the Amateur fraternity. It concerns DX prefixes for certain Pacific countries.

KC6 - Belau.

This prefix is no longer available for amateur radio use since Belau became a politically independent state in its own right. It is no longer a part of Micronesia. The prefix for this country is now T88 and T88 only.

V6 - Micronesia The correct name for this country is The Federated States of Micronesia, and includes Yap, Chuuk, Kosrae, and Pohnpei. As with the situation for Belau, above, the prefix KC6 is no longer used.

T2 - Tuvalu T2 is now not available for amateur use. It is currently in use commercially for shipping, aircraft etc. Amateur prefixes in Tuvalu run T20 through T29. The use of any other form of prefix is definitely illegal. A similar situation exists in Kiribati, where T3 is for commercial use, and T30, T31, T32 and T33 for amateur use.

C2 - Nauru The prefix C2 is now used for commercial purposes only. The prefix C21 is the only one set aside for amateur use.

This important information comes from Jack D Haden, who although not a member of WIA is always ready to help and assist his fellow amateurs. He also advises that he will be QRV from T30 and C21 for about two weeks early in July. Thank you Jack, VK2GJH.

In a special bulletin, the DXCC Desk has announced that a purge of 9U contacts will take place as far back as January 1st 1994, and after. The DXCC Desk reasoning is : " The submission of forged documentation is a clear violation of DXCC Section 1 Basic rule 7, and also rule 12(a). The list includes the following call signs, and may or may not be limited to these. 9U/F5FHI, 9U/EA1FH, 9U5W, 9U5DX, 9U5T, and 9U5CW. The station 4U9U is OK."

Although QSL cards for the E44 operation are arriving in the mail, sadly I cannot add this new entity until about the 1st of October 99. So please be patient.

JT - Mongolia

It is expected that GM4DMA will be active during this month. QSL via home call.

Expeditions are also expected from T31 (Canton Is) 23/9/99 to 3/10/99 and from ZK3 from 7/10/99 until 12/10/99.

E41/E44/4X. Hide, JM1LJS plans to be active from these three areas during the period of 23/7/99 to 1/8/99. Activity will depend entirely on his work schedule.

V6 - Micronesia

Sam, V63KU will be active until year's end. Qsl via JA6NL.

3W6 - Vietnam

Karl, W9XK will be active until 20/7/99 signing 3W6XK. Qsl via home call.

Look for amateurs in Alberta, Canada using the prefix CY6 until July 14th to promote the Calgary Stampede.

Alaska -

The Alaska DX Certificate Contacts with 10 Alaskan amateurs as follows : One each from Southeastern (that part of KL7 east of 141 W longitude) Northern (above the Arctic Circle) Aleutian Islands (including Kodiak Island and the Alaskan peninsula south of 58 degrees North latitude , and Central Alaska (including Anchorage and Fairbanks). The remainder may be from any part of KL7.

However, of these 10, 4 must be members of the Anchorage ARC. Any modes or bands (except WARC bands). Contacts since 1-1-55. No fee, but return postage for certificate is required. GCR list certified by three (3) licensed amateurs or official at National level to :-

Anchorage ARC KL7AA
Box 101987
Anchorage
Alaska 95510

Canada -

Canadian QRP Award Contact all 12 Provinces and Territories of Canada on 2-way QRP. (Defined as using not more than 5 watts CW, or 10 watts PEP SSB). GCR list and fee of 2 IRCs to :-

Jeff Heatherington VA3JFF
3399 Cardinal Drive
Niagara Falls Ont
Canada L2H 3A6.

Denmark - Copenhagen Award

Contact stations in the Copenhagen area. Scandinavian stations need 15. Europeans need 10, all others need 5. Available CW, Phone, or mixed. all bands. SWL OK. GCR list and fee of 5 IRCs or US\$3.00 to :-

Allis Anderson OZ1ACB
Kagsaavej 34
DK-2730 Herlev
Denmark

Malaysia - The All Malaysia Award.

Work 10 9M2, one 9M6 and one 9M8 after 31 Aug 1957. Endorsements available for any combination of band or mode. SWL OK. GCR list and fee of US\$5.00 to :-

MARTS Award Manager
Eshee Razak 9M2FK
PO Box 13
10700 Penang
Malaysia.

Malta - Malta Amateur Radio League Series.

General requirements : Awards are available for amateurs and SWL's. GCR list and fee of 15 IRCs or US\$4.00 for DX applicants. Apply to:-

The President MARL PO Box 575
Valetta Malta

(1) The Diploma Mediterranean Award

Work a minimum of 15 of the 26 listed Mediterranean countries. 9H being mandatory. The countries are : Albania, Algeria, Balearic Islands, Ceuta-Melilla, Corsica, Crete, Cyprus, Dodecanese Is, Egypt, France, Gibraltar, Greece, Israel, Italy, Lebanon, Libya, Malta, Monaco, Morocco, Sardinia, Sicily, Spain, Syria, Tunisia, Turkey and Yugoslavia.

(2) The 9H Diploma

Contact stations in Malta. Europeans must earn 10 points, all others 5. Each 9H qso counts as one point except Club station 9H1MRL, and any 9H4, both of which count for 2 points.

Oman - The A4X Award

Contact A4X stations , 8 on SSB or 5 on CW. GCR and 5 IRC's to :-

Award Manager ROARS
P.O. Box 981
Muscat
The Sultanate of Oman.

Good luck and good hunting, de John,
VK3DP

ar

CONTESTS

Ian Godsil VK3DID

57 Nepean Highway, Aspendale 3195

Contest Calendar July - September 1999

Jul 1	Canada Day Contest	(CW/Phone)	(Jun 99)
Jul 3	Jack Files Contest	(CW)	(May 99)
Jul 3	Australasian Sprint	(CW)	(Jun 99)
Jul 3	NZART Memorial Contest	(CW/Phone)	(Jun 99)
Jul 10	Australasian Sprint	(SSB)	(Jun 99)
Jul 10	Jack Files Contest	(SSB)	(May 99)
Jul 10/11	IARU HF World Championship	(CW/SSB)	(Jun 99)
Jul 10/11	Internet 6 Metres DX Contest	(CW/SSB)	
Jul 17	Pacific 160 Metres Contest	(May 99)	
Jul 17/18	SEANET CW Contest	(Jun 99)	
Jul 18	Colombian Independence Contest	(CW/SSB/RTTY)	(Jun 99)
Jul 23	ACORNZ 'Zip' Contest	(Phone)	(Jun 99)
Jul 24	Waitakere Sprint	(Phone)	(Jun 99)
Jul 24/25	Russian RTTY WW Contest		
Jul 24/25	RSGB IOTA Contest	(CW/SSB)	(Jun 99)
Jul 30	ACORNZ 'Zip' Contest	(CW)	(Jun 99)
Jul 31	SARS Sprint Contest	(SSB)	(Jun 99)
Jul 31	Waitakere Sprint	(CW)	(Jun 99)
Aug 1	YO DX Contest	(CW/SSB)	
Aug 7	SARS Sprint Contest	(CW)	(Jun 99)
Aug 7/8	Worked All Europe DX Contest	(CW)	(Jul 99)
Aug 14/15	Keymen's Club of Japan Contest	(CW)	
Aug 14/15	RD Contest	(CW/SSB)	(Jul 99)
Aug 21/22	SEANET SSB Contest		(Jun 99)
Aug 28/29	SCC RTTY Championship		
Aug 28/29	TOEC WW Grid Contest	(CW)	
Sep 4/5	All Asia DX Contest	(Phone)	(May 99)
Sep 4/5	Bulgarian DX Contest	(CW)	
Sep 11/12	Worked All Europe	(Phone)	(Jul 99)
Sep 18/19	SAC DX CW		
Sep 25	Internet CW Sprint Contest		
Sep 25/26	SAC DX Phone		
Sep 25/26	CQ WW RTTY DX Contest		

Multiplier on each band equals the number of European countries worked on that band (or on RTTY only, the number of DXCC/WAE countries), times a band factor. The band factors are four for 80 m, three for 40 m and two for 20/15/10 m. Add the band multipliers together and multiply by the sum of (QSOs + QTCs) to obtain the final score.

SWLs may log each station heard, European and non-European, once per band. Logs must contain both call signs and at least one of the control numbers. Score one point for each station logged and one point for each complete QTC received (max 10 per station). It is possible to claim up to two multipliers per logged QSO.

Use standard log summary sheet format. Include a check list for more than 100 QSOs on any band and, if more than 100 QTCs have been sent, include another check list to show that the quota of 10 QTCs per station is not exceeded. Logs can be submitted in ASCII on DOS disc, providing a paper summary is included. Send logs to: WAEDC Contest Committee, Box 1126, D-74370 Sersheim, Germany. Deadlines are 14 Sept (CW), 14 Oct (SSB) and 14 Dec (RTTY).

European countries are: C3 CTI CU DL EA EA6 EI EM/N/C ER ES EU/V/W/ F G GD GI GJ GM GM(Shetland) GU GW HA HB HB0 HV I IS IT JW(Bear) JW(Spitzbergen) JX LA LX LY LZ OE OH OH0 OJ OK/L OM ON OY OZ PA R1/FJL R1/MV1 R/U(RUSSIA) RA2 S5 SM SP SV SV5(Rhodes) SV9(Crete) SV(Mt Athos) T7 T9 TA I TF TK UR-UZ(Ukraine) YL YO YU Z3 ZA ZB2 1A0 3A 4U(Geneva) 4U(Vienna) 9A 9H.

Keyman's Club of Japan

14/15 August, 1200z Sat - 1200z Sun
This contest is designed for CW enthusiasts and will particularly suit those who are collecting Japanese prefectures for awards. The only category is single operator multi-band. Suggested frequencies are: 1908-1912 (split), 3510-3525, 7010-7030, 14050-14090, 21050-21090 and 28050-28090 kHz. Exchange RST plus continent code (OC). JAs will send RST plus district code.

Score one point per QSO. Multiplier on each band is the total number of JA districts (max 62 per band). Final score equals total points X total multiplier. Show duplicate QSOs with zero points. Attach a summary sheet showing all usual information and send log to: Yasuo Taneda JA1DD, 279-233 Mori, Sambu Town, Sambu. Chiba 289-12, Japan, postmarked no later than 15 September 1999. ASCII logs on DOS disc most welcome.

ar

Thanks this month go to the ARRL.

Worked All Europe DX Contest

7/8 August (CW), 11/12 September (SSB), 6/7 November (RTTY); 0000z Sat - 2400z Sun. The object is to work European stations (except in the RTTY section where anyone works anyone). Bands are 80 - 10 m. In the contest, avoid 3550-3800 and 14060 - 14350 kHz on CW and 3650 - 3700, 14100 - 14125 and 14300 - 14350 kHz on SSB. The minimum time of operation on a band is 15 minutes, although bands may be changed within this period if, and only if, the station worked is a new multiplier. Categories are single operator all bands; multi-operator single transmitter; and SWL all bands. DX cluster support is allowed. A maximum of 36 hours is allowed for single operator stations, with up to three rest periods (mark them in the log).

Exchange RS(T) plus serial number. Additional points can be gained reporting QTCs as follows: after working a number of European stations, details of those QSOs (ie QTCs) can be reported during a current QSO with a European station. In the CW and phone sections, QTCs are sent from non-European stations to European station. In the RTTY section, QTCs can be sent to any station, including non-Europeans, outside one's own WAC continent. A QTC contains the time, call sign and QSO number of the station being reported, eg: "1307/DA1AA/431" means you worked DA1AA at 1307z and received serial number 431. Commence QTC traffic by sending the QTC series and number of QSOs to be reported, eg "QTC 3/7" indicates that this is the third series and that seven QSOs will be reported. A QSO may be reported only once and not back to the originating station, who can be worked more than once to complete the quota. Only the original QSO, however, will have points value.

SPOTLIGHT ON SWLING

by Robin L. Harwood VK7RH

5 Helen Street, Newstead Tasmania 7250

(03) 6344 2324

E-mail: robroy@tassie.net.au

So far it has been a very mild winter here in northern Tasmania and although we have had some rain, it has not been as cold as we have come to expect. The nearby mountains are without their usual snow covering, causing the ski operators on Ben Lomond to shake their heads.

Usually I hear stations coming from Europe, across Antarctica around 0200 UTC, corresponding to midday locally, on the lower frequencies, particularly on the 49 and 41 metre broadcasting allocations. Strangely enough this year I am not observing any until 0300 with signals coming from another direction. 7 MHz does perform better yet the noticeable auroral flutter is absent. Paul Ormandy in Oamaru NZ is however hearing signals at 2400 UTC, which corresponds with his local midday. At that time signals here are still coming in on the short path from Europe.

Propagation on the higher frequencies in the daylight hours is also very interesting. The WARC band of 17 metres has become extremely lively with Europeans virtually on around the clock. I cannot determine if the propagation is long path or short path, yet I suspect both, as some signals have multipath echoes. Another indication that the Europeans are there is the absence of Asian signals. Usually there are two strong Japanese meteorological stations sending fax weather pictures on 18220 and 18440 kHz and when they are absent, the Europeans come in very well. I also note that when they come up, so do the American stations on 17 metres.

The other WARC allocation between 24890 and 24990, commonly referred to as 12 metres, has not been as active. There seem only to be a few VK's talking to Stateside. 27 MHz and surrounding frequencies do have CBers yet it does not seem as congested as the previous sunspot high. I am aware that there are numerous low power FM and AM signals from up north, across the entire 10 metre amateur allocation. Most of them seem to be in either Thailand or the Philippines.

The 21 MHz broadcasting allocation has probably the best propagation. The United Arab Emirates in Abu Dhabi is excellent on both 21630 and 21735 kHz from 0200 in Arabic.

There is practically no fading and the signal level is constant. To confuse matters, there is another station also called United Arab Emirates Radio on 21700 in Arabic and English but is located in Dubai and is a separate station. I think Abu Dhabi relays domestic programming whilst Dubai is an external service. The Turkish radio from Ankara is broadcasting to Australia around 0200 in Turkish on 21715 and from 0400 UTC they are on with an excellent signal up until 1200 UTC. Signals seem to peak around 0600 UTC and quickly fade here once the Sun has set.

Radio Kuwait has been heard in English on 15105 kHz at 0500 also a relay of the domestic AM /FM networks. The program I heard was a documentary on how they put out all those oil well fires after the Iraqis were expelled. Kuwait is also on 11675 and 15495 kHz in Arabic from 0100 UTC.

On July 12, Globe Wireless will be closing down their remaining HF stations for Morse traffic. WCC, KFS, KPH and WNU have already stopped traffic lists and also their marker signals. They are concentrating now on e-mail and also intend to phase out SITOR. Globe Wireless uses an encrypted form of Clover for e-mail at 200 baud over their worldwide chain. They seem to be the only maritime or public traffic station using Clover, with the majority of the others sticking with SITOR. Amateurs used AMTOR, which is identical for some years but are now using PACTOR, G-TOR, or Clover.

Some are also experimenting with a form of Heller Schreiber, an early German FAX system used by the Nazis. Remember that signal from China that used to be around 14115? It used to sound like a frog. That was it originally sounded like but with computers it sounds much different. The Heller folks hang about on 14065 kHz.

The conflict in the Balkans drags on. NATO has been targeting both telecommunications.

Infrastructure and broadcasting stations in Serbia and Kosovo. Radio Yugoslavia on 7200 kHz was broadcasting at 1100 UTC in Serbian and at 1108 it was silenced by an air raid which destroyed the facility. The senders located in Bosnia are untouched although the lines taking the audio through Serbia to the site were hit. Although Montenegro is a part of the Yugoslav Federation, the government has tried to be neutral and raids have concentrated instead on Yugoslav troops there. Montenegro also took in some refugees from Kosovo, which displeased the Yugoslav government. Also the media in the republic has taken an independent stance from Belgrade.

The VOA has been broadcasting live the daily NATO briefings from Brussels over "News Now" at 1300 UTC. This has been interesting yet when the generals go to a video clip or refer to a map on the screen; the announcers in Washington quickly fade away.

This also occurs when there is a question and reply in French.

Last month I referred to Merlin Network One broadcasting to Australia on 13720 kHz at 0600. No sooner was it written before programming from the independent commercial British station was reduced. Now it has been reported only on for one hour a day, Monday to Friday between 1700 and 1800 on the 49-metre allocation. It is on spasmodically between 0700 and 1600 on 9915 kHz. It no longer is beamed to Australia.

Bob Padula has been publishing the Australian Shortwave Guide for a few years now. It contains listing of the major short-wave stations heard in Australia. It is two parts. The first 16 pages contain the station listings in country and time order, the second 16 usually articles on a station or a theme. Edition 7 was released on the 17th of May and costs \$10, obtainable from Padula Books, 404 Mont Albert Road, Surrey Hills VIC 3127. Phone/Fax (03) 9898 2906 or e-mail bpadula@compuserve.com.

Mr. Padula has also been compiling the Electronic DX Press (EDXP), an e-mail delivery of the latest news on short wave, but he has now put this in recess, and I am uncertain if it will re-appear. The EDXP has helped many keep abreast of happenings, but I appreciate that it has taken a lot of time, dedication and money, with little support.

Well, the consensus is that the Millenium and the 20th Century will finish on December 31st 1999 at 2359 UTC. As somebody said on 40 the other day, it will "suddenly" be realised that 2000 is still the 20th century and we will go through it all over again. But I don't think so although the concept of the Millenium has been a commercial bonanza.

Until next time, the very best of 73 and good listening.

ar

Monitoring Station of Yesteryear

John Wright L21068
4/33 Kerrie Crescent
Peakhurst NSW 2210

I NOTED WITH interest Bill Rice's comment on page 2 of AR May, about Hamads. I have been building up quite a collection of valve communication receivers, otherwise known to most as "Boat Anchors", with help from the Hamads.

I am WIA member L21068 — yes, just a listener member. I became interested in 1970, and have been a listener ever since. The pirate CB craze put an end to my amateur ambitions. With a simple one watt Midland set connected to a beam antenna, my being able to hold a conversation with someone in the USA really started and finished in one big hit in 1970. After that I have chased the shortwave bands for entertainment.

I have always been fascinated with the big communications valve sets, both military and commercial, especially on a cold night seeing the big purple glow from those valves! They give such a warm feeling. Some of the sets seem even to have a personality.

A few years back I visited Ian O'Toole's Castle Hill military museum, with his vast array of military communications gear. I was amazed how many were sets I had passed up over the years. People had often asked if I wanted an old valve set, but I had just politely said no.

Then it hit me. My main interest was monitoring the shortwave bands. The old valve sets could become a monitoring station. Well, why not? It also would preserve the past for others to enjoy, instead of ending up at the tip. So I decided to collect these old valve receivers and restore them to their former glory.

At this time I came to know Robbie Varga at Ermington, about 16 km away across Sydney. Rob had a few valve receivers, but we had no idea of what was to happen. We became firm friends, and with Rob's enthusiasm, we have collected over 80 valve communications receivers!

Rob is blessed with a huge double garage, so earlier this year we decided to set up the

monitoring station in the backyard of his home. So, after some four years, here is the thrust of the Hamads "Give me a hernia", and "will bring a broom".

Imagine, a double garage complete with racks running the length of the walls filled with AR7s, Hallicrafters, Hammarlund, RACAL, Collins, etc. Well, that is what we have. We are up to the stage of restoring some of those magnificent Admiralty B40s. What beasts! At 55kg each these are good for weightlifters! The powerpoints are in. Yes, we have three phase power! The next job, after repairs, is to put up all manner of antennas. Probably a dipole for each metre band. The idea is to have BC221 frequency metres for readout ± 1 kc/s, each receiver being allocated to a certain frequency, and suitable aerial. This not only preserves the past, but gets the old sets going again, hopefully for a future generation. As it is, I

am 42 years of age, but there are precious few people younger than me with an interest in these fields. Hopefully this will bring in a few to

appreciate the goodies this radio hobby has to offer. We also have a huge array of technical manuals, but you can never have too many.

I would like to thank the many amateurs who have called and given their old equipment and or parts and magazines and books. Without these, I doubt that we would have the setup we have now. Rob and I envisage that in November this year all the racks and sets will be complete, and the monitoring station of yesteryear will be there in all its glory. A few photographs have been taken, and will feature shortly, in another article, before the station is finished.

We "L numbers", too, can take an active role in the hobby of radio and more importantly, support the WIA.

If anyone wishes to help out with any gear, etc. the Hamads section is where you'll find me! Thanks again!

SNIPPETS

Genesis of a generator

Although Michael Faraday showed in 1831 that a disk rotated between the poles of a horseshoe magnet would produce electricity; it was not until 1870 that a Frenchman, Zenobie Gramme, developed the first commercially viable generator.

It consisted of a coil of iron wire made into a doughnut (toroid) over which a coil of copper wire was wound as you would wind a balun. The copper coil was tapped every few turns and those taps were terminated on a commutator.

The whole assembly was placed over an iron shaft, separated and positioned by wooden blocks. The resulting armature was spun between iron poles that were wrapped in copper coils.

The coils and armature windings were all connected in series - I believe. As the speed increased the voltage also increased.

The Gramme generator was the first commercially viable generator. It was used to drive the arc-lamps of coastal lighthouses.

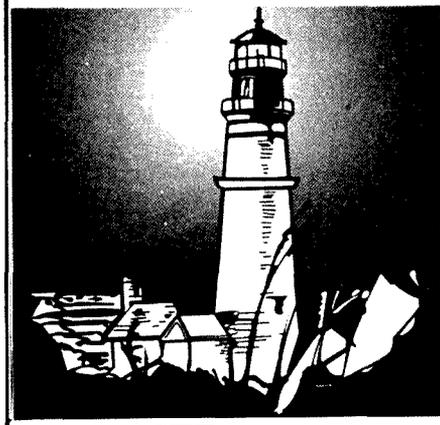

ar

Then it hit me. ... The old valve sets could become a monitoring station

HF PREDICTIONS

by Evan Jarman VK3ANI
34 Alandale Court, Blackburn Vic 3130

Adelaide-Johannesburg 237
Second 4F5-6 4E0 Short 10042 km

Brisbane-Christchurch 141
First 1F5-7 1E0 Short 2517 km

July 1999
T index: 125

Legend

UD
F-MUF - - - -
E-MUF - - - -
OWF - - - -
ALF - - - -
10% 50% - - - -
50% 90% - - - -
90% 100% - - - -

Frequency scale

Time scale

These graphs show the predicted diurnal variation of key frequencies for the nominated circuits. These frequencies as identified in the legend are:-

- Upper Decile (F-layer)
- F-layer Maximum Useable Frequency
- E-layer Maximum Useable Frequency
- Optimum Working Frequency (F-layer)
- Absorption Limiting Frequency (D region)

Shown hourly are the highest frequency amateur bands in ranges between these key frequencies; when useable. The path, propagation mode and Australian terminal bearing are also given for each circuit.

These predictions were made with the Ionospheric Prediction Service program: ASAPPS version 4.

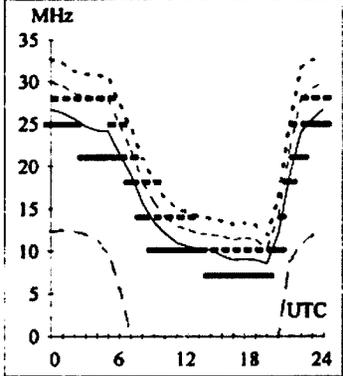
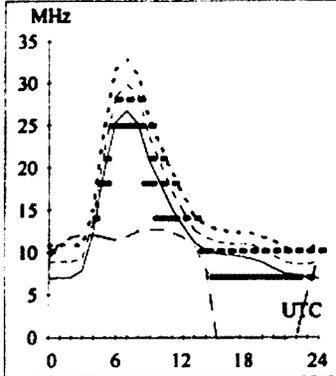

Adelaide-London 132
First F 0-5 Long 23755 km

Brisbane-Honiara 21
First 1F8-11 1E0 Short 2131 km

Canberra-Auckland 102
First 1F7-8 1E0 Short 2300 km

Darwin-San Francisco 54
Second 2F12-21 2E2 Short 12316 km

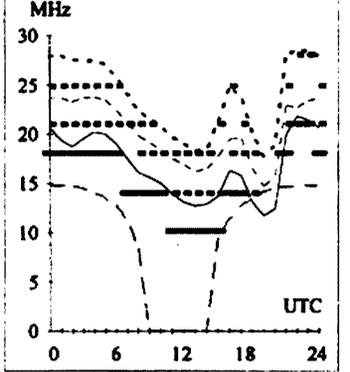
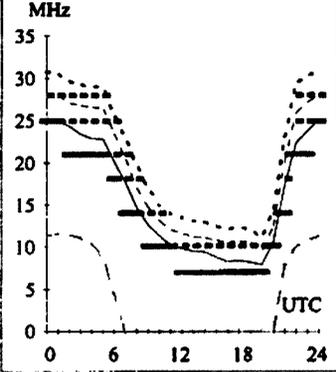
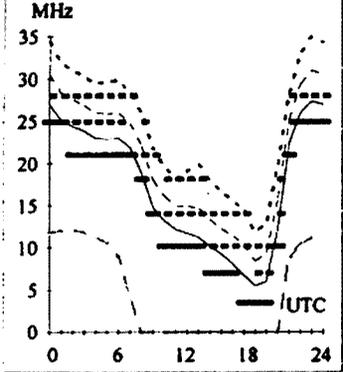
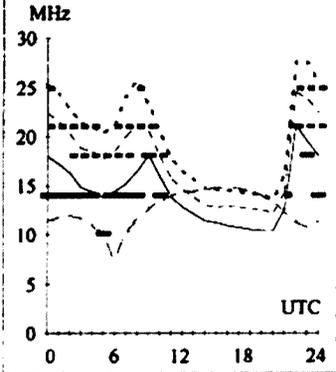

Adelaide-London 312
First F 0-5 Short 16269 km

Brisbane-Montevideo 154
First F 0-5 Short 12431 km

Canberra-Honolulu 50
First 1F3-8 3E0 Short 8407 km

Darwin-Singapore 295
Second 2F12-21 2E2 Short 3351 km

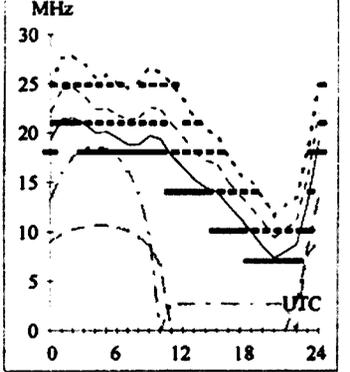
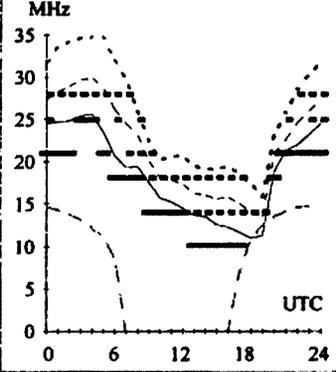
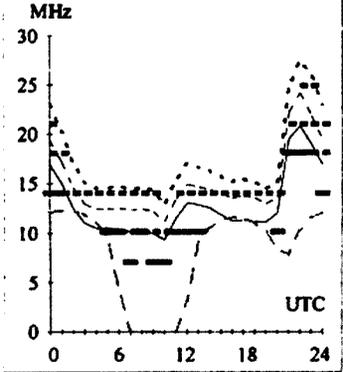
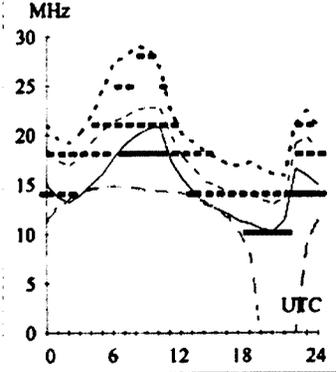

Adelaide-Los Angeles 66
First F 0-5 Short 13158 km

Brisbane-Tokyo 348
Second 3F6-12 3E0 Short 7159 km

Canberra-Paris 130
First F 0-5 Short 23100 km

Darwin-Tel Aviv 301
Second 4F3-11 4E0 Short 11303 km

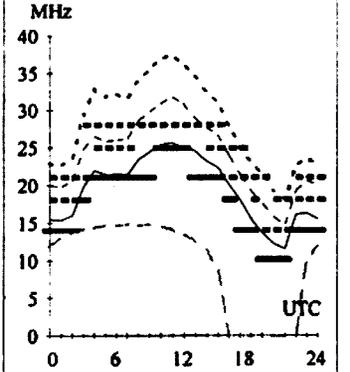
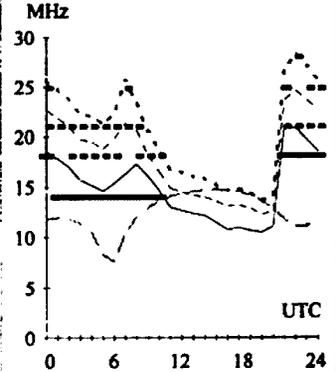
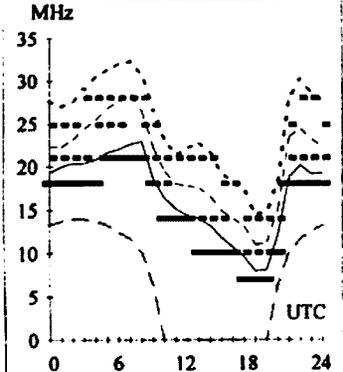
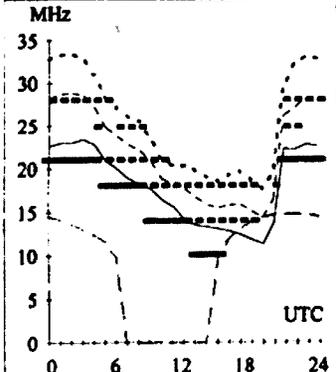

HF PREDICTIONS

Hobart-Berlin

124

First F 0-5 Short 23552 km

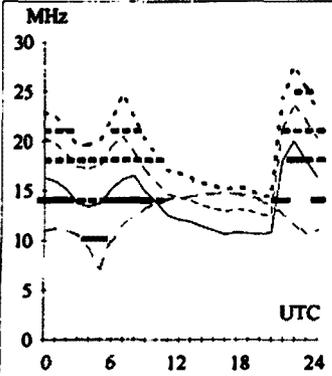

Melbourne-Athens

289

First F 0-5 Short 14950 km

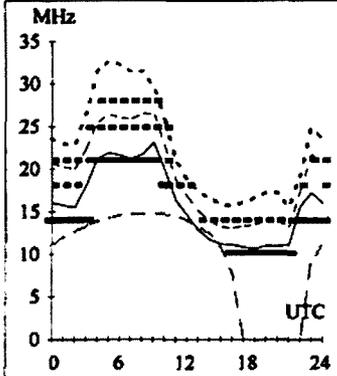

Perth-Cairo

298

Second 4F3-9 4E0 Short 11263 km

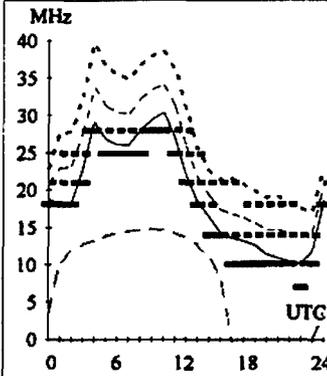

Sydney-Manila

324

First 2F2-6 2E0 Short 6263 km

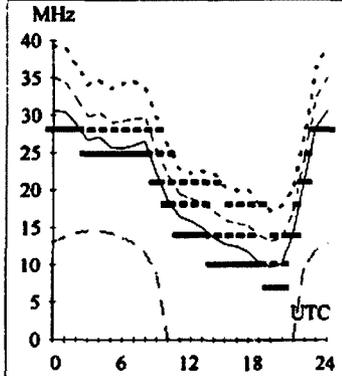

Hobart-Dakar

209

First F 0-5 Short 16556 km

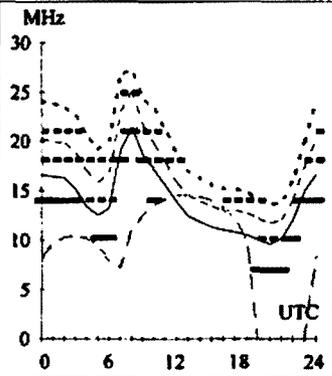

Melbourne-Pretoria

234

Second 4F5-6 4E0 Short 10352 km

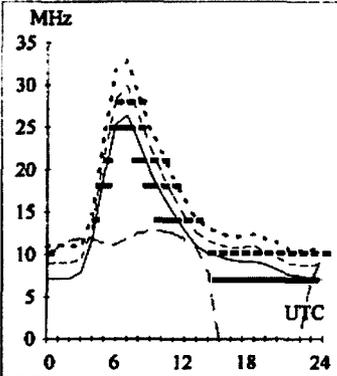

Perth-London

133

First F 0-5 Long 25543 km

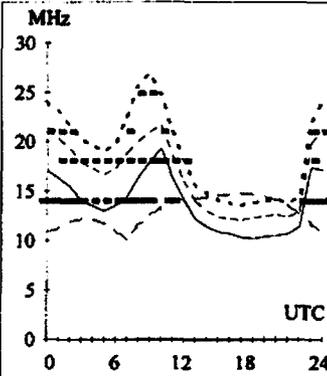

Sydney-Miami

86

First F 0-5 Short 15027 km

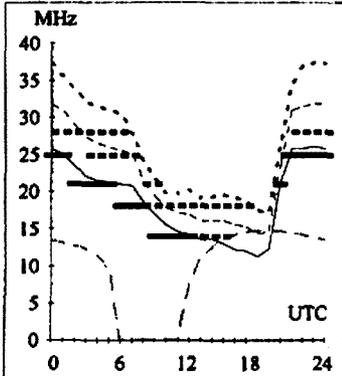

Hobart-Osaka

350

First 3F3-7 3E0 Short 8704 km

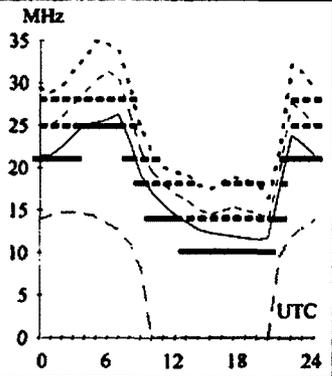

Melbourne-Suva

65

Second 2F9-11 2E0 Short 3913 km

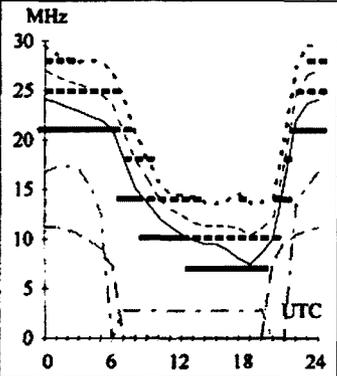

Perth-London

313

First F 0-5 Short 14481 km

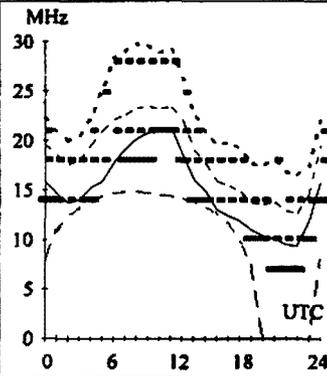

Sydney-Ottawa

58

First F 0-5 Short 15864 km

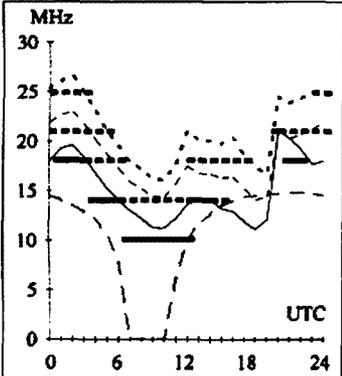

Hobart-Vancouver

49

First F 0-5 Short 13428 km

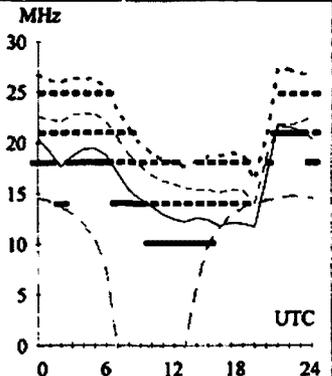

Melbourne-Taipei

337

Second 3F5-11 3E0 Short 7408 km

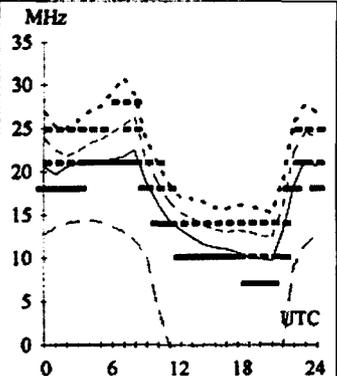

Perth-New Delhi

325

Second 3F5-12 3E0 Short 7872 km

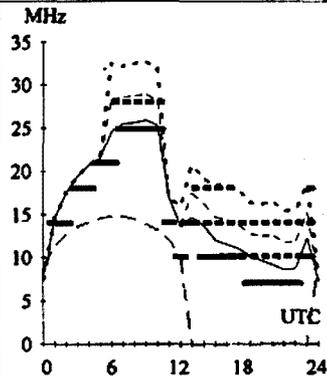

Sydney-Srinam

133

First F 0-5 Short 15907 km

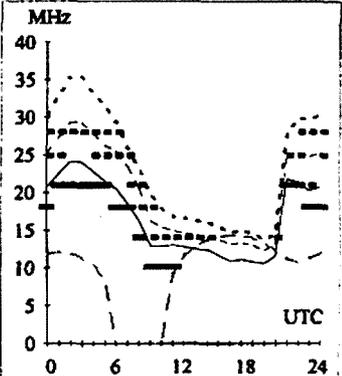

HAMADS

02 4943 8981 Fax 02 4920 6893
aob@hunterlink.net.au

- Hamads may be submitted on the form on the reverse of your current Amateur Radio address flysheet. Please print carefully, especially where case or numerals are critical.
- Please submit separate forms for For Sale and Wanted items, and be sure to include your name, address and telephone number (including STD code) if you do not use the flysheet.
- Eight lines (forty words) per issue free to all WIA members, ninth and tenth lines for name and address. Commercial rates apply for non-members.
- Deceased estates Hamads will be published in full, even if the ad is not fully radio equipment.
- WIA policy recommends that the serial number of all equipment for sale should be included.
- QTHR means the address is correct in the current WIA Call Book.
- Ordinary Hamads from members who are deemed to be in general electronics retail and wholesale distributive trades should be certified as referring only to private articles not being re-sold for merchandising purposes.
- Commercial advertising (Trade Hamads) are pre-payable at \$25.00 for four lines (twenty words), plus \$2.25 per line (or part thereof), with a minimum charge of \$25.00. Cheques are to be made out to: WIA Hamads.
- Copy should be typed or in block letters, and be received by the deadlines shown on page 1 of each issue of Amateur Radio, at:

Postal: Newsletters Unlimited, 29 Tanner Street, Richmond, 3121

Fax: 03 9428 4242

E-mail: news1@webtime.com.au

Please only send your Hamad once

Please send Hamads by mail OR fax OR email (much preferred).

Please do not send by more than one method for any one ad or issue, it is confusing.

FOR SALE ACT

- BIRD 4385 RF Power Analyst for CW, PEP, SWR. Return Loss uses Mod 43 Plug-ins digital display in W or dB. New \$460. ICOM all-mode transceivers 471H 75W 70cm and 271A 25W 2m with Mutek front-end ea \$800 Ed VK1VP QTHR 02 6249 6348
- YAESU FC-700 HF Antenna Tuner \$200 Ed VK1NBH 02 6251 2312 or email gudruned@telstra.easymail.com.au
- YAESU FT-101 s/n 11211367 xcvr, Manuals, \$300 ONO Rick VK1ALR, QTHR or BH (02) 6201 7890 Or AH (02) 6258 9228
- YAESU FT 757 GX2 P/s FP707 ATU FC757 mobile bracket, OUTBACK 7 band 2mts \$1800 ICOM IC 281H, 1/2 wave ant \$300 6m IC502 \$75. VHF HH TH 27A access \$250. MFJ Ant HIQLOOP \$300 or all above plus shack clearance \$100s for \$2500 Greg VK1GPC Home Tel /Fax (02) 6247 3771

FOR SALE NSW

- TRANSFORMER 600 x 600 CT 300mA 2 Filter CHOKES 4H 300mA \$20 Lot. 2- 866 Rectifiers \$10 pair. New KT66 \$10 each. 1-829B new \$10. 1-829B and ceramic socket \$10. AWA VTM \$20 Strobe Flash (DAWE) \$20 Audio and Signal Generators Cheap \$16-20 VK2AHP 02 9746 6858
- YAESU 726R tribander with uhf, vhf, 50m, and satellite modules fitted. Ex.cond. All manuals. \$900. GSL Electronics DC/DC converter 24/12volts. 20 amp output. Model SM-120 switchmode. New never used. \$150. VK2COF David. Phone 02 4861 5734.
- YAESU FL2100B linear \$600.00 Yaesu FL2100Z linear \$850.00 Yaesu FT980 HF tcvr. \$850.00 Yaesu FRG7700 comms revr. \$250.00 Kenwood TH215 2mt. port. \$300.00 Kenwood

TR7625 2mt. xcvr. \$150.00 President HR2510 10mt. xcvr. \$200.00 Glen VK2FC Ph.02 49826800

● LOW NOISE Ham Location. Elevation 1100m in the BlueMountains 3km from Bell, Just 1.5 hours drive from Ryde. Ideal weekender or retirement. Well built one bedroom house (furnished) on 3.5 acres \$95,000 Bob (02) 9878 2359

● YAESU FT901D gc. \$450. YAESU FT101ZD gc. \$450. YAESU F.V.901 ext-vfo Memory unit gc. \$200. YAESU FT301D gc. \$500. YAESU FP 301D p/s gc. \$300. YAESU YO 301 Monitor scope gc. \$280. YAESU FV 301 ext-vfo gc. \$200. YAESU FL2100B Linear Amplifier gc. \$800. YAESU FT209 2m. TX-RX handheld PA3 charger car adapter MH 12 Speaker Mic never used \$300. PALOMAR 12v 200W H.F. linear \$150. Hi-Mound Keyer never used \$75. Home brew ATU \$100 kw. dummy load gc \$75. Peter VK2DBI QTHR 02 6367 5095

● KENWOOD TS430S (FM-ETC) \$550 ono. TOKYO HIGH POWER HC 250 ATU \$100 ono. TOKYO HIGH POWER HC500 ATU \$100 ono. DAIWA CL66 1kw ATU \$100 ono. DAIWA CNW 217 100W ATU \$80 ono. Dick Smith Co-ax switches 1kw \$20 ea ono. MFJ 1040B Preselector \$140 ono. Timewave DSP 9 \$130 ono. 1 x Speech Processor (G3FEW) Amateur or CB \$150 ono. Ian VK2AMM 02 4932 8935

● ICOM IC736 HF/6M 100W 101MEM. \$1400 MFJ 969 Versa tuner \$250. Tandy PRO2005 Scanner 25-520M 760-1300m 400 Mem \$300. Alinco DJ-X1 Miniature Scanner 100K-1200M 100 Mem \$250. Bearcat BC590XLT Scanner 29-512M 100mem \$250. Bearcat UBC9000XLT 25-1300M 500Mem \$300. YAESU FT26 2 Metre Miniature H/Held \$250. REALISTIC HTX-100 10 metre T/Ceiver \$200. KENWOOD TR7800 2M T/Ceiver \$200. PRESIDENT HR25 10 Metre T/Ceiver \$200 S/Ns available Tony VK2BOA

● YAESU FT411 HT 2M XCVR 5W with Spkr/ Mic car adap. charger case and book. s/n IT 461376 P.C. \$200. KENWOOD TM241 50W 2M Mobile XCVR with book P.C \$300. ICOM ICQ 7 Dual band XCVR RX Cover 30-1300 MHz as new s/n/01160 \$250 John VK2CCC 02 4984 9770.

● ICOM IC-P2CT 2m 5 Watt output, 99 memories HH transceiver with 12V nicad pack and dry cell case. As new, complete with instruction book and soft case. 2 available. \$160.00 each or \$300.00 the pair. VK2HL, QTHR, Ph 99719795.

● YAESU FT-757GX HF tcvr SN 3L020097 EC \$550. YAESU FC-700 Antenna Tuner SN 3D020822 EC \$100. MD1 Desk Mic \$40. Bencher YA-1 Low-pass Filter \$60. YAESU FL-2100B linear amp SN 7N240468 GC \$450. YAESU FT-690R 6m tcvr SN 1L020993 GC \$240. Tokyo Hy-power HL-66V 6m linear amp SN 500751 GC \$140. KENWOOD TR-751A 2m tcvr SN 7070102 EC \$450. KENWOOD TR-851A tcvr SN 8080111 EC \$550. AEA PK232 Multi-Mode TNC (No mailbox) SN 19073 EC \$200. Bencher BY-2 Iambic chrome paddle \$60. Emtron EP-2000 SWR/Power meter SN 318 EC \$80. Labtech Q 0155 20MHz scope, RF probes SN 6056185 EC \$450. MFJ-209 HF/VHF SWR analyzer EC \$150. MFJ-440 UHF SWR analyzer EC \$110. YAESU FT-4700RH V/UHF mobile tcvr w/MX-2 diplexer SN 410436 EC \$500. YAESU YH-1 headset & SB-10 PTT switch new \$40. ATN 13-30 log-periodic antenna \$450. SATTRACKER 2/70 antenna, crossed yagi \$300. KENPRO KR-400 Az rotator \$180. KENPRO KR-500A El rotator \$250. NALLY 13.7m tilt/ telescope tower w/comps \$600. Emtron EDM-1 Dip Meter EC \$50. Field Strength meter DSE kit H/brew \$20. Emtronics EM5 whip antenna \$80. Capacitance meter H/brew \$45. WISHER digital Freq. counter 1.2 GHz \$100. DSE AR220 antenna rotator 250 Kg \$100. Revex L20 15w/100w dummy load \$25. Engine immobiliser kit Jaycar \$10. Wireless intercom 2 station \$35. Most items in original packing. Transmitting gear to licensed Amateurs only. Bill VK2APN 02 4421 4947.

● ALINCO DJ100T with extras \$180. ALINCO DR-M40HX 70cm mobile 35 W \$ 280. KENWOOD TS50 hf mobile \$ 950. KENPRO KR400C rotator \$ 200. Andrew VK2AR (02) 9896 5859

● CAVITY FILTERS 2M. Sufficient heavy gauge 100mm copper tube and brass for end caps to make six cavities. What offer? Goulburn Amateur Radio Society David VK2BDT 02 4821 5036.

FOR SALE VIC

● For sale from the estate of the late Norm Eadie VK3UP: 1 - YAESU 101Z transceiver with YD 148 dual impedance mic, manual and cables \$300 O.N.O. 2 - YAESU FL2100B linear with spare 572B tube. \$600 O.N.O. Ring Arthur VK3VQ (03) 9598-4262 anytime

● SHACK CLEARANCE: 1 - GOODWILL 5 MHz single beam CRO with spare mains transformer. \$65 2 - MFJ 114 Giant LED 12/24 hour clock. Brand new. Never used. \$55 3 - GRUNDIG grid dip oscillator 1.7 to 250 MHz. EC. \$125 4 - LEADER LMV10 audio millivoltmeter. 1.0 MHz bandwidth. \$60. 5 -

LEADER LAG120A audio sine/square wave generator to 1.0 MHz. \$40. **6 - WINRADIO 10001** all mode computer based communications receiver. 150KHz to 1300 MHz The original Australian designed computer radio. Minimum needs a 486 with 4 Mb RAM and sound card. Only 5 months old. Can be seen going by arrangement. Cost \$499.95. Will sell for \$400. O.N.O. Harold VK3AFQ (QTHR) (03) 9596 2414 anytime.

• **KENWOOD TS-660**, Covers 6m, 10m, 15m, 12m, 11m, all modes, good condition, \$400. Richard VK3ZCL (03) 9729 1947

• **KENWOOD TS930S HF Transceiver** in mint condition with service manual. \$800.00. Ken VK3FKD QTHR Phone 03 9798 6530.

• **VIDEO (???) IF Sweep Generator Model VP-886A 20-30Mc Sound IF Sweep generator Model VP 884A 5.5Mc. Trap Adjustor model VP 882A 5.5Mc Telequipment Oscilloscope D51 182717** reasonable offers Tony VK3PTV 03 9729 1513.

• **RENOVATORS OR COLLECTORS** delight. Weston LM160 base station and mobile say \$50. Max VK3VI 03 5147 1763.

FOR SALE QLD

• **AEA DSP 232** Never used. This modem allows transmit & receive on all digital modes. DSP can also receive TDM, Navtex, black & white weather fax. Ideal for Digital Short Wave listeners as well. All manuals, cables for two separate radios, connect package, "loop Back" with connector & jumper, RS -232 cable. Cost \$1200.00 Sell \$500. ONO. Email:beejay@power.com.au.VK4YWY (07) 3205 8488, 7 Curran Close Bray Park Qld 4500

• **KENWOOD TS440S AT HF Transceiver** Excellent condition as new MB430 Mobile Bracket \$950. **TOKYO HY-POWER HC500 ATU HF \$125. LEADER LSG-16 Signal Generator \$100. KENWOOD PS-32 Power Supply \$225. SHURE 526-T Amplified Dynamic Base Microphone \$150. HUSTLER 4BTV HF Trapped Vertical \$175 John VK4SKY 04 1741 0503 Box 1166 Coolangatta 4225 QLD.**

• **RADIOTRON Designers Handbook \$50. TRANSWORLD solid state linear 500W \$1500. SWAN 350 DC/AC PSU/S \$350. HALLICRAFTERS SX 101A \$330. SX-111 \$200. STC 4017 Mic \$50 NATIONAL NCX3 DC/PSU spares. OFFER . TERMAN Radio Engineers Handbook 1st 1943 Flyer. Peter VK4APD 07 3397 3751 AH.**

• **KENWOOD TS570S** As new full warranty sn 90400156 \$1650 **KENWOOD PS32 Power supply** as new \$200 boxed. **KENWOOD TM241A 50Watt output 2Metre FM 118-174Mhz receiver \$275. KENWOOD TS 140S MC-43S DC Lead** as new in box \$850. **HUSTLER 4BTV \$150** any inspection welcome. John Abbott VK4SKY 04 1741 0503 PO Box 1166 Coolangatta QLD 4225.

• **KENWOOD TS430S** Mobile bracket, scanning hand mike, owner and service manual \$580 **ono KENWOOD TS440S** with automatic antenna tuner and narrow CW-Filter Mobile Bracket Scanning hand mike, owners and service manual \$780 **ono. LONG WIRE antenna Model A248D 3.5 to 14MHz** takes up to 1KW \$80. Mr F S Nicolls. 11 St Andrews Ave Birkdale QLD.

• **DSP Modem 2232 Timewave sn 14037** never used manuals \$450 VK4YWY 07 3205 8488.

FOR SALE SA

• **KENWOOD TS-130S AT-130 ATU VFO-120 MC-50 Desk Mic, mobile Bracket service** and all other manuals, excellent condition \$830. **SEL log periodic Antenna \$400.** Sell complete for \$1100 more for sale Paul VK5MAP QTHR Ph/Fax 08 8651 2398.

FOR SALE WA

• **EIMAC 4-1000 pull, exc condition, plus ceramic socket, SK506 glass chimney, and HR8 top cap \$300 Doug VK6ER (08) 9361-5594 (10am-6pm).** email to vk6er@telstra.easymail.com.au

• **ICOM IC451A \$280. ICOM IC 251A \$220. ICOM IC551D \$380. JRC JST135 c/w headset/ mic \$1880. HENRY LIN.AMP 2KD 80-10 \$2150. HENRY LIN.AMP 2006A 6m 1KW \$2300. HENRY LIN.AMP 2002A 2m 1KW \$2300. HEATHKIT LIN>AMP SB1000 160-10 \$920. HR2510 28MHz XCVR \$120. AR88D vintage RX \$440. COLLINS R390A mint \$880. All excellent condition, manuals. All ono VK6ACY QTHR 08 9571 4161 fax 08 9571 4340.**

FOR SALE TAS

• **YAESU Service manual suit FT900 all models new \$40. YAESU CT20 Mic. cable adaptor suits YAESU MDIC8 Base Mic to 8pin modular style plug FT900 and other YAESU Mobiles \$20 Allen VK7AN 03 6327 1171 Mob 0417 354410.**

• **KANTRONICS KPC3 VHF packet modem with box and manuals mint condition \$180 Phil VK7PU 03 6431 9284.**

WANTED NSW

• **TUNE-UP AND CIRCUIT INFO** needed for FM-806 Philips Transceivers for rescue squad. Maurie VK2DCC 014 438 215 Box 72 Coleambally 2707.

WANTED VIC

• **DISC DRIVE** with controller and printer interface to suit VZ-300 Vic VK3KVT QTHR 03 9754 4860.

• **KENWOOD DG5** Good working order digital display complete with cables etc to suit TS520S. George VK3VAM QTHR 03 9557 6056

• **AERIAL TUNING UNIT** for surplus military radio type WD c13 Tony VK3PTV 03 9729 1513

WANTED QLD

• **EIMAC. SVETLANA. RF Parts 3-5002 glass transmit tubes. Heavy duty Antenna rotator. Heavy duty HF linear Amplifier. HENRY. TEN TEC. COMMANDO. ALPHA. Antenna Telex HYGAIN TH7DXX. 204BAS TELREX CUSHCRAFT A4S Tower DEEKO butt section or Hills crank up. John Abbott VK4SKY 0417 410 503 PO Box 1166 Coolangatta 4225 Queensland.**

• **BUTTERNUT HF4B** assembly instructions wanted all expenses paid for a copy and postage. Mr FS Nicholls 11 St Andrews Ave Birkdale 4159.

• **ICOM-781 Transceiver** in good condition with manuals Jim VK4JS QTHR 07 3206 4193.

• **VALVES** two only 6A3 or two only 6B4 or dare I ask two or 4 only 2A3. Malcolm, VK4ZMM QTHR 07 32985454

WANTED SA

• **MICRONTA 22-202B** Multimeter operators Instructions will pay costs, photocopy will be OK Paul VK5MAP QTHR Phone fax 08 8651 2398.

• **TEKTRONIX** Sampling unit type ISI plus, if possible the probe to suit. VK5ZST C S Ratcliff 08 8520 2988.

• **HANSEN VSWR Meter** vertical wall mounting approx 5"x 2"x 2" HWD SO239 each end top and bottom. VK5ZLC QTHR 08 8294 6906.

WANTED TAS

• **VALVES QE08-200 +QV08 -100** small quantity required 535-A (as used in Boonton Qmeter model 260-A) T67/ ARC-3 or -49 VHF Transmitter any condition. Trevor VK7TB 03 6398 2118.

MISCELLANEOUS

• **SWAP MORSE KEYS** for other keys or telegraphic items: CLIPSAL PMG Key bakelite Base laquered Brass: WW2 Bomber bathtub key: Bendix MT-118 WW2 Aircraft key: WW2 Australian services small key PMG made: Similar WW2 Australian Key on steel base model B50410. All good restored condition. Ric VK2PH QTHR 02 9817 0337.

• **Amateur and CB magazines** free 1960-1995 Ring to arrange pick-up. 03 9557 6056.

• **The Federal WIA QSL Collection** requires QSLs. All types welcome especially rareDX pictorial cards, special issue. Please contact the Hon. Curator, Ken Matchett VK3TL, 4 Sunrise Hill Road, Montrose VIC 3765 (03) 9728 5350

• **If you got your licence before 1974** you are invited to join the **Radio Amateurs Old Timers Club**. A \$2.50 joining fee plus \$5.00 per year gets you two interesting Journals plus good fellowship

TRADE ADS

• **AMIDON FERROMAGNETIC CORES:** For all RF applications. Send business size SASE for data/price to RJ & US Imports, PO Box 431, Kiama NSW 2533 (no enquiries at office please ... 14 Boanyo Ave Kiama).

www.cyberelectric.net.au/~rjandusimports

Agencies at: Assoc TV Service, Hobart: Truscotts Electronic World, Melbourne and Mildura: Alpha Tango Products, Perth: Haven Electronics, Nowra.

• **WEATHER FAX** programs for IBM XT/ ATs *** "RADFAXZ" \$35.00, is a high resolution short-wave weather fax, Morse and RTTY receiving program. Suitable for CGA, EGA, VGA and Hercules cards (state which). Needs SSB HF radio and RADFAX decoder. *** "SATFAX" \$45.00, is a NOAA, Meteor and GMS weather satellite picture receiving program. Needs EGA or VGA & WEATHER FAX PC card, + 137 MHz Receiver. *** "MAXISAT" \$75.00 is similar to SATFAX but needs 2 MB of expanded memory (EMS 3.6 or 4.0) and 1024 x 768 SVGA card. All programs are on 5.25" or 3.5" disks (state which) plus documentation, add \$3.00 postage. ONLY from M. Delahunty, 42 Villers St, New Farm QLD 4005. Ph 07 358 2785.

WIA Division Directory

The WIA consists of seven autonomous State Divisions. Each member of the WIA is a member of a Division, usually in their residential State or Territory, and each Division looks after amateur radio affairs within its area.

Division	Address Officers	News Broadcasts	Note: All times are local. All frequencies MHz.	Fees
VK1 ACT Division GPO Box 600 Canberra ACT 2601	President Hugh Blemings Secretary John Woolner Treasurer Les Davey	VK1YYZ VK1ET VK1LD	3.590, 146.950, 438.375, 438.325, 438.225 & 438.025 FM each Sunday from 8.00pm AEST. News text on packet BCAST@VK1BBS. http://www.vk1.wia.ampr.org & aus.radio.amateur.misc newsgroup. Send items by packet as personal message BCAST@VK1BBS or e-mail to broadcast@vk1.wia.ampr.org.	(F) \$72.00 (G) (S) \$58.00 (X) \$44.00
VK2 NSW Division 109 Wigram St Parramatta NSW (PO Box 1066 Parramatta 2124) Phone 02 9689 2417 Freecall 1800 817 644 Fax 02 9633 1525	President Michael Corbin Secretary Eric Fossey Treasurer Eric Van De Weyer (Office hours Mon-Fri 11.00-14.00) Web: http://ozemail.com.au/~vk2wi/ e-mail: vk2wi@ozemail.com.au Packet BBS: VK2WI on 144.850 MHz	VK2YC VK2EYF VK2KUR	From VK2WI 1.845, 3.595, 7.146*, 10.125, 14.170, 24.950, 28.320, 29.120, 52.120, 52.525, 144.150, 147.000, 438.525, 1273.500 (* morning only) with relays to some of 18.120, 21.170, 581.750 ATV sound. Many country regions relay on 2 m or 70 cm repeaters. Sunday 1000 and 1930. Highlights included in VK2AWX Newcastle news, Monday 1930 on 3.593 plus 10 m, 2 m, 70 cm, 23 cm. The broadcast text is available on the Internet newsgroup aus.radio.amateur.misc , and on packet radio.	(F) \$69.00 (G) (S) \$56.00 (X) \$41.00
VK3 Victorian Division 40G Victory Boulevard Ashburton VIC 3147 Phone 03 9885 9261 Fax 03 9885 9298	President Jim Linton Secretary Barry Wilton Treasurer Rob Hailey (Office hours Tue & Thur 0830-1530) e-mail: vk3wi@rint.com.au Web: http://www.tbsa.com.au/~wivic/	VK3PC VK3XV VK3NC	VK3BWI broadcasts on the 1st Sunday of the month, starts 10.30 am. Primary frequencies, 3.615 LSB, 7.085 LSB, and FM(R)s VK3RML 146.700, VK3RMM 147.250, VK3RWG 147.225, and 70 cm FM(R)s VK3ROU 438.225, and VK3RMU 438.075. Major news under call VK3WI on Victorian packet BBS and WIA VIC Web Site.	(F) \$75.00 (G) (S) \$61.00 (X) \$47.00
VK4 Queensland Division GPO Box 638 Brisbane QLD 4001 Phone 07 3221 9377	President Colin Gladstone Secretary Peter Harding Treasurer Allstair Elrick e-mail: secretary@wiaq.powerup.com.au Web: http://www.wiaq.powerup.com.au	VK4ACG VK4JPH VK4FTL	1.825 MHz SSB, 3.605 MHz SSB, 7.118 MHz SSB, 14.342 MHz SSB, 21.175 MHz, 28.400 MHz SSB, 29.220 MHz FM, 53.725 MHz FM, 147.000 MHz FM, 438.500 MHz (Brisbane only), and regional VHF/UHF repeaters at 0900 hrs EAST Sunday. Repeated on 3.605 MHz SSB & 147.000 MHz FM at 1930 hrs EAST Monday. Broadcast news in text form on packet under WIAQ@VKNET.	(F) \$74.00 (G) (S) \$60.00 (X) \$46.00
VK5 South Australian Division 34 West Thebarton Rd Thebarton SA 5031 (GPO Box 1234 Adelaide SA 5001) Phone 08 8352 3428 Fax 08 8264 0463	President Ian Hunt Secretary Merv Millar Treasurer Joe Burford Web: http://www.vk5wia.ampr.org/	VK5QX VK5MX VK5UJ	1827 kHz AM, 3.550 MHz LSB, 7.095 AM, 14.175 USB, 28.470 USB, 53.100 FM, 147.000 FM Adelaide, 146.700 FM Mid North, 146.800 FM Mildura, 146.825 FM Barossa Valley, 146.900 FM South East, 146.925 FM Central North, 147.825 FM Gawler, 438.425 FM Barossa Valley, 438.475 FM Adelaide North, ATV Ch 35 579.250 Adelaide. (NT) 3.555 USB, 7.065 USB, 10.125 USB, 146.700 FM, 0900 hrs Sunday, 3.585 MHz and 146.675 MHz FM Adelaide, 1930 hrs Monday.	(F) \$75.00 (G) (S) \$61.00 (X) \$47.00
VK6 West Australian Division PO Box 10 West Perth WA 6872 Phone 08 9351 8873	President Cliff Bastin Secretary Christine Bastin Treasurer Bruce Hedland-Thomas Web: http://www.faroc.com.au/~vk6wia/ e-mail: vk6wia@faroc.com.au	VK6LZ VK6ZLZ VK6OO	146.700 FM(R), 438.525 FM(R), 29.120 FM at 0930 and 1900 hrs Sundays from Perth, relayed (morning only) on 1.865, 3.564, 3.582 (Busselton), 7.075, 14.116 (North), 14.175 (East), 21.185, 50.150; (morning and evening) 146.900(R) Mt William (Bunbury), 147.00(R) Katanning, 147.200(R) Cataby, 147.250(R) Mt Saddleback (Boddington), and 147.350(R) Busselton; (evening only) 1.865, 3.564 MHz.	(F) \$62.00 (G) (S) \$50.00 (X) \$34.00
VK7 Tasmanian Division 24 Targett Street Scamander TAS 7250 Phone 03 6372 5305	President Ron Churcher Secretary Paul Godden Treasurer John Klop Web: http://www.wia.tasnat.net e-mail: vk7kpg@hamnet.hotnet.com.au	VK7RN VK7KPG VK7KCC	146.700 MHz FM (VK7RHT) at 0930 hrs Sunday relayed on 147.000 (VK7RAA), 146.725 (VK7RNE), 146.625 (VK7RMD), 3.570, 7.090, 14.130, 52.100, 144.150 (Hobart), repeated Tues 3.590 at 1930 hrs.	(F) \$74.00 (G) (S) \$60.00 (X) \$46.00
VK8 Northern Territory (part of the VK5 Division and relays broadcasts from VK5 as shown, received on 14 or 28 MHz).				

Membership Grades

Full (F) Pension (G) Needy (G) Student (S) Non receipt of AR (X)
Three-year membership available to (F) (G) (X) grades at fee x 3 times.

ADVERTISERS INDEX

Amateur Transceiver Radio ... 16	Electronic Tube and Valve..... 5
Andrews 5	Icom..... OBC, 43
Av-Com 16	Radio & Communication..... 41
Brisbane Car Sound IFC	Rocom Components..... 17
Dick Smith IBC 28,29	

TRADE PRACTICES ACT

It is impossible for us to ensure that the advertisements submitted for publication comply with the Trade Practices Act 1974. Therefore, advertisers and advertising agents will appreciate the absolute need for themselves to ensure that the provisions of the Act are strictly complied with.

VICTORIAN CONSUMER AFFAIRS ACT

All advertisers are advised that advertisements containing only a PO Box number as the address cannot be accepted without the addition of the business address of the box-holder or seller of the goods.

FT-847 EARTH STATION



Only one transceiver gives you all-mode operation on the HF, 6m, 2m, and 70cm bands with full satellite capability...

the new Yaesu FT-847 "Earth Station"

Ready for action on SSB, CW, AM, FM and Digital modes, the FT-847's compact size makes it ideal for a variety of portable/mobile applications as well as for serious base station operation. You get a solid 100W output on the HF and 6m bands, 50W output on both 2m and 70cm, dual fan cooling and a rugged diecast chassis. Plus, the ultra-quiet HEMT receive pre-amp on 2m and 70cm contributes to the FT-847's industry best sensitivity figures. Advanced Digital Signal Processing (DSP) circuitry enhances received signal/noise ratio for easier copy of signals under marginal conditions through the use of 16 selectable noise reduction algorithms, while the Bandpass and Auto-notch filters aid the IF based Shift and Noise Blanker circuits in reducing interference on crowded bands.

The FT-847 is ready for satellite operation, with crossband full duplex operation, normal and inverted VFO tracking of the satellite uplink/downlink, as well as 12 special satellite memories with alpha-numeric tags. Also provided is a low-noise Direct Digital Synthesiser (DDS) that provides tuning steps as small as 0.1Hz, plus there's an adjustable DSP bandpass filter as narrow as 25Hz for exceptional weak-signal CW performance. You can also install optional Collins® mechanical filters in both the transmit and receive chain for enhanced SSB operation, as well as a 500Hz Collins® filter in the receiver side for CW. An RF-style speech processor with adjustable frequency shift voice tailoring is also provided to add punch to your SSB transmissions.

The FT-847 is ready for data modes, with a rear panel Data In/Out socket and a Packet socket for 1200/9600 baud

VHF/UHF operation. Other features include extended receive operation (37-76, 108-174, and 420-512MHz), a high-speed computer control interface, 10 key keypad for band/frequency entry, and a Shuttle-Jog tuning ring for fast QSY. Also included are encode/decode CTCSS and DCS operation, selectable channelised steps for FM operation, FM narrow/wide modes for 29MHz use, and a large LCD screen with adjustable backlighting.

Each transceiver is supplied with a hand-mic, DC power lead and a comprehensive instruction manual. Call us for a copy of Yaesu's 6 page colour brochure to learn more about this incredible value "Earth Station" transceiver.

D 3425

2 YEAR WARRANTY
YAESU

\$2995

DICK SMITH
ELECTRONICS

That's where you go!

MORE

GREAT

GEAR

FROM

ICOM



PCR100 Cruise the air waves with your computer. Turns your PC into a high performance 0.5 - 1300 MHz receiver (FM/WFM/AM modes) with plug'n play installation. Multi function control panel, wide frequency coverage, and unlimited memory channels.

R2 Fit the world's airwaves in your shirt pocket. Just 8.6cm high, wide 0.5 - 1300 MHz frequency range divided into 9 bands plus FM/WFM/AM, 400 memory channels, great sound in rugged water resistant construction.

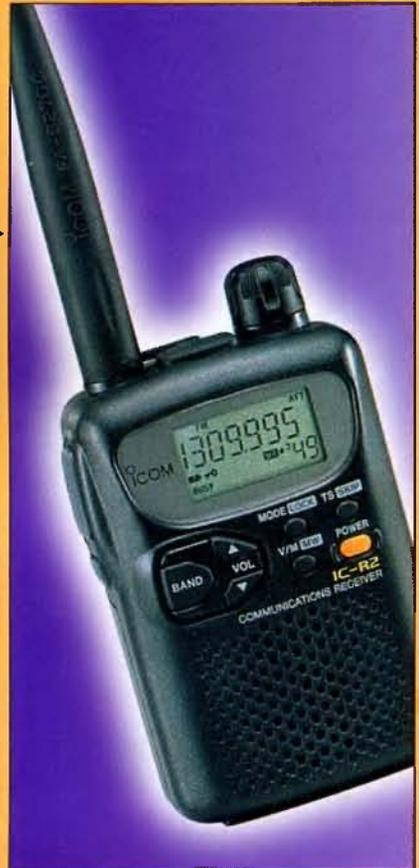

2800H A totally new approach to dual band mobile. Powerful performance on 2m and 70cm bands, remote control capability, and a first for mobile rigs...a multi-function colour LCD screen! All your information is right in front of you in colourful 3D-like characters and icons.

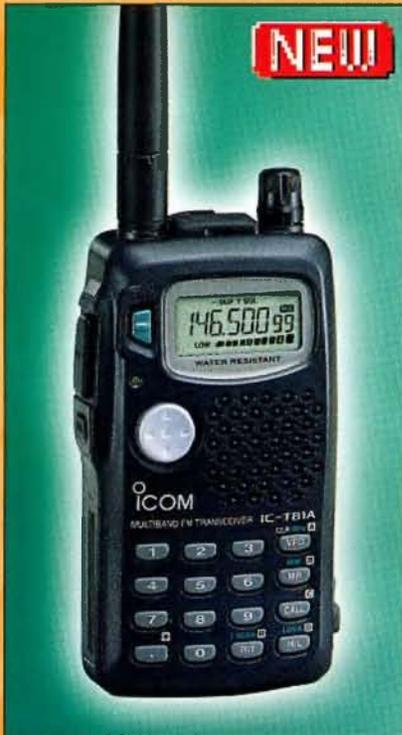

T81A A remarkably compact quad bander. Superb clarity on the 6m, 2m, 70cms and 23cm bands. It's water resistant, with tone squelch and pocket beep functions standard, plus you can change volume and bands even quicker with the 'joy-stick' style multi-function switch.

706MKIIG The amazing evolution of the legendary 706. Frequency coverage is expanded to the 70 cm band and output power is increased for the 2m band. You get base station performance and features in a mobile rig-sized package.



ICOM
Clearly Ahead

2-YR-WARRANTY

See your nearest Icom Dealer, call Icom on 1800 338 915, or visit our website at www.icom.net.au



August 1999

Volume 67 No 8

Amateur Radio

Journal of the Wireless Institute of Australia



Full of the latest amateur radio news, information and technical articles, including...

- ★ ICOM IC-Q7A Review
- ★ Y2K: It's Elementary, My Dear Watson
- ★ VK5s go to Dayton Hamvention '99 - USA
- ★ ARDF Championships - Korea
- ★ WIA/ACA Meeting Report
- ★ An Attenuator Set for Receiver Sensitivity Measurements

Plus *lots of other articles, news and special interest columns.*

The Contest Calendar

Contest Calendar August - October 1999

Aug 1	YO DX Contest (CW/SSB)	
Aug 7	SARS Sprint Contest (CW)	(Jun 99)
Aug 7	Waitkere Sprint (CW)	(Jun 99)
Aug 7	European HF Championship (CW/SSB)	
Aug 14/15	Keymen's Club of Japan Contest (CW)	(Jul 99)
Aug 14/15	Remembrance Day Contest (CW/SSB)	(Jul 99)
Aug 14/15	Worked All Europe DX Contest (CW)	(Jul 99)
Aug 21/22	SEANET SSB Contest	(Jun 99)
Aug 28/29	SCC RTTY Championship	(Aug 99)
Aug 28/29	TOEC WW Grid Contest (CW)	
Sep 4/5	All Asia DX Contest (Phone)	(May 99)
Sep 4/5	Bulgarian DX Contest (CW)	(Aug 99)
Sep 5	Panama Anniversary Contest (SSB)	(Aug 99)
Sep 11/12	Worked All Europe DX Contest (Phone)	(Jul 99)
Sep 18/19	SAC DX CW	(Aug 99)
Sep 25	Internet CW Sprint Contest	
Sep 25/26	SAC DX Phone	(Aug 99)
Sep 25/26	CQ WW RTTY DX Contest	(Aug 99)
Oct 2/3	VK/ZL/Oceania DX Contest	(Aug 99)
Oct 3	RSGB 21/28 Mhz Contest (SSB)	(Aug 99)
Oct 9	Ten-Ten Int. Day Sprint (CW/SSB/RTTY)	(Sep 99)
Oct 9/10	VK/ZL/Oceania DX Contest	(Aug 99)
Oct 16/17	JARTS WW RTTY Contest	(Sep 99)
Oct 16/17	Worked All Germany Contest (CW/SSB)	
Oct 17	Asia-Pacific Sprint (CW)	(Jan 99)
Oct 17	RSGB 21/28 Mhz Contest (CW)	(Aug 99)
Oct 30/31	CQ WW DX Contest (SSB)	(Sep 99)

Main Australian Contests

Remembrance Day Contest (August)

Australia's biggest contest. States compete for RD Trophy. Highly recommended.

VK-ZL-Oceania DX Contest (October)

An opportunity for overseas stations to work Australia and New Zealand and vice versa. If 10 and 15 metres are your best bands, this one is worth a shot.

VHF/UHF Spring Field Day (November)

A chance to go portable on the VHF/UHF bands. Activity is on SSB and FM.

Ross Hull VHF/UHF Contest (December/January)

THE contest for the serious VHF/UHF DXer and microwave enthusiast. Most activity is SSB rather than FM, so Novices will find contacts difficult.

VHF/UHF Summer Field Day (January)

Another opportunity to go portable on VHF/UHF. Activity is on SSB and FM.

John Moyle Field Day (March)

Portable operating on all bands. Great fun!

VK Novice Contest (June)

A HF-only contest originally intended for newcomers to amateur radio - not as popular as most other contests.



Amateur Radio

Volume 67
Number 8
August 1999

The Journal of the Wireless
Institute of Australia

ISSN 0002-6859

Amateur Radio is published by the Wireless Institute of Australia ACN004 920 745 as its official Journal on the first Friday of each month

Editorial

Editor:	Bill Rice*	VK3ABP
Production Manager:	Bob Harper	VK4KNH
Snr Technical Editor:	Peter Gibson*	VK3AZL
Technical Editors:	Evan Jarman*	VK3ANI
	Gil Sones*	VK3AUI
Contributing Editors:	Ron Fisher*	VK3OM
	Don Jackson*	VK3DBB
WIA News Editor:	David Thompson	VK2NH

*Publications Committee member

Advertising

Mrs June Fox, WIA Federal Office
PO Box 2175 CAULFIELD JUNCTION VIC 3161
Tel: (03) 9528 5962 Fax (03) 9523 8191
email armag@hotkey.net.au

Hamads

"Hamads" Newsletters Unlimited
29 Tanner Street, Richmond VIC 3121
Fax: (03) 9428 4242
e-mail: news1@webtime.com.au

Amateur Radio Correspondence

All correspondence, contributions and queries about the **content** should be sent to:

The Editor Amateur Radio

PO Box 2175, CAULFIELD JUNCTION VIC 3161
email armag@hotkey.net.au
Tel: (03) 9528 5962 Fax (03) 9523 8191

Amateur Radio Delivery

All queries regarding delivery should be directed to:

Amateur Radio WIA Federal Office

PO Box 2175 Caulfield Junction Vic 3161
Tel: (03) 9528 5962 Fax (03) 9523 8191

Registered Office

10/229 Balaclava Road
Caulfield North VIC 3161
Tel: (03) 9528 5962 Fax (03) 9523 8191
Business hours: 9.30am-3pm weekdays

Editorial & Display Booking Deadlines

September	13/8/99
October	10/9/99
November	8/10/99

Hamad & Display Material Deadline

September	20/8/99
October	17/9/99
November	15/10/99

Production

Administration, Drafting, Design & Sub-editing
Shadetree Publishing & Imaging
PO Box 288 BEERWAH OLD 4519

Pre-press, print and mail management
Newsletters Unlimited (03) 9428 3458

Printed by Streamline Press, Melbourne (03) 9417 2766

Mailed by IMS, Melbourne (03) 9291 5888

Receipt of Amateur Radio by mail

This issue was delivered to Australia Post on Wednesday July 7 if you are a financial member and have not received your copy by the 15th of the month please check with your local Post Office before contacting the registered office of the WIA.

Copyright and Reproduction

The copyright in this magazine, except where specifically noted, is held by Wireless Institute of Australia ©WIA 1999. Permission to republish articles in any form must be obtained in writing from the Institute (other than for purposes of 'fair dealing'). This permission is usually freely given for information purposes.

General

1999 Remembrance Day Contest	13
<i>Alek Petkovic VK6APK</i>	
Y2K: it's Elementary, My Dear Watson	18
<i>Alar: Shawsmith VK4SS</i>	
VK5s go to Dayton Hamvention '99 - USA	20
<i>Grant Willis V65ZWI</i>	

Technical

An Attenuator Set for Receiver Sensitivity Measurements	22
<i>Drew Diamond VK3XU</i>	
Equipment Review - Icom IC-Q7A	25
<i>Paul McMahon VK3DIP</i>	
Technical Abstracts	32
<i>Gil Sones VK3AUI</i>	

Columns

Advertisers' Index	56	Intruder Watch	45
ALARA	12	Ionospheric Update	51
AMSAT Australia	38	New Members	2
AR on the Web	31	Novice Notes	47
ARDF	15	On Video	14
Club News	11	Pounding Brass	41
Contests	42	Repeater Link	40
WIA Division News		Silent Keys	30
VK1 Notes	8	Spotlight on SWLing	46
VK3 Notes	8	Try This	30
VK6 Notes	9	VHF/UHF - An Expanding World	35
VK4 Notes	9	WIA Comment	3
Editor's Comment	2	WIA/ACA Meeting	4
Education	7	WIA News	5
Hamads	54	WIA Division Directory	56
HF Predictions	52	WIA Federal Directory	2

Our cover this month

Cover photo demonstrates the miniature size of modern Icom and Yaesu handheld transceivers.
Photo courtesy of Paul McMahon VK3DIP

Contributions to Amateur Radio

Amateur Radio is a forum for WIA members' amateur radio experiments, experiences opinions and news. Manuscripts with drawings and or photos are always welcome and will be considered for publication. Articles on disc or email are especially welcome. The WIA cannot be responsible for loss or damage to any material. A pamphlet, How to write for Amateur Radio is available from the Federal Office on receipt of a stamped self-addressed envelope.

Back Issues

Back issues are available directly from the WIA Federal Office (until stocks are exhausted, at \$4.00 each (including postage within Australia) to members.

Photostat copies

When back issues are no longer available, photocopies of articles are available to members at \$2.50 each (plus an additional \$2 for each additional issue in which the article appears).

Disclaimer

The opinions expressed in this publication do not necessarily reflect the official view of the WIA and the WIA cannot be held responsible for incorrect information published.

Amateur Radio Service

A radiocommunication service for the purpose of self-training, intercommunication and technical investigation carried out by amateurs; that is, by duly authorised persons interested in radio technique solely with a personal aim and without pecuniary interest.

Wireless Institute of Australia

The world's first and oldest
National Radio Society
Founded 1910

Representing
The Australian Amateur Radio Service

Member of the
International Amateur Radio Union

Registered Federal Office of the WIA
10/229 Balaclava Road
Caulfield North Vic 3161
Tel: (03) 9528 5962 Fax (03) 9523 8191
<http://www.wia.org.au>

All mail to
PO Box 2175 Caulfield Junction VIC 3161

Business hours: 9.30am-3pm weekdays

Acting Federal Secretary

Peter Naish VK2BPN

Federal Office staff

June Fox Bookkeeper
Rita Trebilco VK3IF Examinations Officer

Council

President	Peter Naish	VK2BPN
VK1 Federal Councillor	Glenn Dunstan	VK1XX
VK2 Federal Councillor	Michael Corbin	VK2YC
VK3 Federal Councillor	Brenda Edmonds	VK3KT
VK4 Federal Councillor	Ross Marren	VK4AMJ
VK5 Federal Councillor	Ian Hunt	VK5QX
VK6 Federal Councillor	Will McGhie	VK6UU
VK7 Federal Councillor	Phil Corby	VK7ZAX

Executive

Peter Naish VK2BPN
Tony Farrow VK2TJF
John Lottus VK4EMM
Wally Howse VK6KZ

Federal Coordinators

AMSAT	Graham Ratcliff	VK5AGR
ARDF	Jack Bramham	VK3WWW
Awards	John Kelleher	VK3DP
Contests	Ian Godsil	VK3DID
Education	Brenda Edmonds	VK3KT
FTAC	John Martin	VK3KWA
Historian	John Edmonds	VK3AFU
IARU	Grant Willis	VK2ZWI
Intruder Watch	Gordon Loveday	VK4KAL
ITU Conference and study group	David Wardlaw	VK3ADW
Public Relations	David Thompson	VK2NH
QSL Manager (VKs, VKs)	Neil Penfold	VK6NE
Videotapes	Don Bland	VK4TVD

ACA Liaison Team

Peter Naish VK2BPN
Glenn Dunstan VK1XX
Michael Corbin VK2YC
Wally Howse VK6KZ
Canberra Liaison Officer
Richard Jenkins VK1RJ

EDITORS COMMENT

Going...Going...When...?

THE TITLE POSES a question to which I have only an approximate answer. You will have seen the announcement on page 27 of the last month's AR, which contains the news that I wish to retire, and seek someone to take the job over. The big question is, precisely when? Any time after August will suit me; and here we are, it's August!

This is the month in which I complete 15 years and 3 months as Editor of AR, to set a new record. Tom Hogan VK3HX held the chair from March 1941 to May 1956 (15 years and 2 months). Tom became Silent Key some decades ago.

One factor not emphasised in the announcement is that a period of some months overlap between editors would benefit all concerned, but particularly the new Editor.

An arrangement, which the armed forces describe as "handover-takeover". So to whom will I hand over? We may know by the time you read this!

Mention of the armed forces reminds me of the RAAF Williams Amateur Radio Club, which has been in what might be described as hibernation for a couple of years. This came about because the RAAF School of Radio, which had been at Laverton, was moved to Wagga Wagga some time back, thereby removing many of the radio club members. One result is that there are now fewer WIA-accredited examiners in Melbourne's Western Suburbs than was the case while the club was active. So there is something I might be able to do rather than just "twiddle" thumbs after my successor takes over! Mind you, I'm not really looking for work, though! Are there any volunteers with a little spare time?

Bill Rice VK3ABP
Editor

NEW WIA MEMBERS

The WIA bids a warm welcome to the following new members who were entered into the WIA Membership Register during the month of JUNE

L21168	MR E KELLY	VK3TPM	MR P MITCHELL
L31548	MR I BEVAN	VK3XBW	MR B WINTON
L50366	MR A DAWSON	VK5AB	MR P MEACHAM
L50532	MR T R MCBAIN	VK5AH	MR A HUNT
VK2AEZ	MR E MARSTELLA	VK5ASN	MR J HARRIS
VK2IOT	MR G TULLY	VK5ZL	MR M G WHITE
VK2LB	MR A S RADFORD	VK6BSW	MR H C BUTLER
VK2TPS	MR R MAIN	VK6DJ	MR E LUCAS
VK3AMM	MR M MUXWORTHY		

<http://www.wia.org.au>

check out the WIA webpage today!



Comment

Federal President, Peter Naish
VK2BPN.

WIA goes into bat with the ACA

The most important role of the WIA is to look after the interests of Australian radio amateurs and to ensure that they can pursue their activities with the knowledge that those who regulate the radio spectrum respect them.

BECAUSE IT IS a national role, the task of representing radio amateurs to the Australian Communications Authority (ACA) is vested in WIA Federal. For this purpose the WIA/ACA Liaison Committee was established some years ago and it works closely with ACA officers in Canberra to progress and resolve the issues that concern amateur radio operators in Australia. The members of the WIA committee are drawn from the divisions of the WIA and are appointed to the committee by the WIA Federal Council at its annual Convention. Those chosen have the knowledge and expertise required to present and debate the issues with the ACA. However, there are frequent occasions when it is necessary to seek assistance from others not on the committee to provide the liaison team with expert opinion to ensure that the proper information is put to the ACA. This means the WIA is able to present a balanced and informed case to the ACA in an effective and professional manner.

So, how does this work in practice? Because the WIA liaison team is spread throughout Australia, most of the time they work together by correspondence using email and occasional telephone conferences. It's demanding work and the team spends a lot of time preparing and updating issues for discussion with the ACA. At least twice a year, the WIA liaison team meets formally with ACA in Canberra to progress the wide range of issues. These are big meetings occupying most of a day and attended by senior level managers of ACA together with appropriate members of their departmental staff. In between these plenary sessions, there is often the need for ad hoc meetings to consider urgent matters that cannot wait for the next scheduled full meeting. Otherwise, there are written submissions on other less strategic matters that can more effectively be dealt with by correspondence.

The WIA/ACA Liaison Committee has

a Canberra-based liaison officer who is tasked with maintaining a day to day relationship with all those government departments and agencies that have an interest in the amateur radio service. Principally, these are the Department of Communications Industry and the Arts (DoCITA) and the ACA. He ensures that these organisations are continually made aware of the WIA and provides a physical presence in Canberra at all times. Another important associated element of the WIA liaison team is the work performed by the Federal Technical Advisory Committee (FTAC) who provide much detailed and vital technical support to the liaison committee.

How do you as a member of the WIA get your particular concern onto the agenda for the liaison discussions? Your Divisional Council together with your Federal Councillor has the responsibility to bring to the attention of the liaison committee all such concerns. The committee will then consider how it should be handled and will prioritise it in relation to other matters for presentation to the ACA. As you will realise, there is an extremely wide range of subjects and the liaison committee needs to rationalise and amalgamate many of these concerns into a format that can be effectively debated with the ACA. Basically these fall into general categories such as licensing matters, spectrum usage, examinations, technical considerations, special privileges, etc.

It must be remembered that the ACA is manager of the radio spectrum in Australia but their terms of reference are largely determined by the government policy of the day and by international agreements. This means that frequently the ACA cannot grant new or extended privileges to the amateur radio service unless and until it has been agreed by those organisations. That is why it is equally important for the WIA to continue to press for benefits to Australian amateurs at the International Telecommunications Union (ITU) in Geneva

through its membership of IARU Region 3. The ITU is the ultimate body whose recommendations are adopted by the Australian Government through its treaty obligations. All these takes time so progress is unfortunately slow.

Over recent months the WIA has raised a great number of topical issues with the ACA. These include major issues that affect all radio amateurs no matter what their special interests may be. To highlight just some of these, the Liaison Committee has made submissions on the proposed new standards for

- Electromagnetic Radiation (EMR),
- temporary operating licences for overseas visitors and
- possible changes to the ACA's policy on the devolvement of examinations.

On matters of vital interest to specific sections of our activity, we have submitted papers on the 80 metre DX window, a request for a better means of access to the LF area of the spectrum, the ever present threat to our VHF/UHF and microwave bands, LIPD's and their incursion into our 70 cm band plus a multitude of other technical and operating concerns.

It takes time and careful attention to detail to finalise any matter. Thanks to the goodwill that exists between the WIA and the regulators, satisfactory outcomes have been achieved and will continue to be achieved, albeit somewhat more slowly than we would desire. The WIA will keep up the pressure on all of the government areas that have a say over our activities.

I hope that this introduction to the WIA/ACA Liaison Committee will provide a better understanding of the work performed on your behalf by dedicated volunteers and will allow a clearer insight into the background to the report given below on the most recent meeting held with ACA. As you will see the range of topics is very wide and includes both technical as well as policy issues.

We will continue to work with the ACA on behalf of all Australian radio amateurs. You can help us by your continuing support of the WIA.

Peter Naish, VK2BPN

WIA Federal President and Chairman of
WIA/ACA Liaison Committee.

WIA/ACA Meeting on 24 June 1999

by Wally Howse VK6KZ

On 24 June the President of the WIA Peter Naish VK2BPN together with other members of the Liaison team Michael Corbin VK2YC, Glenn Dunstan VK1XX, Wally Howse VK6KZ and Richard Jenkins VK1RJ met with officials from the ACA.

The three and a half hour meeting was chaired by Gillian Kempton ACA Manager Customer Access Management Team and a number of ACA officials attended for specific items of business.

Olympic Games (Swiss Timing)

It appears that because of an apparent breakdown in communications between SOCOG and Swiss Timing, there is an application for use of a further segment of the 70 cm amateur band for limited periods in 1999 and 2000 in the Sydney region. The ACA is not happy with this but like the WIA recognises that the Olympic Games have the highest priority with government and that the ACA will do all that is possible to support the success of the games. The ACA noted that further interference to amateur bands cannot be ruled out. The ACA has undertaken to provide greater detail on the proposed use as soon as it is available.

Introduction of EMR provisions on 1/1/2000

Limits on exposure to electromagnetic radiation from radio transmitters are to be introduced progressively in Australia from next year. It is unlikely that amateur radio stations will be covered by such standards from 1 January 2000, but limits should be set during next year. The WIA explained that amateurs need a 'plain language' statement of the rules to allow individual amateurs to understand and interpret the regulation for most situations without a detailed knowledge of the fields and without expensive test equipment. The WIA wants to be involved with the ACA in the preparation of this statement. WIA requests early input into the proposed statement.

80-Metre DX Window

In responding to an ACA discussion paper

on this topic, the WIA rejected a proposal that the Amateur Radio Service exchange 18 kHz from the present 80 metre allocation for 18 kHz to extend the present 6 kHz DX window to become 3776 - 3800 kHz. It also rejected the concept that radio amateurs contribute in cash or kind to the fixed and mobile services that would have to move frequency. The WIA pointed out that many of those services had vacated their frequencies since the last survey. It also suggested that the proposal of time-sharing be reconsidered. A copy of the WIA submission is available on the Federal Web page (www.wia.org.au).

Fixed and mobile licence holders had been asked by the ACA about their continuing use of the frequencies below 3794 kHz, the cost of their migration to new frequencies. Responses were due by 28 June. The WIA response will be pooled with these other licence holders' comments and the ACA agreed to a further meeting on this specific topic in August.

LIPD Devices on 433 - 434 MHz

The WIA reported that the problems of interference to the Amateur Radio Service had continued. What was emerging was a de-facto CB band. The WIA would continue to press for an embargo on 2-way voice communication. The ACA maintained its original position, emphasising the commercial need to license the LIPDs and notes that the amateurs are secondary users in this band. ACA makes the point that amateurs are frequency agile and that the operation complained of occupies only a tiny piece of a large amateur allocation on 70 cm. The WIA gave notice that it will continue to press for a ban on 2-way communication using LIPD devices in this part of the 70 cm band.

LF Band Application

The WIA expanded on a paper submitted to the ACA seeking a frequency allocation of

15 kHz between 165 and 196 kHz. The WIA was criticised for not following the advice provided in an ACA letter of January 1995 which had stated that the WIA should pursue an international allocation through the ITU before the ACA would consider this matter. The WIA submission (copy available on the Federal web page) had addressed this matter pointing out that 13 countries already had an amateur radio band in this part of the spectrum and that the ACA had power to make such an allocation. The ACA was insistent that there was a need for "Global Harmonisation". However when pressed the ACA agreed to investigate an extension of the 'experimental licence' concept to bring its terms and conditions more into line with those applying to the amateur radio service.

EME and High power permits

As previously advised to WIA, the ACA needs an "inconsistency clause" to allow variations to the present licence conditions to enable it to issue high power permits for EME operation. Such a clause has been drafted and it is included in a batch with others relating to the Olympics but their progress through the legal process was unknown at this stage.

EMC from Services Using Power Lines

The WIA expressed concerns about potential for interference to HF users from services bringing broad band signals into homes using the copper cable of power lines. The ACA admitted a difficulty in this area because the some of problems lie outside the current legislation although powers relating to EMC were relevant. The WIA has offered copies of international papers on research on this matter.

CEPT and Licences for Olympic Visitors

The CEPT arrangements allow licensed visiting radio amateurs to operate in signatory countries without the need for formal applications for a licence and new call sign. In light of the large numbers of visitors to the Olympics, the WIA urged the ACA to adopt the European arrangements. The ACA was not prepared to accept this proposal. The ACA pointed out that its offices can issue licences promptly, over the counter or by mail application prior to arrival in Australia. The Radio-communications Act also requires an individual licence to be issued.

WIA NEWS

Prepared, researched and compiled by
Assembled by Richard Murnane VK2SKY
(Sources acknowledged where known)

Other matters

The ACA had not been able to complete its discussion paper on its thoughts on advertising the rights to conduct the amateur radio examination service. The WIA urged a quick conclusion to this matter as uncertainty affected WIA planning and discouraged those providing the service.

The ACA confirmed that beacon callsigns would be limited to the block RSA to RTZ.

The WIA indicated that it would be continuing to press for provision to allow for remote unattended HF radio transceivers to be controlled over a VHF/UHF link to allow access to HF bands for appropriately licensed users. It noted the ACA concern over unattended transmitters and the prevention of unauthorised operation of such transmitters. The WIA will present a paper on this matter.

The WIA observed that recently the financial advantage of a 5-year licence has all but disappeared. The ACA confirmed this was the case in the latest fee schedule and have undertaken to look again at this change.

The next meeting is scheduled for Thursday 2 December 1999 and specific discussions on the 80m DX window are expected in August.

ar

SNIPPETS

People you should thank:

Rutherford, Faraday,
Armstrong, Ohm, Maxwell,
Franklin, Norton, Bell, Volta,
Kelvin, Oersted, Edison, Watt,
Weber, Ampere, Tesla, De
Forest, Morse, Schering,
Cuneaus, Gray, Leclanche,
Moyes, Thevenin, Gauss,
Wheatstone, Cooke, Seimens,
Reber, Schottky, Woolrich,
Barden, Plante, Wilde,
Schmitt, Hertz, Janski,
Gramme, Baudot, Swan,
Hughes, Farranti, D'Arsonval,
Ayrton, Marconi, Fleming,
Heaviside, Hayes, Thomson
and Brattain.

How many do you know of
and what did they
contribute to your hobby?

Can you complete their
names?

(NB the order has been purposely
randomised.)

Get Well soon VK2NH

As reported in *Amateur Radio* magazine last month, David Thompson VK2NH is recovering from major surgery. In the meantime, I have been asked to pick up the proverbial ball and run with it, so here goes...

WIA News Available by Email

There's been a sudden outbreak of email lists recently, thanks to the free services offered by www.onelist.com. For those who miss the live VK2 and VK4 Division broadcasts, and who don't have access to packet and the World Wide Web, the news is available via direct email. Monthly news bulletins and other announcements from WIA Federal are also available in the same way.

While we're at it, I've also created a new discussion forum for those wanting to take positive action to promote the hobby. These lists are open to both WIA members and non-members. Details of these and other Email lists can be found on the WIA Federal web site at www.wia.org.au/links/MailingLists.html.

You can subscribe to the lists mentioned above simply by sending a blank email message to the following addresses:

VK2 (New South Wales) news
vk2news-subscribe@onelist.com

VK4 (Queensland) news QNEWS-subscribe@onelist.com

WIA Federal news
wia-subscribe@onelist.com

Promoting Amateur Radio
AmateurRadioPR-subscribe@onelist.com

If you'd like to set up your own Internet mailing list, you can do so easily, and for free, by visiting www.onelist.com

Y2K – Why Indeed?

Readers will probably notice the occasional Y2K-related item in this column, as the big day approaches. In Y2K circles, the acronym TEOTWAWKI (pronounced "teah-talkie" — short for "The End Of The World As We Know It") still gets bandied about, though less frequently as facts replace speculation about the extent to which the misnamed "Millenium Bug" is being addressed.

While the doomsayers are starting to run out of steam, communication disruptions may still occur, and not just due to technical

factors. It's quite possible that the unique communication services that Amateurs can provide may then be in demand by the wider community — and if that happens, will YOU be ready?

ZL: "Expect 3 Days Of Y2K Disruption"

New Zealand's Department of Internal Affairs has advised citizens to prepare for up to three days of disruption to major services in the case of Y2K-related problems around the new year period.

New Zealanders are well aware of the disruption unexpected incidents can cause. Severed cables caused the loss of power in Auckland's business district for several weeks. The country is hoping Y2K-related problems are not about to cause similar chaos..."

(from Sanger's Review of Y2K News Reports, 30 June 1999

<http://sangersreview.com/>)

"The Other Y2K Problem"

As if computerised calendars weren't problem enough, there's "the other Y2K problem", which will result when our old friend, the 11-year sunspot cycle, reaches its peak in the first few months of next year.

According to a report in *Wired News*, we could experience "electrical power outages, satellites veering off-course, and cellular phone and pager disruptions as the number of sunspots and flares, solar storms, and other "space weather" hits its cyclical maximum."

Richard Altrock of the Air Force Research Laboratory in the aptly named Sunspot, New Mexico, has devised a new method of observing and timing sun-surface activity. Using this method, and applying it to data collected over the last three solar cycles, he has predicted the next solar maximum will occur between January and April 2000.

According to his analysis, Cycle 23 sunspot number will peak at around 160, as they did during Cycles 21 and 22.

Solar events during sunspot maxima can disrupt radio communications, create auroras, and cause enough drag on satellites to make them lose altitude, according to JoAnn Joselyn, of the National Oceanic and Atmospheric Administration Space

Environment Center. Joselyn says that "magnetic field fluctuations can burn out power companies' electrical transformers and cause power outages such as those that occurred in 1989 in parts of the US East Coast and across Quebec."

Using a satellite to monitor the solar winds, NOAASEC researchers will be able to give companies and the public 30- to 60-minute advance warnings of increased solar activity incidents.

(from *Wired New*, via HamRadio-Online, details at <http://www.wired.com/news/news/technology/story/19954.html>)

Maori Win Wireless Rights

Also from *Wired News*: in New Zealand, the Waitangi Tribunal has ruled that the indigenous Maori people own the radio spectrum.

Back in March, the New Zealand's auction of radio spectrum around two gigahertz was postponed when, just three days before the auction, the sale was challenged by the Maori community, who claimed ownership of the radio spectrum. The auction was put on ice for three months.

In 1840, the Treaty of Waitangi gave European settlers the right to stay in New Zealand and promised the Maori people that they would continue to own their lands, forests, and fisheries for as long as they wished, and promised to protect all things valuable to Maori people. It was the Waitangi Tribunal's job to determine whether the 1840 treaty also applies to radio spectrum.

Judge P.J. Savage argued that "all or a generous portion of the net proceeds of the auction of the 2GHz spectrum be devoted to promoting, developing, and protecting *te reo Maori* [the Maori language] and Maori culture."

While the NZ government is not obliged to accept the Tribunal's recommendation, Maori interests are already arguing that the government must enter into negotiations about the "fair and equitable" division of the spectrum.

Professor Whatarangi Winiata has claimed a precedent, where New Zealand's fishing rights were split evenly between the government and Maori. Whether this happens with the radio spectrum remains to be seen.

(More details at <http://www.wired.com/news/news/politics/story/20546.html>)

VK ARDF team back from Region 3

ARDF Contest Australia's finest radio foxhunters recently returned from the Third Region 3 ARDF (Amateur Radio Direction

Finding) Championships in Nonsan, Korea.

The Mongolians, Kazaks and Koreans took most of the prizes, but the WIA team managed to improve over their performance at the previous event in Townsville, achieving 4 out of 6 in Region 3.

The event was held in amongst farmland and rice fields and very dense bush. Jason VK4YOL was doing nicely in one event, before he fell over a tree root, damaging both his ankle and receiver!

During their visit, the VK ARDF group visited the KARL Ham Museum, and appeared on a local TV station.

Bruce Paterson VK3TJN reports the VK results as follows.

Two metres OM Division:

VK3TJN 5th	VK3YNG 9th
VK4YOL 15th	VK3HDF 19th

Two metres Old Timer Division:

VK3WWW came 7th in Region 3.

80 metres OM Division:

VK3HDF 8th	VK3TJN 13th
VK3YNG 14th	VK4YOL 17th

80m OT division:

VK3WWW 8th.

Congratulations to entire VK ARDF team on their fine showing at the championships. (vk4yo/apcnews, via QNEWS)

DX ET with your PC!

Late in May, researchers at Berkeley University in California released the SETI@home screen saver, which uses your PC's unwanted CPU cycles to download and analyse data received by the Arecibo Radio Telescope in Puerto Rico. SETI@home then analyses the data for patterns that might indicate the presence of artificial signals originating other worlds.

The project was devised because the researchers could not gain sufficient time on government supercomputers to analyse the 35 gigabytes of data that Arecibo collects each day. So, instead of using one big computer to do the work, they decided to use lots of little ones. So far, over 600,000 enthusiasts around the world have joined the project; I estimate that so many Pentiums working flat out could analyse the data at least five times as fast as Arecibo can collect it!

On 1st July, SETI@home was upgraded to version 1.05, correcting some minor problems with the original release. As with version 1.0, the download is free.

You'll find the link to the SETI@home project on the WIA Federal home page at www.wia.org.au. While you're there, why not join "Team VK" — Australian Amateurs working as a team in the great hunt for ET!

Wow, That's Fast!

The speed increases on modern PC's don't raise too many eyebrows these days, and Pentium class machines running at up to 600 MHz will soon be commonplace.

But how much faster can we go? Well, Siemens Semiconductor has announced the world's first 45 GHz bipolar transistor. Those SHF Amateur bands may not be quiet for very much longer!

The BFP520 can be used as an oscillator up to the full 45 GHz, and it features a noise figure of 0.95 dB, with a gain of 23 dB at 1.8 GHz.

More details of the new transistor can be found in the May 1999 issue of *CQ* magazine (page 52).

Cross-Channel Radio Centenary

The 100th anniversary of Guglielmo Marconi's first radio contact across the English Channel was celebrated in March, with a re-enactment of the transmission in the presence of Marconi's daughter, Princess Elettra.

GB100SFL was activated from South Foreland Lighthouse in Dover, where Kentish Amateurs received the message from Jean-Claud Barreau F5KBM of the Wimereux Radio Club. The message: "Greetings from France to England across the ether."

Princess Elettra made several contacts herself with F5KBM, and had several other contacts with British Amateurs. She said she appreciated the work of Radio Amateurs to commemorate her father's work.

(RadCom, May 1999)

Here in Australia, the Wahroonga Amateur Historical Radio Association re-enacts the first direct wireless contact from Britain to Australia, on the 22nd September each year. Keep an ear out for the special event station VK2WAH on the day.

All HF Bands for 5 wpm!

Could it happen here? In the UK, two new licence grades have been introduced, allowing access to all HF Amateur bands at 100W PEP, to Amateurs who have passed a 5 wpm Morse test. They can also operate above 30MHz at 400W PEP.

The Radio Society of Great Britain believes that allowing full HF access after passing the lower speed test "will allow greater access to the full range of facilities that Amateur Radio has to offer, and broaden the appeal of the hobby to a wider audience. More amateurs will have the opportunity to experience worldwide communications, and newcomers to the hobby will find it possible to make contacts on a wider range of frequencies."

Existing class A (full call) licensees will

be unaffected; they can transmit at the higher power of 400W PEP. The new "Full A/B" licensees will be identified by call signs in the M5xxx series.

(RadCom, June 1999)

ACA signs first Services Agreement with SOCOG

The Australian Communications Authority has signed a Services Agreement with the Sydney Organising Committee for the Olympic Games.

Under the Agreement, the ACA will be required to provide a reliable communications environment, free from harmful radio interference, that will allow SOCOG to stage the 2000 Olympic Games and the Paralympic Games (the Games) efficiently and safely.

ACA Chairman Tony Shaw said that the value of providing the services to SOCOG is \$5.2 million and the ACA will be fully reimbursed for this expenditure from the \$32 million Federal Budget allocation for the Games. This is the largest expenditure by a Commonwealth agency in providing assistance to the Games.

"While the services provided are part of the ACA's ongoing responsibilities, ensuring there is no radio frequency interference will be vital for international broadcasters, the staging of events and emergency services operations during the Olympic and Paralympic Games in Sydney in 2000," Mr Shaw added.

The fully costed services to be provided by the ACA under the Agreement include inspection of venues to anticipate radio frequency interference problems, interference investigation, and testing of communications equipment.

The ACA's services to SOCOG also include the licensing of radio-communications, for which special provisions are being made for the Games.

The ACA is required under its enabling legislation to recover the costs of its operations through a range of cost recovery based fees and charges.

(from ACA Media Release No. 38 - 30 June 1999, www.aca.gov.au/media/38-99.htm)

A vital component of the ACA's service to SOCOG is the use of part of the 70cm band, which Amateurs and the Australian Defence Forces have "lent" to SOCOG for the period from 31 March 1999 until 31 December 2000. During this period, Amateurs must not transmit between 421 MHz and 432 MHz when they are within 150 km of the Olympic site at Homebush Bay in Sydney. Full details can be found at www.wia.org.au/BandPlans/OlympicsUHF.html

ar

EDUCATION

Brenda M Edmonds VK3KT
PO Box 445, BLACKBURN VIC 3130.

Thank you to those who have written to me about some of my comments in recent columns. In particular, I received some valuable feedback from the February column in which I queried the mechanics of the examination procedures.

Now I would like to consider the syllabuses for the two levels of Theory examination.

If you look up the current syllabuses as promulgated on the ACA web site, you will find that, apart from some re-arrangement, the AOCPP theory syllabus is practically unchanged from that published in 1985. The NAOCP syllabus has been upgraded to some extent to take into account the increased privileges gained by Novice operators in recent years.

The last time either syllabus was reviewed was in 1984. The Examination Question Bank Committee carried out its own review when working on the question banks, but discussion with the ACA on the modifications which we recommended have been postponed until the examination devolvement procedures are clarified.

In the 15 years since 1984, technology has made giant steps. It worries me that much of the content of the syllabus is, at best, obsolescent if not totally obsolete and irrelevant to present-day operation. I am not saying that the theory of radio has changed. It has not. But the "basics" as taught for an amateur radio course have become lost in the technicalities of "chips" and miniaturisation of components which replace the discrete components of the 70s

and 80s. Does it matter how a PLL (or a speech processor, or a filter) works when it comes in a chip that needs a magnifying glass to get the leads connected right way round?

So should we be examining on chips and ready-made sub units instead of separate components? Perhaps all that is needed is detail of transmitters, receivers, power supplies etc to block diagram stage, with one IC for each stage. It is currently possible for a candidate to pass the exam at either level without ever having seen a resistor or a capacitor.

Have a look at the present syllabuses. How much of them could be left out, and how much needs to be added to bring the theory into the new century? Propagation theory has not changed much. Antenna principles do not vary, and antenna designs are fairly standard. But a circuit diagram of a 1980 transceiver is very different from its current counterpart.

I would be pleased to receive comments from you, either newcomer or old timer. I trust that there will be a formal re-consideration of the syllabuses as soon as the devolvement is completed.

ar

How fast can news travel?

SNIPPETS

It took five months for Queen Isabella to learn that Columbus had reached the new world, two weeks for Europe to learn of Lincoln's death and just 1.3 seconds for the world to learn that man had stepped onto the moon.



ar



Divisional News

VK1 Notes

Forward Bias

Peter Kloppenburg VK1CPK

Our guest speaker on Monday, 28 July 1999, was Malcolm Brinkley of Telstra. Malcolm spoke on the Code Division Multiple Access (CDMA) technology, that is currently being installed to replace the analogue mobile phone service in Australia. It is a complex spread spectrum technology that combines some of the best features of GSM and AMPS, including enhanced privacy, extended range (60 km standard with 120 km possible in modified sites), and increased traffic density per cell. Although this technology is new to most of us in amateur radio, the explanation of how CDMA works was explained lucidly by Malcolm, giving examples and comparisons with GSM and other coded systems. Most of us came away with a better understanding of how it is all going to work and we will watch the introduction of this technology to Australia with interest.

Mt Ginini news

The long awaited improvements to this prime site have had to be put on hold until Spring due to the access road being impassable during Winter. We only missed out by a couple of weeks; VK1TEE and VK1GH made a dash for the site a few weeks ago in a suitable loan vehicle with the new mast on board, only to be turned back by the road conditions, having iced up just days before. Replacement equipment includes a new mast, feeders and antennas, plus facilities to extend the linking of the 70 cm voice repeaters.

Members of the VK1 Division have recently installed the first 2 metre WICEN repeater on a prime site in the Brindabella Mountains, 30 km West of Canberra City. A temporary facility on the site was extensively tested, and used in support of the Car Rally in May. The advantages of a high quality, WICEN dedicated repeater on a prime site became obvious very quickly. RF coverage was extensive with good signal strength in the operational area. The WICEN dedicated repeater is an essential part of the plan to foster more member activity in training for possible civil emergencies. The WICEN contact person is

Phil Longworth, VK1ZPL. You can reach him by phone on: (02) 6241 5797.

The Division attracts donations in the form of hardware from a variety of sources. Some donations come from companies and others from individuals. These donations consist mainly of items of equipment, components, or coaxial cables. Some of them come from deceased estates. That means that boxes full of bits and pieces are available for the taking. If you are interested in home brewing, it is worthwhile to come to the general meetings where these donations are always announced. The latest donation consisted of long lengths of coaxial cable ie RG-214 and RG-213. If anyone is interested, please contact Gill, VK1GH, our president. The next general meeting of the Division will be on 23 August 1999, in Room 1, Griffin Centre, Civic, Canberra City.

Cheers to all.

pkloppen@dynamite.com.au

VK3 Notes

WIA Victoria News

By Jim Linton VK3PC

Remembrance Day Contest

Thank you to those who have already pledged support for the "Team Victoria" assault on this month's RD Contest in an effort to have the trophy return to VK3.

We won this contest five years in a row until 1994 when the rules were changed in the name of making it fairer for other less performance driven callsign states, and much harder for VK3 to win.

However with VK3 taking out the wooden spoon last year, and the contest winner being the most improved state on their previous year's effort, we can win the contest this year.

Remember for VK3 to win you have to participate in the contest by exchanging numbers, but also submit a valid log to the contest coordinator.

Why not support VK3 this year, read the contest rules in AR magazine and give it a go. If you're unsure of what to do contact the WIA Victoria office, or if you're also a member of an affiliated club, it will have the answers to your questions.

Our clubs are getting right behind the

"Team Victoria" campaign; individual members are encouraged to join the winning team in the RD Contest on 14-15 August.

Even if you've never been in a contest before, it is very simple, requires about 30-minutes on air as a minimum, a contest log sheet, a declaration, and a 45-cent stamp.

GST on the way

The inevitable changes to occur next year with the introduction of a Goods and Services Tax are to affect the operations of WIA Victoria.

The WIA Victoria Council is currently planning for the GST. Preliminary information received from the Australian Tax Office indicates that the new tax will affect the operation of all clubs and membership organisations.

The GST not only has the potential to increase operational overhead costs and membership subscriptions, but compliance will most certainly lead to an increase in the administrative workload.

Our Chief Executive Officer, Barry Wilton VK3XV, is examining options available to minimise the impact of the GST on members.

This is being done in conjunction with our auditors, Barnard, Baudinette and Company.

The new tax will affect the way we provide membership services and the sale of any books and disposals equipment. It may well influence the manner in which future subscriptions are collected.

DX callsign addresses

The WIA Victoria Office has the 1999 International and North American Callbook on CD ROM, and a computer available for members to use.

If you need an address, and can't get to the office, then telephone Joy on 9885 9261, give her the callsigns you need the address for, and she will provide these if you ring back on the next working day.

Broadcast review

As a result of member feedback and research, the Council has decided that 10.30am on a Sunday morning is not an ideal time for the VK3BWI broadcast.

Our modern lifestyles have changed over the past decade or so, and fewer people are able to listen to a broadcast on Sunday mornings.

The Council, after careful consideration, has decided to end the VK3BWI transmission on Sunday mornings, but maintain the Sunday evening transmission which goes to air at 8pm.

Until now the Sunday night transmission was on 80 metres and has been very well

received. From now on, the Sunday evening broadcast will go on out all broadcast frequencies.

The Sunday morning broadcast will continue until the Remembrance Day Contest in August, and then stop.

From the first weekend in September, the main broadcast will be at 8pm on Sunday night, and there will be a transmission on a weekday night - the day and time is yet to be decided.

Upcoming events calendar

Remembrance Day Contest

This annual contest is in memory of those WIA members who paid the supreme sacrifice during World War II. It is held on the weekend closest to the date when hostilities ended in the Pacific - this year it starts at 6pm Australian Eastern Standard Time, on **Saturday August 14**, and runs for 24 hours.

FAMFARC Hamfest

The Frankston and Mornington Peninsula Amateur Radio Club will hold its Hamfest on **Saturday, 21 August**.

Inquiries to Peter Brennan VK3JPB after hours 9789 9028.

Shepparton and District Amateur Radio Club Hamfest

Sunday September 12 at the Shepparton Youth Club Hall behind the High Street Safeway complex. Traders begin setting up at 7am with the doors opening to buyers at 10am.

Jamboree On The Air - JOTA

Saturday 16 Sunday 17 October, the annual Jamboree On The Air which began in 1958 will involve more than 400,000 scouts and guides around the world "getting together" via amateur radio.

VK6 Notes

Volunteers and Membership

I have just been listening to the Divisional Sunday broadcast, on this deadline day for the Notes, and have been reflecting on what a useful service this broadcast really is, when it can so easily be taken somewhat for granted.

It is certainly an appropriate and very convenient medium for keeping us all in touch with events of common interest. By all accounts some Divisions are struggling to produce broadcasts on a regular basis. We are very fortunate in VK6 to be in a position to enjoy what is surely one of the better weekly productions in the country.

I am well aware that this sort of thing doesn't happen without considerable expenditure of private time by the various volunteers from the VK6 Division (usually by people with already very busy lives).

To this must be added the efforts involved in maintaining many repeaters and beacons (WARG and VHF Group) for the common benefit, general management of our hobby (WIA Councils), and in organising and usually funding several other mutually beneficial "Ham Radio" activities.

It is self-evident that these efforts are appreciated by current WIA members, but what of the remainder? Surely the "hold-outs" must appreciate them too, and given that, you would expect most who have made the effort to struggle through the exams to be fair-minded fellow travellers. Is it not truly baffling why the vast majority of Hams are not supporting their efforts by re-joining the WIA? Even if the WIA does not appear to be taking the hobby in the direction desired by the individual at the moment, so what? Grievances, imagined or otherwise, can only be harboured for too long - life is quite short! I must say, I just can't understand it at all.

Beacons Back

The VK6RSX Beacons at Exmouth Western Australia, which were disabled by Cyclone Vance in March this year, have been restored to service from 11th July 1999. The beacons operate continuously on 50.304 and 144.576 MHz with 50W into omnidirectional, horizontally polarised, antennas. The WA VHF Group wishes to thank Rex VK6ARW of Exmouth and his associate Ned Kelly (yes...Ned Kelly) for their efforts in restoring the system amid a great number of other demands following the severe damage to the town by the cyclone. (Thanks to Don VK6HK for this).

From the Minutes - Council Meeting 6th July 1999. Just a few briefs before closing - the sun is shining outside and it's Sunday! Wal VK6KZ, invited to attend in his capacity as a member of the Federal WIA/ACA Liaison Team spoke informally about the Liaison Committee meeting and gave the Council an insight into the business conducted and the tone of the meeting. He reported that there is to be a further special meeting in August to discuss the 80 Metre DX window, with the next formal meeting scheduled for December 2nd. The impact of the GST was discussed.

There had been no response to a broadcast call for an Education Officer. Tony VK6TS will make a further plea. Gwynne VK6JG had returned from overseas and successfully negotiated the running of another theory course at Tressillian Centre. The course is scheduled to start on 19th July, 1999. About seven candidates had enrolled, the desirable minimum being eight. A request had been received from WARG requesting support for a proposed new repeater at Victoria

Park. Frequencies proposed are: (a) 438.425 MHz Transmit - 433.425 MHz Receive (b) 146.775 MHz - 146.175 MHz (c) Link Frequencies of 420.000(?), 440.150 and 440.000 MHz

As these frequencies conform to the Band Plan, the Secretary was requested to prepare the usual letter supporting the WARG application to the ACA.

Dave VK6IW tabled membership statistics, there being no new members for the month (Like I said. I don't understand it, I must be missing something - somebody please explain).

It was reported that call-backs after the broadcast had reached a total of 150 recently, with greater participation from country members.

General Business items: (1) Cliff VK6LZ will arrange to present Gwynne VK6JG with his plaque as "Amateur of the Year" for 1998, for services to Technical training. The presentation will be made on the opening night of the new training course on 19th July. Well done Gwynne! (2) The availability of possible Group sites was discussed, including one at Victoria Dam and Kalamunda Western Power sub station. Will VK6UU is to examine the latter and had already distributed photographs of Victoria Dam. Both have disused masts and buildings. Investigation continues.

So that's it from Toodyay until next time - see you on 2m SSB and on 6m (some upgrading going on here).

73, Chris VK6BIK
(chrismor@avon.net.au)

VK4 Notes

Qnews

By Alistair Elrick

WIAQ Councillor and QTC Editor

The WIAQ General Meeting on 17th July was quite well attended by a dedicated section of the membership. The discussion on the new Constitution took up most of the session and resulted in a very comprehensive document to serve the members well in to the future. All other matters before the meeting to deal with the continuing liquidation procedure were passed. This should allow the Incorporation to be completed in a timely fashion.

The Annual Dinner that followed was a great success, and it was good to see a cross section of staunch WIAQ members, Family members and others interested, who booked and attended this, the re-instatement of the once Annual Dinner. VK4's BB and BBS certainly got value from the sumptuous Bronco's Leagues Club smorgasbord menu.

Mick VK4JHM and Wayne VK4NWH both have forwarded a report on harmful

Andrews

Communications Systems

(EST. 1976 - ACN 001 968 752)



AUSTRALIA'S FIRST AUTHORISED
FACTORY DIRECT IMPORTER

No 1 & Biggest Importer with one or two
absolutely massive shipments monthly.

FULL 3-YEAR FACTORY WARRANTY
INSTANT REPAIRS ON FRIDAYS

WE SELL MOST BRANDS AND MAKE
BALUNS, VERTICALS, YAGIS, P/S.
ICOM-KENWOOD-JRC-AOR-EMOTATOR-
MJF-DIAMOND-TIMEWAVE-KANTRONICS
-THP - GARMIN - TERLIN - UNIDEN - ETC

DX-1600 HF LINEARS FROM \$ 3,799

HUGE RANGE OF ELECTRONICS

NEW IC-706IIG & IC-756PRO

NOW 3-YEAR WARRANTY ON
NEW ICOM SOLD BY US.

* OVER 20 YEARS OF SERVICE *

WE WANT HF SSB TRANSCEIVERS
& LINEAR AMPLIFIERS

(02) 9636 9060 or (02) 9688 4301

SHOP 8, 41 BATHURST ST. GREYSTANES.

N.S.W. 2145. FAX (02) 9688 1995

SNIPPETS



(With reference to a correspondent)

The young specialist in English Lit,
...lectured me severely on the fact
that in every century people have
thought they understood the
Universe at last, and in every century
they were proved to be wrong. It
follows that the one thing we can say
about our modern 'knowledge' is
that it is wrong.

... My answer to him was, '... when
people thought the Earth was flat,
they were wrong. When people
thought the Earth was spherical they
were wrong. But if you think that
thinking the Earth is spherical is just
as wrong as thinking the Earth is flat,
then your view is wronger than both
of them put together.'



Isaac Asimov

(1920-1992) b. Petrovichi, Russia

The Relativity of Wrong, Kensington Books,
New York, 1996, p 226.

interference, caused by a walkie talkie
legally available to any user, which has
forced the closure due to the device having
the sub-audible tones available to open the
repeater. As Mick says "It could be your
70cm repeater next!"

(Mick Lohse VK4JHM contributed with
permission from the Logan Beaudesert
Amateur Radio Group.)

Radios transmitting on 433 MHz have led
to interference on the 438.750 MHz
repeater. These radios must be transmitting
on or near 433.750 MHz. A lot of language
has been coming over the 70 cm repeater
side. Is this the start of uncontrollable
intruder invasion on 70 cm, especially with
experimenters maybe doing mods to these
radios? This is a real concern for the future
for amateur radio!

(Wayne VK4NWH)

Several weeks ago the RADAR Club
(Rockhampton and District in VK4) was
fortunate to be given a display and
demonstration of LIPD's by Jack VK4JRC.
It was not without a little suspicion that a
strange, regular but intermittent 'packet
type' signal heard on the local 70cm
repeater was investigated by Noel
VK4ZAR and John VK4AJS. Concluding
that it was not a legitimate packet
transmission they contacted Ron the
manager of the local ACA who verified its
existence and with his expertise and
equipment set about finding its origin.

Driving a short distance away from his
headquarters which is located with other
tenants in a central city office building Ron
noticed the signal strength weakening and
then as he returned to the building it was
once again full strength and in fact the
source of the signal.

The rumour suggesting that the signal
was coming from under Ron's desk has not
been confirmed or denied but the twenty
five milliwatts over the eight kilometre
distance to the repeater suggests a good
propagation path.

This is probably the first of many such
intrusions into what we assumed was our
section of the band. It seems that a shift in
frequency for repeaters out of the allocated
(both local and international) LIPD band is
essential and that an updated band plan must
be given priority in order to avert temporary
fixes to this problem.

On a brighter note, the open day at
Redcliffe Radio Club was a great success
and the comment was that it was easier for
some visitors to attend day-time events and
this had made a great deal of difference to
the attendance. Also a great promotional
idea from the Club, as they now have an
operational shack for the use of amateurs
who do not have the facility to be on-air

from their homes. Some members live in
flats, caravans etc. or just do not have the
room or finances to run HF, VHF, UHF and
Packet. Redcliffe also have supervised on-
air activities for non licensed members.

John Stevens VK4AFS, our Office
Administrator, has supplied the 6 monthly
figures on membership for the Division and
they are quite encouraging. June figures
when compared with the membership
figures of January show a little over 7%
increase. Well done!

Les Steel VK4ALS, the TARCinc.
WICEN Co-ordinator says the Inkerman
Station event last weekend was a great
success. WICEN resourcefulness was put to
the test when they discovered that the
repeater antenna was somehow or other
"lurking back at home". The fact that all
operators attending had packed spare
"everything" helped with being able to face
setbacks with a minimum of delay and fuss.
The 22 endurance riders participating in
events that took the more experienced over
80km of countryside, whilst less
experienced riders undertook at 40km
training course. VK4ALS Les thanks all
WICEN members who attended the
weekend. The group will, again support the
Townsville Horse Endurance Riders
Association (Inc), on 11th September to
Sunday 12th September in the Woodstock
Area, Sat arvo to Sun arvo.

The Tablelands Radio and Electronics
Club is keeping the true Amateur spirit
alive. A TREC Project is nearing
completion, where guided by Ray VK4TFT,
TREC members are modifying FM92E
transceivers to the 6metre band. A lot of
work but well worth the finished product!

73's from Alistair

ar

STOLEN

Alan (VK6CQ) here. Unfortunately my
brand new Yaesu FT - 100 was ripped
out of my car in Adelaide during my
drive over to Tasmania. Real mess of
the car door and under the seat (where
it was bolted) was made to get it out.

Not much use to anyone else minus
the manual & connecting cables, but I
guess the idiot who took it thought it
was a CB or CD player.

I would appreciate it if you could
keep an eye out for it — Serial No 9F0
420 36 (9F0 420 36). You never know,
it may show up in a Cash Converters
sometime.

CLUB NEWS

Healesville Amateur Radio Group Inc.

Our annual hamfest will be held on Sunday 26th September 1999 at the Healesville Memorial Hall, Maroondah Highway Healesville. Time is 1000 hrs till 1400 hours. Doors open to traders at 0830 hours Entry \$3. Tables \$15 per 8 foot table. Book early to avoid disappointments as last year people were turned away. Refreshments will be for sale by Healesville Girl Guides with Tea and Coffee supplied free by HARG.

For more info or bookings please phone Gavin (03) 5968 8482 or Carol on (03) 5962 6098.

Yours in Amateur Radio, Graeme Tremellen VK3GPT, Honorary President, HARG.

The North-East Radio Group (NERG) will again be holding classes for the NAOCP commencing early August and running on Tuesday nights for approximately 11 weeks followed by a trial exam. The exam proper will be held a few weeks later at a time convenient to candidates and examiners. Printed notes on various topics and Morse tuition are included in course fees. For further information please contact Stephen Warrillow on 9436.

0435, at P.O. Box 416, Rosanna VIC 3084 or at swarrillow@hotmail.com.

Riverina Field Day

The Wagga Amateur Radio Club presents the Riverina Field Day on the 7th & 8th of August 1999. The Riverina Field Day is held annually and is held alternately in Albury and Wagga Wagga. The 1998 Field Day was hosted by the Albury club. In 1999 it is Wagga's turn.

The Field Day is a get together for Radio Amateurs and enthusiasts with a dinner on the Saturday evening and the field day proper on the Sunday being held at the Koorringal High School Gymnasium. There will be trade displays of new and used equipment, lectures on radio related topics, private trading tables for disposal of equipment, talk-in and hidden transmitter hunts.

Details of the program, dinner, available accommodation and map of the location

of Koorringal High School are available on the club's web page at <http://hamgate.wts.com.au>. Alternatively contact may be made with John Eyles VK2YW on Phone (02) 69265471 H or (02) 69332363 BH or via E-mail to jeyles@csu.edu.au.

Central Highlands

VK4JEM Eddie advises the date for this years gathering is the 4th and 5th of September. The club has booked accommodation in 12 cabins for whoever is coming but a deposit is required. \$10 to Gordon VK4KAL at Rubyvale or contact the Sunrover Resort direct phone (07) 4982 3677.

SUNSHINE COAST SUNFEST - the Ham Radio Day put on each 2 years by the SUNSHINE COAST CLUB is to be held at Nambour Showgrounds August 28. SARC are at present negotiating a reduced rate for weekend cabins at one of the local resorts. Maybe some "out of towners" might like to stay for the sights of the Sunshine coast and a little local hospitality. Table and display space bookings to Angus 5443 2074 or write to SUNFEST Coordinator, 285 Main Rd Maroochydore 4558. Tables are available at \$15 per table and as space is at a premium SARC are asking for firm bookings by 31st July.

Special Interest Groups — Radio Scouting - JOTA

(1st JOTA Circular 1999 World Scout Bureau, Geneva, June 1999)

42nd Jamboree-On-The-Air, 16 - 17 October 1999.

What is the Jamboree-On-The-Air?

The JOTA is an annual event in which about 500,000 Scouts and Guides all over the world make contact with each other by means of amateur radio. Units may operate for 48 hours or any part thereof, from Saturday 00:01 h until Sunday 24:00 h local time.

How can I take part ?

To take part in the JOTA Scout groups enlist the aid of a licensed amateur radio operator. The circular states: "Such a person can

easily be found by contacting the WIA. Radio amateurs throughout the world are very keen on helping scouts to take part in the JOTA."

Finally.

Radio Scouting and the JOTA in particular is an excellent opportunity to meet Scouts, Guides and others from many countries.

(Richard Middelkoop PA3BAR World JOTA Team)

JOTA BROADCAST REBROADCASTERS TO DATE. (Qld list - other states welcome to supply same.)

These Amateurs and stations will combine with the national scout frequency stations to bring you the JOTA address this October, VK4 Originating station on 147.000 MHz will be John VK4AFS, 160 m 1.825 by Ivan VK4AIF, 80 m - 3.605 by Wayne VK4NWH, 40 m - 7.118 Rebroadcaster Paul VK4BGT, 15 m 21.175 Peter VK4NJQ, 10 m 29.660 \diamond 2 m linked system by VK4ZMM, and originate if John, VK4AFS is unavailable.

Rick P29KFS will retransmit on the 147 repeater in Port Moresby and thinks Norm will do the same at Ukarumpa as he has a scout troop there and one of the JARL supplied HF radios for their use.

ar

if you have some club news to share.

Or an event to publicise. this is the place.

The

CLUB NEWS

pages are your pages.

Send your information to

The Editor Amateur Radio

PO Box 2175

**CAULFIELD JUNCTION
VIC 3161**

email armag@hotkey.net.au

Fax (03) 9523 8191

ALARA

Christine Taylor
16 Fairmont Avenue
Black Forest 5035
geencee@picknowl.com.au

New Method Of Communications

At last, I have extended my opportunities for communication. I am now on email so there should be no lack of information flowing in to me for inclusion in this column. Well, that is what I have been led to believe by the advocates of the World Wide Web. My email address is:-

geencee@picknowl.com.au

Please do use the address if you have made an interesting contact or have some information to share. The more you tell me the more I can tell others.

Reminders.

JOTA will be with us soon.

If you have participated previously, why not make contact with the groups and suggest they do it again.

If you have never participated, maybe this is the time to start. It can be a lot of fun and is a marvellous way to introduce girls and boys to the wonders of amateur radio.

If there is a Guide or Scout group in your area, contact them, as it is more likely that you know about them than visa versa. Decide whether it would be more suitable for the group to come to your shack or if you should take some portable equipment to set up in their hall. This can often just be a question of space; yours as well as theirs. You will certainly have enough willing hands available to help raise masts or attach antennas. Guides and Scouts still learn how to tie knots and erect poles and an antenna would make a great project for them.

It is a good idea to have some preliminary meetings with the young people themselves. You can give them practice at using a microphone (or keyboard, if you offer packet as well). Have some questions (and answers) ready to start a conversation with both other Guides and Scouts and with other amateurs. Giggles are OK but words are better!!

The children can also learn about both Morse Code and the phonetic alphabet. They quite like to be able to spell their names phonetically. Some leaders like to have question forms for the children to fill in on the day. They may need help from you

in the preparation of useful and interesting questions.

On the day(s) you can have a great time. The bands are opening up all the time and amateurs are usually very happy to talk to your charges. You can be sure you will be well fed as the scouts and guides test their culinary skills on you!

When it is all over please let me know about it.

The ALARAMEET In Brisbane

The time is approaching when you need to be making your arrangements to be in Brisbane for October 2nd and 3rd (and a few days either side of those dates, if you can). All YLs are welcome though, be warned you could be given an application form to join, and the OMs are welcome, too. So why not contact Bev VK4NBC QTH/R the Callbook or by email:- vk4bgc@bigpond.com.au.

There will be an informal evening meal on the Friday, a fully arranged program for the Saturday and Sunday with optional expeditions on the Monday and Tuesday. We realised that when people travel thousands of miles to participate in an ALARAMEET they want to see as much as possible of the host city. Bev has arranged tours for Saturday afternoon and Sunday, but allowed enough time together for us to meet each other again (or for the first time) face to face. The Monday and Tuesday activities are for those lucky enough not to have to leave immediately after the meet.

Do contact Bev for more information and if you have indicated that you will be there she would appreciate it if you could send the registration fee beforehand so she can pay for deposits etc.

Everyone who has been to an ALARAMEET has enjoyed themselves and been made to feel welcome. I am sure you will as well.

ALARA Contest

Don't forget the ALARA Contest comes up in November. Watch for the details either in AR or in the ALARA Newsletter and keep the second weekend in November free.

If you participate in JOTA, why not

arrange for the same group to participate in the ALARA Contest as a club station. There is a special category for club stations but we need some more clubs to participate.

Of course, it doesn't have to be a Guide or Scout Group club station, if you have a club callsign for your radio group why not give your members some contesting experience. The ALARA Contest is not a rush - rush - rush type contest, people always have time to chat, though we do exchange numbers. Why not give it a go?

Future Reminder

It you are thinking ahead to next year's holiday plans, what could be better than to go to New Zealand in September/October. While you are there you could participate in the YL2000 Meet on Sept 30th/Oct 1st 2000 in Hamilton. Contact Biny ZL2AZY QTH/R or by email on yl2000@iname.com.au.

DX SK

We received a sad packet message from South Africa recently, to say that Iris ZS2AA has become a silent key at 95 years of age.

Until just a week before her death Iris had been on the air. She was the first woman to qualify as an amateur in South Africa, in 1937. She was a foundation member and first President of the South African Women's Radio Club, which in its heyday had over 120 members.

In 1980, when she visited the US Iris was the houseguest of radio amateurs in every place she visited. She was also a very active member of WACRAL, the World Association of Christian Radio Amateurs and Listeners.

She was made an Honorary Life member of the SARL in March 1994 and gave the keynote speech at the AGM of the SARL.

As well as her interest in amateur radio Iris was a keen gardener and cook. She even made her own cake for her 90th birthday party that was attended by family and friends from many countries.

A quote from the packet message says:-
"Iris ZS2AA was somewhat of a legend in her lifetime in the amateur world - a person whose friendliness left a lasting impression on her, an exceptional person whose cheery voice, keen sense of humour and zest for life will be sadly missed by countless ham radio friends worldwide."

I am sure this sentiment will be echoed by all that knew her.

ar

**Where did you go portable in this year's John Moyle?
Tell us about it.**

1999 Remembrance Day Contest

14/15 August 0800z Sat - 0759z Sun
Presented by Alek Petkovic VK6APK

This contest commemorates the amateurs who died during WWII and is designed to encourage friendly participation and help improve the operating skills of participants. It is held close to 15 August, the date when hostilities ceased in the south-west Pacific area.

It is preceded by a short opening address by a notable personality transmitted on various WIA frequencies during the 15 minutes prior to the contest. During this ceremony, a roll call of amateurs who paid the supreme sacrifice is read.

A perpetual trophy is awarded annually to the WIA Division with the best performance. The name of the winning Division is inscribed on the trophy, and that Division then holds the trophy for 12 months. The Division also is given a certificate, as are leading entrants.

Objective: Amateurs in each VK call area will endeavour to contact amateurs in other VK call areas, ZL and P2 on bands 1.8 - 30 MHz (no WARC). On 50 MHz and above amateurs may also contact other amateurs in their own call area.

Contest Period: 0800z Saturday, 14th August to 0759z Sunday, 15th August, 1999. As a mark of respect, stations are asked to observe 15 minutes' silence prior to the start of the contest, during which the opening ceremony will be broadcast.

Rules:

1. Categories:

- High Frequency for operation on bands below 50 MHz;
- Very High Frequency for operation on and above 50 MHz;
- Single Operator;
- Multi-operator.

2. Within each Category the Sections are:

- Transmitting Phone (AM, FM, SSB, TV);
- Transmitting CW (CW, RTTY, Amtor, Pactor, packet, etc);
- Transmitting Open (a) and (b);
- Receiving (a), (b) or (c).

3. All amateurs in Australia, Papua New Guinea and New Zealand may enter the contest, whether their stations are

fixed, portable or mobile.

- Cross-band and cross-mode contacts are not permitted.
- Call "CQ RD", "CQ CONTEST" or "CQ TEST".
- On bands up to 30 MHz stations may be contacted once per band using each mode, ie twice per band using CW and Phone.
- On 50 MHz and above, the same station in any call area may be worked using any of the modes listed at intervals of not less than two hours since the previous contact on that band and mode.
- Both single and multi-operator entries are permitted. To be eligible as a single operator, one person must perform all operating and logging activities without assistance of any type, personal or electronic, using his or her own callsign. More than one person can use the same station and remain a single operator providing that each uses his or her own callsign, submits a separate log under that callsign and does not receive operating or logging assistance in any way during the contest.
- Multi-operator stations are only allowed one transmitter per band/mode at any one time. Simultaneous transmissions on different bands are permitted. Simultaneous transmissions on the same band but different modes are permitted.
- For a contact to be valid, numbers must be exchanged between stations making the contact. Exchange RS(T) followed by three figures commencing at 001 and incrementing by one for each successive contact.
- Contacts via repeater (including satellite) are not permitted for scoring purposes. Contacts may be arranged

through a repeater. Operation on repeater frequencies in simplex is not permitted.

- Score: on 160 m two points per completed valid contact; on all other bands one point; on CW double points.
- Logs should be in the format shown below and accompanied by a Summary Sheet showing callsign; name; address; category; section; for multi-operator stations a list of the operators; total score; declaration: *I hereby certify that I have operated in accordance with the rules and spirit of the contest*; signed; date.
- Entrants operating on both HF and VHF are requested to submit separate logs and summary sheets for both areas.
- VK entrants temporarily operating outside their allocated call area, including those outside continental Australia as defined for DXCC, can elect to have their points credited to their home Division by making a statement to that effect on their summary sheet(s).
- Send logs and summary sheets to: RD Contest Co-ordinator, A Petkovic VK6APK, 26 Freeman Way, Marmion, WA 6020, by Friday 17 September, 1999. Endorse envelope "Remembrance Day Contest" on front outside. Late entries will not be eligible.
- Certificates will be awarded to the leading entrants in each section, both single and multi-operator; in each Division; P2 and ZL. Entrants must make at least 10 contacts to be eligible for awards, unless otherwise decided by the Contest Manager.
- Any station observed as departing from the generally accepted codes of operating ethics may be disqualified.

Determination of Winning Division:

Unless otherwise elected by the entrant concerned, the scores of VK0 stations will be credited to VK7, and the scores of VK9 to the mainland call area which is geographically closest. Scores of P2, ZL and SWL stations will not be included in these calculations.

For each Division, an "improvement factor" will be calculated as follows:

- For transmitting logs only, HF and VHF "Benchmarks" for each Division will be established, against which its performance for the current year is judged. The same formula will be used

for HF and VHF, inserting the appropriate figures:

$$B = 0.25P + 0.75L$$

where B = this year's benchmark, P = last year's total points, and L = last year's benchmark.

- (b) For each Division, HF and VHF Improvement Factors will then be calculated. Once again the same formula will be used for both HF and VHF, inserting appropriate figures:

$$I/F = \text{Total points (this year)} / \text{Benchmark}$$

where I/F = improvement factor.

- (c) For each Division, the HF and VHF Improvement Factors will then be averaged:

$$\text{Overall I/F} = (\text{HF I/F} + \text{VHF I/F}) / 2$$

- (d) The Division which achieves the highest overall improvement factor will be declared the winner.

Receiving Section Rules

1. This section is open to all SWLs in Australia, Papua New Guinea and New Zealand. No active transmitting station may enter this section.
2. Rules are the same as for the Transmitting Section.
3. Only completed contacts may be logged, ie it is not permissible to log a station calling CQ.
4. The log should be in the format shown right.

ar

Example Summary Sheet Remembrance Day Contest 1999

Callsign: VK3DID
Name: Ian Godsil
Address: 57 Nepean Highway, Aspendale, 3195
Category: HF
Section: Transmitting CW
Total Score: 1000
Declaration: *I hereby certify that I have operated in accordance with the rules and spirit of the Contest.*
Signed: Ian Godsil
Date: 30 August 1999

Example Transmitting Log Remembrance Day Contest 1999

Callsign: VK1XXX
Category: HF
Section: Transmitting Phone

Time (UTC)	Band	Mode	Call	Nr Sent	Nr Rcvd	Pts
0801	14	SSB	VK2QQ	58001	59002	1
0802	14	SSB	VK6LL	59002	59001	1
0806	14	SSB	VK5ANW 59003	59001	1	
0808	14	SSB	ZL2AGQ 56004	57004	1	
0811	14	SSB	VK4XX	59005	59008	1

Example Receiving Log

Name/SWL Nr: L33071
Category: HF
Section: Receiving Phone

Time (UTC)	Band	Mode	Calling	Calling	Nr	Nr	Pts
0801	14	SSB	VK1XXX	VK2QQ	58001	59002	1
0802	14	SSB	VK1XXX	VK6LL	59002	59001	1
0806	14	SSB	VK5ANW	VK1XXX	59001	59003	1
0809	14	SSB	VK7AL	VK2PS	59007	58010	1

On VIDEO

"AN EVENING WITH ANDY THOMAS VK5MIR"

A video which shows the presentation evening with Andy Thomas, South Australia's own Astronaut, will be available to Amateur Radio Clubs under the following conditions:-

Radio Clubs and WIA Divisions will be able to obtain a copy of the video for the production cost and cost of tape, packing and postage. This is made up as follows:-

Provision of video -	\$15
Mailing Pack -	\$ 1.15
Postage (within Australia) -	\$ 3.20

TOTAL \$19.35

If Registered Mail is desired an additional amount of \$1.80 will be required. The tapes will be reproduced on professional equipment but on a non-profit basis.

The video shows details of various presentations made to Andy Thomas in connection with his contacts with South Australian Amateur Radio operators, and other interaction with the South Australian community, whilst he was operating as VK5MIR from the Russian 'MIR' Space Station.

It also includes a description of various aspects of Andy's mission on MIR, including his flight to and from the Space Station.

Andy's description included a 'voice over' presentation of his 'flight video' followed by a very interesting question and answer session.

The presentation of the Civic Award of the City of West Torrens to Andy, by Dr Reece Jennings, the acting Mayor of the city is included. This is the highest award the city can present.

The 'flight tape' portion of the presentation will only be included in the video if NASA permission has been obtained to allow its use. This permission is currently awaited.

Radio Clubs wishing to have a copy of the video should submit their request by NO LATER than 18 SEPTEMBER and provide a cheque or money order to the value shown above made out to Ian J. Hunt.

Orders for the tape are to be addressed to Ian J. Hunt, 8 Dexter Drive, Salisbury East, South Australia 5109.

Unfortunately we cannot undertake to provide copies of the tape for individuals. It may be possible for those who would like a personal copy of the presentation to come to some arrangement with their nearest Radio Club.

ARDF

3rd Region 3 ARDF Championships

Nonsan, Korea, 21st-28th June 1999

Jack Bramham VK3WWW
WIA Federal ARDF Co-Ordinator

Ask any travelling Amateur if they managed to involve amateur radio in their itinerary. The answer in most cases would be yes, either by obtaining a reciprocal license, meeting international amateur friends or just looking around the shops in the hunt for amateur related products.



Photos 1 & 2: Australian ARDF team members



AROUND MID JUNE, Adam VK3HDF, Bruce VK3TJN, Bryan VK3YNG, Jason VK4YOL and myself made last minute travel preparations for a trip to Nonsan in South Korea about 3 hours south of Seoul. Nonsan was the site of the 3rd Region 3 ARDF championships.

ARDF is also referred to as Foxhunting, Foxtearing and Radio Sport, to name a few. During the wee hours of Sunday 20th June, two others left Melbourne with me en-route to Sydney where we would change planes and collect the third VK3 who had taken the opportunity to visit family in VK2. The only problem we encountered on the flight to Japan was the constant questioning referring to the ARDF 2m and 80m receivers that were appearing on the Xray screen. Once we explained that they were not explosive devices or hijack material we were allowed to proceed.

Early that Sunday evening we arrived at Narita Airport in Japan where we spent the night at the Nikko hotel and met up with the last member of our group who had arrived direct from Brisbane.

Now we travelled as a complete team each wearing the same screen-printed tops. Upon arrival at Seoul, we were greeted by members of the KARL (Korean Amateur Radio League), then transported by bus to the Konyang University in Nonsan. This was to be our home for the next week.

Tuesday was equipment test day and the opening ceremony. I was required to attend a Jury meeting that morning and missed the start of the receiver testing. When I emerged from the meeting I discovered that one particular version of 80m sniffer we intended to use would not tune down low enough to DF the 3.519MHz. We normally hunt much higher up the band. As it turned out the hunting frequency was to be slightly higher up the band and only a small modification to one receiver was required.

The opening ceremony followed and it was wonderful to see teams from Australia, Belgium, Bulgaria, China, Japan, Korea, Kazakhstan and Mongolia all lined up in their team colours.

After the opening ceremony I attended a reception put on by the Mayor of Nonsan while the others were entertained by traditional music, dancing and martial arts demonstrations. It seems that there was a ploy by the JARL team to slow some of the teams up as they hosted a banquet in the main dining hall with plenty of beer and wine. After a very hot day rain started to fall and I ventured off to bed not really thinking about the possibility of inclement weather.

Wednesday arrived, heavy rain falling. Breakfast was served between 06:00-07:00.



Photo 3 The 80m team members

You could feel the tension as competitors gathered to board the buses which would deliver us to the 2m event start location. This was quite an expensive bus ride as the start was located only 500m from our accommodation, I suppose it was either a ploy, or the organisers didn't want us getting too wet before time. Starting this event in the pouring rain was a nightmare, start groups consisted of 5 and it was difficult to hear your start number called over the rain that thundered down on the temporary awnings.

Personally I would say the 2m course was

easy, but those looking for the number 5 transmitter would disagree. The start sequence begins on number TX 1 as would be expected but the fact number TX 5 was very close to the start. By the time number TX 5 started transmitting competitors were well into the course. All the VK OM competitors fell for the trap and had to return later to punch number 5. With closer inspection of the course layout it was revealed that TX 5 was 250m closer to the start than it should be, later it was explained that the course setter had misinterpreted the rules.

Results for this event were in the OM section (18-40) 1st. Tarassov Nikolay UARK 39:21, 7th VK3TJN 1:08:21, 11th VK3YNG 1:13:25, 18th VK4YOL 1:24:50 (4 TX), 23 VK3HDF 1:47:02 (4 TX overtime). OT section (40-50) 1st. Alexandr Kochergin UARK 36:46, 8th VK3WWW 51:12. Kazakhstan is not in region 3 therefore placings in the OM section for region 3 are: 5th VK3TJN, 9th VK3YNG, 15th VK4YOL. In the OT section: 7th VK3WWW. Team positions for this event saw WIA OM team in 6th place, as there was only one competitor in the OT section, WIA OT team has no result.

It was very obvious that after the 2m event the tension between competitors was breaking down and there were groups of all nationalities discussing the day's events.

Thursday was a rest day, after breakfast competitors were loaded onto buses and shown some of the historical sights of the local area followed by some tourist shopping.

Friday morning, competition day again. This time we went on a real bus ride. After about 20 minutes we arrived at what looked like a commercial market garden, quite steep hills and very dense vegetation. The organisers had done an excellent job in setting up the start area to conform to International ARDF Rules. Weather conditions for this event were hot and humid, so most of the competitors were quite happy to rest in the shade before their start time. The 80m receiver is small compared to the 2m receiver and Yagi, and the bearings are more accurate.

I prefer 80m, rather than lumping around a Yagi, and many others agree. As it turned out wrestling a 2m Yagi through some of this dense jungle would have been very frustrating. Even so the WIA team suffered some equipment damage on this event. After finding two transmitters Bruce VK3TJN fell and his 80m loop became deformed, destroying the excellent unidirectional pattern he was used to. Jason VK4YOL also fell before he found any transmitters. His fall was more devastating as the receiver just died. Final results for this event were: OM open section 1st Qiang Ning 39:35, 9th VK3HDF 1:05:31 (5 TX), 15th VK3TJN 1:24:23 (5TX), 16th VK3YNG 1:34:58 (5TX), 19th VK4YOL 1:24:52 (0TX). In the OT section: 1st Alexandr Kochergin 41:07 (4TX), 10th VK3WWW 1:11:45 (4TX) In Region 3 OM section: 8th VK3HDF, 13th VK3TJN, 14th VK3YNG, 19th VK4YOL. OT section: 8th VK3WWW.

Team results for the OM section saw WIA take 5th place. Again there was only one competitor in the OT section so there is no



Photo 4 Late nights play havoc!

team result. Following the 80m hunt we all returned to the University and prepared for the closing ceremony and presentation dinner, where on behalf of WIA Australia we presented Mr. Kook-Hyun Chung President of the KARL a "Time For DX" 24 hour clock.

After the 2nd Region 3 Competition, where we were slightly embarrassed, we made sure that there were plenty of Australiana gifts to hand out. The WIA team became very popular with those who attended the dinner. In closing I must congratulate the Organisers of the 3rd Region 3 ARDF Championships on a job well done. We all had a wonderful time and in 3 years time when the championships go to Mongolia we will attempt to bring home some medals. If we don't succeed, at least we know the trip will be a lot of fun and certainly a learning experience.

Jack Bramham VK3WWW
WIA Federal ARDF Co-Ordinator
ar



Photos 5 & 6: International Contestants



Photo 7 VK3TJN et al



**AMATEUR
TRANSCIVER
RADIO CENTRE**

ALINCO NO 1 FACTORY DIRECT
IMPORTER
AUTHORISED DEALER
**MASSIVE MONTHLY STOCKIST
LATEST ARRIVALS**

NEW DJ-V5E 6w VHF/UHF
DR-M06T 6m, DR-610E, DJ-GSEY,
ANTENNA TUNERS. POWER SUPPLIES,
BIGGEST DISCOUNTS ON BULK
PURCHASES OF ALINCO AMATEUR
RADIOS & ACCESSORIES.
FULL 3-YEAR FACTORY BACKED
WARRANTY
ALINCO SPECIALIST



IC-706MKIIG, IC-T81A,
IC-2800H, IC-746, IC-756-Pro
IC-T8A, IC-R75, IC-Q7A.

KENWOOD TS-570SG TM-V7A
TH-G71A VC-H1 TH-D7A TM-G707A UBZ-LF48

JRC NRD-545G, JST-245, NRD-345.

AMERITRON AMPLIFIERS
AL-811AX 600 WPEP
AL-811HX 800 WPEP

PHONE (02) 9896 2545

E-mail: atrc@bytelink.com.au

Web Page:

<http://users.bytelink.com.au/atrc>

**HAVE YOU
HEARD...**



this week's
Divisional Broadcast?

See page 56 for times and frequencies.

Y2K:

It's Elementary, My Dear Watson

Alan Shawsmitz VK4SS
35 Whynot St South Brisbane 4101
E-mail: ashawsmi@powerup.com.au

Take heed; an apocalypse cometh. The official countdown is on - only one hundred and ninety days as I write this. Is Planet Earth, ready? NO?

Electronically can Planet Earth be made ready come the 3rd millennium? NO?

No one and, I repeat 'no-one', can really know. So what can we expect?

The words of a USA Armed Forces PRO tells it best. To a group of Journos he said, "come the moment of the 3rd millennium ie 2000AD, we will have modified (made compliant, if necessary), tested and re-tested the thousands of sophisticated systems of our forces. (There are over seven thousand intricate systems used by the USN alone) but not until midnight NY 2000AD will we know the truth".

As more and more conflicting info is spilled out from radio, print and TV media, it's only natural that confusion regarding this event will grow. So it's time to try to sort out the nitty-gritty facts from the inconsequential and gravy train trash.

First of all, there's no such thing as a Y2K or 3rd millennium 'bug' or 'virus' in the sense that at midnight NY 2000AD some acutely destructive 'virus' (like sudden severe flu) will appear and reduce micro-chip and semi conductor equipment to useless pieces of inanimate junk.

The approaching apocalypse will be caused by apparatus failure to keep pace with time ie our calendar for the 3rd millennium (first produced by Pope Gregory, 1580). We have been bom, lived and will die by it. The average computer is as much a part of the Gregorian calendar as we are. It is created (built), provides service and ceases to function fully on the same time scale, in this case the first nanosecond of Y2K.

Detailed info on the Y2K computer problem and its worldwide effect is a subject too long to deal with here. So I suggest to those who can, that they obtain the 16 page brochure titled YEAR 2000 MISCONCEPTIONS AND OPTIONS from the Queensland State Government. Marketing Division, Department of State Development, Queensland. (It's free to all). (Other states may have something similar. -Ed)

Here is a sample of what the brochure provides:

The Year 2000 Problem (or millennium

bug) arises from use of electronic equipment and computerised systems that need to know the date in order to operate, and store or use those year dates as two digits (eg.00) rather than four digits (eg.1900,2000).

The millennium bug may also affect millions of embedded semiconductor chips from toasters to air navigation equipment.

As the year 2000 arrives many computerised systems may respond as if it was 1900 again. This may expose users to the risks of system failures, possibly catastrophic. It's not that there is a problem with working at 1900 but calculations by the embedded chips will come up with unexpected negative numbers.

The issues concerning the Year 2000 are urgent and far reaching with the global costs of correcting the problem estimated at \$900 billion worldwide. The cost to Australian business and industry could be about \$20 billion.

The list of affected items includes:

- Mainframe Computing Environments
- Midrange Computers
- PCs and Desktop Environments
- Software
- Telecommunications
- Emergency Services
- Fire Alarms, Warning Systems
- Airconditioning
- PABX, Voice Recording, Machines
- Surveillance, Security, Lift Controls
- Date/Time Machine Stamps
- Radio Control Systems
- Some Video and Audio Equipment
- Hospital Equipment
- Photocopiers
- Power Supply

Here is a quote from an internationally respected professional - Edward Yardeni, Chief Economist Deutsche Morgan Grenfell.

"The Year 2000 problem is a very serious threat... it could disrupt the entire global economy. I believe there is a 40% risk of a

world wide recession that will last at least 12 months starting in January 2000."

(November 1997)

A four-page insert comes with the Queensland Government brochure. Make sure you ask for it.

Alongside my computer is a fast growing stack of news clips, E-mails, magazine cutouts and my own personal notes. To my perception, about 10-20% of it has merit; another 20% could stand a second perusal and the rightful place of the remaining 60% is in the bin!

To me the main surprise of the pile is the proportion of material devoted to proving the year of the birth of Jesus Christ, as if in some way this is going to change the time scale function of the Y2K problem.

As an example of this, let me relate a short telephone conversation with a young lady: "I'm confused. Yesterday I bought a Windows 95 Computer. Full warranty, and after sales service. This morning as I was about to complete the sale and arrange delivery my next door neighbour tells me to have nothing to do with it. He says that the 3rd millennium doesn't happen until 2001AD and after that my Windows 95 will be useless. Is he right?" My reply, "Can you imagine your neighbour doesn't exist?" "I can try". "Try hard, and go get your computer right now. Just be sure about the Warranty and after sales service and that it's compliant and the best of luck to you." It was that two-minute phone call that caused me to put fingers to my keyboard. Imagine the confusion that misinformation like that will cause if spread daily through the lay community by someone who calls himself a computer 'buff'.

Why are the 2001AD cultists so persistently pedantic when the world's best brains claim they don't know what will happen?

I sought comments from four of the best theologians: Catholic (Roman); Anglican; Islam (Moslem); Judaism (Jewish) and asked exactly the same question of each. "Assuming our present calendar is incorrect, can you tell me the actual year of the birth of Jesus Christ."

- (1) Catholic: "Vatican and Middle East scholars would most likely say the year 4 BC. This is the official Vatican line, minus any dogma."
- (2) Anglican: "Our theologians would probably say sometime between 6BC and 4BC but they add that there's no positive proof."
- (3) Moslem: "Our calendar says we are in the year 1419. As you know it is Arabic calculated from the year our prophet Mohammed moved from Mecca to Medina at the age of 53."

Our calendar is calculated by the lunar months. It is a mistake to assume that there is no 0 in our numeracy. Arabic uses a dot and this dot is calculated as zero."

- (4) Judaism: *"Jesus Christ plays no part in our history so I cannot help you. According to our calendar we are presently living in the year 5759." (Since the presumed beginning of our world. -Ed)*

That was it, not one mention of 2001 AD. I had already tried astronomy by calling up Tidbinbilla, Mt Stromlo, Queensland University and the Brisbane Planetarium. No one trusts the accuracy of the Gregorian calendar as far back as 2000 years.

The article by Chris, VK6KCH in 'AR', January 1999, paints a pretty good picture of the most possible scenario, but omits that law and order may also fail.

I believe the Y2K 'shudder' will fall between bureaucratic deception and 'gravity-train' doomsday hype.

Finally, here are a few international news releases to mull over. Mostly taken from worldwide Radio Broadcast services.

Canada; March '99. *"In the event of post Y2K problems we suggest a four week stockpile of essentials be stored."*

Japan; *"As at 20.3.99 Japan intends to temporarily abort part of its space program so as to protect certain sensitive systems against Y2K malfunction."*

Russia informs the world that US\$500,000 (1/2 million) will be set aside for Y2K compliancy. World reaction: What do they use for computers, cardboard cutouts? (Boris Yeltsin has now been better briefed and boosted the ante to \$7m that many feel is still a joke.)

From the local scene here in VK. The NAB has issued an early notice. No holidays for any employee over the Y2K New Year weekend. All must be on hand plus technicians just in case. This Bank and all finance houses throughout the world must be fairly certain that there will be 'glitches'. Singapore is the latest. Remember the almighty dollar is sacrosanct. Human values are expendable.

"The Jesus Freaks" - religious extremists, will assemble on an island off Gisborne, New Zealand. Theirs will be the first eyes to greet the first sunrise (if it's not raining) of Y2K. Will it be with hope or dread? There's sure to be a Ham with them broadcasting the scene. They believe in the Biblical Book of Revelations. Chapter 20 Verse 1-7 a millennium of peace awaits us all. At the site of Jesus Christ's cross another cult intend to mass immolate - commit suicide. The Jerusalem fathers can hardly wait.

India: Some provinces on the sub-

continent began the 3rd millennium, one-year celebration last March. Nothing like 'fun and games' early, just in case. (Now there's trust for you).

Hackers: Professional "System busters". The Hong Kong Blondes (?) and the Millworm Group have a Y2K plan ready. (That can only mean trouble).

Nostradamus: The Prince of all prophets says, *"The end of the world will occur October 1999"*; this means you are reading your last 'AR' magazine. Wait, before you start dismantling the rig and thumbing through your favourite papers, take note, this man who took 1000 predictions 400 years into the future, made his calculations using the Julian Calendar not the Gregorian, so we can expect the dates to be a little bit out.

You will have by now asked yourself what have some of the above "newsgrabs" to do with Ham Radio post Y2K. Some very little, others everything, but expect the subject via the media to snowball until the last moment of 1999.

It's now the 3rd millennium, we have survived the worst. It's back to the enjoyment of AR and maybe a new log book full of empty pages. The first entries?

Be prepared January through April. Severe Solar Storms predicted, capable of much destruction, satellites, city grids and other gear.

Computer Runs (simulated) declare an "impact winter" long overdue. Earth volcanic explosions of massive size.

Meteor impact. Right now there's a big one (almost 2km across) roughly on course. Could pass as close as 50,000km. That will more than rustle the trees on planet earth.

Arthur C. Clarke quits his predictions at 2100AD with the words "Now history will begin"? (What does he mean?)

Still confused? OK. Study these facts about our calendar and you'll understand why man and computer are tied together as they are,

I found this next piece on the back of a calendar, from Allen Calendars.

Some History And Facts About The Calendar (Ref1)

The calendar ... evolved from a Roman calendar established by Romulus, consisting of a year of 304 days divided into 10 months, commencing with March. This was modified by Numa, who added two extra months, January and February, making the year consist of 12 months of 30 and 29 days alternatively plus one extra day and thus a year of 355 days. This calendar required the use of an intercalary month of 22 or 23 days in alternate years. In the year 46 BC Julius Caesar asked for the help of the Greek astronomer Sosigenes as he had found that the calendar had fallen into some

confusion. This led to the adoption of the Julian calendar in 45BC (in fact the year 46 BC was made to consist of 445 days to adjust for earlier faults and is known as "The Year of Confusion").

In the Christian system the years are distinguished by numbers before or after the incarnation of Christ.

Denoted by the letters BC (Before Christ) and AD (Anno Domini). The starting point taken from the Jewish calendar year 3761 AM (Annus Mundi) and the 753rd year from the foundation of Rome. This system was said to have been introduced into England by St. Augustine about AD 596. It was ordered to be used by the bishops at the Council of Chelsea in AD 816.

In the Julian calendar all centennial years were leap years (ie the years AD 1200,1300,1400,etc.) and for this reason towards the end of the 16th century there was found to be a difference of 10 days between the Tropical and calendar years. This was corrected in 1582 when Pope Gregory ordained that October 5th should become October 15th, thus making the 10-day correction, and that only every fourth centennial year should be a leap year. This is known as the Gregorian calendar and is the one that we now use. It was adopted by Italy, France and Portugal in 1582 and other countries made the correction at various dates up to as late as 1923. The change from the Julian to the Gregorian calendar did not take place in Great Britain and her dominions until 1752, when the correction was made by the omission of eleven days, Wednesday, September 2nd, being immediately followed by Thursday, September 14th.

The Julian and Gregorian calendars are also sometimes referred to as the Old Style and New Style calendars. It is interesting to note that these terms originally applied to the date of the beginning of the year (New Year's Day). In the Old Style this was on the 25th March and was changed to the 1st January (New Style) in England at the time of changing from the Julian to the Gregorian calendar in 1752. New Year's Day was changed to January 1st in Scotland in 1600.

So there it is. Exactly as Holmes said to Watson. "Elementary?" Still confused? Be patient, time resolves all things.

73s 'que Dios le Bendiga'

PS I forgot to ask those theologians. "If the moment of the coming millennium is Jesus Christ's birth, why do we hold it on 25th December?"

Ref:

Allen Calendars, locked bag 326 Kingsgrove NSW 2208 (02) 9740 9744

ar

VK5s go to Dayton Hamvention '99 - USA

By Grant Willis, VK5ZWI
WIA Federal IARU Liaison Officer

On the morning of May 7th, Garry VK5ZK, Adrian VK5ZBR, Conrad VK5ZCK and myself, Grant VK5ZWI, boarded a QANTAS flight bound for the USA. (See photo 1). Our target was the Dayton Hamvention in Ohio, one of the largest Amateur Radio conventions in the world. Along the way, we toured several regions

of the United States, and Canada and met some interesting amateur radio operators.

After touring Colorado and Wyoming for the first week of our trip, we landed in Columbus, Ohio (about 70 miles from Dayton) on the Thursday afternoon. There we picked up a hire car and made our way up Interstate Route 70 (170) to Dayton. We

had pre-booked our accommodation at the beginning of January, and it was a wise move. Some people were staying as much as 50 miles outside of Dayton, just to get a room. Attendances at this event range between 30,000 to 40,000!

The Dayton Hamvention is a 3-day event, commencing on a Friday and concluding Sunday afternoon. A continuous talk-in net on the 146.94 repeater was available throughout the weekend, manned by operators from the Dayton Amateur Radio Association (DARA). Many useful navigation tips, as well as convention details and highlights were discussed on this net, and is a must for anyone attending. With the simplification of FCC requirements for foreign amateurs to operate in the USA, a 2m handheld becomes an almost essential travel companion. It is a credit to the

operators from DARA that the net ran so smoothly and efficiently.

There is so much to see and do at the convention it is difficult to know where to start. Getting to the convention venue is easy enough. Free parking and bus services were available from two of the local shopping malls. The entry tickets into the convention, which is held in the Hara Stadium complex, are US\$20.00 (see photo 2). These are valid for the full three days of the event. Your ticket automatically puts you in the draw for one of the many valuable door prizes. Door prizes at Dayton are not to be dismissed as they include 2m handhelds and other similar goodies. The major prizes included a Kenwood TS870S, Yaesu FT1000MP, Icom IC756 and other similar standard radios.

There are approximately 250 commercial exhibitors in the 5 main show halls, with around 1000 flea market stalls. Every major manufacturer of equipment even remotely related to Amateur Radio has a presence at Dayton. The big names are there, such as Icom, Kenwood, Yaesu, Alinco, MFJ, PacComm, as well as many smaller manufacturers, kit producers, component distributors and test equipment suppliers.

You would not have expected to see some of the companies that were there, including General Motors and Ford, as well as suppliers of weather stations! (It was interesting hearing several USA repeaters during our trip reporting local wind speed and temperature on the hour). There was also a plethora of computer, computer component and peripheral suppliers, servicing every corner of an amateur's interest.

The main arena was quite impressive (see photo 3).

The flea market is something to behold. (See photo 4). It is held outside in what is normally Hara Stadium's car park, covering the area of roughly 3 AFL football ovals. The range of items available on the second hand market in the USA is incredible. You could easily walk away with everything you needed to build a full linked repeater network or a complete ATV station.

If your interests were satellites you could have purchased the components for an Oscar capable satellite station. Computer and packet radio buffs could have obtained many of the base components for their computer networks. If your pet corner of the hobby is portable operation, then everything from antennas, coax, winch up portable towers to complete ex-army mobile communications vans were on sale! I have never been to a convention in Australia (including Gosford) that even comes close to the magnitude and scale of this event!

In addition to the trade displays and flea



Photo 1. "The Guys" - l-r Garry Herden VK5ZK, Conrad Knuepfer VK5ZCK, Grant Willis VK5ZWI, Adrian Waiblinger VK5ZBR assembled at Adelaide Airport prior to departure.

'99 DAYTON hamvention®

P.O. Box 984 • Dayton, OH 45401
www.hamvention.org

Sponsored by
THE DAYTON AMATEUR RADIO ASSN.
Hara Arena Conference
& Exhibition Center
DAYTON, OHIO
Fri., Sat., Sun., May 14, 15, 16, 1999
Admission \$16.00 ea. in advance
Admission \$20.00 ea. days of show
IMPORTANT
This Card Required for Admission and Prize Claim
- NON REFUNDABLE -

CALL VK5ZBR

NAME ADRIAN WAIBLINGER

Photo 2. "Entry Ticket" - This is a sample of the entry tickets at Dayton Hamvention.

An interesting alternate program is also run by DARA. Slanted more towards the non-licensed-YLs, it includes city and shopping tours of Dayton, cooking classes, landscaping tips, arts and crafts and beauty tip lectures and activities. So while the guys are in the halls looking at radios, the wives are out being entertained as well!

One of the behind the scenes results of holding the Dayton Hamvention is the ability for DARA to award college scholarships. These are awarded to students in the USA who hold an FCC amateur licence. It is great to see an event like Hamvention helping foster youth in amateur radio and education in this manner.

The Dayton Hamvention also offered me a chance to meet many of the people involved with IARU and ARRL. I had

discussions with Larry Price W4RA (IARU President), Dave Sumner K1ZZ (ARRL Executive Vice President) and Tom Atkins VE3CDM (IARU Region 2 Chairman). They were most useful and have no doubt helped in further strengthening contacts with the WIA, especially in the lead up to the IARU Region 3 Year 2000 conference in Darwin when these gentlemen will join us here in Australia.

Overall, the entire trip has been an amazing experience. There is nothing I can think of to compare the Dayton Hamvention with. I can thoroughly recommend, if you get the chance, making the journey half-way around the world to Dayton, Ohio in May to attend this hive of Amateur Radio activity. The dates for the 2000 Dayton Hamvention, for those who wish to put them in your diary

are, May 19th, 20th and 21st. The year 2000 will be a special event as the ARRL National Convention will also be held in conjunction with Dayton Hamvention.

On behalf of the VK5s who went to Dayton this year, we would like to say thanks to DARA for an excellent event. If you wish to find out more about the Dayton Hamvention, and have Internet access, try their web site at

<http://www.hamvention.org/>.

Grant Willis, VK5ZWI

P.S. The VK5's had many other adventures while in the USA and made contact with many other hams on 2m and 70cm. Thanks to all those who answered our portable calls and added that extra local dimension to our journey through 12 American states and one Canadian province in 4 weeks.

ar



Photo 3. "Hara Stadium" - This is one of the exhibitor show halls in the main basketball stadium within the Hara Stadium complex.



Photo 4. "Flea Market" - An aerial view of the flea market and convention halls. The cars you see parked are actually the flea market stalls.

An Attenuator Set for Receiver Sensitivity Measurements

Drew Diamond, VK3XU

45 Gatters Rd.,
Wonga Park, 3115

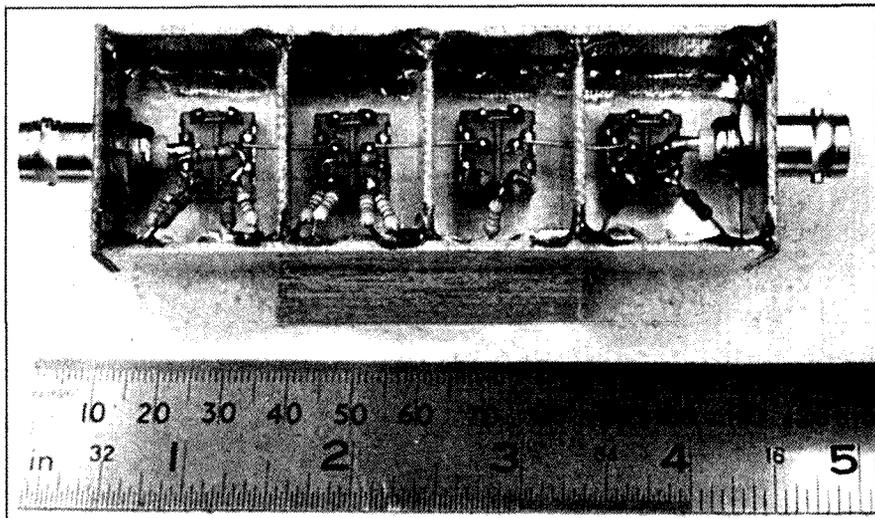

Photo 1

WHETHER WE ARE building, repairing or just checking a receiver, the ability to put an actual figure on the sensitivity is extremely useful. In HF work, the operator of a "laboratory" grade signal generator ("generator" from here on) should be able to reduce the level down to at least 0.1 microvolts, or about -127 dBm, which typically represents the smallest readable signal from an antenna in a quiet location. To obtain such a weak signal, the generator must be properly shielded, and be fitted with a well-made step attenuator of sufficient range.

We have been fortunate in recent years in being able to obtain, at reasonable cost, laboratory grade generators, made surplus by defence and communications bodies. A typical example is the Hewlett Packard model 606, and its cousins. These valve-driven "boat-anchors" represent some of the best-made instruments of their time, and do indeed qualify for the title of "signal generator". But for the amateur with limited bench space, they are very much in the too-big-too-heavy class. So, in the end, something like the Dick Smith's Q-1312 is purchased.

However, it is soon found that even on the low output setting, and with the

attenuator at minimum, the Q-1312's signal simply cannot be reduced sufficiently to permit a meaningful sensitivity measurement. Nor is there any metering of the output level.

Fortunately, the shielding of the Q-1312 is adequate to allow coaxial sensitivity measurements at HF. The maximum output (of my sample) is just over 1 mW, or 0 dBm in 50 ohms. By using the generator's -20 dB (low output) position and variable attenuator, an external level detector, and a 0 to 10 dB attenuator set, a signal level of less than 0.1 microvolt may be obtained.

An attenuator set may consist of a shielded box containing attenuations of 10, 20, 30 and 40 dB, giving 0 to 100 dB in 10 dB steps, and another box containing 1, 2, 3 and 4 dB giving 0 to 10 dB in 1 dB steps. The level may be adjusted to "0 dBm" or 1 mW into the 50 ohms attenuator set, with a simple "in-line" level detector that is connected at the generator's output. These three items will be described presently. We can now obtain a signal level from 0 to -110 dBm in 1dB steps. The Q-1312's low output position gives us another -20 dB, thus a known level of -130 dBm may be obtained with confidence. In practice (perhaps surprisingly), the signal level using this set-

up is within 2 dB of that from a laboratory grade generator.

The same attenuator set will find use in other applications, such as; checking the accuracy/calibration of "S" meters, in fox hunting; to reduce the receiver's input signal by known amounts when closing in, and in gain/loss measurements upon amplifiers, antennas and other devices.

Construction

With careful work, the attenuator set should be quite accurate to 30 MHz, and reasonably accurate to at least 148 MHz. A cheap and effective shielded box for small items of test equipment is one made from double-sided printed circuit board. Thus, in this application, the "earthy" ends of the attenuation resistors may be soldered directly to the box wall with minimum lead length.

My box dimensions are 30 X 34 X 100 mm (HWD) for both attenuators. The 0-100 dB is shown in Photo 1. Dimension and mark out your sheet according to scrap-box availability, but try for a final box size similar to mine. If you have access to a sheet-metal guillotine; accurately cut your panels accordingly. If you must saw the panels; remember to allow for the width of the saw cuts as you go. Clean up rough edges with a smooth file.

Drill the holes for the connectors (type BNC is suggested for test equipment). Plan to solder the centre pin of the end connectors directly to the switch tag. When you are ready to start soldering the panels together, use some kind of right-angled device as a jig, such as a vee-block, as depicted in Photo 2. Apply small tacks of solder at first, then, when the box "looks right", form a continuous fillet of solder along the joins inside.

Carefully mark out on the front panel where the DPDT miniature toggle switches will be. Remember to aim for a direct solder connection of the connectors to the first and last switch tags (if this does not occur, it's no great trauma- a short wire connection will do). Only the 0 - 100 dB attenuator requires partitions between switches. Drill a small hole in these for the connecting wire. Remember to check the switch tag height for a bend-free connection through the partition. Solder in the attenuation resistors using the smallest practicable lead length.

The box for the in-line level detector measures 30 X 34 X 60 mm (HWD), and is made in a similar manner to that described above. The diodes and 10 nF monolithic capacitors should have leads as short as practicable. See Photo 3. Remember to heat-sink the diode lead(s) with long-nose pliers when soldering these parts.

Checking Receiver Sensitivity

A typical set-up for SSB/CW sensitivity measurements upon an experimental receiver is depicted in Photo 4. From the generator, the signal route is; coax cable, detector, 0-100 dB, 0-10 dB, coax, receiver. The receiver must have its covers on to prevent any direct pick up of the generator's signal (which is leaked mainly from the AF banana sockets on the front panel). The generator is set for unmodulated output. If your Q-1312 is like mine, you should have just over 1 mW/0 dBm output with the level pot at maximum. Table 1 (from the 1980 ARRL H'book) shows voltage levels and their corresponding dBm levels, referenced to 1 mW (0 dBm) in 50 ohms. Note how the minus dBm number increases as we go down in signal level. If your HF receiver can "hear" -130 dBm, then it should be sensitive enough for all practical purposes.

The simplest meaningful sensitivity number is probably the expression; "N microvolts for 10 dB signal plus noise, to noise". A typical figure might be 0.2 microvolts. To obtain this number, a measurement is first taken of the receiver's output with no signal present- just the noise that emerges from the headphone jack, or that which can be detected across the speaker's coil with the generator's output at zero. This is Noise reference level. Now the signal (whose frequency lies in the receiver's pass-band) is increased until the signal plus noise level indicated is 10 dB greater than reference level. The actual signal level is now determined by taking into account the amount of attenuation between generator and receiver.

If the generator's output is not metered (such as the Q-1312), we can measure the signal level with a simple in-line meter. Shown in the schematic is a voltage doubler diode detector which operates over HF. Experiments with various germanium diodes of types OA91, 92, 95 and 1N60 demonstrated that the output voltage obtained is remarkably repeatable. Which is just as well, for I'm going to ask you to accept that a 10 Mohm input DMM reading between (+) and (-) at the

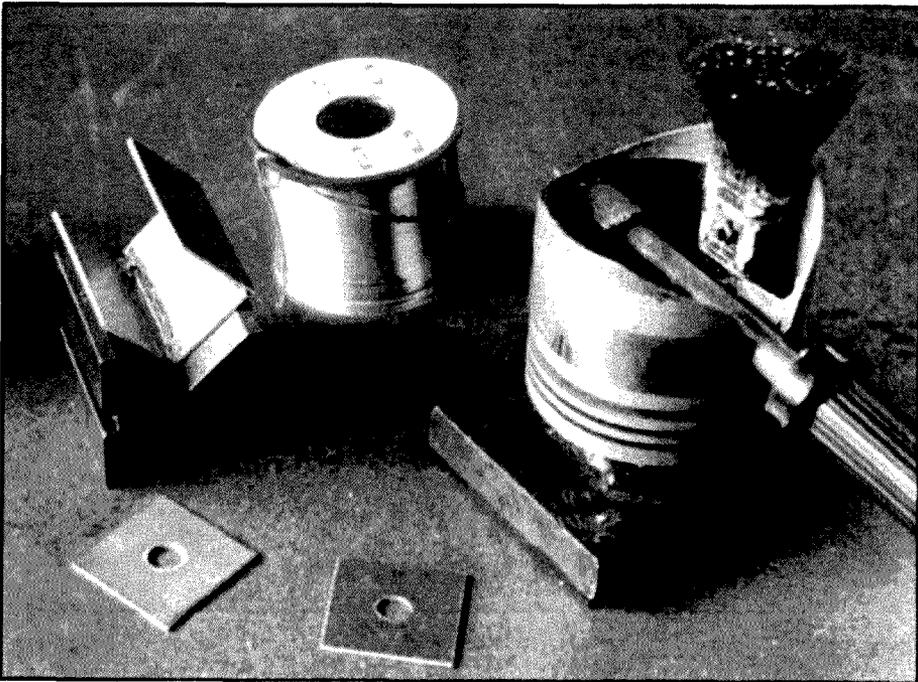

Photo 2

detector feedthrough terminals of 470 mVdc (0.47 V) corresponds to 220 mV/1 mW/0 dBm in 50 ohms. This is an arbitrary figure, because the diodes are not working in a region where their turn-on voltage can be ignored (ideal diodes would give us about $2 \times V_{peak} = 2 \times 1.4 \times .22 = 0.62 \text{ V}$).

Now, if the in-line level is set to 470 mV on our DMM (which corresponds to 0 dBm), and 110 dB worth of attenuation is inserted, then the signal at the receiver's input will be -110 dBm, or 0.7 microvolts, which should be plainly audible if the receiver is half decent. If the -20 dB low-

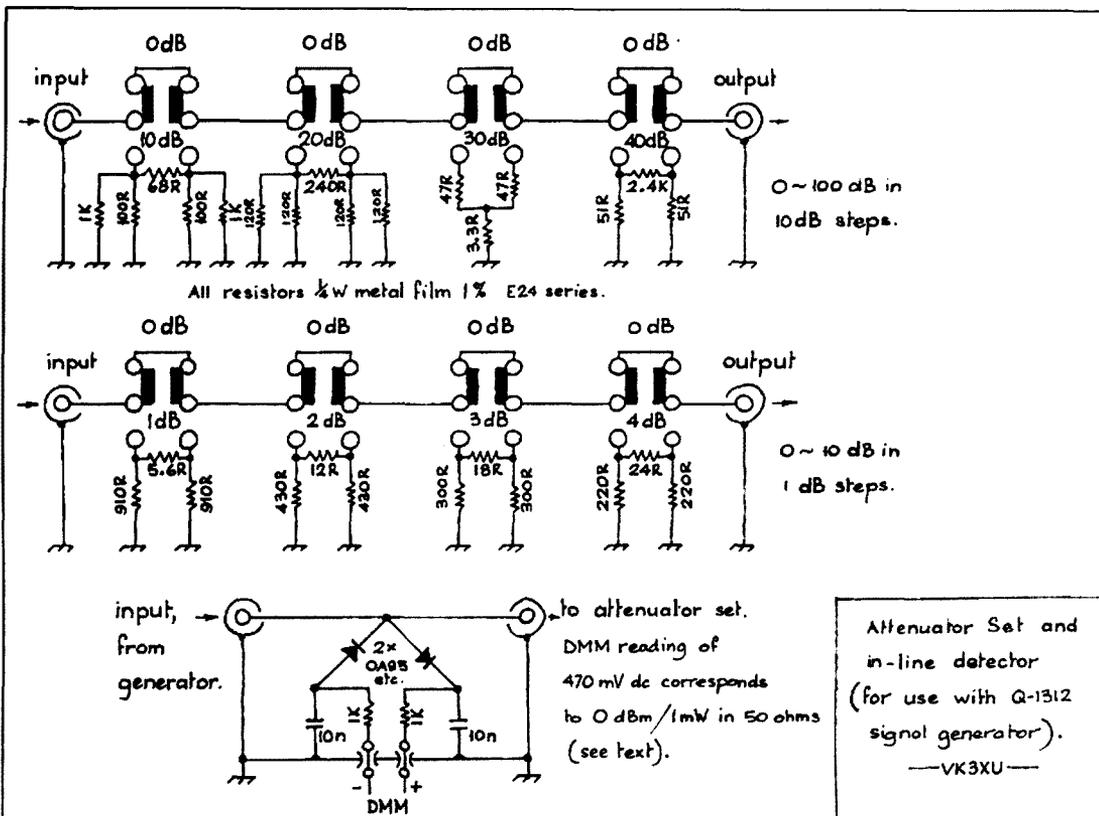

Figure 1

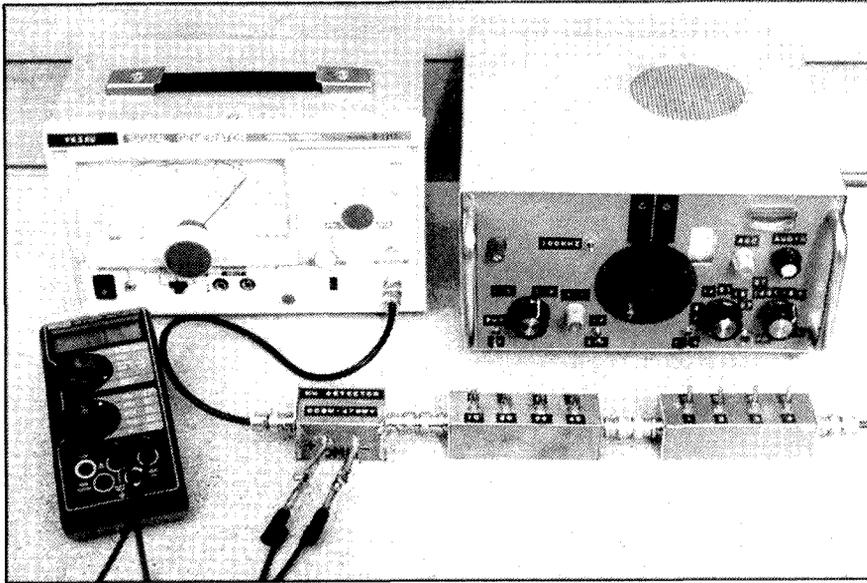

Photo 3

output position is now selected on the generator, the true level will drop to -130 dBm. A good receiver should "hear" this level.

To put a real figure on the sensitivity, an ac millivoltmeter with dB calibration is also required (which ideally should read true rms, but the error is small). Connect the meter to the receiver's AF output, or across the speaker coil. A typical range would be about 300 mV at comfortable loudness. Turn the generator's output pot down to

minimum (so that no signal is heard- just receiver noise). Adjust the receiver's AF gain to obtain a convenient reading of about 1/3 of full-scale (or the -10 dB calibration point on the milli-voltmeter's scale). This is our Noise reference. Set the generator to output 0 dBm as noted above. Switch in or out attenuation as necessary to obtain a signal-plus-noise reading 10 dB greater than Noise reference. Look up Table 1 to find the equivalent microvolt sensitivity. Sounds complicated, but with practice this method

becomes a powerful tool in receiver evaluation.

Parts

The miniature DPDT switches may be Dick Smith P/N DS 7656, or Jaycar ST-0552, or similar. 1000 pF (1 nF, or larger) feedthroughs are available from Electronics World (ph 03 9723 3860). These three can also supply the remaining components. If you have genuine difficulty in obtaining any of the parts, I always keep a few spares, so do please drop me a line at the address shown.

References and Further Reading:

1. Solid State Design for the Radio Amateur; Ch 7; Hayward & DeMaw; ARRL.
2. ARRL Handbook, 1980 (57th) Edition; pp 16.29-34.
3. "Measuring SSB/CW Receiver Sensitivity"; Sabin, WO1YH, QST Oct. '92.
4. Switched Attenuator in Ian Keyser's (G3ROO) column, Rad Com Mar '97.
5. The VHF DX Book; White (Ed.), Ch. 12; DIR Publications.
6. "Improvements to Signal Generator model Q-1312"; Diamond, AR Apr. '98.

ar

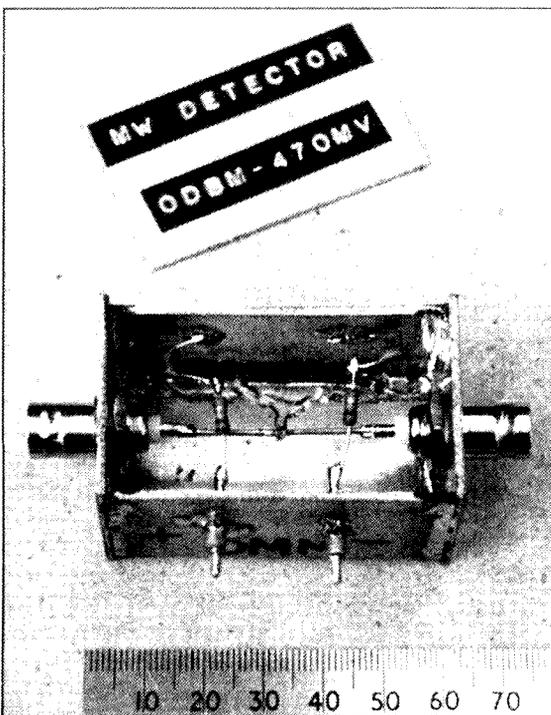

Photo 4

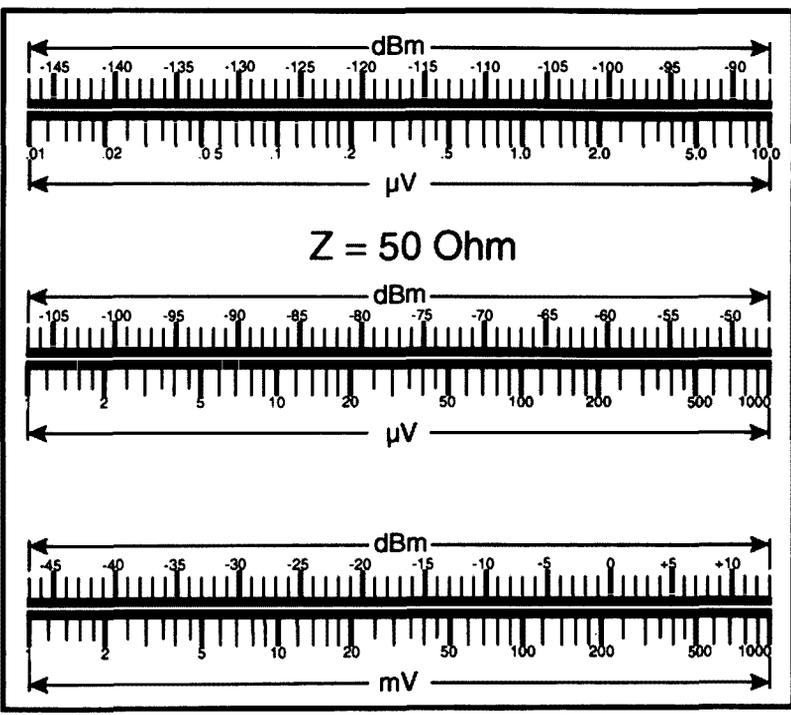

Figure 2

Equipment Review

ICOM IC-Q7A

By Paul McMahon VK3DIP.

What is it?

The IC-Q7A is a low cost dual-band (2 m and 70 m) handheld transceiver, offering about 350mW out on either band, and extended receiver coverage from 30-1300 MHz in FM, AM, and FM Wide, modes. The review set was supplied courtesy of ICOM (Australia) and had a serial number of 01064. The street price of an IC-Q7A is around \$340.

First Impressions

While this review is primarily on the ICOM IC-Q7A, I will be comparing the IC-Q7A to the Yaesu VX-1R a number of times. This is not a full comparison study, nor do I come out with any conclusion as to which is best, however I feel that there are quite a few Hams out there who would be interested in some of the contrasts. Besides, as ICOM don't supply a circuit or block diagram etc, now common practice, it gives me something of substance to talk about in this article.

The first thing that you notice about this set is how much it looks like a small "Transistor" BC band radio. Apart from the rubber ducky and the smallish LCD display the set looks (and feels) like many of the common small AM radios you see around. The second thing you notice (or at least I did as I unpacked the box) was that there is no plug pack charger. In fact the set uses two standard AA cells and while Ni-Cad cells and charger are available as an option there is no mechanism for charging them in situ, or powering the set externally for that matter. The two AA cells are probably in part responsible for the set's shape (58 by 86 by 27 mm) which as you can see from the photos makes the set look and feel a bit more square than the usual handheld form-factor. Having said that, while the set is a bit bigger than the Yaesu VX-1R, which it is obviously intended to compete with, it still fits at least my hand reasonably well. The extra length of the standard antenna (180mm vs 110 mm) can come in very handy over marginal paths. Like the VX-1R the IC-Q7A uses an SMA style connector for the antenna which looks to be the new standard for small handhelds.

Apart from the set itself the package includes the antenna, a carry strap, a belt

clip, and the 40-page instruction book. There is no circuit and virtually no technical detail other than the specifications. There is not even a pin-out or description of the earphone/microphone socket which looks like a standard 3.5 mm type, but on closer inspection appears to be more like that of the Yaesu VX-1R (ie having three conductors plus earth, and being impossible to buy except as a special cable or adapter at great expense). This lack of detail led to a number of difficulties with testing this set.

Technical Bits

As mentioned above, the antenna connection is via an SMA-like connector, I call it SMA-like because

it that appears in an effort to increase mechanical strength ICOM have opted for a connector that is somewhat longer than a standard connector. It will depend on what you want to do with the set whether this compromise is a good one or not. If you only ever intend to use either the antenna that came with the set or genuine ICOM accessories, then the increased mechanical strength will come in handy, especially if you opt for a larger antenna. If however you want to connect this set up to some home brew converter etc. then you may have to do a bit of hunting around to find a suitable SMA plug. In my case I was lucky to have two SMA to BNC patch cords each with a different brand of SMA connector. One worked, the other did not. This also, of course, does make interchanging of antennas from one brand to another more problematic, and I would caution anybody looking at buying a third party antenna to try it on the set first to ensure that it both makes reliable connection and looks OK.

There is no technical information, such



Photo 1. The diminutive handful

as circuit diagrams etc. provided with the set other than the standard specification page reproduced elsewhere in this article. Without some idea of which pin was which with the earphone and other connector. I didn't feel brave enough just to try it with a standard plug so actual measurements of S/N etc to verify the ICOM figures were not possible.

I was however able to verify that the set did cover the range continuously and that sensitivity at least from perceived audible quietening seemed on a par with that quoted in the specs. One thing I did notice however while doing this test was an anomaly in the S-meter. Despite appearing to be nine steps on the LCD S-Meter in fact there are only five. The first eight small blocks come on in pairs leading to a somewhat strange effect where your ears can be more effective at judging the relative strengths of similar signals than the S-Meter.

As a matter of interest, while again I could not do any absolute measurements, I did try to do some comparisons with the

IC-Q7A SPECIFICATIONS

GENERAL

Frequency Coverage:

Transmit:

VHF: 144-148 MHz

UHF: 430-440 MHz

Receive:

30 - 1309.995 MHz

(specifications guaranteed 30 - 1300 MHz)

Mode: FM, AM (receive only), WFM (receive only)

Number of memory channels: 200

Useable Temperature Range: -10°C to +60°C

Tuning steps (kHz): 5, 6.25, 10, 12.5, 15, 20, 25, 30, 50 and 100 kHz

Power supply requirement: 2 x AA(R6) Ni-Cd or alkaline cells (negative ground)

Current Drain (VHF/UHF; at 3.0 V DC):

Tx (max. power): 440 mA/380 mA (typical)

Rx (rated audio): 170 mA (typical)

Rx (standby): 95 mA (typical)

Rx (power saved): 38 mA (typical)

Antenna connector: SMA (50 ohm)

Dimensions (projections not included): 58(W) x 86(H) x 27(D) mm

Weight: 170 g; 6 oz. (with antenna and battery)

MIC / SP connector: 4-conductor 3.5 (d) mm (.125 in); 2 k / 8 Ohms

Transmitter

Modulation system: Variable reactance

Output power (at 3.0 V DC):

VHF: 350 mW typ.

UHF: 300 mW typ.

Maximum frequency deviation: ± 5 kHz

Spurious emissions: Less than -40 dB

Receiver

Receive system: Triple conversion superheterodyne

Intermediate frequencies: 1st: 266.7 MHz;

2nd: 19.65 MHz; 3rd: 450 kHz

Sensitivity (except spurious points; typical values):

FM (at 12 dB SINAD)

30 - 117.995 MHz / 0.32 μ V

118 - 174.995 MHz / 0.16 μ V

175 - 246.995 MHz / 0.32 μ V

247 - 329.995 MHz / 0.32 μ V

330 - 379.995 MHz / 0.32 μ V

380 - 469.995 MHz / 0.32 μ V

470 - 749.995 MHz / 0.32 μ V

750 - 999.995 MHz / 0.32 μ V

1000 - 1199.995 MHz / 0.32 μ V

1200 - 1300.995 MHz / 0.32 μ V

WFM (at 12 dB SINAD)

76 - 108.0 MHz / 1.0 μ V

175 - 221.995 MHz / 1.0 μ V

470 - 770 MHz / 5.6 μ V

AM (at 12 dB SINAD)

118 - 136.0 MHz / 0.56 μ V

222 - 246.995 MHz / 0.79 μ V

247 - 329.995 MHz / 1.4 μ V

Squelch sensitivity:

0.18 μ V (144 - 148 MHz)

0.22 μ V (430 - 450 MHz)

Selectivity:

FM, AM More than 15 kHz / -6 dB, less than 30 kHz / -60 dB

WFM More than 150 kHz / -6 dB

Image rejection ratio: More than 60 dB

Audio output power (at 3.0 V): 100 mW (typ. at 10% distortion with an 8 Ohm load)



Photo 2. Icom left, Yaesu right

receiver in the VX-1R. While there was no real noticeable difference between performance within the Ham bands, to my ear, the IC-Q7A did seem to be noticeably more sensitive with a more uniform frequency response outside the Ham bands. This impression is reinforced by a look at the manufacturers specifications where on 2 metres the sensitivity for 12 dB SINAD is identical at 0.16 μ V, the VX-1R is a bit better at 70 cm, 0.18 μ V vs 0.32 μ V (or about a 5 dB difference), and outside the ham bands the IC-Q7A is claimed as more or less flat at 0.32 μ V while the VX-1R has spots where it needs 15.8 μ V (a 33 dB difference) for the same 12 db SINAD. All of these figures are of course for the normal FM mode, FM wide and AM have similar though not identical relations.

TX power was measured, at least within the limitations of my power meter, and with a newish set of Alkaline Batteries, to be in line with the specifications of around 0.3 to 0.35 watts for UHF and VHF respectively. Again for contrast the VX-1R gives around 0.5 Watts on battery or about 1W when externally powered. The difference in antenna size probably goes most of the way towards closing this gap, so again in practice there is little difference. I would however like to have seen what effect on the output power the slightly lower volts of a pair of Ni-Cads (2.4V vs 3V) had. However I didn't have a set to hand and again there is no easy way to externally power the set.

Operation.

As can be seen from the photos the set has only a small number of controls, in fact there are only nine buttons and one knob, most of which perform more than one task. The multitasking of the buttons is fairly complex and I must admit I did find it difficult to remember which functions required which combinations of buttons to be held down. This is not helped by the set only having the prime role marked on the button and only memory or the manual to guide you to the other secondary or tertiary functions.

I also found the mix of methods used to access some of these functions a bit difficult. In some cases you have to hold the button down for greater than two seconds, in others you have to hold down the function button while pressing the feature button, and in yet others it is a combination of the two. Undoubtedly a regular user would quickly get used to this but I don't like the idea of having to press the function and feature button simultaneously. With the function key being a small button on the side of the set just below the PTT and the rest of the buttons on the front this means that, for example, to start the radio doing a simple scan (which requires pressing the function key and either the up or down volume button at the same time) requires the use of two hands, and an awkward positioning of the set to try to see both the side and the front of the set at the same time.

While many of the common features are accessed by the combination of button presses described above there are also a large number of actions that require using the set or menu mode. This is entered by pressing the VFO/Memory button for longer than two seconds. Once in set mode, rotating the dial knob steps through a number of options such as receive mode, tuning step, duplex/simplex, etc. When the required option is selected, the value can be set by holding down the function key while rotating the dial knob.

Apart from the above minor user interface irritants, the set worked fine on the air with quite reasonable TX reports on both 2m and 70cm. Received audio quality and volume were very good with quality on the FM broadcast band (using FM Wide of course) being equal to any (mono) commercial set I have heard. The basic functions of frequency and volume setting are straight forward, and the LCD display, though smallish, is clear and easy to read.

In terms of memories and other features the IC-Q7 has two banks with 100 memories each plus two call channels. These memories can save the frequency, mode, repeater offset, and tone settings, but do not have the option of setting an alphanumeric label. Normal scan options and a tone squelch pager type functions are also included.

As mentioned above, power for the set is via two AA cells which are fitted in a manner similar to most consumer portable devices these days (as can be seen from the photo). There is one small addition that is worth noting. One problem with the common form of sliding plastic battery cover is that over time the catches tend to wear and the cover can become useless. To try and prevent this ICOM have added a sort of plastic hinged clip-on latch to lock the cover in place.

This seems to work well when new but only time will tell how wear will affect this mechanism and I suspect you will ultimately end up with the same problem. This will of course be exacerbated if you choose to use Ni-Cads and thus have to be continually opening and closing the cover to swap them. The manual gives no guidelines for battery life other than current consumption and while I did manage to flatten one set of alkalines in use over a day, I didn't do it under the sort of controlled conditions that would allow any real conclusions to be drawn. About all I can say is that the current consumption figures would tend to suggest at least a couple of hours use out of a set of rechargeable Nicads.

The 40 page manual is on the whole well



Photo 3. The battery compartment

written and clearly explains the standard functions. I am a little worried by the fact however that there at least two things that I am aware of that are not even mentioned in the manual. For most amateurs these sorts of omissions would not be a problem, but if you are like me then having paid a reasonable sum of money for a new toy you like to know all the things it can do not just the common ones.

Just for the record I found two items by accident. The first is the little tune the set plays when the batteries are starting to get flat. I think this is just an audible warning. This is a good thing, but can be disconcerting when the manual doesn't even mention it. The second is that I can only assume that there is some sort of computer control of the set or downloading of memories available. A couple of third party vendors are advertising compatible software systems for the PC which as far as I can see must connect via the four way mic/ear plug in a similar manner to the VX-1R. If you have access to the internet then you can see an example of this at the RT-Systems pages at "http://www.rtsars.com/icq7_cloning_software.htm". Again there is no mention even of the possibility of doing something like this in the ICOM manual.

Conclusion.

While the IC-Q7A is obviously made as a low cost set with a couple of design compromises to achieve this, the excellent wide band receiver goes a long way towards

balancing this out. In terms of a comparison with the VX-1R and which would I recommend, I'm afraid I'll have to wimp out and say that it is a horses for courses thing. If you want something that you could sticktape to a beam for fox hunting then I would clearly go for the IC-Q7A. In other situations its not quite so clear cut and individual preferences would come in to play. On the whole however the IC-Q7A has quite a bit to offer at a price that we have not seen for quite some time. I can only hope other vendors follow suit.

73, Paul McMahon VK3DIP
ar



FOR ALL YOUR COMMUNICATIONS NEEDS

Weather Data Receiver

The ultimate weather forecaster for boating around Sydney, Melbourne, Brisbane or Adelaide because it utilises the Department of Meteorology weather data via a VHF radio transmission! LCD screen displays the latest forecast and the unit beeps automatically when new forecasts have been received. The number of beeps vary according to updates, warning, or priority data received. Housed in a tough, yellow safety case it operates from just one 9V battery or rechargeable battery (optional). Includes flexible antenna plus full instructions.



\$69⁹⁵
LIMITED STOCKS

D 3940

BONUS 2 x mounting cradles (D 3944) valued at \$19.90

Revex W560N HF/VHF/UHF/SWR/PWR Meter

Quality Revex wide-band SWR meter, offering 2 in-built sensors for 1.8MHz to 525MHz coverage! Provides measurement of 3 power levels (3W, 20W, 200W) and SWR. Uses an N-type socket for the VHF/UHF sensor to ensure minimal loss. Measures 120 x 80 x 85mm.



D 1375

\$199
SAVE \$50



'4 Wheeler' 4WD CB Antenna Pack

Good performance and rugged construction make the 1m long '4 Wheeler' a great choice for 4WD vehicles where a longer antenna is not practical, either aesthetically or because you'll be driving in heavily timbered country. Includes an oversized braid over 1/2" fibreglass whip with polyolefin heatshrink coating, a heavy duty spring to damp out vehicle vibrations and a rugged base with SO-239 socket for easy coax connection.

\$99
SAVE \$40

D 4083

5 year warranty

Rugged HF 5-Band Trap Vertical Antenna

The rugged 5BTV incorporates Hustler's exclusive trap design (25mm solid fibreglass formers, high tolerance trap covers and low loss windings) for accurate trap resonance with 1kW (PEP) power handling. Wide-band coverage is provided on the 10, 15, 20 and 40m bands (SWR typically 1.15:1 at resonance, <2:1 SWR at band edges) with 80kHz bandwidth typical on 80m at 2:1 SWR. An optional 30m resonator kit can be installed without affecting operation of other bands. High strength aluminium and a 4mm (wall thickness) extra heavy-duty base section guarantee optimum mechanical stability. At just 7.65m, the 5BTV can be ground mounted (with or without radials, although radials are recommended), or it can be mounted in an elevated position with radial system. Unlike other antenna designs, the 5BTV can be fed with any length of 50-ohm coax cable.



D 4920



\$399
SAVE \$50

30m Resonator Kit

Adds 30m coverage to the 5BTV and includes all hardware.

D 4921 \$99.95

BOOKS BOOKS BOOKS BOOKS BOOKS BOOKS

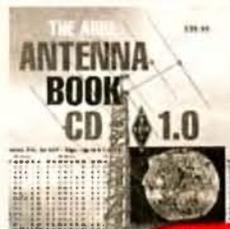

DUE MID AUGUST

ARRL Antenna Book

A wealth of practical information on antennas, feed lines and propagation is provided in The ARRL Antenna Book, available for the first time in a convenient, easy-to-use CD-ROM format.

B 2218

\$75⁺

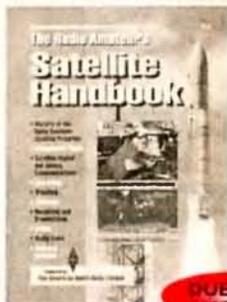

DUE MID AUGUST

ARRL Satellite Handbook

In addition to the 15 chapters packed with the information you're looking for, there are appendices with all active satellites, computer programs, Internet sites, comprehensive glossary and more!

B 2404

\$45⁺

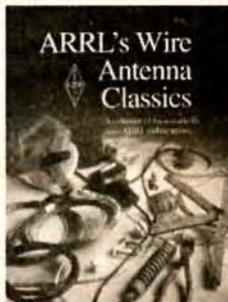

ARRL Wire Antenna Classics

A collection of QST articles covering wire antenna designs for most amateur operators.

B 2211

\$20⁸⁵



3rd Edition

ARRL ON4UN's Low Band DXing

Long considered the Radio Bible for low-band DX operators. Covers radio propagation, antenna designs and operating techniques for serious 160-40m operators.

B 2201

\$55⁺

*Available selected stores only but can be ordered.

CALL INTO DICK SMITH ELECTRONICS

3-15V 25A Heavy Duty Power Supply

This solidly built benchtop power supply provides current of up to 25 amps ICAS at 15V, 20 amp continuous at 13.8V and lower current at lower voltages. It has front panel metering plus high current banana-style and low-current output connections. An internal heatsink and thermally switched fan provides cooling without protrusions in the metal case. Specially modified for more reliable long-term operation, it uses a rugged 50 amp bridge rectifier & trifilar transformer. Also provided is extensive overload protection through dissipation limiting circuitry for the pass transistors, a 30 amp instantaneous current limit, AC mains circuit breaker, a transformer thermal fuse and fused auxiliary secondary winding.

D 3800

\$299
GREAT
VALUE!

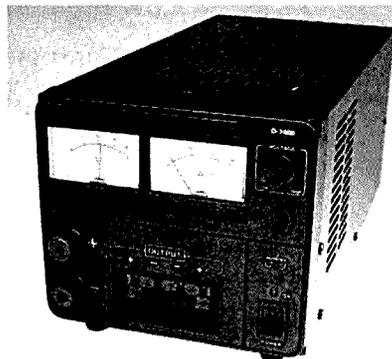

Yaesu FT-100 HF/6m/2m/70cm Mobile

What amazing value! Now you can enjoy the fun of operating on all bands from 160m to 70cm, either at home or in your car. The new Yaesu FT-100 features HF/6m/2m/70cm transmitter coverage, with 100W PEP RF output on HF and 6m, 50W on 2m and 20W on 70cm, plus you can easily mount the detachable front panel using an optional lead for more convenient mobile installations. Powerful interference fighting features, such as a DSP based Bandpass filter, Notch filter and Noise reduction, together with an IF based Shift control, all aid reception quality during tough conditions. A speech processor and VOX are provided for SSB users and an internal electronic keyer is provided for CW operation. Also included are dual VFOs, built-in CTCSS encode, 300 memory channels, all-mode operation (SSB, CW, AM, FM, AFSK, Packet (1200/9600bps), 100kHz - 970MHz receiver (cellular locked-out) and options for additional AM and CW IF filters.

The FT-100 is supplied with an MH-42B6J5 hand mic, DC power lead and comprehensive instructions.

D3285

2 year warranty

YSK-100 Separation Kit. D 3286 \$155



YAESU \$2750

Yaesu FT-1000MP Deluxe HF All Mode Transceiver

Yaesu has created a new 100W HF masterpiece using proven design techniques and a major new technology to the amateur marketplace: Enhanced Digital Signal Processing (EDSP). Teamed up with Direct Digital Synthesis, an outstanding receiver section featuring a high intercept front-end and a variety of IF filters (including a Collins Mechanical Filter), the FT-1000MP's exclusive EDSP facilities provide an impressive array of IF-based noise-reduction and interference reduction filters for enhanced receiver performance. Yaesu's IF-based EDSP system provides 4 random noise-reduction protocols, audio enhancement with 4 equalisation programs for Tx and 3 for Rx, and an automatic notch filter which eliminates multiple interfering carriers. A comprehensive menu system allows you to easily hear the effect of various EDSP settings, so you can choose the best selection for your operating conditions. Front panel selectable EDSP filter contours also aid QRM rejection, providing improved signal-to-noise ratios and razor sharp selectivity. The FT-1000MP also features selectable receiver front-ends, an in-built AC power supply and auto antenna tuner, 2 main antenna sockets, selectable tuning steps as small as 0.625Hz, dual-mode noise blankers, 13.8V DC socket, 500Hz and 6kHz IF crystal filters, an RS-232 computer interface and an MH-31B8 hand microphone.

With so many features in this new transceiver, why not ask for a copy of the 12-page FT-1000MP colour brochure or 46-page technical overview for more detailed information.

D 3400

2 year warranty

YAESU \$4450



PHONE FAX AND MAIL ORDERS

PHONE: WITHIN AUSTRALIA: 1300 366 644
(local call charge)

FAX: (02) 9395 1155 within Australia and
(+612) 9395 1155 from outside Australia

MAIL: DICK SMITH ELECTRONICS, Direct Link, Reply Paid 160,
PO Box 321, North Ryde NSW 1670 (No stamp required)

Excludes packaging and postage. All major credit cards accepted.
14 Day Money Back Guaranteed if NOT completely satisfied. (Software excluded)



Visit our web site at
<http://www.dse.com.au>

**DICK SMITH
ELECTRONICS**

That's where you go!

Yaesu transceivers and accessories stocked in selected stores only.
Other stores can place orders on a deposit-paid basis.

Try This

Robert Milne VK7ZAL/AX2TAR

17 Clifford Street, Moohah 7009 Tasmania

Low Frequency Reception

176.5kHz from Tasmania and 181.4kHz from NZ

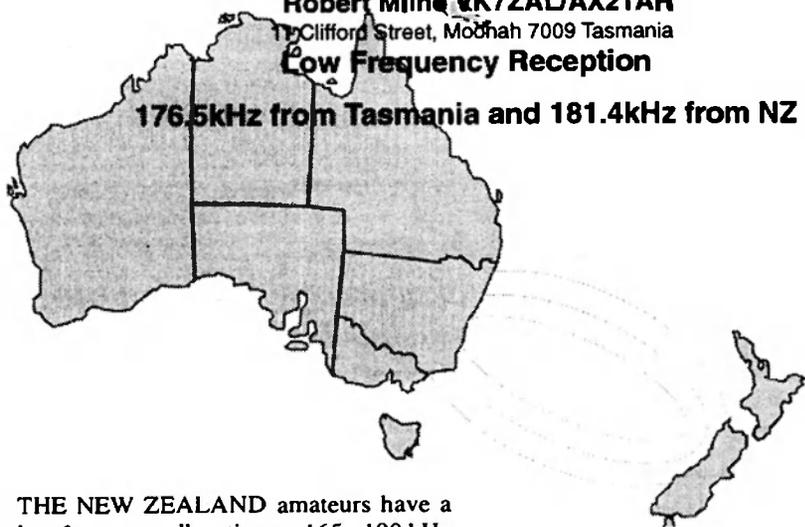

SILENT KEY

Henry Lonsdale VK3DND passed away January 14th 1999. Loving husband to Muriel, father of Ann, Janet, Jon and Susan.

The WIA regrets to announce the recent passing of:-

DR RIGLAR VK3AFB
 HV LONSDALE VK3DND
 J F (John) ANDERSON VK3JA

News Release

CQ Communications, Inc.

25 Newbridge Rd.,
 Hicksville, NY 11801.

CQ Editor Alan M. Dorhoffer, K2EEK, SK (Hicksville, New York) -- Alan M. Dorhoffer, K2EEK, Editor of CQ magazine for nearly a quarter-century, died July 19 from complications of cancer surgery.

He was 61. Dorhoffer was born on February 23, 1938, and spent his entire professional life at CQ, starting as an Assistant Editor in 1964, and becoming the magazine's 10th Editor in 1976. He was also a co-owner of the magazine since 1979.

Dorhoffer lived in Port Washington, New York, and was a ham since his teenage years, concentrating his activity on his favorite band, 10 meters.

At CQ, Alan tried to focus on the "people" aspect of amateur radio. "Ham radio is people interacting with other people," he wrote in the magazine's 50th anniversary issue, and on the things people do with amateur radio. "The act of doing, whether it's contests or awards, that's been my outlook."

CQ Publisher Dick Ross, K2MGA, said Alan had been like a brother to him for over 42 years. "We'd butt heads from time to time on editorial matters, but that in no way diminished our mutual love and respect," Ross said, adding, "He was always there for everybody." Ian's illness was diagnosed only a week or so before he succumbed to it.

Alan was not married at the time of his death, and had no children, but he is survived by an "extended family" of over 1,000,000 close friends, the world's amateur radio operators.

THE NEW ZEALAND amateurs have a low frequency allocation on 165 - 190 kHz and are very keen low frequency operators.

To receive the signals there are some basic requirements. The avid listener needs to first find a fairly quiet location away from man made noise and interference.

That is, away from industrial areas and major power lines. Commutator noise, fluorescent lights and switch mode power supplies create the majority of problems.

The antenna needs to be several hundred metres of wire, the longer the better, about a metre above the ground laid end on, in the direction of the signal.

Keeping the antenna close to the ground reduces the effect of atmospheric noise. If the antenna is raised higher the signal strength will increase but so will the atmospheric noise.

To increase the signal strength, the better method would be to increase the length.

The last requirement is to use a pre-amplifier that can give gain and an effective

coupling to this antenna. The output can then be connected to a good quality low frequency receiver.

The circuit that I have developed provides good coupling and gain. The antenna is made to resonate by adjusting the variable capacitor for the maximum received signal strength.

The signal is applied to the source resistor of the FET, an MPF106, which provides low impedance and a high gain as does the next stage using a BC549.

The 0.1 uF capacitor, C2, provides some regeneration.

Construction is not critical at these frequencies but good general practices should be used and it should be powered by a clean supply. Battery power is quite suitable as the current draw is low.

Have a go at it, have some fun and send in some reports.

ar

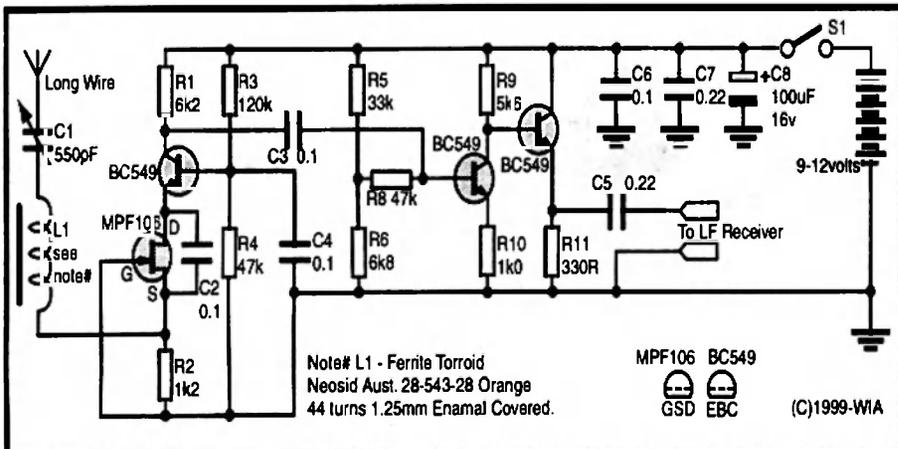

Fig 1. The LF Pre-amplifier circuit.

AR on the WEB

Alan Meredith VK2NNN

295 Iodide Street
Broken Hill
NSW 2880

ameredith@ozemail.com.au

on the Internet a lot easier. The list is automated from the Webring central site, so once you join you just sit back and watch it grow. (The only person who has to do any work after that is the Webring Operator!) You will find the joining form at: <http://www.ozemail.com.au/~amercdith/webring2.html>

The purpose of the AAR Webring is to create a way of accessing Australian Amateur radio related pages on the Net without everyone having to list everyone that they know of on their own pages. This will ensure that everyone is linked to everyone else.... but without the hassle of "re-inventing the wheel". It will also ensure that everyone has the best list of links available on their own page at all times.

Whichever way you approach the Net there is no denying that it is an extremely powerful communications medium. Personally, being an avid Dxer/Contester, I find it hard to imagine how anybody found up to date information about what Expeditions, Contests etc were going on around the world before the Net came along (I can hear all the old-timers cringing now...Hi). Whatever your interest in Amateur radio is, there is sure to be something of interest on the Net for you.

Now I know that the sunspot activity is on the increase, but then again winter is biting at our heels also. So when you turn on your rig and find the bands are dead, try the Net to wile away the cold winter nights and see what's "out there" of interest.

You might be surprised!

If you find something cool while surfing around then let me know and let's share it with everyone. You can email me at: ameredith@ozemail.com.au or ICQ 13626731.

Talking about cool...while you are reading this month's AR the screensaver on your PC has probably kicked in so why not have one that is really cool! It's called Sun Clock and is well worth a look at: <http://www.sk3bg.se/contest/sersaver.htm>

ar

Webrings

Another way of finding Amateur radio related sites (or anything for that matter!) is to hop onto a Webring. A Webring is a listing of subject related pages that are "tied" together by a common link arrangement. You can go from site to site by just following the common link on each site. There is also a central listing, which describes all the sites in the ring. It's this description of each site that set the Webring apart from just another lists of links, as mentioned previously.

There are several major Webrings related to Amateur radio. The largest is the Amateur Radio Webring with over 1500 members!

There are many Webrings related specifically to Amateur radio and these can be found by visiting the home of the Webrings at <http://www.webring.org> and doing a search while you are there for "Amateur radio".

There are even "country specific" Webrings if you are looking for Ham information from somewhere special.

Australia has its own Webring! So far there are over 85 VKs who have joined the Australian Amateur Radio Webring (AAR).

Figure 1 and Figure 2 are samples of what you will find on every member's site (this is the common link that forms the ring) so keeping track of where you are, is easy. If you have a home page on the Net related to Amateur radio then consider joining the AAR. It makes finding Australian content

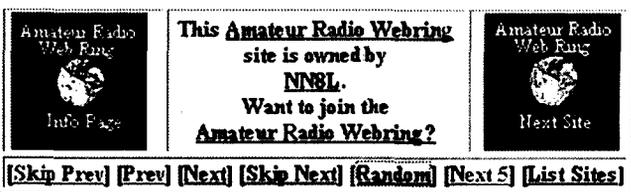
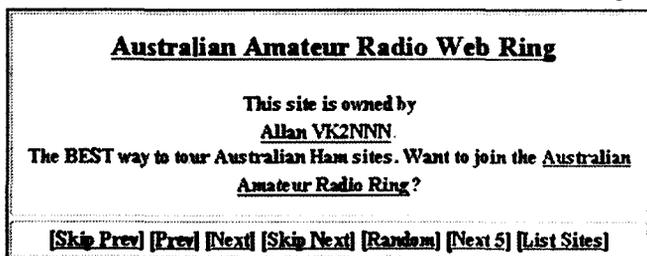

Fig 1

Fig 2



WELCOME to what I hope becomes a regular column and one that I hope everyone will find interesting. Bob assures me that volunteering for things does not get you shot these days.... let's hope not.

I hope over time that this column can tweak an interest in the Net from those of you that are a bit wary of it. At the same time it should, I hope, give some useful information to those of you, who like myself, spend way too much time on the Net.

"Needles in the Haystack"

The reason for my endless time online is the seemingly unlimited number of pages related to Amateur radio. Unfortunately the Internet's greatest strength is also its greatest weakness.

By that I mean that finding the information you need can sometimes feel like looking for the proverbial "needle in a haystack". There is help available though! You can use the Net standard way of searching by using a search engine such as AltaVista (<http://www.altavista.com>) or Yahoo (<http://www.yahoo.com>), but that "needle in the haystack" scenario comes back again! Luckily there are better ways of finding Amateur radio related sites. There are worldwide listings of pages, specifically related to amateur radio, running into many thousands of sites. The best two that I have found are by K1DWU (over 4000 sites) at <http://www.k1dwu.net> (mirrored locally on my own site at: http://www.ozemail.com.au/~ameredith/Info/k1dwu_links.html) and K8SMC's listing of over 5000 sites at: <http://www.modempool.com/k8smc/>

Both of these sites are sorted into categories and alphabetised. Best of all is that they are tested regularly so that "dead" links are kept to a minimum! You'll find everything from Amplifiers to Microwaves to Weather sites amongst these listings.

Some individual Hams have huge sites that contain information about almost everything Amateur radio related and one of the biggest on the Net is Rod Dinkins AC6V, with over 88 pages!

<http://www.ac6v.com>.

TECHNICAL ABSTRACTS

Gil Sones VK3AUI
30 Moore Street
Box Hill South Vic 3128

E-Field Meter

A meter to measure Electric Fields was described in Rad Com April 1999 by Dick Rollema PAOSE. As the immunity of consumer electronic products to nearby electromagnetic sources, such as amateur radio transmitters, is defined in terms of the Electric Field strength in Europe, this is becoming increasingly necessary. The acceptable measurement is either 1 volt/metre or 3 volts/metre.

Whilst a loop type field strength meter will work in the far field, in the near field the relationship between the magnetic and electric fields is more complex. This makes it necessary to use a device that measures the electric field directly when close to the radiating device.

The meter is intended for use as a check on electric field strength for EMC work and for work on antennas.

The E-Field meter uses a short antenna instead of a loop. The voltage induced in a short antenna is independent of frequency provided the antenna is short with respect to the wavelength and the measuring circuit has a high input impedance so as not to load the antenna.

The antenna should be less than a tenth of a wavelength long. The equivalent circuit of a short dipole and the input capacitance and resistance of the E-meter is shown in Fig 1. Both the antenna and the input capacities are in the order of a few pF.

The antenna capacity can be raised by using a short fat dipole and the input capacity and resistance should be

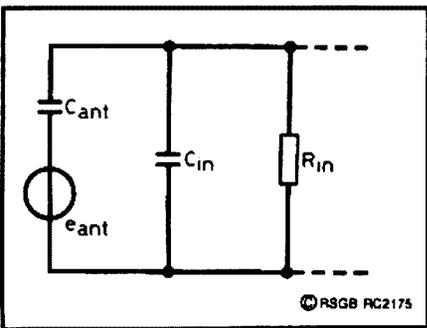

Fig 1. Equivalent Circuit of Short Dipole and E-meter input circuit

minimised by using a dual gate MOSFET.

The meter Dick PAOSE built was based on an earlier design by ZL2BBJ but Dick used a balanced rather than a single ended design. The circuit is shown in Fig 2. The two FET amplifier stages need to have the same gain and this was achieved by adjusting R9, R10, R11 and R12 to equalise the gain of the two FETs. Temporarily short inputs A and B, apply a signal and adjust the resistors for minimum meter reading.

The meter used by Dick gave a convenient 0 - 12 volt/metre scale and different meters will require adjustment of R18, R19, R20 and RV1 that were selected for the author's meter. A more sensitive meter movement could be shunted or the resistor values scaled to suit.

The detector diode D5 should be a germanium type and there is some non-linearity at the bottom end of the scale.

The antenna assembly is shown in Fig 3. The exact construction is not critical but remember that the aim is to maximise the

capacity of the dipole and to minimise the input capacity of the amplifier.

The calibration setup is shown in Fig 4. The RF source could be your transceiver. The author used two metal plates each 1 metre square spaced one metre apart. The plates were made by covering pieces of hardboard such as Masonite with cooking foil.

The spacing was maintained by four PVC (conduit) tubes holding the corners apart plus another placed between the centres of the plates. The whole setup was supported on a non-metallic garden table. The setup is used by providing RF drive to the plates and adjusting the drive for say 10 volts between the plates. This will give a field of 10 volts/metre.

The E-meter is placed in the middle between the plates and may then be calibrated. The digital meter in Fig 4 reads a peak voltage and so for 10 volts the meter should read 13.8 volts.

This is the peak voltage of 10 volts RMS less the 0.3 voltage drop across the germanium diode. You do not need much power and QRP is adequate. You should calibrate on 80 or 160 metres, as this will minimise disturbing effects such as from the connecting wires.

Dick PAOSE found that it was helpful to hold the meter away from his body by attaching a 45-cm long PVC pipe handle to the meter. The meter is a very high input impedance device and stray capacity may be troublesome.

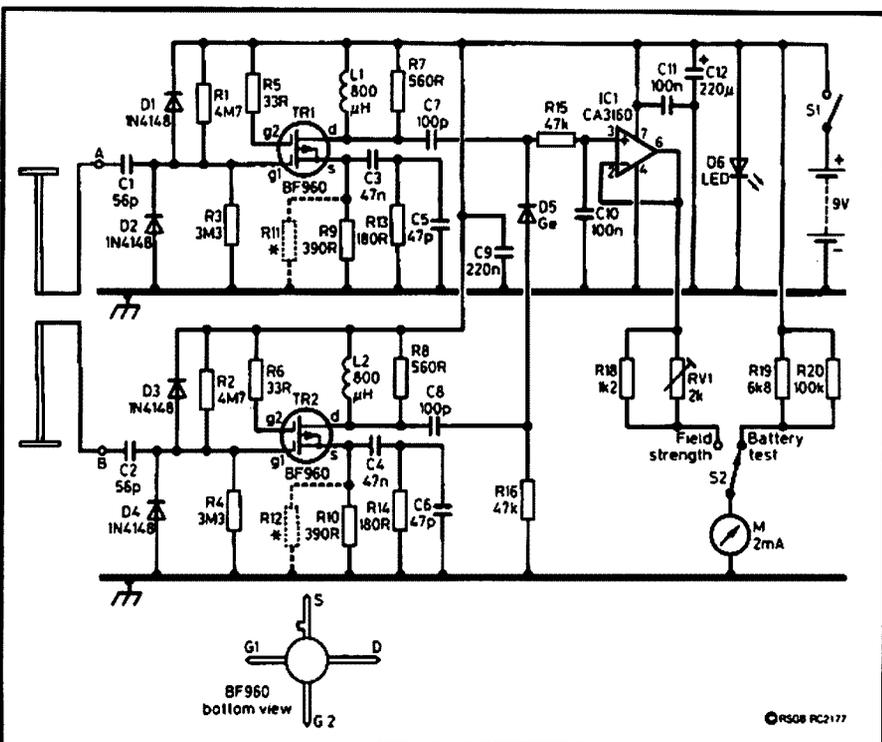

Fig 2. The circuit

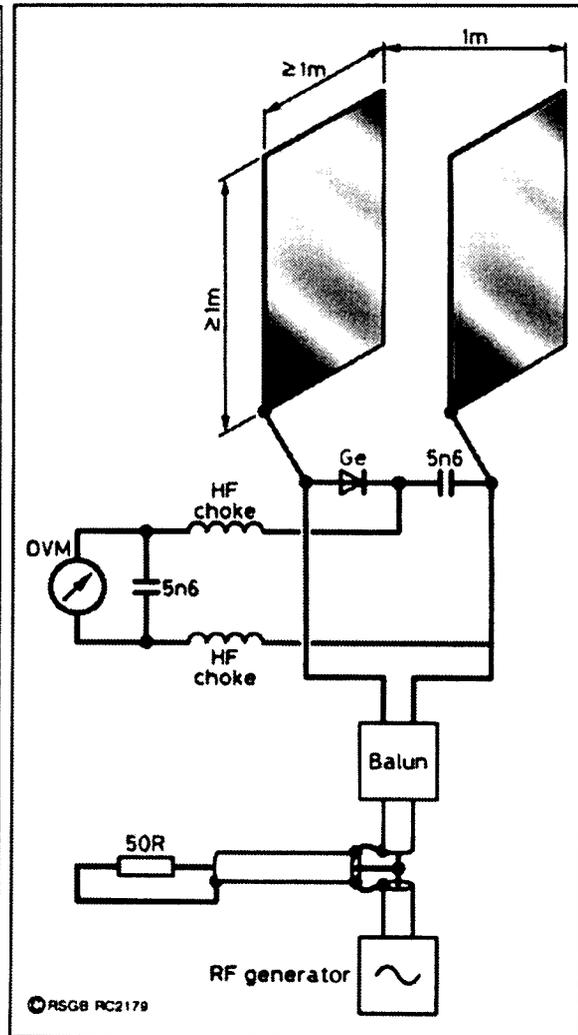
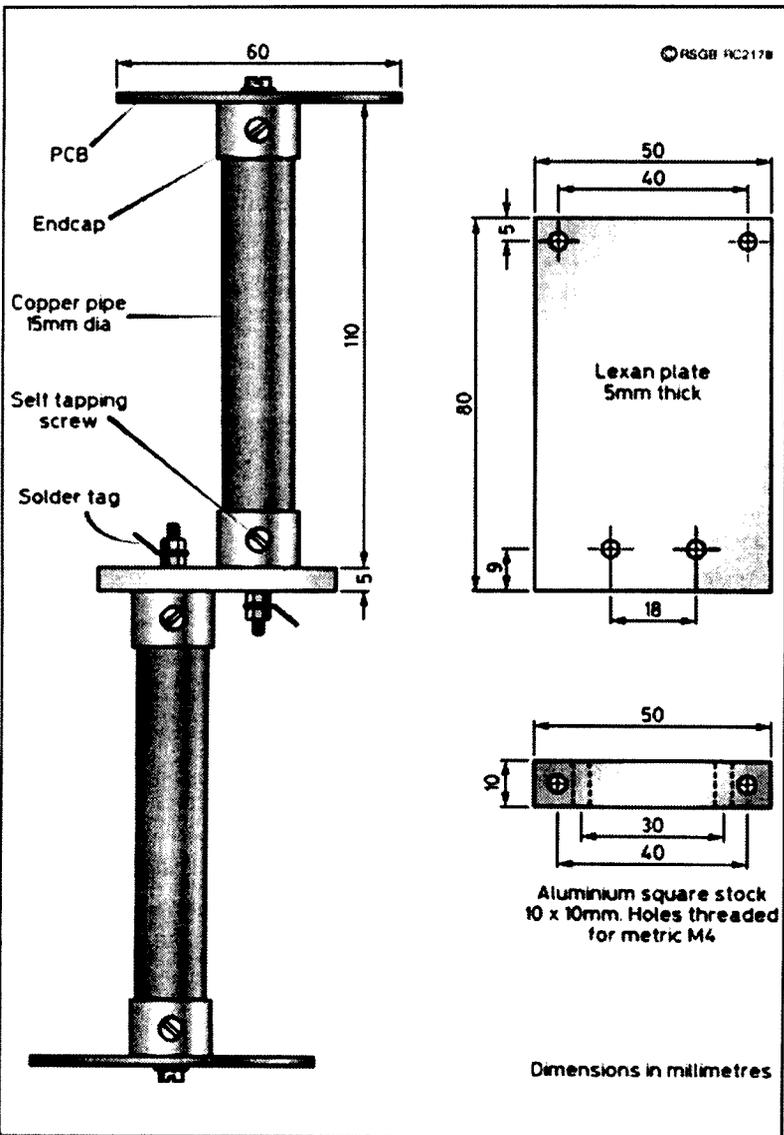

Fig 4. The calibration setup

Fig 3. The antenna assembly

Twin Band Antenna

Bert Veuskens PA0HMY described a twin band 144 MHz and 432 MHz vertical antenna in *Electron* April 1999.

The antenna was built into a radome made of PVC pipe. The antenna appears to be a half wave type on 144 MHz and a collinear on 432 MHz.

The antenna uses a ground plane that is cut for the 432 MHz band. The antenna is fed via a trimmer to a tap on a coil at the bottom of the radiator. The radiator has a slim folded resonator 83-mm long in the middle.

The antenna radiator and base coil is shown in fig 5. The base coil has $5\frac{3}{4}$ turns and the tap for the feed trimmer is one turn from the top.

This is shown in Fig 6. The resonator is shown in Fig 7. The size of the resonator is such that it will slip into the 32 mm PVC

pipe radome. The PVC pipe would probably be plastic conduit similar to that used by Telecom.

The radiator and coil assembly is attached to an N-type coaxial connector. Also connected to the flange of the connector are the four radials, each 173 mm long.

The radome and a bottom section of copper pipe are slotted to pass the radials and the whole assembly is held together with a hose clamp. The copper pipe, 160 mm long is used for the attachment to the mast clamp. This is shown in Fig 8 and Fig 9.

After an initial adjustment the feed trimmer which was a 10-pF type can be replaced with a capacitor fabricated from a scrap of RG58. See Fig 10 for this capacitor substitution.

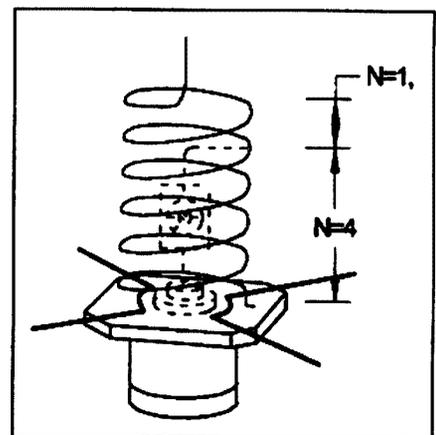

Fig 6. Base Coil with Trimmer and Tap

continued next page

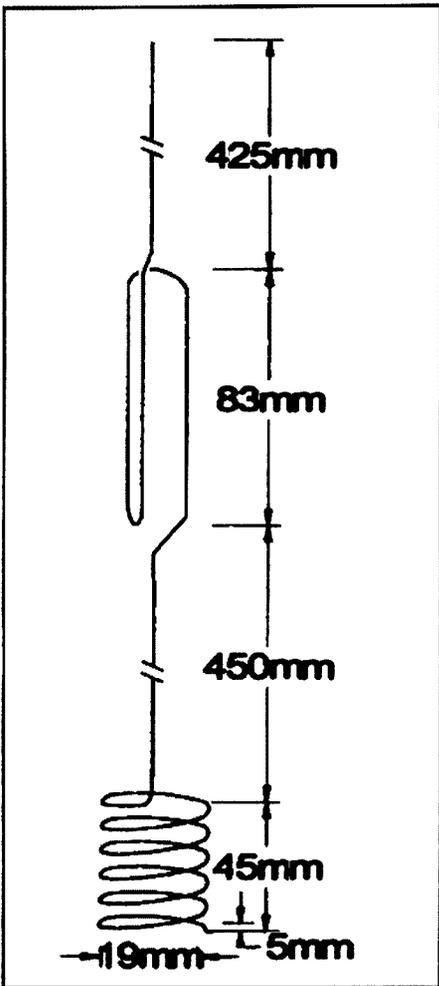

Fig 5. Antenna Radiator, Base Coil and Resonator Assembly

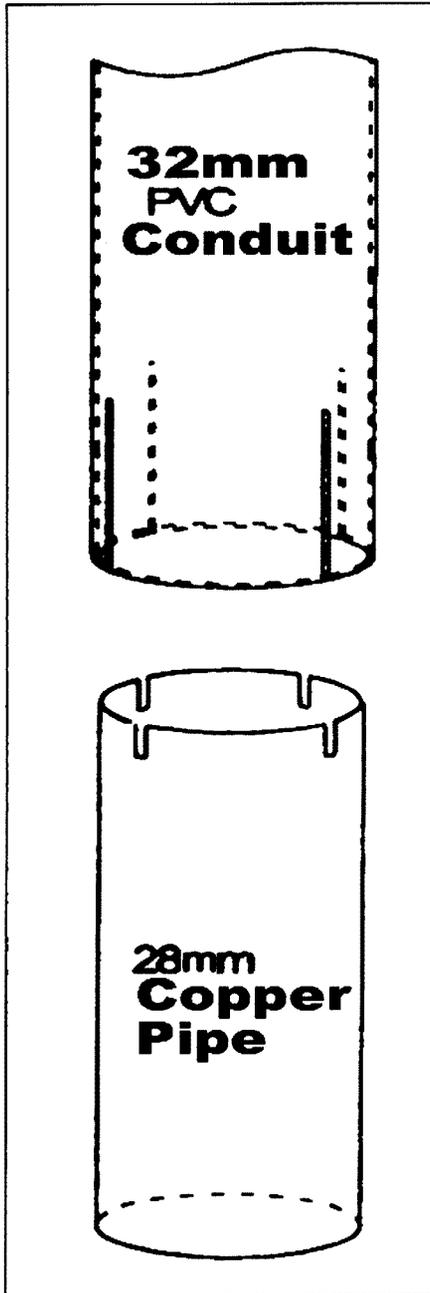

Fig 8. Mounting Pipe and Radome Junction

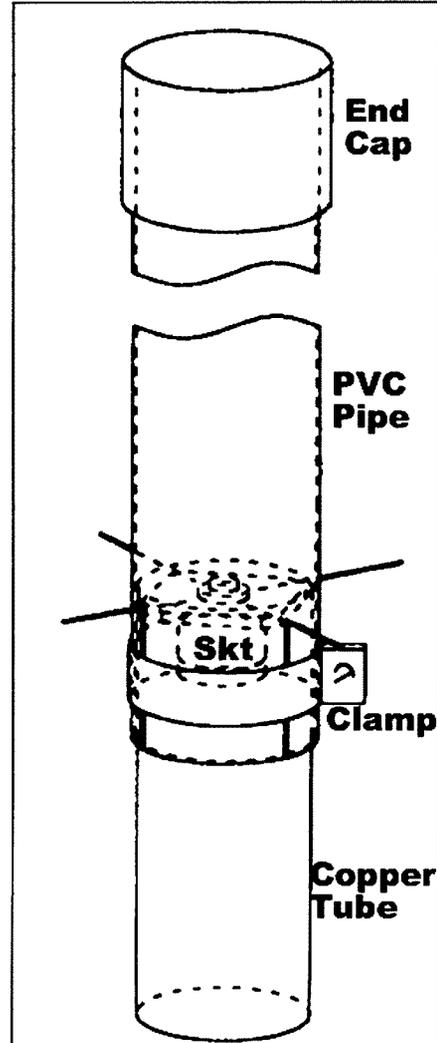

Fig 9. Mounting Junction with Clamp and Antenna Radials

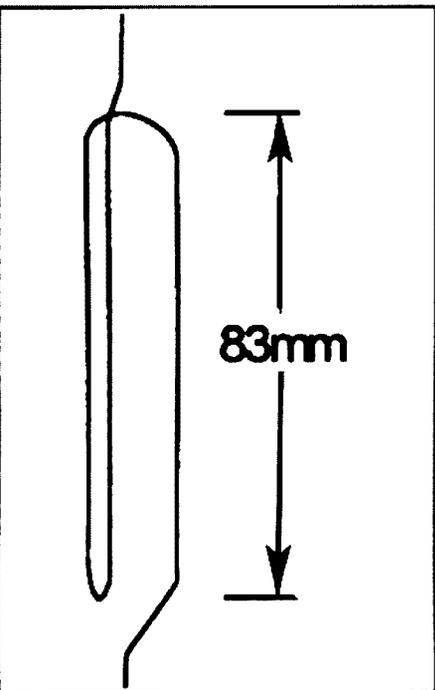

Fig 7. Resonator

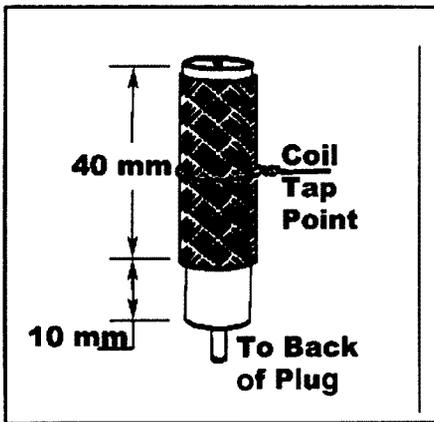

Fig 10. Substitute Feed Capacitor

Have you tried

DXing, microwaves, CW, high speed data, ATV, operating portable, slow scan TV, QRP, contesting, homebrewing, AM, UHF, packet radio, foxhunting, building repeaters, JOTA, 160 metres or publicising amateur radio?

Write about it and send it to Amateur Radio - the magazine which covers more facets of amateur radio than any other.

ar

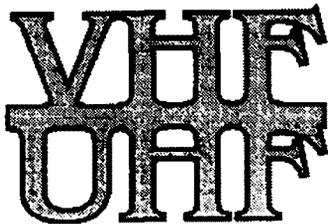

AN EXPANDING WORLD

Eric Jamieson VK5LP

PO Box 169 Meningie South Australia 5264
E-mail: vk5lp@lm.net.au Fax: 08 8575 1777
Packet: VK5LP@VK5WI.#ADL.#SA.AUS.OC

All times are UTC

Beacon repairs

The Official Bulletin of The West Australian VHF Group Inc carries a report on the damage as a result of Cyclone Vance and subsequent repairs to the Exmouth beacons.

The report says: Don (VK6HK) has been repairing the beacons damaged by the recent cyclone that passed through Exmouth. This is best summed up in his own words.

"You may be interested in the results of repairs to the VK6RSX Exmouth beacon transmitters.

"The txs were delivered to this address per courtesy of Bill Snedden from Exmouth, on Friday 16th April. Bill had also been involved with Rex VK6ARW in installing the beacons in the first place.

"After being treated to Cyclone Vance, with extensive damage to the Exmouth Air Charter building where they were housed, falling off their shelf mounting and getting a good soaking, the txs arrived in surprisingly good condition - considering.

"The only visible damage was a couple of minor dents in the covers on one unit. These have been "panel beaten" out.

"Both were given a good clean out. There were some rust spots on the tinplate exciter cans in both units, but they have cleaned up AOK.

"At first the 50 MHz tx would not start, but that turned out to be a broken earth lead to the exciter card - probably a bad joint disturbed when cleaning and a "timebomb" fault that was not really connected to the cyclone.

"I also did a check on the spectrum analyzer and found a small sprog in the 50 MHz PA, which retuning has corrected. So it looks as if it has not been a wasted exercise to give the units the once over anyway.

"In the power supply, a mounting pillar for the filter capacitor bank had broken away - possibly cyclone damage. A substitute anchor has been provided.

"That fixed, it sprang to life and generated about 45 watts out - much as original. So far

it has run for a couple of hours without fault.

"After cleanup the 144 MHz unit worked straight off on switch-on, generating 50 watts as original. This unit had a known fault in that the keyer had been running mysteriously fast at about 30 wpm. It turned out that there were two problems in the keyer. First, (blush) one connection to the clock timing capacitor had never been soldered. This fixed, all was well or was it? On applying heat or cold to the Cap, the speed still varied by more than double. Changing the mini "Monolithic Multilayer Ceramic" type blue 0.1µF cap for a trusty "Greencap Metalized Polyester" type of the same value fixed that problem. The carrier frequency was also found to be low and has been adjusted to 144.576. The tx has now run for a couple of hours in an ambient temp of about 30 degrees without fault.

"Is correction of these potentially fatal faults an example of "an ill wind etc... "?

"Both txs now even sport the correct label - "VK6RSX" instead of the originally proposed (but rejected by ACA) "VK6RXM" and look as good as new.

"Bill has volunteered to take the txs back to Exmouth when he returns in 2-3 weeks time, ready for re-installation when power is returned to the light aircraft strip site in about 8-12 weeks or so.

"Rex VK6ARW reports that the mast and two "U-dipole" antennas appear to have survived, although the vertical pipe support has twisted to the horizontal position on its "Tee piece" mount to the main mast. An antenna bridge test on the 2mX shows all is well with that antenna and cable. 50 MHz shows some problem, but that has been found to be in contact with the mast and will be checked again when the mount position is fixed.

"One feeder had its "N" connector torn off and that can be fixed. Rex says he "has the technology"...

"On behalf of the WA VHF Group, thanks to the Exmouth people who have found time to look at restoring the beacons when there were plenty of other demands following the cyclone."

There is another postscript to the piece about beacons, which should be included to correct a possible misconception about the capacitor type which was temperature sensitive...

As a postscript, tests have since been done on the timing capacitor removed from the keyer. The cap was attached to a digital capacitance meter, which displayed a value about as expected ie 0.1 µF. The capacitor was subjected to warmth from a soldering iron held nearby (not touching) and the value decreased to about 0.05 µF!

The test was repeated on a number of capacitors of the same type, of the same and other values and nothing like the variation noted. So the check confirmed that it was a dud individual unit and not the Monolithic Multilayer Ceramic type in general at fault."

Thanks Don for that and, again, a special thank-you to the Exmouth people involved.

A note on multilayer monolithic ceramic capacitors. These come in several flavours. Listed below are a few, so be careful of the type you use. Each manufacturer has their own marking system to distinguish the type.

NPO characteristic - These are best used for circuits that require stable operation. They have a tolerance of ±5% with a temperature drift of approximately 30ppm/°C.

X7R characteristic - These can have a tolerance of ±10% with a variation of 20% over a temperature range of -55°C to 125°C.

Z5U characteristic - These can have a variation of +22% to -56% over a temperature range of -10°C to 8°C.

2F4 characteristic - These can have a variation of +30% to -80% over a temperature range of -25°C to 85°C. ... Luigi VK6YEH.

Colin VK5DK advises that the Mount Gambier beacons VK5RSE on 144.550 and 432.550 MHz are now back on air after the tower on which the antennas were mounted fell down! Thanks to VK5NC, VK5EE, VK5ZX, VK5MQ, VK5WCC and VK5DK the antennas are on a new tower at about 18 metres above the ground. Any reports of the beacons would be appreciated.

The antennas on 144 MHz are 4 x 4 element Yagi, 1 beamed East, 1 beamed West, 1 beamed North-West and 1 beamed North-East. On 432 MHz 2 x 8 element Yagi are used with 1 beamed East and 1 beamed West.

Web sites

Steve VK2KFJ <vk2kfj@qsl.net> has advised the following: *I have now setup a web page, for my 6 metre repeater list at: <http://www.qsl.net/vk2kfj/6m_rptr.html>.*

Also, for anyone who has their own e-mail account, and being a licensed amateur, can obtain an e-mail address and web space

for amateur related information. The e-mail will provide re-direction to your own home e-mail account and can be changed at anytime. This allows one to move ISPs at will, but still keep a fixed "amateur" related e-mail address, which contains your callsign in it. The fellow running it is a ham and runs it for hams and only asks for donations to keep it running. Just go to <http://www.qsl.net> and follow the instructions to subscribe, but remember, it takes a few days to get a reply!

Another site is <http://www.qrz.com> which is the callsign callbook database; anyone can check in and update their details, leave a photo or QSL card and add a "radio" related biography or just details that DXers will need to find someone.

I thought having my web page and QRZ database setup provides people anywhere in the world with the info on what I am doing or where I can be found and to promote those activities/modes I am interested in. I hope to do some extra pages on 2 metres and 70 cm weak signal activity at some stage in the future.

Also, there are two new mail reflectors that have been created: <vk-repeaters@onelist.com> which covers discussions on voice repeaters, linking, FM etc for VK/ZL region. To subscribe address it as follows: <vk-repeaters-subscribe@onelist.com>.

The other new list: <vk-packet@onelist.com> which covers discussions on packet radio, for VK/ZL region. To subscribe address it as follows: <vk-packet-subscribe@onelist.com>

To the Meteor Monitors

Gordon VK2ZAB reported that on 10/6 at 2150 quite long (8 to 10 words) meteor bursts from, he assumed, VK4TZL in contact with another on 2 metres SSB. Level about S5 to S6 dropping to occasional readability before next fully readable burst. He poses the question: What shower was this and when will it be available again?

Ron Cook VK3AFW replied: To Gordon and others - The Arietids Shower occurs between May 29 and June 19. Rates are 60/hr. According to Mike VK2FLR's article in AR some time back, the best 8 days are centred on June 7. So conditions should be good up to and including June 11.

After that the next shower is the Orionids from October 18-22, peaking nominally on October 22. Rates 25/hr, velocity 66km/s. This is debris from the tail of Halley's Comet. Supposedly best for E-W paths but works well from VK3 to VK4 on 2 metres.

Then there is the BIG ONE. The Leonids, with a nominal peak on Thursday November 18. Keep an ear and an eye on this for a day or so either side. This could be

even more spectacular than last year. At the very least it should provide many 30 second bursts on 2 metres.

Six metres

In a brief message, Graham VK6RO reported that in April he worked 9M2TO on six metres which gave him country number 40 after 20 years!

Ron VK4BRG advised that he was surprised to see a JA opening at this time of the year so early in the morning. On 30/6 at 2300 he worked JA2DDN on SSB. At 2330 he heard JR2HCB working VK4ABW in Townsville.

John VK4FNQ has been blessed with some signals on six, mainly from across the equator, many of them beacons and signal reports not strong. Still, it is winter, but it's a start. He reports as follows:

Monday 28/6

1130 JA2IGY/b 519
JA6YBR/b 319
JE7YNQ/b 319
1132 JA4CQS 5x9 worked VK4ABW
1135 JA9SSB 5x1 CQ on 50.110
JA2IGY/b 519
JA6YBR/b 419
1315 JA2IGY/b 319

Tuesday 29/6

1000 JA2IGY/b 519
V73SIX/b 519
JA1ZYK/b 419
JR0YEE/b 419
JE7YNQ/b 519
1037 C21JH 5x9 worked
V73SIX/b 319
1102 C21JH CQ
1223 V73AT 5x9 worked
V73SIX/b 419
1315 V73SIX/b 319

Wednesday 30/6

0945 49.750 weak, no amateurs

Thursday 1/7 (30/6 UTC day)

2315 JA2IGY/b 519
JA6YBR/b 599
JA1ZYK/b 419
JE7YNQ/b 319
2332 JR2HCB 5x9+ worked VK4ABW

Thursday 1/7

V73SIX/b 419
1300 V73SIX/b 319

Friday 2/7 (1/7 UTC)

2315 JA2IGY/b 419
JA1ZYK/b 419
JE7YNQ/b 419
2323 JR2HCB 5x9+ CQ
2342 JA1AUD 5x9+ worked

2359 JA7KY 5x5 worked - heavy
QSB VK4ABW reported
hearing a BV4 on 50.110

0005 JA2IGY/b 529
JA6YBR/b 419

Saturday 3/7

VK2RSY/b 519
VK2DN 5x9+ heard
0333 VK2TCL 5x9+ worked heavy QSB
0405 VK3SIX/b 419
0640 VK8VF/b 419
0905 V73SIX/b 529

Sunday 4/7

0410 VK8VF/B 599
0700 49.750 S2
0745 JR0YEE/b 419
0800 JE7YNQ/b 599
49.750 S9+

Monday 5/7

1135 JR2HCB 5x9 QRZ VK4 Station
JA2IGY/b 319
1156 JG2BRI 559 50.010
JA2IGY/b 319

Ted Collins G4UPS writes that the first European opening "across the pond" was reported on 28.885 MHz when at on 19/5 at 2045 KP4BZ worked SP6GWB on six metres.

In a QSO with KP4BZ on 28.885 on 29/5 Ted was informed that he had also worked 6 or 7 French stations on six and KP4EIT had worked EH etc. EH7KW reported working W and VE on 26/5. Apparently no QSOs from the UK to North America during May.

Ted was involved in a big opening to LU on 16/5 from 1655 with six stations noted. CX2LI was in at 1732. No South American beacons heard.

Ted reports a series of tremendous openings commencing on May 16, then May 17, 19, 20, 21, 23, 24, 26, 28, 29 and 30. Countries worked: 5H3, 7Q7, 9A, 9H, CN, CT, CU, CX, DL, EH, EH6, EH8, EH9, ES, F, GU6, HB, I, ISO, LA, LU, LW, LY, LZ, OD, OE, OH, OK, OM, PA, S5, SM, SP, TZ6, YO, YU. That's 36 in all.

Whilst we somewhat wistfully look at the above list of countries, it is not all plain sailing.

Ted explains there are many occasions when it is difficult to make contacts, particularly new ones, because the band to 50.300 MHz has a signal on almost every kHz, many of them very strong. Hence the need to be adept at CW.

So, while in one way it must be good to have many signals available, the going would be very slow at times and no doubt, frustrating.

Two metres

Tony VK3CAT reports that the current high-pressure system is providing reasonable tropospheric signals. *From my QTH in Melbourne, on Tuesday 22/6 I worked VK5AKK over Adelaide at 5x2 as well as VK3AEF in Nhill and VK3FIQ in Stawell, all contacts on two metres between 1100 and 1200. The Adelaide beacon VK5VF/b was still audible on 23/6 at 0500. Other stations heard on Tuesday evening were VK3TMP, VK3BRZ and VK3XLD.*

Ron VK3AFW advised that Max VK3TMP reported working Phil VK5AKK at 5x7 on 2 m on 22/6. On the morning of 23/6 Ron found signals to Andrew VK7XR at 529 were stronger by one S point, but were not as strong as expected.

Chas VK3BRZ reported that the same enhancement allowed him and David VK3XLD to work Phil VK5AKK on 2 m and 70 cm on Tuesday 22/6 evening. *Signals on 2 m were up to 5x7 and on 70 cm 5x4, although he gave us only 5x1, having no pre-amp.*

By the way, David now runs 220 watts to his 4 x 15 element DL6WU yagis on 70 cm, and to all intents and purposes has a station capability identical to mine, although he has not installed his mast-head pre-amp yet.

Gridsquare Standings

Guy VK2KU has provided the latest listings as at 1 July 1999. The VK-VHF Reflector carries the full listing down to 1 entry for each band. This is no problem for the Reflector but could be in AR where space is always at a premium.

Therefore the AR listings will commence at 10 squares for 144 MHz, 5 squares for 432 MHz, 3 squares for 1296 MHz and 1 square for all higher bands. There are listings this time for the bands 2304 MHz and above.

They are incomplete at this stage as the numbers have not previously been sought but are now open for additions. I have decided to include them as an incentive to others to add their scores.

144 MHz

VK2ZAB Gordon	58
VK3BRZ Chas	55
VK2DVZ Ross	52
VK2KU Guy	47
VK3CY Des	47 (+4 EME)
VK3TMP Max	45
VK2FLR Mike	42 (+68 EME)
VK3EK Rob	37
VK3XLD David	35
VK3KWA John	32
VK3BDL Mike	31

VK3CAT Tony	29
VK6HK Don	28
VK4KZR Rod	27
VK3BJM Barry	23
VK1MP Rej	21
VK6KZ Wally	19
VK2TZ Dale	16
VK3KAI Peter	16
VK6KZ/p Wally	16
VK3AL Alan	14
VK3TLW Mark	14

432 MHz

VK2ZAB Gordon	33
VK3BRZ Chas	32
VK3XLD David	26
VK3CY Des	23
VK3EK Rob	18
VK3KWA John	18
VK3TMP Max	18
VK2DVZ Ross	17
VK2KU Guy	15
VK3BDL Mike	15
VK3BJM Barry	15
VK4KZR Rod	14
VK6KZ Wally	12
VK3KAI Peter	11
VK3AL Alan	10
VK3TLW Mark	10
VK6KZ/p Wally	8
VK1MP Rej	5
VK3HZ David	5

1296 MHz

VK3KWA John	18
VK3EK Rob	11
VK2ZAB Gordon	10
VK3TMP Max	10
VK2DVZ Ross	9
VK4KZR Rod	7
VK3AL Alan	6
VK3BJM Barry	6
VK3BRZ Chas	6
VK3TLW Mark	6
VK3XLD David	6
VK6KZ/p Wally	5
VK2KU Guy	4
VK3KAI Peter	4
VK6KZ Wally	4
VK3BDL Mike	3

2403 MHz

VK6KZ Wally	4
VK3KAI Peter	2

3456 MHz

VK6KZ Wally	4
-------------	---

5760 MHz

VK6KZ Wally	4
-------------	---

10 GHz

VK6KZ Wally	5
-------------	---

24 GHz

VK6KZ Wally	2
-------------	---

Additions, updates and requests for the guidelines to Guy VK2KU. <guy@ics.mq.edu.au>. or by mail (QTHR 99). Next update in three months.

VK5 Divisional broadcasts

David VK5KK reports: *With the demise of the WIA SA Division's Burley Griffin Headquarters building on 30/6/99, a temporary home was required for the VK5WI station on 160 metres and 2 metres to continue the Sunday morning Divisional broadcast.*

As of 1/7/99, the SA VHF Group now run the VK5WI transmitters from the Water Tower club rooms. While it may sound a bit strange, The Group have maintained a fully operational 160 metre inverted V, with the apex 120 feet above ground level as well a choice of 2 metre antennas at the 120 - 160 foot level to use with the 2 metre link for the broadcast. This made the transplant of VK5WI simple.

On 30/6/99, while testing the 1825 kHz Viking Valiant AM transmitter, we managed to work VK2,3,4 and 5 on 160 metres AM. This attracted the attention of a number of VHF Group members ... surely a sign that the VHF/UHF bands have been dead for some time!

Closure

Specific news of openings generally remains scarce. We certainly are not repeating the winter-time contacts last year of the Northern Hemisphere.

Maybe the next equinox will see a revival of activity on six metres and lead on to improvements on the bands 144 MHz and above. The microwave boys will want to see something worthwhile on 10 and 24 GHz this coming summer.

Closing with two thoughts for the month:

1. All your fingernails grow with inconvenient speed except the broken one, and
2. Show me a man who is a good loser and I'll show you a man who is playing golf with his boss.

73 from The Voice by the Lake.
ar

AMSAT AUSTRALIA

Bill Magnusson VK3JT
RMB 1627 Milawa Vic. 3678
Email: vk3jt@amsat.org

National co-ordinator:
Graham Ratcliff VK5AGR
Email: vk5agr@amsat.org
AMSAT Australia net:

The AMSAT-Australia net is held on 80 or 40 metres LSB (Lower Side Band) each Sunday evening (except over the Christmas/New Year period).

During the winter months in South Australia (end of March until the end of October) the net is on 3.685 MHz +/- QRM with an official start time 1000UTC with early check-ins at 0945UTC.

During the summer months when daylight saving is in operation in South Australia (end of October until end of March) the net is on 7.068 MHz +/- QRM with an official start time of 0900UTC with early check-ins at 0845UTC

The times and frequencies have been chosen as the best compromise for an Australia-wide net taking into consideration seasonal propagation changes and the various state summer time variations.

AMSAT Australia newsletter and software service:

The newsletter is published monthly by Graham VK5AGR. Subscription is \$30 for Australia, \$35 for New Zealand and \$40 for other countries by AIR MAIL. It is payable to AMSAT Australia addressed as follows:

AMSAT Australia
GPO Box 2141
Adelaide SA 5001

Keplerian Elements

Current keps are available from the internet by accessing the AMSAT FTP site, ftp.amsat.org and following the sub-directories to "KEPS".

Phase 3D progress

With hopes high for a launch this year, the phase 3D spacecraft is undergoing its final series of pre-flight checks and tests. This included the successful test firing of the pyro-pins to release the solar panels and allow them to be unfurled by spring pressure.

All RF sub-systems of the spacecraft are reported as working perfectly. The main

thruster and the Arcjet mini-thrusters have also been tested and confirmed as working perfectly.

The 24-GHz transmission was singled out for special mention by project leader, Karl Meinzer DJ4ZC. He was delighted by the sound of the 400-baud PSK signal that was successfully detected using a 24-GHz to 145-MHz converter at the command station. This is ground-breaking stuff as very little RF communication happens on 24-GHz.

Heavy attenuation due to water vapour in the atmosphere restricts frequencies around 24-GHz mostly to non-communication RF devices. It will be a real challenge to receive this beacon from P3D when in orbit. The advantage is that a tiny dish will provide all the gain required. The LNA will be another matter! After the spin-balance and vibration tests, P3D will be transported to the launch site. Here is the frequency and mode table for Phase 3D as published by AMSAT.

Frequency/Mode table for Phase 3D

Uplinks	Digital	Analog
	15m	N/A
12m	N/A	24.920 - 24.960
2m	145.800 - 145.840	145.840 - 145.990
70cm	435.300 - 435.550	435.550 - 435.800
23cm(1)	1269.000 - 1269.250	1269.250 - 1269.500
23cm(2)	1268.075 - 1268.325	1268.325 - 1268.575
13cm(1)	2400.100 - 2400.350	2400.350 - 2400.600
13cm(2)	2446.200 - 2446.450	2446.450 - 2446.700
6cm	5668.300 - 5668.550	5668.550 - 5668.800
Downlinks	Digital	Analog
	2m	145.955 - 145.990
70cm	435.900 - 436.200	435.475 - 435.725
13cm(1)	2400.650 - 2400.950	2400.225 - 2400.475
13cm(2)	2401.650 - 2401.950	2401.225 - 2401.475
3cm	10451.450 - 10451.750	10451.025 - 10451.275
1.5cm	24048.450 - 24048.750	24048.025 - 24048.275

(Downlink is inverting = reverse)

Telemetry

Beacons	General	Middle	Engineering
2m	N/A	145.880	N/A
70cm	435.450	435.600	435.850
13cm(1)	2400.200	2400.350	2400.600
13cm(2)	2401.200	2401.350	2401.600
3cm	10451.000	10451.150	10451.400
1.5cm	24048.000	24048.150	24048.400

Transponder Modes:

Band	Designator
15m/21MHz	K
12m/24MHz	no designation at present
2m/145MHz	V
70cm/435MHz	U
23cm/1.2GHz	L
13cm/2.4GHz	S
6cm/5.6GHz	C
3cm/10GHz	X
1.5cm/24GHz	Ka

What we know as "modes" at present will be represented as a combination of at least two letters indicating the uplink(s) /

downlink(s) in that order.

As an example: Mode - V/U would be 2-m uplink and 70-cm downlink.

More Good News on High-speed Downlinks.

Since last month there have been several developments in this important area.

The new generation digital amateur radio satellites are capable of downlink rates far in excess of the current maximum of 9600 baud.

Until a month or so ago the reception and decoding of such signals was in the realm of the guru. The bandwidths involved are far too wide for the normal amateur transceiver.

It now appears that there will be several ways of achieving good results at this high speed without breaking the budget. A German company called Symek have available a number of choices from reasonably expensive to fairly cheap.

Only anecdotal evidence is available so far on the relative performance of these units. In the meantime Reg VK2RW is developing a design based on a similar principle. Depending on the outcome of tests, Graham, VK5AGR will arrange a 'bulk' purchase of the units, boards or whatever for AMSAT-VK members.

The modem is another area that needs attention to work the higher speed downlinks. Those who already have a 9600 baud G3RUH modem and don't mind 'poking about with it' will have the opportunity to increase the speed to 38k4 with a few modifications.

David ZL2AMD, whose auto-tracker has served the satellite community well for some time has been developing a DSP modem to cope with the higher speed. Announcements are expected shortly on all these fronts.

In these days when one is tempted to think amateurs can't contribute to technology any more, it's remarkable how someone always rises to the challenge when the bar has been raised a few notches. Just a few months ago it seemed that it would all be either in the "too-hard-basket" or simply too expensive for most amateurs.

Want a REAL Challenge?

Tool-up for the "MERLION" payload on UoSat-12, UO-36. This will be a challenging area to enter. Merlion has an "L" band uplink and an "S" band downlink. The transponder supports analog and digital operations. Auto-track steerable antennas will be a must, but think of the SIZE. On "L" band, a dipole is a mere 12-cm or so long and on "S" band it is minuscule, only 6-cm or 2.5 inches long. Small dishes with dipole or helix feeds are often used on these frequencies. They are simple and easy to get going. Many amateurs will already have 1269 MHz transmitting apparatus, and 2.4 GHz converters will already be on hand in the shacks of those of us who operated with Oscar-13 before its demise.

Oscar-10's Spin-rate Drops Even Further.

Despite its age and being out of control for so long, Oscar-10 continues to serve to the amateur radio community. For some time now it has been obvious to users and listeners that Oscar-10 was slowing down. When under ground station control the spin rate was kept around 5 or 6 revolutions per minute which gavethe familiar "whoosh-whoosh" of the back-ground noise as the antennas swung around.

Since loss of control the rate has been seen to drop to a value difficult to measure. Jean-Louis, F6AGR has recently used the FFTDSP digital signal-processing program to analyse the beacon fluctuations. He reports that AO-10 has slowed to one revolution every 1203-seconds or a spin-rate of 0.05-rpm where stabilisation is non-existent resulting in the observed random behaviour of the beacon and through-put signals. Despite this AO-10 has provided some excellent contacts into North America and Europe in recent months ... amazing. Operators are urged to monitor the beacon on 145.810 MHz. If it observed to be "FM-ing", the satellite is in one of its periodic low-sunlight conditions and operation should NOT be attempted. Please observe this restriction as any attempts to operate under that condition could cause the satellite transponder to fail prematurely.

ar

EDITOR "Amateur Radio"

Mr Bill Rice has indicated his intention to retire towards the end of 1999.

Applications are invited for the position of Editor for "Amateur Radio"

The Editor will be appointed by Federal Council to be the Chairman of the Publications Committee. The Publications Committee is responsible for the publication of all WIA publications, subject to the direction of the Council and Executive. The Editor shall ensure that editorial policy of all publications is, in general, in accord with the policy of the WIA.

Applicants are expected to

- have a commitment to maintain and improve the quality of the present "Amateur Radio" magazine and other publications of the WIA
- be skilled in editorial and technical writing matters
- meet the regular deadlines involved in the timely production of a monthly magazine
- work with volunteers both on a one-to-one basis and in a Committee
- be available through email, phone and fax
- be licensed amateur radio operators and members of the WIA.

The Publications Committee is based in Melbourne and applicants outside of this area should not be deterred by this but need to advise on how they would work with this arrangement.

A small honorarium is provided to the Editor.

Applications should be forwarded to the Federal Office by 23 August 1999 addressed to Dr W J Howse, Director.

Enquires about the position can be made to him by phone and fax through the Federal Office or by email to armag@hotkey.net.au

REPEATER LINK

Will McGhie VK6UU

21 Waterloo Cr Lesmurdie 6076
VK6UU@VK6BBR
will2@omen.net.au
(08) 9291 7165

about the job of voice repeater management at a regulation level. You have little way of knowing if their judgement is good or bad.

If you believe you can do more or better then don't expect the WIA to do it all. What is needed is a strong lobby group with expertise that the WIA can call on. No one will look after your interests better than you. If you have something to contribute, the mail server may well be the means to create that strong lobby group. The added benefit is that the WIA can use the mail server as a perpetual questionnaire, sampling members' thoughts on many varied matters.

Low Voltage

A few years back I presented a circuit for low voltage cut out of the 12-volt system at a solar powered repeater site. The point being, that should the charge voltage fail, it would disconnect the battery from the repeater once the battery had discharged below a pre-determined voltage.

This not only protects the battery from being overly discharged and will hopefully avoid accumulator damage, but also prevents the repeater from behaving in a manner that may not be desirable or predictable. Series voltage regulators require a voltage "Buffer" above the regulated output. Once the battery voltage drops below that point the regulator no longer functions and rail voltage falls.

A remote repeater in VK6, protected by a low voltage cut out, started behaving in a most unsatisfactory manner. The repeater was transmitting the low voltage alarm signal and occasionally remaining on transmit for extended periods of time. The control board time-out appeared not to be working.

Investigation showed that the repeater would remain keyed on if the battery voltage fell below about 8 volts. The mute would open and key up the repeater and the time out circuit would work and time out the transmitter. However as the battery voltage went even lower, the time out circuit failed to work and the transmitter would remain on transmit until the battery voltage dropped to a point where the transmitter VCO dropped out of lock and the transmitter turned off, protected by the out of lock circuit. Lucky this worked at the low battery voltage. The repeater was designed around the trusty old FM828.

This demonstrates a remarkable chain of events. The solar installation had not failed, but due to usage of the repeater the battery voltage eventually dropped below the low voltage cut out point of 11 volts.

However the low voltage cut out circuit had failed, for reasons yet to be discovered. This downward spiral of battery voltage resulted in the circumstance as described.

private. Private means only those who have registered and have been accepted gain access. I have set the mail server up to be open.

You don't even have to register to view archived E-mails. However to be on the mailing list you do have to register. This is simple enough by just supplying your E-mail address and the list you want to be on.

What For?

So what is the purpose of the mail server? The intention is to gain, through being in touch, a strong voice in voice repeater regulations. I receive many comments from repeater managers and builders about their disappointment at the restrictions imposed on voice repeaters.

We have not had an organised say in voice repeater regulations in Australia. The WIA by default has taken the role but does not always have the people or expertise. This is not a negative criticism of the WIA.

Having now been in the inner sanctum of the WIA for a few years I believe I understand the way the organisation runs. A simple question, how would the WIA go about looking after voice repeater regulations on an ongoing basis, ever looking for improvements in regulations and even forging directions that would foster clever technological ideas?

I did say a simple question but the answer is not so easy. Ask any amateur and one of the answers might be, "Well it is their job, they should get on with it and do a better job". This then begs the question, who are "they"?

Let's say, for argument sake, that "they" all have a strong interest in HF DXing. That they give up a lot of time as WIA office bearers and are all mad keen HF DXers. Voice repeaters, as far as these amateurs would be concerned, would be a waste of time and spectrum space. These office bearers could well be called upon to sit in judgement on, and be required to give their thoughts on matters relating to voice repeaters.

The point is that, whether you a WIA member or not, you have little way of knowing who "they" are and how they go

Mail Server

The mail server I mentioned last month is up and running. Thanks to Richard VK2SKY who pointed me in the right direction The server can be found at

<http://www.onelist.com/index.html>.

Do a search for vk-repeaters.

A mail server is a simple way to keep in touch with a large number of people who have a common interest via E-mail and more.

E-mail is a great way to keep in touch and is versatile but in its simple form there are a few limitations. With E-mail you can send one message to as many people as you like if you have their E-mail addresses. However one limitation is that it is difficult for all users to see all E-mail sent from all, to all. It can be done, but is time consuming and requires one person to do a lot of work.

A mail or list server does all the hard work for you.

This is how it works. I set up a list on a mail server and call it vk-repeaters. I run my list a bit like a sysop. I then advertise the list giving its name, vk-repeaters, and the web address <http://www.onelist.com/index.html>.

Any person interested in the particular subject, in this case, unified voice repeater representation, can go to the web address given and register to be a member of the vk-repeaters list. The instructions are easy to follow. Once you have registered you now receive all E-mails posted on that list from all members. Any E-mail you send to the list is also sent to all members.

Even more

Not only is it a big forum for discussion but all E-mails are archived or saved on the list server. You can look at all past E-mails, even the ones posted before you registered.

Onelist, the name of the mail server, can also store files under your own directory, vk-repeaters, and members can download them. Files would normally relate to voice repeaters, eg documentation, circuits, photos etc.

Open access

The mail server on Onelist can be set up in a number of ways. It can be private or non-

Had the low voltage cut out worked, the site would have been protected and simply been turned off until the batteries had recovered.

Lessons

The lesson learned here is for repeater operators to check what happens to their repeater as they wind the supply voltage down. Try it and you may get a surprise.

Alternative

Before visiting the site described above and in expectation that the low voltage cut out had failed, a quick replacement was needed. I did not have the time to build up a direct replacement, so I purchased a low voltage cut out kit from Dick Smith. Being a kit it was easy to build up and it worked.

The design is very similar to the one I had put together, except the voltage was removed from the load by using a relay. My design used a power MOSFET to reduce the current drawn by the circuit. The relay design draws 70 mA in total and is a worthwhile addition to any repeater site, particularly remote solar sites.

There are a couple of design changes to the Dick Smith kit that I hope to do; replacing the relay with a MOSFET, or reducing the relay current once the relay switches on.

However finding the time is the problem. **ar**

POUNDRING BRASS

S.P.Smith VK2SPS

9, Peak St
BATEAU BAY
NSW 2261
(T) 0243347743

I HOPE YOU all did well last month in the Australian Sprint Contest, which by the way was run by the Adelaide Hills Amateur Radio Club.

Another great contest the Waitakere 80m Spirit was also held in the latter part of last month. Both contests are of one hour duration and are great fun especially if time is against you. These contests are a great way to hone your operating skills and get in some extra practice before tackling some of the major international events.

The CW Operators QRP Club is pleased to announce a new award. The "MPK" or the Milliwatt Per Kilometre Award is available for both CW and SSB modes. You simply have to work the furthest distance with the least output power. The award will be made available to stations that achieve a successful QSO, over distances equal to, or greater than, the following:

Section	Power no more than	Distance at least	Km/mW at least
A	10mW	100km	10
B	100mW	500km	5
C	200mW	500km	3
D	500mw	1000km	2
E	1W	2000km	2

Verification requires the following:

- (1) Output power, Keydown for CW & PEP for SSB mode.
- (2) Latitude & longitude, grid squares, GPS or map reference (preferably two or more)

(3) Photocopies of QSL sent & received.

The fee for each award is A\$5 or 5 IRC's or five Australian \$1 postage stamps for posting within the UK. A station with individual awards in all sections (A to E) may apply for a special All-Stations Award for CW or SSB. There is no additional fee if applied for at the same time as the fifth individual award.

When sending for award details please send to:

**CW Operators QRP Club
Awards and Contest Manager
Ian Godsil VK3DID
57 Nepean Highway
Aspendale 3195
Australia**

A coloured A4 size certificate featuring appropriate images & the club logo as centrepiece, with the recipients details prominently displayed, will be awarded.

If you are not a member of the CW Operators QRP Club, I highly recommend it. "Lo Key" is a quarterly journal, full of information which includes contests, modification kits, circuits you can build, the list is endless.

Further information can be obtained from:

**Kevin Zietz VK5AKZ
Treasurer, CW Ops QRP Club
41 Tobruk Av
St Marys SA 5042
See you next month
Steve VK2SPS**

ar



AV-COMM

Pty.Ltd

SATELLITE TV EQUIPMENT

-: Established 1981 :-

Specialising in: Free to Air Satellite TV

**CALL OR FAX
FOR FREE INFO PACK.**

198 Condamine Street
Balgowlah 2093 Australia

Tel: 61 2 9949 7417
61 2 9948 2667

Fax: 61 2 9949 7095

Internet: <http://www.avcomm.com.au>

Amateur Radio

**Supporting the
community**

CONTESTS

Ian Godsll VK3DID,
57 Nepean Highway, Aspendale, 3195



Contest Calendar August - October 1999

Aug 1	YO DX Contest (CW/SSB)	
Aug 7	SARS Sprint Contest (CW)	(Jun 99)
Aug 7	Waitkere Sprint (CW)	(Jun 99)
Aug 7	European HF Championship (CW/SSB)	
Aug 14/15	Keymen's Club of Japan Contest (CW)	(Jul 99)
Aug 14/15	RD Contest (CW/SSB)	(Jul 99)
Aug 14/15	Worked All Europe DX Contest (CW)	(Jul 99)
Aug 21/22	SEANET SSB Contest	(Jun 99)
Aug 28/29	SCC RTTY Championship	(Aug 99)
Aug 28/29	TOEC WW Grid Contest (CW)	
Sep 4/5	All Asia DX Contest (Phone)	(May 99)
Sep 4/5	Bulgarian DX Contest (CW)	(Aug 99)
Sep 5	Panama Anniversary Contest (SSB)	(Aug 99)
Sep 11/12	Worked All Europe DX Contest (Phone)	(Jul 99)
Sep 18/19	SAC DX CW	(Aug 99)
Sep 25	Internet CW Sprint Contest	
Sep 25/26	SAC DX Phone	(Aug 99)
Sep 25/26	CQ WW RTTY DX Contest	(Aug 99)
Oct 2/3	VK/ZL/Oceania DX Contest	(Aug 99)
Oct 3	RSGB 21/28 Mhz Contest (SSB)	(Aug 99)
Oct 9	Ten-Ten Int. Day Sprint (CW/SSB/RTTY)	(Sep 99)
Oct 9/10	VK/ZL/Oceania DX Contest	(Aug 99)
Oct 16/17	JARTS WW RTTY Contest	(Sep 99)
Oct 16/17	Worked All Germany Contest (CW/SSB)	
Oct 17	Asia-Pacific Sprint (CW)	(Jan 99)
Oct 17	RSGB 21/28 Mhz Contest (CW)	(Aug 99)
Oct 30/31	CQ WW DX Contest (SSB)	(Sep 99)

I take this opportunity to say thank you to Peter Dawson VK4VW for all his help in keeping me informed with VK4 news and wish him well in his future projects in Amateur Radio. Thanks Peter.

An apology for incorrect dates of the Waitakere Sprints. Final information

arrived after the deadline for the July issue. The two events are one week later than previously advertised.

Thanks this month to VK4VW OH3WW SM3CER VK6NE ZL1BVK VK2LEE

73 and good contesting Ian VK3DID

Result RAC Winter Contest 1998

(Call cat\ score)
VK2APK SOLP 23788

RESULTS 1999 Harry Angel Memorial Sprint

Place	Call	Name	Points
PHONE 17 logs received.			
1.	VK5SR	South East Radio Group	52 points
2.	VK2AKJ	J Patrick	51 points
3.	VK4YZ	C Strong	47 points
4.	VK1TX	A Ihasz	46 points
5.	ZL1CLE	L Riesterer 43 points	Highest DX
5.	VK4DD	N Baker	43 points
6.	ZL1BVK	A Learmond	42 points
7.	VK2LEE	L Noonan	37 points
7.	VK4LAJ	A Jaroszuk	37 points
8.	VK4EHT	B Jones	36 points
9.	VK4DMC	M McCarthy	30 points
9.	VK3VDP	D Pendergast	30 points
9.	VK2SIG	J McL. Bennett	30 points
10.	VK3MGZ	J Laan	26 points
11.	VK4DI	L Effeney	21 points
12.	VK4EJ	B McIvor	20 points
13.	VK3ABP	W Rice	15 points
14.	VK3DID/QRP	1 Godsll	10 points

MIXED 3 Logs Received.

1.	VK2BO	E.L Andrews	50 points
2.	VK5UE	C Low	36 points
3.	VK3YE	P Parker	17 points

CW 7 Logs Received

1.	VK5NJ	J Nieuwenhuizen	44 points
2.	VK2AJE	B Mills	30 points
3.	VK5XE	I Northeast	28 points
3.	VK4LP	J Lamura	28 points
4.	VK3DID/QRP	I Godsll	24 points
5.	VK4XW	G Harmer	22 points
6.	VK8HA	H Anderson	10 points

Results Ross Hull Memorial

VHF-UHF Contest 1998 - 1999

Presented by John Martin VK3KWA Contest Manager

Call	name	score
VK3XPD	A. Devlin	3951
VK3EK	R. Ashlin	3186
VK3CY	D. Clarke	3080
VK2FZ/4	A. Pollock	2496
VK5AKK	P. Helbig	2489
VK7XR	A. Hay	2134
VK3BJM	B. Miller	1452
VK4TZL	G. McNeil	1410
VK3AEF	J. Bywaters	1188

The 1998 - 1999 contest was the most disappointing in many years, with very little activity on the air. It comes after a period of decline in DX activity - not just contest activity - over the last four or five years. I find it surprising because there are more multi-mode radios in circulation than ever before. The problem seems to be that these radios do not get enough use, even during DX openings.

Over the years there have been various

changes to the rules in an attempt to respond to complaints from some entrants, and maybe these changes have failed to encourage activity from the majority who have not complained.

The only significant change last time was to shorten the contest. This may not have caused the crash in activity, but it obviously didn't help either. It is being reviewed, as are other options to widen the appeal of the contest.

Some rules will have to be rewritten to reduce the number of invalid contacts, especially the perennial problem of QRM on DX calling frequencies. I thought this one was just about solved, but it made a major comeback in the last contest. The main reason for the late publication of the results this year was the need to consult with the Contest Co-ordinator about the disqualification criteria. Enough said?

I would like to thank all those who put in logs this time and I hope the next contest - which will be the fiftieth - will be more successful. Full details of the results, and a more detailed discussion of the rules for the next contest, have been posted to all entrants.

Bulgarian DX CW Contest

0000 - 2400z Sun 5 September,
Bands 80 - 10 m. Mode CW only.
Exchange RST plus
ITU zone (P2 = 51, VK4/8 = 55, VK6 - 58,
VK1/2/3/5/7 = 59).

Score six points for each QSO with an LZ, three points for each QSO outside your WAC continent with a non-LZ, and one point for each QSO within your WAC continent. SWLs score three points if both exchange numbers are copied, and one point if only one exchange number is copied.

Multiplier is total ITU zones worked on each band. Final score is total QSO points (all bands) times the total multiplier (all bands). Send logs postmarked by 1 Oct to: Central Radio Club, Box 830, 1000 Sofia, Bulgaria.

Panama Anniversary Contest

6 September, 0001 - 2359z Sunday

The Panama Radio Club invites all radio amateurs to participate in its 26th annual contest. The only category is single operator.

Mode: SSB. Bands: 40/20/15 m.

Exchange RS plus serial number.

Score two points for QSOs with HP stations and one for others.

Multiplier is the total DXCC countries worked on all bands. Certificates of participation will be sent to all amateurs working 10 or more HP stations, upon receipt of three IRCs, and a plaque to the highest scoring station in each continent. Send log postmarked by 28 November to:

Radio Club Panama Contest, Box 10745, Panama 4, Panama, or via packet to HP1BYS@HPICDW.PANCTY.PAN.CEAM, or via e-mail to hlewis@suprempty.com

Scandinavian Activity Contest

CW: 18 - 19 September Phone: 25 - 26 September

1200z Saturday - 1200z Sun

Object is for amateurs world-wide to contact as many stations in Scandinavia as possible, on bands 80 - 10 m (no WARC).

Scandinavian prefixes are: LA/LB/LG/LJ (Norway); KW/JX;

OF/OG/OH/OI (Finland); OF0/OG0/OH0 (Aland Isl); OJ0 (Market

Reef); OX/OY; OZ/5P (Denmark); SI/SJ/SK/SL/SM/7S/8S (SWEDEN);

TF.

Categories (all bands only) are: single operator; single operator QRP (max 5 w o/p); multi-operator single transmitter; SWL. Exchange RS(T) plus serial number starting at 001. For each QSO, score one point on 20, 15 and 10 m, and three points on 40 and 80 m. The multiplier is the number of call areas (0- 9), not prefixes, for each Scandinavian country worked on each band. Portable stations without a district number count as area 0, eg G3XYZ/LA counts as LA0. OH0 and OJ0 are separate call areas. Final score is total QSO points (all bands) times total multipliers (all bands).

Use standard format for logs and summary sheets. Show duplicate QSOs with 0 points. Dupe sheets are required for 200+ QSOs. Send separate logs for CW and phone sections. Logs on 3.5" DOS disc are welcome and must be in ASCII, one QSO per row, and labelled with the call, contest name, section/s and contest date. Include an SASE if you want your disc returned. Summary sheet must be on paper. The mailing address alternates between SSA (Sweden), NRRL (Norway), EDR (Denmark) and SRAL (Finland) in that order. For 1999, send your log postmarked by 31 October to:

Hannu Saila OH3WW,
Muurainkorventie 17,

Ylojarvi, FINLAND. Logs may be sent by e-mail to: <sac99@sral.fi>

CQ WW RTTY Contest

25 - 26 September, 0000z Sat - 2400z Sun

In this contest, the object is to contact as many stations world-wide as possible using digital modes [Baudot, ASCII, AMTOR (FEC and ARC) and packet] on bands 80-10 m. No unattended operation or operation through gateways or digipeaters, etc. Stations may operate for full 48 hours.

Categories are: single operator unassisted, single and multi-band; single operator assisted, all band; multi-operator single Tx, all band ("10 minute" rule applies to this category EXCEPT that one - and only one - other band may be used during the 10 minute period if - and only if - the station worked is a new multiplier); multi-operator multi-Tx, all band. Single operator entrants can enter the low power section (up to 150W) or high power (more than 150 W).

Stations may be contacted only once per band, regardless of the mode used. Exchange RST plus CQ zone; WVE will send RST, state or area, and CQ zone. Score one point for each QSO with stations in your own country, two points for each QSO outside your own country but inside same WAC continent, and three points for each QSO with stations outside your own continent.

On each band the multiplier equals the sum of US states (Max 48) and Canadian areas (max 13) PLUS DXCC countries (including W and VE) PLUS CQ zones (max 40). Note: KL7 and KH6 are claimable as country multipliers only, not state multipliers.

Canadian areas are VO1, VO2, VE1 (NB), VE1 (NS), VE1 (PEI), VE2, VE3, VE4, VE5, VE6, VE7, VE8, VY. Final score equals total QSO points times total multipliers from all bands.

Submit a single summary sheet including scoring calculations for all bands, plus for each band a separate log, duplicate ccheck list, and multiplier check sheet. Send logs postmarked by 1 December to: Roy Gould KT1N, CQ WW RTTY Contest Director, Box DX, Stow, MA 01775, USA. A comprehensive range of plaques and certificates is offered.

1999 VK/ZL/OCEANIA DX Contest

Phone: 2 - 3 October, 1000z Sat to 1000z Sun

CW: 9 - 10 October, 1000z Sat to 1000z Sun

Object is for stations throughout the world to contact as many stations as possible in VK, ZL and Oceania. WAC boundaries apply. Contacts between different countries in Oceania are permitted, but contacts within same country are not permitted.

Bands: 80 - 10 m (no WARC).

Categories are: single operator all ands; multi-operator all bands; and SWL. (Single operator stations are where one person performs all operating, logging and spotting functions.)

Exchange RS(T) plus a three or four digit number starting at 001 and incrementing by one for each contact.

ICOM *Clearly Ahead*



"VK3LZ calling!"

More sound information from your friends at Icom

BOOM IN HAMFEST INTEREST CONTINUES

As we said in last month's column Hamfests are going from strength to strength with the trend to new equipment sales continuing. Some recent examples were the Port Macquarie Hamfest and the Mt. Gambier Hamfest. Port Macquarie attracted near record attendances and, despite atrocious weather, Mt. Gambier also had a good attendance with everyone there taking advantage of the opportunity to snap up some bargains on new equipment. We're sure the trend will continue... Hamfests are really where it's all happening!

ICOM DEALER EVENTS ALSO PROVING POPULAR

The special Icom days we have at various dealers around the country are also being extremely well attended. In fact, they've become more like mini-hamfests as a recent event at the Amateur Transceiver Radio Centre showed. Held on June 19 there was a fantastic response from amateur enthusiasts who were there to check out all the latest communications innovations from Icom. It's an annual event so make sure you mark it down in your diary for next year.

Incidentally, the hospitality provided by Les from ATRC is legendary!

MORE DATES FOR THE DIARY

Wagga Wagga Hamfest August 8
Frankston Hamfest August 21
Nambour Sunfest August 28
Shepparton Hamfest September 12

"...73"

FreeCall 1800 338 915
290-294 Albert Street
Brunswick, Victoria 3056
Tel : (03) 9387 0666
Fax : (03) 9387 0022
www.icom.net.au

ACN 006 092 575

LL Brown Adv 7236

Multiplier: On each band this is the number of prefixes worked on that band. A "prefix" is the letter/numeral combination forming either the first part of the callsign, or else the normal country identifier for stations using their home callsign in another DXCC country, eg W8, AG8, HG7 and HG73 are all separate prefixes. The prefix for both N8ABC/KH9 and KH9/N8ABC is KH9. Portable designators without numbers are assumed to have a zero after the letter prefix, eg N8ABC/PA becomes N8ABC/PA0. Any calls without numbers are assumed to have a zero after the first two letters, eg RAEM becomes RA0EM. Suffixes indicating maritime mobile, mobile, portable, alternate location, and licence class do not count as prefixes, eg /MM, /M, /P, /A, /E.

All stations score 10 points on 80 m; five points on 40 m; one point on 20 m; two points on 15 m; and three points on 10 m. Final score is total QSO points multiplied by the total number of prefixes worked. The same prefix can be claimed on different bands.

Use a separate log for each band, with times in UTC. Show new prefix multiplies the first time they are worked. Logs should be checked for duplicates, correct points and multipliers and should be accompanied by a list of prefixes worked on each band. Summary sheet should show callsign; name; address; category; number of valid QSOs; points and multipliers on each band; claimed score and a signed declaration that the contest rules and radio regulations were observed.

SWL logs should show date; time; callsign of station heard; callsign of station being worked; RS(T) and serial number sent by the heard station; points claimed and new multipliers.

Send logs in written style, or on 3.5" DOS disc in ASCII format with written summary sheet to: VK/ZL CONTEST MANAGER, 2 MOSS COURT, KINGSLEY, 6026, WEST AUSTRALIA. Overseas entrants please use air mail. Logs may be sent by e-mail to: <vk6ne@upnaway.com.au>

Please send all logs within three weeks of CW Contest (1999 = 1 Novemner) Awards: Certificates will be awarded to — DX: top scorer in each continental area; top scorer in each country where there are more than five entries from that country, or if fewer than five, score more than 500 points.

VK/ZL: top scorers for VK & ZL; top scorers for each band in VK & ZL. Where justified, additional awards may also be made at the discretion of the Contest Manager.

The CW entrant with the highest score will be awarded the Frank Hine VK2QL Memorial Trophy and receive an attractive wall plaque in permanent recognition of that achievement.

In matters of dispute, the Contest Manager's decision will be final.

SCC RTTY Championship

28 - 29 August 1200z Sat - 1200z Sun

Object: for amateurs around the world to contact as many other amateurs as possible.
Mode: Baudot.

Bands: 80 - 10 m (no WARC).

Categories: Single operator single band; single operator all bands; multi-operator all bands.

Sections: High power (200 w o/p or more); Low Power (less than 200 w o/p).

Exchange RST plus four digits of the number of the year your amateur licence was FIRST issued.

Score: one point for QSO in own call area; two points for QSOs with other Oceania call areas; three points for QSOs outside own continent.

Multiplier: one point for each different licence year worked on each band.

Final Score is total QSO points X total multipliers on all bands.

Logs must show time UTC; band; callsign; exchange; points claimed; multipliers at first time of working.

Summary Sheet should show callsign; address; number of QSOs; points and multipliers for each band; total score; signed declaration. Send logs in written form or on disk to:

Slovenia Contest Club,
Saveljska 50, 1113 Ljubljana,
Slovenia.

Logs may be sent by e-mail to:
<scs@hamradio.si>

All entries by 1 October.

RSGB 21/28 MHz Contest

SSB: Sunday 3 October 1999

CW: Sunday 17 October 1999

0700 - 1900z

Frequencies: SSB 21.150 - 21.350,
28.450-29.000 MHz

CW 21.000 - 21.150 (but avoid 21.075 - 21.125)

28.000 - 28.100 MHz

Categories: Single operator; multi-operator

Sections: Open; Restricted; QRP (max 10w o/p); SWL

"Restricted" entrants must use only one single element antenna at not more than 15 metre height and 100 w o/p. Any packet cluster or other spotting facilities makes an entrant multi-operator.

Score three points for contacts with UK stations.

Multiplier is each UK district (max 124) worked on each band. Send logs by mail to: RSGB Contest Committee, c/o 77 Bensham Manor Road, Thornton Heath, Surrey CR7 7AF, UK, by 15 November, 1999.

ar

INTRUDER WATCH

Gordon Loveday VK4KAL

Freepost Nr 4
 Rubyvale QLD 4702
 VK4KAL@VK4JEM
 Fax/Ph 07 4985 4168

"An influx of "old fashioned" AM transmitters, running the legal limit, would decrease the amount of illegal CB operation in this popular (28MHz) Band. The solution is in your hands, so grab it."

I wish to thank Rohan ZL1CVK Reg 3 ex co-ord, for all his assistance whilst he held that position. I hope he can find time in his retirement to send in some observations to his ZL coordinator!

On the intruder front, not a great deal has come forward from the rest of region 3. The unhappy state on 40m still exists, with about 70% being used by broadcast stations and CB type intrusions.

A notable nuisance is Radio Republic Indonesia, which for some unknown reason thinks transmitters on 7.098.3 is their best chance of getting out to the world, but we will again make representations to their administration to cease operations within the legal amateur band.

10 MHz band is suffering from FIB but no observations have come forward as to shift and baud rate.

14 MHz over-all rather quiet, but a few still persist, eg, 14.001.8 and 14.003.2 are

"left overs" from 1998, but have a much greater signal strength 14.185.5 seems to be the favourite frequency, with Ui VFT signals un-identified printers to the lay person.

North Korea still persists on 14.250 being the 5th harmonic of 2.850 kHz power of 120kw or there-about.

18 MHz... Indian signals coming through on 18.075 and 18100 are regular, possibly from Government Departments usually speaking Hindi or English, AM or SSB.

21 MHz... Not many reports from the VK area. Other R3 areas are hearing Arabic non-amateurs talking to South American and Africans on the top end of band.

24 MHz... Very quiet.

28MHz... Too many CB type operations going on: with NBFM stations making a play for its use, as well as the Cuban on 28.650, which of course is a 3rd harmonic... obviously their technician has

never found out how to curb harmonics.

I re-iterate, an influx of "old fashioned" AM transmitters, running the legal limit would decrease the number of illegal CB type operations in this very popular amateur band. It is open most days from my QTH to "somewhere". We have plenty of bandwidth, so why don't we use it, not complain about others using it. The solution is in your hands, so grab it and do more than "leave it till tomorrow"... that may be too late.

Thank You,
 Gordon VK4KAL FIWC
 ar

SEND YOUR REPORTS BY PH/ FAX MAIL OR PACKET TO GORDON LOVEDAY

Frequency:.....
 Date:.....
 UTC:.....
 Emission:.....
 RST :
 Ant Bearing:.....
 Content: Identification:

 Other Details:.....

ALL REPORTS HELP TO STOP INTRUDERS IN YOUR BANDS.

SNIPPITS

The electric battery was discovered by Alessandro Volta; although he was just investigating the effect first noticed by Luigi Galvani.

Galvani was an anatomist researching the muscles on frogs. He cut the frog through the waist and pushed an iron wire into the remaining backbone as a handle.

When he laid the legs on his zinc cutting board the legs would twitch every time the iron wire touched the zinc. He referred to this effect in his notes but made no effort to deduce its meaning. (From this experiment we get the old world expression "galvanised into action", which has nothing to do with having a silver-coloured coating.

He did notice however that when the iron wire was left on the zinc for some time it became coated in zinc and the process became known as galvanising.

What did Volta do? He placed dissimilar metals together separated by a piece of cloth soaked in brine. A stack of these cells is known as the Voltaic Pile which generates around a volt per cell.

Hey, that's a one Volta cell, no!

Summary for June 1999

Freq.	Date	UTC	EM	Details
03.560	0506	1025	A3E	R.Korea, Pyongyang, ID Positive
07.098**	3006	1000>	A3E	R.Indonesia Night Transmrx
14.001	1306	0950	AC3	UiFAX drum sp 120rpm @ cf
14.0018	2006	0920	F1B	UiVFT, Nil shift or Baud Rate ??
14.003	2706	0751+	F1B	UiVFT,sum Ac3 & NON.
14.0032	2206	0830	AC3?	UiFax? Stn closed 1130z
14.004	1806	1250	Fxx	UiFax
14.026	0806	1240	J3E/L	UiBC, also on Usb, M&F voicesD.
14.040	1806	1300	A3E	UiBC Chinese text?
14.156	0606	1220	F1B	UiRTTY H speed
14.188	0606	1030	F1B	UiRTTY no further details
14.2115	2806	0555	F1B	UiVFT 850Hz 112Bds
14.239	2806	0430	F1B	UiVFT 250Hz shift copy 1 Hr
14.250	2106	1100>	A3E	UiChinese BC stn + unknown ID
14.317	0406	0629	A3E	UiBC, Singing ...then NON only
18.150	1806	1039	A3E	Ui Phone patch, non-amateur
21.257	2006	1254	F1B	UiVFT Printer System
18.077	2905	0306	J3E	UiBC,CB type op, nil c/sign
28.048	1706	1015	xxx	UiFSK, CW
28.650	2106	2220	A3E	Habana, 3H 9550, Cuba ID 100 CW

WIA Yearbook 2000

Please be quick!

Send your :-

- * Comments
- * Suggestions
- * Club Details
- * Net Details
- * Beacon Details
- * Repeater Details
- * AR Web Site Details
- * Morse Practice Freq.
- * Bureaux Addresses
- * Special Event Dates
- * Reference Data

-or anything else that
you think should be in
YOUR callbook to:-

Callbook 2000

c/o WIA Federal Office

PO Box 2175,

Gaulfield Junction VIC 3121

arimag@hotkey.net.au

SPOTLIGHT on SWLING

by Robin L. Harwood VK7RH

5 Helen Street, Newstead Tasmania 7250

(03) 6344 2324

E-mail: robroy@tassie.net.au

Have you recently checked your connectors to see if they are indeed making contact?

My dipole antenna was up but the guy ropes had absorbed too much UV and had deteriorated. Having some practical assistance from Mark, VK7KMA, the antenna was lowered and hoisted back up with the guys replaced with fencing wire.

We also checked the connections on the switches closest to my receivers and they were making a poor connection. While that was being checked, I also put in a high impedance connection for LW and MW.

What a big difference!

I was beginning to think that my trusty Icom R70 was going deaf but since these minor changes, I now hear signals much better.

For example, I was amazed to hear a low-powered station in the 31-metre band. It is on 9720 kHz and I observed it at around 0715 UTC, naturally in Spanish. Some bulletins and lists say it is Radio Victoria in Lima, Peru but I am not certain if it indeed was that station.

Never assume that a signal you hear, is the same as that reported in a magazine or elsewhere as being on that channel. I recently did see a logging of a Brazilian station yet it turned out to be a relay station of the Spanish Foreign Radio in Costa Rica in Central America.

Listen very carefully and see if you can pull out any identification announcements. It also would assist if you had a tape recorder online because often these hairline signals can last for only a few minutes and by playing it back, often will give important clues.

So I can now listen on the long and medium waves and can hear non-directional beacons (NDBs) between 200 and 438 kHz. These beacons guide aircraft as they fly about Australia and are spaced every 3 kHz. Some also have automatic weather information announcements in voice.

Here in Launceston there is one on 242 kHz between 6:15 a.m. and 7:30 p.m. daily. It is regularly updated. In Devonport and Wynyard, it is an automated voice information service with Devonport on 281 and Wynyard on 302 kHz. All NDB's have a CW identifier and a list of these in frequency order is found on page 50 of the 1999 WIA callbook.

I have even heard an NDB in Charleville (QLD) on 269 kHz in the evening hours, over 1500 miles from northern Tasmania.

When I first commenced listening I do recollect hearing control tower traffic from some of these NDB's. I know that the Launceston beacon often did in the late 50's. Also there used to be a facility at Avalon, near Geelong which was doing this as late as the early seventies on about 260 kHz.

There was a powerful NDB on 1615 kHz until two years ago, located near Mount Egmont on the NZ North Island. This was for Trans-Tasman traffic and became a reliable indicator for 160 metres DX. There may be a few NDB signals from Niugini around 1.7 to 1.8 MHz if they have not been phased out by now.

Kosovo Crisis

The Kosovo Crisis ended when NATO troops entered after the withdrawal of Serbian troops. Almost simultaneously, the NATO bombing campaign ended. Because the media infrastructure within Kosovo was in turmoil, an independent station, Radio 21, started broadcasting via the Flevo transmitters of Radio Netherlands from 1830 to 2027 on 9495 kHz. Programs are in Albanian but an English News bulletin is apparently aired in the final few minutes.

The shortwave transmitters of Radio Yugoslavia are reported to be back on air but I have not personally heard them.

The Electronic DX Press is still going strong. I believe that they are going to issue a regular summary in hard copy approximately every six weeks. It is by subscription only.

For further details, write to 404 Mont Albert Road, Surrey Hills, Victoria 3127 or e-mail to hpadula@compuserve.com.

I believe that Radio St Helena in the South Atlantic will be operational, perhaps for the last time over shortwave. The date will be Saturday October 23 from 1900 to 2300 UTC on 11092.5 USB. Propagation has been fickle to this location and now that the Sunspots have risen dramatically, I do hope to finally hear it this time. Yes it is on the Internet but from a site in Sweden.

Keep listening and until next time! 73,

ar

The best place to start is the Remembrance Day Contest in just a few days time on the weekend of the 14th and 15th August.

NOVICE NOTES

Peter Parker VK3YE

12/8 Walnut Street, Carnegie, Vic 3163

Email: parkerp@alphalink.com.au

Novice Notes Online: <http://www.alphalink.com.au/~parkerp/nonline.htm>

Please note that this is Peter's correct address.

An introduction to Contesting

A major amateur radio interest is contesting. Whether your favourite activity is HF or VHF, Morse, phone or digital modes, there's sure to be a contest for you.

Competition on the air

So what is a contest? A contest is an organised event where participants make as many contacts as possible within a given time.

Apart from being an exciting and absorbing activity in its own right, contesting allows you to test the efficiency of your station together with your operating skills.

Contesters keep a record (log) of the contacts they make and send it to the contest manager afterwards. The contest manager checks the logs and submits the results to be published in Amateur Radio and on the WIA Federal Internet web page -

<http://www.wia.org.au>

Several months later the top scoring stations get a handsome certificate in the mail for their efforts.

Why do people enter contests?

People enter contests for various reasons. Some hams are driven by a competitive urge to be number one. They get a great buzz out of pitting their station and operating skills against others around the world.

Those who wish to talk to as many countries as possible and collect QSL cards for one of the many operating awards on offer find that international contests bring out rare stations not active at other times.

Others use contests to test the effectiveness of a new piece of equipment or antenna because of the large number of stations on air.

Types of contests

There are contests for all types of operators. Some are single band and single mode, while others are multi band and multi mode. The length of contests varies, from under an hour to as much as four weeks. Most major contests, however, run for 24 hours. The

pace of operating ranges from relaxed to hectic.

Further information on major Australian contests is given later.

Choosing a contest

A comprehensive list of coming contests is given each month in Amateur Radio. Rules for the more significant of these is also given there and on the Australian Contesting Web page at URL

<http://www.uq.edu.au/radiosport/>.

If you haven't been in a contest before, start with one of the short scrambles or sprints on 80 metres. If you only have VHF/UHF privileges, try one of the more popular VHF/UHF contests such as the Remembrance Day or John Moyle Field Day.

Local contests are preferred because the pace of operating isn't as fast as international contests and it's easier to make yourself heard, especially with low power

and a limited antenna system.

Other groups also run contests. For example, the CW Operators' QRP Club has hour-long CW scrambles on various bands. Some WIA Divisions also have their own contests. Other novelty contests occur from time to time. An example was this year's successful Radio on Rails Fun Day, sponsored by the Moorabbin and District Radio Club, which encouraged activity from trams and trains around Melbourne. All these are excellent contests for beginners, as the pace of operating is fairly slow and/or the contest period is short.

Most international contests are open to Australian amateurs. Those that give extra points for prefixes worked are particularly good for us, as VK is not a common prefix in many parts of the world. However, participation in these events is suggested only after you have gained experience in one or more of the local contests.



Photo 1. Participating in DX contests is a great way to add more QSL cards to your collection.

The main Australian contests are:

Remembrance Day Contest (August)

Australia's biggest contest. States compete for RD Trophy. Highly recommended.

VK-ZL-Oceania DX Contest (October)

An opportunity for overseas stations to work Australia and New Zealand and vice versa. If 10 and 15 metres are your best bands, this one is worth a shot.

VHF/UHF Spring Field Day (November)

A chance to go portable on the VHF/UHF bands. Activity is on SSB and FM.

Ross Hull VHF/UHF Contest (December/January)

THE contest for the serious VHF/UHF DXer and microwave enthusiast. Most activity is SSB rather than FM, so Novices will find contacts difficult.

VHF/UHF Summer Field Day (January)

Another opportunity to go portable on VHF/UHF. Activity is on SSB and FM.

John Moyle Field Day (March)

Portable operating on all bands. Great fun!

VK Novice Contest (June)

A HF-only contest originally intended for newcomers to amateur radio - not as popular as most other contests.

Making your station contest-ready

There are several aspects to consider when setting up a contest station..

* *Efficient equipment.*

Transceivers with intermittent faults have no place in the fast-paced environment of a major contest. Either fix it or use another rig.

Equipment attributes such as receiver dynamic range, variable selectivity (especially on CW), punchy but clean speech processing, low levels of internally generated receiver noise, and fast transmit-receive switching will all aid HF operating.

A big linear amplifier is not a prerequisite for a successful contest operation; even homebrew QRP rigs can do quite well in contests provided that they are not the ultra-simple 'bare bones' types that omit desirable features such as VFOs, audio filtering, sidetone, easy transmit/receive switching, etc.

On VHF and UHF FM, set your equipment to tune in 25 kHz steps and remember the most popular simplex frequencies to allow quick frequency changes when required.

* *Reasonable antennas.*

You should get some contest contacts with almost any antenna, but to win, good antenna performance is a must.

Receiving performance is as important as transmitting performance - you need to hear them to work them. If noise is a problem in your area (particularly on the lower HF bands) you may need to consider a separate antenna for receiving, such as a rotatable magnetic loop.

Generally speaking, simple dipoles and verticals are entirely adequate for the station not expecting more than an average score, particularly in Australian contests.

* *Freedom from interference.*

There is nothing worse than having to shut down because of a TVI complaint in the middle of a contest. Do some operating

in the week prior to the contest to assess band conditions, station performance and to establish whether TVs in the neighbourhood will be affected by your activity.

Interference to your station is important - ensure others are not using appliances that cause interference while you are operating.

If you plan to use a computer log, test to ensure that the computer does not spoil reception. If there is any degradation to receive performance, use a paper log instead.

* *Station layout and operating position.*

All frequently used equipment should be within arm's reach of the operator. Antennas should be controllable from the shack, so that the contest operator doesn't have to go outside to change them.

Band changing should be easy and quick. If using HF, it is desirable (but not essential) to have a second transceiver or communications receiver handy so you can monitor WWV or scan other bands for activity while operating. The operating table should have plenty of room for writing if a manual log is to be used. Comfort is important as you will be at the radio for several hours at a time, so invest in a good swivel chair and ensure that both it and the table are at a comfortable height.

Preparing for the contest

Before the contest read the rules and consider which section and category to enter. Depending on the contest, there may be a choice of phone, CW or open modes, VHF, HF or all band and various operating periods. Not all contests have as many sections as this - some have the CW and phone sections as separate contests on different weekends. Factors such as station location, equipment and bands available, likely propagation, and time available will influence the section chosen.

Have a realistic expectation of what you can achieve in a contest, taking into account factors mentioned above. As an example, a

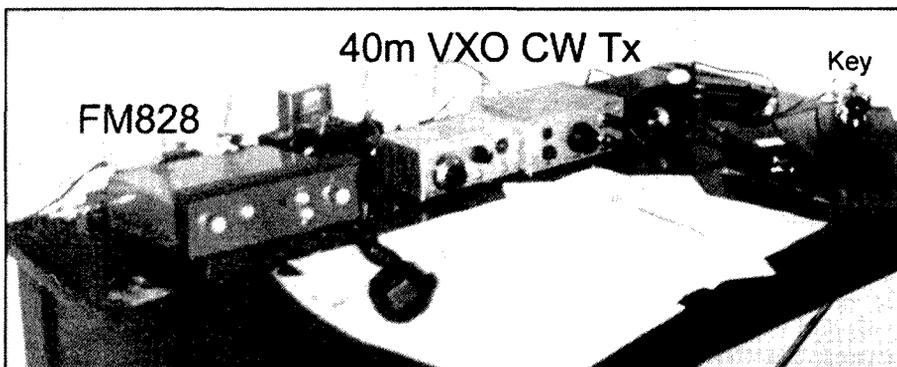

Photo 2. Contest stations can be simple or complex. Shown here is a station for two metres FM and 40 metres CW.

various bands. A good opportunity to check this is to note the signal reports given when several locals are calling a distant station. If the signal reports you get are consistently weaker than for most others, your operating procedure will be different than if you are one of the louder stations.

In the hour before the contest, read the rules, look at propagation charts and check the operation of antennas and equipment. Ensure that you have sufficient pens, paper, and log sheets available. Figure 1 is pro forma contest log sheet suitable for Remembrance Day and many other contests. Photocopy it and use it.

During the Contest

The big hand is approaching the twelve on the station clock, and, with microphone in hand, you're poised to make your first contact in your first contest.

So how do you get contacts during contests? There are two main ways. Either scan the band looking for stations that are calling CQ ('search and pounce' approach), or put out calls yourself. The tactic chosen depends on things like band activity, propagation and the capabilities of your station.

Beginners should use the 'search and pounce' method for their first several contacts. Then later on, when you have worked all the stations calling, put out CQ calls yourself.

Calling allows stations that are tuning across the band to find you and give you a number. This can significantly boost the number of contacts obtained. The reason for this is that during a contest there are all types on the band, from the die-hard contesteer to the station who says they're not really in the contest, but are happy to give out a few numbers. Many of these less serious participants won't put out calls themselves, but will respond to stations calling CQ, especially if they want your callsign.

I mentioned before that operating tactics

are shaped by station capabilities. This is because people often prefer to answer CQ calls from stronger stations. A weak station on SSB with two strong stations either side may not be noticed by people tuning past. Also, strong stations can 'hold' a frequency, and ward off those who may be tempted to stray too close to it, but weaker stations may not be able to do this when the band is crowded.

If you're a weaker station it's best to use the 'search and pounce' technique most of the time, especially during the bigger DX contests when the bands are busy. Carefully scan the band for stations that are calling but haven't been worked before. Even if a calling station is weak, give them a call anyway - they may be using low power or have an antenna worse than yours. When calling, just give your own callsign - the other station already knows theirs!

Notwithstanding the above paragraph, weaker stations should not give up calling CQ altogether. If conditions seem reasonable but there are few stations around (common during many smaller local contests), you will work no one if you just listen. Put out calls yourself - if your signal is readable, people tuning across will answer. As mentioned before, calling CQ attracts many of the types tuning across the band who you'll never work if you only answer other people's calls.

Contest contacts are much shorter than other amateur radio contacts. All you need to exchange with the other station is a five or six digit number, consisting of a signal report followed by a serial number starting at 001. This serial number increases by one for every contact you make, thus you might send 57003 to the third station you work in a contest. Repeat this if your signal is likely to be weak at the other end. Figure 2 shows an example of a typical contest contact.

The pace of operating varies between contests. When it's fast and frantic just give the signal report and number. When it's

slow, some people will tell you their name and location as well. Conciseness is particularly important when signals are weak or if using CW - 5wpm is excruciatingly slow for CW operators, and you'll win the thanks of many if you just send the bare minimum of information the contest rules require.

While operating, fill in a log sheet similar to that in Figure One. Though it was designed for the RD Contest, it should be suitable for most Australian contests. Try to keep it legible - the Contest Manager may need it when he is checking logs.

After the contest

To formally enter a contest, send your log plus a front summary sheet to the address given in the contest rules. The summary sheet usually shows your name, callsign, section entered, score and a signed declaration that you operated ethically. The exact requirements for logs and summary sheets vary slightly between contests - see the contest rules for the requirements of that particular contest.

You will not normally receive notification that your log has been received. Results are generally published 3 to 6 months after a contest has been held, depending on the contest. Certificates are posted to winners after the contest results have been collated.

Conclusion

Contesting can be a highly absorbing facet of amateur radio. May your callsign feature in the results of various contests in the coming months. The best place to start is the Remembrance Day Contest in just a few days time on the weekend of the 14th and 15th August. The rules are printed in this month's Amateur Radio. If you have access to the Internet, further information about contesting appears on the Australian Contesting website at <http://www.uq.edu.au/radiosport/> and on the WIA Federal web page at <http://www.wia.org.au>

ar

Figure 2. An example of a contest exchange.

The following is a typical example of a phone contest exchange between VK3AA and VK6AA.

(VK3AA) **CQ CQ CQ RD CONTEST, THIS IS VK3AA**
{ie VK6AA seeking a contest contact}

(VK6AA) **VK6AA**
{VK6AA responds quickly but clearly}

(VK3AA) **VK6AA, THIS IS VK3AA. MY NUMBER TO YOU IS 57011**
{VK6AA's signal is 5/7, VK6AA is VK3AA's eleventh contact in the contest.}

(VK6AA) **THANK YOU FOR THE 57011. MY NUMBER TO YOU IS 58001**
{VK3AA's signal is 5/8, VK3AA is VK6AA's first contact in the contest.}

(VK3AA) **58001 RECEIVED, 73 AND GOOD LUCK IN THE CONTEST.**

{Contest contact ended successfully and both stations enter the contact in their logs. VK3AA continues calling CQ, while VK6AA looks for other stations calling CQ}

On CW, the procedure is similar, except that there is a heavy use of abbreviations to save time. Very often, nines are sent as 'N' and zeroes as 'T'. Thus, the first station you work might receive a '5NTT1' number from you, which is the equivalent of a 59001 report on phone.

IONOSPHERIC UPDATE

Solar activity

It was noted, last quarter, that the current solar cycle trends indicates that it will not be as good as the previous two cycles. A graph, overlaying the last three solar cycles, is included this time to make the comparison more stark.

Note the difference in the smoothed sunspot numbers between the current cycle (23) and the two previous cycles (21 and 22). While extrapolating data is difficult, you would expect that the current cycle not to be as good as the previous two. But how conditions can change.

The rise in monthly sunspot number during the quarter has run counter to the trend just described. It was 64 in April, 106 in May and 137 in June.

The Ionospheric Prediction Service described the June number as *not only the highest so far this cycle (by a very long way) but also the highest for more than seven years. They go on to say that the smoothed sunspot number has been rising much more slowly than expected [see middle graph] but will now move up much more quickly toward the predicted peak smoothed number of 160. The peak is expected around April 2000[see top graph].*

Geomagnetic activity

One outstanding matter from last quarter's *Ionosphere Update*: the increase in geomagnetic activity in the last days of March to minor storm level was due to a coronal hole.

ar

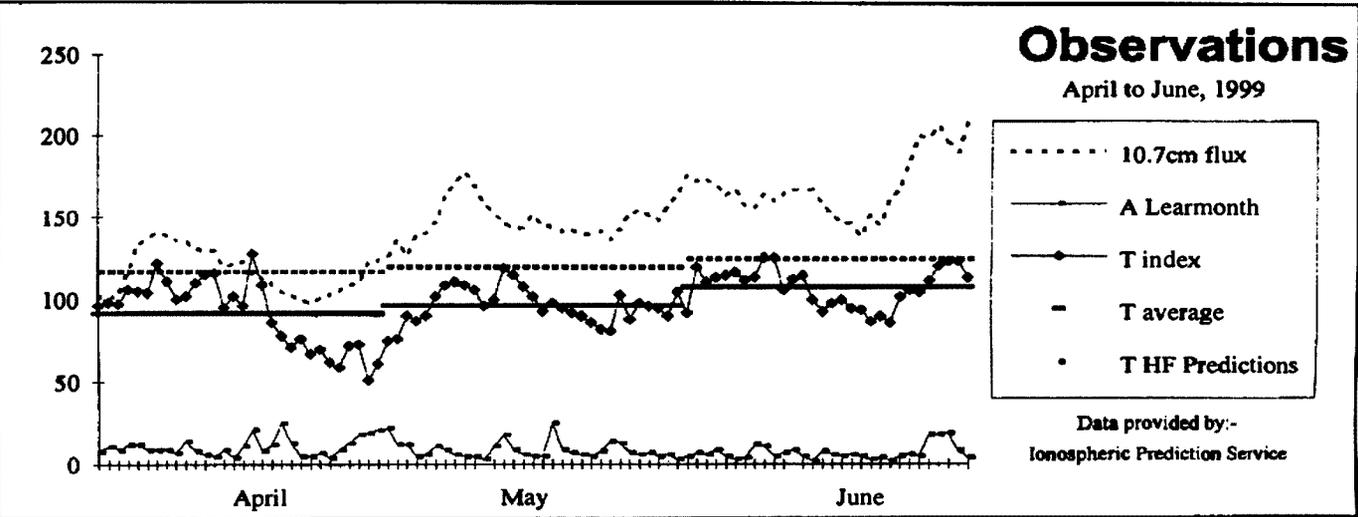
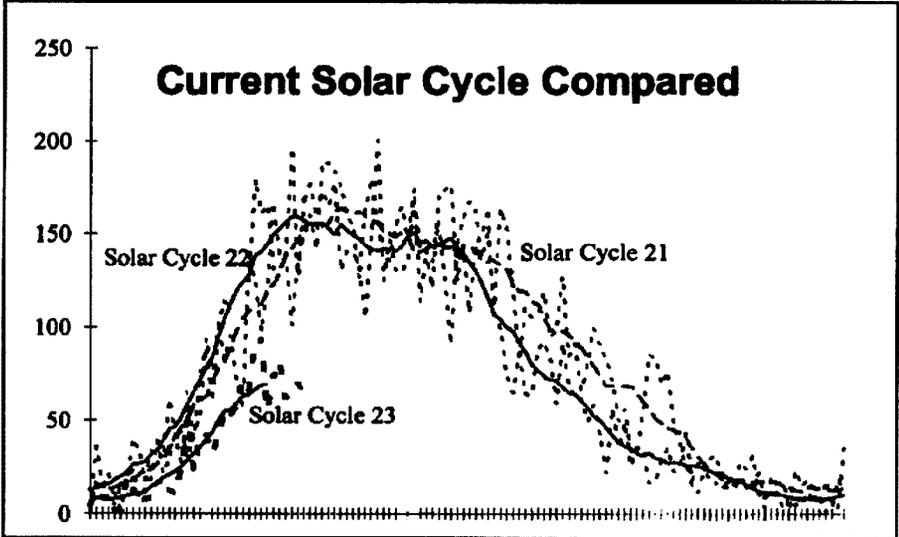
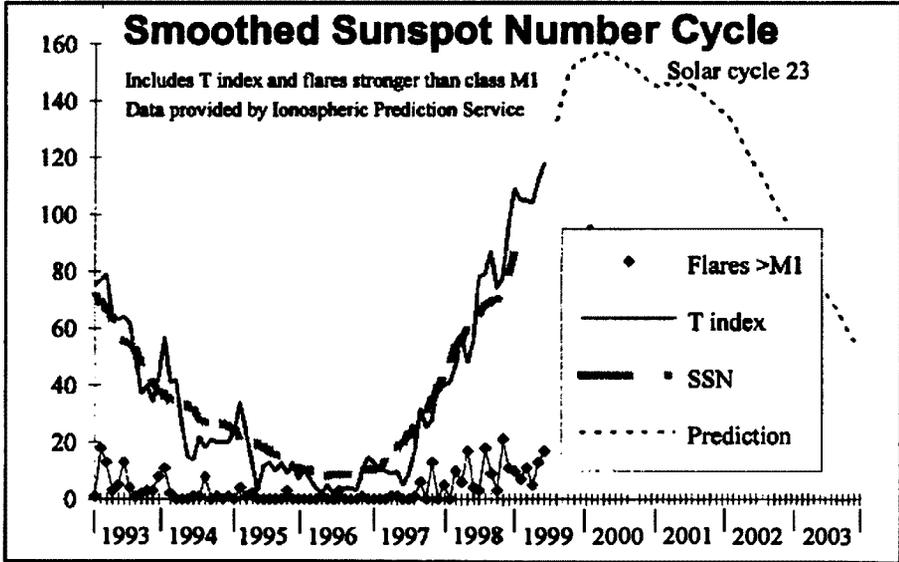

HF PREDICTIONS

by **Evan Jarman VK3ANI**
34 Alandale Court, Blackburn Vic 3130

These graphs show the predicted diurnal variation of key frequencies for the nominated circuits. These frequencies as identified in the legend are:-

- Upper Decile (F-layer)
- F-layer Maximum Useable Frequency
- E-layer Maximum Useable Frequency
- Optimum Working Frequency (F-layer)
- Absorption Limiting Frequency (D region)

Shown hourly are the highest frequency amateur bands in ranges between these key frequencies; when useable. The path, propagation mode and Australian terminal bearing are also given for each circuit.

These predictions were made with the Ionospheric Prediction Service program: ASAPS version 4. **ar**

August 1999

T index: 126

Legend

- | | |
|------------|-------|
| UD | |
| F-MUF | ----- |
| E-MUF | ----- |
| OWF | ----- |
| ALF | ----- |
| 100%-50% | |
| 50%-90% | |
| 90%-100% | ----- |
| Time scale | ----- |

Adelaide-Amman 292
First F 0-5 Short 13022 km

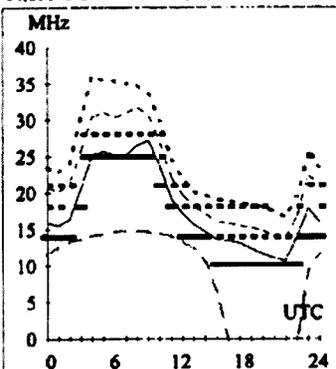

Brisbane-Auckland 123
First F 7-10 Short 2290 km

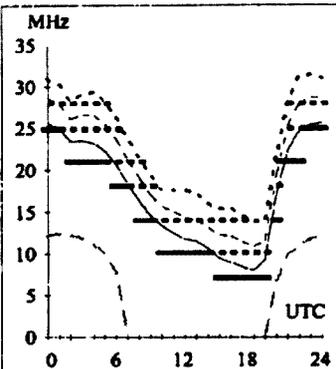

Adelaide-Invercargil 126
Second 2F16-20 2E4 Short 2796 km

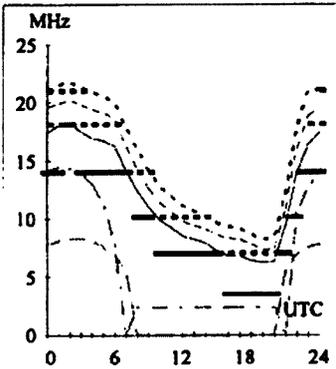

Brisbane-Dakar 217
First F 0-5 Short 18279 km

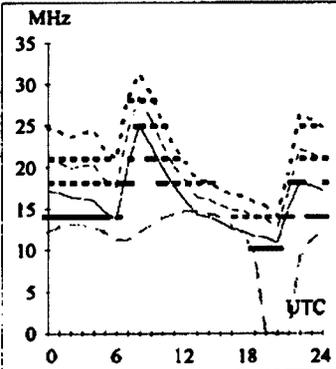

Canberra-Lusaka 239
Second 4F3-4 4E0 Short 11620 km

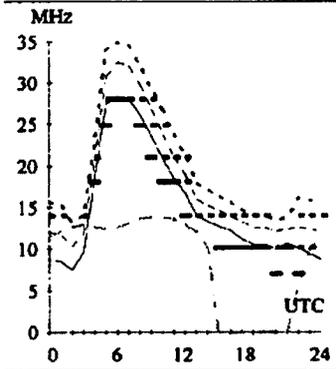

Darwin-London 145
First F 0-5 Long 26171 km

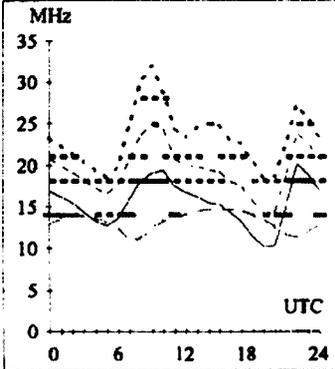

Adelaide-New York 67
First F 0-5 Short 17029 km

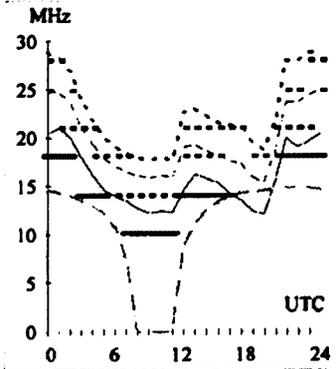

Brisbane-Honolulu 49
Second 3F5-11 3E0 Short 7569 km

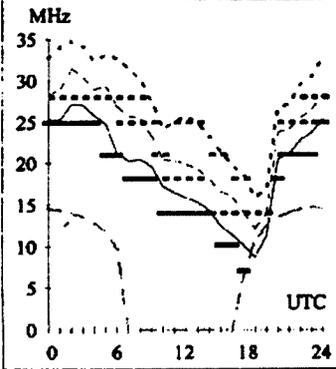

Canberra-Moscow 317
First F 0-5 Short 14481 km

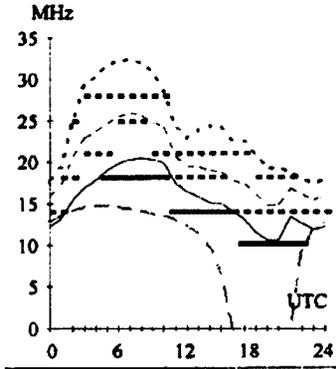

Darwin-London 325
First F 0-5 Short 13853 km

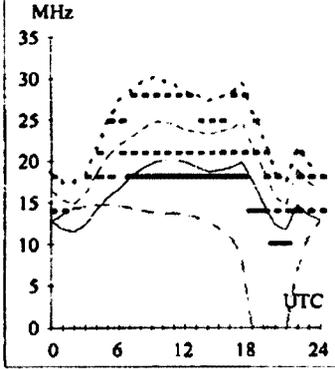

Adelaide-Rome 296
First F 0-5 Short 15337 km

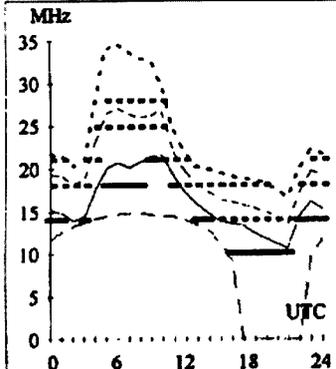

Brisbane-Singapore 293
Second 3F9-15 3E0 Short 6147 km

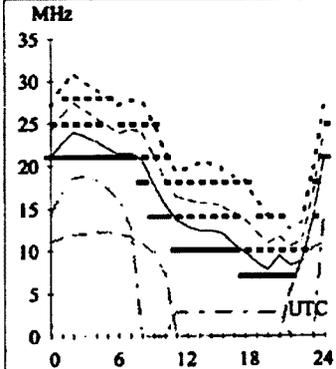

Canberra-Tokyo 352
Second 3F4-9 3E0 Short 7948 km

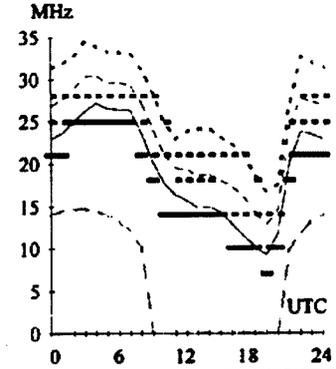

Darwin-Pretoria 242
Second 4F4-6 4E0 Short 10639 km

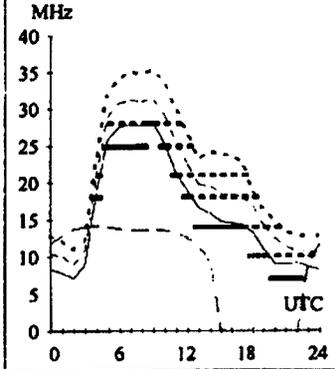

HF PREDICTIONS

Hobart-Montevideo 161
Second 4F4-5 4E0 Short 11044 km

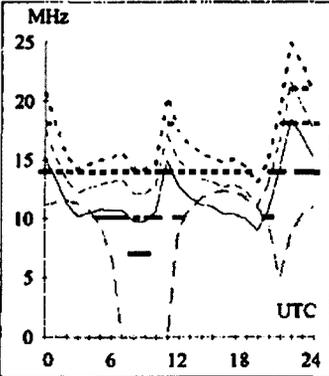

Melbourne-Budapest 302
First F 0-5 Short 15558 km

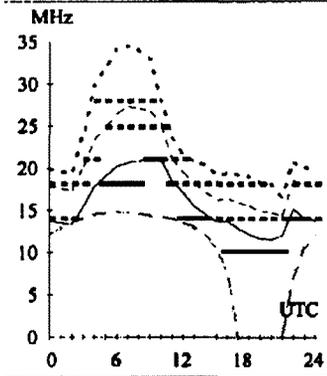

Perth-Capetowa 237
Second 4F8-10 4E0 Short 8703 km

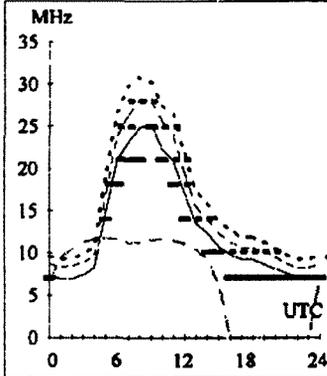

Sydney-Chicago 62
First F 0-5 Short 14876 km

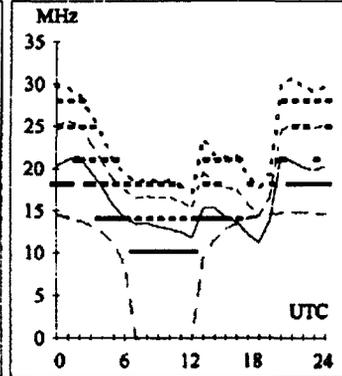

Hobart-Stockholm 136
First F 0-5 Long 23871 km

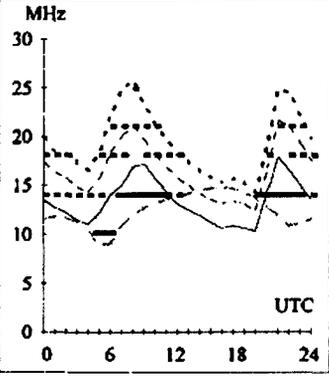

Melbourne-Jakarta 303
Second 3F12-16 3E2 Short 5214 km

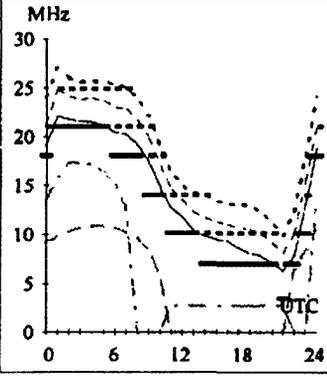

Perth-Osaka 17
Second 3F5-11 3E0 Short 7684 km

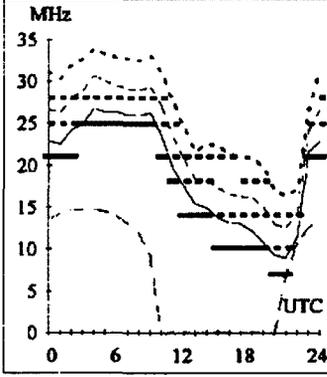

Sydney-London 139
First F 0-5 Long 23032 km

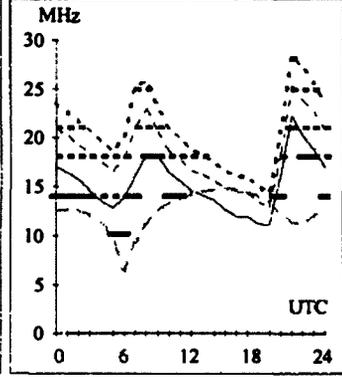

Hobart-Suva 56
First 2F9-12 2E0 Short 4011 km

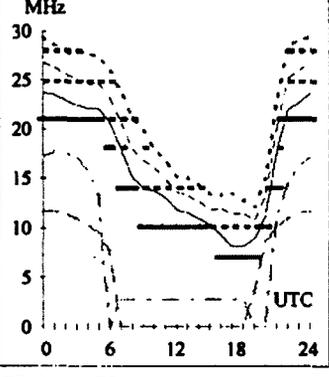

Melbourne-Manila 332
Second 3F8-15 3E0 Short 6341 km

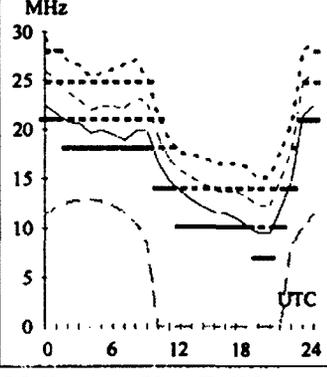

Perth-Santiago 174
First F 0-5 Short 12709 km

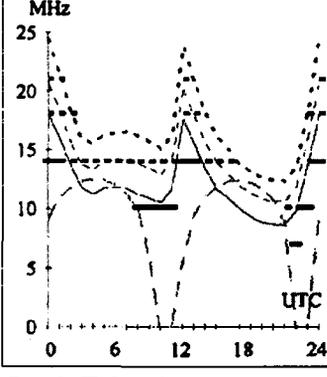

Sydney-London 319
First F 0-5 Short 16992 km

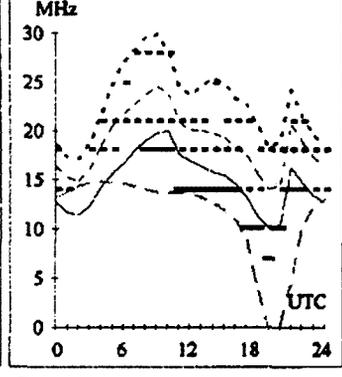

Hobart-Vancouver 49
First F 0-5 Short 13427 km

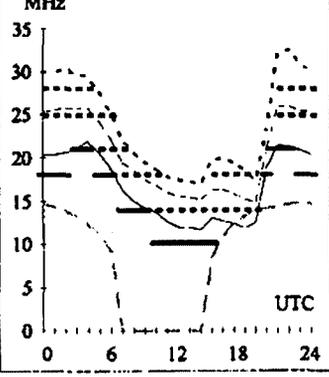

Melbourne-New Delhi 306
Second 4F5-11 4E0 Short 10200 km

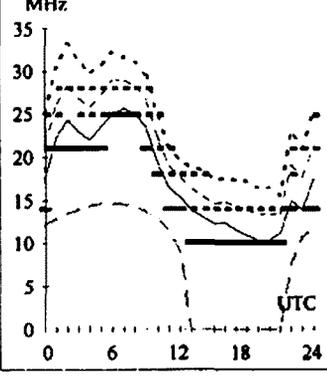

Perth-Tel Aviv 302
Second 4F4-10 4E0 Short 11091 km

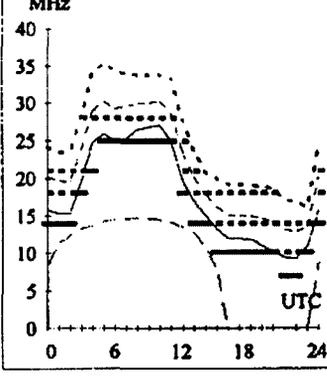

Sydney-Papeete 88
Second 3F9-11 3E0 Short 6121 km

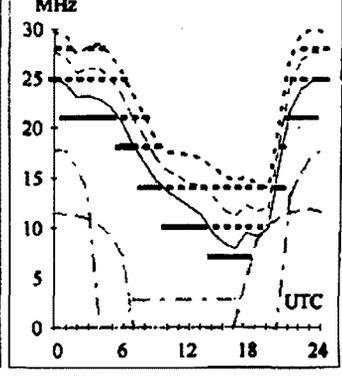

HAMADS

- Hamads may be submitted on the form on the reverse of your current Amateur Radio address flysheet. Please print carefully, especially where case or numerals are critical.
- Please submit separate forms for For Sale and Wanted Items, and be sure to include your name, address and telephone number (including STD code) if you do not use the flysheet.
- Eight lines (forty words) per issue free to all WIA members, ninth and tenth lines for name and address. Commercial rates apply for non-members.
- Deceased estates Hamads will be published in full, even if the ad is not fully radio equipment.
- WIA policy recommends that the serial number of all equipment for sale should be included.
- QTHR means the address is correct in the current WIA Call Book.
- Ordinary Hamads from members who are deemed to be in general electronics retail and wholesale distributive trades should be certified as referring only to private articles not being re-sold for merchandising purposes.
- Commercial advertising (Trade Hamads) are pre-payable at \$25.00 for four lines (twenty words), plus \$2.25 per line (or part thereof), with a minimum charge of \$25.00. Cheques are to be made out to: WIA Hamads.
- Copy should be typed or in block letters, and be received by the deadlines shown on page 1 of each issue of Amateur Radio, at:

Postal: Newsletters Unlimited, 29 Tanner Street, Richmond, 3121

Fax: 03 9428 4242 E-mail: newsl@webtime.com.au

Please only send your Hamad once

Please send Hamads by mail OR fax OR email (much preferred).

Please do not send by more than one method for any one ad or issue, it is confusing.

WANTED NSW

- Big or small preloved valve communications receivers working or not. Give me a hernia. See last month's July "AR" page 51. Manuals, books, magazines, parts, junked sets. I will even bring a broom. Call John (02) 95336261. Will pay \$ if necessary. L21068 WIA.
- Information about Motorola Integrated Circuit MC4044 - full data if possible. Costs reimbursed. David VK2IX QTHR (02) 47516124
- Atlas 215 or 210 dead or alive. Jon VK2WF (02) 67751080.
- Integrated circuits, MC12017p Dual Modulus Prescaler and MC145158p Frequency Synthesiser for use in Microcontrolled HF rig. No luck trying to source in Aust, UK or USA. Will consider used if can be salvaged off boards in working order. Pat Brennan VK2ABE. PO Box 158 Tamworth NSW 2340.
- Digital Display Modification Kit for Yaesu FT101Z. Noel VK2BCA QTHR (02) 4977 3449.
- Old telephones, wood or bakelite phones in any condition or parts ie earpieces, mouthpieces, handsets etc, or literature relating to early communications. Kevin VK2BKG QTHR
- Information on JVC colour video monitor type TM-22g. photo-copies of handbook or circuits only. John Toland.VK2XKX.02-6621-2933,e-mail:jtoland@nor.com.au 101 College Street Lismore 2480

WANTED QLD

- 6 metre all mode transceiver (IC560 or similar). Keying head for paper tape using Wheatstone code. Make-model-condition-price. Gwen VK4CB QTHR (07)32027137.

WANTED WA

- Watt-meter by BIRD, thru-line Model 43, forward & reflected power meter with plug-in modules for various power levels & HF, VHF, commercial, amateur & CB bands. Contact Darrell VK6KDC 08 9772 4443.Dazza@kariweb.com.au
- Assistance in programming a Philips PRP-15 hand-held transceiver. Any information on programming cable etc, or access to a facility, would be appreciated. Peter VK6ZEG 08 9291 8015 e-mail:budgie@cantech.net.au
- Power Supply 13.8volt DC @ 20 Amp from mains 240v AC. Contact Don VK6DP 08 9294 2388.
- For restoration of Kingsley AR7 receiver. Power Supply and Speaker or just the speaker panel would do. Also any coil boxes and an original manual, Contact Wayne - VK6FT on 08 9390 8241 e-mail:vk6ft@inf.net.au
- 420MHz UHF Pulse Amplifier unit as sold by the VHF Group a few years ago. Either the high power or low power version would be suitable. Complete units would be preferred but would also take just the cavity and conduction cooled tube module. Call Alek VK6APK 08 9246 3490 e-mail:vk6apk@eon.net.au

FOR SALE NSW

- TEKTRONIX Model 465B 100MHz Dual Trace CRO with dual timebases and dual triggers, delayed timebase manual good condition \$850 George VKL2KGG
- Swan 500Cwith power and handbook. \$400 or swap for Atlas. Jon VK2WF (02) 6775 1080.
- Tokyo High Power 144MHz Linear Amplifier. Model HL.180v. Brand new. Still in box. Never used. \$850. John VK2AYC (02) 95832056
- Deceased estate Ken Elkington VK2CBI. Yaesu FT101E Transceiver \$200. Various kits

made and unmade. 1 GHZ Freq Counter QRP Transmitter etc. The lot \$100. Various books. Mainly older versions of service and electronics - offers. Contact David VK2IX (02)47516124.

- Icom 725 HF tcvr barely used, service and owner manuals, serial 016116 \$650 ono VK2AGT QTHR (02) 9144 4532
- Antenna 15m 3 element monoband Yagi. Excellent condition \$125. John VK2DX (02) 4751 9795
- Motorola UHF CB syntx base/repeater station.channels 3\33.typeasc700\800. rack mounted unit,12 volt operation,clw microphone control unit and handbook. no antennas,no serial numbers,\$1000 ono.WICEN northern rivers region John Toland.VK2XKX.02-6621-2933,e-mail:jtoland@nor.com.au 101 College Street Lismore 2480
- Kenwood mc-80 desk mike excellent cond.in box \$120 ono.plus frieght e-mail swampy@bmr.com.au Grant VK2VB 02 49658658 QTHR

FOR SALE QLD

- Hy-gain Telex Yagi TH3MK3 Three Element 10-15-20 Metre, all stainless steel hardware, Hygain BN86 Balun, \$650. Kenwood 22amp DC Power Supply \$225. Realistic PRO 2022 Scanning Base Receiver, AC-DC \$100. Kenwood TS140S Transceiver as new \$850. Shure Preamplifier Base Microphone \$125. John Abbott QTHR VK4SKY 0417410503
- Kenwood TS-520S HF xcvr \$300. Paul 07 4778 6031
- Hallicrafters Transmitters HT-32 \$250, HT-37 \$150, Shure carbon mic SW-109 \$20, STC dynamic mic 4017 no stand \$50, RCA valves RC-22 1963 \$5, ARRL handbooks 1949, 1964, 1976 ea \$10 flyer Peter Hadgraft 17 Paxton Street Holland Park Q4121 ph (07) 3397 3751

FOR SALE SA

- Icom IC-W21A 2m/70cm Handheld S/No 1762 speaker mic battery charger mobile cradle cover manual \$395. QTHR John VK5WBJ 08 8277 0225
- YAESU FT 102, 240watt hf transceiver and the FC102 1500 watt antenna tuner, both in excellent condition \$700 for the pair. ph. 08-83966706 ah. 0419815479 BH

FOR SALE TAS

- Kenwood TS520S 160-10m t/ciever perfect condition 150w o/p. Books Boxes \$395. Yaesu FT900 svce manual new \$40. Yaesu CT20 base mic adaptor suit FT900 8 pin modular to 8 pin round, new \$20. Allen VK7AN 03 6327 1171(H), 0417 354 410, (Mob).

FOR SALE VIC

- YAESU FL2100B including 2 spare 572Bs in ex. cond \$720. SN 9K340227. ICOM IC-Q7A VHF UHF Transceiver and scanner from 30MHz to 1.3GHz Brand new still in box. NOT used. RRP \$340 SN 01587 \$285. 2M 14el Beam \$20. 2M RINGO from VK3BWW \$15. Harry QTHR Phone (03) 98025704.
- Philips FM828A OK Conv 2m \$40. Freq Meter Zenith BC221T WWII Era \$40. Linear amp. pr 813 400w 80/40/20 \$90. Keyer Iambic Type Aw. Inbuilt Mon And Paddles \$50. HD Power Transformers - No 1, Tapped Sec. 40-960V

.58A. Cont \$40. No 2, 435V Aside 0.58A Cont \$40. Merv VK3AFO (02) 60242537.

• **IC-PS15 Power Supply VGC \$250.** IC-SP3 External Speaker VGC \$40. Col VK3PJ QTHR (03) 56234926.

• **Transmitting Valves: Like 815, 4-250, 35T, 4307A, etc.** SAE For List. Sockets (2) for 4CX type tubes: Johnson 124-110 and one ceramic collar Eimac SK 62. All new \$160. Linear: Heath HA14. Full Power, 5 Bands. External A.Bles P/S. Manual. Good performer and condition. \$450. Mobile Whips: Yaesu 80,40,20.2. With gutter grip and cable. All in a plastic carry tube. Worked all states. Like new \$120. G. B. Lance VK3DS QTHR..

• **Yaesu FT101ZD DIG Display DC/DC conv WARC HF tcvr, matching desk mic FT101DM VFO FC902 WARC ATU all in original boxes Manuals 1 owner \$850 the lot.** Icom IC735 HF tcvr 0.6 - 30MHz LCD display \$850. Icom IC2GA 2m handheld plus mic \$175. Barry VK3KVB 0419 242 444 anytime.

• **ICOM IC - 735 with PS-15 power supply, mic. manual/G.C \$650.** Leader LTC - 908 transistor/diode tester and curve tracer as new \$120 Leader LDM - 815 GDO 1.5 - 250 MHz with LIM 870 antenna impedance meter \$120. Communication rx. ex Navy R -1051 made by Bendix 2 - 30 MHz digital tuning. AM/ , SSB, ISB, FSK capability. 115V ac . \$ 680. VK3IZ QTHR. Ph 03 51562053 Fax 03 51 562049 e mail : jupiter@net-tech.com.au

• **Going QRT Kenwood TS820S, VFO828, SP820.500kHz Filter Drake LoPass TVI Filter.MC50.MC35 Mics. \$300.00 Nally Tower 13M \$250 Buyer remove. Tailtwister Rotator all cables.\$250. Other bits and pieces Enquire.Usual conditions. Len VK3BYE QTHR 03 93591357 email leonpoyn@jeack.com.au**

• **Estate of the late Fred Uchtman VK3CFU YAESU FT 101E with 12volt supply & spare new & used tubes SN 280114 \$250.00. - YAESU FT 7 some extra xtals SN 08 0903 \$250. - Rotator HAM II CDE SN 11417 \$175. - ICOM IC-02A & ICBP4 pack SN 15694 \$110.00. - HI-GAIN TH3 antenna \$150. Geoff VK3ACZ Phone B/h:- (03) 5021 2666 or AH:- (03) 5022 0166 NOT QTHR**

FOR SALE WA

• **An RCA, AR88D receiver, in immaculate condition, both internally and externally. The receiver performance is as original specifications. Wish to SWAP for a Hammarlund SP-600 receiver, in close to similar condition. Sure would like to find a Hammarlund SP-600 ! Call John VK6XJ tele; 08 9295 3333. Fax; 08 9295 3535 E-mail: jtuppen@q-net.net.au**

• **BBC Model "B" Computer by ACORN, complete with monochrome monitor and 5 1/4" floppy drive. Fully optioned with Aries B20 screen memory, "Sideways" ROM extension card (12 ROMS fitted), including BBC Basic, VIEW word processor, PCB designer, COMMSTAR communications, DISK DOCTOR, TOOLKIT, Graphics and more. Comes with Manuals and several reference books including a main circuit board schematic. Also has TV Gen-lock board. This type of computer was used extensively by schools throughout WA. All items are in good condition. The lot for \$100 Phone: Don VK6HK 9446 2864. E-mail: patndon@cygnus.uwa.com.au**

• **Kenwood TM2550A 2metre FM, 50watt RF output transceiver. \$250 Kenwood SP430**

extension speaker, suit all Kenwood receivers. \$85 Hustler Mobile Antenna for bands from 80 through to 10 metres. \$125 Call Roy VK6XV 08 9246 3642 vk6xv@omen.net.au

• **Kenwood TS811A all mode U.H.F. transceiver. \$750 Kenwood TS680S H.F./6M all mode transceiver. \$750 Call Darrell VK6KDC 08 9772 4443. Dazza@kariweb.com.au**

• **Icom IC 706 Mk1, all mode transceiver, HF thru to 2 metres, good condition with original packaging and accessories. Price \$1275 Contact Bruce VK6CX phone 08 9310 4740 e-mail: williams@omen.net.au**

• **Two Pye "lily" microphones, as used on 1960's base stations. One green, ex Ranger series (I think) and one blue ex F60 series. Any interest to Peter VK6ZEG 08 9291 8015 e-mail: budgie@cantech.net.au**

• **KENWOOD TS450SAT H.F. Transceiver, all mode all bands. \$1000 Call Tim VK6EI 08 9337 5759 e-mail: timj@omen.net.au**

• **Yaesu FT101 H.F. transceiver plus FV101 External VFO. Complete with operator & service manuals for both units. \$120 ono. Call Rex VK6SN 08 9535 7992.**

FOR SALE BY TENDER

• **Yaesu FTDX400, may be operational, no guarantees at all. Unit weighs 40lbs. Freight to be paid by buyer. Mail tender to WIA PO Box 2175 Caulfield Junction Vic 3161. Mark back of envelope "Tender for Tranceiver". Tenders close 31st August 1999.**

MISCELLANEOUS

SUMMERLAND RADIO HAMFEST. GOONELLABAH, LISMORE. SUNDAY 29 AUGUST.

Radios. Computers. Electronics.
Refreshments. Commercial displays.
Trading tables. Disposals. Contact Carl
VK2XLT (02) 66243838. Email
sarc@nor.com.au.

TRADE ADS

• AMIDON FERROMAGNETIC CORES:

For all RF applications. Send business size SASE for data/price to RJ & US Imports, PO Box 431, Kiama NSW 2533 (no enquiries at office please ... 14 Boanyo Ave Kiama).

www.cyberelectric.net.au/~rjandusimports

Agencies at: Assoc TV Service, Hobart: Truscotts Electronic World, Melbourne and Mildura: Alpha Tango Products, Perth: Haven Electronics, Nowra.

• **WEATHER FAX programs for IBM XT/ATs *** "RADFAXZ" \$35.00, is a high resolution short-wave weather fax, Morse and RTTY receiving program. Suitable for CGA, EGA, VGA and Hercules cards (state which). Needs SSB HF radio and RADFAX decoder. *** "SATFAX" \$45.00, is a NOAA, Meteor and GMS weather satellite picture receiving program. Needs EGA or VGA & WEATHER FAX PC card, + 137 MHz Receiver. *** "MAXISAT" \$75.00 is similar to SATFAX but needs 2 MB of expanded memory (EMS 3.6 or 4.0) and 1024 x 768 SVGA card. All programs are on 5.25" or 3.5" disks (state which) plus documentation, add \$3.00 postage. ONLY from M. Delahunty, 42 Villers St, New Farm QLD 4005. Ph 07 358 2785.**

WIA Yearbook 2000

Where can you
Advertise all year
round for one low fee?

By advertising in the
Wireless Institute of Australia
2000 Callbook

Your Advertisement will be
seen by active amateurs
all year round.
As the Millennium Edition
it will no doubt be kept
by many hams for many
years longer than past issues.

Put your name on a
historical document!

For further details, rates &
bookings contact the
Advertising Manager

June Fox
on (03) 9528 5962
fax (03) 9523 8191
or by mail to...

Callbook 2000
c/o WIA Federal Office
PO Box 2175,
Caulfield Junction VIC 3121
armag@hotkey.net.au

WIA Division Directory

The WIA consists of seven autonomous State Divisions. Each member of the WIA is a member of a Division, usually in their residential State or Territory, and each Division looks after amateur radio affairs within its area.

Division	Address Officers	News Broadcasts	Note: All times are local. All frequencies MHz.	Fees
VK1 ACT Division GPO Box 600 Canberra ACT 2601	President Gilbert Hughes Secretary John Woolner Treasurer Les Davey	VK1GH VK1ET VK1LD	3.590, 146.950, 438.375, 438.325, 438.225 & 438.025 FM each Sunday from 8.00pm AEST. News text on packet BCAST@VK1BBS, http://www.vk1.wia.ampr.org & aus.radio.amateur.misc.newsgroup . Send items by packet as personal message BCAST@VK1BBS or e-mail to broadcast@vk1.wia.ampr.org .	(F) \$72.00 (G) (S) \$58.00 (X) \$44.00
VK2 NSW Division 109 Wigram St Parramatta NSW (PO Box 1066 Parramatta 2124) Phone 02 9689 2417 Freecall 1800 817 644 Fax 02 9633 1525	President Michael Corbin Secretary Eric Fossey Treasurer Eric Van De Weyer (Office hours Mon-Fri 11.00-14.00) Web: http://ozemail.com.au/~vk2wi/ e-mail: vk2wi@ozemail.com.au Packet BBS: VK2WI on 144.850 MHz	VK2YC VK2EFY VK2KUR	From VK2WI 1.845, 3.595, 7.146*, 10.125, 14.170, 24.950, 28.320, 29.120, 52.120, 52.525, 144.150, 147.000, 438.525, 1273.500 (* morning only) with relays to some of 18.120, 21.170, 581.750 ATV sound. Many country regions relay on 2 m or 70 cm repeaters. Sunday 1000 and 1930. Highlights included in VK2AWX Newcastle news, Monday 1930 on 3.593 plus 10 m, 2 m, 70 cm, 23 cm. The broadcast text is available on the Internet newsgroup aus.radio.amateur.misc , and on packet radio.	(F) \$69.00 (G) (S) \$56.00 (X) \$41.00
VK3 Victorian Division 40G Victory Boulevard Ashburton VIC 3147 Phone 03 9885 9261 Fax 03 9885 9298	President Jim Linton Secretary Barry Wilton Treasurer Rob Hailey (Office hours Tue & Thur 0830-1530) e-mail: vk3wi@rint.com.au Web: http://www.tsa.com.au/~wlaivc/	VK3PC VK3XV VK3NC	VK3BWI broadcasts on the 1st Sunday of the month, starts 10.30 am. Primary frequencies, 3.615 LSB, 7.085 LSB, and FM(R)s VK3RML 146.700, VK3RMM 147.250, VK3RWG 147.225, and 70 cm FM(R)s VK3ROU 438.225, and VK3RMU 438.075. Major news under call VK3WI on Victorian packet BBS and WIA VIC Web Site.	(F) \$75.00 (G) (S) \$61.00 (X) \$47.00
VK4 Queensland Division GPO Box 638 Brisbane QLD 4001 Phone 07 3221 9377	President Colin Gladstone Secretary Peter Harding Treasurer Allstair Elrick e-mail: secretary@wiaq.powerup.com.au Web: http://www.wiaq.powerup.com.au	VK4ACG VK4JPH VK4FTL	1.825 MHz SSB, 3.605 MHz SSB, 7.118 MHz SSB, 14.342 MHz SSB, 21.175 MHz, 28.400 MHz SSB, 29.220 MHz FM, 53.725 MHz FM, 147.000 MHz FM, 438.500 MHz (Brisbane only), and regional VHF/UHF repeaters at 0900 hrs EAST Sunday. Repeated on 3.605 MHz SSB & 147.000 MHz FM at 1930 hrs EAST Monday. Broadcast news in text form on packet under WIAQ@VKNET.	(F) \$74.00 (G) (S) \$60.00 (X) \$46.00
VK5 South Australian Division 34 West Thebarton Rd Thebarton SA 5031 (GPO Box 1234 Adelaide SA 5001) Phone 08 8352 3428 Fax 08 8264 0463	President Ian Hunt Secretary Merv Millar Treasurer Joe Burford Web: http://www.vk5wia.ampr.org/	VK5QX VK5MX VK5UJ	1827 kHz AM, 3.550 MHz LSB, 7.095 AM, 14.175 USB, 28.470 USB, 53.100 FM, 147.000 FM Adelaide, 146.700 FM Mid North, 146.800 FM Mildura, 146.825 FM Barossa Valley, 146.900 FM South East, 146.925 FM Central North, 147.825 FM Gawler, 438.425 FM Barossa Valley, 438.475 FM Adelaide North, ATV Ch 35 579.250 Adelaide. (NT) 3.555 USB, 7.065 USB, 10.125 USB, 146.700 FM, 0900 hrs Sunday, 3.585 MHz and 146.675 MHz FM Adelaide, 1930 hrs Monday.	(F) \$75.00 (G) (S) \$61.00 (X) \$47.00
VK6 West Australian Division PO Box 10 West Perth WA 6872 Phone 08 9351 8873	President Cliff Bastin Secretary Christine Bastin Treasurer Bruce Hedland-Thomas Web: http://www.faroc.com.au/~vk6wia/ e-mail: vk6wia@faroc.com.au	VK6LZ VK6ZLZ VK6OO	146.700 FM(R), 438.525 FM(R), 29.120 FM at 0930 and 1900 hrs Sundays from Perth, relayed (morning only) on 1.865, 3.564, 3.582 (Busselton), 7.075, 14.116 (North), 14.175 (East), 21.185, 50.150; (morning and evening) 146.900(R) Mt William (Bunbury), 147.00(R) Katanning, 147.200(R) Cataby, 147.250(R) Mt Saddleback (Boddington), and 147.350(R) Busselton; (evening only) 1.865, 3.564 MHz.	(F) \$62.00 (G) (S) \$50.00 (X) \$34.00
VK7 Tasmanian Division 24 Targett Street Scamander TAS 7250 Phone 03 6372 5305	President Ron Churcher Secretary Paul Godden Treasurer John Klop Web: http://www.wia.tasnet.net e-mail: vk7kpg@hamnet.hotnet.com.au	VK7RN VK7KPG VK7KCC	146.700 MHz FM (VK7RHT) at 0930 hrs Sunday relayed on 147.000 (VK7RAA), 146.725 (VK7RNE), 146.625 (VK7RMD), 3.570, 7.090, 14.130, 52.100, 144.150 (Hobart), repeated Tues 3.590 at 1930 hrs.	(F) \$74.00 (G) (S) \$60.00 (X) \$46.00
VK8 Northern Territory (part of the VK5 Division and relays broadcasts from VK5 as shown, received on 14 or 28 MHz).				

Membership Grades

Full (F) Pension (G) Needy (G) Student (S) Non receipt of AR (X)
Three-year membership available to (F) (G) (X) grades at fee x 3 times.

ADVERTISERS INDEX

Amateur Transceiver Radio	17	Editor.....	39
Andrews	10	Icom.....	OBC, 44
Av-Com	41	WIA Call Book	46,55
Dick Smith	IBC, 28,29		

TRADE PRACTICES ACT

It is impossible for us to ensure that the advertisements submitted for publication comply with the Trade Practices Act 1974. Therefore, advertisers and advertising agents will appreciate the absolute need for themselves to ensure that the provisions of the Act are strictly complied with.

VICTORIAN CONSUMER AFFAIRS ACT

All advertisers are advised that advertisements containing only a PO Box number as the address cannot be accepted without the addition of the business address of the box-holder or seller of the goods.

FT-847 EARTH STATION



Only one transceiver gives you all-mode operation on the HF, 6m, 2m, and 70cm bands with full satellite capability...

the new Yaesu FT-847 "Earth Station"

Ready for action on SSB, CW, AM, FM and Digital modes, the FT-847's compact size makes it ideal for a variety of portable/mobile applications as well as for serious base station operation. You get a solid 100W output on the HF and 6m bands, 50W output on both 2m and 70cm, dual fan cooling and a rugged diecast chassis. Plus, the ultra-quiet HEMT receive pre-amp on 2m and 70cm contributes to the FT-847's industry best sensitivity figures. Advanced Digital Signal Processing (DSP) circuitry enhances received signal/noise ratio for easier copy of signals under marginal conditions through the use of 16 selectable noise reduction algorithms, while the Bandpass and Auto-notch filters aid the IF based Shift and Noise Blanker circuits in reducing interference on crowded bands.

The FT-847 is ready for satellite operation, with crossband full duplex operation, normal and inverted VFO tracking of the satellite uplink/downlink, as well as 12 special satellite memories with alpha-numeric tags. Also provided is a low-noise Direct Digital Synthesiser (DDS) that provides tuning steps as small as 0.1Hz, plus there's an adjustable DSP bandpass filter as narrow as 25Hz for exceptional weak-signal CW performance. You can also install optional Collins® mechanical filters in both the transmit and receive chain for enhanced SSB operation, as well as a 500Hz Collins® filter in the receiver side for CW. An RF-style speech processor with adjustable frequency shift voice tailoring is also provided to add punch to your SSB transmissions.

The FT-847 is ready for data modes, with a rear panel Data In/Out socket and a Packet socket for 1200/9600 baud

VHF/UHF operation. Other features include extended receive operation (37-76, 108-174, and 420-512MHz), a high-speed computer control interface, 10-key keypad for band/frequency entry, and a Shuttle-Jog tuning ring for fast QSY. Also included are encode/decode CTCSS and DCS operation, selectable channelised steps for FM operation, FM narrow/wide modes for 29MHz use, and a large LCD screen with adjustable backlighting.

Each transceiver is supplied with a hand-mic, DC power lead and a comprehensive instruction manual. Call us for a copy of Yaesu's 6 page colour brochure to learn more about this incredible value "Earth Station" transceiver.

ID 3425

2 YEAR WARRANTY
YAESU **\$3250**

DICK SMITH
ELECTRONICS

That's where you go!

MORE

GREAT

GEAR

FROM

ICOM



PCR100 Cruise the air waves with your computer. Turns your PC into a high performance 0.5 - 1300 MHz receiver (FM/WFM/AM modes) with plug'n play installation. Multi function control panel, wide frequency coverage, and unlimited memory channels.

R2 Fit the world's airwaves in your shirt pocket. Just 8.6cm high, wide 0.5 -1300 MHz frequency range divided into 9 bands plus FM/WFM/AM, 400 memory channels, great sound in rugged water resistant construction.



2800H A totally new approach to dual band mobile. Powerful performance on 2m and 70cm bands, remote control capability, and a first for mobile rigs...a multi-function colour LCD screen! All your information is right in front of you in colourful 3D-like characters and icons.



T81A A remarkably compact quad bander. Superb clarity on the 6m, 2m, 70cms and 23cm bands. It's water resistant, with tone squelch and pocket beep functions standard, plus you can change volume and bands even quicker with the 'joy-stick' style multi-function switch.

706MKIIG The amazing evolution of the legendary 706. Frequency coverage is expanded to the 70 cm band and output power is increased for the 2m band. You get base station performance and features in a mobile rig-sized package.



ICOM
Clearly Ahead

2 YR WARRANTY

See your nearest Icom Dealer, call Icom on 1800 338 915, or visit our website at www.icom.net.au



SEPTEMBER 1999

Volume 67 No 9

Amateur Radio

Journal of the Wireless Institute of Australia



Full of the latest amateur radio news, information and technical articles, including...

- ★ Vern Kerr - Radio Pioneer
- ★ Amateur Television for JOTA
- ★ A Binaural DC Receiver
- ★ An Automatic Tracker - for tuned circuits.
- ★ VK5 Memories of Walter Burley Griffin Incinerator
- ★ LIPD Device Upsets Repeater

Plus *lots of other articles, news and special interest columns.*

IT'S Coming !

WIA Yearbook 2000

**Your 2000 Callbook
is on it's way !**

**This edition will contain all of the
content you have come to expect
of the WIA callbook as well as
some new items.**

**There are more pages and more
content than ever before !**

- ✓ Callsign Listings
 - ✓ Frequency Listings
 - ✓ Band Plans
 - ✓ Repeater Lists
 - ✓ Beacon Lists
 - ✓ Satellite Lists
 - ✓ Licensing Requirements
 - ✓ Examiner Lists
 - ✓ Special Interest Groups
 - ✓ Public Relations Notes
 - ✓ Radio and TV Freqs.
- and much, much more !

As the 2000 issue, it is sure to be a collectors item in the year that the WIA celebrates it's 90th birthday!

The name has changed to reflect the changes in the *"WIA Yearbook 2000"*.

**CLUBS - Take your orders now and
be ready to take advantage of bulk
order savings for affiliated clubs.**

It is more than a callbook,
it's a Yearbook, the WIA Yearbook!

But DON'T CALL YET

(expected to be released early in November)

**The "WIA Yearbook 2000" will be available from
Divisional Bookshops and selected outlets.**



Amateur Radio

Volume 67
Number 9
September 1999

The Journal of the Wireless
Institute of Australia
ISSN 0002-6859

Amateur Radio is published by the Wireless Institute of Australia ACN004 920 745 as its official Journal on the first Friday of each month

Editorial

Editor: Bill Rice* VK3ABP
Production Manager: Bob Harper VK4KNH
Snr Technical Editor: Peter Gibson* VK3AZL
Technical Editors: Evan Jarman* VK3ANI
Gil Sones* VK3AUI
Contributing Editors: Ron Fisher* VK3OM
Don Jackson* VK3DBB
WIA News Editor: David Thompson VK2NH

*Publications Committee member

Advertising

Mrs June Fox, WIA Federal Office
PO Box 2175 CAULFIELD JUNCTION VIC 3161
Tel: (03) 9528 5962 Fax (03) 9523 8191
email armag@hotkey.net.au

Hamads

"Hamads" Newsletters Unlimited
29 Tanner Street, Richmond VIC 3121
Fax: (03) 9428 4242
e-mail: newst@webtime.com.au

Amateur Radio Correspondence

All correspondence, contributions and queries about the **content** should be sent to:

The Editor *Amateur Radio*
PO Box 2175, CAULFIELD JUNCTION VIC 3161
email armag@hotkey.net.au
Tel: (03) 9528 5962 Fax (03) 9523 8191

Amateur Radio Delivery

All queries regarding delivery should be directed to:

Amateur Radio WIA Federal Office
PO Box 2175 Caulfield Junction Vic 3161
Tel: (03) 9528 5962 Fax (03) 9523 8191

Registered Office

10/229 Balaclava Road
Caulfield North VIC 3161
Tel: (03) 9528 5962 Fax (03) 9523 8191
Business hours: 9.30am-3pm weekdays

Editorial & Display Booking Deadlines

10th of each month prior to issue, or next business day

Hamad & Display Material Deadline

18th of each month prior to issue, or next business day

Production

Administration, Drafting, Design & Sub-editing
Shadetree Publishing & Imaging
PO Box 288 BEERWAH QLD 4519

Pre-press, print and mail management
Newsletters Unlimited (03) 9428 3458

Printed by Streamline Press, Melbourne (03) 9417 2766

Mailed by IMS, Melbourne (03) 9291 5888

Receipt of Amateur Radio by mail

Members who have not received their copy of AR by the 15th of each month should advise the registered office of the WIA

Copyright and Reproduction

The copyright in this magazine, except where specifically noted, is held by Wireless Institute of Australia ©WIA 1999. Permission to republish articles in any form must be obtained in writing from the Institute (other than for purposes of 'fair dealing'). This permission is usually freely given for information purposes.

General

Guglielmo Marconi, Pioneer of Radio	12
<i>translated by Ken Matchett VK3TL, from original by Wolf Harranth OE1WHC</i>	
Honour in Memory of Radio Pioneer — Vern Kerr	16
<i>R C Tulloch VK4BF</i>	
Amateur Television for JOTA	17
<i>Barry Cleworth VK5BQ</i>	
End of an Era	20
<i>Christine Taylor VK5CTY</i>	
Radio Star Alive and Kicking	23
<i>Mandy Smith</i>	
RTTY in VK Land	34
<i>Allan Doble VK3AMD reports Eric Ferguson VK3KF (SK)</i>	
Amateur Radio Questionnaire	48
<i>Bob Harper VK4KNH</i>	

Technical

A Binaural Direct-conversion Receiver	24
<i>Drew Diamond VK3XU</i>	
Technical Abstracts	31
<i>Gil Sones VK3AUI</i>	

Columns

Advertisers' Index	56	Intruder Watch	50
ALARA	10	Lost, stolen, strayed	2
AMSAT Australia	42	New Members	2
AR on the Web	37	Over to You	10
ARDF	44	Pounding Brass	49
Club News	9	Repeater Link	43
Contests	46	Silent Keys	50, 51, 55
WIA Division News		Spotlight on SWLing	51
VK1 Notes	1	Technical Correspondence	30
VK4 Notes	6	Try This	33
VK6 Notes	7	VHF/UHF - An Expanding World	38
VK7 Notes	8	WIA Comment	3
Editor's Comment	2	WIA News	3
Hamads	54	WIA Division Directory	56
HF Predictions	52	WIA Federal Directory	2

Our cover this month

Mrs Joy Kerr stands beside a fitting recognition of her husband,
Vern Kerr's contribution to the outback

Photographer not named

Contributions to Amateur Radio

Amateur Radio is a forum for WIA members' amateur radio experiments, experiences opinions and news. Manuscripts with drawings and or photos are always welcome and will be considered for publication. Articles on disc or email are especially welcome. The WIA cannot be responsible for loss or damage to any material. A pamphlet, How to write for Amateur Radio is available from the Federal Office on receipt of a stamped self-addressed envelope.

Back Issues

Back issues are available directly from the WIA Federal Office (until stocks are exhausted, at \$4.00 each (including postage within Australia) to members.

Photostat copies

When back issues are no longer available, photocopies of articles are available to members at \$2.50 each (plus an additional \$2 for each additional issue in which the article appears).

Disclaimer

The opinions expressed in this publication do not necessarily reflect the official view of the WIA and the WIA cannot be held responsible for incorrect information published.

EDITORS COMMENT

Jottings

I have always been rather envious of people such as the celebrated Wayne Green of "73 Magazine" fame who, in their heyday, were able to write editorials that went on for page after page with topics by the dozen!

There are people who would prefer that I did not write an editorial, or if it must be, that it should be nearer the back page rather than page 2.

These people may get their way, experimentally at least, quite soon. That is if a new editor for this magazine can be found. See the advertisement on page 39 of the August issue. To be fair, the "editorial at the back" school really want a re-arrangement to put technical articles nearer the front, and this may happen soon.

Meanwhile, I shall continue my jottings! (This is editorial number 162!)

What are jottings? They derive their name from the smallest letter in the Hebrew alphabet. (jot, also spelt jod) The phrase "jot or tittle" means something vanishingly small (but still perhaps worthy of being "jotted down"). So we might define jottings as tiny trivialities!

Before I go, I must comment on the trivia item (labelled "Snippets") on page 5 of the August issue. At least ten of the names have been mis-spelt. This was not deliberate; the item was a last-minute filler, editorially unseen. Why not "have a go" at answering the questions as invited, and we will publish the list, correctly spelt with answers in the October issue.

Bill Rice VK3ABP Editor

NEW WIA MEMBERS

The WIA bids a warm welcome to the following new members who were entered into the WIA Membership Register during the month of July

L21092	MR J L BUTCHER	VK3DSA	MR D CRAVEN
L31549	MR M HARDY	VK3FJS	MR J W H SCHULTZE
VK1BUD	MR T O RYMES	VK3FLC	MR P R BEECHEY
VK1FS	MR C HASTIR	VK3GLX	MR H JOHNSON
VK1XAI	MR J B HERRMANN	VK3JNO	MR C LADIGES
VK2AJY	MR J JEFFERY	VK7HGO	MR G P O'SHEA
VK2AM	MR A R MCLEAN	VK8CE	MR W ELDER
VK2GPB	MR P R DERBYSHIRE	VK8MS	MR M G SELLERS
VK3BYY	MR J M HARRISON		

Lost, stolen or strayed

Alan (VK6CQ) here.

Unfortunately my brand new Yaesu FT - 100 was ripped out of my car in Adelaide during my drive over to Tasmania.

Real mess of the car door & under the seat (where it was bolted) was made to get it out.

Serial Nr 9F0 420 36 (9F0 420 36).

Not much use to anyone else minus the manual & connecting cables, but I guess the idiot who took it thought it was a CB or CD player.

Could you put it in the stolen equipment register You never know, it may show up in a Cash Convertors sometime.

It was going to have been used on Macquarie Island (I've been issued with VK0LD)

Amateur Radio Service

A radiocommunication service for the purpose of self-training, intercommunication and technical investigation carried out by amateurs; that is, by duly authorised persons interested in radio technique solely with a personal aim and without pecuniary interest.

Wireless Institute of Australia

The world's first and oldest
National Radio Society
Founded 1910

Representing
The Australian Amateur Radio Service
Member of the
International Amateur Radio Union

Registered Federal Office of the WIA
10/229 Balaclava Road
Caulfield North Vic 3161
Tel: (03) 9528 5962 Fax (03) 9523 8191
<http://www.wia.org.au>

All mail to
PO Box 2175 Caulfield Junction VIC 3161

Business hours: 9.30am-3pm weekdays

Acting Federal Secretary

Peter Naish VK2BPN

Federal Office staff

June Fox Bookkeeper
Rita Trebilco VK3IF Examinations Officer

Council

President	Peter Naish	VK2BPN
VK1 Federal Councillor	Glenn Dunstan	VK1XX
VK2 Federal Councillor	Michael Corbin	VK2YC
VK3 Federal Councillor	Brenda Edmonds	VK3KT
VK4 Federal Councillor	Ross Marren	VK4AMJ
VK5 Federal Councillor	David Box	VK5OV
VK6 Federal Councillor	Will McGhie	VK6UU
VK7 Federal Councillor	Phil Corby	VK7ZAX

Executive

Peter Naish VK2BPN
Tony Farrow VK2TJF
John Loftus VK4EMM
Wally Howse VK6KZ

Federal Coordinators

AMSAT	Graham Ratcliff	VK5AGR
ARDF	Jack Bramham	VK3WWW
Awards	John Kelleher	VK3DP
Contests	Ian Godsail	VK3DID
Education	Brenda Edmonds	VK3KT
FTAC	John Martin	VK3KWA
Historian	John Edmonds	VK3AFU
IARU	Grant Willis	VK5ZWI
Intruder Watch	Gordon Loveday	VK4KAL
ITU Conference and study group	David Wardlaw	VK3ADW
Public Relations	David Thompson	VK2NH
QSL Manager (VKs, VKs)	Nell Penfold	VK6NE
Videotapes	Don Bland	VK4TVD

ACA Liaison Team

Peter Naish VK2BPN
Glenn Dunstan VK1XX
Michael Corbin VK2YC
Wally Howse VK6KZ
Canberra Liaison Officer
Richard Jenkins VK1RJ



Comment

**Federal President, Peter Naish
VK2BPN.**

FROM THE PRESIDENT I do not wish to enter into the debate as to whether or not January 1st, 2000 is the beginning of a new century but I do intend to highlight the fact that next year is a very special one for Australian radio amateurs. There are a number of important events scheduled for 2000 which the WIA is actively involved in or has a significant interest in the outcome.

Of course, everybody knows that the Olympic Games will be held in Sydney in 2000. There will be huge numbers of visitors to Australia and these will certainly include many amateur radio enthusiasts from overseas countries. The ACA has told us that they are prepared should there be a large demand for temporary visitors operating licences. We have offered our services to the ACA should they need assistance with this task. In any case we may expect to hear many of these visitors sharing our bands with us.

In addition, the NSW Division of the WIA will be operating special Olympic Stations with appropriate call-signs to assist radio amateurs visiting the Olympics and to celebrate this great event. The WIA will be a practical supporter of the Games and ensure that any of its facilities or services as may be needed is provided within the Spirit of the 2000 Games.

In August 2000 the WIA will be hosting the IARU Region 3 convention in Darwin. This is a major activity and includes policy debates on many important agenda items for forthcoming WRC meetings. Preparing for the Darwin convention will occupy a lot of time for our specialist coordinators and delegates. You will find elsewhere in this month's "AR" an update on the work that is currently taking place. There will be further regular reports to keep you abreast of progress and how you can be involved.

The WIA Call Book for 2000 will be a bumper edition, worthy of this special year. Indeed, we hope it will be a collector's item that will continue to be useful well into the new century (whenever that starts!). This will become available for purchase in the months ahead and will contain details of lots of things that you need to know about amateur radio in Australia.

In 2000 the WIA intends to continue its vigorous pursuit of a number of high priority initiatives which seek to rationalise and improve our operating privileges. Many of these are interwoven with our international activities because what happens overseas will surely determine how Australia reacts. Last month you will have read in "AR" a report on varied issues currently on the ACA Liaison Committee agenda.

We have less than four months to go before 2000 dawns. Just another year maybe, but let's work together to make it a memorable year, one in which we can feel proud to be associated with amateur radio. As I always say, this is your WIA, let's all make it work the way it should.

Peter Naish, VK2BPN WIA Federal President

WIA NEWS

ACA says "Use it or Lose it" —Investigation into radio licence hoarding

Relax... they're not talking about Amateur Radio — yet. The Australian Communications Authority (ACA) recently released a discussion paper outlining options to address the alleged hoarding of low power open narrowcasting (LPON) radio licences.

Options outlined in the paper include the possibility of applying a 'use it or lose it' condition to licences, increasing LPON licence fees, or issuing an LPON class licence.

There are currently more than 1500 LPON licences on issue, but more than half of these are not being used to provide a radio service. There is a view in the community that many of these licences are being stockpiled, possibly with a view to later sale.

LPON services provide a wide range of program formats on FM radio* to limited reception areas, (usually 2km radius in urban areas). In most areas, only three broadcasting frequencies at 87.6, 87.8 and 88 MHz (FM radio) are available to potential licensees. Typical LPON formats include tourist or racing information, community news or niche music programming.

The ACA is concerned that communities or groups with limited resources are being denied the use of radio broadcasting frequencies, thus being prevented from producing and distributing their own radio services.

While this issue does not directly concern Amateur Radio, it's interesting to note that the ACA's interest goes beyond the licence fees collected. We can only wonder if and when they'll turn their attention to the how well we Amateurs are using our allocations.

The ACA's discussion paper can be found at <http://www.aca.gov.au/issues/discussion/hoarding.htm>. Deadline for comments was 20 August (unfortunately the media release appeared after the deadline for the previous issue of this magazine.)

A summary of comments received will be made available on the ACA Website.

From Media Release No. 45 of 1999 - 22 July 1999 (www.aca.gov.au/media/45-99.htm)

New Email Service for Australian Hams

A new, FREE, web-based email service, for Australian Amateurs has been created. Hams can now get their own email address (or update their old one) to callsign@ausham.zzn.com. This service is provided by 14-year-old Daniel Bartlett, VK4HDB, who hopes to make this a service that all Australian Amateurs will utilise. The website is available at <http://ausham.zzn.com> and enquiries may be forwarded to webmaster@ausham.zzn.com

Special Event Station VK2000

The New South Wales Division of the WIA will be operating Special Event Station VK2000 next year, to commemorate the Sydney 2000 Olympic and Paralympic Games. The Division also hopes to have the use of the special event callsign AX2000 during the four weeks of the games.

Another mailing list has been established for announcements about Amateur Radio and the Games; to subscribe, send a blank email to vk2000-subscribe@onelist.com

American Amateurs to play key Y2K role

Amateurs in the Radio Amateur Civilian Emergency Service (RACES) will be standing by to assist in the event of any communication breakdowns when the clocks tick over to 1st January 2000.

Although emergency officials say the likelihood of widespread phone or computer outages is minimal, they have asked RACES volunteers to help out. That means some ham radio operators in New Jersey will be ringing in the New Year at police departments, hospitals, nursing homes and county communications centres.

Emergency workers will be holding a series of emergency drills, using various Y2K scenarios and ham operators, across the state in the next several months.

"You could have everything from a big nothing to a disaster," said Bill Peterson, a RACES member in Morris County. "If it's disaster, we'll be ready to communicate that there is a problem. "But one thing we can't do," he said, with a nervous chuckle, "is to solve the problem." Most other counties will have ham operators on standby, ready to use their wireless equipment to report any phone outages or other utility disruptions.

"We think we're got everything under control, but you can never be too safe," said Morris County Administrator James Rosenberg. "There is some concern that at 12:01 a.m., we could all be sitting there and think everything's great because we're not getting calls of complaint. But maybe that's because the phone system's not working. So we want to be prepared."

"Communications have come a long way, but just in case of problems, we can fall back on ham radio," said Kerry McGuinness, a spokeswoman for GPU Energy.

RACES developed during World War II, when the military took over all amateur radio frequencies for use in military applications. But the FCC provided some small groups of frequencies for emergency situations, to be accessed by specially licensed ham operators. They became the first members of what is now known as RACES, which has about 2,000 members in New Jersey.

Bob Schroeder, communications officer for the state Office of Emergency Management, said it was logical to turn to ham operators, who have filled the breach in previous disasters. "They work for free, they are available and they are very resourceful," he said.

(from New Jersey Star-Ledger <http://www.nj.com/jersey/ledger/c0f57e.html>)

Sounds of Amateur Radio

The VK2FLR VHF DX sound archive is now operating again. Mike Farrell VK2FLR say he has added new material, including samples from last year's Leonids meteor shower.

The archive can be accessed on Internet at <http://www.minecost.com/hamstuff/>
From Mike Farrell VK2FLR on the VK-VHF list

IARU - World Amateur Radio Day

The International Amateur Radio Union's World Amateur Radio Day takes place on the 18th of September. This year's event celebrates Amateur Digital Communication. From next year the event will shift to the 18th of April, the founding day of the IARU.

Get Lost

British Aerospace has developed a new "personal locator beacon" for the Royal Australian Air Force. The beacon, named "Warrendi" after an aboriginal word meaning "to look for", employs satellite technology, and is intended for use in search & rescue operations with downed pilots.

from What's New in Radio Communications, June/July 1999

New Digital TV Standards

Standards Australia has released draft standards DR99047 and DR99095, which cover the technical requirements for terrestrial digital TV transmitters and receivers. DTV transmissions are due to commence in January 2001.

The drafts were prepared jointly by the Australian Broadcasting Authority and the broadcast television industry. They are based on the European digital video broadcasting (DVB) standards, adapted for Australian conditions.

from What's New in Radio Communications, June/July 1999

A recent addition to the WIA Federal web site is the Current Issues section, where you can download submissions made by the WIA on your behalf on various issues of importance. A quick precis follows:

Overseas Visitors to Australia and Reciprocal Licences

The WIA has proposed that Australia adopt the CEPT licensing arrangements currently in use throughout Europe and the United States. European Conference of Postal and Telecommunications Administrations (CEPT) Recommendation T/R 61-01 allows Amateurs to operate in other participating countries without having to obtain a special visitor's licence.

Implementing CEPT T/R 61-01 would ease the ACA's administrative burden during the Sydney Olympics, when a large number of overseas Amateurs are expected to arrive in Australia. At the same time, Australian Amateurs could operate in CEPT-participating countries.

Spectrum Arrangements for the Amateur 80 Metre DX Window

The WIA recently responded to an ACA options paper pertaining to the 80-metre band "DX window". The options presented by the ACA were:

- * to maintain the status quo
- * to maintain the status quo, but to make Amateurs primary in the sub-band
- * to extend the DX window by 18 kHz, with the WIA paying the cost of frequency changes and the loss of 18 kHz below 3700 kHz.

The WIA would welcome primary status in the DX window, but still seeks an extension of the sub-band and rejected surrendering other parts of the 80m band. Pointing out that allocations to other users in this band have reduced by half since 1995, and that radiocommunication licences do not guarantee tenure, the suggested payment of costs of other users' frequency changes was also rejected.

Allocation of an LF Band to the Amateur Service

The WIA has again presented a submission to the ACA, for the creation of a new Low Frequency allocation between 165 and 197 kHz. When the submission was first presented in 1993, it was rejected as there was no Amateur allocation existing in the ITU's allocation tables. Since then, 13 countries have authorised LF Amateur allocations, so now the ACA would be setting no precedents in accepting the proposal.

In Region III, 160 to 190 kHz is allocated to Fixed Service (primary) and Aeronautical Radionavigation (secondary), which is primary between 190 and 200 kHz. In Australia, 160 to 190 is allocated to Aeronautical Radionavigation, but the band is not used for this purpose.

Both New Zealand and Papua New Guinea permit Amateur operations between 165 and 190 kHz. In Australia, the existing activity in these bands seem to be Amateurs operating experimental stations on 177.5 and 196 kHz.

The WIA has proposed a 15kHz wide allocation, preferably 175 to 190 kHz, allowing narrowband modes, including digital signal processing modes but excluding FM. Existing Amateur power limits should apply and the band be available to all licence grades except Novices.

Promoting the hobby

Richard Murnane VK2SKY
 PO Box 1247, North Sydney NSW 2059
 pr@wia.org.au

When you have visitors in your shack, or when you demonstrate Amateur Radio to others (for example during JOTA or community events), do you give them something to take away, to encourage them to take up the hobby? If not, well, pretty soon you will.

Richard VK2SKY is working on a booklet about Amateur Radio, which you will be able to download from the WIA Federal web site, to print out and give to those you think might be interested in becoming Radio Amateurs. The booklet will give a brief introduction to many aspects of the hobby, and guide them to your local radio club (and hopefully the WIA!) Hopefully, this will become a valuable tool in promoting the hobby and gaining new members for your radio club.

But for this to become reality, Richard needs YOUR help. Can you write a small piece about a particular aspect of Amateur Radio that you enjoy, be it DXing, foxhunting, emergency communications, QRP, satellites, or any other aspect of the hobby? Could you even write a short piece about what you enjoy about Amateur Radio?

Even as little as 50 words along the lines of "I like Amateur Radio because..." would be useful, but if you can write a bit more,

say 100-200 words on a particular topic, that would be even better. The items do not need to be technical, only to get across the idea that Amateur Radio is fun!

The aim is to make the booklet about eight A4 pages long, so it would be easy to produce as a handout for newcomers. Richard will do all of the layout and design, and will make the booklet available in Adobe Portable Document Format, so all you will need is the free Adobe Acrobat reader to print it out on your computer.

Richard can't do all the work by himself (for a start, he doesn't engage in every single aspect of the hobby!), so the more who contribute just a little bit, the better the result will be for all Amateurs, clubs, and maybe your WIA too.

You can contact Richard by email to pr@wia.org.au, or by post to PO Box 1247, North Sydney NSW 2059.

Remember that many hands make light work, so please put pen to paper (or fingers to keyboard) and see what you can come up with! Don't worry if you're "not good at writing", as Richard can tidy up your words. The important thing is to "be in it!"

WIANews
 Richard Murnane VK2SKY

I'm in Ham Radio because I love it!

Next time someone asks you what they get by being a member of the WIA, ask them to consider the following from Ian VK5XE, which appeared on packet and some Divisional broadcasts recently:

Ian says, "Well I've been a member since about 1978. Can't remember really. However I first joined the WIA when studying for the novice licence. I had a TS520 to listen to the ham bands and for practice CW. It was recommended I join the Institute by a local ham who was helping me to study.

Finally got my licence in 1980, VK5NOT. I found the QSL bureau the most useful tool at WIA and got Amateur Radio Magazine. Not being a techno weeni most of the articles in AR seemed heavy going, but probably very useful to someone building this and that. These articles were written by volunteers, people who had had some success with a project and decided to share that knowledge with everyone else.

You may have noticed "volunteers"? Yes, our WIA is made up of many volunteers. For the doom and gloom "knockers" I wonder if YOU have ever volunteered, only to have someone knock your efforts!

As for the membership price structure, well I guess some OTHER volunteers tried to work out the fairest way to charge its members.

Next came the novice 2 metre privileges. Well a whole new world of radio for me, thanks to the WIA.

BUT to talk further away from my area I needed a repeater! Guess what?

The repeaters in my area were all built and maintained by volunteers and the licence fees all paid for by WIA. They probably even used a percentage of MY membership! [How dare they?]

So what next can I do about that? Go to a few working bees at the local repeater site. Not the tech stuff but cut the grass around the tower, paint anything standing still, climb the tower, lots of things as you can imagine.

So after 13 years as VK5NOT and a wonderful time on air meeting lots of FB folk I decided to TRY for my full call.

Where do I go?

To the WIA Publication Officer.. "got any books I can read to do my AOCP?"

Yet another "volunteer".

Read all the books. It sinks in first try [like hell].

I listen to the SLOW MORSE net and guess what, this mob have a different volunteer every night of the week. Amazing!

So, I'm all schooled up on the theory and

able to copy CW OK at 15wpm. Off to the WIA Examination officer to do the TEST. What a patient volunteer this WIA bloke is.

So here I am today enjoying the packet radio network, you guessed it, MORE volunteers.

I hope you all get what I'm on about. Not the politics that might go on. It's in every organisation unfortunately. If you stop and think what you're getting for the money I think its a "fair deal"!

Ever tried to join a golf club, or sporting club of any kind?

What else can I say? I'm in the WIA hoping that I'm represented at Government level by somebody in the organisation. It is only weight of numbers (voters) that affect change in government planning.

I'm in WIA to help out where I can at grass roots level and enjoy the fellowship of others who do the same.

I'm in HAM RADIO because I love the hobby, always curious to see who might be on air next, enjoy a CW QSO every once in awhile and most of all say hi to the fine folk I've met and hope to meet in the future.

Whether YOU decide to join WIA is your choice. I hope if you hear me on air you might like to say G'day... as I would."

Ian's words highlight the importance, not just of being a WIA member, but of being an active member. What could you do to improve the WIA?

(Don't just read this -show it around to non-members.)



Divisional News

Communications are two operators who have prime frequencies in the band under consideration. So there is some progress in this matter after all the waiting.

Col also presented an opportunity to promote AR in conjunction with the Brisbane City Council GOLD program. GOLD is a program initiated by BCC and involves promotion and public relations for the activities of the 55+ age group. GOLD is "Growing Old, Living Dangerously". We will be looking forward to presenting Amateur Radio in the next round of activities scheduled for early February 2000.

Fun Day 2000

VK4BBS, Brian reported a date for the Fun Day could not be set yet, as the date for Gosford Field Day was still not determined. It was decided to try to keep it as last year, to the weekend PRIOR to Gosford.

Coastal Ducting goes Atomic?

Friday evening July 16th Gavin/VK4ZZ was going about his sysop duties when he managed a glance at the BBS screen and saw VK4RCA Mt Bellenden Ker packets direct. Being a lad to have a go, he did just that and connected direct to VK4RCA by just using a j-pole and 20 watts! (That's about 300km with nothing fancy!). Realising that there was a mother of all temperature inversions just above him, Gavin then tuned in the Mt Bellenden Ker voice repeater and sure enough, there was Jeckel/VK4JKL and Joe/VK4VDX having talks. He listened in and at about 23:30 local time when the signals were full strength, tried to get into RCA voice. He was successful and talked to Jeckel and Joe until about midnight when the inversion dropped out. There has also been good temp inversion ducting from Mt Stuart to Bowen during the last week or so. Who would have thought that you would get temp inversion ducting in the winter? Only in the tropics...

TARC - WICEN

This Magnetic Island to Townsville Swim Event Report was submitted by Les, VK4ALS.

WICEN operators had a very good weekend, starting with the Civil Reception held at the Council Chambers on Saturday. Sunday morning came around with a few things happening that would test the ingenuity of the WICEN operators. Don/VK4MC had to navigate through a nasty road accident. Dave/VK4FUY had to dash around the bay to replace a battery and everyone involved had to cope with a change of plans, when it was discovered that they would have to board the tow boats BEFORE going to get the swimmer cages!

The venue for the course is likely to be a room at the Griffin Centre, Civic, Canberra City. Course cost will be modest and affordable. Three subjects will be taught: Electronics and Regulations, with the option of Morse code sending and receiving. The starting date of the course will be announced as soon as I find someone suitable to teach the subject of 'Electronics for the Novice Amateur' and Morse. Text for the course will be "The Novice Operators Theory Handbook", by Graeme Scott, VK2KE. We will obtain these in bulk to save cost. Anyone who is interested in teaching the subject(s), or attending the course as a student should contact either myself by phone on (02) 6231790, fax 6296 5712, email pkloppen@dynamite.com.au or the President, Gilbert Hughes on (02) 6254 3266, email ghughes@dynamite.com.au. Announcements regarding start date and class hours will be put on the Sunday broadcasts, Packet, and sent by letter to those who have given their details to me or Gilbert.

The next general meeting will be held at Room 1, Griffin Centre, Civic, Canberra City, on 27 September 1999. Cheers to all.

VK4 Notes

QNews

By Alistair Elrick VK4FTL
WIAQ Councillor and QTC Editor

The July WIAQ Council Meeting saw the Councillors meet at the home QTH of VK4BBS, Brian. A report from Federal President Peter Naish was read. This contained among other things, an ACA options paper regarding the 80 metre DX window, a paper on LF band proposals and on Reciprocal Licences for the duration of the Olympic Games.

VK4 President Col VK4ACG commented on the possible extension to the 80-metre section based on either, the removal of or cooperation with, the current operators. Most contacted so far are amenable, as commercial frequencies are generally not used at night. In VK4 the Dept. of Primary Industries and Kyle

VK1 Notes

Forward Bias

Peter Kloppenburg VK1CPK

The guest speaker at the July general meeting was Tex Ihasz, VK1TX. Tex made a trip half way around the world recently to pursue his interest in amateur radio and to visit friends. He spoke about his visit to the Dayton Hamvention in Ohio, USA, (<http://www.hamvention.org>) which was being held over a period of three days, the people and fellow amateurs he met there, and his visit to the United Kingdom and Russia. His talk was backed up with photographs, magazines and catalogues, and souvenirs. Tex gave an interesting account of what he saw and did at Dayton. Most amazing was the size of the convention area. As big as the show ground in Sydney! With numerous stands from amateur equipment manufacturers, and endless rows of stands with trash & treasure; second-hand gear and antennas of all kinds, it was a sight to be seen.

Many amateurs in the US know Tex as an avid DX operator and from the 20-metre net that he runs. When they heard of his impending visit, many invitations came his way. A notice board covered with photos of his hosts showed where Tex had been and whom he had met. While in Moscow, Tex observed that many amateurs live on the top floor of apartment buildings, with their antennas situated right above them on the roof among the TV antennas of their neighbours.

A radio amateur who is probably well known to some of you, and who has been absent for a number of years, has returned to the ACT. His name is Olaf Moon, VK1MOJ. Much of his time is spent participating in contests and he is keen to meet local amateurs with a similar interest in amateur radio.

Novice Licences

The executive of the VK1 Division has decided to set up a Novice Licence course. An "Education" position has been created on the committee, which is filled by myself.

Les/VK4ALS and Ian/VK4ZT set up the WICEN repeater on a hill just behind the old Customs House and the repeater was very happy there, operating faultlessly until deactivated about 2pm in the afternoon. Thankfully there were no incidents and the fastest swimmer made it across the line on about 1hr 30mins whilst the oldest competitor broke the 2hr barrier with a 1hr 58min effort!

To Les/VK4ALS, Ian/VK4ZT, Steve/VK4JUS, Peter/VK4PVH, Don/VK4MC, Dave/VK4FUY, Pat/VK4MUY, Alan/VK4PS, Ken/VK4HAI, Bob/VK4WJ, John/VK4MAV, Iain/VK4IGM, Sheila Morrison and Gavin/VK4ZZ, many thanks for providing the equipment and operational skills that made this communications support event a very successful one!

The swim organisers are hinting that next years swim program will be very prolific, being the Olympic year, and that with a vastly expanded event program they will probably need more WICEN participation. So there you go... advance warning for a hectic calendar in 2000.

Intruder Watching

VK4XT Mike reporting in Dalby clubs "Mini News" talks of having audio recordings of intruders on the 146.675 Club repeater. The 2 or 3 intruders were conducting comparison tests with that repeater and a local UHF CB repeater. One was mobile and travelled from Memerambi to Kumbia in order to check out the coverage they could get. They were using the calls 130 and 920. Later heard as 130 and 192, also as Steve and Bill.

They were challenged by a couple of amateurs but simply said something along the lines of "you don't own the airwaves".

The club decided against turning the repeater off in order to get more info on their possible QTH. Try listening to the repeater to identify the voices of these people. Listen to the input frequency of the repeater (146.075) when the intruders are active in order to see what area they are actually operating from. Best of all use a small directional antenna to get a bearing on them, especially if they operate from a fixed location.

73's from Alistair

VK6 Notes

Chris VK6BIK
(chrismor@avon.net.au)

WIA Membership is Fun!

I have been giving some further thought to the problem of low WIA membership with respect to the overall number of registered amateurs and SWL's in the country. The subject is quite topical at present. It has to be said that it is obviously just not right that

a minority of amateurs is being left to carry the cost of keeping amateur radio alive in Australia. I believe that most amateurs, regardless of how they feel about the way the WIA is presently structured, or the way the work of the WIA is carried out, would agree with me.

Somebody has to pay for our capability to represent our mutual interests and ourselves. Otherwise there is just a black hole followed undoubtedly by rapid and severe erosion of our unique privileges. I cannot believe that the vast majority of amateurs are harbouring grudges against the WIA, nor do I believe that we are selfish or mean as a group. Therefore the answers must lie elsewhere. The more of us that put our minds to this vexing problem, the sooner we should get to the solution(s).

For what it is worth, this is what I think;

- (1) It is apparent that the majority of hams, having risen to the challenge of passing the exams and experienced the early excitement of installing equipment, antennas etc, and then enjoyed the novelty of unfettered operating, have now simply become inactive as early interest wanes, and other activities and pressures compete for available time. As a natural consequence WIA membership lapses and is not renewed. Licences, on the other hand, are renewed "just in case"! I suspect the majority of amateurs fall into this category. It seems to me that if we can help these "silent amateurs" re-kindle their initial interest, which would have been substantial, then half the battle is won. One of the ways we can do this, is to focus on the "fun" aspect of the hobby —to me that means simple, and practically useful, construction projects, antennas (and more antennas), more WIA sponsored activities of all sorts, and many more "operating" articles/columns (ie, DXing, rag-chewing nets, award hunting, contesting, field days, satellites, weak signal work, etc). Of course, the WIA's magazine already does this (and very well too) with several columns of this type, (eg VHF/UHF – An Expanding World), but we are preaching to the converted. I think the trick is to get the other (commercial) magazine (s) to do more of the same, or we put our own AR on the stands occasionally (a composited quarterly perhaps?). Somehow we need to reach a wider audience. The non-operators need to see what they are missing.
- (2) Once membership has lapsed (for whatever reason), it can be for many, a bit of a hassle to renew. Many of us

just don't like the act of paying bills! If a renewal notice is received well out of sync with the licence renewal notice (say 6 months later), an inactive amateur will question the worth of continued membership. On the other hand, if the renewal notices could be received together, they could also be paid together, how much simpler is this? In some European countries, membership of the representative body is compulsory, and fees are collected by the licensing agency. I am not advocating this here (although I would love to), but surely the Australian authority also understands and sympathises with the need for a strong representative group with which they can do business? Can they be persuaded to solicit renewals on our behalf, perhaps with a percentage of the fee as payment / compensation? Second best choice, can we slip our own renewal notices into their licence renewal envelopes? We could share some of the mailing costs. The economics of this should be good for them and for us (economies of scale?).

Beacon Update

Well the Augusta project proceeds slowly. The main holdup is the negotiation of a site - as always. The current position is that an approach has been made to a commercial operator by phone and the result was reasonable cause for optimism. This has been followed up with a letter (about 3 weeks ago) and a reply is awaited.

The beacon hardware is largely ready to go, with Tx's for 144, 432 and 1296 MHz. Antennas are nearly complete. Naturally advice of site availability would trigger much activity to do the finishing touches.

The purpose of the beacons at Augusta is to provide a propagation indicator both eastwards across the well-known Bight path and northwards towards Perth and beyond, where there is likely to be extended ducting as well. (Thanks Don VK6HK)

VHF activity

The VHF Group recently held a "Winter Sprint" contest, run over 1 hour, shortly after the weekly broadcast. Those who didn't participate are "square" —it was tremendous fun and you lost out big-time! I took the Elderly Irish Gentleman (Conn VK6PM) with me and we operated portable up one of the many high hills around Toodyay. Talk about the Laurel and Hardy show!

We arrived at our (yet to be) chosen location "on time", but forgot that it takes a bit of time (that stuff you can't stretch) to set up a portable station, and the contest was

nearly half way through by the time we got properly under way on all bands. Of an impressive array of 5 VHF antennas that we brought along, we could only get one working, one which I would hesitate to call an antenna, made (ie. bent straight and cut) from one of Conn's surplus coat hangers pushed through a hole drilled into his car's roof-rack. Nevertheless, we had great fun working simplex into Perth, Greenhills, and elsewhere, on 2m, 6m (1/2 wave vertical), and tried also on 70 cm. I don't know who won the contest, we didn't for sure, but at least we supplied a new square to a few and learnt a lot about the (poor) state of our equipment.

2m SSB

For those keen to test their 2m-sideband capabilities, there is a daily sked involving stations in the South and SW of WA. Your best chance of a 2M SSB contact is weekday mornings between 7.15am & 7.45am Perth time. A group of operators can be found on 144.120MHz.

At 7.15am, everybody tries to make contact with VK6AS in Esperance.

At 7.30am, everyone then works VK6WG in Albany and

At 7.45am, a call is then made for VK6XLR in Geraldton (this one is temporarily in abeyance)

Liaison frequency is on 40M, 7.140MHz. 70cm and 1296 cm equipment can also be tested.

Local Repeater info

A new dual-band antenna has been installed on the Tic Hill mast and both repeaters on 2m & 70cm are now running into the one antenna. There is interference presently getting into the 70cm repeater, DF'ing so far puts it in the Midland area, so quite close to Tic Hill. (LIPD not being blamed, (yet !)) but VK6TRC is on the trail).

A new 70cm repeater is in the early stages of planning & construction. It is to be sited in Victoria Park, about 5kms east of the city and should provide good coverage to handhelds in the city & inner city suburbs as well as around the foreshore areas of Perth, East Perth, South Perth & Burswood. Site tests conducted so far show that UHF coverage from the site is good and providing infill coverage to these areas, where the repeaters on the escarpment can be difficult to access from handhelds. (Thanks Rob 6TRC)

From the Minutes (Aug Council Meeting)

Dave VK6IW advised that there were three new membership applications for the month. These are Marvin Feldman VK6WW, Craig Macintosh SWL and David Rankin 9VIRH. All were warmly

welcomed to the Division. There was concern expressed over the variable support for the monthly on-air net. Only two country members had checked in on the last occasion. (*How about it fellow cockies, even just to let the Councillors know we are listening? We don't want to lose this new facility for airing opinions / grievances*). Information had been received about a VK2 AOCPC correspondence course, which would be publicised shortly.

Will VK6UU proposed that a new "CW Survey" be conducted of all VK6 amateurs using the simple question "Should Morse code proficiency be retained as an examination requirement - Yes or No". Council agreed with the proposal after considerable discussion. Input would be sought from all and any media, with one vote per licensee allowed. Will VK6UU will manage the survey?

It was noted that VK4 had put forward a motion for the consideration of Federal Council that a new model for restructuring the WIA should be sought. The motion had lapsed at the last meeting because of the unfinancial status of VK4. As the motion had some merit, could VK6 pursue this on behalf of VK4 if the latter were unable to do so?

Neil VK6NE advised that in discussion, Jim VK6RU had indicated he wished to resign as QSL Manager at the end of 1999.

Note that minutes of Council Meetings are archived on VK6BBR at C:\wiamins\council

73 from Toodyay, Chris VK6BIK (chrismor@avon.net.au)

VK7 Notes

QRM

First may I apologise for nil Tassy notes for two months - they would not have been very relevant from the other side of the world and my efforts to get a replacement scribe did not work!

Overall there would seem to be an upsurge in interest around the island, winter usually sees a drop in our monthly meeting attendances but reports indicate the very opposite—a very gratifying trend.

The biggest problem financially in the state is the costs of our Hobart main 2metre repeater. Sky high rents and associated costs are crippling our southern branch. A new site is being sought but the biggest consideration is that it has to be able to access the Mt Barrow repeater for our weekly broadcasts to get through to the north and northwest.

The Southern branch is appealing for many more dedicated amateurs to make themselves available as operators, announcers, recording agents etc for our broadcasts. Help is also sought for the

Morse classes. Their novice/full-call classes are working well.

Competition is strong for the lead in the foxhunting points scoring. As this is written, VK7JUF and partner are on top with 30 points with VK7FB hard behind on 29 points. Nail-biting stuff this!

It's nice to be appreciated. Robert, VK7RB and Garry, VK7JGD were recently presented with certificates from the Huon Valley Scouts for their JOTA help.

The state lost another ham recently with the death of Geoff Dineen VK7DF. Sympathy is extended to the family.

Bimonthly family dinners at good restaurants and excellent meeting guest speakers are keeping the northern branch very much alive. They are at present searching for materials for temporary antennas to service the JOTA sites.

The northwest branch members at their August meeting were fascinated by a brilliant talk on the background to the Y2K problems by computer whiz Jim VK7JH. The branch has been concerned at moves by the Government to change the status of the Dial Range—our main repeater site. We have a yearly lease on a two-acre mountaintop.

At the moment things are quiet but it's a case of "eternal vigilance".

Ron VK7RN, State President.
ar

**The North Queensland
Amateur Radio
Convention**

September 24th-26th

**University Hall
James Cook University**

**See all the frontiers
of radio technology**

Technical Lectures
Radio Sports
Trade Displays
WIAQ Council
Auction
Home Brew
Boot Sale

**For Registration Information
Contact
Townsville Amateur Radio Club
Ph (07) 4789 1796
Fax (07) 4779 1161
thetarcinc@email.com**



CLUB NEWS

Melbourne Radio Rail Fun Day

Your Participation is Invited

Buoyed by the success of the first *Radio on Rails* Contest, held back in April, Melbourne's Moorabbin & District Radio Club is holding its next *Radio on Rails* on Sunday October 10.

Radio on Rails encourages amateurs to operate from trains and trams around Melbourne. Participants get to experiment with VHF/UHF portable equipment and antennas and demonstrate amateur radio to the general public. Entrants also meet other contestants, thanks to the unique 'eyeball contact' rule.

MDRC *Radio on Rails* Contest Rules

Object: To make contact with operators on board trains and trams around Melbourne.

Date: Sunday, October 10, 1999

Time: 9am - 1pm

Bands: FM voice segments of two metres and seventy centimetres only

Mode: FM

Sections:

- Transmitting Mobile (in train or tram, also includes waiting at railway stations or tram stops)
- Transmitting Home (includes operators at home or in a car)
- Listening Mobile (in train or tram, also includes waiting at railway stations or tram stops)
- Listening Home (includes listeners at home or in a car)

Contacts: Train or tram mobile stations may work (or hear) any station for points. Home station entrants may work (or hear) train or tram mobile stations only for points.

Repeat contacts: Repeat contacts are valid for scoring purposes provided at least one hour has elapsed between them.

Use of repeaters: Contacts on repeaters count for scoring purposes.

Exchange: Train or tram mobile stations give their nearest railway station, tram route number or tram stop location (if waiting). Home stations give their suburb. No serial numbers are required.

Eyeball contacts: Stations in Sections A and C may claim extra points for 'eyeball contacts'. An eyeball contact is defined as one where participants can shake hands with one another on a train, tram, railway

The rules for *Radio on Rails* appear below. The only change is the inclusion of seventy centimetres as well as two metres. As with last time, both home and train/tram mobile stations may enter. Participants are invited meet for lunch afterwards at a city venue to be arranged on the day.

Don't miss October's *Radio on Rails*. It's on Sunday October 10 between 9am and 1pm. Keep this date free and give this fun contest a go.

Peter Parker VK3YE
MDRC Publicity Officer

station or tram stop.

Prearrangement of eyeball contacts before the contest start time is **not** allowed. However, eyeball contacts may be arranged during the contest period on two metres or seventy centimetres FM only. Unlike with radio contacts, entrants cannot claim extra points for repeat eyeball contacts with the same person. Amateurs or SWLs not active in the contest cannot be claimed as eyeball contacts.

Scoring: Score 1 point per station worked (or heard) on each band. Total score is the number of radio contacts made (or stations heard) plus the number of valid eyeball contacts made.

Logs: Logs should show time, frequency, call sign and exchanges for each contact. Eyeball contacts should also be logged. Train or tram mobile entrants should staple their used Met ticket to their log. Where this is not practical (eg ticket remains current after the contest), a signed photocopy of the ticket will be accepted in lieu.

Logs should be posted to *Radio on Rails*, MDRC, PO Box 58, Highett, Vic, 3190. Logs should be received by 31 October, 1999.

Certificates: These will be awarded to the first three placegetters in each section. Other entrants will receive participation certificates.

Results: Results will be announced in the WIA's *Amateur Radio* magazine and on the MDRC's weekly news transmission (8pm Wednesdays, 146.550 MHz).

Radio Amateurs Old Timers Club of S.A.

The Annual luncheon will be held on Thursday 28th October 1999 (11.30 for 12 noon luncheon) at the Airport Club, James Schofield Drive, Adelaide Airport. RSVP to one of the following before Friday 22nd October 1999 for catering purposes.

Pres. Jack Townsend (VK5HT)
82952209

Sec. Ray Deane (VK5RK) 82715401

A/Sec. Lew Schaumloffal
(VK5AKQ) 82630882

Public Transport T/A bus 278 Stop 9

Ray Deane Secretary

35 Truro Avenue
Kingswood S.A. 5062

Andrews Communications Systems

(EST. 1976 - ACN 001 968 752)

ALINGO

AUSTRALIA'S FIRST AUTHORISED
FACTORY DIRECT IMPORTER

No1 & Biggest Importer with one or two absolutely massive shipments monthly.

FULL 3-YEAR FACTORY WARRANTY
INSTANT REPAIRS ON FRIDAYS

WE SELL MOST BRANDS AND MAKE
BALUNS, VERTICALS, YAGIS, P/S,
ICOM-KENWOOD-JRC-AOR-EMOTATOR-
M/JF-DIAMOND-TIMEWAVE-KANTRONICS
-THP - GARMIN - TERLIN - UNIDEN - ETC

DX-1600 HF LINEARS FROM \$ 3,799

**HUGE RANGE OF ELECTRONICS
NEW IC-706IIG & IC-756PRO**

**NOW 3-YEAR WARRANTY ON
NEW ICOM SOLD BY US.**

* OVER 20 YEARS OF SERVICE *

**WE WANT HF SSB TRANSCEIVERS
& LINEAR AMPLIFIERS**

(02) 9636 9060 or (02) 9688 4301

SHOP 8, 41 BATHURST ST. GREYSTANES,
N.S.W. 2145. FAX (02) 9688 1995

ar

ALARA

Christine Taylor VK5CTY

ALARA Publicity Officer
16 Fairmont Avenue
Black Forest 5035
geencee@picknowl.com.au



Celebrating ALARA's Birthday

July is the anniversary month for ALARA so there are special luncheons to celebrate the occasion.

In VK3 this year there were six members gathered to wish each other "Happy Birthday ALARA".

Bron VK3DYF, Gwen VK3DLY and Jean Shaw were pleased to have Mavis VK3KS, absent for the last couple of months, Elizabeth VK3NEP and Robyn VK3WX. Robyn brought along a couple of exquisite, tiny teddy bears she had made.

Elizabeth has recently had a visit from Judith ZL1JDL whom she sponsors into ALARA. Judith drove out to Elizabeth's QTH in the beautiful outer suburbs of Melbourne to spend the day as part of her time in Victoria. It is always a special occasion to meet someone you sponsor, whether it is for the first time or for the nth time.

In Adelaide the Birthday luncheon was at a new venue. There were 10 YLs this year and as the OMs of some of the ladies also celebrated the day, this year they had a table for 8 nearby.

Jean VK5TSX, Meg VK5YG, Tina VK5TMC, Myrna VK5YW, Janet VK5NEX, Denise VK5YL and Christine VK5CTY, who are regulars at the birthday lunches, were joined by Maria VK5BMT, now spending her winters in Adelaide. New-comers, Jeanne VK5HOX and Colleen were both there for the first time. Greetings but apologies were passed on from Lorraine VK5LM, Mary VK5AMD, Joan VK5BYL and Marilyn VK3DMS (sent an invitation as a 'nearly' VK5) and from Lyndall VK5KLO heard on the air as others were driving to the lunch.

We hear that Lorraine is the regular newspaper photographer for her local paper. Janet was in a group of SES members commissioning a new truck when she discovered Lorraine there to record the occasion.

In Perth the birthday was celebrated in June, as that is the month in which the VK6 lunches have their anniversary. This year it was their 20th birthday and ALARA'S 24th!

Birthday Get-Together on Air

On the fourth Saturday of July a special 80 metre net is run to recognise the birthday, as well. Sometimes people have to be reminded by a phone call (I hide my head in shame) and sometimes we remember ourselves. This year the net was started by Bron VK3DYF and Gwen VK3DYL. They were joined by Pat VK3OZ and Meg VK5YG and later by Christine VK5CTY and Dot VK2DB. Dot had just served what sounded like a particularly delicious Chicken Tandoori when she remembered, so she made everyone hungry by eating it at the microphone. Then Poppy VK6YF came in as well to make the group cover nearly the whole of the country.

As usually happens on Australia wide nets, variations in the weather were experienced in different parts of the country. Whenever one part has too much rain another part is badly in need of it. Dot has had far too much rain this year while Poppy and the VK5s would like some more for the farmers.

The Norma Souper Contest

In April each year this 80-metre contest is run for ZL and VK YLs. This year Gwen VK3DYL won the VK section. She complained that she didn't have enough competition, so why not make her work a little harder for the honour, next year. Read the newsletter or this column for details and set the time aside.

Visitors

Elwyn VK2DLT touring VK6 has been in to see Bev VK6DE in Geraldton and will call in on Poppy VK6YF on her return to Perth.

Dot VK2DB had some interesting visitors from the US recently. Warren WB6TMY, with wife Barbara and daughter Nikki 'found' Dot 'on the Web'. Dot was delighted to have the opportunity to show Warren and family a very special family. He

wanted to see an Australian ham shack. In Dot's household there are three 'hams' and three 'ham shacks'. It was a thoroughly enjoyable visit for all concerned.

The First Clara YL Conference

For the first time CLARA, the Canadian YL group ran a conference, this year, organised by Elizabeth VE7TLK. It was held in North Vancouver on May 1st 1999 and attended by 24 YLs. They hope this will be the first of a number of conferences and get-togethers that will encourage YL participation on amateur radio and to give CLARA a more visible presence in the amateur community. We wish them well.

Reminders ALARAMEET in 1999

It is not too late to decide to join others in Brisbane for the ALARAMEET over the long weekend at the beginning of October. Contact Bev VK4NBC QTHR the callbook with your registration.

If you are coming to ALARAMEET don't forget to bring along a photograph of your pet(s) for a guessing competition and some craft items to show others.

There will be an informal evening meal for those there on Friday night but activities really start on Saturday morning. All the details are on the form Bev will send back to you when you contact her.

At the last count there were over 70 expected including a number from ZL land.

International YL2000

Due to be held in Hamilton on 30th Sept/1st Oct 2000. Expressions of interest have been received from a number of DX countries but the final registration date is not till March 2000, with payment due by June 30th 2000, so there is still some time to save the pennies.

continues next page

ALARA

Contact Biny ZL2AZY,
550 Kane Street,
Pirongia 2450.
NEW ZEALAND
or by email :- yl2000@iname.com

International Lighthouse/Lightship Weekend

This could be an interesting radio activity to listen for over the weekend of Aug 21st/22nd. It runs from 0001UTC on the Saturday to 2359UTC on the Sunday. As over 126 stations have confirmed their participation there could be some rare DX calls among them.

There is more information available on:
<http://www.waterw.com/~weidner/ld.htm>

If you wish to add your callsign and details to the list contact Mike GM4SUC on GM4SUC@compuserve.com

New Callsign

During the week after the Birthday luncheon Jeanne VK5HOX heard that she had passed her 10wpm. She is now VK5JQ. Congratulations.

ar

OVER TO YOU

Band Plans

With reference to the letter "Band Plans" by Brian Welley VK2ZW (AR July 99). Perhaps in some ways Band Planning has outlived its usefulness. What could be the quickest way for the Amateurs to lose bands or band space is not to make maximum use of these bands. Why allot exclusive use of parts of Amateur bands to CW for example, when this group seem to use any part of the band other than their exclusive allocation? Remember that there are many other interests like commercial, pastoral, private, sporting and travel groups who are out for more of the Radio Frequency spectrum. Remember that we have a government that seems to want to flog off everything to the highest bidder. As for CW, I for one would hate to see this dropped, however the Morse requirement could, and perhaps should, be dropped for frequencies above 25 MHz. After all, this requirement has been dropped for others.

Graham J Muirhead VK4WEM
23 Cunningham Street
Warwick Qld 4370

Morse Not Dead

Re article "The passing of an old friend" AR July 1999 submitted by VK6YN Sam Wright.

SOS is alive and well in the UK and China, perhaps not for the purpose designed for, but for the bringing of assistance along the highways.

The enclosed photocopy was taken on A65 in Yorkshire. The boxes are painted orange with a large SOS on each side. They are dotted along the road.

Similar out of Shanghai, similar boxes exist painted blue with large SOS in white.

D Reynolds VK2ANW
9 Arterial Road
Killara 2071 NSW

Is this magazine borrowed?

Join the WIA

and get your **Amateur Radio**
own each month!

The Snags of Fishing from High Rise Buildings

Peter VK3YE's article in June 99 AR on Amateur Radio from tall buildings brought back memories of this some 20 years ago.

My late wife had friends who lived in VK3 in the big Housing Commission Flats on Park St overlooking Albert Park Lake. They lived on one of the uppermost floors.

On one of our campervan tours of Victoria we were invited to stay a few days with them, rather than stay in a caravan park. We accepted the invitation and I thought what a marvellous location for Amateur Radio, HF and VHF.

As I had the FT-7 in the camper and a TS-2200 2M portable I decided to take them up there. 2M FM was marvellous. Stand the transceiver on the window sill and work simplex or repeaters miles away. Connect up the little portable 3-element beam tied to a broomstick in turn lashed to a chair and you worked anywhere.

HF was even better, even with only 10 watts. QRP was good in regards TVI! It was HF and on 7 MHz where I had the amusing incident.

I used to set up the FT-7 along with an ATU by the window. You could not open the windows any more than about 6

inches. This was to stop any one from jumping out! I had about 65 feet of hookup wire. Attached to one end was a small pyramid shaped fishing sinker. Leaving myself 6 feet free, a half hitch was made around the free end of a broom handle. The antenna with weight supported in the broom handle was then poked out the window allowing the wire to hang free some distance out from the building. Closing the window supported the broom and the broom head prevented the lot going out the window. An earth wire was connected to the aluminium window frame with a big battery clip. All connected up to the FT-7/ATU it loaded up well on 7070 kHz.

A sked had been arranged back to VK5 for about 4 o'clock of an afternoon. These went well, 5-8-9 signals both ways even with only 10 watts.

These skeds went on for several days, then one day, during a QSO "BING" the broom nearly went out the window! The broom and antenna was quickly hauled back inside. There was only about 30 feet of antenna wire and NO weight! I quickly poked the remainder of the antenna out the window again and informed the VK5 I had to close down.

We all thought it was a great joke and expected a knock on the door with somebody asking "Who was trying to catch fish out the window?" No one came. I had to go out and buy another fishing sinker. Luckily I had enough wire for another antenna.

I moved the station to the laundry where there was a better earth and 240 AC and nobody to disturb for my sked next day. I explained the goings on to the VK5 with much amusement.

I never caught any more "Radio Fish"! Not such a bad "tail"! (The one that got away?)

S J Mahony
19 Kentish Road
Elizabeth Downs, SA 5113

ar

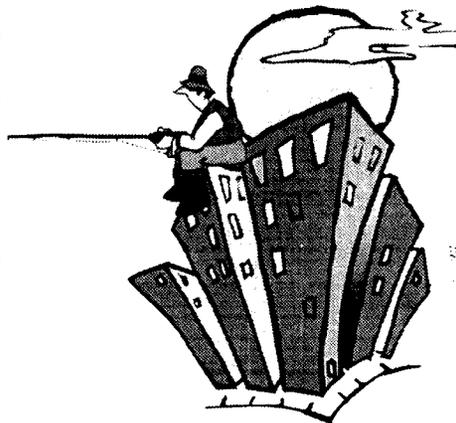

PIONEER OF THE STORY OF RADIO

GUGLIELMO MARCONI

by Wolf Harranth OE1WHC

Translated from the German by Ken Matchett VK3TL Hon. Curator of the WIA QSL Collection

"A certain Signor Marconi from Italy stubbornly maintains to have discovered a wire-less telegraph, by means of which it is possible to carry the human voice over large distances. We are not able to say that this is simply a foolish joke or that this gentleman is a straight out swindler. One thing however is certain: his doubtful discovery will not survive this winter."

(The Morning Post, August 1896)

Born on 25 April 1874 in Bologna, in his parents' home, the Palazzo Marescalchi, Guglielmo Marconi was the third son of Annie Marconi, nee Jameson, half Scot, half Irish, and Giuseppe Marconi, an Italian businessman of considerable wealth. He spent his childhood summers at the Palazzo and in winter, on the family estate, the Villa Griffone, Pontecchio near Bologna, interrupted only by a short period in England between his fourth and seventh years.

His father sent his fourteen-year-old to the Cavallero Institute, where he studied physics and chemistry with particular enthusiasm. One year later he attended the technical institution in Livorno, where Marconi's interest in electricity and its related studies developed. He undertook private tuition under the greatest authority in the land, Professor Rosa of Bologna.

During the year 1894 Marconi, now 20 years of age, spent his holidays in the Biellese Mountains of the Italian Alps with his two elder brothers, Giuseppe and Luigi.

"And there (he wrote in his memoirs) in a modest hotel room in the dawn light of a sleepless night, the hitherto unrealised ideas of my life's goal took shape. All at once I guessed - no - *I knew* that it must be possible to send an electrical signal through the ether from one place to another. And in the still of the night I thought of Hertz and his experiments. In the morning my ideas, conceived that night, grew ever stronger and I felt more and more that wireless telegraphy was indeed possible and had

ceased to be just an inventor's dream."

The German physicist Heinrich Hertz had, some years before, determined experimentally that electromagnetic waves obeyed the same laws as light waves, in particular, that they radiated straight out from their origin at the speed of light. It was this fact that confirmed the previously enunciated theory of electromagnetism of James Clerk Maxwell.

On this basis Marconi was to develop his ideas. In the autumn, after having returned to the Villa Griffone, he requested two large rooms for his research. There he worked day and night, lovingly encouraged by his mother but sceptically regarded by his commercially-minded father, who parted reluctantly with the much-needed money for his son's experiments.

In order to discover the waves emitted from an oscillator, Heinrich Hertz had used a metal ring that was very slightly open at one point. When an electrical current was passed through the ring tiny sparks criss-crossed the gap. Marconi recalled much later:

"It seemed unreservedly possible to send signals through the ether, and even over great distances if it were only possible to

increase and to regulate the intensity of the spark emission. This concept seemed so clear and logical to me that I was at a loss to understand how no-one had previously thought about it - and it appeared inconceivable to me that my theory seemed just a fantasy to others."

Autumn having come and gone, the first real progress with his primitive apparatus could be seen.

"A problem always seems so simple when one has found the answer. To generate the spark was not easy, but in December 1895 my first success was realised. I divided the transmission into a series of short and long phases and thus was able to send Morse characters."

Although the winter was particularly harsh, Marconi's mother decided to remain at the Villa Griffone so that her young son could carry on with his research. The first of the transmissions reached only across the attic, but in the early part of 1896 a distance of two miles was achieved. Shortly after this, Marconi was obliged to travel to London with his mother, but he took his equipment with him. William Preece the Post Office chief engineer, had already



K1VV: Many radio amateurs, including this one from the USA have depicted Marconi on their QSL cards. Several QSL's have celebrated the anniversary of Marconi's successful wireless transmissions

heard of the young Italian and had arranged Marconi's first public demonstration - the wireless transmission from the Central Post Office in St Martin-le-Grand to a receiving station on the banks of the Thames.

Now engineers of both Army and Navy were to take heed of his discovery. On Salisbury Plain Marconi transmitted morse signals over the then incredible distance of eight miles. Preece had assigned an assistant to Marconi, James Steven Kemp, who until his death in 1932 was to remain a true and valuable helper.

The next experiments took place over water, across the Bristol Channel from Penarth to Bream Down. The Kaiser himself had sent an expert, Professor Slaby from Berlin, as a witness to the experiments. In 1896 Marconi took out his first patent, and a year later founded the Wireless Telegraph and Signal Company, so putting his achievements to practical use.

Now the financial benefits really started to flow. Marconi was no longer dependent upon the financial assistance of a rich father and henceforth his distinctive natural ability had the effect of combining a scientific curiosity with commercial ambition.

At the end of 1897 research into the wireless telegraph had been completed and a regular commercial operation could start.

Marconi had not found the support he hoped for in Italy, but in England this was in fact forthcoming. One by one the first Marconi stations were established: Alum Bay on the Isle of Wight, Bournemouth and Poole. Installation of Marconi transmitters in Irish lighthouses quickly followed.

Marconi had been obliged to forgo his military service, but now the 23 year-old was appointed as Naval Attache to the Italian Embassy in London. He could now continue with his experimentation.

Marconi had always shown himself to have an eye for publicity. When the Prince of Wales, (later King Edward VII), became ill on board the yacht *Osborne*, Marconi set up radio communication between the ship and Queen Victoria in Osborne House. Newspapers went overboard with their reports of the incident.

On 3rd March 1899 a human life had been saved thanks to the wireless telegraph as a ship ran aground! During naval manoeuvres in 1899 a distance of 79 miles had been breached by wireless, and in March 1899 the first telegram was sent between Boulogne and Dover over the English Channel:

"Professor Fleming, London. I am pleased to send you greetings through the ether by means of electric waves from Boulogne to South Foreland and from there via postal telegram. Marconi."

Professor J A Fleming was Marconi's

closest adviser. It was he who later discovered the diode valve.

The young Italian inventor in the meantime enjoyed world fame. His business enterprises returned massive dividends.

Now a new and most ambitious aim presented itself... the bridging of the Atlantic. The basis for this undertaking, again typically Marconi, was not only the scientific challenge involved but:

"I am convinced that it is more profitable to send news items to America at the rate of sixpence per word than to send them across the channel for a halfpenny a word!"

For the European transmitting station a suitable location was found at Poldhu Point, the furthest point in south-west England. In January 1901 this station was completed and in Canada on Signal Hill in St John, Newfoundland, the complementary station was established.

On 6 December Marconi arrived there with his co-workers Kemp and Paget. He had brought with him balloons and six kites, the function of which was to support the 185 metre long antenna wires. On 12 December 1901 all was ready. Marconi had left prior instructions in Poldhu for the transmissions to be sent each day between the hours of 12 noon and 3 pm Canadian time.

"Despite a nagging hunger nobody could eat a thing. Each of us had eyes only for the clock, which became the focal point of the room. Time: 12.20 - how long will it go on? Would we be able to hear at all a signal from over there? Suddenly, at 12.30, I heard a series of crackling noises in the receiver. The letter S! Poldhu to Canada!! We had

previously chosen the three dots of the letter S in order not to tax the transmitter by sending dashes in morse. The Atlantic Ocean had been conquered; the electric waves had covered a distance of 1700 miles!"

Now thought could be given to the construction of a large radio station in Canada. This was located at Glace Bay on the coast of Cape Breton.

On 1 November 1902 the experiments there began. At the beginning of December the first two words sent, Greentime and Yellowtime, were quite clear to the ear. On 21 December 1902 the first telegrams were sent from Glace Bay to the King of England and the King of Italy.

In 1915 Marconi began experimenting with the first radio-telephone, signals covering a distance of 30 miles. October 1919 saw the amalgamation of earlier companies in the USA into the Radio Corporation of America, the RCA. In the same year Marconi acquired a large ship, the snow-white yacht *Elettra* which originally had been built for the Grand Duchess Maria Theresa of Austria. This was to become from now on the real home for Marconi and his family. In 1905 he had married Beatrice O'Brien, the daughter of Lord and Lady Inchiquin, from which marriage ensued three children, Degna, Giulio and Gioia. One small setback: the couple were divorced in 1924, and in 1927 Marconi married Maria Christina Bezzi-Scali, the daughter of a high-ranking Vatican official. From this marriage was born a daughter, Maria Elettra Elena Anna.

Marconi quickly involved himself with radio broadcasting, utilising his customary

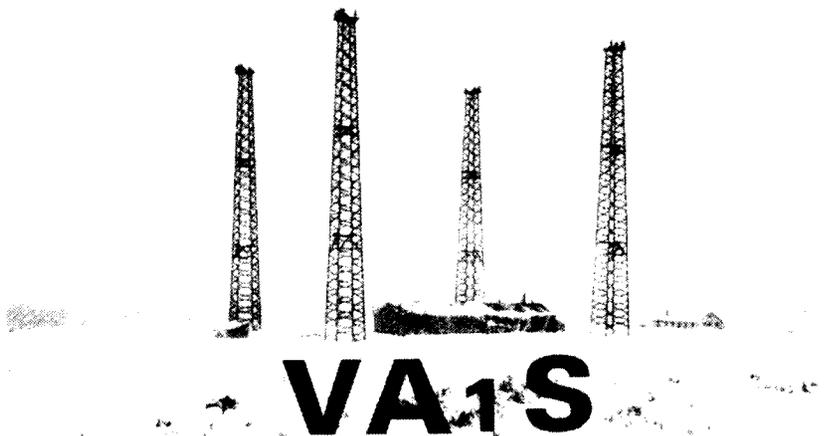

VA1S
CAPE BRETON ISLAND, NOVA SCOTIA, CANADA
IOTA NA-010 CQ ZONE 5 ITU ZONE 9 Cdn IOTA NS-01

Operators: Jack, VE1XT (SSB) Phil, VE1BVD (SSB) Al, VE1AL (CW/SSB & QSL Mgr)
Photo: Marconi Towers & station at Table Head, Glace Bay, Nova Scotia (circa 1903)

VA1S: This QSL from Nova Scotia shows the transmitting towers at Glace Bay from which Marconi made the first successful trans-Atlantic wireless transmission on 15 Dec 1902.

business instinct. In 1920 on board the yacht *Elettra* people were dancing to music that was being transmitted from London. A newly established Marconi firm now was building broadcasting transmitters and receivers. In February 1922 the first commercial broadcasting station in England began transmission under the station call-sign 2MT, and in May of the same year followed station 2LO transmitting from Marconi House in London. On 14 November 1922 the BBC was founded.

In 1923 Marconi began experimenting with short wave using a transmitting power of 12 kilowatts and a wavelength of 92 metres. In 1932 he established microwave communication between the Vatican and the summer residence of the Pope. The year 1934 saw his experimentation with ultra high power transmissions using a wavelength of 57 cm. In 1935 Marconi demonstrated the principle of radar but showed no particular interest in television. The Marconi EMI system developed by his assistants was, however, used by the BBC in 1936 for the first regular TV service in the world.

There had been no lack of honours bestowed upon him. In 1901 he had shared the Nobel Prize for physics with the German Ferdinand Braun, and at the beginning of the First World War Marconi had been elected to the Italian Senate. There followed countless orders, honorary doctorates and memberships of academic institutions in every country of the world. In June 1929 Marconi was elevated to the nobility, being given the title of marquis. Now he could busy himself in politics at the highest level. In 1928 he gained membership of the highest order of the Italian Fascist Party.

Despite his visibly poor state of health, brought about by sheer exhaustion, Marconi nevertheless undertook a world cruise. In

iY1EY • Loano • Elettra Memorial Trophy

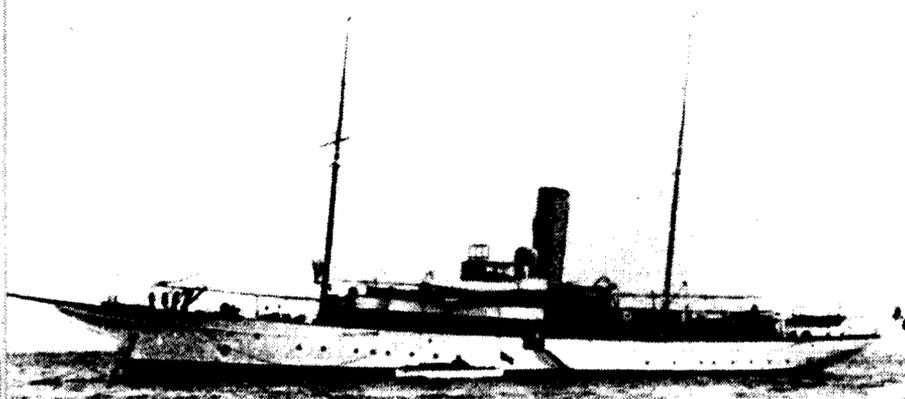

Elettra, the legendary "White Ship" used by Guglielmo Marconi from 1919 to 1936 for his radioelectric experiments, basic for human history

iY1EY: *Elettra* was Marconi's luxury yacht from which he carried out wireless research from 1919 to 1936. This QSL was sent from a special amateur radio station in Loana near the shore of the Ligurian sea, *Elettra's* home waters.

December 1935 he returned to Rome, from which he would no longer venture. After several ongoing heart attacks Marconi passed away on 20 July 1937. His last resting place was the same as that where he had passed his childhood. He was buried in the mausoleum set in the garden of the Villa Griffone.

The news of his death spread like wildfire throughout the world - over every medium of communication, media which Marconi himself had so decisively created. As a mark of respect for Guglielmo Marconi every telegraph and broadcast station throughout the world ceased transmission for two minutes. For those two minutes the ether was as quiet as it ever had been in a time

before Marconi.

Translator's Note:

The above text originally appeared in the magazine *Amateurfunk* under the title *Pionier der Funkgeschichte - Guglielmo Marconi* and was written by Wolf Harranth OE1WHC, curator of the prestigious Austrian QSL Collection.

The National QSL Collection of the WIA has received considerable assistance from the Austrian QSL Collection, information and exchange of QSLs having taken place on a regular basis over several years. Permission to translate and publish this article in Amateur Radio was kindly given to Ken by the author.

ar



GB100SFL: On 19 December 1898 Guglielmo Marconi and Kemp carried out radio experiments from the East Goodwin Lightship in the English Channel. 100 years later radio amateurs celebrated the event by again transmitting from the lightship to a receiving station on the South Foreland Lighthouse, from which this QSL was sent.

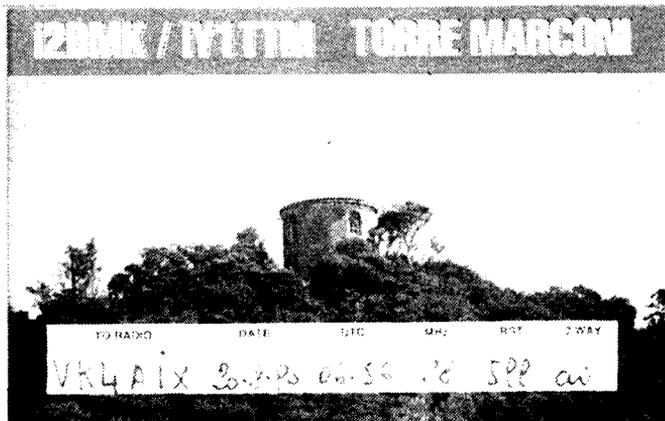

i2DMK/iY1TTM: This portable station operated from the Torre Marconi (Marconi's Tower) in Sestri Levante Italy. Marconi conducted experiments from this tower using microwaves with a wavelength of 63 centimetres.

... and in Marconi's own words

How I thought of Wireless Telegraphy

By Guglielmo Marconi

THE IDEA of transmitting messages through space by means of etheric waves, otherwise wireless telegraphy, came to me in the spring of 1894, while reading an account in an Italian electrical journal of the work of Professor Hertz, who had died in January of that year. I had followed Hertz's experiments for several years previous to that, but they had never before awakened in me more than a passing interest.

For detecting the waves radiated from the transmitting oscillator Hertz had used a metal hoop having a small gap at one side. Upon bringing this hoop within the influence of the electrical disturbance set up by his oscillator, he discovered that minute sparks passed across the gap.

In other words, he showed that electric waves, when radiated into space, could be detected at a distance by means of the metal hoop. It occurred to me that if I could interrupt the wave transmission from the oscillator, breaking it up into long and short periods, similar interruptions would be detected in the spark gap of the metal hoop.

Here, in short, was the possibility of signalling across space by means of the Hertzian waves. A short emission of the transmitted waves would signify the dot of the Morse alphabet, a long emission the dash, and thus words might be spelled out in the distant receiver.

The idea seemed so simple and evident to me that at first I had no thought of attempting practical experiments to demonstrate its possibility,

because I knew there were many clever men in the world experimenting with etheric waves, and I thought someone would quickly work out the problem. After waiting almost a year without seeing any account of attempted applications of the discoveries of Hertz to the transmission of signals, I began my first experiments in December, 1894, and obtained results which surprised me, and which I at once realised were new.

I may say that for several years previous to the beginning of this work I had been deeply interested in electricity, though purely as an amateur. I had fitted up a rude laboratory or workshop in my father's house near Boulogne, where I had begun to work with primary batteries and thermopiles, grappling with the problem which has puzzled so many inventors - a method of transforming heat directly into electricity. I had also experimented with the utilisation of steam in engines, and had likewise been deeply interested in chemistry.

I have seen it stated that Professor Righi, of the University of Boulogne, first suggested to me the idea of communicating messages through space. This, however, is not the truth. I never even attended any of Professor Righi's lectures - I wish now I had though I did have discussions with him, as beginner with master, on the subjects of chemistry and mechanism. He had repeated very successfully the experiments of Hertz, detecting transmitted waves a short distance across a room - but he evidently had not thought of using the waves for the

communication of intelligence, for when I first mentioned the idea to him he said he thought it would not be practicable. I think I am right in saying that previous to my experiments no one had attempted the practical use of the Hertzian waves for telegraphy.

I do not think it occurred to other experimenters that these rays could be so utilised, although Professor Oliver Lodge, who had long been experimenting along the lines suggested by Hertz, gave, in a book which he published in 1894, a number of suggestions as to the uses to which these rays might be put, but never mentioned their application to telegraphy. He suggested that if one should put iron filings in his eye he might see the hertzian waves; but he did not suggest that these rays could be used for signalling.

One English electrical journal in its issue of September 17th, 1897, said that Dr. Lodge's apparatus for thus utilising the Hertzian waves was shown in Oxford in 1894, but I fear that this statement is not quite correct. Either public interest was very low at that time, or the exhibition was very little noticed, because no written report of such an exhibition was made, and I have the word of Professor Fleming of University College, London, who was present at the meeting in question, that to his knowledge no suggestion was made to the effect that the Hertzian waves could be used, for the purpose of signalling over long distances.

Indeed, when I began to utilise Hertzian waves for telegraphy I did not know that anyone else had ever thought of such a thing. I learned later, however, that

many experimenters had been close to the idea, and had even suggested it. One writer in an English electrical journal in April, 1891, said :-

"If we could reduce the frequency about 2,000 times, and produce vibrations of about 200,000 millions per second, we should get waves of about one millimetre long. These radiations would probably pierce not only a fog but a brick wall. When we get such vibrations there will be many interesting uses for them. One, at all events, will be the possibility of communicating between lightships and the shore."

The Hertzian wave was experimented with and its identity with light waves was often demonstrated, but no one used it for telegraphic purposes before I began my experiments. I believe I am right also in saying that I sent the first recorded message through space by electro-magnetic waves in 1894, and was the first to telegraph from a ship in motion (Italian Navy, 1897).

In my apparatus I have made use of known ideas. My instruments are improvements of my predecessors', with the introduction of a few developments which from my observation seemed necessary. It is only fair to say that the introduction of these new elements was the basis of my long distance success. It is the business of science to acquire results with the least possible outlay of work and time, and results are regarded as the standards by which a man's work is judged.

Honour in memory of Radio Pioneer

R C Tulloch VK4BF

3 Andrews Court, Kirwan Qld 4817

Recently the Charters Towers City Council resolved to honour the memory of the late Vern Kerr (VK4LK) who had been associated with the work of the Royal Flying Doctors Service (R.F.D.S.) for more than 40 years.

During this period, between 1952-1973, he was in charge of the Base in Charters Towers, including in his duties the work of The School of the Air, now known as The School of Distance Education.

The Charters Towers Base was situated on the outskirts of town, at 22 Dalrymple Road, leading to one of the main highways to the north and northwest.

Charters Towers is a bustling small city situated in North Queensland 133 kilometres south west of Townsville and on the junction of the Flinders Highway leading west to Mount Isa and beyond, the Gregory Highway to the south and the Lynd Highway to the north and north west.

Charters Towers serves a vast pastoral area, but is probably better known for its association with gold mining, from early this century to the present day.

Vern was born in Longreach in 1912 and on leaving school accepted an Electrical Apprenticeship in Winton. During this time he became very interested in the new innovation of radio. In 1932 he gained his Amateur Radio Licence, an active interest he held for all his life.

As a result of his interest in radio communication, the Reverend John Flynn approached Vern and his parents to see if he would join the newly established Aerial Medical Service to act as an Assistant to the Radio Operator, the late Maurie Anderson, at Cloncurry. In 1934 Vern joined this service, operated by the Australian Inland Mission - later to become the Royal Flying Doctor Service.

Vern obtained his COCP (Commercial Operators Certificate of Proficiency) in Cloncurry in 1941 and assumed control of the base there until moving to Charters Towers in 1952.

The Charters Towers Base operated from 1952-1973 and when it closed, Vern was transferred to Charleville Base where he remained until his retirement in 1977, returning to live in Charters Towers.

During his period with the R.F.D.S. from 1934-1977 it has been said that his voice would have been one of the best known in Queensland, particularly in the rural area. He became a byword for the assistance he gave to those living in these vast areas and for his devotion to duty.

During his service, he kept abreast of modern technology as it was developed and saw equipment change from the old typewriter Morse senders, through the famous pedal radio series to the modern solid state transceivers.

In his continuing amateur radio activities he was always enthusiastic. His operating technique on CW and phone was friendly and courteous. He was a source of encouragement to the new licensees and held regular "skeds" with various friends and groups all over the country until just before his passing on 9th September 1979.

His radio operation and technique resulted in him being awarded Life

Membership of the Society of Wireless Pioneers (USA). This honour has been granted to only two other Australians.

He was a strong member of the WIA for many years.

So, it comes as no surprise that the Charters Towers City Council decided that some honour to the memory of this man who gave so much service to others should be forthcoming.

It was decided that a portion of Dalrymple Road adjacent to the old Charters Towers Royal Flying Doctors Base should be renamed "Vern Kerr Drive" and a memorial plaque at each end of this section should be erected.

The Charters Towers City Council erected the plaques and dedicated them on 19th August 1998. The cover of AR this month features a photo of Mrs Joy Kerr, wife of the late Vern Kerr, standing beside one of the two plaques.

A brief dedication service was held at the site, attended by Mrs Kerr, relatives, friends and ex-staff who worked with Vern at the base.

So if you live around Charters Towers, are stopping there a while or just passing through, drop by Vern Kerr Drive and recognise the tremendous value in taking Amateur Radio seriously. Thank you Charters Towers and thank you Vern. 730m.

ar

VERN KERR DRIVE

Named in memory of Vern Kerr for his contribution to the community. Vern Kerr, MWIA MSWP (USA), was a radio technician for the Royal Flying Doctor Service 1934-1977. He transferred from the Cloncurry Base in 1952 to establish the Charters Towers Base, and in 1963 the School of the Air, both at 22 Dalrymple Road.

Recognised for his dedication to duty where he gave encouragement in illness, tragedy and disaster, often under atmospheric stress.

Vale 7 September 1979

Charters Towers City Council - 19.8.98

'Amateur Television For JOTA

By Barry Cleworth VK5BQ
PO Box 176 Stansbury SA 5582

There is little doubt that among the many modes of transmission available to radio amateurs, television has the potential to capture and maintain the interest of JOTA participants. This is particularly so when a full duplex system is employed, enabling Guides and Scouts at both ends of the link to see and hear each other simultaneously.

The Links

Following our previous year's example, David VK5KK and I set up a wide band FM ATV link, using frequencies on the 1.2GHz and 2.4GHz UHF bands, between my QTH at Stansbury on Yorke Peninsula, and the SA VHF Group headquarters at the Elizabeth water tower. A back up link was also established at David's QTH, where his superior elevation of 185 metres ASL provided continuously reliable results.

Although the path length to VK5KK exceeded 80 kilometres, P5 pictures were achieved for most of the time. The option to establish links between Guide/Scout halls was not considered, due mainly to anticipated propagation problems presented by their locations.

However a link between VK5BQ at Stansbury and Lee VK5YLE at Greenacres made possible a relay on 426.25MHz to the O'Halloran Hill AM ATV repeater. VK5RTV viewers across Adelaide were able to see some of the JOTA activity on the repeater's normal output frequency of 576MHz (Channel 35).

This output frequency being on a public broadcast channel provided a window for the general public to view JOTA activity. Reports of signal quality by some of the viewers were most favourable.

An engineering channel was also established on 70cm to provide liaison between the 'technical directors', Barry VK5BQ and David VK5KK.

The ATV Studio

Since the radio shack at VK5BQ is only a converted fourth bedroom in the house with quite restricted floor space, it was again decided to set up the lounge room as the



Photo 1. The Guide assembly being briefed before operations began. Note the use of reflected lighting to reduce eye strain.



Photo 2. The full complement of guides in "Studio 1" at VK5BQ, with Peter operating the camera.



Photo 3. A junior Guide talking via 1250MHz to a Scout at the water tower whilst watching him on the return 2439MHz link.

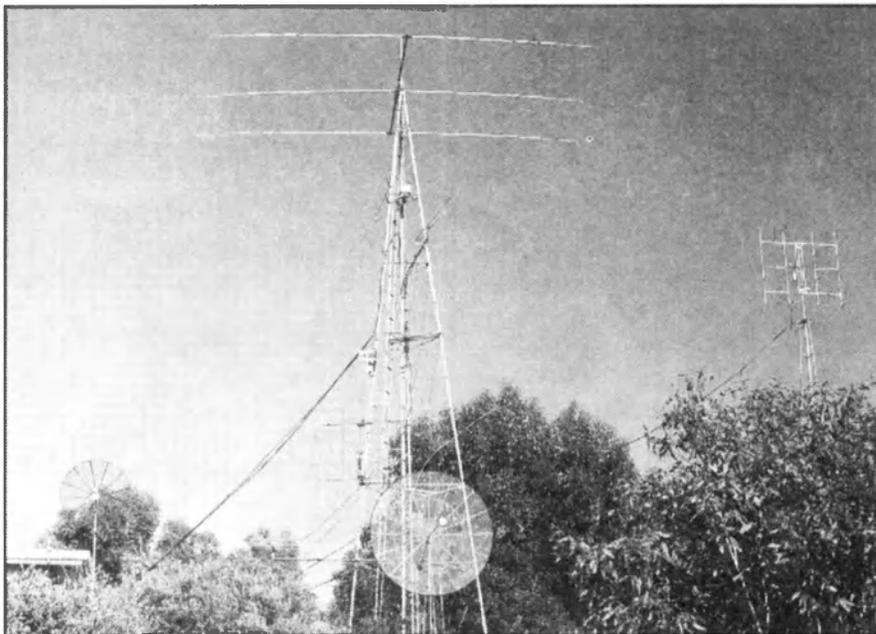
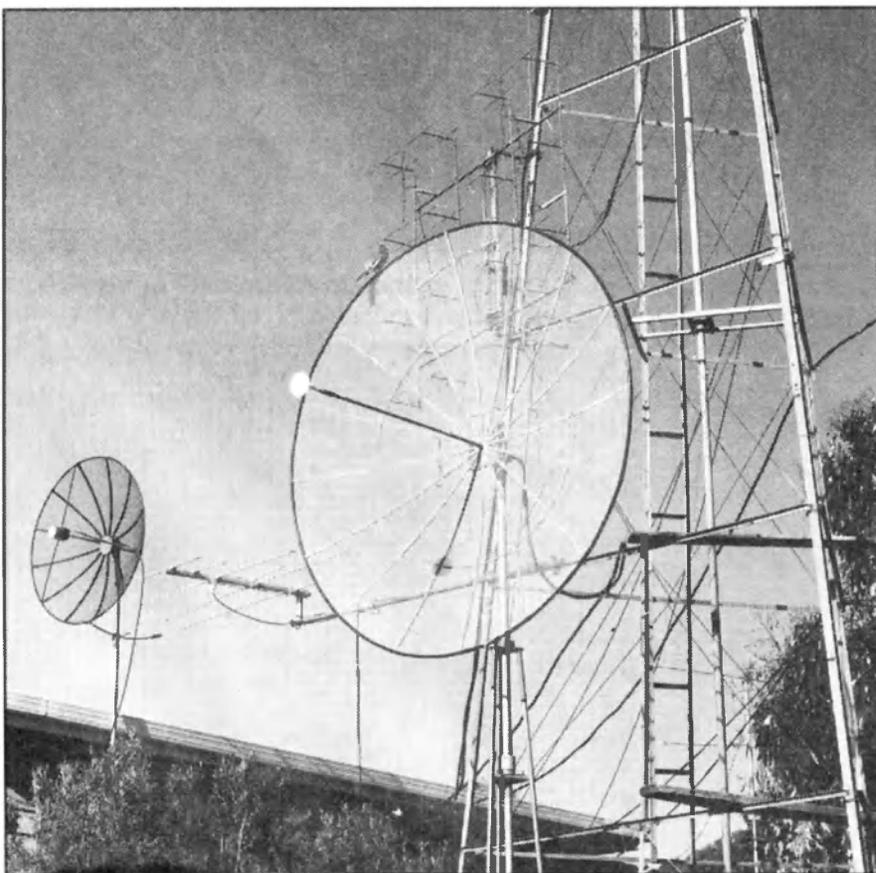

Photo 4. A general view of the antenna systems used at VK5BQ. A HF Yagi, 2 parabolic dishes, 2.4GHz Loop Yagi and two 70cm Co-linear arrays.

Photo 5. The two home brew dishes at VK5BQ. The 2.1m dish used on 1250MHz and the 1.2m dish on 2439MHz.



JOTA studio, where the twenty young Girl Guides and their leaders could be more comfortably accommodated. However it became quickly apparent that the studio was just on the 'overload' point, confirming the author's view that small JOTA groups are to be preferred both for ease of accommodation, and behavioural controls.

In regard to the last subject I am aware that there are many amateurs who have withdrawn their assistance to JOTA through behavioural problems. However I could not have been more satisfied with the behaviour of my group, which included girls from Yorketown, Minlaton and surrounding areas.

Equipment Used

The girls watched their JOTA counterparts on a 63cm receive monitor with audio and video inputs from the 2.4GHz receiver in the shack via shielded tie lines, under the floor. The 2.4GHz transmissions from the water tower emanated from a 25W transmitter and slot antenna. The backup signal from VK5KK radiated from a parabolic dish fed from a 5-watt transmitter.

In the studio at VK5BQ, two cameras were initially employed, utilising a video switcher routed to the shack (transmitter room). However one camera was retired due to malfunction.

Audio via two microphones was fed through an audio mixer prior to being routed to the transmitter.

Two 34-cm monitors were deployed in the studio for monitoring camera output, and final program 'line' output, prior to being applied to the transmitter.

The transmitter was fully home constructed from kits available in VK5, was set up for about 19 watts output, and fed via LD4-50 heliax cable to a fully home constructed 2.1 metre parabolic dish. The output frequency of 1250MHz is an accepted simplex channel regularly used by up to about ten amateur stations in VK5.

Received signals on 2.4 GHz returned via a 1.2 metre dish also fully home-constructed. As most ATVers will be aware, activity on amateur television still remains within the realm of the equipment 'home brewer'. In fact, the only commercially manufactured equipment used for this event at VK5BQ were the camera and monitors, and of course the 70cm liaison transceiver.

Another small piece of equipment used was the vision distribution amplifier, (VDA) or video splitter if you like. These devices are used to obtain several video signals at IVP-p, from the one source. In our case it was required simultaneously to record both incoming and outgoing program, necessitating multiple video and audio outputs.

Two other monitors were also fed from one of these VDA's as it was required to monitor the off-air signal and the incoming received signals.

Lighting in the ATV studio is not something to be overlooked and after some experimentation, a big improvement over last year's effort was realised. Fluorescent tubes were tried but abandoned in favour of incandescent lighting with daylight deliberately excluded, as a mixture of two lighting sources with differing colour temperatures is rarely satisfactory. The improved lighting, coupled with the excellent smooth camera work by my son Peter, drew several favourable comments from various viewers some of whom were not involved in JOTA.

Problems Encountered

Few technical problems became apparent, despite the very hot and windy weather on the Saturday and the resulting brief power outage, fortunately not requiring the generating set. Some SSB interference affecting the audio circuits at the water tower caused some concern, but was quickly dealt with by Dave VK5KK.

Interaction between transmitter and receiver was not a problem, no doubt due in part to the positioning of the parabolic dishes and, of course, their sharp radiation patterns.

Although propagation conditions were a bit variable on the hot and windy Saturday afternoon, a cool change going through the area brought improved signal stability on Saturday evening and Sunday morning.

Other Modes

At about 8PM on the Saturday evening the ATV gear was switched off to facilitate activity on the HF bands, but despite the 400 watts PEP on 20 metres fed to a 3 element triband beam, results were very disappointing. Quite a few contacts were made on 2 metre and 70 centimetre repeaters. Scouts and Guides at the water tower however were involved with JOTA contacts and HF.

Publicity for JOTA

A surprise event emerged this year in the form of a visit to the water tower by a team from a commercial television company based in Sydney. Four staff members including cameraman, sound technician and interview officer were very pleased to record a segment for the Channel Nine weekly children's program "Squawk". They were quite impressed with our TV link for JOTA. Perhaps it should be put on record here, that although the media and professional TV stations regularly involve themselves in two way (duplex) TV links, often on a daily basis, it is probably quite rare among ATV operators, particularly over 80 kilometre paths.

In conclusion I would like to thank my two assistants, Gordon Welsh VK5KGS, and my son Peter, for their excellent help. Hopefully next year more ATV stations with very small groups of Guides or Scouts may become involved, using some of our ATV frequency allocations on the UHF and SHF bands, perhaps with duplex cross-linking. It is certainly a challenge and some planning by David VK5KK and others may already be in the pipeline.

ICOM *Clearly Ahead*



"VK3LZ calling!"

More sound information from your friends at Icom

OUR AMAZING IC-R2, IN SHORT SUPPLY BUT WORTH THE WAIT!

The big performer in a small package, the IC-R2, is breaking sales records right around the world and particularly in Australia. Naturally enough this is causing us a few supply hiccups, so if you're interested in an IC-R2 you may have to be a little patient with your Icom dealer.

All our dealers are dedicated to fulfilling every customer inquiry, however in the case of the IC-R2 it's a case of circumstances beyond their control. If you have your sights set on an IC-R2 let us reassure you it is certainly worth the wait, and hopefully that wait won't be too long.

IC-40S USERS NOW HAVE AN IN-VEHICLE OPTION

IC-40S owners, and there's a lot of them out there, now have no excuse for being out of touch out on the open road. A new accessory, the BE195/196 battery eliminator enables the radio to be operated off the car supply.

The IC-40S is recognised as another proven Icom performer, and this new option makes it just that bit more versatile.

THE HAMFEST FUN CONTINUES!

Shepparton Hamfest
September 12

Townsville Hamfest
September 24 to 26

Gold Coast Hamfest
November 13

"...73"

FreeCall 1800 338 915
290 -294 Albert Street
Brunswick, Victoria 3056

Tel : (03) 9387 0666

Fax : (03) 9387 0022

www.icom.net.au

ACN 006 092 575



Photo 4. The twenty young Guides in attendance at VK5BQ at Stansbury.

The End Of An Era

Christine Taylor VK5CTY

The following is not just a story about the great work done by a group of volunteers but should waken other groups to the possibilities in your area for establishing a permanent meeting place.

Disused water towers also make good meeting venues and great VHF sites.

What other clubs can boast their own venue and share what it took to get it?

On Tuesday 22nd June 1999 a particularly significant meeting of the WIA(SA Div) was held. It was a "wake". The last meeting of the Division in the Burley Griffin Building. Never again will we be able to say we are meeting in an incinerator!

For those of you who do not know the history of the Burley Griffin Building it may come as a surprise to hear that what was once a municipal garbage incinerator that was converted into our Headquarters building.

Geoff VK5TY told the story to those who had gathered to say "Goodbye" to an era.

Geoff had been involved in the search for

a suitable building for the headquarters of the WIA(SA Div) back in the late 60's and early 70's. He was also deeply involved in the removal of the furnace and the beginning of the conversion of an incinerator into a meeting place.

The Burley Griffin Building was not the first site considered for a headquarters but it served the Division very well for over 20 years. For more details of the other options see "Amateur Radio" for November 1975.

That Walter Burley Griffin designed the city of Canberra is known to most of us. That he also designed and built several suburban developments in Sydney is less well known. He was a landscape architect from Chicago before he won the right to design the beautiful city of Canberra. On one of his trips back to the US he bought the agency for reverberatory furnaces to be used for the destruction of domestic waste.

At least five of these furnaces were built in the Eastern cities but only two in South Australia. (One is in Ipswich, Qld. Bob VK4KNH) The one used by the WIA still

stands. It has a Heritage Rating and had this when the SA Div. took on the lease from the Thebarton Council, in 1972, in whose grounds the building stood.

We could do whatever we liked with the interior of the building, only the exterior had to be preserved. Anyone who has walked around the outside, particularly around the area furthest from the Road, will understand why this was important. It has some of the most beautiful masonry-work I have ever seen, and the random colouration of the red bricks is quite spectacular.

One of the features of the building that appealed to radio amateurs was the tall chimney. It was ideal for mounting aerials. However the chimney had its own surprise. The chimney was made square because that is aesthetically pleasing, but a square chimney does not draw well so inside the square chimney there is a round chimney to serve the incinerator! After all bricks were cheap in 1937!

When the SA Division chose it as their future headquarters it was still a municipal

incinerator. It had outgrown its usefulness almost 20 years earlier because the amount of garbage had outgrown the original expectations of Walter Burley Griffin. It had been standing idle for some time and apart from the ramp that had carried the garbage trucks up from the road, it was untouched.

When it was in use the trucks backed up this ramp and emptied their load into a large hopper. From this hopper a sloping ramp fed the garbage into the massive furnace below, at intervals. The furnace occupied the entire ground floor (the room in which the wake was held). From the furnace

Photo 1 The outside showing the remarkable workmanship and detail.



there were a number of channels or flues that could be opened or closed for different purposes. The heat and the waste gas could be fed directly up the chimney, of course, or it could be used to preheat the garbage, or to apply heat to an asphalt cauldron in an annexe. Other channels fed in air under pressure to fan the flames in the oven - altogether, a complicated arrangement.

After the garbage was burned it was scraped out into a small railway type truck below the furnace and emptied into a pit behind the building.

Fortunately a plan of the original building (1937) was found, which was a great help to Geoff and his helpers as they set about their work of internal destruction. They had considerable difficulty sometimes in discovering how to get into or out of particular sections of the building, particularly into the chimney. They even found a room that did not appear anywhere on the plans!

Work started on the Sunday after Easter 1973 and the building was officially opened on April 4th 1977 though it had been in use for some time before that.

As can be imagined, everything was extremely dirty and full of odds and ends of junk, so the first task the workers faced was a basic clean-up once they had made the first survey of their property. However, the destruction of the actual incinerator oven occupied the workers for most of a year.

The furnace itself was a steel box 16ft by 12ft by 8ft high (5.3m by 4m by 2.6m) lined with firebricks. All the corners were reinforced with 3"x3" (80 x 80mm) angle and the sides and back braced with 6" by 3" (150 x 80mm) channel. The whole lot was bolted together with large bolts with their heads concealed on the inside. An oxy-cutter wielded by Leith VK5LG was used to cut the nuts off all the bolts at the pug-hole end of the oven one weekend and four weeks later the pug-hole was full of firebricks and the steel plate from that end was cut into sheets and stacked.

They could see the far end of the basement!

Getting into the chimney presented its own problems. After all one of the advantages of the building was the chimney on which all the antennas would be mounted. It took several evenings with torches to discover that first you had to go down below the floor of the furnace through a channel about a 3ft by 2ft before you could stand up inside the chimney.

That was when it was discovered that there was a circular chimney inside the square one you see from the road. The internal diameter of the circular chimney is

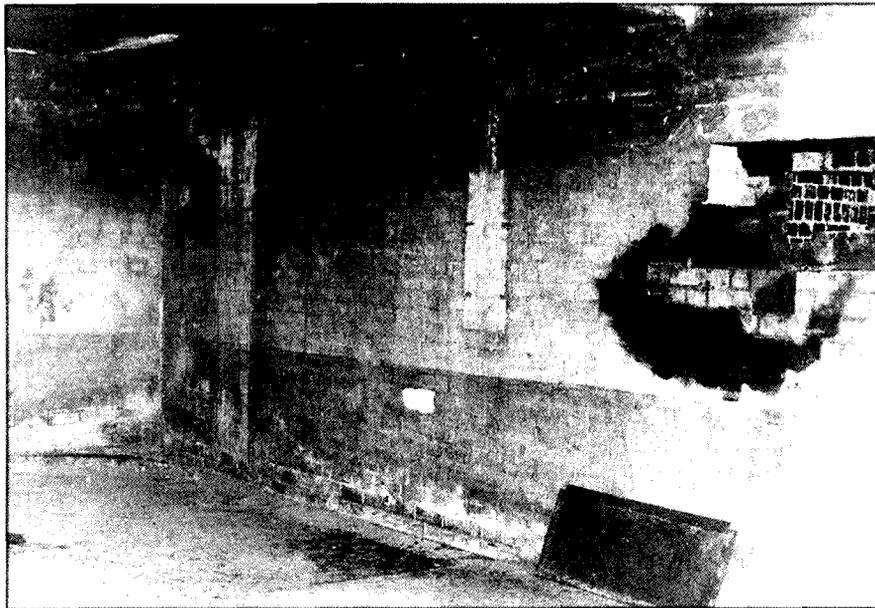

Photo 2 The insides before fitting out.

about 4ft or 1.3m so that to erect a ladder inside the chimney to get to the aerials a number of sections about 5ft long had to be made.

Fortunately there was a small flue that feeds into the chimney from the transmitter room so the cables did not have to go down into the basement first.

Once the way into the bottom of the chimney was discovered the next problem was how to get the first wires down the chimney which was too high to reach with any extension ladder and the workers did not have access to a 'cherry picker'.

Many and varied were the ideas offered - and tried, too. A rocket with a line attached was suggested but not tried. A 12-gauge shotgun loaded with wooden bullets to which a nylon fishing line was tied didn't work. The first bullet just disappeared into the stratosphere. At the second attempt, possibly because the velocity was too high, the line broke.

Then one morning Geoff asked his son Murray to bring along his bow and arrow and give that a try with the fishing line attached. The first arrow flew over the chimney but when he tried to pull it back gently so it would fall into the chimney it came right back over and fell down on the wrong side. The second one hit one or two bricks below the top of the chimney and slowly cartwheeled into the opening and straight down.

Once the first line was down it was easy to draw successively thicker cords till at last the first wire was in place. There was one moment of panic, though. Geoff was lying on the floor looking up the chimney to make

sure the strings didn't snag on anything when, all of a sudden he thought the string had dislodged a brick, as this black blob fell down the chimney towards him.

He wriggled out of the chimney so fast it "looked like the Indian Rope Trick done horizontally", as he described it. What had happened was that someone had tied the reel of fishing line to the first cord and it was the reel he could see, not a brick.

Once they could feed a length of 12-gauge fencing wire down they made it into a loop inside and outside the chimney so should any new wires be required they could be easily lifted. Since that day many more wires have been fed through that chimney.

Once the bricks were removed, emptying the basement was relatively easy. Many of the steel sheets were too heavy to be picked up by hand or easily cut into smaller sections. So Treva VK5ZIS took his car around to the car park across the pug-hole from the incinerator. A rope was attached to the tow-hitch and he drove off while someone kept a foot on the sheet till the tension was judged to be enough. The foot was lifted, whereupon the great sheet of steel flew through the air and into the pug-hole.

Two other major demolition tasks remained. One was to break up the concrete and brick retaining wall where the ramp had originally been and where the new toilet was to be built. The other was to clean away forty years of greasy soot throughout the building but especially in the basement.

The latter was accomplished astonishingly easily when, one day, a heavy-duty fire hose was used as a last resort. The

soot and accumulated dirt almost fell off the walls. It was amazing!

The accompanying photograph shows what had to be used to break up the retaining wall. Instead of pouring a concrete wall and facing it with attractive bricks, Walter Burley Griffin had first built the brick wall and then tied the reinforced concrete facing to the bricks. Without the loan of the council jackhammer and the air compressor to run it, that wall might still be standing!

As the photo also shows the jackhammer was too heavy to be held horizontally by hand (after all it was intended for use breaking up a tarred road surface) so it had to be suspended by a block and tackle. Even so, the operators took it turns at 20 minute intervals and were very glad of the rests in between.

Geoff and Barry VK5ZBQ who shared the supervision had help from 50 or more members from the most junior to one of the oldest, Roy VK5AC (no doubt known to many of the longer-term readers). Roy manned the gate week after week during the four years it took to turn an incinerator into a meeting place.

After of the demolishing team had had their go, the builders, painters and carpenters were called upon. Cupboards were built, partitions erected and stairs constructed. A professional builder, the father of Garry, now VK5ZK, built the toilet block for an extremely reasonable price, but otherwise all the work was done by amateurs themselves (some of whom were, of course, tradesmen as well).

One door, that now opened onto thin air, was bolted shut, another, that led out to a very narrow stairway, was closed off to be used only for bringing large and awkward loads to the top floor. A ramp to allow access to the upper floor and a disabled toilet were later additions.

One of the major projects was the covering and sealing of those most attractive arched 'windows' that were a feature of the lower faces of the building.

Unfortunately these 'windows' were just shaped openings in which the shaped concrete forms had been fitted. They had never had, and had never been intended to have glass in them. After all who needs glass windows in a building designed to house an incinerator?

The building team did try to find a way to put glass in the openings, but it was just not practical, especially where it was realised that the windows would have needed to be lighted from the outside for the lovely shapes to be seen at night meetings.

This was another reason it would have been so much better if the whole building had been turned through 180°. All the most attractive sections face away from the road!!

The other major building task was to close the opening out to the pughole. That became a set of three windows looking out to what was hoped one day would be a garden.

As almost all the meetings held on the incinerator floor were evening meetings the

garden never quite seemed to become a priority.

In terms of time taken, the demolition took something under a year. The conversion of the interior into a meeting-house took well over two years. So it was almost four years from the signing of the contract to the official opening.

A videotape of the official opening by David VK3ADW was shown at the wake. This is when we first heard of the astonishment expressed (by the members in general, and by the Federal Council) when Geoff mentioned the incinerator at a Federal Convention, and how very impressed David was to see the building, now.

The unveiling of the plaque, that day, was done by the Mayor of the Thebarton Council who had been enormously helpful throughout the reconstruction of the building. It is because this Council no longer exists, having been amalgamated with the West Torrens Council, that the WIA(SA Div) can no longer occupy the Burley Griffin Building. The end of another era.

The accompanying photographs go some way to showing what a beautiful building was built to house a municipal incinerator.



Photo 3 Making a hole!



AMATEUR TRANSCEIVER RADIO CENTRE

NO 1 FACTORY DIRECT
IMPORTER
AUTHORISED DEALER

ALINCO

**MASSIVE MONTHLY STOCKIST
LATEST ARRIVALS**

NEW DJ-V5E 6w VHF/UHF
DR-M06T 6m, DR-610E, DJ-G5EY,
ANTENNA TUNERS, POWER SUPPLIES,
BIGGEST DISCOUNTS ON BULK
PURCHASES OF ALINCO AMATEUR
RADIOS & ACCESSORIES.
FULL 3-YEAR FACTORY BACKED
WARRANTY
ALINCO SPECIALIST



IC-706MKIIG, IC-T81A
 IC-2800H, IC-746, IC-756-Pro
 IC-T8A, IC-R75, IC-Q7A.

KENWOOD TS-570SG TM-V7A
TH-G71A VC-H1 TH-D7A TM-G707A TS-870S

DIAMOND X-510NA, D-707E
AMERITRON AMPLIFIERS
 AL-811AX 600 WPEP
 AL-811HX 800 WPEP

PHONE (02) 9896 2545
 E-mail: atrc@bytelink.com.au
 Web Page:
<http://users.bytelink.com.au/atrc>

This Radio Star is alive and kicking

SUNDAY EXAMINER, JUNE 6, 1999

Internet won't kill the radio star: Rob

A SHARP-TONGUED newspaper editor once told cerebral palsy sufferer Rob Harwood he'd never make it as a journalist. That was more than 30 years ago, and Mr Harwood has been writing a monthly column for a national magazine for the past 20 years. His subject of



Robin Harwood at the console.

• Surfing the waves: The

A sharp-tongued newspaper editor once told cerebral palsy sufferer Rob Harwood he'd never make it as a journalist. That was more than 30 years ago, and Mr Harwood has been writing a monthly column for a national magazine for the past 20 years. His subject of interest is short-wave radios, a hobby that he says has kept him in touch with the world and its affairs, all from his Newstead home. He told MANDY SMITH why even the Internet is yet to replace radio as an information source and communication device.

FOR 45 years, Rob Harwood has had a special insight into the world.

As a short-wave radio listener, Mr Harwood has heard broadcasts from around the world, whether they be civilian stations, war communication or police frequencies.

He spent hours glued to his radio during the 1998 Sydney to Hobart yacht race disaster, and is now listening to broadcasts relating to the unrest in Yugoslavia and Kosovo.

"I have heard anything from the US military bombers as they go in; when the Vietnam War was going on and the planes were going across the Pacific, it was almost non-stop chatter," he said.

"Down here in Tasmania we are in a very strong position, we can hear things you can't hear in countries with busier airwaves."

Mr Harwood, 52, writes a regular column in the national Amateur Radio magazine, and does other freelance work, all while keeping in touch with other enthusiasts from around the world.

"I started off when my parents had a big, old mantel radio and I remember in the

middle of June getting out of bed at 6am and rushing to the lounge and managing to pick up the BBC and rushing to tell my parents," he said.

"It was exciting because I wasn't allowed to touch the radio because it belonged to dad, but I was just fascinated by it and by radio signals."

"Because of my disability I suppose it was very, very exciting."

Mr Harwood was eventually given his own mantel radio.

"The first exciting signal I heard on the radio was a Sputnik," he said.

"That started me off."

"It took me another 15 years before I got my own amateur radio."

Mr Harwood's Newstead bedroom now houses two receivers, a VHF transceiver and computer.

He says the Internet has become an invaluable source of information.

"I get more of my information from the Internet than I do my radio now," he said

"By using the Internet I can communicate indirectly with the stations and you can download audio from the Net."

Written by Mandy Smith
Published in the Sunday
Examiner, June 6, 1999

Reprinted here with permission of the editor.

"I can open a receiver in, Sweden from here via the Internet, you can operate receivers in lots of other countries."

"Surfing the waves. -The Internet can be stopped - the conflict in Yugoslavia proved that - but they can't stop radio," says, Rob Harwood.

That allows me to hear things we can't hear here.

"Most of my information for my column I get from the Internet or people send it to me. (But) when there's an international crisis we go to shortwave."

"The Internet can be stopped - the conflict in Yugoslavia proved that - but they can't stop radio."

"The Internet is certainly different from short-wave radio but there's still enough to keep my interest up."

Mr Harwood said that like short-wave, computers had helped open up the world for him, and others with disabilities.

When he started his magazine column, he had to type each article, double-spaced and post them to his editor three weeks before deadline; now he taps them into the computer and sends them via email within minutes.

"If I had a computer when I was at school I reckon I would have gone on further," he said of his journalistic ambitions."

"I know people who are badly handicapped but all their intelligence is up there but with a computer they can communicate."

ar

A Binaural Direct-conversion Receiver

Drew Diamond, VK3XU
45 Gatters Rd.,
Wonga Park, 3115.

If you have been following developments in direct conversion (DC) receiver techniques, you will be aware that there are basically three (non-digital) methods. The first, and traditional approach is to mix the incoming signal with a VFO whose frequency is the same, or near that of the signal frequency. The wanted demodulation product is audio, which is generally band-pass filtered and amplified to the required level for listening.

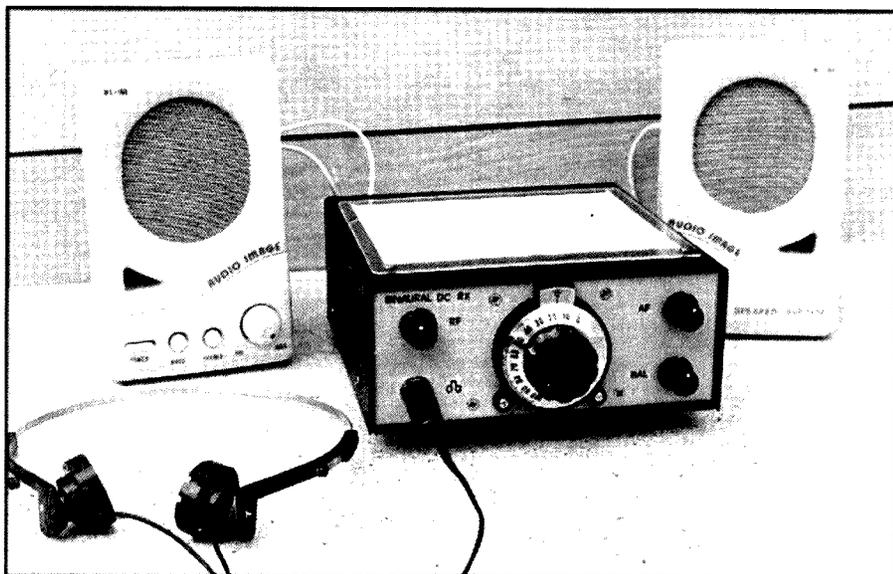

Photo 1: the complete set-up

With care, a quite respectable DC receiver can be built from one of the many descriptions in contemporary radio literature. The performance obtained may seem to be out of all proportion with the simplicity of the set. However, because the unwanted "sideband" is not suppressed, we may hear twice as much noise and adjacent-channel interference than from a "single-signal" receiver. A good straight DC receiver will have a pleasing clarity which, perhaps, partially compensates for this shortcoming. For further information, References 1 and 2 are recommended as being particularly good essays.

Even with a well-made audio filter, reception of the "audio-image" always occurs with a first-method DC receiver. Various ingenious techniques have been applied to the audio-image problem. Most published designs make use of 90-degree phase shifted VFO, and 90-degree shifted audio components which, when correctly combined, results in adequate suppression of the unwanted sideband (see Refs. 4, 5 and 6).

Another technique inclines towards superhet principles, where an additional local oscillator moves the signal to some intermediate frequency for manipulation

(Refs. 7 and 8). However, these last processes are rather complex, and require close-tolerance components and diligent attention to design and layout, which gets away from the beautiful simplicity of the first method.

Binaural Receiver

Happily, there is a middle-ground approach, which was described by Rick Campbell, KK7B, and published in the March '99 issue of QST (Ref. 3). In essence, Rick uses

continued on page 26

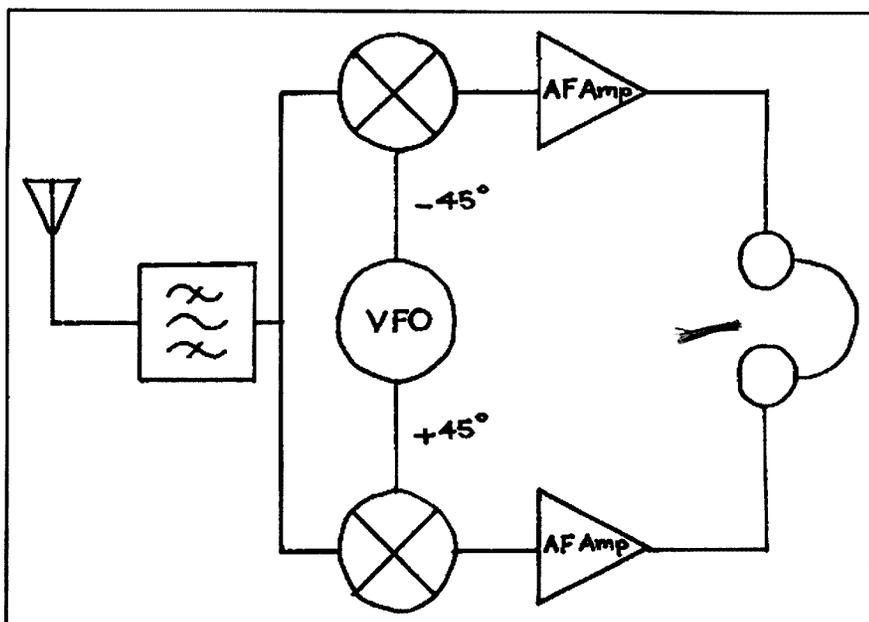

Figure 1. Block diagram

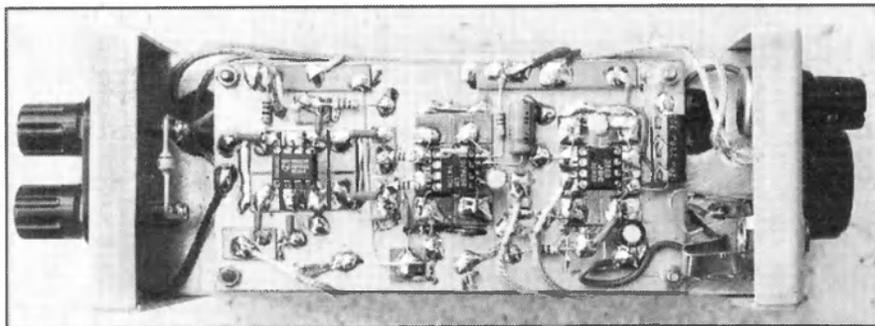

Photo 2. Input band pass filter and shared 7806 regulator chip located on one board

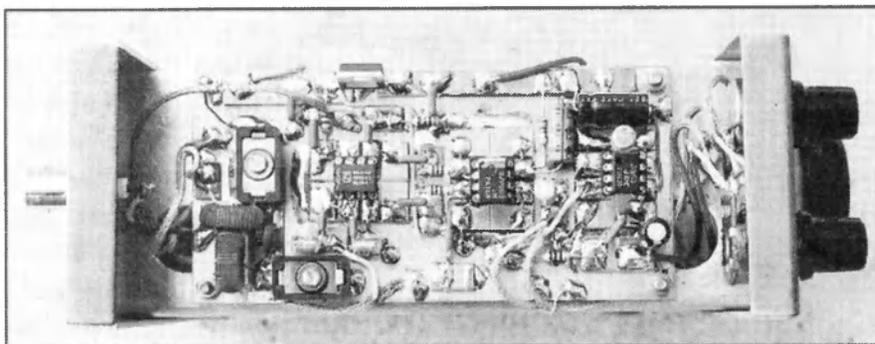

Photo 3. The bare bones receiver

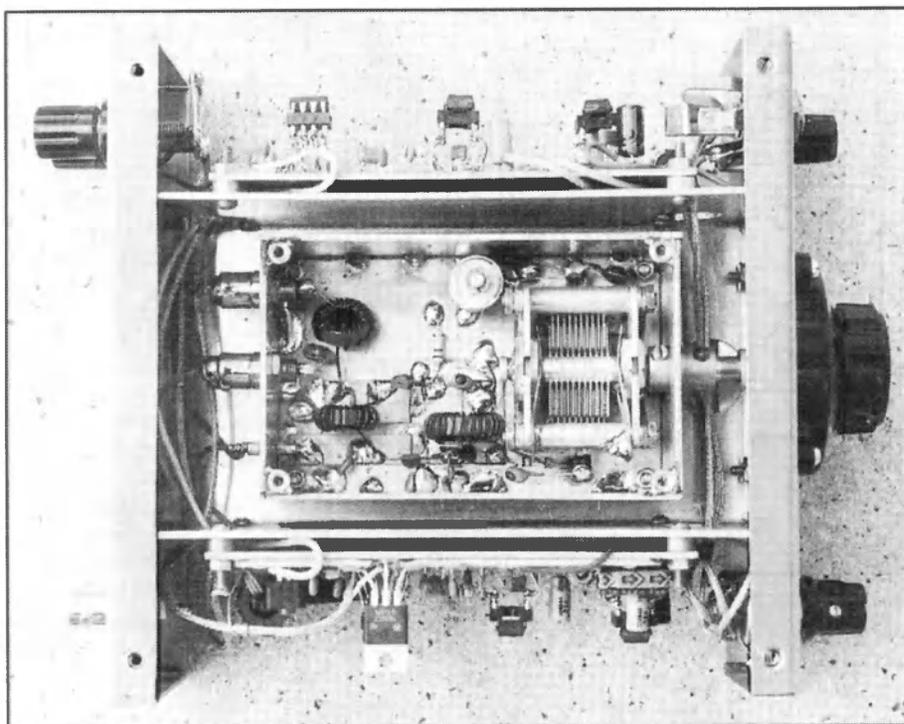

Photo 4. The 95/60mm VFO board

two identical DC receivers, which are fed in-phase from a common antenna input (see block diagram Fig. 1). Each mixer is injected with a VFO signal, which is split into two components whose phase difference is effectively 90-degrees. Detected audio (AF) components are amplified, then applied to the left and right coils of a pair of stereo headphones. The same demodulation products are present in each channel, but their relative phase provides a stereo effect which, to the listener, is perceived as having come from the space around the head.

Listening to CW, and SSB stations on a binaural receiver is a pleasantly novel sensation, to say the least. It's as if the signal were put through a PC sound-card. As a signal is tuned, it seems to move in position, and is perceived to go from one side to the other. The spectrum within the receiver's pass-band appears to be spread out in the space around the listener's head. The wanted signal can be made to take up a location somewhere in the middle. Unwanted, or incidental signals will appear to right and left. Writing personally, I don't mind hearing a bit of adjacent-channel chatter, or other CW signals- it all adds "atmosphere" to the experience. Any necessary selectivity is obtained from the "filter between the ears". Interestingly, receiver noise, natural and man-made noise is observed to be evenly spread, and is therefore less annoying than if it were concentrated in the middle, as in a conventional receiver.

Sensitivity of my model is quite good. Signals as small as 0.2 microvolt may easily be heard. Signal handling, although not as "strong" as the QST pattern, should be adequate for all normal listening. A high-powered local transmitter, only about 900 metres from here causes no significant overload problems. Whilst not as striking as with 'phones, a pair of PC "sound-blasters" style speakers also works well with the receiver. The set operates from a nominal 12 V dc supply, and draws about 30 mA.

Circuit

As some of the components used in the QST circuit may be difficult to obtain here, I have adapted and modified the popular NE602-LM741-LM386 plan to the binaural scheme.

Referring to the schematic, Fig. 2; signals in the 3.5 to (about) 3.9 MHz range from the antenna via the 1 K attenuator pot, are admitted by the top-coupled band-pass filter, and applied simultaneously to the input pin 1 of each NE(SA)602. The conventional Hartley oscillator, maintained with an ordinary MPF102 FET, is variable from 3.5 to about 3.9 MHz, and is followed

by a second MPF102 as buffer amplifier. Broadband transformer T1 steps the drain impedance down to approximately 50 ohms in order to drive the 56 ohm terminations at pin 6 of each '602.

To obtain our -45 and +45-degree VFO signal components, the buffer amplifier's output signal is made to negotiate a capacitor, whose reactance mid-band is -50 ohms for the -45-degree signal, and a coil of +50 ohms to produce our +45-degree signal.

For each receiver channel, demodulated (or detected) audio as applied to a conventional LM741 and LM386 audio amplifier to raise the AF signal to an appropriate listening level. The '741 has 3.3 nF capacitors across each 220 K feedback resistor to roll-off the upper frequency response, starting at about 1.5 kHz, and is 10 dB down at 4 kHz.

Construction

In order to keep unwanted broadcast, TV and FM signals out, the receiver, and especially the VFO, should be housed in a metal box. The home-made aluminium case shown in Photo 1 measures 65 x 155 x 155 mm. Any box or case of similar dimensions will do. I prefer "paddyboard" (see Ref. 9) style board construction, because it allows almost unlimited experimentation during, and after fabrication. Each receiver board measures 55 x 110 mm. The input band pass filter, and shared 7806 regulator chip are located on one board (Photo 2), and the second board has just a "bare-bones" receiver (Photo 3). Wire-wrap sockets mounted upon substrates are recommended for the I.C.'s.

The schematic shows which signal-carrying connections need to be made with shielded wire. Keep wiring to the 'phones connector and AF gain/balance pots well separated. The balance (bal) pot is not essential, as the sensitivity of each of the receive channels are almost (or should be) identical. However, there may be times when it is required to move the wanted signal to one side without using the VFO control.

If you are using a small antenna, and/or there are no strong transmitters in your area, then the RF attenuator pot will probably not be required, but it is shown here just in case.

The VFO board measures 95 x 60 mm, and is shown in Photo 4. The VFO components were mounted paddyboard style first, then the circuit board walls soldered on to make a box 40 mm high. Use a good quality air-spaced variable capacitor of about 95 or 100 pF maximum.

Some method of slow-motion driving the VFO capacitor will be required. The dial shown in Photo 1 is available from Dick

Smiths. However, they do seem rather dear, and anyway, everyone has their own ideas about dials, so naturally I leave that department to you.

Operation

The receiver must operate from a low-impedance 12 V dc source, such as a regulated power supply, or fresh batteries. The earphones do not have to be fancy or expensive (but so much the better if you can use a posh set). The '386s will drive just about any of the customary impedances, but if your 'phones are low impedance, such as 8 ohms, you may need some resistance in series with each coil to limit the power to a reasonable level.

Check all your wiring, component locations and polarities (where applicable). If you have used sockets for the ICs as suggested, remove them from their sockets. Apply 12 V supply. With the means available to you, check that the VFO is working. Adjust the 25 pF trimmer so that 3.5 to about 3.9 or 4 MHz is generated.

Each audio amp may be tested first. Connect 'phones or speakers. Apply 12 V with just the '386s inserted. With the AF gain pot at maximum you should hear just a soft hiss. Touch a screw-driver blade to pin 3 of each '386. A buzz will be heard, indicating that the amplifier is working. Remove 12 V and insert the '741s. Reconnect 12 V. The soft hiss will be a little louder now. Touch the screw-driver to pin 2 or 3 and expect a louder buzz. Insert the '602s. A little more noise now and if all is well, it will have a "spatial" sound.

Connect an antenna. We all hate interference, but this is one time when the line-buzz from a nearby TV set or PC makes a handy alignment tool. Carefully adjust / peak the 55 pF trim caps at the input filter for best sensitivity flatness across the band. Some compromise may be necessary, but the set should be quite sensitive between 3.5 and 3.9 MHz. When all is satisfactory, calibrate the dial, or make a look-up table or graph, as desired.

Some salient dc and p-p oscilloscope voltages are shown on the top circuit to assist in any necessary troubleshooting.

Parts

The majority of components are available from the familiar electronics suppliers, such as Altronics, Dick Smiths, Jaycar and Electronic World. See Hamads in this journal for Amidon core suppliers. Electronic World (ph 03 9723 3860) will also answer mail orders, and can supply all the usual parts, in addition to NE(SA)602s, 1 nF feed-through caps, 5-55 pF compression trim caps, 25 pF beehive trim

caps and 95 (+200) pF variable cap. I always keep a few spares, so do write to the address shown if you have genuine difficulty in obtaining any of the parts specified (SASE please).

References and Further Reading

1. "Direct Conversion Receivers"; J. Carr, Elcktor Electronics Mar 94.
2. "Improving DC Receiver Design"; N. Hamilton, G4TXG, Rad Comm Apr 91.
3. "A Binaural I-Q Receiver"; R. Campbell, KK7B, QST Mar 99.
4. "A New Breed of Receiver"; G. Breed, K9AY, QST Jan 88.
5. "High-Performance, Single-Signal DC Receivers"; R. Campbell, QST Jan 93.
6. "Polyphase Direct Conversion SSB"; R. Hosking, EW + WW* Mar 94.
7. "Direct Conversion SSB Receiver"; F. Dorcy, EW + WW Sep 94.
8. "High Performance Direct Conversion"; R. Green & R. Hosking, EW Jan 96.
9. "Paddyboard Circuit Construction"; D. Diamond, AR Feb 95.

*EW + WW = Electronics & Wireless World. EW = Electronics World.

ar



AV-COMM
Pty.Ltd

**SATELLITE TV
EQUIPMENT**
- Established 1981 -

**Specialising in:
Free to Air Satellite TV**

**CALL OR FAX
FOR FREE INFO PACK.**

198 Condamine Street
Balgowlah 2093 Australia

Tel: 61 2 9949 7417
61 2 9948 2667
Fax: 61 2 9949 7095

Internet: <http://www.avcomm.com.au>

FOR ALL YOUR COMMUNICATIONS NEEDS

High Performance VHF/UHF Base Station Antennas

Diamond base station antennas offer outstanding quality and exceptional value. These stacked collinear types provide high gain, wide bandwidth and a low radiation angle for extended range. The fiberglass reinforced polyester outer radome and gasket seals provide excellent all-weather operation and compact ground-plane radials are supplied. Stainless-steel mounting hardware ensures a long, trouble-free life. Supplied with instruction sheets for easy set-up.

2m Antenna F-23A

Frequency: 144-148MHz
Gain: 7.8dB
Max. Power: 200W
Length: 4.53m, max wind 40m/s
Type: 3 x 5/8"
Connector: SO-239 socket

D 4850

\$199
SAVE \$50

23cm F-1230A

Frequency: 1260-1300MHz
Gain: 13.5dBi
Max. Power: 100W
Length: 3.06m
Type: 25 x 1/2"
Connector: N-type socket

D 4870

\$199
SAVE \$50

Rugged HF 5-Band Trap Vertical Antenna

The rugged 5BTV incorporates Hustler's exclusive trap design (25mm solid fiberglass formers, high tolerance trap covers and low loss windings) for accurate trap resonance with 1kW (PEP) power handling. Wide-band coverage is provided on the 10, 15, 20 and 40m bands (SWR typically 1.15:1 at resonance, <2:1 SWR at band edges) with 80kHz bandwidth typical on 80m at 2:1 SWR. An optional 30m resonator kit can be installed without affecting operation of other bands. High strength aluminium and a 4mm (wall thickness) extra heavy-duty base section guarantee optimum mechanical stability. At just 7.65m, the 5BTV can be ground mounted (with or without radials, although radials are recommended), or it can be mounted in an elevated position with radial system. Unlike other antenna designs, the 5BTV can be fed with any length of 50-ohm coax cable.

D 4920

HUSTLER

\$399
SAVE \$50

30m Resonator Kit

Adds 30m coverage to the 5BTV and includes all hardware.

D 4921 \$99.95

Revex W560N HF/VHF/UHF SWR/PWR Meter

Quality Revex wide-band SWR meter, offering 2 in-built sensors for 1.8MHz to 525MHz coverage! Provides measurement of 3 power levels (3W, 20W, 200W) and SWR. Uses an N-type socket for the VHF/UHF sensor to ensure minimal loss. Measures 120 x 80 x 85mm.

D 1375

\$199
SAVE \$50



FT-3000M 70W 2m Mobile

An amazing 2m mobile transceiver from Yaesu with up to 70W RF output, MIL-STD 810 shock and vibration resistance, wide band receiver coverage (110-180 and 300-520MHz), dual band or dual in-band receiver facility, 1200/9600 baud packet socket, and a very large back-lit alphanumeric LCD screen. The FT-3000M has a total of 81 memories, as well as a Spectrum Scope mode that allows you to view activity above and below the operating frequency, or activity among six programmed memories. A programming menu holds over 50 transceiver settings for easy 'set and forget' access and includes a scrolling text help guide, while twin fans provide optimum cooling during long transmissions for greater component reliability. The FT-3000M is supplied with a MH-42A6J hand mic, DC power lead and detailed instruction manual.

D 3700

Frequency Range: Tx 144-148MHz
Rx 110-180, 300-520, 800-824, 849-869, 894-999MHz
RF Output: 70, 50, 25, 10W
Sensitivity (Ham bands): 0.2uV (Main Rx), 0.25uV (Sub Rx)
Dimensions: 140 x 40 x 180mm (WHD)

\$599
SAVE \$100

YAESU

2 year warranty



BOOKS BOOKS BOOKS BOOKS BOOKS BOOKS



ARRL Antenna Book on CD

A wealth of practical information on antennas, feed lines and propagation is provided in The ARRL Antenna Book, available for the first time in a convenient, easy-to-use CD-ROM format.

B 2218

75%

*Available selected stores only but can be ordered.

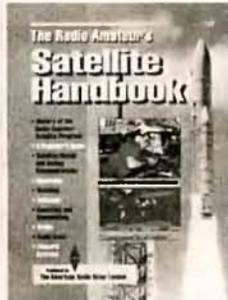

ARRL Satellite Handbook

In addition to the 15 chapters packed with the information you're looking for, there are appendices with active satellites, computer programs, Internet sites, a comprehensive glossary and more!

B 2404

\$4.95

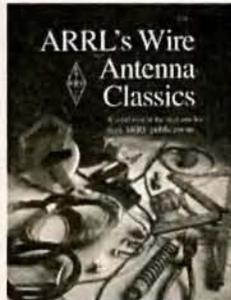

ARRL Wire Antenna Classics

A collection of QST articles covering wire antenna designs for most amateur operators.

B 2211

\$20.85



ARRL ON4UN's Low Band DXing

Long considered the Radio Bible for low-band DX operators. Covers radio propagation, antenna designs and operating techniques for serious 160-40m operators.

B 2201

3rd Edition **\$55***

CALL INTO DICK SMITH ELECTRONICS

Advanced Data Management Software

An advanced way to program many of the functions on the latest Yaesu handheld and mobile transceivers. Each package consists of an interface that plugs into the serial port of a PC and connects to the transceiver via its microphone socket (for handhelds) or its packet socket (for mobiles). Also provided is easy-to-use 3.5" format PC software with pull-down menus that allow for programming and naming of memory channels, selection of output power, CTCSS tones, scan and battery saver operation plus much more.

ADMS-1E Suits FT-10, 50R/RD, 51R, VX-1R, VX-5R D 3754

\$89⁹⁵

ADMS-2D Suits FT-3000M, 8500, 8000R/8100R D 3579

\$69⁹⁵

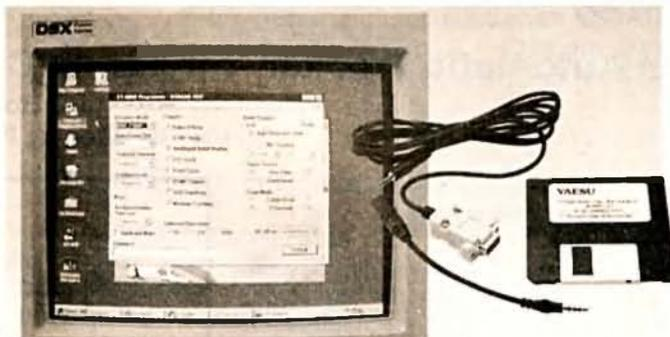

3-15V 25A Heavy Duty Power Supply

This solidly built benchtop power supply provides current of up to 25 amps ICAS at 15V, 20 amp continuous at 13.8V and lower current at lower voltages. It has front panel metering plus high current banana-style and low-current output connections. An internal heatsink and thermally switched fan provides cooling without protrusions in the metal case. Specially modified for more reliable long-term operation, it uses a rugged 50 amp bridge rectifier & trifilar transformer. Also provided is extensive overload protection through dissipation limiting circuitry for the pass transistors, a 30 amp instantaneous current limit, AC mains circuit breaker, a transformer thermal fuse and fused auxiliary secondary winding.

D 3800

\$299
GREAT VALUE!



Yaesu FT-1000MP Deluxe HF All Mode Transceiver

Yaesu has created a new 100W HF masterpiece using proven design techniques and a major new technology to the amateur marketplace: Enhanced Digital Signal Processing (EDSP). Teamed up with Direct Digital Synthesis, an outstanding receiver section featuring a high intercept front-end and a variety of IF filters (including a Collins Mechanical Filter), the FT-1000MP's exclusive EDSP facilities provide an impressive array of IF-based noise-reduction and interference reduction filters for enhanced receiver performance. Yaesu's IF-based EDSP system provides 4 random noise-reduction protocols, audio enhancement with 4 equalisation programs for Tx and 3 for Rx, and an automatic notch filter which eliminates multiple interfering carriers. A comprehensive menu system allows you to easily hear the effect of various EDSP settings, so you can choose the best selection for your operating conditions. Front panel selectable EDSP filter contours also aid QRM rejection, providing improved signal-to-noise ratios and razor sharp selectivity. The FT-1000MP also features selectable receiver front-ends, an in-built AC power supply and auto antenna tuner, 2 main antenna sockets, selectable tuning steps as small as 0.625Hz, dual-mode noise blankers, 13.8V DC socket, 500Hz and 6kHz IF crystal filters, an RS-232 computer interface and an MH-31B8 hand microphone. With so many features in this new transceiver, why not ask for a copy of the 12-page FT-1000MP colour brochure or 46-page technical overview for more detailed information.

D 3400

2 year warranty

YAESU \$4450



PHONE FAX AND MAIL ORDERS



PHONE: WITHIN AUSTRALIA: 1300 366 644
(Local call charge)

FAX: (02) 9395 1155 within Australia and
(+612) 9395 1155 from outside Australia

MAIL: DICK SMITH ELECTRONICS, Direct Link, Reply Paid 160,
PO Box 321, North Ryde NSW 1670 (No stamp required)

Visit our web site at
<http://www.dse.com.au>

**Excludes packaging and postage. All major credit cards accepted.
14 Day Money Back Guaranteed if NOT completely satisfied. (Software excluded)**

**DICK SMITH
ELECTRONICS**

That's where you go!

Yaesu transceivers and accessories stocked in selected stores only.
Other stores can place orders on a deposit-paid basis.

Technical Correspondence

Update on the 160 Metre Bandpass Filter

Keith Gooley VK5OQ

An Automatic Tracker -for Tuned Circuits

Joe Rotenberg VK3BBN

20/104 The Avenue, Parkville VIC 3052

In the early days, radios had a good many knobs. Each circuit in the radio would have to be tuned individually. Later the multi-gang condenser came in enabling several circuits to be tuned off the one shaft. Although this reduced the number of separate controls, it introduced a new problem: tracking. The circuits would need to stay in step.

Modern receivers sometimes partially solve the problem of tracking by having some of the circuits broadband tuned, which makes tuning less critical but introduces another problem: cross modulation by strong signals which haven't been rejected by the broadband network.

Here is a novel way of overcoming this problem. Fig 1 shows a varactor-tuned circuit.

The capacitance to inverse voltage characteristic will be rather idiosyncratic, varying considerably with manufacturing tolerances in the varactors and between various types.

However, we can correct this by using an appropriately adjusted weighting network to apply the control voltage.

The easiest plan would be to design the network in such a way that the apparent frequency vs voltage network is beautifully linear and then all the circuits can be made to track in step.

In this, the computer age, the easiest way of generating an arbitrary curve that I know of is with an EPROM, as shown in Fig 2.

Various voltages are applied to the circuit and the voltage and tuned frequency is tabulated. The resulting data is then used to program the EPROM. The easiest way to convert the data to an analog voltage is with a ladder network as shown in Fig 3, but a large selection of digital to analog devices is readily available.

This circuit opens up some novel ways of designing radios. For example, how about a four stage TRF receiver on the broadcast band with a single dial. No nasty heterodynes!

How about tracking the transmitter and receiver stages of an FM transceiver with 600 kHz offset for the repeaters where necessary? Just an idea!

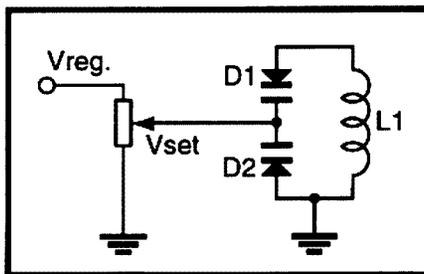

Figure 1. A Varactor Tuned Circuit

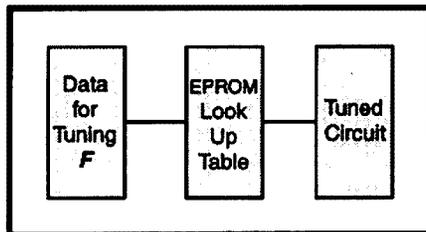

Figure 2. Control Block Diagram

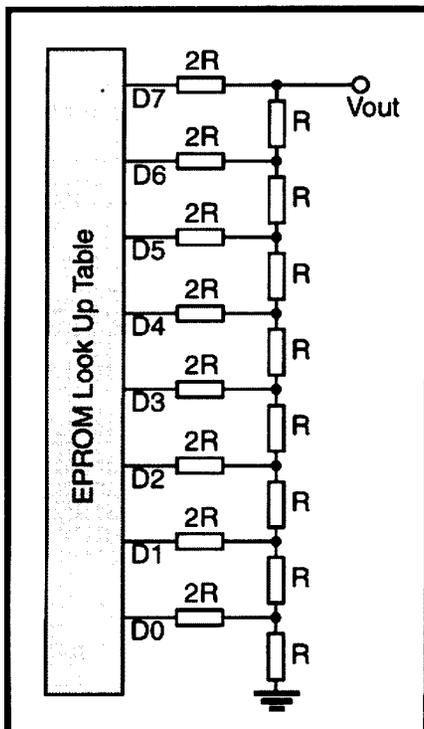

Figure 3. R2R Ladder D/A Circuit

A design for a 3-resonator bandpass filter centred on 1.825 MHz was published in the February 1999 issue. Shortly after publication I received a package from Ron Sanders VK2WB. Ron operates RJ & US Imports the importers of Amidon ferromagnetic cores and a regular advertiser in AR.

The package contained a letter suggesting that I try using inductors in my filter wound on iron powder toroids. This would have the major advantage of drastically reducing the size of the filter, which in the original form, has to be quite large. This is because the high Q airwound inductors must be screened with a shield which is 3 or so times the diameter of the coils in order not to overly reduce the Q.

In the package Ron had also kindly included three 27 uH inductors wound on iron powder toroids to try in the filter. They consisted of 27 turns of 26-gauge wire on 2 stacked T-68-15 iron powder toroids.

Unfortunately the Q of these was much lower than the airwound coils. About 100 compared with 300 for the airwound coils. This resulted in a filter with rounded edges and a higher insertion loss of 9.1 dB compared with 5.5 dB. Attenuation away from the passband was not affected.

This set me thinking and looking through the Q curves of other Amidon toroids. It appeared that Qs comparable to those obtained from the airwound inductors made with Litz wire could be obtained using a larger diameter toroid than those Ron tried. I wound 3 inductors on T-94-2 toroids using 24 SWG (0.6 mm) enamelled copper wire.

The required 57 turns occupies about 80% of the core circumference. It is not a good idea to have the winding start too close to the end as the coil self-capacitance may upset the filter design.

The results were very pleasing. The filter shape was almost identical to the computer simulation shown in the original article with an insertion loss of 5.5 dB.

So a filter can be built with equivalent performance and greatly reduced size compared with the original. RJ & US Imports doesn't stock the T-94-2 toroids but does stock the T-106-2.

This would make an excellent substitute with possibly even higher Q. The inductors would then be 45 turns 24 SWG (0.6 mm) enamelled copper wire.

ar

ar

TECHNICAL ABSTRACTS

Gil Sones VK3AUI
30 Moore Street
Box Hill South Vic 3128

Black-Black-Black

EVERY now and then one encounters a resistor that has assumed this colour code before expiring. If you don't know the value replacement can be difficult.

In the *In Practice* column of Ian White G3SEK in *Rad Com* July 1999 a solution to this problem is provided. The solution came from Dave Lauder G0SNO.

The solution is to carefully file a groove in the centre of the resistor until contact is made with the element. Then try measuring with your Ohmmeter between the file and each end of the resistor. With a little luck you will be able to measure the resistance of one half of the resistor.

This is shown in Fig 1.

This should work for wire wound, carbon film, and metal film resistors.

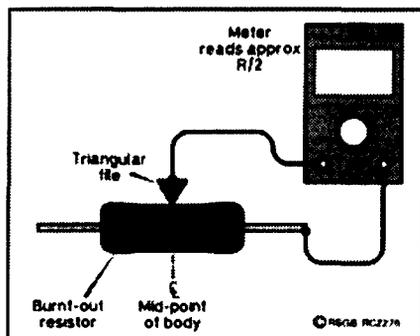

Fig 1. Measuring to mid-point of burnt out resistor

Carbon composition resistors may be tricky as the resistive core is in the centre of the body.

With carbon film and metal film resistors there is a complication due to the practice of cutting a spiral groove in the resistive film to set the resistance value. You may have to carefully expose the spiral so as to be able to judge where the centre point is.

This technique should at least put you on the way to determining the value of a burnt out resistor. The other problem is to work out why it burnt out but that is part of the fault-finding process.

Test Connections

In the *In Practice* column of Ian White G3SEK in July 1999 *Rad Com* a good tip for making temporary test connections to pins of IDC plugs or test points and also making temporary connection to multi way sockets.

The idea comes from Malcolm Perry G8AKX.

The idea for pins is to use a short length of stranded insulated wire with one end

stripped for the test clip and the other end cut off square. The square cut end is simply pushed onto the pin for as long as needed. Soft rubbery insulation is preferable to the normal harder PVC insulation. The idea is shown in Fig 2.

Contact to multi way socket pins can be made by slipping a dressmaking pin between the socket shell and the crimp connector inside. This is also shown in Fig 2.

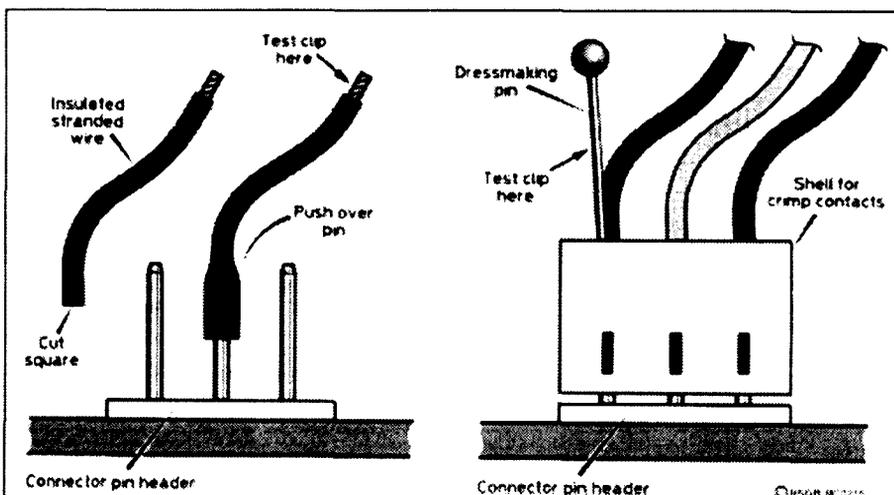

Fig 2. Temporary Test Connections

Correction

Max Riley VK2ARZ has brought to my attention an error in the Compact Mobile Tuner item which appeared in the May issue.

The error is in Fig 2 which appeared on page 30 of the May 1999 issue and which showed an output current meter as an addition to the tuner. The error lies in the wiring of the circuit diagram in Fig 2. The bottom contact on S2B is shown connected to earth. The earth sign should be replaced by an arrow pointing to C2 on Fig 1.

My thanks to Max VK2ARZ for bringing this error to my attention.

Amateur Radio

Do you have or know of a technical project that would interest readers? Contact Gil and tell him about it.

Simple 50 Ohm Feed W8JK Beam.

The W8JK is a simple beam with a bi directional pattern with modest gain. It suffers from some difficulty with matching due to its normal centre feedpoint impedance. However in QST June 1999 Robert K Zimmerman NP4B described a configuration which allows for 50 ohm feed.

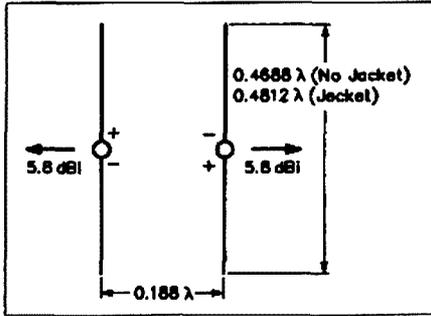

Fig 3. W8JK Beam Centre Fed

By feeding the elements off centre the feedpoint impedance of each element is made 25 ohms. This can be transformed to 100 ohms by the use of a quarter wave transformer of 50 ohm cable. The two 100 ohm impedances combined at the array feedpoint give a 50 ohm point at the feedpoint for the array. Thus the W8JK beam has a 50 ohm feedpoint.

The usual arrangement of a W8JK beam is shown in Fig 3.

The centre feedpoints of each dipole are 17.9 ohms. The dimensions are for elements made out of coax both with and without a jacket. In Fig 4 the beam is shown with offcentre feedpoints arranged to give 25 ohm feedpoints for each dipole.

The gain in each beam direction is 5.8 dBi.

The complete beam made out of RG8X coax is shown in Fig 5. This coax has a foam dielectric and a velocity factor of 79%. You may have some difficulty obtaining RG8X locally but any 50 ohm foam coax with a 79% velocity factor would do. In Fig 6 the feedpoint detail is shown. The beam being made of coax was supported on a frame of PVC pipe such as conduit.

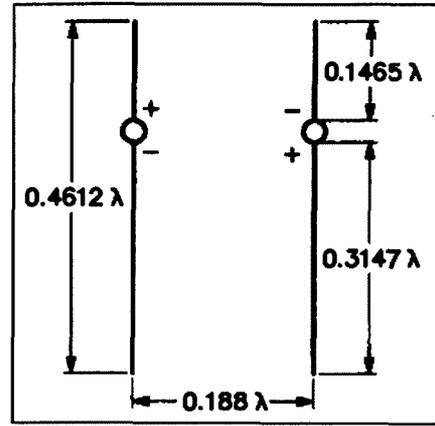

Fig 4. W8JK Beam Offset Feedpoints

Dimensions for 6 and 2 metres are shown in Table 1. The SWR performance of a 6 metre version is shown in Fig 7.

Table 1. Dimensions for 2 and 6 Metre W8JK Beams Using RG8X Dipoles Supported by PVC Pipe.

	2 Metres (144.2 MHz)	6 Metres (50.1 MHz)
Dipole Length	865 mm (34 inches)	2640 mm (104 inches)
Dipole Spacing	510 mm (20 inches)	1230 mm (48.43 inches)
Stub Length	280 mm (11.02 inches)	855 mm (33.66 inches)

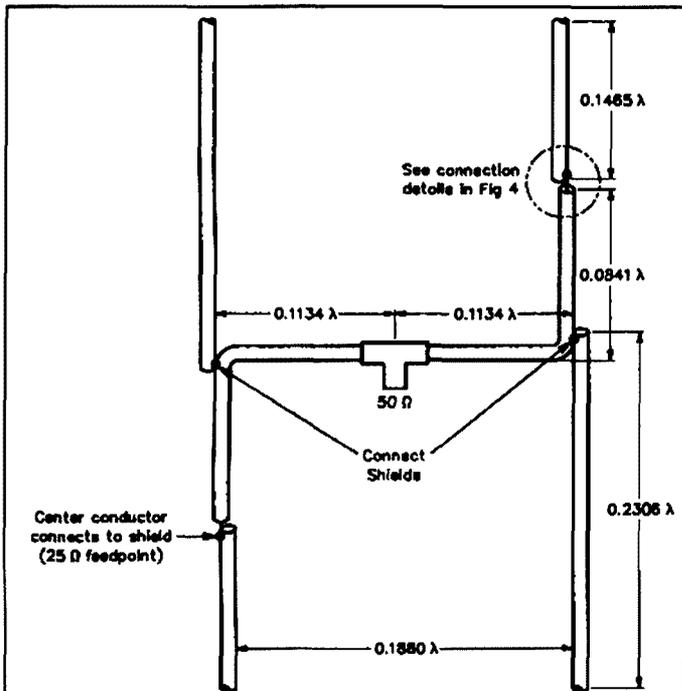

Fig 5. W8JK Beam built and fed with 50 Ohm RG8X foam dielectric Coax

Solder the Center Conductor to the Braid here.

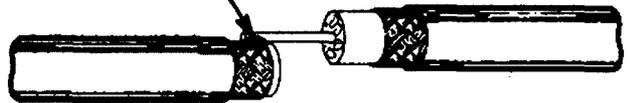

Fig 6. Feedpoint Detail of Offset 25 Ohm Feedpoint

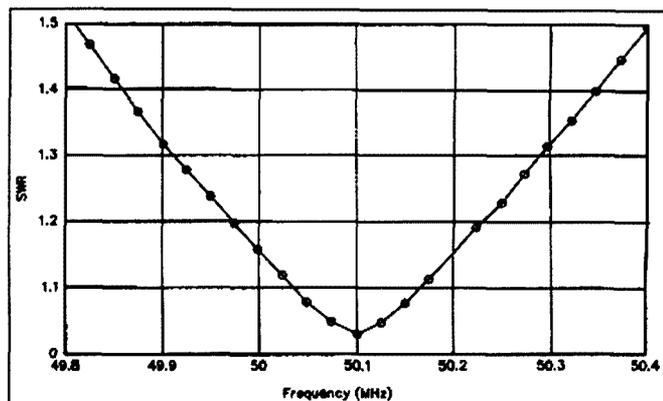

Fig 7. SWR Plot of 6 metre Beam

Try This

PSK31 - Digital RTTY

Fred Johnson ZL2AMJ

Do you have a Computer with a Soundcard? If so and assuming that you have a HF transceiver then you can operate "live keyboard-to-keyboard" and HAVE FUN! Fred ZL2AMJ encourages you to "Have a GO!" with Radio Telegraphy! This message is to draw your attention to the "new" mode PSK31, and to other modes too.

I am VERY impressed with PSK31 and enthusiastic for it to be tried out by others. It is AMAZING! I think that it performs better than the many claims made for it!

You can get details from: <http://aintel.bi.ehu.es/psk31.html>

You can read about it in QST, May 1999 pages 41 to 44. It is also described in RSGB "RadCom" December 1998 pages 14 to 16, and January 1999 pages 26 and 27.

Why am I amazed? All you need to get going is a HF SSB Transceiver of conventional design and a computer with a soundcard. You run two shielded audio cables between the rig and the sound card.

You download FREE software from the web page (the page given above). When all is set up, you have a live-keyboard for chatting with other HF stations in RTTY fashion. This mode is a lot of fun.

All the info you need to get going is obtainable from the web page.

Performance

Measurements here (recognising my limited resources) confirm that the bandwidth of the transmitted signal is very, very, narrow - 31 Hz is claimed. I have successfully resolved two entirely separate QSO's operating about 100 Hz apart!

My first contact was with Dave VE7DPE near Vancouver, around 14.069 MHz. I could not actually HEAR his signal - but the software dragged it out of the noise to print it on the screen! We both switched over to the QPSK mode (which gives a form of error-correction - provided in the software) and we had a satisfactory contact! I cannot recall ever before working a station in such conditions. I was running about 50 watts -

according to my SWR indicator - to a dipole.

PSK31 was developed by Peter Martinez G3PLX (of much AMTOR etc fame). It is in its 2nd or 3rd year of development.

It has suddenly become popular because standard soundcards can be used with Windows 95/98 software (provided free by Peter) to do all the processing.

It turns your computer into a HF keyboard terminal with digital signal processing being done by the soundcard.

No special modems are needed. It is easier to get going than HF packet.

This is a combining of computer techniques and radio techniques. Who said that new developments don't take place in Amateur Radio today? It seems that this mode will be a winner. This should bring back much sparkle to Amateur Radio.

I'm VERY impressed. I hope that you will be too. Other ZL stations are active with this mode. Don't take my word for it ... read about it and give it a go!

But other similar modes are available too! Try Nino IZ8BLY's Hellschreiber program. It is reported that there are nearly 50 countries in action with hundreds of "Hell" operators active. The DX is good - exotic countries like Iceland, Morocco, Fiji and Curacao are active. Europe can be worked using 50W and a dipole.

Read about Hellschreiber in "Break-In", October 1998 pages 7 to 9, November 1998 pages 4 to 7 and December 1998 pages 6 to 8:

The best news of all is that the hardware setup for IZ8BLY's Hellschreiber is EXACTLY THE SAME as for PSK31!

You can check out the world of Hell on the web site at: <http://www.qsl.net/zl1bpu>

and download the latest Hell software from there.

Look at the "Getting Started" page for "Where should I operate?" and "Where will I find Hell signals?"

If you are keen for other modes too, you can also try Slow-Scan Television on the HF bands! See "Break-In", May/June 1999 issue, page 10.

If you thought that you only had a computer with a soundcard, and a separate HF transceiver! You are wrong, you have a very versatile radio telegraph terminal!

Have FUN! Fred Johnson ZL2AMJ

ar

Nally

Radio Towers

Supply only or fully installed

7.5m Pole Masts. 13.7m Towers.

Both 2 stage,

tilt over & freestanding.

Tower has integral rotator plate.

Pole Mast is wall-mountable.

7.5m to 45m guyed towers.

Why risk impending legal implications by building your own.

Nally Radio Towers

are engineered to Australian Standards.

Mention this ad and receive a free top bearing on freestanding tower orders.

For Details Contact

Nally Radio Towers

5 Dorta Court Hampton Park
Vic. 3976 Australia

Ph. (03) 9702 9225 Fax (03) 9799 7813

E-mail nally_rt@net2000.com.au

Have you tried DXing, microwaves, CW, high speed data, ATV, operating portable, slow scan TV, QRP, contesting, homebrewing, AM, UHF, packet radio, foxhunting, building repeaters, JOTA, 160 metres or publicising amateur radio?

Write about it and send it to Amateur Radio - the magazine which covers more facets of amateur radio than any other.

How it Began - RTTY in VK-Land

VK3KF Eric Ferguson (SK)

Eric Ferguson VK3KF was first licensed in 1927 as OA2FE, then in 1937 as VK2BP, in 1938 VK3BP and in 1956, VK3KF until his death. During World War II he was in a secret Army Signals Unit involved in HF/DF and the Japanese Kana code. Eric was very active in the provision of the RAOTC monthly broadcast for some years until poor health overtook him. In the post war years Eric was a communication engineer with the Department of Civil Aviation and specialised in RTTY modes with a laboratory in the old Rialto building. It was during this period that he brought about the inclusion of RTTY as a permissible amateur mode in Australia. The following story was written by Eric about 1980 but was not published until March 1997 in the RAOTC Journal. We thank the RAOTC Journal for permission to publish here.

Allan Doble VK3AMD

I have had my arm twisted in recent times to disclose some of the early trials and tribulations that accompanied the effort to get amateur RTTY introduced into Australia.

On previous occasions I have set out to enumerate some of these, but for one reason or another, I have become bogged down as it were, with the result the drafts have never been completed. However, because the 'arm twisting' has become more consistent in recent weeks, I feel I must make another effort to stimulate the 'grey matter' to the extent that this contribution may be a more successful one.

The first amateur RTTY activity in Australia and as far as I know, in the Southern Hemisphere, erupted early in 1957. It was during a QSO with Forest Castle KR6AK, an American serviceman then stationed in Okinawa. He inquired

about amateur RTTY activity in this neck of the woods, to which I could only reply that I knew of no such activity, but added that I was technically involved as part of my job in a Research and Development organisation of the Government.

As a result of that and subsequent QSOs with KR6AK, it was arranged that I would listen for him on equipment at my place of work on a prearranged frequency in the 21 MHz band. The first attempt to get intelligence was not successful and was proved to be because in my ignorance, I had not realised he would be transmitting 45.45 baud whilst the machines at work were adjusted for 50 baud operation. After this problem was ironed out during a CW QSO, another test was organised and reasonably good print-out was achieved in spite of the receiving location in the city.

I mention 'arm twisting' in the preamble,

but the intensity of this was nothing to that impounded upon me by KR6AK in his effort to make a 2-way contact with him. Not having any RTTY at VK3KF, my involvement was only luke warm and it did not occur to me that perhaps I could, to some extent, satisfy him.

At that time I was conducting propagation studies and the effects of this upon RTTY signalling. This included a 'twin-plex' system under test, whereby two independent RTTY channels were transmitted simultaneously on the one transmitter, but received by separate receivers and decoders. For the purpose of this and other items on the agenda, I had established a radio link between my section of the laboratory via Sydney and then on back to receivers also in the laboratory.

Perhaps a brief run down on this link may be of interest to some. RTTY developed by one or two TD machines was fed to a VHF Transmitter, the antenna for which was on the roof of the building.

Today the roof of that old building is reported to be some 250 metres high). These signals were received, demodulated and applied as FSK via a land line to a transmitter situated some twenty miles to the north of Melbourne. This HF transmitter fed a vee beam centred on the receiving centre in the Sydney environs where the signals were received, demodulated and regenerated. They were then fed by land line to a 5 kW transmitter, beamed back to Melbourne and received in my laboratory 'den'. So by this means, I was able to talk with myself as it were at the same time recording various phenomena.

I have described this briefly as a lead up to the next part of the story and the continued involvement with KR6AK. As I had no trouble (or very little) when receiving him, it appeared to me easy



enough to get him to check reception of the Melbourne transmitter at a time when it was known that the Sydney complex would be shut down. Normally it was in operation from 9 am - 4 pm weekdays.

At the appointed time a series of RYs and quick brown foxes were put to air and even with the vee beam favouring the Sydney direction, S9 plus signals were reported the next day by KR6AK with almost one hundred percent print out. My enthusiasm began to warm up a little, but there was still no RTTY equipment in VK3KF.

The thinking cap was donned once more and it came to mind that a crystal controlled FSK oscillator which I had developed mainly for the 'twi-plex' mode could easily be adapted to excite the VK3KF transmitter and almost over night a simplified version of this was knocked up. Sorting through a box of crystals, one was found which, on a fourth harmonic, would give me an output on 21090 kHz. The stage was set for the next adventure.

During my next scheduled CW QSO with KR6AK, I requested a QSY to 21090 kHz where by means of a hand key I sent a series of marks and spaces (key down - M and key up - S). After some juggling with the shift control my signals entered his M and S filters... What more could I do? Still without a printer, etc.

The following week when working with a Test and Distortion measuring set (TDMS-5) it came to me that I could borrow it as it was capable of sending quick brown fox ad infinitum with various speeds and more importantly, was readily transportable. The following weekend, this was attached to the FS keyer at VK3KF with the result, lines and lines of quick brown fox appeared on KR6AK's page printer. However, no 2-way contacts were yet established although we had printed with a measure of success amateur station to amateur station. It now appeared that I could do no more even though KR6AK renewed his arm twisting with renewed vigour.

The next step to get VK3KF operational on RTTY was an arduous one and entailed the loading into the car one Friday at 5 pm of a model 15 printer, a demodulator, power supplies and a conglomeration of connectors, etc which took until about 3 am on Saturday morning to assemble (shades of the night owl theatre) and make the station operational. One thing had been forgotten, the tuning fork to reset the model 15 to the 46 baud speed and it immediately became obvious when we attempted to have a QSO. However, after juggling with the motor governor good printout was achieved at both ends and so was established the first ever amateur RTTY 2 way QSO out from or into VK-land. The exact date I cannot

recall as the station log for that year cannot be found, but it would have been about the end of June 1957.

On the Monday all the gear had to be dismantled and returned to work but was again loaded up the following weekend and put to into service at VK3KF. Contact with KR6AK was again successful from the word 'go' (the tuning fork having not been forgotten) and it was during this QSO I explained that I was not operating legally as F1 emission was not on our list and that I did not want to bring down the wrath of the PMG on my head. He of course was bitterly disappointed, but I made it clear it would be the last RTTY transmission for the time being until I had sorted things out with Officialdom.

The story may have ended there if it had not been for the reception of some of the stations from the USA during Sunday afternoon. I felt quite frustrated, but was loath to attempt a call because of the reasons given to KR6AK. In any case, it was my work program which put a stop to this nonsense as it became necessary for me to spend time in other parts or Australia and in Papua-New Guinea and this involvement did not end until late in the year.

During my absence, KR6AK must have been really busy as I found a number of letters awaiting me which offered quite a few items such as printer, de-modulators and the like. Offers which I was reluctant to take up, but there was one letter which had me wondering 'what next'. This letter informed me that a Model 15 printer with spares had already been shipped to me. It also contained all the necessary 'paper work' required by Customs... It appeared that I was not to be let off the hook. VK appeared to be a big fish in the USA, RTTY wise, at least.

If I was to become the proud possessor of a model 15, then it behoved me to think about a demodulator. That actually was no real problem as I had already been involved in the development of such a device. Time to build a amplified version being the only drawback. Considerable 'midnight oil' was expended on this project which was eventually taken to work and put through its paces, whilst at the same time I applied to the PMG for a permit to operate the F1 mode.

Needless to say, the demodulator was finished before any sign of a permit appeared and it was not until early 1958 that a three-month permit was as I thought, reluctantly granted. In the mean time I had another problem to contend with. The model 15 had arrived and in their wisdom or lack thereof, the Customs department had assessed duty at an amount which I thought was over the odds, as some might say, an amount which I was not prepared to fork out. However, in the end and in view of its non-commercial application, the printer itself was admitted free, but duty had to be paid on two spare motors as well as the one in the machine itself. Eventually the crate arrived at the home of VK3KF at a cost of about twenty five pounds or fifty bucks we say in this day and age.

It was about the middle of February 1958 before VK3KF was operational on RTTY to my satisfaction and with all my very own equipment. The permit to operate F1 on a frequency of 21090kHz on the wall and my fingers itching. However, I had promised that I would endeavour to make the first VK-W QSO with an old buddy of mine, W6CG who these days is well known among the satellite fraternity, but who dropped out of RTTY some years back and in view of the promise, a schedule was arranged for 28th May 1958 for 0300Z on 21090 kHz.

Whilst waiting for the date to appear on the calendar and to fill in time, I had printed out a number of Americans, among whom were W0BP, W3PYW and W2RUI. Sad to say, both W0BP and old 'Skipper' W2RUI are now both silent keys.

The 28th of May duly arrived and at the appointed time W6CG was heard calling. Nervously I replied, not without typing error because of trembling fingers and was greeted with a 579 report. Following

W6CC, contacts were made with K6OWQ (WS6CG's XYL, now also among the silent keys) W0BP and W3PYW at which time propagation deteriorated and the following day was anxiously awaited.

I cannot say printouts were of the quality we expect these days. One of my difficulties was

receiver instability, which had not worried me when copying CW or AM phone and another, the QRM from adjacent stations. It did appear that copy at W6CG from me was better than I received from him. This was

evident when comparing his print out (which he mailed to me) with copy this end. More about the problem later.

My temporary F1 permit ran out on 30th June and for a time I was QRT which was a good thing in a way as it enabled me to catch up on many of the chores which had been neglected and it was not until the following year that my thoughts turned once more to amateur RTTY.

Another period of long delays and frustration ensued. The PMG's Department appeared reluctant to issue another permit to enable me to operate F1 officially. I might add as there were occasions when I had contacts, particularly with ZL1WB, who had made an appearance after returning home from the USA where he had acquired a pile of RTTY equipment and was experiencing the same problems in getting official sanction to operate RTTY from the NZ authorities.

It was not until a telephone conversation with an executive of the PMG on another matter entirely, that some explanation was forthcoming regarding the delay in issuing the F1 permit.

His inter-departmental inquiry uncovered the state of affairs in which it was revealed that the department had no objections to the use by amateurs of F1 emissions, but it appeared technical advisers to the WIA had recommended that F1 not be a part of amateur radio and the Department were reluctant to add this mode to the official list. This, of course, explained the 'fobbing off' without reason I had been handed out by the Radio Branch... I might add the reason given by the WIA for not approving F1 was its excessive bandwidth occupancy.

How to overcome this objection? I saw the light. Why not invite the objectors to view a spectrographic illustration of bandwidth occupancy of other modes used by amateurs, AM being the more popular in those days as well as the up and coming SSB and with this in mind, letters were sent off to WIA and PMG inviting representatives to such a demonstration.

The date was set and equipment set up in the laboratory in order to demonstrate bandwidth occupancy on a newly acquired HP spectrograph analyser including that of RTTY which, at that time was operated with an 850 Hz frequency shift. I never did find out why no WIA representatives attended that demonstration, but the two PMG reps were duly impressed when it was shown the sidebands of F1 were considerably narrower than AM.

Eventually, permits were granted and it was about then a couple of other VK amateurs appeared on the scene, VK2EG, Bill and VK4RQ, Chas Noble and in New

Zealand, ZL3HJ joined ZL1VB. The continent of Oceania was waking up to RTTY and was very much in demand by the Americans and one or two others who had joined in the fun and games.

I previously mentioned instability of equipment and this appeared to affect most RTTY-ers of the day. My answer to this had been to install 'rubber' crystals in the receiver for the 21 and 14 MHz bands, the latter having been included in our permits. I use the term 'rubber' as this was one used at that time, and possibly still is, to denote a crystal oscillator in a receiver, or for that matter, a transmitter as well in which it is possible to vary the frequency over a restricted range.

The most suitable circuit for this was derived from the Franklin, a form of regenerative concept enabling certain axis cut crystals to be moved about 1 kHz, at the fundamental frequency. Then, by using a crystal in the lower frequency range, the harmonics could be used to provide a tuning range of perhaps 5 or 6 kHz, at the operating frequency.

This was not a complete answer as many of the transmitters in use were prone to drift. Valves were still the norm at that period of time and some fiddling with the tuning was necessary to maintain a QSO. A very ingenious device was developed by VK3PB, who had appeared on the RTTY scene. This was a mechanical unit, motor driven, which coupled to the tuning knob of his Galaxy V transceiver. The direction of the motor was electronically controlled by a form of discriminator in turn operated by two tuning forks resonated above and below the standard mark frequency of 2125 Hz, the action being to develop a positive or negative DC voltage as any change from 2125 Hz occurred in the receiver output. This voltage drove the mini motor in the required direction to retune the receiver. Ingenious to a person looking on.

VK3PB's cunning device set me to thinking again about the drift problem and automatic frequency control. I was not interested in laboriously carving out tuning forks, but why not use a straight out discriminator to provide differential voltages to control a varicap in association with the receiver VFO? A unit was hastily put together and after some minor problems, worked very well, so well actually, that I was sorry I had not thought of it in previous times. This unit was eventually featured in the RTTY Journal and was adopted by many of the Americans who suffered the same problems. In the mid 1960's I was away from home a great deal of the time, including a stint in Europe learning something about what was termed

'telegraph on radio', the forerunner to AMTOR as we know it today, but what a difference in those early valve units as compared to the solid state devices of today. The original TOR complex was housed in two standard seven foot racks, when today one can pack the whole works into a small suitcase. I had no involvement in the amateur sphere for about two years, during which time more and more transistorised devices appeared in amateur items. Among those in the forefront of the hard work involved was K8KDC, later to become W6FFC. His earlier version of the 'Mainline' and TTL demodulators had become the accepted standard of valve operated devices, but in the 1970s his ST-3,4, 5 and 6 solid state versions gained worldwide acclaim and was, or should I say 'is' looked upon as the 'ultimate' amateur demodulator, otherwise, why are so many VK3 amateurs hard at work building the

ST-6 at the time of writing this? Perhaps it is because they have not heard about the TU9-7? Anyway, the TU9-7 was never published and the only unit in captivity is in the shack of VK3KF. During the late 1960s and early '70s I did find a little more time for amateur RTTY and although I had gained the WAC certificate (worked all continents RTTY) as early as 1962, I had not caught up with the swelling number of countries which were appearing and I set about chasing a DXCC on RTTY.

This was not all that difficult as various overseas amateur organisations had introduced world wide contests during which some rare ones would appear to be pounced upon by all and sundry in sometimes hectic 'dog piles'. By 1971, I had achieved the objective and have not kept an accurate record since about 74, when I had a listing of 131 countries.

As a measure of early RTTY activity, I recently examined a 'WAC Honour Roll' published in 1965 in which 79 stations were listed and out of curiosity, I checked to see how many of these made the listing by contacting VK3KF for the award and was surprised to find 56 out of the 79 relied on VK3KF for the Oceania continent. I also noted my own listing as Number 23 which agreed with the certificate on the wall. Most of us patiently had to wait until 1962 for Africa to appear when ZS6UR came up on air.

I suppose I have missed a great deal in trying to bring to light some of the early RTTY activities in Australia. Other stories may come to mind later on, but enough for now.

During the years of amateur involvement with RTTY, I must say that I have enjoyed them.

AR on the WEB

Alan Meredith VK2NNN

295 Iodide Street
Broken Hill NSW 2880
vk2nnn@vk2nnn.com
<http://www.vk2nnn.com>

Aliens on the Bands?

Well no actually all those unusual noises you have been hearing on the bands are probably just VK's out there contesting! While not being everyone's cup of tea, contesting can be a great way of catching up with a few friends that you have not heard from for a while. By the time you read this one of VK's best known contests, the Remembrance Day contest, will have come and gone (VK2 did we win?).

Winter is the season for most of the VK/ZL contests but as we start to approach spring the International contest season begins again in earnest.

There are some excellent Australian contesting resources that will help you find out what's on and when.

Radio Sport, which is run by one of VK's best-known contesters, John VK4EMM, is always a good place to start. <http://www.uq.net.au/radiosport/>

Radio Sport



The home of Radio Contesting in Australia

John has an event calendar of all the major contests as well as hints and tips for the beginner and the experienced alike. The WIA (Wireless Institute of Australia) sponsors quite a few contests throughout the year and information concerning these can be sourced at: <http://www.wia.org.au/>

For the more serious, or curious amongst us, the International contests can be a great way of snagging a few of those elusive countries. They seem to come out of the woodwork for the big contests! Remember you don't have to enter the contest to get on air and chase a few new ones, of course the competitive spirit might be let out of the bottle....Hi.

Some of the bigger international contesting sites are listed below:

SM3CER Contest Service: <http://www.sk3bg.se/contest/>

This is a cool site!

WA7BNM Contest Calendar:

<http://www.homucopia.com/contestcal>

This is also a cool site with a comprehensive calendar of contests. This site also offers an email subscription service (free), for a weekly newsletter updating the latest contest information.

Even RTTY enthusiasts can get in on the contesting action at: RTTY Contest Calendar - by LA9HW

<http://home.sol.no/~janalme/RTTY.html>

Any listing of contesting information would not be complete without mention of the one of the biggest of them all: Contesting Online:

<http://www.contesting.com/>

Contesting On-line

The ultimate site for radio contesting information!

This site has information on almost everything related to contesting ie: Rig comparisons, contesting software reports and comments, discussion groups regarding contest software, contesters shack tours, you name it then its probably here! For the Internet guide to Contesting try the DX-Zone: <http://www.dxzone.com>

The DXZone

Either getting ready for a contest or trying to figure out exactly what to do after you have finished can be as much work as the contest itself. DX-Central

<http://www.dx-central.com/> can help out here with online searchable logs etc to help you find out whether you made it into the log of that DX station and also where to send the card.

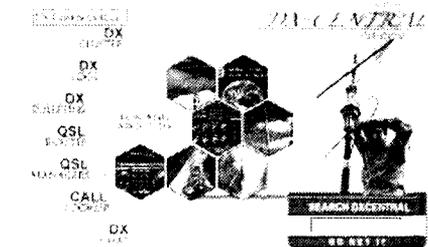

DX-Central Search

August 7, 1999

Another site is: DX-BANDS.com

<http://www.dxbands.com/>

Only new, but well worth a look.

Free Lunch? No such thing?

Well some useful things are still free!

Email subscription services can be a great way of getting information, not only for contests but will keep you up to date with all things DX as well. Most offer a free weekly service delivered to you via email, automatically.

Three of the best are:

Ohio Penn DX Bulletin

<http://www.en.com/users/k8yse/opdx.html>

425DXNews

<http://www.425dxn.org/>



425DXNEWS

599 DX Report

<http://members.aol.com/the599rpt/dx.htm>

The last one may cost you a little (I didn't say everything was free!).

If you are still stuck for a stations QSL address after the contest then try some of the Callsign servers on the Net.

Buckmaster is one of the largest at:

<http://www.buck.com>

Also QRZ.COM offers another excellent Callsign look up service at:

<http://www.grz.com>

Speaking of looking for things, I have been helping to search for ET. SETI@home. <http://setiathome.ssl.berkeley.edu/>

has been mentioned quite a bit lately. It has been running on my work PC for a while now. It finally finished its first block of data yesterday. It only took 347 hours! Maybe I should talk to the boss about a faster PC? Maybe I want to stay employed!

Anyway, while not at work watching my SETI screensaver crunching data, I have been busy relocating my entire web site. It is now located at <http://www.vk2nnn.com> and my new email address is a real hard one: vk2nnn@vk2nnn.com So remember if you find something on the Net that's cool, let me know so we can share it..

Speaking of cool, this one has been around a while but is still one of the best propagation sites on the Net. <http://dxlc.com/solar/> Well worth a look. Remember, no propagation equals no communication (unless you are QRP with 1500 watts!....Hi).

ar

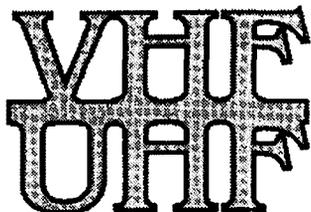

AN EXPANDING WORLD

Eric Jamieson VK5LP

PO Box 169 Meningie South Australia 5264
E-mail: vk5lp@lm.net.au Fax: 08 8575 1777
Packet: VK5LP@VK5WI.#ADL.#SA.AUS.OC

All times are UTC

Six metres

Ron VK4BRG reports that on 13/7 on SSB he worked at 0812 K6MYC/KH6, 0854 T30JH and 0911 V73JK. All signals relatively weak.

Wal Munn VK2YHN of Ballina sent a Fax to say six metres had been quiet. During June there were two openings - 3/6 to VK3DQJ and VK3DUQ. 4/6: VK7JG and VK3YTT. He hears the VK3SIX beacon almost daily with signals variable but occasionally to S9. Despite calling he receives no answers.

On 12/7 KA0BAD DM57 heard VK4WP calling CQ on 50.125 at approx 1700. From Phil N0KE in DM69 via VK-VHF Reflector.

John Goldfinch VK4FNQ QG39ex at Chartres Towers reports that he uses a Realistic Pro 2006 scanner for TV frequencies (plus offsets) from 45 to 106 MHz and the antenna is a discone. From 50.000 to 50.500 MHz he uses an ICOM IC 505 + Tokyo Hy-Power amp with rx amp and a 9 element h/b Yagi (9 metre boom) at 19 metres.

From 15/2/99 John has been keeping a log of signals from 40.000 to 76.000 MHz and uses a Yaesu FT 847 + 1/4 wave vertical on the roof for this rig. He says:

I haven't been sitting in the shack 24 hours a day but the six metre radio and a scanner scan 24 hours and if I hear noises or I am passing the shack I have a quick look and make notes. For example, I have logged the Darwin beacon VK8VF 19 times. These notes are now on a database.

He sends a very extensive report from which only excerpts can be taken. As has been known for a long time, North Queensland enjoys reception conditions on six metres about which those in the south can only dream.

John's reports show an almost daily consistency of signals to be heard or

worked. His listening commences around 40 MHz but it is the area between 45 and 50 MHz where a multitude of video signals exist mainly from countries to our north in the Asian region.

Of course, 49.750 +/- provides the most consistent signals, as is the case in the south where if you are going to hear anything it will usually be on that spot.

Japanese 50 MHz beacons figure prominently in his lists, those heard being JA2IGY 50.009, JA6YBR 50.018, JA1ZYK 50.023, JE7YNQ 50.027, JR0YEE 50.033, JR6YAG 50.037. Signals were often weak but they were there on a regular basis. Another very consistent beacon was V73SIX 50.014.

Australian beacons included VK3SIX 50.053, VK8VF 50.056, VK7RAE 50.057, VK4RGG 50.058, VK2RHV 52.325, and of these VK7RAE was the most consistent, probably being the right distance from Townsville.

Japanese amateur contacts were scattered throughout July with most districts being contacted at some time. Here again signals were quite variable, being from S2 to S9. On many days they came in for awhile from 0600 then faded out only to re-appear around 0900 extending through to 1300 and later.

From time to time a Japanese amateur pile-up filled sections of the band, as only the JAs are able to do! Whilst many JAs were still using 50.110 it was obvious that others were avoiding that frequency with a high degree of success.

Some beacons were heard around 2300 in the morning but these were more the exception than the rule, most appearing from 0600.

John did report almost daily reception of a meteor scatter station in the Philippines on 43.649 MHz with signals varying from S1 to S9, which is interesting.

The following is one day selected from the many provided and is fairly typical of the signals available if you look for them on a regular basis.

13 July

- 0500 43.649 M/S weak
- 0500 49.750 Video weak
- 0500 50.027 JE7YNQ Bcn 519
- 0655 0555 50.023 JA1ZYK Bcn 519
- 0740 43.649 M/S weak
- 0740 49.750 Video S9
- 0740 50.027 JE7YNQ Bcn 519
- 0740 50.033 JR0YEE Bcn 319
- 0740 50.110 JA2IVY Wkd VK4JH 5x9
- 0830 43.649 M/S S8
- 1025 43.649 M/S S1
- 1025 49.750 Video S1
- 1025 50.009 JA2IGY Bcn 519
- 1025 50.023 JA1ZYK Bcn 319
- 1044 50.110 JR2HCB CQ 5x9+
- 1130 43.649 M/S S1
- 1130 49.750 Video S5
- 1130 50.009 JA2IGY Bcn 519
- 1130 50.014 V73SIX Bcn 419
- 1130 50.018 JA6YBR Bcn 529
- 1130 50.023 JA1ZYK Bcn 519
- 1130 50.037 JR6YAG Bcn 419
- 1250 43.649 M/S weak
- 1250 49.750 Video S2
- 1250 50.009 JA2IGY Bcn 519
- 1250 50.018 JA6YBR Bcn 519
- 1250 50.023 JA1ZYK Bcn 319
- 1250 55.250 Vidco S7
- 1250 59.750 Audio weak
- 1250 61.250 Video S5
- 1250 65.750 Audio S1
- 1250 67.250 Video S6
- 1250 71.750 Audio S1

As stated before, it is obvious that North Queensland enjoys an advantage over southern climes when it comes to propagation. However, for the past month or two I have included some items from David Vitek of Adelaide who logs video and sound from TV transmitters and any other signals which appear, principally in the region 40 to 108 MHz which includes the commercial FM band.

Some entries from his log for part of June indicating there always seems to be something available at least between 45 and 50 MHz.

- 3/6:
- 0330 ABMN0 video
- 0225 45.250/239.60 S5 with rapid flutter
- 0358 RTQ0 video

0410 ABCN1 video S7
 0430 51.761A NEN0 video
 0507 62.76A ABSQ1 video
 0340 50.110 VK2DN 5x4 and other
 VK2s; VK2RHV/b, VK2RSY/b
 0342-0409 to S7
 0435 VK4RGG/b S3
 0516 VK4ABP/b S4
 0518 4ABCFM Nambour
 20/6:
 0520 51.67A RTQ0 video
 0540 ABSQ1 62.76A video
 0529-0712 50.047 VK8RAS/b
 28/6:
 0702 51.67A RTQ0 video
 0706 62.76A ABSQ1 video
 0717 51.740 ABMN0 video
 0700-0742 49.750 video S3
 0724 51.761A NEN0 S3
 0747 ABCN1 S4
 1055-1200 RTQ0 video
 0709-0925 50.047 VK8RAS/b to S8
 0810 94.9 8JJJ
 0811 97.9 8ABCFM
 0812 99.7 8ABCRN, all three in
 Alice Springs
 1139 105.7 4ABCRN Toowoomba.
 On this day the Indices were F-
 207, A-20 and K-6.

Ted Collins G4UPS is his monthly report for July 1999 remarks that newcomers to the six metre band must be highly delighted with the DX that has been available so far this year. He writes:

Up to 21 July I worked/heard 72 countries down here in Devon in IO80jv, a far higher total than last year, and picked up two new countries in TZ and VP2E to make my total 148 countries on six metres.

Ted also said that on 4 July hundreds of six metre operators picked up a new country when Jimmy Treybig W6JKV, operating as VP2E/W6JKV had a phenomenal opening into all parts of Europe. At 0944 Jimmy was 559 at Ted's QTH but it took him until 1017 to actually work Jimmy, by then he was 599. His signals were 569 at 1300 and he was still being reported at 1600. There were no signals on 28 MHz.

Ted said that Jimmy must be gifted with much patience as he had to deal with inexperienced operators who insisted on giving him their full locators and who even held up a huge pile of stations by demanding his locator!! A lesson for everyone to learn from that experience.

The Pacific and Japan

Emil Pocock W3EP in *The World Above 50 MHz* in *QST* reported that activity across the Pacific seemed to have wound down a bit (or else it has become too routine to bother reporting). Jack Henry N6XQ, and other Californians found VK4APG and VK4KK on May 21 and 25. Hatsuo Yoshida JA1VOK (PL36), worked AP2WAP in Pakistan on May 2 at 0816 for his fifth new country this year. Japanese also reported XX9TSS (Macao) among their now common run of contacts in the Pacific and East Asia.

Neville VK2QF supplies the following in regard to the C21JH and T30JH expedition.

Summary of prefixes

C21JH: V73, VK8, YB0, VK4, 3D2, AH8, KH7, YF1, YC1, P29. 1,300 QSOs on all bands.

7/7/1999: V73SIX/b from 1935, VK 46.240 video from 2230-2239 to S5, and ZL 45.240-250 video SI, 0012-0016 49.750 to SI.

6/7/1999: V73SIX/b from 2020.

5/7/1999: V73SIX/b from 2000; no VK but ZL video from 2145 to S9+ and all gone by 2250; KH6HME/b 5x1 0820, KH7R 5x1 0852, KH7U 0947 5x1, 0955 and 1045 P29KFS to 5x9; 1240 48.240/250 Malay video, QRT 1320.

From Mike ZL3TIC in RE66:

1 August

2230 46.240 5x9

2345 46.170 5x9

0010 VK3BWT 50.140 5x9

45.240/250/260 5x9, also 55.240/
250 and 260 5x9.

0110 57.240 and 260 5x9

0130 ZL1ADP 5x9

0400 Strong backscatter from the 45
MHz TV and 46.170/240.

0730 49.750 up to 5x9 with many
offsets.

0811 VK9NS 50.110 5x9 with QSB.

0902 JA1JFK 50.140 5x5

0903 JQ1DPP 50.140 5x7

0908 JA1RJU 50.110 5x5

0908 JR2HCB 50.110 5x7

0909 JA7WSZ 50.140 5x7

0913 JA1VVD 50.140 5x5

0917 JA2POK 50.140 5x7

1030 49.750 still in

Note: *This would be the first time I have ever heard JAs in August.*

From Bob ZL3TY

1 August

VKTV 46.240/51.740 S9

0713 VK2RSY/b 529

0715 VK2FHN 50.150 5x8

0726 VK2YOC 50.150 5x9

0735 VK2FC 50.150 5x9

0748 VK2DN 50.150 5x9

0822 VK4RGG/b 50.057 419

0848 Asian TV 49.750 S6 many
carriers, in for 30 minutes.

2 August

0002 VKTV 46.240 SI

0043 VK7RAE/b 50.056 559

0044 VK7JG 50.12 5x7

0048 VK3GRL 50.12 5x9 ZLTV
45.260/50.760 S9

0134 ZL1BIC 50.12 5x5

Its official

John VK4KK has ascertained from the authority of the DXCC Desk of the ARRL in Connecticut, USA, that J88 Belau is not a new DXCC country and will not become one, nor become a deleted country. The same applies to Hong Kong. In each case you are only working a new prefix.

Rod VK2TWR advises:

Good to see a touch of troppo from my QTH at Nimmitabel. I worked Joe VK7JG on 2 m and 70 cm at 5x7 both ways on 23/7 at 0745. Caught up with Andrew VK7XR an hour and a half later. This would have been the peak, as Andrew's signals were 5x9 on 2 m; unfortunately 70 cm was not achievable, as Andrew was having problems with his transceiver. Band stayed open until around 1050. Beacons were not there next morning.

Microwaves

Wally VK6KZ is making his annual pilgrimage to the east coast and on the way he and Neil VK2EI have been playing 10 and 24 GHz again. Wally said that they were able to extend the NSW distance record on 10 GHz with a 319 km contact. Neil was portable at North Brother (Lat 31 39 29S Long 152 46 21E) and Wally VK6KZ/p was at the Rotary Lookout at Ballina (Lat 28 51 51S Long 153 35 22E). Neil gave a 4x2 report and received 4x1. The contact was made between 0615 and 0647 on 3/8/99.

An attempt to extend this distance on

the following day from North Brother to Cape Byron was unsuccessful. Attempts to extend the Australian distance record on 24 GHz were unsuccessful.

The Indian Ocean

Brian VK3BCZ, formerly VK5TN writes as follows:

Your July reprint of Emil Pocock's article on the VHF records held by Paul Liebe KH6HME reminded me of the 1960s when I lived in VK5. KH6HME as well as the VK5s were inspired by the record breaking contact on 144 MHz by KH6UK/W6NLZ across the northern Pacific in 1957.

I am not sure when in the early 60s it was, but I personally took note of the Irish Gentleman (VK5ZDR) when he first worked from Adelaide to Melbourne on 432 MHz by noting from the weather maps appearing nightly on television when the High was located so that the wanted radio path would be across the middle of the High.

In those years, I was working adjacent to radio researchers and advising them of the amateur observations of sporadic E occurrences to supplement investigations they were making on the E and F layers.

I then became aware of their interest in long range tropospheric propagation (via subsidence inversions in the High pressure weather system). It was in those years that the VK5s obtained the first licence in Australia for an unattended beacon station on Mount Lofty.

It turned out that the 144 MHz beacon was ideally suited for warning of openings across the Great Australian Bight to Albany and beyond. For many years, the professional and amateur observations have been done in parallel, the amateurs, of course, have the advantage of having a wider geographical distribution.

My reason for responding to the recent article is that I took the trouble to read Emil Pocock's article in March 1996 QST on "Transoceanic ducting at VHF and above", only to find him suggesting that very much longer paths might be possible across the Indian Ocean via the Reunion High.

This is exactly what I tried to say back in 1969 by means of an article in Pierce Healey's amateur radio page in Radio Television and Hobbies. At the time, I had compared the Weather Bureau's Indian Ocean pressure charts with the temperature inversion heights obtained

from the radiosonde observations then taken at Carnarvon in WA. Initially I recommended monitoring a beacon in Salisbury, Rhodesia, but subsequent work showed that the limit of the oceanic high would be Madagascar.

It is now apparent that the amateurs in Perth and along the WA coast have not yet worked to Madagascar. Now is a good time of the year to once again see if there are stations in Madagascar willing and able to work to WA on 144 and higher frequencies. My work in the 60s showed that it should be possible on a few days per month. Emil Pocock suggests that meteorologically speaking, August might be the best month. Success would double the present records held by the Americans. Who will be the first to conquer the Indian Ocean? Perhaps a trophy is needed as has been offered in respect of the Atlantic Ocean. [See later in these notes for a reference to such a trophy.]

EME News

From Ron VK3AFW:

Just after midnight on 6/7 Des VK3CY, worked K3VGX on 144 MHz CW. This is a good effort because both stations use only 4 Yagis. Des has an AM17 and the other station a PA with 3 dB or so more output power. Another grid square for Des!

But it doesn't stop there. Des VK3CY continues to enjoy success with his AM17 and 4 Yagi's. On 10/7 he gave up golf to work two DLs and OZIHNE on 144 MHz. He also heard his own echoes on several occasions.

Also, Des worked his first JA on 2 m plus two other initials bringing his tally to 12 this last weekend, 17-18/7.

I also heard his tape (audio coupled for record and replay) of a random QSO with W5UN. It was like 20 m without the QRM, 559 as heard in my shack off Des's rebroadcast. No dropouts, just clean crisp CW. He gave Des 54N. It was just after moonrise. I heard Des's "K" echo at the start of the tape. It was at least 539.

So, if you have an AM17 and at least one long yagi, W5UN and a couple of others can be worked. If you have a 4x array with 8 m+ booms you are in the swim.

Living out of town helps as the noise floor in the big cities is horrible. A clear shot to the horizon to make use of ground gain or an AzEl mount is essential.

ATV World Record Notification

Three new ATV world records are registered this summer by the Swiss ATV:

5.7 GHz: 216 km, 15/6/1999

One-way QSO between TK2SHF and F/HB9RXV/p B5 TK2SHF (JN42hf), 15 W, 90 cm offset parabola F/HB9RXV/p JN33kq.

10 GHz: 1031 km 17/6/1999 at 0730

EA/F1AAM/p (IM98XU, Monte Pego, Spain, 220 m) and I5/HB9AFO/p (JN54bc), Rifugio Carrara, Italy, 1320 m). Bi-directional B3-B5 QSO. F1AAM: DRO + 12 W TOP, 1 meter offset parabola. HB9AFO: DRO + 12 W TOP, 1 meter offset parabola, modified LNB + narrow band receiver + home made wide band receiver with automatic research of stations.

47 GHz: 188 km 30/7/1999 at 0630

HB9DLH-F1JSR, one-way B5 QSO. HB9DLH: at Mont Chasseral BE (JN37md), at 1550 m 90 cm modified offset parabola. TX 10 mW on 47.088 GHz. F1JSR: at Mont du Chat (dpt 73, JN25vq) 90 cm modified offset parabola. Phonie transverter NF 9 db + sat converter, sat pointer, TV sat receiver (narrow band).

You can find all details and pictures on the SWISS ATV web site: (in French and in English) <http://www.cmo.ch/swissatv>

From Michel Vonlanthen HB9AFO, Swiss ATV president.

End of an era

With the November 1999 issue I will have completed 30 years of writing these notes for *Amateur Radio*. I now believe it is time to call it a day so my last official columns will cease with the December issue. David VK5KK will take over the helm and continue the columns.

Commencing with the October issue David will provide a segment of information in my notes and this will continue to the December issue, when I will have more to say in my closing columns. Therefore I need to say no more at this moment as I do not wish to repeat myself.

At David's request, I will provide something for the January 2000 issue so as to "have one foot into the year 2000" as he puts it! David will commence his full version of the columns with the

January issue while I will provide a separate summary of my 30 years of writings in the same month. To this the Editor has agreed.

Profile: David Minchin VK5KK

David is one of a family of amateur radio operators. Father Keith VK5AKM, brothers Tim VK5NTM and Hans VK5NME.

I commenced contacts with Keith in 1963 on six and two metres. Keith lives at Wasleys, north of Adelaide, and at a distance of about 56 km, over very rugged terrain, from my then location at Forreston in the Adelaide Hills. Yet, for some reason still unknown to us, it was an excellent VHF path, and contacts could be maintained on both bands using power levels as low as 30 milliwatts!

David first came to my radio notice when at times he would take the microphone from his father and have words with me. I encouraged him to take an interest in amateur radio and particularly VHF. He responded and whilst still at High School passed his examinations in both theory and Morse code to obtain a full call (VK5KK) at the first attempt.

So, in the mid-1970s began almost nightly contacts, usually cross-band, with signals so strong between us that others had difficulty in breaking into the conversations. On occasions we reduced our power levels to such a low state that others could not hear us! We eventually found that 432 MHz worked the same way, always S9+ if we wanted it to be so! Regular contacts continued until 1987 when I left the Hills for Meningie.

Over the years I have seen David extend dramatically his technical knowledge with the result that he now operates on all bands from 50 MHz to 10 GHz and is moving on to 24 GHz. He has the ability to design equipment for any band and many VKs are using his techniques when assembling their own VHF/UHF equipment.

From a personal viewpoint it has been a pleasurable experience to know David. Over the years he has climbed my towers and maintained my antennas - I freeze if I climb higher than about 5 metres! - and we have continuously shared technical experiences. It has also been great to meet and know members of his family to the extent that a continuing spirit of friendship exists between us.

On several occasions when I was

confined to hospital, David filled in and prepared my columns. I feel he will be a worthy successor to me and there is no one I would like better to do the job. I wish him well and ask that those who have supported me with information so loyally over the years will continue to do the same with David.

Spanning the Indian Ocean

I note comments on the above by Brian VK3BCZ. The VHF path across the Indian Ocean from Australia to Africa or the shorter path to Madagascar or Reunion Island has so far eluded any attempts to make a two-way contact on 144 MHz.

As a parting gesture from leaving the VHF writing scene, I am prepared to offer a suitably engraved trophy to the first Australian amateur who successfully completes a two-way terrestrial contact from mainland Australia, to Madagascar or Africa, on 144 MHz. Some details will need to be worked out but number one should be that both sides of the contact must be audio-taped as proof of the contact. The approximate distance from Perth to Madagascar is 6912 km and Durban on the coast of South Africa 7886 km, which would be a world record. Reunion Island is about 6500 km. More later after I give it more thought. VK5LP.

Closure

By the time you read these notes we will be entering the equinox. There is always the possibility that F2 propagation will appear, certainly I would be surprised if eastern seaboard stations don't work to the USA.

As always, it is a case of being aware that 50 MHz can open for long distance contacts. Ten years ago the latter part of 1989 provided contacts to Europe. We may be a year early but one can never be sure.

Closing with two thoughts for the month:

1. If dogs could talk, they wouldn't make such good friends, and
2. One proven way to teach your children to count is to give them different allowances.

73 from The Voice by the Lake.

ar

SNIPPITS

Look out for lightning!

Benjamin Franklin's famous experiment with a kite was an attempt to prove that lightning rods would protect from lightning by attracting it elsewhere.

He intended to experiment on a church steeple but it was not yet built, leaving Franklin to a more resourceful means — the kite.

Having proven that lightning rods worked, the entrepreneurs moved in advertising parasols with built in lightning rod and trailing cable and the "Chapeau paratonnerre" or anti-

lightning hat for ladies that also boasted a wire spike on top and a trailing wire.



Someone Needs You
- Every Day!

Call 13 14 95
to find out more



Australian Red Cross
BLOOD SERVICE

AMSAT AUSTRALIA

Bill Magnusson VK3JT
RMB 1627 Milawa Vic. 3678
Email: vk3jt@amsat.org

NATIONAL COORDINATOR:
Graham Ratcliff VK5AGR
Email: vk5agr@AMSAT.org

AMSAT AUSTRALIA NET:
The AMSAT-Australia net is held on 80 or 40 meters LSB (Lower Side Band) each Sunday evening (except over the Christmas/New Year period). During the winter months in South Australia (end of March until the end of October) the net is on 3.685 MHz +/- QRM with an official start time 1000utc with early check-ins at 0945utc. During the summer months when daylight saving is in operation in South Australia (end of October until end of March) the net is on 7.068 MHz +/- QRM with an official start time of 0900utc with early check-ins at 0845utc. The times and frequencies have been chosen as the best compromise for an Australia-wide net taking into consideration seasonal propagation changes and the various state summer time variations.

AMSAT AUSTRALIA NEWSLETTER AND SOFTWARE SERVICE:

The newsletter is published monthly by Graham VK5AGR. Subscription is \$30 for Australia, \$35 for New Zealand and \$40 for other countries by AIR MAIL. It is payable to AMSAT Australia addressed as follows:
AMSAT Australia
GPO Box 2141
Adelaide SA 5001

KEPLERIAN ELEMENTS.

Current keps are available from the Internet by accessing the AMSAT FTP site, ftp.AMSAT.org and following the sub-directories to "KEPS".

column to a complete update on P3D including the latest projected frequency and mode schedule.

It's definitely time to start tooling-up for this next exciting phase of AMSAT activity.

Instant Track

Having dealt with those two, a third very common question also comes to mind.

The ubiquitous InstantTrack program will not as it stands, work properly after December 31, 1999. This situation will be rectified later in the year.

An updated version is complete and undergoing testing as I write this. It will be published in plenty of time for the transition to 2000.

ar

Let's review the scene at the moment..
The two questions most prominent on everyone's lips as I write this column are,

- 1 How much longer will we have amateur radio operations from the MIR Space Station?
- 2 When will Phase 3D be in operation?

Important as they are, both questions are difficult to answer. The first may well be decided by the time you read this in September.

MIR

The latest breaking news as I key this into my WP suggests that the current MIR crew is making 'last-minute' preparations to leave and that MIR will be put into some kind of sleep-mode for an indefinite period of time. What happens next is anyone's guess.

Miles Mann and others have been valiantly trying to get some definite news on the future of amateur radio operations on MIR and disseminating it ASAP on the ANS bulletins and in other media. Trouble is that no-one really knows, or if someone does, they aren't saying, what the immediate future holds for MIR itself.

Wild stories have been circulating in the world media about the imminent demise of the 'doomed' space station etc. I guess this is par for the course. It seems the only way to grip the public imagination is to suggest that some disaster is about to befall us.

We have heard stories saying that MIR's life may be extended by the intervention of a "White Knight" with lots of money. That one seems to have fallen flat. We have heard that MIR will be supplied with enough fuel to enable it to be kept under control whilst it is unoccupied for up to six (or more) months. We have heard that a last freighter will be sent up carrying enough fuel to send MIR splashing down under control into the Pacific ocean.

We have heard that this may not happen and MIR will come down, out of control in some random location and wreak havoc on re-entry. The SkyLab experience tells us that this would indeed be a situation to be

avoided. MIR is certainly large enough to ensure that huge chunks of it would survive re-entry.... and so the stories go on.

We can be reasonable sure that when the current crew come home we will see the last in a long saga of amateur radio operations on MIR. A saga that has given great impetus to amateur radio satellite operations and unparalleled publicity to amateur radio itself.

The whole AMSAT scene owes a huge amount to the Russian cosmonauts of the past several years and their travelling companions in space.

How fortunate we are that one of our own, Andy Thomas, VK5MIR was among the most active of all the travellers on the space station.

Many of the current AMSAT devotees would have had their first experience of space radio contacts via MIR. An untold number of school children have had a taste of space communications and an introduction to space science. Our own Maggie (Rita) Iaquinto, VK3CFI was a pioneer in this aspect of MIR operations from her home in Colac in country Victoria. Whatever the fate of MIR and its amateur radio component and however the current uncertain situation turns out, two things will remain.

MIR operations will be sadly missed by the world-wide amateur community and the tradition will continue into the International Space Station with the ARISS project.

Phase 3D

The second question regarding the launch and commissioning of phase 3D is also largely not under our (the amateur community's) control.

We are as always in the hands of the launcher. Word is that a launch within a month or two is on the cards but realistically the final launch opportunity will be decided by the other passengers on the launch rocket.

P3D will give AMSAT affairs an enormous and much needed boost. It will really be a satellite for everyone. As the latest launch opportunity is fast approaching, I'll try to devote next month's

REPEATER LINK

Will McGhie VK6UU

21 Waterloo Cr Lesmurdie 6076

VK6UU@VK6BBR

will2@omen.net.au

- (08) 9291 7165 -

LIPDs

I must admit I did not see that LIPDs, Low interference potential devices, would be much of a problem on our 70cm band. These devices are very low power (25mW) and with only limited antennas attached to the hand-helds we could live with any interference that might come our way.

However, when part of the LIPD band was chosen to coincide with some of our voice repeater inputs it is asking for trouble. Even 25mW will go long way when you have a voice repeater's receiver connected to a high gain antenna located in a prime high location listening for the weakest signals. If the LIPD band had been on our voice repeater outputs then we would not have the problem but the LIPD users would have the problem.

What is of real concern is recent developments in VK4. A conversation with Rod VK4ARN the repeater manager of a 70cm/6m/29MHz licensed gateway system, reported deliberate interference from LIPD operation on the input to the 70cm repeater.

The activity was deliberate according to Rod, as the CTCSS tone access was turned on by the LIPD user to key up the 29MHz gateway transmitter. Along with playing music via the linked repeater/gateway system, the interference had caused Rod to turn off the 70cm system.

The 70cm repeater is now back on air with the 70cm repeater's frequencies reversed. Rod tells me this was the recommendation from QTAC and has the approval from the ACA.

I did not foresee this type of deliberate targeted interference. The LIPD users must have a knowledge of the amateur band and the type of use it is put to. Perhaps this is an isolated situation but with LIPD usage in the 70cm band in its early stages it does not look good.

Who would have thought a few years back that we would have seen yet another CB band on yet another amateur band. We lost 27MHz to CB activity and now part of 70cm is under considerable threat. Along with the near wall to wall pirate activity on

28 to 29.7 MHz what band is next?

To further complicate the situation in VK4, a number of the 70cm repeaters in VK4 have been shown not to be on the correct repeater frequencies. The repeaters are on non-voice repeater frequency pairs. Be this as it may LIPDs are a real problem for repeater managers. There are some options, none of which are easy.

The first is CTCSS access only to the repeater input. Makes it difficult for amateur users who don't have CTCSS on their rigs and may only partially solve the problem due to LIPD equipment having CTCSS capability anyway.

The second is to reverse the repeater's input/output frequencies. This is an expense in time money and effort by the repeater manager but would cause the interference to the LIPD user. It would also be a potential means of promoting amateur radio. LIPD users would hear amateur activity and may learn more about our hobby.

The third option is to abandon this portion of the 70cm band to LIPD operation. If we do this could we then see even more of the 70cm band occupied by LIPDs?

VK-Repeaters

The mail server VK-repeaters on the Internet sure has taken off, with a number of topics being discussed. I must admit I have had little time to join in but have monitored the discussions.

Topics so far have shown some degree of misunderstanding of the regulations for starters. Other topics include audio quality on linked systems, the novice filter problem on links, 6 metre repeater locations, a request for information on an Australian built pager transmitter from an American amateur, availability of dual band mobile antennas, to the question, "Does the WIA liaison team monitor the mail server?" The answer to the last question is yes, some do, including FTAC.

Not bad for a new mail server only a few weeks old. The Internet location, <http://www.onelist.com/index.html>. Look for VK-repeaters.

Corrections

While on the subject of the mail server, VK-repeaters, attention has been drawn to the errors on the ACA web page in relation to voice repeaters and the linking of said repeaters. Comments on the page relating to the maximum number of repeaters allowed to be linked and in band linking (off air linking), I believe, are in error. The relevant part is:

"Repeater Cross-Linking

Amateur groups may be granted approval to permanently cross-link repeater stations subject to the following requirements:

1. Linking should not be carried out in the same Amateur band or in bands below 50 MHz.
2. Cross-linking up to a maximum of three repeaters will be allowed. This restriction does not apply in the case of links for 'packet' repeaters."

Regulation 1 excludes in band (off air linking) and regulation 2 limits the maximum number of repeaters to be linked to three.

You might think, "well so what a couple of errors on the web page", but this is the information the ACA area offices read when determining what we are allowed to do. Your application can be rejected on this incorrect information alone.

Attempts so far to correct this information have been unsuccessful.

I have no idea why.

ar

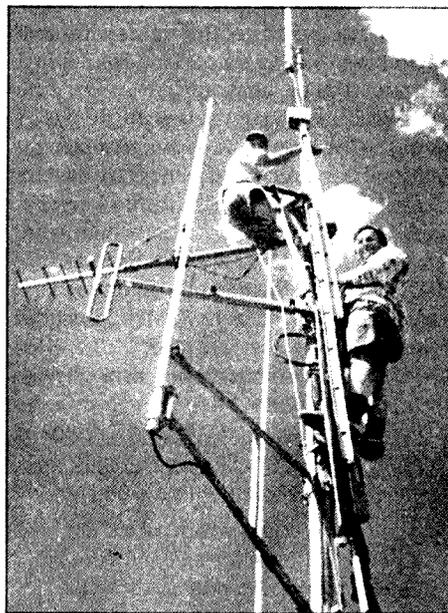

Repairs on VK3RGV Mt Wombat
Photo submitted by M.Mitchell
VK3HMM

ARDF

Ron Graham VK4BRGPO
Box 323 Sarina Qld 4737

Last column we talked about simple ARDF equipment. In this column we will move ahead to what I call the ARDF converter; also often called an attenuator, ultimate attenuator etc. Reference has been made in the last, and in previous columns to this device and the fact that it overcomes some of the limitations with using a handy talkie for ARDF.

Handy Talkie Limitations

In review, most limitations are essentially cause by poor shielding around the front end of the receiver section. This allows a strong signal, which is the case when close to the hidden transmitter, to enter the receiver directly and not via the antenna. So, as we are using the antenna to obtain the required directional information, but the signal isn't arriving via the antenna, we thus have no directional information!

ARDF Converter

As the name somewhat implies, this device is basically a frequency converter. It shifts the input, or hidden transmitter, frequency by a small amount. Thus the handy talkie (HT) is not tuned to the actual hidden transmitter, but to the offset frequency determined by the converter.

Provided the converter is well shielded, and as the handy talkie is no longer tuned to the actual transmitter frequency, the strong transmitter signal is essentially, no longer a problem. The offset frequency, which is in effect the oscillator frequency used in the ARDF converter, is generally quite small. A frequency of 500 kHz. or 1 MHz. is often chosen.

A frequency converter consists of two essential elements:

- the oscillator section referred to above, the frequency of which determines the converter's actual frequency change.
- the mixer section, which mixes the input signal from the antenna with the oscillator signal to produce both the sum and the difference of the two. Normally, just one of these output frequencies is required and that is achieved by tuned circuits on that particular frequency; in this case, the HT.

The Attenuator Aspect

With a frequency converter the output signal level depends, up to a maximum value, essentially on the input signal level and the oscillator signal level. So, if either the input signal or the oscillator signal levels are reduced, the output signal (to the HT) is also reduced. By fitting a control to adjust the oscillator output (or level) we have an effective attenuator incorporated into the ARDF converter.

Typical Circuit Arrangements

The ARDF converter consists of two essential sections, an oscillator and a mixer, mounted in a well shielded enclosure.

If the battery (power source) is also fitted into the shielded enclosure, this obviates the possibility of signals entering via that route.

There is much room for variation and experimentation with the type/frequency of the oscillator section and various mixer designs.

The oscillator frequency needs some consideration:

- the tuning range of your handy talkie (HT) .. if it tunes out of band with good sensitivity.
- consider proposed HT receiver frequency and the image frequency to ensure that there are no strong local signals, local repeater for example, on those frequencies.

An oscillator frequency is typically between 0.5 and 5 MHz., with 1 MHz. being a good choice. This allows you to simply add or subtract 1 MHz. (depending which side of the oscillator frequency you wish to use) to the HT's indicated frequency in

order to determine the hidden transmitter frequency.

Crystal control, free running and even variable oscillators are possibilities. Crystals tend to be expensive below 2 to 3 MHz, so this may be a limiting factor.

For example, if we have a hidden transmitter frequency of 145.3 MHz (as per the Australian Band Plan for ARDF) and an oscillator frequency of 1 MHz., the HT may be tuned to either 144.3 or 146.3 MHz. If we have, say a crystal controlled oscillator at 4 MHz, the HT would need to be tuned to 141.3 or 149.3 MHz., which is fine if your HT tunes out of band, but not usable if it doesn't.

Some form of control, as previously mentioned, is needed to adjust the oscillator output. This becomes the attenuator control.

The mixer section may range from a simple as a 1N4148 diode to a commercial double balanced mixer module.

Controls etc. on an ARDF converter will be the attenuator control, a battery on - off switch, a coax socket connected to the input of the mixer stage (signal input) and a coax socket connected to the output of the mixer stage (signal output).

The ARDF Converter in Use

The input of the converter is connected to your directional ARDF antenna. The converter output is connected to the HT antenna socket. Both these cables, are naturally coax, for shielding purposes.

As per the previous example, assuming a hidden transmitter of 145.3 MHz and an oscillator frequency of 1 MHz., the HT may be tuned to either 144.3 or 146.3 MHz. Set the attenuator for maximum sensitivity and you should hear the signal.

If a free running oscillator is used in the ARDF converter, it may be necessary to tune a little either side with the HT tuning in order to "find" the signal.

Now, unless your HT has a signal strength meter, because of the inbuilt limiting action of the FM HT, it is necessary to adjust the attenuator so the signal is slightly noisy. This is so that limiting action doesn't mask the effects of signal variations as you turn the antenna looking for the direction of maximum signal.

Advantages of the ARDF Converter

- a relatively inexpensive way to overcome the poor input shielding of the average HT or scanner.

continues next page

ARDF

Disadvantages of the ARDF Converter

- the converter has a reasonably high signal attenuation even at maximum sensitivity. This generally means that you will not hear weak signals at the start of an ARDF event. The solution is to use the HT connected directly to the directional antenna at this stage. The ARDF converter is fitted "in line" when you get closer to the source of the signal. At that stage, you may wish to use the attenuator function or the poor HT shielding is becoming a problem.
- if you inadvertently press the transmit button of the HT, you may burn out the mixer diode. With HT's that have adjustable TX output power, set the power level to the minimum. Also, consider a thin metal cover bent to a suitable shape so as to cover the PTT button. This cover may be simply taped in position.
- adds another piece of equipment and associated cables to be carried.

ar



AMATEUR TRANSCIVER RADIO CENTRE

ALINCO NO 1 FACTORY DIRECT
IMPORTER
AUTHORISED DEALER

MASSIVE MONTHLY STOCKIST
LATEST ARRIVALS

NEW DJ-V5E 6w VHF/UHF

DR-M06T 6m, DR-610E, DJ-G5EY,
ANTENNA TUNERS, POWER SUPPLIES.

BIGGEST DISCOUNTS ON BULK
PURCHASES OF ALINCO AMATEUR
RADIOS & ACCESSORIES.

FULL 3-YEAR FACTORY BACKED
WARRANTY

ALINCO SPECIALIST

ICOM

IC-706MKIIG, IC-T81A,
IC-2800H, IC-746, IC-756-Pro,
IC-T8A, IC-R75, IC-Q7A

KENWOOD TS-570SG TM-V7A
TH-G71A VC-H1 TH-D7A TM-G707A TS-870S

DIAMOND X-510NA, D-707E

AMERITRON AMPLIFIERS
AL-811AX 600 WPEP
AL-811HX 800 WPEP

PHONE (02) 9896 2545

E-mail: atrc@bytelink.com.au

Web Page:

<http://users.bytelink.com.au/atrc>

'It hit me like a ton of bricks'

Rob Seaman VK6TRC
robert@shannon.wow.aust.com

We all see the signs "please turn off transmitting devices" at construction and medical sites and understand the consequences of a stray transmission "pushing the red button". Here a member does a little DFing to find a potential danger point.

Just a message to let you all know of a recent interference problem with one of our local 70cm repeaters, VK6RTH, situated at Tic Hill, approx 30kms NE of Perth City on 433.225/438.225MHz.

The problem started about 3 weeks ago, the end of July, 1999 when the repeater was returned to service, after being off-air for about 2 weeks due to an antenna change.

The interference was a data/telemetry type signal on the repeater-input frequency (433.225MHz). The signal appeared at all hours of the day, evening and at night, at random times and transmissions lasted anywhere from several hours to less than 30 seconds.

The interference appeared "slightly mobile" as from time to time it would momentarily dropout of the repeater, then come up again, resetting the time out timer and causing transmissions on the repeater for extended transmissions.

Work commitments prevented me from getting onto the problem for about a fortnight, but I eventually heard the interference first hand, about 4.00am in the morning one day last week, after I left the handheld on the bedside table and forgot to turn it off before going to bed!

Anyway, after about 45 minutes I wasn't able to get back to sleep and the interference was still there. I knew that if I didn't get up and take the opportunity to do some DF'ing, that when I eventually had some spare time the interference wouldn't be heard!

I undertook some DF-ing using a simple 6 element Yagi and ended up at one of Perth's major brick manufacturers, about 5 km away from the repeater site. I found my way into the premises by following the 6am start workers cars into the yard. I was able to narrow the interference down to one of the large factory sheds on the premises.

I returned home and contacted the ACA later that morning with my complaint. They called me back in the afternoon, on site, from the brickworks for clarification on which shed I believed the interference was originating from, because unfortunately at that time, the transmissions had ceased!

The ACA and electrical staff from the

company couldn't come up with any likely sources. The transmissions commenced again briefly whilst they were on site, but didn't stay on air long enough to be found!

The ACA put me in contact with the Electrical Shift Supervisor at the company as the interference was occurring at random times day & night and the ACA were restricted to working daytime, Monday to Friday, whilst the brick company worked 24hrs/7 days a week.

The interference continued to appear and early this morning (Sunday, 15/8/99) it reappeared and I was in a position to attend the brickworks and do some further DF'ing. I met with the Electrical Shift Supervisor and the interference was finally tracked down to a handheld remote control unit that was used to operate a large overhead crane in the workshop.

The crane is designed to lift & move several tonnes. The unit was about the size of an older style HT, with a small antenna fitted to the top, an arrangement of buttons on the front and a large battery pack on the rear. There was no sign of a type approval number or TX frequency on the unit. The unit was tested next to my receiver and immediately when it was powered up, the transmissions commenced, even though no commands were being sent to the crane.

I explained to the Electrical Shift Supervisor the possibility that legitimate, licensed transmissions could cause havoc or worse, an industrial accident on the frequency they were using. He immediately replaced the wireless remote with a wired remote unit and stated that they used several other similar remote control units on other cranes in their operations.

I will be advising the local ACA office & the Electrical Supervisor at the company of the cause of the interference tomorrow morning. I intend to also take the matter up further with the local WIA Division through the WA Repeater Group, who is the repeater licensee. I will have it made known to the Federal WIA as well as Worksafe WA (The statutory Occupational Health & Safety authority).

ar

CONTESTS

Ian Godsil VK3DID

57 Nepean Highway, Aspendale 3195

Contest Calendar September - November 1999

Sep 4/5	All Asia DX Contest	(Phone)	(May 99)
Sep 4/5	Bulgarian DX Contest	(CW)	(Aug 99)
Sep 5	Panama Anniversary Contest	(SSB)	(Aug 99)
Sep 11/12	Worked All Europe DX Contest	(Phone)	(Jul 99)
Sep 18/19	SAC DX CW		(Aug 99)
Sep 25	Internet CW Sprint Contest		
Sep 25/26	SAC DX Phone		(Aug 99)
Sep 25/26	CQ WW RTTY DX Contest		(Aug 99)
Oct 2/3	VK/ZL/Oceania DX Contest		(Aug 99)
Oct 3	RSGB 21/28 MHz Contest	(SSB)	(Aug 99)
Oct 9	Ten-Ten Int. Day Sprint	(CW/SSB/RTTY)	
Oct 9/10	VK/ZL/Oceania DX Contest		(Aug 99)
Oct 16/17	JARTS WW RTTY Contest		(Sep 99)
Oct 16/17	Worked All Germany Contest	(CW/SSB)	(sep 99)
Oct 17	Asia-Pacific Sprint	(CW)	(Jan 99)
Oct 17	RSGB 21/28 MHz Contest	(CW)	(Aug 99)
Oct 30/31	CQ WW DX Contest	(SSB)	(Sep 99)
Nov 1/7	HA QRP Contest	(CW)	
Nov 6/7	Ukrainian DX Contest	(CW/SSB)	
Nov 7	High Speed CW Club Contest		(Jan 99)
Nov 12/14	Japan Int. DX Contest	(SSB)	
Nov 13/14	WAE RTTY Contest		(Sep 99)
Nov 13	ALARA Contest	(CW/SSB)	(Sep 99)
Nov 13/14	OK/OM DX Contest	(CW)	
Nov 20/21	LZ DX Contest	(CW)	
Nov 27/28	CQ WW DX Contest	(CW)	(Sep 99)

Chatham Islands ZL4IR/ZL7 operation

From: Ed Hartz K8VIR/ZL4IR

I will be making numerous trips to the Chatham Islands over the next 18 months. A special QSL will be sent commemorating the next millennium (Chatham Islands will see the first sunrise of the next century).

The QSL card also gives recognition to "Old Blue", a Chatham Islands hero. Main Frequencies will be 18.130, 24.950, 28.550, 21.260 and 14.260 MHz + QRM. All QSL's direct to my manager, Bill Coale, W8WC.

In July something very strange happened, in that about half of what I believe I sent for printing did not make it. I do not know why, but I suppose it was something that I did. However, I do accept full responsibility for the distress caused to several readers and can only offer my sincere apologies that the Remembrance Day Rules in particular were omitted.

To redress the omission I sent immediately to the Federal and State Divisions copies of the Rules and an item for broadcast. In this way I hoped that those who needed a copy of the Rules would be able to get them in plenty of time. So to those who wrote and asked for copies, thanks and I hope that you were ready in time. To those who pointed out my unsuitability for the task of Contest Co-ordinator, thank you also.

In the case of some results also omitted, I re-present them below.

Meanwhile, good contesting and 73 de Ian VK3DID

Thanks this month to S5OU JE1CKA VK3DMS

RESULTS JIDX 1998

(Call\band\score\award)

VK2XT 28 2106

VK4DZ 28 988

VK2APK 14 14194 plaque

VK4BDX 7 26404 plaque

RESULTS CQ/RJ WW RTTY WPX 1999

(Call\cat\score\award)

VK6GOM SOABH 386880

plaque

VK4UC SOABL 412720

plaque

VK2KM SB15 70007 highest VK2

VK6WR SB20 78010 highest VK6

VK2BQS SB20 481 highest VK2

JARTS WW RTTY Contest

16 - 17 October 1999

0000z Sat - 2400z Sun

BANDS: 80 - 10 metres (no WARC).

MODE: Baudot only. CATEGORIES:

Single operator all bands; multi-operator all

bands (multi-tx permitted); SWL all bands.

EXCHANGE: RST+operator's age (00

acceptable for YLs). Multi-operator stations

must send 99 as operator age.

SCORE: two points for QSOs within own

continent; three points for QSOs outside

own continent. MULTIPLIER: (a) each

DXCC country except JA/W/VE/VK

mainland; (b) each call area in JA/W/VE/VK. Count each multiplier once per band. FINAL SCORE is total QSO points X total multipliers. LOGS to contain band; date; time; callsign; exchanges; multipliers; points claimed. Any entry with more than 200 QSOs must submit a DUPE sheet. Use SEPARATE logs for each band. SUMMARY SHEET to show name; address; category; claimed score. Multi-operators list names and callsigns of all operators. SEND LOGS by mail to: JARTS Contest Manager, Hiroshi Aihara JH1BIH, 1-29 Honcho, 4 SHIKI, Saitama 353-0004, JAPAN by 30 December 1999.

ALARA Contest

Sat 13 November, 1999

0001z - 2359z

OBJECT: Open to all licensed operators, YLs work anyone, OMs and Clubs work YLs only. BANDS: 80 - 10 m (no WARC).

SUGGESTED FREQUENCIES:

28.380 - 28.410 MHz; 21.170 - 21.200 MHz; 21.380 - 21.410 MHz; 14.250 - 14.280 MHz; 7.070 - 7.100 MHz; 3.560 - 3.590 MHz.

MODES: CW; SSB. Note: CW is very much encouraged, but please keep it within the suggested frequencies.

CATEGORIES: CW; SSB; MIXED; SWL.

CALL: Phone "CQ ALARA CONTEST"; CW: YLs call "CQ TEST ALARA"; OMs call "CQ YL". EXCHANGE: RS(T) plus serial number starting at 001; name; whether ALARA member or Club station. Note: Stations may be re-worked on the same band and mode after an interval exceeding one hour. No net, list, crossmode or crossband operations permitted.

SCORE: CW/Phone - five points for ALARA member contacted; four points for YL non-member contacted; three points for OM/Club contact. On CW, QSO where one operator is a Novice, score DOUBLE points.

LOGS to show date; time UTC; band; mode; callsign worked; exchange; name of station worked; whether Club; points claimed. Logs may be single entry, except Australian YLs entering for the Florence McKenzie CW Trophy should use separate CW log. Show name, address, callsign of operator, points claimed. Contest Manager's decision will be final.

SEND LOGS by 31 December, 1999, to: Mrs. Marilyn Syme VK3DMS,

99 Magnolia Avenue, Mildura, 3500, Australia.

Various CERTIFICATES will be awarded.

WAE RTTY Contest

13-14 November, 1999

0000z Sat - 0000z Sun

Only 36 hours of operation are permitted and breaks may be taken as one period or no more than periods.

BANDS: 80 - 10 m with minimum time on band of 15 minutes.

MODE: Baudot (RTTY) only. CATEGORIES: Single operator all bands; multi-operator single tx; SWL. DX cluster support is permitted.

EXCHANGE: RS(T) plus serial number starting at 001. Stations may be worked once only per band.

SCORE one point for each QSO and one point for each QTC reported to another station not on your continent. MULTIPLIER is each DXCC/WAE country counted once only per band. MULTIPLIER BONUS: each multiplier on 80 m is multiplied by 4; on 40 m by three and on 20/15/10 by two.

FINAL SCORE is total QSO + QTC points X total multipliers.

Use SEPARATE LOGS for each band, showing band changes and duplicates. Supply DUPE SHEET if more than 100 QSOs on any band.

SEND LOGS by 15 December, 1999, to: WAEDC Contest Committee, Duererring 7, PO Box 1126, D-74370 Serheim, Germany.

Logs may be sent by e-mail to: waedc@compuserve.com in plain ASCII with Summary Sheet.

CQ WW DX Contest

SSB: 30/31 October 1999

CW: 27/28 November 1999

0000z Sat - 2400z Sun

OBJECT: For amateurs around the world to contact other amateurs in as many zones and countries as possible.

BANDS: 160 - 10 metres (no WARC). CATEGORIES: Single operator single band/multi-band; high power (100w+); low power (100w-); QRP (max 5 w o/p); assisted (full power + use of spotting nets permitted). Multi-operator all bands single tx (only one tx and one band permitted during any 10 minute period from first QSO on that band); multi-tx but only one signal per band.

EXCHANGE: RS(T) plus CQ zone. MULTIPLIERS: Each different zone and country contacted per band. WAZ, DXCC and WAE lists, WAC boundaries are standards. Stations may contact their own country and zone for multiplier credit but zero points.

SCORE three points for contacts between stations on different continents.

FINAL SCORE is total QSO points X zone and country multipliers.

LOGS must show time UTC; exchanges; multiplier FIRST time worked on each band; checked for duplicates and correct scores. Separate log for each band. SUMMARY SHEET should show name and address in block letters; all scoring information; category and signed declaration. All entrants should submit cross-check sheets.

SEND LOGS on paper or 3.5 inch disk in CT.BIN or N6TR.DAT format by 1 December (SSB) or 15 January (CW) to: CQ Magazine,

76 North Broadway,

Hicksville, NY 11801, USA.

Various AWARDS available.

Worked All Germany Contest

16/17 October 1999

1500z Sat - 1500z Sun

BANDS: 80 - 10 metres (no WARC). MODES: CW; SSB.

CATEGORIES: Single Operator all bands CW; single operator all bands mixed; single operator all bands mixed QRP (max 5w o/p); multi-operator single tx; SWL. DX cluster support is permitted for all categories. EXCHANGE: RS(T) plus serial number. German stations will send RS(T) plus DOK code.

Stations may be worked only once per band. SCORE three points for local QSO and five points for DX QSO.

MULTIPLIER is number of German districts worked (max 26 per band), plus each country counts one multiplier per band regardless of mode. FINAL SCORE is total QSO points X total multipliers from all bands. Various AWARDS available.

LOGS should show time UTC; exchanges; duplicate contacts.

SUMMARY SHEET and multiplier check list should show name; address; category; points claimed.

SEND LOGS by mail or 3.5 inch disk in ASCII format to:

Klaus Voigt DL1DTL,

PO Box 120937

D-01010 Dresden, Germany,

by 30 November.

Amateur Radio Questionnaire

Bob Harper VK4KNH

BACK IN 1995 there was a survey of amateurs taken to gauge the acceptance of AR and to review the content requirements of the readers. I was not involved with AR then and so feel that I can review those results without any calls of a "pre-wind-up".

The reason for doing this is to make you aware that another survey will be held within the next few months and to encourage you to have your say.

You see back in 1995 there were 5026 surveys sent out and 394 received back which is about a 7.8% return. 10% is considered a good return by many bodies who do such surveys but wouldn't it be nice to get at least a third of the members interested?

In fact it is rather risky making changes based on a small percentage like this, as it is also commonly recognised that in many organisations about 5% are considered the "fringe element". Fringe elements often tend to be more vocal than the other members are.

The main cause for concern with surveys is the make-up of the sample taken. Does it really represent a fair cross section of the amateur radio community and the wishes of

the average member? For this reason, well-designed surveys try to identify the person, not by name, but by membership of subsets of the community being surveyed. This can set off alarm bells with members as they feel their privacy is being challenged and they then refuse to send their survey back.

Please understand that there is a purpose, a genuine need, for each question asked and that names will not be listed against the replies you offer. The only reason for asking for your name and callsign is to identify that you are indeed a member and not voting twice.

The sample may inadvertently be made up of mainly one section and almost without others sections at all. If you belong to a particular interest group you would not want the majority voting to remove you groups item from AR. Take the ATV group as an example. Currently there is no column on ATV and therefore when asked, "Should there be more ATV in AR?" the only possible answer should be yes. No doubt we would get some non-ATV people saying no but how should the survey determine the real wishes of the members in such a conflict?

There are two possible ways: -

- 1) Read the results and make a gut feeling decision -not very scientific and very prone to personal bias. The other problem is the decision-maker will almost certainly be challenged whatever the decision.
- 2) Identify the members of the sample who are also members of the sub-group. Then calculate the percentage of those members who want more (or less) ATV content and compare that against non-ATV members. If this is compared to those who identify with the most popular sub-groups, technical articles for example, and a benchmark can be set. It still comes down to a human decision but with far more defensible criteria.

Ultimately I believe that AR should have something for everybody without monopolising the space for any one interest. There is one great advantage to having a wide selection of content and that is that all readers have a chance to become interested in one more facet of AR perhaps as interest in another facet fades. **PLEASE! Send Your Survey Responses.** Your input will help define the content of AR for the next few years at least.

ar

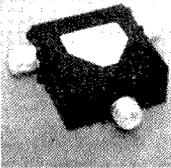
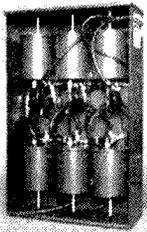

radio and Communications

Incorporating AMATEUR RADIO ACTION and CB ACTION

Edited by
**Chris Edmondson,
VK3CEJ4**
PO Box 123,
Eagle Heights,
Queensland 4271
ph (07) 5545 0666
fax (07) 5545 0622

Okay, so what are these gadgets? Simple. They're The Answer — the answer to that most curly of problems, **intermodulation**. RF guru **Ron Bertrand, VK2DQ** — well known for his excellent series of AOCIP instructional videos — tackles the nasty old intermod problem, and explains it and its cures in simple, understandable English.

So what does our September issue hold in store for you? How about these...?

- **CONTESTS** — all about the VK/ZL/O Contest. Come on, give it a try! And check the calendar...
- **THE RFDS STORY** — Steve Ireland, VK6VZ, makes the pilgrimage to Alice Springs. Join him!
- **REPEATERS** — the very latest listing of Australian amateur repeaters... all states, all bands!
- **REVIEW** — Icom IC-R2. How can something so small do such a lot? Check out Icom's baby...
- **WIA NEWS** — Yes, we know you get it here, but now there's more of it in R&C too!
- *As usual, we have our DX columns, mods and lots more... the best stories and regulars every month!*

Don't miss out — **RADIO and COMMUNICATIONS** is great reading for amateurs!
Check your local newsagent today!

(PS. We also have the biggest collection of radio-oriented Classified adverts in the country. There's lots of them because they work so well. Ask your newsagent to keep a copy for you each month. Hurry — you might miss something!)

vk3ce

POUNDRING BRASS

Steve P Smith
9 Peak Street
Bateau Bay NSW 2261
02 4334 7743

I recently came across an interesting article in relation to restoring telegraph keys, some keys such as the standard American J-38 series having a black plastic looking base, these bases are actually "Black Phenolic". This material can be purchased and easily cut to the required size depending on the size of your key base. Further information can be obtained from the following company:

Lee Valley Tools Ltd
1090 Morrison Drive
Ottawa Ontario K2H1C2
Canada

Give them a call in regards to prices etc as this information was not available at the time of writing.

A very interesting book (to be released in August this year) is an in depth study on the clinical use of Morse code in the education and rehabilitation of people with disabilities. Released by Allyn & Bacon USA, ISBN is 0-205-28751-4.

Written by Dr Thomas W King, Professor & Clinical Supervisor, Department of Communication Disorders, of the University of Wisconsin, the book has taken a number of years to produce.

I look forward in doing a review of this book as soon as one is obtained.

To our German readers, a new

Learn Morse — run the railroad

On the subject of Morse we thought that this 1902 Sears and Roebuck advertisement was of interest. By learning telegraphy you can get to run the railroad.

The price of the set is also interesting, \$1.65 in a monthly wage of \$50 equates to about \$100 today.

club has just recently been formed "Deutscher Telegraf Club" named "DTC" or "DL-CW-c" for short. The club is devoted entirely to the continued use of Morse Telegraphy on the Amateur Bands. DTC also offers radio amateurs a number of easy to work awards to promote CW activity, for readers with internet access further information can be obtained from the following: <http://www.muenster.org/dtc/index.html> or you can write to-

DTC c/o Thomas Koenig
DG6YFY, Secretary,
Rincklakeweg 43,
D-48153 Muenster
GERMANY

Also from Germany the "AGCW-DL". The German "Activity Group Telegraphy" has a new web page in both English & German that can be found from the following <http://www.qsl.net/agcw>

The Radio Society of Austria OVSV has decided to create a specific section for telegraphy within the society called:

"The First Austrian Telegraphy Interest Group" or OE-CW-G for short. Its aims are to promote CW activity and techniques, to establish contacts & create friendship with radio amateurs from around the world. Further information can be obtained from the following:

Georg Csapo, OE4CSK
Nueberg 346
7535- St Michael
AUSTRIA

With all these groups and societies starting up it looks like Morse telegraphy will be around well into the next century, despite the doom and gloom and the lowering of Morse standard by certain countries.

News from America. Ralph Taggart WB8DQT has recently released a new version of his CW software program: version 8.0 is now available. The program offers ways of improving both sending and receiving with a wealth of other information plus support pages if problems are encountered. Ralph's web site is: <http://taggaert.glg.msu.edu/wb8dqt/cwpage.htm> well worth a visit.

That's all the current overseas news I have to report for this month. Hope to see you on the bands soon. VK4SPS

ar

TELEGRAPH INSTRUMENTS.

To those who are about to start in life, either ladies or gentlemen, there is nothing at the present time which offers better inducements than telegraphy. The smallest salaries paid are about \$35.00 per month, but the salaries usually paid are from \$50.00 to \$125.00 per month and many even get much more. Besides, the only inducements are not the salary alone, for it opens the way to other and more expansive fields of work.

A large number of the high officials of railroad companies who command salaries from \$15,000.00 to \$50,000.00 per year started as telegraph operators. Thomas A. Edison, the wonderful inventor, who owns over 900 patents and is immensely wealthy, began as a telegraph operator.

Those who are not familiar with telegraphy are liable to believe that it is something mysterious and difficult to learn, but this is a mistake. It is very easy to learn, can be thoroughly mastered in from two to six months, and with a reasonable amount of care and application it can be learned at home and after a little experience the practice can be made very interesting by constructing a short line between two or more houses, which can be done at a very small expense; all that is necessary is to carefully follow the instructions laid down in the instruction book.

Our Complete Learner's Telegraph Outfit.

PRICE \$1.65

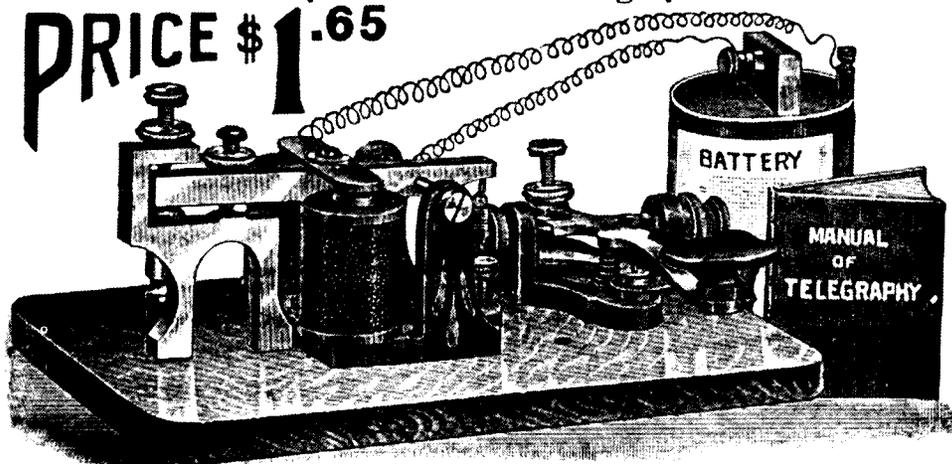

No. 20R4415

For \$1.65 we furnish a LEARNER'S COMPLETE TELEGRAPH OUTFIT, consisting of key and sounder, working battery, wire and Manual of Telegraphy (a complete instruction book), a regular \$5.00 outfit. Use this outfit, follow the instructions and you will soon become a telegraph operator. Positions are open for operators on railroads everywhere at \$40.00 to \$60.00 per month.

SILENT KEY

Darrel Hunziker VK2BHD

Darrel Hunziker VK2BHD was listed as a silent key last July. With permission from Darrel's family I would like to expand on a few facts about Darrel's life. Darrel was born 14th December, 1930.

"Yes Darrel speaking" was how he answered the phone. You knew he was ready to listen, be encouraging, and ready to offer sound advice. Darrel Hunziker was a friendly man, who treated everyone with honour and respect, and in turn was loved and respected by all who knew him.

Darrel grew up in Taree where his faith was nurtured in the Methodist church and developed in the Order of Knights. A school teacher by profession, he was a gifted lay preacher and served as Sunday school superintendent, as an Elder, a member of the parish council, and as a chairperson of the Maclean congregation. Darrel also took part in church concerts, often devising and appearing in skits, enjoying the fun and fellowship of these social occasions.

Darrel was Maths master of Maclean High School. He had to retire many years ago because of bad health, which he had suffered from for 25 years.

In the community, he was a member of the Maclean Probus club, a helper of the disabled, and a member of the heart support group.

As an amateur radio enthusiast, Darrel enjoyed communicating with other Hams across the world. Darrel first became a Ham about 1960 when he resided in Taree.

He died on Wednesday 7th April at the age of 68 years. Darrel is missed as a wonderful friend, neighbour and fellow Ham.

Yours in Radio
John Rowland VK2AHR

John Francis Anderson VK3JA

Jack's many friends will be saddened to hear of his passing on 23rd February 1999. He was on the CW net 2 days before entering hospital.

Jack was born on January 14th 1914 at Warrnambool. He attended the Warrnambool Technical School. Fellow students with an interest in radio were Les Kermond VK3DX and Russ Coulson VK4MA. Les was licensed in 1928 as a 15 year old, Jack followed in 19th August 1930 as a 16 year old.

INTRUDER WATCH

Gordon Loveday VK4KAL
F.I.W.C.
VK4KAL@VK4JEM
Fax/Ph 07 4985 4168

On re-reading the August edition of Amateur Radio mag, I'm wondering how many AM Transmitters have been pulled out of cupboards, dusted off & tested on air. Or did every-one pull theirs to pieces at the advent of SSB. There should be enough talent available to re-build a couple of valves (for preference) into a good rig to help beat these illegal operations we are hearing from our North, or have all those operators who "cut their teeth" on AM forgot how to build a simple transmitter & put it on air?? This could be a new worthwhile experience, to help the monitoring

service, without filling in an observation log! Let us have a go!

The summary for July is not quite as long as last month, however I have only given the general intrusions, not the R7B or B9W modes, these are beyond the average amateur to make any sense of, hence a waste of listening time. I wish to stress the importance of including signal strengths to all observations. I am not a mind reader. If you feel unsure of SINPO, use QSA, at least it gives an idea of how the signal was heard.

Some observers are experiencing spurious products from 7.105 to 7.150

So to the Summary

Freq	Date	UTC	EMM	Details
3.560	1907	1105	A3E	R.Korea, 200 kw, Poss ID
7.098	1907	1025	A3E	YJD R.Indonesia OK ID
14.0018	1607	0950	A3C	UiFAX, drum sp 120 rpm @ CF
14.0025	2607	0920	xxx	UiBUZZ, 0.5 sec pulse int'mit
14.0032	1607	0950	A3C	UiFAX,drum sp 120rpm
14.1065	2307	0530	A1A	UiCW,calls JC2S
14.110	0107	0516	A1A	UiCW, L calls 3VOA de W8GS
14.117	1507	0648	F1B	UiVFT,cont,nil Hz & Bds
14.2115	2907	0623	F1B	UiRTTY, 850 hz/112 bds, RDL. CIS
18.077	2907	0306	J3E	UiBC, CB type op, nil c/sign
18.150	1807	1039	A3E	UiFone Patch, YL op, non amat.
28.650	1907	2215	A3E	R.Habana, H3/9550 Cuba ID OK.

He moved from the potato farm at Southern Cross to Nullawarre where he helped clear the bush on his block. He married Mavis in 1940 and they started dairying.

Jack was a director of the Warrnambool Cheese and Butter Factory for 31 years,much of that time as chairman of directors. An elder of his church and Sunday School teacher, he was highly respected in this district. During the Ash Wednesday fires of 1983, he had the misfortune to lose his daughter-in-law and grandson.

During the war, the authorities sealed Jack's gear- that was the only period in 69 years that Jack's station was inactive. With good operating, helped by his trusty "V" beams, Jack attained the goal of budding DX'ers- the DXCC Roll of Honour, Open Section. His fist will be missed from the CW bands.

Our sympathy is extended to Mavis and their children Judith, Marjorie, John and Max.

(Contributor not named)

SPOTLIGHT ON SWLING

by Robin L. Harwood VK7RH
5 Helen Street, Newstead Tasmania 7250
(03) 6344 2324
E-mail: robroy@tassie.net.au

Well, Spring has arrived and already the higher frequencies have packed up after their winter hibernation, particularly after Sunset. As you are aware, there has been a reduction in the number of broadcasting periods from four to two. Despite that, some broadcasters are still going to make changes on the first Sunday of this month, although the bulk of the alterations will be on the last Sunday of October at 0100 UTC.

A number of international broadcasters have made co-operative agreements to share facilities of late. There is a very interesting one between Merlin Communications in the UK, The Christian Science Publishing Society (HBS) in Boston, Mass, USA and Radio Taiwan International in Taipei.

The HBS used to broadcast from their Saipan transmitters that are now owned by the US Government. HBS programs will be fed to the Merlin Centre in London and then fed via the Internet to Taiwan. Programs from Taipei will be also fed via the Internet to Merlin and then via the Skelton relay on shortwave for Europe.

Details of the HBS broadcasts from Taiwan facilities are as follows: 0900-1000 on 11725 to the Far East and Northern China 1000-1100 on 11840 to South China 1300-1400 on 11725 to India These transmissions are multi-lingual, including English. The transmission via Skelton for Radio Taiwan has been reported on 6175 kHz but the audio quality from the Internet is very poor. The time is 1900 to 2000 UTC. (EDXP)

Another broadcaster to enter into a co-operative agreement with the Taiwanese is Radio Portugal. The target area is the former Portuguese colony of East Timor, which had a referendum last month to decide its future, under UN auspices. It is being well heard here in Australia on 11550 kHz between 1000 and 1100 UTC. Radio Portugal (RDP) is also on 17740 in parallel continuing to 1400 UTC. The 11550 kHz channel relays the American religious broadcaster, WYFR in Chinese and Indonesian at 1100. WYFR also relays Radio Taiwan International to the Americas and Europe.

This year also is the 60th anniversary of

our own Radio Australia. It commenced not long after hostilities broke out in the Second World War. Although still broadcasting on short wave, more emphasis is now placed on co-operative agreements with local domestic broadcasters.

Don't forget that Radio St Helena will be again activated on October 23 from 1900 to 2300 UTC. It will be using a disused utility sender of Cable & Wireless on 11092.5 kHz on USB. They say it will be the final transmission before the sender is placed in the island's museum yet it seems to reappear every second year. I have not had much luck hearing it but now that I have a permanent antenna, this year I do hope to finally hear it. The final transmission of Morse from US maritime HF networks, took place on July 12 at 2359 UTC. The station, WCC, commenced operation in 1904 near Cape Cod, Mass. For many years, listeners assumed the transmitters were still there but it emerges that they are in fact located in Maryland, just near Washington DC. Although Morse may have disappeared, Globe Wireless, the operators are continuing to use the call signs on their SITOR/ CLOVER markers. It looks as if WCC may indeed chalk up its centenary, unlike the Dutch station, PCH, Schevingen Radio, which closed down on the last day of 1998.

In conclusion, I would like to acknowledge help from the Bob Padula's Electronic DX Press (EDXP), the World Utility Network (WUN) and QNews.

73 and good monitoring.

ar

SILENT KEY

Ivor Stafford VK3XB

Ivor was born in Foster, Victoria on 3 December 1912 and passed away on 22 May 1999 at the Valley Private Hospital, Mulgrave surrounded by his loving family. Ivor had been ill for some time but still managed to take a daily walk and work a little DX right up to the time of his death. As a young boy he showed considerable academic ability and went on to qualify as a Primary School teacher. He also engaged in his hobby of amateur radio, operating from country Victoria.

With the advent of war Ivor enlisted in 1939 and spent the next six years as a communications specialist in the RAAF, rising to the rank of sergeant. After the war he returned to teaching and renewed his interest in amateur radio. He also found time to qualify as a Melbourne University

graduate in both Arts and Education.

Most of Ivor's married life was spent at Box Hill South. It was during the war that Ivor had married Mavis, who also took up amateur radio, becoming one of Australia's most successful operators and an active administrator of ALARA. Ivor himself was particularly successful in DX and commemorative day competitions. He was the first Australian operator to gain the USACA certificate by contacting Stateside novices on 40 m. - no mean feat in itself. Like Mavis VK3KS, he held a First Class CW Operator's Certificate and was noted for his high standard of radio operation. He was most solicitous about such standards and behaviour on the bands, this characteristic being clearly reflected in his own skill and operating technique.

After moving into the Cumberland View Retirement Village at Wheelers Hill Ivor was suddenly severely restricted in his radio operation. This restriction became for Ivor a challenge in itself. Despite having been

obliged to erect the most inconspicuous of wire antennas no more than a few centimetres from the sloping roof of their unit, he went on to work the DXCC and what is more, all QRP, but that was the nature of the man.

Also a member ISSB Club, he always gave as much time as he could to the Old Timer's Club and the WIA, of which he was an honorary Life Member. Old Timers will remember that Ivor was for many years the WIA Outwards QSL Manager, a task that he carried out as meticulously as he did all of his activities including gardening and landscape painting.

Ivor will be very sadly missed by his family of three children, Lyn, Geoff and Russ and his six grandchildren. The burden of grief will be even greater for Mavis, his partner with whom he shared a loving relationship spanning nearly sixty years.

Rest in peace, Ivor.

Ken Matchett VK3TL

HF PREDICTIONS

by Evan Jarman VK3ANI

34 Alandale Court, Blackburn Vic 3130

Adelaide-Anchorage 30

First F 0-5 Short 12466 km

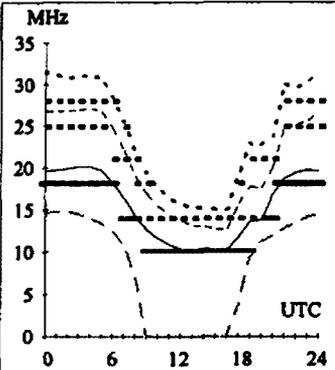

Brisbane-Lima 122

First F 0-5 Short 13056 km

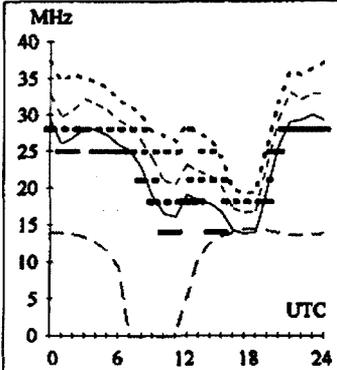

September 1999

T index: 133

Legend

- UD - Upper Decile (F-layer)
- F-MUF - F-layer Maximum Useable Frequency
- E-MUF - E-layer Maximum Useable Frequency
- OMF - Optimum Working Frequency (F-layer)
- ALE - Absorption Limiting Frequency (D region)
- 10%-90% - Shown hourly are the highest frequency amateur bands in ranges between these key frequencies; when useable.
- 50%-90% - The path, propagation mode and Australian terminal bearing are also given for each circuit.
- 90%-100% - These predictions were made with the Ionospheric Prediction Service program: ASAPS version 4.

Frequency scale

Time scale

These graphs show the predicted diurnal variation of key frequencies for the nominated circuits.

These frequencies as identified in the legend are:-

- Upper Decile (F-layer)
- F-layer Maximum Useable Frequency
- E-layer Maximum Useable Frequency
- Optimum Working Frequency (F-layer)
- Absorption Limiting Frequency (D region)

Shown hourly are the highest frequency amateur bands in ranges between these key frequencies; when useable. The path, propagation mode and Australian terminal bearing are also given for each circuit.

These predictions were made with the Ionospheric Prediction Service program: ASAPS version 4.

Adelaide-Budapest 305

First F 0-5 Short 14908 km

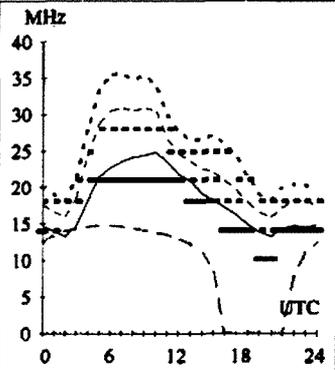

Brisbane-London 147

First F 0-5 Long 23498 km

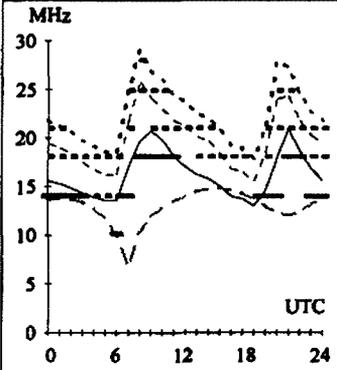

Canberra-Lusaka 239

Second 4F3-6 4E0 Short 11620 km

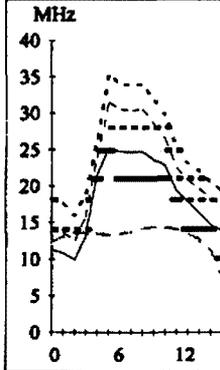

Darwin-Honolulu 65

First 3F3-10 3E0 Short 8635 km

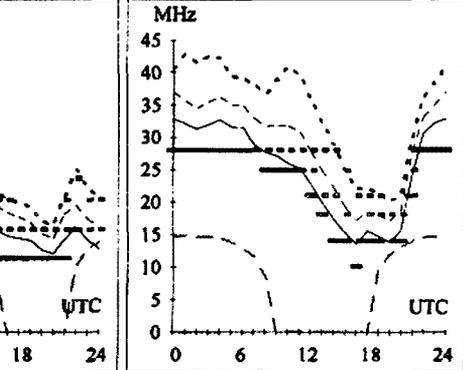

Adelaide-Suva 75

First 2F8-12 2E0 Short 4340 km

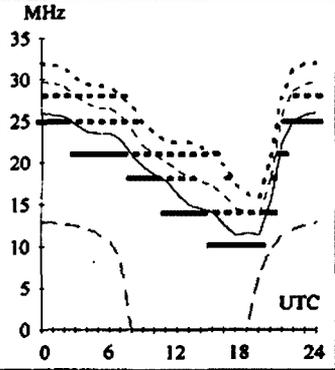

Brisbane-London 327

First F 0-5 Short 16526 km

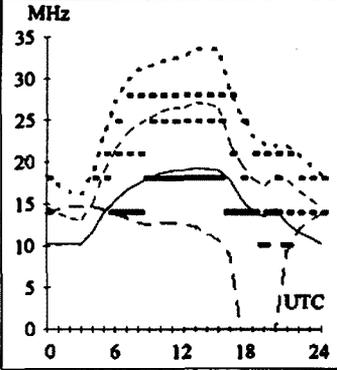

Canberra-Manila 327

Second 3F8-16 3E0 Short 6286 km

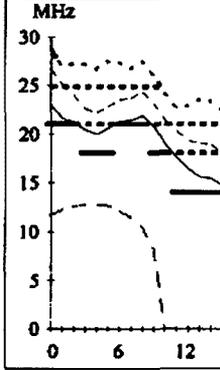

Darwin-Johannesburg 241

Second 4F4-7 4E0 Short 10639 km

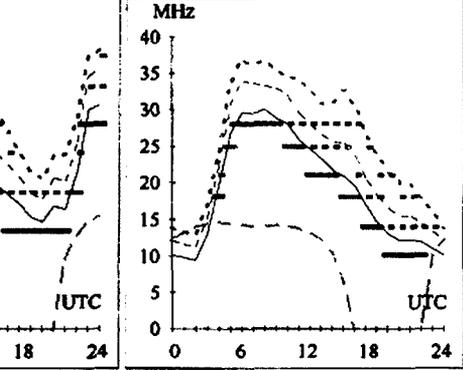

Adelaide-Warsaw 312

First F 0-5 Short 14818 km

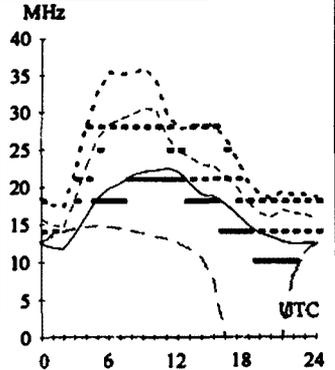

Brisbane-Seattle 44

Second 4F3-7 4E0 Short 11845 km

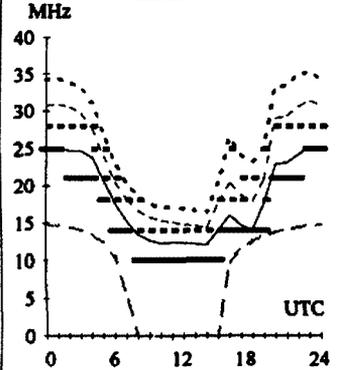

Canberra-Ottawa 59

First F 0-5 Short 16100 km

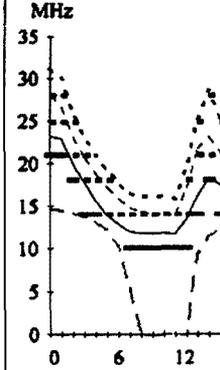

Darwin-Wellington 135

Second 3F12-16 3E1 Short 5322 km

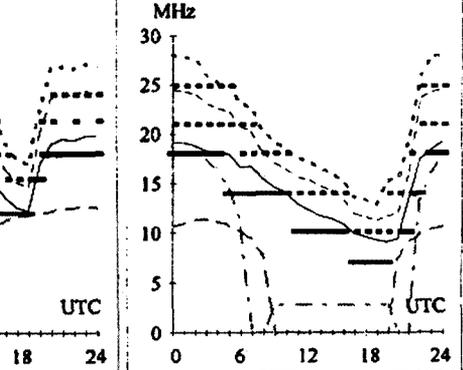

HF PREDICTIONS

Hobart-Capetown 220 **Melbourne-London 131** **Perth-Kuala Lumpur 336** **Sydney-Los Angeles 61**

First 3F1-4 3E0 Short 10026 km First F 0-5 Long 23118 km First 2F8-15 2E0 Short 4179 km First F 0-5 Short 12075 km

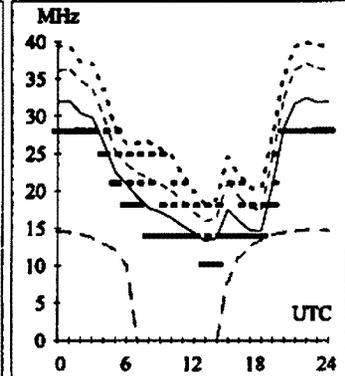
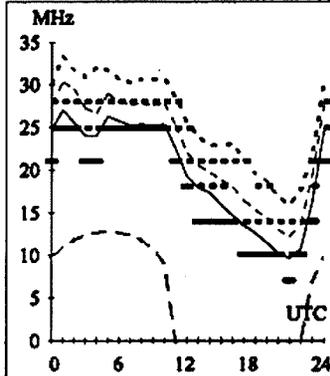
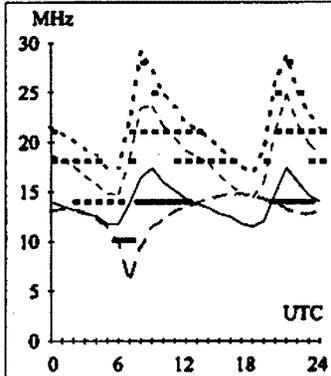
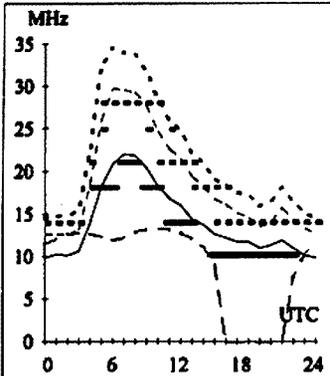

Hobart-New York 80 **Melbourne-London 311** **Perth-Rio de Janeiro 203** **Sydney-Rawalpindi 304**
 First F 0-5 Short 16609 km First F 0-5 Short 16906 km First F 0-5 Short 13523 km Second 4F4-10 4E0 Short 11066 km

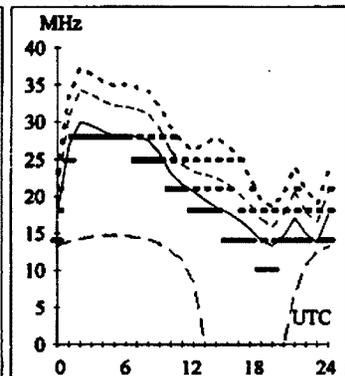
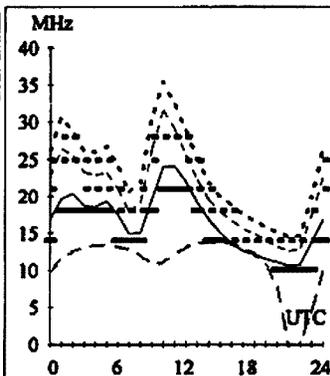
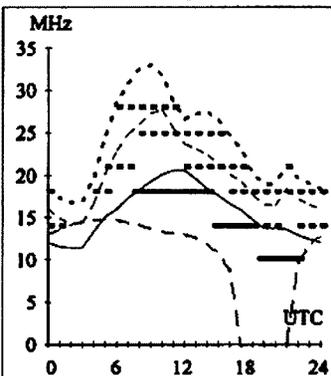
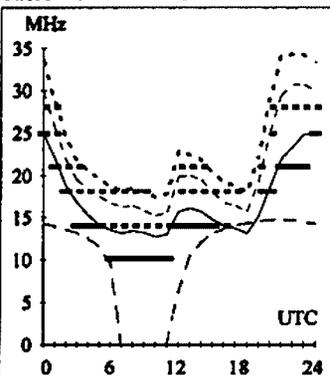

Hobart-Port Moresby 360 **Melbourne-Pretoria 234** **Perth-Stockholm 144** **Sydney-Santiago 145**
 Second 2F11-15 2E1 Short 3710 km Second 4F5-8 4E0 Short 10353 km First F 0-5 Long 26578 km Second 4F3-6 4E0 Short 11347 km

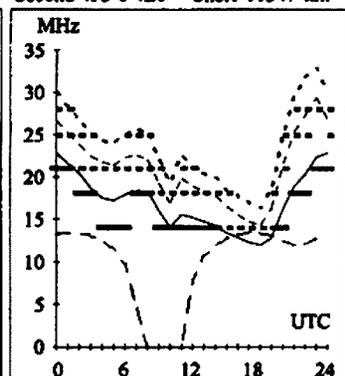
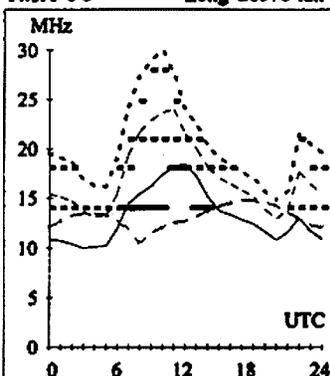
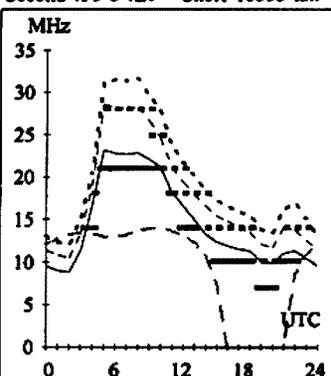
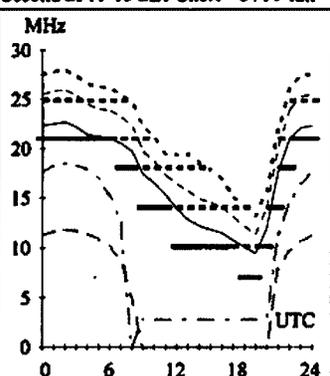

Hobart-Rome 284 **Melbourne-Tokyo 356** **Perth-Vancouver 50** **Sydney-Singapore 298**
 First F 0-5 Short 16350 km First 3F4-9 3E0 Short 8191 km First F 0-5 Short 14823 km Second 3F8-14 3E0 Short 6296 km

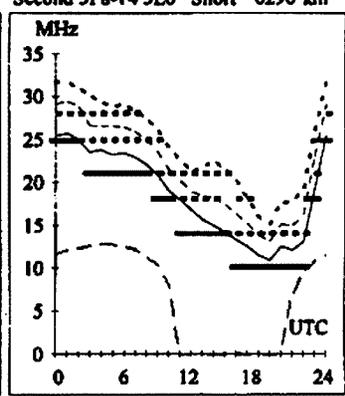
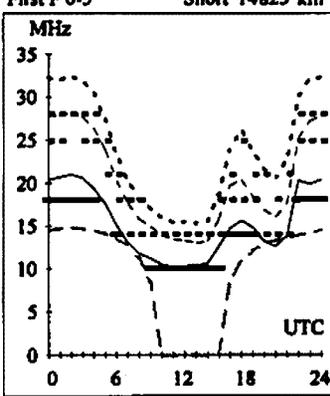
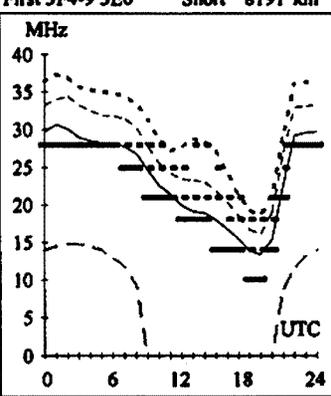
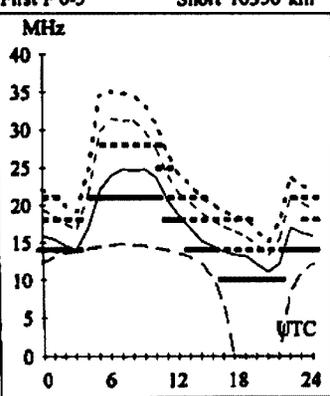

HAMADS

- Hamads may be submitted on the form on the reverse of your current Amateur Radio address flysheet. Please print carefully, especially where case or numerals are critical.
- Please submit separate forms for For Sale and Wanted Items, and be sure to include your name, address and telephone number (including STD code) if you do not use the flysheet.
- Eight lines (forty words) per issue free to all WIA members, ninth and tenth lines for name and address. Commercial rates apply for non-members.
- Deceased estates Hamads will be published in full, even if the ad is not fully radio equipment.
- WIA policy recommends that the serial number of all equipment for sale should be included.
- QTHR means the address is correct in the current WIA Call Book.
- Ordinary Hamads from members who are deemed to be in general electronics retail and wholesale distributive trades should be certified as referring only to private articles not being re-sold for merchandising purposes.
- Commercial advertising (Trade Hamads) are pre-payable at \$25.00 for four lines (twenty words), plus \$2.25 per line (or part thereof), with a minimum charge of \$25.00. Cheques are to be made out to: WIA Hamads.
- Copy should be typed or in block letters, and be received by the deadlines shown on page 1 of each issue of Amateur Radio, at:

Postal: Newsletters Unlimited, 29 Tanner Street, Richmond, 3121

Fax: 03 9428 4242

E-mail: news1@webtime.com.au

Please only send your Hamad once

Please send Hamads by mail OR fax OR email (much preferred).

Please do not send by more than one method for any one ad or issue, it is confusing.

WANTED NSW

- Copy of handbook and circuit for YAESU Active Antenna FRA-7700. Will pay photocopy & postage costs. Bill Crossland VK2TPW. PO Box 334 Ballina NSW 2478.
- Cathode ray tube type 3API will buy or swap 2metre rig Ray VK2AWQ 026494 1347
- Valve receivers. Military, commercial, heavy or not, junked busted or alive, parts, manuals, etc. Will pay if necessary. Specialise in Lifting Receivers over 40kgs!! Part of Radio Weight Lifting Team! Mad B40 collector!! Call John WIA L210628 on (02) 95336261.
- 6M linear amplifier - AWA test set MTS-A210 handbook or circuit - Ray VK2FW QTHR Phone a.m. (02) 6365 3410.
- Manual for Cam Metric Ltd Portable Wheatstone Bridge Catalogue No.7383. Copy OK. Will pay costs. Malcolm VK2BMS Phone (02) 92574583 b/h.
- 6M transceiver or a transverter to suit a FT101. VK2ZVJ 02 4443 2277 or brownsarre@fastrac.net.au
- Philips FM92 in good working order. 2M modification preferred. Ben VK2HVS (02) 43251190.
- Down East model 2335PA 1.2GHz 35W solid state power amplifier. Art VK2AS (02) 9416 7784. Email astowar@telstra.easymail.com.au

WANTED - VIC

- Circuit for General Radio Bridge Type 1656. Contact VK3XAQ (03) 98987559 a.h.
- Yaesu FT-736R options, such as 1.2GHz module, CTCSS board, or even a complete (but broken) FT-736. Please call Chris VK6KCH/3 on 0417 988 970 or 03 5333 6490 (Ballarat).
- Linear amp 144MHz all mode 200W plus. Photocopy of service manual for ICOM IC271 2M all mode. Info on any internet site for ICOM gear this era. Jim VK3AEF (03) 5391 3045 QTHR.

WANTED - QLD

- Instructions, owners manual, universal antenna coupler HC-500 Tokyo Hy-Power LABS (older model). Will pay copying fees, postage, etc. HENRY HF linear amplifier 4K ultra or similar 3-500z tubes preferred. John Abbott VK4SKY (0417) 410503 or PO Box 1166 Coolangatta 4225 QLD.

WANTED - SA

- Output transformer 4000 OHM primary 8 or 15 OHM secondary alternatively 5000 OHM primary with 8 or 15 OHM secondary. Preferably Rola 8 OHM preferred. QTHR (08) 8294 6906.
- Micronta 22-202B Multimeter Operators Instructions, also 0-25 amp meter to fit 70mm hole. Must be in good condition. Paul VK5MAP QTHR Phone/fax (08) 86512398.

WANTED - TAS

- Owners manual for Kenwood R2000 receiver or copy. Will pay costs. VK7TNP P.Denne (03) 62279158. 12/2 Coolamon Road Taroona Tas 7053.

- No.11(Aust.) Military radio, WWII vintage (not working is OK). Call Brian (03) 62295888.

WANTED - NT

- Tentec Delta 580 transceiver, any condition for use/spares in particular Relay one, part no. 32007 - Hamlin relay HE 551c50818, or address/ tel for Tentec Aus agent.. Jim VK8KV QTHR tel 0889450661 or 0418896757

FOR SALE - ACT

- Philips FM900 2 Metre with Motorola Power Supply and long remote cable. \$125 ONO ED VK1NBH 02 62512312
- Philips FM 900 2 metre radio, long remote cable, with Motorola power supply \$125 ono Ed VK1NBH 02 6251 2312
- Free to good home: model 15 TTY, separate paper tape reader and punch, with spare tape and TTY paper rolls. The TTY is on a stand with current loop power supply. Contact John VK2KJB 02 6284 2742 phone /fax.

FOR SALE - NSW

- Kenwood TS830S TCVR, MC-60 desk mic SP230 speaker, AT 230 ATU, Drake TV3300LP low pass filter. All in very good condition with manuals and original packing. \$750. Alex VK2ATY QTHR Phone (02) 48222756(h) or 0418602666(mob).

- ICOM IC735 HF Transceiver 100W as new plus mobile mount and mike original carton plus manual \$800 ono. MFJ antenna tuner MFJ9490 with dummy load, tapped inductor cross need SWR meter as new plus manual \$125 ono. WG Wolf multiband vertical antenna 10-80M 7.9M plus manual \$150ono. Sell separately or lot \$1000. John VK2GMR (02) 66461460.

- Kenwood TS-830S \$640 VF0230 \$230. Mic MC.50 \$95. Original boxes. Good condition. Laurie VK2JI QTHR (02) 99993993.

- Yaesu FT-107M with DMS S/N 0J080220. Yaesu FC-107 S/N 0J050339. Yaesu SP-102 SPK. YM-38 Desk Mic. Narrow Band CW Filter. All in absolute mint condition original manuals and cartons. In storage 6 years. Unused since 1996 (Ccomplete station one price \$550) VK2KS (Bill) QTHR 02 4646 1141 E-MAIL g0tgt@wolf.net.au

- Yaesu FT107M Mint condition. One owner. YM35 mike service manual inbuilt PS WARC \$600 ono. Allan VK2AGR (02)44711059.

- VFO Kenwood VFO120 with cord and booklet serial 921218 \$150 plus freight. Plus - Freq controller Kenwood DFC230 cords and booklet serial 1041409 \$250 plus freight. Both perfect condition. Geoff Bastow VK2UB QTHR Armidale (02) 67728287

- Yaesu FT-7 and FL110 linear amplifier with manuals, mic and cables. Good order. David VK2BDT \$350 (02) 48215036.

FOR SALE - VIC

- Yaesu FL2100B linear VGC S/No. 6H310370 \$550. Kenwood TS120V HF TXCVR S VGC S/ No. 912337 \$250. Kenwood TR7200G VHF FM

TXCVR VGC S/No. 540272 \$100. DSE 6MX 100W all mode linear VGC \$100. Kenwood TS820 HF TXCVR works S/No. 660344 \$90. Jeff VK3AKL (03) 97442422.

• **Pantronic SB10 HF 2-30 MHz 10 CH XTAL** Locked, remote head, remote ATU, valve PA, 100W output, works OK. Best offer. Des VK3VDP (03)51571784 QTHR.

• **ICOM IC-271A 2M all mode (s/n 01983) \$620** ICOM IC-735 HF txvr (s/n 20322) \$750 RF Concepts 2M/70CM High Power FM Amplifier (s/n 56R03-00078) \$600 YAESU FT-75B HF txvr (s/n 7J100292) incl AC & DC power supplies, external VFO \$200 Steve VK3DBL 0411077187

• **Military radios for sale.** R210 receiver, C11 transmitter, ATU#7 tuning unit, 24V rotary supply unit, J1 battery and 4-way interconnect boxes, headphones and wiring harness, \$350. B47 VHF transceiver \$50. A510 HF manpack transceiver with carry case \$150 ono. Glenn VK3FFX QTHR (03) 95319301 a/h.

• **Video enhancer and audio mixer with power supply.** New in carton \$85. Max VK3GMM (03)59852671

• **Antenna Hi-gain TH6DXX 6 element tri-band** excellent antenna erected 1994. Dismantled August 1999. Assembly instructions book \$300 ono. VK3CF QTHR (03) 93363985.

FOR SALE - OLD

• **Uniden 2020** needs good home. P/S doubtful. Lots of homebrew parts inside. Pick up and take away. Alan VK4BWG QTHR (07)34083652

• **IC-245** all mode 2 meter transceiver. Serial no.03022 with manual. VGC. \$240 neg. 4CX25B valve with socket and chimney. (All new Eimac). \$100 neg. Gwen VK4CB QTHR (07) 32027137.

• **Himound morse key HK-706** near new condition \$45. I will pay postage. Sally VK4SHE QTHR (07)47788642 or email rgrattid@ozemail.com.au

• **Spectrum analyser HP8558B** in HP182 mainframe. 0.1 to 1500 MHz. 240VAC. \$2100. **Universal counter HP5315A.** many features. Counts to 1300 MHz in UHF input; period, time interval, delay & ratio to 100 MHz in inputs A & B. 8 digit display & exponent & overflow. Battery & TCXO options. 240VAC. portable. Handbook. \$450. Kenwood TS130 transceiver, Mic, DC lead, handbook. \$375. Gary VK4AR QTHR 07 33531695.

FOR SALE - SA

• **Kenwood TS-130s.** ATU-130, VFO-120, MC-50 desk mic, mobile bracket, service and all other manuals. Excellent condition \$830 ono. 8EL Log Periodic Antenna \$400. Sell complete for \$1100. More for sale. Paul VK5MAP QTHR Phone/fax (08)86512398

Deceased Estate

20 amp VK Power Master Power supply \$120. Electrophone 11amp peak power supply \$120 Icom IC207 VHF/UHF Transceiver \$580, Pearce

Simpson super Cheetah Mark 3 CB transceiver s/n 2091534 \$130, **NeveX power meter W540** from 140/525 MHZ \$130 **VK6HA1 XYL Mrs J Browner** on 9342 3555 or **VK6NN L K Browner** 08 94284852

FOR SALE - TAS

• **IC-551 6 metre rig.** Band pass tuning, FM unit. Near mint. S/no.01268. Extras. \$500 ono. IC-451 70cm rig. Near mint. S/no.01486. \$500 ono. 70cm PA modules 50w \$89, 10w \$69. Mil spec. VK7JB (03)64923197

• **Valves.** TX 811A, 866, 830B, 828, 5763. RX 2A3, 3BP1. Many others. A & R XFMR 1KV-O-1KV 250MA. FTDX401. Prop. Pitch motor. Eddystone variables. Collins mech. Filter. 75A3 VFO. SCR 522, unmod. Siemens teleprinter. Command TX's 3-4 5.3-70 Mc/s. Meters, XTALS. Good quality misc. items. 2021 Murchison Hwy Wynyard 7325. Ken VK7AL QTHR (03)64381226

MISCELLANEOUS

• **GIFT.** Box of old crystal set components. Coils, variable capacitors, headphones etc. Free to collector/restorer. Alan VK3AL, 96901691. QTHR. Email: alanell@netlink.com.au

<http://www.hamsearch.com>
a not-for-profit site that is a
search engine for hams

TRADE ADS

• AMIDON FERROMAGNETIC CORES:

For all RF applications. Send business size SASE for data/price to RJ & US Imports, PO Box 431, Kiama NSW 2533 (no enquiries at office please ... 14 Boanyo Ave Kiama).

www.cyberelectric.net.au/~rjandusimports

Agencies at: Assoc TV Service, Hobart; Truscotts Electronic World, Melbourne and Mildura; Alpha Tango Products, Perth; Haven Electronics, Nowra

• WEATHER FAX programs for IBM XT/ATs

*** "RADFAXZ" \$35.00, is a high resolution short-wave weather fax, Morse and RTTY receiving program. Suitable for CGA, EGA, VGA and Hercules cards (state which). Needs SSB HF radio and RADFAX decoder. *** "SATFAX" \$45.00, is a NOAA, Meteor and GMS weather satellite picture receiving program. Needs EGA or VGA & WEATHER FAX PC card, + 137 MHz Receiver. *** "MAXISAT" \$75.00 is similar to SATFAX but needs 2 MB of expanded memory (EMS 3.6 or 4.0) and 1024 x 768 SVGA card. All programs are on 5.25" or 3.5" disks (state which) plus documentation, add \$3.00 postage. ONLY from M. Delahunty, 42 Villers St, New Farm QLD 4005. Ph 07 358 2785.

SILENT KEY

John Lewis VK3HW

Many would have seen on 'Burke's Backyard' that John Lewis died suddenly on 21 June. John was a well-known DXer throughout his ham radio career that began in 1948. He was particularly well-known in the United Kingdom and the USA. Over the years he used all the HF bands but his preference was 20 and 40 metres.

John had the great ability to turn a schematic into a well-engineered piece of equipment with a finish approaching commercial standards. The large shack and antenna at Ballarat was the complete expression of his vision, drive and construction abilities which extended to a detailed study of Log Periodic antennas which culminated in the 40-10 metre monster which proved the practical aspect of this broad band design.

In recent years he moved to Clifton Springs where, in addition to ham radio, he returned to earlier interests of gardening and fishing.

Bill Sadler VK3AMH

The WIA regrets to announce the recent passing of :-

A H	SANDILANDS	VK2BS
E G	MACDONALD	VK2BTY
J L	LEWIS	VK3HW
(ANDY)	EKLAND	VK4AD
(BERT)	BOEKHOLT	VK4LB
K (JOHN)	MCKECHNIE	VK6AMK
M G	PEGLER	VK6APM
W	DE HOOG	VK7JW

Email Hamads

If you are emailing your Hamad, the method much preferred by our type setters, could you please assist by following these two guidelines.

1

Please use upper and lower case as in normal text in the Hamad.

2

Please enter the words directly into the body of the email.

WIA Division Directory

The WIA consists of seven autonomous State Divisions. Each member of the WIA is a member of a Division, usually in their residential State or Territory, and each Division looks after amateur radio affairs within its area.

Division	Address Officers	News Broadcasts	Note: All times are local. All frequencies MHz.	Fees
VK1 ACT Division GPO Box 600 Canberra ACT 2601	President Gilbert Hughes Secretary John Woolner Treasurer Les Davey	VK1GH VK1ET VK1LD	VK1WI: 3.570 LSB, 146.950 FM each Sunday evening from 8.00pm local time. The broadcast text is available on packet, on Internet aus.radio.amateur.misc news group, and on the VK1 Home Page http://www.vk1.wia.ampr.org	(F) \$72.00 (G) (S) \$58.00 (X) \$44.00
VK2 NSW Division 109 Wigram St Parramatta NSW (Office hours Mon-Fri 1100-1400) (PO Box 1066, Parramatta 2124) Phone 02 9689 2417 Freecall 1800 817 644 Fax 02 9633 1525	President Michael Corbin Secretary Eric Fossey Treasurer Eric Van De Weyer Web: http://marconi.mpce.mq.edu.au/wia e-mail: vk2wi@ozemail.com.au	VK2YC VK2EFY VK2KUR	From VK2WI 1.845, 3.595, 7.146*, 10.125, 14.160, 24.950, 28.320, 29.120, 52.120, 52.525, 144.150, 147.000, 438.525, 1281.750 (* morning only) with relays to some of 18.120, 21.170, 584.750 ATV sound. Many country regions relay on 2 m or 70 cm repeaters. Sunday at 1000 and 1930. Highlights included in VK2AWX Newcastle news, Monday 1930 on 3.593 plus 10 m, 2 m, 70 cm, 23 cm. The broadcast text is available on the Internet newsgroup aus.radio.amateur.misc , and on packet radio.	(F) \$69.00 (G) (S) \$56.00 (X) \$41.00
VK3 Victorian Division 40G Victory Boulevard Ashburton VIC 3147 (Office hours Tue & Thur 0830-1530) Phone 03 9885 9261 Fax 03 9885 9298	President Jim Linton CEO Barry Wilton Secretary Peter Mill Web: http://www.tbsa.com.au/~wivac/ e-mail: vk3wi@rint.com.au	VK3PC VK3XV VK3APO	VK3BWI broadcasts on the 1st and 3rd Sunday of the month at 8.00pm. Primary frequencies, 3.615 LSB, 7.085 LSB, and FM(R)s VK3RML 146.700, VK3RMM 147.250, VK3RWG 147.225, and 70 cm FM(R)s VK3ROU 438.225, and VK3RMU 438.075. Major news under call VK3WI on Victorian packet BBS and WIA VIC Web Site.	(F) \$75.00 (G) (S) \$61.00 (X) \$47.00
VK4 Queensland Division GPO Box 638 Brisbane QLD 4001 Phone 07 5496 4714	President Colin Gladstone Secretary Peter Harding Treasurer Alistair Elrick e-mail: wiaq@brisbane.dialix.com.au Web: http://www.wiaq.powerup.com.au	VK4ACG VK4JPH VK4FTL	VK4WIA: 1.825 MHz SSB, 3.605 MHz SSB, 7.118 MHz SSB, 14.342 MHz SSB, 21.175 MHz, 28.400 MHz SSB, 29.220 MHz FM, 53.725 MHz FM, 147.000 MHz FM, 438.500 MHz (Brisbane only), and regional VHF/UHF repeaters at 0900 hrs EAST Sunday. Repeated on 3.605 MHz SSB & 147.000 MHz FM at 1930 hrs EAST Monday. Broadcast news in text form on packet under WIAQ@VKNET.	(F) \$74.00 (G) (S) \$60.00 (X) \$46.00
VK5 South Australian Division (GPO Box 1234 Adelaide SA 5001) Phone 08 8294 2992	President Jim McLachlan Secretary David Minchin Treasurer John Butler	VK5NB VK5KK VK5NX	VK5WI: 1827 kHz AM, 3.550 MHz LSB, 7.095 AM, 14.175 USB, 28.470 USB, 53.100 FM, 147.000 FM Adelaide, 146.700 FM Mid North, 146.800 FM Mildura, 146.825 FM Barossa Valley, 146.900 FM South East, 146.925 FM Central North, 147.825 FM Gawler, 438.425 FM Barossa Valley, 438.475 FM Adelaide North, ATV Ch 35 579.250 Adelaide. (NT) 3.555 USB, 7.065 USB, 10.125 USB, 146.700 FM, 0900 hrs Sunday. 3.585 MHz and 146.675 MHz FM Adelaide, 1930 hrs Monday.	(F) \$75.00 (G) (S) \$61.00 (X) \$47.00
VK6 West Australian Division PO Box 10 West Perth WA 6872 Phone 08 9351 8873	Acting Pres. Cliff Bastin Secretary Christine Bastin Treasurer Bruce Hedland-Thomas Web: http://www.faroc.com.au/~vk6wia/ e-mail: vk6wia@faroc.com.au	VK6LZ VK6ZLZ VK6OO	VK6WIA: 146.700 FM(R) Perth at 0930hrs Sunday relayed on 1.825, 3.560, 7.075, 14.116, 14.175, 21.185, 29.680 FM, 50.150 and 438.525 MHz, country relays 3.582, 147.200 (R) Cataby, 147.350 (R) Busselton and 146.900 (R) Mt William (Bunbury). Broadcast repeated on 146.700 at 1900 hrs Sunday relayed on 1.865, 3.563 and 438.525 MHz : country relays on 146.350 and 146.900 MHz.	(F) \$62.00 (G) (S) \$50.00 (X) \$34.00
VK7 Tasmanian Division PO Box 271 Riverside TAS 7250 Phone 03 6327 2096 Fax 03 6327 1738	President Ron Churcher Secretary Tony Bedelph Treasurer John Bates Web: http://www.wia.tasnet.net	VK7RN VK7AX VK7RT	VK7WI: 146.700 MHz FM (VK7RHT) at 0930 hrs Sunday relayed on 147.000 (VK7RAA), 146.725 (VK7RNE), 146.625 (VK7RMD), 3.570, 7.090, 14.130, 52.100, 144.150 (Hobart), repeated Tues 3.590 at 1930 hrs.	(F) \$74.00 (G) (S) \$60.00 (X) \$46.00
VK8 Northern Territory (part of the VK5 Division and relays broadcasts from VK5 as shown, received on 14 or 28 MHz).				

Membership Grades
Full (F) Pension (G) Needy (G) Student (S) Non receipt of AR (X)
Three-year membership available to (F) (G) (X) grades at fee x 3 times.

ADVERTISERS INDEX

Amateur Transceiver Radio	45	Icom.....	OBC, 19
Andrews	9	Nally.....	33
Av-Com	27	NQ Amateur Radio Convention.....	8
Dick Smith	IBC, 28,29	Radio & Communications.....	48

TRADE PRACTICES ACT

It is impossible for us to ensure that the advertisements submitted for publication comply with the Trade Practices Act 1974. Therefore, advertisers and advertising agents will appreciate the absolute need for themselves to ensure that the provisions of the Act are strictly complied with.

VICTORIAN CONSUMER AFFAIRS ACT

All advertisers are advised that advertisements containing only a PO Box number as the address cannot be accepted without the addition of the business address of the box-holder or seller of the goods.

▶ YAESU'S DONE IT AGAIN

**NEW
FOR
'99**



Yaesu FT-100 Ultra-compact HF/6m/2m/70cm Mobile

WHAT AMAZING VALUE!

Now you can enjoy the fun of operating on all bands from 160m to 70cm, either at home or in your car, and at a fantastic Yaesu price.

The new Yaesu FT-100 features HF/6m/2m/70cm transmitter coverage with 100W RF output on HF and 6m, 50W on 2m and 20W on 70cm, plus you can easily mount the detachable front panel using an optional lead (YSK-100) for more convenient mobile installations. Powerful interference fighting features such as a DSP based Bandpass filter, Notch filter and Noise reduction together with an IF based Shift control, all aid reception quality during tough conditions. A Speech Processor and VOX facility are provided for SSB users and an internal Electronic keyer is provided for CW operation. Also included are Dual VFOs, built-in CTCSS encode, 300 memory channels, all-mode operation (SSB, CW, AM, FM, AFSK, Packet 1200/9600bps), 100kHz-970MHz receiver (cellular locked-out), and options for additional AM and CW IF filters.

The FT-100 is supplied with an MH-42B6JS hand mic, DC power lead and comprehensive instructions.

D 3285

YSK-100 remote front panel lead \$155

D 3286

Included as standard:

- Digital Signal Processing on both transmit and receive
- Effective IF noise blanker
- Electronic CW keyer with 50 character message memory
- Spectrum Scope function
- Massive receiver coverage (100kHz – 970MHz, less cellular)

\$2750

DICK SMITH
ELECTRONICS

That's where you go!

YAESU

MORE

GREAT

GEAR

FROM

ICOM



PCR100 Cruise the air waves with your computer. Turns your PC into a high performance 0.5 - 1300 MHz receiver (FM/WFM/AM modes) with plug'n play installation. Multi function control panel, wide frequency coverage, and unlimited memory channels.

R2 Fit the world's airwaves in your shirt pocket. Just 8.6cm high, wide 0.5 - 1300 MHz frequency range divided into 9 bands plus FM/WFM/AM, 400 memory channels, great sound in rugged water resistant construction.

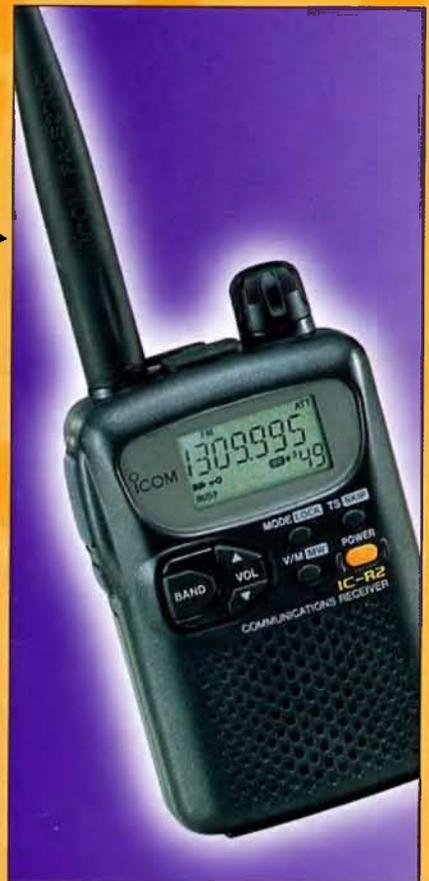

2800H A totally new approach to dual band mobile. Powerful performance on 2m and 70cm bands, remote control capability, and a first for mobile rigs...a multi-function colour LCD screen! All your information is right in front of you in colourful 3D-like characters and icons.



T81A A remarkably compact quad bander. Superb clarity on the 6m, 2m, 70cms and 23cm bands. It's water resistant, with tone squelch and pocket beep functions standard, plus you can change volume and bands even quicker with the 'joy-stick' style multi-function switch.

706MKIIG The amazing evolution of the legendary 706. Frequency coverage is expanded to the 70 cm band and output power is increased for the 2m band. You get base station performance and features in a mobile rig-sized package.



ICOM
Clearly Ahead

2 YR WARRANTY

See your nearest Icom Dealer, or visit our website at www.icom.net.au



OCTOBER 1999

Volume 67 No 10

Amateur Radio

Journal of the Wireless Institute of Australia



Full of the latest amateur radio news, information and technical articles, including...

- ★ JOTA (Worldwide Jamboree On The Air)
- ★ JOTA Preparation
- ★ An RF Return Loss Bridge
- ★ K2 QRP Transceiver
- ★ A Surprise in Bali
- ★ 50 Names to Remember

Plus *lots of other articles, news and special interest columns.*



WIA Yearbook 2000

Callbook Listings
Frequency Listings
Band Plans
Repeater Lists
Beacon Lists
Satellite Lists
Licence Conditions
Examiner Lists
Special Interest Groups
Public Relations Notes
Radio and TV Freqs.
and much, much more !

**Hint now for the
Christmas Stocking !**

**This edition will
contain all of the
content you have
come to expect of
the WIA callbook
as well as some
new items.**

**CLUBS - Take your orders now and be ready to
take advantage of bulk order savings for
affiliated clubs.**

It is more than a callbook, it's a Yearbook, the WIA Yearbook!

But DON'T CALL YET

(expected to be released early in November)

**The "WIA Yearbook 2000" will be available from
Divisional Bookshops and selected outlets.**



Amateur Radio

Volume 67
Number 10
October 1999

Amateur Radio is published by the Wireless Institute of Australia ACN004 920 745 as its official Journal on the first Friday of each month

Editorial

Editor: Bill Rice* VK3ABP
Production Manager: Bob Harper VK4KNH
Snr Technical Editor: Peter Gibson* VK3AZL
Technical Editors: Evan Jarman* VK3ANI
Gil Sones* VK3AUI
Contributing Editors: Ron Fisher* VK3OM
Don Jackson* VK3DBB
WIA News Editor: Richard Murnane VK2SKY (actg)

*Publications Committee member

Advertising

Mrs June Fox, WIA Federal Office
PO Box 2175 CAULFIELD JUNCTION VIC 3161
Tel: (03) 9528 5962 Fax (03) 9523 8191
email armag@wia.org.au

Hamads

"Hamads" Newsletters Unlimited
29 Tanner Street, Richmond VIC 3121
Fax: (03) 9428 4242
e-mail: news1@webtime.com.au

Amateur Radio Correspondence

All correspondence, contributions and queries about the *content* should be sent to:

The Editor *Amateur Radio*
PO Box 2175, CAULFIELD JUNCTION VIC 3161
email armag@hotkey.net.au
Tel: (03) 9528 5962 Fax (03) 9523 8191

Amateur Radio Delivery

All queries regarding delivery should be directed to:

Amateur Radio WIA Federal Office
PO Box 2175 Caulfield Junction Vic 3161
Tel: (03) 9528 5962 Fax (03) 9523 8191

Registered Office

10/229 Balaclava Road
Caulfield North VIC 3161
Tel: (03) 9528 5962 Fax (03) 9523 8191
Business hours: 9.30am-3pm weekdays

Editorial & Display Booking Deadlines

10th of each month prior to issue, or next business day

Hamad & Display Material Deadline

18th of each month prior to issue, or next business day

Production

Administration, Drafting, Design & Sub-editing
Shadetree Publishing & Imaging
PO Box 288 BEERWAH QLD 4519

Pre-press, print and mail management
Newsletters Unlimited (03) 9428 3458

Printed by Streamline Press, Melbourne (03) 9417 2766

Mailed by IMS, Melbourne (03) 9291 5888

Receipt of Amateur Radio by mail

Members who have not received their copy of AR by the 15th of each month should advise the registered office of the WIA

Copyright and Reproduction

The copyright in this magazine, except where specifically noted, is held by Wireless Institute of Australia ©WIA 1999. Permission to republish articles in any form must be obtained in writing from the Institute (other than for purposes of 'fair dealing'). This permission is usually freely given for information purposes.

The Journal of the Wireless
Institute of Australia

ISSN 0002-6859

General

50 People We Should Thank	12
<i>Bill Rice VK3ABP and Bob Harper VK4KNH</i>	
Preparing for JOTA	13
<i>Christine Taylor VK5CTY</i>	
JOTA Worldwide Jamboree On The Air	16
<i>World Organisation of the Scout Movement</i>	
JOTA Callsigns in Queensland	19
<i>Stephen Watson VK4SGW</i>	
A Surprise in Bali	20
<i>Richard Cortis VK2XRC</i>	
K2 Transceiver	21
<i>Adrian Hatherley VK3LK</i>	
QSLs from the WIA Collection	44
<i>Ken Matchett VK3TL</i>	

Technical

Return Loss Bridge (RLB)	24
<i>Ron Sanders VK2WB</i>	
Technical Abstracts	30
<i>Gil Sones VK3AUI</i>	

Columns

Advertisers' Index	56	HF Predictions	52
ALARA	11	Intruder Watch	39
AMSAT Australia	36	New Members	2
AR on the Web	51	Nets	49
Awards	42	Over to You	27
Club News	10	Pounding Brass	40
Contests	45	Repeater Link	38
WIA Division News		Silent Keys	50
VK1 Notes	7	Spotlight on SWLing	48
VK2 Notes	7	VHF/UHF - An Expanding World	32
VK4 Notes	8	WIA Comment	3
VK6 Notes	8	WIA News	3
Editor's Comment	2	WIA Division Directory	56
Education	15	WIA Federal Directory	2
Hamads	54		

Our cover this month

JOTA 99 - The cover photograph is made up of a selection of photos sent in by Christine VK5CTY.

Contributions to Amateur Radio

Amateur Radio is a forum for WIA members' amateur radio experiments, experiences opinions and news. Manuscripts with drawings and or photos are always welcome and will be considered for publication. Articles on disc or email are especially welcome. The WIA cannot be responsible for loss or damage to any material. A pamphlet, How to write for Amateur Radio is available from the Federal Office on receipt of a stamped self-addressed envelope.

Back Issues

Back issues are available directly from the WIA Federal Office (until stocks are exhausted, at \$4.00 each (including postage within Australia) to members.

Photostat copies

When back issues are no longer available, photocopies of articles are available to members at \$2.50 each (plus an additional \$2 for each additional issue in which the article appears).

Disclaimer

The opinions expressed in this publication do not necessarily reflect the official view of the WIA and the WIA cannot be held responsible for incorrect information published.

Amateur Radio Service

A radiocommunication service for the purpose of self-training, intercommunication and technical investigation carried out by amateurs; that is, by duly authorised persons interested in radio technique solely with a personal aim and without pecuniary interest.

Wireless Institute of Australia

The world's first and oldest
National Radio Society
Founded 1910

Representing
The Australian Amateur Radio Service

Member of the
International Amateur Radio Union

Registered Federal Office of the WIA
10/229 Balaclava Road
Caulfield North Vic 3161
Tel: (03) 9526 5982 Fax (03) 9523 8191
<http://www.wia.org.au>

All mail to
PO Box 2175 Caulfield Junction VIC 3161
Business hours: 9.30am-3pm weekdays

Acting Federal Secretary

Peter Naish VK2BPN

Federal Office staff

June Fox Bookkeeper
Rita Trebilco VK3IF Examinations Officer

Council

President	Peter Naish	VK2BPN
VK1 Federal Councillor	Glenn Dunstan	VK1XX
VK2 Federal Councillor	Michael Corbin	VK2YC
VK3 Federal Councillor	Brenda Edmonds	VK3KT
VK4 Federal Councillor	Ross Marren	VK4AMJ
VK5 Federal Councillor	David Box	VK5OV
VK6 Federal Councillor	Will McGhie	VK6UU
VK7 Federal Councillor	Phil Corby	VK7ZAX

Executive

Peter Naish VK2BPN
Tony Farrow VK2TJF
John Loftus VK4EMM
Wally Howse VK6KZ

Federal Coordinators

AMSAT	Graham Ratcliff	VK5AGR
ARDF	Jack Bramham	VK3WWW
Awards	John Kelleher	VK3DP
Contests	Ian Godsil	VK3DID
Education	Brenda Edmonds	VK3KT
FTAC	John Martin	VK3KWA
Historian	John Edmonds	VK3AFU
IARU	Grant Willis	VK5ZWI
Intruder Watch	Gordon Loveday	VK4KAL
ITU Conference and study group	David Wardlaw	VK3ADW
Public Relations (actg)	Richard Murmane	VK2SKY
QSL Manager (VKA, VKO)	Neil Penfold	VK6NE
Videotapes	Don Bland	VK4TVD

ACA Liaison Team

Peter Naish VK2BPN
Glenn Dunstan VK1XX
Michael Corbin VK2YC
Wally Howse VK6KZ
Canberra Liaison Officer
Richard Jenkins VK1RJ

EDITORS COMMENT

A rod for one's back

Last month I referred to the list of names we had published in August of people to whom Radio Amateurs should be grateful - "50 People You Should Thank". I apologised for mis-spelling some of them (in order of listing they were Ampere, Siemens, Bardeen, Jansky and Ferranti). Shockley was also a notable omission, being with Bardeen and Brattain co-inventors of the transistor.

The list was provided by our production manager (Bob Harper) as a last-minute filler, and I did not see it before the August issue was published. However as I wrote in September AR it seemed a good idea to try yourselves out on the list as invited. (How many do you know of, and what are their full names?) We would (I wrote in complete

optimism) publish the correct answers, correctly spelt.

Imagine my surprise to find out a few days after publication that another magazine was running a two-part series on the history of radio, which included many of the names on our list! Eighteen names from their list were also on ours! But we had listed another 34 names which they had omitted, so neither of us can be accused of plagiarism. This, unfortunately, was not the end of the story. Someone (Read "Editor") had to go through the 52 names (no longer 50) to answer the questions so we could publish them in this issue. The list is on page 12

I feel that the expert historians among you will score very highly but have to admit that a few are unknown to me and await Bob's addition for the few I can not trace. How did you score?

Bill Rice VK3ABP

NEW WIA MEMBERS

The WIA bids a warm welcome to the following new members who were entered into the WIA Membership Register during the month of August

L41024	MR R PAGE	VK3XMU	MR M A DODS
L50367	MR I S G PYSDEN	VK4DTM	MR D T MANNERS
L50613	MR N D BITTNER	VK4AAR	MR A ROOCROFT
L50614	MR H J TWINING	VK4VJY	MR S HAZAEL
L60413	MR C A MACKINTOSH	VK4TDL	MR D EYLES
L70155	MR D A GRAY	VK4ERQ	MR L KUBIS
VK2PIT	MR P A KNIGHT	VK4FLC	MR F CRAWSHAW
VK2PRK	MR K A KENNEDY	VK5HSX	MR S J DANIEL
VK2TAB	MR F S JARMUSZ	VK6WW	MR M FELDMAN
VK3GRW	MR G WAINWRIGHT	VL1MOJ	MR O MOON
VK3WU	MR P GLESSI		

Y2K response thwarted by Y1.999K bug

Alan Shawsmith has asked me to thank you, the readers, for the many responses he has had to his Y2K article.

Unfortunately he has been struck with a bad case of the winter flu (a Y1.999K bug perhaps) which has kept him quiet for some time.

He wants to reply to every letter and email but has been confined to bed for several weeks and is under Doctor's orders to stay away from the computer.

Please join with me in wishing Alan a full and speedy recovery.

Bob Harper VK4KNH.



Comment

Federal President, Peter Naish
VK2BPN.

FROM THE PRESIDENT

This is going to be a shorter than usual report this month because I am presently taking a few days holiday with my wife in Tasmania.

This does not mean that the affairs of the WIA have been banished from my mind because I am taking the opportunity of meeting with our members in VK7, an activity that I look forward to.

Despite the many avenues of communications open to us all these days, the face to face meeting still provides the best means of getting to know what the amateur radio enthusiast is thinking and how the WIA ought to be reacting.

This personal association with amateurs, whether they be members of WIA or not, enables me to hear at first hand about the issues that are worrying them.

Equally importantly, it provides a forum for me to explain how the WIA operates at the Federal level and how we contribute to the benefits of membership. Remember, however, that responsibility for the members rests firmly with the state Divisions.

It is their duty to service members requirements but WIA Federal remains ever ready to assist the Divisions in this task. Together we will work to enhance the benefits of WIA membership and the amateur radio service in general.

ar

Peter Naish VK2BPN.

WIA NEWS

Richard Murnane VK2SKY
PO Box 1247, North Sydney NSW 2059
richardm@zeta.org.au
vk2sky@vk2op.nsw.aus.oc

New approach to protect public from exposure to EMR

The Australian Communications Authority (ACA) has embarked on a new co-operative approach for the regulation of human exposure to electromagnetic radiation (EMR) generated by telecommunications equipment. The proposed regime is based on a new EMR standard to be developed by the Australian Radiation Protection and Nuclear Safety Agency (ARPANSA), as well as a Code of Practice, to be developed by the Australian Communications Industry Forum (ACIF).

The ACA's existing regulatory scheme utilises the exposure limits and field strength levels in the document known as AS/NZS 2772.1 (Int): 1998 - Radiofrequency fields Part 1: Maximum exposure levels - 3 kHz to 300 GHz. As part of the proposed changes to this regulatory system, this document will be reviewed by an expert group appointed by ARPANSA - an Agency within the Commonwealth Health and Aged Care portfolio which has the legislative authority to develop standards. A part of this review will require the group to develop exposure limits consistent with scientific research findings and world's best practice. A new ARPANSA EMR standard is expected to be published by the end of 2000.

ARPANSA will consult extensively with the public to ensure that stakeholders have an opportunity to contribute and comment on the development of the new EMR standard

In conjunction with the new standard, ACIF has commenced the process of developing an EMR Code of Practice for the telecommunications industry that will operate in parallel to the standard. The Code will be developed by ACIF in line with the Telecommunications Act 1997. The ACIF Radio and Environs Reference Panel is proceeding to draw up Terms of Reference for the Code for operators of cellular mobile base stations.

To reach this decision, the ACA conducted extensive consultation with representatives of the telecommunications industry, unions and community groups. All groups agreed with the proposal.

The ACA first introduced a regulatory scheme in February 1999 to address community concerns about increasing exposure to EMR. A range of equipment and services generate EMR, including radio and television broadcast stations, mobile phone handsets and base stations, radiocommunications systems and remote garage door openers.

The ACA will keep the public informed of progress on this issue. (ACA Media Release No. 52 of 1999 - 17 August 1999)
www.aca.gov.au/media/52-99.htm

VNG Struggles On

Ron VK3AFW reports that VNG still struggles to survive... are Australian Amateurs sufficiently interested in this service to help it continue operation?

Standard Time and Frequency station VNG is run under a contract that will end in June 2002. After that date the site owner proposes to sell it off to the highest bidder, probably for housing development. If the market is not buoyant at the time the sale might be put off and VNG might limp along for another year. But then it will close down. If you use VNG in your work or hobby then you need to make your need known to the National Time Committee or the VNG User's Consortium.

Have your say (in writing)

ARRL Seeks Future Technology Proposals

The recently formed ARRL Technology Task Force wants to hear from hams with ideas and proposals for new technology to carry Amateur Radio into the next century.

The Task Force and a Working Group will work hand-in-hand to identify, evaluate, and promote the most promising 21st Century technologies for Amateur Radio.

Amateurs are invite to complete the form on ARRLWeb at <http://www.arrl.org/news/ttf/>, e-mail to tftinput@arrl.org, or offer your ideas by mail to the ARRL Technology Task Force, c/o Ed Hare, W1RFI, 225 Main St, Newington, CT 06111.

Suggestions are requested by November 30 .

Full details on next page

It was thought that VNG would close this last June 1999, however, funding was found at the last minute. Earlier this year a voice announcement on VNG asked users to contact the VNG Users Consortium if they needed the service to continue. I believe that about 50 astronomers responded and three other people with different interests, a clock designer, a radio amateur and a physicist at a university.

I find VNG to be the only 24 hour time signal that I can rely on. WWV, WWVH, JJY are all unavailable at times during the day. GPS can give excellent time but there is no audio announcement, which I find very useful.

I urge users of Australia's T&F HF reference to make their needs known. I am prepared to collate emails and forward them. Otherwise donations and comments should be sent to the VNG Users Consortium direct.

Irrelevant to VHF?

Not for me. I use the VNG timing for setting/checking my analog clock for my meteor scatter skeds and to check the station digital clock. I also use it to check my frequency standards, so that I can minimise my transmission frequency errors.

(Ron VK3AFW)

ARRL Seeks Future Technology Proposals

The ARRL Technology Task Force wants to hear from hams with ideas and proposals for new technology to carry Amateur Radio into the next century. The ARRL Board of Directors created the Task Force and the companion Technology Working Group last January, and ARRL President Rod Stafford, W6ROD, has appointed a number of leading amateurs to serve on both panels. The Task Force and the Working Group will work hand-in-hand to identify, evaluate, and promote the most promising 21st Century technologies for Amateur Radio.

The Technology Working Group will evaluate technical proposals and make recommendations to the Technology Task Force, which, in turn, will make specific policy proposals to the ARRL Board of Directors.

The Working group is an expert panel selected from among League members representing a broad spectrum of Amateur Radio interests and activities.

The Task Force invites information and concepts on a wide range of technologies with the potential to improve Amateur Radio and to promote what the FCC calls "continuation and extension of the amateur's proven ability to contribute to the advancement of the radio art." The Task Force invites the submission of ideas and

proposals from all parts of the amateur community, and will use the input to help formulate League policy recommendations on a wide range of technical issues.

Amateurs are invite to complete the form on ARRLWeb at <http://www.arrl.org/news/ttf/>, send e-mail to the Task Force at tfinput@arrl.org, or offer your ideas by mail to the ARRL Technology Task Force, c/o Ed Hare, W1RF1, 225 Main St, Newington, CT 06111. Suggestions are requested by November 30, 1999-09-11

(ARRL Bulletin ARLB061)

FCC Relaxes Rules for Spread Spectrum

The FCC has relaxed rules governing the use of spread spectrum techniques by radio amateurs and opened the door to the possibility of international spread spectrum communication. The Report and Order in WT Docket 97-12 adopted August 31 concludes a proceeding that originated with an ARRL petition in December 1995 and has been pending since 1997.

The FCC adopted rules that will allow Amateur Radio stations to transmit additional spread spectrum emission types. Once the new rules become effective November 1, hams will be able to use techniques other than frequency hopping and direct sequence spreading. In addition, the new FCC rules will permit US hams to use spread spectrum techniques to communicate with amateurs in other countries that permit SS. Spread spectrum communication has been limited to stations within FCC jurisdiction.

The new rules require that spread spectrum stations running more than 1 W incorporate automatic transmitter power control. Amateur stations using SS are restricted to a maximum power of 100 W.

The Commission also amended the rules to eliminate what it called "now-unnecessary record keeping and station identification requirements" that apply only to stations using spread spectrum. The FCC agreed to let SS stations identify themselves using conventions developed by the Amateur Radio community.

Roanoke Division Vice Director Dennis Bodson, W4PWF, who has followed the League's Spread Spectrum initiative through from start to finish was pleased with the outcome of the proceeding. "I'm very happy," he said. "The League got everything it wanted and more—all of which, I believe, will help to promote this mode on the amateur bands."

Stations employing spread spectrum techniques will remain secondary to—and must accept all interference from—stations employing other authorized modes. The

FCC declined to authorize the use of spread spectrum techniques on additional bands or frequencies.

A copy of the FCC's complete Report and Order is available at <http://www.arrl.org/announce/regulatory/wt97-12>.

(ARRL Bulletin ARLB062)

WIA Queensland Incorporation Completed

The Secretary of the WIA VK4 Division reports that the Incorporation of the Division is now complete, and the VK4 Division is now officially "The Wireless Institute Of Australia Queensland Division Incorporated."

We should now have funds released to us by the solicitor to allow us to resume normal operations. During the last couple of months there have been some difficulties particularly in the office, bookshop, disposals and QSL areas due to the lack of available funds to allow normal operations. We thank the people managing these areas for their patience during the period, which started with the start of winding up of the company and ended with incorporation.

I would also like to thank those members on council who used their own funds to keep the division operating during this period, thanks also to David VK4OF our Secretary for all his efforts without which we would not be incorporated yet.

Special thanks to the office of fair trading for their special treatment in fast forwarding our incorporation particularly when they are having a reorganising of their office.

(Via QNEWS)

New 10 GHz Distance Record Set in VK4

On Sunday 5th September, Wally Howse VK6KZ/4 (the traveller!) and VK4OE extended the existing VK4 distance record for the 10 GHz band. The existing record was established when VK3XPD, VK3ZQB, VK5NC and VK5DK did their multi-state microwave 'bash' about three years ago.

VK6KZ/4 set himself up on Springbrook Mountain on the VK2/VK4 state border in behind the Gold Coast, and Doug VK4OE travelled three and a half hours by road up to Hervey Bay to a vantage point near to where Glen VK4TZL lives. The path is about the longest that could be considered in South-East Queensland which has minimal 'terra firma' intervening between the two locations.

After the usual (and necessary) careful setting up of dishes and finding correct beam headings, Wally was hearing Doug's carrier and after final optimisation, they

exchanged 3/1 and 4/1 reports on SSB. Quite characteristic fast QSB or 'wobble' in signal strength over a path of approximately 330 km, which is way longer than line of sight. Propagation could not be regarded as particularly enhanced on the day, but there was a slow moving high pressure ridge aligned with the Southern half of the Queensland coast at the time.

Equipment was pretty similar at each end, being about one watt transmitter output fed to dishes around 600mm in diameter, and HEMT LNA's ahead of what are essentially G3WDG transverter systems and IC202 tunable IF's.

Quite a thrill and reinforcing of efforts to 'push the limits' even further. Much more is possible!!! There are lots of good experiences available in the microwave area, as everyone who has already discovered it will confirm! In an earlier attempt VK4OE did hear his signal (very weak) when an aircraft was on direct alignment with the beam. Maybe there is more research and possibilities for aircraft enhancement on μ wave bands, not just VHF/UHF.

QNEWS understands Rod VK4KZR and Doug VK4OE are building 24 GHz narrowband gear and one of their aims is to 'steal' the distance record for that band back from the VK3's and VK5's who set it at the same time as the 10 GHz record two or three years ago.....

(via QNEWS)



World Survives GPS Rollover

As many will be aware, the Global Positioning System "rolled over" at midnight UTC on 22nd August 1999. The ten-bit counter that records the number of weeks since GPS was "born" on 6th January 1980 ticked over from 1023 back to 0; this made older GPS receivers display incorrect positioning information.

While most GPS users didn't notice, because newer receivers were programmed to take account of the rollover, there were a few problems around the world.

The ABC reported on 5th September that a young pilot in Western Australia got lost during a flight from East Kimberley to Broome. Police in Port Hedland about 600 kilometres south of Broome received a distress call from the pilot around 8.00pm

on 4th September, saying he was lost and running out of fuel.

The Great Northern Highway was closed about 40 kilometres north of Port Hedland to allow the plane to land, but the pilot managed to carry on and land at Port Hedland Airport.

The Australian Financial Review had reported that an estimated 100,000 users of car navigation systems got lost in Tokyo's unnamed back streets as their systems, "froze or went blank as the system rolled over into its new time sequence". The manufacturer of the systems, Pioneer adapted or replaced 210,000 of its 270,000 affected systems.

And the Irish Marine Emergency Service dealt with a yacht on route from the Scilly Isles to Kinsale which ran into fog and heavy weather south of Ireland. Local reports say that "The Tam-o-Shanter" radioed for help when its Global Positioning System began to misread the boat's position. The crew were further hampered by extremely heavy weather and a torn sail. With the aid of the IMES and Coast Radio Stations, a position was given and the yacht made its way back to Kinsale Harbour.

(from the ABC web site, the Risks Digest, and Radio Telefis Eireann web site)

Darryl VK2TDS notes that a complete list of manufacturers, phone numbers, and Web sites is available at:

www.navcen.uscg.mil/gps/geninfo/y2k/gpsmanufacturers/manufacturers.html

As this column was being compiled, people were breathing a sigh of relief that another Y2K cousin, the "9/9/99" bug had few if any serious repercussions (though one US electronics retailer was reported to have paid a customer a sizeable amount of interest on his overpaid account. The interest payment apparently was more than the total value of goods the customer had ever bought from the store!) Notwithstanding this, some may be tempted to think that the "real" Y2K bug may also be a fizzer. Hopefully, all the remediation carried out by companies and governments will make it so, but it would be unwise to assume that will be the case.

Speaking of the misnamed Millenium Bug, those of you with nothing better to do on New Year's Eve can watch how the world - starting with New Zealand - copes with the year 2000, on a special emergency watch web site.

The real-time, comprehensive Web-based view of the Y2K problem - and any havoc it may be wreaking on essential services anywhere - is the work of a World Bank-funded outfit known as the International Y2K Cooperation Centre.

Its Web site will flash colour-coded indicators on everything from energy and communications to financial services,

government services and air, land and sea transport.

Anyone with access to the Internet will be able to monitor, country by country, the status of the technology-challenging date change - assuming the Internet itself does not go haywire.

For more information, visit the International Y2K Cooperation Centre web page at <http://www.iy2kcc.org/>

(via ABC web site)

SCDXC now SK

Stephen Newlyn VK5VKA reports that after 26 years the Southern Cross DX Club has closed down due to a lack of administration staff and a decline in membership.

Stephen asks that references to the club's web page and mailing lists be deleted.

Geolocation Technology Pinpoints Wireless Emergency Calls Within 15 Feet

Researchers at Lucent Technologies' (NYSE: LU) Bell Labs have developed the most sensitive technology yet for pinpointing the location of wireless 911 emergency calls. The approach is accurate within 15 feet when users are outdoors and 100 feet when they are indoors.

The Bell Labs geolocation technology offers marked improvements over currently deployed systems for locating wireless 911 emergency calls. Moreover, it provides network operators the double benefit of meeting a 2001 federal mandate while opening opportunities for new service revenues. For example, pinpointing a customer's location could yield such services as detailed driving directions and local traffic information, especially when combined with improved data services expected two years from now.

"We intend to pursue standardization of this geolocation technology so that it can be widely and inexpensively deployed," said John Freidenfelds, director of wireless technology applications at Lucent's Wireless Networks Group.

The Bell Labs technology works with all of today's global digital networks and also will be compatible with next-generation (3G) broadband wireless networks, which will provide a broad assortment of location-based services, as well as high-speed, Internet-based multimedia services.

The driving force for the Bell Labs research has been a U.S. Federal Communications Commission mandate stating that by October 2001, all wireless 911 calls must be pinpointed within 410

feet. Currently, wireless 911 calls can be pinpointed within only a three- to six-square mile service area on average.

The Bell Labs geolocation technology would provide more precise location information to police, which is especially helpful when callers are unfamiliar with their whereabouts, and also would allow 911 calls to be routed more quickly to the appropriate rescue squad.

The Bell Labs approach involves both the wireless handset and network infrastructure. Global positioning system (GPS) units are placed throughout a wireless network. As the units keep track of GPS satellites orbiting the Earth, they pass along key satellite information - including estimated time of the signal's arrival - to nearby wireless handsets, which are equipped with scaled-down GPS units. Then, based on time differences between when the network's GPS units and the handsets receive signals from the satellites, it's possible to precisely pinpoint the handset's location.

For more information visit the Lucent Technologies site at <http://www.lucent.com> or the Bell Labs web site at <http://www.bell-labs.com>.

From a Bell Labs - Lucent Technologies press release via Science Daily (<http://www.sciencedaily.com/releases/1999/06/990630014801.htm>) and HamRadio-Online



AV-COMM

Pty.Ltd

**SATELLITE TV
EQUIPMENT**

-: Established 1981 :-

**Specialising in:
Free to Air Satellite TV**

**CALL OR FAX
FOR FREE INFO PACK.**

198 Condamine Street
Balgowlah 2093 Australia

Tel: 61 2 9949 7417
61 2 9948 2667

Fax: 61 2 9949 7095

Internet: <http://www.avcomm.com.au>

WIA/IARU News

Prepared by Grant Willis, VK5ZWI

WIA Federal / IARU Liaison Coordinator

Dr David Wardlaw VK3ADW Elected IARU Vice President

In May this year, David VK3ADW was elected to the position of IARU Vice President. Larry Price W4RA was elected President. David takes over from Michael Owen, VK3KI who has held the post for some time. David's appointment is for a period of 5 years. Prior to this, David was on the board of directors for IARU Region 3. His IARU Region 3 position has been decided to be left vacant by the board until next year following David's appointment.

11th IARU Region 3 Conference - Year 2000 Australia

At the May AGM of the WIA Federal Council, a proposal was voted on to stage the 11th IARU Region 3 Conference in Darwin, NT. The dates have been set (25th August to 1st September) and hotel venues selected. Many other arrangements are also already falling into place. The Darwin Amateur Radio Club is supporting the conference at a local level, thanks to the assistance of Spud Murphy VK8ZWM, who has been involved in organising two other international conferences in Darwin in recent years (SEANET '92 and '97).

The 11th IARU Regional conference is a working meeting for all member countries of IARU Region 3. Delegates from all over Asia and the Pacific will be in attendance, as well as members of the IARU Administrative Council, the peak body that oversees global amateur radio policies, particularly those being represented to the International Telecommunications Union (ITU) at the World Radio Conferences.

This is the first time, since the formation of the IARU Region 3 body, that the conference has been held in Australia. The WIA was one of a number of societies who were involved in the formation of the original IARU Region 3 body many years

ago. News on agenda items for this conference will be included in AR Magazine as the dates get closer. Issues that are already expected to arise include the 7MHz amateur band international realignment, the international amateur regulations and Morse code requirement, just to name a few.

Members will be able to be a part of the conference through making contact with the special event station that is planned to be operating from Darwin during the conference.

WIA IARU Liaison Officer Meets Other IARU & ARRL Officials in the USA

While on holidays in the United States, I was fortunate enough to meet with several other IARU officials.

Among those included Larry Price, W4RA (IARU President), Tom Atkins VE3CDM (IARU Region 2 Chairman), Dave Sumner K1ZZ (Executive Vice President ARRL) as well as Rod Stafford (ARRL President) and Paul Rinaldo W4RI (ARRL Washington office) whom we met at the Dayton Hamvention.

Discussions with Larry W4RA and Dave K1ZZ were particularly interesting and covered many of the issues that will be raised at the IARU Region 3 conference in 2000. An opportunity to again meet Dave K1ZZ arose when I visited the ARRL HQ and WIAW in Connecticut. We spoke for several hours, at which time Dave presented me with an ARRL tie. (see photo).

Many of the people I met will be making the trip to Australia next year, and it was very useful meeting many of them beforehand.

ar



Photo 1 Dave Sumner K1ZZ presents Grant Willis with an ARRL Tie.



Divisional News

VK1 Notes

Forward Bias

Peter Kloppenburg VK1CPK

A Novice course is tentatively scheduled for October. However, an instructor/teacher in basic electronics and/or Morse is required for this course. If you have some experience in this field, please let me know. Anyone interested in joining the class, or upgrading from the Novice to the full call licence should take up contact with myself, or Gilbert Hughes, VK1GH, our president (6254 3266).

A useful and beneficial association is likely to develop between the Canberra Scouts and the WIA VK1 Division. Negotiations are underway to set the rules under which the WIA may use the facilities of the Scout hall in Hughes. It comprises three rooms, all of which contain transmitters, transceivers, hand-helds, computers, and teaching aids.

At present, these are used to introduce scouts to the world of communications via the amateur bands, Internet, Packet, and Citizen Band operations. Scouts enjoy learning to operate all the equipment that is there. In return for the use of the facilities, the VK1 Division provides a licensed radio amateur to maintain and demonstrate the equipment when required.

The area around the Scout hall is grassland, ideal for BBQs, antenna testing, field days, fox hunts, Trash & Treasure sales, and let's not forget the monthly meetings.

If you are a VK1 amateur and interested in maintaining the gear and occasionally demonstrate it to young scouts, give me a call on (02) 6231 1790. Just to remind you that the Scouts have their Jamboree-On-The-Air (JOTA) on 16 and 17 October. They are maintaining a four-decade tradition of annual radio communication events for Scouts worldwide. This year's JOTA will be their 42nd. A fact sheet on JOTA, which includes all the operating frequencies, is available at <http://www.scout.org/jota>

A fascinating screensaver that helps in

the Search for Extra Terrestrial Intelligence (SETI) is available from Berkeley University (USA). The screensaver software processes signals received from the Arecibo dish antenna and shows the result on the screen. For details see their website at:

<http://setiathome.ssl.berkeley.edu> and be thrilled.

Our next general meeting will be on the 23rd of October in Room 1, the Griffin Centre in Civic, Canberra City.

Cheers to all.

pkloppen@dynamite.com.au

VK2 Notes

Pat Leeper VK2JPA

patleep@bigpond.com

The Olympic Coordination Officer (Geoff VK2EO) has asked VK2 clubs for a show of interest in using the special event callsign during the year 2000. Response to date has been light and clubs are requested to consider the offer and forward a reply on their decision to Geoff either via the Parramatta office or to Geoff direct at vk2eo@idl.net.au. This is definitely a once-in-a-lifetime offer so think of your members and don't miss out!

It is anticipated that an 'Olympics Award' will also be set up but this is still in the planning stage.

The number of new members who have joined the VK2 Division this year for the period to end July has reached seventy two, consisting of fifty six licensed amateurs and sixteen associates. Why not ask your fellow club members who are not yet members of the WIA to join us and strengthen our voice with the 'powers that be'. In this era of 'sell-off of the spectrum', we need to raise our profile with as many members as possible. Remember: the WIA represents ALL amateurs in dealing with the government - push that point to potential members!

From Council business over the last couple of months, here are some of the matters of interest:

After lengthy discussions about Licence

Fees in general, the following motion was carried "That the WIA/ACA Liaison Committee be asked to discuss with the ACA the possibility of waiving all fees for Amateur licences, starting with the Amateur Repeater licences."

An agenda item has been put forward for discussion at the next VK2 Affiliated Clubs Conference to the effect that NTAC would like to make it WIA policy to encourage the placement of CTCSS encoding on the output of repeaters, to filter out pager interference.

The VK2 QSL Bureau has agreed to handle minor country cards for the VK7 Division Bureau. With improved propagation, QSL card numbers have increased quite considerably, and it was decided that non-members cards will now not be returned to overseas bureaux, but filed in the 'big bin'. If you know someone who is not a member of the WIA and does not intend to QSL, please tell him/her to let the overseas stations know this and save the VK2 bureau a lot of unnecessary work in the coming busy part of the solar cycle.

Our thanks go once more to the Westlakes Club and its members who do such a tremendous job in running the QSL Bureau for VK2.

The shipping container previously used for storage at the Dural transmitter site has become surplus to requirements after rationalisation and sale of outdated and unwanted (for the station, that is) equipment. A buyer has been found and it will be removed in the near future.

FTAC have been in contact regarding a national APRS frequency, but have suggested 145.000 rather than the overseas norm of 144.390. NTAC will make a recommendation in due course.

For some time now Council has been considering a Honour Board showing President, Secretary and Treasurer for each year. Council enlisted the aid of the VK2 Historian Jo Harris VK2KAA who now reports that she has managed to compile an almost complete list of office-bearers from 1910.

The list is only lacking the names of three Treasurers. The Secretary has now called for quotations from suitable suppliers. The Historian would always like to hear from old timers who have reminiscences and/or old magazines, photographs or clippings of historical value to the VK2 Division. You can contact Jo on 02 9489 4393 or write to WIA Historian, 59 Westbrook Avenue Wahroonga NSW 2076.

The VK2 Conference of Affiliated Clubs is to be held on Saturday November 13th at Amateur Radio House, Parramatta. Please ensure registrations are received by the

office not later than Friday November 5th so that final figures can be given to the caterers.

Agenda items from Clubs, who are attending, must be advised to the office not later than Monday 25 October to enable a full agenda to be prepared and forwarded to all delegates. This is particularly important in respect of questions to be directed to the ACA Representative because they require at least 14 days notice to enable any necessary research to be carried out. Please remember that items for the agenda must be supported by an explanation giving the reasons, in brief, for submitting them so that when circulated to delegates it enables positive discussion.

JOTA

Don't forget that JOTA is on the weekend of 16th-17th October! If you can't run a station personally, why not inquire where the nearest station is and go and give a hand, if only for two or three hours. These young people are our future -do your best to encourage an interest in Amateur Radio for the survival of the hobby.

The text of VK2 Broadcasts is now available on the packet system and the web site shortly after the Sunday evening transmission (see the WIA Division Directory in this issue for the web address).

VK4 Notes

Qnews

Alistair Elrick VK4FTL
QTC Editor

We'll begin with a request from Bob VK4HAG who would like to hear from members of the State Emergency Services in any state or territory of Australia who are Amateurs. Bob has started a mailing list on VK4WIP with about 7 members of the SES who are Amateurs. The idea would be to swap comments etc. the usual stuff to foster friendship, that kind of thing. Bob has sent a message to the current list of members asking if they are interested in starting a HF net as well. This will populate the bands a little more and achieve the aims listed above.

If you would like to know more, or if you know of any one that would like to contact Bob VK4HAG in relation to this project, he can be reached many ways.

Packet: VK4HAG @ VK4WIP
Internet: spanky@hypermax.net.au
Phone: (07) 3812 3684
Snail mail: 1 King Edward Pde.
Ipswich. 4305.

Mark this one in your calendars now: SATURDAY NOVEMBER 13th - GOLD COAST HAM FEST. The popular Gold

Coast Amateur Radio Society get together on the Fabulous Gold Coast of Queensland. Venue as usual will be the Albert Waterways Community Centre, Sunshine Blvd. Opposite Pacific Fair Car Park, Mermaid Waters.

Meetings of the GCARS are held on the 2nd Friday of the month, 1930 hrs K with the Committee meeting the LAST Friday of the month. Each and every Saturday from 1400 hrs the clubhouse is open for members and visitors to the Gold Coast. Clubrooms are at 85 Harper Street Nerang. Call the Club on 018 763 044.

The Mackay Amateur Radio Association's Annual General Meeting went off OK!

Good luck to a mostly new Executive Committee. They now have:

President: Bruce Lenahan VK4NPF

Secretary: Wal Douglas VK4AIV

Treasurer: Ron Kerle VK4EN (who agreed to take on the position again this year.) Thanks to Brian VK4KBS colemon@orion-online.com.au for the report on this.

News to hand that after more than 10 years of dedicated and reliable service, George VK4AJL has decided to pull the plug on his packet radio BBS. George says that due to a dwindling amateur packet radio userbase in the Mackay region and an alleged indifference from sysops further inland, he can no longer justify the massive investment he has made.

Packet mail for h.addresses VK4AJL. #CQ.QLD.AUS.OC and VK4BRG. #CQ.QLD.AUS.OC should be directed via the VK4KTD packet BBS at Innes Park QLD. The Townsville Amateur Radio Club wishes George all future success and thanks him for being a reliable and dependable source of packet traffic over all those years!

From further north, parts of the #NQ BBS packet network are trialing the Nordlink TF27-10 XHOST firmware in place of the WA8DED HOST 2.5 firmware in BBS TNC's. VK4RAT and VK4ZZ have the new firmware installed with eventual fitting also to VK4RSB, VK4TUB, VK4DO and VK3TCD. The TF27-10 firmware will allow up to 10 simultaneous connects per radio channel and also automatically sense DAMA capable stations, to improve throughput during congested traffic times.

The JOTA stations in the state are already starting to gear up for the 1999 Jamboree-On-The-Air, with groups contacting their Amateur Radio operators to prepare for the big event during the third weekend of October. If you want to participate, contact the Queensland Radio Scouting Coordinator, Steve VK4SGW, phone 07 4723 2185, there is always room for willing helpers.

From Townsville WICEN, where operators had recently been on the job since 3 AM in the morning. They provided a basic radio relay network plus safety comms for the Horse Endurance Riders during the final planned comms support event for 1999. This last event is helping the NQ WICEN operators hone their operating and map reading skills and preparing equipment for the upcoming cyclone season and possible Y2K shambles in the New Year. Les VK4ALS wishes to thank everyone who participated in the 1999 round of WICEN comms support events and hopes that everyone is now better prepared for disaster communications techniques.

Still staying in the north the Tableland Radio and Electronics Club auction was a great success. News via Mike VK4MIK on the North Queensland Net last Sunday evening that the fantastic TREC auction was an outstanding event, with auctioneer Dave VK4KGV yelling himself hoarse and moving an incredible amount of treasure out of the clubroom. Most recipients are pleased with their new acquisitions and can't wait for the next one!

Finally one of those good news stories this time from Rick P29KFS who says Ray VK4BLK has virtually completed the P29BPL beacon and awaits crystals for the 50.029 MHz. frequency. Rick asked Ray what the PNGARS owed him for his effort and the hardware, VK4BLK says that the Rockhampton and District Radio Club (RADAR) are donating the 828E without cost. PNGARS really appreciate this fine gesture from RADAR, particularly to VK4BLK. Well done RADAR Club for the fine spirit of AR shown, from all Amateurs, especially the devotees of 6 metres.

VK6 Notes

Chris VK6BIK
(chrismor@avon.net.au)

CW Survey

The VK6 Division Councillors are to be lauded for their excellent CW Retention/Abolition survey currently under way. The Division is conducting a survey to find out if VK6 amateurs want Morse code to be maintained as an exam requirement. The question is answered with a YES to keep Morse code, even if you believe the speed requirement should be lowered, or a NO vote if you believe Morse code should no longer be a requirement for any grade of licence.

This survey is open to all VK6 amateurs, not just VK6 WIA members. The survey is very unambiguous, and makes use of ALL

modes of communication available to us, including the "novel" idea of using the radios we all surely possess, by simply casting your vote during the WIA Sunday Broadcast call-backs! More discreet methods of voting (if req'd) include packet, post, telephone, and Internet.

Results so far: NO = 109; YES = 83

If similar results are forthcoming from the other Divisions also conducting surveys, the WIA Federal will have a very clear popular mandate to proceed accordingly!

VK6 Division Internet

The Home Page has been substantially re-vamped and updated recently and is easy to navigate and excellent reading – good job Christine! The URL is via a new server at: <http://www.omen.net.au/~vk6wja/>

Winter Sprint Test

Results are now to hand for the VHF Group's recently held "Winter Sprint" contest, briefly reported last month. Points were scored as follows; VK6KZ 32, ZWZ 25, ZKO 19.5, BIK /p 15, NGW 13, BOS 13, IQ 12, YEH 8, YKS 6.5, ZLT /p 6 – country stations participating were 6BIK, 6PM (both Toodyay), 6ADI (Beverly), and 6ZLT /p. Well done again Wal! Others participating did not submit logs or call in their results. Those who did not participate at all for whatever reason, have my sincerest sympathy.

Avon Valley Group gathering

On Sun 22/8, a surprisingly large group of ± 18 amateurs, wives, partners, and friends got together in response to an invitation from John (VK6BOC) and Claire Hills, for tea and a chat at their QTH in Toodyay. Well done on this initiative John and Claire! The visitors came from a wide area, known as the Avon Arc, stretching from Beverly to Bindoon, and including the areas as far east as Merreden and west to the escarpment. It is planned to follow up with further activities in the summer, such as a BBQ and field station, working bee at VK6RAV near Northam, etc... In the meantime, don't go to ground again folks, and hope to hear you all on the Avon Repeater occasionally!

Microwaves ?

The VHF Group has a net 2nd Monday of every month, in which vhf/uhf gear can be tested, right up to 24 gigs. This net starts at 8:30 p.m. on a liaison frequency of 145.175 FM.

LIPD and Public safety

Congratulations to Rob VK6TRC on solving the vexing interference problem with one of our local 70cm repeaters,

VK6RTH, situated at Tic Hill, approx. 30km NE of Perth City on 433.225 / 438.225MHz. Apparently the situation involved the use of heavy machinery, with implications for workplace safety. It has been fully reported in the Sept. issue of AR.

From the Minutes (Sept. Council Meeting)

Neil VK6NE has been appointed the new QSL Bureau Manager for VK6. The retiring manager Jim VK6RU has been QSL Manager for the VK6 Bureau for a period of 61 years, interrupted only by the closedown of Amateur Activity during the 1939-45 World War. The Secretary will write an appropriate letter of appreciation to Jim.

A letter of resignation was received from Keith VK6XH as Councillor due to pressure of business.

Council accepted Keith's resignation with regret. The President Cliff VK6LZ proposed a vote of thanks to Keith for his participation as Council Member over the past several years. The vote was carried with acclamation. It was proposed that the Secretary write to the NCRG seeking a nomination to fill the casual vacancy created.

The present bookshop stock had been held for a long period. It was agreed that there would be a "monster sale" at heavily discounted prices at the November Ham Fest with the view of quitting the stock.

There was one new member application and Kim Rhodes, VK6TQ was warmly welcomed to the Division. Mel VK6TVA had resigned as evening Broadcast Operator due to pressure of business. Neil VK6BDO has offered to fill the vacancy. The 21 MHz relay position has now been filled with the return of Reg VK6YE.

Finally, many thanks to Chris VK6KCH, for organising the excellent evening presentation (reported elsewhere I believe) on P3D, held at Wireless Hill with a very large audience in attendance. It was worth the 200 km round-trip Chris!

73 from Toodyay, Chris VK6BIK
(chrismor@avon.net.au)

VK7 Notes

QRM

Ron Churcher, VK7RN

Amateurs around Tasmania are really looking forward to a visit by our Federal President in the first week of this month, October.

Peter is holidaying in "Heaven itself", meaning of course Tasmania, and is happy to be able to meet the North and North-west members at a combined meeting and the southern members during the week after that.

We are sorry that John Bates, VK7RT has had to give up the job as our Southern branch Secretary but we are heartened by the news that he has groomed a worthy successor in Dale Barnes, VK7DG. Thank you John for a job well done. John is also State treasurer and QSL manager so he has still got plenty to do!

The Southern branch members have been hard at it in September providing communications for the big "Southern Safari" car rally.

It was a big job performed with the usual expertise. There are some VERY difficult areas around the mountains but portable repeaters at strategic positions made light work of the problems.

It's been great to see some faces at our branch meetings that we have not seen for some time.

Our branch Presidents and Secretaries are working hard to make these meetings interesting and worth making an effort to get to and I think it's working.

Cheers for now — Ron, VK7RN, State President.

ar



**AMATEUR
TRANSCIVER
RADIO CENTRE**

ALINCO NO 1 FACTORY DIRECT
IMPORTER
AUTHORISED DEALER

**MASSIVE MONTHLY STOCKIST
LATEST ARRIVALS**
NEW DJ-VSE 6w VHF/UHF
DR-M06T 6m, DR-610E, DJ-GSEY,
ANTENNA TUNERS, POWER SUPPLIES,
BIGGEST DISCOUNTS ON BULK
PURCHASES OF ALINCO AMATEUR
RADIOS & ACCESSORIES.
FULL 3-YEAR FACTORY BACKED
WARRANTY
ALINCO SPECIALIST

ICOM IC-706MKIIG, IC-T81A,
IC-2800H, IC-746, IC-756-Pro
IC-T8A, IC-R75, IC-Q7A.

KENWOOD TS-570SG TM-V7A
TH-G71A VC-H1 TH-D7A TM-G707A TS-870S

DIAMOND X-510NA, D-707E

AMERITRON AMPLIFIERS
AL-811AX 600 WPEP
AL-811HX 800 WPEP

PHONE (02) 9896 2545
E-mail: atrc@bytelink.com.au
Web Page:
<http://users.bytelink.com.au/atrc>

CLUB NEWS

Assembled by Bob Harper VK4KNH
Send Club details to AR C/o WIA Federal Office
or ar@wia.org.au

Please send all the club news and announcements that is relevant to Amateur Radio in general.

VK6 HAMFEST 1999

The Northern Corridor Radio Group (NCRG) is holding the 1999 VK6 HAMFEST on Sunday November 7th 1999 between 10am and 2pm.

The venue will be The Cyril Jackson Community Centre in Fisher Street Bassendean. (Same as last year)

The NCRG would like to invite all equipment suppliers, clubs or individuals to participate. Please contact the co-ordinator as soon as possible to ensure your space is reserved.

The previous Hamfests have been very successful in attracting a large attendance of the local amateur, CB and radio enthusiasts.

The Hamfest co-ordinator is Jack Borthen VK6KDX, email: jackborthen@bigpond.com or mail to Hamfest: PO Box 244, North Beach WA 6920.

Regards from VK6

High Frequency PACTOR BBS - VK5BAR

The Adelaide Hills Amateur Radio Society (AHARS) has established a High Frequency PACTOR BBS, in Adelaide, to allow remote area stations and those out of range with local VHF Packet BBS stations, to make contact with the AX25 Amateur Packet Network. The project has had the help and cooperation of the South Australian Packet Users Group (SAPUG)

The BBS operates on the following MARK frequencies:

3629.9kHz (LSB) 0831Z to 2200Z

21072.9kHz (LSB) 2201Z to 0830Z

Frequency changes are made manually at present, however these will shortly be program controlled, and may include 28072.9kHz. These have been chosen to allow access to "Intermediate" Licensees, as well as "Full" Calls.

Tones in use are MARK 2095 and SPACE 2295Hz, using PACTOR 1 protocol.

Connection with the BBS is by calling with "C VK5BAR", whereupon, on a successful response, a list of Bulletin

Categories will be displayed. These may be read or listed as required. There are approximately 100 Bulletins in about 25 Categories available.

Full "HELP" information is available from the Command Line prompts.

One ESSENTIAL need is to address any mail left in the VK5BAR BBS, by the correct and full hierarchal address, eg.

VK5FRG@VK5WI.#ADL.#SAUS.OC (or any other address in the world meeting this complete format). Mail left on VK5BAR is forwarded to VK5WI and the AX25 Network once each hour.

Commercial Multimode Modems (TUs or Controllers) including the KamPlus, MFJ 1276 and 1278B, Paccom SCS, etc. have operated successfully on the system, using suitable communications software.

Home built Modems using Shareware programme "TERMAN93" by HB9JNX, and "BMKMULTY" by G3BMK may also be used. Modified older ST6 and ETI730 designs, from early RTTY days, work quite well with these programmes. A source of suitable circuit boards to assist in the construction of a more modern Modem, has been Norm Rosenzweig, VK5ZAH, of Angaston, SA.

Interested PACTOR users are welcome to log into the system at any time, and make this BBS, their "home BBS", if others are not available. Contact for assistance is Rob Gurr —

VK5FRG@VK5WI.#ADL.#SAUS.OC (Packet) or email:

gurrrc@picknowl.com.au.
From Rob Gurr VK5FRG, for the Adelaide Hills Amateur Radio Society

PS. My apologies go to the Adelaide Hills Amateur Radio

Society for not printing this information earlier. We keep records of all items received and try to avoid any lost items but it can happen. If you have sent an item that was not printed when you expected to see it, please follow it up.

1999 Sunfest Qld.

The Sunshine Coast Amateur Radio Club of Qld recently held their Hamfest known locally as Sunfest. It was well attended by Amateurs and non-amateurs alike from far and wide and offered a wide variety of private and commercial tables and stalls. The early rush made for some frantic buying and most of the worthwhile items were gone almost immediately. Enclosed are a few photographs of the event, courtesy of Chris Edmondson VK3CE/4.

ar



ALARA

Christine Taylor VK5CTY

ALARA Publicity Officer
16 Fairmont Avenue, Black Forest 5035
Packet: VK5CTY@VK5TTY
geencee@picknowl.com.au

Alarameet

All is now in readiness for the ALARA-Meet in Brisbane over the first weekend in October. People are arriving from all parts of Australia and overseas. A contingent from New Zealand will be there and a couple of other overseas YL folk are expected, too. We have been following the travels of a number of VK girls through the Travellers' Net for some time. Once all the 'flyers' and 'bussers' have arrived it will be a talkfest as well as a hamfest. There will be much to tell in the next ALARA column.

The 222 net

The girls who regularly join in the Monday afternoon YL net on 14.222 tell me the girls from G-land have been heard frequently in recent weeks. There have been some DL callsigns and at least one from Portugal. If you are after some DX stations listen around. We are very grateful to Dave ZL1AMN who runs the net so efficiently.

October is JOTA month

If you are asked by a Guide or Scout group to help them set up a station for JOTA, please help if you can. In every state there are amateurs who had their first taste of radio at a JOTA station. These days with the prevalence of computers and the easy access to the Internet fewer young people are interested in making the effort required to pass the amateur exam.

This means that in years to come we may find the numbers of amateurs falling to such an extent that we could lose the access to some of the bands we now enjoy, due to lack of usage.

That would be a disaster for the hobby and potentially a disaster for communications in the event of disasters like earthquakes and hurricanes. We all know of occasions where the amateur with his battery operated equipment has been a lifeline to the emergency services.

By running a JOTA station you may be instrumental in introducing a young person to the wonderful world of amateur radio - and you may even have fun yourself!

At the time of writing I have not yet been

contacted by the groups, so it is difficult to tell you what callsigns to listen out for. However there are a few I expect to be on the air.

VK5AMD, Mary, will have some Brownies and Guides in her shack, and maybe some Scouts as well. There will be a station at Woodside operating VK5BP and another at Yundi operating VK5KR. I have no doubt there will be similar stations in the other states where there are regular JOTA camps. This year a few of the usual YL operators will be away from home for the ALARA-Meet, but hopefully they have arranged for other amateurs to fill their places.

The Girl Guide station, VK5GGA, at Douglas Scrub will probably be used but I hope you also hear and contact them earlier, during the school holidays when they are running a State Camp with the theme of communications. They will be using many different modes of communication during this camp so you could 'hear' them on RTTY or packet or CW or voice. Listen for them and give them some contacts please.

A garden full of flowers

Some months ago on the Monday Nets Judy VK3AGC surprised us when she told us her OM Mike had been given some seedlings - seven TRAYS of seedlings, with about a dozen punnets in each - which he was madly planting.

For the next few weeks we heard how many were planted or how many trays still to go. Well now they are all coming onto flower. Judy has flowers in the most unexpected places. Every day she finds more patches of colour. Let's hope some of the flowers are perennials so that they throw their seeds and come up again next year. Judy says she doubts that they will ever again be given so many plants.

Can you just imagine finding somewhere to plant 84 punnets of seedlings. It always seems a shame to waste them, but that is ridiculous! Definitely a colourful garden. Maybe we'll have a photo in this column sometime.

A new callsign in VK5

Jeanne VK5JQ, previously VK5HOQ joined us at the Birthday Luncheon in July and the last monthly luncheon in the city and has been on the Monday Net a couple of times. Jeanne has been working toward her licence for some years but having a couple of children in the middle of her studies made it a slow process.

With the children a little older, now Jeanne started doing some Adult Education classes a number of years ago. One year when the group was discussing what they would like to do next year Jeanne said she had always wanted to get her amateur licence, what did the others think? Immediately it turned out there was another lady who had always thought she would do the same, one day, and another who was interested, too. The teacher even thought he might go all the way, as well. (Full Call?)

Well, Jeanne is now VK5JQ and Betty is VK5ZLU. Subsequently the group has set up a station at their school and done a course on amplifiers, followed by one on receivers during which they built the appropriate units. Now they are studying transmitters. Good Luck to all concerned.

ar

SNIPPITS

During the 1974 Australia Day Floods in Queensland, the main Brisbane water treatment plant was totally cut off from the Brisbane City Council. The only communication that could be established was via Amateur Radio. Dave Hutchins VK4HW and Ron Grandison VK4RG, who worked at the Mount Crosby Water Treatment Plant, and several others at various points in between Mount Crosby and Brisbane, relayed vital river level readings and other information to the Council Engineers in Brisbane. Without their valuable assistance Brisbane may have suffered even higher water levels as these readings formed part of the feedback system controlling the release of flood water from Somerset Dam.

50 People We Should Thank

by Bill Rice VK3ABP and Bob Harper VK4KNH

This is a follow up on an item in August AR (p5) inviting readers to remember contributions made by a list of 50 famous and not-so-well-known people who helped shape our hobby. They are listed here in alphabetical order.

Surname	Other Names	Contribution	Surname	Other Names	Contribution
Ampere	Andre Marie	Early electrical experiments including the measurement of current.	Maxwell	James Clerk	Electromagnetic Theory and a system of Equations.
Armstrong	Edwin Howard	Armstrong Oscillator, Super-Heterodyne Receiver and FM and many more.	Morse	Samuel Finley Breese	Telegraphy Sounders, attributed with defining the Morse code.
Ayrton	WE	With Perry, invented the portable ammeter and the Ayrton Shunt.	Moyes	Dr H.	Observed Carbon arc noting a light source and proving electricity can flow in air.
Bardeen	John	Co-inventor of the Transistor with Brattain and Shockley, 1948.	Norton	K.A.	Norton's Theorem of circuit analysis uses a current source and shunt resistor.
Baudot	Emile	Invented the Baudot Telegraph Transmitter/Receiver.	Oersted	Hans Christian	Discovered Electromagnetism and experimented with the physics of EM.
Bell	Alexander Graham	Invented the Telephone.	Ohm	Georg Simon	Discovered the relationship between current and voltage in a material, and measured the material property known as Resistance. Ohm's Law.
Brattain	Walter Hauser	Co-inventor of the Transistor with Bardeen and Shockley, 1948.	Plante	Gaston	Invented and refined the Lead-Acid Cell
Cooke	William Fothergill	Introduced Telegraphy into England with Wheatstone.	Preece	William Henry	Experimented with Wireless Telegraphy using the Earth as the conducting Medium.
Cunaeus		Discovered the Leyden Jar effect the hard way!	Reber	Grote	Made first radio sky maps and applied the Parabolic Dish to Radio as a Receiving Telescope.
D'Arsonval		Moving-coil Meter Movements.	Rutherford	Ernest	Radiation Physics including High-sensitivity Electromagnetic Detectors.
De Forest	Lee	Added the control grid to the Fleming Diode to form an Amplifying Triode.	Schering		Schering Bridge used to measure Capacitance and dielectric losses.
Edison	Thomas Alva	Numerous inventions including Gramophone and Light Bulb.	Schmitt		The Schmitt Trigger circuit uses Hysteresis to avoid switching "chatter".
Faraday	Michael	Numerous contributions to understanding the physics of electricity.	Schottky		Invented the Metal-Semiconductor Junction (Hot Carrier) Diode.
Fleming	John Ambrose	Used the Edison effect in inventing the Diode Valve, Fleming's Right Hand Rule.	Shockley	William Bradford	Co-inventor of the Transistor with Bardeen and Shockley, 1948.
Franklin	Benjamin	Experiments that proved that Lightning was a form of electricity.	Siemens	Charles William	Invented amongst other items a Dynamo and polarised relay. Formed Siemens Electric Company.
Franklin(2)		Franklin Antenna - Co-linear vertical array of many phased half-wavelengths.	Swan	Joseph Wilson	Electric Light Globe and a system of Urban Electricity Distribution.
Gauss	Johan Carl Friedrich	With Weber established the first working Telegraph. Unit of electromagnetic fields named after him.	Tesla	Nikola	Many discoveries relating to AC electricity. Proposed AC for electricity distribution.
Gramme	Zenobe Theophile	Invented the Commutator and Gramme Ring Armature.	Thevenin		Thevenin's Theorem of circuit analysis uses a voltage source and series resistor.
Gray	Stephen	Discovered the concept of Conductors and Insulators, experimented with static electricity. Transmitted a discharge from a Leyden Jar across the Thames.	Thomson	Elihu	Invented Watt-hour meters and other electricity distribution instruments.
Gray(2)	Elisha	Telegraphy, Western Electric	Thomson(2)	(Sir) William	Many contributions - see Lord Kelvin above.
Hayes	Dennis	Established a universal system of command codes for the control of Modems.	Volta	Alessandro	Primary battery - Volta's Pile - the unit of Potential, Volt.
Heaviside	Oliver	Electromagnetic and Propagation Theories, Rationalised MKS System.	Watt	James	External Condenser and Automatic Valve Gear enabled his Rotating Steam Engine to provide mechanical energy to drive generators.
Hertz	Heinrich Rudolf	First known transmission of Electricity between Tuned Circuits.	Weber	Wilhelm Edward	Invented the Electro-dynamometer, made measurements of Electromagnetic Fields.
Hughes	David Edward	Early RTTY Machine as well as a Microphone and Oscillograph.	Wheatstone	Charles	Known for the Wheatstone Bridge but also invented the Direct Reading Telegraph, Telegraph Relay and the Automatic Telegraph Transmitter.
Jansky	Karl Guthe	Discovered "Background Radiation of the Universe" (Radio Astronomy)	Wilde(not Wild)		?Invented the Self-exciting Dynamo that needed no external current to field coils.
Kelvin	(Lord) Born William Thomson	Made many discoveries and contributions including Telegraphy machines, Atlantic Undersea Cable and Mirror Galvanometer.	Woolrich		Invented a Magneto for use as a current source in commercial electroplating baths.
Leclanche	Georges	Electric Accumulator Cells including the "Dry Cell"			
Marconi	Guglielmo	First use of Radio Waves for Telegraphy. Experiments in long distance Wireless Telegraphy.			

So there they are. Sources of the information were the *Cambridge Biographical Encyclopedia* and the *Encyclopedia Britannica*. The names were originally taken from the *Radio Shack Dictionary of Electronics* and *A History of Electrical Engineering* by Percy Dunsheath.

Preparing for JOTA

Christine Taylor VK5CTY

Many amateurs open their shacks for JOTA or take their equipment to the local Scout Hall. Both they and the scouts, cubs, and guides will have a great time. However, the benefit gained from the experience can be increased with a little preparation.

If the scout group with which you spend JOTA is well organised or have participated before they will have a program prepared. This may include activity sheets for the Guides and Scouts to complete or they may plan to have a number of 'stations' set up to ensure that all the children participate in all the aspects of amateur radio on offer.

Not all scout groups are as well prepared as this, so here are some of the ideas we and others have used in previous years that you might find useful, too.

As any child-minder knows -the trouble begins with idle hands so the secret to a successful JOTA is keep them busy and keep them interested.

Have charts of Morse Code and the phonetic alphabet available. The children not actually talking can find out what their names are in these two languages it gives them something to do. They can either write down their names (or the names of their cats, dogs, etc) or they can send their names to each other with a Morse key and an oscillator.

A map of the World and one of Australia are useful so the children can know where the person they are talking to (or hearing) lives. If the map has a list of DX callsigns it is even better and provides something else to talk about.

Many amateurs participating in JOTA have a portable packet system that will provide hours of fun and be very popular with the children (though the system can become rather overloaded at times). Even if you cannot offer connections to the packet system it is not difficult to rig up a couple of computers hard-wired together so the children can 'talk' to each other that way. All that is needed is a null-modem and a cable.

If you are an ATV buff you can arrange a similar set-up. A TV camera on top of a TV provides an electronic mirror while two television cameras 'looking' at each other and wired to two monitors is very popular. We all seem to like to see ourselves making silly faces into a camera. If you can actually tap into the ATV repeater scouts can see scouts in other troops that way.

If you are likely to have just one group of scouts for the whole time it is a good idea if you can arrange for them to put together a simple circuit, maybe a sander they can key or a LED they can switch on and off. Depending on the time and cost a very simple FM mike can be made with which they can 'talk' to each other through a Walkman type radio. If the kits are made up so they can be laid out on a piece of cardboard with holes in the appropriate places the children can 'do it all themselves' with only a little help.



Photo 1 Guides getting practice on the Mike -off air.



Photo 2 Scouts bearing down on a weak and noisy signal.



Photo 3 Surprise -you're on air!



Photo 4 The all-important briefing.

Obviously if you plan to make many preparations you will be best off to have the cooperation of the leader, and, in any case you should discuss with them what you plan to do altogether. If you are lucky enough to have a really interested leader in your district together you can do wonders.

It is absolutely essential that the children have some idea what to expect from a JOTA weekend. They need to have some practice at holding a microphone in their hands and talking into it. They should have some questions to ask and they should have some answers prepared for the questions they are likely to be asked.

Many amateurs, not able to run a station for the scouts are willing to talk to them from home but that can be hard work if the responses are all just giggles.

Ideally you should try to take some gear down to the scout hall sometime in the previous weeks and give everyone a practice session. Around Adelaide this has been done frequently since the 70s and 80s

and in the last few years, particularly for the Guides, under the leadership of Jenny Housden.

Usually 2-metres is used, though sometimes where it is possible to put up HF aerials, 80-metres has been used. These sessions are enough to introduce microphone technique and teach some communication skills. After such an evening both the leaders and the children have a better idea of what happens during a JOTA weekend. When the actual weekend comes it will all go much more predictably.

If the Scout Group who contacts you have a campsite the situation is rather different. In South Australia there is a large scout camp at Woodhouse, and another one for guides at Douglas Scrub.

Both of these are utilised for JOTA with several groups camping there for the whole weekend and others visiting for a few hours at a time. Black Forest Scout Group has a regular JOTA station at Yundi and certainly many others, in VK5 and the

other States have campsites.

At such a campsite either there is permanent radio equipment or a permanent antenna with the equipment brought in for the occasion. Some campsites are connected to electricity, some others bring along generator sets for the weekend. The important similarity is that they all make available to other groups the opportunity to share the facilities which increases the fun for all.

Permanent or regular arrangements usually also have a full program of camping and radio activities for the children to complete sometimes including projects for them to make. All leading to a busy and enjoyable weekend for everyone.

If you are taking your amateur station to a scout hall or to a campsite you need to make sure everything you are likely to need is packed together, including all cables and connectors. It is a good idea to have a spare extension cord and distribution board with you. The power point never seems to be in

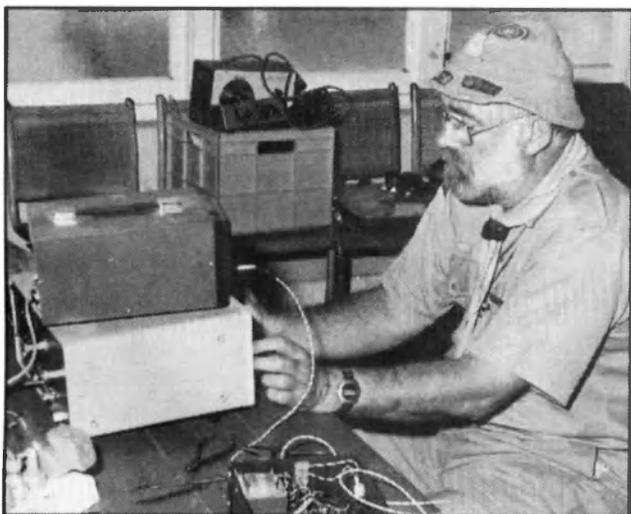

Photo 5 Don VK5ADD at the helm.



Photo 6 Don VK5ADD on site at a Scout Hall.



Photo 7 Greg VK5FK lining up some scheds beforehand

Photo 8 VK5YO operating from Yundi Scout Park.

the right place and there is usually one less powerpoint than required.

It is probably best if you can run all the equipment you will be taking, as a complete station, before the event to make sure it is all ready to go. This will minimise last minute hitches.

If more than one amateur is providing

equipment make sure, beforehand, that it is all compatible.

It is as well to have had a look at the hall you will be using so you know where and how you will be able to erect masts and string aerals, and so you know how long the aerial cables will need to be. Consider setting up the antenna and having a practice

go on the regular Guide/Scout meeting night previous to the event.

This is just as critical for a campsite though you will probably expect to need long cables there.

Remember -Be Prepared!

ar

EDUCATION

Brenda M Edmonds VK3KT
PO Box 445, BLACKBURN VIC 3130.

On a number of occasions lately I have heard of complaints about the standard of service of WIA Exams Service. Although I am not directly involved in the management of this service, there are a few points I can make to try to ease the situation for all concerned.

Many of the complaints relate to the time taken to get materials or results from the Federal Office. Please be aware that, due to severe pruning of the staff of the office, two people are now doing almost all the work that was previously done by five.

The Examination Officer works only three days per week, and not all that time is on examinations. Field examiners here can help considerably by putting orders in as early as possible. Please get the order to the office at least a fortnight before the due date of the examination.

That way, orders can be processed in the most efficient manner. Where possible, try

for larger events. Small orders are time expensive to process. A bundle of Theory and Regs papers can be processed in little more time than a single receiving tape. Remember too that postal handling takes up more time than we tend to expect. Allow a couple of days extra each way to be sure.

Many field staff have at times had a batch of papers held up because of incomplete paperwork. Perhaps a form has to be returned for signature, or candidate identification has not been completed. This all takes staff time, and delays the distribution of results.

Examiners can help by checking that

procedures as specified in the handbook are completed at the proper time - eg the identification of candidates must be completed at the time of the examination - that all signatures required are complete, tapes rewound, number of candidates filled in, and non-attenders listed. Most of these are minor points, but they make the difference between a batch that proceeds smoothly and with maximum efficiency and one that has to be held up.

As I said, these are minor points. However, remember that the WIA is acting as an agent for the ACA, and is accountable to that body. There are some procedures that are specified by the ACA, and cannot be modified. The WIA is subject to audit at the ACA's discretion, and the ACA is the ultimate authority in any disagreement.

Despite any complaints, we have an efficient, effective examination system which provides good service to the majority of candidates. Some of us can remember when examinations were held only twice a year, at only a few locations and results took up to three months to arrive. We ask only that field staff be aware of the constraints and cooperate to make the system work at its best.

Thank-you.

ar

JOTA

(Worldwide Jamboree On The Air)

Scouting on the Air
World Organisation of the Scout Movement, Geneva Switzerland
worldbureau@world.scout.org

JOTA is an annual event in which Boy Scouts and Girl Scouts and Guides from all over the world speak to each other by means of Amateur Radio.

JOTA is a worldwide event. Units may operate for 48 hours, from Saturday 00.00 h until Sunday 2400H local time. Due to the world's time differences, this period is not the same for everyone. To determine the times at which you can most likely contact a certain part of the world, calculate a time difference and ask your amateur radio operator about the radio propagation prediction (a sort of weather forecast for radio waves).

Any authorised frequency may be used to establish a contact. Just call "CQ JAMBOREE", or answer Scout stations who are calling to establish a contact. National radio regulations must be strictly observed (in most countries, a licensed amateur radio operator must be present and a logbook must be held). To find each other easily, listen on the agreed World Scout Frequencies listed below.

World Federation of Great Towers

The World Federation of Great Towers (WFGT) is an organisation in which large towers all over the world cooperate for special activities. It was founded in 1989 with the aim to stimulate communication and exchanges of all sorts between the people of the world.

The WFGT invites Scouts to take part in the JOTA from the top of their Towers. Amateur radio stations will be installed on the towers and professional communication facilities to contact the other towers will be made available also.

The following towers are expected to take part: Centrepoint Tower in Sydney (Australia), Donauturm in Vienna (Austria), CN Tower in Toronto (Canada), Empire State Building in New York (USA), Tour Eiffel in Paris (France), Euromast in

Rotterdam (Netherlands), Ostankino Tower in Moscow (Russia), Blackpool Tower in Blackpool (United Kingdom) and British Telecom Tower in London (United Kingdom).

Some of these stations may use special call signs as well. It is usually planned to establish a television link between New York, Paris and Moscow at some time during the weekend. This will make it possible

for the Scouts at those towers to have a forum discussion.

Further details are not yet known, but can be obtained from the World Bureau's radio station HB9S during the JOTA.

42nd World Scout Jamboree-On-The-Air (JOTA)

World Organisation of the Scout Movement, Geneva Switzerland
worldbureau@world.scout.org
16-17 October 1999

The following text is extracted from Circulars 12/99 of the World Scout Bureau, Geneva Switzerland. (Distributed in July to all national Scout organisations, and national JOTA coordinators.) Email: JOTA@world.scout.org

If there is any last-minute information of general interest, it will be distributed electronically. Check the SCOUTS@WW directory of your local packet-radio BBS and this site.

Jamboree on the Internet will be held on

the same weekend as JOTA. JOTA and JOTI should be conducted together when possible. For questions on the Jamboree on the Internet send E-mail to: JOTI@world.scout.org

Updated 2 July 1999

1. What is the Jamboree-On-The-Air?

The JOTA is an annual event in which about 500,000 Scouts and Guides all over the world make contact with each other by means of amateur radio. It is a real Jamboree during which Scouting experiences are exchanged and ideas are shared, thus contributing to the world brotherhood of Scouting.

The JOTA is a worldwide event. Units may operate for 48 hours or any part thereof, from

Saturday 0000H until Sunday 2400H local time.

Members of the World Association of Girl Guides and Girl Scouts (WAGGGS) are invited to take part in the JOTA and enjoy this international event together with the Scouts.

2. How to take part

To take part in the JOTA requires the help of a licensed amateur radio operator. Such a person can easily be found via the national amateur radio organisation in your country. Every country where Scouting exists has such an organisation, Radio amateurs throughout the world are very keen on helping Scouts to take part in the JOTA.

How to proceed:

- visit an amateur radio station with your Scout group or invite a radio amateur to install his station in your Scout building;
- call "CQ Jamboree" or answer Scout stations calling to establish a contact;



- c) all radio stations must strictly observe the national amateur radio regulations;
- d) any authorised frequency may be used. It is recommended that stations use the agreed World Scout Frequencies or frequencies close by to find each other.

All participating groups are asked to send a report of their activities to their National JOTA Organizer (NJO) after the event. It is of particular importance to make good photographs that can be used in the World Report of the event. Ask the help of a Scout photographer at your station.

NJOs are requested to send a National JOTA Report to the World Scout Bureau, for inclusion in the World Report of the JOTA. Photos in .jpg format are welcome. (Please not over about 100K!) We will ask you for higher resolution if needed for publication.

3. HB9S will operate from Geneva

The radio station of the World Scout Bureau, HB9S, will be on the air from the World Scout Bureau in Geneva, Switzerland. The operator team will consist of station manager, Yves Margot, HB9AOF, Richard Middelkoop, PA3BAR, World Bureau staff members and an international team of Scout radio amateurs.

Experienced Scout radio amateurs who would like to assist the operator team are welcome to contact the station manager and ask him for a place on the team. Prerequisites are: experience in operating a busy amateur radio station, holding a licence for short-wave amateur radio, a working knowledge of the English or French language, and willingness to travel to Geneva.

4. World Scout Frequencies:

Band	SSB (phone)	CW (Morse)
80 m	3.740 & 3.940 MHz	3.590 MHz
40 m	7.090 MHz	7.030 MHz
20 m	14.290 MHz	14.070 MHz
17 m	18.140 MHz	18.080 MHz
15 m	21.360 MHz	21.140 MHz
12 m	24.960 MHz	24.910 MHz
10 m	28.390 MHz (new)	28.190 MHz

Please note that Circular 12/99 contained an error for the 15m frequency: 21.360 is correct.

New frequency!! Note that we have a New World Scout Frequency on the 10-m band. As of this year the official frequency is: 28.390 MHz. Please change your JOTA information.



This change was requested by many Associations, since the lower part of the 10-m band is more active and the old frequency was in a very quiet part of the band. With this change we trust that it is easier to find Scout stations and others –

particularly now that propagation conditions are constantly improving due to the new solar cycle.

5. Kit-contest

Constructing small electronic circuits has become a popular side activity during the JOTA. We know many countries are designing Scout electronic kits for this. If you are among those, here's a challenge...

The 42nd JOTA will have a kit building contest. You can compete for the best designed kit. The winner will be published in the World JOTA Report and its designer will receive a prize. Send your design on paper together with your national JOTA report before 31 December 1999 to the World Scout Bureau in Geneva.

The rules are simple:

- the design must include a printed circuit layout, a component overview, the circuit diagram, and building instructions.
- each kit may contain up to 20 components, maximum.
- building instructions may be 1 page maximum, in English.
- Scouts from 10 years of age onwards must be able to build it themselves in about 1 hour.
- it operates from a standard 9 V battery.
- the design must be free of copyrights; it cannot be copied out of some electronics magazine.
- mark the name, Scout group and address of the designer on the papers.
- your entry must be received in Geneva by 31 December 1999. An independent jury will judge the entries and decide on the winner.

6. JOTA communication game: millennium mission

An exciting game entitled "The Millennium Adventure of John Bont" has been prepared by your world JOTA team for this last JOTA before year 2000. Download it, and photocopy it to share with your group. (To be online soon.)

7. Forthcoming camp contacts (non-JOTA but Scout Stations)

The following radio stations were known at the time of print to be expected to be operating from Scout summer camps.

- 26 Jun - 3 Jul LA2RR Follo 99 Rett, flott og vett, Follo district, Norway.
- 08 - 17 July SK6SS Future Venture 1999, Lysekill, Sweden.
- July 6 VIS Jokkoo '99, 4000 participants, Mboro, Senegal.
- 24 Jul - 06 Aug PA6HJ Haarlem Jamborette, Halfweg, Netherlands.
- 31 Jul - 08 Aug 7S5T Trexixöset, 6000 participants, Olstorp, Sweden.
- 26 Jul - 06 Aug 9A IACD Scout Marine Watch, 150 participants, Pula, Croatia.
- 01 - 08 August LA1SS Hales district camp, Romerike, Hxland, Norway.
- 05 - 09 August JA1YSS 8th Nippon Agoonoree, 900 participants, Ehime, Japan.
- 14 - 15 August VR2EA Communicator Training Camp, 60 participants, Tai Tam Scout Centre, Hong Kong.

To easily find these stations, listen around the Scout frequencies. Scout stations in the European Region are asked to call CQ SCOUT daily during July and August for the "summer camp sked". You may also find additional information in the "SCOUTS" directory on packet-radio networks. European Summer Camp sked: on 7.090 MHz at 07.00 GMT and on 14.290 MHz at 07.30 GMT

The Italian Scout Organisation AGESCI issues a beautiful radio Scouting award this year. You will need to obtain QSL cards of contacts with 10 Italian Scout stations. Cost of the award is 15,000 Lire (Italian Lire). Applications can be sent to: Associazione Guide e Scouts Cattolici Italiani (AGESCI), Radio Scout Section, Piazza Pasquale Paoli 18, I-00186 Roma, Italia. Roma 2000

8. 5th European Radio-Scouting Seminar

From 11 till 14 May of the year 2000, the 5th European Radio-Scouting Seminar will take place in Rome, Italy. It will concentrate on communication means available to

Scouts and how these can best be used in the Scout program. Notably the use of digital communications as packet-radio networks and Internet will be discussed.

Presentations will be given by professional organisations. An excursion around Rome and to Vatican Radio is planned as well. The organisation is in the hands of the Italian NJO, Valerio Berti. He can be contacted by email at: radio@agesci.org or vberti@tin.it

The seminar is aimed at those leaders responsible at a national level for Radio-Scouting, Internet and communication technology. Further details will be mailed by the European Regional Office to all Scout Associations in the European Region as soon as they are available.

9. JOTA Support Tools

A second JOTA circular will be sent to all National Scout Associations and National JOTA Organisers late August with the latest details and information. You will also receive the JOTA /JOTI participation cards for participating Scout groups in your country.

The text of these JOTA circulars is also down-loaded to packet radio mailboxes at regular times. Check the "Scouts@ww" section in your local mailbox.

Latest details can always be found on our web server: www.scout.org/jota

You can also obtain the following JOTA information from Scout Resources International (SCORE):

- JOTA, how to take part in this annual activity; in English, French, Spanish or Russian.

- The JOTA story, a history of the first 35 years, by Len Jarrett, in English (while stock lasts).
- The Radio Scouting Badge.
- The Radio Scouting Lapel Pin (Official JOTA pin).
- The Radio Scouting (JOTA) Car Emblem.
- The World JOTA Report of the 41st JOTA which contains statistical information on the JOTA participation, activity reports from more than 40 countries, a selection of newspaper articles and new program ideas. The report is in English, with French and Spanish summaries.

42nd JOTA Participation Card

(to be up-loaded soon)

10. National JOTA Reports

JOTA organisers are requested to send a report to the World Scout Bureau soon after the event.

The World Bureau is very much interested to get an impression of what the JOTA was like in your country. Please put your ideas and comments, suggestions for future programs and description of the most important and interesting contacts that were made in your National JOTA report. A summary of it will be published in the World JOTA Report, of which each NJO and Scout Association will receive a copy. The figures that are requested on the report form will be used to compile some statistics. A reasonable estimate would be appreciated if they cannot be specified accurately. Please feel free to include any other

information on separate papers.

Since the JOTA is not a competition, you do not need to send a copy of the radio logbook showing every contact you made. We do appreciate to read your description of the most interesting contacts you made. Photographs are especially appreciated. Photos, showing Scouts in uniform at the microphone and of other activities like electronic kit building, foxhunting, semaphore, map plotting and the like are most welcome. How about the self-constructed masts and antennas or a station set up at an unusual location? We're curious to see them.

The World Report editor would very much appreciate it if you could send any additional report text in English on a computer disk or via email. You may use any MS-DOS or Macintosh formatted disk with the text in ASCII format or formatted according to any popular word processor. Alternatively, you may use electronic mail and send your file to:

JOTA@world.scout.org. Clearly mention "JOTA Report" in the subject line.

In any case, send your report to the World Scout Bureau before the 31st of December 1999!!

Information, dates and time for both JOTA and JOTI (Jamboree on the Internet) can be found at:

<http://www.scout.org/>

Amateur Radio would also be pleased to receive JOTA reports, pictures and articles that will be passed along to the Australian Scouting Movement.

ar

90th Birthday — when?

Since mentioning that next year will be the 90th birthday of the WIA the question arose - when is the actual birthday?

According to the WIA Book Vol 1, the NSW Wireless Institute was formed on the 11th March 1910 closely followed by Victoria and then Queensland.

Perhaps 11th March each year should become the WIA Day and be a focus for all divisions and clubs on advertising the WIA, Amateur Radio in general, and gaining new memberships.

It is perhaps a time to recount all that the WIA has achieved on behalf of its members and non-member amateurs as well.

Why not plan a special birthday present to the WIA that will benefit all amateurs.

If each of us found one new member, not only would our numbers swell but the fees would most likely drop. The added number of members would no doubt increase the content and variety of articles of AR and we would all be better off.

The eleventh of March 2000 is in fact a Saturday. Can you imagine a party involving all of the members and their families held at club rooms and halls across Australia, perhaps forming one big party by a hookup/net on twenty metres. Can it be

done? Why not? Please send your thoughts to AR and let's see how the WIA celebrates 90 years.

Let's party!

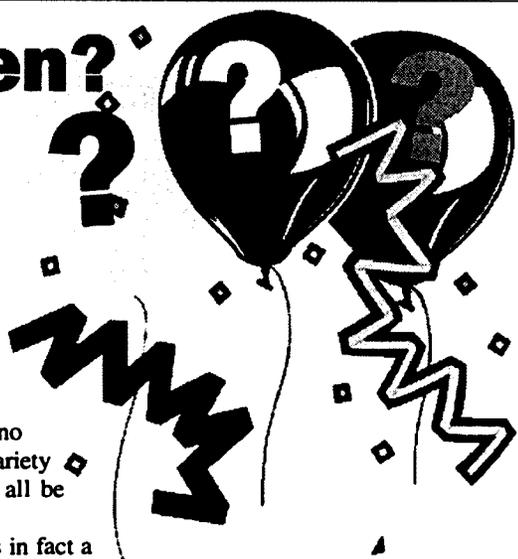

JOTA Callsigns in Queensland

Stephen Watson VK4SGW
Scout JOTA Co-ordinator for QLD

The following are temporary QLD Scout callsigns authorised by ACA for JOTA, 16-17 OCT. 99.

Permanent allocations have also been included.

Callsign	Identity	Proposed Location	Amateur Operator/s
VK4SAA	QLD Branch HQ	BP Park Samford	Permanent allocation
VK4SAB	Nanango	Hazeldean Campsite, Nanango	Trevor Clement VK4YH, John Tucker
VK4WJT	Port Curtis District	Awoonga Dam Campsite	Tom Newton VK4BTN VK4SAC
VK4SAD	Lowood	Lowood	Permanent allocation
VK4SAI	Limestone/Flinders	Allawah Rd, Mt Crosby District	Ken Page VK4AKP, Peter Davies VK4KJP
VK4SAR	Pioneer Park/	Hervey Range (west of Townsville) 'Rangeview Ranch',	Don Terrace VK4MC Alice River
VK4SAW	Woodford	Canadoo St Woodford	A.J. Chappel VK4DY, Udo Von Kujawa VK4DLA
VK4SBB	Boondall	'Brownsea', Shorncliff, Brisbane	ASL Geoff Robinson VK4KJJ
VK4SBC	Bowen	Lascelles St, Merrinda, Bowen	Craig Hampson VK4CWH
VK4SBD	Bundaberg	Bundaberg	Permanent allocation
VK4SBP	Biloela 'Camp Illawong',	Lake Callide, Biloela	Jim Grimes VK4OK, Mark Haseman VK4CMH
VK4SBG	Belgian Gardens	Belgian Gardens Scout Den	Roger Cordukes VK4CD (Townsville)
VK4SBS	1st Sarina,	Sarina	Permanent allocation
VK4SBW	Bluewater	Bluewater Scout Den	Iain Morrison VK4IGM, Sheila Morrison (north of Townsville)
VK4SCC	D'agular District	Rogers St, Beachmere	Mark Van Laecke VK4VG
VK4SCL	Logan City District	Meakin Park, Kingston	Brian Davies VK4AED
VK4SCM	Malanda	Ann St, Malanda	Aubrey McKibben VK4AFO, Wayne Richter VK4ARW
VK4SCR	Rasmussen	Mountain View Lake Van Park,	Gavin Reibelt (Og) VK4ZZ Giru (south of Townsville)
VK4SCT	Richmond Hill	Charters Towers	Vincent C Skinner VK4NBS, Jeff Stinson VK4CCF
VK4SCW	Wulguru	Bowden Rd, Black River	Les Steel (Rusty) VK4ALS (west of Townsville)
VK4SDJ	Jimboomba	Jimboomba Den, Edelsten Rd, Jimboomba	ASL Tony Nuss (Goanna) VK4HTN David Young VK4PUP, Gary Scaff VK4UHF
VK4SDW	Kawana Iluka Ave,	Buddina	Alan Jefferey VK4OR
VK4SDY	Dalby/Yumborra	Scout Hut, Beck St, Dalby	Neil Holmes VK4NF
VK4SEP	Everton Park	Clontarf	Permanent allocation
VK4SMD	Murrumba District	Petrie	Permanent allocation
VK4SML	Manly	Manly	Permanent allocation
VK4SPP	Pioneer Park	Thuringowa Crystal Creek UCA Campsite (north of Townsville)	Permanent allocation ASL Bob Mann (Wallaby) VK4WJ ASL Stephen Watson (Magpie)
VK4SGW	Venturer		Michael Brooke-Taylor VK4HOT
VK4SRD	Rockhampton District	Rockhampton	Permanent allocation

Best wishes for JOTA, I look forward to your report.

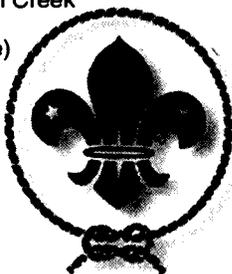

A Surprise In Bali

Richard Cortis VK2XRC

In July 1999, my wife and I spent a couple of weeks holidaying and relaxing on the beach at Sanur in Bali, Indonesia.

As I believe there is no reciprocal amateur licensing agreement between Australia and Indonesia, my only thoughts for amateur radio were to read a few a few magazines on the beach.



One evening, whilst shopping for minor gifts for family and friends, we wandered into a shop owned by Made who introduced himself using his nickname, Yogi. In the usual manner I was given his business card and advised that he could provide transport at a very competitive price. On completing our purchase, we left the shop and I politely put the card in my pocket.

The next day, whilst going through all the accumulated paraphernalia of business cards etc, I came across Yogi's card and noticed the amateur call sign YD9CKY and the radio club logo. My curiosity was aroused and, being on holidays, I had the time to wander around and say hello the next day. Yogi took me into his family's Balinese style house behind the shop. Balinese houses look inwards to a central courtyard rather than outwards.

Yogi made me welcome in his house, made me a Bali Coffee and showed me his two-metre hand held and two metre mobile radios. Yogi said that he could only use the hand held because his station antenna had been damaged.

As he did not appear to have a substantial tool kit. I returned to the hotel and collected my touring tool kit which consisted of a tiny pair of pliers, a couple of small screwdrivers, a piece of hacksaw blade and a Swiss army knife. After a couple of hours we had fashioned a suitable antenna and Yogi found a piece of steel pipe which we used

to elevate the antenna off a timber post on the corner of the building. All seemed to work OK and successful contacts were made.

Later on, Yogi introduced me to Wayan, YC9FLE. The local Denpasar radio club has the call sign YC9ZAI.

I met Yogi several more times in his commercial capacity as a tourist driver and I must say it was very pleasant to have someone as a driver that I knew was not going to take me to his brother's shop.

I was quite surprised and in fact delighted to discover amateur radio in Indonesia. The opportunity to visit a local family as a friend and guest was rare and welcome.

It provided substantial insight into the day to day workings of a typical Balinese extended family. Who knows? If there is a relaxation in the political climate, reciprocal licensing may become a reality. The prospect is exciting.

(While visiting Indonesia some years ago the editor had the privilege of operating from YB2HTD in Solo, Java, at the licensee's invitation. A pleasant, if informal degree of reciprocity! Ed.)

ar



PANCA SARI SHOP.

I MADE PATRA. YOGI
TOURIST DRIVER
MOBILE PHONE : 0812 391 8103

Home Address :
Danau Tamblingan Street No. 10 Br. Sindu Kaja
Sanur - Bali - Indonesia
Phone : (0361) 281876



ORARI DAERAH IX BALI
LOKAL KOTA MADYA DENPASAR
YC9ZAI
CALL FREQ. 145.150 MHz

I WAYAN PURWITA
ENGLISH SPEAKING DRIVER

ARDANA
car rental

Office :
CV. ARDANA
Jl. Pantai Sindu No. 9
Sindu Sanur
Denpasar 80228
Bali - Indonesia
Phone : (0361) 287418

Home Address :
Jl. Pungutan Gg. V/9
Sindu Sanur
Denpasar 80228
Bali - Indonesia
Phone :



Do you know... ?
...that the First Australian
Callbook was printed in 1914 by
the Wireless Institute of Victoria?
It contained an impressive list of
401 "Wireless Experimenters".
The licence fee for experimenters
was then one guinea. That's one
pound, one shilling (£1/1/-), or 21
shillings from memory, equivalent
to \$2.10.

K2 Transceiver

Adrian (Ade) Hatherley - VK3LK.

Last year, my XYL and I turned the big 4-O. We decided that the ideal 4-O gift would be to pack the kids up and go for a trip to the U.S.

I had the opportunity to meet some of the lads from the internet I have "chatted" with for some time, the kids could go to Disneyland, and the XYL... well... would enjoy both.

required for the "field test" would be 100, from around the U.S., Europe, Asia and NOW VK. (You little ripper!!!) I promptly ordered my rig and volunteered to be a field tester.

The K2 as a kit built rig, would definitely be one of those kits where you "READ" the manual before starting anything. It is a full-featured rig, with state of the art electronic components and printed circuit boards. The basic rig is CW only, however, options include SSB adaptor, Auto ATU (20W), Aux I/O (host computer interface), 160M option plus receiver antenna switch, Noise Blanker and internal rechargeable battery (2.5 or 3.0 AH from memory). Everything you need for serious QRP operation.

Now back in VK, I could only wait for the kit to arrive. An Internet reflector was set up by Elecraft for the field testers to chat amongst themselves or directly to Eric and Wayne about what they could expect from the K2 and their respective wish lists for a rig of this type.

Early March 1999 the kit arrived. I had planned all sorts of photos to be taken during the assembly, but as soon as I opened the box I was off, soldering iron in hand and itching to get it on air. (Officially there was not a race to complete the rig, but no one wanted to be last hi hi).

The kit arrived complete with all components, printed circuit boards (screen-printed, double sided with plated through holes) and hardware including alignment tools and special assembly tools. Special parts were separately bagged for easy identification. The assembly instructions are well laid out in a spiral bound manual. (purpose designed for small workbenches) and is probably the best assembly manual for this type kit I have ever seen. (Wayne obviously prides himself on the quality of the manual).

The manual is written in the step-by-step,

So in the August of '98 it was off to NorCal and plenty of QRP/QRPp chit-chat... oh, and yeah—Mickey Mouse (the little rodent). Forgetting about the Disney thing, we arrived in San Francisco close to the home of NorCal, one of the most active gatherings of QRP enthusiasts in the world. QRP-Bob (Bob Dyer KD6VIO from Wilderness Radio) picked me up at the station and took me to a swap meet before the Norcal meeting. Believe me, I have never seen a swap meet like it. The things that were for sale were just unbelievable. Computer gear, test gear, antennae, bits and pieces like I have never seen before. If only I had a 40-foot container instead of the Qantas issue carry bag.

From the swap meet we went to the NorCal meeting, the highlight of the whole trip (for me anyway). NorCal meet at a hamburger store outside Livermore CA. The "meeting" is more a gathering of like-minded QRPers than a club meeting, very informal. There are NO minutes of the previous meeting or the formal guff that seems to drive most radio clubs. It is just a gathering of QRP enthusiasts, sharing their latest project or idea. Some of the more notable rigs to claim their roots from NorCal are the NorCal-40 and 40A, the Sierra, the 38 Special, the NorCal-20, and the St. Louis Special antenna.

Most of the people I had either read about or "spoken" to over the Internet were at the gathering. QRP-Bob introduced me to a lot of the members present, all of who had various projects on hand for show and tell. One of the operators present at the meeting was none other than Eric Swartz WA6HHQ from Elecraft. Elecraft is a small company created by Eric and Wayne (Wayne Burdick

N6KR) located in Aptos CA. Eric had the new prototype rig (99.99% complete) called the K2 on hand for members to pock and prod. I was of course interested. First impressions count for a fair amount in my book, and this rig looked like the rig to take over from my QRP-Plus. Eric took about half an hour to go through the technical aspects of the rig, and I was sold.

Elecraft were after field testers to build the kit who had facilities in place to report assembly progress and any technical/building problems that may arise back to Elecraft over the Internet. The idea being that most home-brewers would tinker, and perhaps come up with better ideas on some aspects of building process. Solutions might arise to problems that the less experienced builder might experience. In short, field testers would have to study all aspects of construction and report areas of concern and possible improvements. Total testers

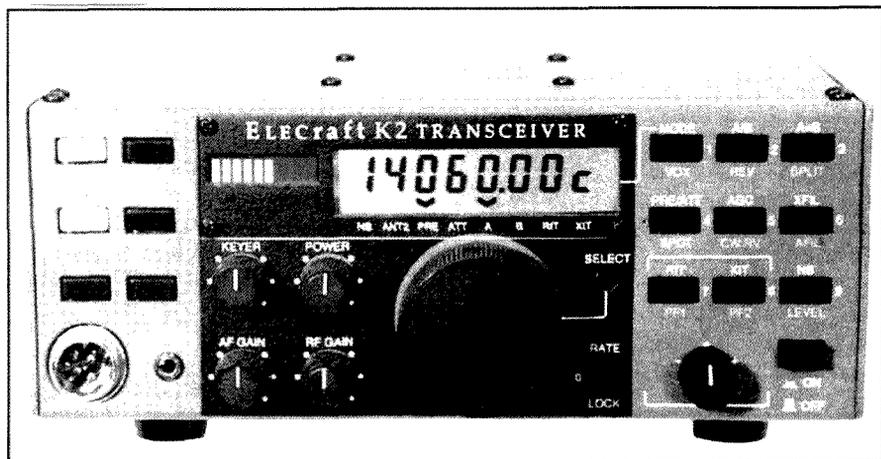

Photo 1

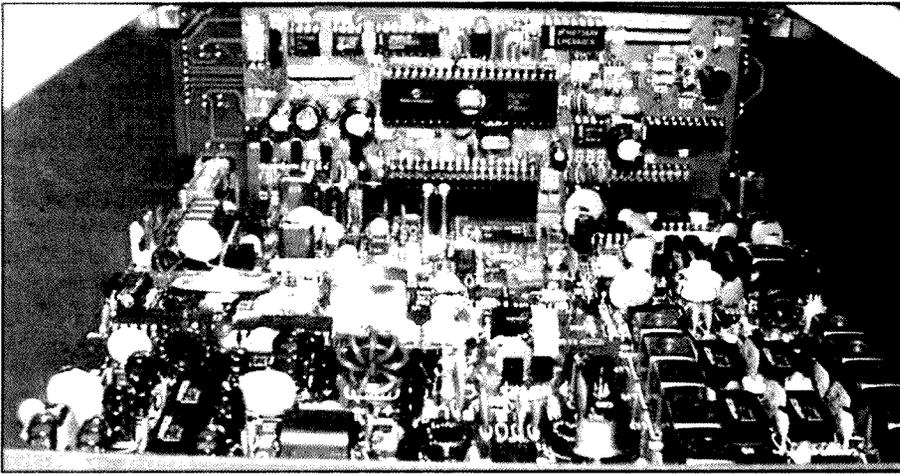

Photo 2

tick as you go approach, which in my opinion is great. It means that you can get to bed at a reasonable time after an evening of building, and the next day, pick up from where you finished the night before. The manual can also be down-loaded from the Elecraft web site, in Word for Windows format.

I found this particularly useful for finding components that did not appear to have a home. It saved hours of wading through the manual, all I had to do is turn on my computer, search for the component number, and up popped all the info required.

The kit is basically divided into six assembly stages.

- Control Board assembly
- Front Panel assembly
- RF Board assembly and test, part 1 (control circuits)
- RF Board assembly and test, part 2 (receiver and synthesizer)
- RF Board assembly and test, Part 3 (transmitter)
- Final assembly (enclosure, speaker etc)

The control board (the first of the three circuit boards to be assembled) is the "brain" of the K2. It monitors all signals during receive and transmit, and handles display and control functions via the front panel board. The microprocessor, analog and digital control circuits, automatic gain control, and audio amplifier are located on the control board. It took approximately 3 to 4 hours to assemble this board. As the first circuit board to be assembled, I took care to "get in sync" with the manual, and the general ideas behind the construction of the K2.

The second circuit board to be assembled is the front panel. This board incorporates all the control and display devices that are used when operating the K2, including the

liquid crystal display, LED bar graph, push button switches, and potentiometers. (The user-interface elements are controlled by the microprocessor on the control board).

The final board to be assembled, and by far the most complex and densely populated, is the RF board. The majority of the receiver and transmitter circuits are located on the RF board, including filters, oscillators and RF amplifiers. The Control board and front panel plug into the RF board, and the enclosure chassis panels are designed to form a tight enclosure around the RF board, thereby securing the completed kit into a neat package.

Testing and alignment is performed at three stages during the assembly. In general, the most complex alignment stages are actually handled by the K2 itself. Routines within EEPROMS align the PLL, VCO/VFO, and the BFO. The user enters calibration commands via the menu button

located on the front panel, and the K2 takes care of everything else. Again, the alignment process is very well documented in the manual and there is very little possibility of messing things up.

If a problem arises, the K2 issues INFO codes via the LCD. The codes are expanded in the manual, indicating the possible problem area, and actions to be investigated as a fix. The entire alignment process took approximately 2 hours to complete the first time.

Once the rig was up and going, there is always the urge to experiment (fiddle) with different parameters, and I was no exception. I can now align the entire rig in about half an hour with no problems. Some parameters can be modified or adjusted while operating, which again is a great feature. It is obviously a great advantage that the constructor does not require fancy test gear to get the K2 on the air.

The proof is in the pudding as they say, and the K2 was put to work on 40 metres. Not bad at all with contacts to ZL and the east coast of the US, from 5 watts out into a G5RV. Next band to be tested was 20 metres. First try to F6 received a 559. The receiver is incredible, with an adjustable band pass filter cutting out unwanted QRM.

Keyer speed is fully adjustable from the front panel, from 8 WPM to 50 WPM. The keyer rate is displayed as soon as the knob is touched. Power output is also adjustable from 1.0W to 10W via a front panel control. Again the output power is displayed as soon as the knob is touched. Other parameters can also be displayed while operating. For example, if the DISPLAY button is pressed, the input voltage and current can be monitored. This feature is handy when

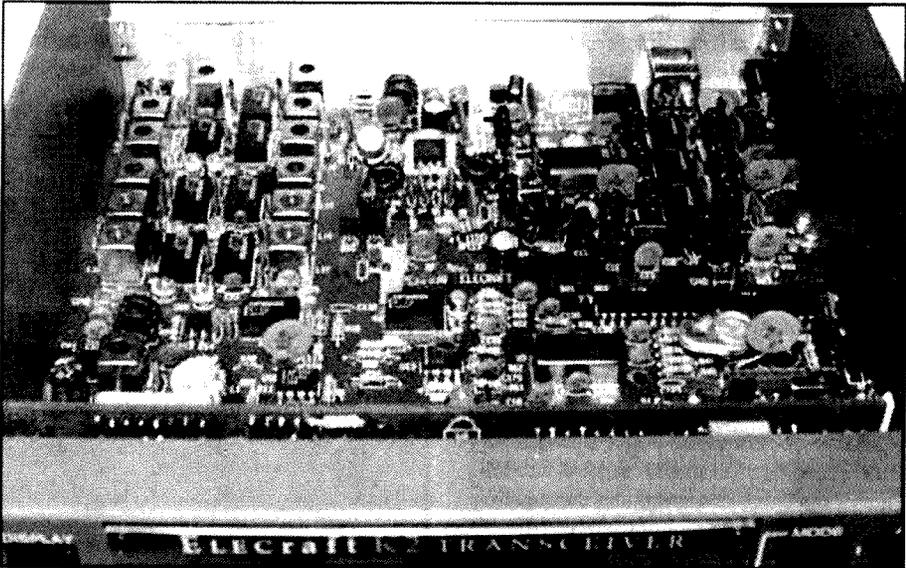

Photo 3

operating field day to monitor battery levels and VSWR levels during transmit. Various options can be turned off to conserve battery life while operating fields, without affecting the rig performance. For example, the S-Meter can be altered to a single LED display or even turned off, the LCD back light can be turned off, and if headphones are used in lieu of the internal speaker the overall power consumption on my unit goes down to about 200mA on receive.

Other features can also be switched in during normal operation. Sidetone pitch and volume can be adjusted via menu function, or stored for easier recall via the PF1 or PF2 (program function) push buttons on the front panel. Scanning is "programmed" by storing the lower frequency in VFO-A and the high frequency in VFO-B. Pressing the RECALL push button, the K2 activates all operating parameters set as the scan range was stored, the receiver is squelched and starts searching for CW signals within the scan range. As CW signals are received the squelch is turned off, and the CW signal "exposed" for 30 seconds. If the signal sounds "interesting" a tap of any button or a tap on the paddle will stop the scan function. The only draw back that I can see is, if the CW signal is not of interest, the scan function has to be started again. (Pressing

the recall button, and starting at the lowest frequency in the stored range).

Apart from that, the K2 is everything you would expect, plus a bit more. As I'm not the world's best CW operator (I do enjoy it ... just not very good) I can hardly wait for the SSB option to be installed. To date, the only option to be released to the field testers is the Battery Option.

I have been told that the next option to be released is the 160-metre option, followed, hopefully by the SSB option some time late May 1999.

This kit is not a first time builder's kit, in fact, it is a reasonably complicated kit that demands a bit of experience and knowledge. The price tag, especially with the current exchange rate with the US, put this rig into the down on hands and knees begging the XYL category. Import Duty and Sales Tax may be tacked on as it enters the country, which once again, will require some breakfasts in bed and or vacuuming duties etc.

In summing up, the K2 is a superb little rig, and in my opinion the best QRP rig on the market. Elecraft after sales service is to say the least, exceptional. Both Wayne and Eric are very dedicated to this product. I was told on many occasions, that no field test will fail, meaning that they were both

determined to see every kit complete and working to spec. I had problems with the VCO that was tracked down to a dead J310 FET. Within a week, two replacement FET's arrived. I also went a bit over the top with a TOKO variable inductor can, and accidentally shattered the ferrite core. Again Eric offered to send a replacement at no additional cost. Now if that's not customer support or what we would like customer support to be, I don't know what is.

If you are interested in more info on the K2 and have access to the Internet, have a look at the Elecraft home page at www.elecraft.com, or you can contact me via the callbook. Likewise, if you are interested in looking up Wilderness Radio, checkout Bob's web page at www.fix.net/~jparker/wilderness. Wilderness Radio sell the Norcal 40 and 40A, The Sierra and various other rigs that will be of interest.

Best 73 and Happy QRP'ing.

(Production Note:- Schematics were provided for inclusion but as they required 6 full pages it was decided to leave them out. They are however good quality schematics that are obviously professionally drawn and should indeed be easy to follow. Copies may be obtained from the Internet site mentioned in the article.)

ar



radio and Communications

Incorporating AMATEUR RADIO ACTION and CB ACTION

Edited by
Chris Edmondson,
VK3CE/4

PO Box 123,
Eagle Heights,
Queensland 4271
ph (07) 5545 0666
fax (07) 5545 0622

The hand-held started life 60 years ago as a rather bulky piece of work with very limited capabilities. Not so these days! Pictured here is the latest Alinco, the DJ-V5, which boasts quite impressive capabilities. We check it out very thoroughly this month...

So what does our October issue hold in store for you? How about these...?

- **MAKING THE BEST OF YOUR LOCATION** — Antenna guru VK6VZ has some remarkable ideas...
- **THE LAST PICTURES FROM MIR** — The Mir station is deserted. Here are some final SSTV images.
- **REVIEW: BARRETT 550** — If you spend time in the bush, then we have the HF transceiver for you!!
- **FEEDBACK** — our letters column is jumping. What do you think? You need to read this mail!
- **KEPLERIAN ELEMENTS** — Our monthly satellite column explains the Keps in simple English.
- *As usual, we have our DX columns, mods and lots more... the best stories and regulars every month!*

Don't miss out — **RADIO and COMMUNICATIONS** is great reading for amateurs!
Check your local newsagent today!

(P.S. We also have the biggest collection of radio-oriented Classified adverts in the country. There's lots of them because they work so well. Ask your newsagent to keep a copy for you each month. Hurry — you might miss something!)

v3cu

Return Loss Bridge (RLB)

Ron Sanders VK2WB

PO Box 431

Kiama NSW 2533

A return loss bridge is a very simple piece of test gear, which is useful if you experiment with HF equipment and need to match impedances between components. It allows you to adjust your antenna system for best matching with very low levels of RF, unlike the normal SWR meter. This is particularly useful if you use an antenna tuner and wire antenna for multi-band operation, or want to adjust a beam for best SWR.

Return loss is related mathematically to reflection coefficient, which in turn is then related to VSWR. The bridge only indicates the magnitude of the reflection coefficient and does not show any phase angle. To use the 50-ohm bridge, it is necessary to have a 50-ohm RF source and a 50-ohm RF detector so that balance is retained. The test setup is indicated in Fig. 1.

The Bridge

The bridge circuit is shown in Fig. 2. Since 51-ohm 1% resistors are commonly available I have used them in the bridge, and any reference to 50 ohms can be read as 51 ohms. This circuit is similar to a normal bridge circuit. If T1 is removed and an RF detector is placed between points A and B, the bridge will be balanced when a 50 ohm resistor is connected at Rx. Alternatively, if Rx is open circuit (infinite resistance) the bridge will be at maximum unbalance.

Since most RF detectors use an unbalanced input (normally a coax connector) it is not possible to directly connect such a detector between points A and B, as one of these points would be grounded and the bridge could never balance. T1 provides effective isolation from points A and B at HF frequencies, so that an unbalanced detector will not upset the bridge. This type of transformer is sometimes referred to as a "sortabalun".

By providing 50-ohm attenuators (at least 10 dB) at the RF and the detector ports, the test setup requirements of 50-ohm sources are substantially met. In practice it is best to use a step attenuator between the output and the detector so that the bridge output signal can be adjusted for best indication.

This attenuator should be adjustable from 0 to at least 60 dB, but should be set at not less than 10 dB in this situation.

Construction details for these attenuators are to be found in the ARRL and RSGB handbooks, the August AR and other publications.

One of the useful features of the return loss bridge is the relationship between the return loss and the value of Rx. Using purely resistive values of Rx the resultant VSWR is as shown in Table 1. As the value of Rx approaches the bridge impedance value of 50 ohms, the detector output approaches zero; ie maximum attenuation of the input signal.

I have shown values for equivalent VSWR of 1, 2, 3, 5, infinity. The change in return loss is greatest near balance (VSWR = 1:1) and smallest for high values of unbalance (VSWR > 2:1). The table in Fig. 2 lists how the VSWR is related to the return loss and clearly shows that the return loss changes are greatest as the VSWR approaches 1:1.

A 75 ohm bridge can be built using 75 ohm resistors and a 75 ohm RF source, detector and attenuators.

RF source and Detector

I used the RF source and detector provided with the YADDS Sweeper as it is calibrated in dBm (dB relative to 1 mW) which allows direct measurement of the return loss. Any signal generator capable of producing a signal on the desired frequencies will be adequate as an RF source and a receiver with an S-meter can be used as a detector. The results from using a dipper (GDO) as the RF source and a receiver S-meter as detector are shown later. If using a dipper (or any other unshielded RF source) the remainder of the test setup must be shielded to prevent direct pickup by the detector.

A simple test setup to calibrate the bridge

Since most amateurs will not have the YADDS sweeper the following simple setup can be used to calibrate the RLB.

Connect the equipment as shown in Fig. 1.

If you are using a dipper as the RF source, make up a suitable coax lead with a single turn loop at one end to couple with the dipper coil. Provided you keep the arrangement physically fixed, the signal frequency and strength should be adequately stable. The 50-ohm attenuators shown in Fig. 1 must be retained in any test setup, since the RF input port and detector port of the RLB must be terminated in 50 ohms for correct operation. Shielding of all equipment must be retained to prevent any direct pickup of the source by the detector.

1. If you use your receiver as the detector make sure that the Rx port of the RLB is open circuit, align the dipper and receiver to the required frequency and adjust the step attenuator to achieve an S9 reading.
2. Connect a 50-ohm termination to the Rx port. Note the S-meter reading. Depending on the calibration of your

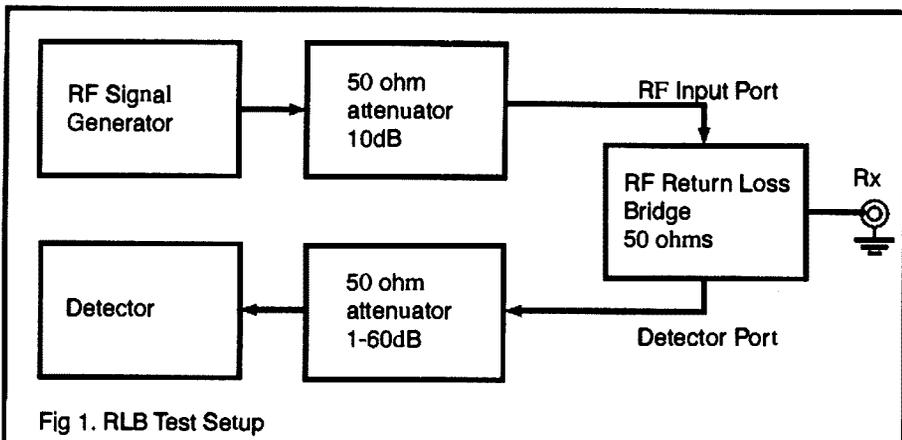
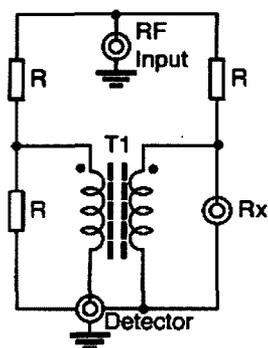

Fig 1. RLB Test Setup

Fig 1



% 51ohm 1%
 T1 10 turns 30awg
 bifilar wound on
 Amidon FT-75 Core
 Rx Network under test
 Det RF detector
 All connectors are BNC.
 Keep leads short and
 use a metal enclosure.
 Winding 'starts' indicated
 by a Dot. •

Fig 2. HF RF Return Loss Bridge

Return Loss dB	VSWR
10	17.40
20	5.850
40	4.420
60	3.010
80	2.320
100	1.920
140	1.50
200	1.220
250	1.120
300	1.070
350	1.040
400	1.020
60	1.002

Fig 2

S-meter the reading should be much lower (theoretically 0): e.g. < 1. This reading is your reference for an equivalent VSWR of 1:1.

- Repeat steps 1 and 2 for the frequencies of interest to check that the bridge covers the HF range without any spurious responses.
- Now connect a 100-ohm termination to the Rx port and repeat the above tests. This will give you a reference for an equivalent VSWR of 2:1.

- Repeat with 150-ohm and 10-ohm terminations at the Rx port. These terminations will give you references for equivalent values of VSWR 3:1 and 5:1.

My calibration used a Yaesu FT747GX as the detector, and the S-meter readings will differ with other receivers depending upon the manufacturers specifications. The important thing is that there should be a big difference between the readings taken for an open circuit and a 50-ohm termination at the Rx port.

FT-23-75, 10 turns 30 awg, bifilar, 51 ohm 1%, sweeper 3.01

Freq	Resistive Termination				
	open cct (MHz)	50 ohms swr = inf	100 ohms swr = 2.0	150 ohms swr = 1	10 ohms swr = 3.0
swr = 5.0					
1.0	- 0 dBm	-30.4 dBm	-10.5 dBm	-7.0 dBm	- 3.0 dBm
2.0	0	30.7	10.5	6.9	3.0
4.0	0	31.0	10.5	6.6	2.9
6.0	0	31.9	10.5	6.9	3.1
8.0	0	32.0	10.4	6.5	3.0
10.0	0	31.0	9.6	6.0	2.7
12.0	0	32.0	9.9	6.0	2.9
14.0	0	30.9	9.3	6.0	3.0
16.0	0	31.7	9.3	5.8	2.9
18.0	0	31.7	9.2	5.9	3.1
20.0	0	31.2	10.0	7.1	3.7
22.0	0	31.3	10.3	7.4	3.8

Table 1

Using receiver S-meter readings for bridge detector. (Yaesu FT747GX)

Freq	Resistive Termination				
	open cct (MHz)	50 ohms swr = inf	100 ohms swr = 2.0	150 ohms swr = 1	10 ohms swr = 3.0
swr = 5.0					
1.0	S = 9	S = 0.5	S = 6	S = 7	S = 8
4.0	9	0.5	6	7	8
10.0	9	0.5	6	7	8
14.0	9	0.5	6	7	8
20.0	9	0.5	6	7	8

Table 1a

Results of calibration tests using the more accurate YADDS sweeper are shown in Table 1, and may be compared to those obtained using a dipper and S-meter shown in Table 1a. It should be remembered that generally we look for VSWR readings less than 1.5:1 (a common limit for network matching). The actual reading is not so important.

Practical applications for the RLB

- Testing a 4MHz Low Pass Filter (LPF) designed for 50-ohm terminations.

The response of the filter is plotted in Fig. 3, and was obtained with the YADDS sweeper. The equivalent results using the simple test setup is shown in Fig. 3a. The filter was terminated with a 50-ohm termination on the output, the input being connected to the Rx port of the RLB.

The design requirement for this type of filter is to keep the VSWR below 1.5:1 for the pass frequencies.

Referring to the calibration data in Table 1a, you can see that for an S-meter reading of 6 the VSWR = 2:1. From the plot of Fig. 3a this occurs at 4.1 MHz. Above this frequency the VSWR rises and is essentially infinite (i.e. there is no measureable return loss) at 4.4 MHz. The line through S = 5 will therefore have a VSWR of about 1.5:1, and any frequency below this line will be within our VSWR limit.

- Adjusting an Antenna Tuning Unit (ATU) for a Balanced Multiband Antenna System.

My ATU is a normal Transmatch type unit which feeds a centre-fed wire antenna via 450 ohm open wire feeders. The transmitter requires a 50-ohm load as is usual. Figs 4 and 5 show the resulting match obtained for the 20m and 17m bands at selected frequencies within each band. These plots were obtained using the YADDS sweeper in conjunction with the RLB, but useful results could be obtained using the simple test setup.

The 50 ohm coax which normally connected to the transmitter was connected to the Rx port of the RLB and the ATU adjusted for the best match at the chosen frequencies. The plots for each band have been superimposed on the one diagram; e.g. 14.0, 14.2, 14.4 MHz for the 20m band.

Referring to Fig. 4 and the table in Fig. 2. Curve 1 indicates the reference level (Rx is open circuit, equivalent to infinite VSWR) and is a straight line at about -29 dBm.

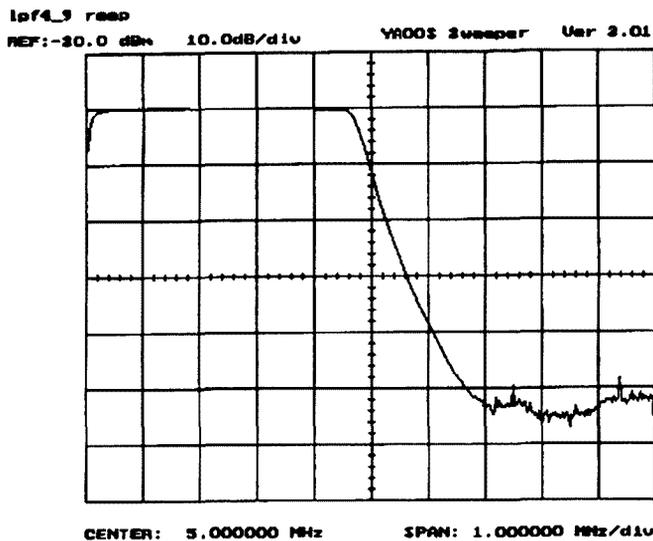

Fig. 3

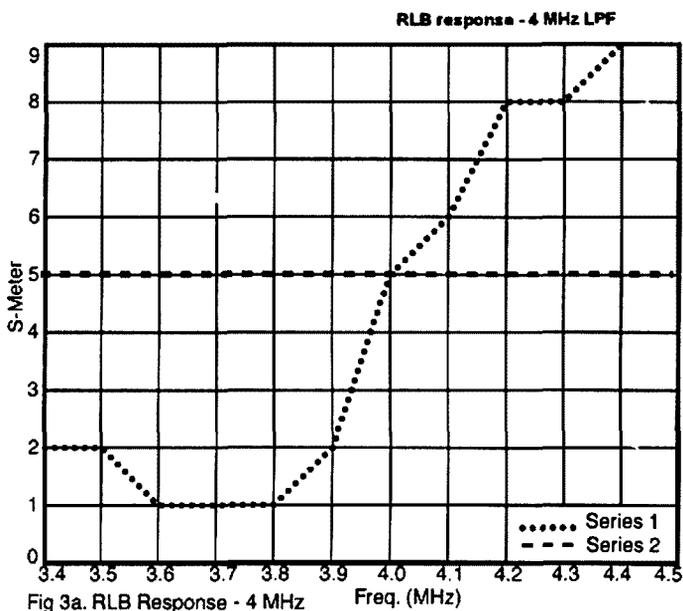

Fig 3a. RLB Response - 4 MHz

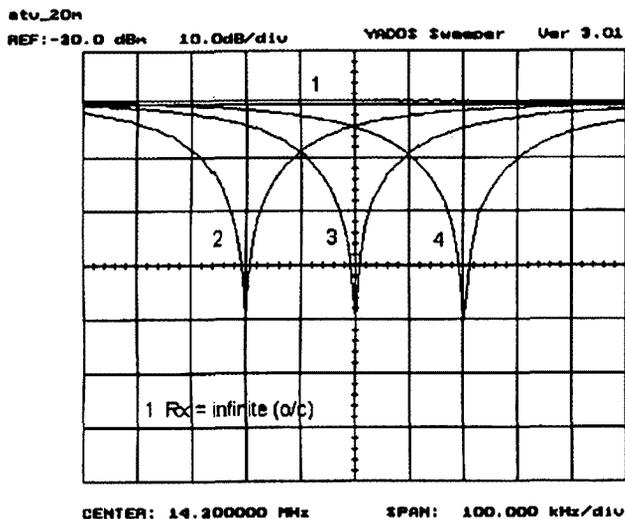

Fig. 4

Curve 2 shows the results after adjusting the ATU for maximum return loss (ie min VSWR) at 14.0 MHz. The maximum return loss is about 40 dBm below the reference level and corresponds to a VSWR of 1.02. Any return loss greater than 14 dBm is equivalent to a VSWR < 1.5:1.

Curves 3 and 4 show results for 14.2 and 14.4 MHz adjustments. In each case the VSWR is about 1.02:1.

By checking the width of the curves at 15 dBm below the reference level we can see that one setting of the ATU at 14.05 MHz would cover the whole of the CW portion of 20m without the VSWR exceeding 1.5:1. Adjusting the ATU for frequency changes is one of the "hassles" with a multiband wire antenna.

Referring to Fig. 5 and the table in Fig. 2.

Curve 1 indicates the reference level (Rx is open circuit, equivalent to infinite VSWR) and is a straight line at about -30 dBm.

Curve 2 is centered on 18.02 MHz and shows the results after adjusting the ATU for best VSWR. The maximum return loss is about 32 dBm below the reference and corresponds to a VSWR of about 1.05.

These curves indicate a much broader response than those in Fig. 4. This means that the ATU tuning is much less frequency sensitive for the 17m band. The width of curve 3 at a return loss of 15 dBm below the reference shows that this one setting will allow operation over the entire 17m band without retuning, while keeping the VSWR less than 1.5:1.

Construction

The bridge is constructed in a small metal box with the 3 BNC connectors fitted to 3 sides. My box is made from tin plate (food container) and is approx. 40(w) x 40(w) x 25(h), and has a 40 x 40 x 5 lid. All corners are soldered inside the box and the lid is attached by small solder points to allow easy removal.

I have found that some die-cast boxes have protrusions on the inside surfaces and make it difficult to fit coax connectors.

Conclusion

The Return Loss Bridge is a very simple piece of test equipment which can provide useful information about matching problems. Some other simple pieces of equipment (e.g. attenuators and dipper) are required, but these are easily constructed and have been featured in past issues of AR (see August 99) and the various amateur handbooks.

ar

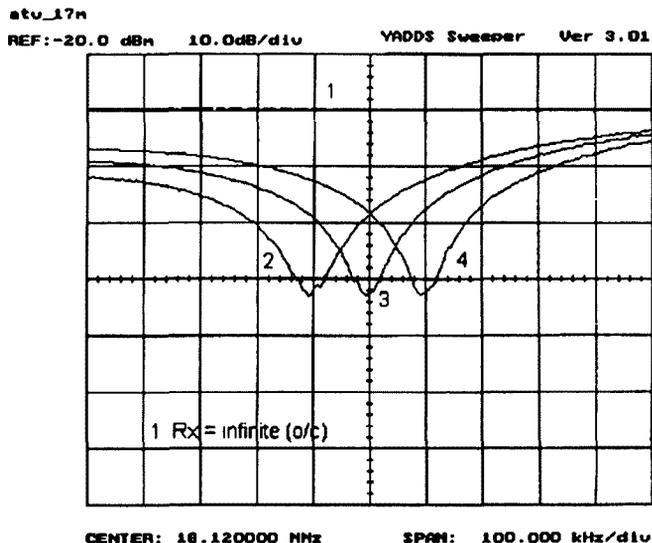

Fig. 5

OVER TO YOU

A maritime mobile radio pioneer



Photograph taken by A.C Green, the noted maritime photographer around 1930

This gaff-rigged yacht is the *Kestrel*, sailing on Hobsons Bay Melbourne in the early 1930s. My authority is Mr Jim Johnston, historian of the Royal Yacht Club of Victoria.

Skipper Noel Toohey was a well-known amateur radio operator. Note the HF antenna

tethered to the starboard shrouds and to a spreader on the bowsprit. The antenna can be seen held aloft by another spreader at the masthead. Cruciform spacers can also be seen keeping the antenna configuration.

The RYCV burgee is at the masthead and

Red Ensign is at the peak of the gaff

I have been unable to establish Noel Toohey's call sign, but surely he must have been one of the first amateur operators to go maritime mobile using HF!

73 Harrow Morgan VK3CHM

QSL cards from QSL — VK

500 FULL COLOUR front and one colour back — **\$229** delivered to your door.

500 two colour front only — **\$159** delivered to your door.

Start 2000 with a new set of Australian theme QSL cards.

We have a collection of Australian motifs, including the world map from a 'Down-Under' perspective. The prices include your supplied single photograph or design of choice. We can also quote for creating designs. *An extra 250 eyeball cards delivered at the same time is \$20.

call (03) 9428 3458 fax (03) 9428 4242 or email news1@webtime.com.au

for a full description and order form

+
250 FREE
EYBALL CARDS*
for WIA MEMBERS

FOR ALL YOUR COMMUNICATIONS NEEDS

High Performance VHF/UHF Base Station Antennas

Diamond base station antennas offer outstanding quality and exceptional value. These stacked collinear types provide high gain, wide bandwidth and a low radiation angle for extended range. The fibreglass reinforced polyester outer radome and gasket seals provide excellent all-weather operation and compact ground-plane radials are supplied. Stainless-steel mounting hardware ensures a long, trouble-free life. Supplied with instruction sheets for easy set-up.

2m Antenna F-23A

Frequency: 144-148MHz
Gain: 7.8dB
Max. Power: 200W
Length: 4.53m, max wind 40m/s
Type: 3 x 5/8"
Connector: SO-239 socket

D 4850

\$199
SAVE \$50

23cm F-1230A

Frequency: 1260-1300MHz
Gain: 13.5dBi
Max. Power: 100W
Length: 3.06m
Type: 25 x 1/2"
Connector: N-type socket

D 4870

\$199
SAVE \$50



Rugged HF 5-Band Trap Vertical Antenna

The rugged 5BTV incorporates Hustler's exclusive trap design (25mm solid fibreglass formers, high tolerance trap covers and low loss windings) for accurate trap resonance with 1kW (PEP) power handling. Wide-band coverage is provided on the 10, 15, 20 and 40m bands (SWR typically 1.15:1 at resonance, <2:1 SWR at band edges) with 80kHz bandwidth typical on 80m at 2:1 SWR. An optional 30m resonator kit can be installed without affecting operation of other bands. High strength aluminium and a 4mm (wall thickness) extra heavy-duty base section guarantee optimum mechanical stability. At just 7.65m, the 5BTV can be ground mounted (with or without radials, although radials are recommended), or it can be mounted in an elevated position with radial system. Unlike other antenna designs, the 5BTV can be fed with any length of 50-ohm coax cable.

D 4920



SAVE \$50
\$399

30m Resonator Kit

Adds 30m coverage to the 5BTV and includes all hardware.

D 4921 **\$99.95**



Yupiteru MVT-9000EU Deluxe Scanner

The Yupiteru MVT-9000EU is an amazing Japanese handheld scanner that provides wide 531kHz to 2039MHz frequency coverage, a large and informative backlit LCD screen, and excellent sound quality. All-mode reception capabilities are provided, (FM, W-FM, AM and SSB modes) plus there are 18 selectable step rates between 50Hz and 125kHz to allow the best tuning choice for the signals being listened to. For easy storage of popular frequencies the MVT-9000EU provides 1000 memory channels (20 banks of 50 channels each) which can store frequency, frequency step, reception mode, as well as the Attenuator setting. Selected memory banks can be scanned to check on activity at a rate of up to 30 channels per second. Search operation is provided across 20 bands, with 500 Search Pass memories provided to "lock-out" unwanted frequencies for more efficient Search operation.

Other features include:

- Inbuilt ferrite rod for AM broadcast band reception
- A Band Scope function allows checking of adjacent channel activity, with two selectable Scope bandwidths. Using the Marker mode you can substitute the centre frequency of the Bandscope with a movable marker, so you can see the frequency and hear the audio of specific adjacent signals
- 10 Priority channels
- 50 Autowrite memories to store active frequencies during Search operation
- Title editing for Band, Bank and Channel name

Complete with NiCad batteries, AC plugpack charger, car cigarette lighter lead, antenna, carry strap and belt-clip. D 2797



YUPITERU

SAVE \$100

\$699

Limited stocks

6m 1/2 Wave Base Antenna

A rugged Australian-made vertical antenna designed to cover 51 to 54MHz, with minimum SWR around 53MHz. Built using high tensile T81 grade aluminium, its just 2.9m long with a sealed base section and 100W minimum power rating. Complete with mounting hardware. D 4825



\$699.95

Advanced Data Management Software

An advanced way to program many of the functions on the latest Yaesu handheld and mobile transceivers. Each package consists of an interface that plugs into the serial port of a PC and connects to the transceiver via its microphone socket (for handhelds) or its packet socket (for mobiles). Also provided is easy-to-use 3.5" format PC software with pull-down menus that allow for programming and naming of memory channels, selection of output power, CTCSS tones, scan and battery saver operation plus much more.

ADMS-1E Suits FT-10, 50R/RD, 51R, VX-IR, VX-5R D 3754

\$89.95

ADMS-2D Suits FT-3000M, 8500, 8000R/8100R D 3759

\$69.95

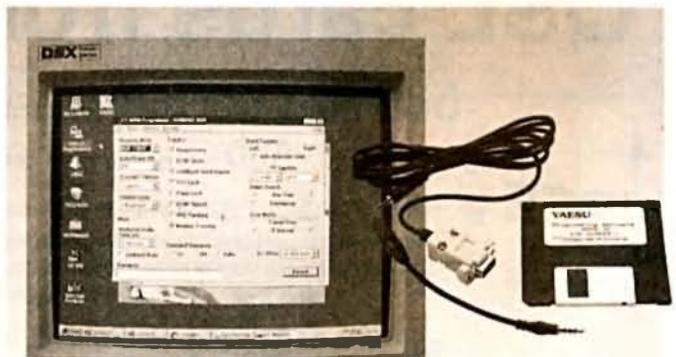

CALL INTO DICK SMITH ELECTRONICS



ARRL Antenna Book on CD

A wealth of practical information on antennas, feed lines and propagation is provided in The ARRL Antenna Book, available for the first time in a convenient, easy-to-use CD-ROM format.

B 2218

75*

*Available selected stores only but can be ordered.

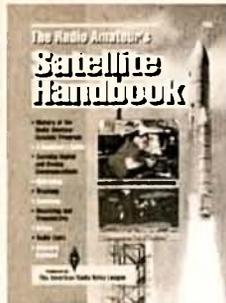

ARRL Satellite Handbook

In addition to the 15 chapters packed with the information you're looking for, there are appendices with active satellites, computer programs, Internet sites, a comprehensive glossary and more!

B 2404

45*

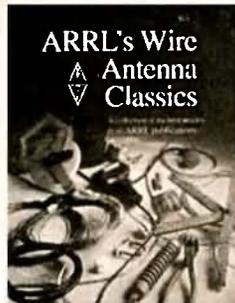

ARRL Wire Antenna Classics

A collection of QST articles covering wire antenna designs for most amateur operators.

B 2211

29.85



ARRL ON4UN's Low Band DXing

Long considered the Radio Bible for low-band DX operators. Covers radio propagation, antenna designs and operating techniques for serious 160-40m operators.

B 2201

1st Edition **55***

3-15V 25A Heavy Duty Power Supply

This solidly built benchtop power supply provides current of up to 25 amps ICAS at 15V, 20 amp continuous at 13.8V and lower current at lower voltages. It has front panel metering plus high current banana-style and low-current output connections. An internal heatsink and thermally switched fan provides cooling without protrusions in the metal case. Specially modified for more reliable long-term operation, it uses a rugged 50 amp bridge rectifier & trifilar transformer. Also provided is extensive overload protection through dissipation limiting circuitry for the pass transistors, a 30 amp instantaneous current limit, AC mains circuit breaker, a transformer thermal fuse and fused auxiliary secondary winding.

D 3800

FT-2500M 2m Heavy-Duty Transceiver

Built tough to take the rough stuff, the Yaesu FT-2500M meets US MIL-STD 810C for shock and vibration so it'll provide years of reliable mobile operation. Its easy-to-operate front panel design, rubber coated knobs, and large Omni-Glow display are teamed up with a one-piece diecast chassis to set the FT-2500M apart from other 2m mobiles. For improved front-end performance, Yaesu's exclusive 3-stage Advanced Track Tuning feature and dual-FET mixer reduce overloads from strong signals while providing excellent sensitivity and wide-band receive operation.

Also includes:

- 31 tuneable memories
- 7 selectable tuning steps
- MH-26 hand mic, mobile mounting bracket & DC power lead.
- Inbuilt CTCSS encoder
- Various scanning modes

Specifications:

Frequency range: Tx 144-148MHz, Rx 140-174MHz
 Output power: 50W, 25W, 5W
 Sensitivity: better than 0.2uV for 12dB SINAD
 Image rejection: better than 70dB
 Max audio output: 2.0W into 8 ohms (10% THD)
 Dimensions: 160 x 50 x 180mm (W.H.D.)

D 3632

2 YEAR WARRANTY **YAESU**



\$299
GREAT VALUE!



LOW PRICING
\$499

PHONE FAX AND MAIL ORDERS

PHONE: WITHIN AUSTRALIA: 1300 366 644
(Local call charge)

FAX: (02) 9395 1155 within Australia and
(+612) 9395 1155 from outside Australia

MAIL: DICK SMITH ELECTRONICS, Direct Link, Reply Paid 160,
PO Box 321, North Ryde NSW 1670 (No stamp required)

Excludes packaging and postage. All major credit cards accepted.
14 Day Money Back Guaranteed if NOT completely satisfied. (Software excluded)



Visit our web site at
<http://www.dse.com.au>



That's where you go!

Yaesu transceivers and accessories stocked in selected stores only.
Other stores can place orders on a deposit-paid basis.

TECHNICAL ABSTRACTS

Gil Sones VK3AUI
30 Moore Street
Box Hill South, VIC 3128

Gillette W9PE. This uses slide switches to convert elements from a yagi configuration to the interferometer configuration. The antenna switching at an audio rate for the TDOA makes use of an integrated circuit GaAs RF switch.

The circuit of the system is shown in Fig 2. The slide switches are mounted on the boom at the centre of each element. The boom was made of a 3/4 inch aluminium U section. The element spacing was 16 inches which is 0.2 wavelength on two metres. The elements used telescoping antenna elements from surplus or spare parts stock. This allowed lengths to be quickly adjusted. The two dipoles of the interferometer can be set the same length and quickly adjusted to the Yagi director and reflector lengths. The cables are fitted with four ferrite beads to act as choke baluns.

These only need to be big enough to slip over the thin coax used. The coax cables to the interferometer elements must be equal lengths of the same cable. The circuitry can be mounted on the boom and the battery can be a small 9-Volt type. The GaAs switch was obtained from Mini Circuits. A web address of www.minicircuits.com was given which may help if there is some difficulty in finding a source.

Lengths used for elements differed slightly from the ARRL handbook values.

Ground Line Tuner

Operating from multi storey apartments is quite a challenge. There is often little opportunity to mount antennas and obtaining a ground connection is difficult. Another problem is the unwanted coupling of RF into the mains lead. The whole rig can be at a considerable RF potential to the surroundings making operation very difficult.

In *JA CQ Ham Radio* July 1999 a Ground Line Tuner was described by 7K3GRX which tunes an earth or ground line to series resonance so as to ground the rig to RF. In the article, which showed a typical balcony for antenna mounting in a reinforced concrete building, the ground line ran to a plate 455mm by 910mm which capacitively coupled to the reinforcing in the concrete structure. This ground line was tuned to series resonance to provide a low RF potential point at the rig ground.

The AC line was also shown decoupled with chokes. This could be achieved by using clip on ferrite cores which are readily available or by winding the mains lead through a core. An RF current meter similar to that used in tuning the RF ground lead can be used to check that RF current in the mains lead is small. The choke winding or the number of clip on ferrites should be adjusted so as to minimise RF current in the Mains lead. This will also help in keeping the power supply free from RF interference effects.

The ground lead tuner is shown in Fig 1. A current meter is used to tune the ground lead to series resonance. The tuner is tuned for maximum current, which corresponds to series resonance. The series tuned circuit is made up of the 250 pF 1.5 KV variable capacitor and the tapped coil. The coil is wound with 1 mm diameter tinned copper wire on a 105 mm diameter former and is made up of 32 turns over 98 mm. The coil is tapped at 3, 5, 7, 9, 11, 13, 16, 20, 24, 27, and 30 turns. The coil used would preferably be an air wound type. The switch shorts out that part of the coil, which is not in use. The original was shown mounted in a plastic box which looked like one of the plastic storage boxes which are available locally.

Any leads around the shack which exhibit the effects of induced RF currents can be decoupled with ferrite chokes. The snap on types used with computer equipment are convenient and easy to use. A little work should make operation simple and free from the effects of stray RF. Also shown in advertisements in *JA CQ* there are a variety of clamps and mounts to mount antennas on balconies. The close proximity of neighbours and EMC would be another problem.

Fox Hunting DF Twin Antenna

An antenna for fox hunting combining a Yagi with an interferometer for the Time Difference of Arrival (TDOA) system was described in *QST* October 1998 by R F

図1 グラウンド・ライン・チューナー

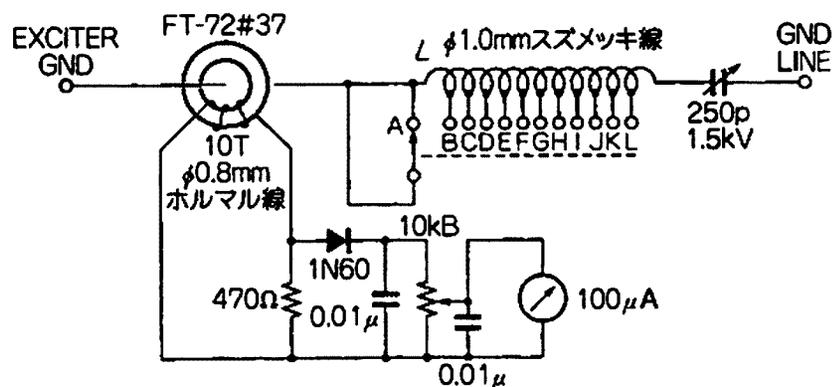

(a) 回路図

コイル・タップ (直径φ105mm 長さ98mm 線径φ1.0mm)

	A	B	C	D	E	F	G	H	I	J	K	L
巻数 (N回)	32	30	27	24	20	16	13	11	9	7	5	3
L (μA)	68	58	48	38	28	18	12	9.5	6.7	4.0	2.3	0.91

(b) コイルデータ

Fig 1. Ground Line Tuner.

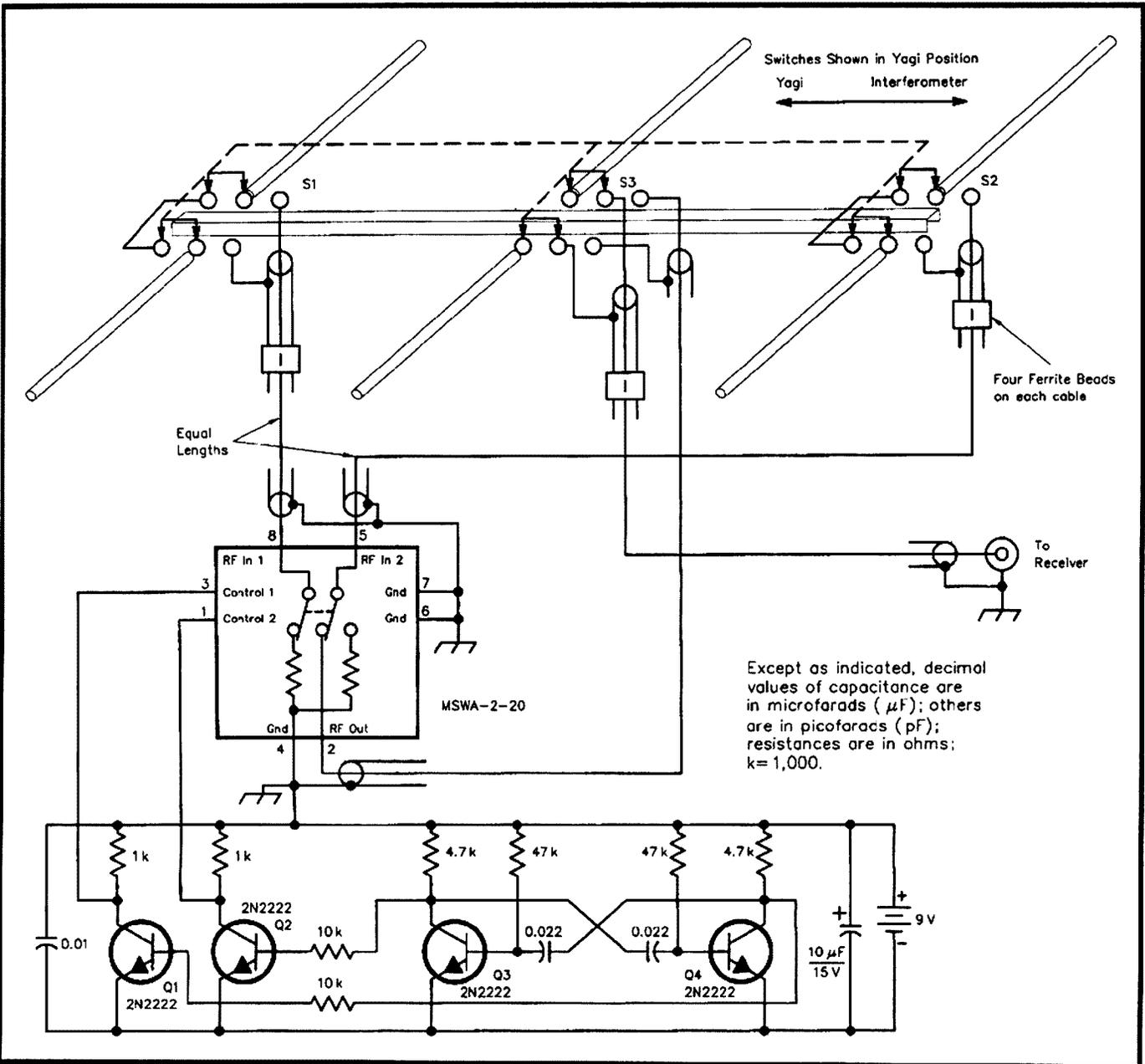

Fig 2. Yagi/Interferometer Antenna System Schematic.

The driven element was 37.75 inches rather than 38.125 inches given for 147 MHz. Similarly the reflector was 40.75 rather than 40 inches and the director was 34.75 rather than 36.125 inches. The lengths can be easily adjusted to cope with individual construction due to the use of telescoping whips as elements.

The interferometer switch runs at around 700 Hz and phase differences result in 700 Hz modulation of the received signal. Broadside the signals should be in phase and modulation should null. The direction can be found very precisely as the null is narrow. The Yagi is much broader but can be handy to resolve directional ambiguity and when the signal is very weak.

ar

Oxley Region Club elections

At the A.G.M. of the Oxley Region Amateur Radio Club Inc., held 7th August 1999, the following executive officers were appointed for the ensuing year.

President:	Charles Edmondson VK2FSH
Vice President:	Bruce Walker VK2HOT
Secretary:	Allan Nutt VK2GD
Treasurer:	Roy Burgess VK2YOR
from WIA Club Liaison Officer: David Pilley VK2AYD	

VHF AN EXPANDING WORLD

Eric Jamieson VK5LP

PO Box 169 Meningie South Australia 5264
E-mail: vk5lp@lm.net.au Fax: 08 8575 1777
Packet: VK5LP@VK5WI.#ADL.#SA.AUS.OC

All times are UTC

Six metres

I don't want to sound pessimistic but the six-metre band is not looking good. Referring back to the last Cycle, on 23/12/88 VK3OT worked OH1VR/2 which heralded the European contacts which were prolific in 1989, first in February and March, then there were hundreds of European contacts throughout October and November. Whilst some video signals have been heard from areas bordering on Europe there has been little about which to become excited.

Where are the JAs? A few are being heard/ worked in our northern areas, but precious little further south. John VK4FNQ has been reporting constant reception of JA beacons almost on a daily basis for the past three months, usually not very strong but reliable. It seems the JAs either have their antennas fixed on Europe or are simply not operating.

Below is reproduced a day of typical reception of signals found in the spectrum 40 to 70 MHz, by John VK4FNQ. The M/S reception is that of a meteor burst experimental station operating from the Philippines.

While on the subject of what can be heard while vainly searching for amateur signals, David Vitek of Adelaide advises that from 1 July to 8 August there were few days when signals could not be found between 45 and 50 MHz, with 25/7 having signals right up to 105.7 MHz (4ABCRN Toowoomba). Others were 4ABCFM Nambour 88.7 MHz, 4CRB Nambour 89.3, and 4SBS Brisbane 93.3. These were heard between 0830 and 0850 and represent a rather high MUF for mid-winter.

Via John VK4FNQ, Wally VK4DO reports that on 27/8 at 2315 he heard the XE1KK beacon in EK09, peaking at 2330 and dropped out at 2350 on 50.0225. Wally said: *I was hearing VK4s on backscatter on ten metres a lot stronger than the Ws, also Channel 0 from Toowoomba 46.172 MHz on backscatter. I called but no Mexicans replied. The beacon is located near Mexico City and appears to have an elevated site.*

Steve VK2KFJ advises that the Lismore six-metre repeater VK2RIC 53.550 is repaired and back on air. Also, on 1/9 Steve asked about six metres FM in Japan. The following reply was received.

JA amateurs have a "band plan" that is enshrined into law. JA FM operators come out on: 51.00-52.00 FM; 52.90-54.00 all mode. Within this, 51.00 calling frequency. 51.00, 51.50 QTC frequency. Many FM stations appear around 51.00-51.20 with 20 kHz spacing, especially when Es appears.

It is illegal for JA amateurs to use duplex TRX (repeater) on 6m, so all of the frequency is used for simplex. We have repeaters on 10m, 2m, 70cm, and 1260 MHz bands. ... Satoru "Mike" Fujitani JM3XAV/1.

Two metres and above

Rob VK3EK at Baimsdale QF32te, reports continuing activity on the Wednesday night net. On 25/8 at 1030 144.150 MHz SSB were Ian VK3AXH 5x3, Fred VK3YFM 5x9, David VK3XDR 5x1, Graeme VK3GRL 5x7, Lee VK3GK 5x5, Max VK3TMP 5x9, Michael VK3KTO 5x6, Tony VK3CAT 5x2. Also there but not heard were Warren VK3BWT from Mallacoota and Bob VK7JR King Island. Absent was Len VK3BMY.

Gordon VK2ZAB reports a reasonable level of morning activity, with the following on 25/8:

- 2141 2m VK2ATS Inverell 5/1
- 2144 2m VK4ZOW Pittsworth 5/2
- 2148 2m VK2KU Springwood 5/9
- 2151 2m VK2PB Narrabri 5/6
- 2159 2m VK3BWT Mallacoota 5/3
- 2205 23cm VK2BE Earlwood 5/9

25 August 1999

0010	43.649 M/S S3, 50.014 V73SIX/b 559	0937	50.110 JN1JFC CQ 5x9
0045	43.649 M/S S5	0959	43.649 M/S S3, 49.750 video S7, 50.009 JA2IGY/b 599, 50.023 JA1ZYK/b 519, 50.027 JE7YNQ/b 599, 50.033 JR0YEE/b 519, 50.120 JN1JFC worked VK4BLK, 50.485 JR9YHP/b 559, 50.490 JG1ZGW/b 529
0121	49.649 M/S S5, 50.033 JR0YEE/b 519	1103	43.649 M/S S19, 49.750 video S3, 50.009 JA2IGY/b 599, 50.018 JA6YBR/b 579, 50.023 JA1ZYK/b 559, 50.027 JE7YNQ/b 559, 50.033 JR0YEE/b 419, 50.130 JH1WHS worked VK4BLK, 50.485 JR9YHP/b 539, 50.490 JG1ZGW/b 519
0134	solar bursts S2 45 seconds	1200	43.649 M/S S5, 49.750 video S9, 50.009 JA2IGY/b 529, 50.018 JA6YBR/b 519, 50.023 JA1ZYK/b 559, 50.027 JE7YNQ/b 559, 50.033 JR0YEE/b 419, 50.485 JR9YHP/b 529, 50.490 JG1ZGW/b 419
0145	43.649 M/S S3, 49.750 video S2, 50.009 JA2IGY/b 419, 50.023 JA1ZYK/b 519, 50.027 JE7YNQ/b 419	1300	43.649 M/S S3, 49.750 video S9, 50.009 JA2IGY/b 559, 50.018 JA6YBR/b 599, 50.023 JA1ZYK/b 599, 50.027 JE7YNQ/b 539, 50.033 JR0YEE/b 419, 50.485 JR9YHP/b 519, 50.490 JG1ZGW/b 519
0220	43.649 M/S S5, 49.750 video S2, 50.009 JA2IGY/b 529, 50.023 JA1ZYK/b 519, 50.027 JE7YNQ/b 519, 50.110 JR0EQQ CQ 5x5	1308	50.110 VR2XMT CQ 5x2
0255	50.110 JH0HQP CQ 5x5	1335	43.649 M/S S5, 49.750 video S9, 50.009 JA2IGY/b 419, 50.018 JA6YBR/b 559, 50.023 JA1ZYK/b 519, 50.027 JE7YNQ/b 519, 50.485 JR9YHP/b 559, 50.490 JG1ZGW/b 419, 55.250 video S9, 56.250 audio S1, 57.750 video S5, 59.750 audio S3, 61.250 video S1, 65.750 video S1, 67.250 video S1
0330	43.649 M/S S1, 49.750 video S9, 50.009 JA2IGY/b 529, 50.018 JA6YBR/b 599, 50.023 JA1ZYK/b 529, 50.027 JE7YNQ/b 519, 50.033 JR0YEE/b 419, 50.110 JA2BZY CQ 5x9, 50.490 JG1ZGW/b 519		
0346	50.110 HL5XF CQ 5x9		
0430	43.649 M/S weak, 49.750 video S9 0530 43.649 M/S S1, 49.750 video S1		
0600	43.649 M/S weak, 49.750 video weak, 50.046 VK8RAS/b 599		
0630	43.649 M/S S3		
0650	43.649 M/S S3, 49.750 video S5, 50.009 JA2IGY/b 519, 50.023 JA1ZYK/b 599, 50.027 JE7YNQ/b 559		
0724	50.110 JA7EVP worked VK4BLK		
0800	43.649 M/S S5		
0900	43.649 M/S S5, 49.750 video S9		

2214 23cm VK3AJN Wangaratta heard at 5/1 later 5/2. Failed to coincide, no contact. VK2BE and VK3AJN did it.

2232 2m VK1ZQR Canberra 5/4

2237 70cm VK2BE Earlwood 5/9

2239 70cm VK3AJN Wangaratta 5/3

2248 2m VK2BUC Canberra 5/5

2251 2m VK2ZRE Adaminaby 5/2

2257 2m VK3TMP Somerville 5/2

He says: *This is fairly typical of late. Yesterday (24/8) VK2BE, VK2ATS and VK3TMP were not worked but on 2m VK3KEG at Frankston was 5x1 and VK1BUC was not in Canberra but was 5/2 on 2m from his portable location in Batemans Bay. A similar situation obtained on Wednesday (23/8) with VK2KU, VK4ZOW, VK2PB, VK3BWT, VK3TMP, VK3KEG, VK3AMH, VK2ZRE, VK2AAS and VK2FLR worked on 2m plus VK3AMH on 70 cm at 5/4. Times are all between 2130 and 2300. SSB activity on 2m and above is alive and well.*

Gordon VK2ZAB also reports that around the end of August or thereabouts there have been frequent, albeit fleeting, contacts between stations in Sydney and Bob VK3AJN in Wangaratta on 23cm SSB. All have taken place between 2200 and 2230. Lyell VK2BE did it first and when Bob was running 10 watts! Later when Bob upped his power to 50 watts VK2ZAB was also able to make contact with him. David VK2CZ has heard Bob and will undoubtedly make the contact when he gets his antenna up off the deck. Distance is about 530 km. Tests are continuing on Monday, Tuesday, Thursday and Saturday mornings.

New 144 MHz world record??

A message from **Chip Angle N6CA** via <vhf@w6yx.stanford.edu> reports: *At 0737 on the 21 August 1999, Paul KH6HME at BK29go on Mauna Loa volcano worked Clint WJLP/mm in DL51ce on 144 SSB. That's two grids South of Cabo San Lucas! Signals peaked S1 on meter. No go on 432.*

Clint had been hearing beacons for several hours prior to contact. There may have been some non-reciprocity to the path. Distance = 2954 miles or 4754 kma new world record.....!! Congratulations to Clint and Paul.

A new 144 MHz world record? The current Australian 144 MHz record is 6763 km for a TEP contact between VK4BFQ and JI7DMB, so maybe the KH6 record is a "USA only" type record! The current world record is shown in the 1999 Call Book at 7843 km and held by I4EAT and ZS3B on 30/3/79.

Now let's hear from David VK5KK

PSK31 and APRS

These two relatively new "modes" have created some debate, both overseas and locally, largely showing the global incompatibility of our bandplans. Leaving the debate for a moment, perhaps a brief definition of each is in order.

PSK31 is essentially a PSK Narrow band (31Hz) Radio Teletype mode, or the digital equivalent of CW! Like CW, it occupies a small amount of spectrum allowing narrowband receiver techniques (either analogue or digital) to be employed. All you need is a PC with a sound card to connect to your transceiver and some PSK31 software (usually freeware).

Simple experimentation has shown a PSK31 system can receive well into the noise floor, certainly below R5 SSB levels and without time integration techniques used with CCW (Coherent CW).

But to be useful for weak signal work frequency stability has to be in the order 0.2ppm or better at 144 MHz, let alone on Microwave frequencies! Software with some DSP filter tracking would help take up the slack.

Whether the mode is a passing fad or a serious alternative to the mode originally invented to create "sparks" will need time. If nothing else, it might test the cooling capabilities of a few amplifiers at 100% duty cycle!

APRS (Automatic Position Reporting System) can be likened to a network of packet stations on one frequency spread over a large, continuous geographic area. The network is based on Unnumbered Information (UI) packets, which don't require acknowledgment when received by another node. With acknowledgment being unnecessary, there is no way to "time out" a connection because there is no "connection" to time out.

For example, two areas of activity may be connected by several intermediate nodes. If one of the interconnecting nodes were to "go away", the single network would simply break into two fully functioning networks. When that node returned, the two separate networks would again be joined, automatically.

The primary function of APRS is a pseudo Amateur GPS system. Why we actually need (or don't need!) an Amateur GPS system would fill the magazine!

One spin off, which seems to have created much interest to those studying propagation, has been employed with the USA "PropNET" system, using the 144.39 MHz APRS frequency.

A normal packet network requires nodes to "log-in" and "log-out", UI-networks allow nodes to come-and-go with little impact on the overall system. In a large system, spread over hundreds of kilometres, most nodes would normally be too far apart to be within range. However, as propagation conditions ebb and wane, nodes will progressively appear and disappear over a greater area. These distant nodes simply appear and disappear as Icons on each other's screens as propagation varies! Participating Nodes are then able to visually plot propagation anomalies in near-real time! Some interesting data has already been logged of Sporadic E and Tropospheric events in the US in the past year or so.

Ah yes I did mention 144.390 MHz. This frequency has been adopted for both terrestrial USA and satellite based systems. On consulting the Australian VHF bandplan, we suddenly have a problem. FM packet stations on the wrong side of the weak signal Beacon segment!

Given the potential advantages of an APRS "PropNET" type system serious consideration is needed on where or what happens. Alternative frequencies or bands are one solution for terrestrial use. PropNET also uses 53.530 MHz in the USA although tracking Sporadic E on six metres is probably not so exciting. The other alternative is to use an obscure frequency above 145 MHz where access is available to all license classes. Two metres is preferred over 70 cm for the Sporadic E propagation factors. We can do little about the Satellite system frequency.

Of course, just how effective such a system would be in this country is yet another question. Getting an effective system in a country of similar size to the USA but with about 1/30th of the Amateur population could be the greatest challenge. A lot of open spaces to cover. Till next month. ... 73 - David VK5KK.

Microwaves

New 10 GHz Distance Record for VK4

Both Wally VK6KZ/4 and Doug VK4OE/4 sent similar reports of their 10 GHz SSB contact on 5/9 over a distance of 330 km, thus breaking the existing VK4 record. Reports were 3xI and 4xI. There appeared to be little or no enhancement of propagation. Wally was at Springbrook Mountain and Doug at Hervey Bay, having spent three and a half hours travelling there! This appears to be one of the least obstructed paths in southern Queensland. Clearly the stage is now set for Doug and

Neil Sandford VK2EI to better the distances for VK2 and VK4.

Equipment was similar at each end, being about one watt transmitter output fed to dishes around 600 mm in diameter, and HEMT LNA's ahead of what are essentially G3WDG transverter systems and IC202 tuneable IF's.

Doug VK4OE says that he and **Rod Preston VK4KZR** are building 24 GHz narrow-band equipment, and one of their aims is to 'steal' the distance record for that band back "from the wondrous group of VK3s and VK5s who set it at the same time as the 10 GHz record about two years ago.

Wally VK6KZ in his report says that **Al Edgar VK6ZAY** has now progressed to the stage where he is willing to release a report on his 47 GHz activities. **Al VK6ZAY** has designed and built two transceivers for 47 GHz and reports as follows on his first successful contact on SSB over a 1km path.

The 47 GHz tests are bearing fruit with a successful 1-km SSB contact with **Terry VK6TRG** on 29/9. Signals varied from 5x3 to 5x9 over a 20-minute period across a water path on the Canning River.

No liaison channel was used but due to the excellent frequency stability and fixed elevation the only variable was in bearing. The path was the same as previously tested so the landmarks were well known and easily recognised. Contact was obtained in a few minutes using carrier and a sideband contact made immediately after.

Several changes have been made to the original design mainly in the area of waveguide feed and dish size. The above test used an 8 inch dish at one end and an 18 inch dish at the other both fed by circular waveguide and shepherd's crook feeds.

Terry Grammer VK6TRG reported as follows:

Just to let you know that **Al VK6ZAY** and I successfully completed a good two-way SSB contact over 1 km on 47.12756 GHz with signals 5x3 to 5x9 both ways. There were large variations in signal strength from not moving to S7 on my IC202 signal strength meter. Fading varied from 30 seconds to 1 minute superimposed on a larger cycle of 15 minutes. Path was over water within half an hour of heavy rain so the air should have been saturated. An 18-inch dish was used at one end and a 6-inch dish at the other. We are looking for a light 12 to 18 inch dish to break the VK record of 18.2 km. **Al** is already working on the Mark II model with active mixers.

The design has been published in the West Australian VHF Group Bulletin and has been submitted to "Amateur Radio". Essentially his 47 GHz linear transverter uses harmonic mixing with local oscillator (LO) injection at one quarter of the desired

mixer input frequency. No transmit/receive switching is required as a single mixer is used for both transmit and receive with IFs being used to determine the direction of operation.

A 200 mm Cassegrain fed dish antenna provides over 40dB of gain with a beam width of less than 1.5 degrees. Local oscillator injection is at 11.75 GHz with a mixer input level of +12 dBm.

Wally VK6KZ also said that his travels have included a long discussion with **Frank VK4CAU** near Rockhampton via FM simplex about his activity on 10 GHz with gunplexor gear and with **Errol Hopper VK4ZHL** about his Tellurometer tests. **Errol** was a mainstay starter of the SA/Vic team who set so many microwave activities across VK1, VK2, VK4 and VK8 about 18 months ago. He encouraged **Errol** to consider building narrowband SSB gear for 10 GHz.

New 144 GHz record

After several months of preparation, on 12 August 1999, **Will Jensby W0EOM** and **Bob Johnson KF6KVG**, have extended the 144 GHz US record from 2.3 miles to 3.36 miles (5.42 km).

Both stations were in CM87vk along I-280 near Stanford. Similar transmitters were used by both, triplers to 36 GHz nominal, and times 4 multipliers using a Hughes diode and surplus parts, assembled by **W0EOM**.

Receiving was by means of Hughes harmonic mixers, previously used on 120 GHz, on loan from the UCLA Microwave Engineering Lab, courtesy of **Matt Espiau**. R7000 receivers were used for the IF.

Antennas were 9 inch Cassegrain feed dishes. **W0EOM**'s margin was about 0.5 of an S unit, while **KF6KVG** had a 1.5 S unit margin, possibly due to a better mixer.

Since both stations also work on 108 GHz, the 3rd harmonic, a quick check there indicated about 15 db margin. The stations will be retuned to 120 GHz for another try there. **From Will Jensby W0EOM and The VK-VHF Reflector.**

Contests

Three contests are looming in VK. The first is the Spring VHF Field Day to be held on Saturday 13/11 and Sunday 14/11. See the Contest pages for details.

The second is the **Golden Anniversary Ross Hull Memorial VHF Contest** commencing on 26/12/99 and finishing on 16/1/2000. The rules and conditions are to be found elsewhere or in the Contest pages of this issue. They follow closely the rules of eight to ten years ago. This is a

desperation move by the Contest Manager **John VK3KWA** to try and stimulate interest of the order, which seemed apparent at that time.

Therefore, an invitation is made to operators to make a special effort to participate in this anniversary contest - the first **Ross Hull Memorial Contest** was held in 1950-51. It is hoped that the award certificates will reflect the golden aspect of this contest.

For the December issue I am preparing a special article devoted to the life of **Ross Hull** whose brilliant career was brought to a sudden end by electrocution in 1938. There will also be a full list of all **Ross Hull Contest** winners.

Then to finish the round of contests there is the **VHF Field Day Contest** to be held over the weekend of 15-16/1/2000. More details on this one a little later.

Station VNG likely to close

A message from **Ron VK3AFW** voices concern about the likely closure of **VNG**. He says: *Standard Time and Frequency station VNG is run under a contract that will end in June 2002. After that date the site owner proposes to sell it off to the highest bidder, probably for housing development. If the market is not buoyant at the time the sale could be put off and VNG might limp along for another year. But then it will close down. If you use VNG in your work or hobby then you need to make your need known to the National Time Committee or the VNG User's Consortium.*

It was thought that **VNG** would close this last June 1999, however, funding was found at the last minute. Earlier this year a voice announcement on **VNG** asked users to contact the **VNG Users Consortium** if they needed the service to continue. I believe that about 50 astronomers responded and three other people with different interests, a clock designer, a radio amateur and a physicist at a university.

I find **VNG** to be the only 24 hour time signal that I can rely on. **WWV**, **WWVH**, **JJY** are all unavailable at times during the day. **GPS** can give excellent time but it lacks the audio announcement that I find very useful.

I urge users of **Australia's T&F HF** reference to make their needs known. I am prepared to collate emails and forward them. Otherwise donations and comments should be sent to the **VNG Users Consortium** directly.

Irrelevant to **VHF**? Not for me. I use the **VNG** timing for setting/checking my analog clock for my meteor scatter skeds and to check the station digital clock. I also use it

to check my frequency standards, so that I can minimize my transmission frequency errors.

On behalf of the VK5LP shack I will be contacting Ron to voice my concern at a possible closure as I use VNG frequently. I urge all other users to do the same. Reply to: Ron Cook <ron.cook@mst.csiro.au>.

On this matter Norm VK2XCI says: *I think that we should all get behind this. I had a quick look around the shack and came up with the following. Remembering that I have had considerable experience in the metrology (the science of measurement) field.*

I for one make extensive use of the standard frequency service of VNG. I have a precision 10 MHz clock locked to the carrier. This provides all the timing signals in my shack, eg the buffered output is used

to directly clock a Dick Smith 1 GHz frequency counter. This in turn is used to check the output of my signal generator, CRO timebase, CB radios, Tx output frequencies etc.

The buffered output also locks the drive motor of an astronomical telescope, directly drives a digital clock with encoded outputs for logging etc. Due to the vagaries of HF propagation, WWV, WWVH etc are unsuitable.

By the way. The simplest method of using the VNG carrier as a reference is the audio heterodyne method. In my case the 10 MHz clock in the DSE counter was divided down to 5 MHz then simply "sniffed off" and coupled to the input of my old DX300 along with the VNG carrier. The trimmer in the counter is then adjusted for "zero beat". The system is accurate to within a few hertz if you

guess the centre of the fairly broad zero beat. I used it for ages before building the clock.

Closure

There's a mixed bag of interest items this month. Thankfully, they fill the column when so little occurs in the way of contacts on six metres.

I am grateful to have had an initial contribution from David VK5KK and look forward to another in November and December.

Closing with a rather appropriate thought for the month:

It is not power that corrupts but fear. Fear of losing power corrupts those who wield it, and fear of the scourge of power corrupts those who are subject to it. ... Aung San Sun Kyi in *Far Eastern Economic Review*.
73 from The Voice by the Lake.

ar

ACA/WIA/IW/Data Base

7th September, 1999 August Log input

Freq	Date	UTC	EMM	R'BY	ANT	SINPO
3.560 Poss ID of Pyongyang N Korea	2108	1105	A3E	VK4AKX 335 deg	DFLP x=15	44444xx
7.025 UIBC Indonesian Commercial stns	2108	1240	J3E	VK6RO	DIPL x=5	55555xx
7.098 YDJ Rep of Indonesia, freq varies	1108	1025	A3E	4AKX 300 deg Bris.	DFLP x=29	33333xx
14.001.8 Has NON with Fax	2108	1003	A3C	4AKX 320 deg	DFLP x=14	33333xx
14.003.2 UiFAX	0808	930	A3C	4AKX 310 deg	DFLP x=11	32223xx
14.016.5 Multi channel printer	1408	1010	xxx	4AKX 300 deg	DFLP x=6	23332xx
14.106 Coded tfc	2108	0617	A1A	4BXC	DIPL x=24	44444xx
14.211 850 hz	2108	0745	FIB	4AKX+	DFLP	33332xx x=30
21.002 Asian Commercial B/cast no tfc	2208	0035	J3E	6RO 360 deg	TH6 x=3	44444xx
21.257 These last 2 are being checked agn.	2808	0800	FKT	6RO 360 deg	TH6 x=3	44444xx

Nothing of much importance

Cuban station R. Habana has cleaned up their 3rd H of 9.550 and are no longer being logged in VK4.... But we still will check!

I expect things will liven up from now on though.

Gordon VK4KAL FIWC

AMSAT AUSTRALIA

Bill Magnusson VK3JT
RMB 1627 Milawa Vic. 3678
Email: vk3jt@amsat.org

National co-ordinator:
Graham Ratcliff VK5AGR
Email: vk5agr@amsat.org
AMSAT Australia net:
The AMSAT-Australia net is held on 80 or 40 meters LSB (Lower Side Band) each Sunday evening (except over the Christmas/New Year period). During the winter months in South Australia (end of March until the end of October) the net is on 3.685 MHz +/- QRM with an official start time 1000utc with early check-ins at 0945utc. During the summer months when daylight saving is in operation in South Australia (end of October until end of March) the net is on 7.068 MHz +/- QRM with an official start time of 0900utc with early check-ins at 0845utc. The times and frequencies have been chosen as the best compromise for an Australia-wide net taking into consideration seasonal propagation changes and the various state summer time variations.
AMSAT Australia newsletter and software service:
The newsletter is published monthly by Graham VK5AGR. Subscription is \$30 for Australia, \$35 for New Zealand and \$40 for other countries by AIR MAIL. It is payable to AMSAT Australia addressed as follows:
AMSAT Australia
GPO Box 2141
Adelaide SA 5001
Keplerian Elements.
Current keps are available from the internet by accessing the AMSAT FTP site, ftp.amsat.org and following the sub-directories to "KEPS".

Time to tool-up for Phase 3D

Recent events have made a launch this year very likely and it's time to start getting your radio shack ready for this exciting new satellite. The successful deployment of Phase 3D into its planned high altitude orbit should mark a return to the halcyon days of AMSAT when thousands of operators found they were able to enjoy satellite operation for the first time. Phase 3D is a satellite for everyone. As you will see from

the frequency chart below, the transmitter/receiver complement has something to interest newcomers and experienced operators alike. The uplinks on 15m and 12m and the up/downlinks on 2m and 70cm will appeal to the many amateurs who will find that their radio shacks are already equipped for these bands. Analog mode is available so that should usher in a return to the voice-mode rag-chewing we saw in the early days of Oscar-10, Oscar-13 and the Russian birds.

Of course experimentation is well catered for with the higher frequency up/downlinks and the digital capabilities. Advanced CCD cameras and high speed modems will provide attractive areas for the more adventurous. The 'bottom' surface of Phase 3D is a veritable antenna-farm. If you have internet capability, have a look at the AMSAT web site. You can find it at www.amsat.org and follow the links to the picture gallery. It contains spectacular shots of the satellite during construction.

The impressive array of antennas is featured in a number of high quality photos. Three-axis stabilisation will ensure that these antennas will always be pointed downwards towards Earth. Squint-angle calculations will become a touch academic but will still be a guide to the very best communication times.

Here is a list of the projected frequencies and modes of Phase 3D.

Uplinks	Digital	Analog
15m	N/A	21.210 - 21.250
12m	N/A	24.920 - 24.960
2m		145.800- 145.840 145.840 - 145.990
70cm		435.300 - 435.550 435.550 - 435.800
23cm(1)		1269.000 - 1269.250 1269.250 - 1269.500
23cm(2)		1268.075 - 1268.325 1268.325 - 1268.575
13cm(1)		2400.100 - 2400.350 2400.350 - 2400.600
13cm(2)		2446.200 - 2446.450 2446.450 - 2446.700
6cm		5668.300 - 5668.550 5668.550 - 5668.800

Downlinks Digital	Analog
2m	145.955 - 145.990 145.805 - 145.955
70cm	435.900 - 436.200 435.475 - 435.725
13cm(1)	2400.650 - 2400.950 2400.225 - 2400.475
13cm(2)	2401.650 - 2401.950 2401.225 - 2401.475
3cm	10451.450 - 10451.750 10451.025 - 10451.275
1.5cm	24048.450 - 24048.750 24048.025 - 24048.275

(Downlink is inverting = reverse)

Telemetry Beacons	General Engineering
Middle	
2m	N/A N/A 145.880
70cm	435.450 435.600 435.850
13cm(1)	2400.200 2400.350 2400.600
13cm(2)	2401.200 2401.350 2401.600
3cm	10451.000 10451.150 10451.400
1.5cm	24048.000 24048.150 24048.400

Transponder Modes:	Band Designator
15m/21MHz	K
12m/24MHz	no designation allocated at present
2m/145MHz	V
70cm/435MHz	U
23cm/1.2GHz	L
13cm/2.4GHz	S
6cm/5.6GHz	C
3cm/10GHz	X
1.5cm/24GHz	Ka

What we now know as "modes", eg. mode B, mode J will be represented in future as a combination of at least two letters indicating the uplink(s) / downlink(s) in that order.

As an example: Mode - V/U would provide a 2m uplink and a 70cm downlink. This will bring the designations more into line with commercial practice and also cater for the large number of combinations that will be afforded by the IF matrix switch.

The mode switching schedule will be decided by the satellite controllers after the period of testing and commissioning.

Phase 3D promises to be a great asset to the AMSAT fleet.

IT'S TIME TO TOOL-UP!

Low-Tech vs High-Tech

Looking through the technical specifications of the new Yaesu FT-847 at a friend's place the other day I was moved to a mood of nostalgia. Such advances in the technology available to amateurs!

I remember listening to the signals from Sputnik-1 on my Eddystone 680x receiver. All shiny, all valve, 19 inches wide and heavy as a boat anchor.

It still has pride of place on my operating desk today. It's an antique radio, but it still works well and I often use it for short-wave listening.

When I looked at the bewildering array of goodies on the Yaesu I recalled my first satellite contact. It was via Oscar-6. Until then I had been content to listen to the telemetry beacons of the earlier Oscars and to the transponder of Oscar-3. Oscar-4 was a fizzer and Oscar-5 had a beacon only but Oscar-6 was a different matter.

The other station was my long time friend Brian VK3BLW. I didn't have a single-sideband radio, continuous modes were not allowed so it was Morse or nothing!

I used my 2 metre FM box to transmit by holding one hand over the microphone and sending the Morse characters on the PTT button. The carrier note was pretty warbly but Brian received it and we made our first satellite QSO.

I used a WW2 Collins 51J-4 to receive his 10-metre downlink. The 'antenna' was a 5-metre length of hook-up wire strung up around the picture rail in my lounge room. The uplink antenna was 19 inches of brazing rod at the chimney end of a piece of RG-58 coax. A crude setup to say the least.

My next major improvement was a 'tracking' antenna. I had been given a very second hand TV antenna rotator. One of the type that had a supposedly synchronous AC motor and a pre-set type controller. It could turn a small antenna to roughly where the pointer was on the scale.

I made up a short aluminium mast with a hinge at the top and by tilting it over to an angle one could follow a satellite across the sky with just one rotator. Miraculously I managed to stack a light 10-metre yagi, a 2-metre quad and a 70cm yagi on that mast. The system worked well right through to Oscars 7, 8 and 9. By that time I had acquired a set of early "Icom twins".

There was still no computer of course. They came along much later.

Reverse tuning was accomplished by stacking one transceiver on top of the other and stretching a rubber band around the dials.

If you put a twist in the rubber band and turned one dial, the other dial turned a similar amount in the opposite direction. Crude as it may sound, this worked surprisingly well. You could QSY from one end of a satellite passband to the other and not be too far off frequency.

I mention this bit of JT history because recently I have been helping a friend to get setup for the 9600 baud digital satellites using WiSP and all the modern goodies, including the Yaesu FT-847. My friend is a computer guru but has no experience with satellites at all. It has been brought home to me just how much, incidental and seemingly unconnected information and skills have to be mastered in order to grapple successfully with the advanced amateur radio satellites.

Coming in cold is, as Sir Humphrey Appleby would say, "very courageous". Those days of struggling with crude gear, calculating satellite orbits on paper, compensating for doppler shift manually, tuning the radios, pointing the antennas and making a contact at the same time amounted to a trial-by-fire and taught one a huge amount in a short time. It was all very exciting, romantic stuff.

Some would argue that the romance has gone. In reality it has just changed its form. Now the excitement is in coping with new computer software and operating systems, learning how to manipulate image files, moving higher and higher in frequency.

Notwithstanding the above, opportunities are still there for the modestly equipped newcomer. The International Space Station's amateur radio component ARISS will afford newcomers the chance to make space contacts with as little as a hand-held transceiver. This is always a thrill for the first-timer and who knows, it may excite someone to move on and try to keep pace, as it did with us in the early 1960s.

HF bands operation on the International Space Station

Latest information to hand says that HF antennas would be installed on the ISS on an early shuttle mission and that HF amateur radio gear will be carried to ISS early in 2000.

I have no details of frequencies or intended operating schedules but the idea of HF operation is exciting, particularly for newcomers to satellite operating. We'll certainly watch for more news on this one.

So ... Finally it's Goodbye to Amateur Radio on MIR

The crew have left and the Russian Space Station MIR is orbiting under remote control.

Latest news indicates that it will briefly play host to a de-commissioning crew in February 2000. They will collect experimental data and prepare MIR for its final plunge into the Pacific Ocean. No doubt at that time we will again be mindful of the immense amount of pleasure given to the amateur radio community over more than a decade of operation.

Voice contacts, packet radio, slow-scan TV, school contacts, Cosmonauts from many countries. From humble beginnings the MIR amateur radio operations became quite sophisticated and a household word among hams all over the world.

SUNSAT SO-35 On-air tests begin

In late August and early September the first on-air tests of the FM transponder on SO-35 were carried out.

From all reports the tests over Australia were successful with good signal strengths and excellent throughput of the uplink transmissions. Watch out for announcements of further tests in October. The FM transponder requires an uplink frequency of 145.950 MHz. The satellite receiver has auto-tune so doppler tuning of the uplink is not required.

The downlink frequency of 436.250 MHz could however move some +/- 9 kHz during a pass and will require tuning to compensate.

Amateur Radio Pico-Satellites set for October launch

Three American Universities have combined their efforts in producing a new concept in small satellite packages.

When launched in October the main package, JAWSAT will separate into two smaller packages, ASUSAT and OPAL. The two amateur radio pico-satellites will separate from OPAL to become StenSat and MSAT-1. These are incredibly small devices about the size of a packet TNC with antennas.

This project will receive more than the usual scrutiny as it may well point the way to future amateur radio "easy-sat" projects. Watch this space!

REPEATER LINK

Will McGhie VK6UU

Mr Will McGhie 21 Waterloo Cr Lesmurdie 6076, (08) 9291 7165
21 Waterloo Cres
LESMURDIE WAS 6076 VK6UU@VK6BBR
will2@omen.net.au

JACK D. HADEN
P O. Box 299
Ryde NSW 1680
Australia



I received this fax in response to the July 99 article about 29MHz repeaters around Australia and thought it worth reproducing in full. If you have some comment about the state of repeaters either in Australia or world wide, please feel free to drop me an electronic or normal mail line.

Thursday 29th July 1999

Dear Will

I read with interest your comments in the July issue of *Amateur Radio* concerning the 29MHz FM repeaters around Australia.

Recently I operated as **C21HH** and **T1MH** and worked quite a number of VK's through various Australian 29MHz FM repeaters. Noting your comments on "linking" I was told on 02nd July when operating as **C21HH** by Andrew **VK3KAS** who I was working on 29.640MHz FM at 0408z that I was being relayed or linked to **70cm**. Not long after I worked other VK's on 70cm through this link on 29MHz FM. So there is at least one repeater in VK3 on 29MHz with a link to 70cm.

Another VK told me, I forgot who it was, that I could work into a VK6 input around 29.120mhz FM and that's its linked to 70cm in WTA, didn't get around to trying that out though.

On some days the propagation was that good in the Pacific I was working VK's through the Hawaii 29MHz FM repeater on 29.660MHz, this isn't listed in the 1999 WTA callbook so it may be a new addition to the network? Sadly, not too many KH6 operators were worked on this repeater, only two or three, on good days I worked into California, Florida and Oregon through the Hawaii 600 repeater. The Hawaii repeater comes into to **C21** and **T36** land right up until around 1100z on good days

Used to be able to work the **DX1HB** repeater in the Philippines, couldn't hear or access it this year, maybe it's off air? Same goes for the Japanese repeater on Hokkaido on 29.650MHz as I used to access this one quite easily in recent years, maybe propagation or just off air? Never worked a local JA on that repeater, was told that JA's not permitted to talk outside of JA on 29MHz repeaters, worked a few Americans with 736 calls from Okinawa and in other parts of JA but not the locals.

The Asian interference, which runs from around 25.000MHz through to 30.000MHz on AM/FM comes mainly from the region starting in the South China Sea going through to the Gulf of Siam, truck drivers, taxi companies and fishing vessels I have been told are the main users, it's a free for all block from top of 25MHz to end of 29MHz I'm told. Lucky they don't have tone burst otherwise the repeaters would be jammed open for hours on end with their ~~beeps~~

Wollongong repeater on 29.620MHz is a hard nut to crack, must be it's location Will, working into VK4 and VK3 repeaters with meter above the nine but the Wollongong one always struggles to make it through, propagation is there as I hear the VK2 beacon on 28MHz a good 9 at times. Got into the Wollongong repeater a few times but never worked anyone! Worked a few VK5 people on the Adelaide repeater on 29.620MHz. (VK5KLD, VK5KAM etc)

There was excellent propagation on 29 FM but sadly a lack of activity both on the repeaters and on 600 simplex. Worked more JA's and DG stations in China on 600 simplex that our own people in the Pacific region.

Great pity that more don't utilise 29 FM, there were many more on the band from VK/ZL in the last cycle than there are now Will. Last cycle I sued an FT 1000D 200 watts out on FM through a converted Stationmaster CB antenna from both Nauru and Tarawa, this season an IC-736 100 watts on FM and the same Stationmaster CB antenna.

Hope the above news is of interest. enjoy your snippets on 29 FM as it's one of my favourite DX bands, better than the nonsense going on 20 meters all the time!

73

VK2 GJH
etc

POUNDRING BRASS

Steve P Smith VK2SPS

9 Peak Street
Bateau Bay NSW 2261
02 4334 7743 (H)

This month I have provided a visual inspection of military Air Force keys as used by the British and Commonwealth nations from early World War Two up to 1960's and early 1970's. I have kept the text to a minimum to encourage the largest size photographs that AR can manage.

Photo 1. Switch Box
Identification

REF No. 5c/3 72

This particular key was used in Spitfires and other fighter aircraft to switch on upper and lower lights as a means of identification or to manually send Morse to ground forces.

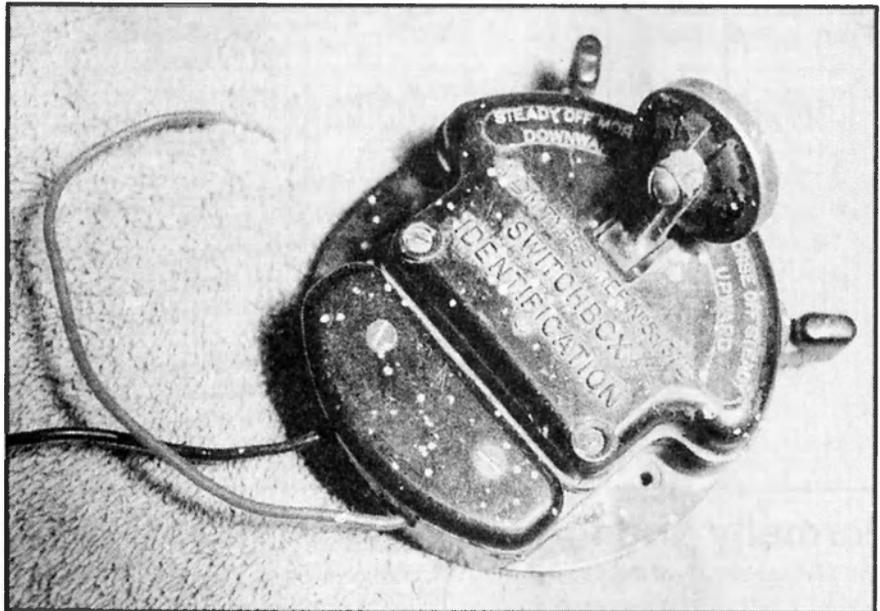

Photo set 2. REF no. 10A17741

Also known as the "Bath Tub Key" due to its shape. This key was used mainly in bomber aircraft, such as Lancaster, Halifax etc. In times of emergency the little spring clip at right was lifted up to cause the key to send a continuous tone while the operator scrambled for the exit. (One wonders whether the short duration screaming of a locked key from a mortally wounded bomber was of greater psychological damage to the listeners than it was of help to the imperilled crew. ed)

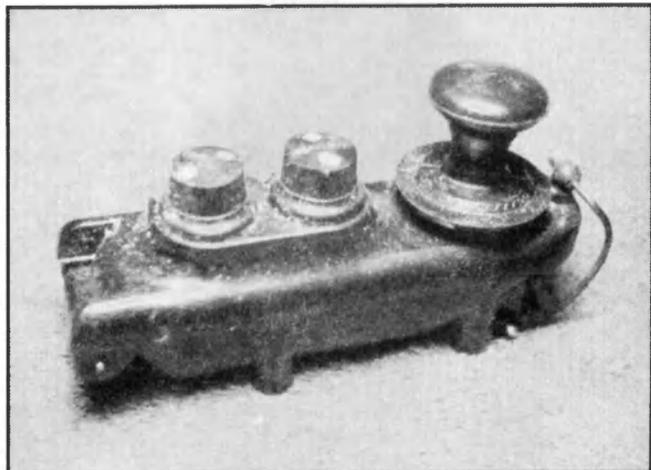
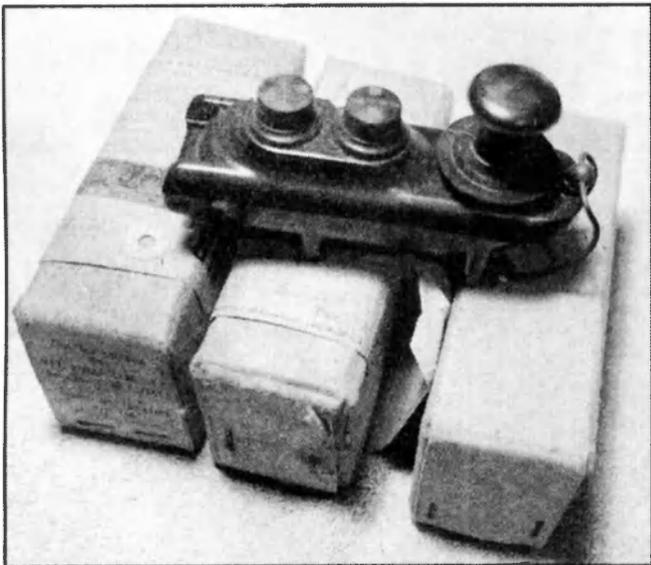

Photo set 3. This particular key sends "SOS" automatically, in groups of three, when the geared mechanism under spring tension is set, by rotating the handle one revolution and depressing the Morse key knob. It could be used by a non-telegrapher and still send clear "SOS" signals.

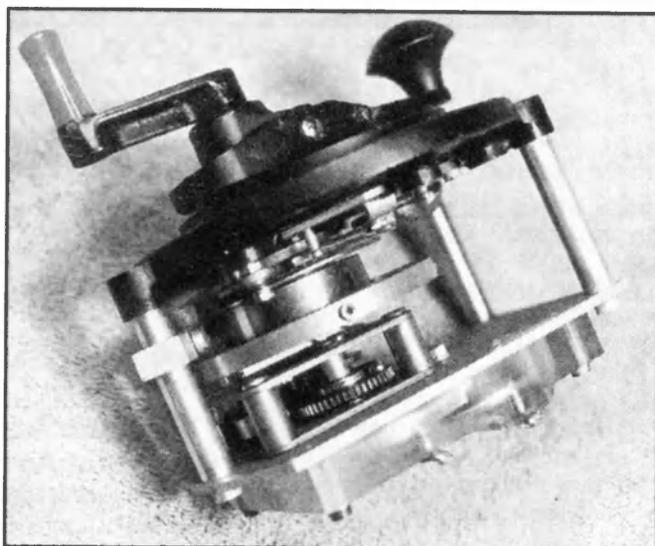
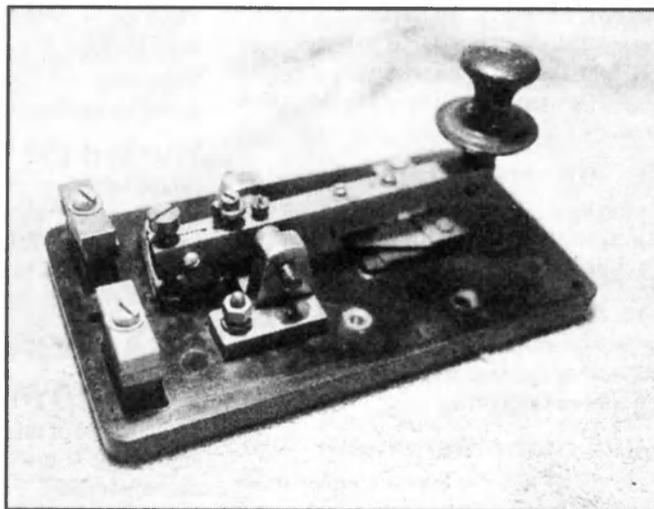

Photo 4. Morse Key Type D. REF No. 10A/7273

This key is much larger and heavier than the above keys. I believe that this key was used in base station installations, possibly used in bombers.



If any reader has any more information in regards to these keys, I would appreciate if you could contact me, as I regularly update my records.

Until next month, ar

SNIPPITS

Man(hole cover) on the Moon

It is reputed that the first man-made object sent into space was done so inadvertently.

While testing the atomic bomb during WWII, initial tests were made in underground pits.

The first pit was covered with a cast iron manhole cover.

When the bomb was triggered, the pit cover was filmed by high-speed movie cameras as it lifted off at a calculated speed in excess of the Earth's escape velocity.

Unfortunately we can neither confirm or deny such a claim!!!



OK, that's escape velocity reached, now for direction!

AWARDS

John Kelleher VK3DP

Federal Awards Officer

4 Brook Crescent, Box Hill South, Vic 3128 (03) 9889 8393

**Another request to local Club Stations who sponsor awards.
Please send details and I will surely publish them**

My profound apologies for the non-appearance of the current DXCC listings which are normally published in the August and February editions of this magazine. It must have gone astray somewhere in the works. Keep the upgrades coming, along with new applications, and I will make doubly sure that the listings appear as normal, in February, 2000.

Awards

USA : The Paper Chaser's Delight Programme.

General Requirements : GCR is accepted along with US\$3.00 for each award. Apply to :- Allen Newton KA5GIM , Rt 1 , Box 187A , Whitney TX , 76692 USA. SWL OK.

The African Dozen.

Work at least 12 stations, each of which was located in different African countries or Republics.

The Asian Dozen.

For working at least 12 stations, each of which was located in different Asian countries or Republics.

Battle of the Benches

Work one of the few licensed amateurs in Whitney, Texas, where there once was a political battle over the placement of benches in the downtown area of the city.

The Canadian Conquest Award.

Work stations in ALL the Canadian Districts.

The Central American Conquest Award.

Work stations in ALL seven countries of Central America.

Worked All Districts.

Contact one station in each of the 10 USA call districts.

Land of the Lake Award.

Work one station along the shores of Lake Whitney, Texas.

Novice/Technician Contact Award.

Work 10 Novice or Technician Class stations.

The South American Conquest Award.

Work stations in all 13 countries of South America.

Work all Texas Districts.

Work 4 Texas stations, one in each of the areas of North, South, East and West Texas.

Worked twelve Islands Award.

Work at least 12 stations located in Island countries or Republics.

Worked the World Award.

Issued on receipt of proof of having worked stations world-wide, with endorsements as follows. 25 countries, 50, 75, 100, 125, 150, 175, 200, 225, 250, 275, 300.

USA - QRPP Low Power Award.

The purpose of this award is to promote the enjoyment of low power operating, while demonstrating its usefulness and practicality. Any authorised amateur frequency and mode of communication may be used. The applicant must demonstrate the following :-

1. That your transmitter output power was accurately measured to be less than one watt (QRPP).
2. That the distance communicated was over 100km (63 miles)
3. That no artificial means of active relay was used to complete the communications (i.e. repeaters, satellite transponders, digi-peaters, land-lines, etc.) However, reflections off the ionosphere, mountains, tropospheric ducts, auroral curtains, meteors, the moon, satellites, buildings, aircraft bodies and other passive reflectors are acceptable and encouraged.

Application :

1. Send a signed statement to the Manager that the power used was less than one watt, the distance greater than 100 Km, and that no artificial means of active relay was used.
2. Provide the Manager with a photocopy of either the station log or QSL card, clearly showing the date, time, mode, and frequency on which the qualifying communication took place.
3. If desired, provide the Manager with information concerning any desired endorsements, such as longer distances, lower power levels, WAC, WAS, WAZ, etc that you want listed.
4. Mail US\$5.00 along with application materials to :-
EFT, Low Power Award
P.O. Box 460101
Aurora, CO 80046-0101 USA

USA - The Redwood Empire Award.

Work at least one amateur in each of the 5 California North Coast counties of Marin, Sonoma, Mendocino, Humboldt, and Del Norte. SWL OK. Any band or mode. Contacts after 1 Jan 1981. Endorsements on request. GCR list and US\$2.00 to :-
Redwood Empire DX Association,
Box 4881 Santa Rosa
CA 95402 USA.

Poland - Award '63 DNI'

The award 63 Dni is published commemorates Warsaw's uprising (Powstanie Warszawskie 1944). This is an official Polish diploma issued by Wlodzimierz Nawrot SP5NHV, with the consent of the Polish Short-Wave Association (PZK). The award is available to all licensed stations and SWL world wide.

The conditions are:- The applicant should obtain 63 points between 01 August and 02 October every year working amateur stations in Warsaw. The points available.

- contacts with SP5NHV (SO5PW, SO5DC, SN5PW, 3Z5PW) 23 points
 - contacts with Scouts-Clubstation (SP5xx) 15 points
 - contacts with other Clubstations (SP5Kxx SP5Pxx SP5Yxx) 8 points
 - contacts with Warsaw individuals 5 points
- Points for non-European stations are counted twice.

Contacts after 01 August 1994. No band or mode restrictions. Send verified GCR list and a fee of US\$8.00 (10 DM or 10 Irc) to :-

The Award Manager
Wlodzimierz Nawrot, DL3KDC
Erzbergerallee 86
D-52066 Aachen Germany.

Another Polish award will be published in the December issue.

DX activity has been from, and is also expected from :-

Tanzania, Reunion Island, The Ivory Coast, Annobon Island, Central Kiribati, Samoa, Singapore, Barbados, Chatham Island, Fernando de Noronha, Guinea (Af), Iraq, and East Malaysia. There is a rumour circulating about the possibility of a new entity in Montenegro. After the dust settles in East Timor, we could be looking at another!

Fee increases

To commemorate my eight years as Awards Officer, and with the authority of the WIA governing body, the fees for WIA Awards to DX applicants and non-members has been raised to ten (10) dollars.

The first rise since 1975, the fee reflects the present cost of processing and posting awards, (an award posted now costs US\$6.20, leaving no margin of workable monies, even to the purchase of stamps and stationery items. To assist in the future, please enclose an SASE for all return correspondence.

I have moved 21 files from my active DXCC list to inactive files, for not adding to their listings since June 1993.

The Radio Amateur Association of Greece Award

This award is available for working and confirming contacts with at least seven (7) different Greek stations from the nine SV calls areas (SV1-9/0). QSL's are not necessary. Applications must be accompanied by a certified list of QSO's (checked and signed by two other amateurs) together with a fee of US\$4.00 or 10 Irc's, and should be sent to:

RAAG Award Manager
PO Box 3564
Athens GR 10210 Greece.

Greek Island Awards

This award is available for working and confirming 10 contacts with at least 3 different groups of Greek Islands;

1. Criti
2. Dodekanisos
3. Ionian
4. Evvoia
5. Kyklades
6. Sporades
7. Lesvos
8. Chios
9. Thasos-Samothraki
10. Ikaria-Limnos.

Awards are issued for 2-way CW, 2-way SSB, Mixed mode or Single mode, Mixed band or Single band. Endorsements and stick for each 10 different Islands. Qsl's are not necessary.

Applications must be accompanied by a certified list of Qso's (checked and signed by two other amateurs) together with a fee of US\$5.00 or 10 Irc's (4 Irc for each endorsement sticker) and should be sent to the address listed above.

The Athenian Award

This award is issued for contacts with 25 amateur radio stations in the Athens area. Diploma is issued in any modes:

- 1st class - Awarded for contacts on 160 and 80 metres.
- 2nd class - Awarded for contacts on 40 and 30 metres.
- 3rd class - Awarded for contacts on the other bands.

Endorsement stickers are available for each 25 new contacts. Fees and contact address are the same as the two previous awards. This information was dated June 99, and came via Antonis Parashis, SV1ENG.

5U - Niger. Dan, AE4RP, the only active operator in this country, hopes to be active soon on 160/80 and 40 metres. At present he is running 100 watts into a 3-element tribander for 10/15/20 metres. QSL is via K4SE.

J8 - St Vincent. Mike, G0GPX will be active until 2001 as J87AB. He is working in Canouan as a missionary.

HS - Thailand. The Thai PTD has authorised HS stations to operate on 160 and 80 metres during any contests through December 1999.

4L - Georgia. Omari 4L50, is active around 50.11 and 50.13 MHz daily.

YASME - A new Awards manager has been appointed. He is Randy Wright W6CUA. His address is 18432 Wilmar Boulevard, Castro Valley CA 94546, USA.

The address of the new Swedish Rtty Awards Manager is Charlie Carlsson SM4RGD, Fjugestavegen 32, SE-692 73, Kumla, Sweden.

ANTARCTICA - Look for ET5YG on 14130 kHz daily around 0530Z, with assist from his manager, F5LBL.

ARGENTINA - Dion, LU8XP is operating as LU1XT from Tierra del Fuego using SSB and digital modes. Qsl is via home call.

GUINEA 3X - Robert 3XY1BO can be found near 14003 kHz just before 0600Z. Qsl is via F5XX.

IRAN EP - Ali EP2MKO is usually Qrv on 21010 kHz around 0130Z. Qsl via RU6FZ.

MAYOTTE FH - Elio FH5CB can be heard on 21292 kHz around 1430Z daily.

UGANDA 5X - Tomo, JE9IKG, is now ace on SSB signing 5X1JA. Qsl to home call.

Arrest

The June 16 issue of *Asahi Shimbun* reported the arrest of Japanese Radio Operator Yasua "Zorro" Miyazawa, JH1AJT. In October 1995, Hirohiko Daikoku JG3QCW, holder of a first class licence in Japan allegedly had taken the second class amateur licence test for Miyazawa using false ID. At the time JH1AJT was a fourth class ticket holder.

The Japanese PTT received information, and started an investigation in March this year. The two men were arrested on June 16.

Last month "Zorro" was announced as the 1999 New Orleans International DX Convention's Dxr of the year. Zorro has been to many DX spots throughout Asia, Africa, and the Pacific including 701A, XW30/XW30A, A51/JH1AJT XU1A, XW8KPL, E31A and many others. during the 1998 Visalia International DX Convention, he announced that he had been invited back to the Kingdom of Bhutan for another Dxpediton. This operation, scheduled for early 1999, has yet to happen.

Herewith a list of top 25 most wanted countries (circa September 1998)

- | | | |
|-----|------|------------------------------|
| 1. | PS | North Korea |
| 2. | BS7H | Scarborough Reef |
| 3. | BV9P | Pratas Island |
| 4. | A5 | Bhutan |
| 5. | VU | Andaman & Nicobar Islands |
| 6. | E3 | Eritrea |
| 7. | 7O | Yemen |
| 8. | FR/T | Tromelin Island |
| 9. | FR/G | Glorioso Island |
| 10. | 3Y | Bouvet Island |
| 11. | ZL9 | Auckland & Campbell Islands |
| 12. | VK0 | Macquarie Island |
| 13. | VU | Lakshadweep Islands |
| 14. | VP8 | South Sandwich Islands |
| 15. | XZ | Myanmar |
| 16. | 3B7 | Agelaga & St Brandon Islands |
| 17. | SV/A | Mount Athos |
| 18. | VK0 | Heard Island |
| 19. | HK0 | Malpelo Island |
| 20. | 3C0 | annobon Island |
| 21. | KH5K | Kingman Reef |
| 22. | FR/J | Juan de Nova, Europa Islands |
| 23. | 5A | Libya |
| 24. | VP8 | South Georgia Island |
| 25. | ZL8 | Kermadec Island |

It seems significant to me (and others) that the majority of entries on this list are islands. Maybe I can do business with my old TS520S and a dipole???

Happy hunting and best 73,
de John VK3DP

ar

QSLs from the WIA Collection

Ken Matchett VK3TL
*Honorary Curator WIA QSL Collection

Interesting QSLs of Mongolia, Rio de Oro and England

JU60MTZ

Indicating the importance of the railway in this vast country the QSL JU60MTZ from Ulaanbeatar (sic) celebrated the 60th anniversary of the Mongolian Railway. On the reverse side of the card we learn that the railway's history dates from 1938 when the line ran from Ulan Bator to a coal mine at Nalaikh. The railway is the country's principal means of transport, accounting for more than 90% of the freight turnover. The railway also has links with amateur radio. Another Mongolian special event station JU5R was actually sponsored by the Mongolian Railway Board.

Mongolia was a DXCC country before the war but was not allocated an international prefix until 1947 at the International Telecommunications Conference in Atlantic City. The allocation was JTA-4TZ but only the prefix JT was used until a second prefix JU came on the air about ten years ago.



EA9DF

Rio de Oro, once a separate DXCC country, was the name given to a coastal portion of the former Spanish Sahara (sometimes described as "Spanish West Africa"), which ceased to be administered as a separate territory in 1958. When Spain relinquished control of the country in 1978 the territory was absorbed by Morocco and Mauritania. Nowadays it is part of the new DX country of Western Sahara. It was officially deleted from the DXCC listing on 1 August 1978 (although several recent publications have quoted the date as 8 January 1976). Despite its name, "River of Gold", the main mineral mined in the region is phosphate.

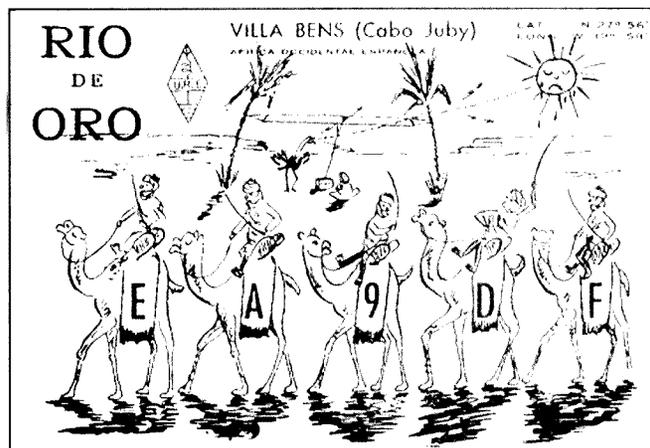

GB800DON

Ibis QSL, GB800DON, dated August 1994, celebrated the 800th anniversary of the granting of a Royal Charter to the settlement of "Doncaster" on 22 May 1194. It was the famous King Richard the Lionheart who put his seal to a document that allowed the town to claim borough status. Essentially this meant that the people of Doncaster could pay taxes directly to the Exchequer rather than to the rapacious Sheriff of the County of Yorkshire. A photograph of the famous Doncaster race appears on the front of the QSL.

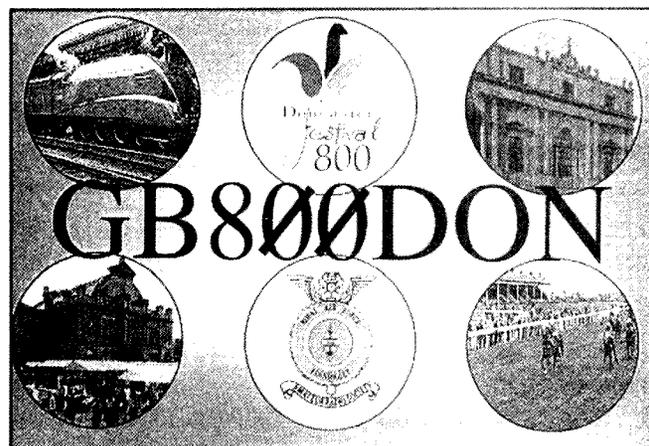

Thanks

The WIA (Federal) would like to thank the following for their kind donation of QSL cards towards the National Collection:

Robin VK6LK Mike VK6HD Barry VK3XW Ken VK3AFJ Len VK3BYE Flans HE9RFF/L40370 Geo Lopatko SWL

Also the families and friends of the following "Silent Keys": Jim Robinson VK2ARJ Ivor Stafford VK3XB Ray Nottage VK5MI.

Courtesy of Jack VK5HT.

CONTESTS

Ian Godsij VK3DID

57 Nepean Highway, Aspendale 3195

Contest Calendar October - December 1999

Oct 2/3	VK/ZL/Oceania DX Contest	(Aug 99)
Oct 3	RSGB 21/28 Mhz Contest	(SSB) (Aug 99)
Oct 9	Ten-Ten Int. Day Sprint	(CW/SSB/RTTY)
Oct 9/10	VK/ZL/Oceania DX Contest	(Aug 99)
Oct 16/17	JARTS WW RTTY Contest	(Sep 99)
Oct 16/17	Worked All Germany Contest	(CW/SSB)(Sep 99)
Oct 17	Asia-Pacific Sprint	(CW) (Jan 99)
Oct 17	RSGB 21/28 MHz Contest	(CW) (Aug 99)
Oct 30/31	CQ WW DX Contest	(SSB) (Sep 99)
Nov 1/7	HA QRP Contest	(CW)
Nov 6/7	Ukrainian DX Contest	(CW/SSB)
Nov 7	High Speed CW Club Contest	(Jan 99)
Nov 12/14	Japan Int. DX Contest	(SSB) (Dec 98)
Nov 13/14	WAE RTTY Contest	(Sep 99)
Nov 13	ALARA Contest	(CW/SSB) (Sep 99)
Nov 13/14	Spring VHF-UHF Field Day	(CW/SSB) (Oct 99)
Nov 13/14	OK/OM DX Contest	(CW)
Nov 20/21	LZ DX Contest	(CW)
Nov 27/28	CQ WW DX Contest	(CW) (Sep 99)
Dec 4/5	EA DX Contest	(CW)
Dec 11/12	ARRL 10 Metres Contest	(CW/SSB)
Dec 18	OK DX RTTY Contest	
Dec 18/19	Croatian CW Contest	
Dec 18/19	International Naval Contest	(CW/SSB)
Dec 19	RAC Canada Winter Contest	(CW/SSB)
Dec 25/26	Original QRP Contest	(CW)
Dec 25/26	Stew Perry Topband Distance Challenge	(CW)
Dec 26	Ross Hull Memorial VHF-UHF Contest	(CW/SSB)

RESULTS of 1999 John Moyle Field Day Contest

From Eric Fittock VK4NEF,

Contest Manager

Thank you to all who took part this year. A total of 53 logs received, 16 of which were received by e-mail.

Scores in the Multi-op section were slightly down this year, with VK3FRC taking first place with 14,254 points, followed by VK3ER and VK3APC with 10,090 and 4,850 points respectively.

The President's Cup will not be awarded this year as no entry was received for the portable CW Section.

The leading home stations are ZL2AWH with 329 points, and VK3CAT with 198 points. On behalf of the operators who were portable, our thanks to the home stations for your support during the contest.

Call/class/mode/band/score)

* = certificate winner.

Portable, Six Hour.

VK3BEZ	Mult	All	All	1062 *
VK2FRE	Mult	All	All	216 *
VK2BOR	Mult	All	All	150
VK5UE	Sngl	All	All	134 *
VK3DPW	Sngl	Phone	All	1056 *
VK5AR	Sngl	Phone	All	834 *
VK4OE	Sngl	Phone	All	80 *
VK5AIM	Sngl	Phone	All	148
VK3GH	Sngl	Phone	All	146
VK3KMF	Sngl	Phone	VHF	750 *
VK3YZR	Sngl	Phone	VHF	61
VK3KAI	Sngl	Phone	VHF	588 *
VK3JED	Sngl	Phone	VHF	368
VK3YE	Sngl	Phone	VHF	358
VK4IS	Sngl	Phone	VHF	218
VK5ZFW	Sngl	Phone	VHF	20
VK5ATQ	Sngl	Phone	VHF	10

Portable, 24 Hour.

VK3FRC	Mult	All	All	14254 *
VK3ER	Mult	All	All	10090 *
VK3APC	Mult	All	All	4850 *
VK4WIS	Mult	All	All	3848
VK3CNE	Mult	All	All	3482
VK2HZ	Mult	All	All	1304
VK4BAR	Mult	All	All	802
VK6ANC	Mult	All	All	524
VK2DKD	Mult	All	All	504
VK2FFG	Mult	All	All	488
VK2LE	Mult	All	All	436
VK2IBT	Mult	All	All	336
VK4QD	Mult	All	HF	1620 *
VK4IZ	Mult	All	HF	1090 *
VK5ARC	Mult	All	HF	938 *
VK5BAR	Mult	All	HF	448
VK5GRC	Mult	All	HF	176
VK4EV	Sngl	All	HF	308 *
VK4VW	Sngl	Phone	HF	576
VK5DG	Sngl	Phone	HF	216
VK4JAE/7	Sngl	Phone	HF	54

Rules Aint Rules (if they are last year's)

Recently I asked that when you come to fill in your logs and send them, will you please be careful to read all the current rules and not to expect that things may be the same as the last time that you sent something for that contest.

Following the current rules makes the Contest Manager's job that much easier. This is important when you consider that most of the Contest Managers work and give of their time willingly but voluntarily. I am sure that you will see that anything that we can do to help them along also helps to get the results out quicker.

By the time this appears in print the VK/ZL "busy period" will be over again for another year.

However, please don't let this stop you from preparing for Contests — there are some good Spring and Summer events coming soon.

Note especially the ALARA Contest next month.

Please make every effort to support the **ROSS HULL MEMORIAL CONTEST** this year. It is different enough to be challenging and well worth the effort of trying something on VHF.

The RD Rules ran into some strife this year, for which again I apologise. However, a mistake has been found in the figures used for calculating the 1999 Benchmark. This has affected the published 1998 results. Alek Petkovic VK6APK, the RD Contest Manager, has sent some updated corrections — see below.

Finally, another request from me. If you ever need to send me any information electronically, PLEASE send it in PLAIN ASCII TEXT — NO Windows/Word/RTF/Excell/fancy formatting — just PLAIN ASCII TEXT, please.

73 and good contesting de Ian VK3DID

It was with interest that I read the following comments about the John Moyle field day results

Home, 24 Hour.

ZL2AWH	Sngl	All	All	329	*
VK3CAT	Sngl	All	All	198	*
VK3TJN	Sngl	All	All	104	
VK4AO	Sngl	All	All	90	
VK3IO	Sngl	All	All	79	
VK3ALD	Sngl	All	All	62	
VK3DID/QRP	Sngl	All	All	55	
VK2AGN	Sngl	All	All	46	
VK4XXT	Sngl	All	All	34	
VK4KF	Sngl	All	All	29	

Home, 6 Hour.

VK2CZ	Sngl	All	All	105	
VK4XD	Sngl	All	All	68	
VK6BGN	Sngl	All	All	11	

Check Logs.

VK4FW and ZL2VW

Comments on the Logs.

Please refrain from scanning a log into the computer and then sending as an Attachment. Rewrite or type into computer and then send. Reason being it took 100 minutes to receive a scanned log and the person sent it TWICE !!

A total of 200 minutes spent late at night waiting for the "read mail" to finish, I was not happy. UTC time in logs please not local. Rule 35, Portable stations shall add the letter "P" to their own cipher ie RS(T)001P. PLEASE DO SO!

Some comments from Logs.

I must point out that rule 35 is silly...VK5. I had a good time camping and contesting in the forestry camping grounds...(VK4VW) It is a pity that many stations do not make use of SSB/CW at V/UHF - they would be able to achieve significantly greater distances...(VK3KA1)

It would be much better to encourage the use of Maidenhead locators as it is less confusing and requires less time to send compared to Latitude and Longitude ..(VK3BEZ)

I observed a variety of "locator" methods used, some of which were very poor eg. "near ABC Hill/XYZ Creek" - I had to make a "best guess" for calculating scores. The station involved could only give a Lat/Long reference to the nearest minute - this is often insufficient for distance calculations. A 6-digit Maidenhead Locator should give accuracy to about 1.5 km (from memory) at worst...(VK3KA1)

Most of the weekend it drizzled with rain but the tent kept us dry and the weather didn't seem to affect the antenna system...(VK3ER)

Asia-Pacific Sprint (June 1999)

call	score	zone	award
VK4EMM	1716	30	T-shirt
VK6NU	806	29	"

RESULT Novice Contest 1999

from Robert Archer VK2TRA, Contest Manager
22 logs received, with three of these being mixed CW/Phone.

Posn	call	score	award
1	VK4SM	429	Highest score overall Highest score Phone Keith Howard Trophy Highest VK2 Novice
2	VK2NNN	421	
3	VK3JWZ	378	
4	VK4LUV/7	303	Highest VK7 Novice
5	VK4JAE/7	231	
6	VK2LEE	229	
7	VK4WSS	203	
8	VK2IBT	163	
9	VK3KQB	149	
10	VK2ATZ	106	
11	VK2CW	103	
12	VK3GH	90	
13	VK6BIK	62	
	VK3YE	62	
	VK2HV	62	
16	VK5NJ	55	Highest score CW
17	VK3DID	41	
18	VK2LT	35	
19	VK2VZB	31	Clive Burns Mem. Trophy

Thanks to all participants. Certificates of Participation (sponsored by Westlakes ARC) have been sent to all who sent logs.

RD Contest Amended Results 1998

Table 1: each Division's placing and its overall Improvement Factors.

Table 1: Divisional Ladder

1st	VK7	2.535
2nd	VK2	1.269
3rd	VK5/8	0.993
4th	VK6	0.807
5th	VK4	0.655
6th	VK1	0.586
7th	VK3	0.502

The total scores in HF and VHF are :

Table 2: Divisional Scores

Div'n	HF	VHF
VK1	694	44
VK2	5513	95
VK3	2775	3145
VK4	3640	317
VK5/8	3890	1416
VK6	3297	3016
VK7	1331	1215

These totals were used to calculate the Improvement Factors, which determined the winning Division. They were also used to calculate Bench-marks for this year's contest.

1999 Benchmarks

These are the total scores which must be obtained by each Division to improve on its results for the previous year.

Div'n	HF	VHF
VK1	714	170
VK2	4771	78
VK3	3773	7988
VK4	3672	820
VK5/8	3662	1532

VK6	2997	5502
VK7	1795	512

Results Pacific 160 metres contest July 1999

from Ian VK3DID Contest Manager

CW Section			SSB Section		
Place	call	score	Place	call	score
1	VK3IO	693*	1	ZL2AS	830*
2	VK5CRS	504*	2	VK3IO	792*
3	ZL2GT	301*	3	ZL2GT	336
4	W8JI	175*	4	VK3WWW/P	210
5	VK4AXM	138*	5	ZL2LF	100
6	VK3DID	120	6	VK2AVQ	50*
7	VK2BQQ	66*	7	VK3DID	24
8	ZL2LF	55	8	W8JI	20*
9	VK2AVQ	35	9	VK4AXM	16*
10	VK3WWW/P	2			

* = certificate winner

Report

Ten logs were received, most being for both CW and SSB modes. Congratulations to ZL2AS and VK3IO as Mode winners. My sincere thanks to those who took part and to those who sent their logs, but I am very disappointed that so few logs were received.

A few difficulties were pointed out by some operators and I hope that I have overcome these for next year. If anyone would like a copy of the revised rules for 2000, please let me know.

Results 1999 BERU Contest

Posn	call	score
from Bob G3PJT		
Open Section		
8	VK4EMM	6312*
11	VK3BJ	6119*
14	VK6VZ	5847*
41	VK5GZ	2807*
43	VK8HA	2620*
58	VK3XB	1761
59	VK3MR	1623
60	VK2DID	1452
64	VK4XW	1318
66	VK8AV/3	1214
71	VK3KS	623
74	VK5HO	498

Restricted Section

2	VK2APK	4115*
11	VK2AYD	2583
22	VK6AJ	2264*
26	VK4TT	2140*
30	VK2BQQ	1994

HQ Stations

2	VK4WIA(VK4XA)	4564
---	---------------	------

* = certificate

50th Annual Ross Hull Memorial VHF-UHF Contest

John Martin (VK3KWA),
Contest Manager

0000z Sun 26 December 1999—2400z Sun 16 January 2000
Special 50th Anniversary trophy to be awarded

This year marks the 50th anniversary of the contest named in honour of Ross A. Hull, the Australian-born amateur who discovered tropospheric propagation and made major contributions to VHF equipment design and construction.

There are several changes to the rules this year. Last year's short contest was not successful, so the duration has been re-extended. Also scoring has reverted to the best 7 UTC days of your choice, and a separate section for the best two consecutive UTC days. You may operate for only part of the contest, or even just one weekend, and still do well.

The band multipliers have been reduced slightly, to provide more incentive for those who do not have microwave gear.

The rules relating to the use of Calling Frequencies have been reworded, so please read them carefully. I do not want to penalise occasional contest operation on Calling Frequencies when it is genuinely impractical to move to another frequency. On the other hand it is important to keep Calling Frequencies clear of local QRM so that it is easier to hear any weak signals.

Try your luck (and your skills) in the contest this year, and good luck and plenty of DX.

The Contest and Special trophy

The WIA maintains a perpetual trophy in honour of the late Ross A. Hull.

This trophy has the name of each year's contest winner engraved on it, and other divisional awards may be made.

To mark this fiftieth anniversary, a special trophy with a representation of the original trophy and winners detail etched into it, will be donated and permanently awarded.

The contest is open to all amateurs.

Duration

0000 UTC Sunday 26 December, 1999 to 2400 UTC Sunday 16 January, 2000. In Eastern Summer Time, that is 11 a.m. on Sunday 26 December to 11 a.m. on Monday 17 January.

Sections

- A. Best 7 UTC days as nominated by the entrant.
- B. Best two consecutive UTC days.

Entrants may submit logs for either section. The overall winner will be the top scorer in Section A. If the overall winner has also entered Section B, his/her log will be excluded from Section B.

General Rules

One callsign and one operator per station. One contact per station per band per UTC day. Repeater, satellite and crossband contacts are not permitted. No contest operation is permitted below 50.150 MHz. Recognised Calling Frequencies should not be used for contest calls, exchanges, or liaison. A contest calling frequency of .150 on each band is suggested. All rulings of the Contest Manager will be accepted as final.

Penalties

Minor errors in distance estimates or score calculations will be corrected and the score adjusted accordingly.

Contacts made on Calling Frequencies will be credited only if the entrant provides a satisfactory explanation of why it was not practical to move to another frequency. Otherwise such contacts will be disallowed. Persistent unnecessary use of Calling Frequencies will lead to disqualification.

Exchange

RS/RST reports plus a serial number. Serial numbers need not be consecutive. For difficult propagation modes such as meteor scatter, exchange of a total of two digits is sufficient for a valid contact.

Scoring

For 2 metres and above, one point per 100 km or part thereof (i.e. up to 99 km: 1 point; 100 - 199 km: 2 points, etc).

For 6 metres only, contacts up to 1000 km: as above. Contacts from 1000 km to 2400 km, 1 point. Contacts over 2400 km, 10 points.

The band multipliers are:

6 m	2 m	70 cm	23 cm	Higher
x 1	x 3	x 5	x 8	x 10

Logs

Logs must cover the full contest period and contain the following for each contact:

- Date and UTC time.
- Station location (if operating portable),
- Specific FREQUENCY (not just band) and callsign of station worked,
- Approximate location of station worked (if not QTHR),
- Reports and serial numbers sent and received,
- Estimated distance worked and points claimed.

Separate scoring columns for each band would be helpful. The Contest Manager reserves the right to correct distance estimates on the basis of computer calculation.

Summary Sheet

Logs must be supplied with a Summary Sheet containing:

- Operator's callsign, name and address,
- Station location (if different from the postal address),
- Section(s) entered, and a list of the UTC days to be scored,
- A scoring table set out as the example below,
- A signed declaration that the station has been operated in accordance with the rules and spirit of the contest, and that the Contest Manager's ruling will be accepted as final.

Send Logs -

1. by MAIL to:
WIA Ross Hull Contest Manager,
3 Vernal Avenue, Mitcham, 3132
2. by e-mail in plain ASCII text ONLY to: jmartin@xcel.net.au

Sample Scoring Table

Band	6 m	2 m	70 cm	etc
Score	xxxx	xxxx	xxxx	xxxx
Band Multiplier	x 1	x 3	x 5	x x
Total	xxxxx + xxxxx + xxxxx + xxxxx = xxxxx (GRAND TOTAL)			

Note on Calculating Distances

Absolute accuracy is not required.

All you need to know is whether the other station is above or below the nearest multiple of 100 km.

An easy method is to use a compass to draw 100 km circles around your location on a map. Better estimates can be made from six-digit Maidenhead locators, using a simple computer program published in December 1996 "Amateur Radio".

A more accurate and fully error-trapped program is available, which also includes calculation of bearings and conversion between lat/long and Maidenhead locators.

It is available if you send a 3.5 inch disc in a mailing box to the above address, together with return postage. Alternatively, you can send a message to the e-mail address above.

Spring VHF-UHF Field Day 1999

John Martin (VK3KWA), Contest Manager
13 - 14 November, 1999

VK6: 0400z Sat - 0400z Sun

Others: 0100z Sat - 0100z Sun

The contest rules are much the same as for previous VHF-UHF Field Days, but there are two changes. The times have been changed to take Summer Time into account - something which I overlooked last year! The starting time will now be Midday local time in most call areas.

The other change is an adjustment to the band multipliers to increase the incentive for stations operating only on the lower bands. The same band multipliers will also be applied to the Summer VHF-UHF Field Day and the Ross Hull Contest. Please check the log requirements and make sure that you supply all the necessary information. Club stations, please note that I need the names and call signs of operators, printed legibly, so that I can include them in the results lists and certificates. Signatures are not much help if I can't read them!

I hope you will be able to head for the hills for at least part of the Field Day weekend. If you can't manage to mount a full expedition, you might even consider just going for a nice long drive and activating a few grid squares on the way.

Sections

A: Portable station, single operator, 24 hours.

B: Portable station, single operator, any 6 consecutive hours.

C: Portable station, multiple operator, 24 hours.

D: Home station, 24 hours.

Single operator stations may enter both Section A and Section B. If the winner of Section A has also entered Section B, his log will be excluded from Section B.

If two operators set up a joint station, they may enter Section C under a single call sign, or sections A/B under separate call signs. Stations with more than two operators must enter Section C.

General Rules

One call sign per station. Operators of stations in Section C may not make contest exchanges using their own call signs. Operation may be from any location, or from more than one location. You may work stations within your own locator square. A station is portable only if its equipment, including antennas, is transported to a location other than the normal home location of its operator. Repeater, satellite and crossband contacts not permitted. No contest operation is allowed below 50.150 MHz. Recognised DX Calling Frequencies MUST NOT be used for any contest activity. Suggested procedure is to call on .150 on each band and QSY up. CONTEST EXCHANGERS/RST reports, a serial number, and your four digit Maidenhead Locator. REPEAT CONTACTS Stations may be worked again on each band after three hours. If the station is moved to a new locator square, repeat contacts may be made immediately. If the station moves back into any previous locator square, the three hour limit still applies to stations worked from that square.

Scoring

For each band, score 10 points for each square in which your station operates, plus 10 points for each locator square worked, plus 1 point per contact. Multiply the total by the band multiplier as follows: 6 m 2 m 70 cm 23 cm
Higher x 1 x 3 x 5 x 8 x 10
Then total the scores for all bands.

Sample Scoring Table

Band	QSO Points	Locator Points	Multiplier
Total 6 m	100	+ 200	x 1 =3002
m 60		+ 120	x 3 =540
Overall Total			840

Logs

For each contact: UTC time, frequency, station worked, serial and locator numbers exchanged, points claimed. The SUMMARY SHEET should contain the names and call signs of all operators; postal address; station location and Maidenhead Locator; section entered; a scoring table and signed declaration that the Contest Manager's decision will be accepted as final.

Send Logs

by mail to:

Spring VHF-UHF Field Day, PO Box 2175, Caulfield Junction, 3161, by 1 December, 1999.

NOTE: Following several requests AR will endeavour to provide a suitable Locator Map in the November issue of AR and the WIA Yearbook (Callbook).

SPOTLIGHT ON SWLING

by Robin L. Harwood VK7RH

5 Helen Street, Newstead Tasmania 7250
(03) 6344 2324

E-mail: robroy@tassie.net.au

The situation in East Timor, following the United Nations referendum, markedly deteriorated with the Pro-Indonesian militia, running amok, forcing the UN personnel to flee to Darwin on RAAF C-130 aircraft. Some monitors heard these aircraft communicating with Air Force Darwin on 8 and 11 MHz. The mode has been USB and digitally encrypted speech.

Radio Australia, our own international service has been following developments as they happen with extended newscasts. No sign yet of the Darwin site being re-activated.

There are hundreds of Indonesian stations on SSB across the HF allocation. Some have been logged in amateur bands and others in exclusive aero allocations, especially between 8.8 and 9 MHz. There are networks between 10 and 11.3 MHz. They seem to shift about and seemingly do not adhere to any regular schedule. Many, I suspect, are illegal operators judging by their on-air behavior. You may have heard this on 7.000 MHz USB and LSB. They also are on 7.005 USB and 7020 LSB. They are not hams.
The official Voice of Indonesia from

Jakarta is broadcasting in English on 11790 kHz at 0800 but their pronunciation is very poor, making it hard to comprehend.

Portugal broadcasts to Timor as follows :
Mon-Fri, Tetum and Indonesian:
1000-1100 Timor 11550 (via Taiwan) and 17740
2100-2200 Timor 17600
2200-2300 Timor 11550 (via Taiwan) and 17600
1100-1200 Timor 17740

Tetum is the language of the Timorese.
There also are broadcasts in Portuguese from 1200 till 1400 on 17740 on weekdays and from 1000 to 1155 at weekends.

Radio HCJB in Ecuador has moved from 15115 to 11755 for their South Pacific service from 0700 till 1100 UTC. The 19-metre frequency was not propagating well.

Deutsche Welle from Cologne is to be cutback from this month. This will result in:

1. Loss of 6 foreign language services
2. Less broadcast time for up to ten other language services
3. Elimination of DW's monthly

international radio/TV program guide

4. Elimination of DW's monitoring service
5. Elimination of DW radio's English language news department. (In future, news would be taken from DW TV)

Elimination of 160 full time jobs and 300 freelance journalists with another 200 jobs lost through future attrition.

The languages to be axed are Spanish to Latin America, Czech, Slovak, Hungarian, Slovenian and Japanese. Portuguese to Brazil would continue but via Internet Audio.

The Southern Cross DX Club in Adelaide has ceased following the failure of nominations for their committee at their Annual General Meeting. I was Member 807 and had paid up until July 2000. This now leaves the Australian Radio DX Club as the sole club in Australia. Don't forget that the new broadcasting period commences at 0100 UTC October 31. This coincides with Europe reverting to Standard Time and some Australian states going over to Summer Time. (Tasmania is going over on Sunday October 3rd and NZ on the 10th). The new period is designated as B99.

Also don't forget the St Helena tests on the 23rd of October from 1900 till 2300 on 11092.5 kHz USB. Well that is it for this month. My thanks go again to the Electronic DX Press (EDXP). 73,

ar

NETS

All Times AEST unless otherwise stated.
 All HF Frequencies are \pm QRM and subject to band conditions.
 All listings are correct as received but may change with little notice.

Daily			
0230	AK Pacific Net		14.292
0600	GNARLY operators net TOWNSVILLE	CW	3.600
0630	GNARLY operators net TOWNSVILLE	SSB	3.600
0800	Gold Coast ARS		146.700
0800	Ipswich & District ARC (not Sundays)		146.900
0815	Good morning Sunshine Coast		146.850
0830	Hervey Bay CW Net		3.528
1300	TRAVELLERS NET	(vk6hh)	14.116
1600	GOLD COAST Almoners Net	VK4AAA George	146.700
1600	Capricornia Club	vhf simplex ch 50 and	3.620
1800	ZL COUNTIES AND BRANCH HUNTERS NET (weekdays)		3.677
2100	Seance Net	(Rodger VK4YB)	1.832

Mon			
0800	Ipswich and District Radio		146.900
0930	Mackay Amateur Radio Association		3.597
0930	Mackay Amateur Radio Association		146.775
1600	YL 222 DX net	ZL1AMN (Dave)	14.222
1930	BARC (BRISBANE AMATEUR RADIO CLUB)		28.450
1930	BAYSIDE DISTRICT AMATEUR RADIO SOC. INC RBS		146.875
1930	Gold Coast ARS		1.840
1930	Gympie ARC	RGY	146.625
1930	MACKAY ARA	3.597RMK	147.000
1930	WIA<q> NEWS AND INFO PROGRAM VK4 followed by.		3.605
2000	REDCLIFFE RADIO CLUB UHF NET		438.325
2000	THE WIA<Q> CLUB NET HELP AND INFORMATION FOR ALL CLUBS		3.605
2000	ALARA during daylight saving hours		3.580
2030	ALARA "proper time"		3.580
2200	ALARA VK6 YL NET VK6YF Poppy		3.585

Tue			
0030	Handi-Ham Disabled Net (USA)		14.265
1200	Working Girls Net (USA)		14.288
1730	RAFARS SSB NET (0730UTC)		14.290
1900	Air Forces AR Net/Northern Div/ daylight saving		3.567
1930	Air Forces AR Net/Southern Div/ "proper time"		3.608
1930	Ipswich Club net	(award available)	3.575
1930	Southside Amateur Radio Society		146.450
1930	Southside Amateur Radio Society		147.075
1930	VK7 WIATAS WIANEWS ReBcast		3.590
2000	Mt Isa ARG Club Net		3.610/605
2000	Air Forces AR Net/Northern Div/ "proper time"		3.567
2030	Air Forces AR Net/Southern Div/ "proper time"		3.608

Wed			
1000	MotorCycle Hams	net control in USA	7.290
1400	PROBUS CLUB NET		7.050
1430	PROBUS CLUB		14.150
1500	PROBUS CLUB INFO FROM VK5XI @ VK5LZ		21.175
1800	Townsville Ladies Net (vk4mum Anne net control)		146.700
1930	Bayside District Amateur Radio Club		3.567
1930	BARC		146.550
1930	Gold Coast ARS		3.605
1930	Land Forces Amateur Radio Group		3.590
1945	Tablelands Radio and Electronics Club		3.580
2000	2ND WED of mth Bris VHF group net	3.608	147.000
2000	Redcliffe Radio Club Award net		3.612
2000	VK1WI DIVISIONAL NEWS BCAST / wact award	7.090	3.570
2030	Royal Sigs AR Society 1030utc VK1GD Dave		3.615
2100	PROBUS CLUB NET VK5XI BRUCE		3.595

Thur			
0300	YL European Net	GM4YMM Christine	14.243
1730	DRL NET 1st THURSDAY Rockhampton Dist. Ladies		3.575

1900	SCARC 80m net		3.595
1915	Hervey Bay WICEN Net		146.650
1930	GLADSTONE AMATEUR RADIO CLUB NET	(VK4BPA)	3.570
1930	Hervey Bay NET	(VK4CHB)	3.615
1930	WICEN Gold Coast		146.700

Fri			
0700	INTRUDER WATCH NET		3.578
0900	VK4 DISABLED PERSONS NETNC.	Norm VK4CNP	3.590
1400	YL CHAT	VK6DE Bev	21.188
1500	YL NET	VE,VK,ZL	14.148
1600	Capricornia Electronics Club Net		146.500
1600	Air Forces AR Net/Southern Div/		3.605
1630	Air Forces AR Net/Southern Div/		7.085
1730	RAFARS CW NET	(0730UTC)	14.055
1930	YL VK4 NET		3.565
2000	Fisher's Ghost Net		3.850
2100	Scout Net.. WA Branch Radio Team	VK6SH	3.590

Sat			
0745	80m AM AUSTRALIA NET	VK4JHM MICK	3.580
1630	Royal Sigs AR Society 0630utc	VK5GZ Lindsay	14.153
1700	IPARC-ON net:	0700utc on	7.075
1930	Darling Downs Club Net	VK4WID award available	3.587
1930	MILITARY RADIO OPS/COLLECTORS Net Control In Europe		7.095

Sun			
0800	Cairns AR & Electronics Club		3.572
0830	Caboorture Amateur Radio Club		3.610
0830	Tablelands Radio Electronics Club	3.550	RTA 146.675
0830	Townsville ARC NET		28.365
0830	WICEN QUEENSLAND HF NET		7.075
0830	VK7 WIATAS DIV NEWS	3.570 7.090	14.130
0900	BRISBANE REPEATERS	438.525 RBN147.0	RLB 53.725
	HF SIMPLEX1.825 3.605 7.118 14.342 28.400		29.220FM
	RBU BUNDABERG		146.800
	RAR CQ BRANCH		146.700
	RET DALBY		146.675
	RGA GLADSTONE		146.900
	RGC GOLD COAST		146.700
	RMV MIRIAM VALE		147.625
	RMI MLISA		146.700
	RSC SUNSHINE C		146.850
	RAT TOWNSVILLE		146.700
	VK4		MOST HF BANDS

0900	R.O.A.R Rotarians of Amaleur Radio	VK3DNE CONTROL	7.080/7.070
1000	Darling Downs Club net & local news		146.750
1200	National Scout Net 1/3/5th Sundays	VK6SAN	14.190
		2nd Sunday of month	21.190
		4th Sunday of month	28.590
1830	MILITARY RADIO OPS/COLLECTORS	Net Control in Europe	14.145
1900	REDCLIFFE RADIO CLUB VHF NET		146.925
1900	Central Highlands ARC	3rd Sun of month only	3.620
1900	SSTV group of South African Airforce Net	ZS1MUS	14.230
1900	WIA<Q> QNEWS rebroadcast of LAST weekends news	3.605	147.000
1930	REDCLIFFE RADIO CLUB HF NET		3.612
1930	WIA<Q> SLOW MORSE		3.535
1930	SEQTRA		3.640
1930	Southside Amaleur Radio Society		28.450
1930	Southside Amateur Radio Society		3.565
1930	Townsville ARC NET 80m @ 8PM RELAYED ON 2m		3.6054
1930	WICEN Bris. area group net		147.000
2000	CBRS (CITY OF BRISBANE RADIO SOCIETY)	3.575	146.475
2000	Ipswich & District WICEN net		146.900
2000	North Queensland Net		146.700
2000	Townsville Amateur Radio Society		3.605
2000	Fisher's Ghost Net		28.520
2000	Rotarians Of Amateur Radio (ROAR)	VK4DP net crf	14.293
2000	Scouts.. Victorian net	VK3JNI	3.59
		Tasmanian net	VK7EI
			3.590
2000	South African Airforce Net	ZS6ZRB7.076	14.170
2030	Sunshine Coast ARC "Ask the Expert"		Tech net 146.850
2030	Townsville Amateur Radio Society		28.365
!!	YL ACTIVITY DAY 6th DAY		14.288 21.188 28.588
	OF EACH MONTH		
	LISTEN ON THE HOUR AND/OR CALL CQ YL		

ICOM Clearly Ahead



"VK3LZ calling!"

More sound information from your friends at Icom

THE LAST HAMFEST OF THE CENTURY!

With 1999 rapidly drawing to a close, the Gold Coast Hamfest on November 13 will be the last Hamfest of the twentieth century.

A fact not lost on the organisers I'll bet. I'm sure they'll have a terrific event in store for those attending to make sure everyone sees out the old year with a bargain. Look for the folks from Icom if you attend.

A YEAR OF ICOM BREAKTHROUGHS

It's the end of the century soon and this year Icom has released some real twenty first century breakthrough products. The amazing IC-R2, at just 8.6cms high you can fit the world's airwaves in your shirt pocket. The IC-PCR100 that turns a PC into a sophisticated 0.5 - 1300 MHz receiver. The 706MKIIIG, an evolution of the legendary 706 delivering base station performance and features in a mobile rig-sized package. The IC-2800H. A powerful dual band mobile rig with a multi-function colour LCD screen with colourful 3D-like characters and icons. And of course the IC-T81A remarkably compact quad bander. Its 'joy-stick' style multi-function switch was an innovative new feature allowing the user to change volume and bands even quicker. These are just a few examples of Icom's breakthrough thinking for the end of the century. There's lots more on the way in the new millennium so there are exciting times ahead for every Icom enthusiast.

"...73"

FreeCall 1800 338 915
290 -294 Albert Street
Brunswick, Victoria 3056
Tel : (03) 9387 0666
Fax : (03) 9387 0022
www.icom.net.au
ACN 006 092 375

LL Brown Adv: 7/2/98

SILENT KEY

The WIA regrets to announce the recent passing of:-

D C FOSTER	VK2VE
A G WILKEY	VK3AGW
D L ROBINSON	VK3ALD
(Harry) COX	VK4OX
L E WERNER	VK5XN

Charlie Miller VK2ADM/ VK4QM

My mind is flooded with memories of my good friend, Charlie Miller, who passed away on 25 May 1999. Many will remember him as VK2ADE from Casino where he had a superior signal from the north coast of New South Wales.

My log book indicates that 21 March 1961 on 15 metres was my first contact with Charlie. His homebrew AM transmitter ran about 100 watts with an 813 in the final. A National receiver, which he completely reworked, with a tri-band spider type quad antenna at 60 feet.

Our first meeting was in December of 1961 in Casino, beginning a lasting and loving friendship with Charlie and his wife Queenie. With his help, I got a job with RTN-8 on the North Coast. We settled in Lismore, NSW and lived there until mid 1967. During those years we became good friends of the Miller family. We returned to NSW occasionally throughout the years and always maintained our relationship via radio.

During our last visit to Charlie's home in December 98, I found this following information in Charlie's log book:

His original AOCPL licence was #3631 issued 1 December 1933 and his call sign was VK4US.

In 1938 Charlie went to England with his RAAF Squadron to bring back a Sunderland flying boat to Australia. Once there, they were pressed into service to fly submarine patrol over the North Sea.

He met and married Queenie there. After his tours of duty, they returned to Casino where Charlie opened a radio repair shop. In July of 1966 they moved to Caloundra, Qld.

His final VK2ADE contact was on 27 June 1966.

His first Caloundra contact, with a new call of VK4CM, was on 3 Sept. 1966. However he gave the 4CM call back to old friend, Tom Elliott.

His new call was VK4QM and the first contact was 22 Sept. 1966.

The last entry on his log was 10 April 1994, listing 100,043 contacts.

Letters in his log indicate that he was authorised to make repairs on fishing vessels in Ballina. One, signed by C.M.King, says he is the only person authorised to do so. He had experimental license #5369 for 50 watts on 50 to 54 and 28 to 29 MHz. It was in effect until 19 December 1945.

In Feb. of 1955, during a major flood in Casino, Charlie provided invaluable communications assistance between the district and the outside world until normal contacts were restored. His efforts were skilful and admirable.

Charlie enjoyed contesting and home brewing equipment. CW was his favourite mode. He was TOP WORLD in the CQ WW CW section in 1958 and at the top of the DXCC Honour Roll for some time. In a 6-metre contest between ZL and VK he won a new 6-metre transceiver. He was continually building and trying new circuits. He was a member of ARRL and the WIA and looked forward to QST and AR each month.

Charlie's dear wife Queenie died in 1982. He is survived by son Ian Miller, daughter Heather Creighton, six grandchildren and one great grandchild.

Charlie was an "Amateur" in the true meaning of the word—giving of his time and talent and asking nothing in return. My family and I will never forget the help and friendship that was so freely given. It was my good fortune to have had such a friend as Charlie Miller, VK2ADE/VK4QM for so many years. He will be lovingly missed

Bill Rogers K6VVY.

Mr K Wood VK4FAA

We regret to announce that Mr K Wood VK4FAA passed away last Thursday morning (9th Sept 1999?) at the Caboolture hospital and his funeral was held on the Friday. Ken, VK4FFA moved to Kilcoy, Queensland a number of years ago, from VK2. Then moving to Caboolture about five years ago where he became a good friend and neighbour of Jason VK4YOL.

Ken also donated his Kenwood 530 to the Redcliffe Radio Club last year.

Now may you rest in peace, Ken

(Jason Morris VK4YOL)

AR on the WEB

Alan Meredith VK2NNN

295 Iodide Street
Broken Hill NSW 2880
vk2nnn@vk2nnn.com
<http://www.vk2nnn.com>

Scouting for Amateurs

Every year in October two large groups join together to further the cause of friendship around the world.

Annually over 50,000 scouts enlist the help of Amateur radio operators from around the world to make contact with other scouts. The scouts who participate each gain a badge as well as an introduction to the world of radio. Amateur radio gains a whole new audience of eager participants willing to learn about the joys of "Ham Radio". It is also a great way to meet a few new people and to share in the enthusiasm of the kids involved while doing what we all love to do.

JOTA/JOTI

This is called the JOTA (Jamboree on the Air) weekend and many Australian amateur operators take time out to participate. Information on JOTA/JOTI in Australia can be found at: http://www.scoutlink.org.au/Radio_S/RSindex.htm or internationally at: <http://users.scoutnet.nl/~inter/joti.html> Coinciding with JOTA is JOTI (Jamboree on the Internet), which is only 3 years old, and is growing quickly in popularity. This is normally held using, what is known as, IRC or Internet Relay Chat, which is similar to our conferences on Packet. A popular program for IRC is MIRC, which is available to download from the Net at: <http://www.mirc.co.uk/linking.html>

General information about Scouting can be found at: <http://www.scout.org/>



Clubs and Events

Amateur radio also has its share of annual events. Again the Internet is a great place to find out about these events and also about the clubs or individuals who sponsor them.

There are many Australian amateur radio clubs with home pages on the Net. The WIA (Wireless Institute of Australia) has quite a comprehensive listing of these sites at: <http://www.wia.org.au/federal/clubs.html>

There are quite a few specialist sites run by some clubs and also individuals focusing

on a particular aspect of Amateur Radio in Australia.

The Australian Amateur Packet Radio Association at: <http://www.aapra.org.au> is a good place to start the search for Packet radio information. From "what is Packet radio" through to hardware and software required etc. Another Packet related site is The Melbourne Packet Radio Group Inc, <http://www.mprg.ampr.org/> run by Peter Hallgarten VK3AVE. Peter runs a CLX DX packet cluster and information, including setup details and user manual, can be found on his site.

ATV enthusiasts (Amateur Television) can access some great information about ATV at the Gladesville Amateur Radio Club (GARC) at: <http://welcome.to/TelevisionGladesville/>

Foxhunting, or Radio Sport as it is known around the world, is another popular amateur radio pastime and the Melbourne Foxhunting pages will provide you with all the information you could want on this aspect of our hobby. <http://www.ozemail.com.au/~efl/fox.html>

"Six Metres isn't a hobby it's a life" Well that's what VK2QF says about it anyway and his site is a good place to look for Six Metre information. You'll find quite a few links to sites devoted to the "Magic Band".

Another excellent 6m site, one of the most comprehensive (on any subject!) I've seen, is run by Jim VK1ZFG.

<http://www.qsl.net/vk1zfg/> Jim's site has everything you could ever wish for regarding 6m.

If you want to go higher than Six then

check out David Minchin VK5KK's "Australia Above 100 MHz" pages.

(Cute dog David!) This site has lots of info about everything from UHF through to Microwave. David has info on Kits, projects, how to get started in Microwave, beacons, distance records, propagation and lots of useful links to other Microwave related information.

Of course not all clubs or groups are maintained just for enjoyment of the hobby. WICEN is "a group of trained Amateur-Radio operators, accredited to take part in disaster situations, and able to provide emergency and safety communications when normal communications do not exist or are inadequate". Information about WICEN can be found at <http://www.wicen.org.au/>

The pages I have reviewed are only a fraction of what is available on the Internet in Australia relating to Amateur radio clubs etc. Check out what is available in your area and remember that without members no club survives, so consider joining one near you.

Of course lets not forget that Australia's "biggest" club is the WIA! Again members are what make it "tick". As well as the Federal WIA home page on the Net at <http://www.wia.org.au> each State also has its own presence on the Net which can be accessed from the Federal pages.

There is also a huge number of club related sites "out there" in the world that all have their own special interest or information and a listing of some of these can be found at the ARRL (Amateur Radio Relay League) site at: <http://www.arrl.org> (1962 at last count!)

Remember if you find something cool then let me know at vk2nnn@vk2nnn.com so we can share it around. Speaking of cool, checkout CQExpress which lets you access your ICQ from anywhere. You can download it from:

<http://www.cqexpress.com/>
(even at work! No I wouldn't do that! Honest!!)

ar



HF PREDICTIONS

by Evan Jarman VK3ANI
34 Alandale Court, Blackburn Vic 3130

Adelaide-Auckland 104
Second 2F14-21 2E2 Short 3240 km

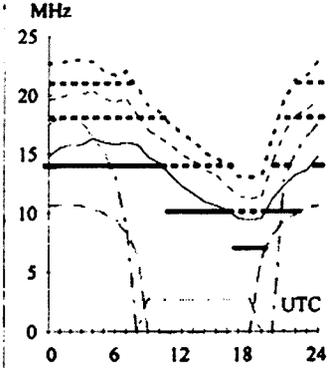

Brisbane-Chicago 57
First F 0-5 Short 14360 km

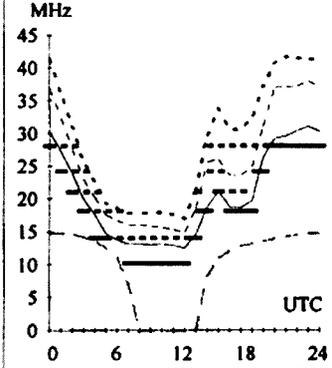

October
1999
T index: 141

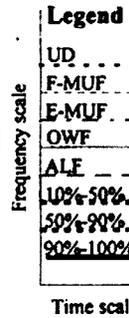

These graphs show the predicted diurnal variation of key frequencies for the nominated circuits.

These frequencies as identified in the legend are:-

- Upper Decile (F-layer)
- F-layer Maximum Useable Frequency
- E-layer Maximum Useable Frequency
- Optimum Working Frequency (F-layer)
- Absorption Limiting Frequency (D region)

Shown hourly are the highest frequency amateur bands in ranges between these key frequencies; when useable. The path, propagation mode and Australian terminal bearing are also given for each circuit.

These predictions were made with the Ionospheric Prediction Service program: ASAPS version 4.

Adelaide-London 132
First F 0-5 Long 23755 km

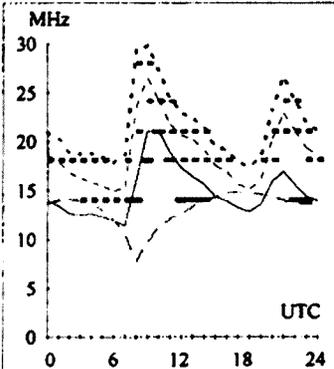

Brisbane-Honolulu 49
Second 3F5-12 3E0 Short 7569 km

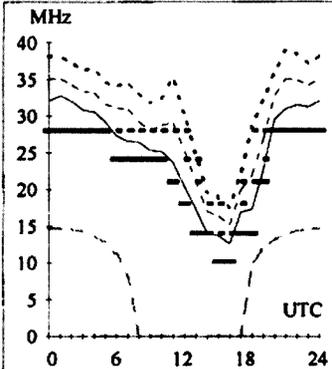

Canberra-Dakar 214
First F 0-5 Short 17361 km

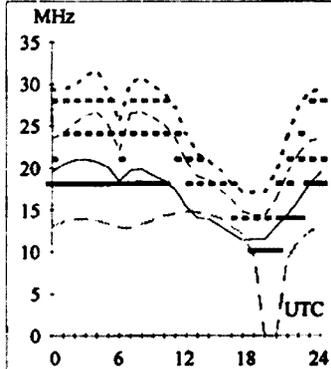

Darwin-Christchurch 139
First 2F5-9 2E0 Short 5281 km

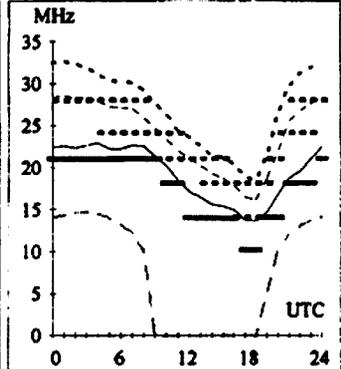

Adelaide-London 312
First F 0-5 Short 16269 km

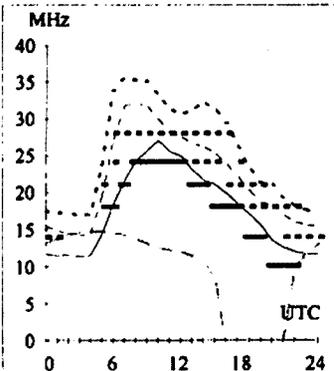

Brisbane-Moscow 321
First F 0-5 Short 14071 km

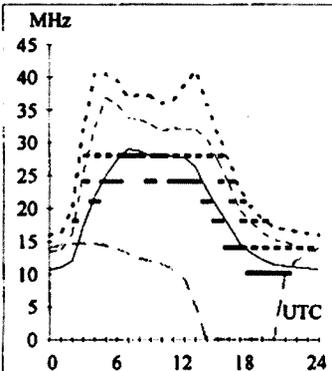

Canberra-New Delhi 303
Second 4F5-11 4E0 Short 10348 km

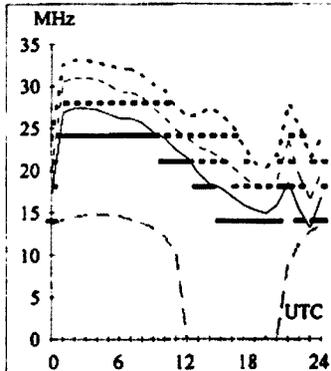

Darwin-Manila 340
First 1F1-12 1E0 Short 3198 km

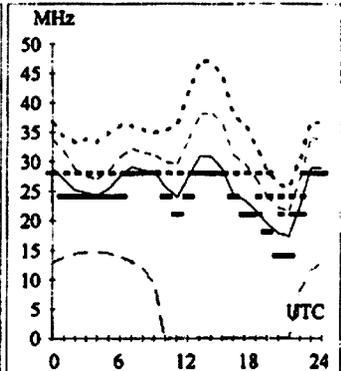

Adelaide-Tokyo 1
Second 3F5-12 3E0 Short 7855 km

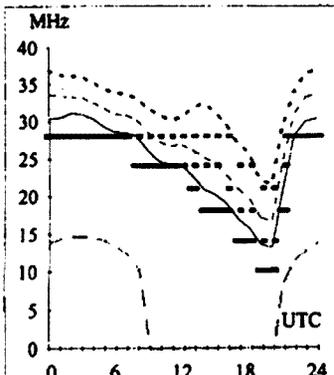

Brisbane-Singapore 293
First 2F2-7 2E0 Short 6147 km

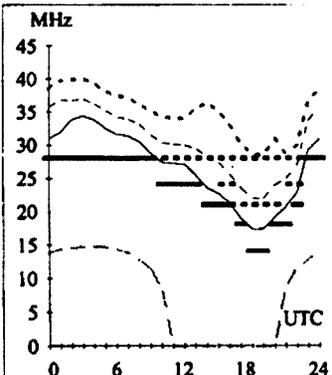

Canberra-Washington 70
First F 0-5 Short 15939 km

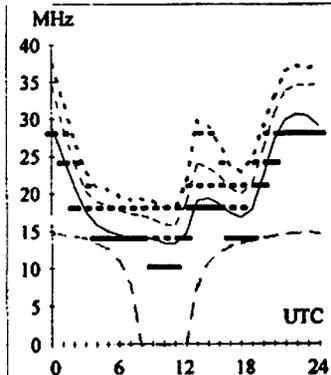

Darwin-Osaka 5
First 2F5-14 2E0 Short 5263 km

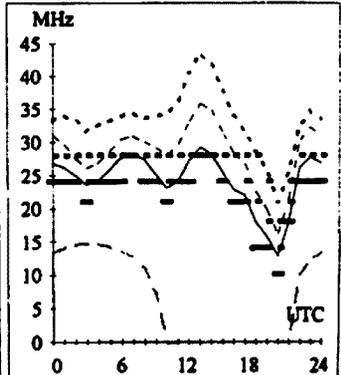

HF PREDICTIONS

Hobart-Amman 283 Short 14003 km **Melbourne-Bangkok** 312 Short 7372 km **Perth-Harare** 257 Short 8496 km **Sydney-Johannesburg** 230 Short 11035 km

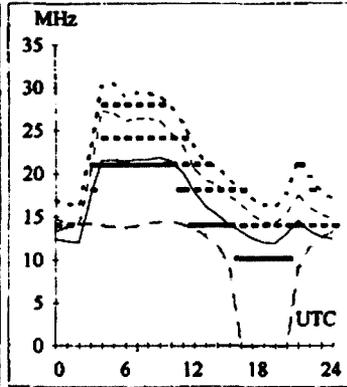
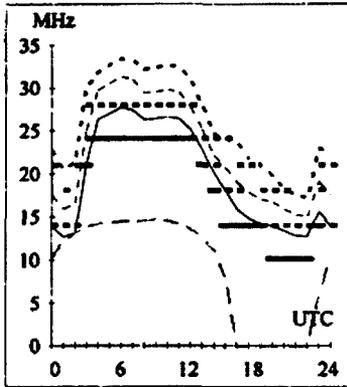
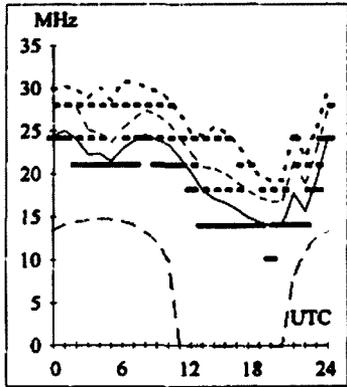
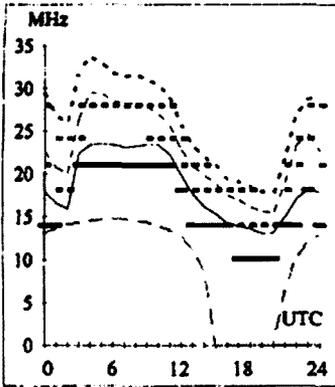

Hobart-Calgary 51 Short 14087 km

Melbourne-Los Angeles 65 Short 12772 km

Perth-Lima 162 Short 14931 km

Sydney-London 139 Long 23032 km

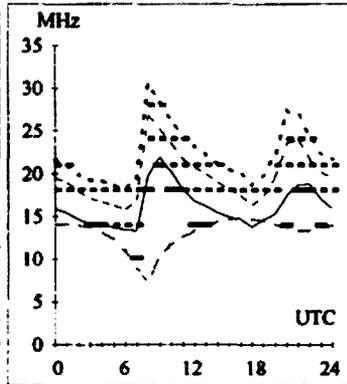
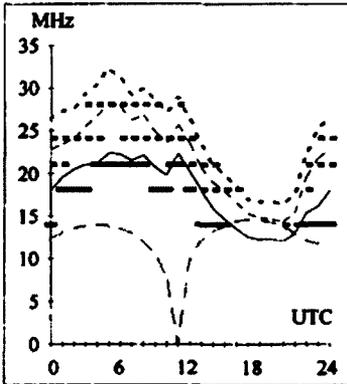
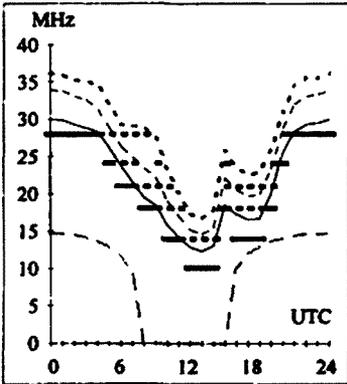
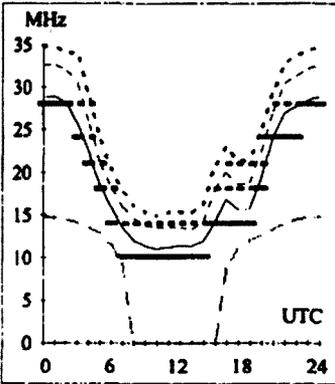

Hobart-Lusaka 239 Short 11045 km

Melbourne-Seattle 50 Short 13180 km

Perth-Ottawa 30 Short 18212 km

Sydney-London 319 Short 16992 km

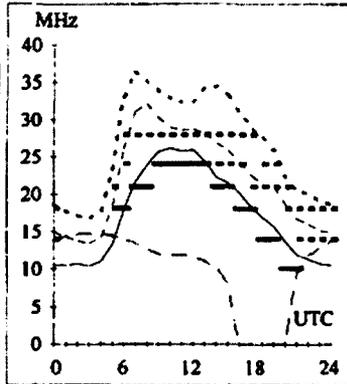
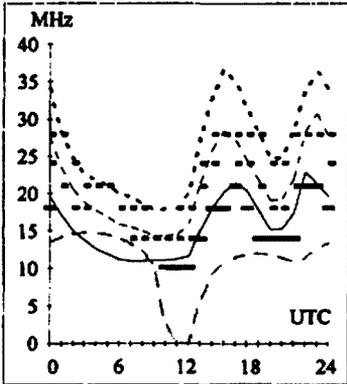
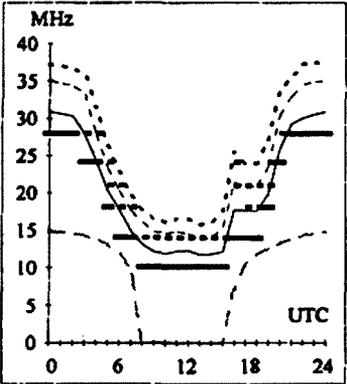
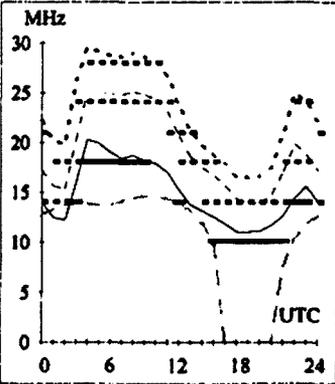

Hobart-Rio de Janeiro 169 Short 12619 km

Melbourne-Stockholm 140 Long 24424 km

Perth-Tokyo 20 Short 7923 km

Sydney-Port Moresby 351 Short 2740 km

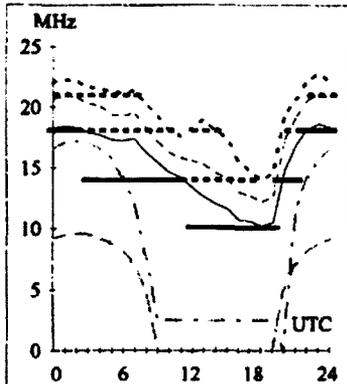
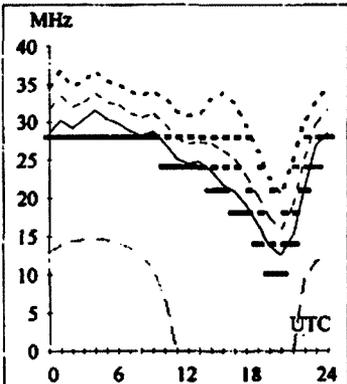
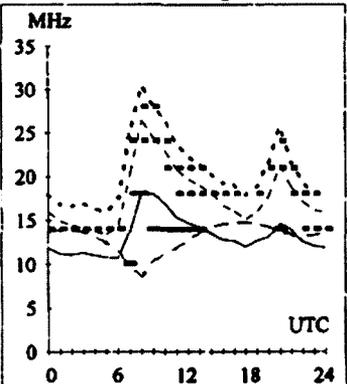
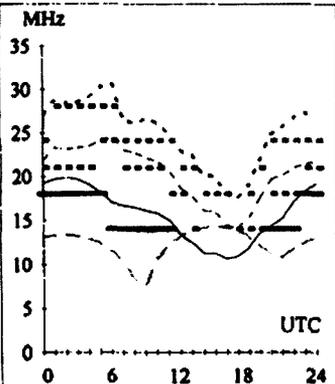

HAMADS

- Hamads may be submitted on the form on the reverse of your current Amateur Radio address flysheet. Please print carefully, especially where case or numerals are critical.
- Please submit separate forms for For Sale and Wanted items, and be sure to include your name, address and telephone number (including STD code) if you do not use the flysheet.
- Eight lines (forty words) per issue free to all WIA members, ninth and tenth lines for name and address. Commercial rates apply for non-members.
- Deceased estates Hamads will be published in full, even if the ad is not fully radio equipment.
- WIA policy recommends that the serial number of all equipment for sale should be included.
- QTHR means the address is correct in the current WIA Call Book.
- Ordinary Hamads from members who are deemed to be in general electronics retail and wholesale distributive trades should be certified as referring only to private articles not being re-sold for merchandising purposes.
- Commercial advertising (Trade Hamads) are pre-payable at \$25.00 for four lines (twenty words), plus \$2.25 per line (or part thereof), with a minimum charge of \$25.00. Cheques are to be made out to: WIA Hamads.
- Copy should be typed or in block letters, and be received by the deadlines shown on page 1 of each issue of Amateur Radio, at:

Postal: **Newsletters Unlimited, 29 Tanner Street, Richmond, 3121**
Fax: **03 9428 4242** E-mail: **news1@webtime.com.au**

Please only send your Hamad once

Please send Hamads by mail OR fax OR email (much preferred).

Please do not send by more than one method for any one ad or issue, it is confusing.

WANTED NSW

• **Kantronics Kamplus Modem.** Details to Doug, VK2DDR. Phone (02) 9949 3426

• **3BZ cover, box, speaker, or power supply** to complete a restoration. These are a grey heavy steel box with rounded corners, similar to the AWA test instrument boxes but bigger. Any parts or units welcome, any condition, costs paid. Ray Robinson VK2ILV 7 Roland Ave Wahroonga 2076 (02) 94898561 (02) 98508765 robinson@srsuna.shlrc.mq.edu.au

WANTED VIC

• **Yaesu RMK 747 Remote Head Kit** for FT747. Contact Ray VK3FQ. Phone (03) 5436 8301.

• **Akai M5 or M7 stereo tape recorder.** Need motor power supply only. No heads required. Stan VK3AYF. (03) 9700 4903 QTHR.

WANTED - QLD

• **Test equipment. Huntron Tracker 1000 Series** or similar for component testing. Must be 100% working condition and instruction manual. June VK4SJ QTHR. (07) 5492 9205.

• **Meter for AVO Mk2 Valve Characteristic Tester** (same meter also possibly fitted to other AVO valve testers) Contact: Peter, VK4COZ, 3378 6047 or p.holtham@mailbox.uq.edu.au

• **Linear amplifier HF prefer Henry 3 or 4K,**

Tentec, Commando; Alpha, must be heavy duty; Monoband 14MHz Yagi and heavy duty rotator; Deeko tower sections. Contact: John Abbott VK4SKY. PO Box 1166 Coolangatta Queensland 4225. (0417) 410 503. Email: benoel@fan.net.au

WANTED - SA

• **Power tranny for linear amp 400 - 600V** a side at 300mA or more. Other sizes OK. Complete power supply would be fine also. Murray VK5BVJ QTHR. Phone (08) 8738 0000.

WANTED WA

• **Kenwood TL922 2KW PEP** input 160 - 10m linear amplifier. Will do the 400W PEP output legal limit with ease. Excellent condition. Complete with manual and two spare 3-500Z tubes. \$1500. Steve VK6VZ (08) 9298 9330.

• **Radar Parts** wanted for museum display LW/ AW Radar Indicator chassis and or parts, Valve Caps to suit 807 and 6J7G valves, insulated extension couplings for potentiometer shafts. Mark VK6AR (08) 9417 4536 or Packet at VK6AR@VK6BBS.#PER.#WA.AUS.OC for the WA RAAF RADAR GROUP

FOR SALE - NSW

• **Morse keys.** Clipsal on bakelite base with lacquered brasswork \$35. WW2 Bomber bathtub (slight damage) \$20. Bendix MT-118 Aircraft type \$20. WW2 Australian Services made by PMG (small model) \$8. Similar WW2 Australian Services on steel base B50410 \$10. All VGC. Ric VK2PH QTHR. (02) 9817 0337. Postage extra.

• **Kenwood R2000 receiver,** including VHF converter service and owner manuals. Original packaging. Serial no. 3070619. \$550. Maurie VK2OW QTHR. Phone (02) 9838 1834.

• **Antenna 2 element tri band Yagi 10-15-20** metre TET Emtron TE23M. Condition as new. \$220. VK2LK QTHR. (02) 9635 6874

• **Yaesu FT50R 2m/70cm hand held** with large battery. Very little used. Original packaging. Leather case. \$400. David VK2BDT (02) 4821 5036

• **Kenwood TS-530S** inc 1.8kHz SSB Filter & IF out \$600, SM-220 with band scope \$350, VFO-230 \$150, AT-230 \$230, MC-50 Mic. \$90, TR-751A 2m all mode inc mobile mount \$650, TH-215A 2m H/Held \$270, Cushcraft R5 vertical \$220, AWA MRT-25A xcvr (3) 70-85MHz FM with service manual \$50, Model 15 TTY inc 100V DC loop supply, decoder and paper \$15, Military HF C11 tx, R210 rx, C45 txcvr 23 to 38 MHz, C42 xcvr 36 to 60 Mhz inc 24V supplies (2), cables, headsets and mics \$600, Military HF Sig Gen No1 MK3 \$150, Leader LSG-11 HF Sig Gen \$50, HP VTVM 410B, Viewpoint RS-232 Terminal, Z80 CPU's, TS-830S Service manual, valves and other components. CBs AM (2), 27MHz SWR meter. Graeme VK2CCK 0414-929 220 or (02) 9810-8386 QTHR.

FOR SALE - VIC

• **Deceased estate. Jack VK3JA.** Kenwood TS430S XCVR. Heathkit SB200 linear. Johnson matchbox ATU. Emtron EAT300A ATU. Codan 7208 MK2B ATU. Icom IC22S XCVR. Codan 8222 Selcall Kenwood PS430 PS VKPowermate PS 2M Yagi. Many miscellaneous items. John (03) 5566 5258 or Max (03) 5566 5182. Mob. 018313441.

• **Yaesu FT-736R 2M-70** all-mode XCVR internal pwr supp with full data & satellite facilities. Mint condition \$1500. Mirage B5016G. 144-148 MHz linear amp. 50W in 160W out. 12V with excellent preamp. EC \$450. Codan 7208 MK2B long wire ant. tuner 2-16MHz \$135. All items with original packing. Len VK3BMY (03) 5862 3116 QTHR.

• **Standard C520 2m/70cm dual band HT.** with leather case, manual, charger and spare batteries. \$275 ono. Ph Chris AH's 03 57 511631 or lorian@albury.net.au

• **Approx. 30 APC Type Variable Caps.** 3 Philips Beehive trimmers. 9 Plunger type trimmers. Free. U pay \$2 P&P. Transmitting Variable Caps out of ATUs. \$2 each + P&P. Allen VK3SM (03) 9386 4406 QTHR.

• **SIEMENS Level Generator** and Selective Level Meter (0-1600kHz) \$90.00. 2 Metre 10EI Beam DL6YX \$80.00 2 Metre Linear MOCOM 25W PEP \$70.00. ROTATOR STOLLE with Controller and Cables \$50.00. Ken VK3DQW (03) 5251 2557

• **KENWOOD H/held TR2600a 2m xcvr 3w c/** case headset chgr-stand SN5022246 \$75 ono. IC 28A/E 2m xcvr 25w extended RX range, SN14889 \$275 ono. Both ex cond. full docs and circuits. Ryobi Drill-driver HB10AR 180rpm, chuck, sockets, bits, variable clutch, ex cond. Keith VK3AFI QTHR 03 5221 3658.

• **Complete Marconi mark 4 camera channel,** from SPG to CCU. Lenses also included. It needs a good home. PYE SPG also available. Please contact Bruce VK3YYD by Email - bcutler@melbpc.org.au. Telephone 03 9531 2962. Any good offer seriously considered!

• **Sig. Gen DSE cat Q1312 \$180 1.2GHz freq** counter DSE Q1322 \$100 Kenwood PG3G DC filter \$30 AT230 ATU \$250 all in as new condx Damien VK3RX (03) 54273121

FOR SALE - QLD

• **Antenna Vertical MFJ-1796 6 band** for 40-20 15-10-6 & 2 m with manual. Excellent condition. 6 months use. AND Antenna Vertical Hustler 4 BTW with 80m add on kit for 10 15-20-40 & 80m with instruction assembly sheets. \$300 each ono. June VK4SJ QTHR (07) 5492 9205

• **Kenwood TS-450 HF t/ciever w Kenwood SP-** 23, Kenwood MC-80, YK-885-1 Filter, internal ATU. Good cond. \$1700. VK4DIC Dick QTH (07) 3264 1655

• **Pakratt PK232 multimode data controller** complete with connectors and manual. Good condition. \$200 ono. Serial number 19065. Ron VK4EMF QTHR. Phone (07) 925211 all hours.

FOR SALE - TAS

• **Realistic Tandy WTX100 10 metre SSB CW** 25 watt mobile base t/ciever. New and unused. \$230.00. VK7AN Allen (03) 6327 1171 or 0417-354410

• **YAESU FT-101B** needs work what offers? DAN VK7DAN QTHR 03 6369 5284 emailto:gdegroot@vision.net.au thanks

FOR SALE - SA

• **KENWOOD TS130S** with 250Hz CW filter #1020354, \$400 KENWOOD TS120S #0041656, \$400 ROB VK5RG QTHR (08) 8379 1889.

• **ICOM IC-21-E Ser No. 2639 Handheld 2 +** 70 complete with manual, charger and spare battery pack.-BP-157A. \$295. QTHR VK5MZ Bill 08 8536 3391.

FOR SALE - WA

• **Kenwood TL922 2KW PEP** input 160 - 10m linear amplifier. Will do the 400W PEP output legal limit with ease. Excellent condition. Complete with manual and two spare 3-500Z tubes. \$1500. Steve VK6VZ (08) 9298 9330.

• **Hills 50' Teletower** telescoping two-section tower. Triangular steel lattice construction, with

mounting brackets for a rotator, plus base mount. Comes with stainless steel winch cable, but no winch. Excellent condition. \$350. Steve VK6VZ (08) 9298 9330.

• **Elements for a 2-element 40 - 10m quad.** Quad elements are around two thirds full size and capacitively loaded on 40m, but full size on 20/10/10m. Uses fibreglass spreaders with aluminium extensions, mounted on angle iron hubs. The elements mount on a 6m long boom (not supplied). If you don't want to use as a quad, the spreaders could be used to make eight large beach fishing rods! \$250. Buyer(s) collect both items. Steve, VK6VZ, telephone (08) 9298 9330

TRADE ADS

• AMIDON FERROMAGNETIC CORES:

For all RF applications. Send business size SASE for data/price to RJ & US Imports, PO Box 431, Kiama NSW 2533 (no enquiries at office please ... 14 Boanyo Ave Kiama).

www.cyberelectric.net.au/~rjandusimports

Agencies at: Assoc TV Service, Hobart; Truscotts Electronic World, Melbourne and Mildura; Alpha Tango Products, Perth; Haven Electronics, Nowra

• WEATHER FAX programs for IBM XT/ATs

*** "RADFAXZ" \$35.00, is a high resolution short-wave weather fax, Morse and RTTY receiving program. Suitable for CGA, EGA, VGA and Hercules cards (state which). Needs SSB HF radio and RADFAX decoder. *** "SATFAX" \$45.00, is a NOAA, Meteor and GMS weather satellite picture receiving program. Needs EGA or VGA & WEATHER FAX PC card, + 137 MHz Receiver. *** "MAXISAT" \$75.00 is similar to SATFAX but needs 2 MB of expanded memory (EMS 3.6 or 4.0) and 1024 x 768 SVGA card. All programs are on 5.25" or 3.5" disks (state which) plus documentation, add \$3.00 postage. ONLY from M. Delahunty, 42 Villers St, New Farm QLD 4005. Ph 07 358 2785.

• QSL CARDS from QSL — VK

500 FULL COLOUR front and one colour back — \$229 delivered to you. 500 two colour front only — \$159 delivered to you

SPECIAL OFFER TO WIA Members: 250 Eyeball cards FREE with each order. (An extra 250 eyeball cards is \$20. We have a collection of Australian motifs, including the world map from a 'Down-Under' perspective. The prices include your supplied single photograph or design of choice. We can also quote for creating designs or longer runs. Call (03) 9428 3458 fax (03) 9428 4242 or email news1@webtime.com.au for a full description and order form.

Amateur Radio

...HAS HAMS TALKING!

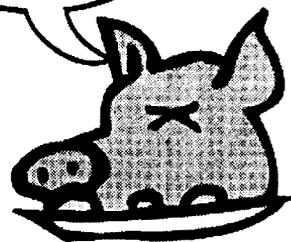

<http://www.hamsearch.com>

**a not-for-profit site
that is a search
engine for hams**

Email Hamads

If you are emailing your Hamad, the method much preferred by our type setters, could you please assist by following these two guidelines.

1

Please use upper and lower case as in normal text in the Hamad.

2

Please enter the words directly into the body of the email.

WIA Division Directory

The WIA consists of seven autonomous State Divisions. Each member of the WIA is a member of a Division, usually in their residential State or Territory, and each Division looks after amateur radio affairs within its area.

Division	Address Officers	News Broadcasts	Note: All times are local. All frequencies MHz.	Fees
VK1 ACT Division GPO Box 600 Canberra ACT 2601	President Gilbert Hughes Secretary John Woolner Treasurer Les Davey	VK1GH VK1ET VK1LD	VK1WI: 3.570 LSB, 146.950 FM each Sunday evening from 8.00pm local time. The broadcast text is available on packet, on Internet aus.radio.amateur.misc news group, and on the VK1 Home Page http://www.vk1.wia.ampr.org	(F) \$72.00 (G) (S) \$58.00 (X) \$44.00
VK2 NSW Division 109 Wigram St Parramatta NSW (Office hours Mon-Fri 1100-1400) (PO Box 1066, Parramatta 2124) Phone 02 9689 2417 Freecall 1800 817 644 Fax 02 9633 1525	President Michael Corbin Secretary Eric Fossey Treasurer Eric Van De Weyer Web: http://marconi.mpce.mq.edu.au/wia e-mail: vk2wi@ozemail.com.au	VK2YC VK2EFY VK2KUR	From VK2WI 1.845, 3.595, 7.146*, 10.125, 14.160, 24.950, 28.320, 29.120, 52.120, 52.525, 144.150, 147.000, 438.525, 1281.750 (* morning only) with relays to some of 18.120, 21.170, 584.750 ATV sound. Many country regions relay on 2 m or 70 cm repeaters. Sunday at 1000 and 1930. Highlights included in VK2AWX Newcastle news, Monday 1930 on 3.593 plus 10 m, 2 m, 70 cm, 23 cm. The broadcast text is available on the Internet newsgroup aus.radio.amateur.misc , and on packet radio.	(F) \$69.00 (G) (S) \$56.00 (X) \$41.00
VK3 Victorian Division 40G Victory Boulevard Ashburton VIC 3147 (Office hours Tue & Thur 0830-1530) Phone 03 9885 9261 Fax 03 9885 9298	President Jim Linton CEO Barry Wilton Secretary Peter Mill Web: http://www.tbsa.com.au/~wivlc/ e-mail: vk3wi@rint.com.au	VK3PC VK3XV VK3APO	VK3BWI broadcasts on the 1st and 3rd Sunday of the month at 8.00pm. Primary frequencies, 3.615 LSB, 7.085 LSB, and FM(R)s VK3RML 146.700, VK3RMM 147.250, VK3RWG 147.225, and 70 cm FM(R)s VK3ROU 438.225, and VK3RMU 438.075. Major news under call VK3WI on Victorian packet BBS and WIA VIC Web Site.	(F) \$75.00 (G) (S) \$61.00 (X) \$47.00
VK4 Queensland Division GPO Box 638 Brisbane QLD 4001 Phone 07 5496 4714	President Colin Gladstone Secretary Peter Harding Treasurer Alistair Eirick e-mail: wiaq@brisbane.dialix.com.au Web: http://www.wiaq.powerup.com.au	VK4ACG VK4JPH VK4FTL	VK4WIA: 1.825 MHz SSB, 3.605 MHz SSB, 7.118 MHz SSB, 14.342 MHz SSB, 21.175 MHz, 28.400 MHz SSB, 29.220 MHz FM, 53.725 MHz FM, 147.000 MHz FM, 438.500 MHz (Brisbane only), and regional VHF/UHF repeaters at 0900 hrs EAST Sunday. Repeated on 3.605 MHz SSB & 147.000 MHz FM at 1930 hrs EAST Monday. Broadcast news in text form on packet under WIAQ@VKNET.	(F) \$74.00 (G) (S) \$60.00 (X) \$46.00
VK5 South Australian Division (GPO Box 1234 Adelaide SA 5001) Phone 08 8294 2992	President Jim McLachlan Secretary David Minchin Treasurer John Butler	VK5NB VK5KK VK5NX	VK5WI: 1827 kHz AM, 3.550 MHz LSB, 7.095 AM, 14.175 USB, 28.470 USB, 53.100 FM, 147.000 FM Adelaide, 146.700 FM Mid North, 146.800 FM Mildura, 146.825 FM Barossa Valley, 146.900 FM South East, 146.925 FM Central North, 147.825 FM Gawler, 438.425 FM Barossa Valley, 438.475 FM Adelaide North, ATV Ch 35 579.250 Adelaide. (NT) 3.555 USB, 7.065 USB, 10.125 USB, 146.700 FM, 0900 hrs Sunday. 3.585 MHz and 146.675 MHz FM Adelaide, 1930 hrs Monday.	(F) \$75.00 (G) (S) \$61.00 (X) \$47.00
VK6 West Australian Division PO Box 10 West Perth WA 6872 Phone 08 9351 8873	Acting Pres. Cliff Bastin Secretary Christine Bastin Treasurer Bruce Hedland-Thomas Web: http://www.faroc.com.au/~vk6wia/ e-mail: vk6wia@faroc.com.au	VK6LZ VK6ZLZ VK600	VK6WIA: 146.700 FM(R) Perth at 0930hrs Sunday relayed on 1.825, 3.560, 7.075, 14.116, 14.175, 21.185, 29.680 FM, 50.150 and 438.525 MHz, country relays 3.582, 147.200 (R) Catby, 147.350 (R) Busselton and 146.900 (R) Mt William (Bunbury). Broadcast repeated on 146.700 at 1900 hrs Sunday relayed on 1.865, 3.563 and 438.525 MHz: country relays on 146.350 and 146.900 MHz.	(F) \$62.00 (G) (S) \$50.00 (X) \$34.00
VK7 Tasmanian Division 5 Kywong Crt, Ulverstone Tas 7315 Phone 03 6327 2096 Fax 03 6327 1738	President Ron Churcher Secretary Tony Bedelph Treasurer John Bates email: wiatas@hamnet.hotnet.net.au Web: http://www.wia.tasnet.net	VK7RN VK7AX VK7RT	VK7WI: 146.700 MHz FM (VK7RHT) at 0930 hrs Sunday relayed on 147.000 (VK7RAA), 146.725 (VK7RNE), 146.625 (VK7RMD), 3.570, 7.090, 14.130, 52.100, 144.150 (Hobart), repeated Tues 3.590 at 1930 hrs.	(F) \$74.00 (G) (S) \$60.00 (X) \$46.00
VK8 Northern Territory (part of the VK5 Division and relays broadcasts from VK5 as shown, received on 14 or 28 MHz).				

Membership Grades

Full (F) Pension (G) Needy (S) Student (S) Non receipt of AR (X)
Three-year membership available to (F) (G) (X) grades at fee x 3 times.

ADVERTISERS INDEX

Amateur Transceiver Radio	9	Icom.....	OBC, 50
Amidon.....	54	QSL-VK.....	27,54
Av-Com	6	Radio & Communications.....	23
Dick Smith	IBC, 28,29	Weatherfax.....	54

TRADE PRACTICES ACT

It is impossible for us to ensure that the advertisements submitted for publication comply with the Trade Practices Act 1974. Therefore, advertisers and advertising agents will appreciate the absolute need for themselves to ensure that the provisions of the Act are strictly complied with.

VICTORIAN CONSUMER AFFAIRS ACT

All advertisers are advised that advertisements containing only a PO Box number as the address cannot be accepted without the addition of the business address of the box-holder or seller of the goods.

YAESU'S DONE IT AGAIN



Yaesu FT-100 Ultra-compact HF/6m/2m/70cm Mobile

WHAT AMAZING VALUE!

Now you can enjoy the fun of operating on all bands from 160m to 70cm, either at home or in your car, and at a fantastic Yaesu price.

The new Yaesu FT-100 features HF/6m/2m/70cm transmitter coverage with 100W RF output on HF and 6m, 50W on 2m and 20W on 70cm, plus you can easily mount the detachable front panel using an optional lead (YSK-100) for more convenient mobile installations. Powerful interference fighting features such as a DSP based Bandpass filter, Notch filter and Noise reduction, together with an IF based Shift control, all aid reception quality during tough conditions. A Speech Processor and VOX facility are provided for SSB users and an internal Electronic keyer is provided for CW operation. Also included are Dual VFOs, built-in CTCSS encode, 300 memory channels, all-mode operation (SSB, CW, AM, FM, AFSK, Packet 1200/9600bps), 100kHz-970MHz receiver (cellular locked-out), and options for additional AM and CW IF filters.

The FT-100 is supplied with an MH-42B6JS hand mic, DC power lead and comprehensive instructions.

D 3285

YSK-100 remote front panel lead \$155

D 3286

YAESU

Included as standard:

- Digital Signal Processing on both transmit and receive
- Effective IF noise blanker
- Electronic CW keyer with 50 character message memory
- Spectrum Scope function
- Massive receiver coverage (100kHz – 970MHz, less cellular)

\$2650 **SAVE \$100**



That's where you go!

MORE

GREAT

GEAR

FROM

ICOM

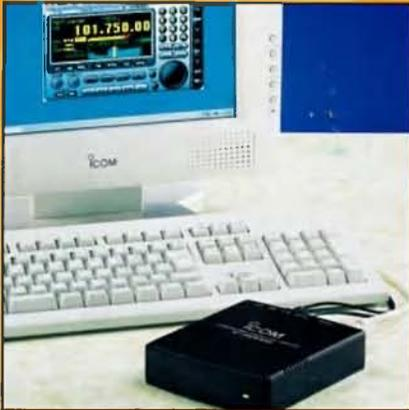

PCR100 Cruise the air waves with your computer. Turns your PC into a high performance 0.5 - 1300 MHz receiver (FM/WFM/AM modes) with plug'n play installation. Multi function control panel, wide frequency coverage, and unlimited memory channels.

R2 Fit the world's airwaves in your shirt pocket. Just 8.6cm high, wide 0.5 - 1300 MHz frequency range divided into 9 bands plus FM/WFM/AM, 400 memory channels, great sound in rugged water resistant construction.

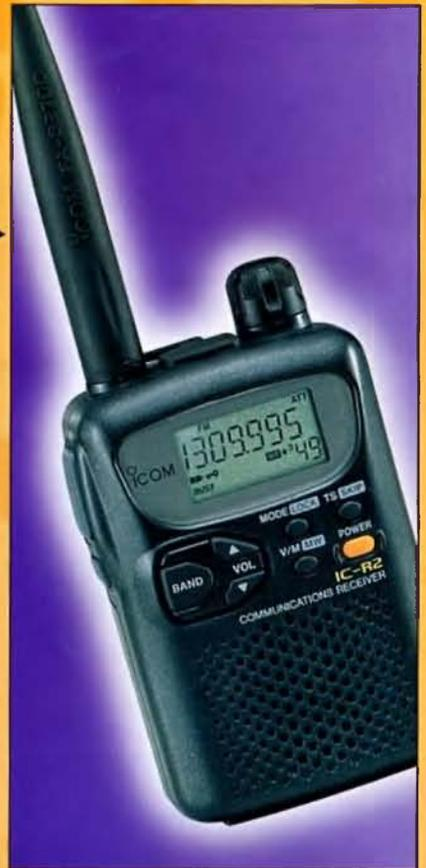

2800H

A totally new approach to dual band mobile. Powerful performance on 2m and 70cm bands, remote control capability, and a first for mobile rigs...a multi-function colour LCD screen! All your information is right in front of you in colourful 3D-like characters and icons.

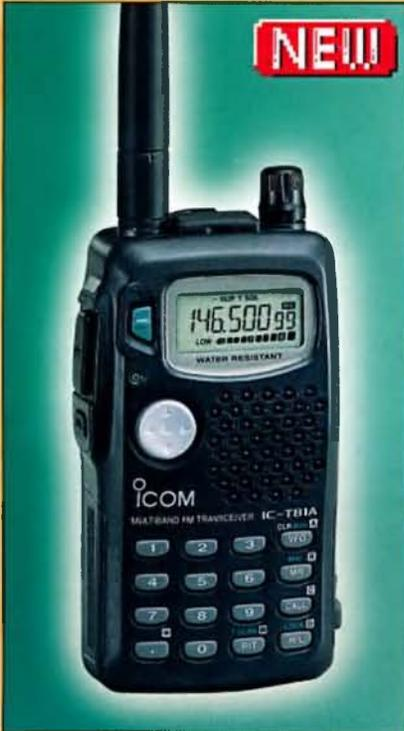

T81A A remarkably compact quad bander. Superb clarity on the 6m, 2m, 70cms and 23cm bands. It's water resistant, with tone squelch and pocket beep functions standard, plus you can change volume and bands even quicker with the 'joy-stick' style multi-function switch.

706MKIIG

The amazing evolution of the legendary 706. Frequency coverage is expanded to the 70 cm band and output power is increased for the 2m band. You get base station performance and features in a mobile rig-sized package.



ICOM
Clearly Ahead

2 YR WARRANTY

See your nearest Icom Dealer, or visit our website at www.icom.net.au

NOVEMBER 1999

Volume 67 No 11



Amateur Radio

Journal of the Wireless Institute of Australia

ALARA ALARAMeet '99 Brisbane



Full of the latest amateur radio news, information and technical articles, including...

- ★ VK5AMD - A Remarkable YL
- ★ ALARA Meet - Brisbane
- ★ An RF Attenuator for 500MHz
- ★ Stacking Yagis
- ★ High Sea Antennas
- ★ Australian Grid Square Map

Plus *lots of other articles, news and special interest columns.*



Callbook Listings
Frequency Listings
Band Plans
Repeater Lists
Beacon Lists
Satellite Lists
License Conditions
Examiner Lists
Special Interest Groups
Public Relations Notes
Radio and TV Freqs.
and much, much more !

WIA Yearbook 2000

**Hint now for the
Christmas Stocking !
This edition will
contain all of the
content you have
come to expect of
the WIA callbook
as well as some
new items.**

**CLUBS - Take your orders now and be ready to
take advantage of bulk order savings for
affiliated clubs.**

It is more than a callbook, it's a Yearbook, the WIA Yearbook!

**The "WIA Yearbook 2000" will be available from
Divisional Bookshops and selected outlets**



Amateur Radio

Volume 67
Number 11
November 1999

The Journal of the Wireless
Institute of Australia

ISSN 0002-6859

Amateur Radio is published by the Wireless Institute of Australia ACN004 920 745 as its official Journal on the first Friday of each month

Editorial

Editor: Bill Rice* VK3ABP
Production Manager: Bob Harper VK4KNH
Snr Technical Editor: Peter Gibson* VK3AZL
Technical Editors: Evan Jarman* VK3ANI
 Gil Sones* VK3AUI
Contributing Editors: Ron Fisher* VK3OM
 Don Jackson* VK3DBB
WIA News Editor: Richard Murnane VK2SKY

*Publications Committee member

Advertising

Mrs June Fox, WIA Federal Office
 PO Box 2175 CAULFIELD JUNCTION VIC 3161
 Tel: (03) 9528 5962 Fax (03) 9523 8191
 email armag@hotkey.net.au

Hamads

"Hamads" Newsletters Unlimited
 29 Tanner Street, Richmond VIC 3121
 Fax: (03) 9428 4242
 e-mail: news1@webtime.com.au

Amateur Radio Correspondence

All correspondence, contributions and queries about the *content* should be sent to:

The Editor Amateur Radio
 PO Box 2175, CAULFIELD JUNCTION VIC 3161
 email armag@hotkey.net.au
 Tel: (03) 9528 5962 Fax (03) 9523 8191

Amateur Radio Delivery

All queries regarding delivery should be directed to:
Amateur Radio WIA Federal Office
 PO Box 2175 Caulfield Junction Vic 3161
 Tel: (03) 9528 5962 Fax (03) 9523 8191

Registered Office

10/229 Balaclava Road
 Caulfield North VIC 3161
 Tel: (03) 9528 5962 Fax (03) 9523 8191
 Business hours: 9.30am-3pm weekdays

Editorial & Display Booking Deadlines

10th of each month prior to issue, or next business day

Hamad & Display Material Deadline

18th of each month prior to issue, or next business day

Production

Administration, Drafting, Design & Sub-editing
 Shadetree Publishing & Imaging
 PQ Box 288 BEERWAH QLD 4519

Pre-press, print and mail management
 Newsletters Unlimited (03) 9428 3458

Printed by Streamline Press, Melbourne (03) 9417 2766
 Mailed by IMS, Melbourne (03) 9291 5888

Receipt of Amateur Radio by mail

Members who have not received their copy of AR by the 15th of each month should advise the registered office of the WIA

Copyright and Reproduction

The copyright in this magazine, except where specifically noted, is held by Wireless Institute of Australia ©WIA 1999.
 Permission to republish articles in any form must be obtained in writing from the Institute (other than for purposes of fair dealing). This permission is usually freely given for information purposes.

General

VK7 Division wins 1999 Remembrance Day Contest	4
<i>Alex VK6APK</i>	
Women in Radio	11
ALARAMEET	11
VK5AMD — a Remarkable YL	15
AWARDS for YLs	17
Where On Earth Are You?	19
<i>Bob Harper VK4KNH</i>	
Stacking Yagis, Phasing and Matching	22
<i>Gordon McDonald VK2ZAB</i>	
An RF Attenuator	30
<i>Keith Gooley VK5OQ</i>	
The 'Moorabbin', a Simple Regenerative AM Receiver	32
<i>Novice Notes — Peter Parker, VK3YE</i>	

Technical

Adapting the Astatic D-104 Microphone	40
<i>Technical Abstracts — Gil Sones VK3AUI</i>	

Columns

Advertisers' Index	56	Ionospheric Update	51
ALARA	11	New Members	3
AMSAT Australia	45	Novice Notes	32
AR on the Web	39	Over to You	50
ARDF	47	Repeater Link	37
Club News	10	Silent Key	46
Contests	48	Spotlight on SWLing	49
WIA Division News		Technical Abstracts	40
VK1 Notes	6	Technical Correspondence	50
VK2 Notes	9	Try This	36
VK4 Notes	8	VHF/UHF - An Expanding World	42
VK6 Notes	7	WIA Comment	3
VK7 Notes	6	WIA News	3
Editor's Comment	2	WIA Division Directory	56
Hamads	54	WIA Federal Directory	2
HF Predictions	52		

Our cover this month

ALARAMEET 1999 participants in Brisbane on 2/3 October

High Sea Antenna Story advertised on cover has been held over

Contributions to Amateur Radio

Amateur Radio is a forum for WIA members' amateur radio experiments, experiences opinions and news. Manuscripts with drawings and or photos are always welcome and will be considered for publication. Articles on disc or email are especially welcome. The WIA cannot be responsible for loss or damage to any material. A pamphlet, How to write for Amateur Radio is available from the Federal Office on receipt of a stamped self-addressed envelope.

Back issues

Back issues are available directly from the WIA Federal Office (until stocks are exhausted, at \$4.00 each (including postage within Australia) to members.

Photostat copies

When back issues are no longer available, photocopies of articles are available to members at \$2.50 each (plus an additional \$2 for each additional issue in which the article appears).

Disclaimer

The opinions expressed in this publication do not necessarily reflect the official view of the WIA and the WIA cannot be held responsible for incorrect information published.

Amateur Radio Service

A radiocommunication service for the purpose of self-training, intercommunication and technical investigation carried out by amateurs; that is, by duly authorised persons interested in radio technique solely with a personal aim and without pecuniary interest.

Wireless Institute of Australia

The world's first and oldest
National Radio Society
Founded 1910

Representing
The Australian Amateur Radio Service

Member of the
International Amateur Radio Union

Registered Federal Office of the WIA
10/229 Balaclava Road
Caulfield North Vic 3161
Tel: (03) 9528 5962 Fax: (03) 9523 8181
<http://www.wia.org.au>

All mail to
PO Box 2175 Caulfield Junction VIC 3161
Business hours: 9.30am-3pm weekdays

Acting Federal Secretary

Petar Naish VK2BPN

Federal Office staff

June Fox Bookkeeper
Rilla Trebilco VK3JF Examinations Officer

Council

President	Petar Naish	VK2BPN
VK1 Federal Councillor	Glenn Dunstan	VK1XX
VK2 Federal Councillor	Michael Corbin	VK2YC
VK3 Federal Councillor	Brenda Edmonds	VK3KT
VK4 Federal Councillor	Ross Marren	VK4AMJ
VK5 Federal Councillor	David Box	VK5OV
VK6 Federal Councillor	Will McGhie	VK6UU
VK7 Federal Councillor	Phil Corby	VK7ZAX

Executive

Petar Naish VK2BPN
Tony Farrow VK2TJF
John Loftus VK4EMM
Wally Howse VK6KZ

Federal Coordinators

AMSAT	Graham Ratcliff	VK5AGR
ARDF	Jack Bramham	VK3WVV
Awards	John Kelleher	VK3DP
Contests	Ian Godsil	VK3DID
Education	Brenda Edmonds	VK3KT
FTAC	John Martin	VK3KWA
Historian	John Edmonds	VK3AFU
IARU	Grant Willis	VK5ZWI
Intruder Watch	Gordon Loveday	VK4KAL
ITU Conference and study group	David Wardlaw	VK3ADW
Public Relations	David Thompson	VK2NH
QSL Manager (VK0, VK0)	Nell Penfold	VK6NE
Videotapes	Don Bland	VK4TVD

ACA Liaison Team

Petar Naish VK2BPN
Glenn Dunstan VK1XX
Michael Corbin VK2YC
Wally Howse VK6KZ
Canberra Liaison Officer
Richard Jenkins VK1RJ

EDITORS COMMENT

By Guest Editor
Bob Harper VK4KNH

Changes

As the end of this year approaches (and perhaps the decade and century depending upon your point of view) there are many changes to contend with.

Externally there is the question of the "Australian Republic" referendum that will be voted on about the time that this magazine is due to arrive. Mid-2000 will see the introduction of the GST, which may be a blessing or threat, depending on how it affects you, and then Spring 2000 is the Sydney Olympics. I cannot imagine how much that will affect the lives of Sydney-siders and Australians generally.

But of greater interest to amateurs, I believe, is the state of health of Amateur Radio. Every time I hear somebody moan about how the hobby has changed, or complain that things have gone bad, I wonder what part that person played in the changes. Certainly most would automatically deny any involvement. Yet that is the very problem we face - lack of enthusiastic involvement. Few people are stepping forward. Fewer people are carrying the load of the general public.

Most amateurs see the costs of their equipment increasing, even though the old gear probably still works as well as the day it was bought. They see their licence fees rising yet usually at a rate lower than the CPI. They see their WIA membership fees rise; yet it is still lower than most comparable organisations and certainly less than the fees of any union that represents its members nationally and internationally. Many people still "cough up" far more money for cigarettes each year.

We are afraid of increasing the costs to members because we see the almighty dollar as one reason we are losing members. Yet many spend more on the Internet than on membership. Costs no doubt influence some, but where there is perceived value for money costs become less of a factor. We also blame the CW for frightening potential members off but if there were sufficient incentive, that would not cause a problem either. The one word that we keep coming to is "incentive", - the "What do I get out of it?" question. The "value for money" judgement crops up time and again.

In fact, for the money, each member gains a very good service from the WIA.

The problem is that few members use every service available and those that they don't use hold no value at all to them. Like it or not we are all at least a little selfish. What use is the examination service to those who have passed all that they wish to? Yes, I know that every member needs to encourage others to gain a licence but does the average member think that way? Every service suffers the same criticism. Those that don't use repeaters can't see the value in supporting them. Those that don't enter contests don't see any value in supporting them either. We become narrowly focused on just those activities that we take part in.

Not every member wants AR Magazine, yet AR reaches more members than any other method of communication, short of direct mailing. Even direct mailing doesn't reach every member! I occasionally hear people ask for more material on a particular topic but rarely have an accompanying offer for more materials. When they do it is usually gratefully accepted and printed.

If you really think about it, AR is the perfect place to share ideas, offer views, advertise your club's events, seek advice and gain new members - as long as the potential members read AR. Do you share your old copies of AR around the club and local amateurs? Perhaps leave some with town or school libraries.

As we age, and we all do, we become less enthusiastic about change. But we all change, our bodies change, our world changes, even our friends change, so we should expect that change is inevitable. Will we face change with grace and dignity or will we go kicking and screaming all the way? Surely it depends on how much involvement we have in those changes. I ask that you become and stay active in your club and with the WIA in order to be a part of our future and not, sadly, relegated to our past.

73 for now,
Thank-you Bill for this opportunity,
Bob VK4KNH



Comment

**Federal President, Peter Naish
VK2BPN.**

During October a teleconference of Federal Council and Executive was held. This is one of a number of occasions when we get together to discuss the wide range of matters which concern the amateur radio service.

Although the vast majority of matters are decided via correspondence as and when they occur, usually by e-mail, it is important that we do meet "live" by telephone from time to time. This gives us a forum for rapid interchange of ideas that can then be progressed by correspondence.

At this latest teleconference your Council make some excellent progress on vital matters embracing key items of policy. These were wide ranging and more detail on these will be made available to you shortly.

Next month we are meeting with the ACA to progress our claim to a wider slice of the top-end of the 80 metre band, the so-called "DX Window". And then, in December, we have the next of our regular meetings with ACA on other matters of concern. Again, as soon as we can after these meetings we will bring you a report on what took place.

All of this means a heavy work load for the Council and the various expert committees, Despite our "amateur" status, the WIA is a professional body and we aim for the highest quality in our negotiations with others. Often it takes a long time to see the progress from our efforts and I ask you to be patient with us. Just as soon as a result becomes available from our work, you will hear about it from the WIA.

Peter Naish, VK2BPN
WIA Federal President.

WIA NEWS

Wireless institute of Australia and the Australian Communications Authority cooperate in Olympic Training exercise.

Radio communications activity in Sydney leading up to and during the Olympics will be at an all time high.

It will be a challenge to ensure that the Sydney Organising Committee for the Olympic Games (SOCOG), local and international broadcasters, commercial enterprises and the general public all enjoy interference free communications during that period.

In order to control the level of interference to communications during the Olympics a large contingent of ACA staff from around Australia will converge on Sydney. Teams will be stationed at strategic locations throughout the Sydney area, ready to respond to any communications problems that may arise.

To familiarise interstate ACA staff with the Sydney area, particularly vehicle traffic and the radio-communications environment, the ACA in conjunction with SOCOG participated in a two week Olympic test event.

The Sydney Office of the ACA was tasked with producing a number of difficult radio fox hunts which would test the ACA's response times and operating procedures. It became apparent that during the test event the ACA required the assistance of reliable technical people who would volunteer their time to assist in the exercises. The Sydney office of the ACA approached the NSW Division of the WIA for assistance and the response was tremendous. A number of WIA sites were offered along with equipment and technical personnel.

In very short time a transmitter supplied by the WIA operating in the 70cm band was set up in the Parramatta area. This ran in parallel with another amateur transmitter on the same frequency in the inner western suburbs. Both transmitters fed multi element Yagis pointed at the Sydney ACA office.

Teams in vehicles commenced direction finding from the far outer suburbs. Using a variety of DF equipment and yagis connected to Rohde Schwarz EB200 receivers they first located the transmitter at Parramatta and it was turned off. On reporting their success Officers were told the transmission still existed. This was a little disheartening for the participants who recommenced their activities in pursuit of the other transmitter. Surprisingly the simultaneous transmissions did not confuse the direction finding exercise.

Aub Topp VK2 AXT, of the WIA spent a lot of time in going back and forth to his shack over the fortnight turning the transmitter on and off as required. His wife must be sick of the telephone calls from the ACA

Other exercises such as a walking and intermittently transmitting mobile in the Darling Harbour and a transmitter located in an office block in Bondi junction kept the ACA field staff on their toes.

Interstate ACA staff had a first hand experience of Sydney traffic particularly during the train strike. Exercises continued in standstill traffic situations. On the humorous side was the pronunciation of suburb names by out-of-towners. I am personally unaware of a suburb named "Rozellie"

The ACA is indebted to the WIA for its involvement. WIA members in Sydney put in a lot of time and effort to assist in the successful trial.

Further test events are scheduled for the new-year.

New Members

The WIA bids a warm welcome to these new members who were entered into the WIA Membership Register in September.

VK4TI	MR Trent SAMPSON of Toowoomba
VK4APH	MR John GALLAGHER of Gaythorne
VK4IJ	MR Sabby CONN of Goodna
VK4KNW	MR Noel WILLIS of Runcorn
VK4WDM	Rev Wayne MELROSE of Alice River
L21169	MR H K GIFFORD
VK2DLF	MR G GOERGE
VK2GWK	MR H TOBBE
VK2MNU	MR K PURVES
VK3ABX	MR V D BOND
VK3DA	MR P ALBERS
VK3HEH	MR J HALL
VK3PP	MR T MITCHELL
VK3SB	MR H MOFFATT
VK5AZ	MR R K VON SANDEN
VK6TQ	MR K R RHODES
VK7WK	MR P W KING

VK7 Division Wins 1999 Remembrance Day Contest

Tasmania Retains Title by Improvement in both HF and VHF

Through consistent improvement in both the HF and VHF sections, the VK7 Division retains the Remembrance Day Contest premiership for 1999. Congratulations to all those who participated and submitted their logs.

The most improved division this year was VK3. From last place in 1998 to a close second this year is an outstanding effort. A modest improvement in the HF section would have seen the trophy in their hands this year.

All divisions except VK2 and VK6 registered some improvements in their divisional scores over last year. Also encouraging this year is the number of Limited Novice class operators who took part. Hopefully this increase in contest activity will continue.

With the rapid progress of technology it seems the rules are once again due for amendment. This year saw a flurry of activity in VHF Packet Radio operation. Packet is of course a legal mode in the contest and should remain as such. The issue of automated contest station operation, however, needs to be clarified and included in the rules for the future. This matter will be debated and clearly defined in time for next year's contest.

For myself, I thoroughly enjoyed participating in the contest and I know by the numerous positive comments I received with the submitted logs that the feelings were similar in all parts of the country.

Here now are the results for the contest.

Divisional Scores

Table 1 shows the placing of each division with their overall Improvement Factors.

Table 1: Divisional Ladder

1st	VK7	2.484
2nd	VK3	1.722
3rd	VK5/8	1.072
4th	VK1	0.975
5th	VK4	0.745
6th	VK6	0.667
7th	VK2	0.447

The total scores in both HF and VHF are shown in Table 2.

Table 2: Divisional Scores

Div'n	HF	VHF
VK1	363	245
VK2	3043	20
VK3	2886	21403
VK4	2741	609
VK5/8	4001	1608
VK6	2389	2950
VK7	2039	1962

Calculating the scores

There is some uncertainty and even mystery as to how scores are calculated. To make it all a little clearer, I have included the following live example of how it is done. I will use the VK3 Division's figures in the calculations.

First is the calculation of Benchmarks for VK3 for 1999 RD Contest.

1998 Benchmarks.

(As published in 1997 Results)

HF 4106 VHF 9602

1998 Scores.

(As published in 1998 Results)

HF 2775 VHF 3145

Formula:

$$1999 \text{ Benchmark} = (0.25 \times 1998 \text{ Score}) + (0.75 \times 1998 \text{ Benchmark})$$

Calculations:

$$\text{HF } 1999 \text{ Benchmark} = (0.25 \times 2775) + (0.75 \times 4106)$$

$$\text{VHF } 1999 \text{ Benchmark} = 693.75 + 3079.5 = 3773$$

$$\text{HF } 1999 \text{ Benchmark} = (0.25 \times 3145) + (0.75 \times 9602)$$

$$1999 \text{ Benchmark} = 786.25 + 7201.5 = 7988$$

Those 2 benchmark figures are the scores the division needs to beat to register a positive improvement factor in each section of the contest.

Now to calculate the final score, let's use the points that the VK3 division scored in HF and VHF this year.

Formula:

$$\text{Improvement Factor} = \frac{1999 \text{ Points}}{1999 \text{ Benchmark}}$$

Calculations:

$$\text{HF } \frac{2886}{3773} = 0.765$$

$$\text{VHF } \frac{21403}{7988} = 2.679$$

The two improvement factors are now averaged to give the division's final result.

Formula:

$$\text{Overall Score} = \frac{(\text{HF Improvement} + \text{VHF Improvement})}{2}$$

Calculation:

$$\text{Overall Score} = \frac{(0.765 + 2.679)}{2}$$

$$\text{Overall Score} = 1.722$$

I trust that takes some of the mystery out of the RD Contest results.

Here now, are the Benchmark figures for the year 2000, the final RD Contest for this millennium.

Table 3: 2000 Benchmarks

Div'n	HF	VHF
VK1	626	189
VK2	4339	64
VK3	3551	11342
VK4	3439	767
VK5/8	3747	1551
VK6	2845	4864
VK7	1856	875

Individual Scores

The individual scores for entrants are listed at right.

Certificate winners are denoted by an asterisk (*) and the top Australian scores in each section by a hash (#).

Certificates will be issued to both the top single operator and top multi-operator stations in each division.

This year we had just one overseas entrant, ZL3TX who scored 43 points in the HF Phone section. I'll endeavour to get a bit more publicity for the contest in ZL so that we may enjoy more activity from there next year.

That's it for 1999. Let's all look forward to RD 2000 and decide what sort of effort we can make to help win the trophy for our division. The opportunity is there for any division to win.

73, Alek. VK6APK

Individual scores

State by state

VK1		VK3		KTO	
HF Phone		HF Phone		HF Phone	
VP	160*	IO	401*	JED	268
EY	108	AHY	158	GK	250
DW	50	GUS	154*	JK	250
KMA	45	OM	150	YE	248
VHF Phone		DS	110	KKJ	234
VP	54*	ABP	90	TTX	218
EY	37	JK	81	AYF	200
HS	32	KQB	79	VNA	186
RG	32	DBL	73	CAT	165
7RG/1	32	EX	72	KBD	160
DW	31	NM	71	XJU	160
KMA	27	AMW	53	GV	145
VK2		KTO	50	FT	138
HF Phone		BWT	49	APC	107*
XN	443*	CAT	47	JTW	105
DCL	257*	CAY	47	CAM	100
XT	152	DPC	39	HIQ	95
BDT	133	SM	39	XBA	79
APP	126	FT	35	NE	67
AGE	101	MMM	35	WI	65
HV	87	APC	31	HEH	61
ALZ	62	DY	30	HGF	61
NNN	57	EWM	30	ABL	60
FUP	48	JNB	28	BYY	60
IRP	46	ADW	27	DYL	53
EJK	23	DKT/4	26	XV	53
SW	18	KKJ	26	ER	51
YW	18	UU	25	KB	50
CF	15	KB	22	ZBI	50
MV	14	AOY	20	US	47
EMU	11	DYL	20	JNB	47
VIM	3	NV	18	DID	45
HF CW		AAJ	15	JNH	41
BHO	208*	DYF	15	PC	39
OI	164	DI	13	SM	37
EL	156	MGZ	12	EWM	35
PH	138	AEO	10	BGS	25
QF	138	SB	9	ATW	23
AZR	110	HF CW		VKC	22
II	52	SV	138*	ZPP	20
RJ	28	ANJ	94	XX	17
HF Open		AMD	62	AEO	10
BO	435*	BKU	28	BWT	2
VHF Phone		JI	24	KQB	1
SW	11*	HF Open		VHF CW	
HV	9	DID	165*	TAY	446*#
SWL		PP	70	VT	444
I McGovern 111*#		YE	61	BGW	442
		FR	34	CNE	378*
		VHF Phone		EA	360
		BJM	546*#	ERG	360
		MZ	500	FII	360
		DI	292	HDD	360
		DBQ	274	DXA	358
				EMF	358
				HAI	358
				HFI	356
				HKR	340

HKD	338
VF	338
WT	338
UI	334
VTX	334
HGF	322
ABL	318
KIR	318
AAU	316
AWT	312
AXJ	312
CKH	312
COD	312
DI	312
DUY	310
TCB	226
TEN	190
VFX	170
VKW	168
VHF Open	
GUS	1289*#
ACR	545*
ZJH	544
SB	489
DBL	473
NM	473
WWW	370
ZUG	353
AQ	335

VK4	
HF Phone	
BAY	236*
DO	194
YZ	107
ZJ	100
BTW	80
PF	75
AWL	70
IS	70
BLK	67
ZA	65
AAH	59
PJ	49
GZ	31
PT	31
EWR	29
FU	20
EV	18
WJG	15
VY	11

HF CW	
LV	282*#
WID	260*
XA	258
XW	152
LP	64
EMM	46
RE	20
HF Open	
LT	198*
IZ	134*
VHF Phone	
3CE/4	200*
ZBV	125
NJE	51

ZA	42
RC	37*
AWL	31
TZL	23
EWR	22
PT	20
PJ	18
EV	15
VY	15
BAY	10

VK5/8	
HF Phone	
ARC	485*#
BWH	244*
BQ	204
8DA	89
WO	86
XY	84
TW	64
EN	62
BWA	58
RV	54
ZK	50
ASN	49
EMI	43
ADD	35
KLD	35
ET	34
NN	33
AIM	30
RK	30
GN	28
PC	26
KMK	23
SFA	23
YX	19
NF	17
ZQ	15
AFZ	12

HF CW	
8HA	202*
AGX	126
HO	86
AU	24
HF Open	
BRC	590*#
ATU	325*
BAR	298
GZ	221
UE	78
AKQ	64
ZL	29
RG	26

VHF Phone	
BRC	404*
EX	257*
AR	201
XY	103
ZKK	89
PC	88
AIM	80
ZBK	63
KCX	62
AVQ	42
AIC	40
GN	36

CTY	31
ZGM	31
RV	26
TTL	20
UE	18
TY	11
YX	6
SWL	
G Mutton	72*

VK6	
HF Phone	
SZ	480*
CSW	225*
BIK	134
SAR	103
JP	101
APK	49
KH	36
WU	31
MIN	28
TS	27
RU	25
AD	21
AR	20
HK	20
DRJ	12
OV	6
KU	5
ANC	4

HF CW	
HQ	232*
AFW	186
AF	118
AJ	30
WZ	20
HF Open	
VZ	279*
DDX	135
WT	62
VHF Phone	
CX	362*
HU	200
SAA	200*
YEI	180
ANC	161
APK	151
AD	146
AR	135
BDO	133
JP	126
SAR	119
4JIP/6	112
ZBP	112
CSW	106
MIN	105
FJA	91

VK7	
HF Phone	
RN	330*
CK	221
KC	197
MS	181
RR	139
JGD	138
KH	91
DG	85
BW	82*
KBE	75
KHZ	67
JAB	63
LCW	62
SV	60
NGC	54
LUV	40
RM	40
JP	39
FD	16
BM	14
KK	13
LS	13
AK	11
HX	8
VHF Phone	
BW	219*
RR	189*
DG	171
JGD	159
RM	112
EB	94
JK	81
KXA	63
HX	46
NDO	39
SV	34
LS	30
BJ	27
PP	11
JP	2
VHF Open	
ZBX	248*
FB	234
HDM	203

Ron Churcher, VK7RN, the VK7 President was visiting Bob VK4KNH when the results came in.
Was he pleased?
Was he what!



Divisional News

VK7 Notes

QRM.

Tasmanian notes.

It has been an absolute pleasure to welcome to Tasmania our Federal President Peter Naish and wife, Monica. Members have been happy to give them our traditional Tasmanian hospitality.

On October 7th the Northern and North-western branches combined to meet him at our traditional "get-together" place Deloraine where the Deloraine amateurs can always be relied on to put on a good supper (a pre-requisite of meetings here!).



Peter Naish with Bob VK7MGW, N/west President and Al VK7AN Northern President

Peter gave us a very informative report on the state of Amateur radio in Australia and then the Chairman (me) threw the meeting open for questions.

Peter must have done a good job initially because it became a "round-table" discussion with everyone putting their point of view in a cheerful, positive way. The Southern branch in Hobart had their chance on the 11th October. I think Peter was impressed with our members' commitment to our hobby.

Personally I would thank Peter for giving up part of his holiday to meet us. It can only add to the "get-togetherness" we strive for in this Division.

The Southern branch's current big deal is their weekly foxhunt and the competition is really hotting up and getting serious - good-natured open warfare can be fun.

Both the northern and North-western branches are planning their Christmas dinners and at the November meetings will need to finalise their bookings. The Northwest dinner is on the 20th November. I have included some shots of the event. Sorry that Al VK7AN was apparently caught mid-sneeze!

Cheers for now Ron, VK7RN Tas. President.

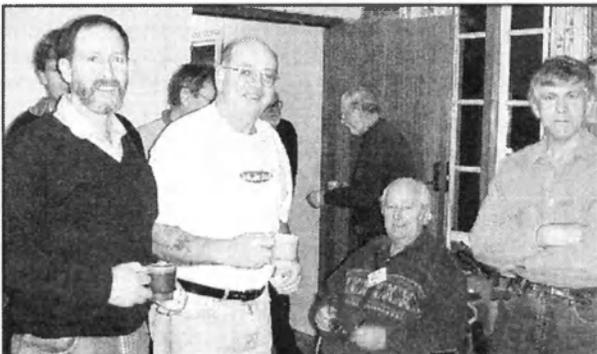

Launceston (Northern Branch) members at supper.



Peter Naish and Ron Churcher.

VK1 Notes

Forward Bias

Peter Kloppenburg VK1CPK

Leonie Tarnawski was the guest speaker at the September general meeting. Leonie is a team member of ACA's Radio-communications Standards Team, where she specialises in Electromagnetic Radiation Regulatory issues.

This subject is of considerable interest to radio amateurs, and users of hand-helds and mobile telephones because of the potential harmful effects of RF radiation at close range. In a chatty manner, Leonie introduced the mandatory standard, based on AS 2772.1 (interim):1998, which came into effect for cellular mobile, cordless phones, and cellular mobile base stations on February 1, 1999.

This mandatory standard includes Specific Absorption Rate (SAR) limits, which apply to devices that have an integral antenna designed to be used close to the human body. The standard also applies power flux density levels (electrical and magnetic field strengths) to antenna installations. She said that the standard currently applies to importers, manufacturers, and installers of that equipment.

The standard does not presently apply to amateurs and the mandatory standard is being progressively introduced over the range of RF services. However, amateurs should be aware of the health implications of emissions from RF transmitters that exceed human exposure limits. For amateurs this means that, for example, an antenna installation fed with a linear amplifier represents a potential health hazard.

The amateur as well as the public is exposed to it. When the mandatory standard is applied to amateur installations, the amateur licensee will be responsible for minimising exposure to the levels designated in the standard.

Leonie explained that compliance with the mandatory standard is related to the power, distance, height of the installation, and duration of exposure. The standard, when promulgated for amateurs and other licensees of RF transmitters, will contain graphs that can be used to calculate compliance of a particular installation with the standard. It was interesting to observe during discussion, the many questions that were asked of her on the issues involved.

As **Education officer of the VK1 Division**, I am facilitating an on-line course on the Internet for Novice and AOCIP students in the Canberra and Illawarra regions.

The course was designed and developed by Ron Bertrand, VK2DQ, who has many years of experience in this field. Ron is

facilitating 35 students in Queensland. The course contains 43 readings and 20 assignments that cover the complete Novice and AOCIP syllabus, and can be downloaded from his website.

After the fifth assignment, students have a choice of following the Novice or the AOCIP strand. The assignments from that point onward reflect that choice. Students work at their own speed and use a facilitator to check and correct their assignments.

At the end of the course, students are ready to apply and sit for the exam in the normal way. When students have a problem with an assignment they can join a keyboard chat-net to exchange views with other students, or the facilitator. Aspiring radio amateurs, Limited call holders, and Listeners in the Canberra and Illawarra regions are encouraged to make inquiries in the first instance at the Ron Bertrand's website.

The address is: <http://members.xoom.com/ronber/amateur.html>
The email address of the VK1 facilitator is: pkloppen@dynamite.com.au Telephone inquiries can be made at (02) 631 1790.

A FAX facility is available at: (02) 6296 5712. Start of the course is the first week of October, and will be on-going.

Cheers to all.

VK6 Notes

Chris Toodyay VK6BIK
(chrismor@avon.net.au)

Are We In VK6, or in Coventry?

What on earth is happening to amateur radio in VK6?

I have to confess I am mystified as to why I can not (easily) get a reply when I put out a general call on either the Perth or local repeaters. Maybe I have upset a few sensitive souls but I don't think so, this lack of response, interest and even consideration, is commonly experienced by the very few that do have the courage (for that is what it seems to take these days) to put out general CQ type calls on repeaters.

I have recently experienced what I can only assume as emphatic rejection, when, after fruitlessly calling on a Perth repeater while mobile, a "ham" calmly called his mate a few seconds after I released the PTT!! How much effort would have been required by this "ham" to just quickly say hello/goodbye to me first?

This sort of offhand treatment, when encountered by a novice making his/her first call with a new rig/licence, is almost certain to quickly result in another "lost" ham, and a further major blow to the survival of our hobby. In my view, each "potentially active" amateur "lost" is worth

30 of the licensed hand-sitters.

Another example. About 15 mins before the Sunday Broadcast, a country ham put out an "emergency" type call on what he assumed would be the most monitored repeater at this time. Storms had knocked out the telephone system, and he requested for someone in Perth to make a local telephone call on his behalf. There was no response at all to numerous desperate appeals.

He had to QSY and call on another accessible (but very quiet) repeater before finally getting a response and help from an OT still imbued with "the spirit" (well done Percy).

If memory serves correctly, doesn't the "Ham Code" call for us to be "considerate" and "helpful to our fellow hams"? I think it does, and so I make it a principle to ALWAYS respond to ANYONE I hear putting out a call for a (maybe first?) QSO on air, on any band. Please, if you hear someone put out a call seeking a contact, respond, even if only briefly, for the sake of the hobby.

Activity

Further on the theme of general amateur activity, here are some words of wisdom on the subject, borrowed from Richard, VK2SKY; (very nicely put I thought)

"If you want to help the hobby of Amateur Radio to thrive, all you have to do is:

- 1) enjoy your hobby
- 2) be active
- 3) do something a little out of the ordinary, and
- 4) tell others about the fun you've had with Amateur Radio!

After all, Amateur Radio is too good to keep a secret!"

VHF Contest Activity

The next Spring VHF-UHF Field Day will take place from 0400 UTC Saturday November 13 to 0400 UTC Sunday Nov. 14.

The contest manager, John Martin VK3KWA writes: "I hope you will be able to head for the hills for at least part of the Field Day weekend. If you can't manage to mount a full expedition, you might

even consider just going for a nice long drive and activating a few grid squares on the way." Sounds like a great excuse to get outside into the country for a bit of hill-topping to that secret spot – the views and fresh air will be terrific, and the grid squares you activate eagerly sought by many "grid-square chasers". You should find the rules published in the contest section in AR, or drop me an email and I will forward the same.

By the way, I can recommend "square chasing" – it is highly infectious, as each new square is a challenge and a real high when you land it. It is also great fun to push the distance envelope on VHF/UHF via the different modes of propagation available.

The VK-VHF email reflector (mentioned in previous columns) maintains a "grid square table" published quarterly, and you only need one square to make the list (QSL card confirmations are not req'd). Of course another, longer, opportunity to harvest squares occurs with the upcoming Ross Hull contest.



14 Mary Street Hazelmere WA 5055

Tel: (08) 9274 1118

Fax (08) 9250 3734

Early Opening Across the Bight



Bill, VK6AS in Esperance, reports a very strong tropo opening across the Australian Bight occurring on 25th & 26th Sept. on VHF, at least one month earlier than usual.

The opening first became apparent at about 6:20pm local time (10:20 hrs UTC), when Bill heard the Mt Lofty and Mt Gambier beacons, both at S9+. He called CQ on 144.100 USB & CW for 45 mins, before being compelled to use the landline to alert possible eastern states contacts to the propagation phenomenon.

Obviously we need to encourage more VHF DX'rs to stay within earshot of the calling frequency, and I suggest you keep your VHF shack inside the house, not out by the dunny or chook pens, ok?

Once the word was out, Bill then proceeded to work VK5NC (Trevor nr Mt. Gambier), VK5NY (Roger at McLarenvale nr Adel.), VK5KK, VK5DK, and VK3ZQB, all at very good strength, S9+ to S9+20. Of note is that VK5KK "repeated" Bill to VK5AKM on 10 Gigs for an interesting cross-band contact. Bill also gave one station (VK5NC?) a S9 report on just 1 WATT! The opening lasted at least until 9:40 p.m. (local) when Bill pulled the switch. The following morning, the propagation was still there, although at reduced strength! At +/- 7:00am local, Bill worked VK3ZL on CW at 5/2/9, and then VK5DK on phone again, this time "only" at S9. In the meantime the beacons had dropped to S2 - S3, peaking S5.

Bill certainly has the station to make maximum use of such openings, with full legal power into an 8 bay x 16-element long-boom VHF Yagi antenna system, comprising 128 elements in all, and complete with both azimuthal and elevational capabilities.

Bill also uses this system for moonbounce (EME) work. I believe it is the only such VHF antenna system of its

type in Australia (I am trying to arrange publication of a picture of this impressive array). Note however that you do not have to have such an antenna to have fun with tropo - a single long boom Yagi, RF amp, and masthead pre-amp will suffice (for a while!).

Of interest is that apparently none of the VK6 beacons were heard during what Bill described as "the strongest opening in years!" It is not known if the opening extended into Perth or Albany. However it may well have, given that perhaps we should not rely completely on beacons as the sole propagation indicators.

There is no substitute for leaving the rig on the calling frequency!

CW Survey

CW Retention/Abolition survey currently under way. Results so far: - YES (ie. keep in exam) = 111, NO (ie. not to retain the code as an exam requirement) = 127. I voted no. Have you voted? Meanwhile, all you retentionists, lets be hearing at least one of you on the bottom end of 80 metres weekday evenings - I am trying to brush up my CW for VHF DX'ing !!

Hamfest '99

Don't forget there is a Hamfest coming up in November sponsored by the NCRG, same place/time, in Bassendean - I have not been given any details but I guess most would expect to hear of these during the weekly broadcasts.

VK6 WIA "On-Air Net"

Just a reminder, 3rd Tues. every month on 146.750 rpt'r and 3564 kHz HF, 7:30 p.m. At least let them know you're listening if you can.

From the Minutes (Oct. Council Meeting)

Membership: Dave VK6IW presented seven applications for membership. They are: John Cox (VK6NJ), Malcolm Armstrong (VK6YFD), Graham Selley (VK6WR), Gordon McDonald (VK2ZAB), Murray Lang (VK6HL), Bob Worthington (VK6RW), Ruth Worthington (VK1YL), and Tom Blakemore (VK6TB). All were warmly welcomed to the Division.

The matter of a closing date for the Morse Survey was raised. It was agreed that this could conveniently be the day of the Hamfest. Those attending would be able to record their vote at the WIA stand.

John Martin VK3KWA, FTAC Chairman, had advised that the ACA had posted a new "Information Paper" for Amateurs on its web site.

Neil VK6NE has prepared a QSL Bureau instruction sheet for the information of members. It will be inserted in AR Magazine and appear on the Home Page.

The matter of the annual dinner was raised. In view of the lack of support from members last year, no function is planned this year.

73 from Toodyay, Chris VK6BIK (chrismor@avon.net.au)

VK4 Notes

QNews

By Alistair Elrick VK4FTL
WIAQ Councillor and QTC Editor

The Inc is in Ink at last

Last months column just missed announcing the receipt of the Incorporation Certificate for the WIAQ. So we are now the Wireless Institute of Australia Queensland Division Incorporated.

This has closed the chapter on the move from the old non-profit company to a more manageable Incorporated Association. It has been a long 12 months since it was first decided to take the steps necessary to alter the administrative structure of the Division.

There have been many trials and errors made during the legal and administrative procedures to wind up the previous company and create the incorporated body.

During this time, the affairs of the Division have been in limbo, as money was not transferred from one to the other in sufficient time to enable the full business of the Division to continue.

But it is over with and many thanks must go to Peter Harding VK4JPH who started the ball rolling and to David Jones VK4OF who very ably took the reins and followed the entire matter to its successful conclusion. The business of the Division can now proceed as normal and we can look to strengthen the membership and address some of the Amateur Radio issues at hand.

North Queensland Amateur Radio Convention

During September the North Queensland Amateur Radio Convention was held at the James Cook University in Townsville, hosted by the Townsville Amateur Radio Club (Inc). The event was strongly supported by the local Amateur Radio population and from as far afield as Papua New Guinea and VK3.

Local Member of Parliament Peter Lindsay VK4TO officially opened the proceedings on Friday night, extolling the virtues of the 'Bottle' where the 'Catswhisker' ruled supreme and

encouraged everyone to keep the pioneering spirit of Amateur Radio alive.

This was followed by a state of the Spectrum address by ACA area manager Gerry Millward VK4HT highlighting the ever-increasing importance of EMC and EMR along with updates on some of the ongoing issues in the radio spectrum. With Gerry were ACA bods Alvin McCann and Kevin Smith. WIAQ President Col VK4ACG presented Gavin VK4ZZ with the Ken Robertson VK4KT Memorial Award for Technical Excellence, this being in the field of Packet Radio and QNews Rebroadcast techniques.

Other displays of interest were Radio Scouting with Steve VK4SGW and Michael VK4HOT, APRS and RadioDirectionfinding with Ron VK4BRG and Frank VK4CAU, the TARC Inc Club Station VK4WIT, VHF, QNews Rebroadcast, Packet, Internet and HF with Gavin VK4ZZ. There was also a PNGARS Display by Rick P29KFS/VK4KRW and an ALARA display by Sally VK4SHE

Finally there was a Home Brew Contest display managed by Dave VK4FUY and Pat VK4MUY.

WIAQ President Col Gladstone VK4ACG, Bookshop Manager John Stevens VK4AFS and yours truly, journeyed up to attend the function, representing the Divisional Council and displaying the wares of the Bookshop. A display of Amateur Radio equipment was given by local Icom dealer Navcom Electronics and Barry VK4TBD was supported by Duncan VK3LZ, Kiyoshi VK3BZX and Yogushi all from Icom Australia in Melbourne.

Saturday Afternoon, the ladies participated in belly dancing and beading crafts classes whilst the blokes went off to Professor Keith Kikkert's lecture on digital communications using PLCs.

Saturday Night, The Convention Banquet at Compass House. Roger VK4CD did some very good bush ballads and in no time it was Amateur Hour, Vern VK4FVC, David VK4BDJ, Sheila Morrison, Gavin VK4ZZ, Wally VK4DO, Ken VK4HAI and a bellydance exhibition by Lyndall.

So, on Sunday Morning when everyone was still sound asleep, a strange rumbling and clanking, sometimes tinkling noise, was heard through the suburbs. Yes! It was the Convention Treasure Team trucking the tonnes of Equipment Treasure to the Monster Auction Site.

Then it was time for the QNews rebroadcast live from the Uni, which went to air very well. Following was the Car Boot Sale, the WIAQ question and answer

session with Col VK4ACG, and then Rick/P29KFS gave a talk at this session, outlining the state of affairs of Amateur Radio in P29.

Wally VK4DO put in a magnificent 3-hour session auctioning off such things as an electric piano, a hifi, radios, computers, BIG VALVES, heavy power supplies and heaps of books. The displays, lectures and discussions spread a wealth of information among the participants. The University facilities made the weekend very enjoyable.

A great deal of thanks must go to the Townsville Club, especially to John Grott VK4MAV the Convention Co-ordinator, for a well run and presented event. The visitors very warmly felt the friendship and friendliness shown and the entertainment at that Saturday night dinner could not only be described as varied but very ably performed by the local talent.

They're saying around Townsville, " See you in 2001 for the 15th NQ Amateur Radio

Convention!"

Travelling and on the air.

Allan VK4URD is an amateur who doesn't do things by "small means". Just back from another trip through the outback, Allan and Ellsie with 2 poodles, Shandy and Brendabella shared their vehicle with: -

1 Codan wireless for RFDS: 1 27meg SSB CB radio: 1 2m/70 cm radio: 1 UHF CB (ch 40): 1 mobile phone: 1 6m radio: 1 100ch scanner.

The Ute has a canopy on it with roof rack mounted to it carrying 6m, 2m/70cm-twin-band and scanner ant. On the bullbar he has a 9dB phone antenna. On the glass a half wave UHF CB ant and on the trailer a Codan ant and HF CB whip. The back door has his call sign for 146.500 plus an UHF CB Ch 40 sign and his RFDS call sign VHQ32. If you can't contact him with all that lot, he must be asleep.

73's from Alistair

VK2 Notes

Pat Leeper VK2JPA
patleep@bigpond.com

The Digital Interest Group of Tamworth has become the latest addition to this Division's affiliated clubs, which now total 46 clubs. The next Affiliated Clubs Conference will be on Saturday 13th November and a good representation of clubs is expected. Many matters are dealt with at these conferences, with some major items becoming agenda items for the next Divisional AGM.

The September Trash and Treasure sale pulled a lower than normal crowd as it clashed with the Rugby League final — attendance was down at the previous year's sale for the same reason, so it is becoming a trend. A change of date, perhaps? This could be awkward as the T&T is listed for the last Sunday of every odd month, except when it clashes with a public holiday, and so can be pencilled in to members' diaries in advance. The next T&T will be held at Parramatta on Sunday 28th November.

Recently, a series of training exercises were undertaken in and around Sydney by

over 40 ACA personnel consisting mainly of field and technical officers from all parts of Australia.

The exercise consisted of interference investigation and the testing of the command structure for the Olympic Games. According to Mr Vlies, Sydney ACA Manager, the exercises were very successful and he praised the cooperation received from the VK2 Division.

VK2's part in the exercise was to provide interfering signals on the ACA command frequency which the field officers, working in teams of three cars, had to identify and locate.

Mr Vlies extended a special vote of thanks to the Divisional Librarian Aub Topp VK2AXT who made the tower available at his QTH for one of the locations. The transmitter was provided by our Dural team.

Council has decided to hold the Divisional Christmas party on Saturday 11th December, with details to be announced on the VK2 broadcast at a later date.

For your diary — the Divisional office will close for the Christmas break at the end of trading on 23rd December and reopen on 10th January 2000.



The early crowd looking for bargains at the September Trash and Treasure

CLUB NEWS

Remember that the Club News column is the perfect place to share club news with non-members and amateurs in general — and perhaps even pick up a few new members. The first piece is from the Moorabbin club who sound like a really well organised group who have a lot of fun and interesting times. I'm a bit out of their territory but I'll bet they get some interest in their activities.

News from the Moorabbin & District Radio Club

Peter Parker VK3YE

Publicity Officer
Moorabbin & District Radio Club
parkerp@alphalink.com.au
(03) 9569 6751
November 1999

Make the MDRC your club

Did you receive a letter last month inviting you to join the MDRC? If so, you're one of the 300 amateurs lucky enough to live within 10 kilometres of Melbourne's best radio club - the MDRC.

We urge you to strongly consider the benefits of joining the only club that promotes amateur activity in your local area.

The MDRC has the best club rooms in Melbourne. We also have more social, on-air and general meetings than any other club. The weekly APC News service is read throughout Australia. VK3APC, the club callsign is often heard in major Australian contests.

Have we mentioned the club's extensive library, the QSL collection service and the free Internet access.

So there's many reasons to make the MDRC your club. Discover what membership has to offer. Come along to one of our meetings - either Tuesday morning, Tuesday evenings or the first and third Fridays of the month. Further details about the Club appear on our website at <http://www.mdrc.org.au>.

If you didn't receive a club brochure, perhaps because you're new to the area, or have just gained your amateur licence, give me a call on 9569 6751 (ah) and I'll send one to you.

MDRC 50th Anniversary Dinner

Here's advance notice of this month's dinner to celebrate the MDRC's 50th Anniversary. It will be held on Thursday November 25, starting 7:30pm. The venue will be the Bentleigh Club in Yawla Street. The Club will subsidise financial members who attend. Keep listening to APC News for more information.

Sunsat Popular

Several MDRC members have recently been enjoying interstate and P29/ZL contacts through the Sunsat 2 metre/70 centimetre repeater satellite. Just a handheld transceiver indoors is sufficient to work the satellite for all but the most distant stations. Last month Tony VK3JED even worked stations via Sunsat from a moving tram. Reports on current Sunsat activity are frequently given on APC News.

Radio on Rails

How did you go in last month's Radio on Rails? The final scores aren't yet out, but if the amount of on-air discussion prior to the contest is any guide, it was a great success. More and more Melbourne amateurs are going bus, train and tram mobile, and there's been a big upsurge in activity since the first MDRC Radio on Rails back in April.

Use 146.550 MHz - our club frequency
What is the MDRC's Club frequency?
It's 146.550 MHz.

You'll hear the Club Net at 7:30pm on Mondays (run by Tony VK3CAT) and the weekly APC News at 8:00pm Wednesdays. There's also activity from club members and others at other times.

So whenever you're in the shack, in the car or out and about set your rig to 146.550 MHz and keep in touch with your fellow club members.

Gold Coast Hamfest

Saturday, November 13th is the date of the Gold Coast Hamfest on the beautiful Gold Coast in South East Queensland.

Close to Brisbane, the Sunshine Coast, Toowoomba and the Darling Downs and closer to many New South Welshmen than Sydney itself. Why not come and enjoy a weekend away in Australia's premier holiday spot, catch up with old friends and share a story or two.

The venue for the 22nd Hamfest is again at the Albert Waterways Community Centre on the corner of Hooker and Sunshine Boulevards, Broadbeach. Doors will open to the public at 0900 on Saturday 13th November 1999.

If you wish to reserve a table or two, or if you have any queries, please contact (07) 5530 5294, or by packet.

(Keith VK4VQ)

Queensland Digital Group

By way of a Xmas Celebration, South East Queensland amateurs please be aware that the QDG have organised a combined visit of VHF/ATV/QDG/Amateurs visit to BTQ-7 Mt Coot-tha on the 28th November, to be followed by a combined BYO BBQ at the Slaughter Falls afterwards. Interested amateurs and particularly new members are welcome.

Graham VK4BB via Qnews.

Historic Yachtsman

A photograph on page 27 of October 1999 AR shows a gaff-rigged yacht named Kestrel sailing in Port Phillip Bay "around 1930".

Its skipper was known to be Noel Toohey, a notable amateur (but call sign not given). The yacht carried a rather elaborate HF antenna, and may have been one of the first amateur maritime mobiles.

Thanks to some research by Ron Fisher VK3OM into pre-war call-books, we now find that Mr F Noel Toohey's call-sign in 1927 was VK3CX, and he lived at The Crescent, Sandringham.

But by 1930 the call had passed to A.G.Brown of Canterbury, who held it until about 1973. It was re-issued in 1974 to Jim Milway (coincidentally, the Editor's brother-in-law!) who died in 1996. The call has now been re-issued once again.

Your Club News

If your radio club has news that is of interest to other amateurs let us know. We have just the spot to publish it.

Women in Radio

ALARA

Christine Taylor VK5CTY

ALARA Publicity Officer

16 Fairmont Avenue

Black Forest 5035

geencee@picknowl.com.au

ALARA ALARAMeet '99 Brisbane



ALARA Group Photograph from ALARAMeet Brisbane - October 1999

Back row Pam VK3NK, Agnas PA3ADR/VK2GWI, Jean VK5STX, Anne VK4ANN, Sally VK4SHE, Margarette VK4A0E, Jennifer VK5ANW and Helene VK7HD

2nd row Meg VK5YG, Aola ZL1ALE, June VK4SJ, Christine VK5CTY, Elwyn VK2DLT, Elizabeth VK3NEP, Shirley ZL2BPX, Eileen ZL1BRX, Marlene VK3QW, Carol ZL2VQ, Cathy ZL2ADK, Muriel May

3rd row. Marilyn VK3DMS, Gwen VK3DLY, Tina VK5TMC, Judy VK3AGC, Bev VK4NBC, Cecily VK4QW, Melva ZL4IO, Jill ZL2BHJ, Bev VK6DE, Sherry KA5VOP

Front row Pat VK3OZ, Patricia ZL1LD, Allison ZL1TXQ, Robin VK3WX, Mary VK5AMD, Dot VK2DB Celia ZL1ALK Raija SM0HNV, Jill ZL2DBO

Missing from the photo are: Dawn VK2HER and Biny ZL2AZY.

THE ALARAMEET

So much planning and anticipation has been concentrated on this gathering of YLs that a pessimist could have expected it to be a flop. The pessimist would have been completely wrong.

The whole event was an enormous success. Altogether 42 YLs (of which 40 are in the group photo on the front cover) attended with 31 OMs joining in the fun. It has always been said that the OMs have as much fun as the YLs, and this MEET confirmed that. Certainly most of the OMs are also licensed but one without a licence, Murray, OM of Mary VK5AMD, stayed the whole course and enjoyed it all, anyway.

The venue was the Kedron Wavell RSL Community Hall, and for the first time all the activities were held in the same hall. While we had our first get-together, tables were set up in the other part of the hall for lunch, and later that evening we had a formal dinner there, which was all prepared while we were out seeing the sights. This system worked very well as it meant we could move from one part of the hall to the other as necessary.

We even had enough room for the group photos without doing anything worse than borrowing some chairs from around the tables. There were a couple of problems with photographs with one gentleman missing the opportunity of a lifetime - to be

surrounded by lovely ladies - and another thinking that he had a 36 shot film after he had been told it was a '35mm' film. That's the trouble with photographers and non-photographers trying to talk the same language. But as is obvious, all the problems were overcome.

There were 25 ZLs, two from the US and one from Finland at the MEET. After the Perth ALARAMEET where there were 13 or 14 ZLs we were warned that there would be more in Brisbane and they lived up to their promise. It was lovely to see them all there and to meet Raija SM0HNV again, whom many of us had met for the first time in Perth. For Sherry (KA5VOP) and Matt (KA5NGO) it was the first visit to Australia, newcomers to Australia were Agnes VK2GWI (ex PA3ADR) and Henk VK2GWK (ex PA0ADC) and Melva VK4TP (ex ZL4IO) and Edwin VK4CYI (ex ZL2AOI), though they have all settled here. For them it was the first ALARAMEET as it was for several of the VKs. Let us hope it will not be the last one.

Although the official beginning of the meet was not till the Saturday morning, over 40 of us sat down to an informal meal on the Friday evening. It was a lot of fun to greet people we have not seen for three years as well as those we see more often. For me it was the first time I had met Sally who was a hard act to follow as ALARA correspondent to AR and it was a surprise to see Raija as I had not known she was coming.

Only Celia ZL1ALK and Geoff ZL1AKY came to the informal dinner as the other New Zealanders had just arrived in Brisbane by plane and had had a meal in flight. They had a snack in another room of "The Crushers Club" instead. As was the case in Perth, Muriel and OM Niel VK3KNM acted as chauffeurs for the ZL group through out the weekend. Those with cars did the same for those who were in Brisbane without transport.

There were two particular innovations this time. All those present were given a certificate of participation and we all took home a copy of the group photograph. Both items will make nice mementos of an enjoyable weekend filled with sightseeing and talk.

ALARAMEETS are not business meetings, they are opportunities for amateurs, particularly YL amateurs, to meet each other face to face and to have some fun together. Gifts are made and sent along to be admired and exchanged. Special craft items that show our interests are put on display on another table. Visitors are welcome to share the happiness we feel at being together.

On Saturday afternoon we were taken by

Women in Radio

bus to the Southbank where we were free to wander among the craft stalls and entertainments of the River Festival. Over the years the export business of Brisbane had moved from the centre of Brisbane to the mouth of the river. This had left many riverside buildings empty.

Visitors to Brisbane for the first time were told of the World Expo held on the site where once there had been wharves and storage sheds. Since the Expo the whole area has been developed into a marvellous open-air boulevard for all to enjoy. If you went to the World Expo or saw images of it on TV you will know what an enormous area was involved in that enterprise. Our visit made it obvious to us, just how close to the centre of Brisbane Expo had been.

On Sunday morning we were taken on the river where our guide told us some of the history of Brisbane and its river. Then in the evening, after the official closing ceremonies, most of us went in buses to Mount Coot-tha to see the city lights surrounding us. After we had had our fill, we were taken again to the river this time to board one of the City Cats (catamarans that constantly carry passengers up and down the winding river) to see the lights from a different perspective.

On Monday many of us went by bus to the shore of Moreton Bay where we were taken by boat out to St Helena Island. St Helena was a terrible prison island used only for the most recalcitrant criminals from the eastern states as well as from other prisons in Queensland.

Two young men, only identified by numbers because this is how prisoners were known, showed us around. The conditions for the prisoners were quite unimaginable to modern eyes. The punishments for what would seem today to be minor infringements of the rules were all graphically described to us by our guides. They also told us of some of the crops grown and the way that even so long ago, the prison was expected to be (and was) self-funded.

The guides demonstrated other skills as we were leaving the island. We were overtaken by a violent storm. We were all drenched right through, as were the guides. Nevertheless they had to go out on the deck in the pouring rain and violent wind to release the mooring ropes. The skill and courage they exhibited was remarkable, as was the captain's control of the ship in very difficult sea and wind conditions.

Introducing

ALARA

The letters stand for Australian Ladies Amateur Radio Association and the organisation specifically represents the interests of the YL (Young Lady) amateurs and the XYLs (wives) of amateurs.

It has affiliations with YL groups in many other countries.

The idea of forming a group to promote the interests of women in amateur radio was formulated by Norma VK3AYL, then a university student, after frequently finding herself the odd one out at amateur radio functions.

It has never been just for YL amateurs but has always encouraged women to become amateurs while also encouraging the family members of OM amateurs to become members of ALARA.

In the beginning (as LARA) the members organised foxhunts and car rallies as well as running regular nets on VHF and HF. Right from the earliest days there were members from almost every state in Australia. Quite soon the idea of sponsoring overseas YLs into ALARA was mooted, with reciprocal membership into their organisations. Currently there are over 200 members of which just under half are overseas members.

There is a DX net on 14.222 MHz on Mondays at 0530UTC where you will often hear ALARA YLs talking. Some of the ladies are able to talk this way to the YLs they sponsor and many of them have met each other during overseas tours.

ALARA conducts monthly meetings on air, including the AGM and has a regular HF Net on Mondays. A number of the states also run VHF Nets once or twice a week. All the members receive four Newsletters each year and are kept informed of matters through the ALARA column in Amateur radio.

The ALARA Contest, run over the second weekend in November, puts more emphasis on meeting friends than on exchanging numbers. OM and Club stations are encouraged to participate and when conditions allow DX stations can be heard. Both men and women can apply for the ALARA Award if they work ten YL stations in at least five states of Australia. The ALARA Contest is a good way to hear the more elusive callsign areas.

The YL who scores the most for CW only contacts in the ALARA Contest is awarded the Florence McKenzie Trophy. This is one way of recognising VK2FV the first licensed VK YL and the important part she played teaching Morse Code to a great number of men and women, within the armed services in WWII, and also encouraging all amateurs to use the code.

ALARA has a quarterly newsletter in which news and items of particular interest to YLs is distributed.

In several states there are monthly luncheons and each year ALARA's birthday is celebrated with a luncheon on the fourth Sunday of July and a special chat session on 80 metres on the Saturday night.

Once every three years an ALARAMEET is held where the YLs (and many of their OMs) can meet face to face. By holding these weekends in different states as many as possible of the members of ALARA have a chance to fit faces to the voices they hear on their regular Nets.

For up-to-date news visit ALARA's Homepage on:
<http://homepages.tig.com.au/~bishops/al>

Women in Radio



Jill ZL2DBO, Cathy ZL2ADK, Patricia ZL1LD, Carol ZL2VQ and Biny ZL2AZY.

Once safely on our way back to shore it was a most happy group. We were all absolutely sopping wet (though, remarkably not cold at all) whereas without the storm we would probably have been aware of the

hills we had walked up and down and the terrible things we had heard about.

We decided that the storm had ended the ALARAMEET with a bang - of thunder and lightning - rather than with a whimper.

SPECIAL PRESENTATIONS

For Bev VK4NBC who so ably masterminded the meeting there will be an extra memento of the occasion. Bev was presented with a mounted Morse key given in recognition of the achievement in winning the Florence McKenzie Trophy three times. It is possibly that someone will win this trophy three times sometime in the future, but now that the rules allow all YLs to strive for the highest CW score, Bev's achievement in winning it when only a Novice could do so, cannot be repeated.

Dave ZL1AMN, who so ably runs the 222 Net for YLs around the world, received best wishes from all those at the ALARAMEET for his birthday. Dave was presented with a birthday card that had gone around the world to be signed by all his regular Young Ladies. He was quite overcome. That is a birthday card that will always hold a very special place on his "memory wall".

Just before the end of the official business, as conveners of the event, Jill ZL2DBO, Cathy ZL2ADK, Patricia ZL1LD, Carol ZL2VQ and Biny ZL2AZY



Bev VK4NBC parsing the ALARA banner to Jean VK5TSX as the convener of the next ALARAMEET.

offered a special invitation to us all to come to New Zealand next year for the International YL2000 in Hamilton next October.

To close the ALARAMEET the banner was removed from the wall and presented to the next convener. This year we had to vote for the location of the next MEET as both Murray Bridge and Alice Springs had been suggested. The decision was Adelaide by ten votes so the banner was handed to Jean VK5TSX as the coordinator. She invites all YLs (and their OMs) to join us in Murray Bridge, for the first weekend in October in 2002.

THE ALARA CONTEST

Don't forget the ALARA Contest on 13/14th November. It is the friendly contest, OMs and YLs and clubs all welcome. Remember, too that you can have repeat contacts on the same band now. Read the rules elsewhere in this issue.



Judy VK3AGC and Bev VK4NBC.

ar

A SPECIAL EVENT STATION

On Wednesday 22nd September Dot VK2DB was one of a number of operators

who 'manned' a Special Event station from home. They were celebrating the anniversary of the date of the very first Direct Wireless Transmission from Great Britain to Australia.

This transmission was from Wales to Wahroonga, so the station callsign was VK2WAH.

Dot operated on both 21.170 and 28.170 MHz at different times for 12 hours altogether but was disappointed to make only a few contacts.

There are some very special events in the relatively short history of radio transmissions and it is right that we recognise them. It is such a shame that more people do not participate because it makes the task of those who man the stations seem so fruitless.

We know there are always some people out there just listening. Sometimes we even hear them talking to their friends but we cannot persuade them to reply to our calling. If you do hear someone calling for

a Special Event station, why not answer him or her? Even if you are not interested in sending for the special QSL card why not let them tell you what the special event was that they are celebrating? Why not learn something new about our great hobby? Think about it next time, please.

ar



Andrews Communications Systems

(EST. 1976 - ACN 001 968 752)

ALINCO

AUSTRALIA'S FIRST AUTHORISED
FACTORY DIRECT IMPORTER
MASSIVE SHIPMENTS EVERY MONTH
FULL 3-YEAR WARRANTY ON
ALINCO and ICOM
WE SELL MOST BRANDS

BALUNS, VERTICALS, YAGIS, P/S.
ICOM-KENWOOD-JRC-AOR-EMOTATOR-
MFJ-DIAMOND-TIMEWAVE-KANTRONICS
-THP - GARMIN - TERLIN - UNIDEN - ETC
DX-1600 HF LINEARS FROM \$ 3,799

**HUGE RANGE OF ELECTRONICS,
ICOM and ALINCO Radios.**

Over 22 Years of
Professional Sales and Service.
Instant Repairs Fridays
HF Transceivers & Linears Wanted

(02) 9636 9060 or (02) 9688 4201

SHOP 8, 41 BATHURST ST, GREYSTANES.

N.S.W. 2145. FAX (02) 9688 1995

Women in Radio

VK5AMD

—A REMARKABLE YL

If you have ever been travelling along the Duke's Highway through Bordertown and put out a call on 2-metres (or maybe on one of the CB channels) the chances are you have spoken to Mary VK5AMD.

Mary monitors 146.500 and has a scanner running as well, all the time. 2-metres is for the pleasure of contacting other amateurs, CB is mostly for the local users she knows or in case there is a call for her help as a very active member of the SES.

MARY has SES qualifications as a rescue person (including from the high places like tops of silos etc). She has frequently had the unpleasant duty of dealing with some of those horrific car accidents we generally only hear of on the TV News. She doesn't say much but that's not surprising.

She has had an amateur licence for more than 10 years. She got it by sheer hard work, entirely on her own. Her OM is not an amateur and has no skill in that area at all, though he is proud of Mary's achievement and supportive of her activities.

It was her father who introduced her to the world of wireless by showing her all the bits in a radio and explaining them to her. He did have trouble explaining to a child why he called it "wireless" when there obviously were so many wires inside it. Mary decided that an amateur licence would be an asset to a country woman, though her father had always said radio wasn't something for a girl to do.

She saw it as being a useful thing to have particularly in an emergency. So she sent away for the correspondence video program from NSW. She passed the Novice and then the Full Theory with a score of over 90% for both exams. Then she did the Morse and got those, too. If you ask her why she did so well she will tell you it was only because she didn't know how much she had to know to pass the exams. She is a very modest lady.

There is no doubt, Mary puts most of the YLs on the air to shame as far as practising electronics is concerned. She has made her own power supplies.

She makes her own antennas and climbs the tower to install or repair them. She has also made up her own modem kit for packet, -and the list goes on.

When she and her OM come to Town he has a list of tractor or motor parts to collect, she has a list of components to pick up for her next project.

Teaching Sunday-School is an important part of each week and once or twice a year the children in the Kids' Club come to Mary's house for some fun. Sometimes this will be playing in the pool (well, in the dam, really) or using proper climbing gear to climb to the top of her radio tower but sometimes they make something to take home.

Illustrating this article you will see a diagram of a Robot Man or Ginger Bread Man.

He is one of a number of small models she has helped the children to make. Sometimes the Dads are roped in with soldering irons (some of which are REAL farmer-sized ones with 'decent sized' heads) but mostly the models can be made with paperclips as this one can.

The children learn a little electronics as well. They are given a resistor colour chart so the children must identify the right resistor for the right place on the robot - otherwise the robot won't work!!

The circuit diagram is just for our benefit. (Mary keeps a close eye on everything to make sure they do get it right of course, but she makes them think it is all their own doing)

This time the children will take home a robot with flashing eyes. Another time they could have made a

bird that goes "Cheep, Cheep" or a rocket ship that sounds real. Mary has a number of small kits and some "Fun with Electronics" type books so she can always come up with a new gizmo. Is it any wonder that these Kids' Club activities are greeted with joy?

Some of these projects are tried out with her own grandchildren (she has 12 of them) so they also have the fun of making something for themselves. The ladies who talk to Mary on the regular ALARA Monday night Net often hear tales of the fun activities she and her "Grandies" get up to. I almost thing I'd like to be a child again to participate.

For Mary, as for a number of others, one of the highlights of her recent radio life was to speak to Andy Thomas on MIR.

For weeks she watched for the times of MIR's passes and slept with her radio set to the right frequency so she would make that contact. She tried from home a couple of times without success, so she decided she'd have to find a higher spot. Three nights in a row Mary jumped out of bed and into the car, driving to a place she knew was higher, and three times she just wasn't heard. On the fourth night Andy did hear her and they had a contact till he disappeared over the horizon.

She was so thrilled about it that she told everyone she met in the street what she had done. Next thing a reporter from the local paper telephoned and asked for an interview.



It made front page!!

Everyone was delighted for her and quite amazed about it. Subsequently Mary was asked to speak at several meetings in the town. You can be sure Mary took the opportunity to tell people about amateur radio itself as well as about talking to MIR. The photograph shows Mary at the Andy Thomas evening arranged in Adelaide by the West Torrens Council.

As well as all her amateur radio and SES activities Mary is a typical busy country-woman. She cooks cakes and biscuits for

her family, she preserves an assortment of fruit in season and makes jams and pickles. On Monday nights she often makes our mouths water with tales of raspberries and loganberries from the garden as well as the more usual fruits.

Once a year Mary and her OM spend a week at Victor Harbour as house parents to the whole Sunday School which they love but after which they are so tired they need a holiday to recover.

Quite a remarkable lady.

ar

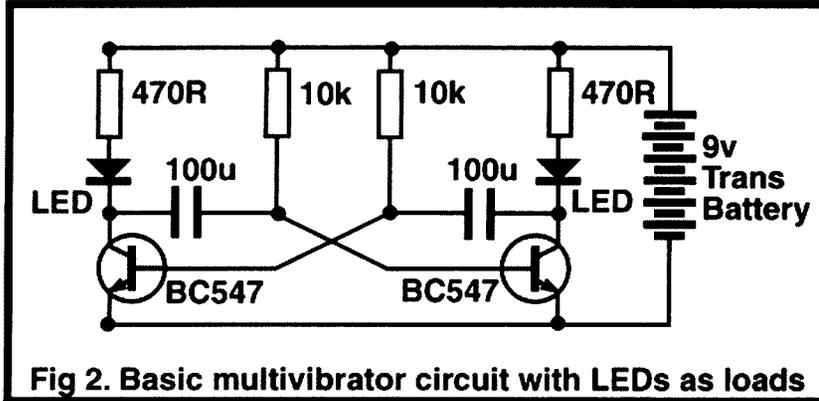

Fig 2. Basic multivibrator circuit with LEDs as loads

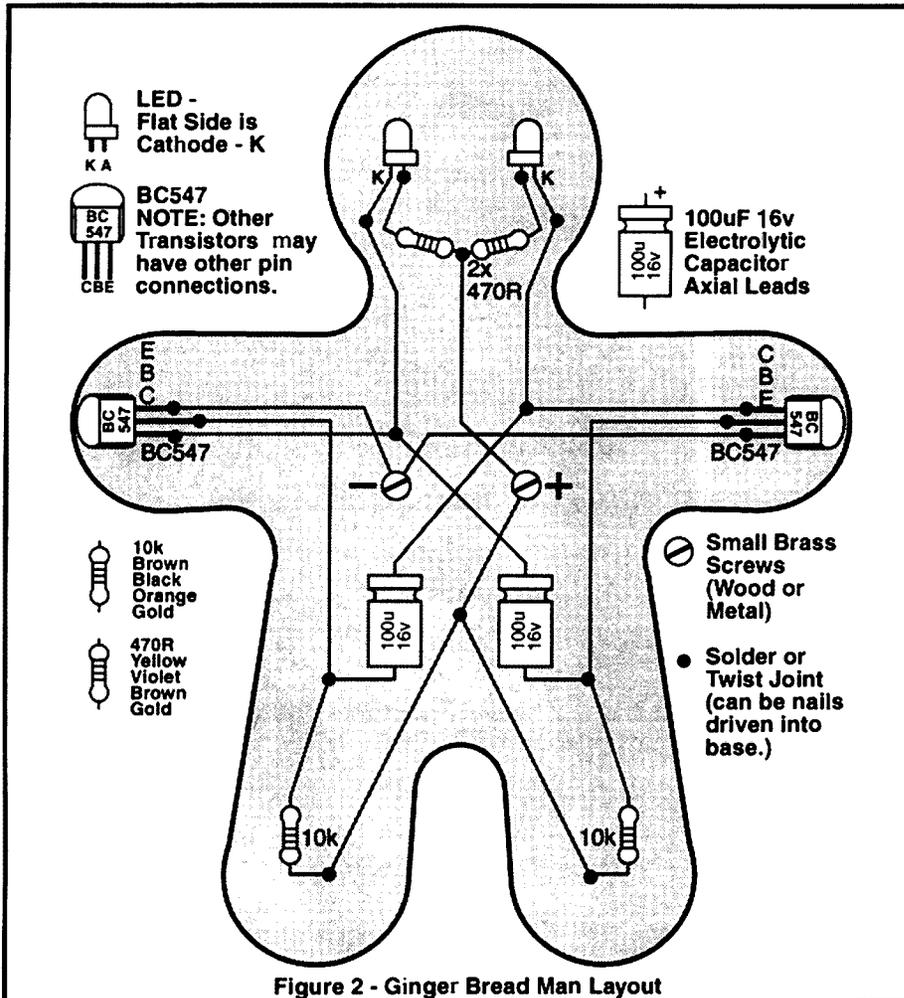

Figure 2 - Ginger Bread Man Layout

icom Clearly Ahead



"VK3LZ calling!"

More sound information from your friends at Icom

EVERYONE'S WAITING FOR NEW UNIT FOR RADIO 'PROS'

The end of November is the expected arrival date of an exciting new unit, the IC-756 Pro. As the name implies this is really a professional unit by any standards. Much more than a mere update of the 756, this unit will be loaded with extra goodies for true professional performance. We'll keep you posted on ETA for the IC-756 Pro.

VERSATILE ALL MODE PERFORMER WINNING FRIENDS

Another unit that has attracted loads of interest since its release, and chalked up some pretty impressive sales, is the IC-R75. This versatile receiver offering HF + 6m all mode performance has attracted a legion of fans. As we do the rounds we keep hearing the same comments... 'great value', 'loaded with features', 'a versatile performer at the right price'.

It seems the IC-R75 keeps winning friends all over Australia.

TWO DAYS TO REMEMBER IN PERTH

Sunday November 7 is the VK6 Hamfest at Bassendean, put on by the Northern Corridor Radio Group.

Saturday December 4 sees an Icom Open Day at Tower Communications in Perth.

"...73"

FreeCall 1800 338 915
290 -294 Albert Street
Brunswick, Victoria 3056
Tel : (03) 9387 0666
Fax : (03) 9387 0022
www.icom.net.au

ACN 006 092 575

L.L. Brown, Adv. 72/9

Women in Radio

AWARDS

John Kelleher VK3DP

Federal Awards Officer

4 Brook Crescent, Box Hill South, Vic 3128 (03) 9889 8393

Each year, about this time, I list a number of Awards directed to all our lovely lady operators. Looking around, I find that they form an integral part, and do contribute greatly to the success of most Amateur Radio Clubs.

Here are few samples of YL awards available, taken from a 1997 list.

ALARA

WARO

CLARA

JA series YL

YL-RL series (USA)

ALARA Award - Australia

VK and ZL contact 10 YL members of the Australian Ladies Amateur Radio Association. Contacts must include 5 VK call areas; others contact 5 in 4 call areas. Contacts on or after June 30 1975. Please, no repeater or 'net' contacts. SWL OK. Endorsements for each additional 10 members. DX only 5. GCR list and 7 IRC for basic award; fee for endorsements is \$A1.00.

The ALARA Awards custodian is :-

Jean Shaw,

10 Huntingfield Drive
Hoppers Crossing
Victoria 3029 Australia.

WARO Award - New Zealand

General requirements. Contact NZ YLs on any mode or band from the same QTH. No repeaters or contest contacts. GCR list and return postage for return to :-

Jeanne Gilchrist ZL4JG

37 Roy Crescent, Concord,
Dunedin 9006
New Zealand.

HF: ZL and VK work 12 WARO members, DX 6. Contacts from June 1 1969. Endorsement seals for ZL and VKs for each additional 12. DX 6. Contacts with DX members of WARO qualify for endorsements, but applications must contain at least 3 ZL contacts.

VHF: 10 VHF contacts with WARO members from Jan 1 1979. Endorsements for each additional 5.

SWLs: ZL and VK list 20, DX list 10 from Jan 1 1979. Endorsements for each

additional 10. (5 for DX).

NZWARO Century Award

Contact 100 NZWARO members (DX members included) from Jun 1 1987. All modes and bands, but each YL claimed must be a financial member at time of contact and may be only counted once. Repeaters, nets and contests are OK. Fee is NZ\$2.00.

NZWARO Mountain Buttercup Award

For contacts with licensed NZWARO members, resident, visiting, mobile etc. in the 60 towns named in the official list (SASE/IRC from manager). All modes and bands, but must have been a financial member at time of contact, and within a 25-km radius of the centre of the town named. Repeaters, nets and contests are OK. Contacts after Jan 1 1989. 30 towns/contacts needed for basic certificate. Stickers for each 5 up to 60. Send SAE and return postage.

CLARA Series - Canada

General requirements; GCR accepted. Apply to

Cathy Hrischenko, VE3GJH,

56 Stockdale Crescent,
Richmond Hill,
Ontario L4C 3S9 Canada.

CLARA Certificate

CLARA members work 12 YL in 6 Canadian call areas (limit 5 VE3); Other YL or OM in Canada work 10 YL in 5 Canadian call areas (limit 4 VE3); DX stations including USA work 5 YL in 3 Canadian call areas (limit 2 VE3). All bands. Contacts after Sept 12 1972. Endorsements available. Fees: VE and USA \$3.00, all others \$4.00.

CLARA Family Certificate

Families must reside in Canada. Work two or more members of the same family to get family status. They need not reside at the same address. Contacts after Jan 1 1975. Log sheets must show full names and relationships of contacts. You get 1 point for the first member of the family, and 2 points for each additional member worked. Remember that you must work 2 or more from the same family. 22 points are needed to earn the certificate. Endorsements for each additional 22 points. Fees: VE and USA \$3, others \$4.

CLARA Ten DX Contacts Certificate

Work 10 YL in different countries from the approved DX countries list. Open to all YL and OM. Contacts after Jan 1 1990. Fee is \$2.00, and a copy of your log sheet.

YL-DXCC

Work YL in 100 different countries from the approved DX countries list. Open to all YL and OM. Endorsements available for each additional 10 YL countries. Fees: VE and USA \$3.00, others \$4.00.

Japan Ladies Radio Society Series

General requirements. GCR list and 10 IRC fee applicable for each award. Endorsement fee for YL-10 is 3 IRC for each group of 10 YL contacts. Member list is available from sponsor for SASE. (Ed: Please note that fees may have risen since 1997).

YL- Alphabet Certificate

Contact 26 licensed YL operators. The last letter of their call signs must represent all 26 letters of the alphabet. No time limitations. Class A for contacts with JRLS members only. Class B for YL anywhere in the world including at least 5 Japanese YL for operators outside Japan. GCR list and 10 IRC to :

Kazuko Isiguro JE2EWW

59-7 Wakinoshima-cho
7-chome Tajimi City
Gifu 507 Japan.

YL-10 Certificate.

Requires 10 confirmed contacts with licensed YL operators worldwide, including at least one Japanese YL. Contacts after Jan 1 1953. Endorsement stickers for each group of 10, though contact with a Japanese YL is not required for endorsements. GCR list and 10 IRC to:

Ayako Inagawa JE3LFH

1-18-11-701 Minamihorie
Nishi-ku Osaka 550
Japan.

YL-CW Certificate

For each of the following 6 awards, GCR list and 10 IRC to :-

Nobuko Nishigori JA3UPR

2-6-11 Hirose-dai, Kaai-machi
Kitakatsuragi-gun
Nara-ken 636
Japan.

YL-CW-AJD

Contact a licensed YL in each of the 10 districts of Japan (1 to 0).

YL-CW-WAJA Certificate.

Contact a licensed YL in each of 43 Prefectures of Japan.

YL-CW-JCA Certificate

Contacts with YLs in 10 different Cities in Japan. Endorsements for each group of contacts with 10 additional different cities.

YL-CW-10 Certificate

10 contacts with different licensed YLs anywhere in the world. Endorsements for each group of 10 additional contacts.

YL -CW- Alphabet Certificate

26 contacts with licensed YL operators world-wide. The last letter of their call signs must represent all 26 letters of the alphabet.

YLRL Series - USA

General requirements.

Contact YLs for a very interesting series of awards. No repeaters. All contacts must be made from the same country. Do not send cards; GCR is encouraged. NO CHARGE for any of the certificates, but sufficient return postage for first class mail or a stamped legal size envelope must accompany the application. The custodian for each award is shown with the appropriate rules.

DX-YL

Available to licensed YL operators only for working 25 different YLs outside your own country after April 1 1958. USA and possessions are counted as separate countries as well as KH6 and KL7. All bands.

Contacts do not have to be with 25 countries, just 25 different DX YLs. GCR list alphabetically by operator's last name. Endorsements for each additional 10 DX YLs. Apply to :-

Phyllis Davis KA1JC

5282 Boyle Terrace, Pt Charlotte, FL 33981
(Oct 10 to July 10)
P.O. Box 1488, Presque Isle, ME 04769 (July
10 to Oct 10)
USA

Worked All Continents - YL

Available to all licensed amateurs. Contact a YL operator in each of the six continents. Cross band contacts are OK. No time restrictions. Apply to :-

Leanna Shaberiy KB8RT

2635 West Sunrise Drive,
Phoenix AZ 85041
USA

Worked All States - YL

Available to all amateurs. Contact a licensed YL in each of the 50 USA States. District of Columbia may be counted for Maryland. No time or band limitations. GCR list alphabetically by State, and to include the YLs first name. Apply to :-

Richea Brigance KU5L

RR2 Box 197
Booneville AR 72927
USA.

YL Century Club.

Available to all licensed amateurs. Contact 100 different YL amateurs. All bands. Contacts with YLs anywhere in the world are recognised as long as the stations were operated by licensed women operators. GCR list arranged by last name of operator. Endorsements for each added 50 stations. Gold stickers awarded to applicants who worked their additional contacts from the same country, otherwise Silver stickers will be awarded. Apply to :-

Le Henderson KB6MXH

857 Tamerack Lane
Sunnyvale CA 94086
USA.

YL - DXCC

Available to all amateurs. Contact licensed YL operators from 100 countries as recognised by the ARRL DXCC list. All bands may be used, but no cross-band contacts. GCR list in order of ARRL DXCC countries list including the YLs name. Endorsements for each added 25 DX countries. Apply to :-

Marty Silver NY4H

3118 Eton Road
Raleigh NC 27608
USA

and one for everyone

OMs YLs and Finally -one late arrival:

Slovenian Diabetes Association -
SLODA

Dunajska 7, SI-1000 Ljubljana

Tel. +386 (0)61 139 94 20

Fax: +386 (0)61 139 94 25

E-mail: sloda@guest.ames.si

Radio Club Radomlje S55T

Presernova 34

SI-1235 Radomlje

Following the initiative of Brian Bott, Secretary of the Tauranga Diabetes Society, New Zealand and also Secretary of the Puke Amateur Radio Club, who licensed Special Events Amateur Radio Station ZL6DNZ to celebrate World Diabetes Day November 14, 1999 and will be transmitting around world wide on 14.2 MHz and 7.1 MHz SSB and CW throughout the day.

The Slovenian Diabetes Association, the full Member of the International Diabetes Federation (IDF) and its regional organisation for Europe (IDF/Europe), together with the Slovenian Radio Club announces the first Special Events Amateur Radio Station, S55T, on a country basis to celebrate World Diabetes Day and to increase public awareness of diabetes.

S55T will be transmitting worldwide on November 14, 1999 throughout the day on
10 m: 28.480 MHz SSB, 28.015 MHz CW, 28.085 MHz RTTY

15 m: 21.220 MHz SSB, 21.020 MHz CW, 21.085 MHz RTTY

20 m: 14.220 MHz SSB, 14.020 MHz CW, 14.084 MHz RTTY

40 m: 7.050 MHz SSB, 7.015 MHz CW, 7.035 MHz RTTY

Any licensed radio ham who makes contact with us will receive a special QSL card via QSL Office to confirm celebration of the World Diabetes Day and the communication.

Regards,

Joze Snoj, S52ZG, President of the Slovenian Diabetes Association, member of the Slovenian Radio Amateurs Association. Ivo Jereb S57AL, Robert Bajuk S57AW, Vito Kregar S56M - Radioclub Radomlje S55T.

All of the above information is considered to be accurate. In some cases, the fees asked may have changed with time. Good luck and good hunting.

73 de John VK3DP

ar

Where on Earth are You?

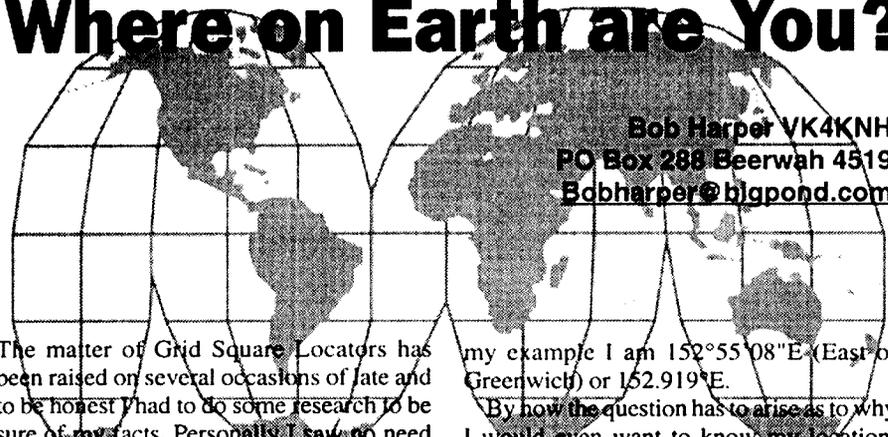

Bob Harper VK4KNH
PO Box 288 Beerwah 4519
Bobharper@bigpond.com

The matter of Grid Square Locators has been raised on several occasions of late and to be honest I had to do some research to be sure of my facts. Personally I saw no need for Grid Squares as latitude and longitude have served so well for so long.

Take my position as an example 26°51'13"S-152°55'08"E would have you within 30m of my QTH. Some may argue that there is no need to be any closer!

Of course exposure to GPS now has us expecting GPS coordinates of each corner of our property accurate to less than a metre. Do we need it?

Now just in case the idea of Latitude and Longitude are a bit rusty, let's review that concept first. The Earth rotates on its axis giving us two poles, North and South. The midpoint around the Earth, between these poles is the equator that circles the earth. Imagine a circle, and as the standard already existed, it made sense to divide circles around the Earth into 360°.

Above and below the equator parallel lines (called "parallel's"!) are drawn, which are all lateral lines. Lateral simply means sideways. The distance from the equator is therefore known as Latitude, measured in degrees North or South to determine which side of the equator the point is on. In my case I am 26°51'13"S or twenty six degrees, 51 minutes and 13 seconds south.

Note that a degree is split into sixty minutes and a minute is split into sixty seconds. That worked fine BC (Before Computers) but to keep the programming easy, decimal degrees can be used as well. 26°51'13"S = 26.854°S. One minute of latitude is equal to one nautical mile or 1.852km. Each second is about 31m.

Longitude

Lines of longitude all pass from pole to pole; all that was required was to agree on a suitable starting point. Late last century, about 1884, the prime meridian was defined as the line of longitude passing through the Royal Observatory in Greenwich, England. The prime meridian is taken as 0°Longitude and a location is defined as the angle between the prime meridian and the line of longitude that passes through that point. In

my example I am 152°55'08"E (East of Greenwich) or 152.919°E.

By how the question has to arise as to why I would even want to know my location, apart from perhaps surveying my property. In amateur radio there are two possible reasons - to calculate a heading for accurate beam/dish pointing or to calculate a distance for claiming a record or a contest score.

The shortest distance around the Earth, regardless of which direction you head, is called the great circle -assuming the Earth to be a sphere. Purists will note that the Earth is slightly oblate but at the age of Earth that is understandable!

The formulas for calculating both the distance and bearing angle for a great circle passing through an origin to a distant point are not difficult to use but need some explaining and so will be left for another article - perhaps in December.

There are also many programs available on the Internet or through members of your own club that will do the maths for you. All you need is the coordinates of the two locations.

Grid Squares or Maidenhead Locators

Maidenhead (51°32'N 0°44'W) is a town west of London, where a group of European VHF managers met in 1980. At that meeting a system was defined to replace around twenty similar Gridmaps from around the world. The "Maidenhead Locator" used a grid, similar to many of the previous grids, but covered the whole Earth and to a better resolution than its predecessors.

The system uses six characters to define a location. The Earth was divided into grid squares 1° in Latitude by 2° in Longitude indicated by two letters and two numbers. Another two letters were added to refine the system to squares 2.5 by 5 minutes.

A map is probably the easiest way to find your location. Now I know that if I show you the easy way first you'll stop before reading the "less easy" alternative -so I'll give that first.

A Maidenhead Locator or Grid Square looks like - QG63kd.

First 2 Characters - Field

Character one defines longitudinal strips 20° wide, beginning at 180°W with the letter "A". I say 180°W because the system then progresses to the East past 0° and on to 180°E. Each successive strip is identified as "B", "C", "D" etc through to "R" making eighteen strips in all. The east coast of Australia, from 140°E to 160°E, is in the strip identified as "Q".

The second character, also a letter, defines parallel bands of longitude each 10° wide starting at the South Pole and progressing to the North Pole. 90°S to 80°S is defined as "A" and each successive band is "B", "C", "D" etc through to "R". The band that includes Perth, Adelaide and all of Victoria is identified as "F". See Fig 1.

The whole of Victoria and most of NSW is therefore identified as being in the "QF" field.

3rd and 4th Characters - Grid Square Numbers

The "field" is further divided into 100 squares. Each square is 1° by 2° and numbered from the bottom left (SW) corner beginning with 00. If you counted up the first strip, 00, 01, 02 03 etc, then the second 10, 11, 12 etc and so forth you would correctly name each square. Sticking with Victoria as QF, Melbourne would be QF22. (I don't know if the Europeans learn about squares in school but in this plan they're not square! Geodesic trapezoids perhaps???) See Fig 1.

Characters 5 and 6

Each square of each field can be further divided into a grid of smaller "squares", 5 minutes by 2.5 minutes. Again the squares are labelled from the bottom left (SW) corner "aa" to the top right (NE) corner "xx", longitude then latitude. See Fig 1.

The Trap

The longitude is marked east and west of the prime meridian and the latitude is marked north and south of the equator but grid squares are numbered from the bottom left corner regardless of latitude and longitude. Therefore you will need to be careful in calculating your position or in writing a program to do it for you. Fig 1 summarises the scheme and will be useful as long as you know your longitude and latitude.

Using the Map

A map of Australia showing grid squares is provided in Fig 2.

The field designators are shown on the map but the squares are not numbered as it would clutter the map. Instead you will need

to read the square numbers from the edge of the map.

Eg Melbourne is in grid QF in the square read from the bottom as 2- and side as -2 making it QF22. Sydney is also in grid QF, square 5- and -6 making it QF56.

To further define your location you can divide each square into another grid of 24

by 24 identified by the letters "a" - "x", or better still read it off figure 1. You will need to know your longitude and latitude down to the minutes. In my case for example my longitude is 152°55', and 55 minutes is "b", (Note that if my longitude was 153°55' it would then be "w".) My latitude is 26°51' and that makes the sixth designator "d".

So after all of that where am I ? - QG63kd. Personally I still prefer 152°55'E,26°51'S but I haven't been bitten by the Grid Square Collecting bug -yet.

ar

First and Second Characters

AR	BR	CR	DR	ER	FR	GR	HR	IR	JR	KR	LR	MR	NR	OR	PR	QR	RR
AQ	BQ	CQ	DQ	EQ	FQ	GQ	HQ	IQ	JQ	KQ	LQ	MQ	NQ	OQ	PQ	QQ	RQ
AP	BP	CP	DP	EP	FP	GP	HP	IP	JP	KP	LP	MP	NP	OP	PP	QP	RP
AQ	BO	CO	DO	EO	FO	GO	HO	IO	JO	KO	LO	MO	NO	OO	PO	QO	RO
AN	BN	CN	DN	EN	FN	GN	HN	IN	JN	KN	LN	MN	NN	ON	PN	QN	RN
AM	BM	CM	DM	EM	FM	GM	HM	IM	JM	KM	LM	MM	NM	OM	PM	QM	RM
AL	BL	CL	DL	EL	FL	GL	HL	IL	JL	KL	LL	ML	NL	OL	PL	QL	RL
AK	BK	CK	DK	EK	FK	GK	HK	IK	JK	KK	LK	MK	NK	OK	PK	QK	RK
AJ	BJ	CJ	DJ	EJ	FJ	GJ	HJ	IJ	JJ	KJ	LJ	MJ	NJ	OJ	PJ	QJ	RJ
AI	BI	CI	DI	EI	FI	GI	HI	II	JI	KI	LI	MI	NI	OI	PI	QI	RI
AH	BH	CH	DH	EH	FH	GH	HH	IH	JH	KH	LH	MH	NH	OH	PH	QH	RH
AG	BG	CG	DG	EG	FG	GG	HG	IG	JG	KG	LG	MG	NG	OG	PG	QG	RG
AF	BF	CF	DF	EF	FF	GF	HF	IF	JF	KF	LF	MF	NF	OF	PF	QF	RF
AE	BE	CE	DE	EE	FE	GE	HE	IE	JE	KE	LE	ME	NE	OE	PE	QE	RE
AD	BD	CD	DD	ED	FD	GD	HD	ID	JD	KD	LD	MD	ND	OD	PD	QD	RD
AC	BC	CC	DC	EC	FC	GC	HC	IC	JC	KC	LC	MC	NC	OC	PC	QC	RC
AB	BB	CB	DB	EB	FB	GB	HB	IB	JB	KB	LB	MB	NB	OB	PB	QB	RB
AA	BA	CA	DA	EA	FA	GA	HA	IA	JA	KA	LA	MA	NA	OA	PA	QA	RA

90°N
60°
30°
0°
-30°
-60°
-90°S

Fig 1. Maidenhead Grid table based on Latitude and Longitude

-180°W -120° -60° 0° 60° 120° 180°E

Grid Fields

Third and Fourth Characters

09	19	29	39	49	59	69	79	89	99
08	18	28	38	48	58	68	78	88	98
07	17	27	37	47	57	67	77	87	97
06	16	26	36	46	56	66	76	86	96
05	15	25	35	45	55	65	75	85	95
04	14	24	34	44	54	64	74	84	94
03	13	23	33	43	53	63	73	83	93
02	12	22	32	42	52	62	72	82	92
01	11	21	31	41	51	61	71	81	91
00	10	20	30	40	50	60	70	80	90

10° -0°
8° -2° } degrees North
6° -4°
4° -6°
2° -8° } degrees South (-)
0° -10°

0° 2° 4° 6° 8° 10° 12° 14° 16° 18° 20° degrees East
-20° -18° -16° -14° -12° -10° -8° -6° -4° -2° -0° degrees West

Grid Squares

Fifth and Sixth Characters

AX	BX	CX	DX	EX	FX	GX	HX	IX	JX	KX	LX	MX	NX	OX	PX	QX	RX	SX	TX	UX	VX	WX	XX
AW	BW	CW	DW	EW	FW	GW	HW	IW	JW	KW	LW	MW	NW	OW	PW	QW	RW	SW	TW	UW	VW	WW	XW
AV	BV	CV	DV	EV	FV	GV	HV	IV	JV	KV	LV	MV	NV	OV	PV	QV	RV	SV	TV	UV	VV	WV	XV
AU	BU	CU	DU	EU	FU	GU	HU	IU	JU	KU	LU	MU	NU	OU	PU	QU	RU	SU	TU	UU	VU	WU	XU
AT	BT	CT	DT	ET	FT	GT	HT	IT	JT	KT	LT	MT	NT	OT	PT	QT	RT	ST	TT	UT	VT	WT	XT
AS	BS	CS	DS	ES	FS	GS	HS	IS	JS	KS	LS	MS	NS	OS	PS	QS	RS	SS	TS	US	VS	WS	XS
AR	BR	CR	DR	ER	FR	GR	HR	IR	JR	KR	LR	MR	NR	OR	PR	QR	RR	SR	TR	UR	VR	WR	XR
AQ	BO	CO	DO	EO	FO	GO	HO	IO	JO	KO	LO	MO	NO	OO	PO	QO	RO	SO	TO	UO	VO	WO	XO
AP	BP	CP	DP	EP	FP	GP	HP	IP	JP	KP	LP	MP	NP	OP	PP	QP	RP	SQ	TP	UP	VP	WP	XP
AQ	BO	CO	DO	EO	FO	GO	HO	IO	JO	KO	LO	MO	NO	OO	PO	QO	RO	SO	TO	UO	VO	WO	XO
AN	BN	CN	DN	EN	FN	GN	HN	IN	JN	KN	LN	MN	NN	ON	PN	QN	RN	SN	TN	UN	VN	WN	XN
AM	BM	CM	DM	EM	FM	GM	HM	IM	JM	KM	LM	MM	NM	OM	PM	QM	RM	SM	TM	UM	VM	WM	XM
AL	BL	CL	DL	EL	FL	GL	HL	IL	JL	KL	LL	ML	NL	OL	PL	QL	RL	SL	TL	UL	VL	WL	XL
AK	BK	CK	DK	EK	FK	GK	HK	IK	JK	KK	LK	MK	NK	OK	PK	QK	RK	SK	TK	UK	VK	WK	XK
AJ	BJ	CJ	DJ	EJ	FJ	GJ	HJ	IJ	JJ	KJ	LJ	MJ	NJ	OJ	PJ	QJ	RJ	SJ	TJ	UJ	VJ	WJ	XJ
AI	BI	CI	DI	EI	FI	GI	HI	II	JI	KI	LI	MI	NI	OI	PI	QI	RI	SI	TI	UI	VI	WI	XI
AH	BH	CH	DH	EH	FH	GH	HH	IH	JH	KH	LH	MH	NH	QH	PH	QH	RH	SH	TH	UH	VH	WH	XH
AG	BG	CG	DG	EG	FG	GG	HG	IG	JG	KG	LG	MG	NG	OG	PG	QG	RG	SG	TG	UG	VG	WG	XG
AF	BF	CF	DF	EF	FF	GF	HF	IF	JF	KF	LF	MF	NF	OF	PF	QF	RF	SF	TF	UF	VF	WF	XF
AE	BE	CE	DE	EE	FE	GE	HE	IE	JE	KE	LE	ME	NE	OE	PE	QE	RE	SE	TE	UE	VE	WE	XE
AD	BD	CD	DD	ED	FD	GD	HD	ID	JD	KD	LD	MD	ND	OD	PD	QD	RD	SD	TD	UD	VD	WD	XD
AC	BC	CC	DC	EC	FC	GC	HC	IC	JC	KC	LC	MC	NC	OC	PC	QC	RC	SC	TC	UC	VC	WC	XC
AB	BB	CB	DB	EB	FB	GB	HB	IB	JB	KB	LB	MB	NB	OB	PB	QB	RB	SB	TB	UB	VB	WB	XB
AA	BA	CA	DA	EA	FA	GA	HA	IA	JA	KA	LA	MA	NA	OA	PA	QA	RA	SA	TA	UA	VA	WA	XA

60° -0°
50° -10°
40° -20° } minutes South (-)
30° -30°
20° -40°
10° -50° } minutes North

0° 10' 20' 30' 40' 50' 60' 70' 80' 90' 100' 110' 120' minutes East
-120' -110' -100' -90' -80' -70' -60' -50' -40' -30' -20' -10' -0' minutes West (-)

Sub-squares

Fig 2. Map of Australia showing Grid Squares

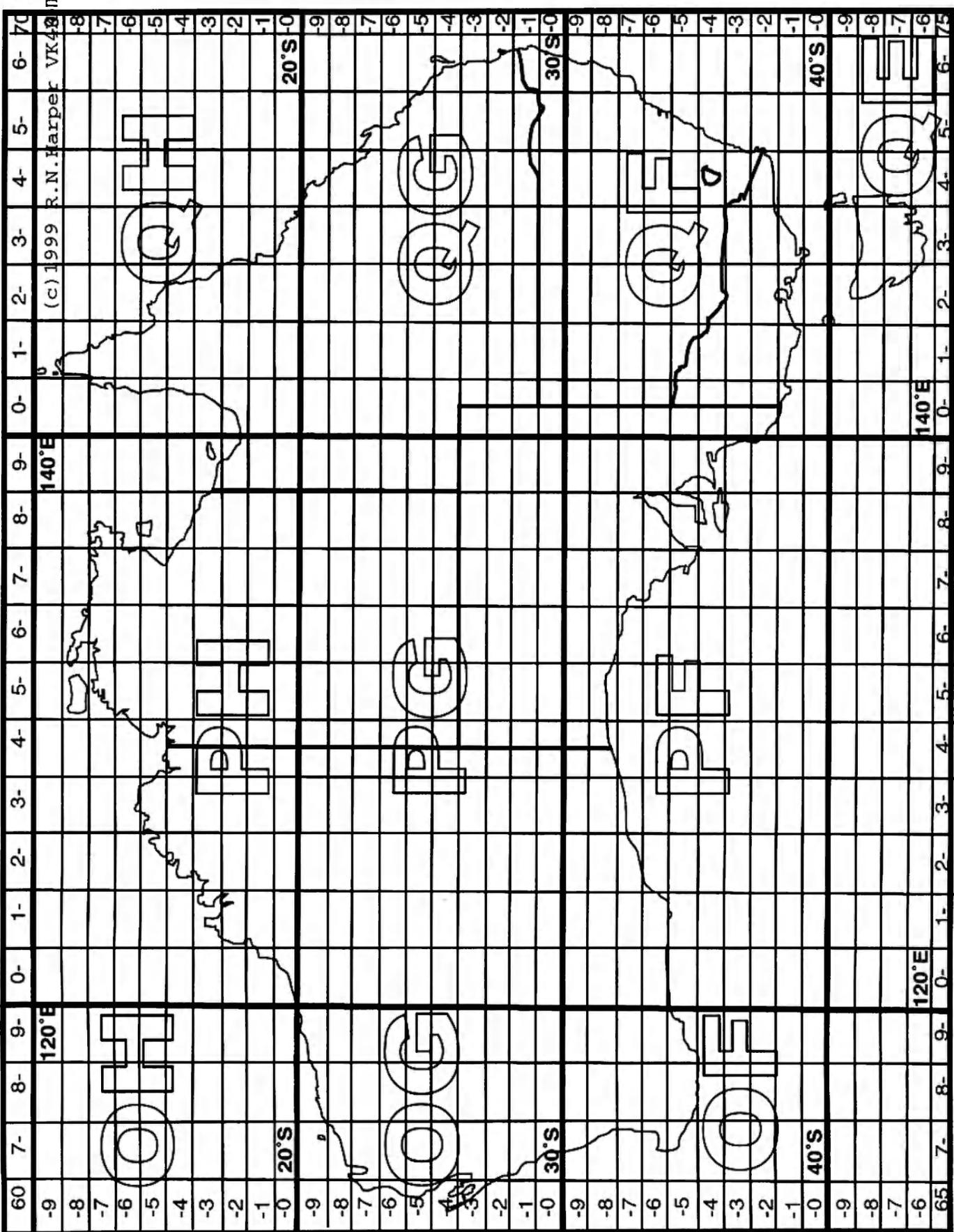

Stacking Yagis

Phasing and Matching

Gordon McDonald VK2ZAB
59 Wideview Road
Berowra Heights
NSW 2082

This is the synopsis of a talk presented to the Sydney VHF DX Group on Tuesday March 16th 1999 by Gordon McDonald VK2ZAB.

When stacking Yagis is being considered the questions which usually arise are :-

- What are the reasons for stacking anyway?
- Would a bigger Yagi better suit our needs?
- If we stack what order of gain increase can we expect?
- Is it better to stack vertically or horizontally?
- How far apart do we stack the Yagis?
- How do we manage the phasing requirements?
- How do we manage the matching requirements?

I will endeavour to answer these questions succinctly.

Why We Stack.

We stack Yagis in order to increase the gain over that obtainable from one Yagi and/or to decrease the beamwidth. The increase in gain is due to the reduction in beamwidth and it should be noted that the beamwidth is reduced in the plane of stacking only. If we stack vertically the beamwidth is decreased in the vertical or H plane of a horizontally polarised Yagi. Stacking horizontally results in a narrower beamwidth in the horizontal or E plane of a horizontally polarised Yagi. In some applications, such as interference from or to points off to one side or below the main lobe, the reduction in beam width is a more important consideration than the gain increase. However most people stack to get more gain.

Can We Use A Bigger Yagi Instead?

Yes of course we can. The increase in gain due to stacking two Yagis approaches the limit of 3dB. We will see that this limit is overly optimistic in practice. Nevertheless it is theoretically possible. So how much

bigger would we have to make a Yagi in order to increase the gain by 3dB? If you think about it the answer is obviously about twice as big.

Consider Figs 1a and 1b. This is a fairly big 2m Yagi with 13 elements on a six-metre boom. It has a gain of 12.74dBd and a clean pattern. That is a pattern that has low side lobes in relation to the main lobe.

Now look at figs 2a and 2b. This is the same basic Yagi with its boom extended to twelve metres in length, elements added as required and the whole subjected to some optimisation adjustments to clean it up a bit. Note that it too has a clean pattern. Its gain of 15.55dBd is not quite a 3dB increase over the original, but close.

So would you put that up? That boom is 40 feet long. How is your rotator going to stand up to the extra torque when the westerlies hit it? How will your neighbours feel about it hanging over their backyard? No thanks I would rather stack two of the six metre jobs. Still the choice is yours.

Some one may suggest that there are additional feeder losses in the stacked arrangement due to the need to connect two Yagis together. This is true but there is also extra feeder loss due to the need to connect your feeder to the dipole that will be further out from the mast with the single Yagi. There is not much in this argument.

Horizontal Or Vertical Stack?

What is your application? Do you think that it would be better to have a wide beam width in the H plane of your horizontally polarised antenna because you are into meteor scatter? Then stack horizontally. Are you concerned that the power density due to your transmissions is high in your

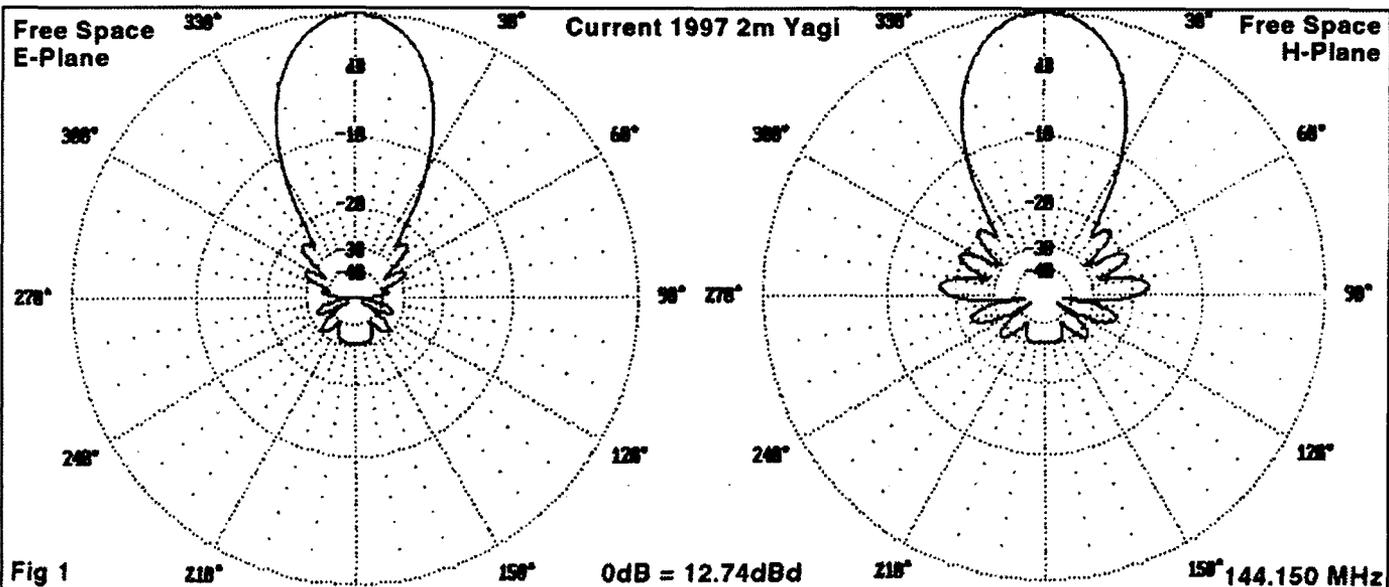

neighbour's kitchen and that it would be better if you had a narrow beam in the H plane? Stack vertically.

Is there a source of noise twenty degrees off to one side of your most used beam heading? Stack your horizontally polarised antennas horizontally. Are you interested in weak signals and want simply more gain? Stack four Yagis two up and two across. Again it's up to you.

However remember that horizontal supports near a horizontally polarised Yagi may give rise to destructive interaction.

How Far Apart Do We Stack?

The old rule of thumb was to stack at two thirds of the boom length. This idea was presumably based on the aim of achieving a 3db increase in gain over one Yagi. Look at Figs 3a and 3b. This is the Yagi of Fig 1

stacked at half and two thirds of the boom length. Note that at half the boom length large lobes have appeared on each side of the main lobe and 14 db down. These are called grating lobes and they are due to the pattern multiplication process so that they appear within the area of the main lobe of a single Yagi. The gain increase is 2.85 dB.

At two-thirds the boom length the gain has increased to slightly more than 3 dB over one Yagi according to the computer and the grating lobes have increased to less than 8 dB down on the main lobe. If you had intended to reduce interference from or to some point off to one side or down from the main lobe this is obviously not going to help much. In fact the pattern has become very dirty.

Digressing a bit:

This idea of a 3dB increase in gain by

stacking two Yagis is explained in some texts by invoking the concept of capture area. It is explained that the 3dB gain is obtained when the capture areas do not touch and do not overlap. However this idea does not lead to a stacking distance because although the capture or effective area can be calculated by $A = \text{Gain} \times \text{Wavelength} / 4\pi$, this does not define the shape of the area.

There is no doubt that the capture or effective area idea is very useful in some other aspects of antenna engineering. It is dealt with at length by Kraus in his book

Antennas.

Returning to Fig 3b, note that the main beam width is half that of a single Yagi. This is where the 3dB increase comes from. The beam width in the non-stacked plane (E plane in this case) has not changed.

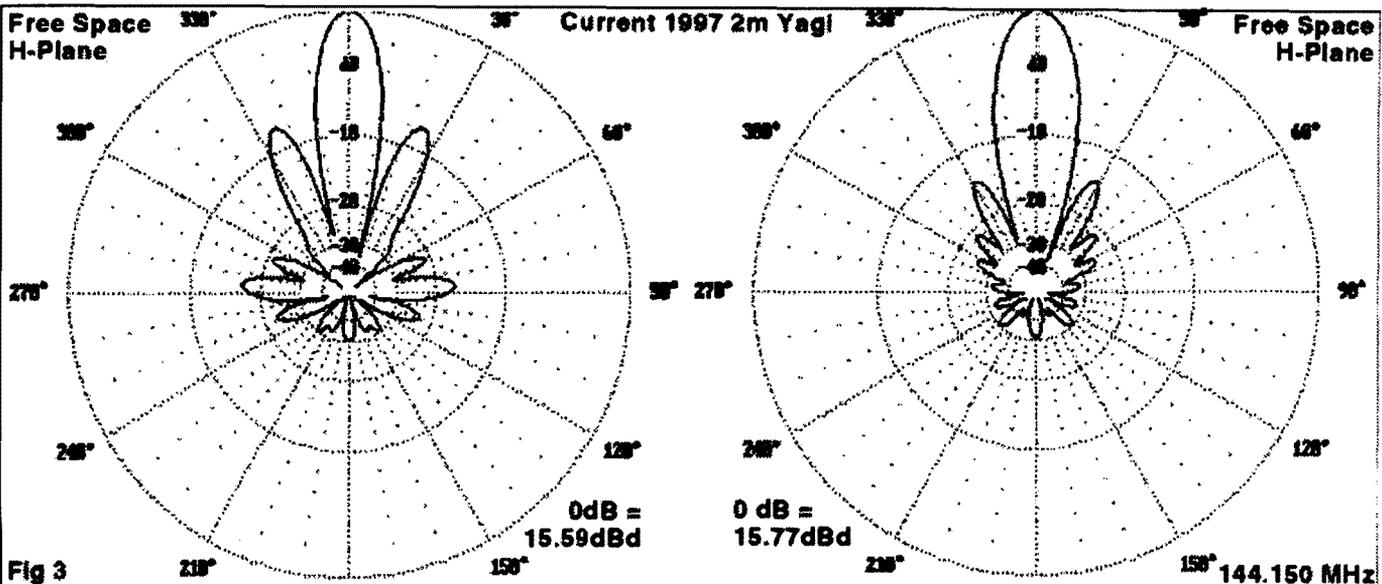
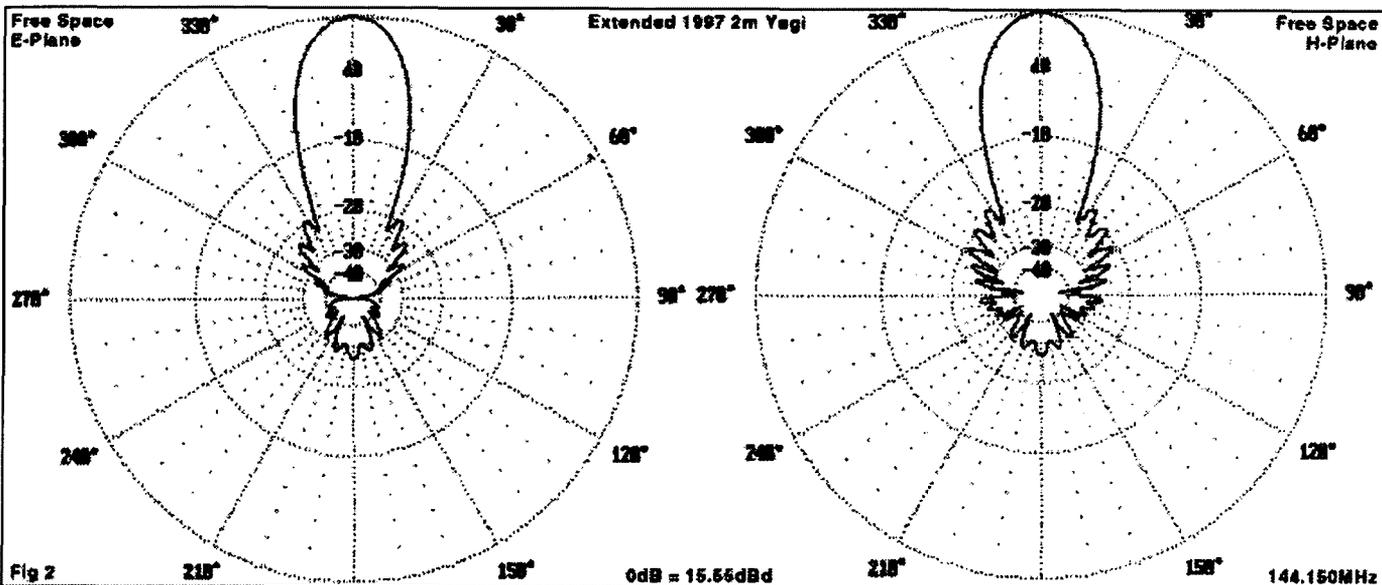

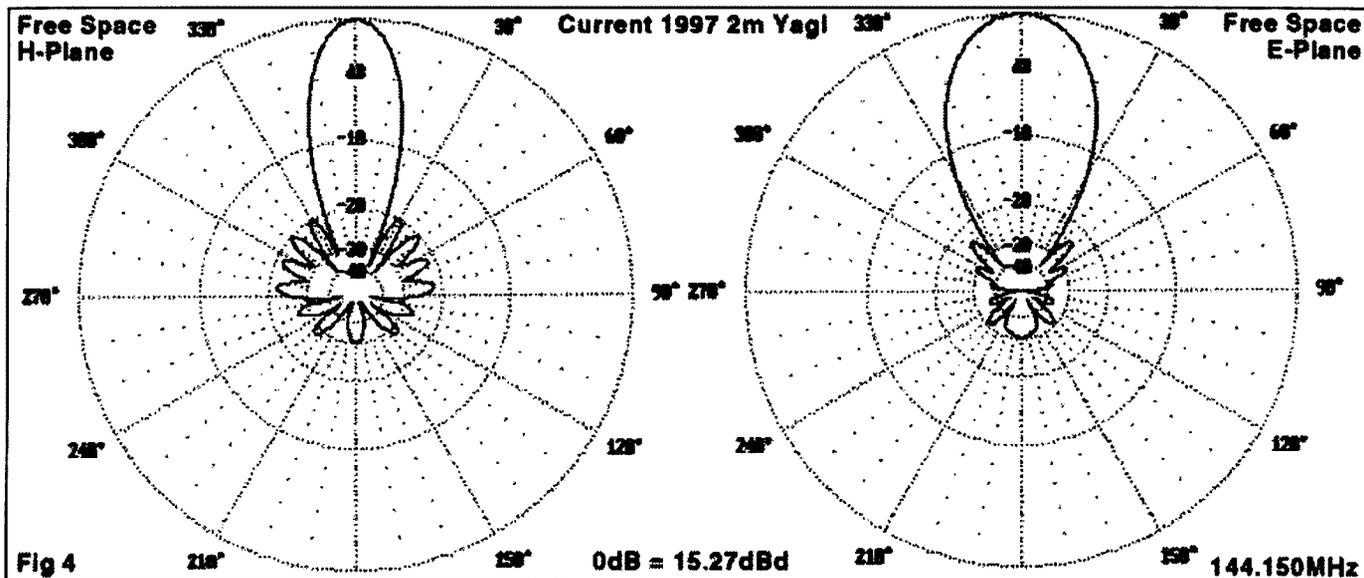

Now look at Figs 4a and 4b. This shows the pattern for the original Yagi stacked at 2.6metres or 1.25wavelengths. Note the clean pattern, -no large grating lobes. The gain increase is slightly more than 2.5 dB over a single Yagi. Most VHF DXers including moonbouncers now agree that this is the way to go. It has a better performance in terms of signal to noise ratio than an arrangement with more gain and a dirty pattern.

So does this mean that we stack all our Yagis at 1.25 wavelengths apart? -certainly not. Remember that the grating lobes are within the area of the main lobe of the single Yagi. So if the single Yagi has a narrower beam to start with we can stack further apart without bringing up large grating lobes. Fig. 5 shows the 12 metre boom Yagi of Figs. 2a and 2b stacked at 4 metres or about two wavelengths.

Recommended Stacking Distance.

As we have seen this is related to the beamwidth of the Yagi you intend to stack. Joe Reiser W1JR reduced this relationship to a simple formula in his articles on Stacking Antennas in the April and May 1985 issues of Ham Radio. He says that providing your Yagi is clean to start with, which means that its side lobes are down more than 18 dB on the main lobe, you should stack at a distance in wavelengths of 57 divided by the 3dB beamwidth in degrees. This will give you a gain increase of more than about 2.8 dB with grating lobes 13 dB down on the main lobe. This is somewhat similar to Fig 3a.

I agree with the formula but I feel that grating lobes only 13 dB down is not good enough so I RECOMMEND that, provided that your Yagi is clean to start with as

defined above, you should stack at a distance in wavelengths of 52 divided by the 3dB beamwidth in degrees.

This will give you a gain increase of more than 2.5 dB over a single Yagi and grating lobes that are better than 17 dB down on the main lobe.

How do you determine the 3dB beamwidth of your Yagi? If you are going to buy the Yagis look on the manufacturers data sheet. If this is not supplied, don't buy the product. If you have the Yagi optimiser program YO5, which was used to produce the patterns of our Yagi examples, or YO6 which is an updated version you are in business. (These are supplied by Brian

Beezley K6STI)

If you intend to stack Yagis which you made from dimensions in a book you will have to measure the beamwidth by rotating the Yagi while watching the signal level from a test oscillator or beacon. In this case it will be easier if you note the angle between the first nulls each side of the main lobe. The 3dB beamwidth is near enough to half this angle. Of course this only gives you the beamwidth in one plane. E plane if you are horizontally polarised, H plane if you are vertical.

For Yagis with boom lengths of three wavelengths the E plane beamwidth is about 88% of the H plane beamwidth. If the

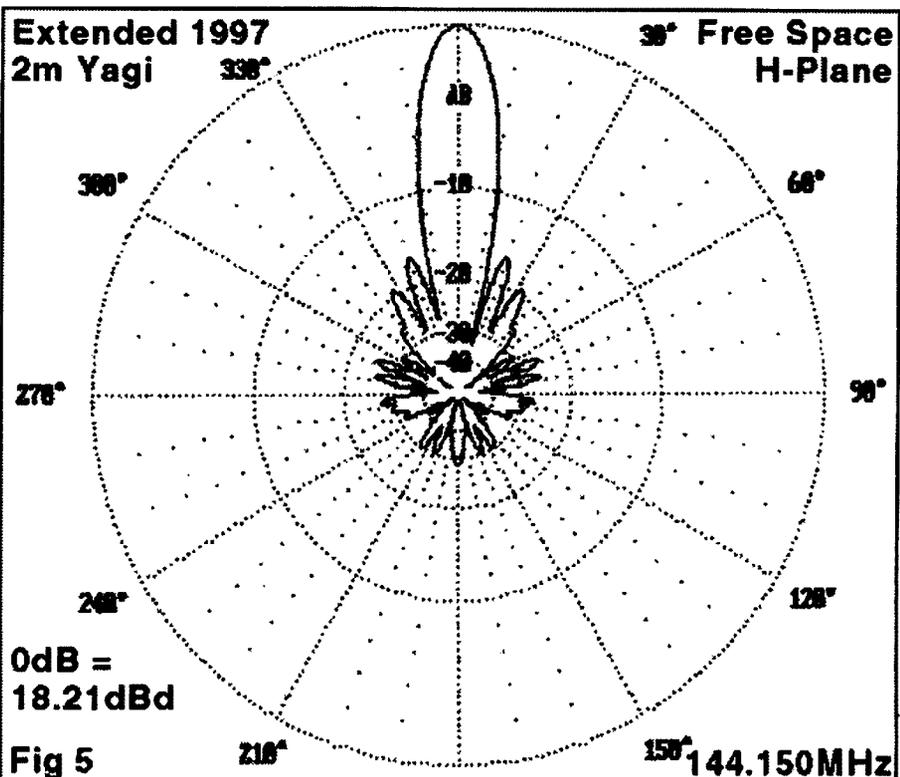

boom is 4 wavelengths E is about 89% of H. If boom is 5 wavelengths E is about 91% of H and if boom is 6 wavelengths E is about 92% of H. This means that the recommended stacking distance is always

greater for the E plane than it is for the H plane.

Phasing.

There isn't much to this. It simply means

that, looking at the stack as a receiving antenna, signals from all the dipoles must be in phase at the feeder junction to the line to the shack. This in turn means that the left-hand side of all dipoles in the array must be

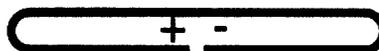
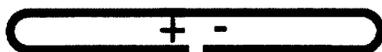

Folded Dipole Array

Connect + to +

and - to -

throughout array.

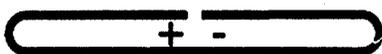

Connection to Down Lead. (Tee Piece)

NO ! - Wrong!

(a)

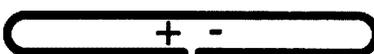

Unequal Lengths

NO ! - Wrong!

(b)

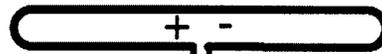

Equal Lengths in Phase

YES ! - Right!

(c)

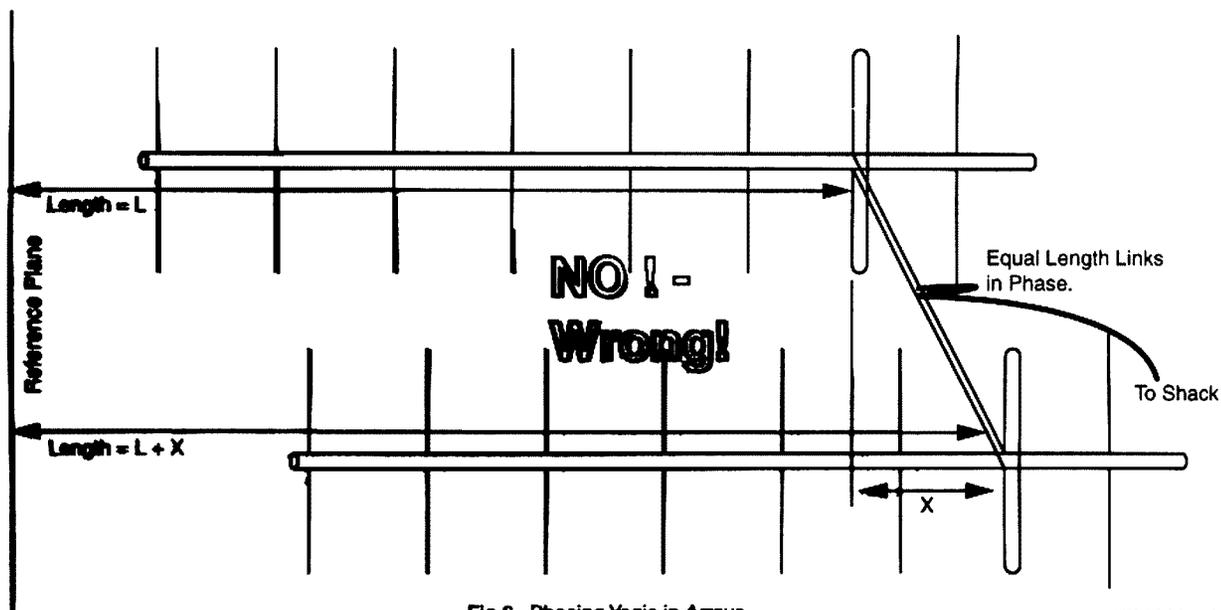

Fig 6. Phasing Yagis in Arrays.

(C)1999 - WIA

connected to the left hand side of all other dipoles in the array. The feeders from each dipole must be the same length as the feeders from each other dipole connected to the same junction and the feeders from any sub-junction must be the same length to the main junction as the feeders from any other sub-junction.

It also means that each Yagi must be mounted so that the distance from its phase reference point (the dipole) to a reference plane in front of the array is the same as that of all other Yagis in the array. Departures from these rules are possible for special applications outside the scope of this discussion.

Refer to Fig. 6.

Matching.

There are two categories here. There are

those who buy Yagis and those who build them.

Those who buy almost invariably have Yagis with a coax lead attached providing a 50 ohm unbalanced connection to each antenna. This limits the number of options available. Home brewers have an almost unlimited range of possible ways to hook up their stack.

(a) Users of store bought Yagis.

If you are in this category about the only thing you can do is to connect the individual Yagis to the common junction by means of quarter wave matching transformers of such impedance as to transform the 50 ohms of each Yagi to that impedance which is equal to $50\sqrt{N}$. Where n is the number of Yagis in the stack. Then of course the parallel

impedance of the lot finishes at 50 ohms again to match the line to the shack.

The impedance of the matching transformers is found by the formula $Z = \sqrt{50N}$. For two Yagis this is 70.71 ohms. For four Yagis this is 100 ohms. For six Yagis this is 122.47 ohms and for eight Yagis this is 141.2 ohms.

These matching transformers are connected to the common connector providing the 50 ohm input/output to the line to the shack in the form of two, four, six, or eight leg power dividers. These are seldom available ready made but are not difficult to make. See Fig 7 for the general idea.

The physical parameters of the air space coaxial matching sections are related to the required impedance by the formula $Z = 138 \log D/d$. Where D is the inside

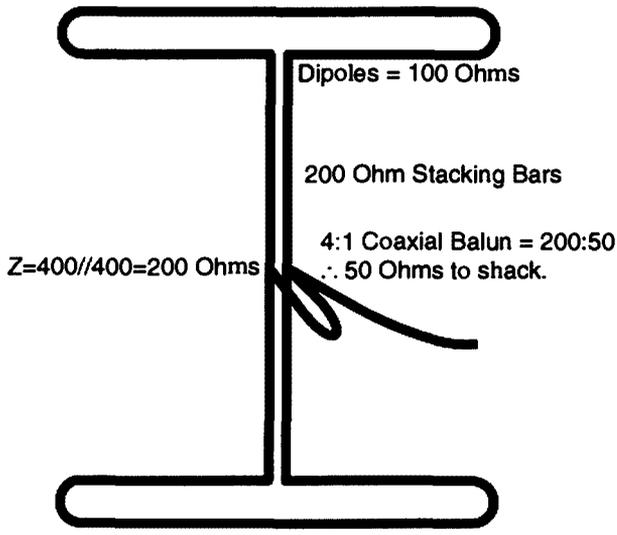

Fig 8a. Stack of Two Yagis

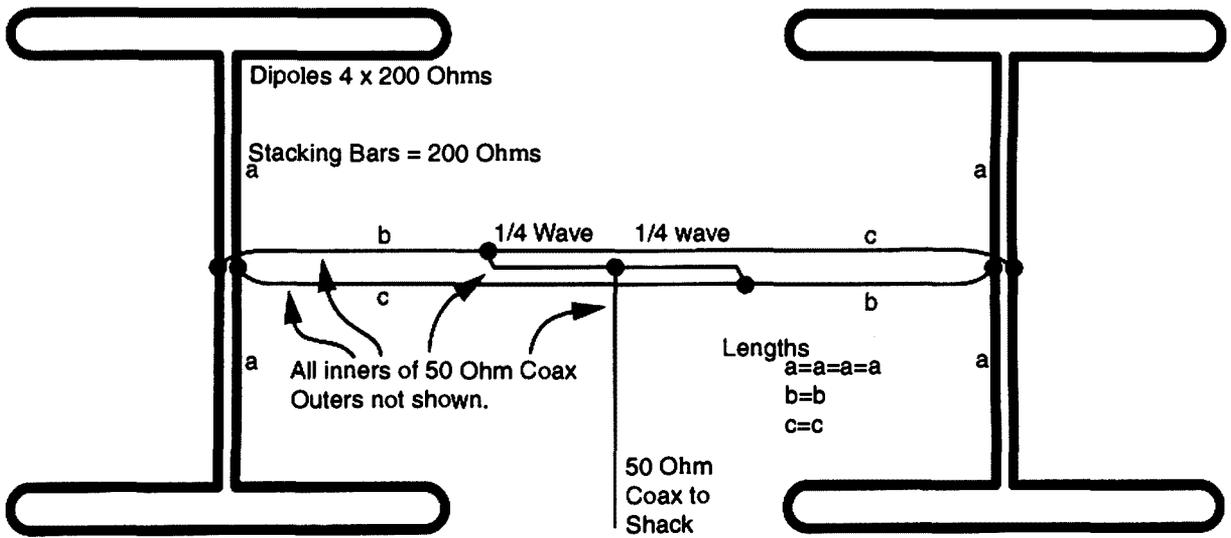

Fig 8b. Stack of Four Yagis

diameter of the outer conductor and d is the diameter of the inner conductor.

(b) Home brewers of Yagis.

There is virtually no limit to the options available and so it is impossible to cover everything. We will therefore limit ourselves to a few examples. For a start you could arrange the connections to your Yagi in the same manner as the store bought examples above and use power dividers in the same manner.

However, home brewers can arrange to have any impedance at the terminals of their dipoles as they like. This is particularly so if the highly recommended, K6STI YO programs are available.

You simply make a folded dipole of such impedance transformation ratio as will bring the straight dipole impedance of your Yagi up to the terminal impedance desired. A two conductor dipole with the two legs the same diameter multiplies the impedance by four times.

A three conductor, same diameters, dipole multiplies by nine times and any other ratio may be fabricated using different conductor sizes for a two conductor dipole. A chart providing a straight-line approximation of conductor sizes for different impedance ratios is in the ARRL Antenna Book.

This freedom of choice facilitates the use of open wire interconnecting lines for your stack. The use of open wire lines is rarely recommended by hams in the northern hemisphere because they have weather conditions which can cause the build up of ice and snow which changes the impedance and loss of lines.

We don't. All we have to worry about is water. Provided our lines are made so that the space between the conductors is not closer than about 6 mm or 1/4" there will be no problem with water bridging the lines.

Properly made open wire lines have less loss than coax. They may be made of aluminium tubing with diameters of 9.5

mm, 6.35 mm, or 4.7 mm with few spacers so that they may also double as boom braces. The loss is related to the spacing, which should not exceed about 1/12 of a wavelength. This means that they are practical up to the 23cm band.

Practical line impedances are therefore between 300 ohms and 150 ohms minimum.

In a stack of horizontally polarised Yagis, it is recommended that the vertical runs of interconnecting lines be of the open wire sort. If this is done with aluminium tubing the lines are referred to as stacking bars. The relationship between the line impedance and the line dimensions is given by $Z = 120 \text{arc}(\cosh(D/d))$ or approximately by $Z = 276 \log(2D/d)$ where D is the centre to centre spacing and d is the diameter of the lines.

Home Brew Stack Examples.

See Fig 8a. This is a stack of two horizontally polarised Yagis. The dipoles are arranged to have terminal impedances of 100 ohms each. This is transformed to 400 ohms at the junction of stacking bars each 3/4 wavelength long and which may double as boom braces by having the central terminal block mounted on the mast. The two 400 ohms in parallel give 200 ohms which is connected to the down lead to the shack via a 4:1 coax balun of the trombone sort.

If we want to stack four Yagis, two alongside two, we could use this arrangement and simply take the 50 ohm coax from one vertical pair of Yagis to a central junction via a two leg power divider to meet the same length of 50 ohm coax from the other vertical pair of Yagis.

See Fig. 8b. This is a stack of four Yagis using a series / parallel connection that achieves flat lines, balance to unbalance conversion with minimum losses and uses

50 ohm coax. It is a favourite of mine because it is a VK2ZAB original.

The dipoles are arranged to have terminal impedances of 200 ohms each. The Yagis in each vertically stacked pair are joined by 200 ohm stacking bars of any length. The centre of the stacking bars is therefore 100 ohms balanced.

This point is connected to the 100ohm centre of the stacking bars of the other Yagi pair by 100 ohm shielded transmission line in the form of the inners of two 50 ohm coax lines of any length with their outers bonded together at convenient points such as the ends and junctions. Note that the left-hand side of one set of stacking bars is connected to the right hand side of the other set.

These lines have a T connection at points one quarter wavelength each side of the centre of the horizontal 50 ohm coax lines, one to the right of centre, the other to the left.

The impedances at these T connections is 25 ohms to ground and signals present are in phase and unbalanced to ground. We then join these two points to the downlead to the 50 ohm down lead to the shack via a two-leg power divider of 50 ohms impedance which can of course be coaxial cable. The two 25 ohm points are transformed to 100 ohms each in parallel at the centre of the divider and so present 50 ohms to the down lead connection.

Conclusion

Stacking Yagis provides gain and control over the radiation pattern more readily and with less mechanical strain than can be done with bigger Yagis. Do it.

ar

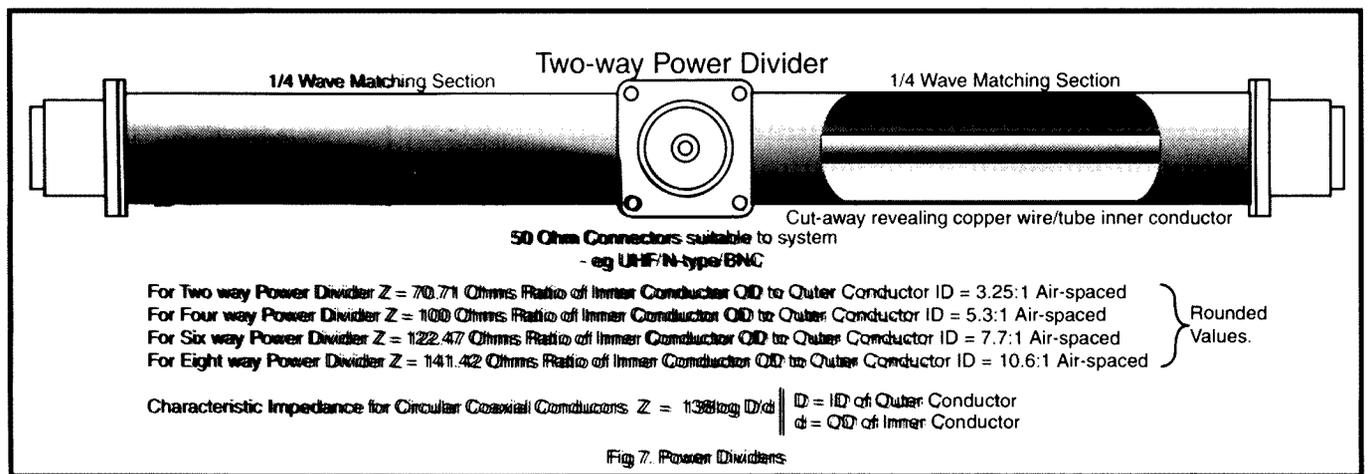

DON'T MISS THE ACTION!

YAESU OPEN DAY!

SATURDAY 13th NOVEMBER 1999

**HUGE SAVINGS ON
EX-DEMO GEAR**

**ON-AIR
DEMONSTRATIONS**

**PLENTY OF ON-SITE
PARKING**

- Special prices on new and ex-demo equipment, with some items below cost!
- See Yaesu's latest release, the FT-90R 2m/70cm micro mobile on display and demonstration.
- A selection of transceiver and accessory samples at really unbelievable prices, many with warranties!
- Qualified amateur staff for advice and assistance.
- See Yaesu's latest computer control software for handhelds and mobiles.
- Huge range of all the latest Yaesu equipment on display plus a large range of antennas and accessories.
- Bring your license with you for on-air demonstrations.
- It's under cover, so come along rain or shine!
- Light refreshments available.
- One Day Sale also running in our North Ryde Showroom, so bring the family for a day of fun and savings.

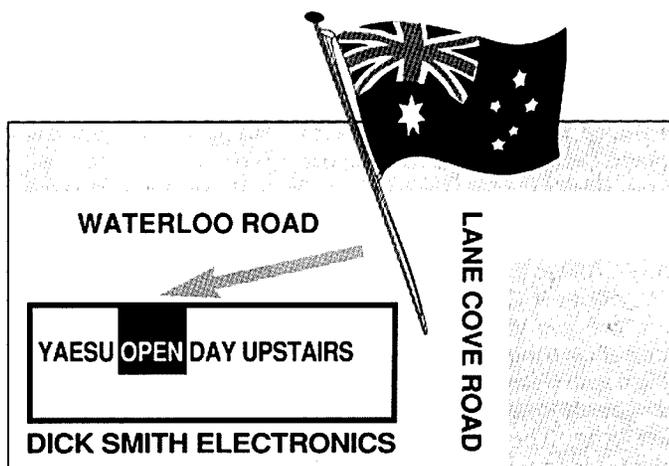

Cnr Lane Cove and Waterloo Roads,

NORTH RYDE

Ph: (02) 9937 3200

Located in the training room.
Directions will be signposted. **Plenty of free parking.**

**DICK SMITH
ELECTRONICS**

That's where you go!

FOR ALL YOUR COMMUNICATION NEEDS

High Performance VHF/UHF Base Station Antennas

Diamond base station antennas offer outstanding quality and exceptional value. These stacked collinear types provide high gain, wide bandwidth and a low radiation angle for extended range. The fiberglass reinforced polyester outer radome and gasket seals provide excellent all-weather operation and compact ground-plane radials are supplied. Stainless-steel mounting hardware ensures a long, trouble-free life. Supplied with instruction sheets for easy set-up.



Rugged HF 5-Band Trap Vertical Antenna

The rugged 5BTV incorporates Hustler's exclusive trap design (25mm solid fiberglass formers, high tolerance trap covers and low loss windings) for accurate trap resonance with 1kW (PEP) power handling. Wide-band coverage is provided on the 10, 15, 20 and 40m bands (SWR typically 1.15:1 at resonance, <2:1 SWR at band edges) with 80kHz bandwidth typical on 80m at 2:1 SWR. An optional 30m resonator kit can be installed without affecting operation of other bands. High strength aluminium and a 4mm (wall thickness) extra heavy-duty base section guarantee optimum mechanical stability. At just 7.65m, the 5BTV can be ground mounted (with or without radials, although radials are recommended), or it can be mounted in an elevated position with radial system. Unlike other antenna designs, the 5BTV can be fed with any length of 50-ohm coax cable.



D 4920

HUSTLER

30m Resonator Kit

Adds 30m coverage to the 5BTV and includes all hardware.
D 4921 **\$99.95**

\$399
SAVE \$50

2m Antenna F-23A

Frequency: 144-148MHz
Gain: 7.8dB
Max. Power: 200W
Length: 4.53m, max wind 40m/s
Type: 3 x 5/8"
Connector: SO-239 socket

D 4850

\$199
SAVE \$50

23cm F-1230A

Frequency: 1260-1300MHz
Gain: 13.5dBi
Max. Power: 100W
Length: 3.06m
Type: 25 x 1/2"
Connector: N-type socket

D 4870

\$199
SAVE \$50

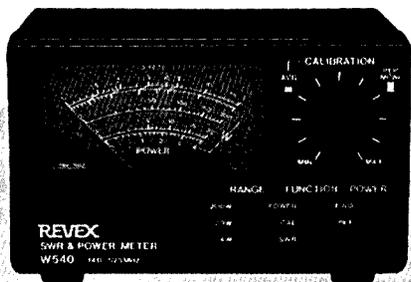

VHF/UHF Power/SWR Meter

A high-quality SWR/power meter suitable for Amateur, UHF CB and commercial applications. Durable Japanese construction assures you of maximum reliability. With an all-metal case, large meter display, 140-525MHz coverage with less than 0.3dB insertion loss, and 4W, 20W and 200W power scales. Revex model W540.

D 1370

\$150
SAVE \$35

FT-2500M 2m Heavy-Duty Transceiver

Built tough to take the rough stuff, the Yaesu FT-2500M meets US MIL-STD 810C for shock and vibration so it'll provide years of reliable mobile operation. Its easy-to-operate front panel design, rubber coated knobs, and large Omni-Glow display are teamed up with a one-piece diecast chassis to set the FT-2500M apart from other 2m mobiles. For improved front-end performance, Yaesu's exclusive 3-stage Advanced Track Tuning feature and dual-FET mixer reduce overloads from strong signals while providing excellent sensitivity and wide-band receive operation.

Also includes:

- 31 tuneable memories
- 7 selectable tuning steps
- MH-26 hand mic, mobile mounting bracket & DC power lead.
- In-built CTCSS encoder
- Various scanning modes

Specifications:

Frequency range: Tx 144-148MHz, Rx 140-174MHz
Output power: 50W, 25W, 5W
Sensitivity: better than 0.2uV for 12dB SINAD
Image rejection: better than 70dB
Max audio output: 2.0W into 8 ohms (10% THD)
Dimensions: 160 x 50 x 180mm (W.H.D.)

D 3632

2 YEAR WARRANTY

YAESU

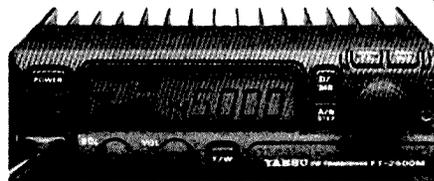

LOW PRICE
\$499

PHONE FAX AND MAIL ORDERS

PHONE: WITHIN AUSTRALIA: 1300 366 644
(Local call charge)

FAX: (02) 9395 1155 within Australia and
(+612) 9395 1155 from outside Australia

MAIL: DICK SMITH ELECTRONICS, Direct Link, Reply Paid 160,
PO Box 321, North Ryde NSW 1670 (No stamp required)

Excludes packaging and postage. All major credit cards accepted.

14 Day Money Back Guaranteed if NOT completely satisfied. (Software excluded)



Visit our web site at
<http://www.dse.com.au>

DICK SMITH
ELECTRONICS

That's where you go!

Yaesu transceivers and accessories stocked in selected stores only.
Other stores can place orders on a deposit-paid basis.

An RF Attenuator

Keith Gooley VK50Q
 Lot 15 Tenfeate Court
 One Tree Hill SA 5114

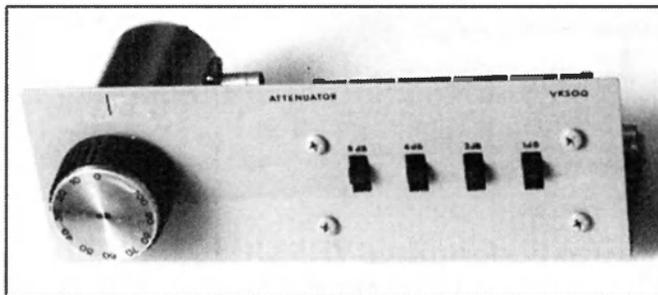

Most RF experimenters know the value of a reliable attenuator. Even old commercial step attenuators such as the Hewlett Packard 355 series still command quite high prices for the amateur on the second hand market.

Many measurements made on receivers, antennas, filters and so on are relative. It is desired to make a response measurement on a device relative to the maximum response or some other reference condition.

For example, if the response of a filter is to be measured, a signal source is fed into the filter and the output monitored on a receiver or other device which may be as simple as a diode detector and moving coil meter. As the frequency of the source is swept over the band of interest, the change in the filter response is indicated on the receiver S-meter or moving coil meter. These are however rarely calibrated.

This is where the attenuator comes in. Inserted in the signal path, it enables the reading on the monitoring device to be held constant as the frequency is changed and so the response of the piece of gear being measured can be determined.

Similarly, if you want to measure the polar pattern of that new antenna, set up a source which may be an oscillator or low power transmitter into any antenna some few wavelengths away and feed the output of the antenna under test into a receiver via an attenuator. Turn the test antenna to give maximum reading and adjust the attenuator to put the reading mid-scale so you know the indicator is not saturating. Then the antenna is rotated step by step and the attenuator adjusted at each step to hold the reading constant.

See that you have plenty of attenuation in when the antenna is on boresight so that when you turn the antenna you have enough attenuation on hand to get into the nulls in the response. The attenuator setting at each increment of angle of rotation subtracted from the setting at the reference position gives the antenna response in dB.

It is possible for the home constructor to build a quite acceptable step attenuator for use up to 500 MHz. (Ref 1) It might not be as convenient to use as a commercial model but the accuracy of the unit described here makes it quite useable for amateur work. I had obtained a commercial 10 dB per step, attenuator and wanted to improve the resolution to 1 dB. The attenuator I built

consists of four pi network sections with attenuations of 8, 4, 2 and 1 dB, giving a total of 15 dB. The sections are switched by low cost DPDT slide switches.

Reference 1 shows it is quite feasible to build an attenuator to 75 dB total, indicating that the secret to getting low insertion loss in the straight through position is to make the connections between sections and to the coax connectors as much like 50 ohm transmission lines as possible. For the 4 sections I achieved 0.4 dB total loss at 500 MHz with all attenuators switched out.

It is fairly easy to obtain an accurate attenuation at frequencies up to 100 MHz or so using 1% metal film resistors but the secret to maintaining the attenuation flat into the UHF band is the 50 ohm transmission line sections mentioned above and making the resistor leads short or non-existent. You could even go to the extent of scraping the fillet of paint away from around the wire on the end of the resistor to enable the soldered connection to be made as close as possible to the resistor end cap.

The simple circuit (Fig 3a)

shows one attenuator section, a pi network. Resistor values are given in the following table for attenuator values constructors are likely to require. You can take your pick. The most accurate results will be obtained by using a combination of 2 resistors in parallel for each non-standard value. If less accurate results are satisfactory and they probably are for most amateur applications, the nearest E24 value can be used.

Attenuation (dB)

dB	R1		
	precise	parallel	E24
1	869.6	910//18k	910
2	436.2	510//3k	430
4	221.0	390//510	220
5	178.5	180//20k	180
8	116.1	150//510	120
10	96.25	100//2k4	100
20	61.11	62//3k9	62

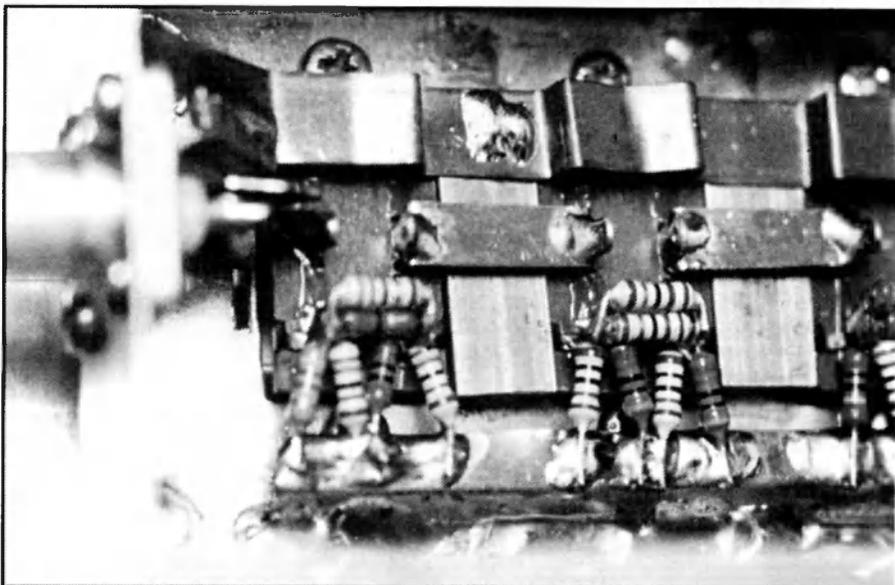
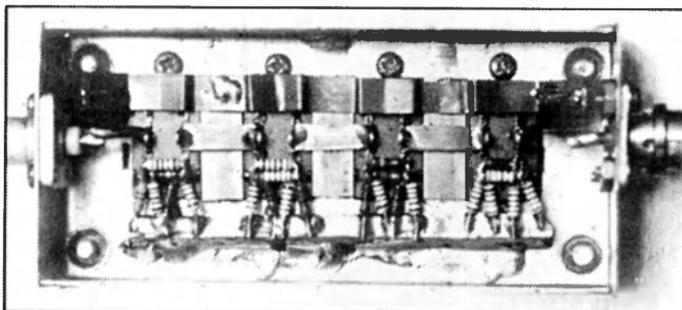

Attenuation (dB)

dB	R1		
	precise	parallel	E24
1	5.77	6.2,82	5.6
2	11.61	15,51	12
4	23.85	24,3k6	22
5	30.40	51,75	30
8	52.84	56,910	51
10	71.15	75,1k3	68
20	247.5	270,2k7	240

Construction

Figures 1 and 2 borrow heavily from reference 1. They show how the slide switches are out in front of the bottom of the box secured by M3 screws and M4 nuts acting as spacers.

The switches are spaced to accommodate a short length of rectangular brass tube, 8 mm by 4 mm in cross section (available from Hobby shops in 300 mm lengths for about \$5). The brass tube is sweat soldered to the panel. The brass acts as the ground plane for the transmission line section connecting each pair of attenuator sections.

The active part of the line is a piece of brass or copper shim, I used 0.3mm thick, 8 mm wide spaced off the brass tube 1.6 mm to result in a 50 ohm line. I chose 1.6 mm spacing as it is the thickness of a piece of fibreglass PCB blank that I used as a spacer while soldering the copper strips in place.

The width of the strip is calculated from the approximate formula for the impedance of a microstrip transmission line in air: $Z_0 = 112 + (H/W)$ where: H is the spacing of the line from the ground-plane and W is the width of the line.

I used a tin-plate box as a housing but copper, brass or galvanised iron or blank PCB laminate would do. The photos show the unit mounted on a panel along with the commercial 10dB step attenuator, a Texscan model RA-100. I used BNC coax connectors but any type could be fitted,

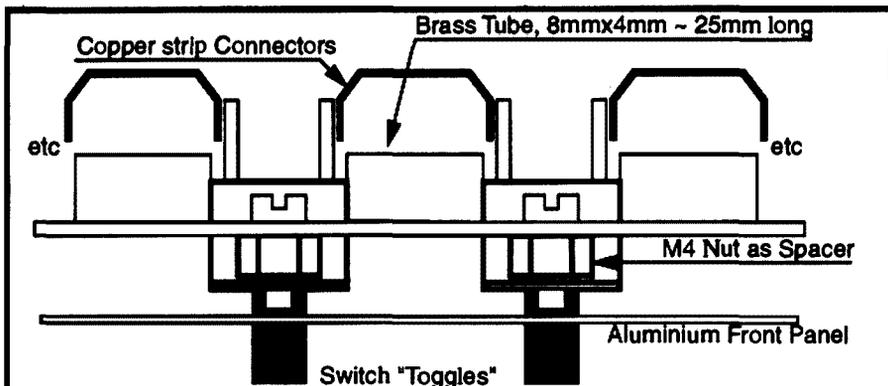

Fig 1. Arrangement of Switch "Common" terminals - end on view to switches.

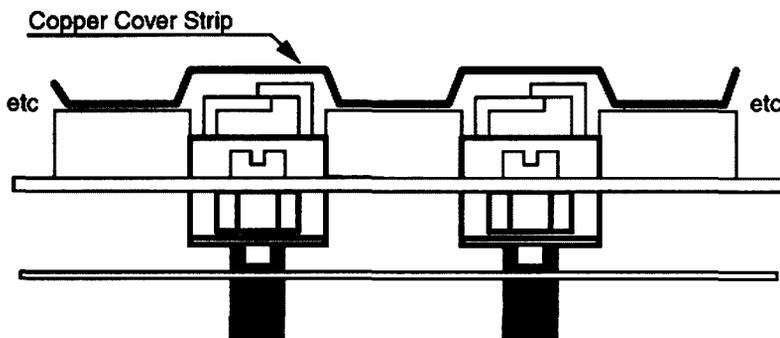

Fig 2. Arrangement of Switch "Shorting" terminals - end on view to switches.

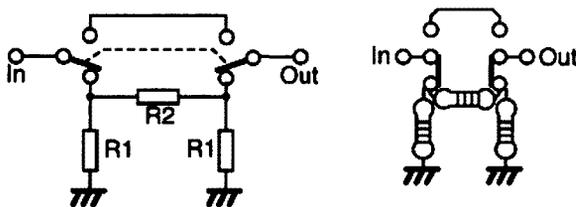

Fig 3. Circuit Diagram Vs Layout

even SO239's if you must.

Results

The graph shows the error in the attenuation measured at 10 MHz and 500 MHz. Employing this method of

construction results in an attenuator useable beyond 500 MHz. The attenuation was measured at 1000 MHz and found to be: - 0dB setting - 1.6 dB, 15 dB - 18.0 dB.

The error at this frequency is perhaps getting a bit high but not unbearable for less demanding situations.

Conclusion

A step attenuator suitable for home construction has been described. The individual constructor can choose which combination of sections is included in his project. The performance of this design makes it suitable for use to beyond 500 MHz.

References

1. Bramwell D. K7OWJ "An RF Step Attenuator" QST June 1995 pp. 33, 34
2. ARRL Handbook "Low Power Step Attenuators" 1993 ed. pp. 25-37 to 25-39

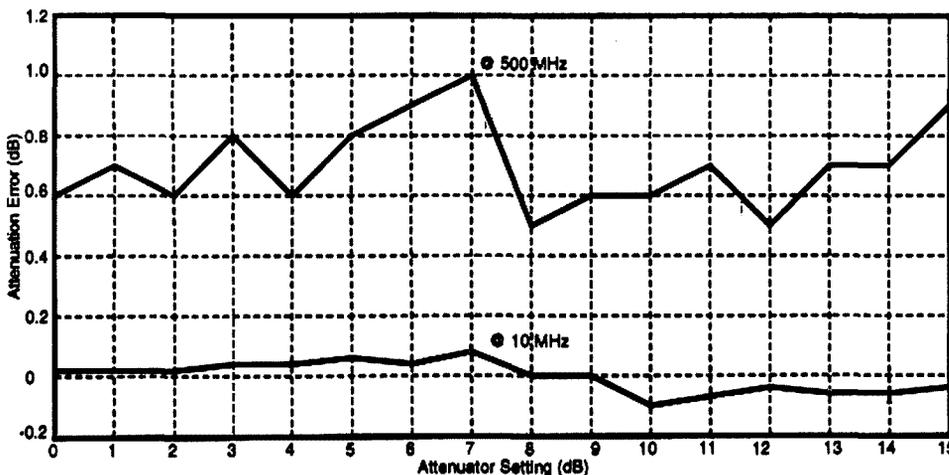

Table 1. 0-15dB Home Brew Attenuator Error at 10 MHz and 500 MHz

NOVICE NOTES

Peter Parker VK3YE

12/8 Walnut Street, Carnegie, Vic 3163

Email: parkerp@alphalink.com.au

Novice Notes Online: <http://www.alphalink.com.au/~parkerp/nonline.htm>

Please note that this is Peter's correct address.

Build the 'Moorabbin', -a simple regenerative receiver for the AM broadcast band.

What can be assembled in a day, cost very little, but will give hours of enjoyment? The answer is the Moorabbin - a two-transistor receiver that anyone can build. It doesn't need an antenna, gives speaker reception of local AM broadcast stations and also receives amateurs on the 160 metre band.

Its performance surpasses most modern AM broadcast sets - you'll be able to hear interstate stations that the others miss.

How is this possible in such a simple set? The secret lies in the use of regeneration or positive feedback. By feeding an amplifier's output back to its input, it is possible to increase the amplifier's gain. However, the amount of feedback needs to be carefully controlled; to prevent the amplifier from oscillating.

Regenerative sets were replaced by superhets in the 1930s because with superhets users did not have to adjust the amount of feedback (regeneration) when they changed stations. However, in the

hands of a skilled user, regenerative receivers can perform as well as more complicated superhets. An added benefit of home built sets is that constructors can use better quality components (such as air-spaced tuning capacitors, vernier dials and efficient ferrite loopsticks) that are missing on the average pocket tranny, which is designed for local reception only.

Circuit Description

Moorabbin is a two transistor regenerative receiver of conventional design. Most parts are mounted on a printed circuit board that you get to make yourself.

The regenerative detector uses a field effect transistor (FET). Like with the better valve designs, feedback is controlled by a variable capacitor. A ferrite rod was used to allow reception of local stations without an external antenna.

This FET stage forms a complete receiver on its own, but the audio output is quite low.

The received audio is amplified by an NPN bipolar transistor. The gain of this transistor amplifier is sufficient to provide speaker reception of local stations in most areas. The 1k to 8 ohm transformer in the collector allows the set to be used with both low and high impedance headphones.

Obtaining parts

The aim of this project was to develop a simple receiver that could be built with readily obtainable parts. With the partial exception of the main tuning capacitor, this has been achieved.

Table 1 - Component list (DSE catalogue numbers shown for convenience)

MPF102 FET	Z1832
BC548 NPN transistor	Z1308
100 ohm 1/4 watt resistor	R1050
330 ohm 1/4 watt resistor	R1062
1k ohm 1/4 watt resistor	R1074
2.2k ohm 1/4 watt resistor	R1082
27k ohm 1/4 watt resistor	R1108
100k ohm 1/4 watt resistor	R1124
1M ohm 1/4 watt resistor	R1150
100pF disc ceramic capacitor	R2285
1nF disc ceramic capacitor	R2307
10nF disc ceramic capacitor	R2321
10uF tantalum capacitor	R4750
33uF electrolytic capacitor	R4340
220uF electrolytic capacitor	R4390
60/160pF variable capacitor	R2970
10-415pF variable capacitor	(see text)
180mm ferrite rod	R5106
1k - 8 ohm transformer	M0216
SPST switch	P7654
6:1 vernier reduction drive	P7170
9 volt battery snap	S6100
6.35 mm headphone socket	P1266
BNC panel mount socket	P2220

Sundry items: non-metal case, enamelled copper wire (for ferrite rod), single-sided PC board material, hook-up wire, battery mounting bracket, other hardware as required.

Variable capacitor

A 10 to 415 pF variable capacitor was used as the main tuning capacitor. These are found in valve radios and early transistor sets. They are rare new but are still common at hamfests. Their wide tuning range make it possible to cover the AM broadcast band and 160 metres without having to sacrifice coverage of the bottom end of the broadcast band. The long shafts of these capacitors make them easier to use with vernier dial drives.

Some constructors may wish to build their set now without waiting for the next hamfest. The first version of the Moorabbin used a 60/160pF plastic tuning capacitor (same as the regeneration control) instead

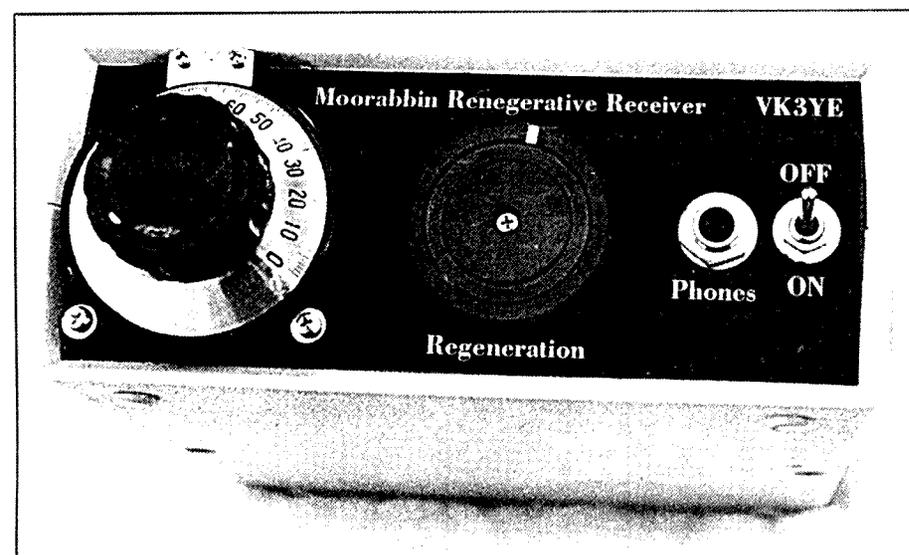

Photo 1 Completed Receiver

of the 10-415 pF unit substituted later. Receiver performance with the plastic capacitor was good. The main difficulty was coupling it to the vernier dial, overcome by extending the shaft with a 2.5 mm diameter screw and a spacer. To compensate for the lower maximum capacitance, more turns need to be wound on to the ferrite rod to cover the whole broadcast band. Details later.

Vernier dial

It is possible to get by without a vernier dial, but using the set will not nearly be as enjoyable, especially if you want to hear more than just the local stations. Though expensive, it is worth it the benefits you get. Dick Smith P7170 is a complete reduction drive and dial, and P7172 is just the reduction drive - add your own calibrated dial for a direct frequency readout.

Ferrite rod

Ferrite rods in various lengths are available. If your ferrite rod is too long, saw a notch around it with a hacksaw. The rod is then quite brittle and can be snapped cleanly.

Transistors

Obtaining the transistors should pose no difficulty. A 2N3819 will work equally well as the MPF102 in the detector and a 2N2222 can be substituted for the BC548 in the audio amplifier. Note that the lead connections of substitute transistors may vary from those shown in Figure 1.

Enclosure

Almost any commercially available housing will do or one can be made at home. Use a wood or plastic box so that the ferrite rod is not shielded and local stations can be received without an external antenna.

Construction

Preparation

Gather the parts and plan how everything will fit. Will the tuning capacitor fit inside the case? Does the ferrite rod need to be shortened? Is the front panel large enough to accommodate the vernier drive? How will the printed circuit board be mounted? Will internal leads be short and direct?

Mounting the larger parts

Begin by mounting the larger parts to the case. Install the vernier drive. Both variable capacitors, the switch and sockets. Photograph one shows the front panel layout in the prototype.

Winding the ferrite rod

The windings on the ferrite rod determine the receiver's frequency coverage, the ability to obtain feedback so important to the set's performance and the amount of coupling between the regenerative detector and any external antenna.

Use 0.4mm diameter enamelled copper wire for all of the windings. The diameter is not particularly critical, but 0.4 mm is easy to work with and still results in fairly compact coils.

Wind all coils the same direction around the ferrite rod. Anchor the ends of each coil with a piece of insulating tape. Leave about 2cm distance between each coil. The layout of coils used in the prototype receiver is shown in Fig 2. Fig 1 shows the turns used in each winding. Note that if you're using a plastic variable capacitor for the main tuning capacitor you will need more turns on the main

coil to cover the lower part of the band. 75-80 turns proved adequate in the prototype.

The ferrite rod should be mounted reasonably close to each of the tuning capacitors and to the circuit board. Try to keep leads to the coil less than 10cm long. Mount the rod horizontally in the case using a plastic or wooden bracket. This bracket could be salvaged from an old transistor radio. Brackets often have rubber grommets and are made of plastic. If this is difficult to arrange, you could use a ferrite rod longer than the width of the case and drill holes in both sides to take the rod.

Etching the circuit board

The next part of building the Moorabbin is obtaining the printed circuit board. Where does this come from? You etch it yourself! Don't worry - it's very simple and requires no special tools.

As with the latest electronic equipment, components are mounted directly on the copper surface of the board. This makes construction easier and quicker as it there is no need to drill holes through the board for

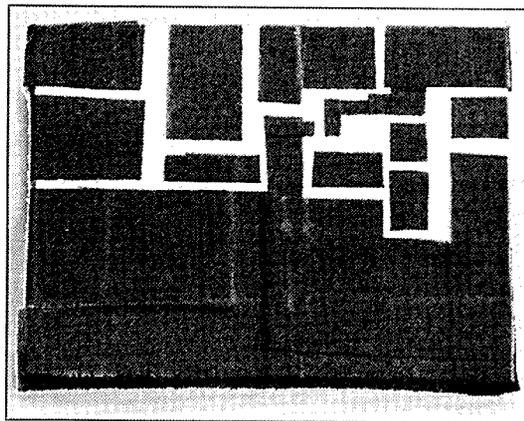

Photo 2 Circuit board prior to etching

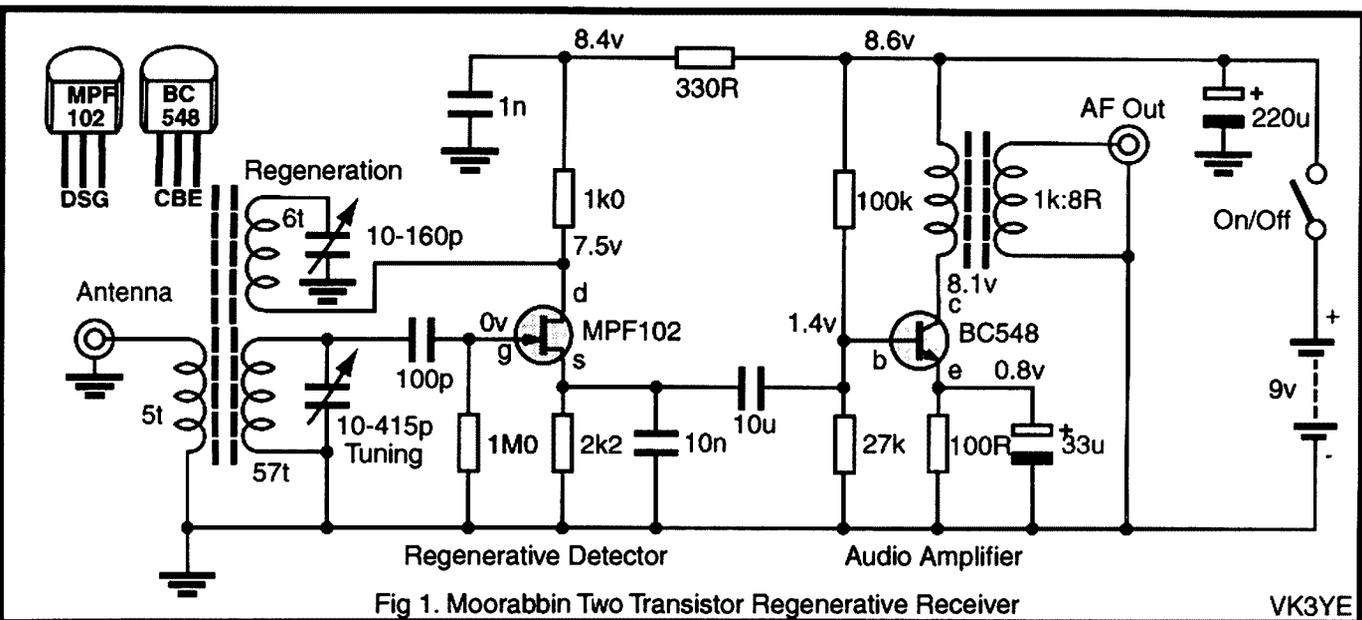

Fig 1. Moorabbin Two Transistor Regenerative Receiver

VK3YE

each component. It also makes troubleshooting and modification easier.

Cut the circuit board to size with a hacksaw. Then clean it with an abrasive powder cleanser (Ajax) and scrubbing brush to ensure a quick etch. Rinse and dry with a cloth.

Using Fig 2 as a guide, stick insulating tape on the areas of copper that will be used to mount components. Rub the tape down well to avoid erosion under the tape. Photo 2 shows the board with the tape applied.

Place the board copper side down into a bath of etching solution of ferric chloride or ammonium persulphate. Use a non-metallic etching bath and agitate gently to ensure a quick etch. Ferric chloride stains easily and ammonium persulphate should be used at about 70°C so make your own mind up.

Mounting the components

Mount the components as per Figure 2. Check that all polarities and component placements are correct. A good way to do this is to trace the connections of parts so that they accord with Figures 1 and 2. Photo 3 shows the completed board, prior to mounting in the case.

Final wiring

Use double-sided tape or stand-offs to attach the circuit board to the case. Then make all the connections between the board and off-board parts, such as the ferrite rod, variable capacitors, sockets, battery snap and power switch. Also check that other off-board connections are in place, such as between the regeneration coil and the regeneration capacitor, antenna coil to the antenna socket and the battery snap to the power switch. Do not overlook the negative (earth) connections joining the variable capacitors, all sockets, the circuit board and the negative power lead.

At this point the receiver is complete. Now time to turn it on!

Switching on

Initial test

Plug in the headphones, connect a wire antenna (any length) and apply power. Turn the regeneration control fully clockwise (ie minimum feedback). Unless you are very close to a broadcast station, you will hear nothing.

Slowly turn the regeneration control anticlockwise. When you pass a certain point, you should hear a faint hiss in the headphones. Adjust the main tuning control until you hear an audio tone (or heterodyne) which decreases in pitch as you tune towards it. You've just tuned into your first station! Then carefully back off the regeneration control (turn it clockwise) until the heterodyne stops.

Tuning a regenerative set is a two-handed affair. For peak performance the regeneration control needs to be reset with every station change. Higher frequency stations will need less regeneration than lower frequency stations. As you tune lower slowly turn the regeneration control anticlockwise to assure best sensitivity and selectivity. Remember clockwise is minimum regeneration and anticlockwise is maximum regeneration.

Calibrating the dial

To know the frequency to which your receiver is tuned, you will need to calibrate the dial. Calibrate by seeing where known stations appear on your 0-100 dial.

Compare the stations this set receives with those heard on another AM receiver. Exact frequencies of stations can be found in the WIA Callbook. Make a calibration chart showing the station call sign, frequency and the reading on the vernier dial. You may want to glue this to the top of the receiver. Do all calibrations with the regenerative receiver set to just after the point of oscillation for best accuracy.

Refer to the Troubleshooting section if the receiver misses stations towards either end of the band.

Use without an antenna

The Moorabbin should receive local stations with just the ferrite loopstick antenna. If stations are weak, turn the receiver around for best signal. Stations as far away as Newcastle have been received from Melbourne at night with no external

antenna connected. Use headphones for best long-distance reception.

Volume is better on both local and distant stations if an external antenna is connected (longer and higher the better). If overload from local signals is a problem remove turns from the antenna coupling coil or wire a small disc ceramic capacitor (10 to 100 pF) in the antenna line.

Receiving 160 metres

The Moorabbin is capable of receiving amateurs using CW, SSB or AM on the 160 metre band. Amateur signals will usually be weaker than the broadcast stations due to the lower power and compromise antennas most amateurs use.

Whether you can hear amateurs on your set depends on several factors. These include the tuning range of your receiver, noise levels and the amount of 160m activity in your area. A vernier dial also helps - SSB and CW signals can be tuned in with a regenerative receiver gently oscillating but require greater care in tuning than for AM signals.

Most states transmit their weekly WIA broadcasts on 160 metres. See Page 56 for times and frequencies. SSB stations can sometimes be heard chatting in the evenings. Morse is mainly used by operators seeking international (DX) contacts. As well as random contacts, there is regular scheduled AM activity on 160 metres. In Melbourne this includes the 'coffee break' net after 11am weekdays (and 9am Sundays) and the VK3ASE 'missions' from 10:30pm Saturdays to the wee small

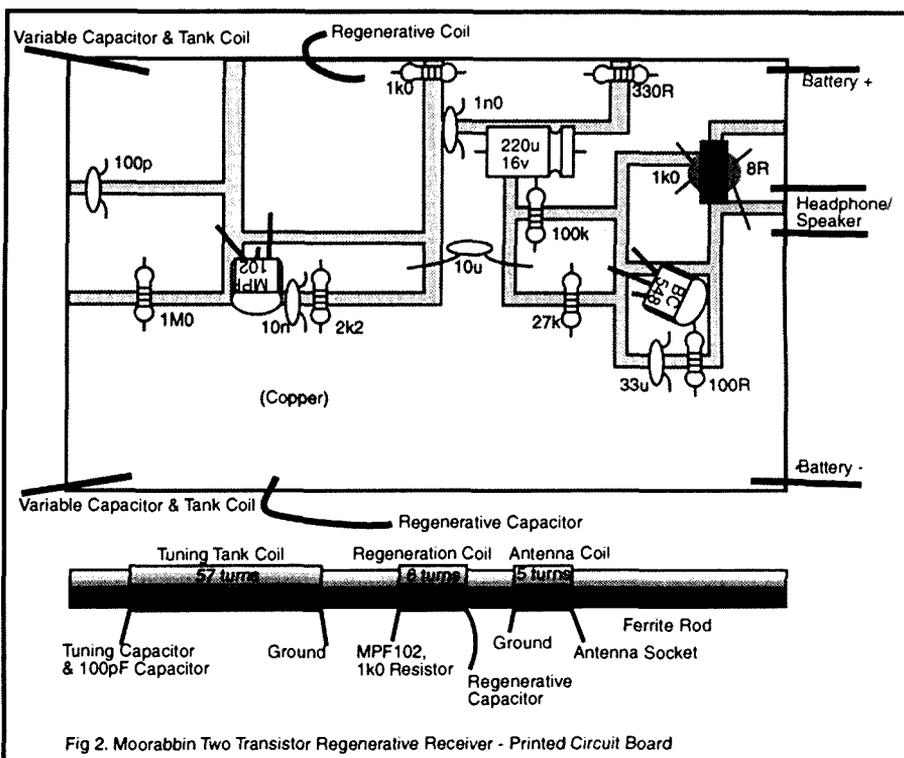

Fig 2. Moorabbin Two Transistor Regenerative Receiver - Printed Circuit Board

hours of Sunday.

Other stations

Mainstream AM broadcast stations and radio amateurs are not the only things that can be received on the Moorabbin. There is a growing number of low power special-interest stations operating between the end of the official AM broadcast band and 1.8 megahertz. Reception of these stations is a good test of the Moorabbin's performance. Frequencies such as 1620, 1629 and 1638 kilohertz are particularly popular. Again the WIA Callbook lists these stations. When AM stations are very weak it sometimes helps to listen with the set gently oscillating, rather than back off the regeneration to just short of oscillation as is often suggested.

Troubleshooting

If, with power on, and antenna and headphones, you can't get the receiver to work, check that all parts have been wired correctly. Use your multimeter to check the set's current consumption. It should be approximately 8mA. Measure voltages at various parts of the circuit. If there are significant departures from the values given, there is likely to be a fault.

The following cover most problems likely with simple regenerative receivers.

Q. WHAT IF I HEAR NOTHING IN THE HEADPHONES?

Check all wiring. See that both transistors are wired in correctly. Also ensure the transformer is connected the right way - the side with three leads coming out of it is the 1k side which connects between the BC548 collector and the supply rail.

Touching a screwdriver on the base of the BC548 is a way to test the audio stage - if you hear nothing the amplifier is faulty, but if a hum or click is heard the stage is okay.

Q. WHAT IF IT DOESN'T OSCILLATE?

Try reversing the connections to the regeneration coil. If this is not successful, add more turns to the coil and try both possible connections of the coil. It should be possible to get the receiver to oscillate with or without an antenna connected.

Q. WHAT IF IT OSCILLATES OVER ONLY THE HIGH FREQUENCY END?

With this fault good reception of stations near the top end of the band is possible, but lower frequency stations are weak and cannot be separated from one another.

Firstly check that your connections to the regeneration capacitor are right. The tag labelled 'G' should be earthed and the 'A' tag should go to the regeneration coil. Do not use the 'O' tag - this is the 60pF section and is too small for our application. If the problem persists, add a few more turns to the regeneration coil.

Q. The set does not appear to cover the entire broadcast band.

If the receiver is not tuning high frequency stations, set any trimmers on the variable capacitor to minimum and try again. If this makes little difference, remove turns from the tuning coil, a few at a time, until these stations can be received. When doing this tune to the bottom end of the band to ensure that lower frequency stations can still be received.

Add turns if you're missing stations near the bottom end of the band. Again ensure that high frequency stations can still be tuned in after any changes made.

If a 60/160pF plastic tuning capacitor is being used for the main tuning control, check that the 'A' tag is being used, not the 'O' tag. If only a small section of the bottom end is missing, try connecting the 'O' terminal to the 'A' terminal to increase the capacitor's maximum capacitance to about 220 pF.

Q. HOW DO I RECEIVE 160 METRES?

If you're lucky enough to be using a 10-415 pF tuning capacitor, it should be possible to find a number of coil turns that covers the AM broadcast band to the top end of 160 metres in one range. The set pictured covers 530 to 1870 kilohertz, which is ideal. If special care is taken to reduce stray capacitance and inductance, an even wider range is possible. The first version of this set used 'dead-bug' construction instead of the circuit board described here. It tuned 480 to 2000 kilohertz - an unusually wide range for a single variable capacitor and untapped coil.

Those using 60/160 pF plastic variable capacitors may not be able to achieve a tuning range wide enough for both the broadcast band and 160 metres. Either compromise by sacrificing the bottom 50 - 100 kilohertz of the broadcast band for 160 metres or add a switch and coil tap (15 to 20 turns from the end) to provide full coverage over two ranges.

If there is no 160 metre activity while adjustments are being done, there are several ways to establish the frequency to which the receiver is tuned. One is to use a dip oscillator, signal generator or transceiver to produce a local signal on 1.8 megahertz.

Another approach is to use a calibrated

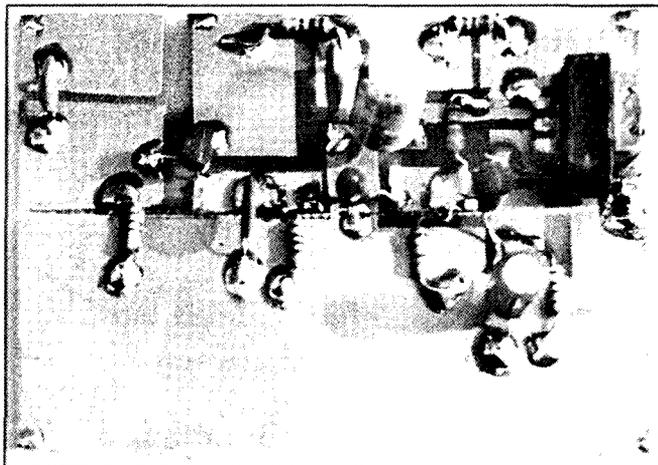

Photo 3 Assembled circuit board

SSB communications receiver. Bring a short pickup wire from the receiver antenna socket to near the receiver. Bring the set into oscillation with the regeneration control. It will be possible to find the frequency of the oscillating set by looking for a carrier on the communications receiver. Backing off the regeneration should cause the carrier to vanish. This method is very accurate and is recommended for calibrating the receiver as well as establishing its precise tuning range.

Q. WHY WON'T THE RECEIVER WORK WITHOUT AN EXTERNAL ANTENNA?

A. There are two possibilities. Either you live in a weak signal area, where there are no strong local stations on the AM band, or you built the set in a metal box. If in a weak signal area, try listening at night - in all but the most remote localities stations will be heard with just the ferrite rod.

If you built the receiver in a metal box, pull the whole thing apart and use a plastic or wooden case instead. Because plastic or wood allows signals to reach the ferrite rod, you will be able to use the set without an external antenna in most places.

Q. DON'T REGENERATIVE RECEIVERS CAUSE INTERFERENCE TO OTHER RADIOS?

Early days of radio are full of stories about the interference that oscillating regenerative receivers caused to other receivers.

These risks still exist, but are less significant nowadays. In bygone years people used valve sets with large antennas. Today broadcast stations are more powerful and no one apart from long-distance radio listeners connects outside antennas to their receivers. Also the strength of signals emitted by oscillating transistorised regenerative receivers is much less than the original regenerative sets, which used valves.

Try This

Jon Lindstad VK2WF
PO Box 457
Armidale NSW 2350

Electret Microphone without a Battery

Many an old crystal or dynamic microphone ends up on the scrap heap because replacement transducers cannot be obtained.

Modern electret microphones offer excellent sound quality, are physically very small and cost next to nothing. But they do need a voltage supply of about 1.5 volts. Although the electret itself has a permanent

electrostatic charge built into the diaphragm material, this voltage supply is needed to power a FET that acts as an impedance converter and amplifier.

This voltage supply can easily be obtained from within your old microphone if it is a Push-To-Talk type where the PTT button activates a relay in your transceiver. The figure shows the circuit diagram for the

original mike and the refurbished mike respectively. The ground connection for the PTT circuit is broken and two ordinary silicone rectifier diodes are wired in as shown. Whenever the PTT is activated the relay current through the two diodes provide a voltage drop of about 1.4 volts as required. A resistor and coupling capacitor completes the microphone circuit.

During the past fifteen years I have used two of these microphones and have had no trouble with RF pick-up or hum. However, if the relay supply is exceptionally noisy, filtering can be provided by inserting another resistor in series with the one shown, and a capacitor to ground between them.

When mounting the electret capsule in the microphone housing observe the following:

- 1 Make a mounting plate of thick cardboard or similar material, that fits snugly in the recess of the original capsule.
- 2 Drill or punch a hole in the mounting plate that provides a snug fit for the electret.
- 3 Seal the mounting plate to the housing and the electret to the mounting plate with beeswax (use a soldering iron).
- 4 Fitting the electret into the housing without sealing off the air volume inside the housing, as described above, could have a detrimental effect on the frequency response of the completed microphone.

Some more modern microphones housings may have extra wires for frequency up/down buttons etc. These can be ignored as long as the diodes are put in the right spot and in the right orientation, ie in the wire between the PTT button and ground only.

ar

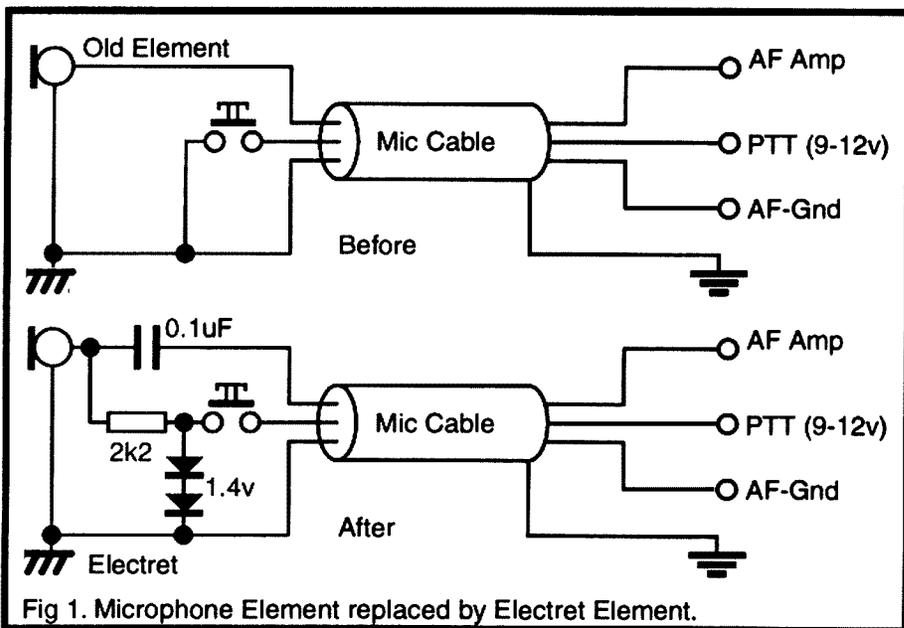

Build the 'Moorabbin' continues

As an experiment, the Moorabbin was brought to oscillation in the same room as a 10 year old clock radio. The oscillation was weak in the clock radio at 1 metre distance. At 5 metres it could not be heard at all. It is thus unlikely that this set will cause interference to neighbours even when it is used oscillating.

What to do next

This set can be made to operate on lower frequencies by adding turns to each winding on the ferrite rod and paralleling all gangs of the tuning capacitor used. Gradually add turns until stations in the bottom end of the

AM broadcast band (530 - 700 kHz) are at the top end of the receiver's tuning range. The main reason why one would wish to do this is to receive the aircraft beacons in the 200 to 500 kHz band and to experiment with receiving the low frequency tests from Tasmania on 177 kHz.

By removing turns higher frequencies can be covered. This will allow reception of some international shortwave broadcast stations, VNG/WWV and the eighty and forty metre amateur bands. This is fun to try, but don't expect top performance; the Moorabbin's plastic case and ferrite rod are okay on MF but not good for HF.

Good results from regenerative receivers are certainly possible on HF.

Readers interested in HF reception are advised to build the set described in Amateur Radio June 1998. This solidly-built receiver uses a metal case, high quality variable capacitors and vernier reduction drives, voltage regulation, adequate bandwidth, and isolation of the regenerative detector from the antenna to deliver good performance. Factors such as these make the difference between a mediocre performer and one that compares favourably with more sophisticated equipment.

ar

REPEATER LINK

Will McGhie VK6UU

21 Waterloo Cr Lesmurdie 6076
VK6UU@VK6BBR
will2@omen.net.au
(08) 9291 7165

A slight diversion from Repeater Link this month with some information on a relatively new facet to Packet operations. Will McGhie VK6UU will return with Repeater Link in December. Please send any news or information on repeaters to Will.

It has been a while between Packet Radio submissions so if you have any Packet information to share please send it to AR Magazine c/o WIA Federal Office. Perhaps there is enough material and interest to constitute a column again. There must be new equipment and recent innovations so please, if you know about it, share it.

TELETEXT - The Silent Revolution

by Gerard VK2DAA

for AAPRA Digipeat
and the National TT Network.

There's a silent revolution happening on your BBS.

It's not the reduction of WIA bashing bulletins, nor the elimination of the packet pirates. It's not even the reduction in volume of trashy WW bulletins. Something far more important has occurred, and it's been so silent that you may not have even heard about it. Alas, let me shatter that silence.

The Hunt

How often have you posed yourself a question and then thought -I bet that information is on the packet network. Armed with that you go to your packet screen and log in to your BBS, ever hopeful that you can find the information you seek. Where do you start?

The BBS seems to have fifty thousand messages. How do you sort all of those? The "LC?" command could list all the categories of messages, and after looking at 300 of these you could list likely categories and then read each relevant message.

Another way would be to do a search through all the message subjects with the LS command and read through each message. There are other ways, but all-in-all it's a bit of a bear trying to track down the information.

The Catch

What is needed is a way of gathering all of the information together and categorising it for easy access, perhaps with a hierarchical system of menus to make it easier to navigate.

Enter Teletext, a data storage and retrieval system based on pages of information accessed by number. Teletext originated in the TV broadcasting industry and has now been adapted for packet. In TV, the unused bandwidth available between each field of the picture was utilised for sending textual data and limited graphics.

The data slipped through unobtrusively and any viewer equipped with the appropriate Teletext signal decoder was able to select pages via a keypad and view them on their TV. Channel Seven runs a very good Teletext system.

Packet Teletext

As with TV, there is Teletext data being shipped unobtrusively around the packet network. Unlike TV though, the data is being stored by each equipped BBS, mainly to allow fast retrieval. The data is unobtrusive because it is all sent as personal messages rather than as bulletins and this is done to guarantee delivery at each operating BBS. The same cannot be said for bulletins that can easily go astray for a variety of reasons.

Using Teletext

There is a good chance that your local F6FBB BBS is a cooperative Teletext system member. If not then there is probably one near.

Most BBSs advertise that they have the Teletext system in the command prompt. They show the command TT, mention Teletext or sometimes it is called Think Tank. You can see it by entering the TT command and watching the response. An error message is not a good sign!

Teletext Commands

There are surprisingly few commands to learn - "what a relief!" Entry to the system is gained by "TT" and you can exit again with "B" to quit completely or "F" to get back to the BBS. A help listing is obtained by entering "?"

The pages of information are displayed by entering a three-digit number such as "100" for the index page. The available number space has been divided up into ranges for various related-interest areas. Each of these has its own index so that it is possible to see by downloading just a few pages what is stored in a particular area.

Categorisation

The categorisation based on number ranges is as shown below. Note that this applies to the Teletext system running on packet BBSs in Australia and New Zealand only. We are pioneers in this area; the essential software for updating the Teletext pages was written in Australia.

000	Help screen (same as "?" command)
001 - 099	Local BBS pages (not released into national grid)
100 - 110	Index screens
111 -	Test page for all to use
112 - 199	FBB BBS overview
200 - 299	Experimenter's corner
300 - 399	NZART (ZL)
400 - 499	PNGARS (P29) and Continuation of pages longer than 7.5k
500 - 599	VK Packet Services
600 - 699	Clubs in VK3, VK5, VK6, VK7, VK8 & VK9/0
700 - 799	Federal Interest
800 - 899	Divisional Interest
900 - 998	Clubs in VK1, VK2, and VK4 plus Special Interest Groups
999 -	New pages released into national grid

As you can see, there are a wide variety of topics. The pages from 001 to 099 are reserved for use by your local sysop. All the rest of the pages are sent around what is referred to as the national grid.

Content

The type of material suitable for inclusion in the Teletext system is that which is of a fixed or slowly changing nature with wide appeal to either the whole amateur community or to a defined interest group. An example would be information on a local club, or the DXCC countries list, or a list of 6m beacons.

Unsuitable material would include the coming events for a club or Keplerian elements for amateur satellites. This material is too transient and is better placed as a bulletin on the packet system.

Organisation

The national grid for the Teletext pages was set up by Graham VK4BB and he administers additions and corrections to the distribution system. He also looks after new pages being added to the system and distributes a page with updates that have been made recently (page 999). In New Zealand, Phillip ZL2TZE fulfils this role.

James VK4XJB wrote the automated TT page "grabba". Yep, SysOps won't need to do a thing! Pages, thanks to James get inserted in the correct "slot" automatically. VK4XJB has also written the LINUX Teletext software. (VK4XJB @ VK4XJB)

Contributions

Anyone can contribute pages to the system. For the national grid, this is done by submitting them to VK4BB or ZL2TZE. They check them and send them on the national grid. They also update any link pages and send these out as well. The recent updates page is also added to and periodically distributed.

If you have information for local distribution, this should be sent to the sysop of your local Teletext BBS. There are special character sequences to be included in a Teletext file, but that is beyond the scope of this article. Consult your sysop for details.

Please try the Teletext system on your local BBS -it's the fastest way to find information on packet -and let the revolution continue!

ar

Slow Morse Practice Transmissions

VK2BWI Nightly at 2000 local on 3550 kHz VK2RCW Continuous on 3699 kHz and 144.950 MHz 5 wpm, 8 wpm, 12 wpm

VK3COD Nightly (weekdays) at 1030 UTC on 28.340 MHz and 147.425 MHz

VK3RCW Continuous on 145.650 MHz, 5 wpm, 10 wpm

VK4WIT Monday at 0930 UTC on 3535 kHz

VK4AV Thursday at 0930 UTC on 3535 kHz

VK4WIS Sunday at 0930 UTC on 3535 kHz

VK5AWI Nightly at 2030 local on 3550 kHz

VK5VF Continuous on 145.650 MHz, 5 wpm to 12 wpm

VK6RCW Continuous on 147.375 MHz, 3 wpm to 12 wpm

Don't forget to send updates and changes as they occur to WIA Federal Office.

Sample of material found on index page 107

700	WIA FEDERAL postal address/ phone	758	NEGATIVE FREQUENCY DISCOVERED
701	AR Magazine publicity #'s	759	YOK PROBLEM 2000 yrs ago
702	WIA and "the brag files".	760	
703	Register of stolen gear	761	ACA OLYMPICS & use of 70cm
704	WIA video cassette service	762	AWARD VK2 "cities'shires"
705	WIA NEWS SERVICE	763	ACA Advertising
706		764	AWARD VK2 "clubs"
707	Amateurs "10 Commandments"	765	ACA Experimental Licence
708	INTRUDER WATCH - FEDERAL	766	AWARD VK2 "25's"
709	Amateurs Code	767	
710	AWARDS VK WIA	768	AWARD VK4 "REDCLIFFE"
711	QSL card collecting & museum	769	
712	NETS 713 CONTESTS and AWARDS	770	AWARD VK4 "Rally Australia"
714	Hunting Lions in the Air Contest	771	World Time Zones
715	CONTEST HOW TO WIN	772	Band Plan Etiquette
716	CONTEST RD	773	Band Plan 50 Below
717	CONTEST VK/ZL	774	Band Plan 50 Plus
718	CONTEST Glsbourne ZL	775	CW Achieve It Easily
719	CONTEST Scouting	776	SLOW MORSE. Cpy WIA & these stns
720	CONTEST ALARA	777	WWV
721	CONTEST Jack Files	778	RFDS Frequencies In VK
722	CONTEST Merv Stinson Sprint	779	CEPT
723	CONTEST WA	780	
724	CONTEST Australasian Sprints	781	IARU BEACONS
725		782	REGION 1 VHF to EHF records
726	WIA Cable TV Report	783	TEN-10
727	AX Prefix Olympics/Aust Day	784	IARU Admin Council Meeting Oct 96
728	HF B/casters pressure HF	785	
729	Craig Shergold Saga	786	IARU Packet guidelines etiquette
732	ACA WIA LIAISON TEAM	787	10 meter gateways/beacons
733	RECIPROCAL JA/VK Licence	788	VK VHF UHF RECORDS
734	ACA DataBase on WWW	789	BEACONS IN VK
735	RECIPROCAL USA Licence 736 ACA Repeater Assignments	790	SAREX & NASA frequencies.
737		791	SATELLITE FREQUENCIES.
740	AMATEUR RADIO OPEN DAY	792	AIRCRAFT HF/VHF frequencies
741	AR PROMOTIONAL MATERIAL	793	
744	Repeaters in VK4	794	
745	CW Learn from flash cards	795	B/cast station call signs.
750	146.000MHz a No No for FM	796	Amateur Cosmonauts & MIR history.
751	FMA No No on HF	797	What is a "HAM"?
756	VHF and AIRCRAFT ENHANCEMENT	798	Amateur "PERSONALITIES".
757		799	REWIND. AR HISTORICAL EVENTS

AR on the WEB

Alan Meredith VK2NNN

295 Iodide Street
Broken Hill NSW 2880
vk2nnn@vk2nnn.com
<http://www.vk2nnn.com>

Look who's on the Web!

IT'S YOU!

Well it could be. The possibilities for your own presence on the web, these days, are almost endless. Comments will have immediately sprung up like: - How much does it cost? I'd have to be a computer guru. This will probably help fade the curtains? - etc. Well OK maybe the last one is stretching it a bit, but all these sorts of questions come up, along with the standard, what, when how and why etc.

Why?

The "why" of it is something that I'll have to leave up to the individual, but there are many reasons to have a personal page on the web. They range from just wanting to show a little bit of information about yourself (picture of the shack, QSL info, brag about the paperchasing you have done etc.) to a large site specifically about an aspect of the hobby that appeals to you most and that you think you can share this info with others of the same mind.

Who, where, cost etc...

Thankfully the cost these days is not a big issue. Many places on the web are vying for your attention with offers of free webhosting. That's means they allow you space on their server for your page, free of charge. The deal may range from a couple of megabytes of space to unlimited space, in some cases. Some of the commercially run sites fund their existence by forcing you to run advertising on your site. This may or may not bother you. Some of these to check out are:

Tripod: <http://www.tripod.com/>
GeoCities: <http://www.geocities.com/>
Angelfire: <http://www.angelfire.com/>
CyberCities: <http://www.cybercities.com/>

YAHOO!
GeoCities

Take a close look at what you are signing up for and check out the pro's and con's of each before committing.

Amateur Radio Only!

Amateur radio operators are fortunate in that we have an option available to us that the general web public do not, its called QSL.net run by AI Waller K3TKJ, and its free! Visit - <http://www.qsl.net>



This whole site is devoted to amateur radio and offers free webspace (unlimited within reason), email forwarding and other services. The only thing you need is an Internet connection to access QSL.net.

QSL.net is only available to licensed amateur operators.

Don't forget that if you have an account with an ISP (hard to get on the net without one!) then it's very likely that you already have space allocated to you on your ISP's (Internet Service Provider) server. These may only be a small amount but you can certainly do a lot with only a couple of megabytes!

How?

A law degree from Philadelphia would help, but only if you want to change jobs...Hi!. Actually creating a webpage is very easy these days. Quite a few of the webhosting sites have an "easy to build - automated" approach to helping you create your masterpiece, though this may limit your creativity somewhat in the early stages (Hams are renowned fiddlers who like to push the boundaries a bit).

If you want to go it alone then there are many programs capable of building web pages. Microsoft of course has many options ranging from its purpose built Frontpage (also with a lite version call Frontpage Express) to web capabilities in several of its other newer programs ie:

Publisher and Word.

[Frontpage Express Logo here please]

Many other programs are available for downloading from the Net. Quality and difficulty ranging from beginner to advanced. Listed below are just a few of the more popular ones, of which some are free, but most are shareware (meaning that they may have a time limit on them unless you pay for a license).



Coffee Cup HTML Express:

<http://www.coffeecup.com>

Hotdog Express: <http://www.sausage.com/>

Splash! Web Authoring:

<http://www.gosplash.com>

Arachnophilia: <http://www.arachnoid.com/>

Hippee 98:

<http://www.troutsoft.com/hippie>

Homesite: <http://www.allaire.com/>

Tarantula: <http://NostrumIndia.com>

<http://NostrumIndia.com>

HotMetal Pro: <http://www.hotmetalpro.com/>

Of course there are many full commercial programs if you want to spend the money. eg: *Coldfusion*, *Dreamweaver* etc. This is just a very small selection but there is sure to be one that fits what you want to do. Oh and don't forget that Microsoft Notepad is quite capable of creating a website. Mind you, a degree in HTML language would be put to good use here...Hi. (A very good text editor that helps a lot with html coding is called NoteTab. You can download a free copy from :- <http://www.notetab.ch/> -Bob)

Of course you can always go the whole hog and setup your very own domain etc. but be prepared to part with some of the hard earned!

Well it all sounds easy, right? OK. So what are you waiting for? Hams are known for sharing information and the Net is just another way of doing the same thing! Remember if you find something cool let me know so we can share it around.

Speaking of cool again, check out Jim Tabor's site at: <http://www.taborsoft.com> that has some very cool "Ham Tools" available to download. There's a "Sked Wizard" to help track those sked times and frequencies. Also the "Active Beacon Wizard++" which is really cool and last but not least "Kcalc" which does lots of interesting things with the time information. Jim has some other interesting "stuff" there as well.

ar



TECHNICAL ABSTRACTS

Technical Abstracts
 Gil Sones VK3AUI
 30 Moore Street
 Box Hill South, VIC 3128

#The wiring of the microphone is altered as shown in Fig 3. This connects the microphone element to the preamp in a balanced configuration and separates the PTT circuit from the audio earth.

The original was used with an IC781 transceiver. Good audio reports were received when using the D-104 microphone with the inbuilt preamp.

Recreating Y-Gerat

In QST May 1999 Brian Kendal G3GDU described an experiment which recreated the German WWII Y-Gerat bombing navigational system. The recreation used a repeater, three transceivers and a CRO.

Y-Gerat was a navigational ranging system that helped a bomber find its target. The system was described in the book *Most Secret War* by R V Jones.

The system worked by transmitting an audio tone to the aircraft on 42.5 MHz. The tone was received and retransmitted by the aircraft on 46.9 MHz. At the base station the

Adapting the Astatic D-104 Microphone for use with modern transceivers

In QST August 1999 Steven Fraasch K0SF described a preamp using an Op Amp to adapt the Astatic D-104 microphone to a modern transceiver.

The preamp is used to match the high impedance D-104 to the low impedance input of a modern transceiver. The microphone was originally intended for use with the high impedance microphone input of a valve transceiver.

Modern transceivers are designed for use with a low impedance microphone. The preamp using an Op Amp is essentially an impedance matching device to allow optimum microphone performance with the modern transceiver.

The pre-amp circuit is shown in Fig 1. The Op Amp used can be substituted if necessary. The Op Amp is a National LPC662 and was in an SO8 surface mount case in the original. The author suggested an Archer TLC274 as a substitute. These may be available from Tandy locally.

The Op Amp is a low distortion, low noise, low bias current device which provides nearly rail to rail output voltage. It also draws only 100 microamps or so which simplifies a power feeding. The

circuit can be built dead bug style on a scrap of printed circuit laminate mounted in the base of the microphone.

Power can be fed down the microphone audio lead as shown in Fig 2 with the capacitor and resistor built into the microphone plug. Or the feed components could be built into the transceiver, or an external power source could be used.

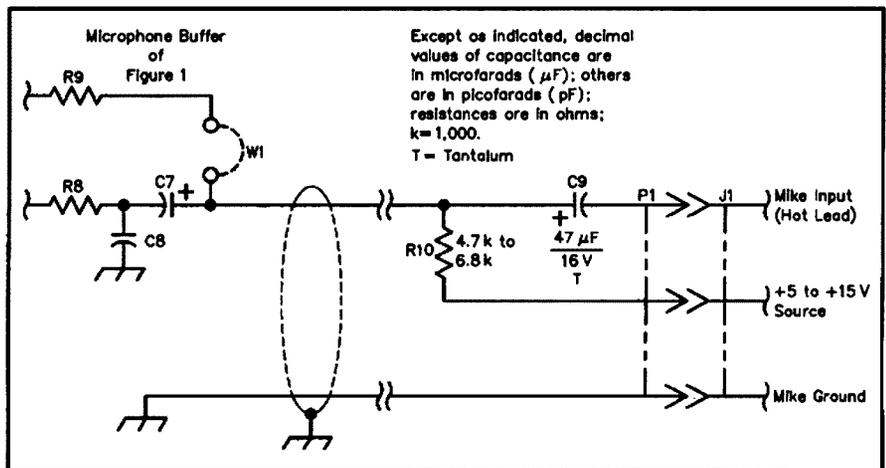

Fig 2. Power Feed Circuit.

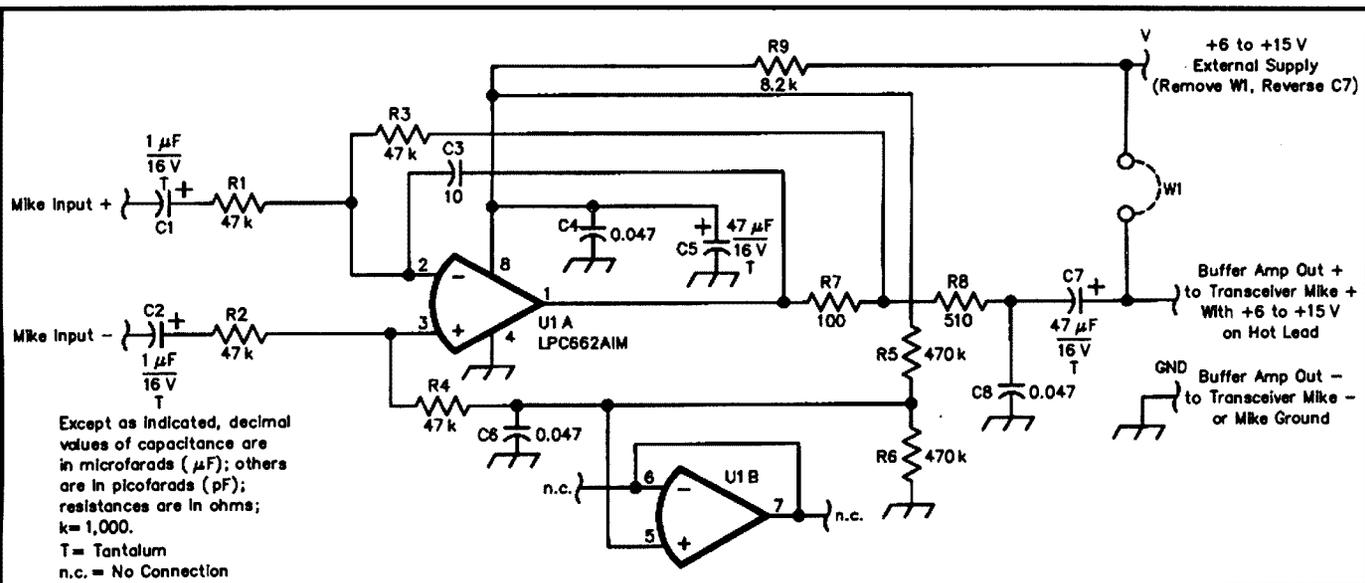

Fig 1. Microphone Buffer Amplifier. The 10 pF cap is ceramic. The electrolytics are tantalum and the remaining capacitors are film types.

received and transmitted audio tones were compared on an oscilloscope and the time taken for the signal to make the return trip determined. This gave the range of the aircraft from the base station. The base station could then determine when the aircraft was over the target.

The use of the 40 MHz frequency was not essential but obviously convenient. To recreate the system a two-metre repeater was used as the re-transmission unit. The repeater access tone used in the UK of 1750 Hz was used as the audio tone.

After some experiment the setup shown in Fig 5 was used. The signal from transceiver 3 is monitored by transceiver 2,

which provides the synchronising signal to the CRO timebase. The signal received from the repeater is received by transceiver 1 and the delay is measured with the CRO. The signals from transceiver 1 and transceiver 2 are applied to two traces on the CRO so that the delay can be determined. The delay through the repeater can be determined by comparing the delay with that expected from a known location.

In the test an IC821 was used for transceiver 3 and two IC2 handheld transceivers were used for transceivers 1 & 2. This allowed the delays in the two handhelds to be cancelled out as their receivers should have equal delays. This can be checked by substituting transceivers.

Working on 10.74 microseconds as the propagation time for a statute mile and 12.36 microseconds for a nautical mile the author succeeded in measuring the distance to a repeater of a measured 12.6 miles as 12.8 miles which is pretty good for a few transceivers and a twin trace CRO in the back seat of a car.

Countermeasures to the original system consisted of re-radiating the signal from the BBC TV transmitter at Alexandra Palace. This resulted in false readings and great confusion.

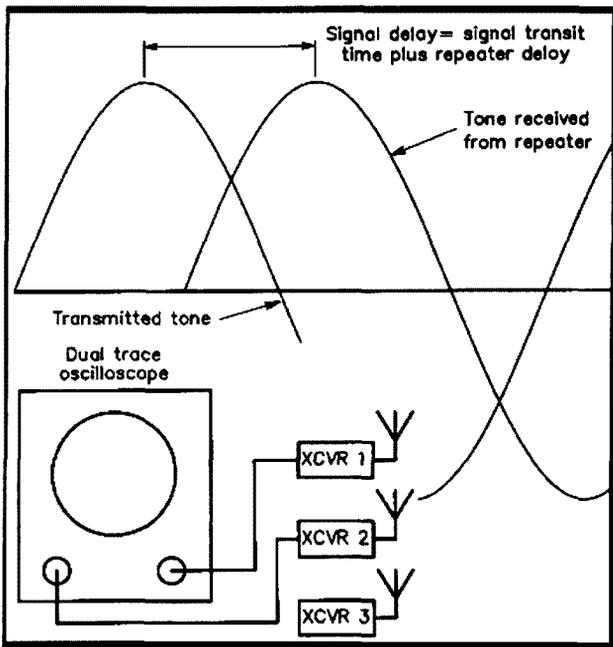

Fig 5. Test Set Up to Recreate Y-Gerat. By alternating transceivers relative delays can be compared. If transceivers 1&2 have the same delay they will cancel and can be ignored.

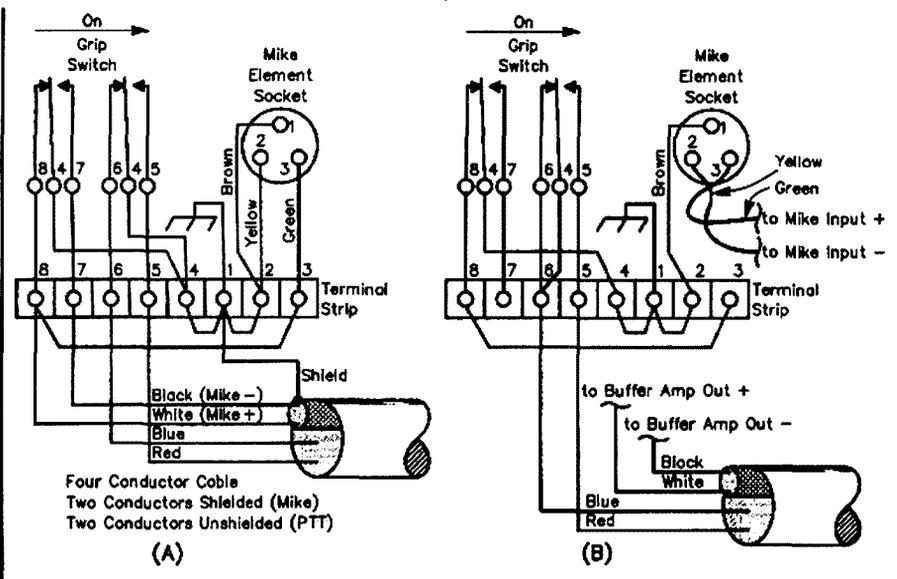

Fig 3. Wiring modifications to D-104 Microphone.

Shielded Balanced Feed Line

In the "Doctor is IN" column in QST May 1999 a useful idea for making a shielded balanced feed line appeared. Two parallel lengths of coaxial cable are wired to act as a shielded balanced feed line. This can be useful where a balanced feed must be run in close proximity to earthed metal structures.

The two coaxial cables are run in parallel held together by cable ties or tape. The shield braids are shorted together at both ends and earthed at the shack end. The inner conductors become the shielded balanced line. The connection is shown in Fig 4.

The drawback of this technique is that the losses are greater than for open wire or ladder line. The benefit is the line can be run over metal structures such as a roof.

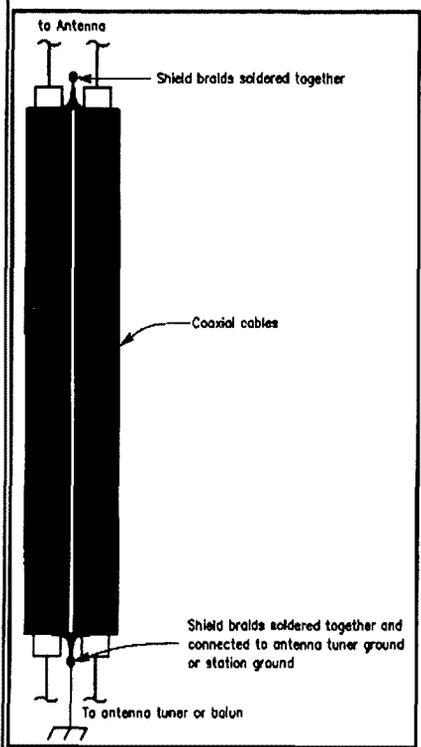
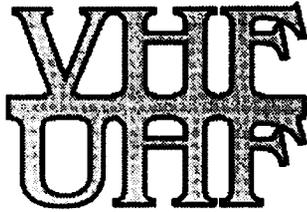

Fig 4. Shielded Balanced Feed Line.

Correction

In Tech Abstracts AR September 1999 p32 an error occurred the Simple 50 Ohm Feed W8JK Beam. (Originally from QST June 1999 it was corrected in the July 1999 edition. The spacings in Table 1 should be 15.4 inches or 390 mm for two meters and 44.3 inches or 1126 mm for six metres..

ar



AN EXPANDING WORLD

Eric Jamieson VK5LP

PO Box 169 Meningie South Australia 5264
E-mail: vk5lp@lm.net.au Fax: 08 8575 1777
Packet: VK5LP@VK5WI.#ADL.#SA.AUS.OC

All times are UTC

frequencies when it is genuinely impractical to move to another frequency. But it is important to keep calling frequencies clear of local QRM so that it is possible to hear any weak signals that may appear.

A list of the 49 past winners will be published next month.

Over to David VK5KK Contests, an important role in activity?

By the time you read this we will be in the middle of the "Late Spring" Field day contest in mid November.

In one form or another, "Contesting" has been part of the amateur radio scene almost since inception and an important part of the VHF/UHF scene. Such contests as the Ross Hull and the John Moyle Field Day are just two examples. For those who have the equipment, there are EME contests.

In the past, and maybe somewhere still, the VHF Scramble was a popular night-time pursuit.

Propagation creates another "contest" ... that of breaking distance records. Each contest has evolved to suit its environment with some form of equitable scoring. But as usual, the fickle finger of fate (propagation and geographic location) rarely gives everyone a fair chance.

Overseas, contesting occurs on a larger scale on the VHF and above bands. In the US and Europe, contesting is a major part of Microwave activity.

Now a quick look at the US "Contest Rover".

Contest Rover

What is a "Contest Rover"? Most are familiar with the "Grid Locator" system, i.e. a global system of grid squares defining location by a 2-alpha/2-digit code. (See the article on Grid Squares in this issue. Ed)

A grid locator type contest is a numbers contest, working as many grid squares as possible in a short period of time. Given the size of a grid square and being surrounded

by up to 8 other grid squares less than 100km away, gives a contest that can survive without propagation. You multiply contacts by working the same stations on multiple bands, adding an incentive for higher bands.

To score well you will need to work multiple grid squares on as many bands as possible. To excel means being portable on a good hill. But with only so many stations available, it is not hard to work everyone and then you are left looking for more.

But! If portable stations can activate multiple grid squares in one contest, you have a new contact multiplier. This is almost as good as having extra participants and if these grid squares are activated in a systematic manner, a new area of exploitation exists.

Enter the Contest Rover.

A Contest Rover is either a lone team or part of a larger group. The group approach enables pooling of resources. This means more bands can be implemented quickly as each group has a specialist who will look after the harder bits, like microwave stuff. After years of work, some impressive 9 band portable stations have been developed and some very basic ones that do almost as well. Some groups may have two or three Rovers and interact with other groups of similar size. It is not unknown to have 30 to 50 Rovers in the field, with a large number within range of each other during contests.

Sound all too hard? Perhaps not. The Rover concept also pushes just how little you need to get going on a particular band. For example, activity above 1200 MHz has been mostly done with basic transverter kits running ~20 mWs, driven by IC202s and alike. While this means portable work may only be successful from good hilltop locations, the 100km/8 grid square contacts are still achievable.

The underlying benefit of all forms of contesting is the increase in activity and usage of VHF and above bands. In the Rover example, activity on Microwave bands has been created where none existed before. With our current calendar of three field day contests, we now have a chance to progress a step further. While we do not have the population density to have contests on the scale of overseas, we do have the geographic ability to mount "local" challenges for grid squares and to use some of the higher frequencies, a simplistic contest as the means to more activity?

The number of portable participants has varied little in recent times, yet the amount of interest seems to be on the increase. Those who often go portable may relate the number of times when others, sharing a common interest in the outdoors, have expressed more than passing interest. The gap between the "would if I could" group

Spring VHF-UHF Field Day Contest

Remember that the Spring Field Day will take place on November 13 and 14. (VK6 runs from 0400 UTC Sat. 13 November to 0400 UTC Sun. 14 November. All other call areas from 0100 UTC Saturday to 0100 UTC Sunday). Time changes take into account daylight savings time.

There is an adjustment to the band multipliers to increase the incentive for stations operating only on the lower VHF bands. The same band multipliers will also be applied to the Ross Hull Contest and the Summer VHF-UHF Field Day.

The various rules and operating conditions are outlined in October Amateur Radio in the contest pages. The Golden Anniversary Ross Hull Memorial Contest commences on 26 December and details for this contest and the Summer VHF-UHF Field Day should appear in this issue. Readers and others are urged to support these contests to ensure their survival.

John VK3KWA, the Contest Manager, says: "This year marks the fiftieth anniversary of the contest named in honour of Ross A. Hull, the Australian born amateur who discovered tropospheric propagation and made major contributions to the development of VHF equipment design and construction.

There are several changes to the contest rules. Last year's short contest was not successful, so the duration has been extended again. There is a return to scoring based on the best 7 UTC days of your choice, and a separate section for the best two consecutive UTC days. This means that you can operate for only part of the contest, or even just one weekend, and still do well.

The band multipliers have been reduced slightly, to provide more incentive for those who do not have microwave gear.

The rules about the use of calling frequencies have been reworded, so please read them carefully. I do not want to penalise occasional contest operation on calling

and "those that do" needs improvement!

If you go portable, take a few interested amateurs with you. If they get the bug then they may go out next time and add to the numbers. Plenty of equipment is available on the second-hand market to take portable. Or maybe you have some equipment to help a portable station get on other bands. Any participation is still better than none! See you in the next contest!

Two-meter Transatlantic Tests Disappointing

Paul Piercy VO1HE, led a group of Canadians attempting to make the first transatlantic contact on 144 MHz. They operated VO1AA from Cabot Tower, the site of Marconi's 1901 transatlantic tests at St John's, Newfoundland, from June 26 to July 3. On the other side of the Atlantic, Bill Ward, GMOICF, led a Scottish team, who operated 2SOICF/p from Ardnarnurdan Lighthouse, the most westerly point in the British Isles. Despite a week of coordinated transmissions, nothing was heard. A Belgian group, under the call OT9D, was forced to cancel its efforts due to generator failure and logistical problems.

Indian Ocean Trophy

Following on from the above two metre tests, I further draw your attention to my offer in the September issue to make a trophy available for the first two metre terrestrial two-way contact across the Indian Ocean.

The title of The Indian Ocean Trophy may not seem startling but is appropriately descriptive. I now believe that the first contact should be between the Australian landmass and the African land mass without any places between them qualifying.

A tape recording of both ends of the contact is mandatory unless I can be otherwise satisfactorily convinced that it should not be required, more later.

New beacon

Peter VK3KAI advises that Ralph VK3WRE has installed a new 23 cm beacon (in test mode) in the Gippsland area at Carrajung, south-east of Traralgon. It runs two watts on 1296.534 MHz to an Alford slot antenna with the callsign VK3RGI. Reports of reception are welcomed.

UK 47 GHz distance record smashed

Roger VK2ZRH sent this from GB2RS, who in turn thanked Peter Day G3PHO, Editor of the *RSGB Microwave Newsletter*.

The UK 47-Gigahertz distance record of 137 km, set up by G3FYX, G3PYB and

G8ACE in June '99, was broken during the RSGB 24 and 47 GHz Contest on 5 September. Martin Farnner GW7MRF/p and David Hall GW8VZT/p, each made two-way contacts over 161 km from the summit of Cyrney Brain in North Wales with Paul Widger G0HNNW/p, located at Shap in the Lake District.

This long path was line-of-sight. Paul's narrow band FM signals were RS 57 with GW7MRF, while the Welsh signals peaked RST 529 at Shap. This difference was due to G0HNNW/p equipment being more potent than that of the GW stations - he was using 25 milliwatts

output to a 3foot diameter dish, as against GW7MRFs 150 microwatts output to a 10-inch diameter dish.

Additions, updates and guidelines requests to Guy VK2KU, <guy@ics.mq.edu.au>, or by mail (QTHR 99).

Note: All scores have been entered this month rather than any minimum numbers. I will discuss the matter of whether or not there will be any entry numbers with David VK5KK whose responsibility the list will become next year. ... VK5LP.

Two metres and above

Rob VK3EK reports as follows: 25/9: 144 MHz: 2205 Des VK3CY 5x9; 2207 Max VK3TMP 5x9; 2210 Ross VK2ZRE 5x1; 2244 Rej VK2MP 5x3; 2256 Gordon VK2ZAB 5x2; 2333 Trevor VK5NC 5x7. 432 MHz: 2258 Gordon VK2ZAB 5x1. 26/9: 144 MHz: 0034 Doug VK3KAY 5x6; 0120 Alan VK3XPD 5x5.

Gordon VK2ZAB reports his contacts: 24/9: 144 MHz: 2137 Ray VK2BRG Coffs Harbour 5x5; 2139 Neil VK2EI Port Macquarie 5x3; 2144 Eric VK2KXG (local) 5x9; 2145 Alan VK2DXE (local) 5x9; 2201 Warren VK3BWT Mallacoota 5x4; 2207 Rej VK2MP Murrumbateman 5x5; 2211 Ross VK2ZRE Adaminaby 5x3. 23cm: 2215 Lyell VK2BE (local) 5x9; 2225 Bob VK3AJN Wangaratta 5x1. 144 MHz: 2230 Bill VK3AMH Nagambie 5x2; 2237

Gridsquare Standings at 20 September 1999

144MHz

VK2ZAB Gordon 58
VK3BRZ Chas 55
VK2DVZ Ross 52
VK2KU Guy 47
VK3CY Des 47 (+26 EME)
VK3TMP Max 46
VK2FLR Mike 42 (+74 EME)
VK3EK Rob 37
VK3XLD David 35
VK2DXE Alan 33
VK3BDL Mike 31
VK3CAT Tony 29
VK6HK Don 28
VK4KZR Rod 27
VK3BJM Barry 23
VK1MP Rej 21
VK6KZ Wally 19
VK3KAI Peter 18
VK2TZ Dale 16
VK6KZ/p Wally 16
VK3WRE Ralph 15
VK3AL Alan 14
VK3TLW Mark 14
VK6BIK Chris 6
VK2TJE John 5
VK1WJ Waldis 4
VK3HZ/2 David 1
VK3HZ/8 David 1

432MHz

VK2ZAB Gordon 33
VK3BRZ Chas 32
VK3XLD David 27
VK3CY Des 23
VK3TMP Max 19
VK3EK Rob 18
VK2DVZ Ross 17
VK2KU Guy 16
VK3BDL Mike 15
VK3BJM Barry 15
VK4KZR Rod 14
VK6KZ Wally 12
VK3KAI Peter 11
VK3AL Alan 10
VK3TLW Mark 10
VK6KZ/p Wally 8
VK3WRE Ralph 6
VK1MP Rej 5
VK3HZ David 5
VK1WJ Waldis 4
VK2TZ Dale 4
VK2DXE/p Alan 2
VK3HZ/2 David 2
VK3HZ/8 David 1

VK2DVZ Ross 9
VK3BRZ Chas 9
VK3XLD David 9
VK4KZR Rod 7
VK3AL Alan 6
VK3BJM Barry 6
VK3TLW Mark 6
VK6KZ/p Wally 5
VK2KU Guy 4
VK3KAI Peter 4
VK6KZ Wally 4
VK3WRE Ralph 3
VK2DXE/p Alan 2
VK2TZ Dale 1
VK3HZ/2 David 1

2403MHz

VK6KZ Wally 4
VK3WRE Ralph 3
VK3KAI Peter 2

3456MHz

VK6KZ Wally 4

5760MHz

VK6KZ Wally 4

10GHz

VK6KZ Wally 5

24GHz

VK6KZ Wally 2

Rob VK1ZQR Canberra 5x6; 2243 Carl VK2TP Wellington 5x8. 70cm: 2246 Bob VK3AJN Wangaratta 5x3. 144 MHz: 2256 Mike VK2FLR (local) 5x9; 2300 Peter VK3KAI Churchill 5x1. 70cm: 2301 Peter VK3KAI Churchill 5x1.

25/9: 144 MHz: 2130 Bob VK4ZOW Pittsworth 5x1; 2133 Ray VK2BRG Coffs Harbour 5x2; 2137 Bill VK2ZCV Port Macquarie 5x6; 2143 Wayne VK2TEV Uralla 5x6; 2151 John VK2TJE (local) 5x9; 2202 Warren VK3BWT Mallacoota 5x3; 2215 Rej VK2MP Murrumbateman 5x8. 70cm: 2216 Rej VK2MP Murrumbateman 5x5. 144 MHz: 2222 Rob VK1ZQR Canberra 5x5; 2229 Ross VK2ZRE Adaminaby 5x2; 2231 Carl VK2TP Wellington 5x8; 2238 Bob VK3AJN Wangaratta 5x7; 2240 Des VK3CY Wedderburn 5x3; 2244 Max VK3TMP Somerville 5x2; 2255 Robbie VK3EK Bairnsdale 5x1. 70cm: 2256 Robbie VK3EK Bairnsdale 5x1.

26/9: 144 MHz: 0120 Lou VK2NZ (local) 1 watt 5x4; 0129 John VK2ATU (local) 5x8; 0309 Rod VK2TGB Valley Heights 5x9. 23cm: 0138 John VK2ATU (local) 5x4.

Six metres

Ray VK4BLK at Yeppoon writes a short six metre report. 25/8: 0724-1109 - worked 16 JAs. 26/8: 0703-0947 - worked 27 JAs. 29/8: 0312-0502 - worked 2 HLs, 59 JAs. 10/9:

0300 - worked KH6IAA 5x5. 16/9: 0128-0211 - worked NH6YK 5x9, KH6IAA 5x9, WH6XM/m 5x5, KH7L 5x9, KH6CM 5x9.

Graham VK6RO of Perth sent a joyful note to say that he finally worked and confirmed his 40th country with a contact to 9M2TO 559 on 4/4/99 at 0817. Graham said it has been a long hard slog of 20 years to reach that goal from the most remote capital city on earth. We hope the coming Cycle will reward Graham with a few more countries.

Opening to the US

The equinox is living up to its reputation of providing interesting contacts with an opening to the US.

Ron VK4BRG reports: *A great opening today 23/9 between 0110 and 0137 UTC. Worked 22 stations from South Dakota in the north to the very south of Texas. Most easterly was in Illinois. Six new grids, one new state. Interesting solar conditions were predicted a week or so ago for the period from the equinox through to the end of this month. More to come?*

Stations worked: 0110 W7XU 5x9+; 0112 KOFF 5x9+; 0113 W0SD 5x9; 0114 N5DDB 5x9; 0116 WA0KBZ 5x9+; 0117 K9KE 5x9; 0118 K0TLM 5x9; 0120 W0FN lost; 0122 WA5JCI 5x9; 0123 W5WP 5x9; 0125 WA5TKU 5x9; 0126 W3UUM 5x9; 0127 N5WS 5x9+40; 0128 AA5XE 5x9+40; 0129 W5OZ1 5x9+; 0130 W3XO/ 3 5x9+40; 0132 W5UWB 5x9+; 0133 K5VH 5x9; 0134 W5AAW 5x9; 0135 KC5NOB 5x9; 0136 WA5UFH 5x9; 0137 KC5NOA 5x7. All were 2 way SSB.

I like to think reports were genuine. Most signals into this QTH were S9 or better. Main problem was sorting stations out from the pile up. Most contacts were on 50.130, when it was quiet I would go back to 50.110, try to attract attention and move back to 50.130. Most stations exchanged grid squares.

John VK4KK phoned me immediately after the opening and then reported stating he also found strong contacts on 23/9: 0051 KA0PQW MN 5x9; 0052 KB9JZL IL 5x9; 0053 K9AM IL 5x9; 0054 N0UR MN 5x9; 0055 W9RC IL 5x9; 0055 K9JI WI 5x9; 0056 W7XU SD 5x9; 0056 N0SPP IA 5x9; 0057 N09Z IL 5x9; 0058 K0GJX MI 5x9; 0059 N0QJM SD 5x9; 0059 W0SD SD 5x9; 0102 WB9Z IL 5x5; 0105 KA9CFD IL 5x7; 0105 KG9N IL 5x5; 0106 KOFF MO 5x5; 0111 KB0PYO MN 5x5; 0112 KC0BMF IO 5x5; 0116 KM0T IO 5x9; 0118 KA0JGH NE 5x7; 0122 WBOHHM SD 5x5. Five new northern-most states were worked during the 21 contacts.

John wasted no time with his contacts, the first 12 contacts in 9 minutes is good DX operating. The 5x9 signals for most of the stations indicated a very solid opening, such signal reports being common to all those who participated. On 28/9 John also

worked T31K in Central Kiribati at 0204 5x5. Others to work him were VK4ZAA, VK4KJL and VK4APG.

Peter VK4APG writes: *Ten minutes prior to the W opening on 23/9 at 0050 there were strong inband JA signals. The 49.750 video had been building and JAs had previously reported ZL and VK indicators. Was this JA opening F or TEP? I was checking Pacific indicators all morning. The 55.250 Pago Pago and Hawaii TV have been reliable indicators of openings this cycle. 55 MHz signals S1 at 0040.*

At 0049 NH6YK heard S1 on 50.110 and stations in Illinois 30 seconds later. Northern VK stations (Townsville, Sarina, Ayr) working same W areas so a big footprint at this end. Big at the other end too - an area which included MI, IL, WI, SD, NE and MS, TX and NM. MS is, I guess, on the same arc distance-wise from here. TX and NM a little shorter. The NM station was heard here from 0130 til 0155...no other stations during that time. NA was enjoying AU conditions at the time of the opening.

John VK4FNQ relayed a Packet message from Wally VK4DO: *At 0045 heard JHIWHS S9 off the side of the beam and then KA9CFD 5x9. Lasted about half an hour. Had 13 contacts, 11 in a small band through South Dakota/Iowa/Nebraska/Missouri/Illinois. The other two were in SE/TEXAS EL17 and EL07. Other grids EN13(4), EN10(3), EN31(1), EN40(1), EM48(1), EM57(1). Some weak signals but dropped out 0115. Never thought it would happen - 27 days after I heard the XE1 beacon!*

John VK4FNQ also joined in, working the following on 23/9: 0046 KA9CFD 5x5 EN40; 0049 NDOJ 5x9 EN31; 0052 N9BJG 5x9 EM57; 0057 N9AZZ 5x2 EM57; 0059 KA0ABA 5x9 EN10; 0116 W7XU 5x5 EN32; 0117 N0QJM 5x5 EN32.

Interesting to note the lead-up to this opening from John's heard report which at 0015 showed video on 49.750 was S9+, at 0030 the four 50 MHz JA beacons were 599 and video and audio was strong between 55.250 and 59.250. So the indicators were something could happen. It did, with simultaneous strong opening to Japan and the US, with the S9 signals from Japan causing a few problems.

Thanks to the *VK-VHF Reflector* for much of the above information.

The USA ham radio show *Newsline's* Bill Pasternak WA6ATF sent *QNEWS* a draft of a story for his next *Newsline* report, dealing with a possible record setting VK4 to W9 set of contacts that took place on 23/9.

Only one problem. Everyone on his side of the Pacific Pond was so excited that nobody thought to start a tape recorder and capture it for posterity! *QNEWS* contacted 5 of the VK4s concerned, hopefully one of

them supply *Newsline's* with some audio.

Six metres surprised many mid-Western US hams late on September 23rd by exploding with a DX opening to end all openings. Would you believe Australia to Illinois, Indiana, Minnesota and Wisconsin, on the 50 MHz band?

It started at 0300. That's when K9APW in Wisconsin gridsquare EN53 worked VK4PU in Australian grid PG75 on 50.130 MHz SSB. K9APW says that he has been on 6 meters since the early 1970s but this is the first really solid VK to nine-land opening he has ever heard.

Nor was K9APW the only station to make the path. Jay Hainline KA9CFD, in Illinois grid EN40 reports that after listening to the aurora signals, he turned his beam west and immediately heard Australian and New Zealand stations. Jay worked VK4s FNQ, DO, ABW, NW, JH, GPS, KK and PU. He also heard VK4BRG. That station had been his one and only QSO with Australia from 1998. And to top it off JA3EGE in Japan said he heard Jay on backscatter as well... QNEWS.

Ted Collins G4UPS advises that Frank PA7FF (ex-PA3BFBM) says he was giving away the six-metre band for some time. He removed his six-metre antenna and sold his amplifier so that he can devote more time to the HF bands! A very active station during the last Cycle, Frank's strong signal will be missed.

Ted's monthly report shows August as having been an active six metre month with the best day being 21/8 from 0710 to 2300 - a long day! He makes a comment: 2054 .. lots of EU activity .. now also DL and all of Europe - same pattern through to 2300. Obviously a very full band!

David Vitek sent his usual report and on 20/9 commented: 'Conditions have been terrible, little to hear. 28 MHz is dead and 50 MHz very quiet. Solar storms have closed everything down. I really miss the Es, it has just ceased to exist. The F2 is supposed to make up for it! Six months with no DX is a bit much!

His log sheet shows what he means. Virtually no signals above 49.750 MHz and those listed below have not been strong. I guess that when David reads about the US opening on 23/9, which appeared not to arrive this far south, he will not be consoled!

Closing with two thoughts for the month.

1. A smile is an inexpensive way to improve your looks, and
2. Strange how much you've got to know before you know how little you know.

73 from *The Voice by the Lake* - for the second last time!

ar

AMSAT AUSTRALIA

Bill Magnusson VK3JT
RMB 1627 Milawa Vic. 3678
Email: vk3jt@amsat.org

National coordinator:

Graham Ratcliff VK5AGR

Email: vk5agr@amsat.org

AMSAT Australia net:

The AMSAT-Australia net is held on 80 or 40 meters LSB (Lower Side Band) each Sunday evening (except over the Christmas/New Year period). During the winter months in South Australia (end of March until the end of October) the net is on 3.685 MHz +/- QRM with an official start time 1000utc with early check-ins at 0945utc. During the summer months when daylight saving is in operation in South Australia (end of October until end of March) the net is on 7.068 MHz +/- QRM with an official start time of 0900utc with early check-ins at 0845utc. The times and frequencies have been chosen as the best compromise for an Australia-wide net taking into consideration seasonal propagation changes and the various state summer time variations.

AMSAT Australia newsletter and software service:

The newsletter is published monthly by Graham VK5AGR. Subscription is \$30 for Australia, \$35 for New Zealand and \$40 for other countries by AIRMAIL. It is payable to AMSAT Australia addressed as follows:

AMSAT Australia

GPO Box 2141

Adelaide SA 5001

Keplerian Elements

Current keps are available from the Internet by accessing the AMSAT FTP site, ftp.amsat.org and following the sub-directories to "KEPS".

Good News about Launch of Phase 3D

The most exciting piece of news about the long awaited launch arrangements for the new AMSAT 'flagship' satellite, Phase 3D, released recently by AMSAT News Service. Here is the announcement as it was sent to thousands of subscribers to the AMSAT News Service mailing list:

MARBURG, GERMANY (October 8, 1999) AMSAT's most ambitious project to date... the International Phase 3D

communications satellite...has now been accepted for launch aboard an Arianespace Ariane 5 launch vehicle.

Dr. Karl Meinzer, DJ4ZC, AMSAT-Germany's President and Phase 3D Project Leader released the following statement: - "As the primary agency responsible for securing a launch opportunity for Phase 3D, I am pleased to announce that AMSAT-Germany and Arianespace have now come to an agreement calling for the launch of P3D as a secondary payload aboard the "first suitable" Ariane 5 flight.

Dr. Meinzer went on to comment that, "From the very beginning of the Phase 3D project, we considered the Ariane 5 series our primary launch vehicle. Our long history of success and mutual cooperation with both the European Space Agency (ESA) and Arianespace, coupled with our need to lift P3D into a high geostationary transfer orbit, made the Ariane 5 the unanimous choice by AMSAT."

Following standard protocol, specific details of the launch agreement were not released.

AMSAT-NA President Keith Baker, KB1SF, was elated with the latest news. "I'm very pleased to see that AMSAT-DL's negotiations with Arianespace have resulted in a launch contract for Phase 3D, and I'm delighted we are again slated to fly on an Ariane vehicle," he said.

"Following the resounding success of Ariane flight 503, the Ariane 5 has now proven itself to be a very capable launcher. When coupled with our many past successes with ESA and Ariane, I believe we now have an unbeatable combination. Once it is in orbit, the Phase 3D satellite will not only help us usher in the new Millennium, it will also signal the dawn of a brand new era for Amateur Radio," he concluded.

While both AMSAT presidents expressed optimism for an early launch of the satellite, Dr. Meinzer expressed caution that the wait for the "first suitable" flight could still turn out to be a long one. "While the launch of Phase 3D could come as early as the first half of the year 2000, we must remember that Ariane's launch manifests are

continually being updated to accommodate market changes as well as the availability of other payloads. Thus, one or more changes to P3D's anticipated launch date, along with its specific Ariane 5 mission number, are a very real possibility before our satellite actually flies," he said.

Nevertheless, based on its new 'stand by' launch status, Phase 3D is slated to be delivered to the Guiana Space Centre in Kourou, French Guiana later this month so as to be ready for quick integration once Arianespace identifies a specific Ariane 5 launch vehicle for P3D's ride to orbit.

While its primary focus is on improved worldwide satellite communications, the Phase 3D satellite will also have a very positive influence on the very future of Amateur Radio.

Built primarily from donated resources, the International Phase 3D team includes participating AMSAT groups from Austria, Great Britain, Japan, Canada, Finland, Russia, Belgium, the Czech Republic, Slovenia, France, New Zealand and Hungary - in addition to the groups from AMSAT-Germany and AMSAT-North America.

AMSAT is very proud of its long tradition of excellence and the contributions it has made to the advancement of space communications, space education and the space sciences. Phase 3D will be Amateur Radio's premier vehicle to continue the quest for new communications technologies for generations yet unborn.

[end-quote from AMSAT News Service].

Those with Internet access should check the AMSAT-NA web page www.amsat.org for all the latest details of this satellite.

The web-site has many photographs showing the progress of construction and testing of Phase 3-D. You will be impressed by the design, workmanship and complexity of the project and the dedication of the project team, all of whom are captured very well in the highly detailed photographs.

I was fortunate to hear Oscar-13's PSK beacon turn on for the first time shortly after its launch. I must confess to being rather excited about the prospect of Phase 3-D achieving its design objectives.

KO-23—Signs of Life

Since going off the air with battery trouble in January this year KO-23's BBS has been silent. The satellite has occasionally been heard transmitting 1200-baud telemetry and once or twice a silent carrier.

News is scarce but it is assumed that the control stations have been carrying out tests to see if there is any possibility of re-activating this once reliable bird.

In one recent announcement the reason for the latest period of activity was deemed

SILENT KEY

necessary to alleviate extreme power problems during one of KO-23's regular eclipse periods. At that stage things didn't look very good at all.

KO-23 is out of eclipse and again active though not yet fully operational. The signal seems much weaker than when last in full operation, perhaps due to lower power being used to accommodate the battery problem.

I can easily access the satellite with 5 watts but despite many acknowledgments, no file information was downloaded.

As I watch, many call signs are in the broadcast queue along with mine. KO-23 was by far the most popular of the current batch of digital store and forward satellites. It will be interesting to watch the outcome.

SUNSAT, SO-35 Tests Continue.

Many VK/ZL operators have had success during the scheduled periods of operational testing of this satellite. Further tests have been conducted during October and will continue for the rest of this year.

One such time-slot for Australia occurs on 06-November from 02:16 to 02:34utc when the satellite transponder will again be switched into mode 'B'.

Uplink is on 436.291 MHz (+/- Doppler up to 9 kHz). Downlink is on 145.825 MHz. FM mode is used and whilst the downlink can remain fixed during a pass, the 70cm uplink will need to be 'tweaked' to compensate for Doppler effect.

Up-to-date information on SUNSAT can be obtained from

<http://sunsat.ee.sun.ac.za>,

ar

Ray Kilby, VK7RK.

Ray Kilby of Launceston passed away on Monday, 4th October after a long illness. Ray was first licensed in 1936 and spent most of his operating time on CW. He occasionally ventured onto the satellites on phone as well as CW. During WWII Ray enlisted in the AIF and served in the South Pacific with the 33rd heavy Wireless group.

During the early 50's when the bands hit rock bottom Ray set himself for a commercial licence and went to sea, serving throughout the Indian and Pacific Ocean areas. When the opportunity arose he joined the Bass Strait Ferries as Sparks and served on a number of these vessels before retiring. The Tasmanian branch of the WIA expresses their sincere condolences to his XYL Jean and family.

Tom Heaney, VK6MOT

After a long period of illness, and just before his 70th birthday, Tom passed on peacefully on the morning of 26th August, 1999. He will be missed by many radio operators on the Amateur & CB bands.

73s Tom

Len North VK6KLN

Edward Cole, VK6DC

I am sad to report that Harry Edward Cole VK6 Delta Charlie became a silent key on Wednesday July 28. Everyone knew him as Henry – one of the old school of operators. He was 83 and had been ill for some eight years.

When Henry was four, he lost his father. As the eldest of four he left school at 14 to help fend for the family. He worked at anything he could get, being the middle of the depression. He worked for a butcher, in a fruit shop and on a farm.

He studied part time and obtained a Diploma of Electrical Engineering from the old 'Perth Tech' now Curtin University.

He joined the Air Force as an Electrical Fitter. He also worked at various times running power-houses at mines in Wiluna and Kalgoorlie.

Henry retired at 58 from a position of Systems Operator at East Perth Power Station and very proud he was of that job too, often willing to show his friends over the installation.

He built much of his early amateur gear and it was a delight to behold. When SSB succeeded AM he purchased a Yaesu FT101, which he lovingly referred to as his "FT one – eleven" (no doubt from his Air

Force connections).

He powered this into an 80-metre dipole between two A frame masts in his backyard in Como. Recently he was mostly active on two metres and listened to the news on Sundays on his hand-held. He was a very loyal member of the Wireless Institute, attending meetings regularly until he was just too ill to go.

Henry found in 1960 that I had attended the first two JOTAs with Jim VK6RU and I was invited to inspect his station. To me, knowing only 12 volt electric trains, that experience was an absolute revelation. Lined up on a table under the back window, with cables through the louvres, was a number of "units" (in obviously the correct order!) for which there was a significant ritual for changeover from Transmit to Receive (and also, obviously, in the opposite direction!).

I seem to remember five or more units, although there may only have been five or more switches and the routine went something like "Okay old man, thanks for that, please stand by a time while I switch all this gear." Whereupon the mike went onto the bench and Henry literally danced down the bench to throw a series of switches, some up, some down, until (as I now suspect) the mike gain was killed, then heaters, power amplifier and transmitter and finally the receiver (with Geloso vernier tuner?) switched on for an answer to return from the contact. Wonder of wonders, I was like a boy in a lolly shop.

Later (1970) when I could not get over the 12v dc obstacle Henry suggested I could look at direct current as "nought frequency alternating current". There was no way current could pass through an open circuit (capacitor) and I knew that current would pass through a coil – after all I was using such devices as point motors. Henry thus fixed that notion and I am eternally grateful.

Henry and Glad were married for 54 years and my family saw a fair bit of them and their family of Owen, Murray and Julie – and they us, living so close. I have lost a good friend and amateur radio has lost a good operator.

Vale Henry VK6 Delta Charlie

Peter Hughes VK6HU

and the VK6 Divisional Council.

The WIA also notes the passing of the following members.

(John) Higson VK3ABW

(Charles) Orr VK4CHO

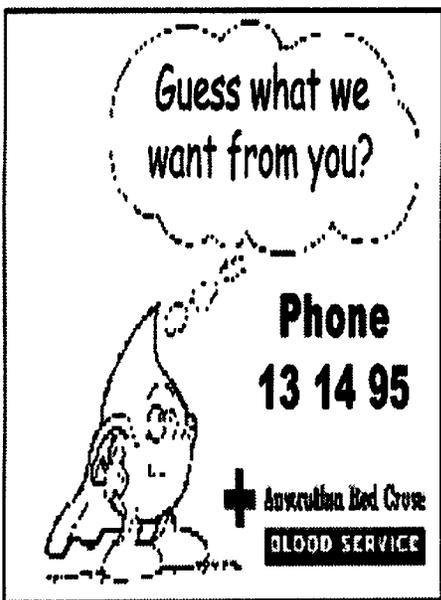

Guess what we want from you?

Phone
13 14 95

Australian Red Cross
BLOOD SERVICE

ARDF

Ron Graham VK4BRGPO
Box 323 Sarina Qld 4737

I intended to follow up the last column, on the ARDF converter, with some schematics of the various sections that comprise that converter. However, these are quite standard, and are available in numerous textbooks such as the ARRL Handbook.

Referring to the September column, which discusses the essential design of the ARDF converter, we note it consists of:

- a) an oscillator — crystal controlled or free running. It could use bipolar or FET devices. CMOS IC's can be used for crystal controlled oscillators, the common 555 timer could be used for a low frequency free running oscillator with the value of the R and C timing components calculated from the readily available 555 timer design data.
- b) an optional buffer — not mentioned previously. It gives the obvious advantage (particularly with a free running oscillator) of isolating the oscillator from the mixer stage loading and thus the possibility of "pulling" the oscillator frequency with adjustments around the mixer stage, eg adjusting the attenuator control.
If an emitter or source follower creates the buffer, the emitter or source resistance may be formed by the resistive element of the attenuator control.
So now we have an oscillator stage of your choice, say capacitively coupled to the base or gate of a buffer stage. The moving arm of the attenuator control, forming the emitter or source resistor, feeds the variable level oscillator signal to the mixer stage.
- c) a mixer - also mentioned in September, ranging from a simple diode (1N4148's work OK at 2 metres) to complex arrangements of balanced mixers. Initially these appear to offer advantages, but they do need the complexity of input and output RF transformers. These may be relatively simple devices of just a few turns of wire on a small ferrite bead. The simple single diode mixer is preferable given the distinct possibility of accidentally transmitting through the ARDF converter, (if a handy talkie is used)

and thus zapping the mixer diode(s).

Naturally, tied up with the mixer stage, is the necessity to have fitted suitable coax sockets. One for the antenna -the mixer input. The other to connect to the radio -the mixer output.

The ARDF converter should be built into a metal box to provide the necessary shielding. So, with many and varied design arrangements, its a good home brew project.

A couple of years ago, I built up an ARDF converter design along these lines. A free running oscillator on 500 KHz feeding a buffer stage followed by a simple diode mixer. It is all built into a small diecast box measuring 90 x 38 x 30mm and powered by a single internal AA cell.

The unit is quite a neat fit into the smallest die cast box and some quite critical fitting is required so its unsuitable as a homebrew project. I would consider organising kits if the demand warrants the work involved.

Reminiscence

I was pondering my first involvement with direction finding. In 1956 I became a member of the Air Force Reserve. With no private pilot's licence flying was out so I opted for Radio Technician (Air). The "air" bit meant working with aircraft equipment. I recall amazing myself and the hierarchy by obtaining a 98% pass at the trade test.!

A couple of Wirraways, a couple of Vampires and a number of Meteors made up 22 Squadron. The jets, and the later Neptunes, were all fitted with the ARN-6 radio compass, which was the only navigation aid in Vampires and Meteors.

They took bearings on mainly:

- a) the beacons in the 200 to 400 KHz band were known as NDBs, which were installed at or near most airports.
- b) medium wave broadcast stations, of which there are many in existence and spread nicely around the country.

This gave the facility of simply "homing in" on the CORRECT beacon.

More complex navigation was effected by noting time when say, abeam of a beacon. This intercept with the aircraft track gave a position and/or confirmed distance made good. Cross bearings, or better still, triangulation could also determine position.

Equipment

- a) the actual receiver -mounted at some convenient place in the aircraft. It also contained the loop control circuitry.
- b) the control unit -mechanically tuning the remote receiver plus the other necessary controls and an S meter.
- c) the loop antenna -mounted on the centre line of the fuselage (so there is a symmetrical expanse of metal on either side) either at top or bottom.
- d) the sense antenna -a raked metal whip about half a metre long fitted, from memory, just behind the loop.
- e) the radio compass indicator -calibrated 0 to 360° and coupled by Selsyn motors to follow the loop's position.

A function switch on the control unit allowed for "loop", "sense", and "auto" operation. Another switch allowed for manual loop rotation when in the "loop" position. So it was possible to manually look for nulls in the signal and read out the bearings from the indicator. From memory, in the "sense" position, only the sense antenna was used, so the unit just functioned as a straight receiver.

In the "auto" mode, the unit functioned completely automatically. It was only necessary to tune, and identify, the required station, as the system would look for the peak and stay peaked at that position if the aircraft changed course. The bearing to the station could be read off relative to the aircraft heading.

Naturally, the "auto" function was used almost exclusively!

Technical note

Using a loop antenna for direction finding involves rotating that loop through 360°. Two nulls in the signal strength, 180° apart should be obtained when the axis of the loop is aligned with the direction to the transmitting station. So one null is the direction "to" the station, the other null is the direction "from" the station.

In many instances, from a navigational point of view, it is apparent which null is which. In some instances, it may not be apparent, so what is often known as the 180° ambiguity results. Enter the "sense" antenna! This is generally a simple whip antenna which has its output mixed with the signal from the loop antenna. With the correct phase relationship and amplitude between these two signals, a cardioid response is obtained as the loop is rotated. This heart shaped response has a peak at 90 degrees to the axis of the loop. Thus, with a sense antenna and the phase shifting/level adjusting circuitry, the 180° ambiguity is resolved.

CONTESTS

Ian Godsil VK3DID
57 Nepean Highway, Aspendale 3195

Contest Calendar November 1999 - January 2000

Nov 1-7	HA QRP Contest	(CW)
Nov 6/7	Ukrainian DX Contest	(CW/SSB)
Nov 7	High Speed CW Ciub Contest	(Jan 99)
Nov 12/14	Japan Int. DX Contest	(SSB) (Dec 98)
Nov 13	ALARA Contest	(CW/SSB)(Sep 99)
Nov 13/14	Spring VHF-UHF Field Day	(CW/SSB)(Oct 99)
Nov 13/14	WAE RTTY Contest	
Nov 13/14	OK/OM DX Contest (CW)
Nov 20/21	LZ DX Contest	(CW)
Nov 27/28	CQ WW DX Contest	(CW)
Dec 3/5	ARRL 160 Metres Contest	(CW) (Nov 99)
Dec 4/5	EA DX Contest	(CW)
Dec 11/12	ARRL 10 Metres Contest	(CW/SSB)(Nov 99)
Dec 18	OK DX RTTY Contest	(Nov 99)
Dec 18/19	Croatian CW Contest	
Dec 18/19	International Naval Contest	(CW/SSB)
Dec 19	RAC Canada Winter Contest	(CW/SSB)
Dec 25/26	Original QRP Contest	(CW)
Dec 25/26	Stew Perry Topband Distance Challenge	(CW) (Nov 99)
Dec 26-Jan 11	Ross Hull Memorial VHF-UHF Contest	(CW/SSB)(Oct 99)
Jan 7-9	Japan International Low Band DX Contest	(CW)
Jan 8/9	Summer VHF-UHF Field Day Contest	(CW/SSB)
Jan 11	Ross Hull Contest - Final Day	
Jan 16	HA DX CW Contest	
Jan 28-30	CQ WW 160 m DX Contest	
Jan 29/30	REF CW Contest	

Thanks this Month to VK3KWA ARRL UBA ZL2BIL ZL1BVK

ARRL 160 Metres Contest

2200z Fri 3 December -
1600z Sun 5 December

Object: for DX stations to work as many W/VE stations as possible. MODE: CW. CATEGORIES: Single operator; multi-operator. SECTIONS: QRP (max 5w o/p); low power (max 100w o/p); high power (100w+ o/p). EXCHANGE: RST. SCORE: 5 points per QSO. MULTIPLIER is total number of W/VE sections plus VE8/VY1 (total 77). FINAL SCORE is total QSDO points X total multipliers. SEND LOGS by mail to: ARRL 160 Metres Contest, 225 Main Street, Newington, CT 06111, USA, by 2 January. Logs may be sent by e-mail to: <contest@arrl.org>

ARRL 10 Metres Contest

0000z Sat - 2400z Sun 11/12
December

OBJECT: to work as many stations worldwide as possible. Maximum operating time is 36 hours and listening time counts as operating time. MODES: CW; Phone; Mixed. CATEGORIES: as for 160 Metre Contest above. SEND RS(T) plus serial number. W/VE will send RS(T) plus state or province. CW entrants should stay below 28.3 MHz and avoid beacon frequencies. Entrants in mixed mode may work the same station on each mode. SCORE two points per Phone QSO, four points per CW QSO and eight points per CW QSO with US novice or technician stations signing /N or /T (28.1 - 28.3 MHz only). MULTIPLIERS are 50 US states; District of Columbia (DC); Canadian provinces; DXCC countries except Canada and US; ITU regions (/MM and /AM QSOs only). Multipliers may be counted separately for each mode. FINAL SCORE is total QSO points X total multipliers. SEND LOGS as above ("ARRL 160m Contest") by 13 January. Include dupe sheet for 500+ QSOs. Stew Perry Topband Distance Challenge

1500z Sat - 1500z Sun, 25/
26 December

This is a major challenge to copy weak signals through QRN. BAND is 160 metres. EXCHANGE is a four-character grid square (see Amateur Radio, December 1996, p16 for details of how to work out your grid square and distances). RST is optional, but if given MUST be accurate. POINTS for each contact depend on the distance between the two stations, which is computed by taking the distance between the centres of the two grid squares. Claim a minimum of one point per QSO and add one extra point of each 500-km distance. [Eg: a

Results ACORNZ ZIP Contest July 1999

from Bill ZL2BIL, Contest Manager

PHONE

(Name\call\score)

Kevin	VK5SR (Club stn)	181
John	VK5NJ	125
John	ZL1ALZ	91
Bill	ZL2AVL	60
Brian	ZL2AJS	57
Warren	ZL3TX	50
Leo	ZL2AJB	47
Denys	ZL2AWH	46
Ian	VK3DID	17

CW

John	VK5NJ	91
John	ZL1ALZ	76
Leo	ZL2AJB	65
Neville	VK2QF	57
Ian	VK3DID	21
Denys	ZL2AWH	15

Results WAITAKERE SPRINT, 1999 (VKs only)

from Alex ZL1BVK Contest Manager

(Place\ call\ score\ award)

CW

1	VK5NJ	28	1st O/A
2	VK2QF	15	2nd VK
3	VK23DID	14	3rd VK

PHONE

1	VK5NJ	51	1st O/A
2	VK5SR	40	2nd VK
3	VK7JGD	31	3rd VK
4	VK7LUV	23	
5	VK3DID	12	
6	VK7JAB	3	

COMBINED CW/Phone

1	VK5NJ	158	Sprint Champion
12	VK3DID	52	

SPOTLIGHT ON SWLING

by Robin L. Harwood VK7RH

5 Helen Street, Newstead Tasmania 7250

(03) 6344 2324

E-mail: robroy@tassie.net.au

The conflict in East Timor has changed since the arrival of the Australian-led INTERFET troops to restore law and order there. As you probably are aware, relations between Australia and Indonesia have cooled with daily demonstrations in Jakarta outside the Australian Embassy.

By the time you are reading this, Indonesia will have elected their president. Our external service has commenced using transmitters in Taiwan to get an effective signal into western Indonesia. Currently they are reportedly using 11550 kHz between 2300 and 2400 UTC and again between 0900 and 1000 UTC with 250 kW. It is also interesting that after Radio Australia signs off at 1000; The Taiwan senders are used by Radio Portugal International for a broadcast to East Timor in Portuguese and Timorese.

It is strange indeed that the facility near Darwin is not being utilised and there apparently are no plans to re-activate it. The senders did have excellent signals into SE Asia. Unlike the other senders the Darwin site was not privatised. However they are being maintained for instant readiness.

Ecuador

In late September a volcano erupted close to Quito, the Ecuadorian capital, high in the Andes Mountains and home to evangelical broadcaster, HCJB. Although the senders

at Pifo were not affected, the studios in Quito were closer to the volcano and plans were made to evacuate studio personnel if required. Also HCJB has changed the frequency of their South Pacific release from 15115 to 11755 kHz at 0700 UTC.

The Stafford Broadcasting Society will be hiring time on Merlin Network One every Friday night from Oct-01 1900-2000 on 6010 via Ascension Island. The on-air name will be Imagination and the station will feature an hour of soft rock from bands such as Barclay James Harvest and Pink Floyd. They have a website at <http://www.imagination.clara.net/index.html>. The address is PO Box 346, Stafford ST17 4AF, United Kingdom. The broadcasts will air for an initial period of six months. (World DX Club / Mike Barraclough via Glenn Hauser).

Wales is the latest station to be using the Merlin facilities. According to the Electronic DX Press, Wales Radio International is on Saturdays from 1230 to 1330 on 17650 kHz. This would be a new radio "country" for some. They are also supposed to be on from 2030 to 2100 on 7235 kHz. A third release on 9795 also on Saturdays at 0200 would not be audible in our summer months. (Joe Hanlon, PA, USA, in World of Radio via Glenn Hauser).

There is a new American station on shortwave putting in good signals into

Australia. It is yet another "religious" station based in North Carolina. It is WTJC and I am hear it under a radio-teletype station on 9370 kHz peaking at 0730 UTC till s/off at 0930. The programming was Southern Gospel music interspersed with sermons.

The Voice of America in Washington DC is putting excellent signals with their "News Now" format on 6160kHz from 1100UTC. I do not know the site as some of the Filipino senders were recently decommissioned.

Radio Ukraine International in Kiev recently dropped their English programming to Australia on 21520kHz, although they continue on a lower frequency which does not propagate well. The reason apparently was a rationalisation of the various sites within the Ukraine

The Southern Cross DX Club in Adelaide SA has regrettably folded after no nominations were received at its AGM at the end of August. This leaves only one club left in Australia; the Australian Radio DX Club Inc presently based in Sydney. Sadly SWL clubs in other parts of the world are also in decline. Interest in radio monitoring has not excited today's youth, primarily interested in the Internet with instant communications. This also has affected interest in amateur radio as reported recently by Peter Naish, our Federal President when he recently addressed a combined meeting of the Northern Branches of the Tasmanian Division in Deloraine. Although interest may be waning, it can quickly swing upwards again with an improvement in propagation or an international crisis. East Timor relies heavily on shortwave radio because the local infrastructure was destroyed.

Well that is all for this month, the second last of this millenium.

Until then, the very best of monitoring and 73 from Robin L. Harwood VK7RH.

ar

CONTESTS

station 1750-km away will count for four QSO points.] No additional distance for long path is allowed. If you work a station that does not know its grid square, you may claim only one point for the QSO.

FINAL SCORE is the total number of QSO points. No country or grid square multipliers, but stations using low power (6 - 100w o/p) multiply their score by two, and stations using QRP (less than five watts) multiply by four. SEND LOGS postmarked by 26 January to: BARC, PO Box 1357, Boring, OR 97009, USA.

Logs on disk in ASCII format are welcome, or logs may be sent by e-mail to:

<tbdc@contesting.com> Judges' decisions are final.

OK DX RTTY Contest

0000z - 2400z Sat, 18
December

BANDS: 80 - 10 m. MODE: RTTY - BAUDOT. CATEGORIES: Single operator single band; single operator all bands; multi-operator all bands. CALL: CQ OK Test. EXCHANGE: RST plus CQ zone. SCORE: On 20/15/10m one point for own continent and two points DX. On 80/40m three points within own continent and six

points DX. MULTIPLIERS: OK stations plus DXCC countries on each band. FINAL SCORE is total QSO points all bands X total DXCC countries all bands X total OK stations all bands.

Special Note:

Please support the ALARA and VHF-UHF Field Day Contests (see dates above).

Only your support will make these really worthwhile.

Thanks and 73 de Ian VK3DID

OVER TO YOU

What Price Amateur Radio?

Every man has his price. Indeed, every one of us has a price for everything that is negotiable!

A statement as such begs the question — as Hams, how many dB's are we prepared to lose in order to maintain the status quo?

THAT's the bottom line and, we need to be completely honest with ourselves, in order to answer that fundamental question.

Of course, it's all about priorities and the writer places Ham Radio close to the top of the list - hi. All Hams need to be a cohesive force in order that we survive the pressures being placed upon us by commercial interests.

The writer believes that (a) we need the WIA as a national voice to provide us with qualified representation, and (b) we need the state divisions to provide a degree of "local government" for our regional affairs.

The arguments being offered to abandon the federal or state offices are fraught with danger. If dollars are behind these ideas then we should go back to square one and ask ourselves... What Price Amateur Radio?

MAX MORRIS VK3GMM
PO BOX 222 RYE, VIC 3941
Ph (03)5985 2671

Misspelling of Names on AR Magazine.

I refer to your editorial in the September, 1999 issue.

I really cannot see what the fuss is about spelling members names correctly. My name has been mis-spelt for the last few years. I made the corrections on the subscription renewal slip last year but it appears that the NIA has happy to take the money but not make the change.

Therefore, it would appear that individuals are no longer important to the Institute, so why worry about a few minor things like mis-spelt names.

To change the subject, when can members expect to receive Amateur Radio Magazine at the beginning of the month again. It is a real pain waiting for the month to be almost over before getting AR in the mail.

Robert Demkiw VK2TG

(I have bowed to your wishes and left the spelling mistakes in your letter Robert. Apologies for past errors. We are trying to accelerate and streamline our production schedules, but "time is money"! Ed.)

More Packet Please

I notice that AR has been void of packet radio articles for a while now. Would you like some articles?

Regards Steve VK2KFJ

(Yes Please Steve! We can only print what we receive. Please note that we have a Packet item for you this month on packet teletext. I hope you enjoy it. Ed.)

There Ain't No Gain In Bits Of Wire!

I wrote this in haste and anger but I think it should stir up some discussion on the subject. I hope you can use it?

Why is it that seemingly sane and rational people lose the plot when it comes to antenna gain? I hear talk of 'frying the pigeons' with the latest dish or yagi.

In fact only this morning I heard of two otherwise sane hams who were about to set up an experiment with a (?)Watt 2.4GHz transmitter into a -30 dBi dish to see if they could boil an egg!

Let me say it one more time, the gain displayed by antennas is EFFECTIVE gain! It looks to the distant listener AS THOUGH you were running 1000Watts instead of 1 Watt. It does NOT mean there is 1000Watts coming out of your antenna. Yes, it is focussed into a nice narrow beam but it's still only 1 Watt out!

Phill Harden VK3ZED
pharden@ozemail.com.au
Ph: 03-9752-5553
Mob: 0418-381-732

QSL-VK Go into 2000 with new QSL cards

Australian made QSL cards
We're overwhelmed.

The response to our first, market-testing ad was so great that we have had to re-think how we are going to do this. Also the differing requests from various people have also caused a re-assessment. The response means an even better, even more inexpensive way can be arranged.

So, for those still waiting on a detailed response, it's coming and it will be better for you. For those who didn't enquire yet, now is the time.

Phone (03) 9428 3458 Fax (03) 9428 4242

news1@webtime.com.au

Technical Correspondence

Linear Amplifier vs Svetlana Tubes

I seek advice on using Russian built Svetlana 572B tubes in a Yaesu FT 2100 Z Linear Amp. The Linear came from a deceased estate already fitted with these tubes. Investigation showed someone had tried unsuccessfully to make it operational. The resistors on the parasitic chokes were burnt out.

They were 22 R 3W Carbon resistors, which are not exactly a common item. We got hold of several from the Yaesu agent but quickly blew them out when we endeavoured to get the set working. The tubes have significantly more gain than the originals and the unit "takes off".

I would appreciate any advice from anyone who has solved this problem. A number of friends are watching with great interest as they will one day want the answer. So please, HELP from anyone that knows the secret.

Graham Jackson VK3GBJ PO
Box 39 Upper Beaconsfield 3808
Tel (03) 5944 3554
FAX (03) 5944 3554



**AMATEUR
TRANSCIVER
RADIO CENTRE**

ALINCO NO 1 FACTORY DIRECT
IMPORTER
AUTHORISED DEALER
**MASSIVE MONTHLY STOCKIST
LATEST ARRIVALS**

NEW DJ-V5E 6w VHF/UHF.
DR-M06T 6m, DR-610E, DJ-G5EY,
ANTENNA TUNERS, POWER
SUPPLIES, BIGGEST DISCOUNTS ON
BULK PURCHASES OF ALINCO
AMATEUR RADIOS & ACCESSORIES.
FULL 3-YEAR FACTORY BACKED
WARRANTY
ALINCO SPECIALIST



IC-706MKIIG, IC-T81A,
IC-2800H, IC-746, IC-756-Pro,
IC-T8A, IC-R75, IC-Q7A.

KENWOOD TS-570SG TM-V7A
TH-G71A VC-H1 TH-D7A TM-G707A TS-870S

DIAMOND X-510NA, D-707E
AMERITRON AMPLIFIERS
AL-811AX 600 WPEP
AL-811HX 800 WPEP

PHONE (02) 9896 2545

E-mail: atrc@bytelink.com.au

Web Page:

http://users.bytelink.com.au/atrc

IONOSPHERIC UPDATE

Evan Jarman VK3ANI

34 Alandale Court, Blackburn VIC 3130

Solar activity

The graph of observations this quarter shows the rise and fall in solar activity with the solar rotation quite distinctly. It also shows how parlous solar predicting can be.

Solar activity was predominantly in the latter half of July. Of the 23 flares in July, 5 were in the first 5 days. The remainder were all in the more active latter half. However, just to be different, shortwave fadeout alerts (2) were issued for periods within the first 2 days. There were numerous coronal mass ejections in the latter half of the July.

August saw a lull in solar activity peaking at the beginning and end of the month. The graph of observations shows this very distinctly. Stronger flares were also back with 2 class X flares (X1.4/1B @ 2125UTC 2 Aug and X1.1/2N @ 1805UTC 28 Aug). A class M9.8 solar flare @ 1418 on 20 August might have made the grade if the solar region it came from had merged earlier with the region that subsequently produced the latter X flare. This latter class X flare, together with some middle strength class M flares from this merged region, gave rise to greater geomagnetic activity and prompted the Ionospheric Prediction Service to issue a shortwave fade-out alert.

September was markedly lower as the graph of observations shows. While a pattern of higher solar activity as shown in the previous two solar rotations was predicted; it didn't happen.

On 2 September 1999, a revised

prediction for the solar cycle was released. I am currently transcribing the data to a graphical form for publication next quarter.

Ionospheric activity

Conditions over the quarter were fairly normal, except in September when the low solar flux combined with a sustained increase in geomagnetism meant that MUFs were markedly depressed. (see graph) Note how the median T index line for the month has fallen away from the predicted T index value which is actually the one used in the HF Predictions.

Geomagnetic activity

It is believed that activity around the 16-20 August is related to a coronal hole. The increase in activity around 23-24 August is tied to the class M9.8 solar flare.

Activity rose during September although this increased level was not sustained over the month. There were three distinct periods of higher activity.

The first was from 12-16 September and is believed to be associated with a coronal hole and coronal mass ejections. There were three geomagnetic impulses in this time; 0400UTC 12 September, 0700UTC and 2019UTC on 15 September. The two on 15 September being sudden.

The second period, which was around 22-23 September, had major to severe storm level activity. It is believed to have been caused by a coronal mass ejection.

The third period, around 26-30 September, is believed to be coronal hole related and was not as severe.

ar

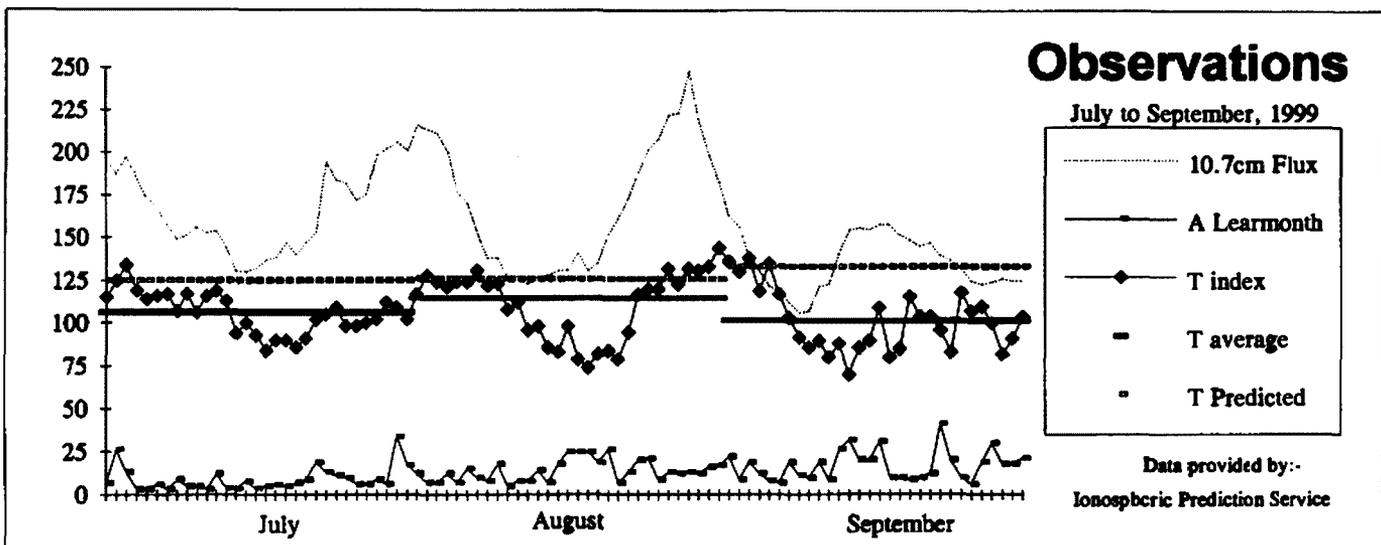
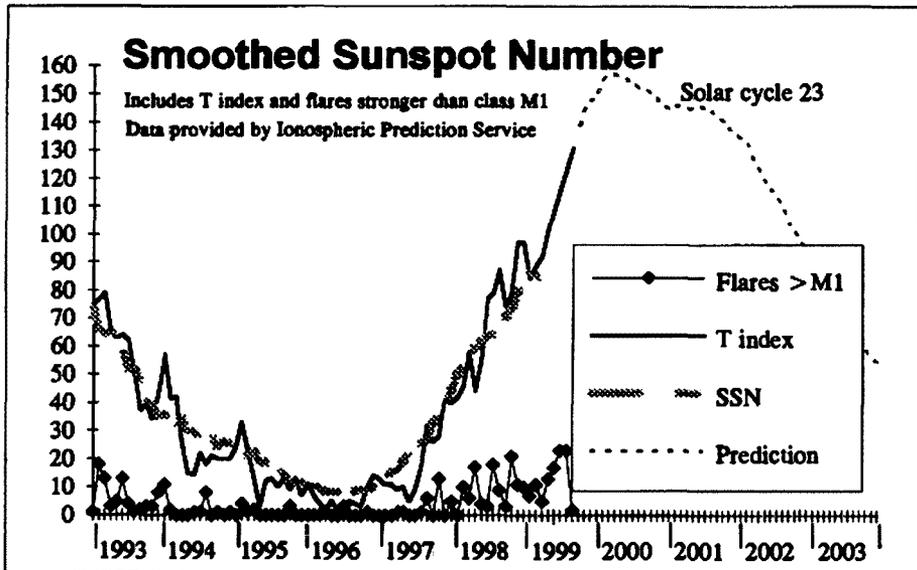

HF PREDICTIONS

by Evan Jarman VK3ANI
34 Alandale Court, Blackburn Vic 3130

Adelaide-Capetown 226
Second 4P6-15 4E0 Shor 10154 km

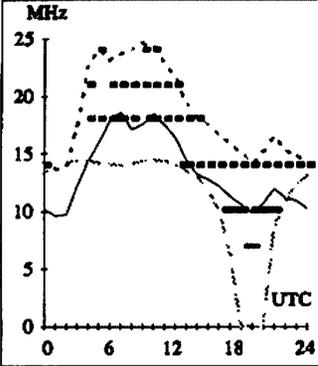

Brisbane-Dublin 335
First F 0-5 Shor 16670 km

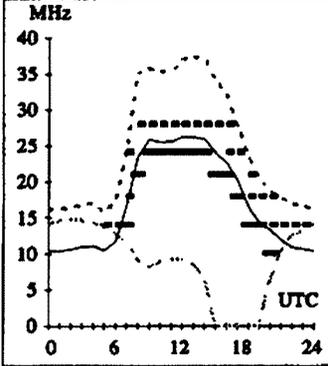

November 1999
T index: 145

Legend
UD
F-MUF
E-MUF
OWF
ALF
10%-50%
50%-90%
90%-100%
Time scale

These graphs show the predicted diurnal variation of key frequencies for the nominated circuits.

These frequencies as identified in the legend are:-

- Upper Decile (F-layer)
- F-layer Maximum Useable Frequency
- E-layer Maximum Useable Frequency
- Optimum Working Frequency (F-layer)
- Absorption Limiting Frequency (D region)

Shown hourly are the highest frequency amateur bands in ranges between these key frequencies; when useable. The path, propagation mode and Australian terminal bearing are also given for each circuit.

These predictions were made with the Ionospheric Prediction Service program: ASAPS version 4. ar

Adelaide-Honolulu 57
Second 4F7-13 4E0 Shor 9160 km

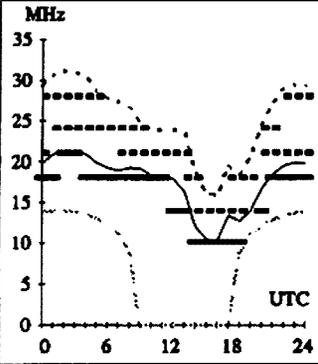

Brisbane-Lima 122
First F 0-5 Shor 13056 km

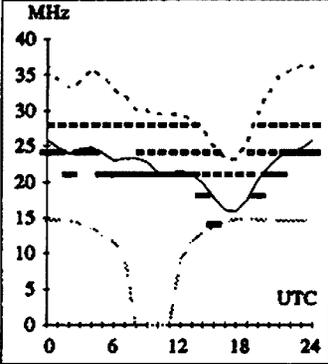

Canberra-Barbados 123
First F 0-5 Shor 16232 km

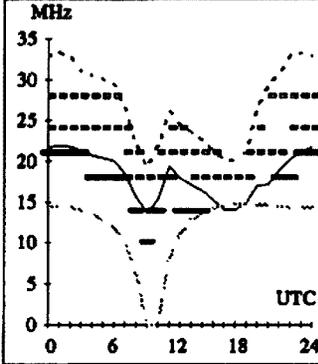

Darwin-Bangkok 310
First 2F7-20 2E0 Shor 4435 km

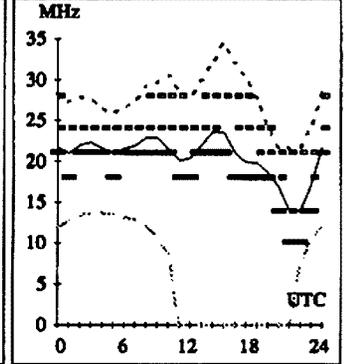

Adelaide-Lusaka 246
Second 4F4-12 4E0 Shor 10788 km

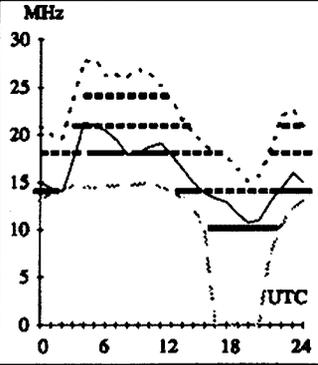

Brisbane-Seattle 44
Second 4F3-7 4E0 Shor 11845 km

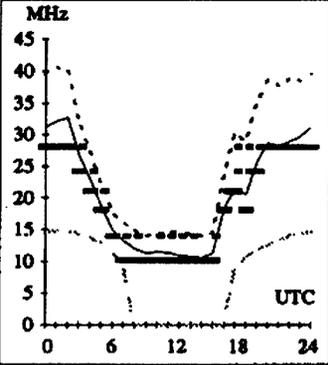

Canberra-London 136
First F 0-5 Long 23042 km

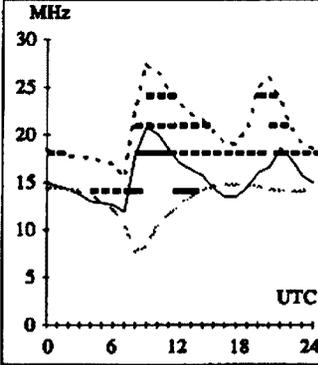

Darwin-San Francisco 54
First F 0-5 Shor 12316 km

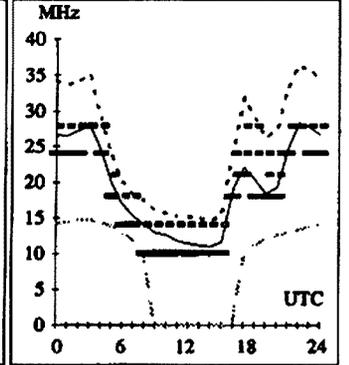

Adelaide-Singapore 311
First 2F4-12 2E0 Shor 5414 km

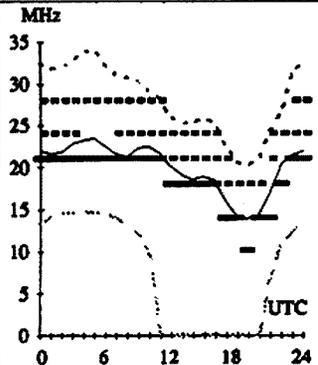

Brisbane-Tokyo 348
Second 3F6-13 3E0 Shor 7159 km

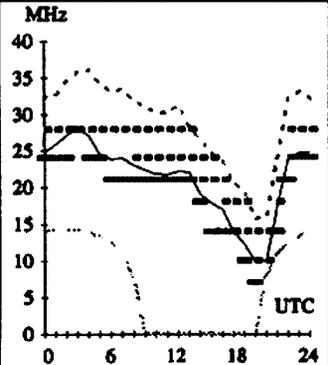

Canberra-London 316
First F 0-5 Shor 16982 km

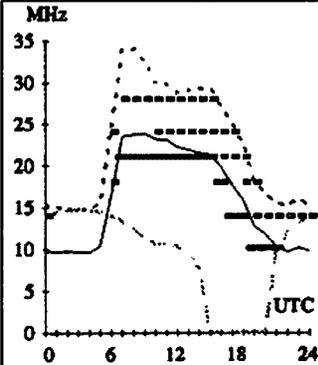

Darwin-Seoul 356
First 2F4-11 2E0 Shor 5576 km

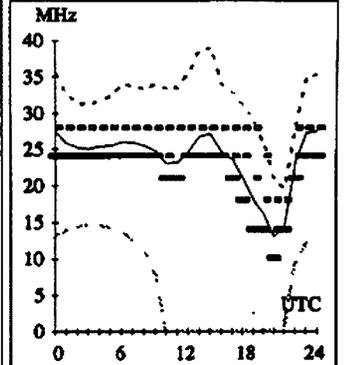

HF PREDICTIONS

Hobart-Anchorage 28 **Melbourne-Chicago 67** **Perth-London 133** **Sydney-Invercargil 139**
 First F 0-5 Shor 12871 km First F 0-5 Shor 15569 km First F 0-5 Long 25543 km First 1F10-19 1E0 Shor 2017 km

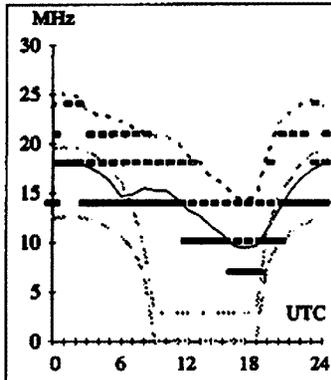
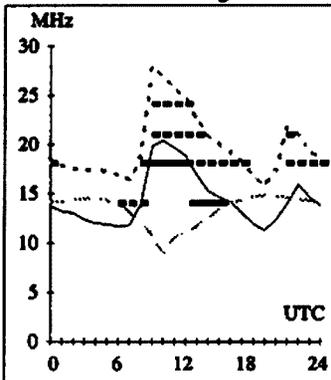
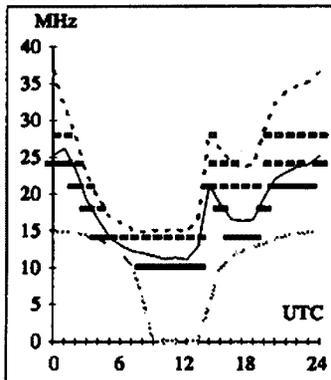
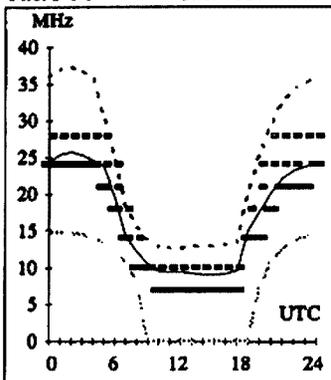

Hobart-Dakar 209 **Melbourne-Moscow 316** **Perth-London 313** **Sydney-New York 66**
 First F 0-5 Shor 16556 km First F 0-5 Shor 14428 km First F 0-5 Shor 14481 km First F 0-5 Shor 15989 km

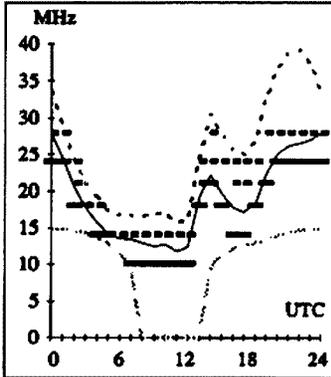
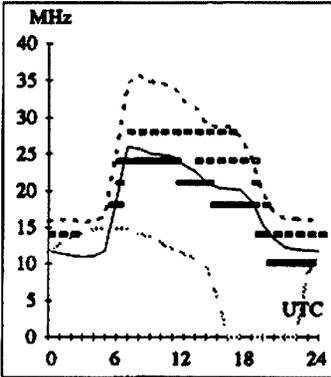
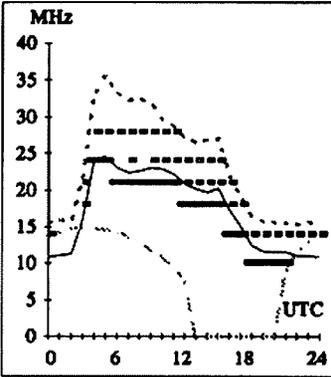
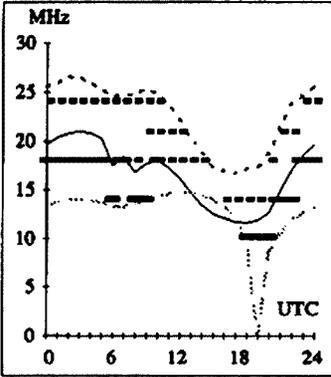

Hobart-Montevideo 161 **Melbourne-Nairobi 258** **Perth-London 313** **Sydney-St Petersburg 143**
 Second 4F7-10 4E0 Shor 11044 km Second 4F3-10 4E0 Shor 11501 km First F 0-5 Shor 14451 km First F 0-5 Long 25123 km

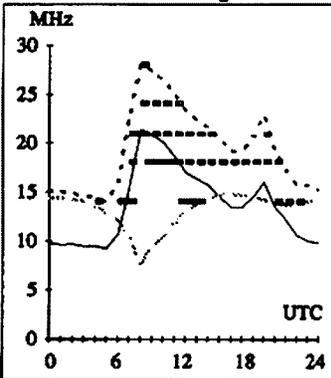
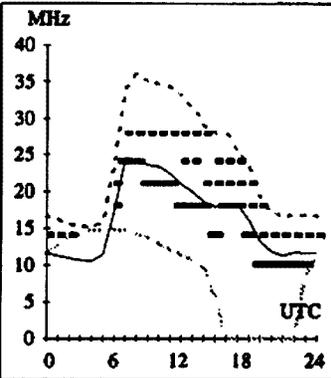
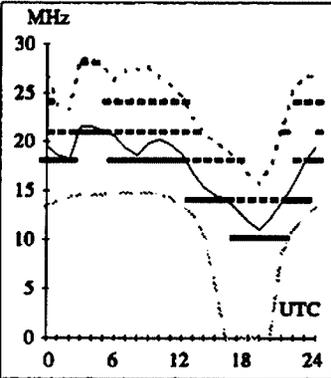
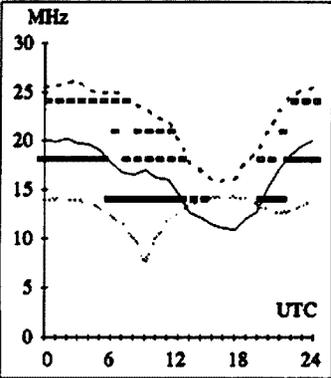

Hobart-Vancouver 49 **Melbourne-Santiago 150** **Perth-Rio de Janeiro 203** **Sydney-Tel Aviv 287**
 First F 0-5 Shor 13428 km Second 4F4-10 4E0 Long 11272 km First F 0-5 Shor 13523 km First F 0-5 Shor 14173 km

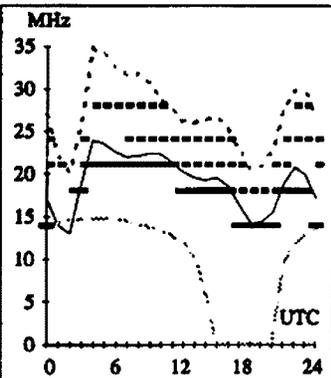
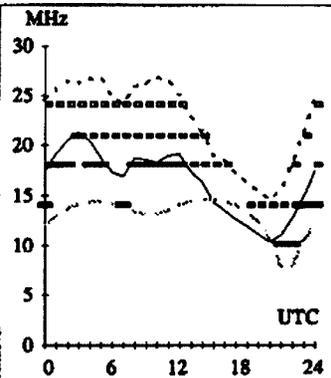
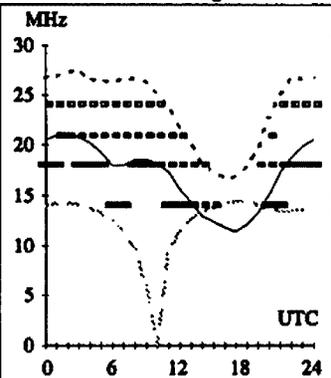
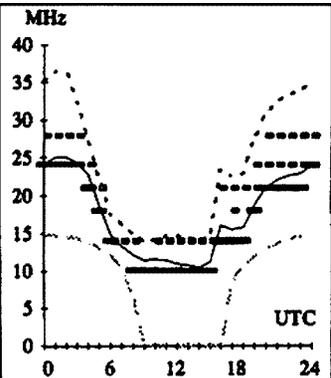

HAMADS

- Hamads may be submitted on the form on the reverse of your current Amateur Radio address flysheet. Please print carefully, especially where case or numerals are critical.
- Please submit separate forms for For Sale and Wanted items, and be sure to include your name, address and telephone number (including STD code) if you do not use the flysheet.
- Eight lines (forty words) per issue free to all WIA members, ninth and tenth lines for name and address. Commercial rates apply for non-members.
- Deceased estates Hamads will be published in full, even if the ad is not fully radio equipment.
- WIA policy recommends that the serial number of all equipment for sale should be included.
- QTHR means the address is correct in the current WIA Call Book.
- Ordinary Hamads from members who are deemed to be in general electronics retail and wholesale distributive trades should be certified as referring only to private articles not being re-sold for merchandising purposes.
- Commercial advertising (Trade Hamads) are pre-payable at \$25.00 for four lines (twenty words), plus \$2.25 per line (or part thereof), with a minimum charge of \$25.00. Cheques are to be made out to: WIA Hamads.
- Copy should be typed or in block letters, and be received by the deadlines shown on page 1 of each issue of Amateur Radio, at:

Postal: Newsletters Unlimited, 29 Tanner Street, Richmond, 3121

Fax: 03 9428 4242 E-mail: news1@webtime.com.au

Please only send your Hamad once

Please send Hamads by mail OR fax OR email (much preferred).

Please do not send by more than one method for any one ad or issue, it is confusing.

FOR SALE NSW

YAESU FT707 HF Transceiver S/n 060310 and YAESU FV707DM external VFO S/n 040248 \$650, ICOM IC730 HF Transceiver S/n 01254 \$500, YAESU FT209RH 2m. H/held S/n 180659 with speaker mike \$100, MFJ-1224 RTTY/CW Computer interface \$100. Neil VK2KCN QTHR - Phone: 0418 243 880 b/h OR, (02) 9894 5678 after 7pm - E-mail: neilcorp@hotmail.net.au

Internet Flea Market - see the Waverley Amateur Radio Society's web site for club and members items for sale and wanted. Its URL is http://www.zip.com.au/~sb/wars/w_flea.htm

YAESU FT 209 RH - 2 Metre Handheld XCVR - 140-150 MHZ - 5 WATTS output - Case-Instr. BookK - VGC - \$ 190.= O.N.O. PETER VK2BPO QTHR - PH: 02 - 9713 1831

YAESU FT-101Z HF TXCVR S/N 9C020308. G.C. Spare PA valves. Built in fan. DC-DC converter \$250.00, Kenwood TR-2400 2m FM TXCVR S/N 0115038. Leather case, spkr mic, AC charger, car charger. G.C. \$120.00 Kenwood AT-200 antenna tuner S/N 840855. \$120.00 Dipole antenna kit 80, 40, 20, 10m. Never used. \$50.00 VK2KRQ John (02) 4369 0458 12A Rickard Road Empire Bay NSW

Compaq 486 Prolinea computer, includes keyboard but no monitor, \$40, 386 Compaq Lite mono screen Notebook in docking station \$40, Compaq 486Dx Contura mono screen Notebook with 1.4Gb harddisk \$450, ono. VK2QF, QTHR, PH: 02 6373 8624 or email: vk2qf@winsoft.net.au.

BOOK: "Radiotelegraph and Radio-telephone Codes Prowords and Abbreviations." 2nd Edition. \$16 posted Australia 90 Pages. Q,X,Z Codes, 97 Phonetic, 20 Morse Codes Phillips, Myer, 10,11,12,13 Codes. Much other info. Internet - <http://www.nor.com.au/community/sarc/phonetic.htm> VK2JWA, John W.

Alcorn. QTHR. 02-66215217
jalcorn@nor.com.au

Kenwood SSB Transceiver type TS520S S/N 710532531. Jim VK2DER 02 9453 2531

Kenwood TS440S inbuilt ATU \$900. ICOM IC725 with IC120 automatic ATU \$900. ICOM IC3200A 2m and 70cms 25W \$400. Kenwood TM201A 144mhz 10W \$190. YAESU YC55D frequency meter to 200mhz \$90. VK2ABU 0293281261 (AK)

FOR SALE VIC

Kenwood R5000 HF comm. RX \$700 AoR AR2002 wideband scanner \$120. Both GC/GWO Damien VK3RX (03) 5427 3121

One 90ft wind up telescopic lattice tower with base. Good condition. Phone Dave - VK3JKY (03) 59774808 for further information.

YAESU FT900 S/N 4N090707. All HF bands proc. Keyer Collins filter. Near new in carton. Bonus Drake L.P.F.+ speaker. All \$1450. YAESU FC902 A.T.U. All HF bands 160-10m 25/250/500 watts. Dual meters 4pos. Anti-load sw-50 OHM 400W external load resistor V.G.C. \$100. Antenna Hy-Gain TH3JR 10/15/20m \$100. Antenna Cushcraft (ARX2B) 2m.7 DB Gain \$50. Andy VK3UJ 9726 8879

Marconi sig. Gen No.18 1.5-220mhz AM.FM.CW \$100. Transformer H.D. Tapped. 45v.55v.60v.6A.cont. 18A.int. \$40. Paton H.D. Rotary switches 4 pole 3 position 2 bank \$15. 2 pole 6 position 2 bank \$15. 2 pole 5 position \$15. Latter includes two normal wafers at rear. All switches unused with H.D. spring loaded contacts, ideal linear amp bandswitch. Merv. VK3AFO Wodonga 02 6024 2537

Kenwood TS.870 Topline HF xcvr with inbuilt ATU handheld mic and DCPSS2 pwr supply. Very good condition \$2550. Power supply S/N 507

00115 TS870 S/N 8030020. Jim 03 9367 6920
KENWOOD H/held TR2600a 2mtr txcvr 3w c/ case headset chgr-stand SN5022246 \$75 ono. IC 28A/E 2mtr txcvr 25w extended RX range, SN14889 \$275 ono. Both ex cond. full docs and circuits. Ryobi Drill-driver HB10AR 180rpm, chuck, sockets, bits, variable clutch, ex cond. Keith VK3AFI QTHR 03 5221 3658.

FOR SALE QLD

Deceased Estate

Lot1 ICOM Transceiver 735, AT500 Automatic tuner, PS50 power supply. Lot 1 total \$1200. Lot 2 Hi-Gain 14 Beam, KR400 rotator with controller, tower, winch and cable. Lot 2 total \$800. On behalf of lat VK4WJB. Ted VK4OW QTHR 07 41252039 or Pat 0741281752

Rotator YAESU G400RC clamp GC038 7 strand cable. TE33 Tet-emtron HF beam .3m All. Most co-ax \$450. Surfers Qld 4226. Ph 07 5578 8052

Three bedroom house on 1.5 acres. 5 years old. Ensuite in main bedroom. Built in robes. Hills cyclonic telescopic tower with tilt over. Five element beam plus eleven element two metre beam also 40 and 80 metre dipoles. \$165,000. VK4IK 07 5465 6053

CDE rotator model H-3/CD-44 115V.A.C with transformer 240-110 V.A.C. 30m multi strand cable. Gordon VK4GNN 07 4121 4405

FT101 ZD.FM. FV101 digital VFO FC901 ant.tuner. FL2001B amp. YAESU phone patch spkr. Total \$1000. Nally crank up tower 50ft high gain 3EL heavy duty Thunderbird. DAIWA rotator with coax cable Total \$400. Gray VK4OH QTHR. 07 4125 7167

IRCs for sale. Aust Post charge \$2.00 ea and I can cash them for \$1.50 in stamps (new rates since 4/10/99). I'll split the difference and sell for \$1.60. You save 40¢ and I make only 10¢. Baycom modem for AX25 packet....perfect order.....\$30.00. TS-820s & VFO-820 (ext vfo). Worked well when last used about a year ago, includes manual & Swan desk mic\$550.00. IC2-GAT, NO NiCad but will include ext spkr mike, rubber, duck ant, Yaesu AD-12 power adaptor for cigarette lighter socket...\$350.00, 486SX-25, 14" colour monitor (Win3.1 installed various others)....4Mb RAM, 200 Mb HDD...best offer considered. Panasonic KX-P1180 multi mode printer.....\$100.00. Archer "15-1995" audio/video mixer/enhancer. never used. \$50.00. All items in good working order at time of advert. Contact: Alan VK4AAR, POB 421, Gatton 4343. Ph: 07-5466 1880 0407-752 742 almea@locknet.com.au

FOR SALE SA

ICOM IC738 S/N 2456, 100w HF Transceiver, 101 memory channels, automatic antenna tuner, excellent condition, manual, in original packaging. \$1600. John VK5HJ 08 8535 4278.

AR7 Power Supply, Kingsley Radio and RAAF identification plates on front panel, 12VDC/240VAC PSU type as shown in the AR7 manual, with spare 6X5GT valves, \$40. Norbert VK5MQ (08) 87230315 QTHR

CREATE model RC5 antenna rotator serial No 043397E. Manual. 40mtrs connecting cable. Little used. \$350. Derek QTHR 0883830447. Email- glenhardy@chariot.net.au

FOR SALE WA

HF Tranceivers:- Kenwood TS830s, Icom IC735,
VHF 2mTranceivers Kenwood TM231A, Phillips
FM900. Accessories:- Kenwood AT230, Emotator
Rotator, 4 Element 15/10 Duobander, 80/40
Dipoles, J pole 2M vertical, Timewave DSP-59.
Offers and queries to Len, on 08 9964 3423 or
email vk6kln@qsl.net

FOR SALE TAS

A full VHF/UHF Amateur Satellite station for
sale. I really want to sell the lot together if
possible....asking price \$3200. Yaesu FT-736R
(about \$3000 new) std UHF and VHF plugins with
input to varactor and output from discriminator
and cables for TNC interface. DSP-12 TNC (about
\$1400 new) 9600baud, 1200 baud, etc, full featured
antennas, helix and yagi sattrak4 (bought through
Amsat_Aust) automates the station. rotators
kenpro KR-5400-B full AZ/EL setup about (\$1200
new) plus all necessary antenna/rotator cables, etc
to complete the full station setup ALSO
included...40plus metres of unused Heliax
(Andrew LDF5-50A..foam dielectric about 1"...
this retails at over \$20/metre) ALSO included...
quantity of WIA and other Amateur Radio
magazines Dennis Grubb VK7YAO 9 Saunders
St Wynyard 7325 Tasmania Ph 6442 4344
Mobile 0409 856 103

WANTED NSW

Tower sections ex-army steel galvanised 6ft. Will
pay \$20 each. Peter VK2EMU 02 9584 3236 or
vk2emu@arrl.net

Plug in elements for thruline watt meter bird
model 43 for 2m band 25/50 watt. Also Phillips
FM92 U band transceiver. Ken VK2KJ 0412
003517 anytime

Copy of workshop manual and/or circuit diagram
of Drake model SSRI cohmn receiver (SEIWA)
S/N 774054. S R Dogger Tunnel Road, Stokers
Siding NSW 2484 A/Hrs 02 6677 9292.

OCTAL Relays 8 or 11 Pin DPDT contacts.
12VDC coils. six required Peter VK2BEU (02)
9872 3381 pstuart@usf.com.au

WANTED VIC

Wanted two Phillips UHF FM 828 transceivers
T band in good condition. To be used for UHF
links in the East Gippsland Repeater network.
Details to Bob VK3ZAN. Ph 03 51567654. or
Paket VK3ZAN@VK3BVP.Vic. or Email
Bobprille@net-tec.com.au

WANTED OLD

YAESU FT101B owners manual or copy, tubes,
6JS6A power. Amplifier 12By7A Driver for 101B.
YAESU FL2100 final amplifier tubes 572B. John
VK4SKY.0417 410503 P O Box 1166 Coolangatta
Qld 4225 Email: benoel@fan.net.au

Data for Pye 10.7MHz crystal filter. Copy of
handbook and circuit for Kenwood TR3200 VHF
transceiver. Len VK4JZ P O Box 1108 Tewantin 4565

WANTED - WA

Radar Parts wanted for museum display LW/
AW Radar Indicator chassis and or parts, Valve
Caps to suit 807 and 6J7G valves, insulated
extension couplings for potentiometer shafts.

Mark VK6AR 08) 9417 4536 or Packet at
VK6AR@VK6BBS.#PER.#WA.AUS.OC for the
WA RAAF RADAR GROUP



14 Mary Street Hazelmere WA 5055

Tel: (08) 9274 1118

Fax (08) 9250 3734

TRADE ADS

• AMIDON FERROMAGNETIC CORES:

For all RF applications. Send business size SASE
for data/price to RJ & US Imports, PO Box 431,
Kiama NSW 2533 (no enquiries at office please
... 14 Boanyo Ave Kiama).

www.cyberelectric.net.au/~rjandusimports

Agencies at: Assoc TV Service, Hobart: Truscotts
Electronic World, Melbourne and Mildura: Alpha
Tango Products, Perth: Haven Electronics, Nowra

<http://www.hamsearch.com>
a not-for-profit site that is a
search engine for hams

• WEATHER FAX programs for IBM XT/ATs
*** "RADFAXZ" \$35.00. is a high resolution
short-wave weather fax, Morse and RTTY
receiving program. Suitable for CGA, EGA, VGA
and Hercules cards (state which). Needs SSB HF
radio and RADFAX decoder. *** "SATFAX"
\$45.00. is a NOAA, Meteor and GMS weather
satellite picture receiving program. Needs EGA
or VGA & WEATHER FAX PC card, + 137 MHz
Receiver. *** "MAXISAT" \$75.00 is similar to
SATFAX but needs 2 MB of expanded memory
(EMS 3.6 or 4.0) and 1024 x 768 SVGA card. All
programs are on 5.25" or 3.5" disks (state which)
plus documentation. add \$3.00 postage. ONLY
from M. Delahunty, 42 Villers St. New Farm QLD
4005. Ph 07 358 2785.

WIA Division Directory

The WIA consists of seven autonomous State Divisions. Each member of the WIA is a member of a Division, usually in their residential State or Territory, and each Division looks after amateur radio affairs within its area.

Division	Address Officers	News Broadcasts	Note: All times are local. All frequencies MHz.	Fees
VK1 ACT Division GPO Box 600 Canberra ACT 2601	President Gilbert Hughes Secretary John Woolner Treasurer Les Davey	VK1GH VK1ET VK1LD	VK1WI: 3.570 LSB, 146.950 FM each Sunday evening from 8.00pm local time. The broadcast text is available on packet, on Internet <i>aus.radio.amateur.msc</i> news group, and on the VK1 Home Page http://www.vk1.wia.ampr.org	(F) \$72.00 (G) (S) \$58.00 (X) \$44.00
VK2 NSW Division 109 Wigram St Parramatta NSW (Office hours Mon-Fri 1100-1400) (PO Box 1066, Parramatta 2124) Phone 02 9689 2417 Freecall 1800 817 644 Fax 02 9633 1525	President Michael Corbin Secretary Eric Fossey Treasurer Eric Van De Weyer Web: http://marconi.mpc.e.mq.edu.au/wia e-mail: vk2wi@ozemail.com.au	VK2YC VK2EFY VK2KUR	From VK2WI 1.845, 3.595, 7.146*, 10.125, 14.160, 24.950, 28.320, 29.120, 52.120, 52.525, 144.150, 147.000, 438.525, 1281.750 (* morning only) with relays to some of 18.120, 21.170, 584.750 ATV sound. Many country regions relay on 2 m or 70 cm repeaters. Sunday at 1000 and 1930. Highlights included in VK2AWX Newcastle news, Monday 1930 on 3.593 plus 10 m, 2 m, 70 cm, 23 cm. The broadcast text is available on the Internet newsgroup <i>aus.radio.amateur.msc</i> , and on packet radio.	(F) \$69.00 (G) (S) \$56.00 (X) \$41.00
VK3 Victorian Division 40G Victory Boulevard Ashburton VIC 3147 (Office hours Tue & Thur 0830-1530) Phone 03 9885 9261 Fax 03 9885 9298	President Jim Linton CEO Barry Wilton Secretary Peter Mill Web: http://www.tbsa.com.au/~wiviav/ e-mail: vk3wi@rint.com.au	VK3PC VK3XV VK3APO	VK3BWI broadcasts on the 1st and 3rd Sunday of the month at 8.00pm. Primary frequencies, 3.615 LSB, 7.085 LSB, and FM(R)s VK3RML 146.700, VK3RMM 147.250, VK3RWG 147.225, and 70 cm FM(R)s VK3ROU 438.225, and VK3RMU 438.075. Major news under call VK3WI on Victorian packet BBS and WIA VIC Web Site.	(F) \$75.00 (G) (S) \$61.00 (X) \$47.00
VK4 Queensland Division GPO Box 638 Brisbane QLD 4001 Phone 07 5496 4714	President Colin Gladstone Secretary Peter Harding Treasurer Alistair Eirick e-mail: wiaq@brisbane.dialix.com.au Web: http://www.wiaq.powerup.com.au	VK4ACG VK4JPH VK4FTL	VK4WIA: 1.825 MHz SSB, 3.605 MHz SSB, 7.118 MHz SSB, 14.342 MHz SSB, 21.175 MHz, 28.400 MHz SSB, 29.220 MHz FM, 53.725 MHz FM, 147.000 MHz FM, 438.500 MHz (Brisbane only), and regional VHF/UHF repeaters at 0900 hrs EAST Sunday. Repeated on 3.605 MHz SSB & 147.000 MHz FM at 1930 hrs EAST Monday. Broadcast news in text form on packet under WIAQ@VKNET.	(F) \$74.00 (G) (S) \$60.00 (X) \$46.00
VK5 South Australian Division (GPO Box 1234 Adelaide SA 5001) Phone 08 8294 2992	President Jim McLachlan Secretary David Minchin Treasurer John Butler	VK5NB VK5KK VK5NX	VK5WI: 1827 kHz AM, 3.550 MHz LSB, 7.095 AM, 14.175 USB, 28.470 USB, 53.100 FM, 147.000 FM Adelaide, 146.700 FM Mid North, 146.800 FM Mildura, 146.825 FM Barossa Valley, 146.900 FM South East, 146.925 FM Central North, 147.825 FM Gawler, 438.425 FM Barossa Valley, 438.475 FM Adelaide North, ATV Ch 35 579.250 Adelaide. (NT) 3.555 USB, 7.065 USB, 10.125 USB, 146.700 FM, 0900 hrs Sunday. 3.585 MHz and 146.675 MHz FM Adelaide, 1930 hrs Monday.	(F) \$75.00 (G) (S) \$61.00 (X) \$47.00
VK6 West Australian Division PO Box 10 West Perth WA 6872 Phone 08 9351 8873	Acting Pres. Cliff Bastin Secretary Christine Bastin Treasurer Bruce Hedland-Thomas Web: http://www.faroc.com.au/~vk6wia/ e-mail: vk6wia@faroc.com.au	VK6LZ VK6ZLZ VK6OO	VK6WIA: 146.700 FM(R) Perth at 0930hrs Sunday relayed on 1.825, 3.560, 7.075, 14.116, 14.175, 21.185, 29.680 FM, 50.150 and 438.525 MHz, country relays 3.582, 147.200 (R) Cataby, 147.350 (R) Busselton and 146.900 (R) Mt William (Bunbury). Broadcast repeated on 146.700 at 1900 hrs Sunday relayed on 1.865, 3.563 and 438.525 MHz: country relays on 146.350 and 146.900 MHz.	(F) \$62.00 (G) (S) \$50.00 (X) \$34.00
VK7 Tasmanian Division PO Box 271 Riverside TAS 7250 Phone 03 6425 2923 Fax 03 6425 2923	President Ron Churcher Secretary Tony Bedelph Treasurer John Bates Web: http://www.wia.tasnet.net	VK7RN VK7AX VK7RT	VK7WI: 146.700 MHz FM (VK7RHT) at 0930 hrs Sunday relayed on 147.000 (VK7RAA), 146.725 (VK7RNE), 146.625 (VK7RMD), 3.570, 7.090, 14.130, 52.100, 144.150 (Hobart), repeated Tues 3.590 at 1930 hrs.	(F) \$74.00 (G) (S) \$60.00 (X) \$46.00
VK8 Northern Territory (part of the VK5 Division and relays broadcasts from VK5 as shown, received on 14 or 28 MHz).				

Membership Grades

Full (F) Pension (G) Needy (G) Student (S) Non receipt of AR (X)
Three-year membership available to (F) (G) (X) grades at fee x 3 times.

ADVERTISERS INDEX

Amateur Transceiver Radio	50	Icom.....	OBC, 19
Andrews	14	Tower.....	7,55
Dick Smith	IBC, 28,29		

TRADE PRACTICES ACT

It is impossible for us to ensure that the advertisements submitted for publication comply with the Trade Practices Act 1974. Therefore, advertisers and advertising agents will appreciate the absolute need for themselves to ensure that the provisions of the Act are strictly complied with.

VICTORIAN CONSUMER AFFAIRS ACT

All advertisers are advised that advertisements containing only a PO Box number as the address cannot be accepted without the addition of the business address of the box-holder or seller of the goods.

YAESU VX-1R MICRO DUALBAND HANDHELD TRANSCEIVER

Wide receiver coverage, leading edge features, and Lithium Ion technology, packaged for convenience at a price that will surprise!

**PRICE
BREAKTHROUGH**



VX-1R shown full size

The Yaesu VX-1R is one of the world's smallest dualband amateur rigs, sporting a 2m/70cm transceiver with wideband receiver in a case sized just 47 x 81 x 25mm WHD. It has impressive memory and scanning facilities as well as receive coverage of VHF and UHF TV, AM and FM broadcast bands, AM aircraft band and other public service frequencies from 76 to 999 MHz*.

Leading-edge technology from the VX-1R's 500mW MOSFET power amplifiers together with the supplied 3.6V 700mA/H high-capacity Lithium Ion battery will provide many hours of superb local communications. Up to 1W output is available for longer range when external DC power is used. Extensive battery-saving features together with the Li-Ion battery's 2-hour recharge system yields long operating times under real-world conditions.

The VX-1R's extensive memory system provides 291 memory channels, most with Alpha-numeric labelling for easy recognition. A Smart Search™ system allows you to search a portion of a band you define, then loads any active frequencies into 31 special Smart Search™ memories for later inspection (great for finding activity when visiting a new area).

Besides being a fully-featured dual-band amateur transceiver, the VX-1R has extraordinarily wide receiver frequency coverage; you'll also be pleasantly surprised by the great audio on the FM broadcast band. A dual-watch facility is provided – and together with the AM, FM-narrow and FM-wide reception modes – you'll be having fun even when you're not operating on the amateur bands. For selective calling and listening, the VX-1R also includes a CTCSS encoder/decoder and a 104-code Digital Code Squelch (DCS) system as well as a Tone Search facility for both CTCSS and DCS encoded transmissions.

A great range of accessory lines for the VX-1R are available such as speaker/mics, a carry case, as well as a battery holder for 1 x AA alkaline battery which includes an inbuilt voltage step-up converter. Computer programming of the VX-1R is available via the optional ADMS-1E programming kit.

So when Yaesu says "Dick Tracy, we're waiting for your call" you can be sure they have good reason to do so. In fact, call into your Dick Smith Electronics' Hams Shack store for a demo of this fun new rig. Or phone 1300 366 644 for a copy of the Yaesu colour brochure.

D 3665

2 YEAR WARRANTY

\$399

SAVE \$50

YAESU

PHONE FAX AND MAIL ORDERS

PHONE: WITHIN AUSTRALIA: 1300 366 644
(Local Call Charge)

FAX: (02) 9395 1155 within Australia and
(+612) 9395 1155 from outside Australia

MAIL: DICK SMITH ELECTRONICS, Direct Link Reply Paid 160, PO Box 321,
North Ryde NSW 2113 (No Stamp Required)

*Excludes packaging and postage. All major Credit Cards accepted.
14 Day Money Back Guaranteed if NOT completely satisfied. (Software excluded)*



Visit our web site at
<http://www.dse.com.au>



That's where you go!

*Less cellular coverage

MORE

GREAT

GEAR

FROM

ICOM



PCR100 Cruise the air waves with your computer. Turns your PC into a high performance 0.5 - 1300 MHz receiver (FM/WFM/AM modes) with plug'n play installation. Multi function control panel, wide frequency coverage, and unlimited memory channels.

R2 Fit the world's airwaves in your shirt pocket. Just 8.6cm high, wide 0.5 - 1300 MHz frequency range divided into 9 bands plus FM/WFM/AM, 400 memory channels, great sound in rugged water resistant construction.

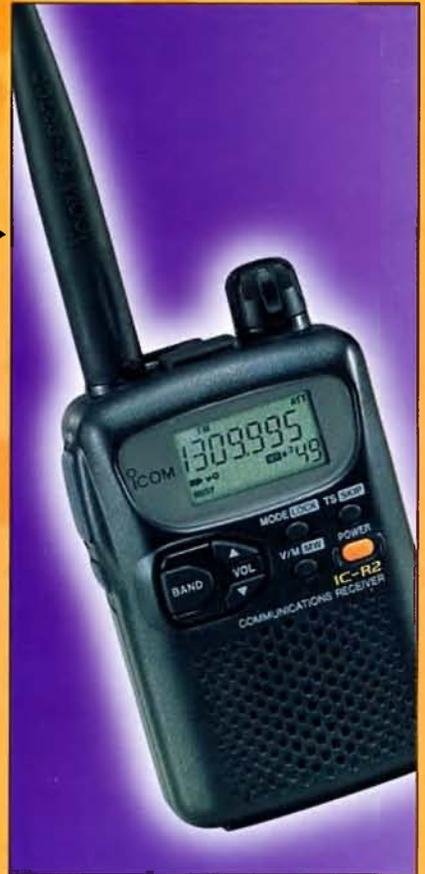

2800H A totally new approach to dual band mobile. Powerful performance on 2m and 70cm bands, remote control capability, and a first for mobile rigs...a multi-function colour LCD screen! All your information is right in front of you in colourful 3D-like characters and icons.

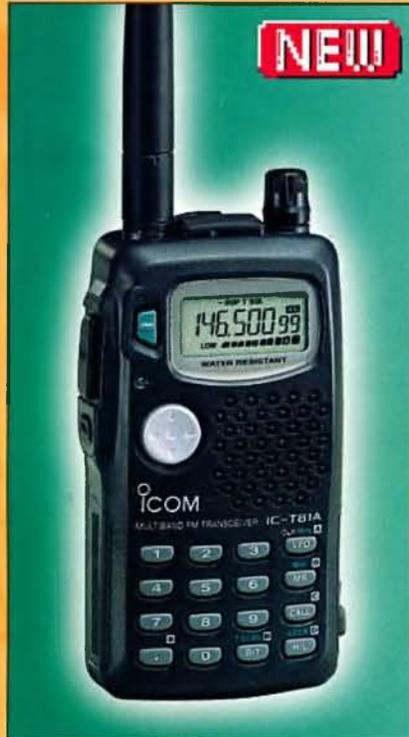

T81A A remarkably compact quad bander. Superb clarity on the 6m, 2m, 70cms and 23cm bands. It's water resistant, with tone squelch and pocket beep functions standard, plus you can change volume and bands even quicker with the 'joy-stick' style multi-function switch.

706MKIIG The amazing evolution of the legendary 706. Frequency coverage is expanded to the 70 cm band and output power is increased for the 2m band. You get base station performance and features in a mobile rig-sized package.



ICOM
Clearly Ahead

2 YR WARRANTY

See your nearest Icom Dealer, or visit our website at www.icom.net.au

DECEMBER 1999

Volume 67 No 12



Amateur Radio

Journal of the Wireless Institute of Australia



ROSS A. HULL 1902 - 1938

- ★ The Ross Hull Story
- ★ The End of an Amateur Radio Era
- ★ An AM/CW Transmitter
- ★ A Spectrum Attenuation Measuring Set
- ★ High Sea Antennas
- ★ An Inconspicuous Antenna

Plus *lots of other articles, news and special interest columns.*



WIA Yearbook 2000

**Callbook Listings
Frequency Listings
Band Plans
Repeater Lists
Beacon Lists
Satellite Lists
License Conditions
Examiner Lists
Special Interest Groups
Public Relations Notes
Radio and TV Freqs.
and much, much more !**

**Hint now for the
Christmas Stocking !
This edition will
contain all of the
content you have
come to expect of
the WIA callbook
as well as some
new items.**

**CLUBS - Take your orders now and be ready to
take advantage of bulk order savings for
affiliated clubs.**

It is more than a callbook, it's a Yearbook, the WIA Yearbook!

**The "WIA Yearbook 2000" is now available from
Divisional Bookshops and selected outlets.**



Amateur Radio

Volume 67
Number 12
December 1999

Amateur Radio is published by the Wireless Institute of Australia ACN004 920 745 as its official Journal on the first Friday of each month

Editorial

Editor: Bill Rice* VK3ABP
Production Manager: Bob Harper VK4KNH
Snr Technical Editor: Peter Gibson* VK3AZL
Technical Editors: Evan Jarman* VK3ANI
Gil Sones* VK3AUI
Contributing Editors: Ron Fisher* VK3OM
Don Jackson* VK3DBB
WIA News Editor: Richard Mumane VK2SKY

*Publications Committee member

Advertising

Mrs June Fox, WIA Federal Office
PO Box 2175 CAULFIELD JUNCTION VIC 3161
Tel: (03) 9528 5962 Fax (03) 9523 8191
email armag@hotmail.net.au

Hamads

"Hamads" Newsletters Unlimited
29 Tanner Street, Richmond VIC 3121
Fax: (03) 9428 4242
e-mail: news1@webtime.com.au

Amateur Radio Correspondence

All correspondence, contributions and queries about the *content* should be sent to:

The Editor *Amateur Radio*
PO Box 2175, CAULFIELD JUNCTION VIC 3161
email armag@hotmail.net.au
Tel: (03) 9528 5962 Fax (03) 9523 8191

Amateur Radio Delivery

All queries regarding delivery should be directed to:

Amateur Radio WIA Federal Office
PO Box 2175 Caulfield Junction Vic 3161
Tel: (03) 9528 5962 Fax (03) 9523 8191

Registered Office

10/229 Balaclava Road
Caulfield North VIC 3161
Tel: (03) 9528 5962 Fax (03) 9523 8191
Business hours: 9.30am-3pm weekdays

Editorial & Display Booking Deadlines

10th of each month prior to issue, or next business day

Hamad & Display Material Deadline

18th of each month prior to issue, or next business day

Production

Administration, Drafting, Design & Sub-editing
Shadetree Publishing & Imaging
PQ Box 288 BEERWAH QLD 4519

Pre-press, print and mail management
Newsletters Unlimited (03) 9428 3458

Printed by Streamline Press, Melbourne (03) 9417 2766

Mailed by IMS, Melbourne (03) 9291 5888

Receipt of Amateur Radio by mail

Members who have not received their copy of AR by the 15th of each month should advise the registered office of the WIA

Copyright and Reproduction

The copyright in this magazine, except where specifically noted, is held by Wireless Institute of Australia CWIA 1999. Permission to republish articles in any form must be obtained in writing from the Institute (other than for purposes of 'fair dealing'). This permission is usually freely given for information purposes.

The Journal of the Wireless Institute of Australia

ISSN 0002-6859

General

An Inconspicuous Antenna	11
<i>Tom Walker VK4BTW.</i>	
The end of an Amateur Radio era!	16
<i>Peter Naish VK2BPN</i>	
The Great Ross Hull	17
<i>Eric Jamieson VK5LP</i>	
High Sea Antennas	22
<i>Mark Dowdidge VK4MFX</i>	
73, Bob Harper VK4KNH	50

Technical

A Spectrum/Attenuation Measuring Set	24
<i>Drew Diamond VK3XU</i>	
An AM/CW Transmitter for 1.8, 3.5 and 7MHz	30
<i>Drew Diamond VK3XU</i>	
Exploring Rechargeable Batteries	33
<i>Novice Notes — Peter Parker VK3YE</i>	
Technical Abstracts	36
<i>Gil Sones VK3AUI</i>	

Columns

Advertisers' Index	56	Hamads	54
ALARA	14	HF Predictions	52
AMSAT Australia	38	Intruder Watch	50
Awards	46	Novice Notes	33
Club News	12	Over to You	21
Contests	48	Pounding Brass	47
WIA Division News		Repeater Link	45
VK1 Notes	7	Spotlight on SWLING	51
VK2 Notes	7	Technical Abstracts	36
VK3 Notes	7	VHF/UHF - An Expanding World	40
VK4 Notes	8	WIA Comment	3
VK6 Notes	9	WIA News	3
VK7 Notes	10	WIA Division Directory	56
Editor's Comment	2	WIA Federal Directory	2
Education	13		

Our cover this month

Front cover picture of Ross Hull: Ross A Hull 1902-1938

Contributions to Amateur Radio

Amateur Radio is a forum for WIA members' amateur radio experiments, experiences opinions and news. Manuscripts with drawings and or photos are always welcome and will be considered for publication. Articles on disc or email are especially welcome. The WIA cannot be responsible for loss or damage to any material. A pamphlet, How to write for Amateur Radio is available from the Federal Office on receipt of a stamped self-addressed envelope.

Back Issues

Back issues are available directly from the WIA Federal Office (until stocks are exhausted, at \$4.00 each (including postage within Australia) to members.

Photostat copies

When back issues are no longer available, photocopies of articles are available to members at \$2.50 each (plus an additional \$2 for each additional issue in which the article appears).

Disclaimer

The opinions expressed in this publication do not necessarily reflect the official view of the WIA and the WIA cannot be held responsible for incorrect information published.

Amateur Radio Service

A radiocommunication service for the purpose of self-training, intercommunication and technical investigation carried out by amateurs; that is, by duly authorised persons interested in radio technique solely with a personal aim and without pecuniary interest.

Wireless Institute of Australia

The world's first and oldest
National Radio Society
Founded 1910

Representing
The Australian Amateur Radio Service

Member of the
International Amateur Radio Union

Registered Federal Office of the WIA
10/229 Balaclava Road
Caulfield North Vic 3161
Tel: (03) 9528 5962 Fax (03) 9523 8191
http://www.wia.org.au

All mail to
PO Box 2175 Caulfield Junction VIC 3161

Business hours: 9.30am-3pm weekdays

Acting Federal Secretary

Peter Naish VK2BPN

Federal Office staff

June Fox Bookkeeper
Rita Trebilco VK3IF Examinations Officer

Council

President	Peter Naish	VK2BPN
VK1 Federal Councillor	Glenn Dunstan	VK1XX
VK2 Federal Councillor	Michael Corbin	VK2YC
VK3 Federal Councillor	Branda Edmonds	VK3KT
VK4 Federal Councillor	Ross Marren	VK4AMJ
VK5 Federal Councillor	David Box	VK5OV
VK6 Federal Councillor	Will McGhie	VK6UU
VK7 Federal Councillor	Phil Corby	VK7ZAX

Executive

Peter Naish VK2BPN
Tony Farrow VK2TJF
John Loftus VK4EMM
Wally Howse VK6KZ

Federal Coordinators

AMSAT	Graham Ratcliff	VK5AGR
ARDF	Jack Bramham	VK3WWW
Awards	John Kelleher	VK3DP
Contests	Ian Godsill	VK3DID
Education	Brenda Edmonds	VK3KT
FTAC	John Martin	VK3KWA
Historian	John Edmonds	VK3AFU
IARU	Grant Willis	VK5ZWI
Intruder Watch	Gordon Loveday	VK4KAL
ITU Conference and study group	David Wardlaw	VK3ADW
Public Relations	David Thompson	VK2NH
QSL Manager (VKE, VKO)	Nail Penfold	VK6NE
Videotapes	Don Bland	VK4TVD

ACA Liaison Team

Peter Naish VK2BPN
Glenn Dunstan VK1XX
Michael Corbin VK2YC
Wally Howse VK6KZ
Canberra Liaison Officer
Richard Jenkins VK1RJ

EDITORS COMMENT

Guest editorial
by Evan Jarman VK3ANI

Y2K compliance: a reminder

In an attempt to give our editor time to clear his desk, some of his many and various tasks have this month been taken up by other members of the Publications Committee. To me comes the editorial comment and some proofreading.

As previously announced, Bill Rice is retiring as editor of *Amateur Radio*. Our beloved editor readily admits that his editorship lacks Y2K compliance. I wish Bill Rice a happy new year and all the best in his second retirement. Time to throw out the production schedule and replace it with an on air sked.

Eric Jamieson VK5LP has written his final VHF-UHF column this month. More will be said about Eric next month but we on the Publications Committee would like to say *thank you Eric*. Your efforts have been appreciated.

But these are not the only big changes to occur; computers are facing a watershed.

When the year changes to 2000, tragedy has been predicted by doomsday merchants having a picnic. Recently some airlines have indicated that they will not have any aircraft in the air when the clock ticks over to the new year. This is not because they don't trust their systems. It's due to customers limiting their reliance on any equipment when the change takes place. These airlines simply cannot sell enough tickets on the scheduled flights.

In business, a lot of people have made a lot of money checking, and rechecking, computer systems to eliminate all problems. A bank CEO recently wrote to all customers to assure them that the bank has thoroughly checked and now guarantees that they will have no problem with the bank's services. I was then a little distressed to read about the Tasmanian council in *Spotlight on SWLing* this month. I still accept my bank's guarantee.

It is now expected that the most widespread problem will be the lack of preparedness with personal computers at home.

As an example, the executive office has checked its systems: a group of personal computers. They did a simple BIOS test and half of the office computers failed. The problem is not terminal and a procedure is now in place to overcome it. Have you checked your PC?

One member of the Publications

Committee mentioned putting the date forward to the end of the year on his laptop as a check. The year ticked over as expected he announced proudly. "Can't understand what all the fuss was about". It too failed the BIOS test.

But it doesn't mean that computers that do fail (usually older models) are immediately obsolete. Various devices have been tried to circumvent the problem. I am aware of at least two major industry systems where the solution was to wind the clock back 28 years. The day and date (the year is not displayed) align and these systems are now on line with their customers unaware that the computer is using a date prior to the equipment existing. Unlike home computers, these are mainframes that simply could not be replaced in time. Twenty eight years is considered sufficient time to find a replacement but there is always the option of cranking the clock back again.

But back to the humble PC. I suspect that most amateurs would have one: probably an older model. It doesn't hurt to check your PC, but be careful. If you use one of the Y2K test programs, remember that they may change the date and then test systems. This can be embarrassing. I am aware of a household accounts package that checks the data files for currency (ie up to date) and if they are more than six months old, they are deleted. How did the user find out? After using a Y2K test program, the data was gone. Always keep back up copies!

The PC being used to prepare this text is known not to be Y2K compliant. But like most it should not be a problem. It just requires being ready before turning on for the first time next year. But you should be aware of the potential problem: before switch on occurs. Be like the scouts; be prepared.

The check required is easy and recommended. It's published in an AMSAT article in *Amateur Radio* March 1999 page 40.

Please remember that behind all this Y2K fuss is the new millennium that awaits.

May none of your worries be Y2K compliant. Have a happy new year, new decade, new century and new millennium.

ar



Federal President, Peter Naish
VK2BPN.

DX Window compromise

In October the WIA ACA Liaison Committee met with the ACA and commercial users in Canberra to progress the request by WIA for a larger 80 metre DX Window.

The ACA had previously tabled a paper containing three possible options for the DX Window. In June we responded with a further submission rejecting the first two options (which failed to achieve our objectives), but finding merit in the third option to extend the existing very narrow Window to a 24 kHz segment below 3800kHz. The major hurdle was the number of commercial users licensed to operate in this segment.

At the October meeting the WIA submitted a further paper indicating how the amateur radio service could share with the incumbent commercial users. The ACA complemented the WIA on its submissions but was not prepared to accept such a sharing plan. Instead, the ACA proposed that the 24 kHz DX Window be allocated to the amateur service as sole users, once the established commercial users had been able to relocate to other frequencies outside the 80 metre amateur band.

An implementation schedule was proposed that will make the full DX Window available to the amateur radio service as soon as possible, taking into account the need for changes to the Australian Radio-frequency Spectrum Plan following WRC2000. Full clearance of commercial users is expected by 2004. Effective immediately, ACA will make no new frequency assignments in the 24 kHz segment.

Although the implementation period is much longer than the WIA desires, it is a practical solution and one we consider fully acceptable. There may be an opportunity to shorten the period or phase-in part of the Window at an earlier date should the commercial users be able to move out of the band at a faster rate. The WIA expressed a desire to assist the ACA in any way it could to achieve earlier access.

Another meeting with the ACA is scheduled for this month, December. As I write this in November the Agenda is still being compiled but it will likely include further discussion on a LF Band allocation, the examination service, licensing matters, possible EMR regulations and other topical issues for the Australian amateur radio service.

As we approach the end of another year I would like to thank again all of the many volunteers who work tirelessly for the WIA in their many roles. Without our coordinators and regular columnists the WIA would not be the force it is.

On behalf of the WIA Federal Council and Executive, I extend greetings to all of our members. We wish you a Happy Christmas and Best Wishes for the New Year. I hope that 2000 will be a year of success for each of you in your particular area of amateur radio activity.

ar

Richard Murnane VK2SKY

Progress on 80m DX Window

Friday 5th November saw a meeting between the WIA ACA Liaison Committee and the ACA. You will recall this concerned the application by the WIA to expand the 80 Metre DX window to bring it in line with the overseas allocation of this portion of the 80 Metre Band.

In a nutshell, the WIA wanted to expand the Band to cover 3775 kHz to 3800 kHz and asked that this expansion become available immediately on a shared basis. At present there are around 40 licences on issue for this part of the spectrum.

It was suggested by the ACA that a gradual relocation of these users was the obvious way to go.

These users would agree the relocation on the following basis:

- That the moves would NOT be made immediately, but gradually.
- That any move before this would be at the cost of the WIA
- That the move would need to be to a frequency close to where they were at the moment.

Agreement was reached on these matters.

The ACA on the 8th November, 1999, issued instructions throughout VK to all offices that there are to be NO FURTHER ALLOCATION in the frequency range of 3776 to 3800 kHz from that date.

It is hoped that all necessary legalisation etc. will be complete by sometime in 2004.

Rick Warnett P29KFS has noted Papua New Guinea (PNG) uses some of the 80M band for commercial land mobile allocations, however the 'Hams' share part of the band with those commercial services on a very informal "non-interference" basis.

Most VK/P2 traffic overlaps to a greater or lesser degree dependent on time of day and sunspots, almost always hearing VK's after 1830 EST which would make for problems with many fixed land stations in PNG if VK amateurs were running high power. Most P2 service users use 100W transmitters and often, low-efficiency antennas.

The next ACA Liaison meeting is scheduled for December 9.

(Michael VK2YC for the WIA / ACA Liaison Committee, VK2News, and P29KFS via QNEWS)

ACA-WIA LIPDs

Low Interference Potential Devices on 433.050 - 434.790 MHz

In 1998, the Australian Communications Authority (ACA) amended the Low Interference Potential Devices Class Licence determination to include operation of devices on the band 433.05 to 434.79MHz, in line with a similar frequency band that is available in most CEPT countries in Europe (ITU Region 1).

My apologies for not compiling a WIANews column last month... the demands of Real Life (tm) pushed Amateur Radio matters into the background. Like most WIA volunteers, I perform multiple jobs, which means I get overloaded occasionally. Unfortunately, many people assume that "The WIA" will do all necessary work, conveniently forgetting that it eventually comes down to a few dedicated individuals "doing the actual doing"... I wonder how much the overall performance of the WIA would improve if more members were willing to take on just one volunteer job, won't you?

Richard Murnane

The result of this decision by the ACA is that the significant occurrences of interference have been observed on Amateur 438/433MHz band FM repeater systems right across Australia. The ACA's original proposal was strongly rejected by the Wireless Institute of Australia (WIA) when it was first mooted and the WIA's stand has now been vindicated.

After reading the ACA LIPD determination papers it would appear the ACA is REQUIRED to remove any offending LIPD interference from amateur operations.

The Amateur Radio Service, by this determination, is not required to tolerate interference from LIPDs, nor is the Amateur Radio Service required to modify its activities to avoid this interference, as the determination puts the responsibility back on the LIPD, and hence the ACA who must manage this interference!

LIPDs have NO PROTECTION from interference!

If, as an amateur radio operator, you believe that you are receiving interference from these devices, then you are encouraged to take the matter up with the ACA and to push for the ACA to remove the interference. If you encounter resistance from the ACA, then please contact VK5ZWI Grant Willis

In VK5 recently problems were solved by the Amateurs encouraging the channel change of an interfering crane controller. VK5ZWI says is unfortunate that throughout this exercise, despite the ACA's apparent obligations under the radiocommunications class license determination and the RadCom Act in general, that their assistance was minimal in resolving this issue, almost to the point of being detrimental.

The ACA consideration of existing licensed radiocommunications users appears virtually non-existent when considering the Amateur Service.

The fact that the ACA is quite happy for voice devices to be used in Australia, to effectively create another defacto CB band in an attempt to overrun the existing amateur service use of the band could perhaps be construed as sinister! There seems little merit in creating another CB band, when there is already a free CB service band around 477MHz as well as 27MHz. As a minimum, the amateur service in Australia must demand that the ACA place restrictions on all voice/audio equipment, in line with what current Region 1 practice generally appears to be.

Refer <http://www.cck.net.au/areg/radio/lipd/lipd.html> for more information.

(via QNEWS, from a packet message posted by Grant Willis VK5ZWI)

Communications for 2000 Games

With less than a year to go before the Sydney Olympic Games, the Australian Communications Authority (ACA) has been working to ensure a reliable communications environment for the Games.

The internal organisation of the Games itself requires an extensive communications network, and when you add the broadcasting and media communications and the other visitors, the demands are staggering.

There is significant potential for problems such as interference and network disruption to occur.

The services to be provided by the ACA will include pre-games inspection of venues to anticipate telecommunications cabling and radiofrequency interference problems, radiocommunications licensing, radiofrequency interference investigation during the Games and equipment testing.

Prior to the Games a radio-communications audit of all facilities at each venue will be conducted, to ensure the electromagnetic compatibility of all devices used at these venues, and to ensure that the level of radio emissions from the devices does not exceed prescribed safety standards.

An equipment assessment service for communications equipment imported for use at the Games is also needed. This inspection work must be conducted in conjunction with other authorities, such as Testing and Certification Australia, to ensure both the electrical safety and electromagnetic compatibility of devices.

(ACA Media Release 57 of 1999)

Olympics Want 5 GHz

Michael Corbin VK2YC, a member of the WIA/ACA Liaison Committee says they are in discussion with the ACA regarding a request from the Olympic Organisation for use of frequencies in the 5.7 GHz Band for television broadcast links during the Olympic Games.

Many Amateurs will be aware that a new Amateur Satellite is due to be launched in the near future and will operate in this 5650-5670 MHz band, precisely the frequency proposed for Olympic use.

News of SOCOG's request prompted this response from Paul Rinaldo, W4RI of the ARRL:

There might be some basis for gently asking the Australian administration to avoid the band 5650-5670 MHz amateur-satellite Earth-to-space allocation per RR No. S5.282, perhaps with the suggestion to consider an alternative of 5670-5830 MHz.

This would clear the amateur-satellite band but may conflict with something else locally, such as ISM at 5800 MHz +/-75 MHz.

Nevertheless, this potential interference problem is bounded in a number of ways that make it of limited impact:

- (a) This assumes that P3D will be operational by the time of the Olympic games 15 September - 1 October 2000;
- (b) The time the TV remotes use it should be limited just to a few weeks, affecting only the Sydney area;
- (c) While there is no fixed service allocation in the ITU Region 3 frequency table, nor in footnotes, Australia can make a NIB allocation on the basis of RR No. S5.43 "... a service may operate in a specific frequency band subject to not causing harmful interference, this means also that this service cannot claim protection from harmful interference caused by other services to which the band is allocated under Chapter SII of these Regulations."
- (d) The footnote under which the amateur-satellite service would operate uplinks in the band 5650-5670 MHz, as you know, states: "...the amateur-satellite service may operate subject to not causing harmful interference to other services operating in accordance with the Table (see No. S5.43)."
- (e) So I believe that the basis for the remote TV and amateur-satellites is of the same order of magnitude and who gets preference is within the sovereign power of the Australian administration.
- (f) Also, to keep things in context, this is a primary radiolocation band. This plus RR Nos. S5.451 (land mobile secondary in the UK) and S5.453 (fixed and mobile on a primary basis in many Region 1 and 3 countries) would appear to be a more significant problem than temporary remote TV use in Sydney.

Needless to say your WIA is opposing this temporary allocation.

(Paul W4RI/Bill WA6ITF via QNEWS)

ACA / WIA Cooperation

Still with the Olympics— During October, a series of training exercises were undertaken in and around Sydney by over 40 ACA personnel consisting mainly of Field and Technical Officers from all parts of Australia.

The exercises consisted of interference investigation and the testing of the Command Structure for the Olympic Games. According to Mr Vlies, Sydney ACA Manager, the exercises were very successful and he praised the cooperation received from the WIA's VK2 Division.

WIA VK2 provided interfering signals on the ACA Command frequency which the field officers, working in teams of three cars, had to identify and locate.

(From VK2WI News)

Changes to Club Portable Operation

Please be advised that it is no longer necessary for Amateur radio clubs to provide the Australian Communications Authority with details of proposed portable use of club call signs.

Rather, as part of revised amateur club licence conditions, the clubs are required to maintain a club station log book. The log book must have details of.

- (i) a chronological record of all transmissions (including time/date);
- (ii) the frequency and type of emission used;
- (iii) the station(s) communicated with; and
- (iv) the name and call sign of the qualified person operating the station.

Other special conditions listed on your licence/s are:

"This Amateur station is a club station and must be operated in accordance with the Radiocommunications Licence Conditions (Amateur Licence) Determination No. 1 of 1997 that equals to the qualifications held by the operator of the station.

This licence authorises the operation of a class of licence Amateur Station at location of station".

Further details and questions should be directed to Ian Brown on (02) 9245-4097.

— Ian Brown of the Australian Communications Authority, via VK2WI

New Editor for Amateur Radio magazine

An Acting Editor has been appointed for the January 2000 edition of AR. He is VK5UE Colwyn Low. Colwyn is willing to be Editor for the year 2000 and a formal motion for his appointment will be circulated to Federal Councillors.

International Representative

Currently the WIA is discussing the expenditure and operation of our International Representative. Federal Council had requested a greater degree of accountability and reporting in future.

Examiners List

The possibility of refreshing the list of authorised examiners by calling for re-applications has been discussed but no resolution reached.

Sponsorship

The possibility of attracting sponsorships for the IARU Region III conference in Darwin also has been discussed and ideas sought.

Learning Amateur Radio via Internet

The Education officer of the VK1 Division is facilitating an on-line course on the Internet for Novice and AOCIP students. The course was developed by Ron VK2DQ and contains 43 readings that can be downloaded from his website, and covers the complete Novice and AOCIP syllabus.

At the end of the course, students apply and sit for the exam in the normal way. Aspiring radio amateurs, limited call holders, and Listeners are encouraged to make inquiries in the first instance at the Ron Bertrand's website.

The address is <http://members.xoom.com/ronber/amateur.html>

The facilitator is Peter VK1CPK. VK2 news also reports the WIA is running a course on the web, also developed by Ron VK2DQ. See <http://www.ozemail.com.au/~vk2wi/Education.html>

(from VK1 and VK2 Divisional news, via QNEWS)

What a Buzz!

We've highlighted the US problem of VDSL over the weeks, Barry VK2AAB has pointed us to a web address where we can hear this "beast" so we can report it if and when it hits our shore.

For those of you coming in late, VDSL type systems use high speed data on "ordinary" phone lines. They use frequencies between 1.5 and 30 MHz and present an interference threat similar to the power line data systems.

<http://hamradio-online.com/> and go down the page to the article by WA7NBF near the bottom of the page. There are two clickable sound bites which will show you what we could be up against if VK carriers go ahead with these systems.

More Things that go Buzz in the Night

The HF buzz saw is dead; long live the HF "buzz saw!" That might be the cry from the crowd these days as various buzzing intruders have been showing up with some regularity on HF. Sometimes, though, it's hard to distinguish one intruder from the other on the basis of anecdotal reports from amateurs.

Recent reports of the so-called 125-Hz "buzz saw" intruder on the 80-metre band are a case in point. The intruder, heard

primarily in the US northeast, had plagued amateurs as well as an aeronautical weather station just below 80. In the wake of protests from amateurs and coordination between the ARRL and Radio Amateurs of Canada, the transmissions, determined to come from two HF surface wave radar facilities in Newfoundland, moved off the amateur band.

First ATV Repeater Licence granted in EI.

The Cork ATV group has been granted the first Fast Scan TV Repeater licence in EI and it operates in the 23cm band. What is unique about this project is that it was put together and set up by a white stick operator Aedan O'Meara EI3EG.

(John Barry EI8IR of IRTS)

(Note from Richard VK2SKY: some might be surprised by this news item, but I knew Aedan when I was living in Cork some fifteen years ago, sporting the call sign EI6BTB. Aedan's not one to let anything get in the way of his enjoyment of any aspect of Amateur Radio. I wish all Amateurs were as enthusiastic about this hobby.)

Still looking to the Stars

As of 22 October, 1999 the SETI@home (see "DX ET with Your PC", WIANews Aug 1999) has accumulated more than 100,000 years of computer time, more than any other computing project in history! The project has recorded over 85 million "candidate signals" (spikes and Gaussians) in its database, which will soon be subjected to a second phase of analysis, looking for "repeat events".

You can find the SETI@home web site, including a list of the Australian Amateurs participating in the project, by visiting the WIA Federal home page, clicking to the links index, and selecting "Space Exploration".

Free Publicity on Talkback Radio

While "cash for comment" has been in the news recently, it's worth remembering that you can get free publicity through various media channels, if you have something interesting to say.

In September, the Wairoonga Amateur Historical Radio Association operated Special Event Station VK2WAH, celebrating the anniversary of the first wireless message sent direct from Britain to Australia on 22nd September 1918.

One of the operators of the station this year, Ted Miles VK2FLB, earned some good publicity for Amateur Radio when he phoned the Alan Jones talk back show on radio station 2UE.

Alan Jones's ears pricked up when Ted mentioned that he was operating using Morse code - like many, perhaps Mr. Jones thought that CW was no longer in use, but Ted set him straight on that. Jones asked Ted to demonstrate CW on the program, sending the word "Alan", and a short message.

After Ted's "fifteen minutes of fame" ended, his phone started ringing, and Ted took a number of calls from 2UE listeners who wanted to find out more about radio communications. A nice publicity hit for Amateur Radio, and so easy to do - after all, don't we all like to talk on the radio?

There's a lesson to be learnt here: if you want to help the hobby of Amateur Radio to thrive, all you have to do is:

- enjoy your hobby
- be active
- do something a little out of the ordinary, and
- tell others about the fun you've had with Amateur Radio!

After all, Amateur Radio is too good to keep a secret, isn't it?

...and speaking of doing something out of the ordinary:

A Tram Ride into Space with Tony Langden VK3JED

Around lunchtime on Saturday October 2nd, 1999, the first successful QSO from a tram via an amateur satellite was conducted via an FM crossband repeater aboard the South African satellite, SUNSAT, otherwise known as OSCAR-35.

Considerable preparation went into the QSO, with attention being paid to the alignment of the tram relative to the satellite pass. In the end, a section of line running south from Airport West to Niddrie (Route 59) in Melbourne's north-western suburbs was chosen, which put the satellite square on the western side of the tram.

Just as the transponder finished sending its usual minute of data, the downlink signal improved sufficiently for a QSO and Jack, VK3WWW was heard on the downlink working a VK5. A call was put out to Jack and the first tram mobile QSO was logged, with a good report from Jack.

(Via the QNEWS Q-TINUOUS NEWS site, <http://www.wiaq.powerup.com.au/qnews/upload/qnews.htm>)

Radio on Rails successful

One world first and the smashing of a nine year old record. These are the early results from VK3's successful Radio on Rails Fun Day.

At noon Tony VK3JED became the first amateur to work through the Sunsat satellite from a moving train. Just a few weeks ago Tony made history for being first to work Sunsat from a moving tram.

A nine year old record was also broken during Radio on Rails. The record was the number of train mobile amateurs simultaneously participating in the one QSO. For a short time on Sunday afternoon there were four train mobile amateurs in contact via 70 centimetre VK3RCC repeater. These were VK3s KBD, JED, HEM and YE.

After being the first amateur station to work the Sunsat satellite as a passenger in a moving tram, and then in a train, Tony VK3JED has laid down a challenge for other train mobile Sunsat operators.

It's called the VK RailSat Challenge and is an attempt to make contacts between trains in various capital cities via amateur satellite.

More information on the VK RailSat Challenge appears on Tony's webpage at URL: <http://quest.apana.org.au/~tl/vk3jed/pt.html>

(apcnews)

Trams, trains... what mode of transport will be next???

Amateur Radio magazine index online

Mike VK3KRO sure has been busy and has an almost complete index of our Amateur Radio magazine on his website.

It spans the period from October 1945 to December 1967 and is now available for downloading as shareware from his site, <http://www.autoscan.com.au>, which also has a comprehensive set of Amateur Radio links.

You can contact Mike via email to kroch@autoscan.com.au

(via QNEWS)

Ringling the Changes with Amateur Radio

Dick Smith VK2DIK, is Chairman of the National Council for the Centenary of Federation, an event still a year or so away.

VK2DIK plans to use CB and Amateur Radio operators for a project to ring church bells in relays right across the continent from Perth to Sydney.

It should take about two hours.

Everyone knows Dick Smith as an energetic, dynamo-like person with a clear idea of his targets and the paths he needs to tread, to reach them.

This story in the Orange and District Radio Clubs newsletter came from their local Observer newspaper article by a Mr Graham Cooke and is the first that I,

personally, have heard of Dick's plan to have the citizen radio fraternity (which he did so much to create in the mid- to late-70s) and amateurs share the ringing of celebratory bells for the Federation Centenary.

Nevertheless, when he engages with the WIA to organise for Australia's hams to help, I trust that each of us will do our best for this historic occasion. After all, how often have CB-ers and radio hams ever been called-upon to work together, let alone help coordinate the pulling of ropes to belt out tunes on bronze?

Whether it ends up as a cacophony of mis-tuned bells and mis-timed clangers, or the flow of beautiful peals across the countryside and the mathematical precision in the ringing of the changes, the plan has merit for the celebration.

So, fellow amateurs, go find the bells and, if you can, the CB-ers!

(Peter Carter VK2ETK)

Ricky to the Rescue!

A 10-year-old California ham recently used ham radio to help save the life of an injured fellow amateur. As a result, Ricky Rothbart, KF6VSH, of San Rafael, California, who only got his Technician ticket in April, received a Public Service commendation from the ARRL. He also gained a new appreciation of Amateur Radio's emergency service potential.

On August 28, Ricky was in the family car heading home from a trip to LA. "Ricky was in the back seat absorbed in monitoring his favourite frequencies on his H-T," his dad, George Rothbart, KF6VSG, relates. "At about 6:10 PM, he suddenly said, 'Hey Dad, there's a guy on the radio who is bleeding all over the place and needs help!'"

It turned out the other ham had sliced his arm with plate glass and was bleeding profusely and asking on-the-air for medical help. The injured ham, Mike Lewis, KF6YDN, apparently was mobile in a remote area of Pittsburg, California, at the time and his cell phone was not working.

Ricky immediately replied, identifying himself and requesting the man's location and additional details. George Rothbart got on his cell phone, contacted a family member as Lewis had requested, then dialled 911. With Ricky working the emergency on his H-T, the Rothbarts were able to give the 911 dispatcher all the necessary information.

George Rothbart says he now knows "ham radio still works great, and through ham radio a 10-year old can make a difference."

(ARRL, via QNEWS)

ar



Division Notes

Parramatta commencing at 2 pm; and the Divisional office will close for the Christmas break at the end of trading on 23rd December and reopen on 10th January 2000.

As this is the last column for the year, the VK2 Councillors and all of us here at the office wish you the compliments of the season and may your holiday break be both safe and pleasant

VK1 Notes – Forward Bias

Peter Kloppenburg VK1CPK

A Novice class is about to start again in the ACT. Chris Davis (VK1DO) has volunteered to prepare aspiring amateurs for the Novice exam. For up to date details watch this space and/or listen to the weekly broadcasts on 3590 kHz every Sunday at 8:00 pm. Or, call me on (02) 6231 1790 for the latest.

Here is a bit of good news for VK1 members. To cover the cost of maintaining the WIA Federal Office in Melbourne, the federal component of your fee will be increased by \$7.50 per year. However, the committee has decided to absorb this increase by reducing the divisional component of your fee by the same amount. In addition to this good news is the fact that the GST will not apply to the membership fee!

Supported by the weather, Neil Pickford (VK1KNP) is organising weekly foxhunts again in the Belconnen area. The first one began this summer on October 28, 1999. The operating frequency is 146.2 MHz. Starting hunters gather at 14 Wales St, Belconnen at 6:30 pm every Thursday. Extra equipment can be borrowed from the hound's gathering point such as Spare Sniffers, Beams, and Attenuators from 6:50 pm onwards. For inquiries you can contact Neil by phone: (02) 6279 1322, Fax (02) 6279 1340, or Email: neilp@goldweb.com.au

Stop Press: The ACT Division is starting a Novice course for radio amateurs on February 2, 2000. An Information Evening will be held on January 26, 2000 for those who want to know more before they commit themselves. Address: Hughes Community Centre, Wisdom St, Hughes, 7.00 pm.

The next general meeting will be on December 27, 1999 in Room 1, Griffin Centre, Civic, Canberra City.

VK2 Notes

Pat Leeper VK2JPA

patleep@bigpond.com

The VK2 Division welcomes Brian Keegan VK2TOX as he takes his seat on Council, filling a vacancy that had arisen.

The Company Secretary, Treasurer and the office Administrative Assistant have attended a GST course run by MYOB as

preparation for fiscal changes in 2000. The office computer has been upgraded with a larger hard disk drive in readiness for this event.

Three new members and one associate member were accepted into the VK2 Division at the October Council meeting. They were : Paul Hanna VK2HV, Neil Jeffries VK2KYG, Richard Mackay VK2HRM and Robert Jones. We hope they have a long and fruitful association with the WIA.

By the time you read this, the second Affiliated Clubs Conference for this year will have been held, and, at the time of writing, registrations received show that the Conference is still growing in size and this will be the largest yet.

The Education Officer, Barry White VK2AAB, reported that Ron Bertrand, who did the original Gladesville Club educational videos, is running a free education course on the Internet based on that course, and has been looking for alternative tutors. The VK2 Council decided to take on a study group for this course, as well as running the Correspondence Course for those without Internet access. This would appear to be an opportunity to make the Internet work for Amateur Radio, rather than against it.

The Dural transmitter site has benefited with a donation of equipment from the NSW Police Department. An appropriate letter of thanks has been sent to the Commissioner.

In line with the current Council policy of supporting club field days and similar events, directors and office staff were in attendance at the Westlakes Field Day on Sunday 7th November with a complete selection from our book store, and items from our Deceased Estates section.

Members are reminded that our book store has a large selection of books on all aspects of amateur radio. Books may be ordered by mail by either cheque or credit card, and our selection of educational books is quite comprehensive. For more information on titles, ring the office on (02) 9689 2417.

A last reminder — the VK2 Division Christmas Party will be held on Saturday 11th December at Amateur Radio House



VK3 Notes

WIA Victoria News

By Jim Linton VK3PC

RD Contest - the rules stop us winning, again

The Remembrance Day Contest rules are being described by some members as a disgrace. We know they were rewritten some years ago with the objective of ending VK3's previous winning streak in this premier WIA contest.

However it was widely considered that with VK3 being the 1998 wooden spooners it had an excellent chance of winning this year.

The 1999 results have been released. They state that the most improved division this year was VK3. It came from last place in 1998 to a close second this year, and is an outstanding effort.

The question is now being asked. How VK3 can be the most improved, yet not be the winner?

Congratulations to the 1999 RD Contest winner, VK7, who with its small number of radio amateurs had managed to improve the performance that saw it win the contest last year.

Getting back to the rules. WIA Victoria also notes that the contest rules could be set to change again for next year, and you guessed it, the implication of the suggested change is targeted at VK3's use of automated packet contest robots.

Action flowing from the Special General Meeting

One important recommendation made by the members at the WIA Victoria Special General meeting held in October is destined to reshape the operation of the Federal WIA.

The meeting recommended that WIA Victoria seek the support of the VK2 Division and take positive action to rectify the current system of voting in the Federation.

Both VK2 and VK3 believe that the current system of one vote for each Division is inequitable as VK2 and VK3 members provide most of the funding for Federal.

Following recent discussions, VK2 and VK3 intend to have this situation changed in the immediate future and we simply want to be able to have better control over Federal expenditure of the monies we provide.

In short we both want proportional voting according to financial input and we hope to be able to achieve this by constructive negotiation with other Divisions.

In the event of negotiation being unsuccessful the future of the Federation as it now exists will be cast in considerable doubt. It is only sound business practice to require that funds are being used to benefit the provider.

Also from the Special General Meeting was a recommendation that WIA Victoria explore alternative publishing options for news and information including Amateur Radio magazine.

This matter has been raised at the first possible opportunity - during a recent WIA Federal teleconference.

The matter is now on the discussion agenda. WIA Victoria understands that the federal body is about sign new contracts for the production and publishing of AR magazine. These are likely to see the cost of the magazine increase substantially.

However WIA Victoria will continue to explore alternative means of providing news and information to its members, which includes the emerging multimedia.

Plenty of VHF/UHF activity

To promote greater use of simplex VHF/UHF frequencies, a new award called the WIA Victoria George Bass Diploma is now available. Who will be the first to qualify?

Tell your VK7 friends that they too can obtain this award! In fact any mainland radio amateur no matter where what their QTH can also qualify.

Full details of the award rules have been

sent to WIA Victoria members, affiliated clubs, and are posted on the WIA Victoria web site www.tbsa.com.au/~wiavic

In addition, the web site now has a section devoted to VHF/UHF operation. It is written with the beginner in mind and includes topics such as propagation and antenna polarisation.

WIA 2000 Callbook delayed

The long awaited callbook was originally promised for delivery late September, or very early October, is now expected to be available this month.

WIA Victoria has been taking orders from members anxious to get their hands on the publication, and making inquiries of WIA Federal on a weekly basis about when deliveries can be expected.

WIA Victoria apologises to its members - however the circumstance is beyond our control, and not one of our making.

(Ed Note: There was a five-week delay in negotiating a suitable arrangement with the ACA for use of their database. The Callbook is to be out in late November.)

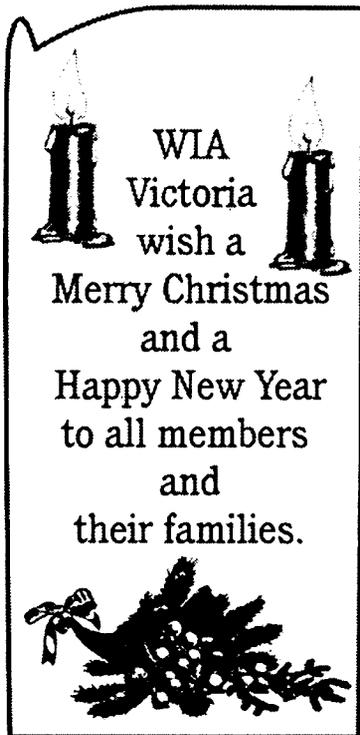

VK4 Notes - QNEWS

By Alistair Elrick VK4FTL
VK4 Councillor and QTC Editor

Meeting on the Go-ahead

The inaugural meeting of the Wireless Institute of Australia Queensland Division Incorporated was held on Saturday 30th of October at the Bronco's Leagues Club. The meeting went well with, as usual, some lively and at times protracted debate, but all

in good spirit, with the desire to progress the Division on into the year 2000.

A major announcement at this meeting was that the WIAQ Inc was once again a voting member of the WIA, as the Federal Office had received the outstanding monies. One of the items, on the appointment of the Auditor, was moved to have further investigation on the cost, with the results to be advised to the members when received.

The matter of fees for the year 2000 was hotly discussed with the result that the estimated increase required to cope with the rises from Federal due to GST, was carried. It was noted that there has been no fee increase since 1991. Unfortunately the fee increase has had to be done at the same time as the Federal rises are passed on.

Subsidising the running costs from the profits of the Bookshop and Disposals will be more prominent in the next few years, with funds to be directed to projects with, as suggested to the meeting, the future establishment of a permanent home for the WIAQ. Discussion on the return of the Membership Database to the Federal Office was postponed, due to the expected lengthy discussion which would have ensued on this matter.

Townsville to Charters Towers

The Townsville Amateur Radio Club Inc. visited Charters Towers on Saturday October 30th, where they paid a visit to Mrs. Joy Kerr. TARCinc member Ron Tulloch VK4BF presented Mrs. Kerr with a framed replica of the September 1999 Amateur Radio magazine front cover and article that he wrote about Vern Kerr VK4LK (SK). Vern was a technician with the RFDS from 1934 to 1977 and was honoured with the Vern Kerr Drive being named in recognition of his dedicated service to the community. A very kind gesture by TARCinc on behalf of the Amateur Radio fraternity.

Use it ...or else

John VK4HJP has been concerned with the lack of use on the 438.525 MHz repeater on Mt Coot-tha, so has decided to start a net. In a letter to the WIAQ, John asks as many as possible to join in, with possibly any subject open for discussion.

Wednesday nights at 8pm!

ALARAMEET

Sally VK4SHE reported on an excellent ALARAMEET in Brisbane, held at the RSL Club at Chermerside. About 80 were in attendance at this International Conference, all states except VK1 and VK8 were represented, with quite a few attendees from overseas. That is an excellent roll up of members and would be the envy of many organisations that sponsored an event such as this. Congratulations to the Ladies of

Amateur Radio. If you are an "Aussie" YL they would love you to join ALARA.

Just \$12.00 per year to the Treasurer is all it takes, and that is:

Bev Clayton, VK4NBC at 5 Lenz Street, Chermside Qld. 4032.

Next ALARAMEET will be in 2002 at Murray Bridge, SA.

New Club Warranted?

A group of amateurs in the Lockyer Valley (west of Brisbane) have formed a steering committee to canvas the local amateur population to see if a social amateur radio club is needed. To date the response has been excellent with approximately 20 potential members very supportive of a club in the area. A full meeting will soon be held to decide the direction of such a club.

If anyone would like any further information, please phone:

Alan VK4SN on 04 1137 3679 or Warren VK4FJ on (07) 5465 3219, or packet a message to either at VK4WIP, VK4FJ @ VK4WIP.#IPS.QLD.AUS.OC or E-mail Neville VK4TNA at nevt @ hypermax.net.au

(Warren VK4FJ, Alan VK4SN and Neville VK4TNA.)

Those of us retired or semi-retired (or otherwise less fully occupied!), look forward to your company on the bands, particularly on the very challenging but less populated vhf-uhf bands which will be "humming" at this time of the season with increasing summer Es, tropospheric ducting, TEP etc... Likewise the HF dx bands will be in good shape, with interesting things happening on 15m and 10 m, due to the rapidly rising 23rd sunspot cycle.

If travelling, find room in your car or suitcase for some portable gear. Make full use of the salad days, or spend the long winter regretting - be there or be square!

Having said all that, I am very likely to be away in Africa through late Dec and nearly all of January, so much to my chagrin, will again miss out on the Ross Hull contest and some of the best of the propagation. No doubt I can expect to be informed on my return of all the mega-strength openings which have taken place in my absence (with everybody working the east-coast with 1 watt FM).

Hamfest '99

This annual event has just taken place at the time of writing. It was great to catch up and put a face to nearly the whole of the vhf group with whom I have been having daily skeds on 2m sideband. If for no other reason at all than to actually meet and talk to the "voices from the ether", it is certainly worth making the effort (200 km round trip in my case) to get to this event, although once again I came away with many useful bits and pieces. However there were no new rigs brought back to Toodyay this time - where were the suppliers to tempt us? (Not all were absent of course). Also the numbers attending appeared to be well down on last year. Do we have a chicken and egg situation here, or is there some other, more disturbing, explanation?

Avon Valley Repeater down! (But not out)

Sad, but true. Our 2m repeater (located outside Northam), is off the air at time of writing, the 100 ft mast having been brought down by a fierce late-winter storm. All guy wires were stretched with those supporting the middle giving way - as a consequence the 4-section tower collapsed in the centre, with the antenna lodged in the treetops holding all the "spaghetti" up off the ground. The tower has been removed to the QTH of John VK6BOC, who will apply his welding skills to the problem, with the assistance of Jim VK6CA and Ray VK6ET. This unhappy incident is of course also a setback for the UHF linking project. In the meantime some locals are using 146.500MHz simplex to meet.

CW Survey

The CW Retention/Abolition survey is currently under way. The survey is due to close at the Hamfest.

I am concerned that amateurs do not lose CW skills completely, as the ability to employ CW certainly helps with weak-signal vhf and other work, and it would be very frustrating not to be able to make/complete contacts into new "squares" or countries as a consequence. Non-compulsory CW may prove to be more attractive to prospective amateurs however. Perhaps a requirement to at least learn the alphabet would be a solution? I do find it ironical that I am now using CW daily for long-haul VHFcontacts!

From the Minutes (Nov. Council Meeting).

Some items of interest:

Membership:

One new member, Wayne VK6JR, was warmly welcomed to the Division.

Federal:

The possibility of refreshing the list of authorised examiners by calling for re-applications was discussed but no resolution reached. (BTW, I have just been appointed an accredited examiner - if you know of anyone east of the divide looking to sit, please contact me at the email address at the foot of the column). There is to be a meeting with ACA on 5th November 99 to discuss the 80m DX window.

General Business:

- (1) Greg VK6YEI advised that there had been three candidates for the last NCRG exam service examination.
 - (2) Don VK6HK drew attention to the existence of Ron Bertrand's AOCP training course on the Internet. The course was free and offered mediated assignments or self study. The web URL is: http://members.xoom.com/_XOOM/ronber/about.html.
 - (3) Will VK6UU described an "incident" involving a "LIPD" transmission on the appropriate frequency of 152.025 MHz. The signal was radiated from the Darling Scarp as part of a link testing a remote HF receiver. ACA investigated what was thought to be excessive radiated power given the received signal level on the Perth coastal plain, but all was found to be in order.
 - (4) Will VK6UU had obtained a copy of the VK4 motion about having a consultant investigate the structure of the WIA. He will redraft the motion for consideration at the next meeting.
- Merry Xmas, good luck with Y2K bug, and 73 from Toodyay, Chris VK6BIK
(chrismor@avon.net.au)

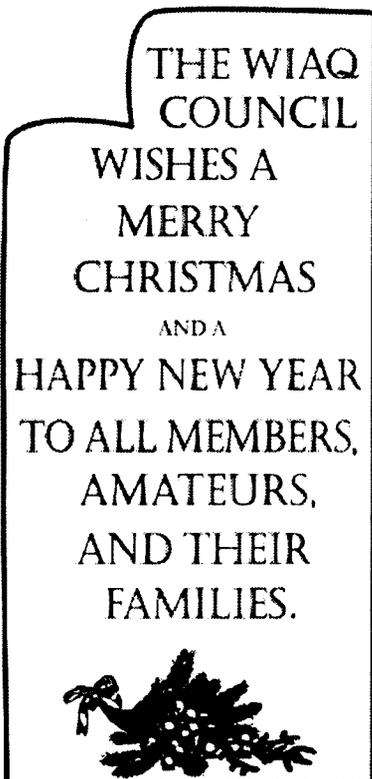

VK6 Notes - Dec'99

The December issue of AR comes out at a time when many hardworking hams can at last take a decent break from the salt mine - hopefully to spend much more time being active on air, putting up new antennas, building things or what have you.

A Carol to sing round the Xmas tree

by Bob Harper VK4KNH

The Twelve Days of DXmas

On the first day of Christmas
My true love gave to me...
A dipole strung up in a gum tree.
Etc Etc until...
On the twelfth day of Christmas
My true love gave to me...
Twelve metres of coax
Eleven QSL Cards
Ten Tiny FETs
Nine Numbered Knobs
Eight Glowing Valves
Seven Insulators
Six Metre Beam
Five Morse Code Keys
Four Microphones
Three Headsets
Two rubber duckies
And a dipole strung up in a gum tree.



Merry Christmas
and a
Happy New Year
to all members
and
their families
from the
West Australian
Division of
the WIA.

VK7 Notes

QRM — The Tasmanian notes

Ron Churcher VK7RN

The writer has just come back from three and a half weeks in Queensland and NSW so I am relying on my ever faithful Secretary and our north-west President Bob for this month's information.

TASMANIAN AMATEURS DO IT. AGAIN

Overcoming tremendous odds to deliver the goods! I'm referring to our involvement with communications for the Tasmanian Classic Car Challenge held on the Northwest coast over the October 30th November 1st long weekend. The weather didn't like us one bit - snow, sleet, howling winds, rain — we got the lot and much of the Challenge was in the mountains. The official SES communications channels were practically non-existent at some stages but excellent cooperation between them and our communications system worked wonders thanks to David VK7C and Tony VK7AX. The last straw for some of the officials was when the mobile phone system collapsed west of Wynyard. Amateur Radio to the rescue again with Malcolm, VK7CA travelling with the CAMS officials for the last 2 days achieving what they thought impossible! Even our repeater was showing some problems in the high wind and snow.

All the operators who assisted in the event must be congratulated on their efforts and

the CAMS officials and the rally organiser sincerely thanked all our amateurs.

Special mention must be made of the efforts of Mike VK7ME, Kevin VK7HKN and Gavin VK7HGO for their persistence and skills in managing the Hellyer Gorge stage in some of the worst conditions.

Andrew, VK7XR manned the base control for two days with VK7ZMR, VK7AY, VK7HKN, VK7KC, VK7NGC, VK7KH, VK7BY, VK7ME, VK7KT, VK7PU and VK7MD in the field plus two - VK7HGO and VK7DG who made the special effort to travel from Hobart to assist.

The next items to come up will be the branch Christmas festivities but they are something for our next report.

Cheers for now,
And a very Merry Christmas to one and all,
Ron VK7RN, VK7 State President.

31

Merry Christmas
and a
Happy New Year
to all members
and
their families
from the
South Australian
Division of
the WIA.

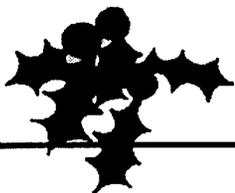

To all Amateurs
and
their families

Merry Christmas
and a
Happy New Year

from the
Tasmanian Division
of the WIA.



An Inconspicuous Antenna

Tom Walker VK4BTW
IARUMS VK4 Coordinator
13 Bothwell Street,
Toowoomba QLD 4350

The article Low Profile Amateur Radio in Novice Notes of April 1999 AR was of considerable interest to Col VK4AKX and myself

Although he would be the last to acknowledge it Col is possibly the most effective observer that we have in the Intruder Watch Service despite operating under difficulties of both health and location. Col is located in Holland Park Brisbane.

Being another of those amateurs who prefer to keep a low profile Col has developed and is using to good effect the antenna shown in Fig 1 as the AKX Special.

With an overall height of 12 feet it only just escapes use as a clothesline. With the 7/22 bare copper wire tarnished to a light brown it is not very visible among the trees in the back yard.

Using an FT77 transceiver with 80 watts output into this antenna the following QSO's have been achieved on CW :- 14 MHz - KORDW 549, CT1BIX 559, VE6KBS 549. 10.1 MHz - SMITDE 539, LU5WW 559, XE1FGB 559, XE1/NP2AQ 559, HB9US 449. 7 MHz - K5CA 559, VE1ZZ 559, HL4CJJ 579, W8VLN 549, JA4MWZ 579, JA3PST 579.

In his regular attendance on the 3.578

MHz Intruder Watch Net on Friday afternoons using this transceiver on SSB at 12 Watts Col's signal to me in Toowoomba is usually 59+ improving as the evening closes in.

If your antenna farm needs only to be a farmlet the AKX Special would be well worth considering.

Technical Editor's Note.

L1, which is described as an ex D/W receiver slug tuned grid coil, may be difficult to duplicate or obtain. Such coils are 35 or more years old. They were wound on 3/4 inch or 20 mm or smaller slug tuned formers. You could try an air wound tapped coil as a substitute. A good starting point would be 10 turns spaced 20mm to 25 mm on a 20 mm (3/4 inch) or 25 mm (1 inch) diameter and then add or subtract turns to suit. The variable capacitor will give some adjustment range. The aim is to achieve a result that will not produce too great an SWR for the transceiver.

ar

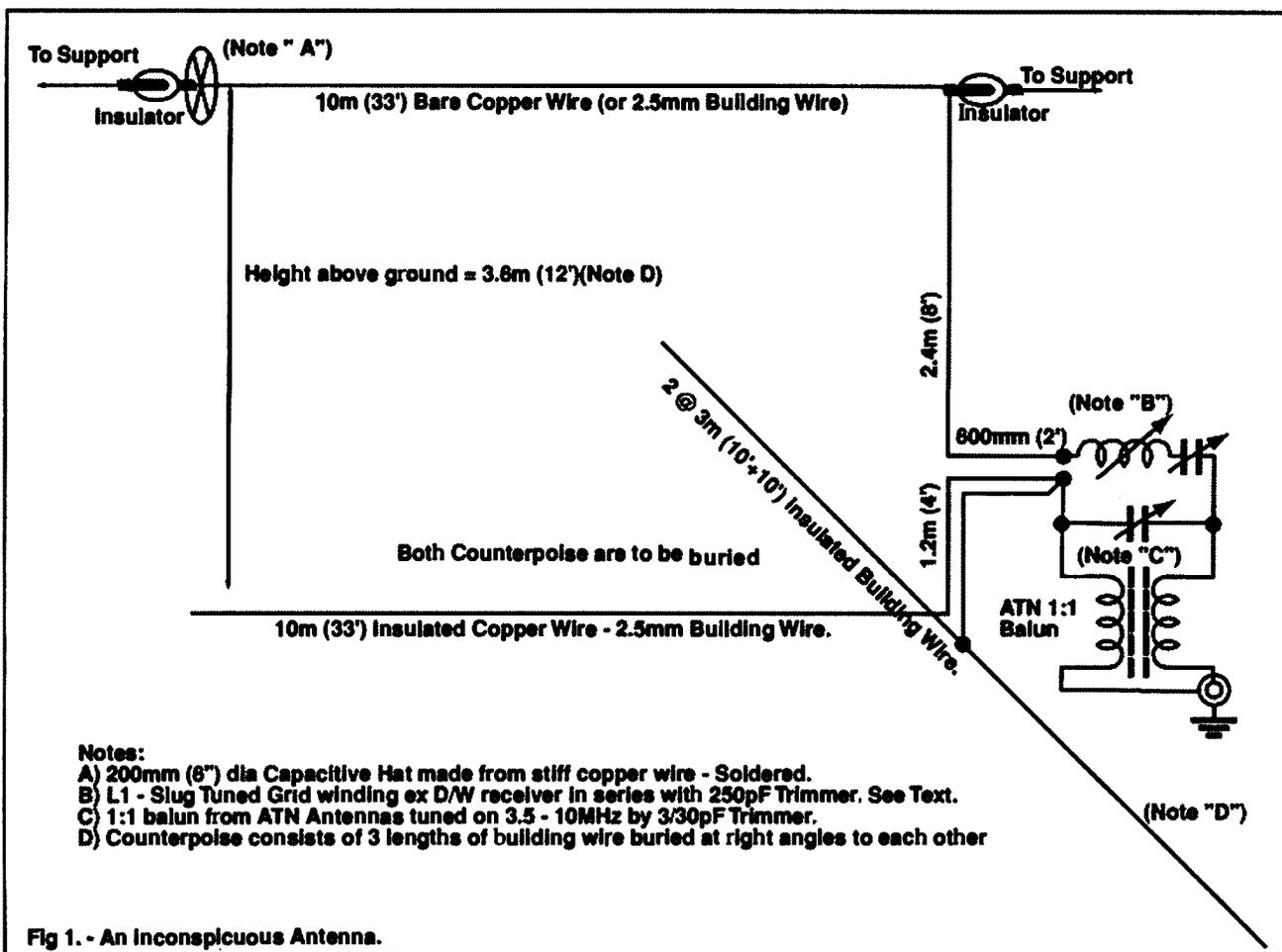

Fig 1. - An Inconspicuous Antenna.

Fig 1 The AKX Special an Inconspicuous Antenna Designed By Col VK4AKX.

CLUB NEWS

News from the Moorabbin and District Radio Club

MDRC promotes AR at hobby show

Amateur radio was on display at the inaugural St Kilda Hobby show held on the weekend of November 6 and 7. The stall, run by members and friends of the MDRC, included activity from club station VK3APC on HF, VHF and UHF. The venue was the Army Hall in Chapel Street, St Kilda.

Our display included various pieces of working amateur radio equipment. Homebrew items also featured prominently with HF receivers, ATUs, power supplied and more being on the table. A large banner we made for this and future shows graced the wall behind the table.

The hobby show was a first event, and the poor weather didn't help attendance, which was somewhat less than expected. However we still managed to re-sign one former member and expose dozens of people to amateur radio. Several visitors also took PR brochures that we had prepared for the event.

Those manning the stall included Keith VK3JNB, Tony VK3JED, Mai (SWL), Craig (SWL) and Peter VK3YE. MDRC members who visited included Tony VK3CAT, Darryl VK3HEM and Chris VK3JEG.

Several other amateurs visiting the show also introduced themselves to us.

One highlight was contacts via the Sunsat satellite by Tony VK3JED. These had to be made outside due to the hall's corrugated iron roof.

HF wasn't much good to start with, but got better as the day progressed. Our ten watts to an end-fed half wave wire on a squid pole provided excellent reports throughout south-east Australia on 40 metres.

However the extreme level of RF noise on all HF and VHF bands made it difficult to hear everyone who called us.

The MDRC thanks those who made contact with us or paid us a visit. The Club has been invited to attend the next Hobby Show, which is planned for next February.

MDRC Monday net continues

Just a reminder that the MDRC's weekly 80 metre net went into recess last month with the introduction of Daylight Saving Time. However the 2 metre net continues each Monday (except the first Monday of the month) on 146.550 MHz at 7:30pm local. This net is a great opportunity to hear what your fellow club members are up to and collect some contacts for the Moorabbin Award.

Publicity brochures now available

As part of the preparations for the Moorabbin and District Radio Club's stand at the St Kilda Hobby Show, the MDRC produced two brochures to hand to interested visitors. The first brochure explains what amateur radio is all about, and is thus suitable to give to the complete newcomer. The second focuses on the services and activities of the MDRC, but could easily be customised to suit your club. Both brochures are A4 size, and thus can easily be copied. Electronic copies of them both (in Word 6.0 format) can be obtained by e-mailing the MDRC Publicity Officer. The address is parkerp@alphalink.com.au. That's parkerp@alphalink.com.au for AR PR leaflets.

The year that was

By the time you read this, we will be near the end of 1999, the MDRC's fiftieth year of existence. It is time to reflect on past achievements and consider new ideas to create a better future for the Club and amateur radio generally.

1999 was a year of innovation and new projects for the MDRC. The club-sponsored Radio on Rails Fun Days promoted rail mobile amateur radio and increased local VHF/UHF activity. In January the Club launched APC News, a high-quality weekly amateur radio news program for Melbourne amateurs. May saw a boost for homebrewing at the 'Even

Greater Crystal Set Competition' held in conjunction with the Club's Hamfest, attendance at which set new records.

Raising club membership and attracting newcomers to amateur radio was a key MDRC activity this year. In September we wrote to 300 non-member amateurs who lived near the Club, inviting them to enjoy the benefits of membership. The mail-out resulted in many new and former members re-joining the Club. November saw the running of a stall at the inaugural St Kilda Hobby Show to demonstrate amateur radio to the general public. We hope that this and future projects will increase amateur activity and further strengthen the MDRC.

Regular activities at the MDRC continued throughout the year. Our club rooms remained well-used with the Tuesday morning and evening activities and the Friday social and general meetings. The Club callsign continues to be used on the Monday nets and has featured prominently in the results of major Australian contests.

So what's in store for next year? The future is what we make it. Let's work to build on the achievements of 1999 and make 2000 another vintage year for the MDRC!

The Committee of the MDRC wishes members and friends a merry Christmas and a safe and prosperous new year.

Peter Parker VK3YE
Publicity Officer
Moorabbin & District Radio Club
parkerp@alphalink.com.au
(03) 9569 6751

ar

**Do you have some club news to share?
Or an event to publicise?
Then THIS is the place.**

The
**Amateur
Radio**

**pages are your pages.
Send your information to
The Editor Amateur Radio
PO Box 2175
CAULFIELD JUNCTION
VIC 3161
email armag@hotkey.net.au
Fax (03) 9523 8191**



Sumerland Hamfest.

The photo shows Martin Davis, VK4HMD representing Michael's Electronics presenting the ICOM Q7A Handheld to Mr. Eric Baker for Mr Jim Fraser.

EDUCATION

Brenda M Edmonds, VK3KT
PO Box 445, BLACKBURN 3130

WICEN on standby for Summer emergencies

Seasonal greetings and all good wishes for the year 2000 to all readers.

We are looking forward to a number of interesting developments in the forthcoming year, but in most respects the new-year will differ very little from the usual.

In the southern states especially, we are coming up to a time of high fire risk, and it is likely that the services of WICEN (Wireless Institute Civil Emergency Network) will be called upon to assist with emergency management situations.

Newer members may not be well acquainted with WICEN activities, and older members may not be aware of the changes that have taken place within the organisation.

For many members, the best contribution they can make is to ensure that they do not interfere with any emergency traffic which WICEN may be passing, that they stay clear of frequencies or repeaters which may be in use or that they vacate active frequencies if requested.

WICEN began as a loosely knit group of amateurs who put their abilities, time and equipment at the service of the authorities during emergencies such as bushfires. They practised their skills at events such as charity runs, bike rides, Murray River canoe marathons and car rallies, but in a major emergency many amateurs volunteered to provide and man stations without any previous experience of such operation.

In recent years however, WICEN along with other volunteer services has been

formalised and structured. It is now required to carry out formal training for its operators, and to conform to Occupational Health and Safety guidelines. Members must be registered, and must complete training activities regularly. This does not mean the end of the off-the-cuff volunteer — these can be registered as casual workers for a call-out — but it does reduce the pool from which trained operators can be drawn.

This is not necessarily a bad thing. It is much easier and more effective to manage a small, trained, aware group than a larger number of inexperienced, uncoordinated volunteers who have to learn procedures and skills under pressure.

However, depending on the extent of the emergency, it may be necessary to accept volunteers from the amateur ranks to supplement the registered WICEN operators. Let us hope that the situation does not arise, but WICEN is always willing to register and train more members.

ar

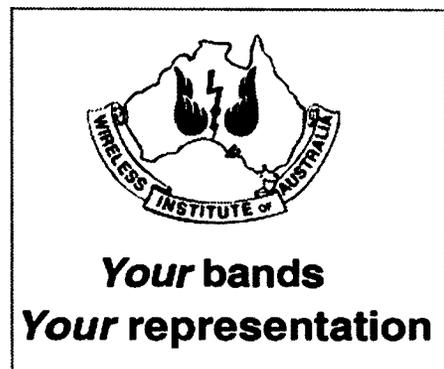

ALARA

Christine Taylor VK5CTY
ALARA Publicity Officer

16 Fairmont Avenue, Black Forest SA 5035
Packet: VK5CTY@VK5TTY

A Historical Item of Interest

This information came to Dot VK2DB via Warren WB6TMY who, with his wife Barbara, visited Dot and JohnVK2ZOI recently. We are assured that it is true, and that Dick W6AWO (who is known to many, we suspect) would be delighted to tell you more.

The Story of the Commemoration of the first Wireless Message

ACCORDING TO the California Historical Radio Society this is the 100th anniversary of radio in America. On August 23, 1899 a wireless transmission was made from Lightship No. 70 off the San Francisco bar to the Cliff House on the beach.

The message was simple: "Sherman is sighted" but history was made. The "Sherman" was bringing US troops home from the Mexican-American war and the city turned out to greet them in grand style.

The event was recreated on August 23

1999 through the good offices of Bart Lee, the CBRs, the Coast Guard and many others. The Coast Guard cutter Point Brower/NMEX stood off the entry to the Golden Gate and transmitted the same message in Morse on 16.907 and 3.387MHz. This in itself was a big event since the Coast Guard abandoned the use of Morse years ago.

Tom Horsfall, WA6OPE and I participated as part of the Maritime Radio Historical Society.

We set up a station consisting of a military AN/GRC-9 on the roof of the San Francisco Maritime Museum. We used the antenna we have just erected that is destined to work with the restored Radiomarine 4U radio console from a WWII Victory ship that will be part of a permanent exhibit on maritime communications at the museum.

We heard NMEX tuning up about an hour before the event. They were putting in a great honking signal so we knew we were in business. At 11:50 on the dot they sent "Sherman is sighted" on 16MHz and then again on 3MHz. But this time the op on board used his bug at the end of the message to send "ZUT CW forever"! A great, unexpected touch.

Now it was our turn. We came up on 3.540MHz and sent a message of welcome and acknowledgment as a QST. Taking the lead of NMEX I also signed off with "CW forever". Unexpectedly, NMEX acknowledged the message cross-band! Not wishing to tempt fate or the FCC I simply acknowledged that with the radio-man's traditional "dit dit". It was a good day and great fun for all. Dick/"RD" Dick Dillman, W6AWO

Chief Operator at K6KPH the Maritime Radio Historical society Collector of Heavy Metal: Harleys, Willys and Radios Over 100lb."

Has this been your experience?

Have you ever run a Special Event Station or a JOTA station and called and called and called and had nobody respond? Have you sat there for hours fulfilling your obligations and had nobody respond? Have you listened around and heard other people operating or calling CQ but still had no response to your call? Most of us have had this happen some time. Isn't it frustrating?

Why don't people answer you when they hear you? Is it that they are wary or scared of talking to strangers? Is it that they think they will be bored by a whole lot of information they don't want about the purpose of the special event, or by having to talk to a whole lot of Scouts or Guides? Is it that they don't collect or want to send out QSL cards? Or is it that they have just can't be bothered?

Next time you hear someone operating a Special Event Station, please, answer them. They will be so delighted, and you will be well rewarded for your efforts. You do not need to be bothered about QSL cards unless you want to. You just might find it interesting to hear the story behind the station (like the story up above, for instance). Next time someone is calling for JOTA, please answer them, please spend a little time talking to the children - after all, one of them might be a budding amateur, inspired by their experience at JOTA. It really won't take much time, but it will give a lot of pleasure.

ALARA and JOTA this year

Our involvement this year was less than usual because of the Brisbane gathering but we were still involved. Mary VK5AMD had her Bordertown Brownies, Dot VK2DB ran a station for the Hornsby Scouts and Meg VK5YG helped out with the Murray Bridge group for whom Colin VK5JP runs a preliminary practice session each year.

June VK4SJ has run a station for the Mundingburra Guides but was uncertain whether she would be doing it this year in her new shack - the children had not always been as well behaved as the presence of delicate equipment requires, in previous years. To avoid this sort of problem Bev

Andrews

Communications Systems

(EST 1976 - ACN 001 968 752)

ALINCO

AUSTRALIA'S FIRST AUTHORISED
FACTORY DIRECT IMPORTER

MASSIVE SHIPMENTS EVERY MONTH

FULL 3-YEAR WARRANTY ON

ALINCO and ICOM
WE SELL MOST BRANDS

BALUNS, VERTICALS, YAGIS, P/S.

ICOM-KENWOOD-JRC-AOR-EMOTATOR-

MFJ-DIAMOND-TIMEWAVE-KANTRONICS

-THP - GARMIN - TERLIN - UNIDEN - ETC

DX-1600 HF LINEARS FROM \$ 3,799

**HUGE RANGE OF ELECTRONICS,
ICOM and ALINCO Radios.**

Over 22 Years of

Professional Sales and Service.

Instant Repairs Fridays

HF Transceivers & Linears Wanted

(02) 9636 9060 or (02)
9688 4301

SHOP 8 41 BATHURST ST. GREYSTANES.

N. S. W. 2145. FAX (02) 9688 1995

VK6DE uses a roster system so that only one or two Guides are in the shack at a time. The others have other activities to keep them busy.

For the YLs I spoke to in Brisbane I gained the impression that there had been some less than pleasant experiences with running stations for JOTA, both in the home shack and when using the equipment in Scout Halls. This is possibly something that should be addressed by the JOTA organisers and by local leaders.

In VK5 the Guide participation in JOTA this year was very low because of a large Information Technology Camp run during the school holidays, immediately before the date of the world-wide JOTA weekend! In other years the Guides have been extremely active.

Marilyn has done it again

Marilyn VK3DMS has won another large Vermeil medal with her "Radiomania" stamp collection. She was a little disappointed not to win gold this time but pleased that she gained another point above her previous score. Maybe next time!

It would have been particularly fitting if Marilyn had won this year as the "Stapex" Exhibition and competition was held on the weekend of her Ruby Wedding. Marilyn and OM Geoff VK3ACZ celebrated the wedding anniversary with a group of VK5 friends on the actual day though they had also been 'well-wished' at the Stampex Gala Dinner the evening before.

Congratulations to you both from your ALARA friends!

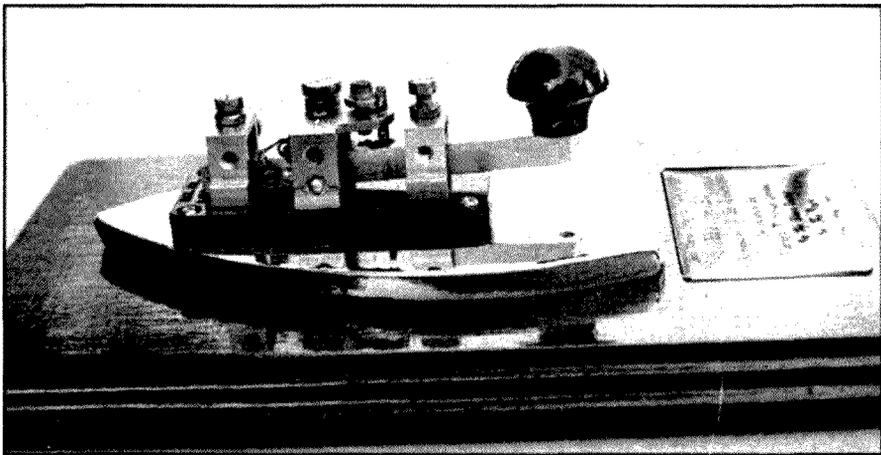

The Florence Mckenzie Trophy: no wrinkles

Presented to Bev at the ALARAMEET, The Florence McKenzie Trophy is a mounted, working, solid 1930/40 Morse key, such as is used by many keen operators. It came from the collection of Harro VK5HK and is mounted on the base from an electric iron. Although this may seem somewhat chauvinistic in this day and age, it is a very practical idea and makes a really solid-feeling key.

THE WHOLE assembly was taken apart, the base chrome plated and the key cleaned within an inch of its life before reassembly. Geoff VK5NDZ kindly provided ALARA with a beautiful piece of Australian cedar on which to mount the key. There is no new Australian cedar available because all the cedar trees were cut down in the early days so this block is very special.

The presentation was a complete surprise to Bev but we are sure the key will be put to use rather than sit on a shelf. Bev was taught Morse by her OM Graham VK3BGC, a war-taught operator, and is used by both of them in contests and just for pleasure.

ALARA certainly hopes there will be other winners of the Morse section of its Contest (for which the Florence McKenzie Trophy is awarded), including the 1999 Contest just past; but Bev's achievement cannot be surpassed. The rules of the Contest have been changed, now to allow all YL operators to compete for the Trophy. When Bev won it only Novice operators were allowed to enter that section.

With all the moves to remove or, at least to reduce the Morse requirements from the amateur licence conditions, those who use and enjoy CW deserve to be encouraged.

Congratulations Bev!

ar

As a final note for the last column of 1999:

Season's Greetings to everyone

The YL in the accompanying cartoon says it all. (Note the time!). The artist is Sally VK4SHE. Thanks very much.

Happy Christmas. May the DXBE 5 By 9+

SEE YOU ALL IN THE NEW CENTURY

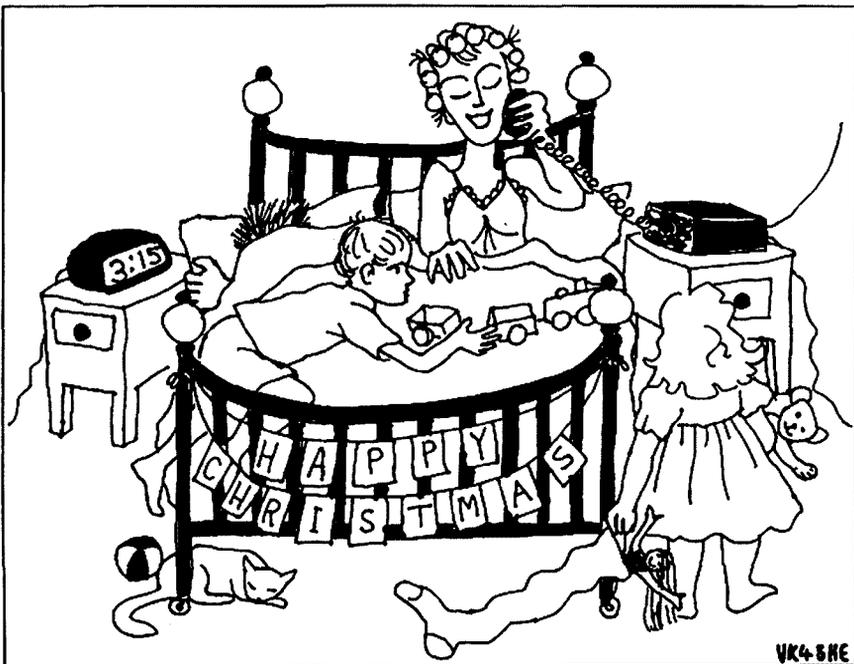

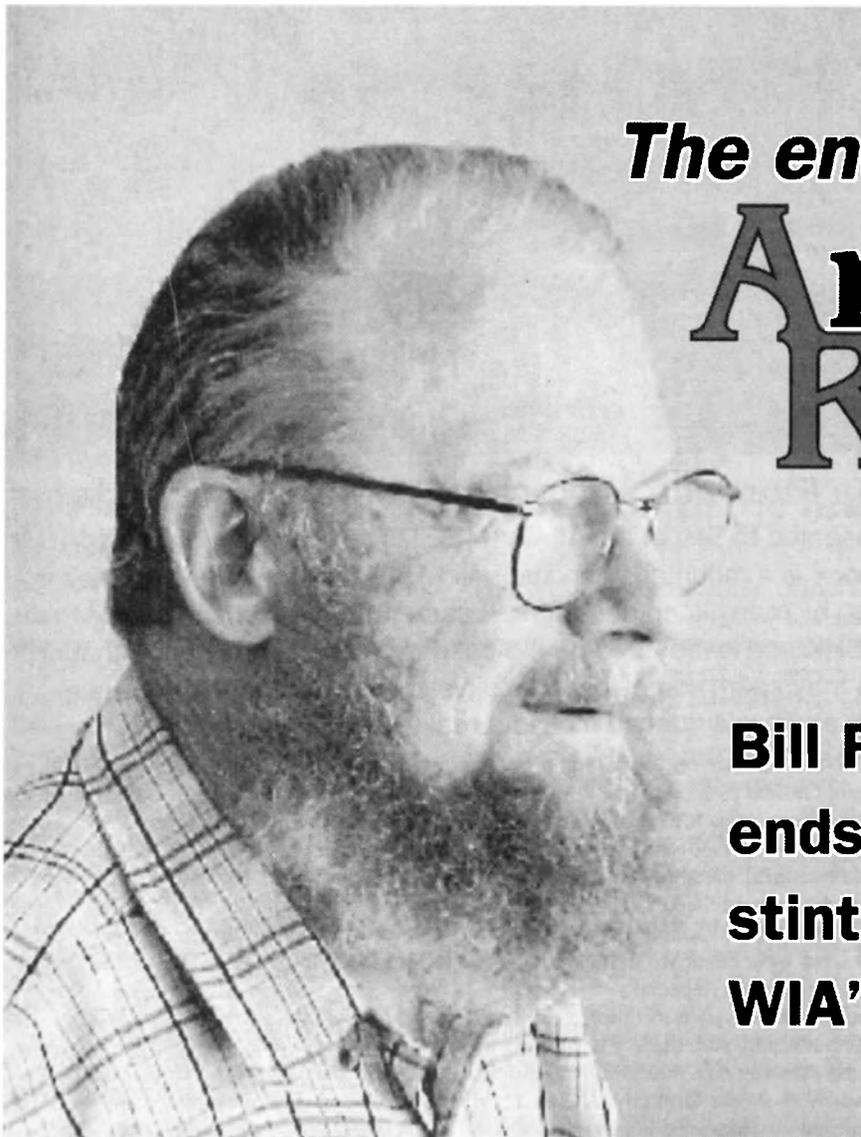

The end of an

Amateur Radio era!

**Bill Rice VK3ABP
ends record breaking
stint as editor of the
WIA's journal**

Bill Rice, who has served as editor of *Amateur Radio* since 1984, is retiring with effect from this December 1999 issue of the magazine. Bill says the year 2000 seemed to him to be an auspicious occasion to leave, after setting a new record for length of time in the Editorial chair of 15 years and seven months.

BILL WAS BORN IN 1927, almost a Victorian. The Mallee town of Pinnaroo SA is only 8 km over the border from Victoria. Bill spent his first 12 years on the family farm but, Mallee farming being what it was (and still is!), the family left the farm and moved to Murray Bridge in 1940. After stints at Murray Bridge and Adelaide High Schools, Bill eventually became an electrical engineering student at Adelaide University, having been fortunate to pick up a scholarship along the way.

Bill also picked up an Amateur licence in 1947.

He graduated with honours in 1952

having spent the previous three years on RAAF sponsored antenna research.

In 1953 Bill moved to Melbourne to work for the RAAF as a civilian "boffin" with the Aircraft Research and Development Unit at Laverton.

He and Margaret were married in 1953, and he continued at ARDU until 1976 when the unit moved to Edinburgh RAAF Base north of Adelaide. Bill elected to remain in Melbourne and moved to the Aeronautical Research Labs at Fisherman's Bend. He retired in 1987 after 34 years with the Defence Department.

After retiring from full time employment,

Bill had more time to concentrate on editing *Amateur Radio* magazine, a task he had taken on in 1984 after 12 years as a member of the Publications Committee as Senior Technical Editor.

With his encyclopaedic general knowledge, and outstanding electronics knowledge, Bill has taken great pride in being at the helm of a hobbyist technical magazine which has published a lower number than average of technical and other errors.

Bill is rather hopeful that he will now be able to devote much more of his time to the practice of Amateur Radio as distinct from its journalism.

On behalf of the Federal Council, the Executive and all WIA members, thank you Bill for your outstanding service over a very long time to your fellow amateurs.

Peter Naish VK2BPN

Federal President.

ar

THE GREAT ROSS HULL

by Eric Jamieson VK5LP



ROSS HULL is best known for his pioneering work in the field of development of the VHF and UHF spectrum, in particular equipment for the 56 MHz amateur band and later for the 112 and 224 MHz amateur bands. These were the bands offered to the amateurs during the period between World War I and World War II. Initially they were shunned by the professionals due to their perceived "line-of-sight" limitations.

ALTHOUGH MUCH of Ross's developmental work took place in the USA, he was an Australian, born in Melbourne in 1902. Although he was trained to be an architect, early in his life he developed a great interest for radio, amateur radio in particular and operated with the call sign of OA3JU. By 1922 he had progressed to become one of Australia's best achieving amateurs, being the first to receive signals from amateurs in the US.

He firmly believed in the Wireless Institute of Australia and became its Federal Vice-President in 1924. Later he was appointed Secretary.

In 1925 the Victorian Division of the WIA formed a committee to undertake tests to establish contacts with ARRL stations in the USA. The Committee consisted of Howard Kingsley-Love 3BM, Ross A Hull 3JU, WFM Howden 3BQ, EK Cox 3BD and C Philpott. The VK prefix was to be added to their call signs later. (1)

On 25 July 1925 Australia was visited by the US Naval Fleet which called at Melbourne. The vessels included the Flagship *Seattle* with station NRRL aboard manned by Lt Fred H Schnell, USNRF, and IMO-1XW was greeted as the first ARRL contact by Ross A Hull A3JU and H Kingsley-Love A3BM and others. The latter was Editor and the former Associate Editor of *Experimental Radio and Broadcast News*. (1)

The US recognises his value

As the result of meeting Fred Schnell, Ross was determined to see America so in 1926 in his capacity as Secretary of the WIA he visited the United States to study American radio activity, particularly amateur radio.

The ARRL was quick to recognise his potential and appointed him to a junior position in the editorial department, the technical information service. He extended his stay in the US and was eventually appointed to the position of Assistant Technical Editor of *QST*. (2)

When, in 1928, the Board of Directors authorised a special technical development program at ARRL HQ to devise new apparatus and methods, to meet the trying conditions that would confront amateur

radio in 1929 when the Washington Convention took effect, Hull was the logical man to head the program and became its director. The brilliant success of that program is a matter well known to every old time amateur. Much new gear of Hull's devising was introduced and it is not going too far to say that his studies over that period revolutionised our technique. (2)

He popularised "band-spread" for amateur receivers and was responsible for the first serious use of the superheterodyne

The Ross Hull Memorial VHF/UHF Contest

The annual Ross Hull Memorial VHF/UHF Contest commences on 26

December (see page 40) This year's contest has special significance in that it is the 50th such contest to be held. It is the Golden Anniversary Contest.

Therefore, it seems appropriate that this article accompany the commencement of the Golden Anniversary Contest. The list of each year's winner is included in *VHF/UHF*

— *An Expanding World* in this issue.

While the name Ross Hull is familiar to many amateurs, those new to the ranks may well ask who is/was Ross Hull? In the January 1998 issue of *Amateur Radio*, when promoting the contest, John Martin VK3KWA wrote an excellent article about some of the achievements of this radio pioneer. Again, because there are newcomers who may not have read John's article, so with his permission and that of *Amateur Radio*, it is proposed to re-

present some of his points together with additional information that may be new to most people.

I am greatly indebted to Mark Wilson K1RO, Editor of *QST*, *QST* magazine and the ARRL, for the provision of scanned copies of *QST* on CDs from the 1930s together with photographs which have provided much sought after background information regarding Ross Hull and the work in which he was involved. This kind of co-operation across national borders helps to keep alive one's faith in amateur radio in particular and mankind in general.

Thank you gentlemen.

Of necessity when preparing an article such as this, one is forced to draw on archived material, for the simple reason that so many of the events occurred before I began to take an interest in radio. In fact, Ross Hull died in the same year that I began to write SWL notes for *The Adelaide Advertiser* - 1938. Therefore, there are frequent references to material supplied by *QST* and John Martin's article of 1998.

Eric Jamieson

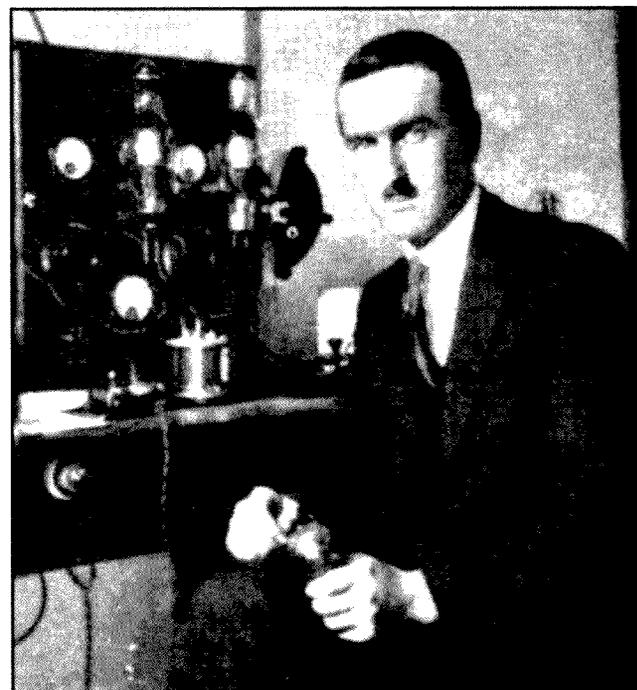

Photo 1. Australian 3JU - at his station in Melbourne, about 1924. *QST* 11/38.

in amateur circles as the logical receiver for phone stations. He produced the first practical apparatus employing the high-C circuit for self-excited oscillators, made the first presentations in amateur radio of 100%-modulation and the use of linear RF amplifiers, first introduced the signal monitor. This technical-development program was the beginning of real development work in the ARRL Headquarters laboratory and shop, thereafter carried on almost entirely under his direction. (2)

He himself had a flair for building unorthodox equipment. He popularised the practice of putting tubes upside down or at unusual angles to shorten leads and was largely responsible for the abandonment of bread-board construction in favour of bent metal chassis. The apparatus he built, although often put together under stress of time, was beautifully constructed, mechanically rigid, and with losses minimised to work at the greatest efficiency, whatever its purpose. He set the pace in apparatus design for many years. (2)

He returned to Australia in 1929 and became the technical editor of *Wireless Weekly*, which was edited by his brother, A Galbraith Hull. *Wireless Weekly* was the fore-runner of today's *Electronics Australia*.

Ross joins the staff of *QST*

But he had been well and truly bitten by the American bug so he returned to the US and

in January 1931 he joined Kenneth B Warner W1EH (Secretary of the ARRL, Editor-in-Chief and Business Manager of *QST*) as Associate Editor of *QST*, a position from which he became the mainspring of the *QST* editorial staff. Ross Hull had the ability to organise and direct; he could keep his eye on the ball and inspire others to do the same; and at the same time he worked like three ordinary men in the laboratory himself. Here he developed new equipment for use by W1AL, the ARRLs own experimental station. Much of the equipment was

designed to work in the UHF spectrum, which in those days was considered that portion above 30 MHz, with particular emphasis on the 56-60 MHz (five metres) amateur band. (2)

Typical five-metre equipment of the day, was a modulated oscillator using a single valve which was quite unstable and could produce almost as much FM as AM as they drifted across the band. Hull recognised the shortcomings of this form of transmitter and the accompanying super-regenerative receiver that radiated spurious signals to interfere with others on the band or surrounding services. He worked to improve frequency stability and reduce operating bandwidths. If transmitters could be made more stable then receiver bandwidths could be reduced. The benefits would be less interference and a better chance to hear distant stations. Thus came his designs for separate oscillator and amplifier stages to reduce frequency pulling and FM and also receivers with improved selectivity. (4)

Improvements for five metres

The first step in this direction was when for that band he pioneered relatively simple apparatus using ordinary receiving valves. That they worked so well was testimony to his skills in achieving efficiencies never intended for such devices. A sample of his design work is shown in the transmitter, modulator and receiver circuits in ref. (4), where those ordinary radio valves were

used on 56 MHz to provide contacts over considerable distances. The transmitter follows the principle of separate oscillator and amplifier, the receiver had a tuned RF stage ahead of the super-regenerative detector. This was quite a step forward in the design of equipment, simple as it remained. By now his efforts in this direction showed amateurs the great enjoyment which could be had from five metre contacts.

In the early 1930s the average five-metre station was capable of working about 15 miles. But in August 1934 Ross amazed his colleagues at *QST* by announcing that he had worked from Hartford to Boston, a distance of 100 miles. His secret was the antenna. At the time everyone used vertical antennas, but Ross put up a beam. It was a simple antenna by today's standards - four quarter-wave radiators fed in phase with four reflectors - but it made a startling difference to station performance. (6) The word spread and before long the distance records were tumbling.

Then Ross made a big discovery. He had observed that signal strengths varied over time; a signal could be strong today and gone tomorrow - or it could be present in the morning but absent in the afternoon. To find the answer he now turned his attention to a detailed study of VHF propagation.

Propagation studies

He did a long-term piece of original research work of great value in recording received UHF signals and correlating their transmission with weather observations, establishing for the first time the true cause for the bending of these waves in the lower atmosphere. For Hull, by means of high gain antennas, was regularly communicating on five metres over distances in excess of a hundred miles, when others were still labouring to exceed fifteen miles except on the occasions when they talked to Hull. (2,11)

Over a period of several years he made regular recordings of distant UHF signals, accumulating a vast quantity of data which required prodigious labour to correlate and analyse. He delivered several scientific papers on this work before technical societies. (2)

For this work, in March 1935 he built the equivalent of a chart recorder. (7.11) He fed the output of a receiver to a meter, and focussed the image of the meter needle through a slit on to a strip of photographic film. The film was drawn slowly past the slit by a gramophone motor. This enabled him to correlate signal strength with other data, and it became clear that signal variations were associated with changes in atmospheric pressure and moisture. This led

to the discovery that VHF signals are refracted in the lower atmosphere, in much the same way as light rays.

Record distances increased

This was a major scientific discovery, on a par with the discovery of ionospheric reflection on HF frequencies. But it was made by an amateur with no scientific training, using home-made equipment. (11)

Ross published his findings in *QST* (8,9), and they led to a flurry of experimental activity and another dramatic increase in VHF record distances. Within a short time, five metre contacts were being made half way across the country - a far cry from just a couple of years before, when even the most die-hard experimenters thought that VHF would never be useful for anything other than chatting across town.

Ross applied the same techniques of stable oscillators and beam antennas to the 112 and 224 MHz bands. As early as 1934 he had succeeded in working over 75 miles on 224 MHz. (10) As more amateurs adopted his techniques, it was not long before the 112 and 224 MHz bands started to deliver the same kind of DX that had been achieved at 56 MHz. (11)

Ross was also the editor of *The Radio Amateur's Handbook*. He joined Communications Manager Handy in the rewriting of the fourth edition. Shortly, of course, it became a family affair; the product of the entire staff, and all successive editions were under his editorship. (2)

The tragic end of a life

[The following comes direct from and is part of the Obituary to Ross Hull contained in ref(2).]

Ross Hull was also greatly interested in television, particularly in the ultimate opportunities for its employment in amateur radio. He had an elaborate experimental setup of his own devising at his home on a Connecticut hilltop, a thousand feet above sea level. With his remarkable ability to scoop up UHF signals, he was succeeding, in his last few weeks, in receiving the NBC experimental transmissions from New York, a hundred miles distant, about as well as they were received in New York City, much to the amazement of the NBC engineers.

He had, in fact, built an experimental amateur television transmitter in the ARRL laboratory which was sufficiently promising to indicate that amateurs may soon expect low cost two-way television communication without the need for precise standardisation on number of lines and so on.

It was the power supply for his television receiver which caused his death. This receiver required a 6,000 volt plate supply for its large Kinescope. While only a few milliamperes were required, small transformers had caused trouble through surface leakage and he had replaced them by a husky 1.5 kw 4,400 volt pole transformer. The power supply was on a shelf under the table, and the mains outlet was on the wall behind and immediately above this apparatus. It was a dangerous setup. While wearing phones connected to the converter and receiver, and grounded on one side, he reached over the power supply to plug into the 120 volts mains. Upon withdrawing his hand he came in contact with the high-tension lead to the rectifier plate, pulled it off, and fell so that the 4,400 volt lead was contacting his body, the phones providing the ground.

He had as a dinner guest that evening a doctor who was an x-ray expert and familiar with high voltages. Sensing trouble from the next room within thirty seconds after Hull plugged in the power supply, the doctor ran to his aid, dragged him clear and applied artificial respiration.

Two other doctors arrived in a short time, adrenalin was administered, a pulmotor was quickly got, and every effort was promptly made by experts. But to no avail: death had been instantaneous on 13 September 1938.

There is an awful lesson in Ross Hull's tragic end. He did not need to die. If the small transformer had still been in use instead of the brute with a powerhouse behind it . . . if the power supply had been covered . . . if the plug had been somewhere else . . . if the line had been lightly fused . . . if he had not had on the headphones. . .

Hull was himself the author of the warning against high voltages which appears in the *ARRL Handbook*. But skilful experimenters are too often

contemptuous of the dangers in which they work. Far too many amateur transmitters are potential lethal machines. When death comes to as clever and versatile experimenter as Ross Hull, it must be a painful object lesson to the rest of us.

Of the most endearing personal qualities, Ross Hull leaves aching hearts in all who knew him. He was a grand guy. He will live forever in the thoughts of his friends.

His other interests

The story of Ross Hull does not end there. He had many other fine qualities and these should be mentioned. Kenneth Warner W1EH, Editor-in-Chief of *QST* writes as part of *It Seems to Us* (2):

The electrocution of Ross Hull tragically closed the life of the man whom we consider the most brilliant and ingenious and indefatigable amateur we have ever known. Possessed of a restless, inquiring mind, a determination to out-do all others in everything he attempted, and never satisfied with the accomplishments either of himself or of others, Ross Hull poured unbelievable numbers of hours and an



Photo 2. An Enthusiastic Skier - of considerable ability; Hull made frequent weekend pilgrimages to the hills of upper New England. Snapped in New Hampshire in 1937. *QST* 11/38.

astonishing enthusiasm into numberless projects, both in and out of amateur radio.

Most of our readers know him as a radio amateur who left a deep impress upon our field but, although amateur radio was his greatest love, he was proficient in many fields. He was a brilliant pianist, with a great love of music, and played for hours every day. He was an artist of considerable ability in oils, water colours and crayon. He was an expert amateur photographer, both as a pictorialist and in scientific work, and many of *QST's* cover illustrations have been his work. He was interested in astronomy and had built several reflecting telescopes.

Model aircraft was one of his passions from childhood. The last several years, he and W1ANA had been building model soaring planes of considerable span, large enough to carry radio apparatus for control in flight. With it all, Hull found time to read everything and the time to play; skiing in the winter, golf in the summer. With his radio gear, his piano, his cameras and his workshop he lived the life of the ideal amateur at his cottage in the Connecticut countryside. He was unmarried.

The need for safety measures

Just prior to his death, in an ironical twist of fate, Ross Hull responded to a letter on safety measures written by Mr Howard Chinn of the engineering department of the Columbia Broadcasting System, in the following manner:

Dear Howard: Of course you are quite right about the insane fashion in which

amateurs operate high-voltage equipment and about the equally stupid fashion in which we even go to the trouble of providing photographic illustrations of just how to do it. I would explain (not that it helps any) that the W1AW transmitters were, when the photograph was taken, still in the laboratory undergoing final checking. Since then, the transmitters have been fitted with elaborate "dust covers" and illuminated signs. There will also be much more space between the back of the transmitters and the wall and I understand appropriate cushions are to be placed along the wall and behind each of the units.

Seriously Howard, we should take some steps to keep amateurs impressed with the dangers involved and possibly insist on some protective devices, and I think we shall come to that. We have of course run quite a lot of material on the general subject - including a problem contest for ideas on the subject - but we should do more. Aren't you impressed though, with the better performance in the amateur world than in the professional world, particularly when one thinks of the relationship between the high-voltage-hours involved in the ham game? The most important problem is that amateurs seem to insist on the right to tune their transmitters with a lead pencil. They will not use a complete enclosure with interlock. And any of the other "safety" devices are probably worse than nothing.

How about writing a story for *QST* on ways and means?

*Sincerely yours,
Ross A Hull, Editor, QST.*

Conclusion

10) Had Ross lived a normal life span one wonders to what extent the amateur radio movement would have benefited from his brilliant mind. Certainly VHF, UHF, SHF and microwaves would have been high on his list. Improvements in these areas coupled with better antennas had to lead to ever increasing distances for contacts.

It was a sad day for the wireless/radio/electronics industry when such a great man had his life cut short doing what he loved - amateur radio.

References

- 1) *WIA Book Volume 1.*
- 2) *It Seems to Us, QST* November 1938.
- 3) *Firing Up on the Newly Opened Ultra-High Frequencies, QST* September 1934.
- 4) *New Equipment for the 56 Mc Station, QST* August 1934.
- 5) *A New Receiving System for the Ultra-High Frequencies, QST* November and December 1935.
- 6) *Extending the Range of Ultra High Frequency Amateur Stations, QST* October 1934.
- 7) *A Simple Photographic Recorder for the Experimenter, QST* March 1935.
- 8) *Air-Mass Conditions and the Bending of Ultra High Frequency Waves, QST* June 1935.
- 9) *Air Wave Bending of Ultra High Frequency Waves, QST* May 1937.
- 10) *Progress on the Ultra High Frequencies, QST* January 1935.
- 11) *Ross A Hull VHF Pioneer, Amateur Radio* January 1998.

Photo 3. Hull (right) and his model soaring plane - at the Elmira soaring meet in the summer of 1938. The plane is a gull-wing of 16-foot span, and had been equipped with radio control by Hull and Bourne W1ANA, the latter acting as control operator in flight. *QST* 11/38.

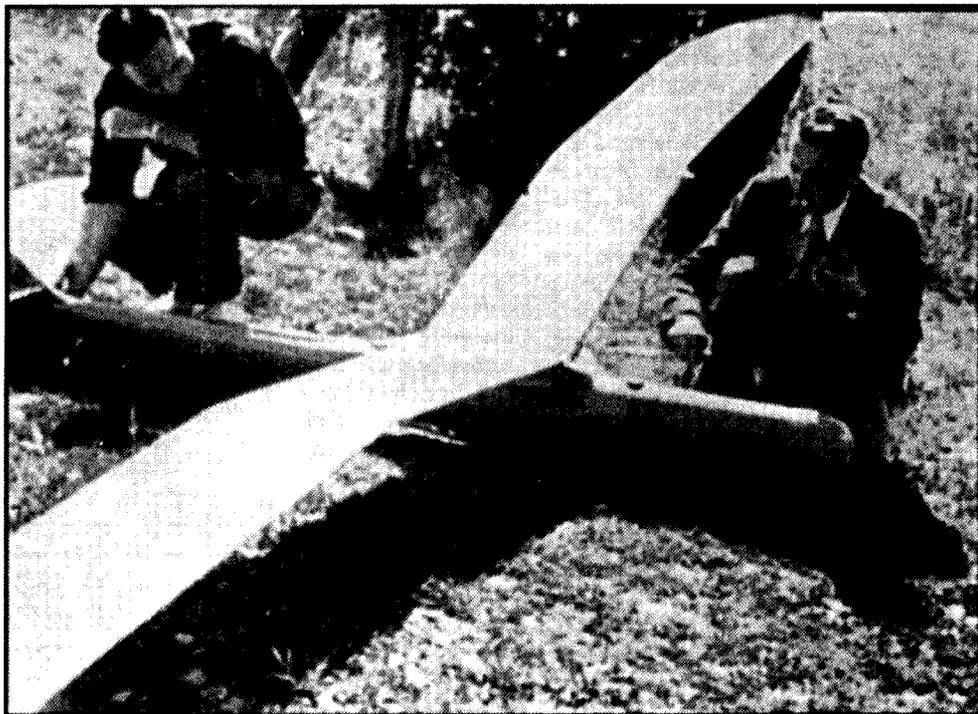

ar

OVER TO YOU

The WIA and its record

October "AR" proposes a 90 year celebration party, to be held during AD 2000, great, I'm all for it even though a long bow will need to be drawn to give authenticity to the claim.

The fact is, the final touches to the WIA, as we know it today did not occur until April 1929. However the WIA can rightly claim that its 'roots' do go back to 1910. This was the year the first recognised Wireless Club was formed in Sydney, Australia. Its members were a mix of academics, PMG engineers, techs and others of a like mind. In fact a few of them had been 'Wireless freaks' since the turn of the century ie. 1900. So by 'stretching the bow' just a little more it's possible to hold one party for two events. Let's do it!

This may be appropriate time to ask, "How well do we know the history of what we plan to celebrate?" Would you be found wanting? Now the cynic may defend his ignorance or lack of interest with, "Does it matter all that much"? Make no error, those who think this latter way will put the WIA on the fast track to oblivion.

You could rightly argue that every AR event worthy of reporting has appeared in some journal, magazine or newsletter somewhere in VK since it all began in 1900. True, but have you ever spent a whole day at some library or university thumbing through endless pages of print material in an effort to find the few items or info?

There is a better way to preserve our history! Interviewing SEQEB's (now ENERGEX) curator I commented on his detailed knowledge of the Power Authority's history. I have never forgotten his reply. "Any group, club, society, authority etc, worthy of its name, keeps a detailed up to date, easily referenced account of its activities and personnel."

Is this where we are at the WIA? Sorry NO! Does the Institute plan to put all past pertinent events and the Hams involved, between the covers of one book or perhaps better still on CD? Are the divisional historians doing any research to this end?

The WIA would never have survived to

hold a 90 year party without its journal "AR" and it's a must that its standard be maintained. Whatever 'future shock' awaits us, so sudden will be the changes come Y2K.

The years AD 2040-50 should see another generation of "amateurs" (?), hopefully in the majority. Many of them will carry the perception that electronics and the global village began with the computer and the Internet, only those few with historical knowledge will know better.

Out of respect to our 'Wireless' forebears, let's set our past history in stone or the modern equivalent. No dull tome is needed, simply a chronological (dated) run down of pertinent events and persons involved, highlighting VK's development from Spark to Internet. To be sure no "selective inattention" creeps in, each divisional historian should research his own state.

It will never be done you say. It's the WIA's choice. Tens of thousands of very

worthy Clubs, Societies etc have come and gone this 20th century simply because insufficient steps were taken to preserve their identity and existence.

The party

All things considered, let's lay it on - big. There'll never be another, 90 years on. Man and the Ham will have become something else by then; part of "Smart Space", whatever that is.

The uniqueness of the event demands the absolute best be made of it, on air and on computer sites, all over VK and beyond. All bands, modes and some 'AM fone'.

If, as we claim, our 'roots' began with the club of 1910, then we are indeed unique. This has been our century. Our forebears gave the world the "Global Village".

Access to the activities of the club of 1910 should be no problem via the NSW State Library, and the member's names could be obtained. The least we can do is to raise a toast (or 3) to those men and women who enabled the WIA to claim to be the second oldest club in the world. The WIA has indeed had a long run.

Just in case I can't attend Party 2000AD, maybe some kind member of the fraternity will offer up this toast on my behalf.

"Here's to WIA members, present and past, and to all others, who in a 1000 different ways, helped advance the state of the art to what we enjoy today. Thanks for the memories, cheers, bottoms up, and LANG MAY YER LUMS REEK."

73 Allan Shawsmith VK4SS

ar

SNIPPETS

During the 1974 Australia Day Floods in Queensland, the main Brisbane water treatment plant was totally cut off from the Brisbane City Council. The only communication that could be established was via Amateur Radio. Dave Hutchins VK4HW and Ron Grandison VK4RG, who worked at the Mount Crosby Water Treatment Plant, and several others at various points in between Mount Crosby and Brisbane, relayed vital river level readings and other information to the Council Engineers in Brisbane. Without their valuable assistance Brisbane may have suffered even higher water levels as these readings formed part of the feedback system controlling the release of flood water from Somerset Dam.

High Sea Antennas

Mark Dowdidge VK4MFX* shares his experience with maritime mobile antennas.

I'm writing this article in reply to "Yacht Antennas" (*Random Radiators, "Amateur Radio" February 1997*) to help clarify and explain the associated problems with marine antennas on timber and fibreglass vessels. Antenna efficiency is based upon R_r and ohmic losses or R_g . Since the length of the antenna or R_r (using the backstay wire), cannot be improved, we can, however, reduce our ground loss. Ground loss can come in many forms, but the construction material of a vessel is not one of them.

Earth straps from the ATU to the earth

plate should be kept short, and if possible not exceeding 1.5 meters. If the distance between the ATU and the main earthing body is too great, secondary radiation from the strap will take place, or the strap will form part of an RF loop circuit and propagate RF energy back into the set, boat, ocean, "household" wiring and whatever else is nearby, including YOU.

Earth straps should also be as large as possible, ie 100 mm copper strap. Do not use copper braid, as used in the automotive industry, as it is prone to electrolysis in the marine environment, quickly corroding and thereby increasing AC resistance or R_g .

Earth plates are "spongy" bronze plates measuring 160 x 60 x 25 mm approximately

and having an electrical area of about 12 square feet or 1.1 square metres. These are bolted on the outside of the hull and placed in a position which is in constant contact with the ocean under all sea conditions.

The US Coast Guard specifies that any vessel having HF on board must provide an undersca ground of at least 12 square feet or 1.1 square metres of copper. However, it further states that, although earth plates provide a large "spongy" surface area for interface with the sea, the conducting cross section of the water, one thousandths of an inch away from the plate, is still less than a fraction of a square foot; not the 12 square feet required.

A typical yacht has a compounding problem. The earth strap is usually insufficient in width, approximately 2-3 metres in length, which is then connected to only one of the two protruding earth plate bolts, and also the earth plate is electrically too small.

By moving the earth plate further aft, this will shorten the copper strap, but the plate will not be in constant contact with the ocean under all sea conditions.

We haven't yet included a further increase in R_g due to anti-fouling, slime and barnacles, etc. Incidentally, earth plates should not be anti-fouled, but regularly

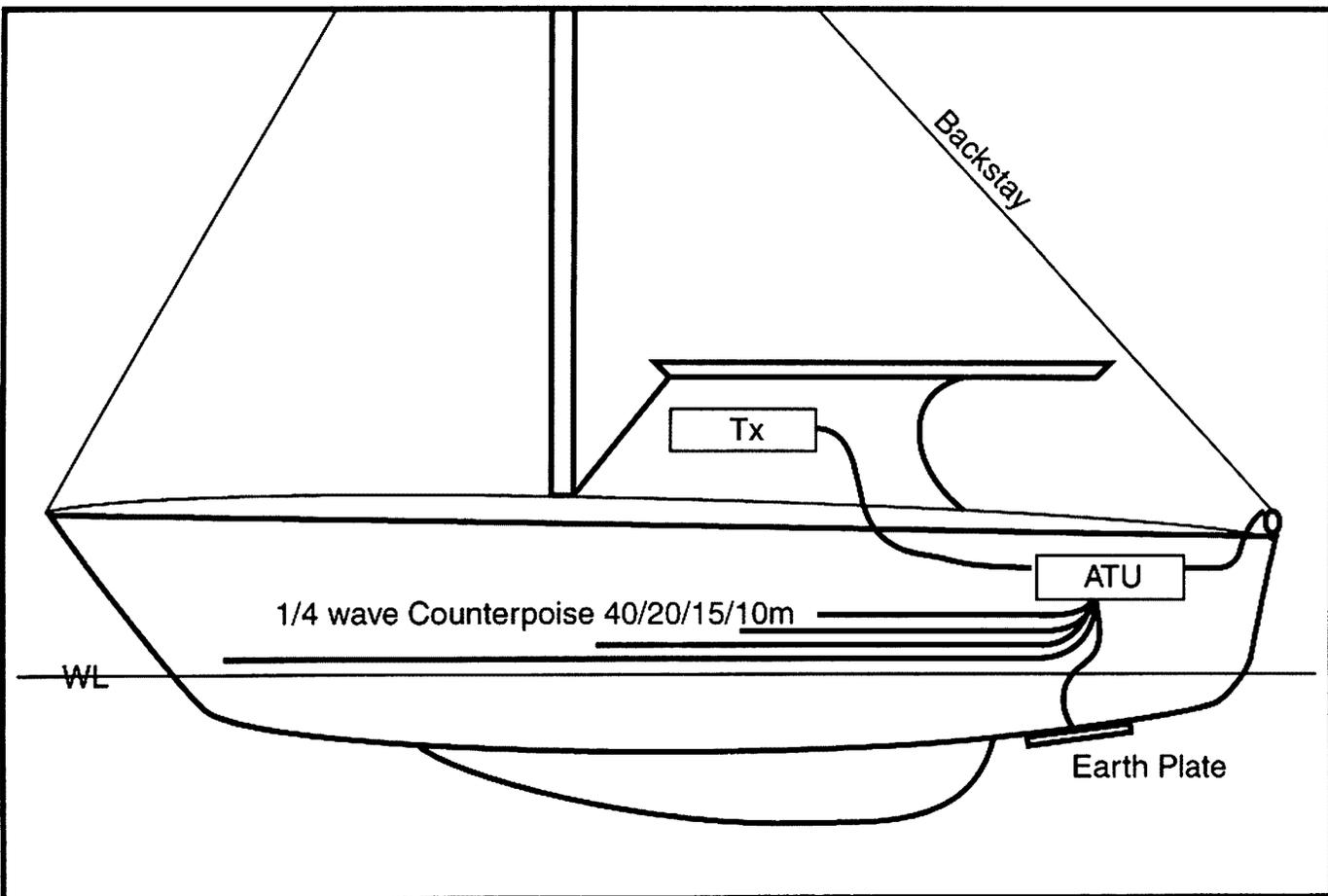

cleaned and kept shiny. Codan's technical manual recommends an earth strap of 100 mm minimum and no less than two earth plates.

ATUs can also pose a problem in that they can mask the effects of a bad ground. It will match whatever it sees to the transmission line; however, if what it sees is a high loss ground connection, it will match this too, thereby pumping all the energy into a connection that doesn't do much more than warm the ocean.

An example of this was a vessel whose system employed a Codan transmitter and ATU, and one metre of 50 mm copper strap connected to an earth plate. With my SWR meter in place, we tuned in 8 MHz until the green light appeared on the transmitter (indicating the rig was SWRed in), yet, the meter showed an SWR of 10:1. Between different frequencies the SWR varied between 10:1 and 3:1.

The problem was twofold. Firstly, between the ATU and the copper strap was a two inch copper braid section, green with electrolysis. Secondly, the earth bolt on the ATU had worked itself loose inside the set, not providing a good connection. After fixing both problems the SWR fell to 1.2:1.

The above exercise shows a textbook

example of how an ATU can both match and mask bad grounds.

Cruising for the past six years on our 40 foot timber/fibreglass catamaran "Inflight", and being an avid QRPer, I've thrown away the earth plate and now use radials.

This system consists of a quarter wavelength radial per band covering all marine and ham bands, wound on to a four inch plastic spool. This spool is located approximately two feet from the ATU (manual) and three feet above the water line. I've experimented with rolling the radials out, but both VK and DX contacts reported a better signal with it rolled up.

To achieve excellent results you don't need a steel or alloy boat, or even an ATU. Every vessel has different electrical characteristics and each one must be "tuned in"; this can only be done with experimentation, perseverance and a few bits and pieces.

However, next time you "crank up" the rig, try QRP and, as we say in our QRP club, "we do more with less!"

Special thanks to Gavin VK4ZZ
***PO Box 609, Townsville QLD**
4810
ar



AMATEUR TRANSCIVER RADIO CENTRE

ALINCO

NO 1 FACTORY DIRECT
IMPORTER
AUTHORISED DEALER

**MASSIVE MONTHLY STOCKIST
LATEST ARRIVALS**

NEW DJ-V5E 6w VHF/UHF
DR-M06T 6m, DR-610E, DJ-G5EY,
ANTENNA TUNERS, POWER SUPPLIES,
BIGGEST DISCOUNTS ON BULK
PURCHASES OF ALINCO AMATEUR
RADIOS & ACCESSORIES.
FULL 3-YEAR FACTORY BACKED
WARRANTY

ALINCO SPECIALIST



ICOM

IC-706MKIIG, IC-T81A,
 IC-2800H, IC-746, IC-756-Pro,
 IC-T8A, IC-R75, IC-Q7A.

KENWOOD TS-570SG TM-V7A
 TH-G71A VC-H1 TH-D7A TM-G707A TS-870S

DIAMOND X-510NA, D-707E

AMERITRON AMPLIFIERS
 AL-811AX 600 WPEP
 AL-811HX 800 WPEP

PHONE (02) 9896 2545
 E-mail: atrc@bytelink.com.au
 Web Page:
<http://users.bytelink.com.au/atrc>

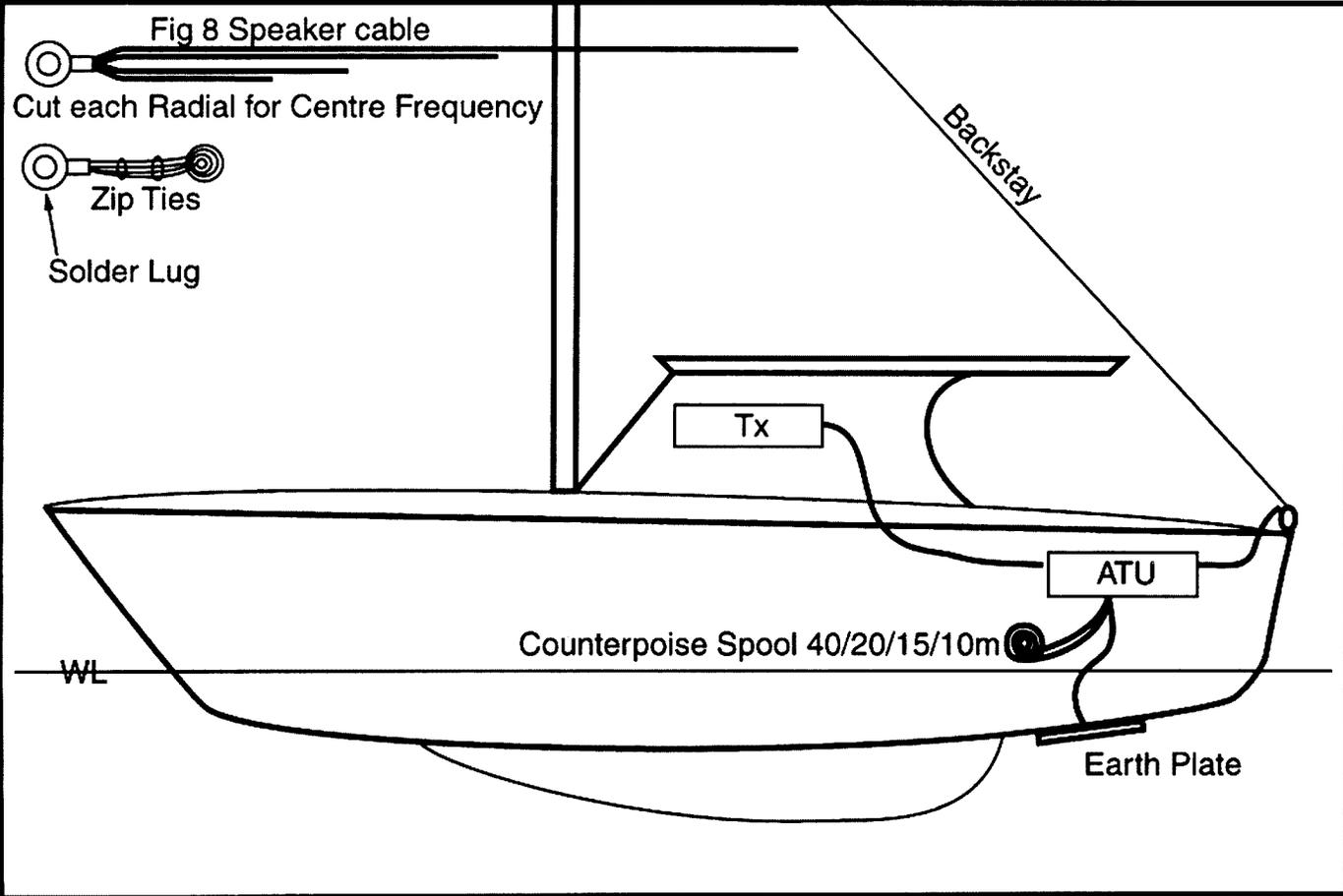

A Spectrum/Attenuation Measuring Set

Drew Diamond, VK3XU

45 Gatters Road
WONGA PARK 3115

In the interests of spectrum conservation, and to preserve good relations with fellow users, our transmissions should be as clean as can reasonably be made. As far as I know, there are no actual figures placed on the permitted level of unwanted emissions in this country- just a requirement that our transmissions should be reasonably free of defects. In the USA for instance, the FCC requires that for amateur transmitters below 30 MHz, at power levels between 5 and 500 W; spurious outputs must be at least 40 dB below the main signal, which probably represents a reasonable figure to aim for, and can easily be achieved in most instances.

The ideal tool for measuring and displaying transmission characteristics is a spectrum analyser. Fortunate is the radio worker who has access to a laboratory or communications-style instrument, but few of us have that privilege. If you are seriously interested in putting out clean signals (and we should be); then this test set may be just the thing.

Rather than the usual CRT display (where an oscilloscope is required), I have used an ordinary moving coil meter and speaker as indicators. Additional equipment required to make measurements are a 0 - 110 dB switched step attenuator (see Ref. 8), and a signal generator or signal source, such as the Q-1312. The resulting measuring set may be used to test for harmonics and spurs, and derive a real dB figure. The set also finds use in measuring actual values of attenuation and gain.

Performance

Basic sensitivity (for f.s. meter deflection) is -60 dBm (220 microvolts).

Minimum discernible signal on speaker is -110 dBm (0.65 microvolts).

Dynamic measuring range is 40 dB, then another 20 dB on the meter, making 60 dB.

Maximum input signal level is -20 dBm (22 mV), and, perhaps surprisingly,

Response flatness is within +/-2 dB from less than 100 kHz to at least 60 MHz.

The receiver (for that's what it is) draws about 25 mA from a 9 V supply.

Circuit

At first examination, it was thought that an ordinary double-balanced ring-diode mixer would do the job. However, they are rather insensitive, and usually require a local oscillator (L.O.) power of about +6 dBm (4 mW). Furthermore, the outputs obtained from such a mixer, even when the signal level is small, were found to be too many, which causes confusing results. This idea was discarded in favour of the ubiquitous NE(SA)602AN, which does a much better mixing job in this application.

What we have is a simple direct-conversion receiver, with un-tuned input. Signal is applied to one of the inputs at pin

1, which is terminated with a 51 ohm resistor in order to correctly match the external attenuator set. A 1 mW (or thereabouts) L.O. signal from a calibrated signal source (or generator) is applied to the OSC. port at pin 6. When the input signal is within about 10 kHz of the L.O. signal frequency, an audio frequency product is created at the output pins 4 and 5 of the '602, which is passed through a simple RC filter comprised of a 10 k resistor and 3.3 nF capacitor before being applied to the input pins 2 and 3 of the LM386 audio amplifier chip. The RC filter is necessary to attenuate ultrasonic and RF components, and thus prevent overload of the '386 by these unwanted products. In addition, a 10 mH RF choke coil and 2.2 uF capacitor are connected in series across the gain pins 1 and 8 of the '386, which gives the amplifier a very useful broadly-peaked response at around 1 kHz.

The output of the '386 amplifier is applied to a small speaker so that beats and signals may be heard, and also to a voltage-doubler diode detector which produces a dc voltage in proportion to signal strength. The dc signal thus derived is presented to a simple single-FET voltmeter, which drives the 1 mA meter coil. A small-signal silicon diode is connected between gate and negative rail (chassis ground) to prevent damage to the FET in the event of very strong signals being applied. The diode also imparts a very nice quasi-log law to the voltmeter's response, making it possible to obtain over 20 dB of on-scale range.

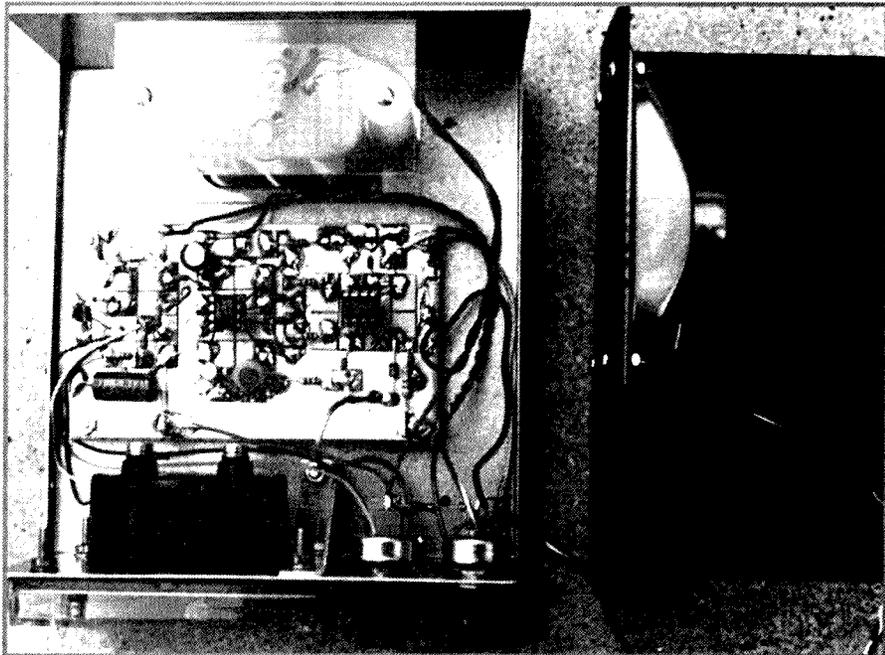

Photo 1. Internal view of the receiver

In operation, the main, or fundamental signal is first tuned-in by adjusting the L.O. to a frequency which differs by about 1 kHz. The external attenuator set is then adjusted to provide an on-scale reading on the meter, typically -60 dBm for 1 mA full-scale (f.s.) deflection. Harmonics and spurs of the main signal are then searched-for by carefully varying the L.O. generator frequency. When a signal is found, sufficient attenuation is removed to bring the meter reading back to that noted for the main signal. Now, the amount of attenuation removed equals the number of dB that the unwanted signal is below the wanted one. A similar measurement is made to find the value of gain or loss for other devices. More later.

Construction

In order to keep extraneous signals out of measurements, the receiver must be accommodated in a metal box or case. The prototype is housed in an off-the-shelf box measuring 150 x 76 x 134 mm which is available from the usual suppliers. Any home-made or other metal case, such as a die-cast box of similar dimensions would be fine. The device operates from six type AA cells providing a nominal 9V supply. The ordinary plastic battery holders of my experience always warp from the constant pressure of the springs, so it is suggested that the battery holder should be sandwiched top and bottom between perspex or other insulating material, with plastic rod spacers between, and fitted upright in a manner similar to that shown in Photo 1.

If the receiver is to function properly to at least 60 MHz, the '602, '386 and associated components must have reasonably short lead connections. One of the quickest and easiest wiring methods (in my opinion) for one-off projects of this kind is to use "paddyboard" or "ugly" style. It is quick, stable, functional, easy to troubleshoot, and allows further work without having to remove the board. Also, if the device ever becomes redundant, the parts can easily be reclaimed and used again. The plain circuit board measures 100 x 60 mm. The wiring job is made less fiddly by accommodating the '602 and '386 chips in wire-wrap sockets soldered upon substrate pad-boards measuring 20 x 30 mm, which in turn are soldered or super-glued to the main board. Take care with the socket pins- they are made (I think) from phosphor-bronze, so they must be gently flared, rather than just bent to fit. Dick Smith experimenter boards fitted with ordinary sockets would also serve. See References 3, 4, 5 and 6 for further information on these, and other techniques.

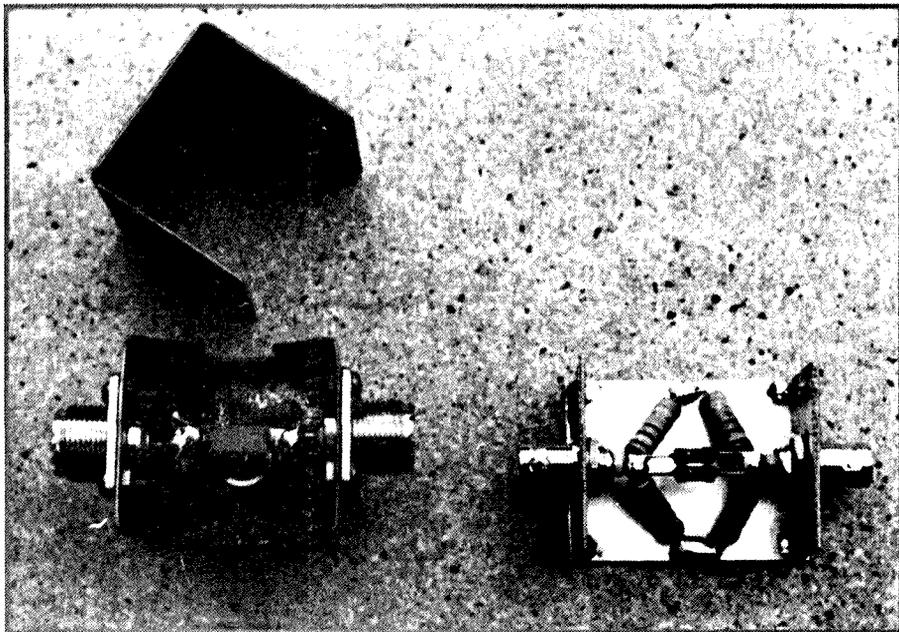

Photo 2. Signal Sampler and 40dB power attenuator

For good resolution, and ease of reading, the 1 mA meter should be a fairly large one. Volume control, balance pot, L.O. connector, signal input connector, on/off switch and LED "on" indicator are fitted upon the front panel. The 2" X 3" oval speaker may be fixed inside the top cover, and lined up with the vent holes. Verify that there are no clashes when the cover is fitted. If you are using a box similar to mine, an additional bracing member is suggested for the front panel.

Use shielded wire, or miniature 50 ohm coax for the L.O. and signal connections between panel and board. Hook-up wire leads to the battery, speaker, volume pot, balance pot and meter are not critical, and may be any reasonable length. Use miniature 1 K lin. pots to conserve space if necessary.

When transmitters or sources greater than 250 mW are being measured, a signal sampler or power attenuator will be required. Shown in Photo 2 is a -40 dB in-line signal sampler for high power (to 100 W), built from brass sheet, and a 40 dB 6 W power attenuator made from double-sided circuit board. One method of constructing circuit board boxes was outlined in Ref. 8. Their use is described below.

Operation

Inspect your circuit board and wiring again, and check that all is correct. Set the balance pot to about mid travel. Connect 9 V battery and switch on. The meter should deflect upwards initially, then drop back near zero. Adjust the pot for zero deflection. A number of 2N5484's were tried in the FET VM

circuit, and all of them could be balanced. However, if you find that the meter will not zero, but all appears correct otherwise- try another 2N5484 or 2N5457. The more common MPF102's have a rather large spread, and may not work in this circuit.

A quick and easy test that the receiver is working can be made by connecting a calibrated signal generator to the L.O. BNC with a 50 ohm coax cable, and a short antenna of about 2 metres of hook-up wire, which is laid upon your bench and connected to the signal input BNC. It should be possible to tune-in all your local BC band radio stations by setting the warmed-up generator exactly onto the station's frequency. It may even be possible to hear some SW stations by tuning the generator to the 9 MHz band. If you have access to a signal generator with calibrated output; confirm that a signal level of about -60 dBm (220 microvolts) when tuned for a 1 kHz (thereabouts) beat-note produces f.s. on the meter. Some salient voltages are shown on the circuit to aid in any troubleshooting.

A typical measuring set-up is depicted in Photo 3, where a 4 W CW QRP transmitter is being checked for spurious emissions and harmonics. The 4 W signal must be reduced to an appropriate level before it is applied to the step attenuator (mine uses 1/4 W resistors, which would burn up at the 4 W level). A 6 W rated 40 dB attenuator pad is shown at the left-hand end of the attenuator set.

The generator's dial is used as if it were part of the receiver. Initially, the generator (our L.O.) is set to within about 1 kHz either side of the transmitter's frequency. Basic

sensitivity of the receiver is about -60 dBm. In this example the 4 W signal is +36 dBm, and therefore the -40 dB attenuator will drop the signal level to -4 dBm. A further -56 dB of attenuation, from the step-attenuator set, will result in a signal level of -60 dBm being presented to the receiver's input.

Suppose we want to check for harmonics. For a 7 MHz source, the generator is adjusted as described above for a f.s. reading at 7 MHz (not 3.5 MHz, or any lower frequency than the "fundamental"—otherwise serious errors will result) and the number of dB "in-line" is noted. We can then tune to the expected harmonic frequencies of 14, 21 and 28 MHz. If a harmonic is more than -30 dB down, we may not be able to easily detect it by looking at the meter, or listening, so the amount of attenuation may be reduced (switched out) in steps of say, 10 dB, and harmonics looked for again. We may hear a weak signal at 14 MHz for instance.

The attenuator is again adjusted to obtain f.s. reading. The new attenuation reading is now subtracted from the initial reading to obtain the actual number of dB that the harmonic (or other spur) is below the fundamental. Let's assume we had 56 dB worth of attenuation in-line as noted before, but this had to be reduced to only 14 dB to obtain f.s. on the 14 MHz harmonic; $56 - 14 = 42$. The 14 MHz harmonic is therefore 42 dB below the fundamental, which would be an acceptable figure. Sounds tricky, but with a bit of practice on various sources, the technique is soon learned, and becomes a powerful tool in our measurement repertoire.

The same basic method may be applied to test for non-harmonically related spurs, but now the entire HF spectrum to 60 MHz should be carefully searched. If no spurious signals are found, some attenuation is removed, and another search is made. If a signal is now found, the same procedure as noted above may be used to determine the value, in -dB, of the unwanted signal. Should the fundamental- or main signal be accidentally tuned after 40 or so dB has been removed, the meter will pin, but not so violently that any damage is done (the diode at the FET gate limits the voltage to a reasonable level, and the '602 can take a lot of punishment. The -20 dB maximum signal level refers to linearity- not damage). Care must be taken when searching below the fundamental. In the example shown above, if we tuned the generator to 3.5, 2.33 or 1.75 MHz for instance, we would hear a strong signal, but these are "legal" products of the generator's harmonics and the fundamental.

To measure gain (an amplifier), or loss (an attenuator, filter, or other passive

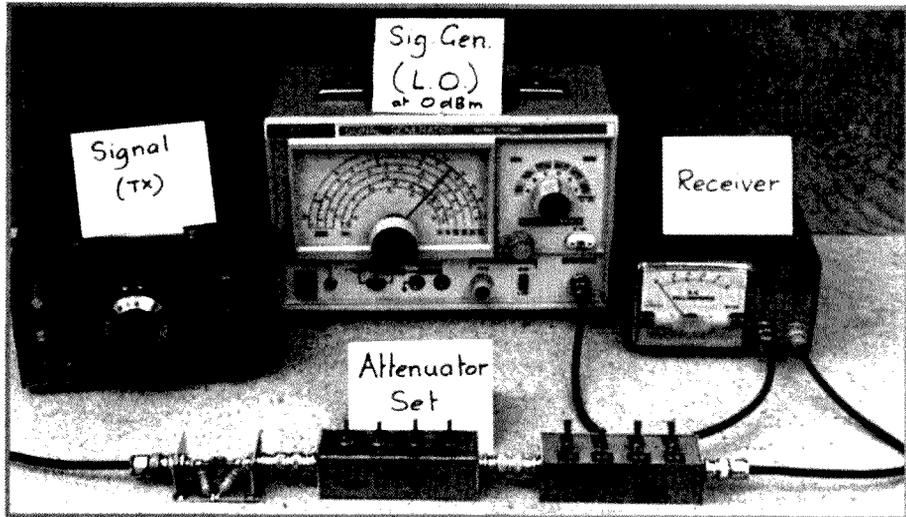

Photo 3. Typical measuring set-up

device), the technique is simply an extension of the above. A second signal source, or generator, is required. The second generator is first tuned in and the attenuator set is adjusted to obtain f.s. on the meter. The device under test (DUT) is placed between the second signal source and the step attenuator set (keeping power levels in mind). If an attenuator is being tested, insertion of the DUT will cause the meter reading to fall. The amount of attenuation which needs to be switched out to restore f.s. equals the attenuation of the DUT. Conversely, if an amplifier is inserted, the gain of the amplifier equals the amount of additional attenuation necessary to restore f.s. Repeat at as many frequencies as necessary.

Similarly, a filter's pass-band and stop-band attenuation can be determined. For example, a 7 MHz low-pass filter for a transmitter may first be measured for pass-band loss at 7 MHz by substitution. A typical figure may be perhaps less than 0.3 dB. Then the test frequency is increased in convenient steps up through the roll-off region and into the stop-band, where the attenuation (for a typical 7-element filter) may be 40 or 45 dB.

Parts

No fancy or hard-to-get components are specified, and the majority of them are available from the usual electronics vendors, such as Altronics, Dick Smith, Jaycar, Rockby and Electronics World. NE(SA)602AN's and 100R 3 W metal film resistors are available from Electronics World (03 9723 3860), who also answer mail orders. D.S. have the 10 mH RFC's and 470 nF monolithic caps. I always keep a few spares, so if you have genuine

difficulty in obtaining any of the parts specified, please send a request and SASE to the address shown.

References and Further Reading:

1. For an explanation of "dB"; look up "Decibels" in any recent radio handbook.
2. See also Chapter 12 of "The VHF/UHF DX Book"; White, DIR Publishing.
3. "Paddyboard" Circuit Construction"; Diamond, AR, Feb. '95.
4. "Build It Yourself From QST"; Hale, KB1MW, QST, Apr-July '92 (series).
5. "How to Lay Out RF Circuits"; White, G3SEK, Rad Com, Feb-Mar. '91.
6. "Try Building Your Own Equipment" Diana, N2JGU, QST, Mar. '95. 7.
7. "Improvements to Signal Generator model Q-1312"; Diamond, AR, Apr. '99.
8. "An Attenuator Set for Receiver Sensitivity Measurements"; Diamond, AR, Aug '99.



DON'T MISS THE ACTION!

2-Way Coax Switch

A heavy-duty, 2-way coax switch suitable for amateur, CB or commercial applications. It is well constructed with a die-cast case and can handle up to 2kW PEP or 1kW CW at 30MHz with less than 0.2dB insertion loss. SO-239 sockets. D 5200

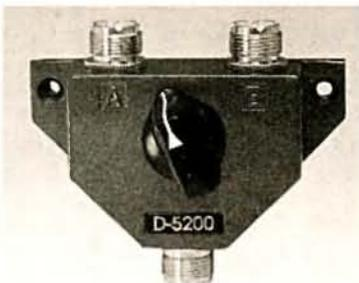

\$29⁹⁵
SAVE \$10

1kW HF Antenna Balun

Designed as a centre support for wire dipole or yagi antennas, this 'T' shaped 1:1 balun has 52 ohm unbalanced input and 52 ohm balanced output. An SO-239 socket is mounted into the base of the balun for easy coax connection. RF input power handling is 1kW PEP maximum, and insertion loss is less than 1dB. It can handle the entire HF band of 3-30MHz. RAK model BL-50A. Made in Japan. D 5310



\$49⁹⁵
SAVE \$20

VX-5R 6m/2m/70cm Deluxe Hand-Held

Tiny yet incredibly rugged, the VX-5R provides 6m, 2m and 70cm amateur band operation with 5W output as standard (4.5W on 70cm), made possible by a unique PA design and a super high capacity 7.2v 1100mA/H Lithium-ion battery. Plus, ultra-wide VHF and UHF as well as AM medium-wave and shortwave reception facilities are provided, along with a large backlit dot-matrix LCD screen. All this in a diecast aluminium enclosure just 58 x 87 x 28mm WHD (w/o knobs or antenna)!

Features

- Tx: 50-54, 144-148, 430-450MHz
- RX: 0.5-1.8MHz, 1.8-16MHz, 47-729MHz, 800-999MHz (cellular blocked)
- Full feature keypad, CTCSS encode/decode, digital code squelch
- Comprehensive menu system
- Over 200 memories
- 8 digit alpha-numeric memory labelling
- 5 battery saving systems, plus Tx/Rx usage monitor
- Spectra-Scope™ for monitoring adjacent channel activity
- Comes with FNB-58LI Lithium-ion battery, flexible antenna and AC adaptor/charger D 3670



\$699
YAESU

VX-5R Accessories

CSC-73 Carry Case	D 3671	\$26.95
CD-15 Fast Desk Charger	D 3672	\$49.95
FBA-23 Dry-Cell Battery Case	D 3673	\$49.95

Yaesu FT-90R 2m/70cm micro mobile

Another engineering breakthrough from Yaesu – a tiny dual-band mobile rig with high power output, a remoteable front panel, and a rugged receiver front-end. The FT-90R provides 50W RF output on the 2m band as well as 35W output on the 70cm band, a solid diecast casing with microprocessor controlled cooling fan for reliable operation, and a large back-lit LCD screen, all in a package measuring just 100mm x 30mm x 138mm.

Also includes:

- Wide dynamic range receiver for reduced pager breakthrough
- Huge receiver coverage – 100-230, 300-530, 810-999.975MHz (Cellular blocked)
- 180 memories and a variety of scanning functions
- Built-in CTCSS encode/decode, battery voltage metering
- Designed for 1200 and 9600 baud Packet operation
- Tiny remoteable front panel (requires optional YSK-90 separation kit)

Includes MH-42 hand mic, DC power lead, and easy to follow instructions. D 3312

\$850

YSK-90 Front Panel Separation Kit D 3317 **\$129⁹⁵**



YAESU

FOR ALL YOUR COMMUNICATION NEEDS

High Performance VHF/UHF Base Station Antennas

Diamond base station antennas offer outstanding quality and exceptional value. These stacked collinear types provide high gain, wide bandwidth and a low radiation angle for extended range. The fibreglass reinforced polyester outer radome and gasket seals provide excellent all-weather operation and compact ground-plane radials are supplied. Stainless-steel mounting hardware ensures a long, trouble-free life. Supplied with instruction sheets for easy set-up.

2m Antenna F-23A

Frequency: 144-148MHz
Gain: 7.8dB
Max. Power: 200W
Length: 4.53m, max wind 40m/s
Type: 3 x 5/8"
Connector: SO-239 socket

D 4850

23cm F-1230A

Frequency: 1260-1300MHz
Gain: 13.5dBi
Max. Power: 100W
Length: 3.06m
Type: 25 x 1/2"
Connector: N-type socket

D 4870

\$199
SAVE \$50

\$199
SAVE \$50



Rugged HF 5-Band Trap Vertical Antenna

The rugged 5BTV incorporates Hustler's exclusive trap design (25mm solid fibreglass formers, high tolerance trap covers and low loss windings) for accurate trap resonance with 1kW (PEP) power handling. Wide-band coverage is provided on the 10, 15, 20 and 40m bands (SWR typically 1.15:1 at resonance, <2:1 SWR at band edges) with 80kHz bandwidth typical on 80m at 2:1 SWR. An optional 30m resonator kit can be installed without affecting operation of other bands. High strength aluminium and a 4mm (wall thickness) extra heavy-duty base section guarantee optimum mechanical stability. At just 7.65m, the 5BTV can be ground mounted (with or without radials, although radials are recommended), or it can be mounted in an elevated position with radial system. Unlike other antenna designs, the 5BTV can be fed with any length of 50-ohm coax cable.

D 4920



30m Resonator Kit

Adds 30m coverage to the 5BTV and includes all hardware.
D 4921 **\$99.95**



\$399
SAVE \$50

FT-2500M 2m Heavy-Duty Transceiver

Built tough to take the rough stuff, the Yaesu FT-2500M meets US MIL-STD 810C for shock and vibration so it'll provide years of reliable mobile operation. Its easy-to-operate front panel design, rubber coated knobs, and large Omni-Glow display are teamed up with a one-piece diecast chassis to set the FT-2500M apart from other 2m mobiles. For improved front-end performance, Yaesu's exclusive 3-stage Advanced Track Tuning feature and dual-FET mixer reduce overloads from strong signals while providing excellent sensitivity and wide-band receive operation.

Also includes:

- 31 tuneable memories
- 7 selectable tuning steps
- MH-26 hand mic, mobile mounting bracket & DC power lead.
- In-built CTCSS encoder
- Various scanning modes

Specifications:

Frequency range: Tx 144-148MHz, Rx 140-174MHz
Output power: 50W, 25W, 5W
Sensitivity: better than 0.2uV for 12dB SINAD
Image rejection: better than 70dB
Max audio output: 2.0W into 8 ohms (10% THD)
Dimensions: 160 x 50 x 180mm (W.H.D.)

D 3632

2 YEAR WARRANTY

YAESU



LOW PRICE
\$499



VHF/UHF Power/SWR Meter

A high-quality SWR/power meter suitable for Amateur, UHF CB and commercial applications. Durable Japanese construction assures you of maximum reliability. With an all-metal case, large meter display, 140-525MHz coverage with less than 0.3dB insertion loss, and 4V, 20W and 200W power scales. Revex model WS40.

D 1370

\$150
SAVE \$35

PHONE FAX AND MAIL ORDERS



PHONE: WITHIN AUSTRALIA: 1300 366 644
(Local call charge)

FAX: (02) 9395 1155 within Australia and
(+612) 9395 1155 from outside Australia

MAIL: DICK SMITH ELECTRONICS, Direct Link, Reply Paid 160,
PO Box 321, North Ryde NSW 1670 (No stamp required)

Visit our web site at
<http://www.dse.com.au>

Excludes packaging and postage. All major credit cards accepted.
14 Day Money Back Guaranteed if NOT completely satisfied. (Software excluded)



That's where you go!

Yaesu transceivers and accessories stocked in selected stores only.
Other stores can place orders on a deposit-paid basis.

An AM/CW Transmitter for 1.8, 3.5 and 7 MHz

Drew Diamond, VK3XU

45 Gatters Road
WONGA PARK 3115

makes a very acceptable 3-band CW VXO transmitter, particularly on 3.5 MHz, where an ordinary 3.580 ceramic resonator covers about 3.515 to well over 3.6 MHz- the best of CW segment, and much of the 'phone band.

Circuit

The classic oscillator (VXO)-buffer-driver-PA configuration is used. Depending upon crystal type, a useful "pull" of the nominal frequency is obtained. Very light coupling (1 pF) between VXO and buffer effectively isolates the keyed and modulated stages from the VXO. The BFR84 buffer amplifier provides gain, and a means of adjusting the drive level by use of a pot at Gate 2, which

type telephone receiver as microphone, which provides quite adequate voice-quality transmission.

On CW mode, the keyed wave-form is "text-book" in appearance. The device



Photo 1. AM/CW Transmitter

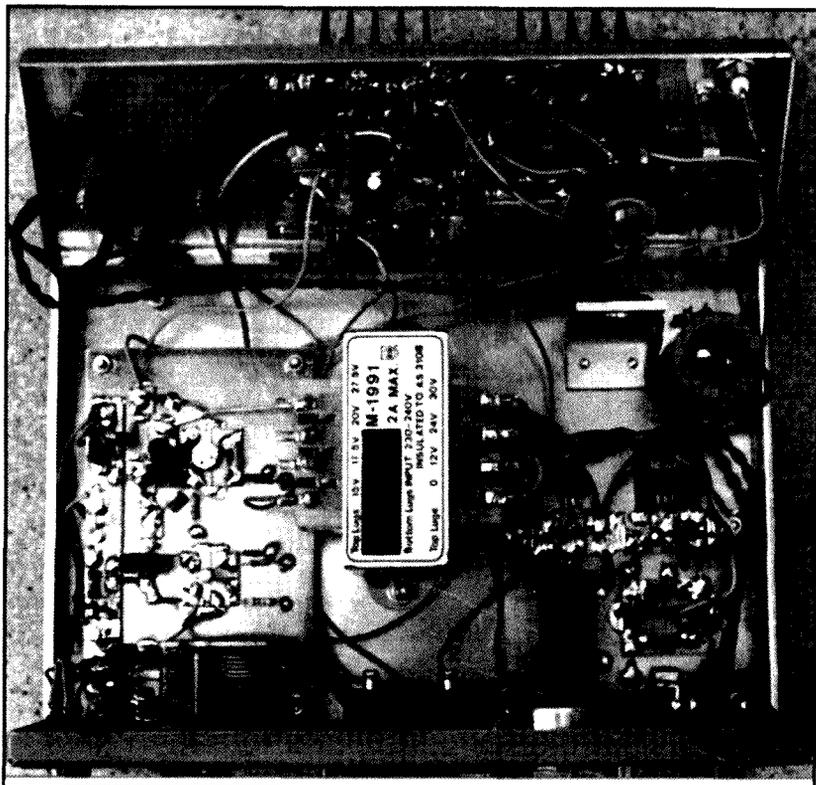

Photo 2.. General Layout

For various technical and operational reasons, amplitude modulation (AM) continues to be used by some services. Most well-known of course is in broadcasting on LW, MW and SW. Aircraft use VHF AM for its lack of "capture" effect (where two FM signals are present, it is difficult to hear a weak signal under a stronger one). On the amateur bands, numerous enthusiasts keep alive the spirit of AM, particularly on 160 M, where here near Melbourne for instance, a popular regular mid-morning net runs on 1825 kHz. Another stimulating net runs on 80 M/ 3580 kHz each Friday starting 1230 Z. 40 M too attracts a number of AM users.

During periods of low occupancy, the additional bandwidth required by AM is not usually a problem, and so it may even be possible, if desired, to aim for something approaching "broadcast quality", which indeed some stations do. Having listened "on the side" to many interesting AM QSO's, and not being able to join in, motivated me to have a go at building a little AM/CW transmitter. The simplification of crystal control is not a serious handicap, because, as far as I know, only a handful of frequencies are regularly used for AM (and 3580 kHz is a common cheap crystal frequency).

There is an abundance of valve designs in the standard radio handbooks pre circa 1965, but it was felt that a solid-state plan would be more acceptable (and some of our younger members may not be particularly comfortable with valves- and where does one get things like "mod-trannies"?). I therefore offer the following circuit, which was a lot of fun to build and get going, and intentionally uses purchasable components.

Characteristics

Bands: 1.8, 3.5 and 7 MHz.

Output Power: 25, 20, 15 Watts CW. 16, 12, 8 Watts AM.

Spectral Purity:

Harmonics at least -40 dB below fundamental.

Modulation bandwidth at the -3 dB points is 100 Hz to 10 kHz. However, spectrum should be conserved by using a microphone with limited frequency response. The prototype employs a "rocking-armature"

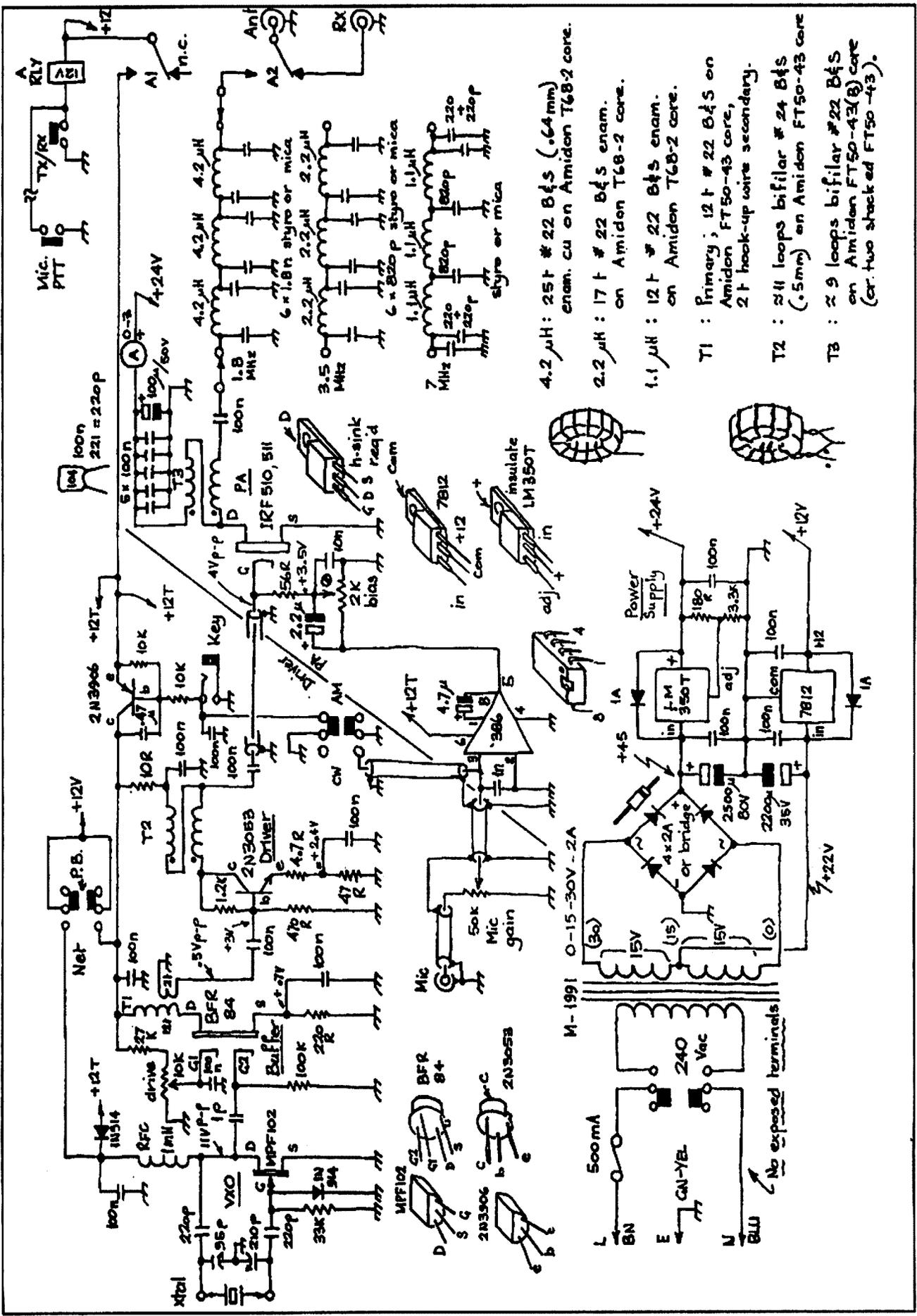

4.2 µH : 25 t # 22 B&S (.64mm) enam. cu on Amidon T68-2 core.
 2.2 µH : 17 t # 22 B&S enam. on Amidon T68-2 core.
 1.1 µH : 12 t # 22 B&S on Amidon T68-2 core.
 T1 : Primary; 12 t # 22 B&S on Amidon FT50-43 core, 2 t hook-up wire secondary.
 T2 : 24 loops bifilar # 24 B&S (.5mm) en Amidon FT50-43 core
 T3 : 29 loops bifilar # 22 B&S on Amidon FT50-43(B) core (or two stacked FT50-43).

Figure 1

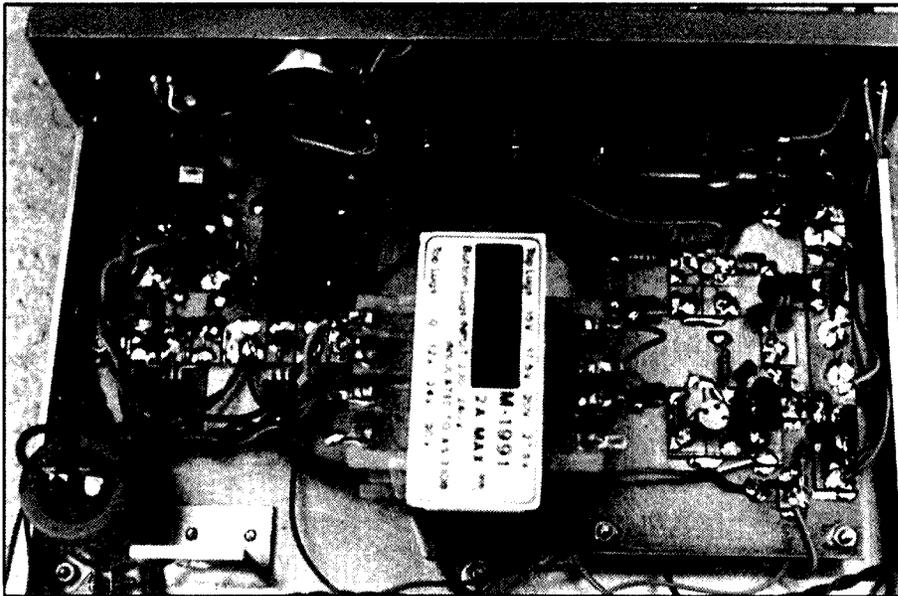

Photo 3. Power Supply and VXO

varies the DC voltage applied to G2.

Driver, type 2N3053 provides further gain, and impedance matching to the gate of the PA MOSFET. A relatively low gate load resistance of 56 ohms is used in order to "swamp" the rather large gate-source capacitance at the input of the IRF510, and thus make driving the IRF510 less frequency dependant than if we relied on a higher impedance gate resistance.

For both CW and AM operation, the no-signal gate bias on the IRF510 is held at a value (typically +3.5 to 4V) which provides class B operation of the PA stage. That is, near the point of drain current cut-off. This bias voltage is derived from the output of an

LM-386 audio-amp IC. With a nominal supply voltage to the '386 of 12 V, the quiescent DC output from the chip will be about half supply; 6 V.

Amplitude modulation of the RF waveform is accomplished by varying the gate voltage with our audio signal from the mike and '386. The gate voltage/drain current transfer function is quite sensitive, and only a relatively small audio signal (from the '386) is required to obtain full 100 % modulation. The PA operates in similar mode to a class B SSB linear amplifier, where the output tank supplies the missing RF half-cycles by flywheel action. In this instance, the (necessary) output low-pass

filter, even though it is of very low Q, does the job. On AM, the output power is run at approximately half the CW level, thus allowing headroom for correct "upwards" modulation.

On CW mode, 12 V supply to the buffer and driver is ramped up and down in response to the key with a 2N3906 as keyer/shaper. The VXO is not keyed, but runs continuously during transmit periods.

After much experimentation with the PA supply voltage, it was found that about 24 to 30 V results in best modulation, keying and output power characteristics. A common 0-15-30 V (or "15 volts-a-side") 2 Amp transformer is ideal for the power supply. An LM-350T regulator chip is wired to supply +24 V for the PA, and a '7812 chip supplies +12 V for the low-level stages.

Construction

The prototype is built in a home-made aluminium box measuring 250 x 195 x 80 mm WDH. Any ventilated metal box or case of similar dimensions will do. Photo 2 shows the general layout, where the back PA/heatsink panel has been dropped down for clarity. The schematic attempts to show that the VXO/buffer/driver is accommodated upon one circuit board, the PA/audio amp. on a second circuit board, and the power supply on a third. It would be a good plan to build the project in stages, starting with the power supply, VXO/driver board, then PA/audio board. Hence, each stage may be tested as you go.

"Paddyboard" (see Ref. 2) style construction was used for the three boards, which measure 130 x 80 mm for the VXO/buffer/driver, 130 x 70 mm for the PA/audio amp., and 85 x 70 mm for the power supply. Yours may be slightly larger or smaller as desired, but try not to crowd things too much. Layout is not particularly critical. However, all leads and un-shielded wires which carry an RF signal must be reasonably short. Use ordinary hook-up wire for DC connections. All mains wiring must be covered to prevent accidental contact, and mains earth must be connected to chassis with a dedicated solder lug, screw, lock-washer and nut.

The variable capacitor for the VXO should be mounted so that the shaft projects through the front panel, as shown in Photo 3. Any ordinary physically small 2-gang type will do. Mine uses one of those MSP. 95/210 pF gangs which have been available around the ham-fests for years. Largest "pull" will be obtained with a dual 415 pF BC type (but note that some crystals will mode hop, or drop out if pulled too far).

Transformer T1 is an Amidon FT

ar

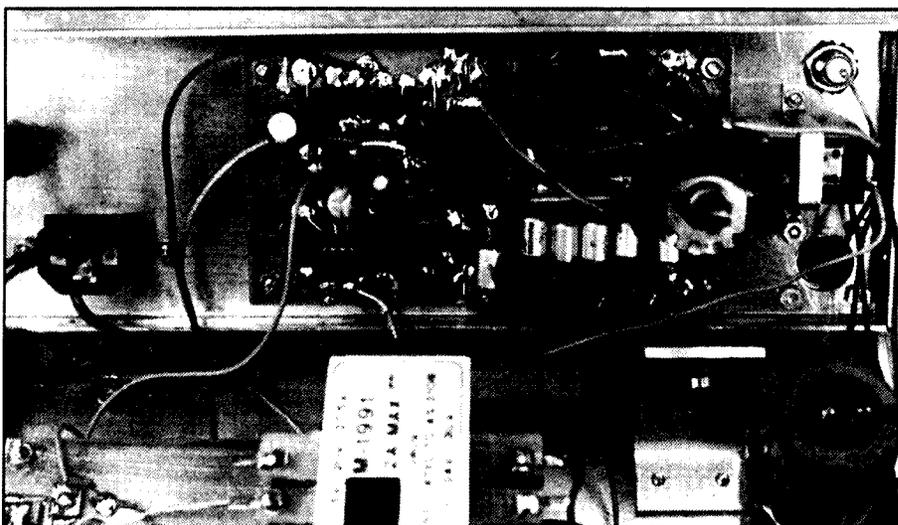

Photo 4. PA Board and low-pass filters

NOVICE NOTES

Peter Parker VK3YE

12/8 Walnut Street, Carnegie, Vic 3163

Email: parkerp@alphalink.com.au

Novice Notes Online: <http://www.alphalink.com.au/~parkerp/nonline.htm>

Please note that this is Peter's correct address.

Nickel-cadmium (NiCad)

Nickel-cadmium cells are the most commonly used rechargeable batteries in consumer applications. They come in similar sizes to non-rechargeable cells, so they can directly replace non-rechargeable alkaline or carbon-zinc cells. NiCads have a lower voltage output than non-rechargeable cells (1.2 vs 1.5 volts). This difference is not important in most cases.

NiCad battery packs have voltages of 2.4, 3.6, 4.8, 6, 7.2, 9, 10.8 volts, etc. This corresponds to 2, 3, 4, 5, 6, 7, 8 and 9 cells respectively, shown in the following table:

cells								
2	3	4	5	6	7	8	9	
volts								
2.4	3.6	4.8	6	7.2	8.4	9.6	10.8	

NiCads perform best between 16 and 26 degrees Celsius. Their capacity is reduced at higher temperatures. Hydrogen gas is created and there is a risk of explosion when cells are used below 0 degrees.

NiCad batteries have a low internal resistance. This makes them good for equipment that draws large amounts of current (eg portable transmitting gear). However low internal resistance means that extremely high current will flow if cells are short-circuited (as much as 30 amps for a C size cell!). Short-circuiting should be avoided as it can cause heat buildup and cell damage.

Most portable transceivers come with NiCad battery packs where the cells are welded to metal connecting straps. There is good reason for this. In high-current

Exploring Rechargeable Batteries

Rechargeable batteries: they're used everywhere and there's many different brands and types. Almost every amateur has their own opinions on the merits of different types and the best ways to look after them. This month we examine the main types available and their suitability for various equipment amateurs use.

How rechargeable batteries work

Batteries convert stored chemical energy into electrical energy. This is achieved by causing electrons to flow whenever there is a conductive path between the cell's electrodes.

Electrons flow as a result of a chemical reaction between the cell's two electrodes that are separated by an electrolyte. The cell becomes exhausted when the active materials inside the cell are depleted and the chemical reactions slow. The voltage provided by a cell depends on the electrode material, their surface area and material between the electrodes (electrolyte). Current flow stops when the connection between the electrodes is removed.

Rechargeable cells operate on the same principle, except that the chemical reaction that occurs is reversed while charging. When connected to an appropriate charger, cells convert electrical energy back into potential chemical energy. The process is repeated every time the cell is discharged and recharged.

Different cells use different electrode materials and have different voltage outputs (1.2, 1.5, 2 and 3.6 volts for the types discussed here). Higher voltages are possible by connecting cells in series. A set of several cells connected together is called a battery. However, because lay people do not distinguish between a 1.5-volt cell and a 9-volt battery (which comprises several cells), the term battery is widely used for both batteries and cells.

The capacity of cells is expressed in amp-hours (Ah) or milliamp-hours (mAh). The approximate time that a battery will last per charge can be found by dividing the battery pack capacity (normally written on the battery pack itself) by the average current consumption of the device. Thus a 600-mAh battery pack can be expected to power a receiver that takes 60mA for 10 hours.

Cells can be visualised as consisting of a cell with a resistor in series. You won't find an actual resistor should you split open a battery pack, but the effect is the same. Some battery types have higher values of internal resistance than others. High internal resistance doesn't matter if powering items that draw fairly low currents (eg a clock or small receiver). However, if running something like a 5-watt handheld transceiver, a battery with a high internal resistance will not deliver the current asked of it.

Having explained some of the characteristics important to all batteries, we will now look at each cell type in turn.



Photo 1. Rechargeable batteries now widely used in a range of electronic equipment.



Photo 2. Shown are three types of rechargeable battery - lithium ion, nickel cadmium and sealed lead acid.

You'll often hear discussions about the so-called 'memory effect' exhibited by NiCad cells. This refers to the claimed tendency of cells not to deliver their rated voltage when placed in a charger before being fully discharged. Belief in the existence of the 'memory effect' is widespread amongst users of NiCad batteries. However, textbooks and data from battery manufacturers make little or no mention of it. Believers say that to prevent it batteries must be discharged to 1 volt per cell before charging. Non believers say that this discharging merely reduces cell life.

Evidence suggests that true 'memory effect' is rare. It was first noticed in communications satellites where cells were discharged to precisely the same discharge point every time. In casual amateur use batteries are most unlikely to be discharged to the same point after every use. Much of what is mistaken for the 'memory effect' is voltage depression, which is caused by long, continuous overcharging, which causes crystals to grow inside the cell. Fortunately both the 'memory effect' and voltage depression can be overcome by subjecting the battery to one or more deep charge/discharge cycles.

Another term you will hear is 'cell reversal'. This can occur when a battery of cells is discharged below its safe 1.0 volt per cell. During this discharge, differences between individual cells can lead to one cell becoming depleted before the rest. When this happens, the current generated from the remaining active cells will 'charge' the weakest cell, but in reverse polarity. This can lead to the release of gas and permanent damage to the battery pack.

NiCads can short circuit due to the build up of crystals inside the battery. The use of a fully charged electrolytic capacitor placed across the cell can effect a temporary cure. Over discharging of batteries invites short-circuiting. Batteries should be stored charged. A lifespan of 200 to 800 charges is typical for NiCad batteries.

Nickel metal hydride (NiMH)

Like NiCads, nickel-metal hydride cells provide 1.2 volts per cell. Battery makers claim that NiMH cells do not suffer from

the 'memory effect' and can be recharged up to 1000 times.

NiMH cells are not as suitable as NiCads for extreme current loads, but do offer a greater capacity in the same cell size. A typical AA NiCad may have a 750 mAh, but a NiMH may provide 1100 mAh - 45 percent more. This makes NiMH cells a good choice for applications where long life is desired but current demands are not high eg portable receiving equipment.

NiCad chargers can be used to charge NiMH batteries, but the charging time needs to be lengthened to take NiMH's typically larger capacity into account. The main enemy of rechargeable cells is heat. If cells get hot during charging, reduce the charging current to no more than that recommended.

Rechargeable alkaline manganese

Unlike the preceding two battery types, rechargeable alkaline manganese (RAM) cells give 1.5 volts each. They are therefore suitable for applications where the substitution of 1.2-volt NiCads for 1.5-volt dry cells results in degraded equipment performance.

RAM cells are cheaper to buy than NiCads. They can be recharged between 50 and 750 times. They also have a greater capacity than do NiCads - 1500 mAh is typical for size AA cells. RAM cells are good for use with outdoor and solar equipment as they will work efficiently at temperatures up to and exceeding 60 degrees Celsius.

RAM cells have a much higher internal resistance than NiCads (0.2 ohms vs 0.02 ohms). This means that they cannot supply high peak values of current. For this reason they are unsuitable for use with standard amateur HTs. However, their high capacity and long shelf life (5 years) makes them suitable for low powered or emergency-use applications, such as clocks and emergency torches.

Chargers intended for NiCad and NiMH cells will not charge rechargeable alkalines. This is because rechargeable alkaline cells require a constant voltage source of between 1.62 and 1.68 volts to charge. RAM cells should be connected in parallel rather than in series when charging several cells at a time. Unlike other rechargeable batteries, RAM cells are pre-charged and do not require charging before first use.

Lithium Ion

Lithium ion cells are the most recent of the battery types discussed here to come onto the market. They offer higher cell voltage (3.6 volts) and greater capacity for a given volume. This makes them especially

applications, the unknown (and varying) resistance between cells and battery holder contacts can result in erratic operation. This is especially so when the transceiver is used in a salt-laden environment. An encased battery pack overcomes these difficulties and provides more reliable operation.

The normal charging rate is 10 per cent of a battery's capacity for 14 hours. For example, if a battery pack has a 600-mAh rating, its correct charging current is 60 mA. Because the charging process is not 100% efficient, the charger needs to be left running for about 14 hours instead of 10 hours. Higher charging currents are possible, but the charging time needs to be proportionally reduced. NiCads can be left on a trickle charger indefinitely if the charging current is reduced to 2% of the battery's amp-hour rating. Avoid the build up of heat during charging for long battery life.

NiCad batteries require a constant current charger; ie one where the current provided to the battery is fixed over the entire charging period. Such a charger can be something as simple as an unregulated DC power supply with a series resistor to limit the charging current into the cells. If the charger's voltage and the battery's desired charging current are known, Ohm's Law can be used to calculate the correct series resistor value. Because NiCads have a low internal resistance, proper charging can occur with several cells in series.

For best life, do not discharge NiCads to less than 1.0 volt per cell. When charging, NiCads should read 1.45 volts per cell. If the cell voltage is higher during charging (eg 1.6 or 1.7 volts), the cell is faulty and should be discarded.

suitable for handheld equipment where long operating times are important, such as mobile phones.

As an example of what Lithium ion battery packs can do, the battery pack pictured is 55x45x20mm but provides 7.2 volts with an 1100 mAh capacity. Lithium ion batteries are still quite expensive, but are coming into amateur use through their inclusion in handheld transceivers such as Yaesu's VX-1R and VX-5R models.

Sealed lead acid

Sealed lead acid batteries (or 'gel cells') are less popular than NiCads in handheld equipment, but find widespread use as back up batteries in security systems and for amateur portable operation. Per-cell voltage is 2.3 volts when charged, and 1.8 volts when discharged. This equates to 13.8 and 10.8 volts respectively for a battery of six cells. For best use of the full battery charge, equipment intended to operate with '12 volt' sealed lead acid batteries should operate well (if not at full power) at voltages of 10.8 volts or less.

Gel cells are cheap, rugged and reliable and should last several years at least. If you want a battery to run a QRP HF station or a VHF/UHF handheld for several hours, they are the ideal choice. They are also widely used with small solar systems.

Sealed lead acid batteries can either be used on a cyclic charge regime (battery connected to charger for a specific time) or continuous float use, where the battery is across the charger any time it's not in use. Cyclic chargers should charge at 2.4 or 2.5 volts per cell and be current limited to prevent overcharge. In contrast continuous float charging (or trickle charging) requires a charging voltage of only 2.3 volts per cell (13.8 volts for a '12 volt' battery). With both types of use the charger voltage is held constant. Connect batteries in parallel if charging two or more from the one charger.

Chargers for sealed lead acid batteries are available commercially or can be made at home. Special gel cell charger ICs exist to provide the necessary voltage and current regulation. Alternatively chargers can be made from the more common regulator chips such as the 723 or LM317. These chargers can be used to directly trickle charge the smaller '12 volt' gel batteries. No damage is done if the charger remains on, even when the battery is fully charged. This is because as the battery voltage approaches 13.8, the charging current will fall to negligible levels.

Sealed lead acid batteries should not be charged at voltages higher than those indicated as safe above. This is because high charging voltages (eg 2.6 volts per cell.) will

endanger the battery due to the production of excess gas. At a 13.8 volt charging voltage the production of gas is low, and the battery should give years of service. Charging current should not exceed 20 per cent of the rated amp hour capacity of cells. If using a high current 13.8-volt power supply as a charger, some form of current limiting is desirable to stay within the battery's limits.

Conclusion

This article has examined the characteristics of all major types of rechargeable batteries used by amateurs. We learned that NiCads and sealed lead acid cells were best for high current applications, while other varieties, such as rechargeable alkaline and nickel metal hydride work well for low current applications. The charging of batteries varies too - Rechargeable alkaline and sealed lead acid required a constant voltage, but nickel cadmium and nickel metal hydride cells needed a constant current to charge properly. In all cases over-charging, through excessive voltages, currents or charging periods can cause heating, gas build-up and possible cell damage. However, if you treat your batteries well, you should have many years of successful operation from them, whichever type you choose.

Acknowledgments

I wish to acknowledge the people and organisations that have contributed to the writing of this article. These include:

Bill Trenwith VK3ATW for suggestions on the manuscript and imparting of knowledge gained through many years as a mechanics teacher, model engineer and radio amateur.

Peter Wegner from Coorey & Co, distributors of BIG rechargeable alkaline cells.

Danielle Cvetkovic from Invensys Energy Systems Pty Ltd for material on Hawker sealed lead acid batteries.

Adeal Pty Ltd for information on Varta's range of NiCad and NiMH cells.

References

1. Hawker PG3VA, Technical Topics Scrapbook 1990-1994, RSGB, pages 1, 16, 142
2. ARRL, Handbook 1988, ARRL, pages 6-25, 27-32
3. Gruber N WA I SVF, QST November 1994, ARRL, page 70.

For All Your Requirements

AUTHORISED DEALER
ICOM
KENWOOD

AMATEUR COMMERCIAL

 Tower
Communications

14 Mary Street
Hazlemere

Western Australia 6055
Telephone: (08) 9274 1118
Facsimile: (08) 9250 3734

E-mail: tower@eon.net.au

www: <http://www.tower.visionimage.com.au>

We manufacture a comprehensive range of HF, VHF and UHF antennas, baluns, power dividers, etc. to suit your application. Some of our log periodics provide continuous coverage from 23-30 MHz including WARC frequencies and replace outdated tribanders. Now in use in 48 overseas countries.

- Create rotators, coax cables & non-conducting guy & halyard materials
- Hard-drawn copper antenna wire
- Insulators for DIY projects
- Inverted vee kits 160-30m
- High gain VHF & UHF amateur, scanning & TV Antennas
- High Sierra HF mobile antennas
- Butt section triangular aluminium towers for fixed or tilt-over applications
- Selection of power chips & TX tubes
- Diamond VSWR/PWR meters to 1300 MHz & accessories

FREE CATALOGUE AVAILABLE FROM



ATN ANTENNAS PTY LTD
A.C.N. 062 557 644

37 Morrison Street
PO Box 80, Birchip Vic, 3483
Ph: (03) 5492 2224
Fax: (03) 5492 2666

ar

TECHNICAL ABSTRACTS

Gil Sones VK3AUI
30 Moore Street
Box Hill South Vic 3128

Feedline Verticals

A useful antenna for portable use was described in CQ August 1999 by Rolf Brevig LA1IC. The antenna is a half wave vertical made of coaxial cable with a resonant choke to isolate the radiating part of the antenna from the feedline outer.

The antenna is shown in Fig 1. The half wave dipole is made from the coaxial cable used for the feedline. The upper quarter wave or upper half of the dipole has the outer and braid stripped. The lower quarter wave which is the other half of the dipole is isolated from the feedline outer by a resonant choke formed from a coil of feedline.

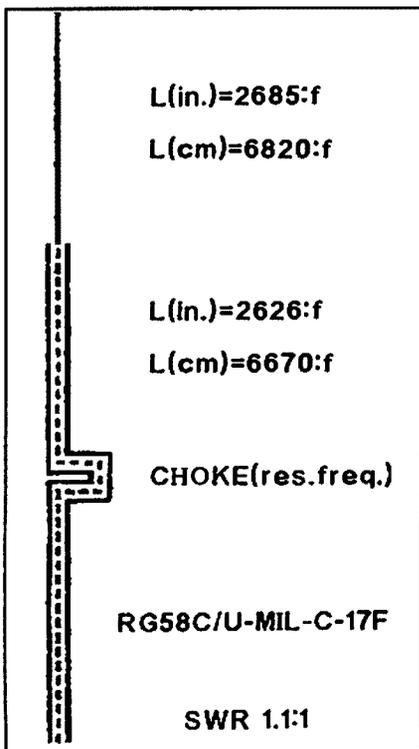

Fig 1. Feedline Vertical with Resonant Choke.

The choke for two metres consists of 4.6 turns on a 32mm (1.25 in) OD piece of PVC tubing. For six metres the choke is 11.8 turns on a 50 mm (2 in) OD piece of PVC tubing.

The antenna is suspended from a convenient point by a length of plastic cord. A loop in the top of the radiator helps to attach the suspension cord. You may need to adjust the length slightly to compensate for the loop but this is no more than part of the process of tweaking the antenna onto frequency.

Balanced Video

An interesting idea using a balanced transmission line for video appeared in the MATH'S NOTES column of Irwin Math WA2NDM in CQ August 1999. The idea was to use data balun transformers to allow video to be passed over an existing twisted pair. The application was to enable the use of existing cabling to a doorbell push button to carry video from one of the small video cameras monitoring the door.

The basic circuit for using a balanced line with unbalanced source and load is shown in Fig 2. The transformers used were the baluns sold for data use. These have one of the RJ11 connectors on the balanced side and a BNC connector on the unbalanced side. They have been available recently from Jaycar and should be available in the computer and data industry.

A somewhat more complicated circuit was used as it was necessary to use a phantom circuit to run the doorbell and power the camera. This is shown in Fig 3. The baluns had to be modified in order to provide the centre taps. The modification

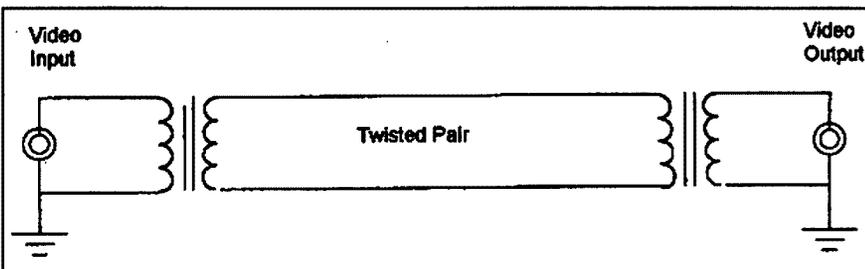

Fig 2. Balanced Video Transmission over a balanced pair.

involved unwinding them to make the centre tap and then rewinding. This should be done carefully as the circuit operation depends on the centre taps being accurate. The AC power source cancels in the balanced circuit and so does not affect the video. There is some disruption when the push button is activated.

The camera power is obtained by a bridge rectifier and filter from the AC used by the bell/chime circuit. The power required is small compared to that necessary for the operation of the chime, which is powered from a small transformer.

For longer runs video equalisation may be needed as many twisted pair cables do not have an extended upper frequency capability.

Skeleton Slot Revisited

The skeleton slot was a popular antenna some time ago. The design appeared in the sixties in the RSGB Handbook and was also sold as a factory built antenna by Jaybeam. The design uses a skeleton slot to feed two Yagi arrays spaced five eighths of a wavelength by the feed arrangement of the skeleton slot.

In Break In July/August 1999 Peter Johnson ZL4LV provides an update of the original which he optimised using the AO6.5 Antenna Optimiser program from Brian Beezley K6ST1. The program is advertised in QST along with a number of antenna programs and it was possible to input the configuration of the skeleton slot antenna using the program.

A computer plot of the antenna is shown in Fig 4. A comparison of the original antenna and the optimised design both calculated by the program are shown in Fig 5. The dimensions are given in Table 1. The antenna is built with insulated mounting of all elements. The feed makes use of the original delta but with a quarter wave matching section to 200 Ohms where a coaxial loop balun is used to match to 50 Ohm coaxial cable. To duplicate the antenna it would be necessary to look at the RSGB Handbook which still carries the original design.

The use of computer modelling makes antenna design simpler than building many models but you must ultimately check the result by building the design and seeing how it performs.

ar

Table 1

Frequency 144.25 MHz	Dimensions in Inches.
Element Diameter	0.375 Inches (3/8 inch)
Reflector Length	39.58 Inches
1st Director Length	37.86 Inches
2nd Director Length	35.31 Inches
3rd Director Length	36.29 Inches
4th Director Length	34.53 Inches
Spacing Driven Element to Reflector	8.16 Inches
Spacing Driven Element to 1st Director	2.45 Inches
Spacing Driven Element to 2nd Director	33.75 Inches
Spacing Driven Element to 3rd Director	58.79 Inches
Spacing Driven Element to 4th Director	82.42 Inches
Width of Horizontal Part of Skeleton Slot	15 Inches
Height of Vertical Part of Skeleton Slot	44.75 Inches
Short Joining Section Between Y and Skeleton Slot (f)	1 Inch
X axis length of Y section plus "f"	7.625 Inches
Matching Section (m) Quarter Wave plus "f" and "e"	28.75 Inches
Centre to centre spacing of matching section	2 Inches

The matching section appeared to be made of the same material as the elements and the skeleton slot.

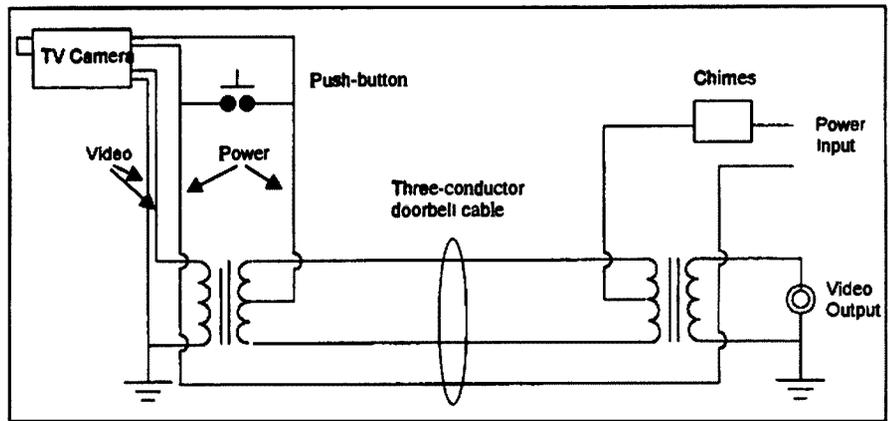

Fig 3. Transmitting Video over a twisted doorbell cable.

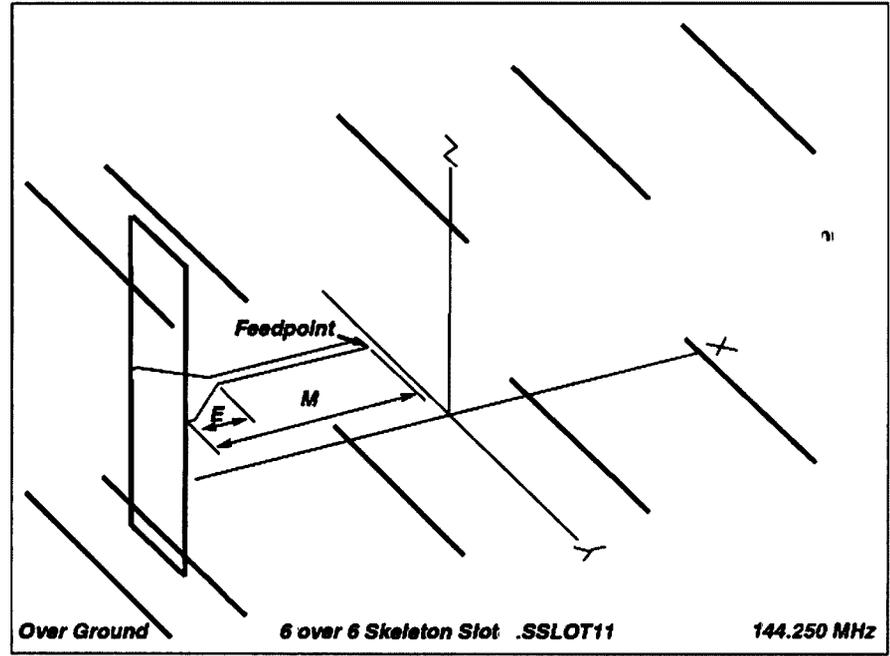

Fig 4. Computer Plot of 6 over 6 Skeleton Slot Antenna.

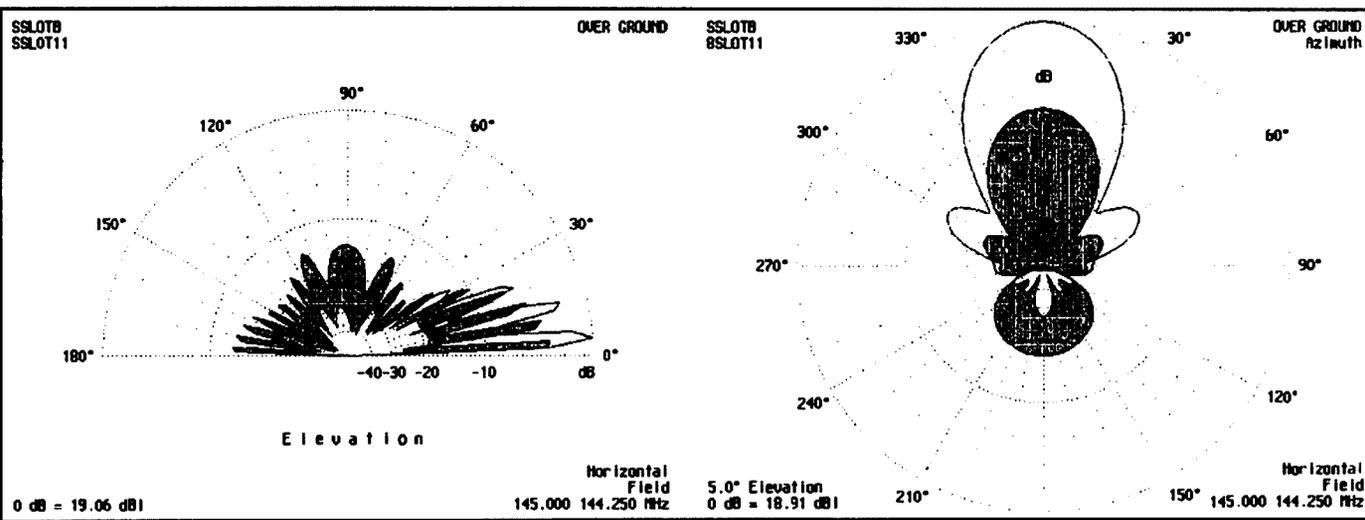

Fig 5. Plots of ZL4LV's original antenna (Shaded) and Optimised Plot (Overlaid). Left: Elevation Plot Right: Front to rear plot.

AMSAT AUSTRALIA

Bill Magnusson VK3JT
RMB 1627 Milawa Vic. 3678
Email: vk3jt@amsat.org

National co-ordinator:
Graham Ratcliff VK5AGR
Email: vk5agr@amaat.org

AMSAT Australia net:
The AMSAT-Australia net is held on 80 or 40 metres LSB (Lower Side Band) each Sunday evening (except over the Christmas/New Year period). During the winter months in South Australia (end of March until the end of October) the net is on 3.685 MHz +/- QRM with an official start time 1000utc with early check-ins at 0945utc. During the summer months when daylight saving is in operation in South Australia (end of October until end of March) the net is on 7.068 MHz +/- QRM with an official start time of 0900utc with early check-ins at 0845utc. The times and frequencies have been chosen as the best compromise for an Australia-wide net taking into consideration seasonal propagation changes and the various state summer time variations.

AMSAT Australia newsletter and software service:

The newsletter is published monthly by Graham VK5AGR. Subscription is \$30 for Australia, \$35 for New Zealand and \$40 for other countries by AIR MAIL. It is payable to AMSAT Australia addressed as follows:

AMSAT Australia
GPO Box 2141
Adelaide SA 5001

Keplerian Elements.

Current keps are available from the Internet by accessing the AMSAT FTP site, ftp.amsat.org and following the sub-directories to "KEPS".

the planned VOXSAT-1 are examples. ISS will have equipment suitable for 'entry-level' operation, as will Phase 3-D. With the rise in popularity of the 'Pico-satellites' concept, this trend should continue into 2000 and beyond giving the newcomer many easy and satisfying avenues into AMSAT activities.

One of the major news items of 1999 was the signing of a launch agreement with ArianeSpace for the launch of the new

This year we have watched as the new International Space Station (ISS) takes shape to replace MIR. As we have come to expect, AMSAT stalwarts have been involved since the outset to ensure that Amateur Radio is an integral part of the new space complex. Amateur radio equipment will be on board, ready and waiting for the first crew to arrive to activate the station.

Graham VK5AGR participated in the San Diego symposium in October. He noted in the newsletter on his return just how difficult it is to gain 'space qualification' to fly amateur radio equipment on a manned space flight. Without the dedicated effort of the ARISS team the dream of amateurs communicating with Astronauts on the ISS would remain just that, a dream.

Earth imaging via amateur radio took a giant leap forward early this year with the commissioning of the Surrey satellite TMSAT-1, TO-31. Its high resolution digital cameras and wide band downlinks have caused us all to re-appraise the picture quality expected from 'amateur' satellites. The bar has been raised several notches and has taken amateur radio satellite imaging to a level rivalling that of commercial earth-imaging satellites. This has probably been the major challenge thrown out to the amateur radio satellite community in 1999. For some time it looked like this new area may be put in the 'too-hard-basket' by many amateurs but as is usually the case, amateur ingenuity has come to the fore. New, simple ways around the problems of wide bandwidth reception and high speed modems have begun to emerge. This promises to be one of the most exciting areas of interest in the coming year. Superb quality pictures at download rates rivalling a fast internet connection could become commonplace.

Newcomers to AMSAT activities have not been overlooked in 1999. Whilst the emphasis has been on complex digital technology over the past few years, in 1999 we have seen a trend towards a 'back-to-basics' approach. The analog FM transponder of SUNSAT OSCAR-35 and

Summer Time and the AMSAT Sunday Evening Net.

As the heading indicates, the Sunday evening nets have moved from 80 metres to 40 metres for the duration of summer daylight saving. Early call-ins to the net are welcome from 0845UTC on 7.068 MHz +/- QRM. Due to the fall of dates this year, the nets will not be conducted on Sunday 26th December 1999 or on Sunday 2nd January 2000 as both of these occur during the Christmas/New Year holiday break.

The Year in Review.

Well, here we are at the end of 1999. I won't enter the debate regarding whether or not it marks the end of the current century, the millennium or whatever. Many will have the view that it's just the end of another hard year. In any case it's a good enough excuse for a party and I'm sure there will be a lot of celebrating come December 31. It is my personal hope to celebrate by watching as my computer tracks a satellite successfully across the transition from Dec 31 1999 to Jan 1 2000. Forward predictions indicate that a number of likely candidates including the 'old-faithful' Oscar-10 will be in our sky at that time.

There is certainly good reason to celebrate in AMSAT circles. We have seen another bumper year in the Amateur Radio Satellite Service. Our heroes have been hard at work and continue to provide us with a host of new satellites and new modes of operation. A lot of new launches took place in 1998 and although 1999 has seen the birth of only one brand new satellite, SUNSAT OSCAR-35, this year has heralded the re-birth of an old friend, KO-23 and the successful commissioning of several satellites that were born in 1998.

The final crew departure and end of amateur radio operations from the Russian Space Station MIR was one of the more nostalgic events of 1999. What wonderful fun it was to be able to communicate with all those Cosmonauts over so many years.

Phase 3-D satellite. This is how it was announced on the Arianespace internet web site.

*Arianespace Launch To Benefit
Amateur Radio Operators
15-OCT-99 Geneva.*

Today at Telecom '99, Arianespace and AMSAT-DL, the German branch of the international amateur radio satellite community, announced the signing of a launch contract for the AMSAT Phase 3-D communications satellite, to be carried aloft on an Ariane 5 as auxiliary payload.

The launch will take place in the year 2000 from Europe's Spaceport in Kourou, French Guiana. AMSAT Phase 3-D will be one of the first secondary payloads boosted by Ariane 5, which will use a special adaptor for orbital injection.

Weighing 650 kg (1,430 lb) at launch, AMSAT Phase 3-D will be injected into a geostationary transfer orbit. It will then use its own propulsion system to reach elliptical orbit (4,000 x 47,000 km, inclined at 60 degrees), where it will be used as a relay by the international community of amateur radio operators for nearly ten years.

In 2000, Arianespace will also inaugurate its new ASAP-5 (Ariane Structure for Auxiliary Payloads), designed for micro-satellites weighing less than 100 kg (220 lb) or mini-satellites weighing less than 300 kg (660 lb). ASAP-5 replaces the previous-generation ASAP-4, which has been used 6 times on Ariane 4. Arianespace has orbited some 27 auxiliary payloads since 1980.

All AMSAT personnel can take some pride from the mention of ASAP-4/5 in those last paragraphs. AMSAT developers have kept the time-honoured amateur radio pioneering tradition alive despite the 'gloom and doom merchants' who keep telling us that amateur radio is dead. They have demonstrated to the world the worthiness of small, inexpensive, yet state-of-the-art satellite packages. The theme has been taken up by humanitarian aid agencies, higher education centres, countries with developing technology and now, recognition by Arianespace with their development of a launch system devoted to these small satellite packages. Not bad for an organisation which can trace its roots back to the building of Oscar-1 in a basement garage in 1961. BRAVO! I think the AMSAT organisation can look forward to the new century/millennium with confidence.

SUNSAT SO-35 Doppler Compensation.

SUNSAT is proving to be a very popular satellite, particularly as it affords an opportunity for people with more modest equipment to experience satellite communication first hand. Many contacts can be monitored between stations using nothing more than VHF/UHF hand-held transceivers. Doppler shift, particularly on 70cm can be a challenge. A few minutes listening will reveal that it is those who take the trouble to compensate for frequency change who make the most successful contacts. Modern hand-held transceivers have copious memory capacity and it is possible to use this as a form of de-facto doppler compensation. Chris Hill VK6KCH has put together this explanation and given permission to print it here. Over to Chris:

"I thought I'd put together a list of frequency pairs which people can program into their radios, to use when operating SO-35's mode B. Coming up with the frequency pairs is quite easy... here they are (for nominal uplink of 436.291 MHz, nominal downlink 145.825 MHz):

Pair	Uplink	Downlink
A	436.280	145.830
B	436.285	145.825
C	436.290	145.825
D	436.295	145.825
E	436.300	145.820

But which pair to use at any given instant of time? The best method would be to use computer control (with fresh Keps and accurate time keeping) to automate the TX and RX frequency control (and rotate the 22 element Yagis etc). What about the more basic stations (like my hand-held FT-50R)? Trying to work any satellite while standing in a car park is less than ideal, therefore the simpler the instructions, the better! I have attempted to reduce the "which TX and RX frequencies to use versus time" issue down to a simple list of frequency pair versus elapsed pass time. The Doppler shift characteristic varies depending on the geometry of the orbit with respect to the observer. Simplifying SO-35's orbit to a circular orbit (it's slightly elliptical), a set of tables of which frequency pair to use versus elapsed time for a pass can be generated for various passes, each pass 'type' being classified by the maximum elevation which will be experienced during that pass.

Overhead Pass

For mid-latitude stations, an overhead pass will last approximately 13 minutes. Doppler on the UHF uplink is an almost constant +10kHz for the first third of the

pass (hence transmit low to compensate), rapidly changes as the satellite "zooms overhead", and is then an almost constant -10kHz for the last third of the pass (hence transmit high to compensate).

As the pass progresses, use the following pairs:

0.0 to 4.5 mins	A
4.5 to 5.5 mins	B
5.5 to 7.0 mins	C
7.0 to 8.0 mins	D
8.0 to 13.5 mins	E

58 degree Pass

Essentially the same as an overhead:

0.0 to 3.5 mins	A
3.5 to 5.5 mins	B
5.5 to 6.5 mins	C
6.5 to 7.5 mins	D
7.5 to 12.5 mins	E

13 degree Pass

Doppler shift on this type of pass follows an almost linear change throughout the pass, thus requiring more frequent changes, but making tracking less critical during the time of closest approach.

0.0 to 4.5 mins	B
4.5 to 7.0 mins	C
7.0 to 11.0 mins	D
11.0 to 12.5 mins	E

Why Bother?

Regardless of relatively wide IF filters being used on the satellite's receiver, the FM demodulator is going to exhibit optimal SINAD (Signal to Noise and Distortion) when the uplink signal is centred within the passband (rather than being pushed into one wall or another). Similarly, our receivers should be tuned to the Doppler shifted satellite's downlink signal, in order to exhibit the best possible SINAD. ("Best possible SINAD" is another way of saying "maximum sensitivity"). With the marginal power link budgets associated with handheld stations, optimal frequency operation may make the difference between a contact or no contact, whereas fixed stations with gain antennas and surplus power can afford to waste a few dB.

Thanks Chris. I use computer control via WiSP to achieve the above effect and I can assure you it is worthwhile to do SOMETHING about doppler compensation. If you give this system a go, you should be delighted with the results. Feedback would be good either to Chris or myself.

As usual, the January column will feature a summary of all currently operational amateur radio satellites, their transponder and beacon modes and frequencies.

A Merry Christmas and Happy New Year to you all.

Bill...VK3JT

VHF AN EXPANDING WORLD

Eric Jamieson VK5LP

PO Box 169 Meningie South Australia 5264
E-mail: vk5lp@ozemail.net.au Fax: (08) 8575 1777
Packet: VK5LP@VK5WI.#ADL.#SA.AUS.OC

All times are UTC

The Ross Hull Memorial Contest

This year marks the fiftieth anniversary of the inauguration of the Ross Hull Memorial Contest and has become known as the Golden Anniversary Contest. It will run from 26 December 1999 to 16 January 2000. In addition to the usual trophy and certificates, a 50th anniversary trophy will also be awarded, making the contest worth entering.

The Ross Hull Contest Manager John VK3KWA, has featured the contest rules more elaborately in this issue in the Contest pages. Also, I have prepared a special article on Ross Hull himself that appears in this issue.

Collectively, we are doing our best to promote the contest, the rest is now up to you, the contestants, to play your part by entering

Ross Hull Contest: List of winners: 1950 - 1998

1950 - 1951	VK5QR	R.V. Galle	1975 - 1976	VK5SU	J.W.K. Adams
1951 - 1952	VK5BC	H.F. Lloyd	1976 - 1977	VK4DO	H.L. Hobler
1952 - 1953	VK4KK	A.K. Bradford	1977 - 1978	VK3OT	S.R. Gregory
1953 - 1954	VK6BO	R.J. Everingham	1978 - 1979	VK4DO	H.L. Hobler
1954 - 1955	VK4NG	R. Greenwood	1979 - 1980	VK3ATN	T.R. Naughton
1955 - 1956	VK3GM	G. McCullough	1980 - 1981	VK6KZ	W.J. Howse
1956 - 1957	VK3ALZ	I.F. Berwick	1981 - 1982	VK6KZ	W.J. Howse
1957 - 1958	VK3ALZ	I.F. Berwick	1982 - 1983	VK6KZ	W.J. Howse
1958 - 1959	VK3ALZ	I.F. Berwick	1983 - 1984	VK6KZ	W.J. Howse
1959 - 1960	VK4ZAX	D.R. Horgan	1984 - 1985	VK3ZBJ	G.L.C. Jenkins
1960 - 1961	VK3ARZ	W.E.J. Roper	1985 - 1986	VK3ZBJ	G.L.C. Jenkins
1961 - 1962	VK5ZDR	M.J. McMahon	1986 - 1987	VK3ZBJ	G.L.C. Jenkins
1962 - 1963	VK4ZAX	D.R. Horgan	1987 - 1988	VK5NC	T.D. Niven
1963 - 1964	VK5ZDR	M.J. McMahon	1988 - 1989	VK5NC	T.D. Niven
1964 - 1965	VK3ZER	R.W. Wilkinson	1989 - 1990	VK3XRS	R.K.W. Steedman
1965 - 1966	VK3ZDM	J.R. Beames	1990 - 1991	VK3XRS	R.K.W. Steedman
1966 - 1967	VK5HP	J.H. Lehmann	1991 - 1992	VK3XRS	R.K.W. Steedman
1967 - 1968	VK3ZER	R.W. Wilkinson	1992 - 1993	VK3XRS	R.K.W. Steedman
1968 - 1969	VK5ZKR	C.M. Hutchesson	1993 - 1994	VK3XRS	R.K.W. Steedman
1969 - 1970	VK3ZER	R.W. Wilkinson	1994 - 1995	VK3XRS	R.K.W. Steedman
1970 - 1971	VK4ZFB	E.F. Blanch	1995 - 1996	VK2FZ/4	A. Pollock
1971 - 1972	VK5SU	J.W.K. Adams	1996 - 1997	VK2FZ/4	A. Pollock
1972 - 1973	VK5SU	J.W.K. Adams	1997 - 1998	VK2FZ/4	A. Pollock
1973 - 1974	VK5SU	J.W.K. Adams	1998 - 1999	VK3XPD	A. Devlin
1974 - 1975	VK5SU	J.W.K. Adams			

Six metres

Don VK6HK said that in a phone call, Bill VK6JQ at Broome reported working EY8CQ and EY8MM on 50 MHz on 10/10 around 0700, for probably the first VK-EY QSOs this solar cycle. VK6JQ runs 10 watts to a 6 element yagi and is on CW only.

Bill VK6JQ also reported working AP2WAP on CW and SSB on 15, 16 and 18th October around 0745-0945. He also comments in a letter that "Indian FM stations were heard on 50.100 each time contacts were made..." India and Bangladesh were being worked in Japan at the time as well. (No callsigns provided). Bill also reports working 12 countries in Europe on 25th October, 1999). No details as yet.

Bill also mentioned that he had heard IW5BMI on 50.110 last November (7th) 1998 for probably the first EU-VK propagation this cycle. He worked A45ZN during the same opening. ... Don VK6HK.

[A letter arrived from Bill VK6JQ with details of his contacts just too late for inclusion here, but details next month. Bill said that up to 31/10 he had worked 19 countries in Zones 14, 15, 16 and 20, also Pakistan in 21 and Tajikistan in 17. Six metres is well and truly alive, he said. ... VK5LP.]

By e-mail Selva 9V1UV advised that he had been allowed to operate on six metres through the weekends of November. Of course, this was received too late for us, except those whom I could advise on the VK-VHF Reflector, but the following is of interest.

I am hoping that for the months December to January 2000 I will get a greater dispensation of facilities from the authorities such as permission to operate every day. I could let you know later.

A note from David VK2CZ says: *You would not believe the difficulties ham radio operators face in Singapore. I met Selva when he was working at DBS Bank while I was on contract in 9V1. The ham radio licence there is CW only for the first year, with choice thereafter. Yagis or any gain antennas are not allowed. Mobile or portable operation is not permitted. Make the most of this rare opportunity!*

Wally VK4DO reports considerable activity and contacts with stations across the Pacific, with the following as a sample: 2/10 0327 T31K; 6/10 0228 N6XQ, 0238 XE2EED; 7/10 0420/55 XE2/b and K5FV/b; 9/10 0850 VR2XMT, 0852 JD1BIA.

On 16/10 XE2UZL/b was in from 0335-0510 with QSB. Maximum strength was S3 around 0440. JA and KH6 at the same time. Many VK4s workable on backscatter.

17/10: 0030 XE1/b until 0200. Worked T17WAM/4 CW. 429. Difficult contact not really sure of the ?? may have been 6. Next 0136 K6MYC 5x5 DM06, 0150 N7STU 5x2, 0151 N6XP 5x3 DM06, 0153 N6AJ 5x2

DM06, 0211 W6BYA 5x5 DM87, 0215 K6KLY 5x4 DM87, 0237 KG6KH 5x5 DM12.

For the second day in a row (18/10) there has been a good opening into the States. Oregon, California (San Francisco and Los Angeles), Arizona and Mexico. XE2/b 0050-0350 up to S4. Contacts from 0124-0323. XE2EED worked A35SO at 0335. Heard VK4FNQ, VK4JH, VK4BLK in there.

I have put together some thoughts about the openings 17-20/10 into North America as they apply to this location.

The stations worked were in an arc, the distances being a narrow band of 11230 - 11600 km. This time there were no KH6 stations heard here, the distance being 7350 km. So it was either a single hop or a double hop missing KH6. The path to LA is 54 deg and XE2 is 60 deg, KH6 is 53 deg, so basically the signals pass over KH6. At the same times the West Coast USA were into A35 and FO0. XE beacons heard 16/10 to 20/10; Worked only W1VDE/7 CW 0305 CN92 Oregon.

The opening on 23/9 was around 13000 km and KH6 were in at the same time. One interesting observation is that all contacts in these openings have been in a narrow band each time spreading in an arc from here. Each time the XE beacons have given a strong indication of an opening, and are worth listening for. XE1, XE2 and XE3 are on the gulf coast. W1VDE/7 was using a rhombic 660 feet long from an elevation over 4000 feet.

Also, Wally reports that at last an opening from his QTH of Strathdickie into Europe. 3/11 0923 SP2SGZ JO82 5x3, 0929 DJ3TF JN59 5x3, 0933 SP4MPB KO03 5x3. Very quick and intense.

Les VK1BUC said that he worked 7J7ACV, JE2DWZ, JR1IQL on 15/10 between 0400 and 0430. Heard many other JAs. Ed VK1VP was also among them. The JAs reported working Hawaii shortly before the band opened to VK1.

Rob VK6TRC also worked the following on 15/10: 0500 JR1IQL 5x3, 0510 HL5XF 5x5, 0515 JA5NLN 5x7, 0612 JG7HRZ 5x9, 0615 JH7DFZ 5x7, 0620 JI3KGW 5x5.

Scott VK4JSR heard VK6BIK on 31/10 at 5x2 on backscatter during an evening TEP opening to JA. No other details.

Ray VK4BLK reports as follows: 24/9: 1134-1306 V73SIX/b 529. 25/9: 0358 DS1CCU/2 559. 28/9: 0250 XE2HWP 429; 0616 KH6IAA 5x6; 0622 AH6TM 5x2; 0625 K6MIO/KH6 5x4. 29/9: 0042 NH6YK 5x7; 0057 KH6SX; 0101 KH6IAA 5x7.

2/10: 0404-0520 V73SIX/b 539. 3/10: 0445 NH6YK 5x7. 6/10: 0227 N6XQ 5x5; 0233 XE2EED 4x4; 0237 KG6KH 5x4. 17/10: 0059 K5SCM 539; 0110 N6XQ 529; 0117

XE1GRR 5x2; 0150 N6JV 559; 0155 K6MYC 5x4; 0220 W6BYA 5x4; 0222 N7STU 5x3; 0225 N6XQ 5x6; 0236 KG6KH 5x5; 0237 N6AJ 5x6; 0327 N6XP 5x5, N6AJ 5x5; 1136 V73CW 5x9. 18/10: 0226 KJ6HI 5x4; 0227 KO6WQ 5x4, K7JA 5x4; 0228 KF6FCE 5x5; 0229 N6JV 5x6; 0232 W7EW 559; 0234 W6QUV 569; 0238 W6WVK 569; 0239 N7CW 5x4; 0243 K6MYC 5x3; 0249 AB6PY 4x4; 0251 K6QXY 5x6; 0252 AA6G 5x5; 0254 K6FEE 4x4; 0322 WA6KLLK 5x4; 0324 WD6HDY 5x4; 0326 W6YM 549; 0329 K6KLY 559; 0350 W6FV/b. 22/10: 2311 YJ8UU 5x4; 0650 JD1YBJ 559; 0809 JR6YAG/b 519; 0835 JD1BIA 5x5 Ogasawara Is. 24/10: 0717 KH4/W4ZYV 5x8. 25/10: 0325 W6JWM 5x5; 0331 K6QXY 559; 0356 AA1Z 549. 27/10: 0224 N6XQ 529.

From Doug VK4DUG: 23/9: 0053 W7XU 5x3; 0120 N0QJM 4x3, each South Dakota.

Warwick VK4NW from Bagara near Bundaberg: 1/9: 0235 7J7ACU 5x8; 0310 HL5XF 5x7. 16/9: NH6YK 0220 5x4. 22/9: 0250 JA1WLA 5x5. 23/9: 0055 KA9CFD 5x9 EN40; 0100 ND0J 5x9 EN31; 0101 WA0CED 5x2 EN33; 0102 KC0BNZ 5x1; 0105 W0SD 5x9 EN15; 0106 KB0PYO 5x5 EN24; 0115 W7XU 5x7; 0125 N0QJM 5x7 EN30; 0126 W5EU 5x7; 0127 N5JEH 5x5 EM65; 0137 AA5XE 5x5 EM00; 0140 W5OZI 5x4 EM00. 28/9: 0435 JR2AJS 5x9; 0640 KH6IAA 5x4.

From Don VK6HK: Opening 24/10: Worked by Perth Stations on CW - 9M2JKL and 9V1JA. Heard 9M2TO/b 50.005. All around 0800-0920 at this station.

John VK4FNQ reports many contacts from across the Pacific. Because these are a representative sample of what was worked from North Queensland, they are presented in columnar form.

17/10

0132 N6XP DM06
0135 N6AJ DM06
0146 K6MYC DM06
0152 KB6NAN -
0154 K6KLY CM87
0212 W6BYA -
0215 FK8FU RG37
0223 N6XQ -
0729 WH6O -
1240 VK4BLK -

18/10

0055 K7ICW DM26
0056 NW6O DM26
0124 W7RV DM35
0126 N5JEH -
0127 K5AM DM54
0131 N6CA -
0135 WB8VLC DM34
0138 N6KK DM03
0140 N5JHV DM62

0141 K7JA DM03
0142 W6KK DM14
0143 KH7L -
0144 K6SYW DM03
0149 N0XX CN84
0152 WA6PEV DM15
0153 K6QXY -
0208 N2KK DM04
0210 W6BYA -
0211 W6QUV -
0212 W6SYW -
0213 W7EW CN84
0216 WX7R CN85
0217 N7CW DM12
0218 N6JV CM98
0218 W6WVK CM88
0219 N6KBBX CM98
0220 K6MYC DM06
0222 AB6PY CM88
0224 K7RAT CN85
0229 W16Z CN84
0231 NF6L DM13
0233 KJ6HI DM08
0235 W7GE CM98
0236 KC6IPF CN80
0243 N6BZY DM12
0253 XE2EED DM12
0258 WB6AAG CM95
0300 K7KX CM96
0306 N6XQ -
0313 HL5XF -
0328 XE2EED -
0332 XE2XC CM12
0350 N6XQ -

19/10

0113 K6QXY -
0118 KC7IJ DN44
0119 N9JIM CM87
0120 WA6KLLK CM89
0121 W6QUV CM98
0125 WA6ETB CM87
0128 WD6HDY CM89
0131 K6FV CM87
0132 K6LLQ CM97
0134 W6JWM CM97
0138 AB6PY CM88
0139 K6UM -
0141 K6HEW CM98
0143 K6FEE CM98
0146 W4LZP -
0149 K7YVZ DN13
0158 K6PXT CM87
0200 K6MI -
0205 W6BYA -
0207 W6JRY CM99
0210 W6WVK CM88
0214 W6RD CM97
0215 K6QXY -
0216 AA1Z CM88
0219 AB6PY -
0223 W6QUV -
0224 WD6HDY -
0255 AB6PY -
0257 W6QUV -
0300 N6KBBX CM98

For a change of scenery John VK4FNQ worked the following: 23/10 1236 JY9NX 4x1/5x2 1249 S21YU 4x1/4x8

24/10

0855 SVIUN 5x9/5x9 KM18
0857 SV1DH 4x1/5x5 KM27
0859 SV1OE 5x1/5x5
0901 IT9RZR 4x1/5x5
0933 VR2XMT 4x1/5x5
0942 SV5BYR 4x1/5x5
0944 SV5AZP 4x1/5x5

28/10

0943 HB9QQ 5x5/5x8 JN47
0947 IK5YZW 5x2/5x5 JN53
0949 IK2DRY 5x1/5x5 JN64
0951 F4PAN 5x5/5x7 JN26
0953 DK7SP 5x1/5x6 JN48
0954 SQ8GKA 4x1/5x5 K???
0955 IK1IZB 5x1/5x5 JN45
1001 IK5YJY 5x1/5x5 JN53
1004 IZ5EME 5x1/5x5 JN52
1006 F5LNU 5x2/5x2 JN04
31/10

0831 P29KFS

0832 YU7FU KN04
0839 YO4AUL KN44
0906 YO7VS KN14
0912 9A3AQ JN75
0915 F5JJK IN87
0916 9A4CD JN75
0921 JA6RUP
0923 IK3TPP JN65
0924 IK1EGC JN35
0927 IK3OCD JN65
0928 I3LLH JM65

Frequencies used were 50.110, 50.115 and 50.120. Obviously the EU stations still don't go far away from 50.110.

Equipment used was a Yaesu FT 847 100w to a 9 element H/B yagi on a 30 foot boom up 62 feet. Grid square QG39EX. I am approx. 1150 feet above sea level and about 60 miles inland from the coast and south west of Townsville, and 7 miles outside Charters Towers on the main highway from Townsville to Mount Isa.

From the above, it seems next February/March should provide contacts to Europe. After that, will it be too late?

Ron VK4BRG said: *I missed the Monday opening being away re-installing a local 2m repeater. On Tuesday 19/10 the band opened for me at 0122 with KC7IJ in Idaho DN44 .. actually the border area between Idaho, Wyoming and Montana. Worked 18 stations mostly North California area.*

Conditions dropped considerably around 0200, but interestingly, marginal conditions existed for another hour with the same KC7IJ being audible most of that time. Did also work a couple of stations in Montana and North Ca. during that hour. Other stations I heard participating this end were VK4s FNQ, JH, DO, BLK.

Further to the Monday 6m opening .. and, vaguely along the the current theme of horizontal omni antennae, I had a report of my VK4BRG 6m beacon being heard by W6QUV in CM98 at 0153 at S5. The VK4BRG beacon, 50.0775 MHz, is solar powered and about 3 watts into a turnstile antenna. It was heard in Colorado last cycle. Helps when propagation is "on side"! The following stations were worked:

19/10: 0122 KC7IJ DN44; 0136 K7YVZ DN13; 0138 WA6ZFK CM99; 0139 W6QUV CM99; 0141 N6JV CM98; 0141 W7GE CM98; 0142 K6QXY; 0144 AB6PY CM88; 0146 K6UM CM88; 0147 WD6HDY CM89; 0148 WA6KLK CM89; 0149 K6HEW CM98; 0151 W6JRY CM95?; 0153 W6QUV called, reported copying VK4BRG beacon S5; 0153 K6KLY CM87; 0155 K6PX CM87; 0157 W6BYA; 0201 K6MI DN06; 0235 W7GJ DN27; 0259 WD6HDY CM89.

As noted, initial station, KC7IJ heard plus chit chat between us from 0122 to about 0230 .. just seemed to be a pipe line between us.

23/10: *YJ8UU into here most of the morning .. he worked a few W5s plus XE1BEF, but did a lot of calling in between. Had KH6 this morning .. again now at 0640. KH6s have reported activity from FO, A35, 3D2, AH8 and of course YJ8.*

Dick KH4/W4ZYV, on Midway Island, has had good signals into this QTH for the last few days, particularly yesterday (25/10) afternoon. Heard him work heaps of VK4s plus VK2, ZL and FK. For those who need his QSL info, simply: Dick, W4ZYV, PO Box 444, Alva, FL. 33920.

Had a weak (one could say, CW type!) opening into Central CA on 26/10 across to Nevada from 0227 to 0323. The guys around the Townsville area have worked Bangladesh, Jordan, Cyprus and Italy over the last couple of days. ... Ron VK4BRG.

Repeater news

Steve VK2KFJ reports a new six metre repeater on 53.625 MHz has come on air with 25 watts. It is located about 20 km south west of Caboolture on the Queensland Sunshine Coast and uses the same frequency as VK2RSN at Newcastle. At present the callsign is unknown.

The VK2RMB 53.675 repeater in north east Sydney is back on air. The receiver was dead and antenna damaged in a storm last year, both have been repaired. The VK2RWI 53.850 repeater in north west Sydney is nearing completion.

Tony VK3JED reports that the VK3RMS 53.900 repeater in Melbourne has regular nighttime scheds operating it.

Six metre repeater updates can be found at <http://www.qsl.net/vk2kfj/6m_rptr.html> ... Steve VK2KFJ

New beacon

Via APCNews, Tony VK3CAT advises of a new two metre beacon near Moe, with the callsign VK3RGI. It transmits on 144.533 MHz running 10 watts to a halo.

Wally VK6KZ reports that after some tests with the Esperance beacon on his visit to Bill VK6AS, he discovered a major fault in the antenna - like about 20 mm of inner of coax acting as the major radiating element - the cockatoos are really hungry and had removed the insulation around the joint and half the dipole had somewhat sagged. A "you-beaut bend dipole" originally built for Esperance dispatched post-haste to Bill.

Two metres

Chris VK6BIK sends a report from Bill VK6AS in Esperance of a very strong tropo opening across The Great Australian Bight occurring on 25 and 26 September, at least one month earlier than usual. Bill runs full legal power into an 8 bay x 16 element long-boom 144 MHz antenna system, comprising 128 elements in all.

The opening first became apparent at about 1020, when Bill heard the Mount Lofty and Mount Gambier beacons, both at S9+. He called CQ on 144.100 for 45 mins, before being compelled to use the landline to alert possible eastern states contacts to the propagation phenomenon.

Bill proceeded to work Trevor VK5NC, Roger VK5NY, David VK5KK, Colin VK5DK, Russell VK3ZQB, all 5x9+. Of note is that VK5KK "repeated" Bill to VK5AKM on 10 GHz for an interesting cross-band contact. Bill also gave one station a 5x9 report on just one watt! The opening lasted at least until 1340 when Bill pulled the switch. The following morning, the propagation was still there, although at reduced strength. About 2300, Bill worked VK3ZL on CW at 529, and then VK5DK 5x9. In the meantime the beacons had dropped to S2-S3, peaking S5. At no time were any VK6 beacons heard.

Aurora propagation

Max VK3TMP reported the aurora on 22/10 and on two metres from 0658 to 0730 worked: VK2KU 5x6 to 5x9, unusually good audio for an aurora; VK2EK 5x5; VK2TWR 5x5 was heard for 20 minutes after everyone else disappeared; VK3DUT, VK3ZQB 5x9; VK3BWT 5x3; VK1VP 5x6; VK5LP 5x2 lots of phase distortion and Doppler shift.

Guy VK2KU: *The opening lasted from 0655 to at least 0730. No VK5s or VK7s were heard, nor VK1s, though I know VK1VP and VK5LP were active. Rod VK2TWR and Warren VK3BWT were quite weak.*

Outstanding signals were VK3TMP in Somerville and VK3ZQB in Port Fairy, both with good enough audio quality for some kind of real conversation. Contacts made were limited more by available stations than length of the opening. Worked: VK3ZQB, VK3TMP, VK3DUT, VK3XQ, VK3KEG, VK2TWR.

Eric VK5LP worked Russell VK3ZQB and Max VK3TMP both 4x6A. Called VK1VP but no reply.

Correction

In the October issue under the title of "New 144 MHz world record" I mentioned at the end that the Australian record is held by VK4BFQ and JI7DMB. Mike VK4BFO has drawn my attention to the correct callsign as being his, and not VK4BFQ, and made when he lived at Mount Isa. Sorry about that error.

WIA Victoria George Bass Diploma

Jim Linton VK3PC has asked me to mention the above Diploma in these notes.

As part of a program to encourage more simplex operation on VHF/UHF, a new award called the WIA Victoria George Bass Diploma is available for contacts across Bass Strait.

All operation must meet the diploma rules and comply with WIA Band Plans. Disqualification may occur for using FM in a SSB band segment, or prolonged operation on DX calling frequencies.

The rules are simple:

Operation must be two-way simplex telephony contacts across Bass Strait, between 1 November 1999 and 30 April 2000.

Only FM or SSB modes are permitted on the 6-metre, 2-metre and 70-centimetre bands.

Mainland stations must work five VK7 stations on a single band.

VK7 stations require 20 mainland contacts on a single band.

Diplomas are issued for single mode (FM or SSB) only.

Only one callsign may be used by each radio amateur (no multiple callsigns).

To obtain a diploma, send a signed copy of a log of contacts, plus \$5 to: WIA Victoria George Bass Diploma, 40G Victory Boulevard, Ashburton, Victoria, 3147. Claims received more than one month after the diploma period will not be accepted.

Note: The WIA Victoria web site <www.tbsa.com.au/~wiavic> will from 1 November also include VHF/UHF operating tips for newcomers, discussing band plans, antenna polarisation and trans-Bass Strait propagation. It is also going to promote participation in the Spring Field Day and Ross Hull Contest.

... Now over to David VK5KK

Activity at the "Right" time

Just how many people are active on the VHF/UHF Bands, who are they, where are they? There would seem to be a lot of Amateur Operators with some general interest, but only a small percentage able to be active at any given time. Anomalous propagation drives our "DX" activity yet just who is at the other end of the path to actually work? Just how many openings are missed because the band is open to nowhere? By nowhere I mean where there is no activity or, worse still, where there is activity but no one on at the right time.

It's a fact that the hit and miss nature means that it is more good luck than good management that some of the harder paths are actually worked. Some may argue that this is all part of the fun. But for some propagation modes, where propagation may only occur once every few years, chances have to be maximized! Beacons provide a pseudo "active station" so a path can be monitored, but few beacons give out QSL cards or count for distance records!

To get better results, individuals have banded together into groups to communicate via various means between times of propagation. Columns like this have promoted, over a long period of time, those who are active in various areas so others can establish contact. Some groups have regular scheds during high probability periods, e.g Meteor Scatter, Aircraft Scatter, etc. Others keep regular contact on another band, Email or in some cases even HF! Instantaneous communications has been mostly restricted to panicked phone calls or a shout over the local repeater to get some extra activity!

Email has become an efficient means of rapid broad communications over a non-geographic area for many activities, including amateur radio. The existence of Email reflectors has proven to be a useful tool to boost activity. In addition to Email another Internet based system has also developed, the "DX Cluster".

A DX Cluster is an Internet "Notice" board, updated in real-time by participants connected to that cluster. The Cluster operates a bit like the panicked call on the local repeater, except the geographics and recipients have been delimited.

Each Cluster has a title interest. This may be as broad or as narrow as activity dictates, e.g a VHF Cluster or a more specific group like a 10 GHz Cluster. Those contributing to the cluster, input information about activity or propagation specific to that Cluster. Information updates within seconds as messages are usually not subject to an

intermediate clearance point. You may access multiple Clusters by opening multiple windows in your web browser.

In Europe and the US, DX Clusters have gone from strength to strength in the last few years. Recent visitors to Europe/UK, in particular, have reported the number and speed (within minutes!) at which stations appear during an opening, once the information is available on a DX Cluster. The only down side of using a cluster as a real-time indicator, is the time you are prepared to be connected to the Internet. If you only connect for a short time per day, a lot of what you will read on a cluster will already be history!

In Australia, we have a little way to go. Again our populous and demographic sparsity are our limiting factors. I suspect that beneath the VHF Reflector(s) level we do have some Cluster type activity but of a limited type. Australia is rapidly progressing to a point where households will have affordable "time independent" data connections making Internet access cheap enough for this type of activity. So part of the reason of writing this section is to uncover any "Clusters" and promote this into a more broad area of users. On this subject it is very much "Over to you".

With this segment, as with the previous two, the common theme has been that of promoting activity. As I write, the October segment has generated a reasonable amount of feedback from those who have already dabbled in APRS & PSK31. Through this medium, I hope to publish "how to contact" other amateurs experimenting in the various areas covered.

Correspondence for the column can be forwarded to me as follows. On email <tecknolt@arcom.com.au> or Telephone 0414 808060 between 2000-2200 EST or via Snail mail to P.O. Box 789 Salisbury, SA, 5108. As I spend an amount of time outside of South Australia, Email is probably the most reliable method followed by the Mobile phone to get in touch. The deadline for each month is the 3rd day of the month prior.

On a more general note, this column marks the end of an era, in more ways than one. Firstly, this is the last column in this millenium. More importantly, this is Eric's last column. We all have enjoyed Eric's journalism in these columns over a generation. A style that has both congratulated and thrown brick bats as required! While I have been involved in the preparation of some of the columns since 1982, the size of shoes to be filled from January 2000 is not to be underestimated! I am in the negotiation stage with Eric to maintain his input in one or two areas. More next month, till then happy New Year!

All things must come to an end ...

That's it! The last of my notes for these columns after 30 years and one month. In the January issue there will be a special article which looks back at my lifetime in wireless/radio/electronics.

Writing for so long the monthly preparation of VHF notes have been an important part of my life. Taking an overall view it has been an interesting experience and one which has brought to me a wide circle of friends and correspondents from all over Australia and other parts of the world. A pleasing experience knowing you all even if only from the written word, the phone calls and more recent times the e-mails.

Fearful that I will miss someone I don't propose mentioning too many of the long list of amateurs who have contributed information over the years, I am very grateful to you for your support. However, there are a few who stand out for the continuity of their contributions. These include John VK4KK who often telephones news of contacts as soon as they have happened, Ron VK4BRG, John VK4FNQ, Ray VK4BLK and Wally VK4DO; Mike VK2FLR; Geoff VK3AMK, Gil VK3AUI, Russell VK3ZQB and Steve VK3OT; Wally VK6KZ, Don VK6HK, Graham VK6RO;

David VK5KK and more recently David Vitek for a long list of hand-written SWL info covering 30 to 150 MHz. Then there are many who have responded with detailed information when I have requested it of them - thank you. I apologise if I should have mentioned someone and have not done so.

A gratis copy of The West Australian VHF Group News Bulletin has been arriving on my desk each month for so many years that I have lost count. Another regular has been the Newsletter from the Geelong Amateur Radio Club. Thanks folks for thinking of me.

Sharing my notes with others, particularly with overseas correspondents, has been one of the highlights. One of the longest standing contacts has been with the conductors of *The World above 50 MHz* published in *QST*. For many years we have shared columns, first with Bill Tynan W3XO now W3XO/5 and then Emil Pocock W3EP. Both have been truly great correspondents and I am truly indebted to them for the friendship extended and the information that they have supplied for so long. Believe me, much more happens in the Northern Hemisphere than down here and they have kept me informed. Of more recent times, the receipt of *Six News* from the UK Six Metre Group has been a source of good reading.

I must also include Ted Collins G4UPS for the years of faithfully arriving pages of contacts and other information from the UK. I learnt much of the European perspective from Ted's writings. Ted doesn't have e-mail so we have each month swapped notes by air mail.

I cannot close without saying how well I have been treated by the Publications Committee of *Amateur Radio*, who appear to have accepted my notes without resorting too heavily to the blue pen to shorten or change them - not to my immediate knowledge anyway! I enjoyed a long association with Bill Roper VK3BR who received my monthly notes for many years. I think Bill Rice VK3ABP has looked after me rather well too, as have June Fox in the office and Brenda Edmonds VK3KT. More recently I have built up a good rapport with Bob Harper VK4KNH who has taken the place of Bill Roper in the preparation of information for publication.

So, it has to be with more than a tinge of regret that I now put aside the keyboard and turn my writings to other directions. If my health continues to allow me, then you may read some further contributions from me in the future. Thank you one and all for a great 30 years of sharing experiences, something I will remember and cherish for the remainder of my life.

As the result of these writings, if down the track I should be remembered in any way it would be that for me having given of my best for the good of my friends, the amateur radio operators, the amateur radio movement in general and VHF/UHF in particular. The information listed in these notes now provides a lasting record of how the VHF/UHF scene has unfolded with the passage of time. I am proud to have been part of it.

I now leave the helm to David VK5KK, a close friend of many years, and one who provided fill-in columns when I was indisposed and confined to hospital, whom I see as a very worthy successor to my writings. I wish him well for the future and hope that the support given to me will be forthcoming to David. Cheers all.

Closing with two final thoughts for the month:

1. While it may be true that a watched pot never boils, the one you don't keep an eye on can make an awful mess of your stove, and
2. Anyone can become angry. That is easy. But to be angry with the right person, to the right degree, at the right time, for the right purpose and in the right way - that is not easy!

73 from The Voice by the Lake - for the last time.

ar

ENJOY THE HOBBY OF AMATEUR RADIO

W.I.A. (NSW Division) Education Service

NOVICE STUDY KIT — \$28.00 INC. POSTAGE

Includes Novice Electronics, 1000 Questions, Learning Morse Code Kit with 3 cassettes, and the Novice Handbook with syllabus, regulations and general information

NOVICE KIT WITHOUT MORSE CODE — \$17.00 INC. POSTAGE

NOVICE ELECTRONICS — \$7.00 INC. POSTAGE

An easy to follow text that extent from Into Electronics to a complete Novice theory course, covering all syllabus topics

1000 QUESTIONS AND ANSWERS — \$7.00 INC. POSTAGE

A collection of typical exam questions covering all areas of Novice theory and regulations. A must for the Novice candidate.

LEARNING MORSE CODE PACK — \$13.50 INC. POSTAGE

Three 60 minute Morse cassettes with 120 programmed steps keyed to a comprehensive text and spoken prompts. Letters, numbers and sentences at 5WPM for Novice standard Morse.

100 PROJECTS — \$7.00 INC. POSTAGE

Simple, cheap, well-explained electronics projects for High Schools and hobbyists, using common components.

MORSE CODE CASSETTES — \$6.00 INC. POSTAGE

60 minute Morse tapes at any speed from 5 to 30WPM, three versions of each available. Specify speed when ordering.

500 QUESTIONS AND ANSWERS — \$7.00 INC. POSTAGE

A collection of typical exam questions that serves to bridge the gap between Novice and Full Call examination standard

FREE — Amateur Radio Internet Course

Email: vk2wi@ozemail.com.au

- these services are provided voluntarily by radio Amateurs.
- Above prices include postage anywhere in Australia
- Bulk prices (10+) available on request, buyer to pay freight.

CORRESPONDENCE COURSES

NOVICE — \$52.00 INC. POSTAGE

AACP BRIDGING COURSE — \$52.00 INC. POSTAGE

For orders and further enquiries, contact

WIA — NSW DIVISION

PO Box 410, Harris Park, NSW 2150 TELEPHONE (02) 9689 2417

REPEATER LINK

Will McGhie VK6UU

21 Waterloo Cr Lesmurdie 6076
will2@omen.net.au VK6UU@VK6BBR

Time

Finding the time to write this regular column is becoming more and more difficult but I would like to keep it going. One way around the time problem is to make the column shorter and even miss the odd month from time to time. There is a need for some focus on voice repeaters in Australia and perhaps this column has contributed. So with limited time a couple of topics for this month.

LIPDS

Rarely out of amateur radio news these days are LIPDS. An interesting event happened of recent, when the ACA rang me to say that one of our repeater sites was radiating the Royal Flying Doctor Service from HF onto 152.025 MHz, a LIPD frequency. It turned out an experiment to find out what this site would be like on HF was being conducted from this amateur repeater site. Without going into the detail, what was of interest was the ACA's initial comment to me. "We find it hard to believe that the LIPD is only radiating 100 mW, as it is S5 in Perth city." The distance is about 20 kilometres from our repeater site to the ACA monitoring position. LIPDS on this frequency can radiate up to 100 mW, effective isotropic power.

The ACA visited the site and found the LIPD was transmitting 70 mW. This 70 mW was fed via a 3dB coax loss into a 2dB gain dipole over an isotropic radiator. This equates to about 50 mW effective radiated power. A bit of a smile on my face as the ACA discovered that 50 mW can go a long way.

More LIPDS

In my work situation working in the RF and microwave area of the ABC, I get interesting requests from time to time, and this one involved using LIPDS.

In the television production area a program is under ongoing production that involves several stand-alone cameras. This type of production is very simple and does not involve the complex outside broadcast vehicle but just several cameras. Each camera records the same picture but from different positions. The pictures are then returned to the editing suite and a final program is produced. What is important is the timing of each camera, as each camera has what is called time code. This is a frame by frame number (25 per second) in order to make editing possible. Each tape from each camera can then be synchronised to within one twenty fifth of a second and precise editing done. The problem is how to make sure all cameras remain locked together with time code.

Cables can be run to each camera but this is often difficult. The solution is to radiate the time code on a radio frequency and a lightweight radio receiver picks up the time code and it is fed into the camera. All cameras have their own receiver and all cameras now have the same time code so they all have the exact same frame by frame time code information. The use of a LIPD frequency makes this easy.

No licence is required and low power is all that is required as the cameras are at the most 100 metres apart. The problem for me is what LIPD frequency, particularly in terms of what cheap lightweight equipment is available? To me it brings home the point that there are more uses for LIPD operation than you can imagine. Uses that have a genuine need for spectrum. The difficult decision is, what spectrum? Our 70cm band is one slice of spectrum that is under threat and just how to co-exist is of utmost importance.

FTAC (John Martin) has prepared a well thought out paper on what options we may or may not have, and it is under discussion. One important point John makes is that LIPD operation is here to stay, so we best get on with finding solutions that don't include removing LIPD operation from 70cm, and I agree. More on what we can and cannot do in regards to our 70cm repeater segment and living with LIPDS next month, time permitting.

This article took only one hour to write, edit, spell check and email to AR magazine, rather than the 4 to 8 hours it often takes. When you need to work fast you can. I just hope it is of some readability and interest to you, the reader.

ar

Have you ordered your

WVA Yearbook 2000

*More than a
callbook!*

(see ad inside
front cover for
details)

AWARDS

John Kelleher VK3DP

Federal Awards Officer

4 Brook Crescent, Box Hill South, Vic 3128 (03) 9889 8393

I have had frequent enquiries about CQ Magazine Awards. Apart from those who are subscribers to this magazine, little has been said about the awards available to radio amateurs world-wide. Here is a list of the awards...

Single band WAZ (Worked all CQ Zones)

5 Band WAZ

WARC Bands WAZ

RTTY WAZ

WNZ (Worked all Novice Zones)

160 Metre WAZ

Satellite WAZ

WPX (Worked all Prefixes)

CQ DX Award

All applications for WAZ should be sent to :-

The WAZ Manager

Jim Dionne K1MEM

31 DeMarco Road

Sudbury MA 01776.

Should you find this method unappealing, then you may wish to send your applications through me, or one of the following representatives here in VK land :- VK4LC, VK3AKK, or VK5IE, all QTHR.

The CQ application form 1479 should be used, which is available through myself, or one of the above members.

I still receive applications and upgrades for DXCC in an incorrect form.

Please send your correspondence as such strictly in alphabetical order of prefix. Without your help in this regard, it takes me four times as long to copy or transcribe your

listings to the DXCC database.

Poland : Polski Zwiasek Krotkofalowcow (PZK) Series.

General requirements. Awards are available to licensed amateurs or SWLs. Fees for each award are DM10, US\$7 or 10 Irc. All contacts, with the exception of Satellite or repeaters, regardless of band or mode, are valid for these awards. You must possess all necessary QSLs but GCR rule applies.

Apply to :-

PZK Awards Manager

Augustyn Wawrzunek SP6BOW

PO Box 61

PL-64-100 Leszno 1 Poland.

All Countries of the 15th Zone (AC 15 Z)

Contact at least 23 countries/call areas located in CQ Zone 15 as follows :-

Aland Island OH0

Albania ZA

Austria OE 2 call areas

Bosnia T9

Corsica TK

Czech Rep. OK

Estonia ES

Finland OH 3 call areas

Hungary HA

Italy I

Kaliningradsk UA2

Latvia YL

Lithuania LY

Macedonia Z3

Malta 9H

Market Reef OJ0

Poland SP 4 call areas

San Marino T7

Sardinia IS

Sicily IT9

Slovak Rep. OM

Slovenia S5

Vatican City HV

Yugoslavia YU 4 call areas

The contacts with 4 call areas of Poland are mandatory. Contacts since 1 Jan 55

Polska Award.

Contact provinces of Poland since 1 June 1975. Available in 3 classes. Class 1-

All 49 provinces. Class 2 - 35, and Class 3 - 20. When applying for a higher class,

please supply the number of your award (of a lower class) and a list of the additional contacts. The Province list is as follows :-

BB Bielsko Bialla SP9

BK Bialystok SP4

BP Biala Podlaska SP8

BY Bydgoszcz SP2

CH Chelm SP8

CI Ciecnanow SP5

CZ Czestochowa SP9

EL Elblag SP2

GD Gdansk SP2

GO Gorzow SP3

JG Jelenia Gora SP6

KA Katowice SP9

KI Kielce SP7

KL Kalisz SP3

KN Konin SP3

KO Koszalin SP1

KR Krakow SP9

KS Krosno SP8

LD Lodz SP7

LE Leszno SP3

LG Legnica SP6

LO Lomza SP4

LU Lublin SP8

NS Nowy Sacz SP9

OL Olsztyn SP4

OP Opole SP6

OS Ostroleka SP5

PI Pila SP3

PL Plock SP5

PO Poznan SP3

PR Przemysl SP8

PT Piotrow Tryb SP7

RA Radom SP7

RZ Rzeszow SP8

SE Siedlce SP5

SI Sieradz SP7

SK Skiermiewice SP7

SL Slupsk SP1

SU Suwalki SP4

SZ Szczecin SP1

TA Tamow SP9

TG Tarnobrzeg SP7

TO Torun SP2

WA Warszawa SP5

WB Walbrzych SP6

WL Wloclawwk SP2

WR Wroclaw SP6

ZA Zamosc SP8

ZG Zielona Gora SP3

Applicants are asked to give the abbreviations denoting provinces in alphabetical order.

W-21-M Work 21st Meridian

Issued for contacts with at least 16 countries located on the 21 east meridian.

QSO with Poland is mandatory. Contacts since Jan 1 1955. Countries list is :-

Aland Island OH0

Angola D2

WIA Awards are free to members.

Have you got yours?



Botswana A2
 C.Afr.Republic TL8
 Chad TT8
 Czech.Republic OK
 Estonia ES
 Finland OH
 Greece SV
 Hungary HA
 Kaliningradsk UA2
 Albania ZA
 Macedonia Z3
 Latvia YL
 Libya 5A
 Lithuania LY
 Namibia V5
 Norway LA
 Poland SP5
 Rep. Of S.Africa ZS2-6
 Rep. Of Zaire 9Q
 Romania YO
 Slovak Rep. OM
 Svalbard JW
 Sweden SM
 Yugoslavia YU

DX News

Marcel, ON4QM is presently active as FO0DEH from the AUSTRAL Islands.

FT5X/FR5HR QSLs are being rejected by the DXCC Desk.

VQ9- Chagos Islands.

Ron, AA5DX will be QRV until end of January 2000.

Jukka, OH2BR will be active on Pitcairn Island in January 2000.

9U - Burundi. Ragge, SM5DIC will be signing 9U5D until Christmas.

Abdollah,

EP2PM is QRV from Iran around 0400z using SSB on 14186 Khz.

Various operators will be using special prefix 3F until Jan 5 2000, to commemorate the acquiring of the Panama Canal. QSL via HPIAC.

Another group of operators will activate IOTA SA-05, Juan Fernandez Island between January 6-16 2000.

Until December 31, some Philippine amateurs will be using prefix DU67 to celebrate the 67th anniversary of the Philippine Amateur Radio Association.

Antarctica.

EM1KGG can be heard from the Vernadsky base on Galindez Island IOTA - AN-006. QSL via UT7UA.

Denis, VE2DPS will be active until December 22 from 3XY Guinea, his antenna is a G5RV. QSL to home call.

Best Regards, and good hunting.

73 de John, VK3DP.

ar

POUNDRING BRASS

S P Smith VK2SPS

9 Peak Street, Bateau Bay NSW 2261
 02 4334 7743

Merry Christmas to everyone and a very big thank you for your continued support and interest in this column, by the number of letters and phone calls received lately there is still great interest in telegraphy, once again thank you very much.

In a recent article in QST Magazine Vibroplex Company has recently reintroduced the Blue Racer and given it the name of "Millennium bug" or the "Blue Racer 2000".

The Millennium Bug sells for US\$179.95 (standard) which has a blue base and the deluxe model with Chrome base for US \$219.95.

The Company President is S. Felton (Mitch) Mitchell, W4OA. Mitch took over the company in 1994 and is the first radio amateur to do so. Mitch is re-introducing some of the old Vibroplex classics to his range of Bugs and Paddles and should be on sale early next year.

Further inquiries can be made to the following address: The Vibroplex Co. Inc. 11 Midtown Park Mobile AL, USA 36606

Turning to collectors of telegraphic paraphernalia, I've recently come across two very interesting books which are as follows.

Perera's Telegraph Collectors Guide 2nd Edition by Tom Perera. W1TP

Tom Perera has over 45 years collecting and trading experience and would have to be Americas most authoritative expert in this field today.

This book would make an excellent reference guide to all collectors worldwide and to historians.

The book covers such things as, advice on buying keys, adjustments, restoring old keys, manufacturer codes plus historical background on all keys.

Further information can be obtained from the following web site.

<<http://w1tp.com>>

The last book looked at was - A History of the GPO Mark 1,2 and 3 Morse Telegraph Keys. By Dennis Coacher G3LLZ

The book covers such subject's as.

- 1) Manufacturers Codes
- 2) Construction Details
- 3) Technical Drawings
- 4) Key Maintenance

I highly recommend this book to collectors of GPO Type Series Keys.

Until next month a very warm and Happy Christmas and to the new millennium 2000, a very safe and joyous New Year.

See you next year,

ar

FROM:

Asimov, Isaac

(1920-1992) b. Petrovichi, Russia.

At two-tenths the speed of light, dust and atoms might not do significant damage even in a voyage of 40 years, but the faster you go, the worse it is—space begins to become abrasive. When you begin to approach the speed of light, hydrogen atoms become cosmic-ray particles, and they will fry the crew. ...So 60,000 kilometers per second may be the *practical* speed limit for space travel.

Isaac Asimov, *Sail On! Sail On! In The Relativity of Wrong*, Kensington Books, New York, 1996, p 220.

SNIPPITS

CONTESTS

Ian Godsil VK3DID,
57 Nepean Highway, Aspendale, 3195

Contest Calendar December 1999 - February 2000

Dec 3/5	ARRL 160 Metres Contest	(CW)	(Nov 99)
Dec 4/5	EA DX Contest	(CW)	
Dec 11/12	ARRL 10 Metres Contest	(CW/SSB)	(Nov 99)
Dec 18	OK DX RTTY Contest		(Nov 99)
Dec 18/19	Croatian CW Contest		
Dec 18/19	International Naval Contest	(CW/SSB)	
Dec 19	RAC Canada Winter Contest	(CW/SSB)	
Dec 25/26	Original QRP Contest	(CW)	
Dec 25/26	Stew Perry Topband Distance Challenge	(CW)	(Nov 99)
Dec 26	Ross Hull Memorial VHF-UHF Contest	(CW/SSB)	
Jan 11			(Oct 99)
Jan 1/2	Original QRP Contest		
Jan 7-9	Japan International Low Band DX Contest	(CW)	(Dec 99)
Jan 8/9	Summer VHF-UHF Field Day Contest	(CW/SSB)	(Dec 99)
Jan 11	Ross Hull Contest - Final Day		
Jan 16	HA DX CW Contest		
Jan 28-30	CQ WW 160m DX Contest	(CW)	
Jan 29/30	REF CW Contest		(Dec 99)
Feb 5/6	Ten-Ten Winter Party	(SSB)	
Feb 12/13	WW RTTY WPX Contest		
Feb 12	Asia-Pacific Spint (CW)		
Feb 19/20	ARRL International DX Contest	(CW)	
Feb 26/27	RSGB 7 MHZ Contest	(CW)	
Feb 26/27	REF SSB Contest	(Dec 99)	
Feb 27	High Speed Club CW Contest		
Thanks this month to REF VK3KWA			

By now you will have seen the results of this year's Remembrance Day Contest. It was most pleasing to see them published so promptly after the event, so our sincere thanks go to Alek VK6APK for his efficient management.

As a VK3 I was delighted to see the improvement in the Division's score, but sorry that the "whipping up" that went on prior to the Contest did not quite achieve the winner's place.

There are always some who are not happy with aspects of a contest, particularly a big one like the RD. There is often room for improvement and your comments are always welcome. Certainly there may need to be an adjustment to one section of the Rules for next year - see comments below.

I have spoken to several people about the scoring formula. On the surface it seems inordinately complex. However, with a country as diverse as Australia, it really is most difficult to find a formula that is unbiased to everyone in all circumstances. Despite claims that the present formula "was devised by a VK3 to prevent VK3 winning" - a claim that I find extraordinary - it does seem that this formula affords the

best balance for everyone (quite apart from a personal preference that far more emphasis should be given to CW!).

1999, however, threw up one aspect with which I was most unhappy, viz the use by a group of VK3s of programs for fully automated, unattended QSOs in Packet mode. My concerns are:

- (1) Packet currently falls under the CW section, which it is not.
- (2) The operators of this mode did not submit Exchanges in accordance with the Rules for CW section, ie a three-digit format. Instead, their program allowed for only a two-digit style. Either the Contest Manager or I would have been quite justified in removing the logs from consideration on this ground alone.
- (3) While I agree with the Amateurs' Code that we should all be working to keep abreast of technology, I do not see that contesting has come to the stage where unattended operations can be said to be "within the Spirit of the Contest". There is no challenge or sense of achievement in just switching on a

machine, then walking away while it does the work for you!

From this I deduce that

- if there are operators who want this style of contest, then please present your ideas and we can organise something for you;
- if you would like a section for this style of operation in next year's RD, so be it. We can amend the rules to make it legal, even if The Spirit may still be open to debate.

Finally, I draw your attention to the fact that all WIA Co-ordinator positions fall vacant at the May AGM and applications should be received at Federal Office by February.

If anyone would like to apply for Contest Co-ordinator, here is a Job Specification for your consideration —

Federal Contest Co-ordinator — Job Specification

Applicants for the position of Federal Contest Co-ordinator are asked to consider the following guidelines>

1. report frequently to the member of the Federal Executive appointed to oversee Contest activity and to keep him fully informed, especially of budgetary costs;
2. liaise frequently with the Federal Office;
3. write an Annual Report in February each year for presentation at the WIA's Annual General Meeting;
4. liaise closely with the NZART Contest Co-ordinator;
5. liaise closely with other Contest Co-ordinators and Managers, both in Oceania and world wide;
6. produce a monthly information column in "Amateur Radio";
7. organise for production and forwarding of trophies at various times each year as appropriate;
8. keep accurate records of trophy winners and to arrange for engraving of Perpetual Trophies;
9. oversee the supplies of available certificates and to organise replacements when necessary;
10. write and post certificates on behalf of individual Contest Managers;
11. arrange a speaker for the annual Remembrance Day Contest and to produce and distribute tapes of the speech for each Division;
12. be available via telephone, postal mail and e-mail.

Spring VHF-UHF Field Day

Rule Clarification

The rules for the Spring VHF-UHF Field Day were published on page 48 of October "AR". The second rule under the heading "General Rules" needs clarification. The rule is: "Operators of stations in Section C may not make contest exchanges using their own call signs".

This is fine for operators of club stations, using the club's call sign rather than their own, but it doesn't quite work with non-club stations that use the call sign of one of their operators. Under the above wording, the amateur whose call sign was being used would be prohibited from operating himself! So the wording of this rule should be changed to: "Operators of stations in Section C may not make contest exchanges using call signs other than the club or group call sign."

Summer VHF-UHF Field Day 2000

John Martin (VK3KWA), Contest Manager

15 - 16 January, 2000 0100z Sat - 0100z Sun

The contest rules are the same as for the 1999 Spring Field Day. Please note the couple of minor changes that were discussed in more detail on page 48 of October 1999 "Amateur Radio".

The next Field Day should provide plenty of opportunities. It will take place over the last weekend of the Ross Hull Contest, so there will be extra home stations there to work. And if you live in Tasmania or anywhere within reach of it, remember that any Field Day contacts can be counted for the new George Bass Diploma offered by WIA Victoria.

I would like to briefly repeat my request to club stations for the names and call signs of operators, printed legibly so that I can read them!

Duration

VK6 only: 0400 UTC Saturday, 15 January to 0400 UTC Sunday, 16 January, 2000. All other call areas: 0100 UTC Saturday to 0100 UTC Sunday.

Sections

- A: Portable station, single operator, 24 hours.
- B: Portable station, single operator, any 6 consecutive hours.
- C: Portable station, multiple operator, 24 hours.
- D: Home station, 24 hours.

Single operator stations may enter both

Section A and Section B. If the winner of Section A has also entered Section B, his/her log will be excluded from Section B.

If two operators set up a joint station, they may enter Section C under a single call sign, or sections A/B under separate call signs. Stations with more than two operators must enter Section C.

General Rules

One call sign per station. Operators of stations in Section C may not make contest exchanges using call signs other than the club or group call sign. Operation may be from any location, or from more than one location. You may work stations within your own locator square. A station is portable only if its equipment, including antennas, is transported to a location other than the normal home location of its operator. Repeater, satellite and crossband contacts are not permitted. No contest operation is allowed below 50.150 MHz. Recognised DX calling frequencies must not be used for any contest activity. Suggested procedure is to call on .150 on each band, and QSY up.

Exchange RS (or RST), serial number and your four digit Maidenhead locator.

Repeat Contacts

Stations may be worked again on each band after three hours. If the station is moved to a new locator square, repeat contacts may be made immediately. If the station moves back into the previous locator square, the three hour limit still applies to stations worked from that square.

Scoring

For each band, score 10 points for each square in which your station operates, plus 10 points for each locator square worked, plus 1 point per contact. Multiply the total by the band multiplier as follows:

6m 2m 70cm 23cm Higher
x1 x3 x5 x8 x10

Then total the scores for all bands.

Sample Scoring Table

Band	QSO	Points	Locator	Points
Multiplier	Total			

6m 100 + 200 x 1 = 300

2m 60 + 120 x 3 = 540

etc. ———

Overall Total 840

Logs

For each contact: UTC time, frequency, station worked, serial numbers and locator numbers exchanged, points claimed. The front sheet should contain the names and call signs of all operators, postal address, station location and Maidenhead locator.

The section entered, a scoring table and a signed declaration that the Contest Manager's decision will be accepted as final.

Deadline

Logs must be received by Monday, February 14, 2000. Early logs would be appreciated. Logs may be posted to: WIA VHF-UHF Field Day Manager, 3 Vernal Avenue, Mitcham, Vic 3132. Logs may also be e-mailed (in ASCII text form ONLY) to <jmartin@xcel.net.au>

Japan International DX Contest

LF CW: 2200z 7 Jan - 2200z 9 Jan 2000

HF CW: 2300z 7 Apr - 2300z 9 Apr 2000

PHONE: 2300z 10 Nov - 2300z 12 Nov 2000

OBJECT is to work as many JA stations and JD1 islands as possible.

BANDS: LF CW 160/80/40; HF CW 20/15/10; Phone 80 - 10 (no WARC).

CATEGORIES: Single operator, single/multi-band high power (more than 100w o/p), single operator, single/multi-band, low power (less than 100w o/p), multi-operator and maritime mobile.

General

Operate for maximum of 30 hours only and show rest periods in log; single op must perform all tasks himself; multi-op must remain on band for at least 10 minutes and during this time multi-op may transmit on another band only if new station is multiplier; ops may use spotting networks.

Exchange

RST plus CQ Zone number. JAs will send RST plus Prefecture number (01 - 50). SCORE on 160m four points; 80m two points; 40/20/15m one point; 10m two points.

Scoring

The multiplier is total JA prefectures and JD1 islands worked (possible 50 per band).

Multiply total points by the multipliers.

LOGS (one per call sign) must show times in UTC; exchanges; multiplier first time worked; duplicate QSOs shown as no points; rest periods clearly marked; use separate sheet for each band.

Send logs and summary sheet to: JIDX Contest, c/o Five-Nine Magazine, PO Box 59, Kamata, Tokyo 144, Japan, by 28 Feb, 31 May or 31 Dec.

Logs may be submitted on 3.5 inch disk in ASCII with summary sheet, or by e-mail. For instructions send e-mail to <jidx-info@ne.nal.go.jp> with command #get jidxlog.eng or #get jidxlog.jpj

INTRUDER WATCH

Gordon Loveday VK4KAL

At the end of October, I received some reliable news, which may be rejected by most amateurs. How many operators have considered that the 3.5 to 3.7 MHz portion of the 80m band is only used by the amateur fraternity? We have all heard about Radio Pyongyang in North Korea on 3.560 MHz. Have you considered that this station might be operating legally?

Not all countries are members of the ITU and some members still go their own way in region 3. There are more than 2,667 legal operators in 3.5-3.7 MHz and 7,725 across

the 3 regions. None are in Australia thankfully. This shows how many registered users of the band there are.

This being so, we should be aware that the Amateur Service does not have 80m exclusively to itself. I've hinted at this before, maybe in not such a blunt way. We ALL have to learn to live with the situation and it can be done quite easily. Have patience picking your frequency. It is about time "frequency claiming" was stamped out, it is not the Amateur code.

A review of all illegal operations I have recorded since 1990 showed that the majority are listed as once only. They possibly "offend" daily under another callsign, (if any) or on another frequency. This fills my records with useless info with no chance of getting a "conviction" and represent little more than nuisance value reports. How genuine is the Amateur about getting the intruder removed?

I stress again; **single reports are useless.** An observer sincere about removing an offender must listen daily on the frequency for at least 10 minutes, to ascertain if the intruder is the "desired" one: a repeat offender.

Single reports are only left on my system for 2 months.

NB: At present my Freepost is under review. So until further advised please use 56 Keilambete Road Rubyvale Qld 4702.

Thank you.

Gordon Loveday FIWC

ar

73 Bob Harper VK4KNH

HERE IT IS the end of another year, and for me another job. That's right I am not continuing in my current role with AR although I expect to submit materials from time to time. Bill Rice is taking his well-earned rest with the knowledge that he is the longest serving Editor of AR. That alone deserves applause but the quality of his input has been excellent and it will be strange to not be receiving his corrections. I have to say that he has always been able to find errors that others have missed and has done so in less time than most would take to simply read the material.

In contrast to Bill's "Longest Serving Editor" title, I can claim to be the shortest serving as I was accepted as editor but my bid to produce AR was not successful. I was effectively editor for a few seconds. It was my decision to tie the two together and therefore I could not take up the appointment as Editor. I thank the divisions for their support of my application.

Colwyn Low has now been chosen and I trust that all the current contributors, both columnists and article writers will give him the support that I have been thankful for over the past year.

The AR team of contributors and editors are conscientious volunteers and their devotion and efforts should be recognised by the members in some form that endures. I suggest that the WIA present each with a Certificate of Appreciation for each year

of service to their fellow members. After all they are paid nothing and often spend their own money to help keep the magazine running.

This month we also lose Eric Jamieson VK5LP who has decided to retire and I know that there is an article in the pipeline on his contributions and experiences over the many years that he has written for AR. I look forward to reading that in January AR.

I was lucky enough to be on this AR team for one year and it was I think a good year. We have seen a lot of well-written articles and many by one particular person -Drew Diamond VK3XU.

I would like to personally thank Drew for his high quality, truly professional approach to his writing and for the variety of material he submits. His articles rarely need editing and invariably when I do find a spelling that I am not sure of, Drew's spelling is usually correct. His diagrams are so well drawn, not to mention detailed, that they never need redrafting. He provides crisp clear photographs that contain just the right balance of detail. In short, he has provided top quality, complex articles at the rate of at least one a month. Now that is dedication!

Many other columnists and article writers have provided materials of a very professional nature and I doubt that the average member would realise the work that it takes to produce AR every month. Yet the scant feedback that we receive is often negative or requesting content that we

would happily publish if we received suitable material.

In my humble opinion the magazine already covers a wide range of topics but would benefit from some construction articles on Microwave, ATV and perhaps Repeaters. Where are the beam antenna articles that were once in almost every radio magazine?

From the technical angle we obviously have some very talented writers out there and some that write articles for the IREE, IEEE, and other engineering societies. Perhaps a version in layman terms for AR would be fairly easy to produce.

There are other members working for Universities and TAFE. They no doubt write teaching notes that could be adapted to AR for those of us that need a better grounding.

We need to nurture the High School Teachers both to write on basic topics and to develop an interest in AR among students. As I see it if there are no new Radio Amateurs there will soon be no Amateur Radio.

What do I wish for this Christmas - some renewed public enthusiasm in AR, some new interests, and some new members?

What do I think all amateurs should have as their New Year Resolutions the first of January, 2000? To bring at least one new person into our hobby, to make better use of our bands, to use at least one new band, to build at least one home brew item, to make the image of Amateur Radio shine in the eyes of the public.

Merry Christmas and a Happy New Year, Bob VK4KNH

SPOTLIGHT ON SWLING

by Robin L. Harwood VK7RH

5 Helen Street, Newstead Tasmania 7250

(03) 6344 2324

E-mail: robroy@tassie.net.au

In a few weeks, this year of 1999 will be over as will the Millennium. This will be extensively covered in all the print and electronic media as you would expect. However the primary focus is going to be on the unknown effects of the Year 2000 or Y2K bug. This bug has the potential to disrupt everyday life throughout the entire Globe. Programmers once wrote years in two digits instead of four, which has led to some programs potentially failing when the number changes from 99 to 00. The first individual who first spotted this anomaly was scoffed and ignored. He apparently wrote a simple correcting code on his C64 computer and if it had been adopted as standard then, literally billions of dollars could have been saved.

Eventually the realisation that there was a huge problem as computers had proliferated throughout the world, all programmed with 2 digits instead of four for the years. Since then, governments and the commercial sector have been frantically working to see if their systems are Y2K compliant before December 31st at midnight local time or UTC. Some have cautiously opted not to take any chances. The Australian Stock Exchange will not trade on December 31st. Ansett Airlines will not be flying any aircraft between 11 p.m. and 12 noon the next day. Also emergency services are on standby not only here in Australia but in other nations on New Year's Eve and beyond.

In North America there have been several major nationwide exercises of emergency services held over the past three months in preparation for any eventuality resulting from the Y2K bug. Because of the possibility of power, telephone and satellites being down, it was realised that co-ordination would have to be primarily over high frequency and in voice. My American and Canadian contacts say that there is likely to be intense activity on the utility frequencies between 5.2 and 5.3 MHz, 10.2 to 11.00 MHz, 13.8 to 14 MHz and locally over VHF/UHF.

The only local reports of the effects I have heard of Y2K are of a Tasmanian council, who made a big statement that they were Y2K compliant, apparently issuing summons for parking fine defaulters to

appear in court on a date in February 1900. Red-faced officials hurriedly withdrew these and sent them out with the correct year.

The end of the Millennium has been the focus of many programs over international broadcasters. Over the past year, the BBC World Service has been airing retrospective programs looking back over the 20th century, a format also adopted by others. However as Britain's Royal Observatory and the American National Bureau of Standards has pointed out, the century actually does not end until December 31st 2000. This has been ignored by the Public and Media alike, choosing instead to pursue the perception that it is going to end this year.

The Sydney to Hobart Yacht race is on this year after last year's traumatic event. Substantial changes have been made to safety and all yachts must now be fitted with satellite tracking transponders allowing the controllers to instantly ascertain their location. I do not know if HF will continue to be utilised as it has in previous years, although HF is still mandatory on yachts. The channels of 2182, 4125 and 4483 kHz should be monitored yet I find that 2524 kHz is always active with other races being held concurrently.

Radio New Zealand International has been stuck on 17675 kHz since the failure of a switch. I do not know when they will resume on the lower channels in the evening hours. The broadcaster now has to pay commercial rates for their relays of the private Radio Sport network. Apparently RNZI are looking for a sponsor to pay out US\$37,000 to continue shortwave relays of these. Many listeners have been puzzled because Radio Sports apparently relays a Florida sports network overnight complete with American commercials and RNZI has relayed these when they have been carrying special overnight broadcasts of Sport involving New Zealanders.

I was extremely disappointed to miss out hearing the final shortwave broadcast from Radio St Helena on Sunday October 23rd. The transmission was on 11092.5 kHz from a disused Cable & Wireless USB transmitter. Propagation was poor and I was

also experiencing severe splatter from China National Radio on 11100 kHz. Monitors on the East Coast of North America were indeed fortunate and the signals made it to Europe yet were not as good as last year. The transmitter has now been permanently retired yet I believe that enthusiasts are eagerly hunting around for another transmitter to continue these semi-annual broadcasts.

Incidentally I can confirm that East Timor is off HF after the Indonesians turned off the senders and departed with them. There are moves to re-establish a community radio network primarily on FM with Australian aid. I don't know when HF will be reactivated yet no doubt it will. Timor is pretty mountainous and a substantial number of Timorese are in Australia, Indonesia and in Portugal. East Timor will be under UN administration until full independence and they too will probably have a network.

In conclusion, may I extend my best wishes for the Season and hope that 2000 will be a happy one as we start the millennium. I also hope that you are not inconvenienced by Y2K, if it is at all.

Good monitoring and 73

Robin L Harwood VK7RH

ar

Another Carol to sing round the Xmas tree

by Bob Harper VK4KNH

Jingling Valves

Chorus

Jingling valves, rattling valves,

Stored for another day,

You know how to make a regen go.

To tune in Santa's Sleigh.

Santa was a ham,

With lots of skeds to keep.

What do you think he does at night,

When the elves are sound asleep.

Chorus

Tuning HF bands,

He stays up all the nights,

Reflecting lots of QRP,

Off all those northern lights.

Chorus

Now every little ham,

Off to their bed should go,

To listen for the little bells

And for that Ho, Ho Ho.

HF PREDICTIONS

by Evan Jarman VK3ANI

34 Alandale Court, Blackburn Vic 3130

These graphs show the predicted diurnal variation of key frequencies for the nominated circuits.

These frequencies as identified in the legend are:-

- Upper Decile (F-layer)
- F-layer Maximum Useable Frequency
- E-layer Maximum Useable Frequency
- Optimum Working Frequency (F-layer)
- Absorption Limiting Frequency (D region)

Shown hourly are the highest frequency amateur bands between these key frequencies: when usable. The path, propagation mode and Australian terminal bearing are also given for each circuit.

These predictions were made with the Ionospheric Prediction Service program: ASAPS version 4.

Adelaide-Accra 242

First F 0-5 Shor 14682 km

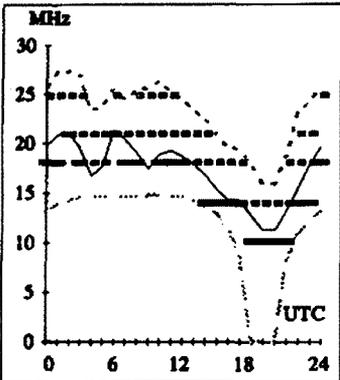

Brisbane-Auckland 123

First 1F7-15 1E0 Shor 2289 km

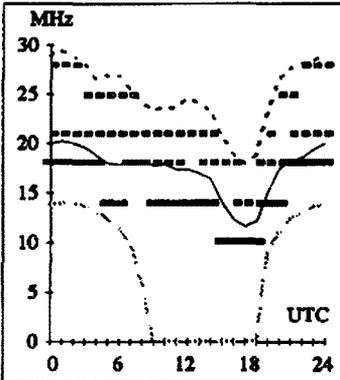

December

1999

T index: 148

Legend

UD
 F-MUF
 E-MUF
 OWF
 ALE
 10%-50%
 50%-90%
 90%-100%

Frequency scale

Time scale

Adelaide-Moscow 318

First F 0-5 Shor 13807 km

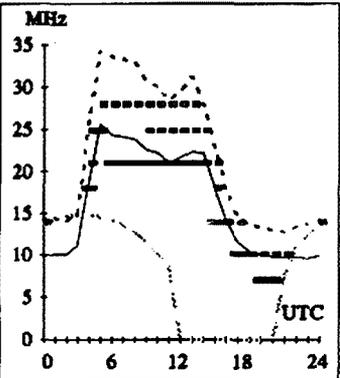

Brisbane-London 147

First F 0-5 Long 23498 km

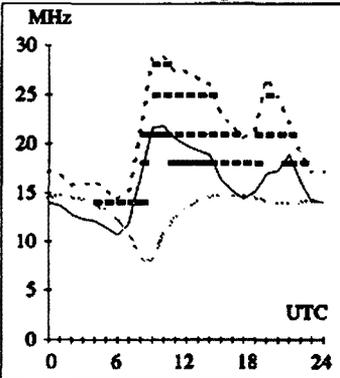

Canberra-Capetown 219

Second 4F5-14 4E0 Shor 10778 km

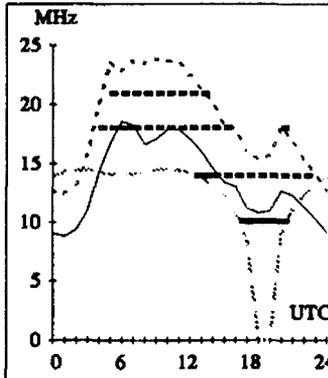

Darwin-Invercargill 144

Second 3F13-23 3E Shor 5159 km

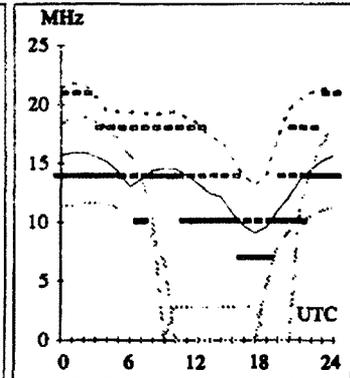

Adelaide-Ottawa 58

First F 0-5 Shor 16901 km

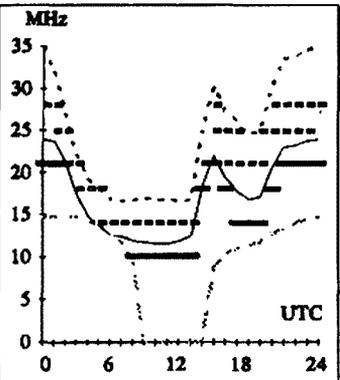

Brisbane-London 327

First F 0-5 Shor 16526 km

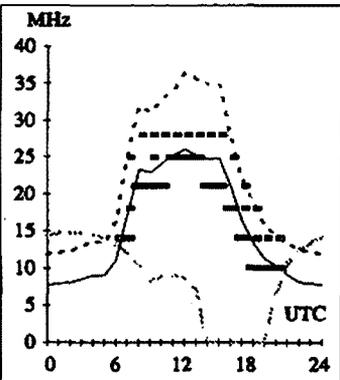

Canberra-Los Angeles 62

First F 0-5 Shor 12309 km

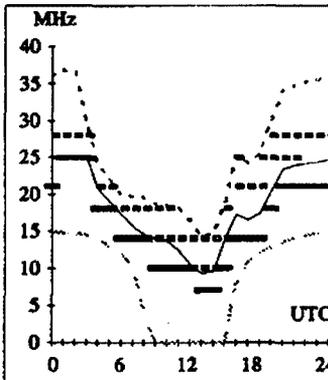

Darwin-Paris 322

First F 0-5 Shor 13818 km

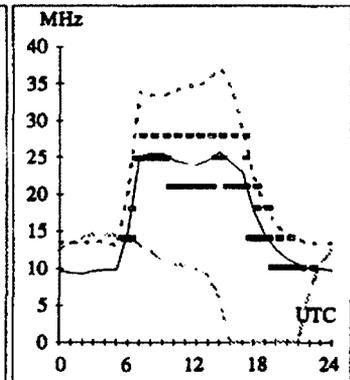

Adelaide-Vancouver 49

First F 0-5 Shor 13421 km

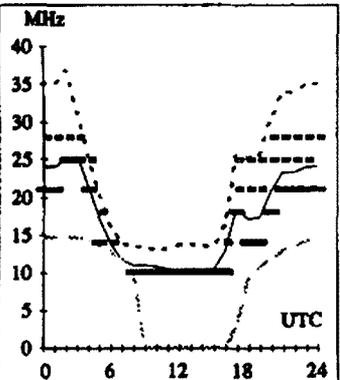

Brisbane-Manila 320

First 2F3-11 2E0 Shor 5813 km

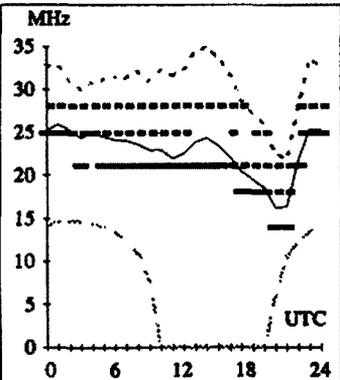

Canberra-Wellington 115

First 1F7-15 1E0 Shor 2324 km

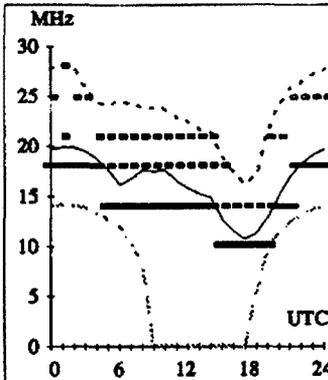

Darwin-Tokyo 10

First 2F4-11 2E0 Shor 5436 km

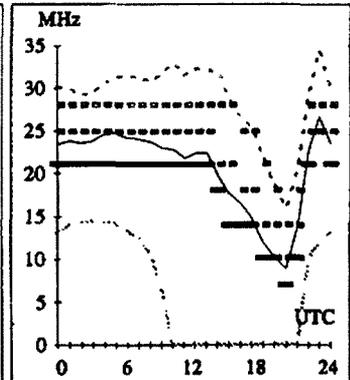

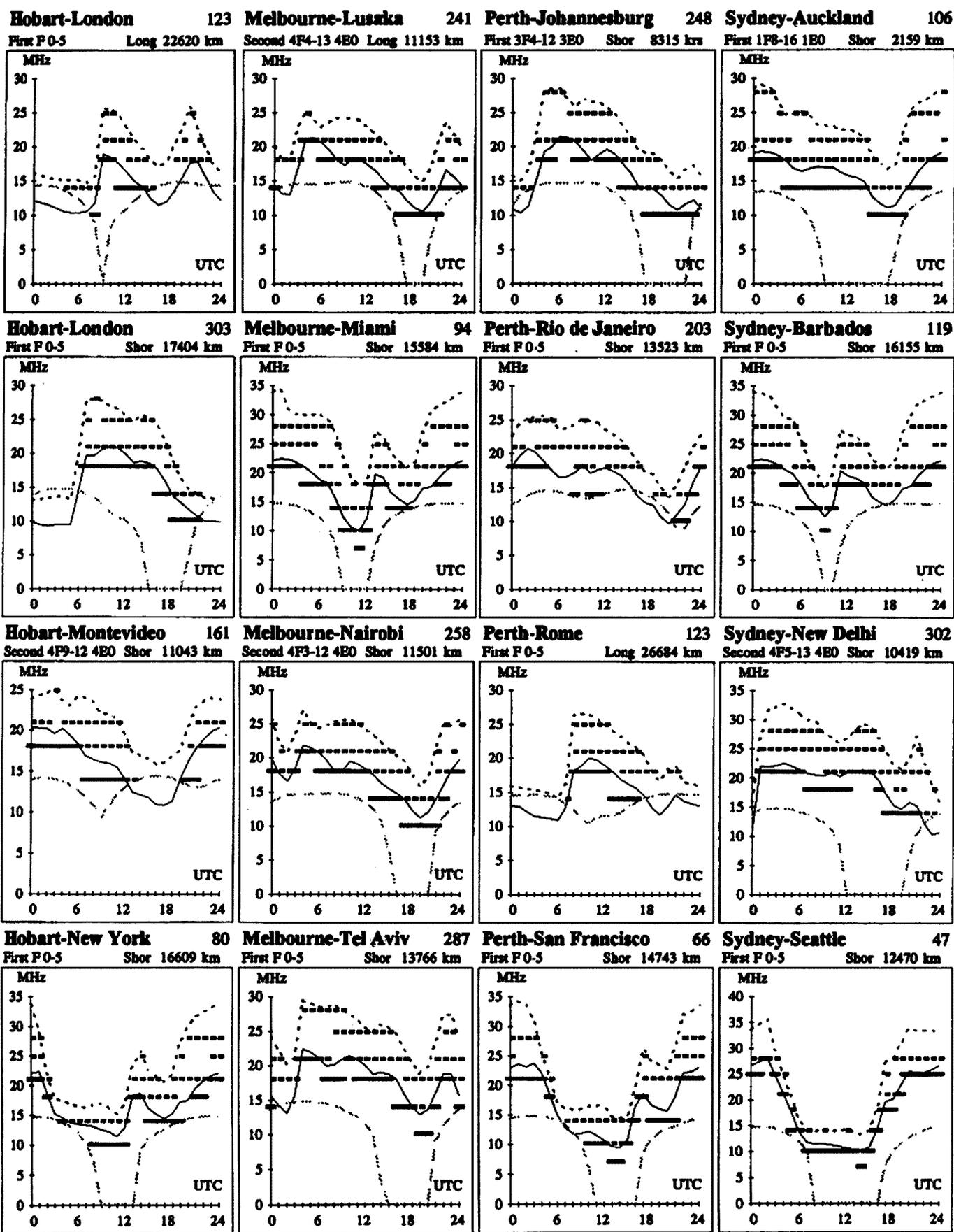

HAMADS

- Hamads may be submitted on the form on the reverse of your current Amateur Radio address flysheet. Please print carefully, especially where case or numerals are critical.
- Please submit separate forms for For Sale and Wanted items, and be sure to include your name, address and telephone number (including STD code) if you do not use the flysheet.
- Eight lines (forty words) per issue free to all WIA members, ninth and tenth lines for name and address. Commercial rates apply for non-members.
- Deceased estates Hamads will be published in full, even if the ad is not fully radio equipment.
- WIA policy recommends that the serial number of all equipment for sale should be included.
- QTHR means the address is correct in the current WIA Call Book.
- Ordinary Hamads from members who are deemed to be in general electronics retail and wholesale distributive trades should be certified as referring only to private articles not being re-sold for merchandising purposes.
- Commercial advertising (Trade Hamads) are pre-payable at \$25.00 for four lines (twenty words), plus \$2.25 per line (or part thereof), with a minimum charge of \$25.00. Cheques are to be made out to: WIA Hamads.
- Copy should be typed or in block letters, and be received by the deadlines shown on page 1 of each issue of Amateur Radio, at:

Postal: *Newsletters Unlimited, 29 Tanner Street, Richmond, 3121*
Fax: *03 9428 4242* E-mail: *news@webtime.com.au*

Please only send your Hamad once

Please send Hamads by mail OR fax OR email (much preferred).

Please do not send by more than one method for any one ad or issue, it is confusing.

FOR SALE ACT

• Tower triangular 14m "ROHN" (USA) foldover 8 guys rotor TH6 4EL beam new coax \$450. Realistic AX-190 11-band Comm Rx HAM bands \$160. Realistic SX-190 11-band SW Rx \$160. Both XTAL band set plus VFO. Speakers as new. VKIUS QTHR 02 6281 3587

• Kenwood DFC230 external VFO for TS1205/V txcvrs c/w cables mounting bracket manual and microphone s/n 1041377 \$120 Ph Eric VKIEP 02 6249 6907 QTHR.

FOR SALE NSW

• YAESU FT107 one owner YM35mic AC power supply, serviced. DSE service manual, mint condition WARC \$500 plus freight. Allan VK2AGR 02 4471 1059 Lic'd hams only.

• IC725 HF transceiver in excellent condition. 12V.A.C. Best offer. Fax 02 6021 8813 Tel 02 6021 8897 email gscott@albury.net.au.

• Yaesu FT-101Z HF TXCVR S/N 9C020308. G.C. Spare PA valves. Built in fan. DC-DC converter \$250.00. Kenwood TR-2400 2m FM TXCVR S/N 0115038. Leather case, spkr mic, AC charger, car charger. G.C. \$120.00 Kenwood AT-200 antenna tuner S/N 840855. \$120.00 Dipole antenna kit 80, 40, 20, 10m. Never used. \$50.00 VK2KRQ John (02) 4369 0458 12A Rickard Road Empire Bay NSW

• Internet Flea Market - see the Waverley Amateur Radio Society's website for club and members items for sale and wanted. Its URL is http://www.zip.com.au/~sb/wars/w_flea.htm

FOR SALE VIC

• DSE 3-15v 25amp regulated power supply, D3800 twin meters EC \$210. Kenwood PG-3G DC line noise filter 25 amp new, \$35. Comet C-400 SWR & power meter 430-450 MHz and UHF CB. As new \$55. Len VK3BMY. 03 5862 3116.

• Yagi antenna, 6m 3 El. Good condition, gamma matched. CUSHCRAFT 6m Ringo, near new, plus 18 (60ft) RG218 Coax cable with PL259 plugs and also ATU for 6m. These 4 items for only \$85 the lot. (ex QTH) EMTRON EP-2000 cross needle meter for SWR/PWR. 20/200/2000.watts, 1.8 to 60MHz. As new, \$75. Equipment console, laminex desk level, 3 upper shelves and 1 shelf underneath plus 2 storage cabinets, plenty leg room. 5 double power points, circuit breaker and AC voltmeter. Solid construction. Ready to plug in and use. Easy to transport in two sections. Dimensions H5'10", W4'10", D2'. Worth inspection \$65 o n o. Andy VK3UJ QTHR 03 9726 8879

• Kenwood power mic MC60A 18 months old s/n/ 122 \$130. VK3NR 03 9367 6910. Kenwood headphone HS50. 1 year old. \$105. VK3NR Jim.

• Tower - 40ft wind up lattice includes all necessary hardware in good condition. \$350. Ph Michael VK3MRG 03 9747 9342 A.H.

• High voltage power supply, 2500V @ 500mA, 1A pk. Huge oil filled transformer, oil filled block paper capacitors, soft start. Beautifully made, 260W x 570D x 490H, \$250. Single band power

amplifier (40m CW), 900W output, good working order, could rebias for SSB, \$90. Peter VK3APN QTHR (03) 9337 9981 pnesbit@melbpc.org.au

• One 90ft wind up telescopic lattice tower with base. Good condition. Phone Dave VK3JKY 03 59774808

FOR SALE SA

• Kenwood TS-130S \$450. AT-130 ATU \$120. 120 Ext VFO \$120. MC 50 desk mic \$80. Mobile bracket \$60. Sell lot \$800. More for sale send s a s e for list. VK5MAP Paul. QTHR 08 8651 2398

• TS-430S HF transceiver with optional filters, service manual, in original carton. Excellent condition. \$900 o.n.o. David - Clark headset with NATO plug and adaptor. Suitable for helicopters. Excellent condition \$300 o.n.o. John VK5KBE QTHR. 08 8250 7259

• CREATE model RC5 antenna rotator serial No 043397E. Manual. 40mtrs connecting cable. Little used. \$350. Derek VK5AFP QTHR 0883830447. Email- glenhardy@chariot.net.au

• AR7 Power Supply, Kingsley Radio and RAAF identification plates on front panel, 12VDC/240VAC PSU type as shown in the AR7 manual, with spare 6X5GT valves, \$40. Norbert VK5MQ (08) 87230315 QTHR

FOR SALE WA

• CUSHCRAFT R-7 seven band vertical. This 5/8 wave antenna gives 3db advantage over the normal 1/4 wave ground plane. Doesn't need cumbersome radials \$300. Call MARV VK6WW 08 9375 5946.

FOR SALE TAS

• 1 TONO 150 watt all mode linear amp with switchable preamp, as new with book and box, \$300 FIRM. 1 Oskerblock VHF/UHF SWR/POWER meter, perfect condition with instructions \$100 FIRM. 1 HF SWR/POWER meter with twin meters is rated at 100watts perfect condition, \$80 o.n.o. 3 Kenwood MB-403 mobile mounting brackets, new in boxes to suit TS-430/440 etc \$30 ea FIRM. 300 5 1/4 floppy disks some have programs, the lot \$20. 1 ICOM IC-71A communications receiver, this unit is in perfect condition and comes with leads and instruction manual. \$750 FIRM. Kenwood TH-78A FM dual hand held in mint condition with charger handbook and box, it also comes with these optional extras, carry case, SMC33 speaker/microphone, BT-8 dry cell battery case, and car cigarette lighter power charger/regulator, \$600 o.n.o 1 MH-1 B8 YAESU microphone, brand new in box, \$50 FIRM. 1 Kenwood SW200-A SWR/Power control head, in good condition in original box, no couplers. \$100 FIRM. 1 grid dip meter, home brew, very good condition, \$40 FIRM. Approx 300 brand new boxed radio and TV valves to be sold as one lot \$100 FIRM. 1 Toshiba 386 laptop docking station \$25. 1 Compaq 386 laptop docking station \$25. Ph David VK7ZSDJ 03 6425 2030, mobile 0413 219 680

<http://www.hamsearch.com>
a not-for-profit site that is a
search engine for hams

WANTED NSW

- **691DM** all mode transceiver. Ros VK2ZRE QTHR 02 6454 2249
- **Kenwood ATU180** Tony VK2VIC Ph 0412 809 590 or email tonestar @ interact.net.au
- **YAESU FC10** auto tuner or equiv. VK2VUX Ph 02 6772 3006. Fax 02 67723996
- **Old valve receivers** no matter what condition. Manuals parts all welcome. Don't throw it out, give me a call. Specialise in big, heavy sets. Call John 02 9533 6261
- **6M Multi Mode** Transceiver or Transverter to suit FT 101E. Jim VK2ZVJ.(02) 4443 2277 or Email brownsarre@fastrac.net.au.

WANTED VIC

- **Two Philips UHF FM 828** transceivers T band in good condition. To be used for UHF links in the East Gippsland Repeater network. Details to Bob VK3ZAN. Ph 03 51567654. or Paket VK3ZAN@VK3BVP.Vic. or Email Bobprille@net-tec.com.au
- **AMR100** receiver made by AWA during WWII. Also looking for a Barlow Wadley XCR-30 mark 2. Contact Fred VK3JM 03 9801 4972
- **Hi-mound MK 701** paddle for EL keyer also meter for FT-101E. Lindsay VK3ANJ 03 5155 1380

WANTED QLD

- **Wanted 7289, 3CX100A5** or similar tubes. Used pullouts fine. PH 07 4972 9811 Stuart VK4YFI
- **YAESU FT101B** instruction manual; 6JS6C power amplifier tubes. Any 101B accessories. Kenwood SP520 speaker matches TS520S DS-1A DC-DC converter; AT-200 ATU. Kenwood TL922 working or not. HENRY linear amplifier HF console model preferred. Tubes 572B; 6146B; 3-5002G John Abbott VK4SKY 0417 410 503 PO Box 1166 Coolangatta 4225 QLD.

MISCELLANEOUS VIC

- **Geelong Radio and Electronics Society.** Hundreds of antique to modern radio items from chassis to complete sets. Surplus from our electronic and museum collection. Full listing, additional information and contacts on web site <http://www.pccare.net.au/~keithv/> Auction on Sunday 26th February 2000 at GRES clubrooms.

PLEASE NOTE

Our Hamad typist is not an expert in your field.

Please write legibly on your form, in capitals and lowercase, and use legitimate abbreviations.

This saves excessive corrections by the proofreader, and reduces the chance of errors being published, which inconveniences everyone.

TRADE ADS

• AMIDON FERROMAGNETIC CORES:

For all RF applications. Send business size SASE for data/price to RJ & US Imports, PO Box 431, Kiama NSW 2533 (no enquiries at office please ... 14 Boanyo Ave Kiama).

<www.cyberelectric.net.au/~rjandusimports>

Agencies at: Assoc TV Service, Hobart; Truscotts Electronic World, Melbourne and Mildura; Alpha Tango Products, Perth; Haven Electronics, Nowra

- **WEATHER FAX** programs for IBM XT/ATs *** "RADFAXZ" \$35.00, is a high resolution

short-wave weather fax, Morse and RTTY receiving program. Suitable for CGA, EGA, VGA and Hercules cards (state which). Needs SSB HF radio and RADFAX decoder. *** "SATFAX" \$45.00, is a NOAA, Meteor and GMS weather satellite picture receiving program. Needs EGA or VGA & WEATHER FAX PC card, + 137 MHz Receiver. *** "MAXISAT" \$75.00 is similar to SATFAX but needs 2 MB of expanded memory (EMS 3.6 or 4.0) and 1024 x 768 SVGA card. All programs are on 5.25" or 3.5" disks (state which) plus documentation, add \$3.00 postage. ONLY from M. Delahunty, 42 Villers St, New Farm QLD 4005. Ph 07 358 2785.

**A new year
a new century
a new millennium
a new Amateur
Radio
era!
see you in 2000**

The
Wireless Institute of Australia
Wishes all Amateurs, Advertisers
and especially,
WIA members and their families
a
Very Merry Christmas
and a
Happy and Prosperous
New Year.

WIA Division Directory

The WIA consists of seven autonomous State Divisions. Each member of the WIA is a member of a Division, usually in their residential State or Territory, and each Division looks after amateur radio affairs within its area.

Division	Address Officers	News Broadcasts	Note: All times are local. All frequencies MHz.	Fees
VK1 ACT Division GPO Box 600 Canberra ACT 2601	President Gilbert Hughes Secretary John Woolner Treasurer Les Davey	VK1GH VK1ET VK1LD	VK1WI: 3.570 LSB, 146.950 FM each Sunday evening from 8.00pm local time. The broadcast text is available on packet, on Internet aus.radio.amateur.misc news group, and on the VK1 Home Page http://www.vk1.wia.ampr.org	(F) \$72.00 (G) (S) \$58.00 (X) \$44.00
VK2 NSW Division 109 Wigram St Parramatta NSW (Office hours Mon-Fri 1100-1400) (PO Box 1066, Parramatta 2124) Phone 02 9689 2417 Freecall 1800 817 644 Fax 02 9633 1525	President Michael Corbin Secretary Eric Fossey Treasurer Eric Van De Weyer Web: http://marconi.mpce.mq.edu.au/wia e-mail: vk2wi@ozemail.com.au	VK2YC VK2EFY VK2KUR	From VK2WI 1.845, 3.595, 7.146*, 10.125, 14.160, 24.950, 28.320, 29.120, 52.120, 52.525, 144.150, 147.000, 438.525, 1281.750 (* morning only) with relays to some of 18.120, 21.170, 584.750 ATV sound. Many country regions relay on 2 m or 70 cm repeaters. Sunday at 1000 and 1930. Highlights included in VK2AWX Newcastle news, Monday 1930 on 3.593 plus 10 m, 2 m, 70 cm, 23 cm. The broadcast text is available on the Internet newsgroup aus.radio.amateur.misc , and on packet radio.	(F) \$69.00 (G) (S) \$56.00 (X) \$41.00
VK3 Victorian Division 40G Victory Boulevard Ashburton VIC 3147 (Office hours Tue & Thur 0830-1530) Phone 03 9885 9261 Fax 03 9885 9298	President Jim Linton CEO Barry Wilton Secretary Peter Mill Web: http://www.tbsa.com.au/~wia/vic/ e-mail: vk3wi@rnt.com.au	VK3PC VK3XV VK3APO	VK3BWI broadcasts on the 1st and 3rd Sunday of the month at 8.00pm. Primary frequencies, 3.615 LSB, 7.085 LSB, and FM(R)s VK3RML 146.700, VK3RMM 147.250, VK3RWG 147.225, and 70 cm FM(R)s VK3ROU 438.225, and VK3RMU 438.075. Major news under call VK3WI on Victorian packet BBS and WIA VIC Web Site.	(F) \$75.00 (G) (S) \$61.00 (X) \$47.00
VK4 Queensland Division GPO Box 638 Brisbane QLD 4001 Phone 07 5496 4714	President Colin Gladstone Secretary Peter Harding Treasurer Alistair Eirick e-mail: wiaq@brisbane.dialix.com.au Web: http://www.wiaq.powerup.com.au	VK4ACG VK4JPH VK4FTL	VK4WIA: 1.825 MHz SSB, 3.605 MHz SSB, 7.118 MHz SSB, 14.342 MHz SSB, 21.175 MHz, 28.400 MHz SSB, 29.220 MHz FM, 53.725 MHz FM, 147.000 MHz FM, 438.500 MHz (Brisbane only), and regional VHF/UHF repeaters at 0900 hrs EAST Sunday. Repeated on 3.605 MHz SSB & 147.000 MHz FM at 1930 hrs EAST Monday. Broadcast news in text form on packet under WIAQ@VKNET.	(F) \$74.00 (G) (S) \$60.00 (X) \$46.00
VK5 South Australian Division (GPO Box 1234 Adelaide SA 5001) Phone 08 8294 2992	President Jim McLachlan Secretary David Minchin Treasurer John Butler	VK5NB VK5KK VK5NX	VK5WI: 1827 kHz AM, 3.550 MHz LSB, 7.095 AM, 14.175 USB, 28.470 USB, 53.100 FM, 147.000 FM Adelaide, 146.700 FM Mid North, 146.800 FM Mildura, 146.825 FM Barossa Valley, 146.900 FM South East, 146.925 FM Central North, 147.825 FM Gawler, 438.425 FM Barossa Valley, 438.475 FM Adelaide North, ATV Ch 35 579.250 Adelaide. (NT) 3.555 USB, 7.065 USB, 10.125 USB, 146.700 FM, 0900 hrs Sunday. 3.585 MHz and 146.675 MHz FM Adelaide, 1930 hrs Monday.	(F) \$76.00 (G) (S) \$61.00 (X) \$47.00
VK6 West Australian Division PO Box 10 West Perth WA 6872 Phone 08 9351 8873	Acting Pres. Cliff Bastin Secretary Christine Bastin Treasurer Bruce Hedland-Thomas Web: http://www.faroc.com.au/~vk6wia/ e-mail: vk6wia@faroc.com.au	VK6LZ VK6ZLZ VK6OO	VK6WIA: 146.700 FM(R) Perth at 0930hrs Sunday relayed on 1.825, 3.560, 7.075, 14.116, 14.175, 21.185, 29.680 FM, 50.150 and 438.525 MHz, country relays 3.582, 147.200 (R) Cataby, 147.350 (R) Busselton and 146.900 (R) Mt William (Bunbury). Broadcast repeated on 146.700 at 1900 hrs Sunday relayed on 1.865, 3.563 and 438.525 MHz: country relays on 146.350 and 146.900 MHz.	(F) \$62.00 (G) (S) \$50.00 (X) \$34.00
VK7 Tasmanian Division PO Box 271 Riverside TAS 7250 Phone 03 6425 2923 Fax 03 6425 2923	President Ron Churcher Secretary Tony Bedelph Treasurer John Bates Web: http://www.wia.tasnet.net	VK7RN VK7AX VK7RT	VK7WI: 146.700 MHz FM (VK7RHT) at 0930 hrs Sunday relayed on 147.000 (VK7RAA), 146.725 (VK7RNE), 146.825 (VK7RMD), 3.570, 7.090, 14.130, 52.100, 144.150 (Hobart), repeated Tues 3.590 at 1930 hrs.	(F) \$74.00 (G) (S) \$60.00 (X) \$46.00
VK8 Northern Territory (part of the VK5 Division and relays broadcasts from VK5 as shown, received on 14 or 28 MHz).				

Membership Grades

Full (F) Pension (G) Needy (G) Student (S) Non receipt of AR (X)
Three-year membership available to (F) (G) (X) grades at fee x 3 times.

ADVERTISERS INDEX

Amateur Transceiver Radio	23	G. & C. Communications.....	IBC
Andrews	14	Tower.....	35
ATN Antennas.....	35	WIA NSW Division	44
Dick Smith	OBC, 28,29		

TRADE PRACTICES ACT

It is impossible for us to ensure that the advertisements submitted for publication comply with the Trade Practices Act 1974. Therefore, advertisers and advertising agents will appreciate the absolute need for themselves to ensure that the provisions of the Act are strictly complied with.

VICTORIAN CONSUMER AFFAIRS ACT

All advertisers are advised that advertisements containing only a PO Box number as the address cannot be accepted without the addition of the business address of the box-holder or seller of the goods.

G. & C. COMMUNICATIONS

Graham Brennan VK3 KCS



HF Transceiver TS-870S

We're proud to introduce you to the TS-870S All-Mode HF Transceiver with *Next Generation Digital Signal Processing* at the IF stage on transmit and receive. This radio has set entirely new performance standards, unmatched by any other product in its class. With the TS-870S as the centrepiece of your station, you will experience the top level of HF operating convenience.

INTELLIGENT DIGITAL ENHANCED COMMUNICATIONS SYSTEM

Features at a glance:

- | | | |
|--|----------------------------------|----------------------------|
| 160 m ~ 10 m amateur band operation | 57.6 Kbps computer control | 100 W output |
| 100 kHz ~ 30 MHz general coverage receiver | Built-in K1 LogiKey | AIP system |
| Next Generation IF-stage DSP (Digital Signal Processing) | Built-in automatic antenna tuner | Dual antenna terminals |
| DSP filters & noise reduction | IF Auto-Notch | Programmable function keys |
| Speech processor | Beat Cancel | |
| | Variable AGC circuit | |

KENWOOD
Amateur and
Commercial
Systems

GME Electrophone
AM/SSB &
UHF CB
Radios

BARRETT
R.F.D.S. HF SSB
Radios

uniden
AM/SSB & UHF
Radios and
Scanners

Talk to us about your
favourite brand. You could
be pleasantly surprised

RF Industries
Antennas and
Accessories

DIAMOND
Antennas

**SALES
INSTALLATIONS
REPAIRS**

We specialise in Australia-wide mail order

Cheque or money order

(03) 5996 3298

e-mail: gccom@netspace.net.au

www.netspace.net.au/~gccom

Fax (03) 5995 0184

19 Arleon Crescent, Cranbourne 3977

An active amateur offering professional service, advice and product.

YAESU VX-1R MICRO DUALBAND HANDHELD TRANSCEIVER

**Wide receiver coverage, leading edge features,
and Lithium Ion technology, packaged for
convenience at a price that will surprise!**

**PRICE
BREAKTHROUGH**



VX-1R shown full size

The Yaesu VX-1R is one of the world's smallest dualband amateur rigs, sporting a 2m/70cm transceiver with wideband receiver in a case sized just 47 x 81 x 25mm WHD. It has impressive memory and scanning facilities as well as receive coverage of VHF and UHF TV, AM and FM broadcast bands, AM aircraft band and other public service frequencies from 76 to 999 MHz*.

Leading-edge technology from the VX-1R's 500mW MOSFET power amplifiers together with the supplied 3.6V 700mA/H high-capacity Lithium Ion battery will provide many hours of superb local communications. Up to 1W output is available for longer range when external DC power is used. Extensive battery-saving features together with the Li-Ion battery's 2-hour recharge system yields long operating times under real-world conditions.

The VX-1R's extensive memory system provides 291 memory channels, most with Alpha-numeric labelling for easy recognition. A Smart Search™ system allows you to search a portion of a band you define, then loads any active frequencies into 31 special Smart Search™ memories for later inspection (great for finding activity when visiting a new area).

Besides being a fully-featured dual-band amateur transceiver, the VX-1R has extraordinarily wide receiver frequency coverage; you'll also be pleasantly surprised by the great audio on the FM broadcast band. A dual-watch facility is provided – and together with the AM, FM-narrow and FM-wide reception modes – you'll be having fun even when you're not operating on the amateur bands. For selective calling and listening, the VX-1R also includes a CTCSS encoder/decoder and a 104-code Digital Code Squelch (DCS) system as well as a Tone Search facility for both CTCSS and DCS encoded transmissions.

A great range of accessory lines for the VX-1R are available such as speaker/mics, a carry case, as well as a battery holder for 1 x AA alkaline battery which includes an inbuilt voltage step-up converter. Computer programming of the VX-1R is available via the optional ADMS-IE programming kit.

So when Yaesu says "Dick Tracy, we're waiting for your call" you can be sure they have good reason to do so. In fact, call into your Dick Smith Electronics' Hams Shack store for a demo of this fun new rig. Or phone 1300 366 644 for a copy of the Yaesu colour brochure.

D 3665

2 YEAR WARRANTY

\$399
SAVE \$50

YAESU

PHONE FAX AND MAIL ORDERS

PHONE: WITHIN AUSTRALIA: 1300 366 644
(Local Call Charge)

FAX: (02) 9395 1155 within Australia and
(+612) 9395 1155 from outside Australia

MAIL: DICK SMITH ELECTRONICS, Direct Link Reply Paid 160, PO Box 321,
North Ryde NSW 2113 (No Stamp Required)

Excludes packaging and postage. All major Credit Cards accepted.

14 Day Money Back Guaranteed if NOT completely satisfied. (Software excluded)



Visit our web site at
<http://www.dse.com.au>



That's where you go!

*Less cellular coverage