



# RADIO SERVICE NEWS

PUBLISHED - IN - THE - INTEREST - OF - RADIO - SERVICE - SALES - ENGINEERS

VOLUME XII, No. 2

EDITORIAL OFFICES, RCA, HARRISON, NEW JERSEY

March-April, 1947

## TUBE BOOKLETS CONTAIN LATEST TECHNICAL DATA

Give Characteristics of  
RCA'S Extensive Tube Line  
to Help Service Work

The excellence of technical information published by RCA's Tube Department has long been recognized in the industry. RCA engineering groups are constantly at work gathering and compiling the latest facts about tubes to help you with your servicing work.

Recently, three new booklets were added to RCA's comprehensive line of authoritative technical literature. One is the 16-page booklet—"Receiving Tubes for Television, FM, and Standard Broadcast" (1275-C) which charts the characteristics and socket connections of RCA's line of receiving tubes, including projection and directly viewed kinescopes for television picture reproduction. Information on discontinued types has also been included for use in servicing old equipment. In addition, it contains a chart classifying RCA receiving tubes according to their functions and their cathode voltages.

### Television Tubes

Another booklet is "Phototubes, Cathode-Ray Tubes and Special Tubes" (CRPS-102). Together with PG-101 it covers RCA's group of non-receiving tubes. CRPS-102 is brand new in all respects. The cathode-ray section includes tubes for oscillographs and for television cameras. Each type listed in the booklet is covered by a text description and ample technical data, together with its base diagram.

Also just off the press is RCA's new 16-page booklet—"Power and Gas Tubes for Radio and for Industry" (PG-101). This covers 138 RCA air- and water-cooled power tubes, voltage regulators, thyratrons, ignitrons, and gas rectifiers. Many of the types are illustrated with photographs.

The up-to-the-minute information in these three publications will enable you to select rapidly the correct tube type for radio and television servicing, as well as for industrial installations and maintenance. These pamphlets are available at your RCA Tube and Parts Distributor.

## MEET SALLY SERVICE!



Meet Sally Service—a girl whose only job is to help create business for you! She's 21" tall, in full color from head to toe. She's built to sit on the Giant Carton, or on any other flat surface in your windows, on your shelves or counters. She'll be available soon—so make a date now with your Distributor to see her. Her Form Number is 2F374.

## MODERN SERVICING METHODS CALL FOR GREATER KNOWLEDGE

By JOHN F. RIDER

A short while ago the writer received a communication from the owner of a service shop located in a small town in Holland. This letter became of special interest because it raised a point which justifies serious discussion. The correspondent commented that servicemen operating in the United States were extremely fortunate in many respects. The reasons for the comment were that in the United States all necessary service data are readily available, test equipment is plentiful, and an abundance of replacement parts exists; whereas operations in Holland were much more difficult, almost like manufacturing on a small scale. The absence of replacement parts and service data made service operations in that country more technical and definitely raised the technical requirements of personnel who do the service work. In other words, the foreign serviceman was always called upon to display greater technical ability and knowledge than that demanded of the American repairman.

We cannot deny the validity of the statement made. For that matter, nothing would be gained by discussing the circumstances which brought about the conditions existing in the United States. Of far greater importance is the fact that despite adequate test equipment, replace-

ment parts, and service data, the demand for a better understanding of radio theory on the part of the American radio serviceman is growing daily. In other words, our American servicemen may never find them-

(Continued on Page 2, Column 1)

## RAPID STRIDES FOR TELEVISION SEEN THIS YEAR

Increasing Audiences  
Point Way to Bright Future  
in Television Field

1947 will witness television's approach to full commercial stature. New transmitting stations are opening at the rate of nearly two a month. Hundreds of thousands of television receivers are scheduled for production during the year.

New stations have already been opened in Washington, St. Louis, and Detroit this year. The remaining 4 channels in the New York area have already been assigned and work will begin on them shortly. Elaborate plans are underway by many of the country's principal newspapers, radio stations, and other major organizations, for the operation of television stations in their communities. At least thirty cities will have television broadcast facilities before long.

Programming, a principal factor in the sale of receivers and the growth of audiences, has made tremendous advances. With the increased production of RCA's Image Orthicon tubes and cameras, leading television broadcasters are making arrangements for the coverage of the country's principal sport events, civic activities and other features of headline importance.

### Wide Demand

The public is already demanding more varied receivers. In compliance with this demand, RCA will soon introduce television consoles ranging in type from those offering television alone to sets with AM, FM, and short wave radio and phonograph combinations.

Also on their way are receivers utilizing reflective optics to create brilliant pictures projected from a 5" picture tube on to a screen 15" x 20" in size. The screen brilliance of 50-foot lamberts compares favorably with that of direct-view television pictures.

The serviceman who is interested in the future growth of his business will prepare himself for the intricacies of television servicing, the most promising potential on today's electronics horizon.

### JOHN F. RIDER



John F. Rider, widely known author of articles and books on radio servicing, gives his views on technical requirements for today's servicemen. His article appears on page 1 of this issue of RADIO SERVICE NEWS.

In keeping with RCA's policy of giving you the finest technical information in the industry, Mr. Rider is retained as a consultant. His timely articles will appear from time to time on these pages.

Over 25 years of experience in radio research and servicing make him an outstanding authority in the radio field.

### MODERN SERVICING

(Continued from Page 1, Column 3)

seives reduced to the same difficulties of operation which have existed in foreign countries, but they will find that neither test equipment nor diagnosing techniques will be able to compensate for lack of adequate theoretical background.

To believe that more advanced design of test equipment will compensate for whatever technical educational deficiencies exist on the part of the serviceman is tantamount to hanging one's hopes on a plume of smoke. Advances in test equipment during the past ten years have made it possible for the American radio repairman to probe within the innards of receivers almost at will. . . but there is a limit to how far even that can be carried. Signal tracing methods of diagnosis, vacuum tube voltmeters, electron tube and crystal probes, cathode-ray oscillographs, and other similar devices have been advances in methods of successful diagnosis of faults, but at best, with very few exceptions, such as the electronic calculating machines, these devices cannot take the place of brains.

### Technical Skill Needed

It may be all well and good to gain access to any part of a receiver, transmitter, amplifier, or other kind of electronic device sold for public consumption, to locate a fault without interfering with the performance of the unit, but the full benefits of the system or testing device cannot be attained unless adequate knowledge of what is within the unit under observation is possessed by the operator. As a matter of fact, it is equally important to appreciate fully the capabilities of the testing device.

No amount of information, no matter how painstakingly detailed, about a receiver, transmitter, or other device, can describe every possible fault, symptom, or remedy. No matter how detailed the description of a testing device, its full capabilities will not be realized, unless the reader knows and understands the information printed on the pages.

The expansion of the frequency spectrum covered by modern radio equipment . . . the necessity for cutting corners in production, that is, production of sensitive yet stable receivers with the minimum number of components . . . is introducing such modifications of conventional circuit design, as to be confusing to the repairman unless he can understand the circuit structure.

There was a time when a basic tube circuit consisted of comparatively few parts, usually a tuned circuit of conventional character in the grid system and perhaps a resistor or a transformer primary in the plate system, as shown in Fig. 1. Whatever bypassing was employed likewise was simple. In other words, failure of any of these components caused definite indications which were easily identified by an individual with somewhat more than casual familiarity with radio theory. As long as he was familiar with the ordinary application of conventional test equipment, he could determine faults and apply the necessary remedy.

### Modern Receivers

Such conventional procedures are destined to failure in the long run, for the repair of the present-day receiver, and those to come, will demand a deeper understanding of what is in the receiver. The day is fast disappearing when it will be possible to remedy an obscure fault by the installation of some component which removes the complaint but does not cure the fault. It is like administering a drug to kill the pain without removing the cause.

Fundamentally, the modern receiver is like the old. This is true in all classes of service, yet the modern receiver is not like the old. The over-all theory of operation of a superheterodyne receiver has not changed since the days of World War I, but the manner in which the desired receiver capabilities are developed has seen many changes. As is readily understandable, only a few details can be shown herein, but these are significant examples of what we have in mind. They are the shadows of the coming events.

(Continued on Page 11, Column 1)

# Talking Things Over

By W. L. ROTHENBERGER  
Manager, Renewal Sales

One of the problems looming large on the serviceman's horizon is unbalanced inventories. Part of this problem is caused by dealers having heavy stocks of unknown brands and surplus items. In spite of this, many dealers are understocked on standard items. This is a potentially dangerous situation because it forces customers to look elsewhere for the merchandise they need.

In order to operate successfully it is important for dealers to carry adequate, well-balanced stocks. With television and FM growing by leaps and bounds—the development of new tubes, new type components, and an ever-increasing number of electronic devices—servicemen will find it profitable to carry larger stocks than in the past. The renewal market is now the greatest in the history of electronics. The well-stocked dealer will cash in on this potential.

### Improved Supply

During the war years, shortages were the general rule. Service was, in many cases, sadly neglected. The serviceman, and the consumer were willing to accept little-known and non-branded products. Now the picture has changed: today's consumer is a critical buyer. He insists on quality and looks for trade names which have a reputation for reliability. When he sets out to make a purchase, he wants what he wants when he wants it, which is generally at once.

Servicemen face an excellent opportunity to build business and create a good reputation. To do this, they must become known as a reliable source of supply. When a customer knows that a dealer carries items which he needs, even though they're

not called for frequently, he will also call on him for standard items and services which he can get elsewhere. Chances are he will also recommend your store to other customers. This is the time to lay the groundwork for future business.

Fortunately it is now possible to balance inventories. Tubes are available in most types and the situation is improving daily. Parts and other component items are also becoming less scarce. This offers servicemen an excellent chance to acquire adequate stocks. Doing this will reduce the number of trips you make to your distributor and enable you to give better, faster service.

### Watch Inventories

Inventories should be carefully checked against turnover. Some type of stock control, however limited, should be maintained, and orders guided by it. In order to properly function as a good servicing organization it is important to keep abreast of new developments in the manufacture and use of tubes and component parts.

Many newer tube types which are now being used in new sets will shortly be called for by your customers. Anticipate these calls by having sufficient stock on hand to meet demands.

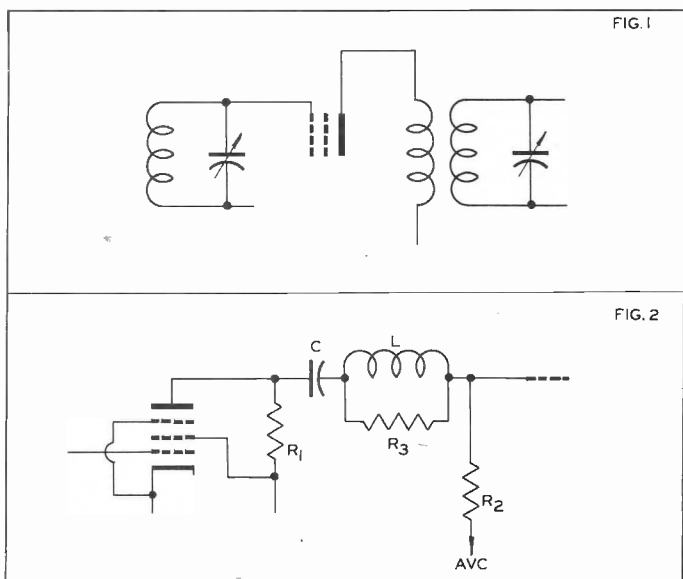

Fig. 1—Basic tube circuit formerly used in radio receivers.  
Fig. 2—Circuit eliminating the need for a tuned transformer between an r-f amplifier and a mixer stage.

# EXPLANATION OF THE RATIO DETECTOR AS AN AID IN F M SERVICING

By JOHN A. CORNELL

RCA Service Company

The ratio detector is a new device for converting a frequency-modulated carrier to an audio signal, while at the same time offering a high degree of attenuation to any incident amplitude modulation. The relative insensitivity to amplitude variations, which is an inherent characteristic of ratio detectors, enables them to be used without the usual preceding limiter stage, thus permitting the use of a high-gain i-f stage in place of the low-gain limiter.

A brief review of the theory of the discriminator detector will help the serviceman to understand the action of the ratio detector.

### Theory of Operation

Fig. 1 portrays a conventional discriminator stage; it can be seen that it consists essentially of two diode rectifiers which are differentially connected so that the d-c potentials across their respective load resistors are subtractive. These two d-c voltages (across R1 and R2 in Fig. 1) are proportional to the a-c voltages applied to the diodes. The a-c voltage applied to each diode is the vector sum of E1 and the voltage across that half of L1 which is connected to the diode plate, as shown in the diagrams of Fig. 2. E1 has practically the same amplitude and phase as the voltage across the tank in the limiter plate circuit. The current in this same tank circuit induces a voltage in L1, which causes a circulating current to flow in the resonant circuit composed of L1 and C1. E2 and E3 are the voltage drops which occur across each half of L1 as a result of this circulating current. When the carrier frequency is equal to the frequency at which the discriminator transformer is tuned (Fig. 2A), the a-c voltage applied to diode 1 equals that applied to diode 2, therefore the rectified voltages are equal and since they are bucking voltages, the output of the discriminator is zero.

When the carrier frequency increases during a half-cycle of modulation, the phase relations between E1, E2 and E3 change in accordance with Fig. 2B, and it is evident that the vector sum of the voltages applied to diode 2 exceeds the vector sum of the voltages applied to diode 1, resulting in a higher rectified voltage across R2 than across R1. The instantaneous difference of the rectified voltages appears as a negative voltage in the discriminator output. Fig. 2C shows the condition occurring when the carrier frequency swings below the resonant frequency of the discriminator transformer, the end result being a positive voltage at the output of the discriminator.

The important fact in discriminator action is that the output voltage is proportional to the difference between E diode 1 and E diode 2. This is true because the d-c voltages

appearing across R1 and R2 vary directly with E diode 1 and E diode 2, respectively, and the instantaneous output voltage is the difference between the rectified voltage drops.

In considering the effect of amplitude variation on discriminator output, refer again to the vector diagram of Fig. 2. An increase in the amplitude of the voltage applied to the discriminator would increase all of the vectors in the diagram proportionately. In other words, the effect would be as though the vector diagrams were enlarged photographically. It can be seen that while the phase relationships would remain the same, the difference between E diode 1 and E diode 2 would increase, so long as the frequency of the applied voltage differed even slightly from the receiver i-f. Thus, components of amplitude modulation would be detected and passed on to the audio amplifier.

### Discriminator Action

Ordinarily, discriminators are preceded by limiters which remove most of the amplitude variation from the F-M carrier, but the discriminator itself is not a device capable of rejecting amplitude modulation, except when the instantaneous frequency of the applied carrier is exactly equal to the resonant frequency of the discriminator transformer. This condition occurs only twice in every modulation cycle.

Note that while an increase in the amplitudes of the vectors in Fig. 2 results in a proportionate increase in the difference between E diode 1 and E diode 2 for off-resonant conditions, the ratio of E diode 1 to E diode 2 is a constant, as far as amplitude variations are concerned. Therefore, a detector responsive only to changes in the ratio of E diode 1 to E diode 2, and insensitive to changes in the difference between these voltages would be a detector capable not only of converting frequency variations to audio variations, but of rejecting any amplitude modulation. Such a detector is the ratio detector.

*In the next issue we will discuss the fundamental ratio detector appearing in RCA postwar FM receivers.*

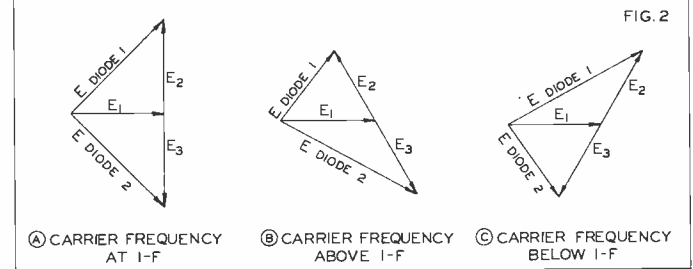
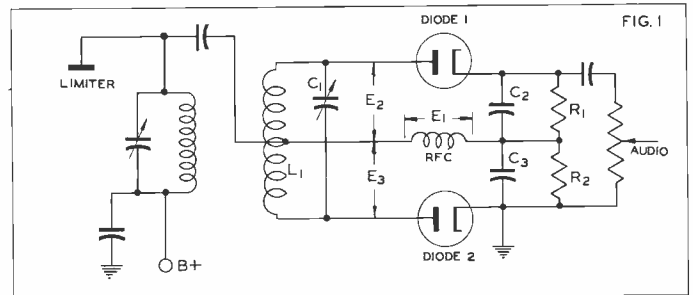

Fig. 1—A conventional discriminator stage.  
Fig. 2—Vector diagrams showing carrier frequencies in three stages.

## BRIGHT FUTURE SEEN FOR MINIATURE TUBES

The application of miniature tubes in the electronic field makes possible many new types of equipment. Since the space requirements for these tiny tubes are considerably less than and their efficiency as high as for conventional glass and metal types, miniatures open new sales and service vistas. RCA presently has 48 miniature tube types—a comprehensive line matching most of the earlier glass and metal types.

The use of miniatures in war-time equipment provided a good proving ground and brought out potentialities for many peace-time uses. With the end of the war the engineering knowledge and mass-production techniques have been directed intensively toward peace-time products. The promise of widespread commercial use of miniatures is evident. The shift in frequency allocations to establish FM in the band of 88 to 108 megacycles, the higher-frequency requirements for television, and a general trend toward more compact ac/dc and battery-portable receivers all indicate that miniature tubes will eventually carry the bulk of the peace-time production load for the new designs of broadcast receivers.

### Many Advantages

In order to provide for operation at both AM and FM frequencies, the miniature rf amplifier and the converter were designed to have higher gain and improved high-frequency characteristics as compared with the pre-war equivalent larger types intended for the lower frequencies only. As a result, the combination AM/FM receivers now in production are using the same miniature tubes for both AM and FM bands. This makes possible economies in receiver costs.

In December 1945, the new miniature rectifier 117Z3 together with existing filament types, provided a complete miniature complement for portable ac/dc-battery receivers. A miniature line for automobile receivers is also made possible with the

availability of the 6X4 rectifier, the 6BF6 twin diode low-mu triode, and the 6AQ5 beam power amplifier.

In the television field the space savings and performance afforded by miniatures are particularly desirable because of the large number of tubes required for each receiver and the high frequencies of operation. The table model RCA Victor television receiver Model 630TS uses 15 miniatures out of a total complement of 30 tubes.

### Industrial Applications

The industrial field which in recent years has outgrown its swaddling clothes and grown into sturdy manhood, has many uses for miniature tubes. Each day still more applications are discovered for these—both for industrial controls and in actual production processes—and with each new application comes an increase in their sale. The 2D21 thyratron, OA2 voltage regulator, and 1654 high-voltage rectifier are employed in many industrial applications where their small size and ruggedness are of advantage. Recently, a nine-pin miniature twin-triode, 12AU7, has been made available in a slightly larger envelope for industrial applications as well as for home receiver use.

Visualize if you can the sales potential of miniature tubes when component parts, are similarly reduced in size. When that time arrives, a host of new electronic devices, undreamed of today, will create a still greater demand for miniatures.

**HAVE YOU SEEN THESE SALES AID CATALOGS?**



*These new booklets are brimful of field-tested selling helps. Ask your distributor's salesman to show you one.*

**WHEN IS A SALE MADE?**

When a customer walks into a store, it's usually not by accident. Chances are he's been sold on that particular store a long time before.

Jack Morse, director of the trade and technical advertising department for J. Walter Thompson, RCA's advertising agency, and incidentally, the largest agency in the world, tells of a personal experience that bears out this view.

"Recently I went to a small store to buy some radio tubes. I'd been passing this store every day for a year or so. I had never taken much notice of the store before—or so I thought. However, a Cunningham Tube Clock was in the window and I had gotten into the habit of consulting it each day. Thus, when I needed some tubes, I automatically went to the store where I had seen the clock."

What Mr. Morse is saying in effect is that the sale had actually been made a long time before he entered the store. The impression of the sales message in the store window had remained with him. When he needed the quality radio product and the quality service advertised, he went there to make his purchase.

**Window Displays**

To show the value of window displays, here is an interesting fact. Store rents are usually based on location and window space. Unless this is realized and full advantage taken of both, part of the money paid for rent is actually being wasted.

It takes only a few seconds, at most, to pass the average store window. In that short space of time a

complete story of the product and service offered must make its impact. To do this, the displays that go into a window must be carefully planned. Think of your store window as an extra salesman—working for you 24 hours a day—to attract customers. It is important to provide this "salesman" with adequate promotion material to do the job well.

The consumer's choice of where to buy depends on your ability to convince him that your store represents quality service and merchandise.

**Customer Acceptance**

RCA is constantly developing window displays to help you build prestige and increase your sales. A new dealer Sales-Aid Folder featuring RCA's comprehensive line of sales promotion items will be available from your distributor this month. It will present several startling innovations for window and store displays.

All of these sales aids are designed to pep up store and window displays and give more sales appeal per square foot. Take advantage of this wide variety of promotion items and use them to create a modern selling tempo.

**HIGH FREQUENCY PROBE CONVERTS VOLT-OHMYST TO V-H-F VOLTMETER**

RCA's new Crystal Probe will bring any model VoltOhmyst up to date for testing FM, television, and other high frequency circuits within the sensitivity range of the instrument. This instrument can be used with any model VoltOhmyst, including the Senior and the Junior models. It also can be used in the Voltmeter channel of the RCA Chanalyst.

The RCA Crystal Probe is designed for converting the dc circuit of the VoltOhmyst to read ac so that voltages at frequencies of up to 100 megacycles or more are indicated directly on the dc scale.

**Specifications**

Here are the specifications of this handy little instrument. It has a maximum input voltage of 20 rms volts and a frequency range of 1000 cycles to 100 megacycles, and will give useful readings up to 175 megacycles. An important feature is the low input capacitance of 3.5 uuf which won't upset most circuits being tested. The Probe gives an overall accuracy of  $\pm 7.5\%$  at full scale.

Some of the features of this new crystal probe are:

- Reads flat to 100 Mc.
- Low-capacitance, high impedance input.
- Good frequency characteristics.
- Excellent linearity over entire range.
- Withstands dc loads of 250 volts.
- Highly accurate, even with high-resistance circuits.
- Fits any RCA VoltOhmyst.

The RCA Crystal Probe is an accessory for all models of the Volt-Ohmyst and connects to the dc input for measurement of af and rf voltages. It employs a Germanium crystal which rectifies the applied ac voltage so that it may be measured by the dc circuit of the Volt-Ohmyst. The reading is proportional to the positive peak of the applied ac voltage.

Since this half-wave crystal rectifier involves no heater, it eliminates a possible source of hum and provides a rectifier which is operated far above ground potential. Use of a crystal rectifier means simplicity, compactness, and durability. The Probe is lightweight and rugged; it will withstand abuse from shock and vibration.

A detachable phone plug is used at one end of the cable for connection to the older models of the Volt-Ohmyst and Chanalyst. The phone plug may be unscrewed and the cable can then be attached to the single wire microphone connector used on the latter models.

**Easy Testing**

The Probe point is long and narrow for easy testing in crowded places. The front part of the Probe body is made of insulating material while the back part is made of metal for shielding against hand-capacitance effects. A detachable ground lead with an alligator clip is provided for use at high frequencies where the lead length becomes an important factor in the overall accuracy. The regular Volt-Ohmyst ground lead can be used with the Crystal Probe for low-frequency measurements.

As an addition to your service facilities, this probe will prove a wise investment. The list price is only \$8.95 which should prove the best test equipment investment you can possibly make. Quantities of this probe are now available at your RCA Tube and Parts Distributor.

**CUNNINGHAM DISPLAY KITS**



*These displays, vividly colored, identify your store with the Cunningham reputation for quality, and help boost your sales and service volume. Ask your distributor for Form Number 1F9924.*

# QUICK SELECTION CHART FOR RCA RADIO BATTERIES

A BATTERY REPLACEMENT GUIDE  
FOR PORTABLE RADIOS



Radio engineered for **EXTRA** listening hours

**RCA** TUBE DEPARTMENT  
**RADIO CORPORATION of AMERICA**  
HARRISON, N. J.

## QUICK SELECTION CHART FOR RCA RADIO BATTERIES

Portable Radios				RCA BATTERY		RCA BATTERY					
MAKE	MODEL NUMBER	"A" or "AB"	"B" or "C"	"A" or "AB"	"B" or "C"	MAKE	MODEL NUMBER	"A" or "AB"	"B" or "C"		
<b>Admiral</b>	78-XP6, 79-XP6, 76-P5, 77-P5, 78P6, 77-P6 164-4D, 335-4Z, 311-4D, 635-4Z, 1035-4Z 336-5N, 236-5N, 636-5N, 1036-5N 331-4F 319-4Z, 76-XP5, 77-XP5 231-4F, 231-4Z 33F5, 34F5, 36H5, 35G6, 37G6 51-D4 27G4, 28G5 N28G5, 29G5	1-VS008 1-VS007 1-VS003 1-VS004 1-VS005 1-VS004 1-VS037 1-VS016 1-VS016	2-VS013 2-VS013 2-VS013 2-VS014 2-VS014 2-VS014 2-VS001 2-VS001	<b>Beimont</b>	403, 460, 509, 553, 511 407 507, 513, 590, 546 6P11	1-VS007 1-VS005 1-VS009 2-VS002	2-VS013 2-VS014 2-VS013	<b>Fada</b>	P-40, PD-40, PL-40, P-47, PD-47 PL-58, PL-24, P49-SW, P-72, PL-72, PD-49-SW (Export)	1-VS007	2-VS013
<b>Aeolian Hall</b>	BP2, BP3 BP4, BP5 BP36 BP8, BP10 BP6, BP943	1-VS011 1-VS007 2-VS002 1-VS009 1-VS043	2-VS013 2-VS013 2-VS014 2-VS015 2-VS013	<b>Bestone</b>	D-115 PT-50, PT-51 PQ61	1-VS004 1-VS009 2-VS002	2-VS013 2-VS013 2-VS013	<b>Fidelitons</b>	583 485	1-VS004 1-VS007	2-VS013 2-VS013
<b>Aetna</b>	All Models	1-VS009	2-VS013	<b>Corayette</b>	WR675	1-VS007	2-VS013	<b>Firestone</b>	S-7397-2, S-7397-1 S-7426-9, S-7426-7, S-7426-6, S-7427-5 S-7402-6 500	1-VS043 1-VS050 1-VS004	2-VS002 2-VS013
<b>Air Castle</b>	900, 4D, 178, 553, 554, TF1, 2861, 2952 5N 591, 1BR50 130 KD, KD73 560-1, 561-1, 561-1M, 611-1, 18	1-VS004 1-VS003 1-VS009 1-VS007 1-VS010 1-VS007	2-VS013 2-VS013 2-VS013 2-VS013 2-VS013 2-VS013	<b>Chevrolet</b>	985514 985775	1-VS007 1-VS001	2-VS013 1-VS016	<b>Garod</b>	BP11, BP12Q, BP-15, BP-24, BP-25, BP307, BP308, BP309 BP27, BP28, BP29 BP37, BP36A, BP38 BP12, BP12A, BP12B BP5, BP5A, 5P7, BP4 BP9, BP10 BP20 BP6, BP8 BP118, BP115	2-VS002 1-VS002 2-VS002 1-VS003 1-VS004 1-VS009 3-VS001 1-VS043 1-VS010	2-VS013 2-VS013 2-VS015 2-VS013 2-VS015 1-VS016 2-VS013
<b>Air Chief</b>	S-7397-2, S-7397-1 S-7426-9, S-7426-7, S-7426-6, S-7427-5 S-7402-6	2-VS002 1-VS043 1-VS050	2-VS013	<b>Clarion</b>	O-464 O-534, 535, 539 531, 532, 533, 536, 541, 543, O-53 1-53	1-VS008 1-VS009 1-VS010 1-VS017	2-VS013 2-VS013 2-VS013	<b>General</b>	568, 561, 575 507, 509, 578, 512, 592 611 73	1-VS007 1-VS009 2-VS002 1-VS004	2-VS013 2-VS013 2-VS013
<b>Air Guide</b>	TR-1 D4-A BR1 BR-D4	1-VS007 1-VS010 2-VS001 *	2-VS013 4-VS015 2-VS013 4-VS015	<b>Clark</b>	457 948, 949	1-VS004 1-VS007	2-VS013 2-VS013	<b>General Electric</b>	GB400, HB408, 401 GB440 HB504, 505 HB402, HB403, HBX-467 HB410, 411 JB513, JB508, HB412, JB523, JB524, JB514 LB700, 702, JB630, LB701, LB702, LB703, LB673, JB631 JB410, LB412, LB502, LB603, LB612, LB641, LB642	1-VS007 1-VS007 1-VS010 1-VS004 1-VS004 1-VS011 2-VS002 2-VS001	2-VS013 2-VS013 2-VS013 2-VS013 2-VS013 2-VS013 1-VS016
<b>Air King</b>	3906, 3910 3916 4112, 3950 4016 3905, 3912 444	1-VS007 1-VS007 1-VS011 1-VS011 1-VS043 2-VS001	2-VS013 2-VS013 2-VS013 2-VS013 1-VS016	<b>Climax</b>	73 561, 568 578, 578B	1-VS004 1-VS004 1-VS009	2-VS014 2-VS013 2-VS013	<b>General Motors</b>	985514 985775	1-VS004 1-VS001	2-VS013 1-VS016
<b>Air Line</b>	454, 555, 557, 565, 5019 460, 462, 403, 555 663, 668, 672, 687 407, 461, 464 566, 569	1-VS007 1-VS004 2-VS002 1-VS005 1-VS009	2-VS013 2-VS013 2-VS013 2-VS013 2-VS013	<b>Colonial</b>	985514 563, 575 GM-985775 620, 623 621, 621A, 622	1-VS004 1-VS007 1-VS033 1-VS011 2-VS002	2-VS013 2-VS013 1-VS016 2-VS013 2-VS013	<b>Columbia</b>	164	1-VS004	2-VS013
<b>Andrea</b>	21AF5, 21F5, UF51 6G61, 6G61A 6G63, 6G63A	1-VS007 2-VS002 2-VS002	2-VS013 2-VS013 2-VS013	<b>Coronado</b>	583, 1F456KC CS90 687, 6B10, 6B16, 6B18 6P11 2543	1-VS004 1-VS009 2-VS002 2-VS002 1-VS050	2-VS013 2-VS014 2-VS013 2-VS013	<b>Crosley</b>	B429A 27BD, 27BE 458V 549 439 5549A	1-VS007 1-VS011 1-VS001 1-VS010	2-VS013 2-VS013 1-VS016 2-VS013
<b>Arcadio</b>	583 485 0-551	1-VS004 1-VS007 1-VS009	2-VS013 2-VS013 2-VS013	<b>Cruzeir</b>	PT50, PT51 PQ61	1-VS009 2-VS002	2-VS013 2-VS013	<b>Delco</b>	R-1400 R-1401, R-1402 R-1405, R-1406, RC-527E R-1407, RC-562	1-VS007 1-VS005 1-VS007 1-VS002	2-VS013 2-VS014 2-VS013 2-VS013
<b>Aria</b>	583 485 0-551	1-VS004 1-VS007 1-VS009	2-VS013 2-VS013 2-VS013	<b>Detrola</b>	Pee Wee No. 282 286, 288 295 289, 299 303 339, 3401, 3412, 360, 3601, 3602, 3603 372, 378, 389	1-VS004 1-VS007 1-VS004 1-VS007 2-VS002 2-VS001	2-VS013 2-VS013 2-VS013 2-VS013 2-VS013 1-VS016	<b>De Wald</b>	408 544, 408R Tourist, 409 544, 544LW, 544P 415-R, 415-RA 545, 545SW, 545LW, 565 410, 564 415 Cub	1-VS004 1-VS007 1-VS010 1-VS007 1-VS011 2-VS001 1-VS043	2-VS013 2-VS013 2-VS013 2-VS013 1-VS016
<b>Arlington</b>	583 485 0-551	1-VS004 1-VS007 1-VS009	2-VS013 2-VS013 2-VS013	<b>Emerson</b>	CE259 CE263, CT275, CX305, DC308, CX263, CX283, CX284, CX308 DF302, DF306 DJ310, 311, 312, EA-338, 339 357, EA-312, 357-A, 385, 389, 402, EA1-341, EE-340, 390, 401, EF-363, 424, 427, 428 DU-379, 380, 411	1-VS004 1-VS007 2-VS002 1-VS007 1-VS011 2-VS002 2-VS001	2-VS013 2-VS013 2-VS013 2-VS013 1-VS016	<b>Espey</b>	942, 942A, 942C, 958, 942F, 942P, 943 040 050 052 053	1-VS043 1-VS004 1-VS009 1-VS009 1-VS011	2-VS013 2-VS013 2-VS013 2-VS013
<b>Arvin</b>	802, 803, 822	1-VS008	2-VS013	<b>Imperial</b>				<b>Health Aviation</b>	M4	3-VS001	1-VS016
<b>Autocrat</b>	90, 98 120 131, 132 161 531, 533	1-VS004 1-VS010 1-VS009 1-VS004 1-VS044	2-VS013 2-VS013 2-VS013 2-VS014	<b>Howard</b>	14-ACB 108 118	2-VS002 1-VS007 1-VS007	2-VS013 2-VS013 2-VS013	<b>Hudson</b>	583 485	1-VS004 1-VS007	2-VS013 2-VS013
<b>Automatic</b>	P43, 45, P72, UF51 P57, 58, 61 P40, 41, 50, 51 P60 P80, 81 P30, 33, Tom Thumb, Tom Thumb Deluxe Tom Thumb 3 in 1 Personal	1-VS004 1-VS009 1-VS011 4-VS001 1-VS011 1-VS001 2-VS001	2-VS013 2-VS013 2-VS013 2-VS013 2-VS013 1-VS013 1-VS016	<b>Kadette</b>	L34 L46	1-VS011 2-VS002	2-VS013 2-VS013	<b>Karadio</b>	905	4-VS001	2-VS013
				<b>La Fayette</b>	A-221, CC-72, BS33A, T56 BB-70, BS-56, E-6, E-72 BB-73 BP-7, BS-72, BS-85, CC-55, CC-55A BS-33, D-93 C-116, C-121, C-125, CC-58, CC-58A, CC-58B, E-193 C-160 E-94 JS-130 S-50 E-191, EB-164, S-161 JS-114, JS-115 E-80, E-94 E-92	1-VS003 1-VS007 2-VS002 1-VS004 1-VS009 2-VS002 1-VS002 1-VS011 1-VS008 1-VS007 2-VS001 3-VS001 1-VS010 1-VS004	2-VS013 2-VS013 2-VS013 2-VS013 2-VS013 2-VS013 2-VS013 2-VS013 2-VS013 1-VS016 2-VS013 2-VS013				





# SELL RCA BATTERIES...

**RCA Batteries are radio-engineered for EXTRA listening hours**



There are good reasons why RCA Batteries are in the lead today—reasons that add up to bigger profits and repeat sales for you.

**1. RCA BATTERIES ARE LONG LASTING—**

Because they're engineered for radio every RCA Battery has the correct capacity for the current drain of the sets it was designed for. That's one reason why your customers want extra listening hours from RCA Batteries.

**2. RCA BATTERIES HAVE "BALANCED LIFE"—**

All "A-B" types are so designed that both sections deliver effective voltage for the full life of the battery pack. That's another reason why your customers get full value from every RCA "A-B" Battery they use.

**3. YOU GET A BALANCED LINE—**

RCA keeps up-to-date on battery types. There is an RCA Battery type for most receiver models. It's seldom you have to turn a customer away when you handle the RCA line of Radio Batteries.

**4. RCA BATTERIES SELL THEMSELVES—**

RCA is the greatest name in radio. Your customers know that the RCA trade-mark means a quality product.

Smart packaging, competitive prices, RCA quality, and "radio engineering," add up to outstanding customer acceptance. That's why you'll want to hitch on to the fastest moving radio battery line now. See your local RCA Distributor today for full details.



**TUBE DEPARTMENT**

**RADIO CORPORATION of AMERICA**

**HARRISON, N. J.**



# SALES *and* SERVICE TIPS

Once again you can win a handsome RCA Resistor-Code Pencil by sending tips to RCA Radio Service News, Harrison, New Jersey . . . All tips become the property of RCA to be used as it sees fit . . . Service Tips are our readers' ideas, not ours. While we believe they are worthwhile, we cannot be responsible for them.

## HYPODERMIC NEEDLE USED FOR NOISY CONTROLS

The next time you get a noisy volume control try this easy remedy. Mix carbon tetrachloride and lubricate solution in equal parts. Place the mixture in an ordinary hypodermic needle, and inject into any available aperture on the control. The small space where the shaft enters the control is sufficient to permit entrance of the needle.

You can also use the same method for push-button controls, RCA band switches, and other similar parts that are tucked away in inaccessible places.

Skip Ashby  
Marfred's Radio  
Maintenance Labs.  
460-462 Broadway  
Paterson 4, N. J.

## OVERCOME INTERFERENCE FROM FLUORESCENT LAMPS

When using fluorescent lamps you will sometimes notice interference from the audio frequencies of these lamps on receiver signals. Sometimes they cover a good part of the dial and blanket out many stations. Many types of incandescent lamps, too, may cause interference on various frequencies. Checking the lamps in the store and service department while a radio set is playing, will locate the trouble.

You can usually eliminate these

interferences by bypassing one side of the fluorescent lamp to ground with a 0.01 uf condenser, and also doing the same to the ballast. This should cure the difficulty and save a lot of trouble.

Ben Wolf  
Tremont Electrical  
Supply Co. Inc.  
372 Tremont Street  
Boston, Mass.

## SIMPLE METHOD TO PREVENT THE BLOWING OF TUBES

When a portable receiver is serviced, make certain after disconnecting the line cord that several seconds are allowed to elapse before it is plugged back into the line.

The delay is important because unless the condensers are fully discharged, there is a possibility that the tubes in the receiver may be damaged.

Bob Hartford  
Radio Servicenter  
92 Bowers Street  
Newtonville, Mass.

## MORE USES FOR RIDER CHANALYST RF PROBE

Upon checking a receiver which played clearly on very low volume but which was noisy on high volume, we traced the cause of noise to the "built-in" antenna. After placing an rf probe near the speaker field

## FIRST PUBLIC SHOWING OF NEW OSCILLATOR

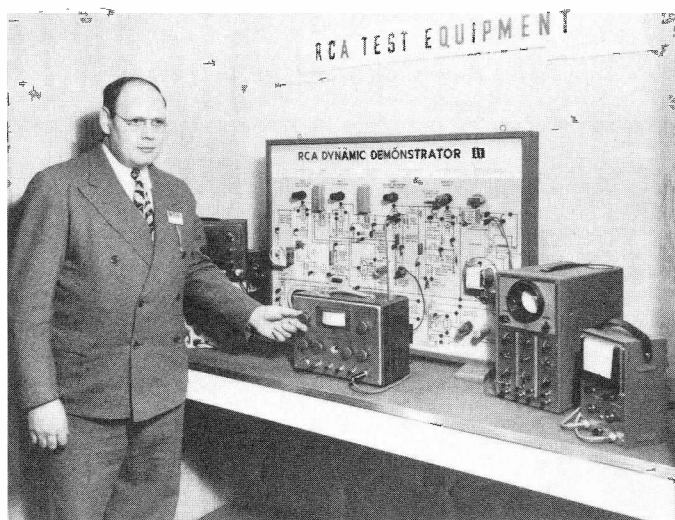

Art Liebscher of RCA's Test and Measuring Equipment Section demonstrates RCA's new W-A-54.1 Audio Oscillator at the American Association of School Administrators Convention at Atlantic City. Also shown are the RCA Dynamic Demonstrator, 195-A VoltOhmyst, 155-C Oscilloscope, 162-C Chanalyst, and the 167-B Test Oscillator.

we found that this field was sending out the "signal" which the antenna picked up and sent through the receiver. Changing the speaker or shielding the field coil was found to correct this defect.

Vincent Hohman  
Radio Sales & Repairs  
Bothell, Washington

## QUICK LINE CORD CHECK FOR AC-DC RADIO SETS

Here is a simple method for checking continuity in line cords, switches and the primary winding of power transformers.

As an illustration, connect the two leads of a transformer winding to terminals X and Y of the circuit shown below. Turn the switch to the "on" position. If the neon lamp does not light, there is an "open" in the winding; if the neon lamp glows brightly, the winding is shorted; if the lamp is dim, the winding is undoubtedly O.K.

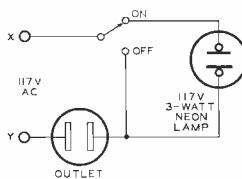

This circuit can be wired right to your test panel by connecting it to a 117 V-ac flush mounting receptacle.

Albert C. Hart  
Certified Radio Service  
4848 Linden Avenue  
Hammond, Indiana

## VOLTOHMYST METER STICKING ELIMINATED

In cold weather you may find that the VoltOhmyst meter sticks at some point below half-scale. At first sight, the trouble may seem to lie

in the delicate movement. However, this is rarely true unless the instrument has been subjected to abuse. Breathing a puff of moist air on the window should relieve a static charge and return the pointer to zero.

On the new, one piece plastic meters, dry and windy weather may cause a static charge resulting in a "locked pointer". To check for static lock, remove the zero adjust screw plug and blow lightly into the hole. This will usually correct the trouble.

In climates where static becomes troublesome you can recoat the inside of the meter window with anti-static solution. One ounce bottles with directions will be sent free to Volt-Ohmyst owners whose guarantee is on file at the RCA Camden Office.

Requests for solution should be addressed to the Test and Measuring Equipment Section, Bldg. 15-7, RCA Camden, N. J. Indicate type, code and serial number found on bottom of instrument.

Art Liebscher  
Test Equipment Section  
RCA Victor Division  
Camden, N. J.

## ON THE HOME FRONT

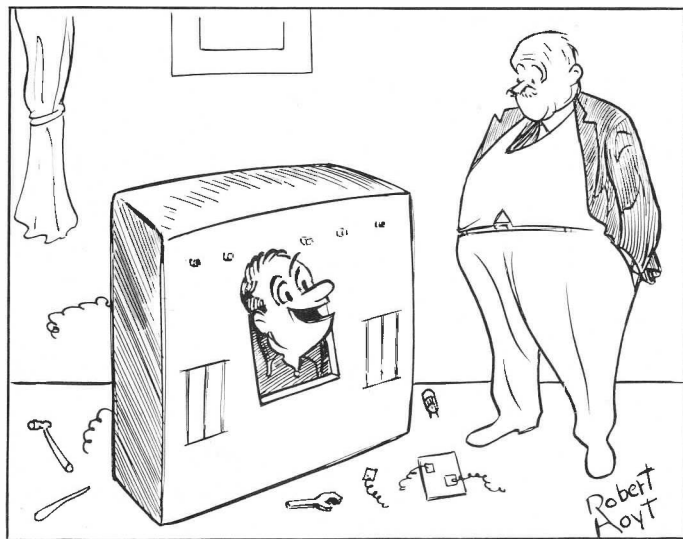

"There's nothing like making a thorough check."

## SEND IN SERVICE TIPS

Tricks of the trade that other servicemen may find helpful are an important feature of RCA RADIO SERVICE NEWS. For each tip we print you receive one of the famous RCA Resistor-Code Automatic Pencils in addition to the gratitude of your fellow servicemen. Let's keep passing those tips along. We have a large supply of pencils just itching to be yours.

# REPLACEMENT PARTS

## Section

### NEW RCA LOUD SPEAKERS

The RCA Tube Department has announced a line of high-quality, permanent-magnet, dynamic-speaker units. It will find many uses in the repair and replacement field as well as in the experimental and industrial markets.

To date eight types are available as listed below. New styles and sizes will be released at later dates which will round out and provide a complete and standard line.

Size	Type	Voice Coil Impedance	Magnet Weight
2" x 3"	423S1	11.75 ohms at 900 CPS	1.5 oz. Alnico 5
4" x 6"	346S1	3.2 ohms at 400 CPS	1.0 oz. Alnico 5
4" x 6"	446S1	3.2 ohms at 400 CPS	1.47 oz. Alnico 5
5"	305S1	3.2 ohms at 400 CPS	1.0 oz. Alnico 5
5"	405S1	3.2 ohms at 400 CPS	1.47 oz. Alnico 5
12"	312S1	3.2 ohms at 400 CPS	2.15 oz. Alnico 5
12"	412S1	3.2 ohms at 400 CPS	6.8 oz. Alnico 5
12"	412S4	6.8 ohms at 400 CPS	6.8 oz. Alnico 5

The 412S1 and the 412S4 are identical speakers with the exception of the voice-coil impedance and the type of mounting. The 412S1 is designed with standard RMA mounting holes to permit the use of rubber grommets in five of the eight holes. The 412S4 is equipped with a standard cardboard gasket around the mounting flange and is suitable for mounting directly to a metal or wooden baffle.

### SPEAKER SUBSTITUTIONS

The introduction of RCA's new line of standard permanent-magnet speaker units will enable many substitutions to be made in the regular replacement parts line. To date, the following direct substitutions have been made, and these new speakers will be shipped after the depletion of the present stock:

Type Number	Replaces Speaker
405S1	37612, 38682, 39747, 70372, 70132
423S1	37807, 70428
446S1	70470, 71058
412S1	70686

Additions will be made to this listing from time to time and will be published in RADIO SERVICE NEWS.

### MAGIC TONE CELL MODERNIZATION KIT



New RCA Crystal Kits are packaged in colorful self-merchandising cartons to stimulate more sales. Ten Tone Cells are contained in each carton.

### THE SERVICEMAN'S "INFORMATION PLEASE"



Containing thousands of answers to time consuming problems, these RCA Victor Service Data Volumes are indispensable to the busy serviceman.

### DEALERS RCA VICTOR SERVICE DATA

All radio repair shops should have the RCA VICTOR service data. Practical service information on the repair of Radio Receivers, Radio Phonograph Combinations, and Phonograph Models manufactured from 1923 to 1942 is contained in these volumes.

Vol. #1, Stk. #112-880 Pages, 1923 to 1937 Inc.

Vol. #2, Stk. #113-816 Pages, 1938 to 1942 Inc.

Price \$6.00 per Volume.

ACT NOW—order from your Distributor to insure your copy

### MAGIC TONE CELL MODERNIZATION KIT

Just released are the new Magic Tone Cells. They feature a lower record noise pick up than any conventional crystal cartridge now on the market and eliminate needle changes. These kits have a wide potential in the modernizing of record players containing the old style cartridge. Stock number is 9890. Suggested list price is \$8.00

### CRYSTAL PICK-UP FOR RP-160 CHANGER

Stock 39550 Crystal (zinc) is superseded by Stock 39919 Crystal (aluminum) as used in the RP-160 changer for Instruments V-215, V-219 and V-221. The sapphire pressure for the RP-160 is approximately 1¼ ounces. The pressure is governed by the spring inside the end of the pick-up arm. Correct spring for the aluminum crystal is indicated below:

For Zinc Arm, use Spring RCA 39673

For Aluminum Arm, use Spring RCA 30585

The Zinc Arm can be identified by the use of a rivet in the rear which holds one end of the spring. The Aluminum Arm does not use a rivet.

### STOCK 70121 PHONO-MOTOR

Stock 70121 Phono-Motor Turntable Assembly is available for immediate delivery. This is a complete Phono-Motor including turntable and mounting plate suitable for modification of spring-wound RCA Victor Victrola Record Players and in building phonographs for record sales promotion. The unit operates on 117 V, 60 cycles. Suggested list price is \$7.95.

### IDENTIFICATION OF PARTS 612 V SERIES

These instruments have 3 glass dial scales and, also a glass window, namely "short-wave band" dial, stock 71652; "standard broadcast band" dial, stock 71653; "FM band" dial, stock 71654; and glass window, stock 71810.

When ordering, please be careful to indicate whether the window or dial scale is needed. If a dial scale is needed, please specify which type is required.

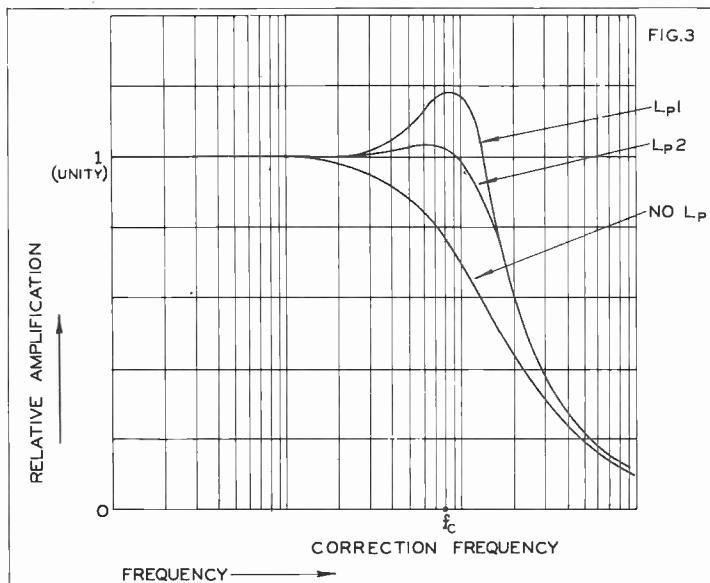

Fig. 3—Chart showing a peaking coil compensating for loss in amplification over the high end of band.

**MODERN SERVICING**

(Continued from Page 2, Column 2)

Let us examine a few of these. The use of the conventional tuned transformer is not a necessity. Coupling between tubes can be accomplished by any one of a number of means; a-f systems have for many years utilized resistance-capacitance means of transferring energy from the plate circuit of one tube to the grid of another. Today similar systems with modifications are being used in broadcast receivers as a means of effecting economy in manufacture, yet still result in a satisfactory receiver. For example, in Fig. 2 is shown a means of eliminating the tuned transformer between an r-f amplifier and the mixer stage. The coupling method is resistance-capacitance with the addition of a series peaking circuit. The normal plate load on the r-f tube is R1. The constants of the resistance-capacitance combination are so chosen as to be responsive over an r-f band, say 540 kc to 1700 kc. However, since the amount of amplification is not uniform over the entire band, use is made of the series peaking circuit L-R3 to increase amplification by a certain amount at the high end of the frequency band.

**New Circuits Complex**

Now a number of very significant details must be mentioned. Unless the individual is familiar with the various means of coupling between the tubes, such a circuit used in an r-f system will be confusing, for not only is it unconventional with respect to the methods used in the past, but its function must be appreciated in order that a sensible test be applied in the event of a defect in the receiver. The conventional resistance or voltage test is meaningless to determine proper operation, since its performance is a function

of frequency. Moreover, the usual signal-tracing test also means very little unless it is properly correlated with frequency.

To add still further to the confusion, the relationship between a resonance condition and the presence of such a resistance shunted winding is not immediately evident unless one understands that resonance is caused by the inductance of the coil and the input capacitance of the converter tube, also the associated circuit wiring. . . . Again we repeat: this is not evident unless the purpose and behavior of the circuit is understood. To determine if the system is functioning properly, it is necessary to appreciate the performance with respect to frequency. The same applies to the resistor which shunts the coil. Its function is to keep the peak at the resonant frequency down to the proper value, as a matter of fact, to broaden the frequency range over which the peaking circuit will raise the amplification so that it is in line with what is obtained over the remainder of the frequency range being covered by the receiver. The need for checking such a resistor would be based upon knowledge concerning the behavior of the circuit.

**Peaking Systems**

An idea of how such a peaking coil may compensate for a falling off in amplification over the high end of a band is shown in Fig. 3. No specific receiver is being described in these illustrations, it being unnecessary to identify any one in particular, since the application of the system with minor modifications is increasing in numbers.

The frequency range is shown along the abscissa, whereas the relative amplification is shown along the ordinate. The three curves in Fig. 3 illustrate the peak developed at that frequency which is to

be corrected with two types of peaking coils; also, the drop in frequency response when no peaking coil is used. As is evident, the action of the circuit with respect to frequency without the peaking coil would be definitely efficient, whereas with LP1 the peak would exceed that which would be considered satisfactory with respect to the action of the circuit at all frequencies. Thus, whatever would be the value or arrangement of the peaking coil indicated as LP2, that would be the one considered as accomplishing the desired purpose in the circuit.

The use of such peaking system is not limited to the series peaking circuit of Fig. 2. It could just as readily be used as shunt peaking by placing the coil in series with the r-f tube plate as the load, and using the plate circuit capacitance as the parallel resonating capacitance. Of course, the associated circuit wiring also would play a part in the action. A combination of both shunt and series peaking also is used, all to develop the proper frequency band width.

**Coupling Methods**

Shunt and series peaking of this type is not new, having been used in high-frequency receivers and amplifiers for a long time. However, such amplifiers and receivers have not received much attention in conventional receiver servicing circles; therefore, the introduction of these modified coupling systems can be said to be new in commercial broadcast receivers.

The use of such systems in receivers leads to another requirement with respect to servicing procedures. The determination of inductance of inductive components in radio receivers has been spoken of pro and con for quite some time, although never to a great extent. Admittedly it could be circumvented in the conventional type of tuned circuit because it was easy to determine the frequency range of the receiver. Now a different light is thrown on the subject of inductance.

Since resonance is caused by tube capacitance and other stray capacitances, lead dress becomes important on another count in addition to stability. Further, incorrect values of inductance resonating with these capacitances will produce response curves which will differ greatly from the desired. Put all these together and we come to the conclusion that what has hitherto been ignored may now require attention.

What we have discussed is just one of many affiliated with the rising need for a better technical background. Such things as neutralized oscillator circuits; the employment of "gimmicks", or capacitance formed by twisting two pieces of wire; coupling between open-ended coils, which in effect act as capacitance; the use of a variable-frequency intermediate amplifying stage in a double superheterodyne, whereby a single oscillator serves to beat against the received signal and the first intermediate signal to produce the second i-f signal; the application of control-grid bias voltages secured from oscillator circuits when no signal is received; regenerative feedback of varied kinds in audio systems, some between the transformer and the cathode circuit of a preceding tube, or back to the grid circuit; also regenerative feedback in audio, r-f and/or i-f systems, and many more.

**Knowledge Key Factor**

None of these new circuit modifications is in itself difficult, but, in order to recognize and understand them, technical background is imperative. An understanding of what is shown in a schematic will determine the proper application of the test equipment so as to develop the desired information with the greatest accuracy and the greatest speed. Without adequate knowledge servicing must be a cut-and-dry procedure, no matter how good and versatile the test apparatus, in fact the best of equipment will gather dust. Competition on such a basis is doomed . . . It cannot survive. . . .

**GOOD EQUIPMENT + WISE PLANNING = THIS**



Plenty of thought went into the building of this well-lighted roomy test bench. It's the proud baby of V. W. Hodge, Radio Repair Service, Clermont, N. H.



## Authoritativeness...the fountainhead of tube information is RCA



Throughout the radio and electronic worlds, the RCA symbol on a tube publication has become synonymous with the latest in tube development, accurate data, unquestioned *authoritativeness*.

RCA tube publications are standard reference works wherever tube information is needed . . . in the laboratory . . . in industry . . . in the shop . . . at the counter. They have had an important part in spreading the popularity of RCA tubes.

All of this authoritative tube information is yours . . . to keep you up-to-date

and help you become the best-informed man on tubes in your locality.

Here's the latest! Booklet 1275-C on Receiving Tubes for Television, FM and Standard Broadcasting. It has the newest data on tubes, both new and older types . . . easy-reference method of identifying miniature and metal tubes . . . and socket diagrams for all types. Get your copy from your RCA Distributor.

The best in technical literature is another reason why *you're in the lead with RCA*. So, push RCA Tubes and watch your business grow!

**THE FOUNTAINHEAD OF MODERN TUBE DEVELOPMENT IS RCA**

### RADIO SERVICE NEWS

RCA RADIO SERVICE NEWS is published by the RCA Tube Department in the interest of radio servicemen and dealers everywhere. It is distributed free of charge to members of the radio-service fraternity through the courtesy of RCA and its tube, battery, test equipment and parts distributors.

H. S. Stamm, Editor. Editorial Offices, RCA, Harrison, N. J.