

RCA Victor
SERVICE NOTES

for

1937

Broadcast Radio Receivers

All-Wave Radio Receivers

Phonograph Combination Instruments

Miscellaneous Service Information

Service Division

RCA Manufacturing Company, Inc.

Camden, N. J., U. S. A.

RCA Victor SERVICE NOTES for 1937

Broadcast Radio Receivers
All-Wave Radio Receivers
Phonograph Combination Instruments
Miscellaneous Service Information

| RCA Victor Service Notes | | | |
|--------------------------|------------------|-------------|------------------|
| <i>Year</i> | <i>Stock No.</i> | <i>Year</i> | <i>Stock No.</i> |
| 1923-28 | 100 | 1934 | 104 |
| 1929-30 | 101 | 1935 | 105 |
| 1931-32 | 102 | 1936 | 106 |
| 1933 | 103 | 1937 | 107 |

Net Price \$1.25 Each, F. O. B. Camden, N. J., U. S. A.

Service Division

RCA Manufacturing Company, Inc.

Camden, N. J., U. S. A.

Copyright 1937 and 1938
(Individual Sections)

RCA Manufacturing Co., Inc.
Camden, N. J., U. S. A.

First Edition

Printed in U. S. A.

ELECTRONIC SWEEP TEST OSCILLATOR

STOCK NO. 150

This new RCA Victor Electronic Sweep Test Oscillator is ideal for every application in which a wide frequency oscillator is needed. Frequency range—90 kcs. to 32,000 kcs. Variable electronic sweep—1 to 40 kcs. Internal 400-cycle, or external amplitude modulation. Large dial—4 inches in diameter. Indirect illumination; no parallax; two vernier ratios, 2:1 and 5:1. High r-f output—0.25 volts. Operates from 110-volt, 60-cycle supply. Price complete, \$64.50. (25-cycle model, \$72.50.)



TEST OSCILLATOR

STOCK NO. 9595

It is no longer necessary to use a Test Oscillator having high leakage, poor calibration, unsymmetrical modulation or any of the undesirable features of earlier type oscillators. This new RCA Victor Test Oscillator overcomes the above and all other features heretofore considered unavoidable in instruments of this type. The 90 kcs. to 25,000 kcs. frequency range covers all r-f and i-f alignment points of all receivers. Eight overlapping bands with high output and low leakage. Jack provided for Frequency Modulator connection. Price, less batteries, \$34.50.

UNIVERSAL A-C BRIDGE

STOCK NO. 9600

For the simplification and quick analysis of laboratory problems. This bridge gives quick and accurate check of inductance, capacity and resistance over extremely wide ranges—ranges including the low values which ordinary resistance and capacity meters do not check. Measures: Inductance—100 microhenries to 10 henries. Capacity—10 micro-microfarads to 10 microfarads. Resistance—1 ohm to 1 megohm. The only additional equipment needed is a headphone for use as a null indicator.

Comparatively few laboratories are permanently set up to cover the extremely wide ranges of the RCA Universal Bridge. This small portable Universal A-C Bridge—because it has such wide ranges with built-in standards—is an extremely useful piece of apparatus, regardless of other equipment available. Price, including all tubes and standards, \$49.65.



BEAT FREQUENCY OSCILLATOR STOCK NO. 9633

In school and university laboratories, fidelity measurements of receivers, loudspeaker testing, frequency measurements and many other applications constantly call for the use of a variable frequency a-c source.

This RCA Victor Beat Frequency Oscillator (Stock No. 9633) is ideal for any application requiring a source of a-c frequencies ranging from 30 to 15,000 cycles per second. Small, light in weight, and highly accurate, this unit incorporates design features found only in the highest priced laboratory oscillators. Operates from 110-volt, 60-cycle supply. Price complete, \$64.50.

TABLE OF CONTENTS

| <i>Model No.</i> | <i>Service Notes Page No.</i> | <i>Supplementary Information Page No.</i> | <i>Model No.</i> | <i>Service Notes Page No.</i> | <i>Supplementary Information Page No.</i> |
|---------------------------------------|---------------------------------------|---|--|---------------------------------------|---|
| AC TABLE AND CONSOLE MODELS | | | BATTERY OPERATED MODELS (Cont.) | | |
| 5T1 | 17 | 365G | 85BK | 203 | 366H |
| 5T6 | 21 | 365A, G | 85BT | 203 | 366H |
| 5T7 | 21 | 365A, G | 85BT6 | 209 | |
| 5T7-O | 365B | | 86BK | 215 | 366H |
| 5T8 | 21 | 365A, G | 86BT | 215 | 366H |
| 6K3 | 27 | | CV-8 | 221 | 366H |
| 6T5 | 33 | 365G | RADIO-PHONOGRAPH COMBINATIONS | | |
| 7K1 | 27 | | U-101 | 223 | 365G; 367A; 368B |
| 7T1 | 27 | | U-102E | 53 | |
| 9K1 | 39 | 365C | U-103 | 223 | 365G |
| 9K3 | 39 | 365C | U-105 | 231 | 365J; 367B |
| 10K1 | 49 | | U-107 | 231 | 365J; 367C; 370A |
| 10T (2nd Prod.) | 49 | | U-108 | 367E | 367D, F, G; 370A |
| 85E | 53 | | U-109 | 243 | 365J, M; 366A; 367D, F, G; 370A |
| 85K | 59 | 365D | 88U | 259 | 367H |
| 85T | 61 | 365E, G | 88U2 | 367J | 367H |
| 85T1 | 65 | 365F, G | AUTOMOBILE RECEIVERS | | |
| 85T2 | 59 | 365E | 67M | 267 | 371A |
| 85T5 | 69 | 365G | 67M1 | 267 | 371A |
| 85T8 | 73 | | 67M2 | 267 | 371A |
| 86E | 79 | | 67M3 | 267 | 371A |
| 86K | 79 | | RECORD PLAYERS AND ELECTROLAS | | |
| 86K7 | 79 | | R-93 (Supp.) | 279 | 368A |
| 86T | 79 | | R-93-A | 279 | 368A, B |
| 86T1 | 79 | | R-93-S | 279 | |
| 86T2 | 138 | | R-93-2 | 279 | |
| 86T3 | 89 | | R-94 | 279 | 368A |
| 86T4 | 95 | | R-96 | 287 | |
| 86T44 | 95 | | R-97 | 287 | |
| 87K | 79 | | R-99 (2nd Prod.) | 293 | 368C |
| 87K1 | 101 | 365H | PORTABLE VICTROLAS | | |
| 87K2 | 138 | | O-11 | 297 | 368D |
| 87T | 79 | | O-15 | 298 | |
| 87T1 | 89 | | AMATEUR RECEIVERS | | |
| 87T2 | 138 | | ACR-111 | 299 | 368E |
| 88K | 107 | 365J, K | ACR-155 | 327 | 368F |
| 810K | 113 | 365J | ANTENNAS | | |
| 810K1 | 113 | 365J, L | 395 | 359 | |
| 810T | 113 | 365J | Magic Wave | 354 | 368G |
| 810T4 | 119 | | Spider Web | 356 | |
| 811K | 125 | 365J, M; 366A, B, C | MISCELLANEOUS | | |
| 811T | 137 | 365M; 366A, B, C | Appendix | 365 | |
| 812K | 139 | 365J, M; 366A, B, C | Chassis Layouts | 362 | |
| 813K | 151 | 365J, M; 366A, B, D | Instruction Sheets | 353 | |
| 816K | 163 | 365J, M; 366A, B, D, E | L-C-F-Z Chart | 384 | |
| G-8 | 353 | 365M | Miscellaneous | 353 | |
| AC-DC TABLE AND CONSOLE MODELS | | | Parts Prices | 376 | |
| 86X | 175 | | Receiver Alignment | 343 | |
| 86X4 | 179 | | Record Changers | 369D, E | |
| 87EY | 185 | | Tube Charts | 371 | |
| 87X | 185 | | Wave Trap | 357 | 369B |
| 87Y | 185 | | | | |
| 812X | 191 | | | | |
| BATTERY OPERATED MODELS | | | | | |
| 84BT | 197 | 366F | | | |
| 84BT6 | 197 | 366G | | | |

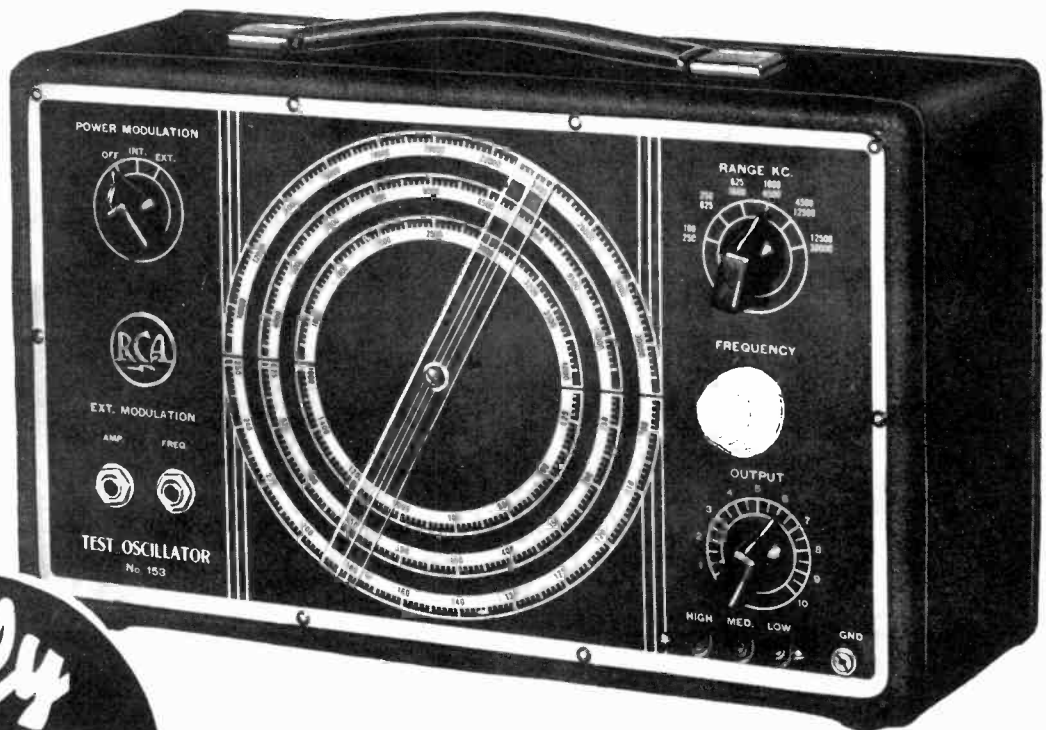

Only
\$29⁹⁵
 NET

COMPLETE WITH
 RCA METAL TUBES
 STOCK No. 153

● **LARGEST DIAL**
 ● **LOWEST PRICE**

New RCA A-C Operated Test Oscillator

Again RCA sets the pace in test oscillator values with this fine new instrument. Every requirement for servicing the most complex receiver is included—frequency range from 100 to 30,000 kc., maximum output of one volt, over 50 inches of dial scale, and a host of other fine features.

With this new oscillator, you are ready to offer your customers a service that is impossible with less modern instruments. This instrument is complete in itself, and in addition is

designed so that external frequency modulation may be added for the oscillographic method of servicing.

The giant dial insures an easily read setting, the high frequency range alone covers over 10 inches. RCA all-metal tubes give stability to circuit design and eliminate tube shielding. Six ranges give adequate dial separation and cover every frequency necessary for servicing receivers of all types.

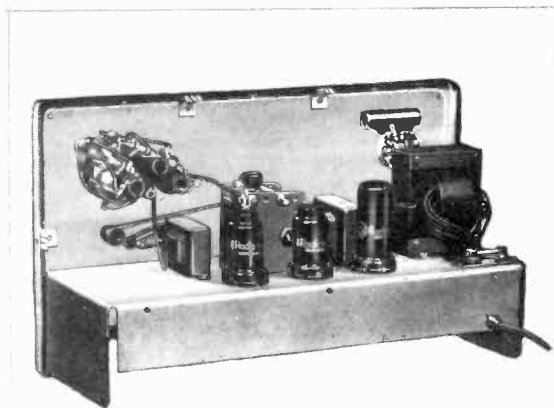

Check the following features and see what this modern oscillator offers:

- Completely a.c. operated.
- Complete fuse protection.
- Wide frequency range on fundamental frequencies (100-30,000 Kc.). Harmonics of Last Band may be used for ultra H.F. testing.
- High R.F. Output (1.0 volt). Essential for locating trouble on an inoperative or completely misaligned set or for single stage alignment work.
- Three attenuator taps plus fine control gives continuous control of output from minimum to 0.25 volts.
- Internal Modulation of 30% of approximately 400 cycles. Jack provided for external amplitude modulation. Modulation characteristic essentially flat up to 8000 cycles.
- External Frequency Modulator Jack provided for use with sweep condenser for visual I.F. alignment.
- 400 cycle output of 8 volts available for audio circuit testing.
- Large airplane type full vision dial 6½" in diameter gives a scale length of over 50 inches.
- Calibration accuracy—2%.
- RCA all-metal tubes.
- Special Snap Handle—large soft rubber feet.

ELECTRICAL SPECIFICATIONS

RCA Test Oscillator No. 153

| | | | | | | | | | | | | | | | | | | | | | | | | | | | | | | | | | | | | | | | | | | | | | | | | | | | | | | | | | | | | | | | | | | | | | | | | | | | | | | | | | |
|---|--|-----------------------------|---------------|-----------------------------|----------|---------------------|--------------|---------------------------|------------|--------------------------|----------------|--|--|---------------------------|---|--|--|---|------------|--|--|---------------|---------------|----------------|--|--|------------------|----------------|--|--|----------------|---------------|--|--------------------------|--------------|--|--|-------------------|------------|--|--|---------------------|---------------|---------|--|--|------------------|----------|--|--|----------------|-----------|--|-------------------|-----------|--|--|-------------------|------------------|--|--|-------------------|-----------------|--|--|---|--|--|--|-----------------------------------|--|--|--|---|--|--|--|--|--|--|--|
| <ul style="list-style-type: none"> ● POWER SUPPLY RATING ● RANGE AND APPLICATION ● TUBE COMPLEMENT ● DIAL SCALE ● DIMENSIONS ● FINISH | <table border="0"> <tr> <td>Voltage</td> <td>110-120 volts</td> <td>Power Consumption</td> <td>30 watts</td> </tr> <tr> <td>Frequency</td> <td>50-60 cycles</td> <td>Fuse Protection</td> <td>1/2 ampere</td> </tr> <tr> <td>R.F. Frequency</td> <td colspan="3">100-30,000 kc.</td> </tr> <tr> <td>Number of Bands</td> <td colspan="3">6</td> </tr> <tr> <td>Audio Modulation Frequency, Approximately</td> <td colspan="3">400 cycles</td> </tr> <tr> <td>R.F. Output {</td> <td>Low</td> <td colspan="2">0.01 volt max.</td> </tr> <tr> <td></td> <td>Medium</td> <td colspan="2">0.25 volt max.</td> </tr> <tr> <td></td> <td>High</td> <td colspan="2">1.0 volt max.</td> </tr> <tr> <td>Minimum Signal</td> <td colspan="3">2 Microvolts</td> </tr> <tr> <td>Leakage</td> <td colspan="3">Negligible</td> </tr> <tr> <td>Output Impedances {</td> <td>Low</td> <td colspan="2">10 ohms</td> </tr> <tr> <td></td> <td>Medium</td> <td colspan="2">750 ohms</td> </tr> <tr> <td></td> <td>High</td> <td colspan="2">4000 ohms</td> </tr> <tr> <td>RCA-5W4</td> <td colspan="3" style="text-align: right;">Rectifier</td> </tr> <tr> <td>RCA-6C5</td> <td colspan="3" style="text-align: right;">Audio Oscillator</td> </tr> <tr> <td>RCA-6J7</td> <td colspan="3" style="text-align: right;">R.F. Oscillator</td> </tr> <tr> <td colspan="4">Full vision Airplane Type, 6 1/2 ins. in diameter, over 50 ins. scale calibration</td> </tr> <tr> <td colspan="4">Calibration accuracy 2%</td> </tr> <tr> <td colspan="4">13 3/4" x 9 1/4" x 6 1/2" deep. Weight, 12 1/2 lbs.</td> </tr> <tr> <td colspan="4">Blue-Gray wrinkle lacquer with lithographed panel.</td> </tr> </table> | Voltage | 110-120 volts | Power Consumption | 30 watts | Frequency | 50-60 cycles | Fuse Protection | 1/2 ampere | R.F. Frequency | 100-30,000 kc. | | | Number of Bands | 6 | | | Audio Modulation Frequency, Approximately | 400 cycles | | | R.F. Output { | Low | 0.01 volt max. | | | Medium | 0.25 volt max. | | | High | 1.0 volt max. | | Minimum Signal | 2 Microvolts | | | Leakage | Negligible | | | Output Impedances { | Low | 10 ohms | | | Medium | 750 ohms | | | High | 4000 ohms | | RCA-5W4 | Rectifier | | | RCA-6C5 | Audio Oscillator | | | RCA-6J7 | R.F. Oscillator | | | Full vision Airplane Type, 6 1/2 ins. in diameter, over 50 ins. scale calibration | | | | Calibration accuracy 2% | | | | 13 3/4" x 9 1/4" x 6 1/2" deep. Weight, 12 1/2 lbs. | | | | Blue-Gray wrinkle lacquer with lithographed panel. | | | |
| Voltage | 110-120 volts | Power Consumption | 30 watts | | | | | | | | | | | | | | | | | | | | | | | | | | | | | | | | | | | | | | | | | | | | | | | | | | | | | | | | | | | | | | | | | | | | | | | | | | | | | | |
| Frequency | 50-60 cycles | Fuse Protection | 1/2 ampere | | | | | | | | | | | | | | | | | | | | | | | | | | | | | | | | | | | | | | | | | | | | | | | | | | | | | | | | | | | | | | | | | | | | | | | | | | | | | | |
| R.F. Frequency | 100-30,000 kc. | | | | | | | | | | | | | | | | | | | | | | | | | | | | | | | | | | | | | | | | | | | | | | | | | | | | | | | | | | | | | | | | | | | | | | | | | | | | | | | | |
| Number of Bands | 6 | | | | | | | | | | | | | | | | | | | | | | | | | | | | | | | | | | | | | | | | | | | | | | | | | | | | | | | | | | | | | | | | | | | | | | | | | | | | | | | | |
| Audio Modulation Frequency, Approximately | 400 cycles | | | | | | | | | | | | | | | | | | | | | | | | | | | | | | | | | | | | | | | | | | | | | | | | | | | | | | | | | | | | | | | | | | | | | | | | | | | | | | | | |
| R.F. Output { | Low | 0.01 volt max. | | | | | | | | | | | | | | | | | | | | | | | | | | | | | | | | | | | | | | | | | | | | | | | | | | | | | | | | | | | | | | | | | | | | | | | | | | | | | | | |
| | Medium | 0.25 volt max. | | | | | | | | | | | | | | | | | | | | | | | | | | | | | | | | | | | | | | | | | | | | | | | | | | | | | | | | | | | | | | | | | | | | | | | | | | | | | | | |
| | High | 1.0 volt max. | | | | | | | | | | | | | | | | | | | | | | | | | | | | | | | | | | | | | | | | | | | | | | | | | | | | | | | | | | | | | | | | | | | | | | | | | | | | | | | |
| Minimum Signal | 2 Microvolts | | | | | | | | | | | | | | | | | | | | | | | | | | | | | | | | | | | | | | | | | | | | | | | | | | | | | | | | | | | | | | | | | | | | | | | | | | | | | | | | |
| Leakage | Negligible | | | | | | | | | | | | | | | | | | | | | | | | | | | | | | | | | | | | | | | | | | | | | | | | | | | | | | | | | | | | | | | | | | | | | | | | | | | | | | | | |
| Output Impedances { | Low | 10 ohms | | | | | | | | | | | | | | | | | | | | | | | | | | | | | | | | | | | | | | | | | | | | | | | | | | | | | | | | | | | | | | | | | | | | | | | | | | | | | | | |
| | Medium | 750 ohms | | | | | | | | | | | | | | | | | | | | | | | | | | | | | | | | | | | | | | | | | | | | | | | | | | | | | | | | | | | | | | | | | | | | | | | | | | | | | | | |
| | High | 4000 ohms | | | | | | | | | | | | | | | | | | | | | | | | | | | | | | | | | | | | | | | | | | | | | | | | | | | | | | | | | | | | | | | | | | | | | | | | | | | | | | | |
| RCA-5W4 | Rectifier | | | | | | | | | | | | | | | | | | | | | | | | | | | | | | | | | | | | | | | | | | | | | | | | | | | | | | | | | | | | | | | | | | | | | | | | | | | | | | | | |
| RCA-6C5 | Audio Oscillator | | | | | | | | | | | | | | | | | | | | | | | | | | | | | | | | | | | | | | | | | | | | | | | | | | | | | | | | | | | | | | | | | | | | | | | | | | | | | | | | |
| RCA-6J7 | R.F. Oscillator | | | | | | | | | | | | | | | | | | | | | | | | | | | | | | | | | | | | | | | | | | | | | | | | | | | | | | | | | | | | | | | | | | | | | | | | | | | | | | | | |
| Full vision Airplane Type, 6 1/2 ins. in diameter, over 50 ins. scale calibration | | | | | | | | | | | | | | | | | | | | | | | | | | | | | | | | | | | | | | | | | | | | | | | | | | | | | | | | | | | | | | | | | | | | | | | | | | | | | | | | | |
| Calibration accuracy 2% | | | | | | | | | | | | | | | | | | | | | | | | | | | | | | | | | | | | | | | | | | | | | | | | | | | | | | | | | | | | | | | | | | | | | | | | | | | | | | | | | |
| 13 3/4" x 9 1/4" x 6 1/2" deep. Weight, 12 1/2 lbs. | | | | | | | | | | | | | | | | | | | | | | | | | | | | | | | | | | | | | | | | | | | | | | | | | | | | | | | | | | | | | | | | | | | | | | | | | | | | | | | | | |
| Blue-Gray wrinkle lacquer with lithographed panel. | | | | | | | | | | | | | | | | | | | | | | | | | | | | | | | | | | | | | | | | | | | | | | | | | | | | | | | | | | | | | | | | | | | | | | | | | | | | | | | | | |

RCA FREQUENCY MODULATOR

This high quality motor-driven sweep condenser unit is ideal for use with the new RCA Test Oscillator No. 153. It enables you to align circuits visually in conjunction with the Cathode Ray Oscillograph. When in operation, it sweeps the R.F. voltage of your test oscillator over the resonant frequency of the circuit under test and generates an a.c. synchronizing voltage simultaneously. Tuning condenser has two ranges, one of 22.5 mmfd. and one 45 mmfd. A front panel switch permits choice of either range during operation. Sweep frequency, 25 per second.

No. 9558

NET PRICE

\$27⁵⁰

READY TO
OPERATE

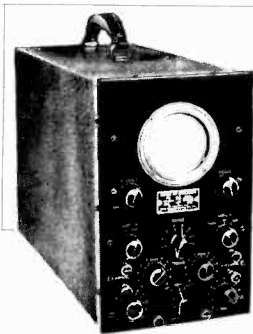

**RCA CATHODE
RAY
OSCILLOGRAPH**
No. 9545

NET PRICE **\$63⁹⁵**
Complete with All Tubes

A high quality three-inch Cathode Ray Oscillograph designed for the most advanced applications. Has wide range amplifiers, internal saw-tooth sweep oscillator and high voltage power supply. Front panel controls for all operating requirements. Uses six RCA Radiotrons, including RCA-906 Cathode Ray Tube. Translucent calibration screen makes reading and duplication of curves easy. Attractive Black lacquer finish. Also available for 25-cycle operation at \$68.95.

**RCA CATHODE
RAY
OSCILLOGRAPH**
No. 151

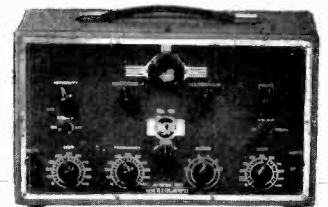

NET PRICE **\$39⁹⁵** *Complete with All Tubes*

A high quality one-inch Cathode Ray Oscillograph complete in every detail. Includes internal saw-tooth sweep oscillator, vertical and horizontal amplifiers, power supply — everything necessary for all service and experimental applications. Uses five RCA Radiotrons, 1 RCA-913, 1 RCA-885, 2 RCA-6C5, 1 RCA-80. All controls on front panel. Attractive gray wrinkle lacquer case with reverse-etched nickel silver panel. Has large soft rubber feet and sturdy snap handle.

Another RCA Antenna Leader . . .

RCA SPIDER-WEB ANTENNA SYSTEM

. . . a transoceanic communications type antenna for the home

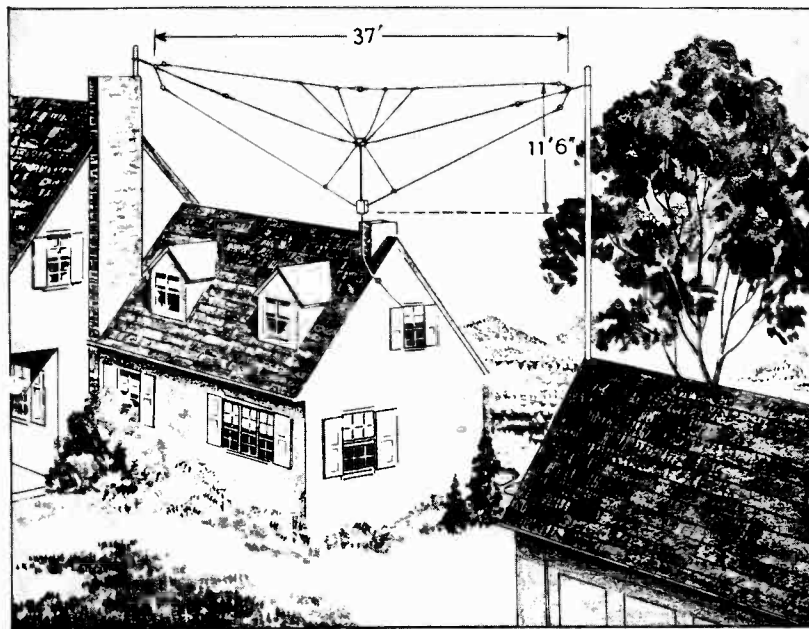

List Price

\$8.95

Stock No. 9685

Combining its experience in transoceanic communications work with its knowledge of home receiver requirements, RCA has produced a remarkable new antenna system. This antenna, which is known as the RCA Spider-Web Antenna, consists of a series of doublet antennas and an improved transmission line to the receiver. It is so constructed that additional doublets may be added to increase the frequency range to 70,000 K.C. (4 meters). More stations, less noise on the short-wave bands and an extremely wide frequency range are built-in characteristics of this remarkable new antenna.

Only with the **RCA SPIDER-WEB ANTENNA** *do you get all of these features*

- **FULL FREQUENCY COVERAGE**—The RCA Spider-Web Antenna System gives excellent signal pickup over the frequency range from 140 to 23,000 kc. By adding the Stock No. 9689 High Frequency Kit, List Price \$1.50, the range is increased to 70,000 kc. with full noise reduction. This feature is especially important because of the increased frequency range of modern all-wave receivers. The high frequency kit may be added at any time, not necessarily when the antenna is first installed.
- **LESS NOISE**—The balanced doublets and transposed transmission line eliminate all pickup on the lead-in in the short-wave bands. This greatly reduces man-made static (noise) from automobiles and electrical devices that mar short-wave reception.
- **MORE STATIONS**—A multiple doublet of unique design insures greater signal pickup in every receiving band. You'll hear many stations not previously heard.
- **FACTORY ASSEMBLED**—Complete soldering and assembling make it possible to erect the antenna in a few minutes after providing supports.
- **STURDY CONSTRUCTION**—Use of seven-strand No. 22 wire and a truss-type mechanical design insures the strength necessary to withstand severe winter weather disturbances, including heavy ice formation. The illustration shows one of these installations at Camden, N. J., during the severe winter of 1936.
- **SMALL SPACE REQUIRED**—A span of 38 feet and a vertical clearance of 12 feet are the entire space requirements of the RCA Spider-Web Antenna. You'll find it easy to install in almost any location. Because double-supports are eliminated, it is considerably easier to install than the former double-doublet antenna systems.

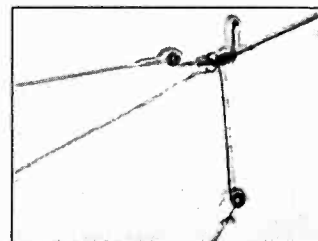

RCA MAGIC WAVE ANTENNA SYSTEM

OPERATES 1 TO 16 RADIOS FROM ONE ANTENNA



GIVES NOISE REDUCTION ON BOTH STANDARD BROADCAST AND INTERNATIONAL SHORT-WAVE BANDS (530 TO 23,000 KCS.)

List Price **\$6.95** Stock No. 9812
(SINGLE OUTLET INSTALLATION)

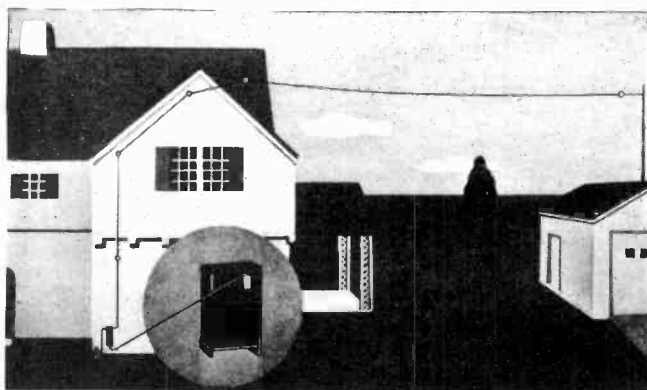

The new RCA Magic Wave Antenna makes possible greatly improved radio performance and offers real profit-making possibilities for service engineers and radio dealers.

By use of the newly developed magnetite core antenna and coupling transformers, RCA engineers have produced an antenna with many outstanding features. Scientific tests show that the RCA Magic Wave Antenna has greater noise reducing properties and is more easily installed than any antenna previously offered by RCA for home use. The operation of from one to sixteen sets on one antenna with only a slight reduction in efficiency is a feature exclusive in the RCA Magic Wave Antenna System. This is accomplished by the use of the new RCA Distribution Transformers in conjunction with this antenna.

FEATURES

- Easily installed with antenna lengths from 20 to 120 feet.
- Adaptable to existing installations — No doublets or critical antenna transmission line lengths.
- Operates up to 16 outlets simultaneously when used with RCA distribution and coupling transformers.
- Adaptable to many different types of installations — vertical, horizontal, apartment house or home. Transmission line can be installed underground avoiding unsightly appearance.

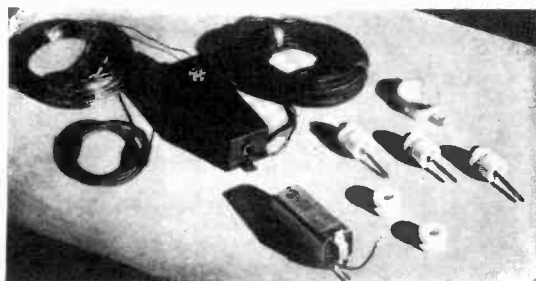

CONTENTS OF KIT

(Completely assembled ready to install)

| | |
|---------------------------------|---------------------------|
| 1 Antenna Coupling Transformer | 60 ft. Antenna Wire |
| 1 Receiver Coupling Transformer | 45 ft. Transmission Cable |
| | 5 ft. Ground Wire |
| | 5 Porcelain Insulators |
| | 1 Ground Clamp |

EASILY INSTALLED • NOISE REDUCING



395 ANTENNA SYSTEM

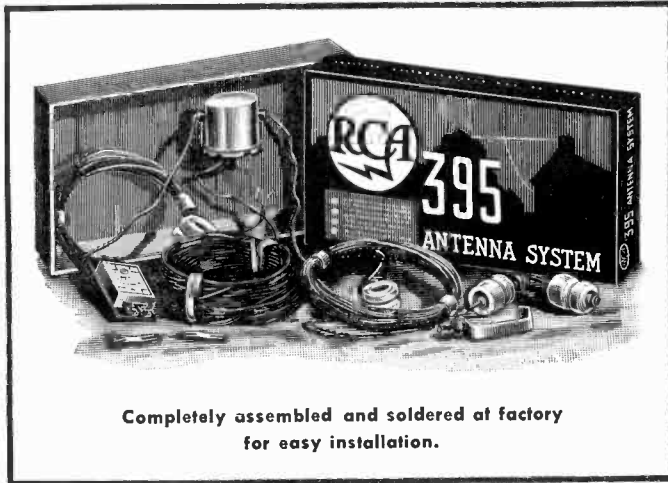

Completely assembled and soldered at factory for easy installation.

STOCK NO. 395

LIST PRICE

\$3.95

Contents of Kit

- 2 ANTENNA WIRE COILS—EACH 20 FEET LONG
- 2 STRAIN INSULATORS
- 1 TRANSMISSION LINE—45 FEET
- 1 JUNCTION BOX
- 1 RECEIVER COUPLING UNIT
- 2 COUPLING UNIT LINKS
- 2 NAIL-ON KNOB INSULATORS
- 1 GROUND CLAMP
- 1 INSTRUCTION SHEET

- Factory assembled—no soldering
- Easily installed—40-foot span
- Wide frequency range—extends from 140 to 23,000 kcs.
- Doublet type—efficient pickup
- Works efficiently with all receivers

Here's a genuine RCA antenna, giving highly efficient performance, priced at a figure everyone can pay. It is a scientifically designed system, operates perfectly with receivers of all types and manufacture and is unusually easy to install. Two supports, forty feet apart are all that is required for installation. All parts, antenna wires, strain insulators, junction box, transmission line are assembled and soldered.

The antenna proper acts as an efficient pick-up medium, giving high signal strength over a very wide frequency range. A new type transmission line conveys the signal to the receiver while the coupling unit matches the transmission line to the receiver input circuit.

Cash in on this low-priced antenna. Recommend it to your customers who need a quality antenna at a popular price.



AUTO ANTENNAS

OFFER OUTSTANDING PERFORMANCE AT POPULAR PRICES



RCA MONOGRAM ANTENNA

A new top antenna of outstanding appearance and efficiency. Streamlined Bakelite Insulator with special rubber suction cup provides easy installation. Has high-gloss satin finish, guaranteed rust proof. Extends from 21" to 35½" in length. Cowl bar also telescopic. Fits and enhances the beauty of any automobile. Includes eight-inch rubber cable fitted with male connector. Weight — 13 ounces. Individually packed.

Shielded cable for above included.

LIST PRICE \$4.95
NO. 9823

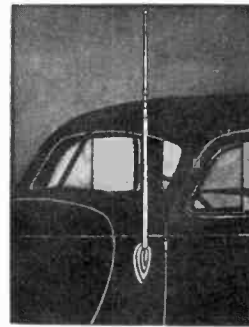

RCA COWL TENNA

RCA's latest vertical type auto antenna. Permanently installed to side of cowl. Streamlined insulator includes rubber pad to insure perfect seal. Extends from 28¾" to 49½" in length. Beautiful appearance, guaranteed rust and corrosion-proof, high-gloss satin finish. Easily installed, all soldering eliminated. Weight 9 ounces; individually packed.

Shielded cable for use with above. Length 36". Fitted with metal shield can for antenna connection and male bayonet fitting for receiver connection. Stock No. 9829—List Price \$0.75.

LIST PRICE \$3.65
NO. 9825



RCA ROD TENNA STOCK NO. 9793 LIST PRICE \$3.50

Here's RCA's most easily installed auto antenna—just requires five minutes for a complete job. Remove either door hinge-pin, attach the RCA Rodtenna and return the pin. That is all there is to it—no drilling, no soldering or cementing required. Made of high carbon vanadium steel, triple chromium plated. Weather-proof moulded rubber insulator and special 10½" flat connection lead complete with female bayonet connector. Has high signal pickup and eliminates wheel static. A high-quality, flexible, easily installed antenna. Weight 10 ounces; individually packed.

Extension cable for above. 36" low-capacity shielded cable with male bayonet fittings on each end. Stock No. 9830—List Price \$0.60.

RCA TELESCOPIC ROD TENNA LIST PRICE STOCK NO. 9827 \$2.75

A new hinge mounting type antenna that extends from 29½" to 50½" in height. Has excellent pickup qualities. Made of a new non-rusting metal having high-gloss satin finish. Easily installed by removing hinge-pin. Uses heavy duty weatherproof insulator having attractive chromium band. Furnished with special 10½" flat moulded rubber-covered lead, terminated with female bayonet fitting. Bracket designed to permit streamlining antenna to car when so desired. Weight 9 ounces; individually packed.

Cable for above. 36" low-capacity shielded cable with male bayonet fittings on each end. Stock No. 9830—List Price \$0.60.

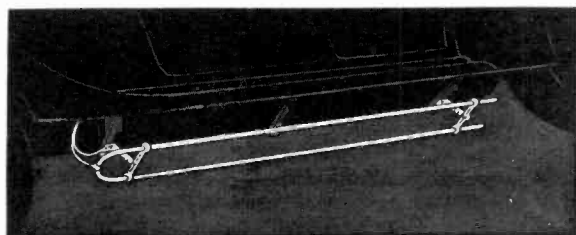

RCA DI-POLE ANTENNA

STOCK NO. 9605

LIST PRICE \$2.60

For efficient under-car installations the RCA Di-Pole Antenna will be found to be unexcelled. It is simple in design, efficient in operation and easily installed on any car. Because of its construction and the location of the antenna, ignition interference is reduced to a minimum. Adjustable brackets provide a wide variety of installation locations and adjustment for road clearance. Where the signal level is exceptionally low, two may be installed, one under each running-board. Such an installation gives improved pickup. Complete with 50-inch shielded lead-in cable having female bayonet connector, and all necessary fittings. Individually packed.

RCA Victor

AUTOMATIC RECORD CHANGERS



\$99⁵⁰
LIST

Stock No. 9820 (Replaces No. 9655)



DE LUXE AUTOMATIC RECORD CHANGER

- Automatically changes either eight 10-inch or seven 12-inch records.
- Gives uninterrupted record reproduction for 35 minutes when using 12-inch records.
- Uses new inertia type crystal pickup with balanced tone arm. (40,000 ohms impedance.)
- Pickup arm has 3 oz. needle pressure. (Adjustable to a greater or lesser pressure if desired.)
- Needle easily loaded from top of head. Automatically adjusts to proper position.
- 18 $\frac{5}{8}$ " long, 12 $\frac{5}{8}$ " wide, 8 $\frac{3}{8}$ " high, including parts below motor board. Requires space at left of motor board 7 $\frac{1}{4}$ " x 15 $\frac{1}{4}$ " and 11 inches deep for record well.
- Brown wrinkle finish—Shipping weight—31 lbs.

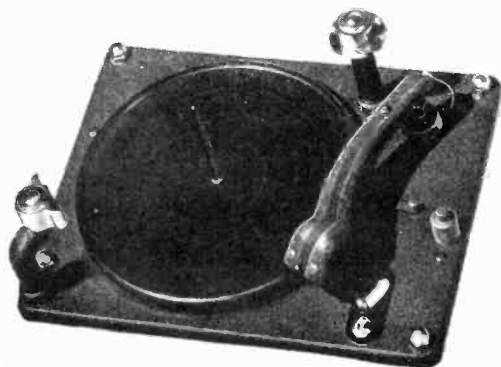

\$49⁹⁵
LIST

Stock No. 9800



JUNIOR AUTOMATIC RECORD CHANGER

- Automatically changes seven 10-inch records. Plays 12-inch records manually. Repeats last record of either size.
- Uses magnetic type pickup, 1400 ohms impedance. Also available as Stock No. 9801, 96 ohms impedance.
- Dimensions: length 13 $\frac{1}{2}$ ", depth 10 $\frac{1}{4}$ ", height above motor board 4 $\frac{1}{2}$ ", depth below motor board 3 $\frac{7}{8}$ ".
- Small, compact, easily installed. Ideal for phonograph modernization. Takes less space than usual manual motor board.
- Brown wrinkle finish—Shipping weight—15 lbs.

RCA CRYSTAL PICKUP AND ARM

- High impedance pickup—40,000 ohms.
- Crystal completely sealed.
- Spring-counterbalanced tone arm.
- Adjustable needle pressure.
- Ball bearing, rubber cushioned, pivot mounting.
- Top loading of needle.
- Needle positioning bracket included.
- Crystal offset to give minimum tracking error.
- Wide frequency response, 45-7000 cycles.
- Brown wrinkle lacquer finish with attractive chromium trim.
- Shipping weight—3 $\frac{1}{2}$ lbs.

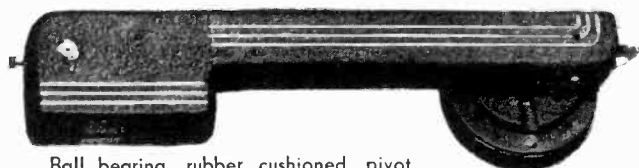

Ball bearing, rubber cushioned, pivot mounting. Requires 2 $\frac{3}{4}$ inches mounting space below top of motor board.

This new crystal pickup and arm is ideal for replacement use. Has excellent frequency response and works directly into the grid circuit without coupling transformers. Needle positioning bracket comes packed with pickup.

\$14⁹⁵
LIST

Stock No. 14818



VISCOLOID DAMPED PICKUPS

De Luxe Type

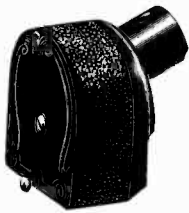

\$6.50
LIST PRICE

Viscoloid damping blocks assure undistorted vibration—free reproduction over the widest possible tone range, giving a degree of reproducing perfection hitherto impossible.

Wide frequency range, excellent mechanical construction and high output voltage make RCA De Luxe Type Pickups ideal for the finest record reproduction. Through the use of viscoloid damping blocks and chromium steel magnets, long and carefree service is a built-in quality. Use with RCA Inertia-Type Suspension Arms.

MAGNETIC PICKUPS

| STOCK NO. | LIST PRICE | FINISH | IMPEDANCE AT 1000 CYCLES | OUTPUT VOLTAGE AT 400 CYCLES |
|--------------|---------------|--------|----------------------------|------------------------------|
| 9661 | \$6.50 | Walnut | 8.5 | .038 |
| 11721 | 6.50 | Brown | 8.5 | .038 |
| 11481 | 7.50 | Brown | 22 (with hum bucking coil) | .080 |
| 9665 | 6.50 | Walnut | 30 | .083 |
| 9676 | 6.50 | Black | 400 | .285 |
| 9669* | 6.50 | Walnut | 700 | .46 |
| 9670 | 6.50 | Walnut | 2800 | .65 |
| 9675 | 6.50 | Black | 8500 | 1.21 |
| 9749 | 6.50 | Walnut | 8500 | 1.21 |

*Viscoloid Damping not included.

SUSPENSION ARMS

Inertia Type



\$7.50
LIST PRICE

INERTIA TYPE SUSPENSION ARMS

| STOCK NO. | LIST PRICE | FINISH |
|-------------|-------------|--------|
| 9678 | 7.50 | Walnut |
| 9679 | 7.50 | Black |

All RCA Suspension Arms fit any of the pickups shown above. Suspension Arms include a plain escutcheon and a plug for connecting to the magnetic pickup. **They fit all automatic record changers except the RAE-59, RAE-26 and RAE-79.**

PICKUP AND ARM *Junior Type*



Small in size yet great in quality of performance, this Junior Type RCA Pickup and Arm is particularly adaptable to modernization jobs on old phonographs where space is limited. Its use is especially recommended for installations with the Junior Type Motor and Turntable shown at right.

LOW-COST MOTOR AND TURNTABLE (JUNIOR TYPE)

for 10" AND 12" RECORDS

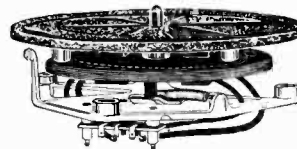

STOCK No. 11873

LIST PRICE \$10⁵⁰

Low-cost phonograph operation is offered by this Junior Type Motor for 78 r.p.m. records. The small physical size of this motor enables its application on jobs where space is limited or it is desirable to conserve space. Voltage—105-125 volts; frequency—60 cycles (can be supplied for 50 cycles). Diameter—7 inches.

Stock No. **3813** Motor Mounting Assembly contains rubber bushings, etc., to mount No. 11873 motor. List Price, package of three, **\$0.56.**

| Stock No. | List Price | Impedance at 1000 Cycles | Output Voltage at 400 Cycles |
|--------------|---------------|--------------------------|------------------------------|
| 12329 | \$6.75 | 1400 | .30 |

Prices shown on this sheet supersede those shown in the RCA Test Equipment, Accessories and Parts Catalog, pages 18 and 19, and those shown on RCA Catalog sheet, Form 1210.

PHONOGRAPH OSCILLATOR

A Miniature Broadcast Station For Every Receiver

Show your customers how to broadcast records to themselves with the RCA Phonograph Oscillator. Possessing all the appeal of a distinct novelty, it has RCA practicability and durability built in.

It makes additional profits for the Service Engineer through the sale of additional equipment and solves one of his toughest problems in phonograph modernization work. The output from the pickup coil modulates the oscillator which is coupled to the antenna of the receiver. This modulated signal is tuned in on the receiver just like any broadcasting station.

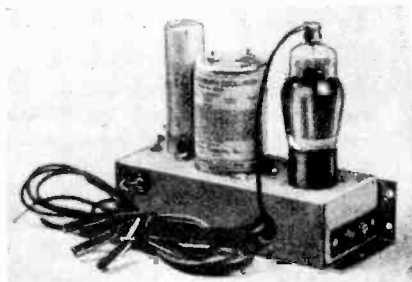

STOCK NO. 9554
LIST PRICE **\$9.75**
(WITHOUT TUBE)

MAKE AN INEXPENSIVE PUBLIC ADDRESS SYSTEM

with the RCA Phonograph Oscillator and any radio receiver. The connections and additional parts required are shown in the diagram. Cash in on this large field and make your share of the profits.

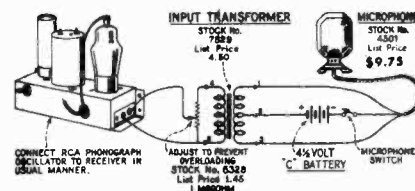

CATHODE RAY "MAGIC EYE" KIT

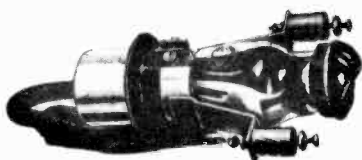

CONTENTS OF KIT

One each

RCA 6E5 Electron-Ray Tube.

Socket complete with 24-inch cable.

Tube mounting clamp and bracket assembly.

Escutcheon.

Clamp screw complete with nut and lock washer.

Rubber gasket.

Two each

Mounting bushings.

Mounting screws complete with nuts and washers.

Now you can install a genuine RCA Cathode Ray Tuning Indicator, just like the famous RCA Magic Eye, in almost any receiver having an automatic volume control. By means of this complete kit of parts, installation work is but a matter of moments—just drill one large hole, install three screws and make a few connections.

Always carry an RCA Cathode Ray Tuning Kit to demonstrate to your customers when doing other service work.

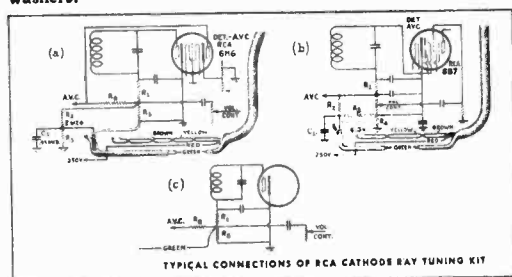

LIST PRICE **\$3.00**

STOCK NO. 9688

THE NEW UNIVERSAL WAVE TRAP

LIST PRICE **\$2.65**
STOCK NO 13467

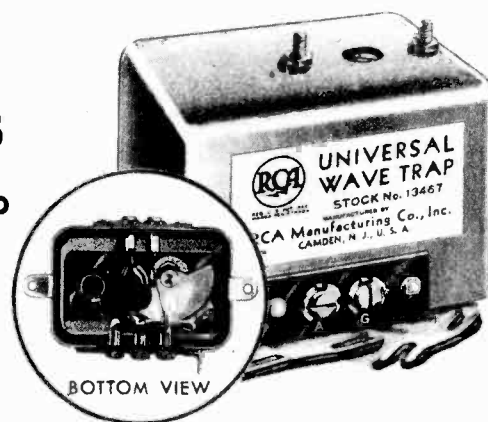

ELIMINATES

- Cross-modulation.
- Long-wave Signals.
- Code Interference.
- Blanketing by Powerful, Nearby Broadcasting Stations.
- Broad Tuning.
- And many other kinds of interference.

FEATURES

- Extensive range of adjustment—430-1700 kcs.
- High degree of attenuation—30 db. or 32-1 in voltage.
- Universal Mounting Adaptability. Shielding of electrical elements.
- Low Loss—Air dielectric—Adjustable capacitor.
- Magnetite core coil—Provides a high-Q circuit.
- Short-wave performance not hampered by use of trap.

Easily Installed On Any Radio



UNIVERSAL AUDIO TRANSFORMER

FOR INTERSTAGE AUDIO TRANSFORMER REPLACEMENTS IN ALL RADIO SETS AND POWER AMPLIFIERS

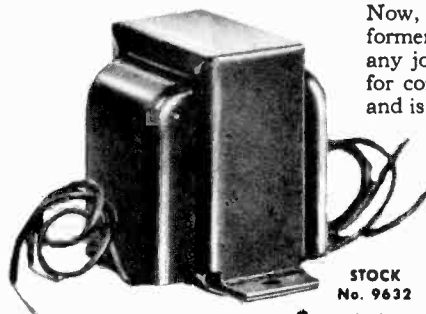

Now, with the new RCA Universal Audio Transformer, you can make all interstage transformer replacements with a single unit. No need to carry more than this one transformer for any job that may occur. It contains a center tapped primary and a center tapped secondary for connecting either from or to any *single* or *push-pull* stage. Has proper step-up ratio and is easily and quickly mounted on any type of chassis.

SPECIFICATIONS

OVERALL SIZE—2 in. x 2 1/4 in. x 2 1/4 in. Shielded black finish case—Vacuum wax impregnated.
FREQUENCY RESPONSE—30-10,000 cycles.
TURN RATIO—Primary to secondary 1:3 overall.
PRIMARY CURRENT—10 milliamperes d.c. (maximum).

PRIMARY CONNECTIONS—Primary connects to any single or push-pull triode, such as O1A, 26, 27, 30, 37, 55, 56, 76, 85, 6C5 or others of similar plate impedance. Secondary, to any single or push-pull stage regardless of tube type.

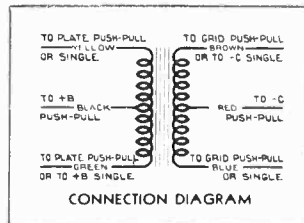

STOCK No. 9632
LIST PRICE \$2.00



UNIVERSAL OUTPUT TRANSFORMER

FOR OUTPUT TRANSFORMER REPLACEMENT IN ALL SETS



Special TROPICAL MODEL

For extreme tropical conditions of high temperature and humidity. Special cased model, having vacuum wax impregnated windings and complete potting in an asphalt or compound for protection. Case is cadmium plated, fitted with bakelite terminal board.

LIST PRICE \$2.35
Stock No. 7853

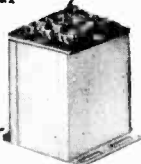

● One transformer for exact matching of all output tubes (either single or push-pull) to all dynamic loudspeakers. (Covers voice-coil impedances from 1 ohm to 15 ohms.)

● Angle bracket with slots for easy mounting on either chassis or loudspeaker frame.

● Silicon steel core eliminates damage from shock or overload.

● Tinned terminals for quickly attaching tube and speaker leads.

● Baked varnish impregnation gives protection against normal climatic conditions.

SPECIFICATIONS

SIZE—Standard Model—2 1/4 in. x 2 1/4 in. x 2 in. Cased Model—2 1/4 in. x 2 1/4 in. x 3 in.
VOICE-COIL IMPEDANCES—1 to 15 ohms.
PRIMARY LOAD IMPEDANCES—1000 to 20,000 ohms.
MAXIMUM WORKING POTENTIAL—500 volts.
MAXIMUM PLATE CURRENT (each tube)—55 milliamperes.
FREQUENCY RANGE—30 to 10,000 cycles.

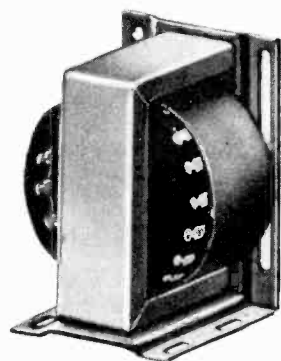
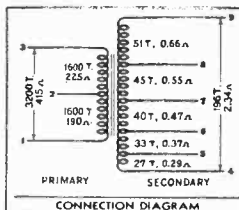

STOCK NO. 7852

LIST PRICE \$2.00



UNIVERSAL POWER TRANSFORMER

FOR SETS HAVING BOTH 2.5 AND 6.3 VOLT HEATERS

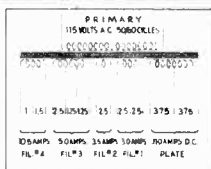

10-12 TUBE SETS
Stock No. 9551
LIST PRICE \$3.50

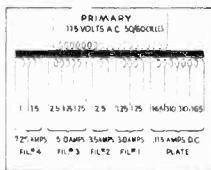

CLASS B SETS
Stock No. 9552
LIST PRICE \$6.00

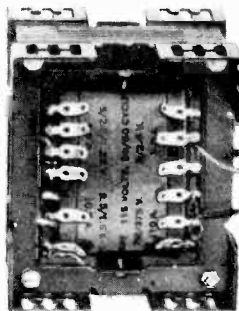
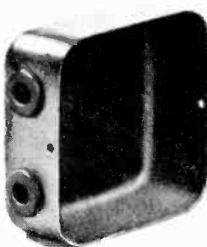

SPECIFICATIONS

Slotted in every conceivable position for quick attachment, "H" type holes are provided in the mounting lugs differently spaced on opposite surfaces to allow maximum flexibility in mounting. Only four types needed for the 12-tube jobs down to 4-tube midgets.

Terminals allow flexibility for adapting transformer to any circuit. Plenty of windings are available to meet the requirements of any circuit. Four types fit practically all sets from 1927 to 1937.

For 4-TUBE SETS

A high quality small transformer for midget 4-tube receivers.

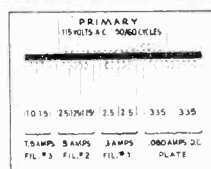

5-9 TUBE SETS
Stock No. 9553
LIST PRICE \$4.75

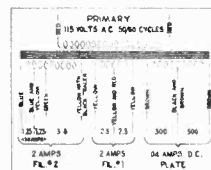

4-TUBE SET
Stock No. 9556
LIST PRICE \$2.00

No longer is it necessary to "send away" for transformers. RCA Universal Transformers for practically all makes of radio receivers from 1927 to 1937 have been perfected... even anticipating future receiver design.



MODEL 85T2



MODEL 86T2

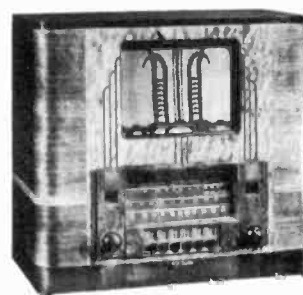

MODEL 87T2

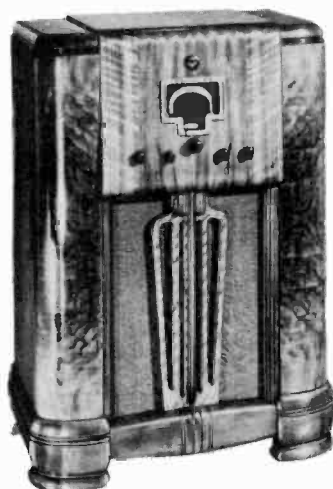

MODEL 10K1

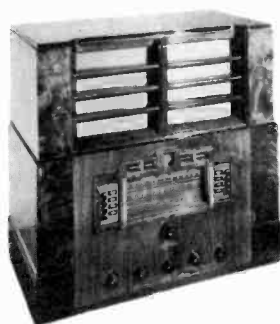

MODEL 811T

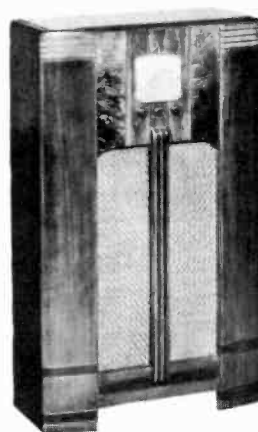

MODEL 85K

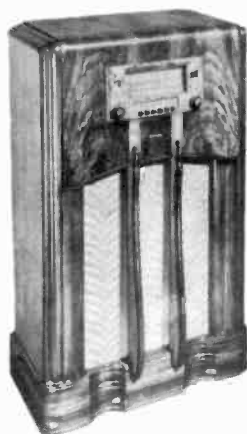

MODEL 87K2

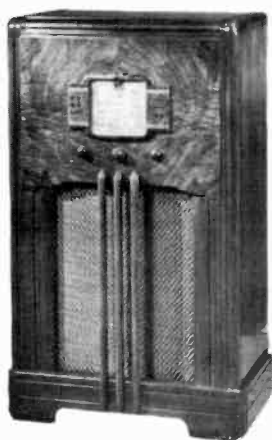

MODEL 88U2



MODEL U-108



MODEL R-93-2



MODEL R-93-S



MODEL R-94



MODEL O-11

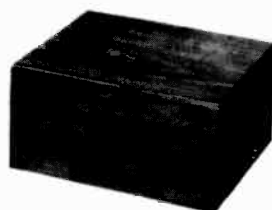

MODEL R-93-A



MODEL O-15

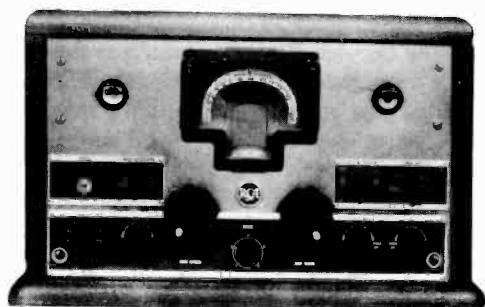

MODEL ACR-111



MODEL CV-8

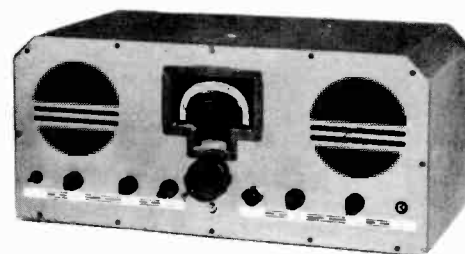

MODEL ACR-155

RCA CABINET REFINISHING KIT

You won't call in the cabinet refinisher nearly so often after you get the RCA Cabinet Refinishing Kit. Of course, you can't do every refinishing job with it, but you can do most of them—saving time and money on every job. It's the little touch-up jobs that occur most often anyhow. Someone in the shop lays a hammer on the cabinet; a button on the truck driver's coat scratches it in delivery; or perhaps it has been marred in home demonstrations or while on display in the dealer's store. But whatever the cause, you have the remedy at hand for use.

CONTENTS

One each of the following: Can Refco Oil, can Rubbing Oil, can Tripoli, assortment Sand Paper, assortment Stick Shellac, Touch-up Brush, Spatula, Rubbing Block, Instruction Sheet and two packages of Aniline Stain Powders, all packed in durable leatherette case.

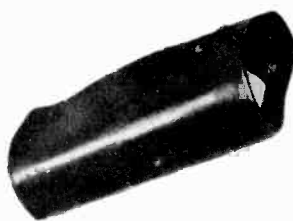

STOCK NO.

9546

\$2.90

NET PRICE



RCA VICTOR SERVICE NOTES

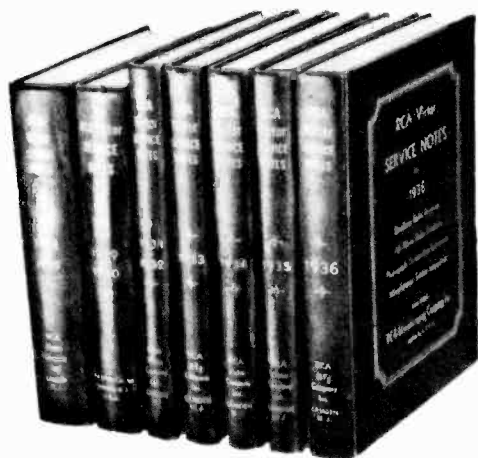

Now IN SEVEN
BOUND VOLUMES

These volumes cover all RCA or Victor models produced from 1923 to 1936 except old Victrola instruments that did *not* contain a radio receiver. Complete replacement parts lists are provided for all models issued since 1929.

When the Service Engineer wants technical information on any RCA Victor model, he turns to the index of his bound volume; a moment later diagrams, parts lists and prices and service notes are lying *flat* on the table before him.

Service Engineers who use the volumes regard them as their "Business Bible," not alone for the diagrams and drawings but for the time-saving service information. Schematic drawings can be obtained elsewhere, but the technical information is not so readily found.

In addition, each volume contains other valuable information, such as impedance, inductance and capacity charts, and other data peculiar to the receivers described therein.

COVER ALL RCA OR VICTOR MODELS FROM 1923 TO 1936

This library contains complete service information, drawings and price lists from 1923 to 1936 as follows:

\$1.25

PER VOLUME NET PRICE

| STOCK NO. | STOCK NO. | STOCK NO. |
|---------------|---------------|-----------|
| 100 1923-1928 | 102 1931-1932 | 104 1934 |
| 101 1929-1930 | 103 1933 | 105 1935 |
| | | 106 1936 |



RCA Victor

MODEL 5T1

Five-Tube, Two-Band, A-C, Superheterodyne Receiver

TECHNICAL INFORMATION AND SERVICE DATA

SERVICE DIVISION • RCA MANUFACTURING COMPANY, INC. • CAMDEN, N. J., U. S. A.

A Service of the Radio Corporation of America

Electrical Specifications

| | | | |
|-------------------------------|---------------------------|--|---|
| FREQUENCY RANGES | | ALIGNMENT FREQUENCIES | |
| "Standard Broadcast" (A)..... | 540-1,820 kc | "Standard Broadcast" (A)..... | 600 kc (osc.), 1,700 kc (osc., ant.) |
| "Short Wave" (B)..... | 1,820-6,600 kc | "Short Wave" (B)..... | None required |
| Intermediate Frequency..... | | | 460 kc |
| RADIOTRON COMPLEMENT | | (3) RCA-75..... Second Det., A-F Amp. and A.V.C. | |
| (1) RCA-6A7..... | First Detector—Oscillator | (4) RCA-42..... | Audio Power Amplifier |
| (2) RCA-6D6..... | Intermediate Amplifier | (5) RCA-80..... | Full-Wave Rectifier |
| Pilot Lamp (1)..... | | | Mazda No. 46, 6.3 volts, 0.25 ampere |
| POWER SUPPLY RATINGS | | | |
| Rating A..... | | | 105-125 volts, 50-60 cycles, 80 watts |
| Rating B..... | | | 105-125 volts, 25-60 cycles, 80 watts |
| Rating C..... | | | 100-130/140-160/195-250 volts, 40-60 cycles, 80 watts |
| POWER OUTPUT RATING | | LOUDSPEAKER | |
| Undistorted..... | 2.0 watts | Type..... | Electrodynamic |
| Maximum..... | 4.5 watts | Voice Coil Impedance..... | 3.2 ohms at 400 cycles |

Mechanical Specifications

| | |
|------------------------------|---|
| Height..... | 17½ inches |
| Width..... | 13¼ inches |
| Depth..... | 8 inches |
| Weight (Net)..... | 17½ pounds |
| Weight (Shipping)..... | 19½ pounds |
| Chassis Base Dimensions..... | 12 inches x 7 inches x 2½ inches |
| Over-all Chassis Height..... | 7½ inches |
| Operating Controls..... | (1) Power Switch—Tone, (2) Tuning, (3) Volume, (4) Range Selector |
| Tuning Drive Ratio..... | 10 to 1 |

General Description

This receiver employs a superheterodyne circuit, the arrangement of which is shown on figure 2. Its design includes magnetite-core adjusted i-f transformers and wave-trap; aural-compensated volume control; two-point, high-fre-

quency tone control; automatic volume control; resistance-coupled audio system; phonograph terminal board; and a six-inch, dust-proof, electrodynamic loudspeaker.

Copyright, 1937, RCA Manufacturing Co., Inc.

Trademark "Radiotron"
Reg. U. S. Pat. Off. by RCA Mfg. Co., Inc.

Service Data

The various diagrams of this booklet contain such information as will be needed to isolate causes for defective operation if such develops. The ratings of the resistors, capacitors, coils, etc., are indicated adjacent to the symbols signifying these parts on the diagrams. Identification titles such as R1, L1, C1, etc., provide reference between the illustrations and Replacement Parts List. The coils, transformer windings, and reactors are rated in terms of d-c resistance to permit continuity checks.



Model 5T1

Loudspeaker.—Centering of the loudspeaker is made in the usual manner with three narrow paper feelers after first removing the front dust cover. This may be removed by softening its cement with a light application of acetone, using care not to allow the acetone to flow into the air gap. The dust cover should be cemented back in place with ambroid upon completion of adjustment.

Phonograph Attachment.—A terminal board is provided for connecting a phonograph into the audio-amplifying circuit. RCA Victor Models R-93, R-93-2, R-93-A, or R-94 Record Players should be connected as follows: Remove link between terminals 1 and 2 on receiver. Connect green wire in Radio-Record switch cable to terminal 1, yellow to terminal 2; and shield extension to terminal 3. Tape unused red and blue leads separately. Connect a 2-conductor twisted cable between the Record Player binding posts and the screw terminals on Radio-Record switch.

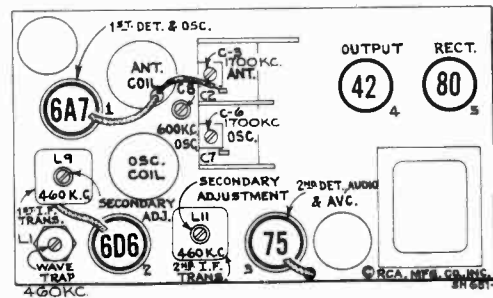

Figure 1—Radiotron, Coil, and Trimmer Locations

Alignment Procedure

Calibrate the tuning dial by adjusting dial pointer to the extreme low-frequency end calibration mark on the "Standard broadcast" dial scale with the two-gang tuning condenser in full-mesh position.

Perform alignment in proper order tabulated below, starting with No. 1 and following all operations across, then No. 2, etc.

Cathode-ray alignment is preferable; the connections to the chassis are shown on figure 3. If an output indicator is used, connect it across the loudspeaker voice-coil and advance the receiver volume control to full-volume position.

Connect the "low" output terminal of the test oscillator to

the receiver chassis for all alignment operations. Regulate the output of the test oscillator so that minimum signal is applied to the receiver to obtain an observable output indication. This will avoid a-v-c action.

The term "Dummy antenna" means the device which must be connected between the "high" test-oscillator output and the point of connection to the receiver in order to obtain ideal alignment. "No signal, 550-750 kc" means that the receiver should be tuned to a point between 550 and 750 kc where no signal is received from a station or the local (heterodyne) oscillator.

For further details on alignment, refer to booklet "RCA Victor Receiver Alignment."

| Order of Alignment | Test Oscillator | | | Receiver Dial Setting | Circuit to Adjust | Adjustment Symbols | Adjust to Obtain |
|--------------------|------------------------|---------------|-------------------|-----------------------|-------------------|--------------------|------------------|
| | Connection to Receiver | Dummy Antenna | Frequency Setting | | | | |
| 1 | 6D6 i-f Grid Cap | .001 Mfd. | 460 kc | No signal 550-750 kc | 2nd i-f Trans. | L10 and L11 | Max. (peak) |
| 2 | 6A7 Det. Grid Cap | .001 Mfd. | 460 kc | No signal 550-750 kc | 1st i-f Trans. | L8 and L9 | Max. (peak) |
| 3 | Ant. Post | 200 Mmfd. | 460 kc | No signal S. W. Band | Wave Trap | L1 | Minimum Output |
| 4 | Ant. Post | 200 Mmfd. | 600 kc | 600 kc | L-F Osc. | C8 | Max. (peak) |
| 5 | Ant. Post | 200 Mmfd. | 1,700 kc | 1,700 kc | H-F Osc. | C6 | Max. (peak) |
| 6 | Ant. Post | 200 Mmfd. | 600 kc | Rock thru 600 kc | L-F Osc. | C8 | Max. (peak) |
| 7 | Ant. Post | 200 Mmfd. | 1,700 kc | 1,700 kc | H-F Osc. | C6 | Max. (peak) |
| 8 | Ant. Post | 200 Mmfd. | 1,700 kc | 1,700 kc | Ant. | C3 | Max. (peak) |

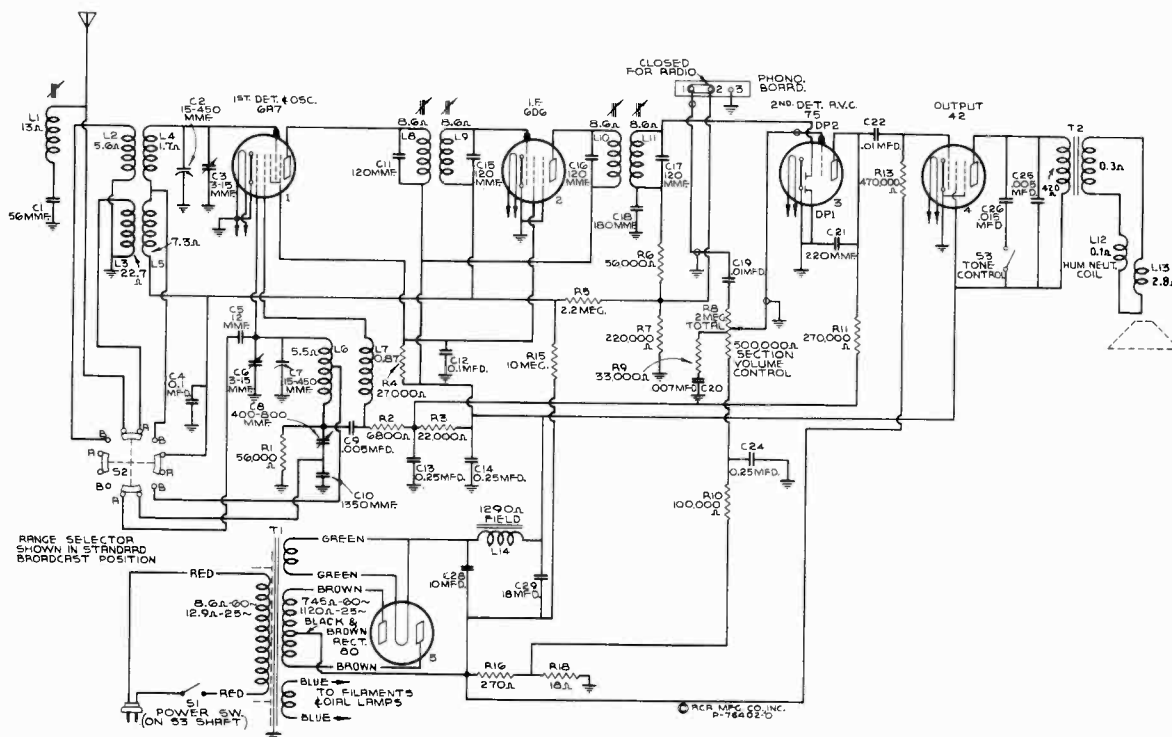
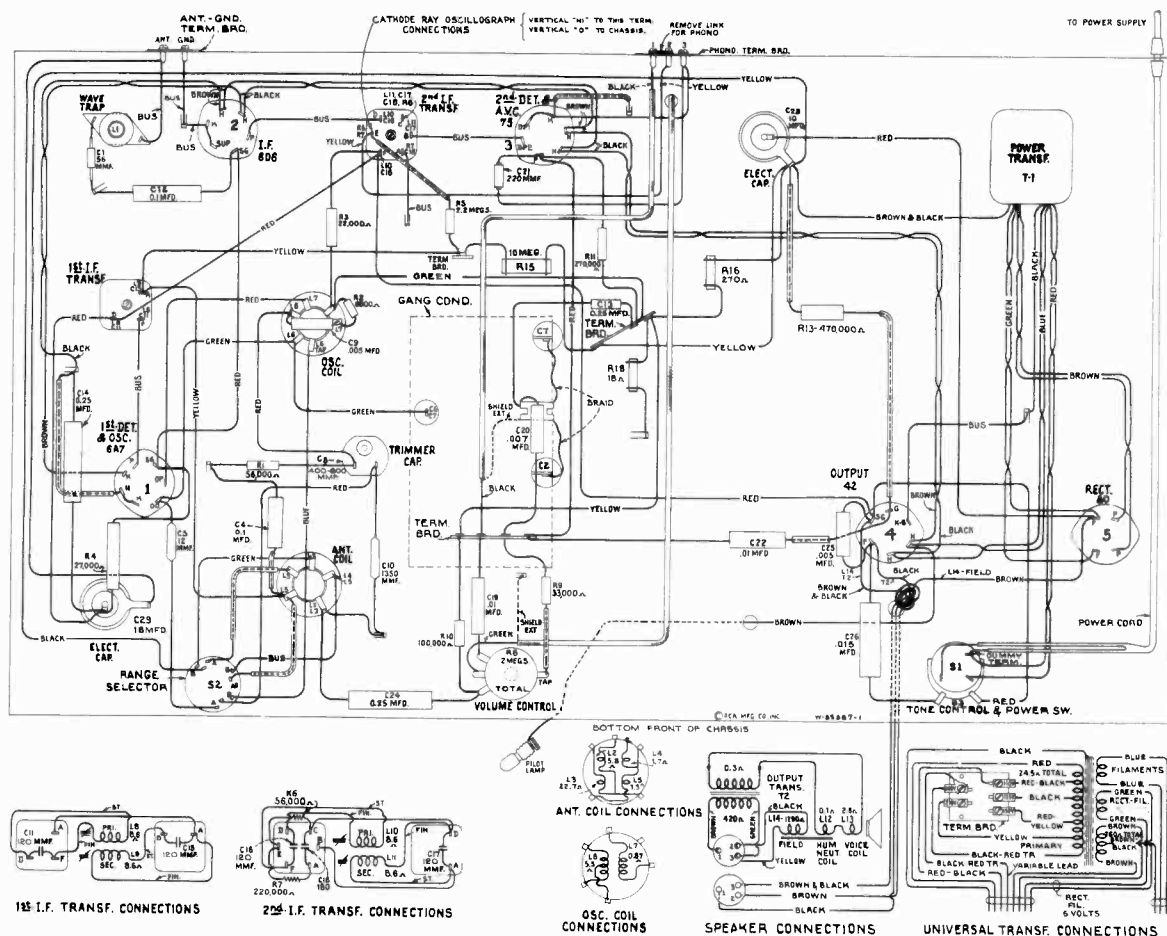

Figure 2—Schematic Circuit Diagram



1st I.F. TRANSF. CONNECTIONS

2nd I.F. TRANSF. CONNECTIONS

ANT. COIL CONNECTIONS

OSC. COIL CONNECTIONS

SPEAKER CONNECTIONS

UNIVERSAL TRANSF. CONNECTIONS

Figure 3—Chassis Wiring Diagram

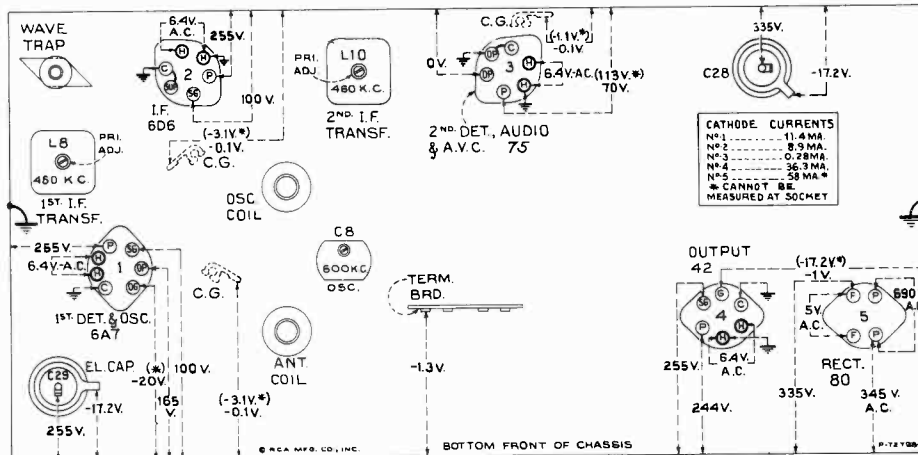

Figure 4—Radiotron Socket Voltages, Coil, and Trimmer Locations
 Measured at 115 volts, 60-cycle supply—Tuned to approximately 1,000 kc ("Standard Broadcast")—
 No signal being received—Volume control minimum

Note: Two voltage values are shown for some readings. The value shown in parentheses with asterisk (*) indicates operating conditions without voltmeter loading. The other value (generally lower) is the actual measured voltage and differs from the value shown in parentheses because of the additional loading of the voltmeter through the high series circuit resistance.

Voltage values as specified should hold within $\pm 20\%$ when the receiver is normally operative at its rated line voltage. To duplicate the conditions under which the voltages were measured requires a 1,000-ohm-per-volt d-c meter, having ranges of 10, 50, 250, and 500 volts. Use the nearest range above the specified measured voltage. A-c voltages were measured with a corresponding a-c meter.

REPLACEMENT PARTS

Insist on genuine factory tested parts, which are readily identified and may be purchased from authorized dealers.

| STOCK No. | DESCRIPTION | STOCK No. | DESCRIPTION |
|----------------------------|--|---------------------------------|---|
| RECEIVER ASSEMBLIES | | | |
| 12930 | Board—Antenna and ground terminal board | 11398 | Resistor—220,000 ohm, carbon type, 1/10 watt (R7) |
| 5237 | Bushing—Variable condenser mounting bushing assembly | 11323 | Resistor—270,000 ohm, carbon type, 1/2 watt (R11) |
| 11591 | Button—Chassis plug button | 12285 | Resistor—470,000 ohm, insulated, 1/2 watt (R13) |
| 12118 | Cap—Grid contact cap | 11626 | Resistor—2.2 megohm, carbon type, 1/2 watt (R5) |
| 11465 | Capacitor—Adjustable capacitor (C8) | 13673 | Resistor—10 megohm, carbon type, 1/2 watt (R15) |
| 12659 | Capacitor—12 Mmfd. (C5) | 12650 | Shield—Antenna coil shield |
| 12661 | Capacitor—56 Mmfd. (C1) | 12607 | Shield—First I-F transformer shield top |
| 12946 | Capacitor—133 Mmfd. (C11, C15, C16, C17) | 12008 | Shield—First or second I.F. transformer shield |
| 12406 | Capacitor—180 Mmfd. (C18) | 12651 | Shield—Oscillator coil shield |
| 12662 | Capacitor—220 Mmfd. (C21) | 12581 | Shield—Second I.F. transformer shield top |
| 12660 | Capacitor—1,350 Mmfd. (C10) | 3950 | Shield—6D6 Radiotron shield |
| 4868 | Capacitor—.005 Mfd. (C9, C25) | 3682 | Shield—6A7 or 75 Radiotron shield |
| 5148 | Capacitor—.007 Mfd. (C20) | 4794 | Socket—4-contact rectifier Radiotron socket |
| 4858 | Capacitor—.01 Mfd. (C22) | 4786 | Socket—6-contact 42, 75 and 6D6 Radiotron socket |
| 13138 | Capacitor—.01 Mfd. (C19) | 4787 | Socket—7-contact 6A7 Radiotron socket |
| 11315 | Capacitor—.015 Mfd. (C26) | 11199 | Socket—Dial lamp socket |
| 4841 | Capacitor—.1 Mfd. (C4, C12) | 12007 | Spring—Retaining spring for core, Stock Nos. 12006 and 12664 |
| 4840 | Capacitor—.25 Mfd. (C13, C24) | 13664 | Tone Control and Switch (S1, S3) |
| 5170 | Capacitor—.25 Mfd. (C14) | 13106 | Transformer—First I.F. transformer, complete (L8, L9, C11, C15) |
| 11240 | Capacitor—10 Mfd. (C28) | 13107 | Transformer—Second I.F. transformer, complete (L10, L11, C16, C17, C18, R6, R7) |
| 5212 | Capacitor—18 Mfd. (C29) | 12644 | Transformer—Power transformer, 115 volt, 60 cycle (T1) |
| 12648 | Coil—Antenna coil—less shield (L2, L3, L4, L5) | 12645 | Transformer—Power transformer, 115 volt, 25 cycle (T1) |
| 12649 | Coil—Oscillator coil—less shield (L6, L7) | 12646 | Transformer—Power transformer, 240-210-150-125-110 volts, 60 cycle (T1) |
| 13662 | Condenser—2-gang variable tuning condenser (C2, C3, C6, C7) | 12654 | Trap—Wave trap (L1) |
| 5119 | Connector—3-contact female speaker cable connector | 13144 | Volume Control (R8) |
| 12006 | Core—Adjustable core and stud assembly for I-F transformer, Stock Nos. 12652 and 12653 | REPRODUCER ASSEMBLIES | |
| 12664 | Core—Adjustable core and stud assembly for wave trap, Stock No. 12654 | 13676 | Coil—Field coil (L14) |
| 13666 | Dial—Station selector dial | 13677 | Cone—Reproducer cone and dust cap (L13) |
| 13663 | Drive—Variable condenser drive shaft and pinion | 5118 | Connector—3-contact male speaker cable connector |
| 12657 | Indicator—Station selector indicator | 9798 | Reproducer, complete |
| 5226 | Lamp—Dial lamp | 13678 | Transformer—Output transformer (T2) |
| 13665 | Range Switch (S2) | MISCELLANEOUS ASSEMBLIES | |
| 13674 | Resistor—18 ohms, carbon type, 1/2 watt (R18) | 13872 | Crystal—Station selector crystal |
| 13675 | Resistor—270 ohms, carbon type, 1 watt (R16) | 12638 | Knob—Station selector knob |
| 8070 | Resistor—22,000 ohm, carbon type, 1/2 watt (R3) | 11347 | Knob—Tone control, volume control or range switch knob |
| 12011 | Resistor—27,000 ohm, carbon type, 1 watt (R4) | 11456 | Screw—Chassis mounting screw assembly |
| 11364 | Resistor—33,000 ohms, carbon type, 1/2 watt (R9) | 11349 | Spring—Retaining spring for knob, Stock Nos. 11347 and 12638 |
| 11282 | Resistor—56,000 ohm, carbon type, 1/10 watt (R6) | | |
| 5029 | Resistor—56,000 ohm, carbon type, 1/2 watt (R1) | | |
| 11454 | Resistor—6,800 ohm, carbon type, 1/2 watt (R2) | | |
| 5145 | Resistor—100,000 ohm, carbon type, 1/2 watt (R10) | | |



RCA Victor

MODELS 5T6, 5T7, and 5T8

Five-Tube, Two-Band, A-C, Superheterodyne Receivers

TECHNICAL INFORMATION AND SERVICE DATA

SERVICE DIVISION • RCA MANUFACTURING COMPANY, INC. • CAMDEN, N. J., U. S. A.

A Service of the Radio Corporation of America

Electrical Specifications

| | | | |
|-------------------------------|------------------------|---|---|
| FREQUENCY RANGES | | ALIGNMENT FREQUENCIES | |
| "Standard broadcast" (A)..... | 540-1,820 kc | "Standard broadcast" (A) 600 kc (osc.), 1,700 kc (osc., ant.) | |
| "Short wave" (B)..... | 1,820-6,600 kc | "Short wave" (B)..... | None required |
| Intermediate Frequency..... | | | 460 kc |
| RADIOTRON COMPLEMENT | | (3) RCA-6Q7..... Second Det., A-F Amp. and A.V.C. | |
| (1) RCA-6A8..... | First Det.—Oscillator | (4) RCA-6F6..... | Audio Power Amplifier |
| (2) RCA-6K7..... | Intermediate Amplifier | (5) RCA-5W4..... | Full-Wave Rectifier |
| Pilot Lamps (3)..... | | | Mazda No. 46, 6.3 volts, 0.25 amperes |
| POWER SUPPLY RATINGS | | | |
| Rating A..... | | | 105-125 volts, 50-60 cycles, 80 watts |
| Rating B..... | | | 105-125 volts, 25-60 cycles, 80 watts |
| Rating C..... | | | 100-130/140-160/195-250 volts, 40-60 cycles, 80 watts |
| POWER OUTPUT RATING | | LOUDSPEAKER | |
| Undistorted..... | 2.0 watts | Type..... | Electrodynamic |
| Maximum..... | 4.5 watts | Voice Coil Impedance..... | 2¼ ohms at 400 cycles |

Mechanical Specifications

| | MODEL 5T6 | MODEL 5T7 | MODEL 5T8 |
|------------------------------|---|-----------------|------------------------------------|
| Height..... | 10 inches..... | 10 inches..... | 11 inches |
| Width..... | 16¾ inches..... | 16¾ inches..... | 17¼ inches |
| Depth..... | 7¾ inches..... | 7¾ inches..... | 7¾ inches |
| Weight (Net)..... | 18½ pounds..... | 17½ pounds..... | 20 pounds |
| Weight (Shipping)..... | 21 pounds..... | 21 pounds..... | 23 pounds |
| Chassis Base Dimensions..... | | | 13¼ inches x 6½ inches x 2⅞ inches |
| Over-all Chassis Height..... | | | 7½ inches |
| Operating Controls..... | (1) Range Selector, (2) Tuning, (3) Volume, (4) Power Switch—Tone | | |
| Tuning Drive Ratio..... | 10 to 1 | | |

General Description

These receivers are of the superheterodyne type and have many outstanding features. Their design includes magnetite-core adjusted *i-f* transformers and wave trap; aural-compensated volume control; high-frequency tone control; resistance-coupled audio system; phonograph terminal board; illuminated, band-indicating dial pointers; and a six-inch, dust-proof, electrodynamic loudspeaker.

Tuning is continuous through the "Standard broadcast" and "Short wave" bands (including 49 meters). The "Short wave" portion of this extensive range also includes channels assigned for police, amateur, and aviation communication. The tuning-drive ratio of ten-to-one permits ease of tuning, especially in the "Short wave" band.

Circuit Description

The first detector and oscillator functions are accomplished in a single tube, an RCA-6A8. The input of this tube is coupled to the antenna through a tuned transformer. A shunt (magnetite-core adjusted) wave trap is connected across the primary of this transformer to prevent signals of intermediate frequency (460 kc) from being introduced into the first stage as interference. The two-section gang condenser, which tunes the antenna transformer secondary and the heterodyne oscillator coil, has adjustable trimmers for obtaining exact alignment. Each of these coils is tapped so that the range switch increases the range of tuning by decreasing the amount of inductance.

The intermediate-frequency amplifier stage is coupled to the RCA-6A8 and to the RCA-6Q7 by means of tuned transformers. These transformers resonate with fixed capacitors and are adjusted by molded magnetite cores to tune to 460 kc.

The modulated signal as obtained from the output of the i-f system is detected by one of the diodes of the RCA-6Q7. Audio frequency secured by this process is applied to the control grid of this same tube, for voltage amplification, through the acoustically tapered volume control. The d-c voltage, which results from detection of the signal, is used for automatic volume control. This voltage, which develops across resistor R8, is applied as a-v-c bias to the first detector and i-f tubes through a suitable resistance-capacitance filter. Minimum operating bias for these tubes, under conditions of little or no signal, is developed across resistors R6 and R8 which form a portion of the bias divider circuit R5, R6, and R8. These latter three resistors are connected in shunt with the main bias resistors R15 and R14.

The output of the RCA-6Q7 is transmitted by resistance-capacitance coupling to the input of the RCA-6F6 power-output stage, which, in turn, is transformer coupled to the electrodynamic loudspeaker. High-frequency tone control is provided by means of a shunt capacitor C23 across the plate circuit of the output tube. This capacitor may be cut in or out of the circuit with a control switch S3.

The power-supply system consists of an RCA-5W4 full-wave rectifier tube, power transformer, and suitable filter network. The loudspeaker field coil is used as the filter reactor.

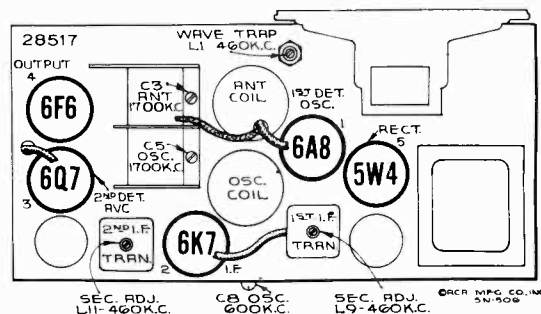

Figure 1—Radiotron, Coil, and Trimmer Locations

Alignment Procedure

Calibrate the tuning dial by adjusting dial pointer to the horizontal center line (between the two dial scales) with the two-gang tuning condenser in full-mesh position. Two screws are provided on the dial hub for this adjustment.

Perform alignment in proper order tabulated below, starting with No. 1 and following all operations across, then No. 2, etc.

Cathode-ray alignment is preferable; the connections to the chassis are shown on figure 3. If an output indicator is used, connect it across the loudspeaker voice-coil and advance the receiver volume control to full-volume position.

Connect the "low" output terminal of the test oscillator to the receiver chassis for all alignment operations. Regulate

the output of the test oscillator so that minimum signal is applied to the receiver to obtain an observable output indication. This will avoid a-v-c action.

The term "Dummy antenna" means the device which must be connected between the "high" test-oscillator output and the point of connection to the receiver in order to obtain ideal alignment. "No signal, 550-750 kc" means that the receiver should be tuned to a point between 550 and 750 kc where no signal is received from a station or the local (heterodyne) oscillator.

For further details on alignment, refer to booklet "RCA Victor Receiver Alignment."

| Order of Alignment | Test Oscillator | | | Receiver Dial Setting | Circuit to Adjust | Adjustment Symbols | Adjust to Obtain | Adjustment Location |
|--------------------|------------------------|---------------|-------------------|-----------------------|-------------------|--------------------|------------------|---------------------|
| | Connection to Receiver | Dummy Antenna | Frequency Setting | | | | | |
| 1 | 6K7 i-f Grid Cap | .001 Mfd. | 460 kc | No signal 550-750 kc | 2nd i-f Trans. | L11 and L10 | Max. (peak) | Figs. 1-4 |
| 2 | 6A8 Det. Grid Cap | .001 Mfd. | 460 kc | No signal 550-750 kc | 1st i-f Trans. | L9 and L8 | Max. (peak) | Figs. 1-4 |
| 3 | Ant. Post | 200 Mmfd. | 460 kc | No signal S. W. Band | Wave Trap | L1 | Minimum Output | Fig. 1 |
| 4 | Ant. Post | 200 Mmfd. | 600 kc | 600 kc | L-F Osc. | C8 | Max. (peak) | Fig. 1 |
| 5 | Ant. Post | 200 Mmfd. | 1,700 kc | 1,700 kc | H-F Osc. | C5 | Max. (peak) | Fig. 1 |
| 6 | Ant. Post | 200 Mmfd. | 1,700 kc | 1,700 kc | Ant. | C3 | Max. (peak) | Fig. 1 |
| 7 | Ant. Post | 200 Mmfd. | 600 kc | Rock thru 600 kc | L-F Osc. | C8 | Max. (peak) | Fig. 1 |
| 8 | Ant. Post | 200 Mmfd. | 1,700 kc | 1,700 kc | H-F Osc. | C5 | Max. (peak) | Fig. 1 |
| 9 | Ant. Post | 200 Mmfd. | 1,700 kc | 1,700 kc | Ant. | C3 | Max. (peak) | Fig. 1 |

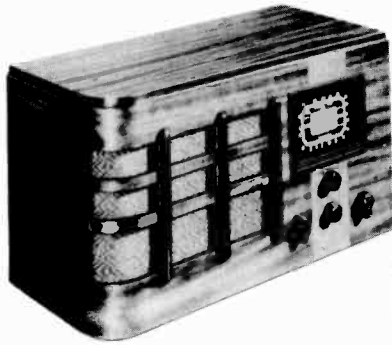

Model 5T6

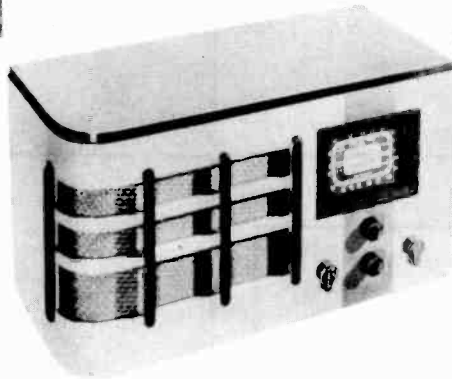

Model 5T7

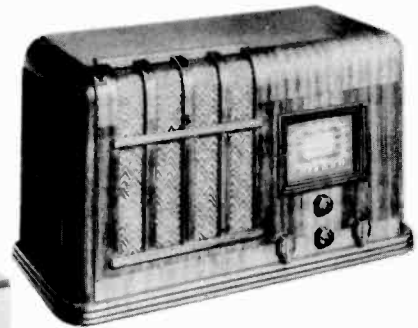

Model 5T8

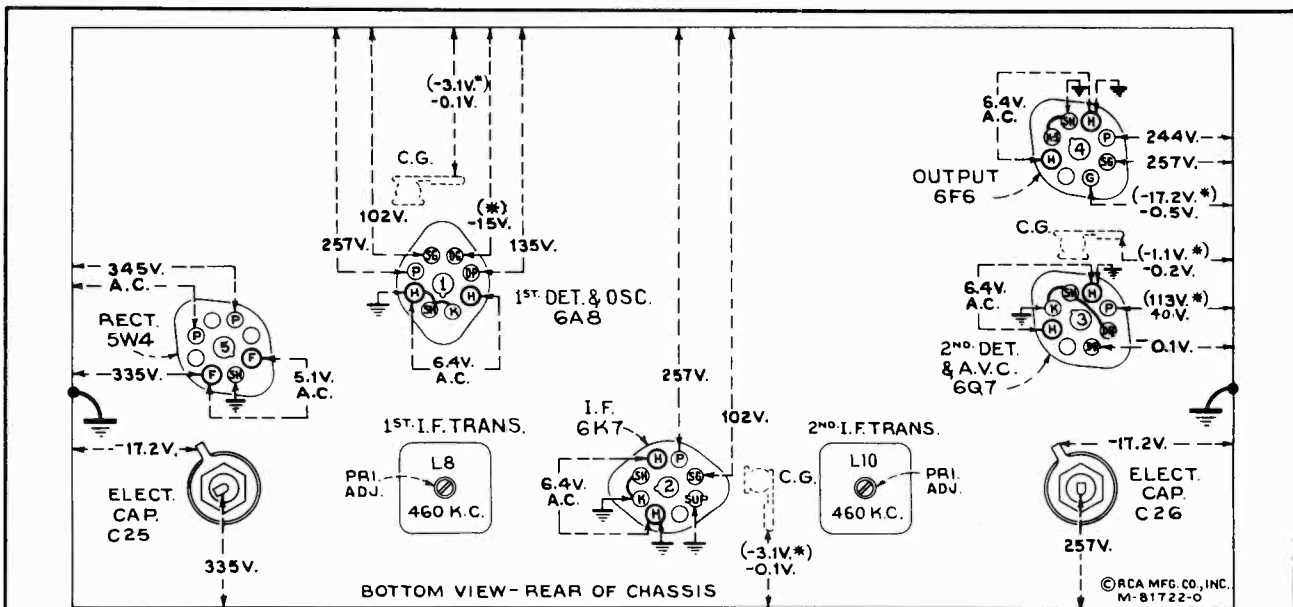

Figure 4—Radiotron Socket Voltages, Coil, and Trimmer Locations

Measured at 115 volts, 60-cycle supply—Tuned to approximately 1,000 kc ("Standard broadcast")—No signal being received—Volume control minimum

Radiotron Socket Voltages

Note: Two voltage values are shown for some readings. The value shown in parentheses with asterisk () indicates operating conditions without voltmeter loading. The other value (generally lower) is the actual measured voltage and differs from the value shown in parentheses because of the additional loading of the voltmeter through the high series circuit resistance.*

The voltage values indicated from the Radiotron socket contacts, grid caps, resistors, and terminals to receiver

chassis ground on figure 4 will assist in locating cause of faulty operation. Each value as specified should hold within $\pm 20\%$ when the receiver is normally operative at its rated line voltage. Variations in excess of this limit will usually be indicative of trouble in the basic circuits. To duplicate the conditions under which the voltages were measured requires a 1,000-ohm-per-volt d-c meter, having ranges of 10, 50, 250, and 500 volts. Use the nearest range above the specified measured voltage. A-c voltages were measured with a corresponding a-c meter.

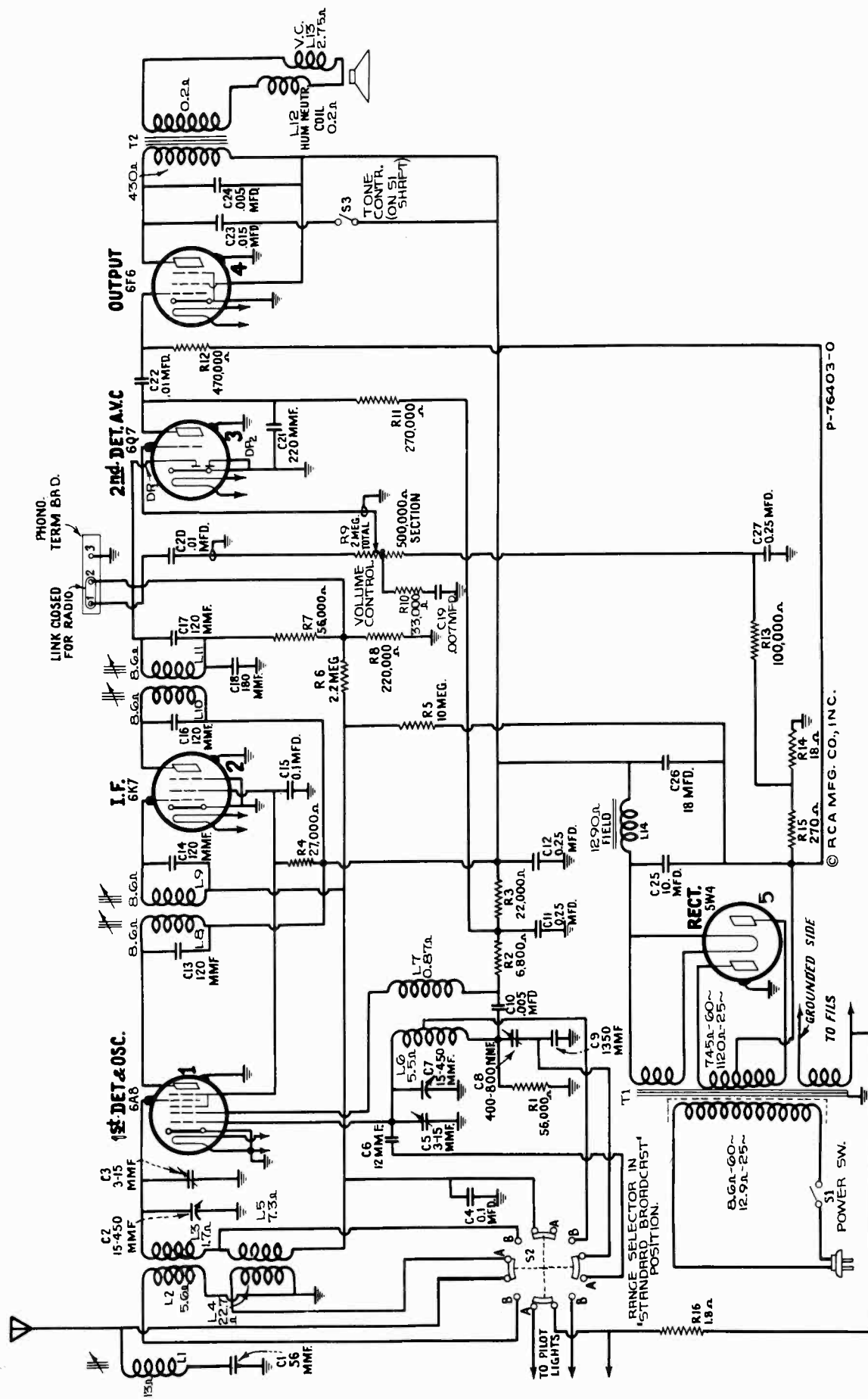

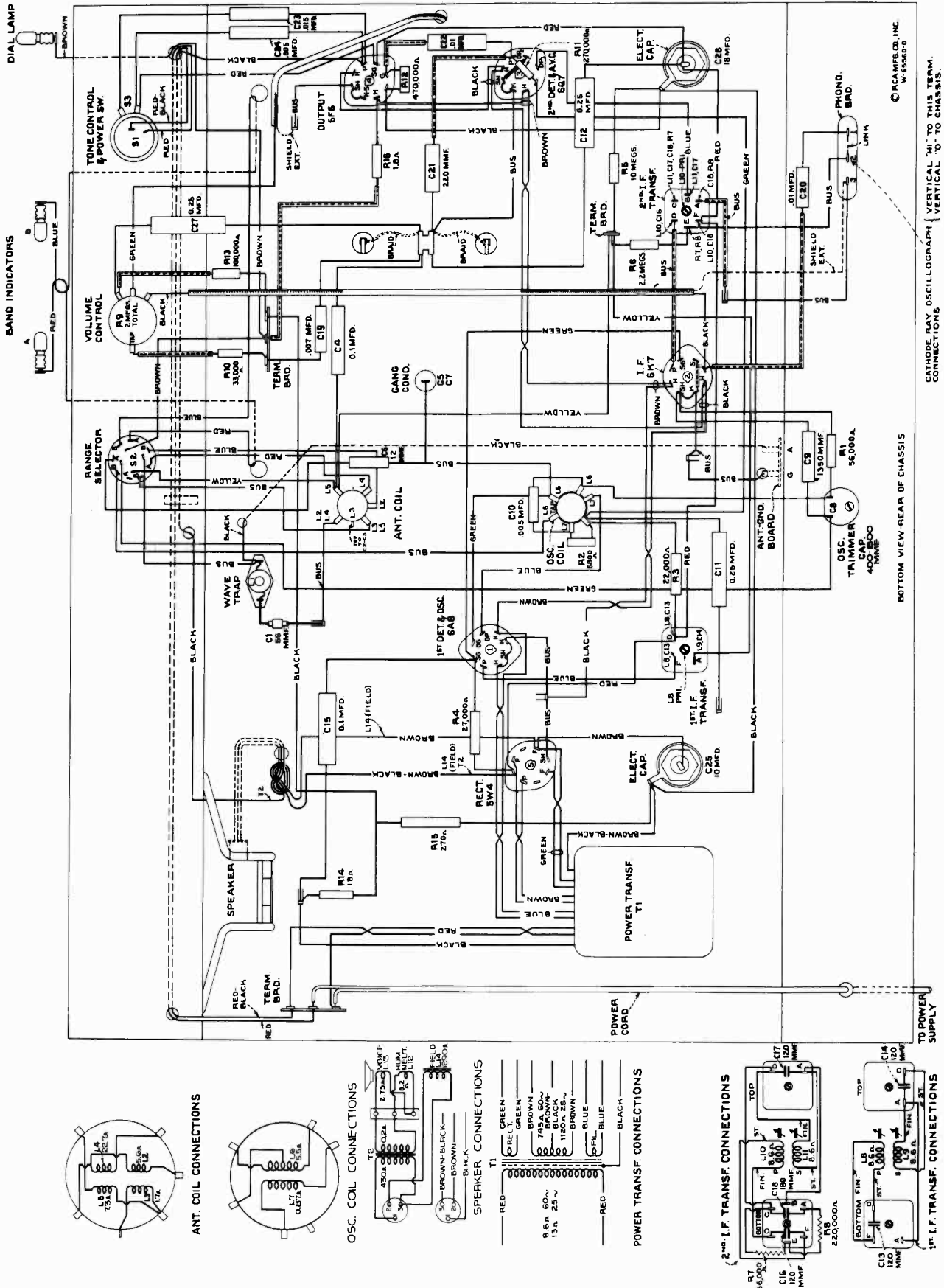

© RCA MFG. CO., INC.
M-5558-B

CATHODE RAY OSCILLOGRAPH | VERTICAL 'H' TO THIS TERM. CONNECTIONS | VERTICAL 'V' TO CHASSIS.

BOTTOM VIEW-REAR OF CHASSIS

Figure 3—Chassis and Loudspeaker Wiring Diagrams

Service Data

The various diagrams of this booklet contain such information as will be needed to isolate causes for defective operation if such develops. The ratings of the resistors, capacitors, coils, etc., are indicated adjacent to the symbols signifying these parts on the diagrams. Identification titles such as R1, L1, C1, etc., provide reference between the illustrations and Replacement Parts List. The coils, transformer windings, and reactors are rated in terms of d-c resistance to permit continuity checks.

Loudspeaker.—Centering of the loudspeaker is made in the usual manner with three narrow paper feelers after first removing the front dust cover. This may be removed by

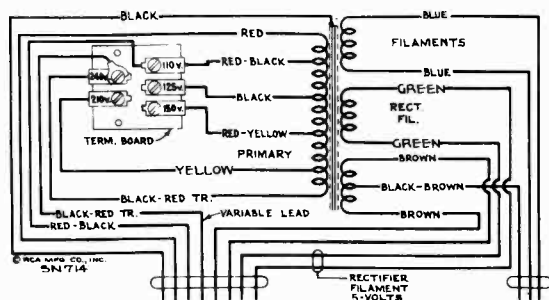

Primary resistance—24.5 ohms total
Secondary resistance—760 ohms total

Figure 5—Universal Transformer

softening its cement with a light application of acetone, using care not to allow the acetone to flow into the air gap. The dust cover should be cemented back in place with ambroid upon completion of adjustment.

Phonograph Attachment.—A terminal board is provided for connecting a phonograph into the audio-amplifying circuit. RCA Victor Models R-93, R-93-2, or R-93-S Record Players should be connected as follows: Remove link between terminals 1 and 2 on receiver. Connect green wire in Radio-Record switch cable to terminal 1, yellow to terminal 2; and shield extension to terminal 3. Tape unused red and blue leads separately. Connect a 2-conductor twisted cable between the Record Player binding posts and the screw terminals on Radio-Record switch.

Radiotron Cathode Current Readings

Measured with Milliammeter Connected at Tube Socket Cathode Terminals Under Conditions Similar to Those of Voltage Measurements

- (1) RCA-6A8—1st Det.—Osc. 11.7 ma.
 - (2) RCA-6K7—I. F. Amp. 9.4 ma.
 - (3) RCA-6Q7—2nd Det., A.V.C. and A. F. 0.3 ma.
 - (4) RCA-6F6—Power Amp. 39.6 ma.
 - (5) RCA-5W4—Rectifier. 61.0 ma.*
- * Cannot be measured at socket.

REPLACEMENT PARTS

Insist on genuine factory tested parts, which are readily identified and may be purchased from authorized dealers.

| STOCK No. | DESCRIPTION | STOCK No. | DESCRIPTION |
|-----------|--|-----------|---|
| 13098 | Board—Antenna and ground terminal board | 11398 | Resistor—220,000 ohm, carbon type, 1/10 watt (R8) |
| 12717 | Board—Phonograph terminal board | 11323 | Resistor—270,000 ohm, carbon type, 1/2 watt (R11) |
| 5237 | Bushing—Variable condenser mounting bushing assembly | 11172 | Resistor—470,000 ohm, carbon type, 1/2 watt (R12) |
| 12511 | Cap—Grid contact cap | 11826 | Resistor—2.2 megohm, carbon type, 1/2 watt (R6) |
| 11465 | Capacitor—Adjustable capacitor (C8) | 13873 | Resistor—10 megohm, carbon type, 1/2 watt (R5) |
| 12659 | Capacitor—12 Mmfd. (C6) | 4669 | Screw—No. 8-32x5/32 set screw for drive disc, Stock No. 13816 |
| 12661 | Capacitor—56 Mmfd. (C1) | 12650 | Shield—Antenna coil shield |
| 12404 | Capacitor—120 Mmfd. (C13, C14, C16, C17) | 12735 | Shield—Dial lamp shield |
| 12406 | Capacitor—180 Mmfd. (C18) | 12607 | Shield—First I.F. transformer shield top |
| 13818 | Capacitor—220 Mmfd. (C21) | 12008 | Shield—First or second I.F. transformer shield |
| 12660 | Capacitor—1,350 Mmfd. (C9) | 12651 | Shield—Oscillator coil shield |
| 4868 | Capacitor—.005 Mfd. (C10, C24) | 12581 | Shield—Second I.F. transformer shield top |
| 5148 | Capacitor—.007 Mfd. (C19) | 11195 | Socket—5-contact 5W4 Radiotron socket |
| 13138 | Capacitor—.01 Mfd. (C20) | 11196 | Socket—8-contact 6A8, 6F6, 6K7 or 6Q7 Radiotron socket |
| 4858 | Capacitor—.01 Mfd. (C22) | 11199 | Socket—Dial lamp socket |
| 11315 | Capacitor—.015 Mfd. (C23) | 12007 | Spring—Retaining spring for core, Stock Nos. 12006 and 12664 |
| 4841 | Capacitor—0.1 Mfd. (C4, C15) | 13813 | Tone Control and Power Switch (S1, S3) |
| 4840 | Capacitor—0.25 Mfd. (C11, C27) | 13106 | Transformer—First I.F. transformer, complete (L8, L9, C13, C14) |
| 5170 | Capacitor—0.25 Mfd. (C12) | 13107 | Transformer—Second I.F. transformer, complete (L10, L11, C16, C17, C18, R7, R8) |
| 12400 | Capacitor—10 Mfd. (C25) | 12644 | Transformer—Power transformer, 115 volt, 60 cycle (T1) |
| 5212 | Capacitor—18 Mfd. (C26) | 12645 | Transformer—Power transformer, 115 volt, 25 cycle (T1) |
| 12648 | Coil—Antenna coil—less shield (L2, L3, L4, L5) | 12646 | Transformer—Power transformer, 240-210, 150-125-110 volts, 60 cycle (T1) |
| 12649 | Coil—Oscillator coil—less shield (L6, L7) | 12654 | Trap—Wave trap (L1) |
| 13811 | Condenser—2-gang variable tuning condenser (C2, C3, C5, C7) | 13144 | Volume Control (R9) |
| 5119 | Connector—3-contact female speaker cable connector | | REPRODUCER ASSEMBLIES |
| 12006 | Core—Adjustable core and stud assembly for I.F. transformer, Stock Nos. 12652 and 12653) | 13822 | Coil—Field coil (L14) |
| 12664 | Core—Adjustable core and stud assembly for wave trap, Stock No. 12654 | 13821 | Cone—Reproducer cone and dust cap (L13) |
| 13814 | Dial—Station selector dial | 5118 | Connector—3-contact male speaker cable connector |
| 13816 | Disc—Station selector drive disc and lamp socket assembly | 9776 | Reproducer, complete |
| 13815 | Drive—Variable condenser drive shaft, spool and bearing | 13823 | Transformer—Output transformer (T2) |
| 14301 | Fuse—1/2 amp. resistor-fuse, 1.8 ohms (R16) | | MISCELLANEOUS ASSEMBLIES |
| 13817 | Indicator—Station selector indicator | 13824 | Escutcheon—Station selector escutcheon |
| 5226 | Lamp—Dial lamp | 12673 | Knob—Station selector or volume control knob |
| 13812 | Range Switch (S2) | 13825 | Knob—Tone control or range switch knob |
| 13674 | Resistor—18 ohm, carbon type, 1/2 watt (R14) | 11586 | Screw—Chassis mounting screw No. 14x1 in. |
| 13819 | Resistor—270 ohm, wire wound, 1.1 watt (R15) | 13885 | Screw—No. 8-32x1/2 in. headless set screw for knob, Stock No. 13825 |
| 8070 | Resistor—22,000 ohm, carbon type, 1/2 watt (R3) | 4119 | Screw—No. 8-32x1/4 in. headless set screw for knob, Stock No. 12673 |
| 12011 | Resistor—27,000 ohm, carbon type, 1 watt (R4) | | |
| 11364 | Resistor—33,000 ohm, carbon type, 1/2 watt (R10) | | |
| 11282 | Resistor—56,000 ohm, carbon type, 1/10 watt (R7) | | |
| 5029 | Resistor—56,000 ohm, carbon type, 1/2 watt (R1) | | |
| 11454 | Resistor—6,800 ohm, carbon type, 1/2 watt (R2) | | |
| 5145 | Resistor—100,000 ohm, carbon type, 1/2 watt (R13) | | |



RCA Victor

MODELS 6K3, 7T1, and 7K1

Six- and Seven-Tube, Three-Band, A-C, Superheterodyne Receivers

TECHNICAL INFORMATION AND SERVICE DATA

SERVICE DIVISION • RCA MANUFACTURING COMPANY, INC. • CAMDEN, N. J., U. S. A.

A Service of the Radio Corporation of America

Electrical Specifications

FREQUENCY RANGES

"Standard Broadcast" (A)..... 540— 1,625 kc
 "Medium Wave" (B)..... 1,625— 5,700 kc
 "Short Wave" (C)..... 5,700—18,000 kc
 Intermediate Frequency..... 460 kc

ALIGNMENT FREQUENCIES

"Standard Broadcast" (A)..... 600 kc (osc.), 1,400 kc (osc. and ant.)
 "Medium Wave" (B)..... None required
 "Short Wave" (C)..... 15,000 kc (osc. and ant.)

RADIOTRON COMPLEMENT

(1) RCA-6A8..... First Detector—Oscillator
 (2) RCA-6K7..... Intermediate Amplifier
 (3) RCA-6H6..... Second Detector—A.V.C.

(4) RCA-6F5..... Audio Voltage Amplifier
 (5) RCA-6F6..... Audio Power Amplifier
 (6) RCA-5W4..... Full-Wave Rectifier
 (7) RCA-6G5—(Models 7T1 and 7K1 only) Tuning Tube

Pilot Lamps (5)..... 7T1 and 7K1, Mazda No. 40, 6.3 volts, 0.15 amp.; 6K3, Mazda No. 46, 6.3 volts, 0.25 amp.

POWER SUPPLY RATINGS

Rating A..... 105-125 volts, 50-60 cycles, 90 watts
 Rating B..... 105-125 volts, 25-60 cycles, 90 watts
 Rating C..... 100-130/140-160/195-250 volts, 40-60 cycles, 90 watts

POWER OUTPUT

Undistorted..... 2.0 watts
 Maximum..... 4.5 watts

LOUDSPEAKER

Type..... Electrodynamic
 Impedance (v.c.)..... 2.2 ohms at 400 cycles

Mechanical Specifications

| | MODEL 6K3 | MODEL 7T1 | MODEL 7K1 |
|------------------------------|---|--|--|
| Height..... | 38 inches..... | 22 ³ / ₄ inches..... | 40 inches..... |
| Width..... | 23 ¹ / ₈ inches..... | 15 ¹ / ₂ inches..... | 25 ¹ / ₂ inches..... |
| Depth..... | 11 ¹ / ₈ inches..... | 8 ¹ / ₂ inches..... | 11 inches..... |
| Weight (net)..... | 48 pounds..... | 25 pounds..... | 51 pounds..... |
| Weight (shipping)..... | 58 pounds..... | 32 pounds..... | 63 pounds..... |
| Chassis Base Dimensions..... | 12 inches x 7 inches x 2 ¹ / ₂ inches | | |
| Over-all Chassis Height..... | 8 inches | | |
| Operating Controls..... | (1) Power Switch—Music Speech, (2) Tuning, (3) Volume, (4) Range Selector | | |
| Tuning Drive Ratios..... | 10 to 1 and 50 to 1 | | |

General Description

These receivers are of the superheterodyne type and have many distinctive features. Model 6K3 is a six-tube console model employing a 12-inch loudspeaker. Models 7T1 and 7K1 are table and console models respectively having similar chassis to Model 6K3 except for the addition of a tuning tube "Magic Eye": the former has an 8-inch loudspeaker while the latter has a 12-inch loudspeaker. Features of de-

sign include an antenna wave-trap, magnetite-core adjusted i-f transformers; full automatic volume control; resistance-capacitance coupled audio system; three-point "Music—speech" control; phonograph terminal board; edge-lighted band-indicating dial; and a dust-proof electrodynamic loudspeaker.

Service Data

The various diagrams of this booklet contain such information as will be needed to isolate causes for defective operation if such develops. The ratings of the resistors, capacitors, coils, etc., are indicated adjacent to the symbols signifying these parts on the diagrams. Identification titles such as R1, L1, C1, etc., provide reference between the illustrations and Replacement Parts List. The coils, transformer windings, and reactors are rated in terms of d-c resistance to permit continuity checks.

Loudspeaker.—Centering of the loudspeaker is made in the usual manner with three narrow paper feelers after first removing the front dust cover. This may be removed by softening its cement with a light application of acetone, using care not to allow the acetone to flow into the air gap. The dust cover should be cemented back in place with ambroid upon completion of adjustment.

Radiotron Cathode Current Readings

Measured with Milliammeter Connected at Tube Socket Cathode Terminals Under Conditions Similar to Those of Voltage Measurements

- | | |
|-------------------------------------|-----------|
| (1) RCA-6A8—1st Det.—Osc..... | 12.3 ma. |
| (2) RCA-6K7—I-F Amp..... | 9.8 ma. |
| (3) RCA-6H6—2nd Det. and A.V.C..... | |
| (4) RCA-6F5—Audio Driver..... | 0.2 ma. |
| (5) RCA-6F6—Power Amplifier..... | 34.0 ma. |
| (6) RCA-5W4—Rectifier..... | 76.0 ma.* |
| (7) RCA-6G5—Tuning Tube..... | 2.0 ma. |

*Cannot be measured at socket.

Phonograph Attachment.—A terminal board is provided for connecting a phonograph into the audio-amplifying circuit. RCA Victor Models R-93, R-93-2, or R-93-S Record Players should be connected as follows: Remove link between terminals 1 and 2 on receiver. Connect green wire in Radio-Record switch cable to terminal 2, yellow to terminal 1; and shield extension to terminal 3. Tape unused red and blue leads separately. Connect a 2-conductor twisted cable between the Record Player binding posts and the screw terminals on Radio-Record switch.

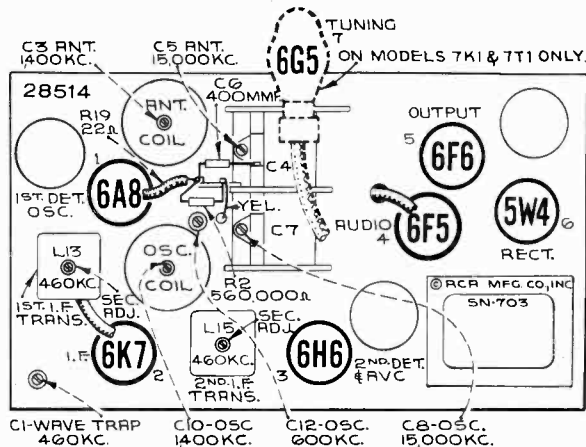

Figure 1—Radiotron, Coil, and Trimmer Locations

Alignment Procedure

Calibrate the tuning dial by adjusting dial pointer to the low-frequency (end) calibration mark on "Standard broadcast" scale with the gang tuning-condenser plates in full-mesh position. This is a friction adjustment.

Perform alignment in proper order tabulated below, starting with No. 1 and following all operations across, then No. 2, etc. Adjustment locations are shown by figures 1 and 4.

Cathode-ray alignment is preferable; the connections to the chassis are shown on figure 3. If an output indicator is used, connect it across the loudspeaker voice-coil and advance the receiver volume control to full-volume position.

Connect the "low" output terminal of the test oscillator to the receiver chassis for all alignment operations. Regulate

the output of the test oscillator so that minimum signal is applied to the receiver to obtain an observable output indication. This will avoid a-v-c action.

The term "Dummy antenna" means the device which must be connected between the "high" test-oscillator output and the point of connection to the receiver in order to obtain ideal alignment. "No signal, 550-750 kc" means that the receiver should be tuned to a point between 550 and 750 kc where no signal or interference is received from a station or local (heterodyne) oscillator.

For further details on alignment, refer to booklet "RCA Victor Receiver Alignment."

| Order of Alignment | Test Oscillator | | | Receiver Dial Setting | Circuit to Adjust | Adjustment Symbols | Adjust to Obtain |
|--------------------|------------------------|---------------|-------------------|-----------------------|-------------------|--------------------|------------------|
| | Connection to Receiver | Dummy Antenna | Frequency Setting | | | | |
| 1 | 6K7 i-f Grid Cap | .001 Mfd. | 460 kc | No signal 550-750 kc | 2nd i-f Trans. | L14 and L15 | Max. (peak) |
| 2 | 6A8 Det. Grid Cap | .001 Mfd. | 460 kc | No signal 550-750 kc | 1st i-f Trans. | L12 and L13 | Max. (peak) |
| 3 | Ant. Post | 200 Mmfd. | 460 kc | No signal 550-750 kc | Wave Trap | C1 | Minimum Output |
| 4 | Ant. Post | 300 Ohms | 15,000 kc | 15,000 kc | "C" Osc. | C8 | Max (peak)* |
| 5 | Ant. Post | 300 Ohms | 15,000 kc | Rock thru 15,000 kc | "C" Ant. | C5 | Max. (peak) |
| 6 | Ant. Post | 200 Mmfd. | 600 kc | 600 kc | L-F Osc. | C12 | Max. (peak) |
| 7 | Ant. Post | 200 Mmfd. | 1,400 kc | 1,400 kc | H-F Osc. | C10 | Max. (peak) |
| 8 | Ant. Post | 200 Mmfd. | 1,400 kc | 1,400 kc | "A" Ant. | C3 | Max. (peak) |
| 9 | Ant. Post | 200 Mmfd. | 600 kc | Rock thru 600 kc | L-F Osc. | C12 | Max. (peak) |
| 10 | Ant. Post | 200 Mmfd. | 1,400 kc | 1,400 kc | H-F Osc. | C10 | Max. (peak) |
| 11 | Ant. Post | 200 Mmfd. | 1,400 kc | 1,400 kc | "A" Ant. | C3 | Max. (peak) |

* Use maximum capacity peak if two peaks can be obtained.

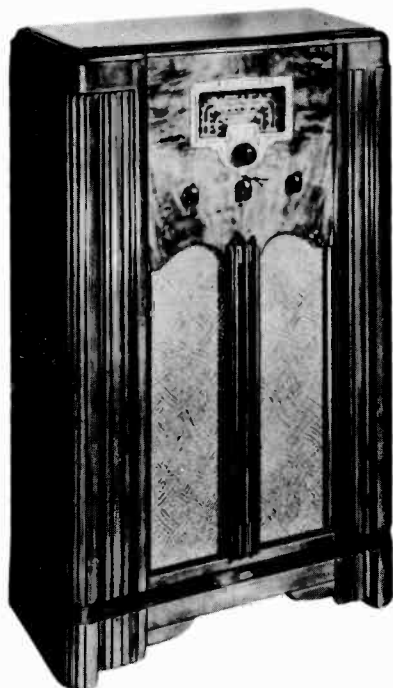

Model 6K3

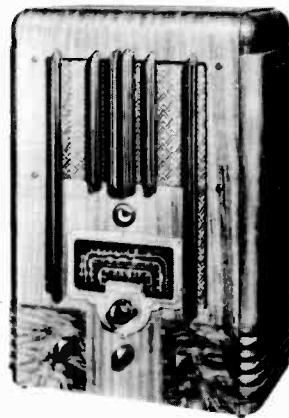

Model 7T1

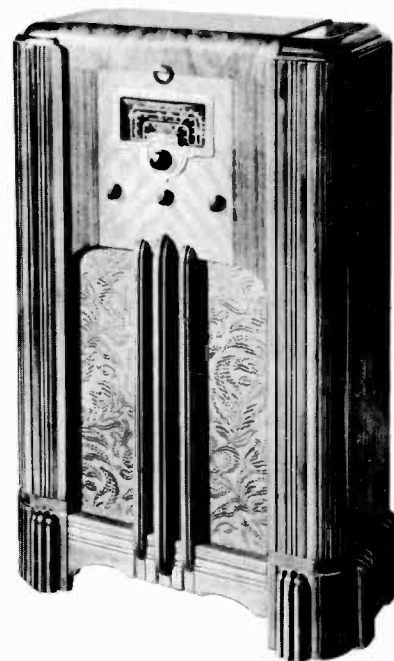

Model 7K1

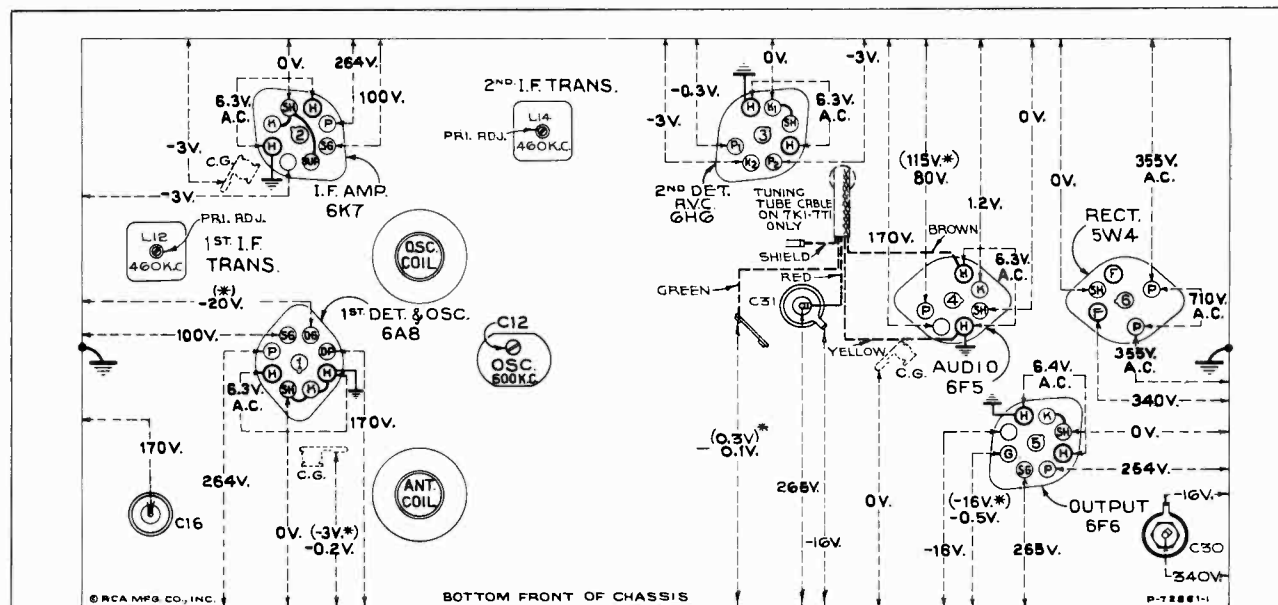

Figure 4—Radiotron Socket Voltages, Coil, and Trimmer Locations

Measured at 115 volts, 60-cycle supply—Tuned to approximately 1,000 kc ("Standard broadcast")—
No signal being received—Volume control minimum

Radiotron Socket Voltages

Note: Two voltage values are shown for some readings. The value shown in parentheses with asterisk () indicates operating conditions without voltmeter loading. The other value (generally lower) is the actual measured voltage and differs from the value shown in parentheses because of the additional loading of the voltmeter through the high series circuit resistance.*

The voltage values indicated from the Radiotron socket contacts, grid caps, resistors, and terminals to receiver

chassis ground on figure 4 will assist in locating cause of faulty operation. Each value as specified should hold within $\pm 20\%$ when the receiver is normally operative at its rated line voltage. Variations in excess of this limit will usually be indicative of trouble in the basic circuits. To duplicate the conditions under which the voltages were measured requires a 1,000-ohm-per-volt d-c meter, having ranges of 10, 50, 250, and 500 volts. Use the nearest range above the specified measured voltage. A-c voltages were measured with a corresponding a-c meter.

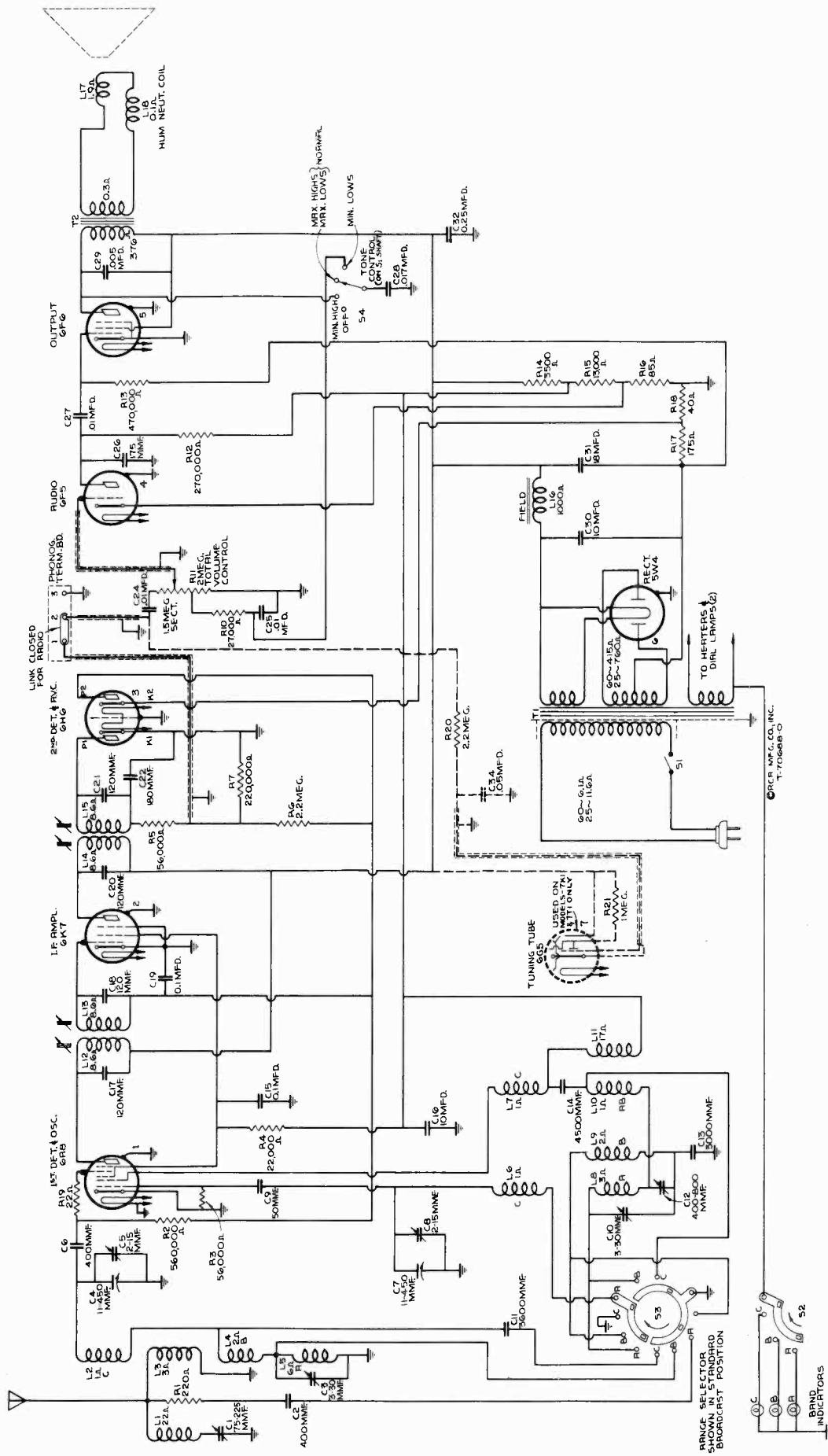
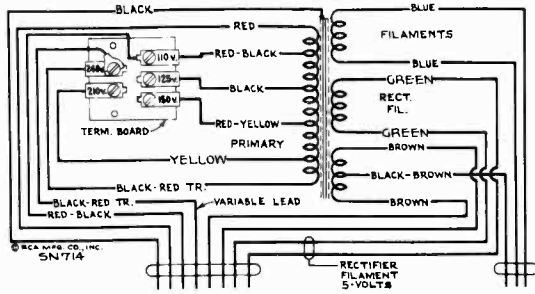

Figure 2—Schematic Circuit Diagram



Primary resistance—17.3 ohms total
Secondary resistance—108 ohms total
Figure 5—Universal Transformer

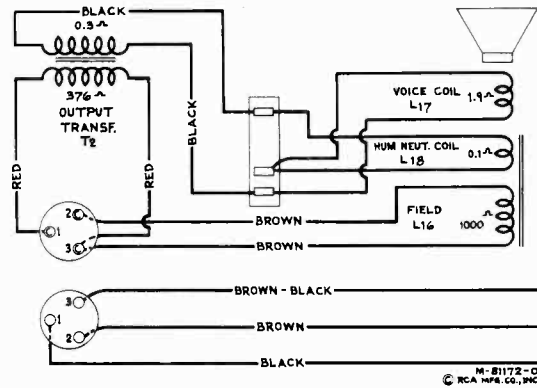

Figure 6—Loudspeaker Wiring

REPLACEMENT PARTS

Insist on genuine factory tested parts, which are readily identified and may be purchased from authorized dealers.

| STOCK No. | DESCRIPTION | STOCK No. | DESCRIPTION |
|----------------------------|---|---------------------------------|--|
| RECEIVER ASSEMBLIES | | | |
| 12930 | Board—Antenna and ground terminal board | 12013 | Resistor—1 megohm—Carbon type—1/10 watt (R21)—Models 7T1 and 7K1 only |
| 12717 | Board—Phonograph terminal board | 11626 | Resistor—2.2 megohms—Carbon type— $\frac{1}{4}$ watt (R6, R20) |
| 12772 | Bracket—Top dial lamp socket bracket | 12008 | Shield—I. F. transformer shield for Stock Nos. 13106 and 13107 |
| 5237 | Bushing—Variable tuning condenser mounting bushing assembly | 12607 | Shield—First I. F. transformer shield top |
| 11888 | Cable—Tuning tube cable and socket—Models 7T1 and 7K1 only | 12581 | Shield—Second I. F. transformer shield top |
| 12511 | Cap—Grid contact cap | 11603 | Shield—Coil shield for Stock Nos. 11617 and 11618 |
| 11350 | Cap—Grid contact cap used on resistor—Stock No. 11624 | 12735 | Shield—Dial lamp shield |
| 11465 | Capacitor—Adjustable capacitor (C12) | 12771 | Socket—Dial lamp socket—Located at top of dial scale |
| 11256 | Capacitor—Adjustable trimmer (C1) | 11199 | Socket—Dial lamp socket |
| 12404 | Capacitor—120 Mmfd. (C17, C18, C20, C21) | 11195 | Socket—5-contact 5W4 Radiotron socket |
| 11289 | Capacitor—50 Mmfd. (C9) | 11198 | Socket—7-contact 6F5, 6H6 Radiotron socket |
| 11623 | Capacitor—175 Mmfd. (C26) | 11196 | Socket—8-contact 6A8, 6F6 or 6K7 Radiotron socket |
| 12406 | Capacitor—180 Mmfd. (C22) | 11381 | Socket—Tuning tube socket and cover—Models 7T1 and 7K1 only |
| 11290 | Capacitor—400 Mmfd. (C2, C6) | 12007 | Spring—Retaining spring for core, Stock No. 12006 |
| 11622 | Capacitor—3000 Mmfd. (C13) | 12769 | Switch—Range switch (S2, S3) |
| 11621 | Capacitor—3600 Mmfd. (C11) | 13681 | Tone Control—Tone and power switch (S1, S4) |
| 11287 | Capacitor—4500 Mmfd. (C14) | 13106 | Transformer—First I. F. transformer (L12, L13, C17, C18) |
| 4868 | Capacitor—.005 Mfd. (C29) | 13107 | Transformer—Second I. F. transformer (L14, L15, C20, C21, C22, R5, R7) |
| 11395 | Capacitor—.01 Mfd. (C24) | 11458 | Transformer—Power transformer—105-125-volt, 50-60-cycle (T1) |
| 4858 | Capacitor—.01 Mfd. (C25, C27) | 11585 | Transformer—Power transformer—105-125-volt, 25-40-cycle (T1) |
| 11315 | Capacitor—.015 Mfd. (C33) | 11584 | Transformer—Power transformer—105-250-volt, 40-60-cycle (T1) |
| 11451 | Capacitor—.017 Mfd. (C28) | 11391 | Trap—Wave trap (L1, C1) |
| 4836 | Capacitor—.05 Mfd. (C34)—Models 7T1 and 7K1 only | 13144 | Volume Control (R11) |
| 4841 | Capacitor—.01 Mfd. (C19) | REPRODUCER ASSEMBLIES | |
| 11414 | Capacitor—.01 Mfd. (C15) | 12841 | Board—Reproducer terminal board |
| 5170 | Capacitor—.025 Mfd. (C32) | 12640 | Bracket—Output transformer mounting bracket and clamp |
| 11387 | Capacitor—10 Mfd. (C16) | 13600 | Coil—Field coil (L16) |
| 11240 | Capacitor—10 Mfd. (C30) | 11469 | Coil—Neutralizing coil (L18) |
| 5212 | Capacitor—18 Mfd. (C31) | 12642 | Cone—Reproducer cone complete (L17)—Model 7T1 |
| 11617 | Coil—Antenna coil less shield (L2, L3, L4, L5, C3, R1, L11, C10) | 12667 | Cone—Reproducer cone complete (L17)—Models 6K3 and 7K1 |
| 11618 | Coil—Oscillator coil less shield (L6, L7, L8, L9, L10, L11, C10) | 5118 | Connector—3-contact male connector for speaker cable |
| 13697 | Condenser—2-gang variable tuning condenser (C4, C5, C7, C8) | 9771 | Reproducer complete—Model 7T1 |
| 5119 | Connector—3-contact female connector for speaker cable | 9766 | Reproducer complete—Models 6K3 and 7K1 |
| 12006 | Core—Adjustable core and stud for Stock Nos. 13106 and 13107 | 11253 | Transformer—Output transformer (T2) |
| 13682 | Dial—Station selector dial | 11886 | Washer—Spring washer to hold field coil securely |
| 13598 | Drive—Variable tuning condenser vernier drive | MISCELLANEOUS ASSEMBLIES | |
| 13599 | Foot—Chassis mounting foot and bracket | 12038 | Band—Rubber band for tuning tube |
| 12770 | Holder—Dial scale holder and lamp bracket assembly less bracket for top dial lamp socket | 13615 | Bracket—Tuning tube mounting bracket and clamp |
| 12712 | Indicator—Station selector indicator pointer | 12698 | Crystal—Station selector crystal and escutcheon |
| 4340 | Lamp—Dial lamp—Models 7T1 and 7K1 only | 12742 | Escutcheon—Tuning tube escutcheon |
| 5226 | Lamp—Dial lamp—Model 6K3 only | 12699 | Knob—Large station selector knob |
| 13683 | Mask—Dial light diffuser complete with colored screen | 12700 | Knob—Small (vernier) station selector knob |
| 11466 | Resistor—Voltage divider resistor—comprising one 3,500-ohm, one 13,000-ohm, one 85-ohm, one 40-ohm and one 175-ohm sections (R14, R15, R16, R17, R18) | 11347 | Knob—Tone control, range switch or volume control knob |
| 11624 | Resistor—22 ohms—Flexible type complete with grid contact cap (R19) | 11377 | Screw—Chassis mounting screw assembly—Used on Model 7T1 |
| 11620 | Resistor—220 ohms—Carbon type—1/10 watt (R1) | 11210 | Screw—Chassis mounting screw assembly—Used on Models 6K3 and 7K1 |
| 8070 | Resistor—22,000 ohms—Carbon type— $\frac{1}{4}$ watt (R4) | 11349 | Spring—Retaining spring for knob—Stock Nos. 11347 and 12700 |
| 11400 | Resistor—27,000 ohms—Carbon type— $\frac{1}{4}$ watt (R10) | 4982 | Spring—Retaining spring for knob—Stock No. 12699 |
| 12286 | Resistor—58,000 ohms—Insulated— $\frac{1}{4}$ watt (R3) | | |
| 11282 | Resistor—58,000 ohms—Carbon type—1/10 watt (R5) | | |
| 11398 | Resistor—220,000 ohms—Carbon type—1/10 watt (R7) | | |
| 11453 | Resistor—270,000 ohms—Carbon type—1/10 watt (R12) | | |
| 11452 | Resistor—470,000 ohms—Carbon type—1/10 watt (R13) | | |
| 11397 | Resistor—560,000 ohms—Carbon type—1/10 watt (R2) | | |



RCA Victor

MODEL 6T5

Six-Tube, Two-Band, A-C, Superheterodyne Receiver

TECHNICAL INFORMATION AND SERVICE DATA

SERVICE DIVISION • RCA MANUFACTURING COMPANY, INC. • CAMDEN, N. J., U. S. A.

A Service of the Radio Corporation of America

Electrical Specifications

FREQUENCY RANGES

"Standard Broadcast" (A) 530-1,900 kc
"Short Wave" (C) 5,800-21,600 kc

Intermediate Frequency 460 kc

RADIOTRON COMPLEMENT

(1) RCA-6A7 First Detector—Oscillator
(2) RCA-6D6 Intermediate Amplifier
(3) RCA-75 Second Det., A-F Amp. and A.V.C.

ALIGNMENT FREQUENCIES

"Standard Broadcast" (A) 600 kc (osc.), 1,700 kc (osc.)
"Short Wave" (C) 20,000 kc (osc., ant.)

Pilot Lamp (1) Mazda No. 46, 6.3 volts, 0.25 ampere

POWER SUPPLY RATINGS

Rating A 105-125 volts, 50-60 cycles, 75 watts
Rating B 105-125 volts, 25-60 cycles, 75 watts
Rating C 100-125/200-250 volts, 50-60 cycles, 75 watts

POWER OUTPUT RATING

Undistorted 2.0 watts
Maximum 4.5 watts

LOUDSPEAKER

Type Electrodynamic
Voice Coil Impedance 2¼ ohms at 400 cycles

Mechanical Specifications

Height 21 inches
Width 15¼ inches
Depth 9 inches
Weight (Net) 25 pounds
Weight (Shipping) 31 pounds
Chassis Base Dimensions 12 inches x 7 inches x 2½ inches
Over-all Chassis Height 7¾ inches
Operating Controls (1) Volume, (2) Tuning, (3) Range Selector, (4) Power Switch—Tone
Tuning Drive Ratio 10 to 1 and 50 to 1

General Description

This receiver employs a superheterodyne circuit and has many outstanding features. Its design includes magnetite-core adjusted i-f transformers and wave-trap; aural-compensated volume control; two-point, high-frequency tone control; automatic volume control; resistance-coupled audio system; phonograph terminal board; an eight-inch, dust-proof, electrodynamic loudspeaker; and an electron-ray tuning tube "Magic Eye."

Tuning range includes the "Standard broadcast" (A) and "Short wave" (C) bands. The "Short wave" (C) position of this extensive range includes channels assigned for amateur, and international short-wave broadcast on 49, 31, 25, 19, 16, and 13 meters. The tuning dial ratio of 10 to 1 with a 50 to 1 vernier permits ease of tuning, especially in the "Short wave" band.

Service Data

The various diagrams of this booklet contain such information as will be needed to isolate causes for defective operation if such develops. The ratings of the resistors, capacitors, coils, etc., are indicated adjacent to the symbols signifying these parts on the diagrams. Identification titles such as R1, L1, C1, etc., provide reference between the illustrations and Replacement Parts List. The coils, transformer windings, and reactors are rated in terms of d-c resistance to permit continuity checks.

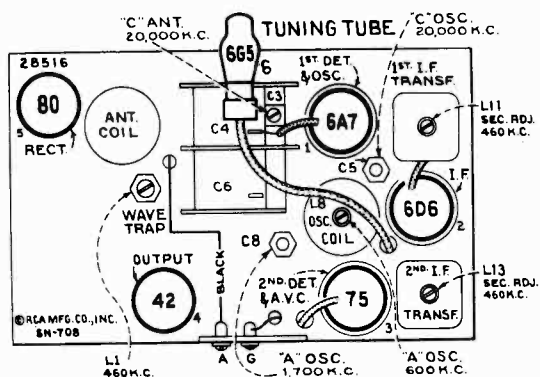

Figure 1—Radiotron, Coil, and Trimmer Locations

Phonograph Attachment.—A terminal board is provided for connecting a phonograph into the audio-amplifying circuit. RCA Victor Models R-93, R-93-2, or R-93-S Record Players should be connected as follows: Remove link between terminals 1 and 2 on receiver. Connect green wire in Radio-Record switch cable to terminal 1, yellow to terminal 2; and shield extension to terminal 3. Tape unused red and blue leads separately. Connect a 2-conductor twisted cable between the Record Player binding posts and the screw terminals on Radio-Record switch.

Radiotron Cathode Current Readings

Measured with Milliammeter Connected at Tube Socket Cathode Terminals Under Conditions Similar to Those of Voltage Measurements

- (1) RCA-6A7—1st Det.—Osc. 11.0 ma.
 - (2) RCA-6D6—I-F Amp. 10.0 ma.
 - (3) RCA-75—2nd Det., A.V.C. and A. F. . 0.22 ma.
 - (4) RCA-42—Power Amplifier 42.0 ma.
 - (5) RCA-80—Rectifier 66.0 ma.*
 - (6) RCA-6G5—Tuning Tube 2.0 ma.
- (*Cannot be measured at socket.)

Alignment Procedure

Calibrate the tuning dial by adjusting dial pointer to the low-frequency (end) calibration mark on "Standard broadcast" scale with the gang tuning-condenser plates in full-mesh position. This is a friction adjustment.

Perform alignment in proper order, tabulated below, starting with No. 1 and following all operations across, then No. 2, etc. Adjustment locations are shown on Figures 1 and 5.

Cathode-ray alignment is preferable; the connections to the chassis are shown on Figure 3. If an output indicator is used, connect it across the loudspeaker voice-coil and advance the receiver volume control to full-volume position.

Connect the "low" output terminal of the test oscillator to the receiver chassis for all alignment operations. Regulate the output of the test oscillator so that minimum signal is applied to the receiver to obtain an observable output indication. This will avoid a-v-c action.

The term "Dummy antenna" means the device which must be connected between the "high" test-oscillator output and the point of connection to the receiver in order to obtain ideal alignment. "No signal, 550-750 kc" means that the receiver should be tuned to a point between 550 and 750 kc where no signal or interference is received from a station or local (heterodyne) oscillator.

For further details on alignment, refer to booklet "RCA Victor Receiver Alignment."

| Order of Alignment | Test Oscillator | | | Receiver Dial Setting | Circuit to Adjust | Adjustment Symbols | Adjust to Obtain |
|--------------------|------------------------|---------------|-------------------|-------------------------|-------------------|--------------------|------------------|
| | Connection to Receiver | Dummy Antenna | Frequency Setting | | | | |
| 1 | 6D6 I-F Grid Cap | .001 Mfd. | 460 kc | No Signal 550-750 kc | 2nd I-F Trans. | L12 and L13 | Max. (peak) |
| 2 | 6A7 Det. Grid Cap | .001 Mfd. | 460 kc | No Signal 550-750 kc | 1st I-F Trans. | L10 and L11 | Max. (peak) |
| 3 | Ant. Post | 200 Mmfd. | 460 kc | No Signal S-W Band | Wave Trap | L1 | Minimum Output |
| 4 | Ant. Post | 300 Ohms | 20,000 kc | 20,000 kc | "C" Osc. | C5 | Max. (peak)* |
| 5 | Ant. Post | 300 Ohms | 20,000 kc | Rock Thru 20,000 kc | "C" Ant. | C3 | Max. (peak)† |
| 6 | Ant. Post | 200 Mmfd. | 600 kc | 600 kc | "A" L-F Osc. | L8 | Max. (peak) |
| 7 | Ant. Post | 200 Mmfd. | 1,700 kc | 1,700 kc | "A" H-F Osc. | C8 | Max. (peak) |
| 8 | Ant. Post | 200 Mmfd. | 600 kc | Rock Thru 600 kc | "A" L-F Osc. | L8 | Max. (peak) |
| 9 | Ant. Post | 200 Mmfd. | 1,700 kc | 1,700 kc | "A" H-F Osc. | C8 | Max. (peak) |

* Use minimum capacity peak.

† Use maximum capacity peak.

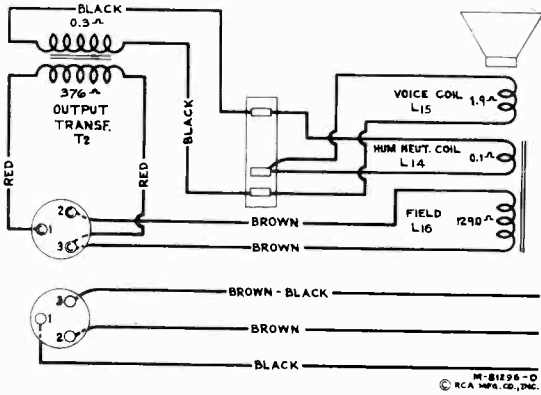

Figure 4—Loudspeaker Wiring

Loudspeaker.—Centering of the loudspeaker is made in the usual manner with three narrow paper feelers after first removing the front dust cover. This may be removed by softening its cement with a light application of acetone, using care not to allow the acetone to flow into the air gap. The dust cover should be cemented back in place with ambroid upon completion of adjustment.



Model 6T5

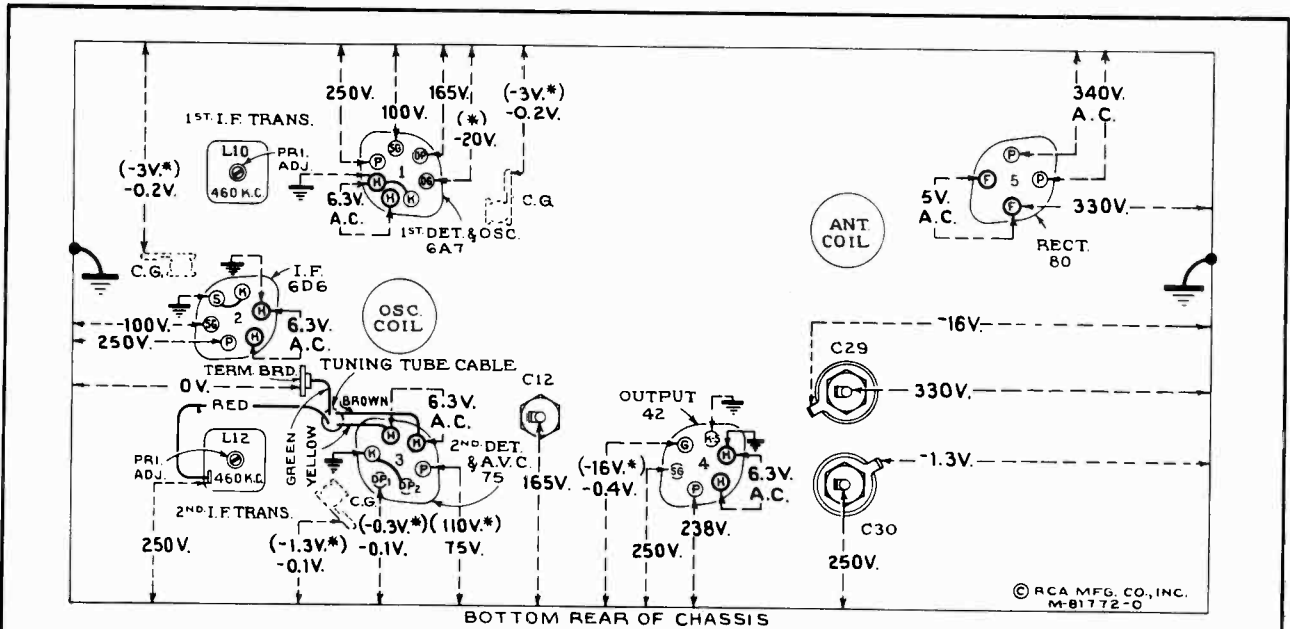

Figure 5—Radiotron Socket Voltages, Coil, and Trimmer Locations

Measured at 115 volts, 60-cycle supply—Tuned to approximately 1,000 kc ("Standard broadcast")—No signal being received—Volume control minimum

Radiotron Socket Voltages

Note: Two voltage values are shown for some readings. The value shown in parentheses with asterisk (*) indicates operating conditions without voltmeter loading. The other value (generally lower) is the actual measured voltage and differs from the value shown in parentheses because of the additional loading of the voltmeter through the high series circuit resistance.

The voltage values indicated from the Radiotron socket contacts, grid caps, resistors, and terminals to receiver chassis ground on Figure 5 will assist in lo-

ating cause of faulty operation. Each value as specified should hold within $\pm 20\%$ when the receiver is normally operative at its rated line voltage. Variations in excess of this limit will usually be indicative of trouble in the basic circuits. To duplicate the conditions under which the voltages were measured requires a 1,000-ohm-per-volt d-c meter, having ranges of 10, 50, 250, and 500 volts. Use the nearest range above the specified measured voltage. A-c voltages were measured with a corresponding a-c meter.

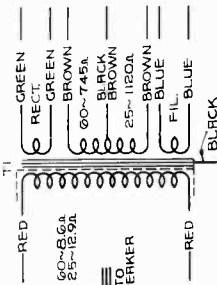
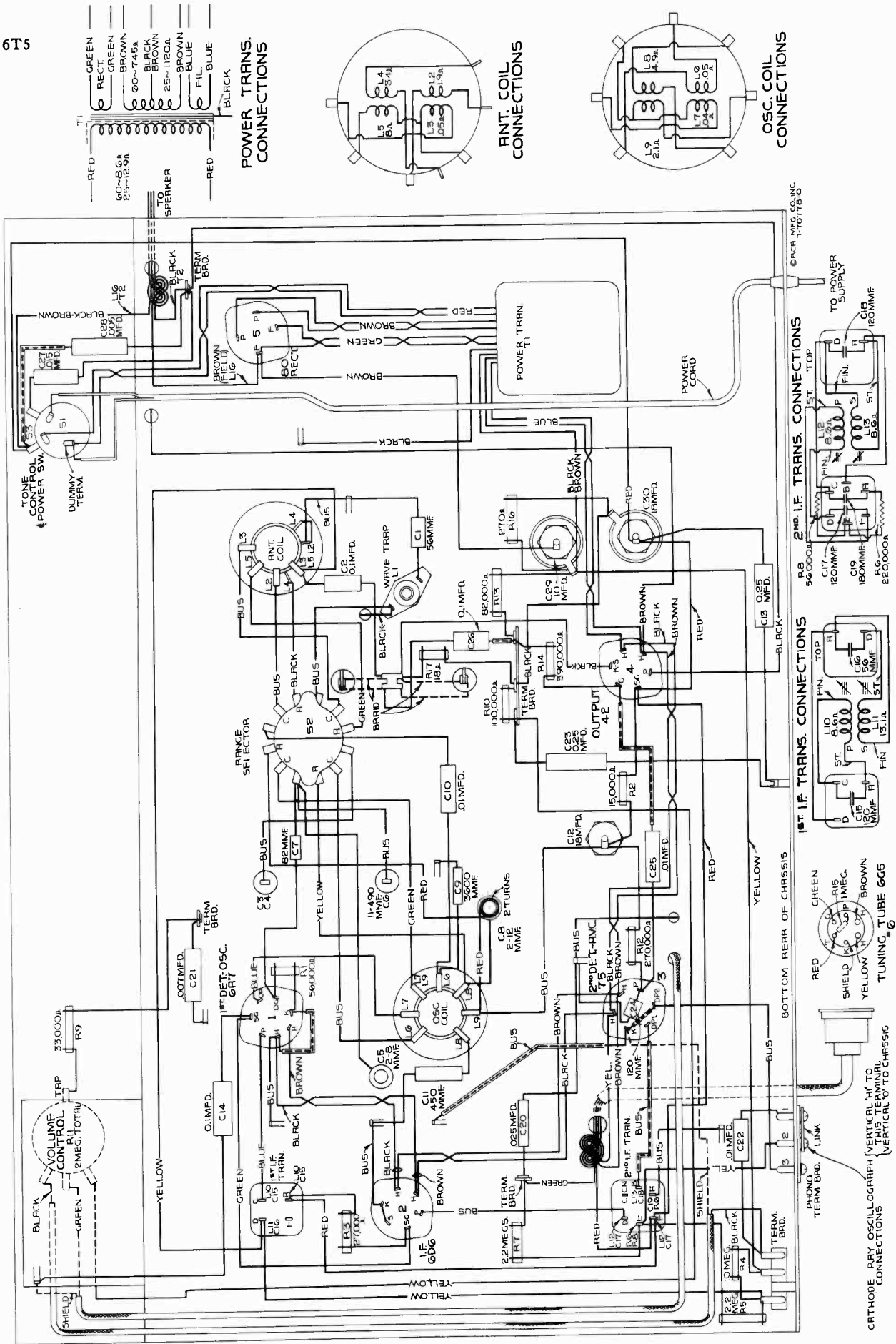

POWER TRANS. CONNECTIONS

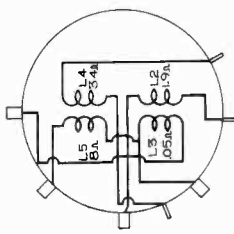

RNT. COIL CONNECTIONS

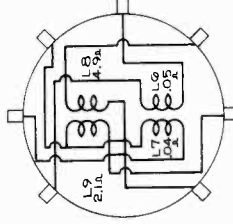

OSC. COIL CONNECTIONS

Figure 3—Chassis Wiring Diagram

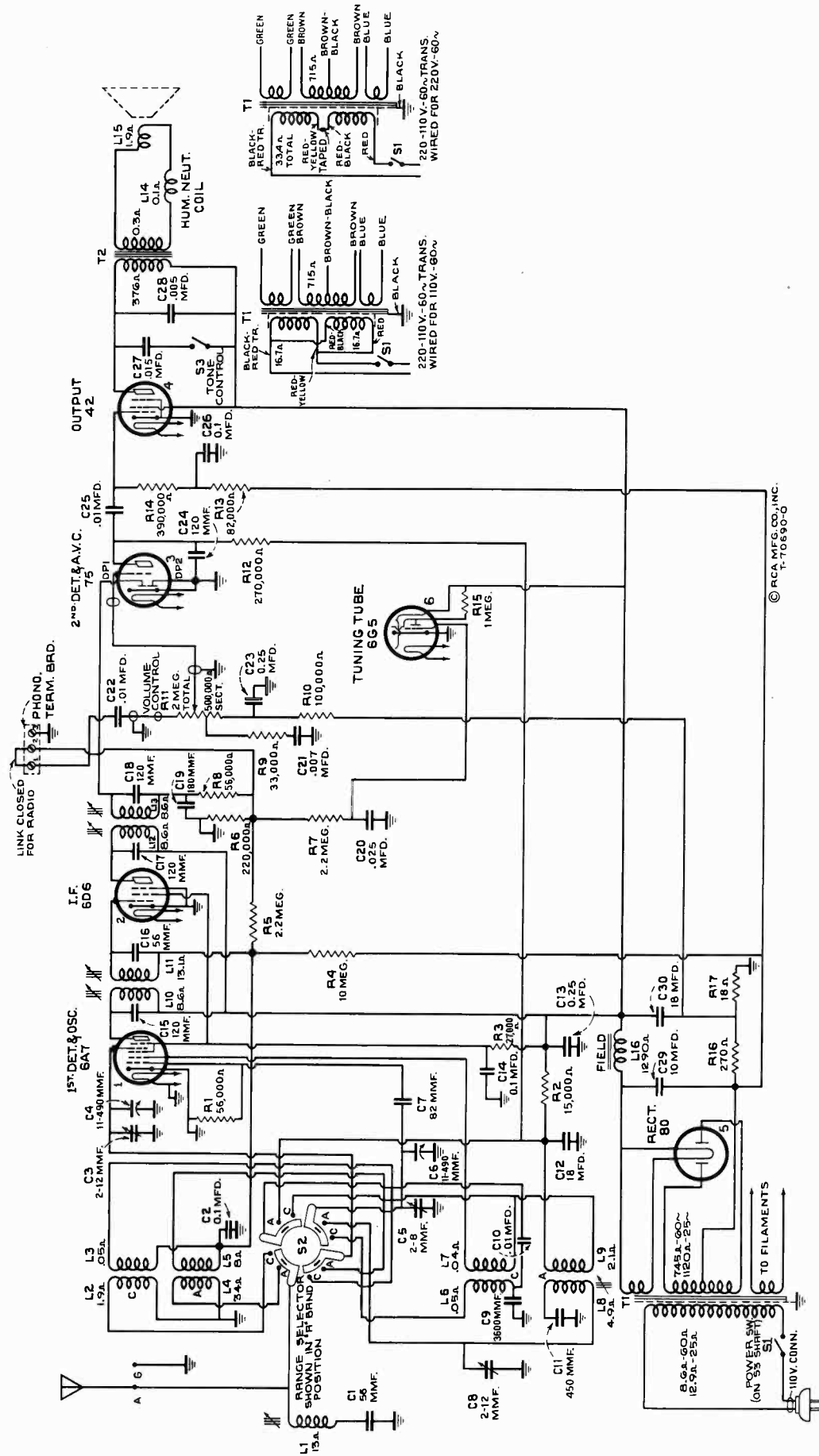

© RCA MFG. CO., INC. T-70690-Q

Figure 2—Schematic Circuit Diagram

REPLACEMENT PARTS

Insist on genuine factory-tested parts, which are readily identified and may be purchased from authorized dealers

| STOCK No. | DESCRIPTION | STOCK No. | DESCRIPTION |
|----------------------------|--|---------------------------------|---|
| RECEIVER ASSEMBLIES | | | |
| 13216 | Board—Antenna and ground terminal board | 13732 | Resistor—10 meg., carbon type, 1/4 watt (R4) |
| 12717 | Board—Phonograph terminal board | 12651 | Shield—Antenna coil shield |
| 5237 | Bushing—Variable condenser mounting bushing assembly | 13311 | Shield—Chassis end shield and rubber mounting foot assembly |
| 13870 | Cable—Tuning tube cable and socket | 12607 | Shield—First I. F. transformer shield top |
| 12118 | Cap—Grid contact cap | 12008 | Shield—I. F. transformer shield |
| 12714 | Capacitor—Adjustable trimmer (C8) | 12799 | Shield—Oscillator coil shield |
| 12807 | Capacitor—Adjustable trimmer (C5) | 12581 | Shield—Second I. F. transformer shield top |
| 12723 | Capacitor—56 Mmfd. (C1) | 3682 | Shield—6A7 or 75 Radiotron shield |
| 12629 | Capacitor—56 Mmfd. (C16) | 3950 | Shield—6D6 Radiotron shield |
| 13394 | Capacitor—82 Mmfd. (C7) | 13871 | Socket—Tuning tube socket and cover |
| 12724 | Capacitor—120 Mmfd. (C24) | 4794 | Socket—4-contact 80 Radiotron socket |
| 12404 | Capacitor—120 Mmfd. (C15, C17, C18) | 4786 | Socket—6-contact 6D6, 42 or 75 Radiotron socket |
| 12406 | Capacitor—180 Mmfd. (C9) | 4787 | Socket—7-contact 6A7 Radiotron socket |
| 12812 | Capacitor—450 Mmfd. (C11) | 11199 | Socket—Dial lamp socket |
| 12811 | Capacitor—3,600 Mmfd. (C9) | 12007 | Spring—Retaining spring for Stock Nos. 12006 and 12664 |
| 4868 | Capacitor—.005 Mfd. (C28) | 12796 | Switch—Range switch (S2) |
| 5148 | Capacitor—.007 Mfd. (C21) | 13309 | Switch—Tone control and power switch (S1, S3) |
| 11315 | Capacitor—.015 Mfd. (C27) | 12801 | Transformer—First I. F. transformer complete (L10, L11, C15, C16) |
| 4858 | Capacitor—.01 Mfd. (C10, C22, C25) | 12653 | Transformer—Second I. F. transformer complete (L12, L13, C17, C18, C19, R6, R8) |
| 4841 | Capacitor—.01 Mfd. (C2, C14, C26) | 12644 | Transformer—Power transformer, 105-125 volts, 50-60 cycles (T1) |
| 4840 | Capacitor—.025 Mfd. (C23) | 12645 | Transformer—Power transformer, 105-125 volts, 25-60 cycles (T1) |
| 5170 | Capacitor—.025 Mfd. (C13) | 13869 | Transformer—Power transformer, 110 and 220 volts, 50-60 cycles (T1) |
| 11240 | Capacitor—10 Mfd. (C29) | 12654 | Trap—Wave-trap complete (L1) |
| 5212 | Capacitor—18 Mfd. (C12, C30) | 13144 | Volume control (R11) |
| 12797 | Coil—Antenna coil and shield (L2, L3, L4, L5) | REPRODUCER ASSEMBLIES | |
| 12798 | Coil—Oscillator coil and shield (L6, L7, L8, L9) | 12641 | Board—3-contact reproducer terminal board |
| 13679 | Condenser—2-gang variable tuning condenser (C3, C4, C6) | 12640 | Bracket—Output transformer mounting bracket |
| 5119 | Connector—3-contact female connector for speaker cable | 12012 | Coil—Field coil (L16) |
| 12006 | Core—Adjustable core and stud for Stock Nos. 12653 and 12801 | 11469 | Coil—Neutralizing coil (L14) |
| 12664 | Core—Adjustable core and stud for Stock No. 12654 | 12642 | Cone—Reproducer cone and dust cap (L15) |
| 13868 | Dial—Station selector dial | 5118 | Connector—3-contact male speaker cable connector |
| 13680 | Drive—Vernier drive for variable condenser | 9699 | Reproducer—Complete |
| 13314 | Indicator—Station selector indicator pointer | 11253 | Transformer—Output transformer (T2) |
| 5226 | Lamp—Dial lamp, 6.3 volts | 11886 | Washer—Spring washer to hold field coil securely |
| 13674 | Resistor—18 ohms, carbon type, 1/4 watt (R17) | MISCELLANEOUS ASSEMBLIES | |
| 13819 | Resistor—270 ohms, wire wound, 1.1 watts (R16) | 12038 | Band—Rubber band for tuning tube |
| 12759 | Resistor—15,000 ohms, carbon type, 1/2 watt (R2) | 13615 | Bracket—Tuning tube mounting bracket and clamp |
| 12011 | Resistor—27,000 ohms, carbon type, 1 watt (R3) | 12785 | Crystal—Station selector escutcheon and crystal |
| 11364 | Resistor—33,000 ohms, carbon type, 1/4 watt (R9) | 12742 | Escutcheon—Tuning tube escutcheon |
| 5029 | Resistor—56,000 ohms, carbon type, 1/4 watt (R1) | 12699 | Knob—Large station selector knob |
| 11282 | Resistor—56,000 ohms, carbon type, 1/10 watt (R8) | 12700 | Knob—Small (vernier) station selector knob |
| 11365 | Resistor—82,000 ohms, carbon type, 1/4 watt (R13) | 11347 | Knob—Volume control, tone control or range switch knob |
| 5145 | Resistor—100,000 ohms, carbon type, 1/4 watt (R10) | 11377 | Screw—Chassis mounting screw and washer assembly |
| 11398 | Resistor—220,000 ohms, carbon type, 1/10 watt (R6) | 4982 | Spring—Retaining spring for knob, Stock No. 12699 |
| 11323 | Resistor—270,000 ohms, carbon type, 1/4 watt (R12) | 11349 | Spring—Retaining spring for knob, Stock Nos. 11347 and 12700 |
| 11847 | Resistor—390,000 ohms, carbon type, 1/4 watt (R14) | | |
| 12013 | Resistor—1 meg., carbon type, 1/10 watt (R15) | | |
| 11626 | Resistor—2.2 meg., carbon type, 1/4 watt (R5, R7) | | |



RCA Victor

MODELS 9K1 and 9K3

Nine-Tube, Three-Band, A-C, Superheterodyne Receivers

TECHNICAL INFORMATION AND SERVICE DATA

SERVICE DIVISION • RCA MANUFACTURING COMPANY, INC. • CAMDEN, N. J., U. S. A.

A Service of the Radio Corporation of America

Electrical Specifications

FREQUENCY RANGES

| | |
|--------------------------------|-----------------|
| "Standard Broadcast" (A) | 530-1,800 kc |
| "Medium Wave" (B) | 1,800-6,400 kc |
| "Short Wave" (C) | 6,400-23,000 kc |

Intermediate Frequency

RADIOTRON COMPLEMENT

| | |
|-------------------|----------------------------|
| (1) RCA-6K7 | R-F Amplifier |
| (2) RCA-6L7 | First Detector |
| (3) RCA-6J7 | Heterodyne Oscillator |
| (4) RCA-6K7 | Intermediate Amplifier |
| (5) RCA-6H6 | Second Detector and A.V.C. |

Pilot Lamps (3, Model 9K1) (4, Model 9K3)

POWER SUPPLY RATINGS

| | |
|----------------|---|
| Rating A | 105-125 volts, 50-60 cycles |
| Rating B | 105-125 volts, 25-60 cycles |
| Rating C | 100-130/140-160/195-250 volts, 40-60 cycles |

POWER OUTPUT

| | | |
|-------------------|-----------|------------|
| Undistorted | 2.0 watts | 7.0 watts |
| Maximum | 4.5 watts | 12.5 watts |

ALIGNMENT FREQUENCIES

| | |
|--------------------------------|--|
| "Short Wave" (C) | 20,000 kc (osc., det., ant.) |
| "Medium Wave" (B) | 6,000 kc (osc., det., ant.) |
| "Standard Broadcast" (A) | 600 kc (osc.), 1,500 kc (osc., det., ant.) |

| | |
|-------------------------|-------------------------|
| (6) RCA-6F5 | Audio Voltage Amplifier |
| (7) RCA-6F6 (9K1) | Power Output |
| (7) RCA-6L6 (9K3) | Power Output |
| (8) RCA-5Z4 | Full-Wave Rectifier |
| (9) RCA-6G5 | "Magic Eye" Tuning Tube |

Mazda No. 46, 6.3 volts, 0.25 amp.

| | | |
|----------------|------------|------------|
| | 9K1 | 9K3 |
| Rating A | 95 watts | 135 watts |
| Rating B | 95 watts | 135 watts |
| Rating C | 95 watts | 135 watts |

LOUDSPEAKER

| | |
|-------------------------|------------------------|
| Type | 12-inch Electrodynamic |
| Impedance (v. c.) | 2.2 ohms at 400 cycles |

Mechanical Specifications

| | | |
|-------------------------------|------------------------------------|------------|
| | 9K1 | 9K3 |
| Height | 40 inches | 41 inches |
| Width | 26½ inches | 29 inches |
| Depth | 12½ inches | 14¼ inches |
| Weight (net) | 56 pounds | 80 pounds |
| Weight (shipping) | 71 pounds | 124 pounds |
| Chassis Base Dimensions | 14½ inches x 7¾ inches x 3¼ inches | |
| Over-all Chassis Height | 8½ inches | |

Operating Controls

9K1: (1) Volume—Power Switch, (2) Tuning, (3) Range Selector, (4) Tone

9K3: (1) Music-Speech—Power Switch, (2) Volume, (3) Tuning, (4) Range Selector, (5) H-F Tone

Tuning Drive Ratios

(9K1) 10 to 1 and 50 to 1, (9K3) 20 to 1 and 100 to 1

General Description

These receivers each employ a nine-tube, three-band superheterodyne circuit. Model 9K1 uses an RCA-6F6 power-output tube, delivering a maximum output of 4.5 watts, while Model 9K3 uses an RCA-6L6 beam-power-output tube, delivering a maximum output of 12.5 watts. The tuning range for each model is continuous from 530 to 23,000 kc, which includes the standard broadcast band and the important short-wave bands at 49, 31, 25, 19, 16, and 13 meters, along with channels assigned for police, aviation, and amateur communication.

Features of design include an r-f amplifier stage; magnetite-core adjusted i-f transformers, wave-trap, and low-frequency oscillator tracking; full automatic volume control; phonograph terminal board; "Magic Eye" tuning tube; 12-inch electrodynamic loudspeaker; new plunger-type, air-dielectric trimming capacitors; aural-compensated audio volume control; continuous high-frequency tone control; and a two-point low-frequency tone control. In addition, Model 9K3 has a cabinet incorporating the "Magic Voice."

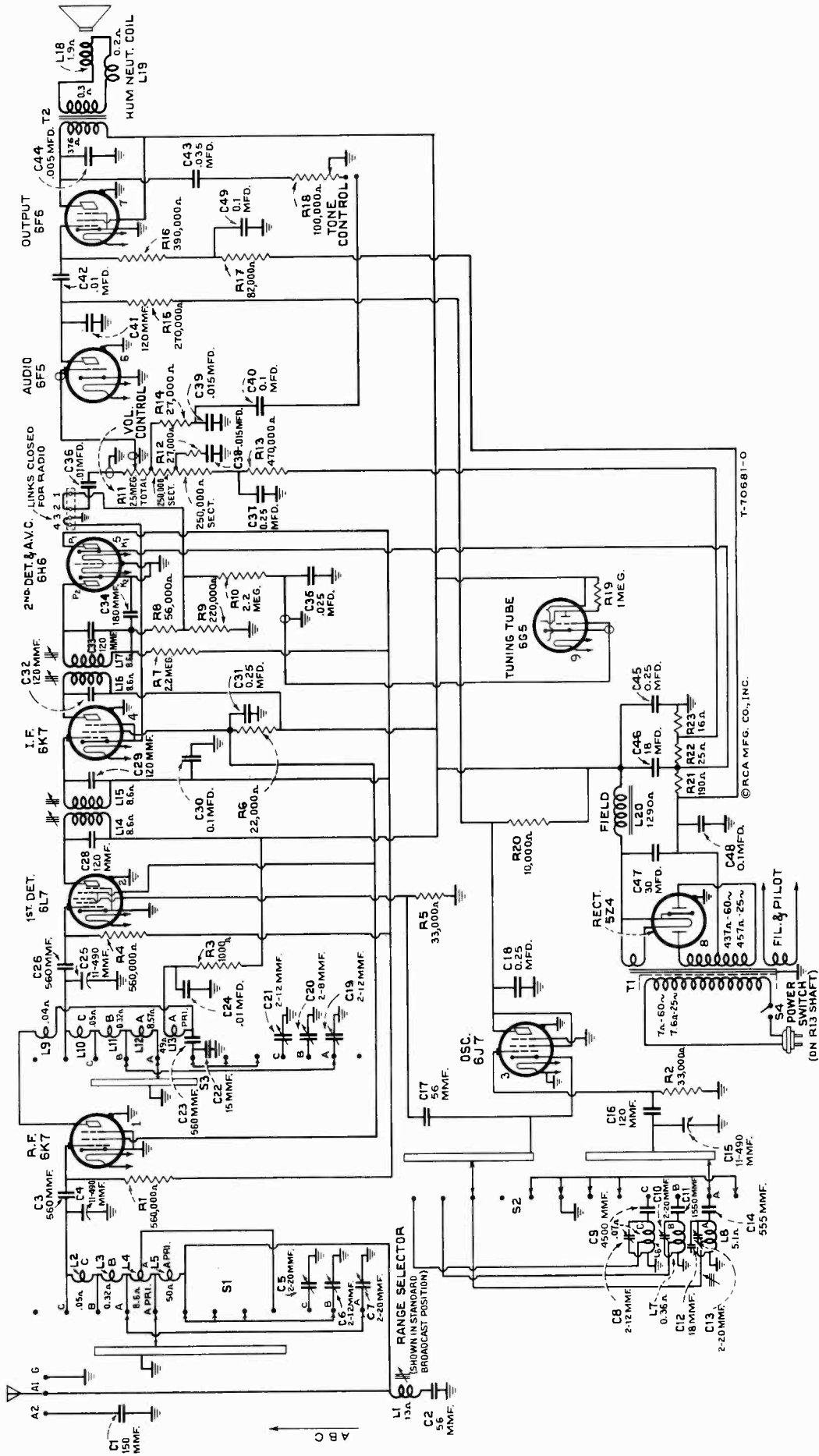

Figure 1—Schematic Circuit Diagram (Model 9K1)

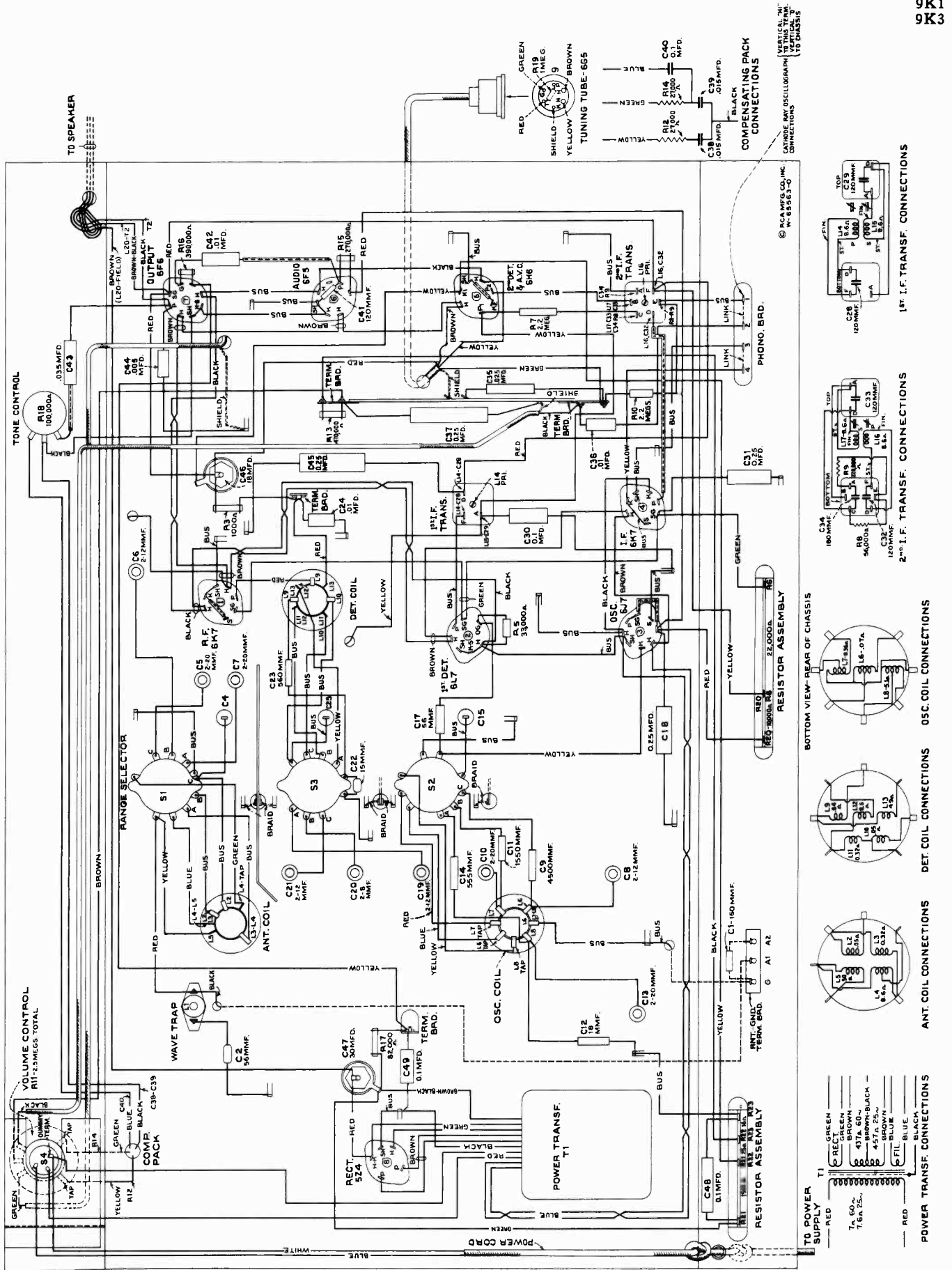

Figure 2—Chassis Wiring Diagram (Model 9K1)

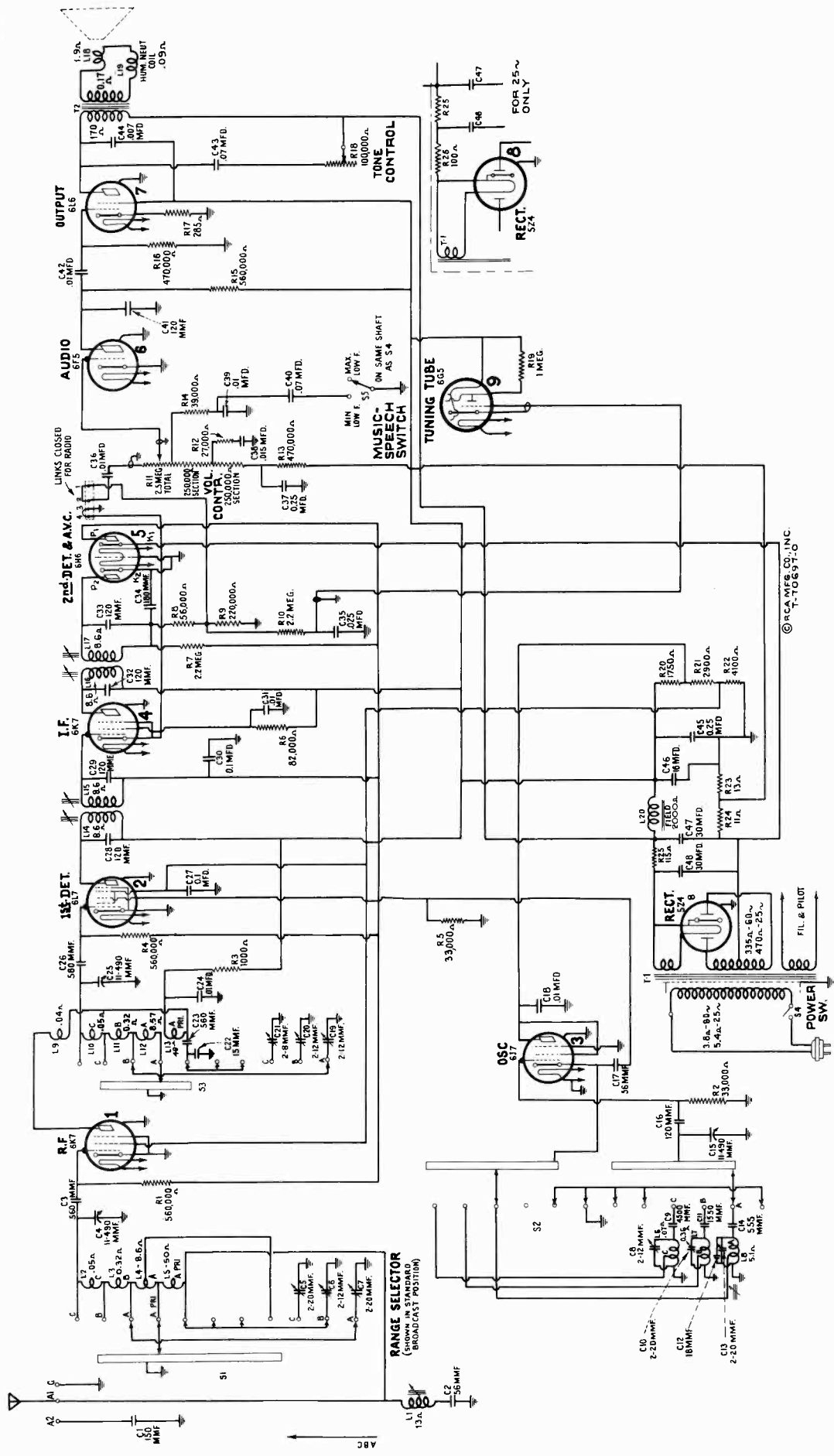

Figure 3—Schematic Circuit Diagram (Model 9K3)

Alignment Procedure

Calibrate the tuning dial by adjusting dial pointer to the low-frequency (end) calibration mark on "Standard broadcast" scale with the gang tuning-condenser plates in full-mesh position. This is a friction adjustment.

Perform alignment in proper order, tabulated below, starting with No. 1 and following all operations across, then No. 2, etc. Adjustment locations are shown on Figures 5, 6, 7, and 9.

Cathode-ray alignment is preferable; the connections to the chassis are shown in Figures 2 and 4. If an output indicator is used, connect it across the loudspeaker voice-coil and advance the receiver volume control to full-volume position.

Connect the "low" output terminal of the test oscillator to the receiver chassis for all alignment operations. Regulate the output of the test oscillator so that minimum signal is applied to the receiver to obtain an observable output indication. This will avoid a-v-c action.

The term "Dummy antenna" means the device which must be connected between the "high" test-oscillator output and the point of connection to the receiver in order to obtain ideal alignment. "No signal, 550-750 kc" means that the receiver should be tuned to a point between 550 and 750 kc where no signal or interference is received from a station or local (heterodyne) oscillator.

For further details on alignment, refer to booklet "RCA Victor Receiver Alignment."

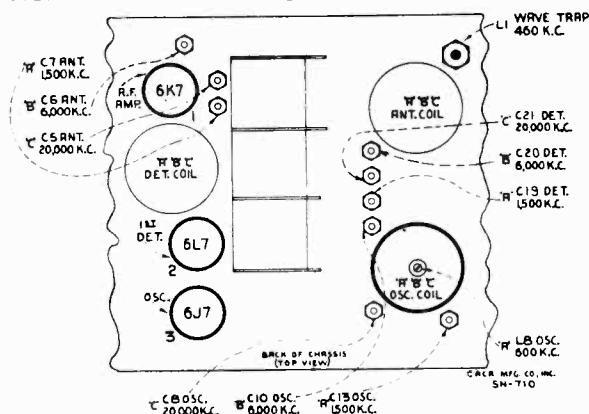

Figure 5—R-F Trimmer Locations

Note.—The locations of C20 and C21 are interchanged on some chassis of Model 9K1.

| Order of Alignment | Test Oscillator | | | Receiver Dial Setting | Circuit to Adjust | Adjustment Symbols | Adjust to Obtain |
|--------------------|------------------------|---------------|-------------------|-----------------------|-------------------|--------------------|------------------|
| | Connection to Receiver | Dummy Antenna | Frequency Setting | | | | |
| 1 | 6K7 I-F Grid Cap | .001 Mfd. | 460 kc | No Signal 550-750 kc | 2nd I-F Trans. | L16 and L17 | Max. (peak) |
| 2 | 6L7 Det. Grid Cap | .001 Mfd. | 460 kc | No Signal 550-750 kc | 1st I-F Trans. | L14 and L15 | Max. (peak) |
| 3 | "A1" Ant. Term. | 200 Mmfd. | 460 kc | No Signal 550-750 kc | Wave Trap | L1 | Minimum Output |
| 4 | "A1" Ant. Term. | 300 Ohms | 20,000 kc | 20,000 kc | "C" Osc. | C8 | Max. (peak)* |
| 5 | "A1" Ant. Term. | 300 Ohms | 20,000 kc | Rock thru 20,000 kc | "C" Det. | C21 | Max. (peak)† |
| 6 | "A1" Ant. Term. | 300 Ohms | 20,000 kc | 20,000 kc | "C" Ant. | C5 | Max. (peak)‡ |
| 7 | "A1" Ant. Term. | 300 Ohms | 6,000 kc | 6,000 kc | "B" Osc. | C10 | Max. (peak) |
| 8 | "A1" Ant. Term. | 300 Ohms | 6,000 kc | 6,000 kc | "B" Det. | C20 | Max. (peak) |
| 9 | "A1" Ant. Term. | 300 Ohms | 6,000 kc | 6,000 kc | "B" Ant. | C6 | Max. (peak) |
| 10 | "A1" Ant. Term. | 200 Mmfd. | 600 kc | 600 kc | "A" L-F Osc. | L8 | Max. (peak) |
| 11 | "A1" Ant. Term. | 200 Mmfd. | 1,500 kc | 1,500 kc | "A" H-F Osc. | C13 | Max. (peak) |
| 12 | "A1" Ant. Term. | 200 Mmfd. | 1,500 kc | 1,500 kc | "A" Det. | C19 | Max. (peak) |
| 13 | "A1" Ant. Term. | 200 Mmfd. | 1,500 kc | 1,500 kc | "A" Ant. | C7 | Max. (peak) |
| 14 | "A1" Ant. Term. | 200 Mmfd. | 600 kc | Rock thru 600 kc | "A" L-F Osc. | L8 | Max. (peak) |
| 15 | "A1" Ant. Term. | 200 Mmfd. | 1,500 kc | 1,500 kc | "A" H-F Osc. | C13 | Max. (peak) |

* Use minimum capacity peak if two peaks can be obtained.

† Use maximum capacity peak if two peaks can be obtained.

‡ After this adjustment, check for image signal by shifting receiver dial to 19,080 kc.

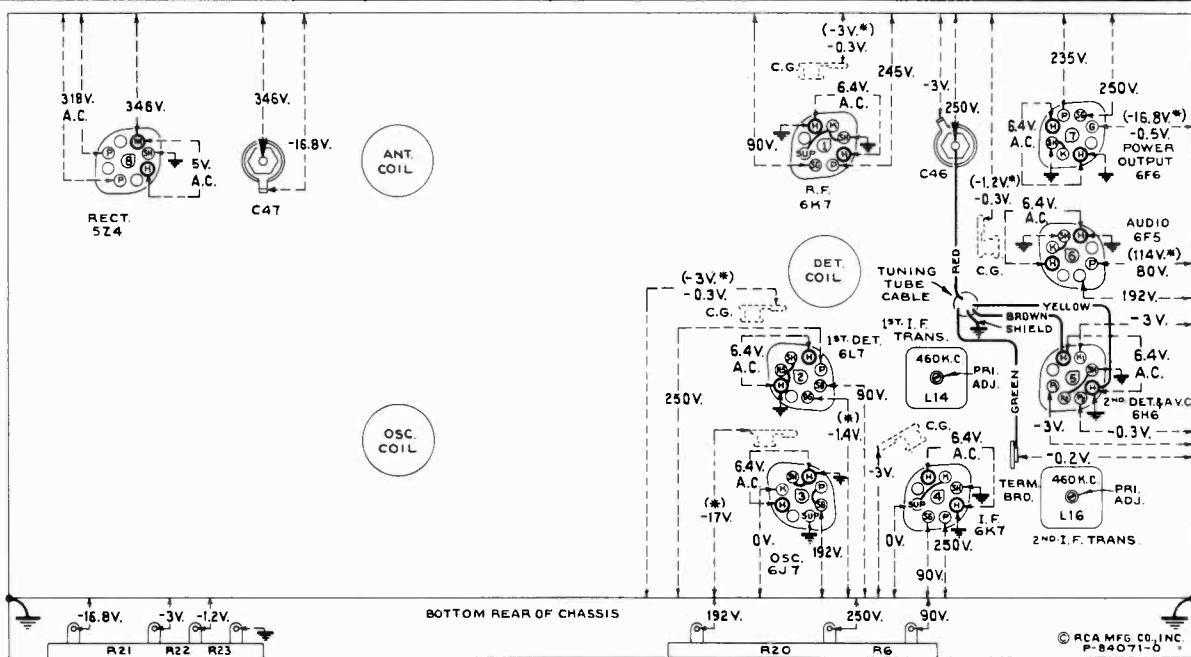

Figure 6—Radiotron Socket Voltages and I-F Trimmer Locations (Model 9K1)

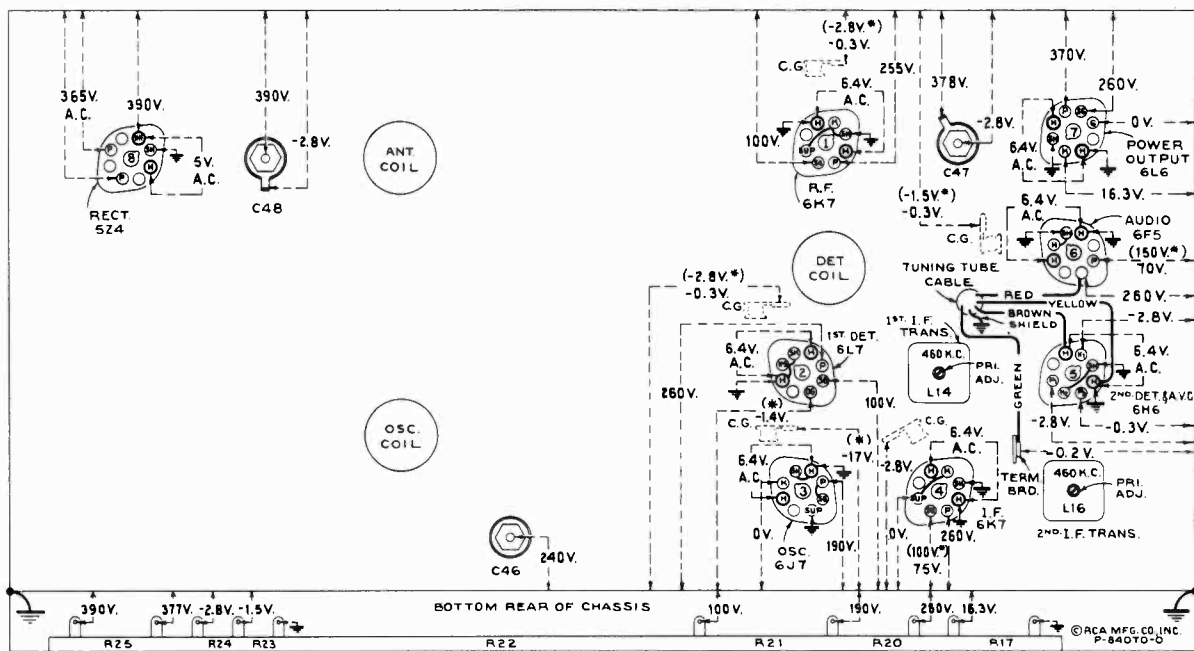

Figure 7—Radiotron Socket Voltages and I-F Trimmer Locations (Model 9K3)

Measured at 115 volts, 60-cycle supply—Tuned to approximately 1,000 kc ("Standard broadcast")—
No signal being received—Volume control minimum

Note: Two voltage values are shown for some readings. The value shown in parentheses with asterisk () indicates operating conditions without voltmeter loading. The other value (generally lower) is the actual measured voltage and differs from the value shown in parentheses because of the additional loading of the voltmeter through the high series circuit resistance.*

The voltage values indicated from the Radiotron socket contacts, grid caps, resistors, and terminals to receiver chassis ground on Figures 6 and 7 will assist

in locating cause of faulty operation. Each value as specified should hold within $\pm 20\%$ when the receiver is normally operative at its rated line voltage. Variations in excess of this limit will usually be indicative of trouble in the basic circuits. To duplicate the conditions under which the voltages were measured requires a 1,000-ohm-per-volt d-c meter, having ranges of 10, 50, 250, and 500 volts. Use the nearest range above the specified measured voltage. A-c voltages were measured with a corresponding a-c meter.

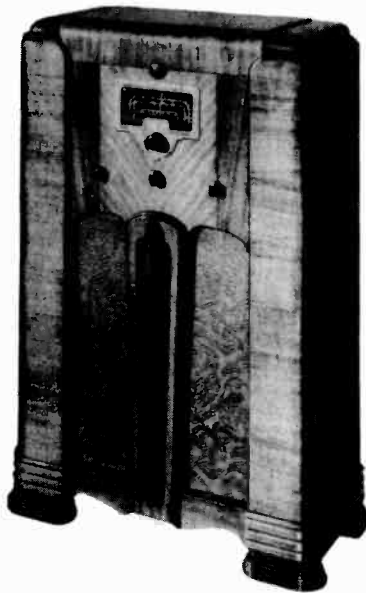

Model 9K1

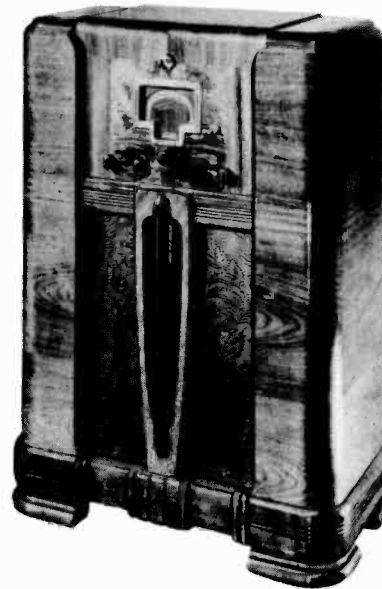

Model 9K3

Service Data

The various diagrams of this booklet contain such information as will be needed to isolate causes for defective operation if such develops. The ratings of the resistors, capacitors, coils, etc., are indicated adjacent to the symbols signifying these parts on the diagrams. Identification titles such as R1, L1, C1, etc., provide reference between the illustrations and Replacement Parts List. The coils, transformer windings, and reactors are rated in terms of d-c resistance to permit continuity checks.

Phonograph Attachment.—A terminal board is provided for connecting a phonograph into the audio-amplifying circuit. RCA Victor Models R-93, R-93-2, R-93-A, or R-94 Record Players should be connected as follows: Remove the two links from the phonograph terminal board. Connect green wire in Radio-Record switch cable to terminal 2; yellow to terminal 1; red to terminal 4; and both the blue lead and shield to terminal 3. Connect a 2-conductor twisted cable between the Record Player binding posts and the screw terminals on Radio-Record switch.

Loudspeaker.—Centering of the loudspeaker is made in the usual manner with three narrow paper feelers

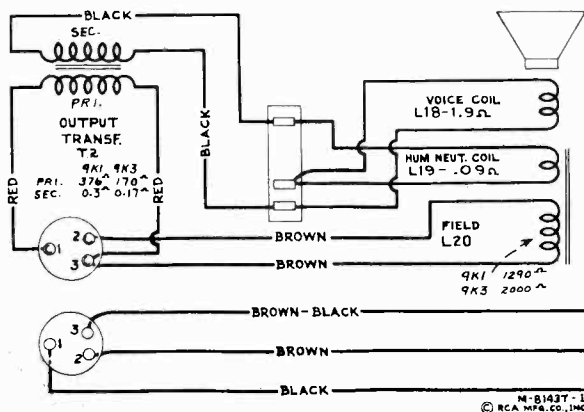

Figure 8—Loudspeaker Wiring

after first removing the front dust cover. This may be removed by softening its cement with a light application of acetone, using care not to allow the acetone to flow into the air gap. The dust cover should be cemented back in place with ambroid upon completion of adjustment.

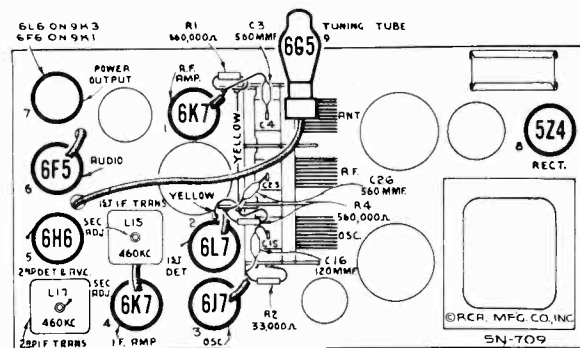

Figure 9—Radiotron and I-F Trimmer Locations

| Radiotron Cathode Current Readings | | |
|---|-----|----------|
| Measured with Milliammeter Connected at Tube Socket Cathode Terminals Under Conditions Similar to Those of Voltage Measurements | | |
| | 9K1 | 9K3 |
| (1) RCA-6K7—R-F Amp. | 7.5 | 7.5 ma. |
| (2) RCA-6L7—1st Det. | 6.4 | 7.2 ma. |
| (3) RCA-6J7—Osc. | 5.4 | 6.3 ma. |
| (4) RCA-6K7—I-F Amp. | 7.5 | 7.5 ma. |
| (5) RCA-6H6—2nd Det. & A.V.C. | — | — |
| (6) RCA-6F5—1st Audio | 0.3 | 0.2 ma. |
| (7) RCA-6F6—Output | 41 | — ma. |
| (7) RCA-6L6—Output | — | 60 ma. |
| (8) RCA-5Z4—Rectifier | 72* | 118 ma.* |
| (9) RCA-6G5—Tuning Tube | 2.0 | 2.0 ma. |

(*Cannot be measured at socket.)

Selector Dial (Model 9K3).—Figure 10 illustrates the relation of the various parts of the dial mechanism when in its "Standard broadcast" position with the range switch likewise turned to its "Standard broadcast" position. In re-assembling the dial after repairs, see that the gears are meshed in accordance with the diagram, at

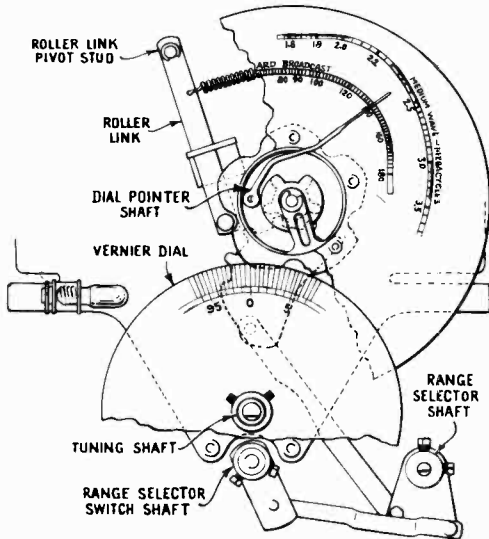

Figure 10—Selector Dial Mechanism (Model 9K3)

the same time noting that the range switch is in its "Standard broadcast" position and the lever attached to the range-switch shaft placed in the position shown.

To adjust the dial mechanism, set the range switch to its "Standard broadcast" position. Place a straight-edge across the center of the dial so that its edge is even with the lower (end) marking at both the low-frequency and high-frequency ends of the dial. Under such conditions the straight-edge should be parallel with the top of the

chassis base. If the straight-edge is not parallel with the top of the chassis base, loosen the nut on the rear of the roller link pivot stud and move the stud up or down until the link roller moves the dial to the desired position so that the end calibration marks obtain the position mentioned above. Tighten the nut on the roller link pivot stud.

Set the gang tuning condenser to its maximum capacity position. Adjust the dial pointer to the low-frequency (end) mark on "Standard broadcast" scale. This is a friction adjustment.

With the gang tuning condenser plates still in full mesh, loosen the two set screws on the vernier-dial hub. Rotate the vernier dial until the "0" marking is in a vertical plane above the center of the shaft. Tighten set screws.

Antenna and Ground Terminals.—These receivers are equipped with an antenna-ground terminal board having three terminals. These terminals are marked "A2," "A1," and "G," the latter being the ground terminal and should always be connected to a good external ground. The transmission-line leads of the RCA RK-40A antenna system should be connected to terminals "A2" and "A1." The receiver coupling units of the RCA RK-40 and the RCA Spider-Web antenna systems should be connected to terminals "A1" and "G." Connect a single-wire antenna to terminal "A1."

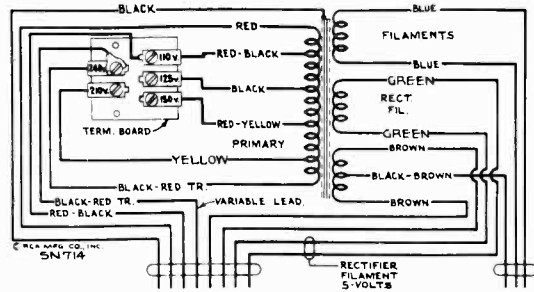

Primary Resistance—7.4 ohms total
Secondary Resistance—284 ohms total

Figure 11—Universal Transformer (Model 9K3)

REPLACEMENT PARTS

Insist on genuine factory-tested parts, which are readily identified and may be purchased from authorized dealers

| STOCK No. | DESCRIPTION | STOCK No. | DESCRIPTION |
|----------------------------|---|-----------|---|
| RECEIVER ASSEMBLIES | | | |
| 12706 | Arm—Hub and arm assembly complete with set screws for operating shutter link (located on range-switch shaft) (Model 9K1 only) | 4841 | Capacitor—0.1 Mfd. (Model 9K1, C30, C48, C49) (Model 9K3, C27, C30) |
| 12806 | Board—3-contact antenna and ground terminal board | 4840 | Capacitor—0.25 Mfd. (Model 9K1, C31, C37) (Model 9K3, C37) |
| 12863 | Board—4-contact and 2-link phonograph terminal board | 5170 | Capacitor—0.25 Mfd. (Model 9K1, C18, C45) (Model 9K3, C45) |
| 12929 | Bracket—Mounting bracket for L. F. tone control or volume control (Model 9K3 only) | 5212 | Capacitor—16 Mfd. (C46) |
| 5237 | Bushing—Variable condenser mounting bushing assembly | 12467 | Capacitor—30 Mfd. (Model 9K1, C47) (Model 9K3, C47, C48) |
| 13656 | Button—Plug button for top of detector coil shield, Stock No. 12799 | 13655 | Capacitor pack—Comprising two sections each .015 Mfd., one section 0.1 Mfd., and two 27,000-ohm resistors (C38, C39, C40, R12, R14) (Model 9K1 only) |
| 11625 | Cable—Tuning tube cable and socket | 12708 | Coil—Antenna coil and shield (L2, L3, L4, L5) |
| 12511 | Cap—Grid contact cap | 13654 | Coil—Detector coil and shield (L9, L10, L11, L12, L13) |
| 12884 | Capacitor—Adjustable trimmer (long) (C5, C7, C10, C13) | 12709 | Coil—Oscillator coil and shield (L6, L7, L8) |
| 12714 | Capacitor—Adjustable trimmer (medium) (C6, C8, C19, C21) | 13657 | Compensator pack—Comprising one .015 Mfd., one .01 Mfd., one .07 Mfd. capacitors and one 27,000-ohm and one 39,000-ohm resistors (C38, C39, C40, R12, R14) (Model 9K3 only) |
| 12807 | Capacitor—Adjustable trimmer (short) (C20) | 13650 | Condenser—3-gang variable tuning condenser (C4, C15, C25) (Model 9K1 only) |
| 12896 | Capacitor—15 Mmfd. (C22) | 12922 | Condenser—3-gang variable tuning condenser (C4, C15, C25) (Model 9K3 only) |
| 12722 | Capacitor—18 Mmfd. (C12) | 5119 | Connector—3-contact female connector for reproducer cable |
| 12723 | Capacitor—56 Mmfd. (C2, C17) | 12006 | Core—Adjustable core and stud for Stock Nos. 12652 and 12653 |
| 12404 | Capacitor—120 Mmfd. (C28, C29, C32, C33) | 12654 | Core—Adjustable core and stud for Stock No. 12654 |
| 12724 | Capacitor—120 Mmfd. (C16, C41) | 12800 | Core—Adjustable core and stud for Stock No. 12709 |
| 12725 | Capacitor—150 Mmfd. (C1) | 13653 | Dial—Station selector dial scale (Model 9K1 only) |
| 12406 | Capacitor—180 Mmfd. (C34) | 12870 | Dial—Vernier dial and disc assembly (Model 9K3 only) |
| 12727 | Capacitor—555 Mmfd. (C14) | 13651 | Drive—Variable tuning condenser vernier drive with pinion gear (Model 9K1 only) |
| 12537 | Capacitor—560 Mmfd. (C3, C23, C26) | 12712 | Indicator—Station selector indicator pointer (Model 9K1 only) |
| 12729 | Capacitor—1,550 Mmfd. (C11) | 5226 | Lamp—Dial lamp, 6.3 volts |
| 12728 | Capacitor—4,500 Mmfd. (C9) | 12868 | Link—Range switch and band indicator operating link, complete with set screws (Model 9K3 only) |
| 4838 | Capacitor—.005 Mfd. (C44) (Model 9K1 only) | 13683 | Mask—Dial scale mask, complete with colored screens (Model 9K1 only) |
| 13033 | Capacitor—.007 Mfd. (C44) (Model 9K3 only) | | |
| 4858 | Capacitor—.01 Mfd. (Model 9K1, C24, C36, C42) (Model 9K3, C18, C24, C31, C36, C42) | | |
| 4870 | Capacitor—.025 Mfd. (C35) | | |
| 12670 | Capacitor—.035 Mfd. (C43) (Model 9K1 only) | | |
| 13841 | Capacitor—.07 Mfd. (C43) (Model 9K3 only) | | |

REPLACEMENT PARTS (Continued)

| STOCK No. | DESCRIPTION | STOCK No. | DESCRIPTION |
|-----------|--|-----------|--|
| 13834 | Resistor—100 ohms, wire wound, 4 watts, for 25-cycle model only (R26) (Model 9K3 only) | | REPRODUCER ASSEMBLIES (Model 9K1 Only) |
| 5112 | Resistor—1,000 ohms, carbon type, 1/4 watt (R3) | 12641 | Board—3-contact reproducer terminal board |
| 11300 | Resistor—33,000 ohms, carbon type, 1/10 watt (R2, R5) | 12640 | Bracket—Output transformer mounting bracket and clamp |
| 11282 | Resistor—56,000 ohms, carbon type, 1/10 watt (R8) | 12012 | Coil—Field coil (L20) |
| 11365 | Resistor—82,000 ohms, carbon type, 1/4 watt (Model 9K1, R17) (Model 9K3, R6) | 11469 | Coil—Neutralizing coil (L19) |
| 11398 | Resistor—220,000 ohms, carbon type, 1/10 watt (R9) | 12667 | Cone—Reproducer cone and dust cap (L18) |
| 11453 | Resistor—270,000 ohms, carbon type, 1/10 watt (R15) (Model 9K1 only) | 5118 | Connector—3-contact male speaker cable connector |
| 13005 | Resistor—390,000 ohms, carbon type, 1/10 watt (R16) (Model 9K1 only) | 9696 | Reproducer—Complete |
| 11172 | Resistor—470,000 ohms, carbon type, 1/4 watt (R13) | 11253 | Transformer—Output transformer (T2) |
| 11452 | Resistor—470,000 ohms, carbon type, 1/10 watt (R16) (Model 9K3 only) | 11886 | Washer—Spring washer to hold field coil securely |
| 11397 | Resistor—560,000 ohms, carbon type, 1/10 watt (R1, R4) | | REPRODUCER ASSEMBLIES (Model 9K3 Only) |
| 5035 | Resistor—560,000 ohms, carbon type, 1/4 watt (R15) (Model 9K3 only) | 12914 | Board—Reproducer terminal board |
| 12013 | Resistor—1 megohm, carbon type, 1/10 watt (R19) | 13842 | Bracket—Output transformer mounting bracket and clamp |
| 11626 | Resistor—2.2 megohms, carbon type, 1/4 watt (Model 9K1, R10) (Model 9K3, R7, R10) | 13660 | Coil—Field coil (L20) |
| 12679 | Resistor—2.2 megohms, insulated, 1/4 watt (R7) (Model 9K1 only) | 11469 | Coil—Neutralizing coil (L19) |
| 12927 | Resistor—Voltage divider, comprising one 16-ohm, one 25-ohm, and one 190-ohm sections (R21, R22, R23) (Model 9K1 only) | 12667 | Cone—Reproducer cone and dust cap (L18) |
| 12715 | Resistor—Voltage divider, comprising one 10,000-ohm, and one 22,000-ohm sections (R6, R20) (Model 9K1 only) | 5118 | Connector—3-contact male speaker cable connector |
| 13840 | Resistor—Voltage divider, comprising one 115-ohm, one 11-ohm, one 13-ohm, one 4,100-ohm, one 2,900-ohm, one 1,750-ohm, and one 285-ohm sections (R17, R20, R21, R22, R23, R24, R25) (Model 9K3 only) | 9778 | Reproducer—Complete |
| 4669 | Screw—No. 8-32 x 5/32 set screw for link, Stock No. 12868 (Model 9K3 only) | 12913 | Transformer—Output transformer (T2) |
| 3903 | Screw—No. 8-32 x 3/16 headless, cup-point set screw for dial, Stock No. 12870 (Model 9K3 only) | 11886 | Washer—Spring washer to hold field coil securely |
| 12925 | Shaft—Range switch and band indicator operating shaft and hub assembly (Model 9K3 only) | | DRIVE ASSEMBLIES (Model 9K3 Only) |
| 12710 | Shield—Coil shield for Stock No. 12709 | 10705 | Ball—5/32-inch diameter steel ball for planetary drive |
| 12799 | Shield—Coil shield for Stock Nos. 12708 and 13654 | 10941 | Ball—1/8-inch diameter steel ball for planetary drive bearing |
| 12926 | Shield—Chassis end shield and mounting foot assembly | 12904 | Bushing—Plate and bushing assembly for planetary drive mounting |
| 12735 | Shield—Dial lamp shield (Model 9K1 only) | 12905 | Coupling—Flexible coupling and shaft assembly, complete |
| 12008 | Shield—I. F. transformer shield for Stock Nos. 12652 and 12653 | 12909 | Dial—Band indicating dial and cam assembly |
| 12607 | Shield—Top shield for I. F. transformer, Stock No. 12652 | 12899 | Drive—Variable tuning condenser drive, complete—including mounting bracket, drive, dial scale and indicator, less vernier dial, Stock No. 12870, and link, Stock No. 12868 |
| 12581 | Shield—Top shield for I. F. transformer, Stock No. 12653 | 12906 | Gear—Anti-lash drive gear, complete |
| 13652 | Shutter—Dial scale holder and shutter assembly complete with link (Model 9K1 only) | 12910 | Gear—Sector gear and link assembly for band selector |
| 11195 | Socket—5-contact 5Z4 Radiotron socket | 12908 | Indicator—Station selector indicator pointer |
| 11198 | Socket—7-contact 6F5, 6H6, 6K7, or 6L7 Radiotron socket | 8051 | Link—Link and roller assembly, complete with spring |
| 11196 | Socket—8-contact 6F6, 6J7, or 6L6 Radiotron socket | 12911 | Screen—Dial lamp screen and light diffuser |
| 11222 | Socket—Dial lamp socket (Model 9K1, all sockets) (Model 9K3, upper right or lower left socket) | 4669 | Screw—Set screw for flexible coupling or gear, Stock Nos. 12905 and 12906 |
| 13095 | Socket—Upper left or lower right dial lamp socket (Model 9K3 only) | 12901 | Shaft—Direct drive shaft and pinion gear for planetary drive |
| 11381 | Socket—Tuning tube socket and cover | 12900 | Shaft—Vernier drive shaft for planetary drive |
| 12007 | Spring—Retaining spring for core, Stock Nos. 12006, 12664, or 12800 | 12903 | Spring—Tension spring for planetary drive bearing |
| 12849 | Spring—Tension spring for dial shutter link (Model 9K1 only) | 12907 | Spring—Tension spring for gear, Stock No. 12906 |
| 13648 | Switch—Range switch (S1, S2, S3) (Model 9K1 only) | 8052 | Spring—Tension spring for link, Stock No. 8051 |
| 13839 | Switch—Range switch (S1, S2, S3) (Model 9K3 only) | | MISCELLANEOUS ASSEMBLIES (Model 9K1 Only) |
| 13649 | Tone control (R18) (Model 9K1 only) | 11996 | Bracket—Tuning tube mounting bracket and clamp |
| 12921 | Tone control—High-frequency tone control (R18) (Model 9K3 only) | 12666 | Cover—Reproducer field coil and yoke cover |
| 12860 | Tone control—Low-frequency tone control switch and power switch (S4, S5) (Model 9K3 only) | 12698 | Crystal—Station selector escutcheon and crystal |
| 12652 | Transformer—First I. F. transformer, complete (L14, L15, C28, C29) | 12742 | Escutcheon—Tuning tube escutcheon |
| 12653 | Transformer—Second I. F. transformer, complete (L16, L17, C32, C33, C34, R8, R9) | 12699 | Knob—Large station selector knob |
| 12918 | Transformer—Power transformer, 105-125 volts, 50-60 cycles (T1) (Model 9K1 only) | 12700 | Knob—Small (vernier) station selector knob |
| 12857 | Transformer—Power transformer, 105-125 volts, 25-60 cycles (T1) (Model 9K1 only) | 11347 | Knob—Range switch, tone control, or volume control knob |
| 11211 | Transformer—Power transformer, 105-125 volts, 50-60 cycles (T1) (Model 9K3 only) | 11210 | Screw—Chassis mounting screw, washer, and lockwasher assembly |
| 11212 | Transformer—Power transformer, 105-125 volts, 25-60 cycles (T1) (Model 9K3 only) | 4982 | Spring—Retaining spring for knob, Stock No. 12699 |
| 11213 | Transformer—Power transformer, 100-250 volts, 40-60 cycles (T2) (Model 9K3 only) | 11349 | Spring—Retaining spring for knob, Stock Nos. 11347 or 12700 |
| 12654 | Trap—Wave trap, complete (L1) | | MISCELLANEOUS ASSEMBLIES (Model 9K3 Only) |
| 13647 | Volume control and power switch (R11, S4) (Model 9K1 only) | 13615 | Bracket—Tuning tube mounting bracket and clamp |
| 12861 | Volume control (R11) (Model 9K3 only) | 12915 | Crystal—Station selector escutcheon and crystal |
| | | 12742 | Escutcheon—Tuning tube escutcheon |
| | | 12699 | Knob—Large station selector knob |
| | | 12700 | Knob—Small (vernier) station selector knob |
| | | 11347 | Knob—Low-frequency tone control and power switch, volume control, range switch or high-frequency tone control knob |
| | | 11210 | Screw—Chassis mounting screw assembly |
| | | 11349 | Spring—Retaining spring for knob, Stock Nos. 11347 or 12700 |
| | | 4982 | Spring—Retaining spring for knob, Stock No. 12699 |

RCA VICTOR MODEL 10K1

and

MODEL 10T (Second Production)

TECHNICAL INFORMATION AND SERVICE DATA

These receivers are similar to Models 10T (first production) and 10K except for slight changes in the filter and bleeder circuits, loudspeakers, power transformers, and a few component parts. The loudspeakers, for the Model 10T second and first productions may be identified by the stampings RL63E1 and RL63D2 respectively. Model 10T (second production) chassis may be identified by visual inspection of the resistor assembly at the rear bottom of chassis. In the second production the assembly is comprised of one 4,700-ohm and one 4,100-ohm section (R38, R39), while the assembly in the first production consists of a single 17,000-ohm section R34. Model 10T (second production)

has the 20 mfd. capacitor C76 at the bottom left rear of chassis omitted. Service data for Models 10T and 10K is directly applicable to these receivers except for the data contained herein. Power Supply Ratings (A, B and C)—135 watts. Undistorted and Maximum Power Outputs—7 and 10 watts. Cabinet Dimensions (height, width, and depth) Model 10K1—41, 29, and 14 $\frac{3}{4}$ inches. Weights (net and shipping) Model 10K1—91 and 135 pounds. Resistance Diagram and Cathode Current Readings to be disregarded. Universal Power Transformer resistances (pri. and sec.)—7.4 and 240 ohms total.

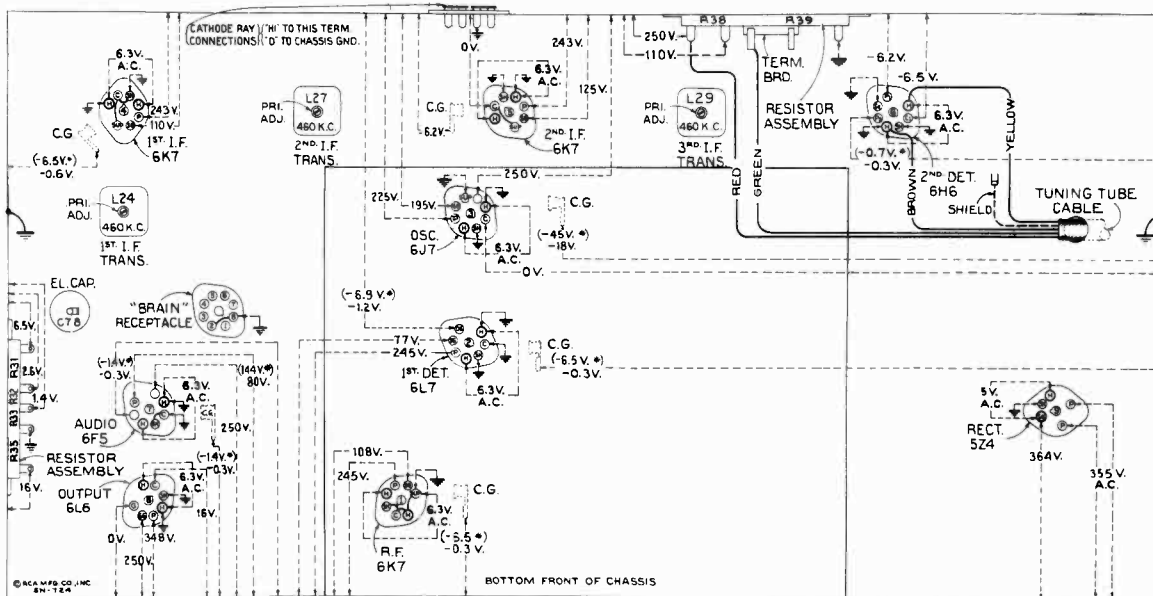

Figure 1—Radiotron Socket Voltages, Coil, and I-F Trimmer Locations
[Model 10K1 and Model 10T (Second Production)]

REPLACEMENT PARTS

Insist on genuine factory tested parts, which are readily identified and may be purchased from authorized dealers.

| STOCK No. | DESCRIPTION | STOCK No. | DESCRIPTION |
|----------------------------|---|-----------|---|
| RECEIVER ASSEMBLIES | | | |
| 12863 | Board—Phonograph input terminal board | 4886 | Capacitor—.05 Mfd. (C70) |
| 4427 | Bracket—Volume control mounting bracket | 4870 | Capacitor—.025 Mfd. (C61) |
| 12987 | Bracket—Band changer switch bracket | 4840 | Capacitor—.025 Mfd. (C49, C63, C79) |
| 12986 | Cable—Tuning lamp cable and socket | 12741 | Capacitor—.05 Mfd. (C74) |
| 12991 | Cable—3-conductor shielded fidelity control cable, approximately 74 inches long | 5212 | Capacitor—18 Mfd. (C78) |
| 12511 | Cap—Grid contact cap | 12467 | Capacitor—30 Mfd. (C73, C75) |
| 12948 | Capacitor—33 Mmfd. (C62) | 13657 | Compensator Pack—Comprising one .015-Mfd., one .01-Mfd., one .07-Mfd. capacitors, one 27,000-ohm and one 39,000-ohm resistors (C64, C65, C66, R23, R24) |
| 12629 | Capacitor—56 Mmfd. (C60) | 12006 | Core—Core and stud assembly for intermediate frequency transformer |
| 12404 | Capacitor—120 Mmfd. (C56, C57) | 12866 | Foot—Chassis foot assembly |
| 12724 | Capacitor—120 Mmfd. (C87) | 5226 | Lamp—Pilot lamp |
| 13022 | Capacitor—390 Mmfd. (C45, C47, C51, C53) | 12868 | Link—Link mechanism on band indicator operating arm |
| 13033 | Capacitor—.007 Mfd. (C69) | 12871 | Reactor—Filter reactor (L32) |
| 4858 | Capacitor—.01 Mfd. (C46, C48, C50, C52, C54, C55, C58, C68) | 13658 | Resistor—Voltage divider—Comprising one 4,700-ohm and one 4,100-ohm sections (R38, R39) |
| 4624 | Capacitor—.01 Mfd. (C59) | | |
| 11315 | Capacitor—.015 Mfd. (C71) | | |

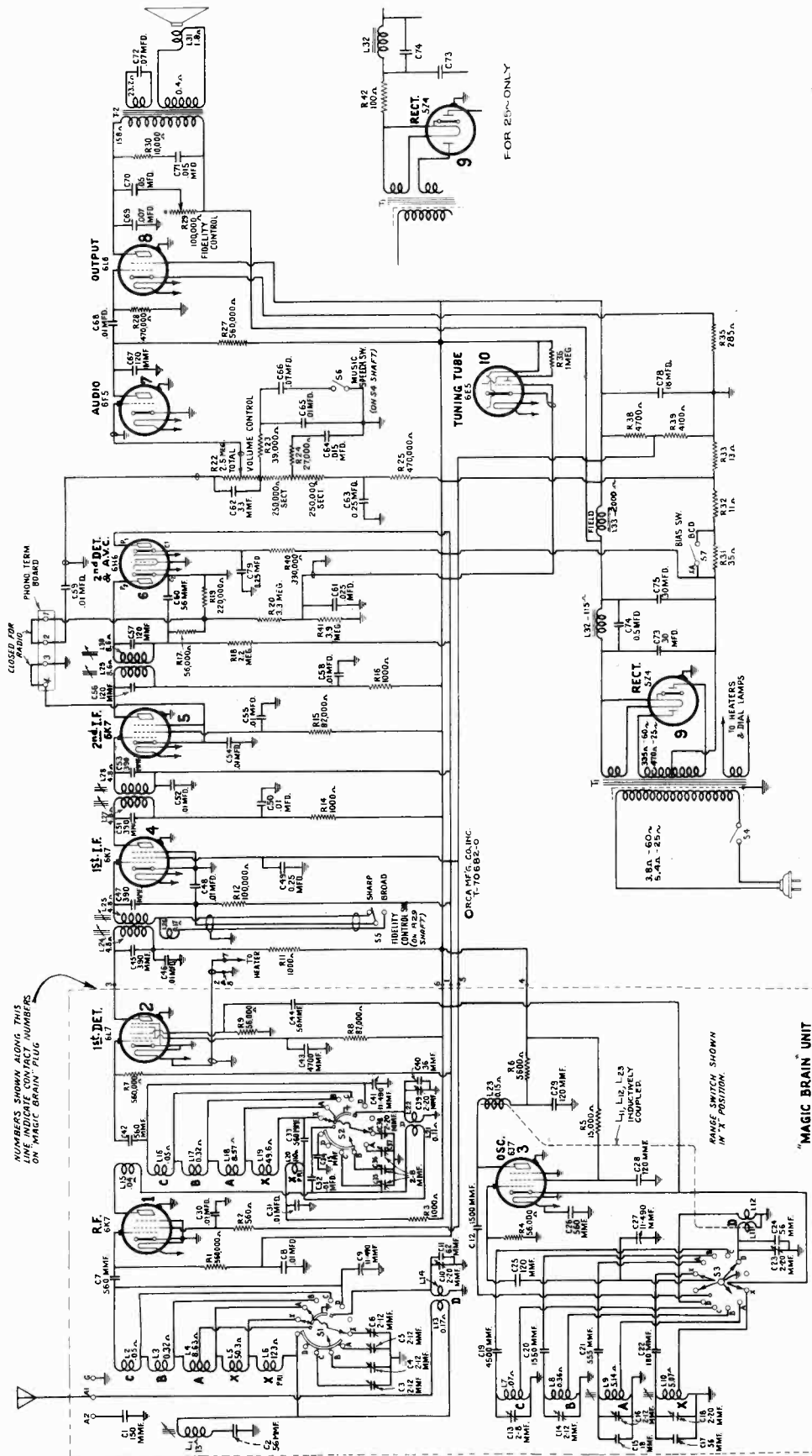

Figure 2—Schematic Circuit Diagram
[Model 10K1 and Model 10T (Second Production)]

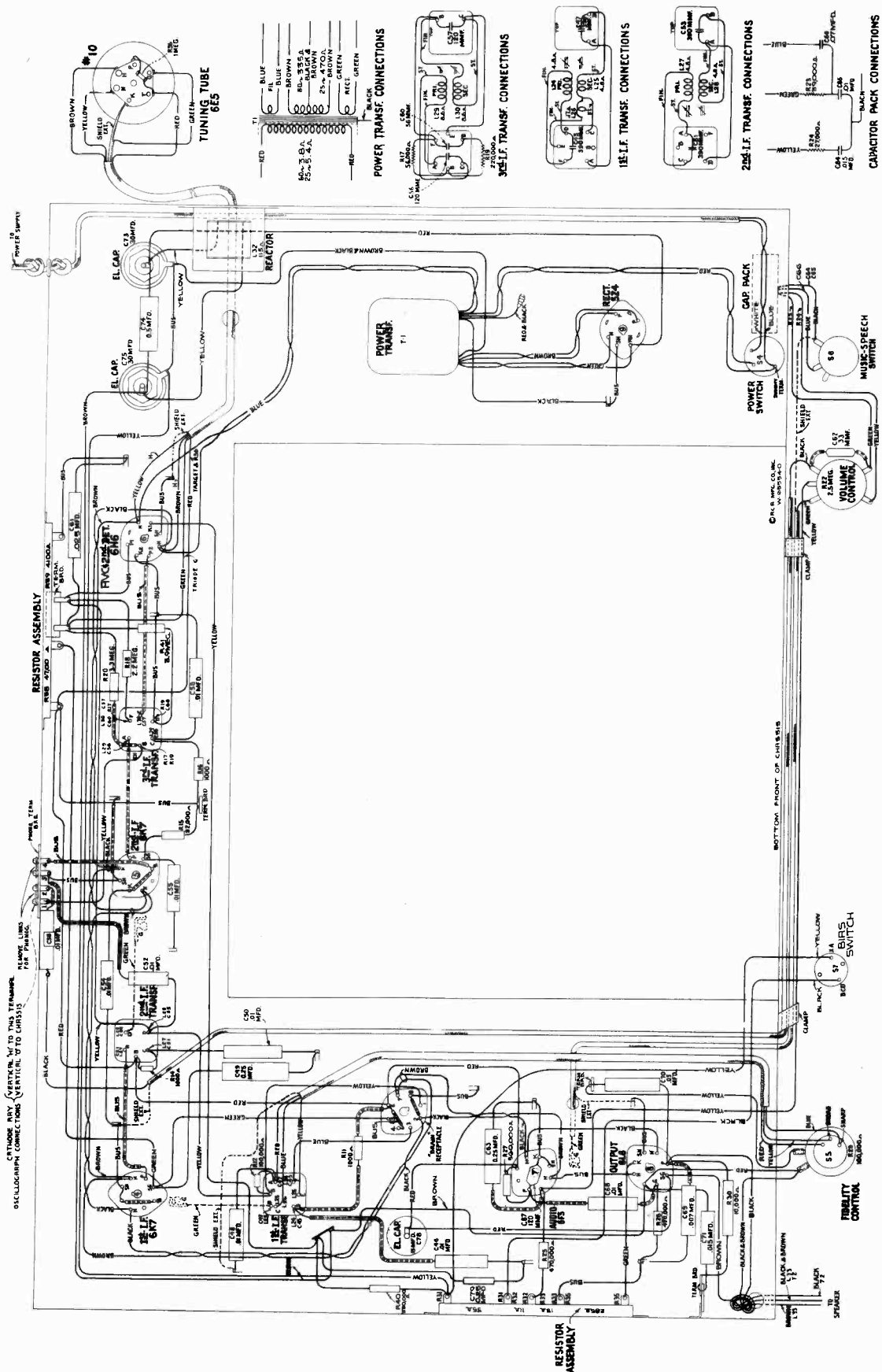

Figure 3—Chassis Wiring Diagram (Less "Magic Brain")
[Model 10K1 and Model 10T (Second Production)]

REPLACEMENT PARTS—(Continued)

Insist on genuine factory-tested parts, which are readily identified and may be purchased from authorized dealers.

| STOCK No. | DESCRIPTION | STOCK No. | DESCRIPTION |
|------------------------------------|--|---------------------------------|---|
| 13659 | Resistor—Voltage divider—Comprising one 285-ohm, one 13-ohm, one 11-ohm and one 35-ohm sections (R31, R32, R33, R35) | 12881 | Coil—Oscillator coil and shield, X band only (L10) |
| 13834 | Resistor—100 ohms—wire wound, 4 watt—For 25-cycle model only (R42) | 12890 | Coil—Oscillator coil, "D" band (L11, L12, L23) |
| 12311 | Resistor—1,000 ohms—insulated, 1/2 watt (R11, R16) | 12889 | Coil—R.F. coil, "D" band (L21, L22) |
| 13030 | Resistor—1,000 ohms—carbon type, 1/10 watt (R14) | 12877 | Condenser—3-gang variable tuning condenser (C9, C27, C41) |
| 13097 | Resistor—10,000 ohms—insulated, 1 watt (R30) | 12887 | Connector—8-contact male connector and cover for power cable, Stock No. 12886 |
| 11282 | Resistor—56,000 ohms—carbon type, 1/10 watt (R17) | 12664 | Core—Adjustable core and stud for Stock No. 12654 |
| 11365 | Resistor—82,000 ohms—carbon type, 1/2 watt (R15) | 12800 | Core—Adjustable core and stud for Stock No. 12709 |
| 11281 | Resistor—100,000 ohms—carbon type, 1/10 watt (R12) | 12882 | Core—Adjustable core and stud for Stock No. 12881 |
| 11398 | Resistor—220,000 ohms—carbon type, 1/10 watt (R19) | 11324 | Resistor—560 ohms—carbon type, 1/2 watt (R2) |
| 5108 | Resistor—330,000 ohms—carbon type, 1/2 watt (R40) | 5112 | Resistor—1,000 ohms—carbon type, 1/2 watt (R3) |
| 11172 | Resistor—470,000 ohms—carbon type, 1/2 watt (R25, R28) | 11298 | Resistor—5,600 ohms—carbon type, 1 watt (R6) |
| 5035 | Resistor—560,000 ohms—carbon type, 1/2 watt (R27) | 3998 | Resistor—15,000 ohms—carbon type, 1/2 watt (R5) |
| 12013 | Resistor—1.0 megohm—carbon type, 1/10 watt—Located in tuning tube socket (R36) | 11282 | Resistor—56,000 ohms—carbon type, 1/10 watt (R4, R9) |
| 11626 | Resistor—2.2 megohm—carbon type, 1/2 watt (R18) | 8064 | Resistor—82,000 ohms—carbon type, 1/2 watt (R8) |
| 12874 | Resistor—3.3 megohm—carbon type, 1/2 watt (R20) | 11397 | Resistor—560,000 ohms—carbon type, 1/10 watt (R1, R7) |
| 13167 | Resistor—3.9 megohm—carbon type, 1/2 watt (R41) | 12651 | Shield—Coil shield for Stock Nos. 12879, 12880 |
| 12870 | Scale—Vernier dial scale | 12710 | Shield—Coil shield for Stock No. 12709 |
| 12008 | Shield—Intermediate frequency transformer shield | 12883 | Shield—Coil shield for Stock No. 12881 |
| 12607 | Shield—1st or 2nd I.F. transformer shield top | 11198 | Socket—7-contact 6K7 Radiotron socket |
| 12581 | Shield—3rd I.F. transformer shield top | 11279 | Socket—7-contact 6L7 Radiotron socket |
| 11195 | Socket—5-contact 5Z4 Radiotron socket | 12885 | Socket—8-contact 6J7 Radiotron socket |
| 11198 | Socket—7-contact 6K7 or 6H6 Radiotron socket | 12007 | Spring—Retaining spring for core, Stock Nos. 12664, 12800, 12882 |
| 11196 | Socket—8-contact 6F5, 6L6 Radiotron or Magic Brain power supply socket | 12878 | Switch—Range switch and mounting nut (S1, S2, S3) |
| 13095 | Socket—Upper left or lower right hand dial lamp socket | 12654 | Trap—Wave-trap, complete (L1) |
| 11222 | Socket—Upper right or lower left hand dial lamp socket | DRIVE ASSEMBLIES | |
| 11381 | Socket—Tuning tube socket and cover | 10705 | Ball—5/32-inch diameter steel ball for planetary drive |
| 12007 | Spring—Retaining spring for core in I.F. transformer | 10941 | Ball—1/4-inch diameter steel ball for planetary drive bearing |
| 12986 | Stud—Band indicator operating arm stud | 12904 | Bushing—Plate and bushing assembly for planetary drive mounting |
| 12860 | Switch—Low frequency tone and power switch (S4, S6) | 12905 | Coupling—Flexible coupling and shaft assembly, complete |
| 12988 | Switch—Bias switch (S7) | 12909 | Dial—Band indicating dial and cam assembly |
| 12979 | Tone Control—High frequency tone and fidelity control (R29, S5) | 12899 | Drive—Variable tuning condenser drive, complete, including mounting bracket drive, dial scale and indicator, less vernier dial, Stock No. 12870 and link, Stock No. 12868 |
| 12981 | Transformer—First intermediate frequency transformer (L24, L25, L26, C45, C47) | 12906 | Gear—Anti-lash drive gear, complete |
| 12990 | Transformer—Second intermediate frequency transformer (L27, L28, C51, C53) | 12910 | Gear—Sector gear and link assembly for band selector |
| 12982 | Transformer—Third intermediate frequency transformer (L29, L30, C56, C57, C60, R17, R19) | 12908 | Indicator—Station selector indicator pointer |
| 11211 | Transformer—Power transformer, 105-125 volts, 50-60 cycles (T1) | 8051 | Link—Link and roller assembly, complete with spring |
| 11212 | Transformer—Power transformer, 105-125 volts, 25-60 cycles (T1) | 12911 | Screen—Dial lamp screen and light diffuser |
| 11213 | Transformer—Power transformer, 110-125-150-210-240 volts, 40-60 cycles (T1) | 4669 | Screw—Set screw for flexible coupling or gear, Stock Nos. 12905 and 12908 |
| 12861 | Volume Control (R22) | 12901 | Shaft—Direct drive shaft and pinion gear for planetary drive |
| MAGIC BRAIN UNIT ASSEMBLIES | | | |
| 12806 | Board—3-contact antenna and ground terminal board | 12900 | Shaft—Vernier drive shaft for planetary drive |
| 5237 | Bushing—Variable condenser mounting bushing assembly | 12903 | Spring—Tension spring for planetary drive bearing |
| 12886 | Cable—Shielded power cable, approximately 4 inches long, complete with 8-contact male plug | 12907 | Spring—Tension spring for gear, Stock No. 12906 |
| 12511 | Cap—Grid contact cap | 8052 | Spring—Tension spring for link, Stock No. 8051 |
| 12714 | Capacitor—Adjustable trimmer capacitor (C3, C4, C5, C6, C14, C16) | REPRODUCER ASSEMBLIES | |
| 12884 | Capacitor—Adjustable trimmer capacitor (C10, C18, C23, C38, C39) | 12914 | Board—Reproducer terminal board |
| 12807 | Capacitor—Adjustable trimmer capacitor (C13, C35, C36, C37) | 12640 | Bracket—Output transformer mounting bracket and clamp (Model 10T, 2nd Production) |
| 12896 | Capacitor—15 Mmfd. (C34) | 13842 | Bracket—Output transformer mounting bracket and clamp (Model 10K1) |
| 12722 | Capacitor—18 Mmfd. (C15) | 13660 | Coil—Reproducer field coil (L33) |
| 12891 | Capacitor—36 Mmfd. (C40) | 12642 | Cone—Reproducer cone and dust cap (L31) (Model 10T, 2nd Production) |
| 12629 | Capacitor—56 Mmfd. (C24) | 12667 | Cone—Reproducer cone and dust cap (L31) (Model 10K1) |
| 12895 | Capacitor—56 Mmfd. (C17) | 5118 | Connector—3-contact male connector for speaker leads |
| 12723 | Capacitor—56 Mmfd. (C2, C44) | 9768 | Reproducer, complete (Model 10T, 2nd Production) |
| 13307 | Capacitor—62 Mmfd. (C11) | 9780 | Reproducer, complete (Model 10K1) |
| 12724 | Capacitor—120 Mmfd. (C25, C28, C29) | 13661 | Transformer—Output transformer (T2, C72) |
| 12725 | Capacitor—150 Mmfd. (C1) | 11886 | Washer—Spring washer to hold field coil securely |
| 12894 | Capacitor—180 Mmfd. (C22) | MISCELLANEOUS ASSEMBLIES | |
| 12727 | Capacitor—555 Mmfd. (C21) | 12038 | Band—Rubber band for tuning tube |
| 12537 | Capacitor—560 Mmfd. (C7, C26, C33, C42) | 11996 | Bracket—Tuning lamp bracket and clamp |
| 12898 | Capacitor—1,500 Mmfd. (C12) | 12915 | Escutcheon—Station selector escutcheon and crystal |
| 12729 | Capacitor—1,550 Mmfd. (C20) | 12742 | Escutcheon—Tuning lamp escutcheon |
| 12728 | Capacitor—4,500 Mmfd. (C19) | 12699 | Knob—Large station selector knob |
| 12897 | Capacitor—4,700 Mmfd. (C43) | 12700 | Knob—Small (vernier) station selector knob |
| 4858 | Capacitor—.01 Mfd. (C8, C30, C31, C32) | 11347 | Knob—Music-speech and power switch—volume control—range selector or fidelity control knob |
| 12879 | Coil—Antenna coil and shield, XABC bands (L2, L3, L4, L5, L6) | 11377 | Screw—Chassis mounting screw assembly (Model 10T) |
| 12888 | Coil—Antenna coil, "D" band (L13, L14) | 11210 | Screw—Chassis mounting screw assembly (Model 10K1) |
| 12880 | Coil—Detector coil and shield, XABC bands (L15, L16, L17, L18, L19, L20) | 12916 | Shield—Complete r-f unit top shield |
| 12709 | Coil—Oscillator coil and shield, ABC bands (L7, L8, L9) | 4982 | Spring—Holding spring for station selector or volume control knob, Stock No. 12699 |
| | | 11349 | Spring—Retaining spring for knob, Stock Nos. 12700 and 11347 |

SERVICE DIVISION
RCA Manufacturing Co., Inc.
Camden, N. J., U. S. A.



RCA Victor

MODELS 85E and U-102E

Five-Tube, Two-Band, A-C, Radio and Radio-Phonograph

TECHNICAL INFORMATION AND SERVICE DATA

-1937 No. 33-

SERVICE DIVISION • RCA MANUFACTURING COMPANY, INC. • CAMDEN, N. J., U. S. A.

A Service of the Radio Corporation of America

Electrical Specifications

FREQUENCY RANGES
 "Broadcast" (A)..... 540-1,720 kc
 "Short Wave" (C)..... 5,800-18,000 kc
 Intermediate Frequency.....

R-F ALIGNMENT FREQUENCIES
 "Broadcast" (A)..... 600 kc (osc.)
 "Short Wave" (C)..... 15,000 kc (osc., ant.)
 460 kc

RADIOTRON COMPLEMENT
 (1) RCA-6A7..... First Detector—Oscillator
 (2) RCA-6D6..... Intermediate Amplifier
 Pilot Lamp (1).....

(3) RCA-75..... Second Det., A-F Amp. and A.V.C.
 (4) RCA-42..... Audio Power Amplifier
 (5) RCA-80..... Full-Wave Rectifier
 Mazda No. 46, 6.3 volts, 0.25 ampere

POWER SUPPLY RATINGS
 Model U-102E
 A-6. 105-125 volts, 60 cycles..... 75 watts.. 100 watts
 A... 105-125 volts, 50-60 cycles..... 75 watts.. 105 watts
 B-2. 105-125 volts, 25 cycles..... 75 watts.. 105 watts
 C-6. 105-125/200-250 volts, 60 cycles. 75 watts.. 100 watts
 C.. 105-125/200-250 volts, 50-60 cycles 75 watts.. 105 watts

Model 85E
 A..... 105-125 volts, 50-60 cycles, 75 watts
 B..... 105-125 volts, 25-60 cycles, 75 watts
 C..... 105-125/200-250 volts, 50-60 cycles, 75 watts

POWER OUTPUT
 85E U-102E
 Undistorted..... 2.0 watts..... 2.5 watts
 Maximum..... 4.0 watts..... 4.5 watts

LOUDSPEAKER
 85E U-102E
 Type, Electrodynamic..... 6-inch..... 12-inch
 Impedance (v.c.) at 400 cycles..... 2.6 ohms.. 2.2 ohms

PHONOGRAPH (Model U-102E only)
 Type..... Manual
 Turntable Speed (Adjustable)..... 78 r.p.m.

Type of Pickup..... High-impedance magnetic
 Pickup Impedance..... 1,400 ohms at 1,000 cycles

Mechanical Specifications

Model 85E
 Height..... 20⁹/₁₆ inches
 Width..... 21³/₈ inches
 Depth..... 12¹³/₁₆ inches
 Weight (Net)..... 27¹/₂ pounds
 Weight (Shipping)..... 35¹/₂ pounds
 Over-all Chassis Height..... 7¹/₄ inches
 Chassis Base Dimensions..... 11³/₈ inches x 5³/₄ inches x 2¹/₄ inches
 Operating Controls..... (1) Power Switch—Radio Volume; (2) Tuning; (3) Range Selector ("A" left, "C" right); (4) Phono-Radio Transfer—Phono Volume (on motorboard, Model U-102E only)
 Tuning Drive Ratio..... 12 to 1

Model U-102E
 Height..... 22³/₄ inches
 Width..... 16¹/₁₆ inches
 Depth..... 25¹⁵/₁₆ inches
 Weight (Net)..... 52¹/₂ pounds
 Weight (Shipping)..... 63 pounds
 Over-all Chassis Height..... 7¹/₄ inches
 Chassis Base Dimensions..... 11³/₈ inches x 5³/₄ inches x 2¹/₄ inches
 Operating Controls..... (1) Power Switch—Radio Volume; (2) Tuning; (3) Range Selector ("A" left, "C" right); (4) Phono-Radio Transfer—Phono Volume (on motorboard, Model U-102E only)
 Tuning Drive Ratio..... 12 to 1

General Description

The Model U-102E combination instrument consists of a five-tube superheterodyne receiver and a manually operated phonograph combined in an end-table cabinet. Its design includes magnetite-core adjustments for i-f transformers and

low-frequency, "A"-oscillator tracking; automatic volume control; aural-compensated volume control; resistance-coupled audio system; phonograph compensation pack; self-starting

phonograph motor; improved magnetic pickup; and a twelve-inch, dust-proof, electrodynamic loudspeaker.

The Model 85E instrument consists of a similar radio re-

ceiver in an end-table cabinet. The speaker is a six-inch electrodynamic unit. The circuit arrangement of both instruments is shown on figure 2.

Service Data

The various diagrams of this booklet contain such information as will be needed to isolate causes for defective operation if such develops. The ratings of the resistors, capacitors, coils, etc., are indicated adjacent to the symbols signifying these parts on the diagrams. Identification titles such as R1, L1, C1, etc., provide reference between the illustrations and Replacement Parts List. The coils, transformer windings, and reactors are rated in terms of d-c resistance to permit continuity checks.

Precautionary Lead Dress—(1) Dress power line leads to the on-off switch away from grid connection terminal on volume control to reduce hum pickup. (2) Keep leads of capacitor C3 as short as possible. (3) Bus leads from range selector (ter. 6) to oscillator-coil tap L6-L8 should be maintained 3½-inches long for proper alignment. (4) Capacitor C25 should be dressed free of adjacent parts to maintain correct alignment at high-frequency end of "A" band. (5) Bus lead from range selector (ter. 3) to antenna coil L1 should be maintained 2¼-inches long for proper alignment. (6) The RCA-6A7 grid-cap lead (50-ohm resistor R18) to top of tuning capacitor C2 should be dressed properly to prevent shorts and should be maintained flexible to prevent acoustic howl.

Loudspeaker.—Centering of the loudspeaker is made in the usual manner with three narrow paper feelers after first removing the front dust cover. This may be removed by softening its cement with a light application of acetone, using care not to allow the acetone to flow into the air gap. The dust cover should be cemented back in place with ambroid upon completion of adjustment.

Phonograph Attachment (85E only).—See Schematic Circuit Diagram.

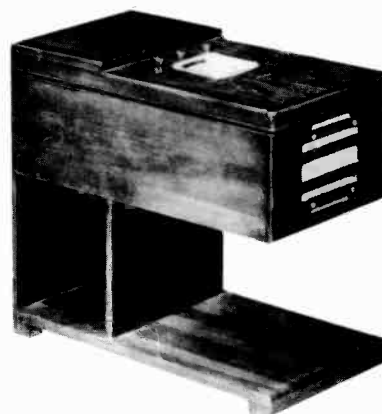

Model 85E

Centering Armature.—Refer to figure 1 showing the pickup inner structure. The armature is shown in its proper relation to the magnet pole pieces, i. e., exactly centered. Whenever this centering adjustment has been disturbed it will be necessary to remove the pickup mechanism from the tone arm by removing the needle holding screw and the two mounting screws from the front of the tone arm, holding the pickup assembly to keep it from dropping. Unsolder the two leads from the lugs on the terminal board at the rear of the pickup. Insert a small rod or nail into the armature needle hole and replace the needle holding screw, tightening it to hold the rod securely. If the armature clamping screws A and B have not been disturbed, screws C should be loosened which will permit the armature to be moved from side to side, the rod acting as a lever to perform this operation. Proper adjustment is obtained when the armature is moved to the

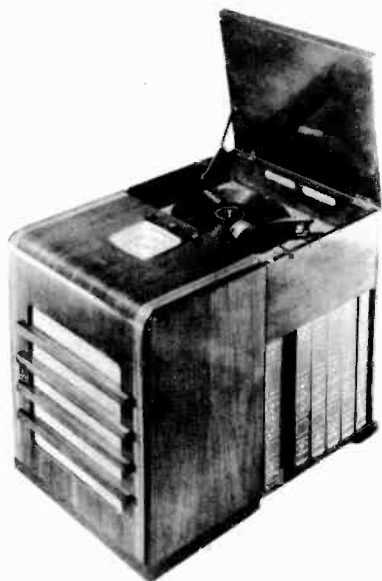

Model U-102E

Magnetic Pickup (Model U-102E)

The pickup used in the phonograph unit is of an improved design. The horseshoe magnet is rigidly welded to the pole pieces and is irremovable. There is a centering spring attached to the armature to maintain proper adjustment and to provide a limiting effect on the movement of the armature. The frequency response is substantially uniform over a wide range. Service operations which may be necessary on the pickup are as follows:

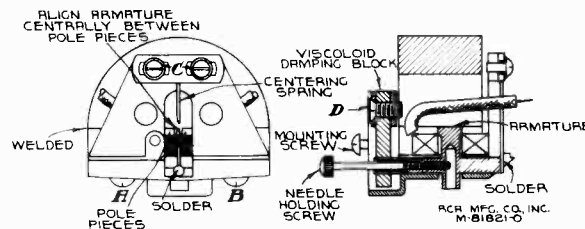

Figure 1—Details of Pickup

extreme position on each side (the movement being limited by the armature striking the pole pieces) and then brought to the mid-position between these two extremes. Screws C should then be tightened. The armature position should then be central between the pole pieces and at right angles to them. With a little practice, the correct adjustment of the armature will be obtained. The air gap between the pole pieces and the armature should be kept free from dust, filings, and other foreign material which would obstruct the movement of the pickup armature.

Damping Block.—The viscoloid damping block which is attached to the front end of the armature shank serves as a mechanical filter to eliminate undesirable resonances and to cause the frequency response to be uniform. Should it be necessary to replace this damping block, the pickup mechanism should be removed from the tone arm as explained above. Remove screw D and the damping block from the pickup assembly. Make sure that the shaft of the armature which contacts the viscoloid is clean. Then insert the new damping block so that it occupies the same position as that of the origi-

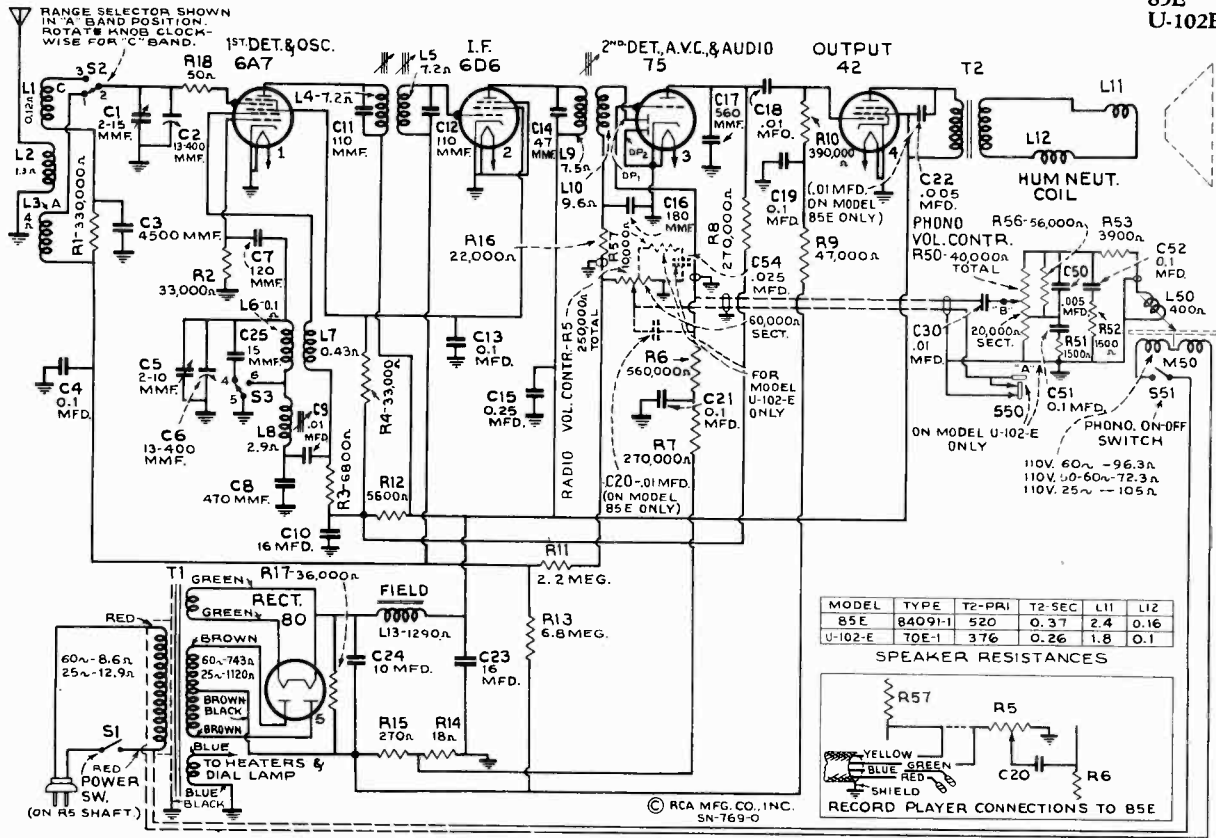

Figure 2—Schematic Circuit Diagram

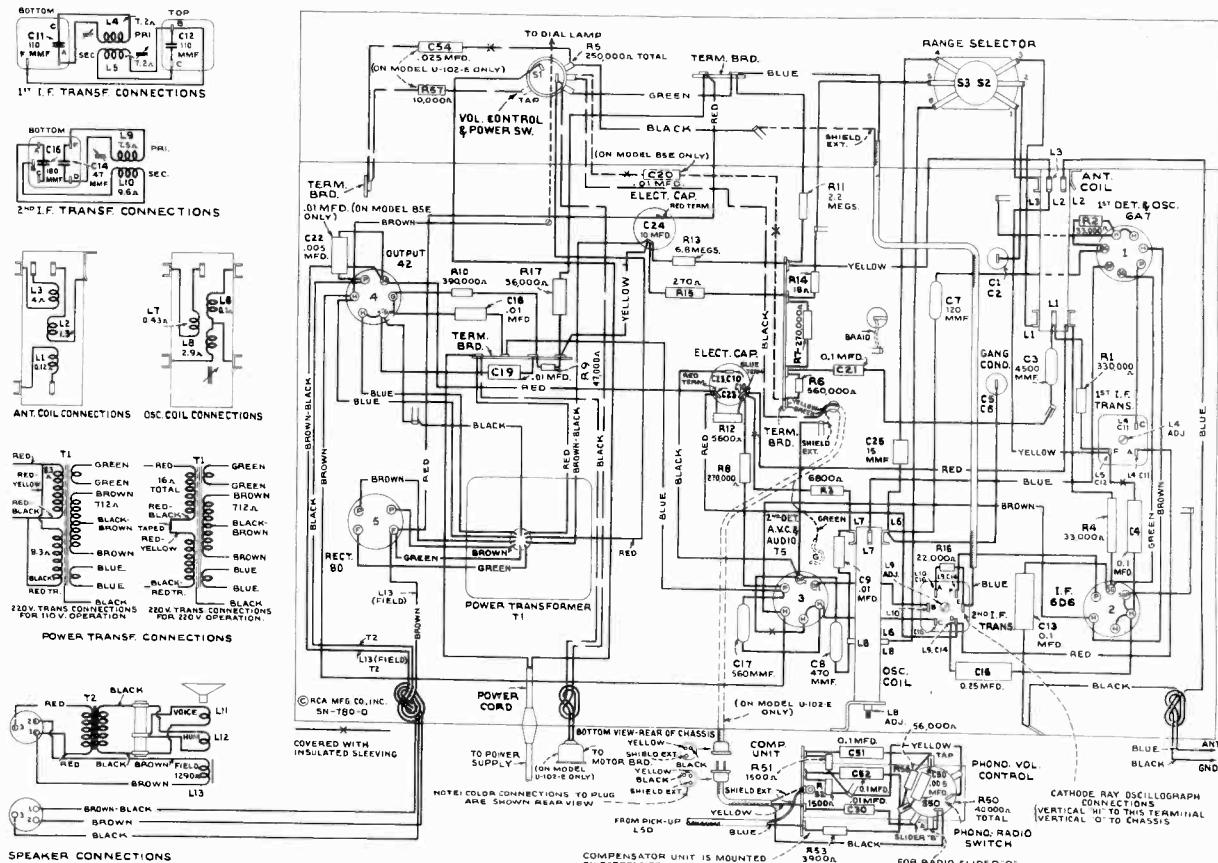

Figure 3—Chassis Wiring Diagram

nal block, and is in correct vertical alignment with the armature. The hole in the block is somewhat smaller than the diameter of the armature in order to permit a snug fit. With the damping block properly aligned on the armature, screw D with its washer should then be replaced. Heat should be applied to the armature (viscoloid side) so that the damping block will fuse at the point of contact and become rigidly attached to the armature. A special-tip soldering iron, constructed as shown in figure 4 will be found very useful in

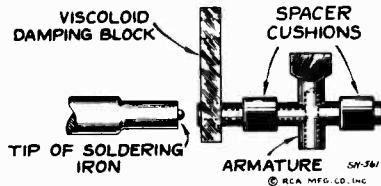

Figure 4—Special Soldering-Iron Tip

performing this operation. The iron should be applied only long enough to slightly melt the block, causing a small bulge on both sides.

Replacing Coil.—Whenever there is defective operation due to an open or shorted pickup coil, this coil should be replaced. Remove the pickup mechanism and terminal board as described above. Remove screws A and B and the magnet assembly. Remove the bakelite coil support (with coil attached) and insert the new coil support assembly in its place, after which replace the magnet assembly and center the armature as described above, then re-assemble the remainder of the unit.

Magnetizing.—In case it becomes necessary to re-magnetize the unit, first remove the pickup mechanism from the tone arm, and then remove the magnet assembly. Place the magnet assembly on the poles of a standard pickup magnetizer

such as the RCA Stock No. 9549 Pickup Magnetizer and charge the magnet in accordance with the instructions accompanying the magnetizer. It is preferable to check the polarity of the pickup magnet and to re-magnetize it so that the same polarity is maintained.

Motor and Motorboard (Model U-102E)

The adjustments for tone-arm height and automatic stop-switch position are shown in figure 5.

The phonograph motor is of the governor induction type and designed to be simple and foolproof. Occasionally, however, certain adjustments may be required. These adjustments are illustrated and explained in figure 6. Apply a few drops of light machine oil in the three holes provided and around the motor spindle every six months to ensure smooth operation.

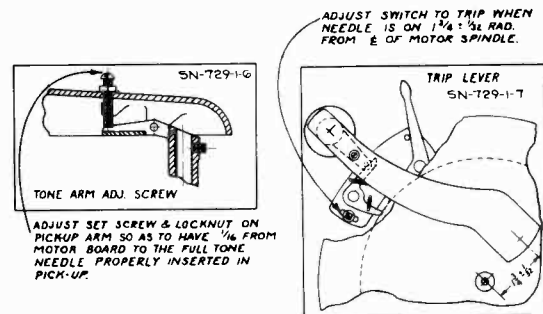

Figure 5—Tone Arm and Motor Switch Adjustments

Alignment Procedure

Calibrate the tuning dial by adjusting dial pointer to the center horizontal line with the gang tuning-condenser plates in full-mesh position. This is a screw-driver adjustment.

Perform alignment in proper order, tabulated below, starting with No. 1 and following all operations across, then No. 2, etc. Adjustment locations are shown on figures 7 and 8.

Cathode-ray alignment is preferable; the connections to the chassis are shown on figure 3. If an output indicator is used, connect it across the loudspeaker voice-coil and advance the receiver volume control to full-volume position.

Connect the "low" output terminal of the test oscillator to the receiver chassis for all alignment operations. Regulate

the output of the test oscillator so that minimum signal is applied to the receiver to obtain an observable output indication. This will avoid a-v-c action.

The term "Dummy antenna" means the device which must be connected between the "high" test-oscillator output and the point of connection to the receiver in order to obtain ideal alignment. "No signal, 550-750 kc" means that the receiver should be tuned to a point between 550 and 750 kc where no signal or interference is received from a station or local (heterodyne) oscillator.

For further details on alignment, refer to booklet "RCA Victor Receiver Alignment."

| Order of Alignment | Test Oscillator | | | Range-Selector | Receiver Dial Setting | Circuit to Adjust | Adjustment Symbols | Adjust to Obtain |
|--------------------|------------------------|---------------|-------------------|----------------|------------------------|-------------------|--------------------|------------------|
| | Connection to Receiver | Dummy Antenna | Frequency Setting | | | | | |
| 1 | 6D6 I-F Grid Cap | .001 Mfd. | 460 kc | "A" Left | No Signal 550-750 kc | 2nd I-F Trans. | L9 | Max. (peak) |
| 2 | 6A7 Det. Grid Cap | .001 Mfd. | 460 kc | "A" Left | No Signal 550-750 kc | 1st I-F Trans. | L4 and L5 | Max. (peak) |
| 3 | Ant. Lead (blue) | 300 Ohms | 15,000 kc | "C" Right | 15,000 kc | "C" Osc. | C5 | Max. (peak)† |
| 4 | Ant. Lead (blue) | 300 Ohms | 15,000 kc | "C" Right | Rock Through 15,000 kc | "C" Ant. | C1 | Max. (peak)*‡ |
| 5 | Ant. Lead (blue) | 200 Mmfd. | 600 kc | "A" Left | 600 kc | "A" Osc. | L8 | Max. (peak) |

† Use maximum capacity peak if two peaks can be obtained.

* Use minimum capacity peak if two peaks can be obtained.

‡ After this adjustment, check for image signal by shifting receiver dial to 15,920 kc.

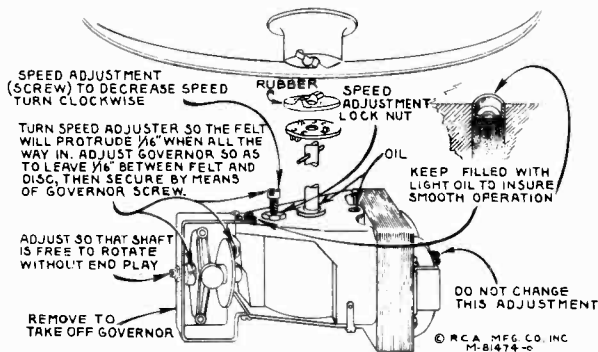

Figure 6—Details of Motor

© RCA MFG. CO., INC.
SN-781

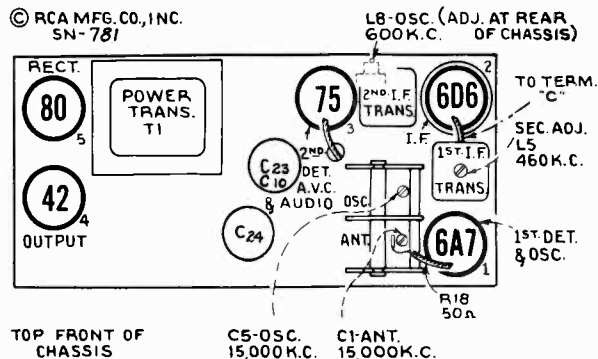

Figure 7—Radiotron, Coil, and Trimmer Locations

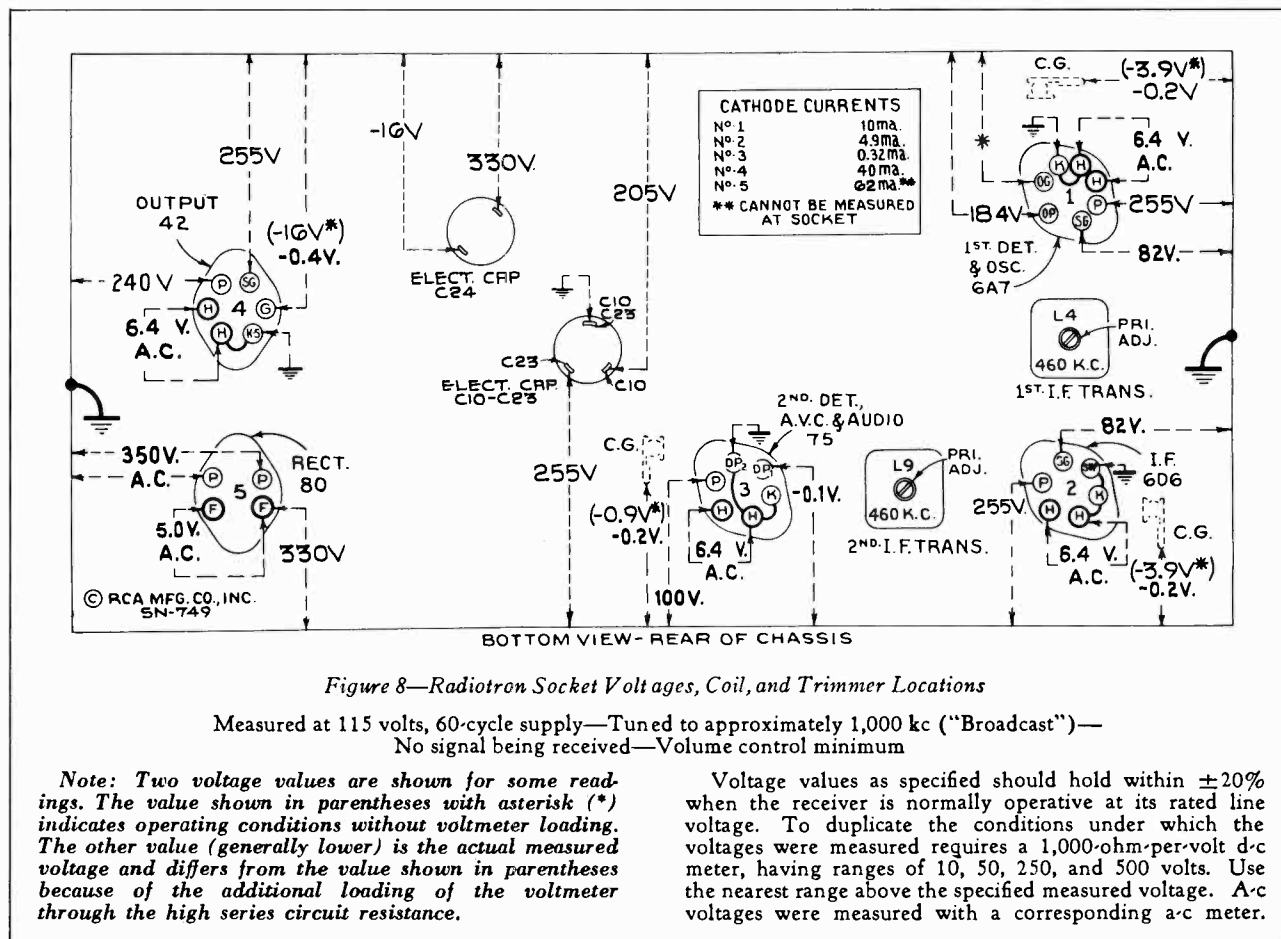

Figure 8—Radiotron Socket Volt ages, Coil, and Trimmer Locations

Measured at 115 volts, 60-cycle supply—Tuned to approximately 1,000 kc ("Broadcast")—
No signal being received—Volume control minimum

Note: Two voltage values are shown for some readings. The value shown in parentheses with asterisk (*) indicates operating conditions without voltmeter loading. The other value (generally lower) is the actual measured voltage and differs from the value shown in parentheses because of the additional loading of the voltmeter through the high series circuit resistance.

Voltage values as specified should hold within ±20% when the receiver is normally operative at its rated line voltage. To duplicate the conditions under which the voltages were measured requires a 1,000-ohm-per-volt d-c meter, having ranges of 10, 50, 250, and 500 volts. Use the nearest range above the specified measured voltage. A-c voltages were measured with a corresponding a-c meter.

REPLACEMENT PARTS

Insist on genuine factory-tested parts, which are readily identified and may be purchased from authorized dealers.

| STOCK No. | DESCRIPTION | STOCK No. | DESCRIPTION |
|----------------------------|---|-----------|--|
| RECEIVER ASSEMBLIES | | | |
| 30461 | Belt—Flat, endless drive belt | 12724 | Capacitor—120 Mmfd. (C7) |
| 30460 | Belt—Phosphor-bronze belt for indicator-pointer drive | 12406 | Capacitor—180 Mmfd. (C16) |
| 30473 | Cable—3-conductor shielded compensation cable with female connector and grid clip (Model U-102E only) | 30396 | Capacitor—470 Mmfd. (C8) |
| 12118 | Cap—Grid contact cap | 14724 | Capacitor—560 Mmfd. (C17) |
| 12896 | Capacitor—15 Mmfd. (C25) | 30245 | Capacitor—.0045 Mfd. (C3) |
| 12405 | Capacitor—47 Mmfd. (C14) | 4838 | Capacitor—.005 Mfd. (C22) (Model U-102E only) |
| 14262 | Capacitor—110 Mmfd. (C11, C12) | 4858 | Capacitor—.01 Mfd. (C20, C22) (Model 85E only) |
| | | 14393 | Capacitor—.01 Mfd. (C9, C18) |
| | | 4870 | Capacitor—.025 Mfd. (C54) (Model U-102E only) |
| | | 4839 | Capacitor—0.1 Mfd. (C4, C13, C19, C21) |

REPLACEMENT PARTS (Continued)

| STOCK No. | DESCRIPTION | STOCK No. | DESCRIPTION | |
|-----------|--|-----------|--|---|
| 12484 | Capacitor—0.25 Mfd. (C15) | | MOTOR ASSEMBLIES (Model U-102E only) | |
| 14814 | Capacitor—10 Mfd. (C24) | | | |
| 14813 | Capacitor Pack—Comprising 2 sections each 16 Mfd. (C10, C23) | | | |
| 14646 | Coil—Antenna coil (L1, L2, L3) | 11703 | Governor—Motor governor complete | |
| 14647 | Coil—Oscillator coil (L6, L7, L8) | 30475 | Motor—105-125 volts, 50-60 cycle (M50) | |
| 14633 | Condenser—2-gang variable tuning condenser (C1, C2, C5, C6) | 14800 | Motor—105-125 volts, 60 cycle (M50) | |
| 14783 | Connector—2-contact female connector for motor power cable (Model U-102E only) | | PICKUP AND ARM ASSEMBLIES (Model U-102E only) | |
| 5119 | Connector—3-contact female connector for speaker cable | | | |
| 30474 | Connector—3-contact female connector for cable Stock No. 30473 (Model U-102E only) | | | |
| 12006 | Core—Adjustable core and stud assembly for I.F. transformers | 14291 | Armature—Pickup armature | |
| 14631 | Dial—Station-selector dial scale and holder | 11732 | Coil—Pickup coil (L50) | |
| 14651 | Drive—Vernier drive and pinion gear for tuning condenser | 14292 | Damper—Pickup damper block complete with clamp and screw | |
| 14635 | Indicator—Station selector indicator pointer | 30476 | Pickup and Arm complete | |
| 5226 | Lamp—Dial lamp | 3811 | Screw—Pickup needle screw | |
| 30465 | Pulley—Drive-belt intermediate pulley—located on side of belt opposite idler pulley | | REPRODUCER ASSEMBLIES (Model 85E only) (Speaker No. 84091-1) | |
| 14639 | Pulley—Drive-belt pulley—fastens on vernier drive of tuning condenser | | | |
| 14636 | Pulley—Idler pulley—less spring | | | |
| 30464 | Pulley—Indicator-belt pulley—fastens on rotor shaft of tuning condenser | 14616 | Coil—Reproducer field coil (L12, L13) | |
| 30459 | Pulley—Indicator-pointer pulley and shaft—less screw to hold belt | 14614 | Cone—Reproducer cone and voice coil (L11) | |
| 14660 | Resistor—18 ohms, insulated, 1/2 watt (R14) | 5118 | Plug—3-contact male plug | |
| 14653 | Resistor—50 ohms, flexible type, 1/10 watt (R18) | 14613 | Reproducer—Complete | |
| 13819 | Resistor—270 ohms, insulated, wire wound, 1.1 watt (R15) | 14615 | Transformer—Output transformer (T2) | |
| 5175 | Resistor—5,600 ohms, carbon type, 1/2 watt (R12) | | REPRODUCER ASSEMBLIES (Model U-102E only) (Speaker No. RL-70E-1) | |
| 14659 | Resistor—6,800 ohms, carbon type, 1/2 watt (R3) | | | |
| 14559 | Resistor—10,000 ohms, insulated, 1/2 watt (R57) (Model U-102E only) | | | |
| 11305 | Resistor—22,000 ohms, carbon type, 1/2 watt (R16) | 13866 | Cap—Dust cap for cone center | |
| 13735 | Resistor—33,000 ohms, carbon type, 1/2 watt (R2) | 14354 | Coil—Reproducer field coil (L13) | |
| 5033 | Resistor—33,000 ohms, carbon type, 1 watt (R4) | 11469 | Coil—Hum neutralizing coil (L12) | |
| 5206 | Resistor—36,000 ohms, wire wound, 20 watt (R17) | 12667 | Cone—Reproducer cone and voice coil (L11) | |
| 11646 | Resistor—47,000 ohms, carbon type, 1/2 watt (R9) | 5118 | Plug—3-contact male plug | |
| 11323 | Resistor—270,000 ohms, carbon type, 1/2 watt (R7, R8) | 14395 | Reproducer—Complete | |
| 13733 | Resistor—330,000 ohms, carbon type, 1/2 watt (R1) | 14358 | Screw—Screw and lockwasher to hold core in yoke | |
| 13479 | Resistor—390,000 ohms, carbon type, 1/2 watt (R10) | 14355 | Transformer—Output transformer (T2) | |
| 5035 | Resistor—560,000 ohms, carbon type, 1/2 watt (R6) | 14357 | Washer—Spring washer to hold field coil | |
| 12679 | Resistor—2.2 Megohms, insulated, 1/2 watt (R11) | | MISCELLANEOUS ASSEMBLIES (Model 85E only) | |
| 14661 | Resistor—6.8 Megohms, insulated, 1/2 watt (R13) | 14654 | | Escutcheon—Station-selector escutcheon and crystal |
| 30340 | Retainer—Indicator pulley or drive-belt intermediate-pulley retainer | 12673 | | Knob—Tuning, volume control, or range switch knob |
| 5129 | Ring—Retaining ring for Radiotron shield | 4119 | Screw—No. 8-32, headless set screw for knob Stock No. 12673 | |
| 30463 | Screw—No. 4-40 x 3/16-in. binder-head screw to fasten indicator drive belt | 30466 | Screw—Chassis mounting screw and washer assembly | |
| 4389 | Screw—No. 6-32 x 3/16-in. headless set screw for pulley Stock No. 14639 | | MISCELLANEOUS ASSEMBLIES (Model U-102E only) | |
| 5042 | Screw—No. 8-32 x 1/8-in. headless set screw for pulley Stock No. 30464 | 11762 | | Box—Used-needle box |
| 14638 | Shaft—Knob shaft and pulley | 30478 | | Cable—2-conductor shielded compensator cable complete with 3-contact male connector |
| 12008 | Shield—First I.F. transformer shield can | 14393 | Capacitor—.01 Mfd. (C30) | |
| 12408 | Shield—Second I.F. transformer shield can | 4839 | Capacitor—0.1 Mfd. (C50, C51) | |
| 11265 | Shield—Radiotron shield complete | 14782 | Connector—3-contact male connector for cable Stock No. 30478 | |
| 4794 | Socket—4-contact 80 Radiotron socket | 11704 | Damper—Turntable rubber damper and damper plate | |
| 4786 | Socket—6-contact 6D6, 75, or 42 Radiotron socket | 14654 | Escutcheon—Station-selector escutcheon and crystal | |
| 4787 | Socket—7-contact 6A7 Radiotron socket | 12673 | Knob—Tuning, radio-volume control, range switch or phonograph-volume control knob | |
| 14658 | Socket—Dial-lamp socket | 4119 | Screw—No. 8-32, headless set screw for knob Stock No. 12673 | |
| 30462 | Spring—Idler-pulley tension spring | 30477 | Screw—Chassis mounting screw, washer, lockwasher and nut—for rear of chassis | |
| 12007 | Spring—Retaining spring for core Stock No. 12006 | 30535 | Screw—Chassis mounting screw and washer—for front of chassis | |
| 14640 | Switch—Range switch (S2, S3) | 30249 | Screw—Motorboard mounting screw, spring, spacer, washer, lockwasher and rubber washer assembly | |
| 14376 | Transformer—First I.F. transformer (L4, L5, C11, C12) | 14499 | Resistor—1,500 ohms, insulated, 1/2 watt (R52) | |
| 14642 | Transformer—Second I.F. transformer (L9, L10, C14, C16) | 12955 | Resistor—3,900 ohms, insulated, 1/2 watt (R53) | |
| | | 12286 | Resistor—56,000 ohms, insulated, 1/2 watt (R56) | |
| 30607 | Transformer—105-125/200-250 volts, 50-60 cycles (T1) | 14801 | Turntable | |
| 14826 | Volume control and power switch (R5, S1) (Model U-102E only) | 14815 | Volume Control—Phonograph volume control and switch (R50, S60) | |
| 14645 | Volume control and power switch (R5, S1) (Model 85E only) | | | |
| | MOTORBOARD ASSEMBLIES (Model U-102E only) | | | |
| 14803 | Brake—Turntable brake and switch | | | |
| 14805 | Connector—2-contact male connector for motor and switch leads | | | |
| 3261 | Rest—Pickup needle rest | | | |
| 30248 | Screw—Motor mounting screw, washer, rubber washer and clamp plate | | | |
| 30100 | Springs—Tension springs for brake Stock No. 14803—comprising one long and one short spring | | | |
| 14804 | Switch—Motor switch—located on turntable brake (S51) | | | |

RCA VICTOR MODELS 85K and 85T2

TECHNICAL INFORMATION AND SERVICE DATA

MODEL 85K

Model 85K is a console model employing a chassis similar to Model 85T1. Speaker marked 84091-1 is used, and its cable connects to the chassis as follows: Brown lead (L13) to positive (center) terminal of capacitor C24. Brown-black lead (L13-T2) to "SG" terminal of tube No. 4, RCA-42. Black lead (T2) to "P" terminal of tube No. 4, RCA-42. Resistance values for speaker 84091-1 are: Field coil (L13), 1,300 ohms; Voice coil (L11), 2.4 ohms; Hum neut. coil (L12), 0.16 ohm; Output transformer (T2) primary, 520 ohms--secondary, 0.37 ohm. The voice-coil impedance is 2.6 ohms at 400 cycles.

The following corrections should be made in the Service Data for Model 85T1. These corrections apply to all Models 85T1 and 85K.

- (1) Change resistance of L2 from .07 ohm to 1.3 ohms, (Figs. 2 and 3).
- (2) Add shield extension to Record Player cable and ground same to chassis, (Fig. 2).
- (3) Voltage from negative terminal (case) of C24 to chassis should be -17 volts, (Fig. 4).
- (4) Voltage from negative terminal (case) of C10 to chassis should be 0 instead of -17 volts, (Fig. 4).
- (5) Omit Stock No. 12812 Capacitor, 450 mmfd. (C8) and add in its place Stock No. 30396 Capacitor, 470 mmfd. (C8).
- (6) Change C8 on Figures 2 and 3 to read 470 mmfd. instead of 450 mmfd.

All Service Data for Model 85T1 are directly applicable to Model 85K except the data given above and the Replacement Part changes listed below.

| <u>Stock No.</u> | <u>Description</u> |
|------------------|--|
| 14393 | Capacitor-- .01 mfd. (C9, C18) |
| 5119 | Connector--3-contact female connector for speaker cable |
| 30467 | Screw--Chassis-mounting screw and washer assembly |
| 30607 | Transformer--Power transformer, 105-125/200-250 volts, 50-60 cycles (T1) |
| 30571 | Transformer--Power transformer, 105-125 volts, 25-60 cycles (T1) |
| 14616 | Coil--Reproducer field coil (L12, L13) (for Spkr. 84091-1) |
| 14614 | Cone--Reproducer cone and voice coil (L11) (for Spkr. 84091-1) |
| 5118 | Plug--3-contact male plug (for Spkr. 84091-1) |
| 14613 | Reproducer--Complete (marked 84091-1) |
| 14615 | Transformer--Output transformer (T2) (for Spkr. 84091-1) |

Stock Nos. 14632, 5237, 13138, 14655, 14656, 14657, 14679, 14941, 14678, 14680, 14942, and 14267 are not used in Model 85K.

MODEL 85T2

Model 85T2 is an upright table model employing a chassis similar to Model 85T. Either of two loudspeakers may be employed and are readily identified by the numbers stamped on them--84128-1 or 84128-2. The speaker cable connects to the chassis as follows: Brown lead (L11) to "F" terminal of tube No. 5, RCA-80, to which the red lead from the capacitor pack connects. Black-brown lead (L11-T2) to "SG" terminal of tube No. 4, RCA-41. Black lead (T2) to "P" terminal of tube No. 4, RCA-41.

Resistance values for speaker 84128-1 are: Field coil (L11), 1,300 ohms; Voice coil (L9), 2.3 ohms; Hum neut. coil (L10), 0.15 ohm; Output transformer (T2) primary, 470 ohms--secondary, 0.35 ohm; Voice-coil impedance, 2.6 ohms at 400 cycles.

Resistance values for speaker 84128-2 are: Field coil (L11), 1,300 ohms; Voice coil (L9), 4.2 ohms; Hum neut. coil (L10), 0.23 ohm; Output transformer (T2) primary, 610 ohms--secondary, 0.5 ohm; Voice-coil impedance, 5 ohms at 400 cycles.

All Service Data for Model 85T are directly applicable to these instruments except: (1) the d-c socket voltages, which are approximately 5% higher; (2) the loudspeaker data given above; and (3) the Replacement Part changes listed below.

| <u>Stock No.</u> | <u>Description</u> |
|------------------|--|
| 30460 | Belt--Flat, phosphor-bronze drive belt for indicator pointer |
| 30469 | Belt--Flat, endless drive belt for tuning condenser |
| 5119 | Connector--3-contact female connector for speaker cable |
| 30459 | Pulley--Indicator-pointer pulley and shaft |
| 30465 | Pulley--Drive-belt intermediate pulley--located on side of drive opposite idler pulley |
| 30468 | Pulley--Variable-condenser drive pulley--located on condenser shaft |
| 30340 | Retainer--Indicator-pulley or drive-belt intermediate pulley retainer |
| 30463 | Screw--No. 4-40 x 3/16 in. binder-head screw to fasten indicator drive belt |
| 30471 | Cone--Reproducer cone (L9) (for Spkr. 84128-2) |
| 30687 | Cone--Reproducer cone (L9) (for Spkr. 84128-1) |
| 5118 | Connector--3-contact male connector (for Spkr. 84128-2) |
| 30470 | Reproducer complete (Marked 84128-2) |
| 30472 | Transformer--Output transformer (T2) (for Spkr. 84128-2) |
| 30686 | Transformer--Output transformer (T2) (for Spkr. 84128-1) |

Stock Nos. 14663, 14664, 14676, 14939, 14675, 14677, and 14940 are not used in Model 85T2.

SERVICE DIVISION
RCA Manufacturing Company, Inc.
Camden, N. J., U. S. A.



RCA Victor

MODEL 85T

Five-Tube, Single-Band, A-C, Superheterodyne Receiver

TECHNICAL INFORMATION AND SERVICE DATA

SERVICE DIVISION • RCA MANUFACTURING COMPANY, INC. • CAMDEN, N. J., U. S. A.

A Service of the Radio Corporation of America

Electrical Specifications

| | | | |
|------------------------------|---------------------------|---|---|
| Frequency Range | 530—1,720 kc | R-F Alignment Frequency | 1,500 kc (osc., ant.) |
| Intermediate Frequency | | | 460 kc |
| RADIOTRON COMPLEMENT | | (3) RCA-75 | Second Det., A-F Amp. and A.V.C. |
| (1) RCA-6A7 | First Detector—Oscillator | (4) RCA-41 | Audio Power Amplifier |
| (2) RCA-6D6 | Intermediate Amplifier | (5) RCA-80 | Full-Wave Rectifier |
| Pilot Lamp (1) | | | Mazda No. 46, 6.3 volts, 0.25 ampere |
| POWER SUPPLY RATINGS | | | |
| Rating A | | | 105-125 volts, 50-60 cycles, 55 watts |
| Rating B | | | 105-125 volts, 25-60 cycles, 60 watts |
| Rating C | | | 100-125/200-250 volts, 50-60 cycles, 55 watts |
| POWER OUTPUT RATING | | LOUDSPEAKER | |
| Undistorted | 1.0 watts | Type | Electrodynamical |
| Maximum | 2.5 watts | Voice Coil Impedance { (84011-3) 3.1- } | ohms at 400 cycles |
| | | { (84011-6) 2.7- } | |

Mechanical Specifications

| | | |
|-------------------------------|---|---|
| Height | | 8 ¹³ / ₁₆ inches |
| Width | | 12 ¹³ / ₁₆ inches |
| Depth | | 7 ¹ / ₁₆ inches |
| Weight (Net) | | 16 pounds |
| Weight (Shipping) | | 18 pounds |
| Chassis Base Dimensions | 11 ³ / ₈ inches x 5 ³ / ₄ inches x 2 ¹ / ₄ inches | |
| Over-all Chassis Height | | 6 ¹ / ₂ inches |
| Operating Controls | (1) Power Switch—Volume, (2) Tuning | |
| Tuning Drive Ratio | | 2 ³ / ₄ to 1 |

General Description

This receiver employs a superheterodyne circuit, the arrangement of which is shown on figure 2. Its design includes magnetite-core adjusted i-f transformers; automatic volume

control; resistance-coupled audio system; and a 5-inch, electrodynamic loudspeaker.

Service Data

The various diagrams of this booklet contain such information as will be needed to isolate causes for defective operation if such develops. The ratings of the resistors, capacitors, coils, etc., are indicated adjacent to the symbols signifying these parts on the diagrams. Identification titles such as

R1, L1, C1, etc., provide reference between the illustrations and Replacement Parts List. The coils, transformer windings, and reactors are rated in terms of d-c resistance to permit continuity checks.

Precautionary Lead Dress—(1) The green RCA-75 grid cap lead should be twisted with the yellow lead to the volume control to maintain proper position for prevention of hum pickup. (2) The green lead from oscillator coil L3 to tun-

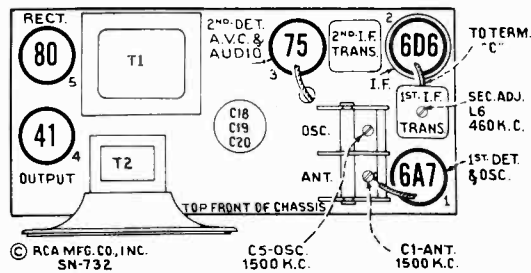

Figure 1—Radiotron, Coil, and Trimmer Locations

ing condenser C4 should be kept free from chassis. (3) Keep power cord and red primary leads of power transformer away from the green RCA-41 grid lead to prevent hum pickup.

(4) Red lead from electrolytic capacitor C19 to RCA-80 socket should be dressed between power transformer and chassis apron to prevent hum pickup.

Phonograph Attachment—See Schematic Circuit Diagram, figure 2.

Loudspeaker—Centering of the loudspeaker voice coil is made in the usual manner with three narrow paper feelers.

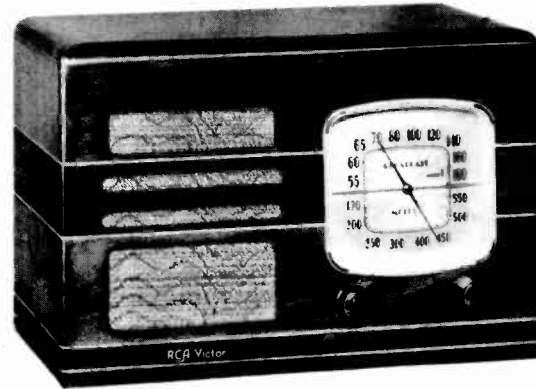

Model 85T

Alignment Procedure

Calibrate the tuning dial by adjusting dial pointer to the center horizontal line with the gang tuning-condenser plates in full-mesh position. This is a screw-driver adjustment.

Perform alignment in proper order, tabulated below, starting with No. 1 and following all operations across, then No. 2, etc. Adjustment locations are shown on figures 1 and 4.

Cathode-ray alignment is preferable; the connections to the chassis are shown on figure 3. If an output indicator is used, connect it across the loudspeaker voice-coil and advance the receiver volume control to full-volume position.

Connect the "low" output terminal of the test oscillator to the receiver chassis for all alignment operations. Regulate

the output of the test oscillator so that minimum signal is applied to the receiver to obtain an observable output indication. This will avoid a-v-c action.

The term "Dummy antenna" means the device which must be connected between the "high" test-oscillator output and the point of connection to the receiver in order to obtain ideal alignment. "No signal, 550-750 kc" means that the receiver should be tuned to a point between 550 and 750 kc where no signal or interference is received from a station or local (heterodyne) oscillator.

For further details on alignment, refer to booklet "RCA Victor Receiver Alignment."

| Order of Alignment | Test Oscillator | | | Receiver Dial Setting | Circuit to Adjust | Adjustment Symbols | Adjust to Obtain |
|--------------------|------------------------|---------------|-------------------|-----------------------|-------------------|--------------------|------------------|
| | Connection to Receiver | Dummy Antenna | Frequency Setting | | | | |
| 1 | 6D6 Grid Cap | .001 Mfd. | 460 kc | No Signal 550-750 kc | 2nd I-F Trans. | L7 | Max. (peak) |
| 2 | 6A7 Grid Cap | .001 Mfd. | 460 kc | No Signal 550-750 kc | 1st I-F Trans. | L5 and L6 | Max. (peak) |
| 3 | Ant. Lead (blue) | 200 Mmfd. | 1,500 kc | 1,500 kc | "A" Osc. | C5* | Max. (peak) |
| 4 | Ant. Lead (blue) | 200 Mmfd. | 1,500 kc | 1,500 kc | "A" Ant. | C1 | Max. (peak) |

* Tighten capacitor C6 on bottom of gang (under chassis) for maximum capacity before adjusting C5.

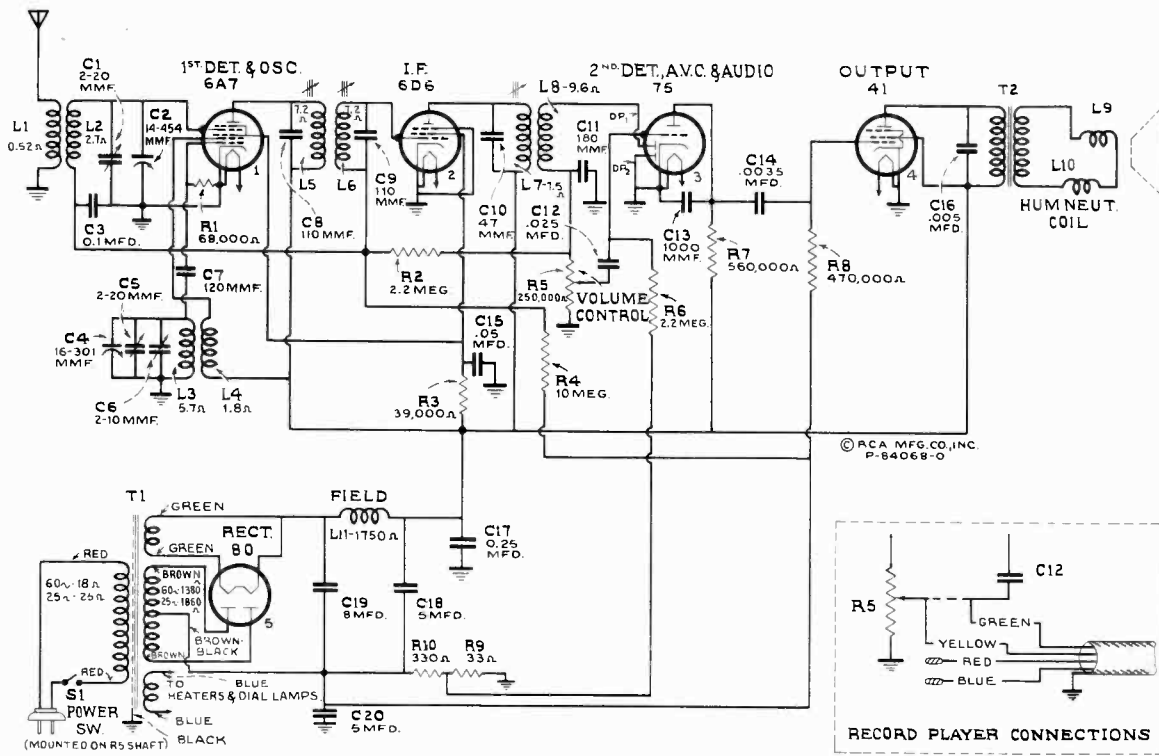

Figure 2—Schematic Circuit Diagram

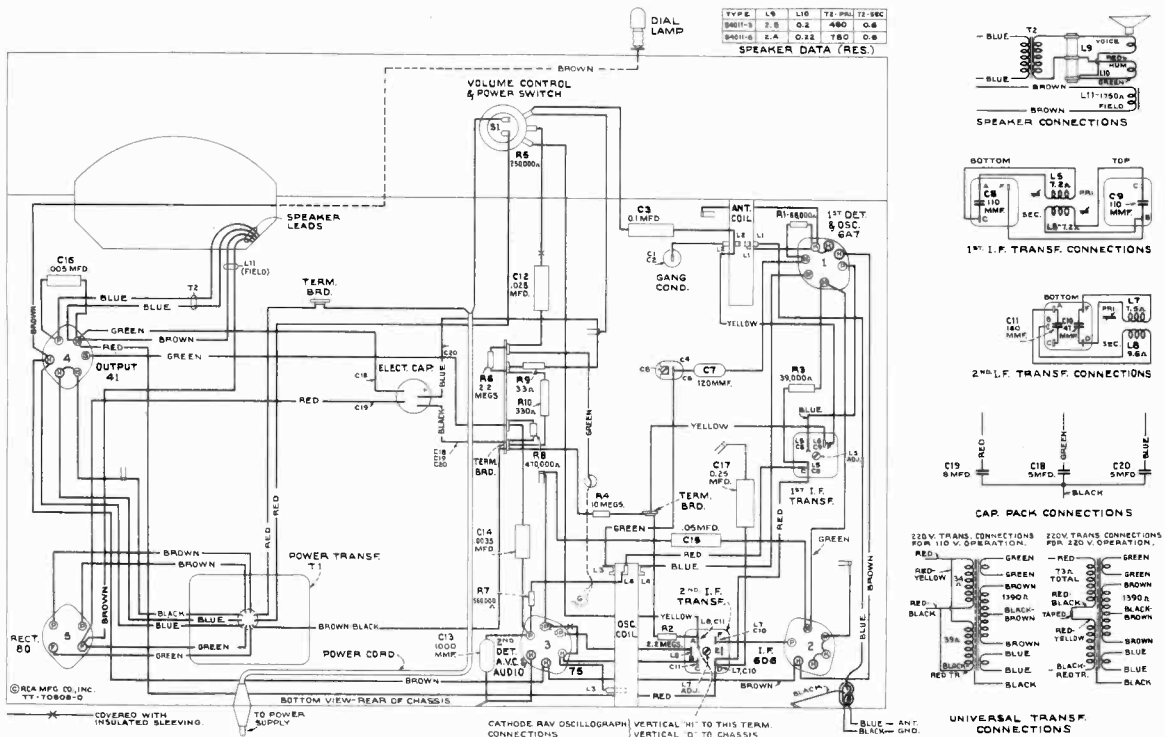

Figure 3—Chassis Wiring Diagram

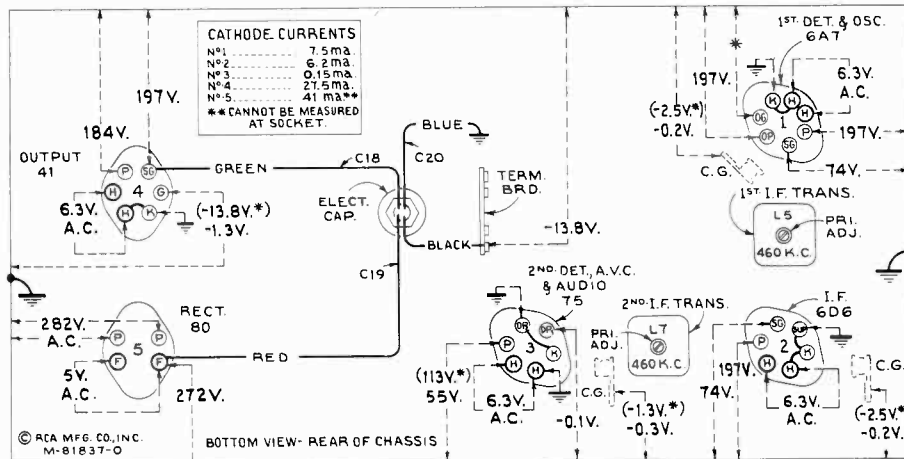

Figure 4—Radiotron Socket Voltages, Coil, and Trimmer Locations
 Measured at 115 volts, 60-cycle supply—Tuned to approximately 1,000 kc ("Broadcast")—
 No signal being received—Volume control minimum

Note: Two voltage values are shown for some readings. The value shown in parentheses with asterisk (*) indicates operating conditions without voltmeter loading. The other value (generally lower) is the actual measured voltage and differs from the value shown in parentheses because of the additional loading of the voltmeter through the high series circuit resistance.

Voltage values as specified should hold within $\pm 20\%$ when the receiver is normally operative at its rated line voltage. To duplicate the conditions under which the voltages were measured requires a 1,000-ohm-per-volt d-c meter, having ranges of 10, 50, 250, and 500 volts. Use the nearest range above the specified measured voltage. A-c voltages were measured with a corresponding a-c meter.

REPLACEMENT PARTS

Insist on genuine factory tested parts, which are readily identified and may be purchased from authorized dealers.

| STOCK No. | DESCRIPTION | STOCK No. | DESCRIPTION |
|----------------------------|--|---------------------------------|--|
| RECEIVER ASSEMBLIES | | | |
| 14663 | Belt—Variable condenser drive belt | 14638 | Shaft—Station selector knob shaft and pulley |
| 14632 | Bracket—Dial mounting bracket | 12008 | Shield—First I. F. transformer shield |
| 12118 | Cap—Grid contact cap | 12408 | Shield—Second I. F. transformer shield |
| 12405 | Capacitor—47 Mmfd. (C10) | 11265 | Shield—Radiotron shield |
| 14282 | Capacitor—110 Mmfd. (C8, C9) | 14658 | Socket—Dial lamp socket |
| 12724 | Capacitor—120 Mmfd. (C7) | 4794 | Socket—4-contact 80 Radiotron socket |
| 12406 | Capacitor—180 Mmfd. (C11) | 4786 | Socket—6-contact 6D6, 41 or 75 Radiotron socket |
| 12835 | Capacitor—1,000 Mmfd. (C13) | 4787 | Socket—7-contact 6A7 Radiotron socket |
| 5005 | Capacitor—.0035 Mfd. (C14) | 14637 | Spring—Idler pulley tension spring |
| 4838 | Capacitor—.005 Mfd. (C16) | 12007 | Spring—Retaining spring for core, Stock No. 12008 |
| 4870 | Capacitor—.025 Mfd. (C12) | 14378 | Transformer—First I. F. transformer (L5, L6, C8, C9) |
| 4886 | Capacitor—.05 Mfd. (C15) | 14642 | Transformer—Second I. F. transformer (L7, L8, C10, C11) |
| 4841 | Capacitor—.01 Mfd. (C3) | 14666 | Transformer—Power transformer, 105-125 volts, 50-60 cycle (T1) |
| 12484 | Capacitor—.025 Mfd. (C17) | 14667 | Transformer—Power transformer, 105-125 volts, 25-60 cycle (T1) |
| 14669 | Capacitor Pack—Comprising one 8-Mfd. and two 5-Mfd. sections (C18, C19, C20) | 14668 | Transformer—Power transformer, 100-125/200-250 volts, 50-60 cycle (T1) |
| 14670 | Coil—Antenna coil (L1, L2) | 14645 | Volume Control and power switch (R5, S1) |
| 14257 | Coil—Oscillator coil (L3, L4) | REPRODUCER ASSEMBLIES | |
| 14662 | Condenser—2-gang variable condenser (C1, C2, C4, C5, C6) | 14676 | Cone—Reproducer cone (L9) for speaker marked 84011-3 |
| 12006 | Core—Adjustable core and stud for I. F. transformer | 14939 | Cone—Reproducer cone (L9) for speaker marked 84011-6 |
| 14665 | Dial—Station selector dial | 14675 | Reproducer complete (84011-3) |
| 14636 | Indicator—Station selector indicator pointer | 14677 | Transformer—Output transformer (T2) for speaker marked 84011-3 |
| 5228 | Lamp—Dial lamp | 14940 | Transformer—Output transformer (T2) for speaker marked 84011-6 |
| 14638 | Pulley—Idler pulley—less spring | MISCELLANEOUS ASSEMBLIES | |
| 14664 | Pulley—Variable condenser drive pulley—located on condenser shaft | 14654 | Escutcheon—Station selector escutcheon and crystal |
| 14671 | Resistor—33 Ohms—Carbon type, $\frac{1}{4}$ watt (R9) | 12673 | Knob—Station selector or volume control knob |
| 11670 | Resistor—330 Ohms—Carbon type, 1 watt (R10) | 14267 | Screw—Chassis mounting screw and washer |
| 8067 | Resistor—39,000 Ohms—Carbon type, $\frac{1}{4}$ watt (R3) | 4119 | Screw—No. 8-32 x $\frac{1}{16}$ headless set screw for knob, Stock No. 12673 |
| 12333 | Resistor—68,000 Ohms—Carbon type, $\frac{1}{4}$ watt (R1) | | |
| 11172 | Resistor—470,000 Ohms—Carbon type, $\frac{1}{4}$ watt (R8) | | |
| 5035 | Resistor—560,000 Ohms—Carbon type, $\frac{1}{4}$ watt (R7) | | |
| 11626 | Resistor—2.2 Megohm—Carbon type, $\frac{1}{4}$ watt (R2, R6) | | |
| 13732 | Resistor—10 Megohm—Carbon type, $\frac{1}{4}$ watt (R4) | | |
| 5129 | Ring—Radiotron shield ring | | |
| 4389 | Screw—No. 6—32x3/16 headless set screw for pulley, Stock No. 14639 | | |



RCA Victor

MODEL 85T1

Five-Tube, Two-Band, A-C, Superheterodyne Receiver

TECHNICAL INFORMATION AND SERVICE DATA

SERVICE DIVISION • RCA MANUFACTURING COMPANY, INC. • CAMDEN, N. J., U.S.A.

A Service of the Radio Corporation of America

Electrical Specifications

| | | | |
|-----------------------------|---|--|---------------------------------------|
| FREQUENCY RANGES | | R-F ALIGNMENT FREQUENCIES | |
| "Broadcast" (A)..... | 540-1,720 kc | "Broadcast" (A)..... | 600 kc (osc.) |
| "Short Wave" (C)..... | 5,800-18,000 kc | "Short Wave" (C)..... | 15,000 kc (osc., ant.) |
| Intermediate Frequency..... | | | 460 kc |
| RADIOTRON COMPLEMENT | | (3) RCA-75..... Second Det., A-F Amp. and A.V.C. | |
| (1) RCA-6A7..... | First Detector—Oscillator | (4) RCA-42..... | Audio Power Amplifier |
| (2) RCA-6D6..... | Intermediate Amplifier | (5) RCA-80..... | Full-Wave Rectifier |
| Pilot Lamp (1)..... | | | Mazda No. 46, 6.3 volts, 0.25 ampere |
| POWER SUPPLY RATINGS | | LOUDSPEAKER | |
| Rating A..... | 105-125 volts, 50-60 cycles, 75 watts | Type..... | Electrodynamic |
| Rating B..... | 105-125 volts, 25-60 cycles, 75 watts | V.C. Impedance..... | { (84010-1) 3.6- } ohms at 400 cycles |
| Rating C..... | 100-125/200-250 volts, 50-60 cycles, 75 watts | | { (84010-3) 3.1- } |
| POWER OUTPUT RATING | | | |
| Undistorted..... | 2.0 watts | | |
| Maximum..... | 4.0 watts | | |

Mechanical Specifications

| | |
|------------------------------|---|
| Height..... | 8 1/4 inches |
| Width..... | 13 3/8 inches |
| Depth..... | 7 1/16 inches |
| Weight (Net)..... | 17 1/2 pounds |
| Weight (Shipping)..... | 19 1/2 pounds |
| Chassis Base Dimensions..... | 11 3/8 inches x 5 3/4 inches x 2 1/4 inches |
| Over-all Chassis Height..... | 6 1/2 inches |
| Operating Controls..... | (1) Power Switch—Volume, (2) Range Selector ("A" left, "C" right), (3) Tuning |
| Tuning Drive Ratio..... | 12 to 1 |

General Description

This receiver employs a superheterodyne circuit, the arrangement of which is shown on figure 2. Its design includes magnetite-core adjusted i-f transformers, automatic

volume control, resistance-coupled audio system, and a five and one-half inch electrodynamic loudspeaker.

Service Data

The various diagrams of this booklet contain such information as will be needed to isolate causes for defective operation if such develops. The ratings of the resistors, capacitors, coils, etc., are indicated adjacent to the symbols signifying these parts on the diagrams. Identification titles

such as R1, L1, C1, etc., provide reference between the illustrations and Replacement Parts List. The coils, transformer windings, and reactors are rated in terms of d-c resistance to permit continuity checks.

Precautionary Lead Dress—(1) Dress power line leads to the on-off switch away from grid connection terminal on volume control to reduce hum pickup. (2) Keep leads of capacitor C3 as short as possible. (3) Bus lead from range

be maintained 2¼ inches long for proper alignment. (6) The RCA-6A7 grid-cap lead (50-ohm resistor R18) to top of tuning capacitor C2 should be dressed properly to prevent shorts and should be maintained flexible to prevent acoustic howl.

Phonograph Attachment—See Schematic Circuit Diagram, figure 2.

Loudspeaker—Centering of the loudspeaker voice coil is made in the usual manner with three narrow paper feelers.

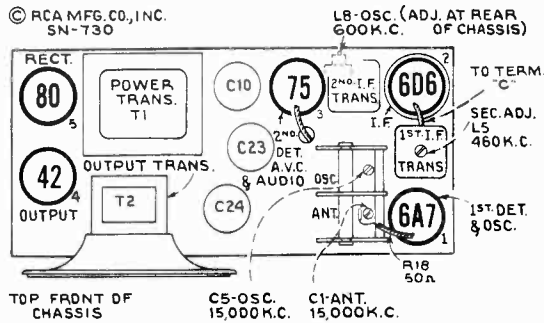
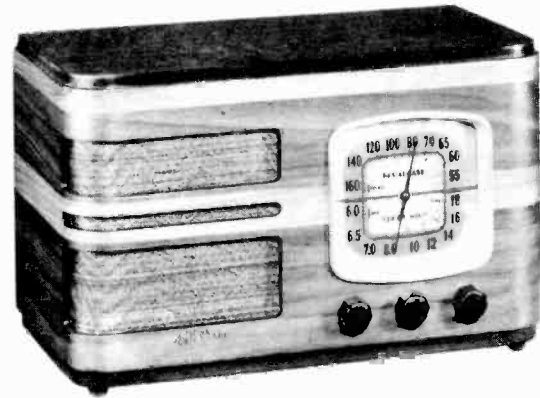

Figure 1—Radiotron, Coil, and Trimmer Locations

selector (ter. 6) to oscillator coil tap L6L8 should be maintained 3½ inches long for proper alignment. (4) Capacitor C25 should be dressed free of adjacent parts to maintain correct alignment at high-frequency end of "A" band. (5) Bus lead from range selector (ter. 3) to antenna coil L1 should



Model 85T1

Alignment Procedure

Calibrate the tuning dial by adjusting dial pointer to the center horizontal line with the gang tuning-condenser plates in full-mesh position. This is a screw-driver adjustment.

Perform alignment in proper order, tabulated below, starting with No. 1 and following all operations across, then No. 2, etc. Adjustment locations are shown on figures 1 and 4.

Cathode-ray alignment is preferable; the connections to the chassis are shown on figure 3. If an output indicator is used, connect it across the loudspeaker voice-coil and advance the receiver volume control to full-volume position.

Connect the "low" output terminal of the test oscillator to the receiver chassis for all alignment operations. Regulate

the output of the test oscillator so that minimum signal is applied to the receiver to obtain an observable output indication. This will avoid a-v-c action.

The term "Dummy antenna" means the device which must be connected between the "high" test-oscillator output and the point of connection to the receiver in order to obtain ideal alignment. "No signal, 550-750 kc" means that the receiver should be tuned to a point between 550 and 750 kc where no signal or interference is received from a station or local (heterodyne) oscillator.

For further details on alignment, refer to booklet "RCA Victor Receiver Alignment."

| Order of Alignment | Test Oscillator | | | Range-Selector | Receiver Dial Setting | Circuit to Adjust | Adjustment Symbols | Adjust to Obtain |
|--------------------|------------------------|---------------|-------------------|----------------|------------------------|-------------------|--------------------|------------------|
| | Connection to Receiver | Dummy Antenna | Frequency Setting | | | | | |
| 1 | 6D6 I-F Grid Cap | .001 Mfd. | 460 kc | "A" Left | No Signal 550-750 kc | 2nd I-F Trans. | L9 | Max. (peak) |
| 2 | 6A7 Det. Grid Cap | .001 Mfd. | 460 kc | "A" Left | No Signal 550-750 kc | 1st I-F Trans. | L4 and L5 | Max. (peak) |
| 3 | Ant. Lead (blue) | 300 Ohms | 15,000 kc | "C" Right | 15,000 kc | "C" Osc. | C5 | Max. (peak)† |
| 4 | Ant. Lead (blue) | 300 Ohms | 15,000 kc | "C" Right | Rock Through 15,000 kc | "C" Ant. | C1 | Max. (peak)* ‡ |
| 5 | Ant. Lead (blue) | 200 Mmfd. | 600 kc | "A" Left | 600 kc | "A" Osc. | L8 | Max. (peak) |

† Use maximum capacity peak if two peaks can be obtained.

* Use minimum capacity peak if two peaks can be obtained.

‡ After this adjustment, check for image signal by shifting receiver dial to 15,920 kc.

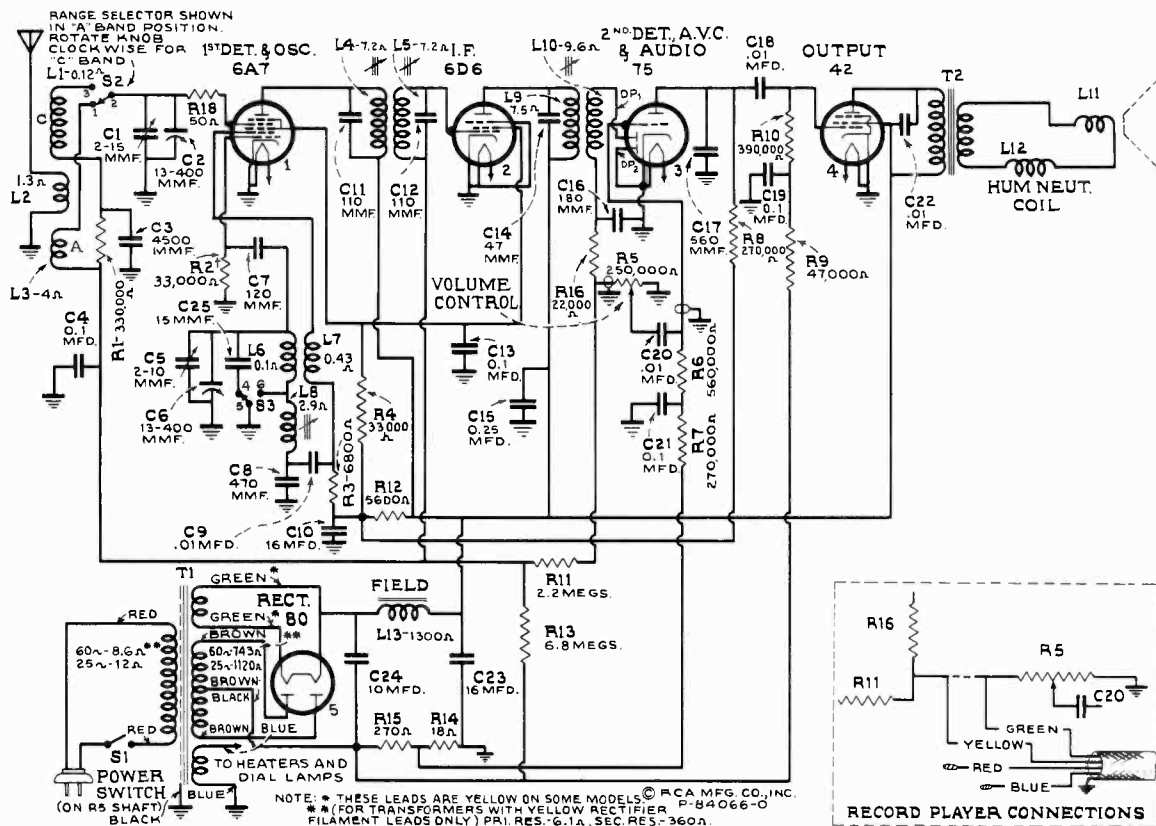

Figure 2—Schematic Circuit Diagram

† Resistor R2 is 58,000 ohms in some instruments. Replace with Stock No. 13735.

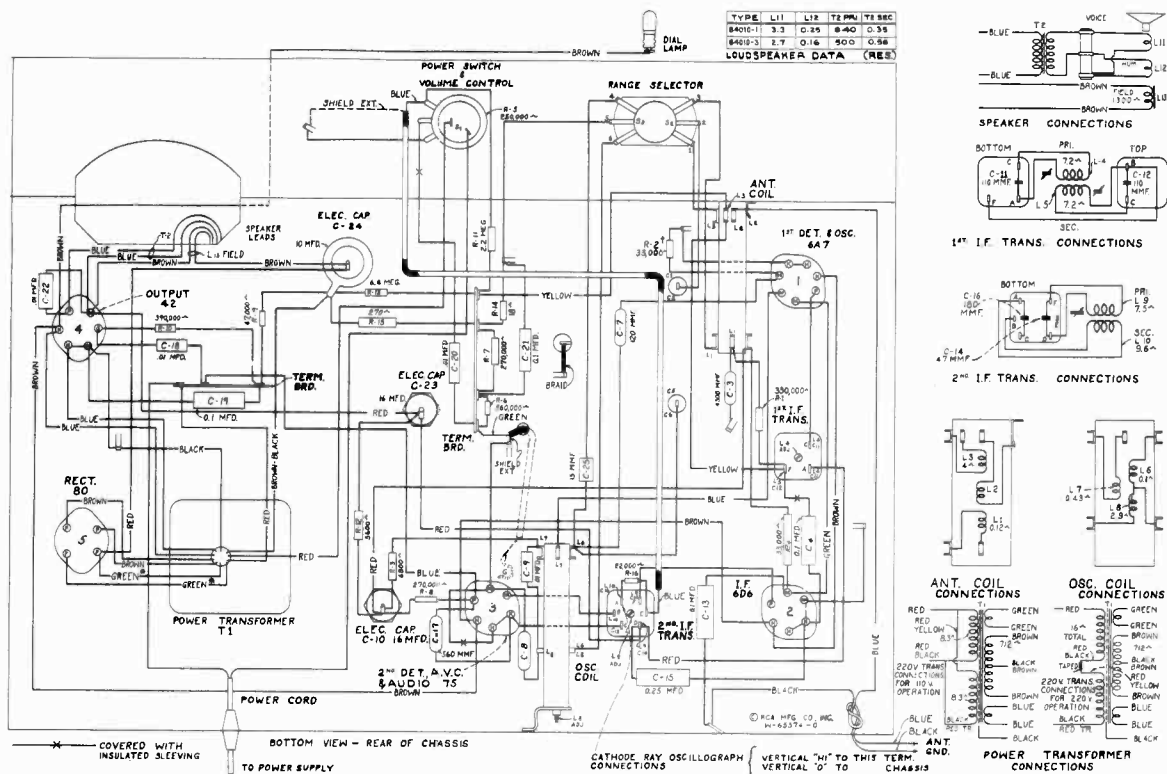

Figure 3—Chassis Wiring Diagram

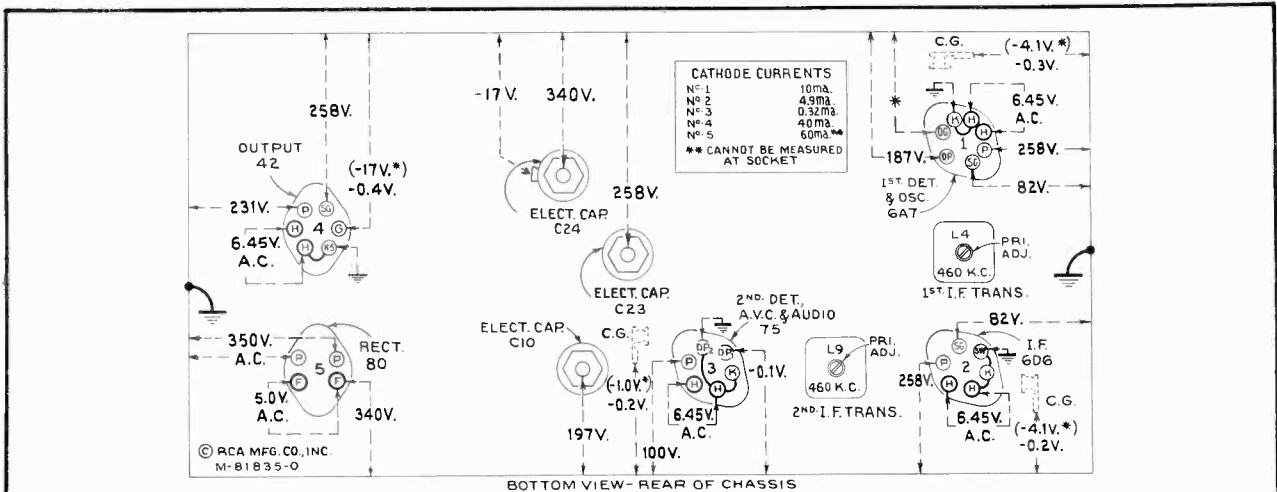

Figure 4—Radiotron Socket Voltages, Coil, and Trimmer Locations
 Measured at 115 volts, 60-cycle supply—Tuned to approximately 1,000 kc ("Broadcast")—
 No signal being received—Volume control minimum

Note: Two voltage values are shown for some readings. The value shown in parentheses with asterisk (*) indicates operating conditions without voltmeter loading. The other value (generally lower) is the actual measured voltage and differs from the value shown in parentheses because of the additional loading of the voltmeter through the high series circuit resistance.

Voltage values as specified should hold within $\pm 20\%$ when the receiver is normally operative at its rated line voltage. To duplicate the conditions under which the voltages were measured requires a 1,000-ohm-per-volt d-c meter, having ranges of 10, 50, 250, and 500 volts. Use the nearest range above the specified measured voltage. A-c voltages were measured with a corresponding a-c meter.

REPLACEMENT PARTS

Insist on genuine factory tested parts which are readily identified and may be purchased from authorized dealers.

| STOCK No. | DESCRIPTION | STOCK No. | DESCRIPTION |
|----------------------------|---|---------------------------------|--|
| RECEIVER ASSEMBLIES | | | |
| 14634 | Belt—Variable condenser drive belt | 12679 | Resistor—2.2 Megohm—Insulated, 1/4 watt (R11) |
| 14632 | Bracket—Dial mounting bracket | 14661 | Resistor—6.8 Megohm—Insulated, 1/4 watt (R13) |
| 5237 | Bushing—Variable condenser rubber mounting bushing | 5129 | Ring—Radiotron shield ring |
| 12118 | Cap—Grid contact cap | 4389 | Screw—No. 6—32 x 3/16 headless set screw for pulley, Stock No. 14639 |
| 12896 | Capacitor—15 Mmfd. (C25) | 14638 | Shaft—Station selector knob shaft and pulley |
| 12405 | Capacitor—47 Mmfd. (C14) | 12008 | Shield—First I. F. transformer shield |
| 14262 | Capacitor—110 Mmfd. (C11, C12) | 12408 | Shield—Second I. F. transformer shield |
| 12724 | Capacitor—120 Mmfd. (C7) | 11265 | Shield—Radiotron shield |
| 12406 | Capacitor—180 Mmfd. (C16) | 14658 | Socket—Dial lamp socket |
| 30396 | Capacitor—470 Mmfd. (C8) | 4794 | Socket—4-contact 80 Radiotron socket |
| 14724 | Capacitor—560 Mmfd. (C17) | 4786 | Socket—6-contact 6D6, 42 or 75 Radiotron socket |
| 30245 | Capacitor—.0045 Mfd. (C3) | 4787 | Socket—7-contact 6A7 Radiotron socket |
| 4858 | Capacitor—.01 Mfd. (C20, C22) | 14637 | Spring—Idler pulley tension spring |
| 13138 | Capacitor—.01 Mfd. (C9, C18) | 12007 | Spring—Retaining spring for core, Stock Nos. 12006 and 14648 |
| 4839 | Capacitor—0.1 Mfd. (C4, C13, C19, C21) | 14640 | Switch—Range switch (S2, S3) |
| 12484 | Capacitor—0.25 Mfd. (C15) | 14376 | Transformer—First I. F. transformer (L4, L5, C11, C12) |
| 11203 | Capacitor—10 Mfd. (C24) | 14642 | Transformer—Second I. F. transformer (L9, L10, C14, C16) |
| 5212 | Capacitor—16 Mfd. (C23) | 14655 | Transformer—Power transformer, 105-125 volts, 50-60 cycle (T1) |
| 14377 | Capacitor—16 Mfd. (C10) | 14656 | Transformer—Power transformer, 105-125 volts, 25-60 cycle (T1) |
| 14646 | Coil—Antenna coil (L1, L2, L3) | 14657 | Transformer—Power Transformer, 100-125/200-250 volts, 50-60 cycle (T1) |
| 14647 | Coil—Oscillator coil (L6, L7, L8) | 14645 | Volume Control and power switch (R5, S1) |
| 14633 | Condenser—2-gang variable tuning condenser (C1, C2, C5, C6) | REPRODUCER ASSEMBLIES | |
| 14648 | Core—Adjustable core and stud for oscillator coil | 14679 | Cone—Reproducer cone (L11) for speaker marked 84010-3 |
| 12006 | Core—Adjustable core and stud for I. F. transformer | 14941 | Cone—Reproducer cone (L11) for speaker marked 84010-1 |
| 14631 | Dial—Station selector dial | 14678 | Reproducer complete marked 84010-3 |
| 14651 | Drive—Variable condenser vernier drive and pinion gear | 14680 | Transformer—Output transformer (T2) for speaker marked 84010-3 |
| 14635 | Indicator—Station selector indicator pointer | 14942 | Transformer—Output transformer (T2) for speaker marked 84010-1 |
| 5226 | Lamp—Dial lamp | MISCELLANEOUS ASSEMBLIES | |
| 14636 | Pulley—Idler pulley—less spring | 14654 | Escutcheon—Station selector escutcheon and crystal knob |
| 14639 | Pulley—Variable condenser drive pulley—located on condenser shaft | 12673 | Knob—Station selector, volume control or range switch knob |
| 14660 | Resistor—18 Ohms—Insulated, 1/4 watt (R14) | 14267 | Screw—Chassis mounting screw and washer |
| 14653 | Resistor—50 Ohms—Flexible type, 1/10 watt (R18) | 4119 | Screw—No. 8—32 x 1/4 headless set screw for knob, Stock No. 12673 |
| 13819 | Resistor—270 Ohms—Wire wound, 1.1 watt (R15) | | |
| 5175 | Resistor—5,600 Ohms—Carbon type, 1/4 watt (R12) | | |
| 14659 | Resistor—6,800 Ohms—Carbon type, 1/4 watt (R3) | | |
| 11305 | Resistor—22,000 Ohms—Carbon type, 1/4 watt (R16) | | |
| 5033 | Resistor—33,000 Ohms—Carbon type, 1 watt (R4) | | |
| 13735 | Resistor—33,000 Ohms—Carbon type, 1/4 watt (R2) | | |
| 11646 | Resistor—47,000 Ohms—Carbon type, 1/4 watt (R9) | | |
| 11323 | Resistor—270,000 Ohms—Carbon type, 1/4 watt (R7, R8) | | |
| 13733 | Resistor—330,000 Ohms—Carbon type, 1/4 watt (R1) | | |
| 13479 | Resistor—390,000 Ohms—Carbon type, 1/4 watt (R10) | | |
| 5035 | Resistor—560,000 Ohms—Carbon type, 1/4 watt (R6) | | |



RCA Victor

MODEL 85T5

Five-Tube, Two-Band, A-C, Superheterodyne Receiver

TECHNICAL INFORMATION AND SERVICE DATA

SERVICE DIVISION • RCA MANUFACTURING COMPANY, INC. • CAMDEN, N. J., U. S. A.

A Service of the Radio Corporation of America

Electrical Specifications

| | | | |
|------------------------------|---------------------------|---|--------------------------------------|
| FREQUENCY RANGES | | R-F ALIGNMENT FREQUENCIES | |
| "Broadcast" (A) | 530-1,900 kc | "Broadcast" (A) | 600 kc (osc.), 1,700 kc (osc.) |
| "Short Wave" (C) | 5,800-21,600 kc | "Short Wave" (C) | 20,000 kc (osc., ant.) |
| Intermediate Frequency | | | 460 kc |
| RADIOTRON COMPLEMENT | | (3) RCA-75 | Second Det., A-F Amp. and A.V.C. |
| (1) RCA-6A7 | First Detector—Oscillator | (4) RCA-42 | Audio Power Amplifier |
| (2) RCA-6D6 | Intermediate Amplifier | (5) RCA-80 | Full-Wave Rectifier |
| Pilot Lamps (2) | | | Mazda No. 46, 6.3 volts, 0.25 ampere |
| POWER SUPPLY RATINGS | | | |
| Rating A | | 105-125 volts, 50-60 cycles, 75 watts | |
| Rating B | | 105-125 volts, 25-60 cycles, 75 watts | |
| Rating C | | 100-125/200-250 volts, 50-60 cycles, 75 watts | |
| POWER OUTPUT RATING | | LOUDSPEAKER | |
| Undistorted | 2.0 watts | Type | Electrodynamic |
| Maximum | 4.5 watts | Voice Coil Impedance | 2¼ ohms at 400 cycles |

Mechanical Specifications

| | |
|-------------------------------|---|
| Height | 19¼ inches |
| Width | 13¾ inches |
| Depth | 9⅛ inches |
| Weight (Net) | 22½ pounds |
| Weight (Shipping) | 27½ pounds |
| Chassis Base Dimensions | 12 inches x 7 inches x 2½ inches |
| Over-all Chassis Height | 8 inches |
| Operating Controls | (1) Volume, (2) Tuning (large inner knob), Range Selector (small outer knob) (3) Power Switch—Tone |
| Tuning Drive Ratio | 20 to 1 |

General Description

This receiver employs a superheterodyne circuit, the arrangement of which is shown on figure 2. Its design includes magnetite-core adjusted i-f transformers and wave-trap; aural-compensated volume control; two-point, high-fre-

quency tone control; automatic volume control; resistance-coupled audio system; phonograph terminal board; and an eight-inch, dust-proof, electrodynamic loudspeaker.

Service Data

The various diagrams of this booklet contain such information as will be needed to isolate causes for defective operation if such develops. The ratings of the resistors, capacitors, coils, etc., are indicated adjacent to the symbols signifying these parts on the diagrams. Identification titles

such as R1, L1, C1, etc., provide reference between the illustrations and Replacement Parts List. The coils, transformer windings, and reactors are rated in terms of d-c resistance to permit continuity checks.

Precautionary Lead Dress.—(1) Keep leads of C2 and C9 as short as possible. (2) Dress leads from power transformer and a-c switch away from antenna coil and associated wiring. (3) Red lead from range selector "ter 4" to oscillator coil L9 should have two tight turns around trimming capacitor C8.

Phonograph Attachment.—A terminal board is provided for connecting a phonograph into the audio-amplifying circuit. RCA Victor Models R-93, R-93-A, R-93-2, R-93-S, or

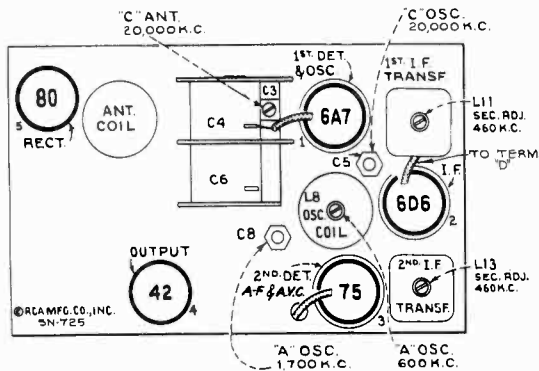
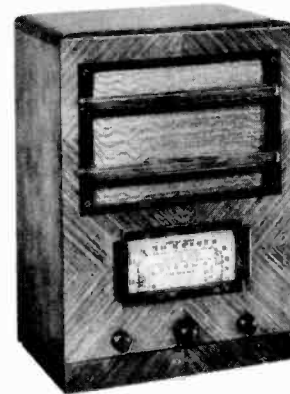

Figure 1—Radiotron, Coil, and Trimmer Locations

R-94 Record Players should be connected as follows: Remove link between terminals 1 and 2 on receiver. Connect green wire in Radio-Record switch cable to terminal 1, yellow to

terminal 2; and shield extension to terminal 3. Tape unused red and blue leads separately. Connect a 2-conductor twisted cable between the Record Player binding posts and the screw terminals on Radio-Record switch.

Loudspeaker.—Centering of the loudspeaker is made in the usual manner with three narrow paper feelers after first removing the front dust cover. This may be removed by softening its cement with a light application of acetone, using care not to allow the acetone to flow into the air gap. The dust cover should be cemented back in place with ambroid upon completion of adjustment.



Model 85T5

Alignment Procedure

Calibrate the tuning dial by adjusting dial pointer to the low-frequency (end) calibration mark on "Broadcast" scale with the gang tuning-condenser plates in full-mesh position. This is a friction adjustment.

Perform alignment in proper order, tabulated below, starting with No. 1 and following all operations across, then No. 2, etc. Adjustment locations are shown on figures 1 and 4.

Cathode-ray alignment is preferable; the connections to the chassis are shown on Figure 3. If an output indicator is used, connect it across the loudspeaker voice-coil and advance the receiver volume control to full-volume position.

Connect the "low" output terminal of the test oscillator

to the receiver chassis for all alignment operations. Regulate the output of the test oscillator so that minimum signal is applied to the receiver to obtain an observable output indication. This will avoid a-v-c action.

The term "Dummy antenna" means the device which must be connected between the "high" test-oscillator output and the point of connection to the receiver in order to obtain ideal alignment. "No signal, 550-750 kc" means that the receiver should be tuned to a point between 550 and 750 kc where no signal or interference is received from a station or local (heterodyne) oscillator.

For further details on alignment, refer to booklet "RCA Victor Receiver Alignment."

| Order of Alignment | Test Oscillator | | | Receiver Dial Setting | Circuit to Adjust | Adjustment Symbols | Adjust to Obtain |
|--------------------|------------------------|---------------|-------------------|-----------------------|-------------------|--------------------|------------------|
| | Connection to Receiver | Dummy Antenna | Frequency Setting | | | | |
| 1 | 6D6 I-F Grid Cap | .001 Mfd. | 460 kc | No Signal 550-750 kc | 2nd I-F Trans. | L12 and L13 | Max. (peak) |
| 2 | 6A7 Det. Grid Cap | .001 Mfd. | 460 kc | No Signal 550-750 kc | 1st I-F Trans. | L10 and L11 | Max. (peak) |
| 3 | Ant. Post | 300 Ohms | 20,000 kc | 20,000 kc | "C" Osc. | C5 | Max. (peak)* |
| 4 | Ant. Post | 300 Ohms | 20,000 kc | Rock Thru 20,000 kc | "C" Ant. | C3 | Max. (peak)† |
| 5 | Ant. Post | 200 Mmfd. | 600 kc | 600 kc | "A" L-F Osc. | L8 | Max. (peak) |
| 6 | Ant. Post | 200 Mmfd. | 1,700 kc | 1,700 kc | "A" H-F Osc. | C8 | Max. (peak) |
| 7 | Ant. Post | 200 Mmfd. | 600 kc | Rock Thru 600 kc | "A" L-F Osc. | L8 | Max. (peak) |
| 8 | Ant. Post | 200 Mmfd. | 1,700 kc | 1,700 kc | "A" H-F Osc. | C8 | Max. (peak) |

* Use minimum capacity peak.

† Use maximum capacity peak.

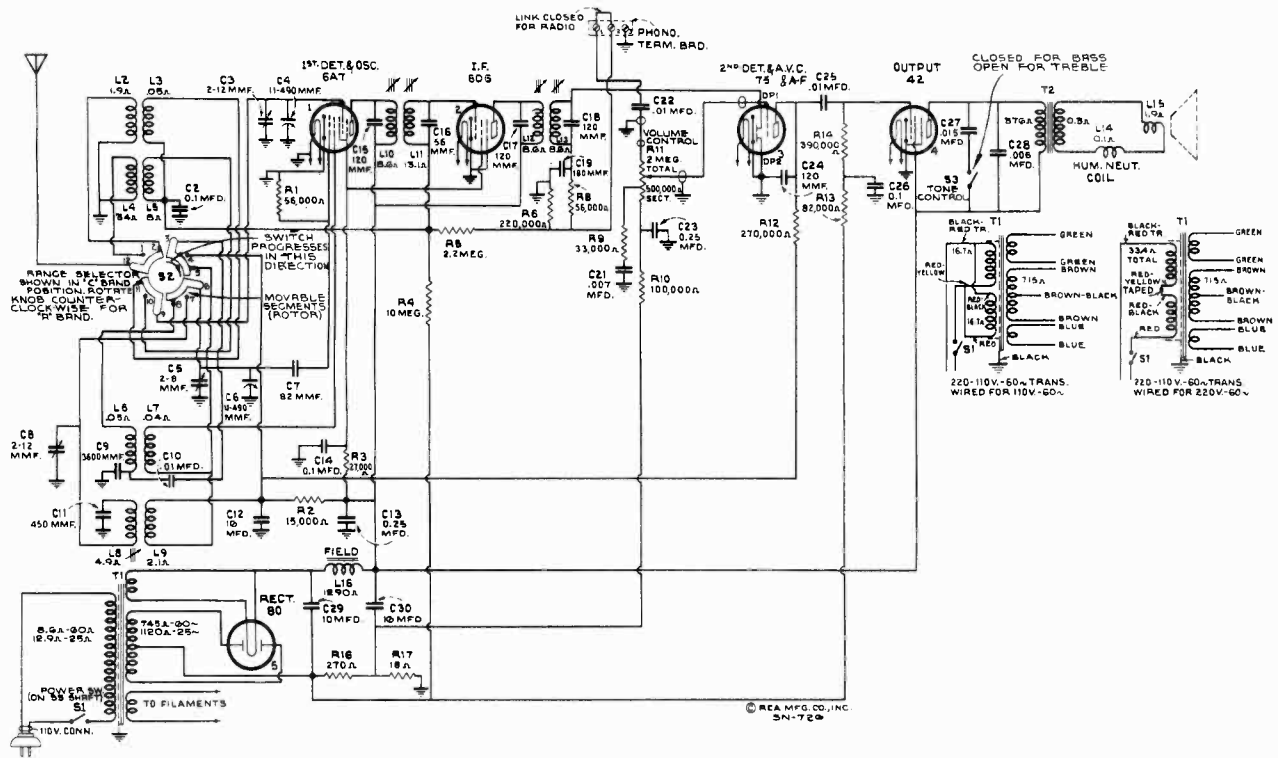

Figure 2—Schematic Circuit Diagram

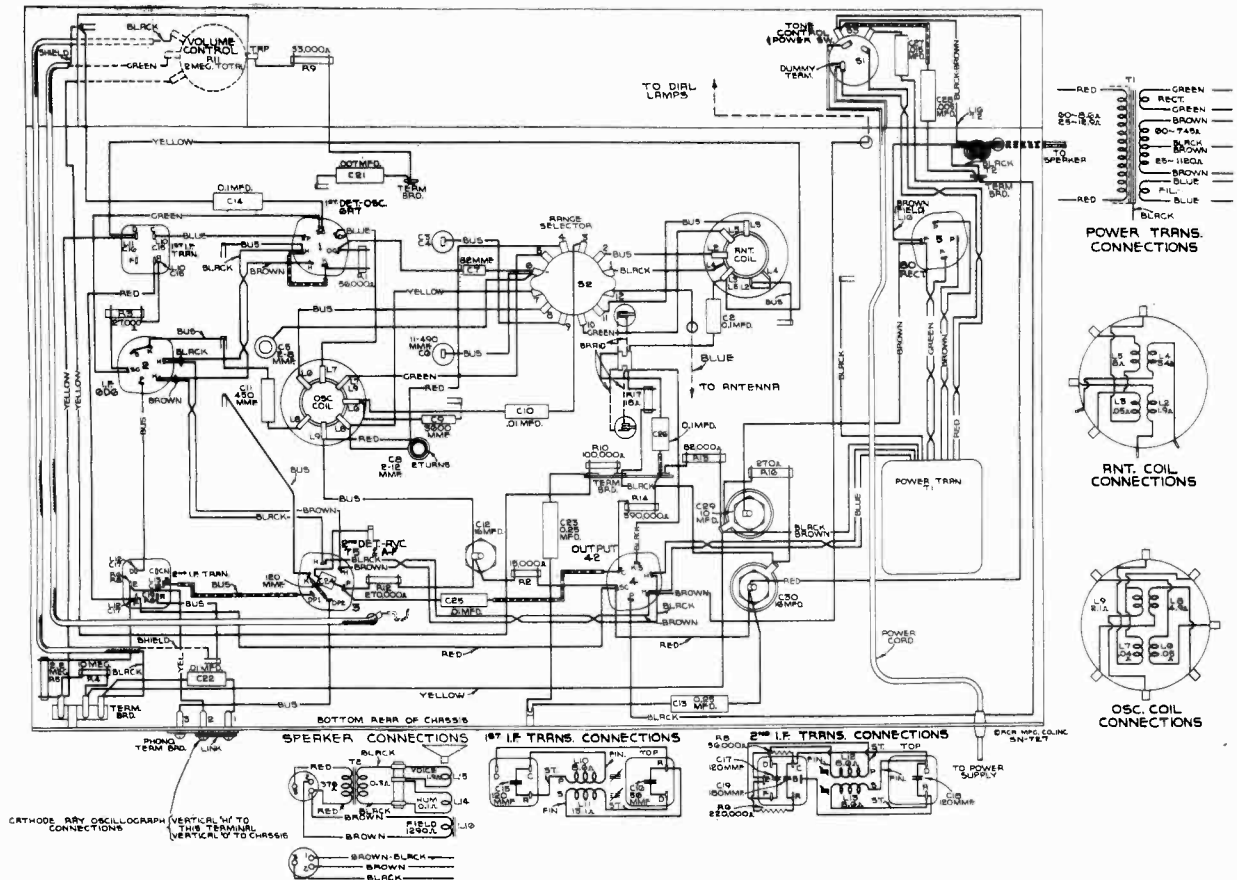

Figure 3—Chassis Wiring Diagram

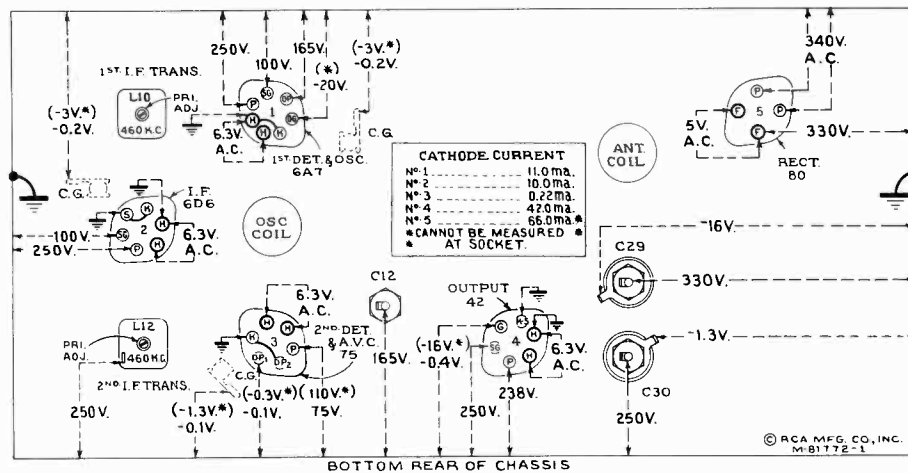

Figure 4—Radiotron Socket Voltages, Coil, and Trimmer Locations
Measured at 115 volts, 60-cycle supply—Tuned to approximately 1,000 kc ("Broadcast")—
No signal being received—Volume control minimum

Note: Two voltage values are shown for some readings. The value shown in parentheses with asterisk (*) indicates operating conditions without voltmeter loading. The other value (generally lower) is the actual measured voltage and differs from the value shown in parentheses because of the additional loading of the voltmeter through the high series circuit resistance.

Voltage values as specified should hold with in $\pm 20\%$ when the receiver is normally operative at its rated line voltage. To duplicate the conditions under which the voltages were measured requires a 1,000-ohm-per-volt d-c meter, having ranges of 10, 50, 250, and 500 volts. Use the nearest range above the specified measured voltage. A-c voltages were measured with a corresponding a-c meter.

REPLACEMENT PARTS

Insist on genuine factory tested parts, which are readily identified and may be purchased from authorized dealers.

| STOCK No. | DESCRIPTION | STOCK No. | DESCRIPTION |
|----------------------------|---|---|---|
| RECEIVER ASSEMBLIES | | | |
| 14352 | Belt—Variable condenser drive belt | 11365 | Resistor—82,000 Ohms, Carbon type, $\frac{1}{2}$ watt (R13) |
| 12717 | Board—Phonograph terminal board | 5145 | Resistor—100,000 Ohms, Carbon type, $\frac{1}{2}$ watt (R10) |
| 14338 | Bushing—Variable condenser mounting bushing assembly | 11398 | Resistor—220,000 Ohms, Carbon type, 1/10 watt (R6) |
| 12607 | Cap—First I.F. transformer shield top | 11323 | Resistor—270,000 Ohms, Carbon type, $\frac{1}{2}$ watt (R12) |
| 12581 | Cap—Second I.F. transformer shield top | 13479 | Resistor—390,000 Ohms, Carbon type, $\frac{1}{2}$ watt (R14) |
| 12118 | Cap—Grid contact cap | 11626 | Resistor—2.2 Megohm, Carbon type, $\frac{1}{2}$ watt (R5) |
| 12714 | Capacitor—Adjustable trimmer (Medium) (C8) | 13732 | Resistor—10 Megohm, Carbon type, $\frac{1}{2}$ watt (R4) |
| 12807 | Capacitor—Adjustable trimmer (Short) (C5) | 14350 | Screw—No. 8-32 x 3/16 Square head set screw for gear Stock No. 14349 and drum Stock No. 14345 |
| 12629 | Capacitor—56 Mmfd. (C16) | 12799 | Shield—Antenna or oscillator coil shield |
| 13394 | Capacitor—82 Mmfd. (C7) | 13311 | Shield—Chassis end shield and mounting bracket assembly |
| 12404 | Capacitor—120 Mmfd. (C15, C17, C18) | 12008 | Shield—I. F. transformer shield for Stock No. 12801 and No. 12653 |
| 12724 | Capacitor—120 Mmfd. (C24) | 3682 | Shield—Shield for 75 Radiotron |
| 12406 | Capacitor—180 Mmfd. (C19) | 3950 | Shield—Shield for 6D6 Radiotron |
| 12812 | Capacitor—450 Mmfd. (C11) | 11114 | Socket—Dial lamp socket |
| 12811 | Capacitor—3,600 Mmfd. (C9) | 4794 | Socket—4 contact 80 Radiotron socket |
| 5148 | Capacitor—.007 Mfd. (C21) | 4786 | Socket—6 contact 6D6, 42 or 75 Radiotron socket |
| 4868 | Capacitor—.005 Mfd. (C28) | 4787 | Socket—7 contact 6A7 Radiotron socket |
| 11315 | Capacitor—.015 Mfd. (C27) | 12007 | Spring—Retaining spring for core Stock No. 12006 |
| 4858 | Capacitor—.01 Mfd. (C10, C22, C25) | 14342 | Spring—Tension spring for idler Stock No. 14341 |
| 4841 | Capacitor—.01 Mfd. (C2, C14, C26) | 12907 | Spring—Tension spring for indicator gear Stock No. 14351 |
| 4840 | Capacitor—.025 Mfd. (C23) | 14336 | Switch—Range switch (S2) |
| 5170 | Capacitor—.025 Mfd. (C13) | 14337 | Switch—Tone control switch and power switch (S1, S3) |
| 11240 | Capacitor—10 Mfd. (C29) | 12801 | Transformer—First I. F. transformer (L10, L11, C15, C16) |
| 5212 | Capacitor—16 Mfd. (C30) | 12653 | Transformer—Second I. F. transformer (L12, L13, C17, C18, R6, R8) |
| 14377 | Coil—Antenna coil and shield (L2, L3, L4, L5) | 13392 | Transformer—Power transformer, 105-125 volts, 50-60 cycle (T1) |
| 12797 | Coil—Oscillator coil and shield (L6, L7, L8, L9) | 13566 | Transformer—Power transformer, 105-125 volts, 25-60 cycles (T1) |
| 12798 | Coil—Oscillator coil and shield (L6, L7, L8, L9) | 13393 | Transformer—Power transformer, 105-125, 210-250 volts, 50-60 cycle (T1) |
| 14348 | Condenser—2-gang variable tuning condenser (C3, C4, C6) | 14335 | Volume Control—(R11) |
| 5119 | Connector—3-contact female connector for speaker cable | 13192 | Washer—Felt washer for indicator pointer |
| 12800 | Core—Adjustable core and stud assembly for coil Stock No. 12798 | REPRODUCER ASSEMBLIES (RL-63F-1) | |
| 12006 | Core—Adjustable core and stud for transformer Stock No. 12801 and No. 12653 | 14356 | Board—3 contact reproducer terminal board |
| 14339 | Dial—Station dial and mounting bracket assembly | 13866 | Cap—Cone center dust cap |
| 14353 | Drive—Variable condenser vernier drive pinion gear and shaft | 12012 | Coil—Field coil (L16) |
| 14345 | Drum—Variable condenser drive belt drum complete with set screws | 11469 | Coil—Hum neutralizing coil (L14) |
| 14349 | Gear—Indicator drive gear and hub complete with set screws | 12642 | Cone—Reproducer cone and dust cap (L15) |
| 14351 | Gear—Indicator pointer stem and gear complete with tension spring | 5118 | Plug—3 contact male plug for reproducer |
| 14341 | Idler—Station selector drive belt idler | 14360 | Reproducer—Reproducer complete |
| 14344 | Indicator—Station selector indicator pointer | 14358 | Screw—Screw, washer and lockwasher to hold core in yoke |
| 5226 | Lamp—Dial lamp | 14355 | Transformer—Output transformer (T2) |
| 14028 | Nut—Jamb nut for trimmer capacitors | 14357 | Washer—Spring washer to hold field coil |
| 14340 | Pulley—Station selector drive belt pulley and knob shaft | MISCELLANEOUS ASSEMBLIES | |
| 14347 | Reflector—Dial reflector and lamp bracket assembly | 14479 | Escutcheon—Station selector escutcheon and crystal |
| 14343 | Retainer—Drive shaft and pulley retainer—holds tuning knob shaft and pulley on range switch shaft | 14269 | Knob—Volume control, tone control or range switch knob |
| 13674 | Resistor—18 Ohms, Carbon type, $\frac{1}{2}$ watt (R17) | 11377 | Knob—Station selector knob |
| 13819 | Resistor—270 Ohms, Insulated wire wound, 1.1 watt (R16) | 4982 | Screw—Chassis mounting screw and washer assembly |
| 12759 | Resistor—15,000 Ohms, Carbon type, $\frac{1}{2}$ watt (R2) | 4982 | Spring—Retaining spring for knob Stock No. 14359 |
| 13477 | Resistor—27,000 Ohms, Carbon type, 1 watt (R3) | 14270 | Spring—Retaining spring for knob Stock No. 14289 |
| 13735 | Resistor—33,000 Ohms, Carbon type, $\frac{1}{2}$ watt (R9) | | |
| 5029 | Resistor—56,000 Ohms, Carbon type, $\frac{1}{2}$ watt (R1) | | |
| 11282 | Resistor—56,000 Ohms, Carbon type, 1/10 watt (R8) | | |



RCA Victor

MODEL 85T8

Five-Tube, Three-Band, A-C, Superheterodyne Receiver

TECHNICAL INFORMATION AND SERVICE DATA

SERVICE DIVISION • RCA MANUFACTURING COMPANY, INC. • CAMDEN, N. J., U. S. A.

A Service of the Radio Corporation of America

Electrical Specifications

FREQUENCY RANGES

| | |
|-------------------------------|-----------------|
| "Standard Broadcast" (A)..... | 540-1,500 kc |
| "Short Wave—1" (B)..... | 2,300-7,000 kc |
| "Short Wave—2" (C)..... | 7,000-22,000 kc |

R-F ALIGNMENT FREQUENCIES

| | |
|-------------------------------|--------------------------------|
| "Short Wave—1" (B)..... | 6,000 kc (osc., ant.) |
| "Short Wave—2" (C)..... | 20,000 kc (osc.) |
| "Standard Broadcast" (A)..... | 600 kc (osc.), 1,500 kc (osc.) |

INTERMEDIATE FREQUENCY..... 460 kc

RADIOTRON COMPLEMENT

- (1) RCA-6A8-G..... First Detector—Oscillator
- (2) RCA-6K7..... Intermediate Amplifier
- (3) RCA-6Q7-G.. Second Detector, A.V.C., and A-F Amp.
- (4) RCA-6F6-G..... Power Output
- (5) RCA-5Y3-G..... Full-Wave Rectifier

POWER SUPPLY RATINGS

| | |
|---------------|---|
| Rating A..... | 105-125 volts, 50-60 cycles, 75 watts |
| Rating B..... | 105-125 volts, 25-60 cycles, 75 watts |
| Rating C.... | 105-125/200-250 volts, 50-60 cycles, 75 watts |

PILOT LAMPS (2)..... 6.3 volts, 0.25 amp.

POWER OUTPUT RATING

| | |
|------------------|-----------|
| Undistorted..... | 2.5 watts |
| Maximum..... | 4.5 watts |

LOUDSPEAKER

| | |
|---------------------|------------------------|
| Type..... | 8-inch Electrodynamic |
| V.C. Impedance..... | 2.2 ohms at 400 cycles |

Mechanical Specifications

| | |
|------------------------------|--|
| Height..... | 17½ inches |
| Width..... | 12½ inches |
| Depth..... | 8 ¹⁰ / ₁₆ inches |
| Net Weight..... | 21 pounds |
| Shipping Weight..... | 26 pounds |
| Chassis Base Dimensions..... | 9½ inches x 7½ inches x 2½ inches |
| Over-all Chassis Height..... | 7 ³ / ₁₆ inches |
| Operating Controls..... | (1) Power Switch—Tone; (2) Tuning (large inner knob), Range Selector (small outer knob, left to right "A," "B," "C"); (3) Volume |
| Tuning Drive Ratio..... | 20 to 1 |

General Description

Model 85T8 is a table-type instrument, designed to cover three ranges of tuning, including the standard American broadcast range, the Aviation, Police and major Amateur bands, and the Short Wave band extending between 7,000 kc and 22,000 kc. The circuit consists of the superheterodyne

type, employing five tubes, two of which serve multiple purposes. Magnetite core I-F transformers are used. The r-f coils are of a design that provide excellent gain and proper alignment at all times. The loudspeaker is an electrodynamic type.

Radiotron Cathode Currents

Measured with Milliammeter Connected at Tube Socket
Cathode Terminals

| | |
|--------------------|----------|
| (1) RCA-6A8-G..... | 12.7 ma. |
| (2) RCA-6K7..... | 8.2 ma. |
| (3) RCA-6Q7-G..... | 0.35 ma. |
| (4) RCA-6F6-G..... | 38 ma. |
| (5) RCA-5Y3-G..... | 59.5 ma. |

Alignment Procedure

Calibrate the tuning dial by adjusting dial pointer to the low-frequency (end) calibration mark on dial with the gang tuning-condenser plates in full-mesh position. The pointer is soldered in place on the drive cable.

Perform alignment in proper order, tabulated below, starting with No. 1 and following all operations across, then No. 2, etc. Adjustment locations are shown on figures 1 and 2.

Cathode-ray alignment is highly preferable; the connections to the chassis are shown on figure 4. If an output indicator is used, connect it across the loudspeaker voice-coil and advance the receiver volume control to full-volume position.

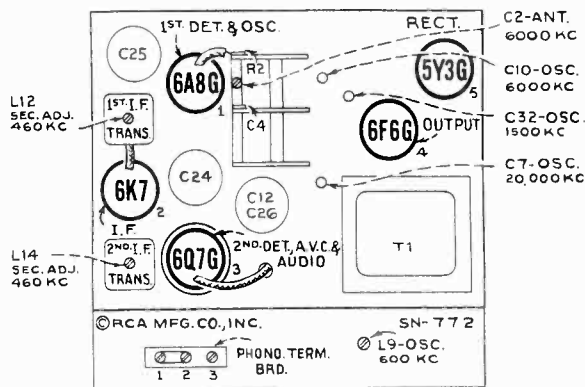

Figure 1—Radiotron, Coil and Trimmer Locations

Connect the "low" output terminal of the test oscillator to the receiver "G" (ground) terminal for all alignment operations. Regulate the output of the test oscillator so that minimum signal is applied to the receiver to obtain an observable output indication. This will avoid a-v-c action.

The term "Dummy antenna" means the device which must be connected between the "high" test-oscillator output and the point of connection to the receiver in order to obtain ideal alignment. "No signal, 550-750 kc" means that the receiver should be tuned to a point between 550 and 750 kc where no signal or interference is received from a station or local (heterodyne) oscillator.

For further details on alignment, refer to booklet "RCA Victor Receiver Alignment."

| Order of Alignment | Test Oscillator | | | Range Selector | Receiver Dial Setting | Circuit to Adjust | Adjustment Symbols | Adjust to Obtain |
|--------------------|------------------------|---------------|-------------------|----------------|-----------------------|-------------------|--------------------|------------------|
| | Connection to Receiver | Dummy Antenna | Frequency Setting | | | | | |
| 1 | 6K7 I-F Grid Cap | .001 Mfd. | 460 kc | "A" Left | No Signal 550-750 kc | 2nd I-F Trans. | L13 and L14 | Max. (peak) |
| 2 | 6A8 Det. Grid Cap | .001 Mfd. | 460 kc | "A" | No Signal 550-750 kc | 1st I-F Trans. | L11 and L12 | Max. (peak) |
| 3 | Ant. Term. | 300 Ohms | 6,000 kc | "B" Center | 6,000 kc | "B" Osc. | C10 | Max. (peak) |
| 4 | Ant. Term. | 300 Ohms | 6,000 kc | "B" | 6,000 kc | "B" Ant. | C2 | Max. (peak) |
| 5 | Ant. Term. | 300 Ohms | 20,000 kc | "C" Right | 20,000 kc | "C" Osc. | C7 | Max. (peak)* |
| 6 | Ant. Term. | 200 Mmfd. | 600 kc | "A" Left | 600 kc | "A" L-F Osc. | L9 | Max. (peak) |
| 7 | Ant. Term. | 200 Mmfd. | 1,500 kc | "A" | 1,500 kc | "A" H-F Osc. | C32 | Max. (peak) |
| 8 | Ant. Term. | 200 Mmfd. | 600 kc | "A" | 600 kc | "A" L-F Osc. | L9 | Max. (peak) |
| 9 | Ant. Term. | 200 Mmfd. | 1,500 kc | "A" | 1,500 kc | "A" H-F Osc. | C32 | Max. (peak) |

* Use maximum capacity peak if two peaks can be obtained. After this adjustment, check for image signal by shifting receiver dial to 20,920 kc.

Service Data

Loudspeaker.—Centering of the loudspeaker is made in the usual manner with three narrow paper feelers after first removing the front dust cover. This may be removed by softening its cement with a light application of acetone, using care not to allow the acetone to flow into the air gap. The dust cover should be cemented back in place with ambroid upon completion of adjustment.

Phonograph Attachment.—A terminal board is provided for connecting a phonograph into the audio amplifying circuit. RCA Victor Models R-93, R-93-A, R-93-2, or R-94 Record Players should be connected as follows: Open link between terminals 1 and 2 on terminal board. Connect green wire in Radio-Record switch cable to terminal 2, yellow to terminal 1, and shield extension to terminal 3. Tape unused red and blue leads separately. Connect a 2-conductor twisted cable between the Record Player binding posts and the screw terminals on Radio-Record switch.



Model 85T8

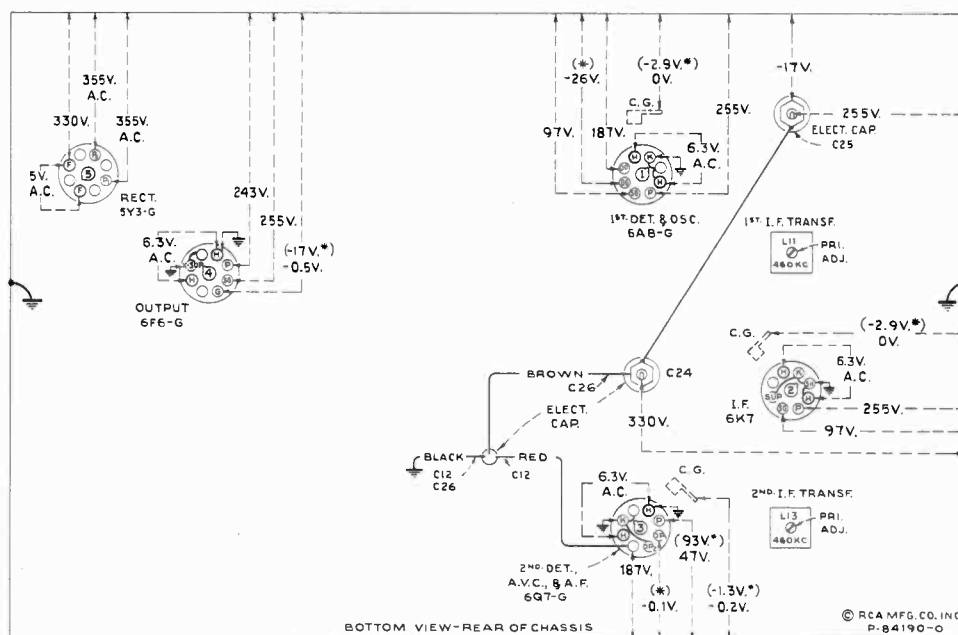

Figure 2—Radiotron Socket Voltages and Trimmer Locations

Measured at 115 volts, 60-cycle supply—Tuned to approximately 1,000 kc ("Standard Broadcast")—
No signal being received—Volume control minimum—Tone control optional

Note: Two voltage values are shown for some readings. The value shown in parentheses with asterisk (*) indicates operating conditions without voltmeter loading. The other value (generally lower) is the actual measured voltage and differs from the value shown in parentheses because of the additional loading of the voltmeter through the high series circuit resistance.

Voltage values as specified should hold within $\pm 20\%$ when the receiver is normally operative at its rated line voltage. To duplicate the conditions under which the voltages were measured requires a 1,000-ohm-per-volt d-c meter, having ranges of 10, 50, 250, and 500 volts. Use the nearest range above the specified measured voltage. A-c voltages were measured with a corresponding a-c meter.

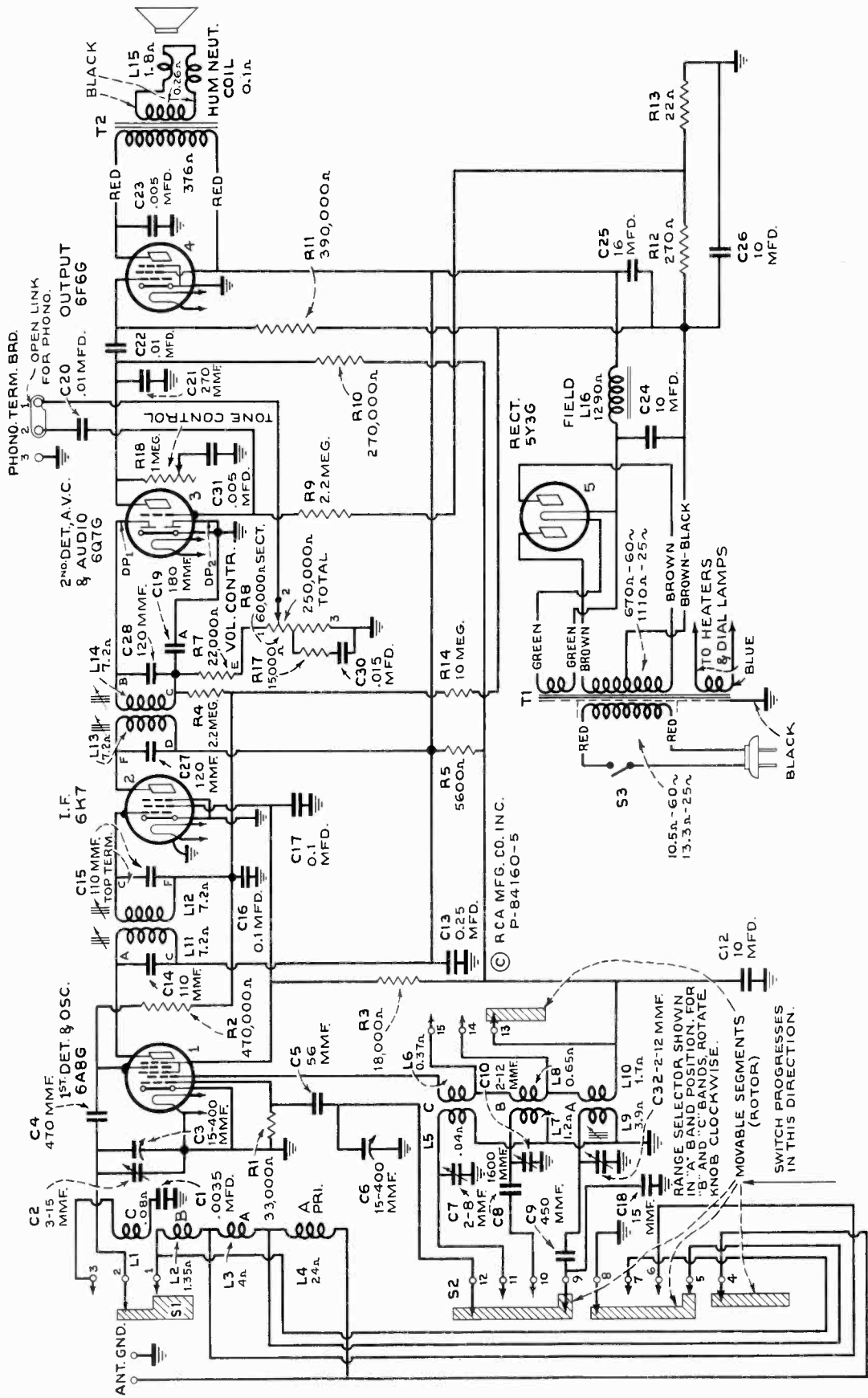
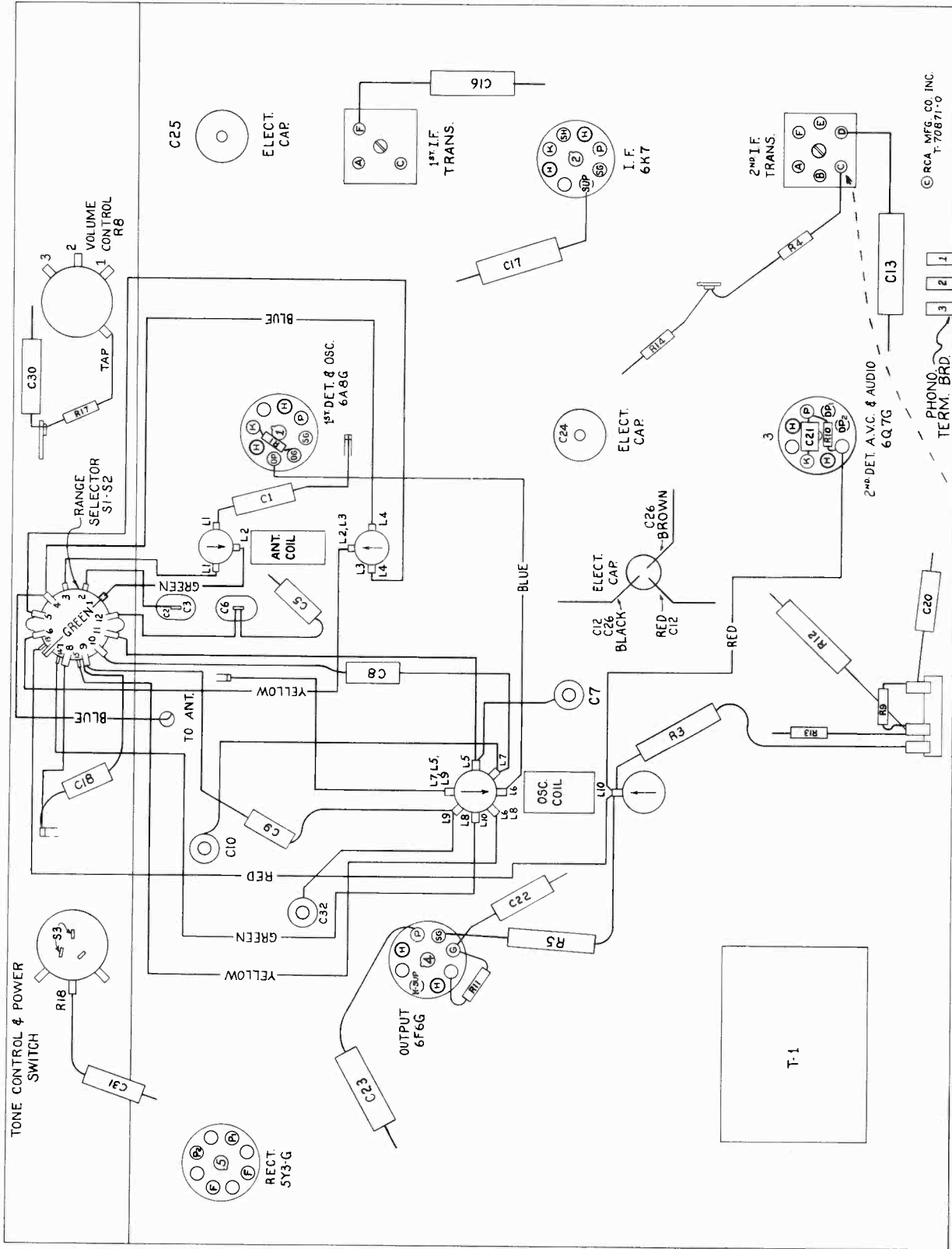

Figure 3—Schematic Circuit Diagram



BOTTOM VIEW - REAR OF CHASSIS

Figure 4—Chassis Parts Location Diagram

REPLACEMENT PARTS

Insist on genuine factory-tested parts, which are readily identified and may be purchased from authorized dealers.

| STOCK No. | DESCRIPTION | STOCK No. | DESCRIPTION |
|----------------------------|--|-----------|---|
| RECEIVER ASSEMBLIES | | | |
| 14380 | Arm—Hub and arm for operating band indicator shutter —fastens on range switch shaft | 30151 | Resistor—18,000 ohms, insulated, 1 watt (R3) |
| 14352 | Belt—Station selector drive belt | 14284 | Resistor—22,000 ohms, carbon type, 1/10 watt (R7) |
| 13216 | Board—Antenna and ground terminal board | 12454 | Resistor—33,000 ohms, insulated, 1/2 watt (R1) |
| 12717 | Board—Phonograph terminal board | 12199 | Resistor—270,000 ohms, insulated, 1/2 watt (R10) |
| 12607 | Cap—Top shield cap for first i-f transformer | 13005 | Resistor—390,000 ohms, carbon type, 1/10 watt (R11) |
| 12581 | Cap—Top shield cap for second i-f transformer | 11452 | Resistor—470,000 ohms, carbon type, 1/10 watt (R2) |
| 11350 | Cap—Grid contact cap | 11626 | Resistor—2.2 meg., carbon type, 1/2 watt (R4, R9) |
| 12807 | Capacitor—Adjustable trimmer (short) (C7) | 13601 | Resistor—10 meg., insulated, 1/2 watt (R14) |
| 12714 | Capacitor—Adjustable trimmer (medium) (C32) | 30582 | Retainer—Band indicator disc retainer |
| 12896 | Capacitor—15 mmfd. (C18) | 14343 | Ring—Retaining ring for range switch shaft |
| 12723 | Capacitor—56 mmfd. (C5) | 14350 | Screw—No. 8-32 x 3/16-inch square-head set screw for drum, Stock No. 30584; arm, Stock No. 14380, and pulley, Stock No. 30587 |
| 14262 | Capacitor—110 mmfd. (C14, C15) | 14340 | Shaft—Drive pulley and knob shaft—fastens on range-switch shaft |
| 12404 | Capacitor—120 mmfd. (C27, C28) | 3682 | Shield—Radiotron shield |
| 12406 | Capacitor—180 mmfd. (C19) | 12008 | Shield—I-f transformer shield can |
| 12488 | Capacitor—270 mmfd. (C21) | 5119 | Socket—3-contact speaker cable socket |
| 12812 | Capacitor—450 mmfd. (C9) | 11196 | Socket—8-contact Radiotron socket |
| 30433 | Capacitor—470 mmfd. (C4) | 14114 | Socket—Dial lamp socket |
| 30592 | Capacitor—1,600 mmfd. (C8) | 12007 | Spring—Retaining spring for core, Stock No. 12006 |
| 30303 | Capacitor—.0035 mfd. (C1) | 30585 | Spring—Tension spring for pointer cord |
| 4838 | Capacitor—.005 mfd. (C23, C31) | 30588 | Spring—Tension spring for idler pulley |
| 14393 | Capacitor—.01 mfd. (C20, C22) | 30620 | Switch—Range switch (S1, S2) |
| 11315 | Capacitor—.015 mfd. (C30) | 30574 | Tone control and power switch (R18, S3) |
| 4839 | Capacitor—0.1 mfd. (C16, C17) | 14376 | Transformer—First i-f transformer (L11, L12, C14, C15) |
| 12484 | Capacitor—0.25 mfd. (C13) | 14308 | Transformer—Second i-f transformer (L13, L14, C19, C27, C28, R7) |
| 11203 | Capacitor—10 mfd. (C12) | 30571 | Transformer—Power transformer, 105-125 volts, 25-60 cycles (T1) |
| 30577 | Capacitor Pack—Comprising two sections, each 10 mfd. (C24, C26) | 30617 | Transformer—Power transformer, 105-125 and 200-250 volts, 50-60 cycles (T1) |
| 5212 | Capacitor—16 mfd. (C25) | 30575 | Volume Control (R8) |
| 4358 | Clamp—Mounting clamp for capacitor pack, Stock No. 30577 | | REPRODUCER ASSEMBLIES (RL-63F-1) |
| 30621 | Coil—Antenna coil (L1, L2, L3, L4) | 14356 | Board—3-contact reproducer terminal board |
| 30579 | Coil—Oscillator coil (L5, L6, L7, L8, L9, L10) | 13868 | Cap—Cone center dust cap |
| 30573 | Condenser—2-gang variable tuning condenser (C2, C3, C6) | 12012 | Coil—Field coil (L16) |
| 30586 | Cord—Station selector indicator pointer cord | 11469 | Coil—Hum neutralizing coil (L17) |
| 12800 | Core—Adjustable core and stud for oscillator coil | 12642 | Cone—Reproducer cone and dust cap (L15) |
| 12006 | Core—Adjustable core and stud for i-f transformers | 5118 | Plug—3-contact male plug for reproducer |
| 30622 | Dial—Station selector dial scale | 14360 | Reproducer—Complete |
| 30581 | Disc—Band indicator disc with celluloid window | 14358 | Screw—Screw, washer, and lockwasher to hold core in yoke |
| 30572 | Drive—Vernier drive shaft and pinion gear for variable condenser | 14355 | Transformer—Output transformer (T2) |
| 30584 | Drum—Station-selector drive-cord drum with set screws | 14357 | Washer—Spring washer to hold field coil |
| 30583 | Indicator—Station-selector indicator pointer and holder assembly | | MISCELLANEOUS ASSEMBLIES |
| 5226 | Lamp—Dial lamp | 30593 | Escutcheon—Dial escutcheon and crystal |
| 14028 | Nut—Jamb nut for adjustable capacitor, Stock Nos. 12807 and 12714 | 14359 | Knob—Station selector knob |
| 30587 | Pulley—Drive-belt pulley for condenser shaft | 14269 | Knob—Tone control, volume control, or range-switch knob |
| 14636 | Pulley—Drive-belt idler pulley | 14267 | Screw—Chassis mounting screw and washer assembly |
| 14525 | Resistor—22 ohms, carbon type, 1/2 watt (R13) | 14270 | Spring—Retaining spring for knob, Stock No. 14269 |
| 13819 | Resistor—270 ohms, insulated, wire-wound, 1.1 watt (R12) | 4982 | Spring—Retaining spring for knob, Stock No. 14359 |
| 11298 | Resistor—5,600 ohms, carbon type, 1 watt (R5) | | |
| 12695 | Resistor—15,000 ohms, insulated, 1/2 watt (R17) | | |



RCA Victor

MODELS 86E, 86K, 86K7, 86T, 86T1, 87K, and 87T

Six- and Seven-Tube, Three-Band, A-C, Superheterodyne Receivers

TECHNICAL INFORMATION AND SERVICE DATA

-1937 No. 19-

SERVICE DIVISION • RCA MANUFACTURING COMPANY, INC. • CAMDEN, N. J., U. S. A.

A Service of the Radio Corporation of America

Electrical Specifications

FREQUENCY RANGES

"Broadcast" (A)..... 530- 1,720 kc
 "Medium Wave" (B)..... 2,100- 6,800 kc
 "Short Wave" (C)..... 6,800-22,000 kc
 Intermediate Frequency.....

R-F ALIGNMENT FREQUENCIES

"Short Wave" (C)..... 20,000 kc (osc.)
 "Medium Wave" (B)..... 6,000 kc (osc., ant.)
 "Broadcast" (A)..... 600 kc (osc.), 1,500 kc (osc.)
 460 kc

RADIOTRON COMPLEMENT

(1) RCA-6A8..... First Detector—Oscillator
 (2) RCA-6K7..... Intermediate Amplifier
 (3) RCA-6H6..... Second Detector and A.V.C.

(4) RCA-6F5..... Audio Voltage Amplifier
 (5) RCA-6F6..... Audio Power Amplifier
 (6) RCA-5W4..... Full-Wave Rectifier
 (7) RCA-6G5 (Models 87K and 87T only).. Tuning Tube

Pilot Lamps (2)..... Mazda No. 46, 6.3 volts, 0.25 amp.

POWER SUPPLY RATINGS

Rating A..... 105-125 volts, 50-60 cycles, 80 watts
 Rating B..... 105-125 volts, 25-60 cycles, 80 watts
 Rating C..... 100-130/140-160/195-250 volts, 40-60 cycles, 80 watts

POWER OUTPUT

Undistorted..... 2.5 watts
 Maximum..... 4.5 watts

LOUDSPEAKER

Type..... Electrodynamic
 Impedance (v.c.).. { (RL-70E-1) 2.2 ohms }
 { (84001-3) 2.6 ohms } at 400 cycles
 { (84001-6) 4.7 ohms }

Mechanical Specifications

MODELS

| | 86E | 86K | 86K7 | 86T | 86T1 | 87K | 87T |
|--|--|---------------------------------|---------------------------------|---------------------------------|---------------------------------|--------------------------------|---------------------------------|
| Height (inches)..... | 23 ³ / ₈ | 38 | 40 | 11 ⁷ / ₁₆ | 11 ⁷ / ₈ | 40 | 11 ⁵ / ₁₆ |
| Width (inches)..... | 26 ³ / ₄ | 23 ³ / ₄ | 20 ³ / ₄ | 17 ¹ / ₃₂ | 16 ⁹ / ₁₆ | 25 ³ / ₈ | 18 ³ / ₄ |
| Depth (inches)..... | 14 ⁷ / ₈ | 12 ⁷ / ₁₆ | 12 ⁹ / ₁₆ | 8 ¹⁵ / ₁₆ | 9 ³ / ₃₂ | 13 ¹ / ₄ | 8 ³ / ₁₆ |
| Net Weight (pounds)..... | 52 | 46 | 52 | 19 | 22 | 51 ¹ / ₂ | 20 ¹ / ₂ |
| Shipping Weight (pounds)..... | 61 | 59 ¹ / ₂ | 66 | 23 ¹ / ₂ | 26 | 67 ¹ / ₂ | 25 |
| Chassis Base Dimensions (86E, 86K, 86K7, 87K)..... | 14 ⁷ / ₈ inches x 9 ³ / ₄ inches x 3 ¹ / ₄ inches | | | | | | |
| Over-all Chassis Height..... | 9 ¹ / ₂ inches | | | | | | |
| Chassis Base Dimensions (86T, 86T1, 87T)..... | 15 ¹ / ₄ inches x 6 ¹ / ₂ inches x 2 ³ / ₄ inches | | | | | | |
| Over-all Chassis Height..... | 9 inches | | | | | | |
| Operating Controls..... | (1) Power Switch—Tone; (2) Tuning (large inner knob), Range Selector (small outer knob, left to right "A", "B", "C"); (3) Volume | | | | | | |
| Tuning Drive Ratio..... | 20 to 1 | | | | | | |

General Description

These receivers employ a conventional three-band superheterodyne circuit, the arrangement of which is shown by the Schematic Circuit Diagram. Models 87K, 86K, and 86K7 are console models, each employing a 12-inch electrodynamic loudspeaker. Models 87T, 86T, and 86T1 are chest-type table models, each employing a 6-inch electrodynamic loud-

speaker. Model 86E is an arm-chair model with the chassis mounted vertically to afford operation from the top, and includes a 12-inch electrodynamic loudspeaker. Models 87K and 87T incorporate a "Magic-Eye" tuning indicator.

The extensive tuning range afforded by the three tuning bands includes the "Standard broadcast" band and the im-

Copyright, 1937, RCA Manufacturing Co., Inc.

Trademarks "Radiotron," "Magic Eye"
Reg. U. S. Pat. Off. by RCA Mfg. Co., Inc.

portant short-wave international broadcast bands of 49, 31, 25, 19, 16, and 13 meters along with channels assigned for police, aviation, and amateur communication.

Features of design include magnetite core i-f transformers and low-frequency oscillator tracking; antenna wave trap; full automatic volume control; phonograph terminal board; aural-

compensated audio volume control; two-point, high-frequency tone control; dust-proof electrodynamic loudspeaker; "Magic-Eye" tuning tube on 87K and 87T only; and a new sunburst dial with band indicator and short-wave stations listed by name.

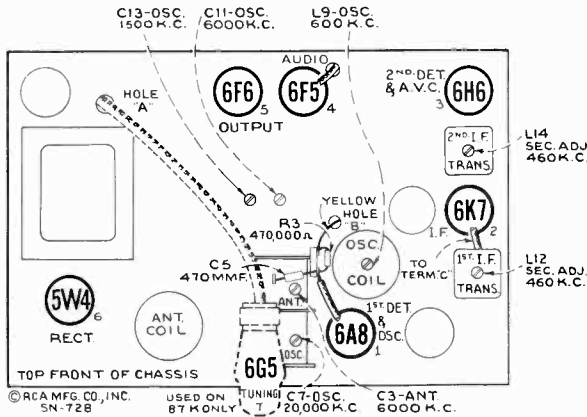

Figure 1—Radiotron, Coil, and Trimmer Locations (Models 86E, 86K, 86K7, and 87K)

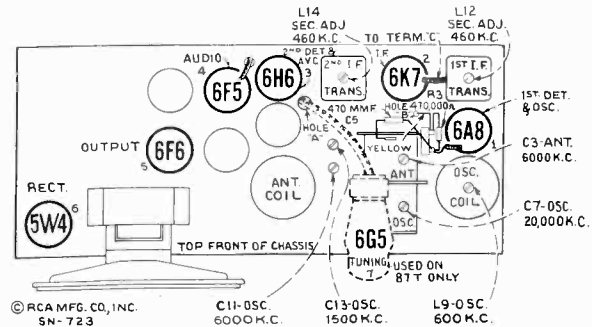

Figure 2—Radiotron, Coil, and Trimmer Locations (Models 86T, 86T1, and 87T)

Alignment Procedure

Calibrate the tuning dial by adjusting main dial pointer to the low-frequency (end) calibration mark on dial with the gang tuning-condenser plates in full-mesh position; then adjust the small (vernier) pointer to "O." These are friction adjustments.

Perform alignment in proper order, tabulated below, starting with No. 1 and following all operations across, then No. 2, etc. Adjustment locations are shown on figures 1, 2, 3, and 4.

Cathode-ray alignment is highly preferable; the connections to the chassis are shown on figures 6, 7, and 8. If an output indicator is used, connect it across the loudspeaker voice-coil and advance the receiver volume control to full-volume position.

Connect the "low" output terminal of the test oscillator to the receiver "G" (ground) terminal for all alignment operations. Regulate the output of the test oscillator so that minimum signal is applied to the receiver to obtain an observable output indication. This will avoid a-v-c action.

The term "Dummy antenna" means the device which must be connected between the "high" test-oscillator output and the point of connection to the receiver in order to obtain ideal alignment. "No signal, 550-750 kc" means that the receiver should be tuned to a point between 550 and 750 kc where no signal or interference is received from a station or local (heterodyne) oscillator.

For further details on alignment, refer to booklet "RCA Victor Receiver Alignment."

| Order of Alignment | Test Oscillator | | | Range Selector | Receiver Dial Setting | Circuit to Adjust | Adjustment Symbols | Adjust to Obtain |
|--------------------|------------------------|---------------|-------------------|----------------|-----------------------|-------------------|--------------------|------------------|
| | Connection to Receiver | Dummy Antenna | Frequency Setting | | | | | |
| 1 | 6K7 I-F Grid Cap | .001 Mfd. | 460 kc | "A" Left | No Signal 550-750 kc | 2nd I-F Trans. | L13 and L14 | Max. (peak) |
| 2 | 6A8 Det. Grid Cap | .001 Mfd. | 460 kc | "A" | No Signal 550-750 kc | 1st I-F Trans. | L11 and L12 | Max. (peak) |
| 3 | Ant. Term. | 300 Ohms | 20,000 kc | "C" Right | 20,000 kc | "C" Osc. | C7 | Max. (peak)*‡ |
| 4 | Ant. Term. | 300 Ohms | 6,000 kc | "B" Center | 6,000 kc | "B" Osc. | C11 | Max. (peak)* |
| 5 | Ant. Term. | 300 Ohms | 6,000 kc | "B" | 6,000 kc | "B" Ant. | C3 | Max. (peak) |
| 6 | Ant. Term. | 200 Mmfd. | 600 kc | "A" Left | 600 kc | "A" L-F Osc. | L9 | Max. (peak) |
| 7 | Ant. Term. | 200 Mmfd. | 1,500 kc | "A" | 1,500 kc | "A" H-F Osc. | C13 | Max. (peak) |
| 8 | Ant. Term. | 200 Mmfd. | 600 kc | "A" | 600 kc | "A" L-F Osc. | L9 | Max. (peak) |
| 9 | Ant. Term. | 200 Mmfd. | 1,500 kc | "A" | 1,500 kc | "A" H-F Osc. | C13 | Max. (peak) |

* Use minimum capacity peak if two peaks can be obtained.

‡ After this adjustment, check for image signal by shifting receiver dial to 19,080 kc.

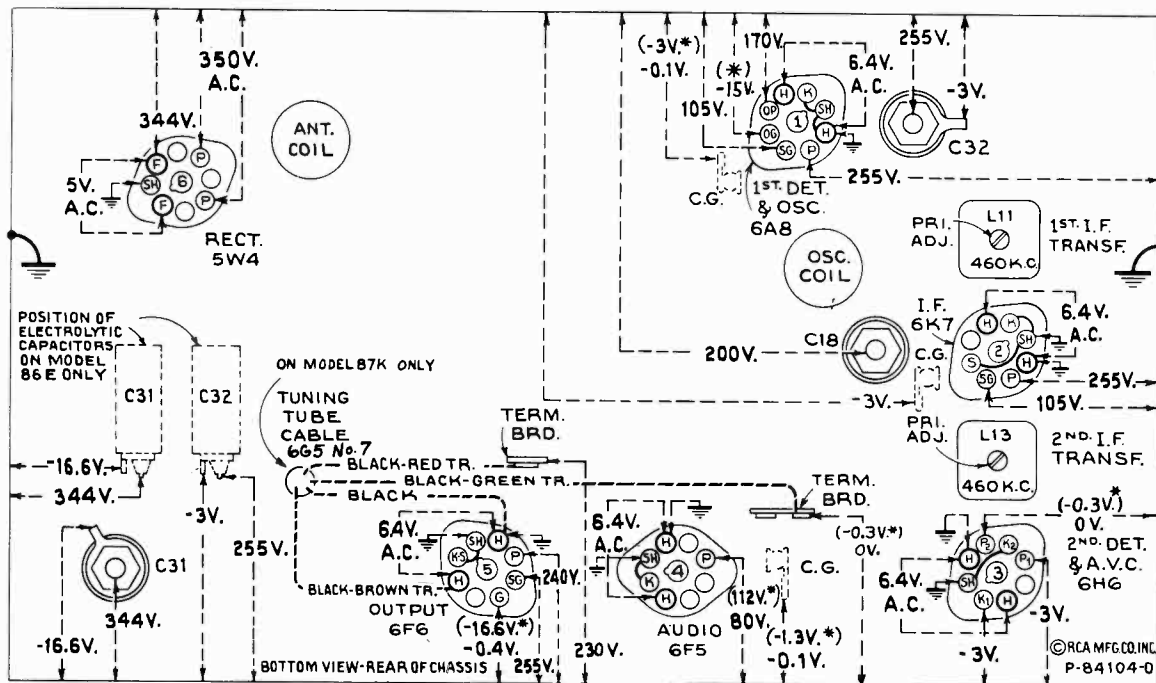

Figure 3—Radiotron Socket Voltages, Coil, and Trimmer Locations
(Models 86E, 86K, 86K7, and 87K)

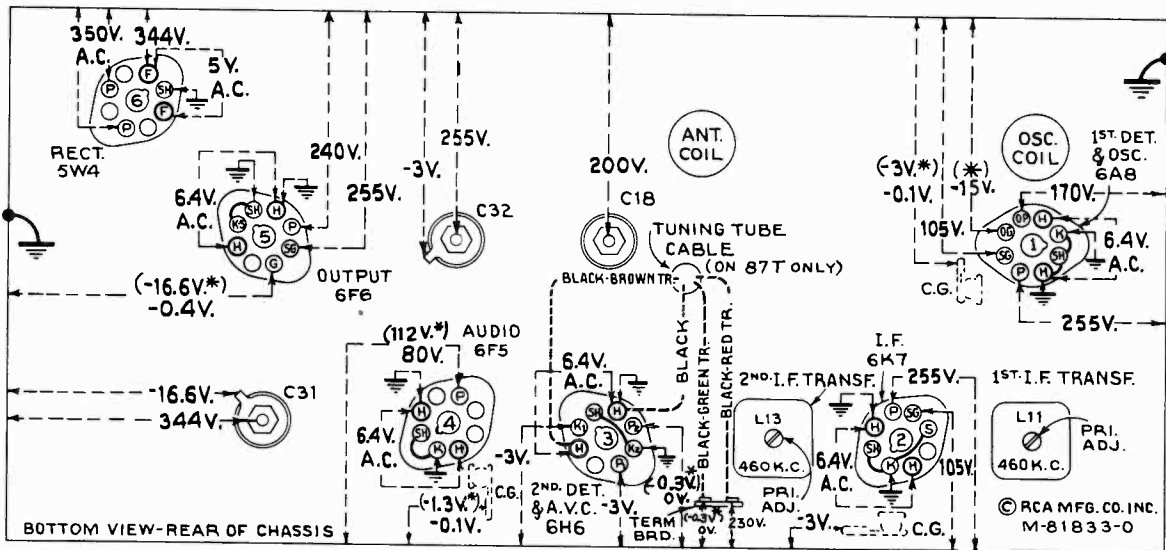

Figure 4—Radiotron Socket Voltages, Coil, and Trimmer Locations
(Models 86T, 86T1, and 87T)

Measured at 115 volts, 60-cycle supply—Tuned to approximately 1,000 kc ("Standard Broadcast")—
No signal being received—Volume control minimum

Note: Two voltage values are shown for some readings. The value shown in parentheses with asterisk () indicates operating conditions without voltmeter loading. The other value (generally lower) is the actual measured voltage and differs from the value shown in parentheses because of the additional loading of the voltmeter through the high series circuit resistance.*

Voltage values as specified should hold within $\pm 20\%$ when the receiver is normally operative at its rated line voltage. To duplicate the conditions under which the voltages were measured requires a 1,000-ohm-per-volt d-c meter, having ranges of 10, 50, 250, and 500 volts. Use the nearest range above the specified measured voltage. A-c voltages were measured with a corresponding a-c meter.

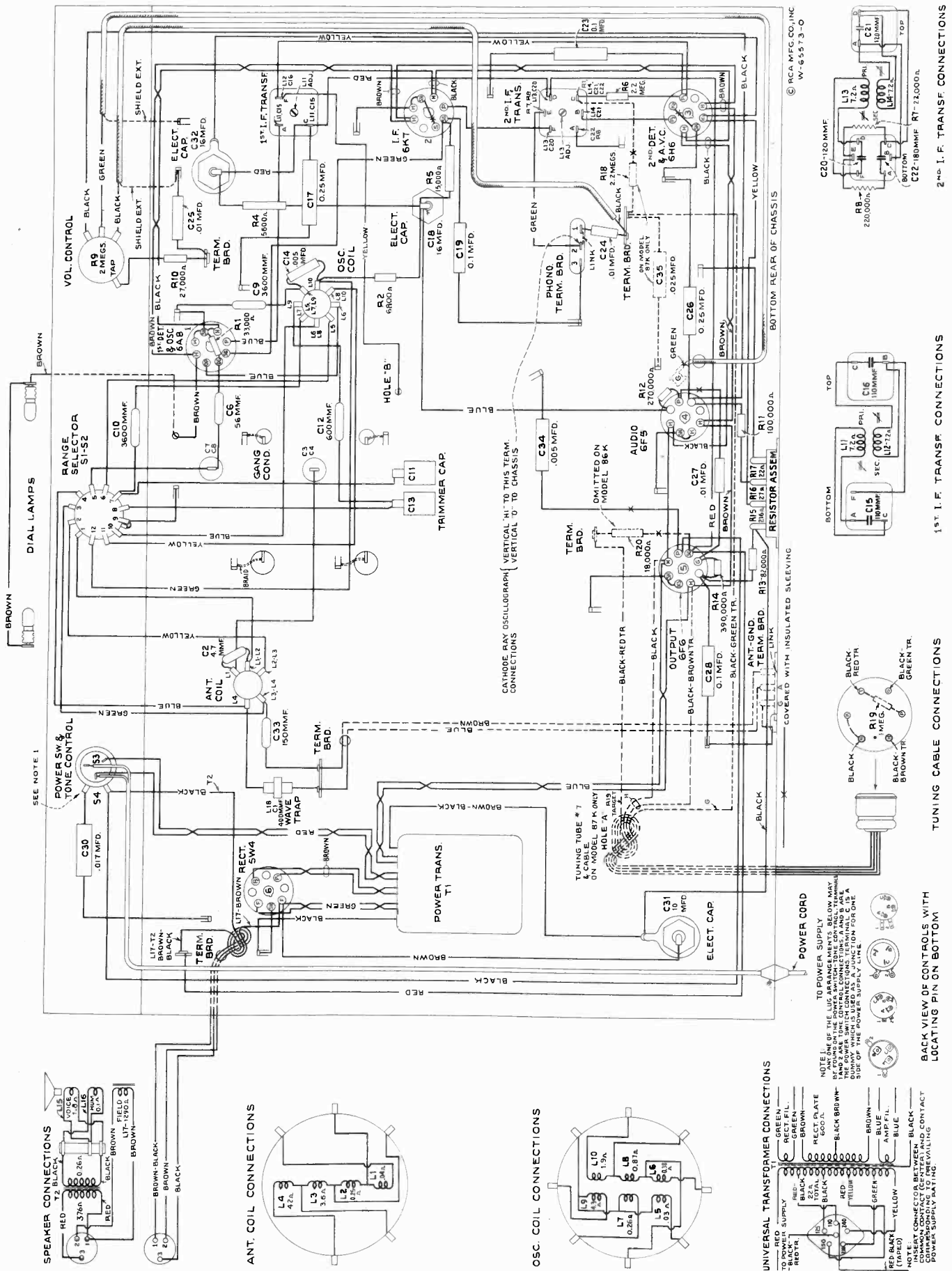

Figure 6—Chassis Wiring Diagram (Models 86K, 86K7, and 87K)

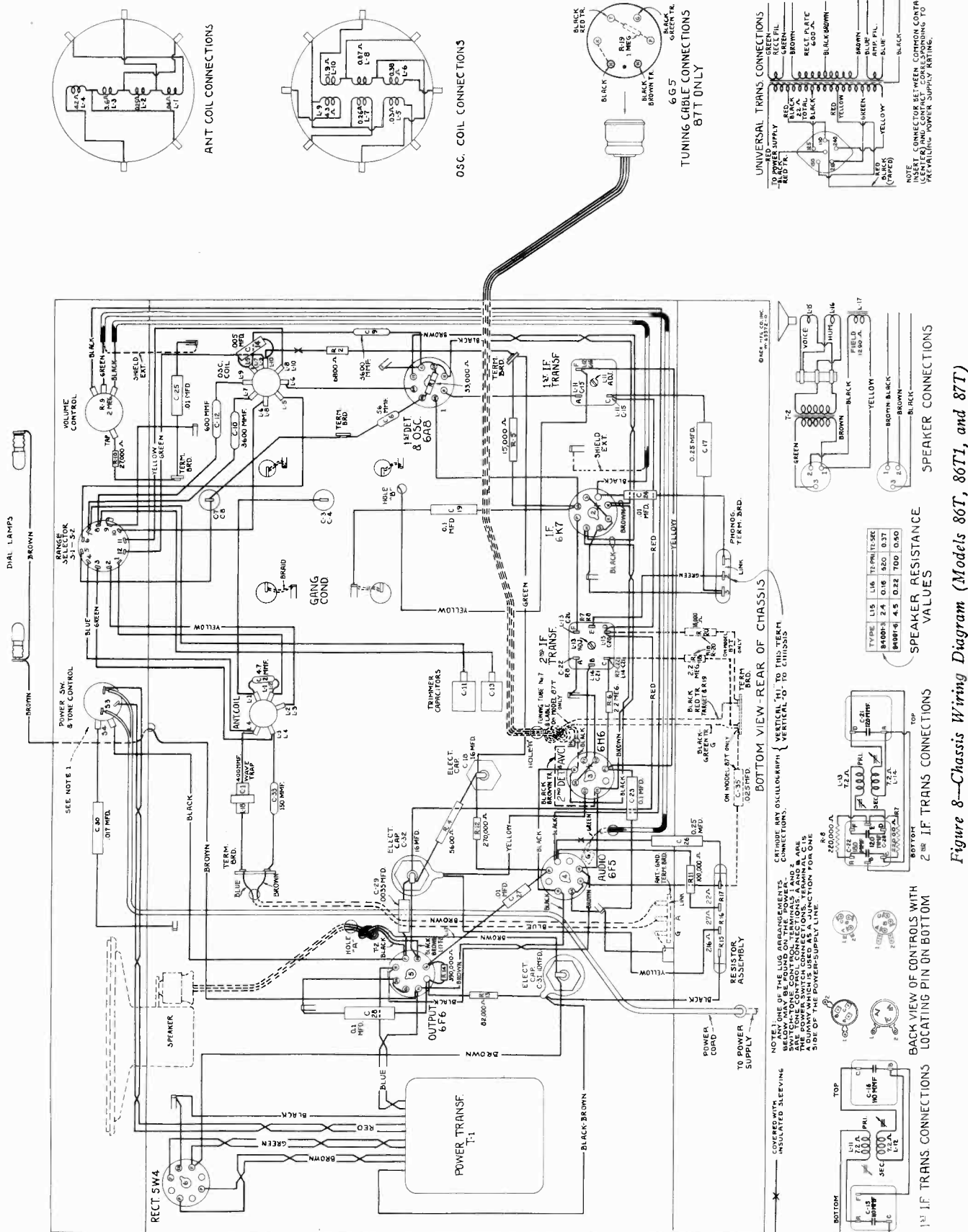
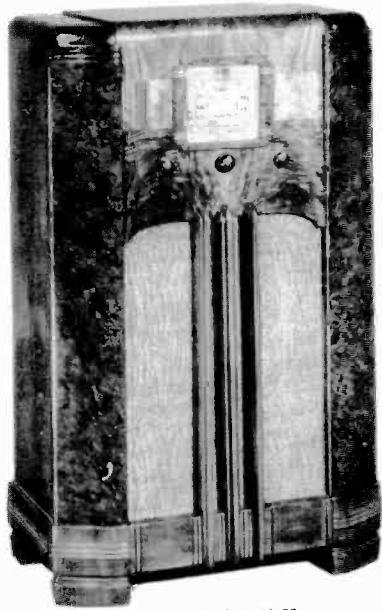
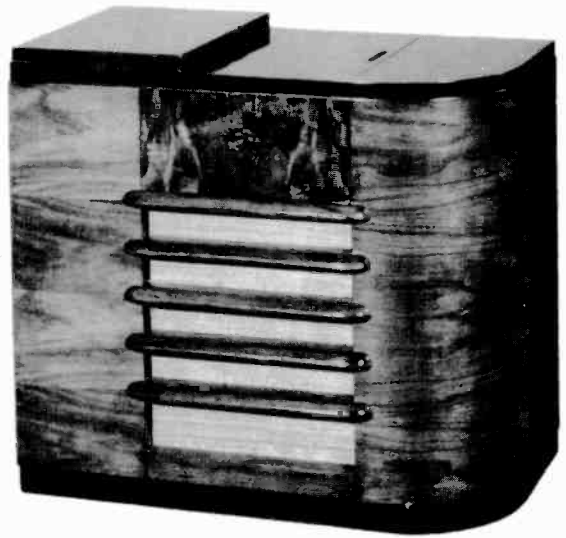

Figure 8—Chassis Wiring Diagram (Models 86T, 86T1, and 87T)

86E, 86K, 86K7, 86T, 86T1
87K, 87T



Model 87K



Model 86E

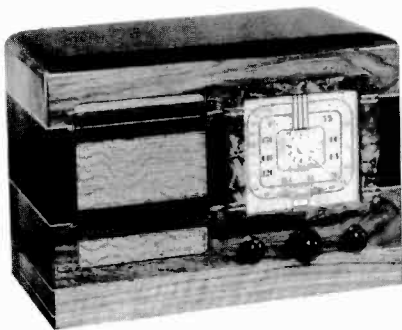

Model 86T1

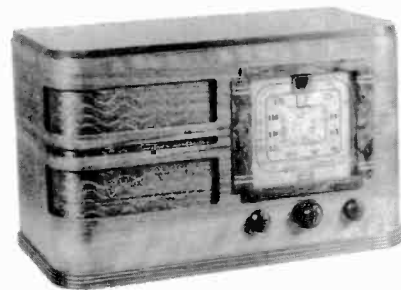

Model 87T

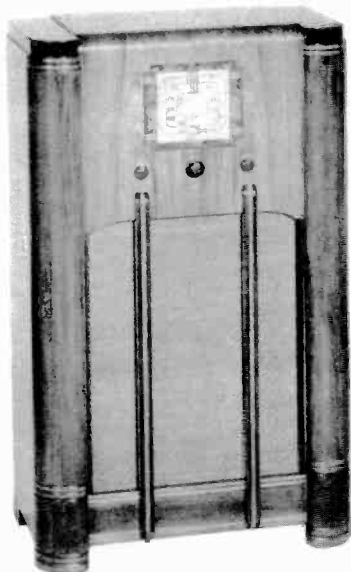

Model 86K7



Model 86T

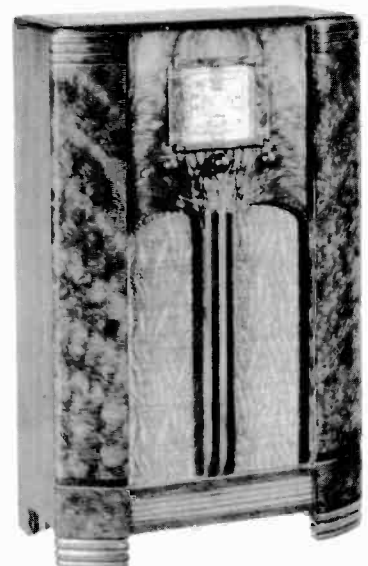

Model 86K

Service Data

The various diagrams of this booklet contain such information as will be needed to isolate causes for defective operation if such develops. The ratings of the resistors, capacitors, coils, etc., are indicated adjacent to the symbols signifying these parts on the diagrams. Identification titles such R1, L1, C1, etc., provide reference between the illustrations and Replacement Parts List. The coils, transformer windings, and reactors are rated in terms of d-c resistance to permit continuity checks.

Loudspeaker.—Centering of the loudspeaker is made in the usual manner with three narrow paper feelers after first removing the front dust cover. This may be removed by softening its cement with a light application of acetone, using care not to allow the acetone to flow into the air gap. The dust cover should be cemented back in place with ambroid upon completion of adjustment.

Phonograph Attachment.—A terminal board is provided for connecting a phonograph into the audio amplifying circuit. RCA Victor Models R-93, R-93-A, R-93-2, or R-94 Record Players should be connected as follows: Remove link between terminals 1 and 2 on terminal board. Connect green wire in Radio-Record switch cable to terminal 1, yellow to terminal 2, and shield extension to terminal 3. Tape unused red and blue leads separately. Connect a 2-conductor twisted cable between the Record Player binding posts and the screw terminals on Radio-Record switch.

Precautionary Lead Dress (Models 86E, 86K, 86K7, 87K).—(1) Keep bus lead from term. 9 of S1-S2 to ground lance as short as possible. (2) Bus lead from term. 6 of S1-S2 to L5 should be 4 inches long. (3) Bus lead from term. 5 of S1-S2 to C7-C8 should be 2 1/8 inches long. (4) Keep bus lead from term. 1 of S1-S2 to L1-L2 as short as possible. (5) Bus lead from L1 to C3-C4 should be 3 3/4 inches long. (6) Keep C6, C9, C10, and C12 so that broad side is perpendicular to chassis and keep their leads as short as possible. (7) Keep blue lead from "OP" of tube 1 to L6 dressed away from chassis and other leads. (8) Yellow and

green leads from terms. 11 and 12 of S1-S2 to oscillator coil must be twisted and dressed under all range switch bus leads. (9) Keep green lead from term. E of 2nd i-f trans. to term. 2 of phono. board as short as possible.

Precautionary Lead Dress (Models 86T, 86T1, 87T).

(1) Keep bus lead from term. 9 of S1-S2 to ground lance as short as possible. (2) Bus lead from term. 6 of S1-S2 to L5 should be 3 1/4 inches long. (3) Bus lead from term. 5 of S1-S2 to C7-C8 should be 2 1/4 inches long. (4) Keep bus lead from term. 1 of S1-S2 to L1-L2 as short as possible. (5) Bus lead from L1 to C3-C4 should be 3 1/4 inches long and dressed above bus lead from antenna coil to range switch. (6) Keep C6, C9, C10, and C12 so that broad side is perpendicular to chassis and keep their leads as short as possible. (7) Power cord should be dressed over C27 and under bus from C32 to "SG" of tube 5. (8) C26 from dummy term. of tube 4 must be grounded to end lug of R-17. (9) Keep green lead from term. E of 2nd i-f trans. to term. 2 of phono. board as short as possible. (10) Keep bus lead from term. 10 of S1-S2 to L6-L8 as short as possible. When necessary to replace bus leads, use only wire having same diameter as original.

Radiotron Cathode Current Readings

Measured with Milliammeter Connected at Tube Socket Cathode Terminals Under Conditions Similar to Those of Voltage Measurements

- (1) RCA-6A8—1st Det.—Osc. 14. ma.
- (2) RCA-6K7—I-F Amp. 8.5 ma.
- (3) RCA-6H6—2nd Det. and A.V.C.
- (4) RCA-6F5—Audio Driver 0.26 ma.
- (5) RCA-6F6—Power Amplifier 37. ma.
- (6) RCA-5W4—Rectifier 63. ma.**
- (7) RCA-6G5—Tuning Tube 1.2 ma.

** Cannot be measured at socket.

REPLACEMENT PARTS

Insist on genuine factory-tested parts, which are readily identified and may be purchased from authorized dealers.

| STOCK No. | DESCRIPTION | STOCK No. | DESCRIPTION |
|----------------------------|--|-----------|--|
| RECEIVER ASSEMBLIES | | | |
| 14380 | Arm—Band indicator operating arm and hub—less set screw, Stock No. 14350 | 11315 | Capacitor—.015 Mfd. (C25) (for Model 86E only) |
| 12038 | Band—Rubber band for tuning tube | 11451 | Capacitor—.017 Mfd. (C30) |
| 14384 | Belt—Variable condenser drive belt for Models 86E, 86K, 86K7, and 87K only | 4870 | Capacitor—.025 Mfd. (C35) (Used in Models 87K and 87T only) |
| 14388 | Belt—Variable condenser drive belt for Models 86T, 86T1, and 87T only | 4841 | Capacitor—.01 Mfd. (C19, C23, C28) |
| 14378 | Board—Antenna and ground terminal board | 4840 | Capacitor—.025 Mfd. (C26) |
| 12717 | Board—Phonograph terminal board | 5170 | Capacitor—.025 Mfd. (C17) |
| 14338 | Bushing—Variable condenser mounting bushing and screw assembly | 11240 | Capacitor—.10 Mfd. (C31) |
| 14394 | Cable—Tuning tube cable and socket, complete, for Models 87T and 87K only | 5212 | Capacitor—.16 Mfd. (C32) |
| 12607 | Cap—First I.F. transformer shield top | 14377 | Capacitor—.16 Mfd. (C18) (Models 86K, 86K7, 86T, 86T1, 87K, and 87T only) |
| 12581 | Cap—Second I.F. transformer shield top | 30105 | Capacitor—.16 Mfd. (C18) (Model 86E only) |
| 11350 | Cap—Grid contact cap | 14372 | Coil—Antenna coil and shield (L1, L2, L3, L4) |
| 14383 | Capacitor—Adjustable dual trimmer (C11, C13) | 14373 | Coil—Oscillator coil and shield (L5, L6, L7, L8, L9, L10) |
| 14392 | Capacitor—4.7 Mmfd. (C2) | 14363 | Condenser—2-gang variable tuning condenser (C3, C4, C7, C8) |
| 12723 | Capacitor—56 Mmfd. (C6) | 5119 | Connector—3-contact female connector for reproducer cable |
| 14262 | Capacitor—110 Mmfd. (C15, C16) | 12800 | Core—Adjustable core and stud assembly for coil, Stock No. 14373 |
| 12404 | Capacitor—120 Mmfd. (C20, C21) | 12006 | Core—Adjustable core and stud for Stock Nos. 14376 and 14283 |
| 12725 | Capacitor—150 Mmfd. (C33) | 14385 | Dial—Band indicator dial and mounting bracket assembly for Models 86K, 86K7, and 87K only |
| 12406 | Capacitor—180 Mmfd. (C22) | 30106 | Dial—Band indicator dial and mounting bracket assembly for Model 86E only |
| 13052 | Capacitor—470 Mmfd. (C5) | 14389 | Dial—Band indicator dial and mounting bracket assembly for Models 86T, 86T1, and 87T only |
| 14391 | Capacitor—600 Mmfd. (C12) | 14381 | Dial—Station selector dial scale for Models 86E, 86K, 86K7, 86T, and 86T1 only |
| 12811 | Capacitor—3,600 Mmfd. (C9, C10) | 14386 | Dial—Station selector dial, complete, with tuning tube escutcheon assembly for Models 87K and 87T only |
| 5005 | Capacitor—.0035 Mfd. (C29) (Used in Models 86T, 86T1, and 87T only) | 14364 | Drive—Variable condenser vernier drive pinion gear and shaft |
| 4838 | Capacitor—.005 Mfd. (C34) (Used in Models 86E, 86K, 86K7 and 87K only) | 14345 | Drum—Variable condenser drive belt drum, complete, with set screws |
| 4868 | Capacitor—.005 Mfd. (C14) | | |
| 13138 | Capacitor—.01 Mfd. (C27) | | |
| 14393 | Capacitor—.01 Mfd. (C24, C25) (C25, .01 Mfd. used in Models 86K, 86K7, 86T, 86T1, 87K, and 87T only) | | |

REPLACEMENT PARTS—(Continued)

| STOCK No. | DESCRIPTION | STOCK No. | DESCRIPTION |
|-----------|--|---|--|
| 14387 | Escutcheon—Tuning tube escutcheon for Models 87K and 87T only | 14371 | Switch—Tone control switch and power switch (S3, S4) |
| 11982 | Fastener—Station selector dial scale fastener | 14376 | Transformer—First I-F transformer (L11, L12, C15, C16) |
| 30085 | Gear—Indicator drive gear and hub assembly and indicator pointer stem and gear | 14283 | Transformer—Second I-F transformer (L13, L14, C20, C21, C22, R7, R8) |
| 14341 | Idler—Station selector drive belt idler | 14367 | Transformer—Power transformer, 105-125 volts, 50-60 cycles (T1) |
| 14344 | Indicator—Station selector indicator pointer | 14368 | Transformer—Power transformer, 105-125 volts, 25-60 cycles (T1) |
| 14382 | Indicator—Vernier indicator pointer | 14369 | Transformer—Power transformer, 105-125/210-250 volts, 50-60 cycles (T1) |
| 5226 | Lamp—Dial lamp | 13838 | Trap—Wave trap, complete (L18, C1) |
| 14340 | Pulley—Station selector drive belt pulley and knob shaft | 14335 | Volume Control (R9) |
| 14361 | Reflector—Dial reflector and lamp bracket assembly for Models 86E, 86K, 86K7, 86T, and 86T1 only | 14379 | Washer—Felt washer for indicator pointer |
| 14362 | Reflector—Dial reflector, lamp bracket and tuning tube bracket assembly for Models 87K and 87T only | REPRODUCER ASSEMBLIES Models 86T, 86T1, and 87T | |
| 14343 | Retainer—Drive shaft and pulley retainer—holds tuning-knob shaft and pulley on range-switch shaft | 14616 | Coil—Field coil (L17) (for speaker marked 84001-3) |
| 11298 | Resistor—5,600 Ohms, Carbon type, 1 Watt (R4) | 14614 | Cone—Reproducer cone (L15) (for speaker marked 84001-3) |
| 11726 | Resistor—6,800 Ohms, Carbon type, 1/2 Watt (R2) | 14934 | Cone—Reproducer cone (L15) (for speaker marked 84001-6) |
| 5114 | Resistor—15,000 Ohms, Carbon type, 1 Watt (R5) | 5118 | Plug—3-contact male plug for reproducer |
| 14078 | Resistor—18,000 Ohms, Carbon type, 1 Watt (R20), for Models 87K and 87T only | 14613 | Reproducer—Complete |
| 14284 | Resistor—22,000 Ohms, Carbon type, 1/10 watt (R7) | 14615 | Transformer—Output transformer (T2) (for speaker marked 84001-3) |
| 11400 | Resistor—27,000 Ohms, Carbon type, 1/2 Watt (R10), for Models 86E, 86K, 86K7, and 87K only | 14935 | Transformer—Output transformer (T2) (for speaker marked 84001-6) |
| 14390 | Resistor—27,000 Ohms, Carbon type, 1/10 Watt (R10), for Models 86T, 86T1, and 87T only | REPRODUCER ASSEMBLIES Models 86E, 86K, 86K7, and 87K (RL-70E-1) | |
| 13735 | Resistor—33,000 Ohms, Carbon type, 1/2 Watt (R1) | 13866 | Cap—Dust cap for cone center |
| 11365 | Resistor—82,000 Ohms, Carbon type, 1/2 Watt (R13) | 14354 | Coil—Field coil (L17) |
| 5145 | Resistor—100,000 Ohms, Carbon type, 1/2 Watt (R11) | 11489 | Coil—Hum neutralizing coil (L16) |
| 11398 | Resistor—220,000 Ohms, Carbon type, 1/10 Watt (R8) | 12667 | Cone—Reproducer cone and dust cap (L15) |
| 11453 | Resistor—270,000 Ohms, Carbon type, 1/10 Watt (R12) | 5118 | Plug—3-contact male plug for reproducer |
| 13005 | Resistor—390,000 Ohms, Carbon type, 1/10 Watt (R14) | 14395 | Reproducer—Reproducer complete |
| 11452 | Resistor—470,000 Ohms, Carbon type, 1/10 Watt (R3) | 14358 | Screw—Screw, washer, and lockwasher to hold core in yoke |
| 12013 | Resistor—1 Megohm, Carbon type, 1/10 Watt (R19), for Models 87K and 87T only | 14355 | Transformer—Output transformer (T2) |
| 11626 | Resistor—2.2 Megohm, Carbon type, 1/2 Watt (R6, R18) (R18 used in Models 87K and 87T only) | 14357 | Washer—Spring washer to hold field coil |
| 12004 | Resistor—Voltage divider resistor—comprising one 216-ohm, one 27-ohm, and one 22-ohm sections (R15, R16, R17) | MISCELLANEOUS ASSEMBLIES | |
| 14350 | Screw—No. 8-32 x 3/16 square-head set-screw for gear, Stock No. 30085, and drum, Stock No. 14345, and arm, Stock No. 14380 | 14396 | Escutcheon—Station selector escutcheon and crystal |
| 14374 | Shield—Antenna coil shield | 14359 | Knob—Station selector knob |
| 12008 | Shield—First or Second I-F transformer shield | 14269 | Knob—Volume control, tone control or range switch knob |
| 14375 | Shield—Oscillator coil shield | 4560 | Screw—Chassis mounting screw and washer assembly—(Model 86E only) |
| 14114 | Socket—Dial lamp socket | 11210 | Screw—Chassis mounting screw and washer assembly—(Models 86K, 86K7 and 87K only) |
| 11195 | Socket—5-contact 5W4 Radiotron socket | 11377 | Screw—Chassis mounting screw and washer assembly—(Models 86T, 86T1 or 87T only) |
| 11196 | Socket—8-contact 6A8, 6K7, 6H6, 6F5, or 6F6 Radiotron socket | 4982 | Spring—Retaining spring for knob—Stock No. 14359 |
| 12007 | Spring—Retaining spring for core, Stock Nos. 12006 and 12800 | 14270 | Spring—Retaining spring for knob—Stock No. 14269 |
| 12907 | Spring—Tension spring for indicator drive gear, Stock No. 30085 | | |
| 14342 | Spring—Tension spring for idler, Stock No. 14341 | | |
| 14370 | Switch—Range switch (S1, S2) | | |



RCA Victor

MODELS 86T3 and 87T1

Six- and Seven-Tube, Three-Band, A-C, Superheterodyne Receivers

TECHNICAL INFORMATION AND SERVICE DATA

- 1937 No. 35 -

SERVICE DIVISION • RCA MANUFACTURING COMPANY, INC. • CAMDEN, N. J., U. S. A.

A Service of the Radio Corporation of America

Electrical Specifications

FREQUENCY RANGES

"Standard Broadcast" (A)..... 540- 1,740 kc
"Medium Wave" (B)..... 2,300- 7,000 kc
"Short Wave" (C)..... 7,000-22,000 kc

Intermediate Frequency..... 460 kc

RADIOTRON COMPLEMENT

(1) RCA-6A8..... First Detector—Oscillator
(2) RCA-6K7..... Intermediate Amplifier
(3) RCA-6H6..... Second Detector and A.V.C.

Pilot Lamps (2)..... Mazda No. 46, 6.3 volts, 0.25 amp.

POWER SUPPLY RATINGS

Rating A..... 105-125 volts, 50-60 cycles, 75 watts
Rating B..... 105-125 volts, 25-60 cycles, 75 watts
Rating C..... 105-125/200-250 volts, 50-60 cycles, 75 watts

POWER OUTPUT

Undistorted..... 2.2 watts
Maximum..... 4.5 watts

R-F ALIGNMENT FREQUENCIES

"Medium Wave" (B)..... 6,000 kc (osc., ant.)
"Short Wave" (C)..... 20,000 kc (osc.)
"Standard Broadcast" (A)..... 600 kc (osc.), 1,500 kc (osc.)

(4) RCA-6F5..... Audio Voltage Amplifier
(5) RCA-6F6..... Audio Power Amplifier
(6) RCA-5W4..... Full-Wave Rectifier
(7) RCA-6U5 (Model 87T1 only)..... Tuning Tube

LOUDSPEAKER

Type..... 6-inch Electrodynamic
V.C. Impedance..... $\left\{ \begin{array}{l} 84091-1 \\ 84001-3 \end{array} \right\}$ 2.6 ohms at 400 cycles
 $\left\{ \begin{array}{l} 84091-2 \\ 84001-6 \end{array} \right\}$ 4.7 ohms at 400 cycles

Mechanical Specifications

Models

| | 86T3 | 87T1 |
|-------------------------------|--|--------------------|
| Height (inches)..... | 18 $\frac{1}{2}$ | 10 $\frac{15}{16}$ |
| Width (inches)..... | 12 $\frac{7}{16}$ | 19 $\frac{1}{16}$ |
| Depth (inches)..... | 8 $\frac{15}{16}$ | 8 $\frac{15}{16}$ |
| Net Weight (pounds)..... | 18 $\frac{1}{2}$ | 18 $\frac{1}{2}$ |
| Shipping Weight (pounds)..... | 23 $\frac{1}{2}$ | 23 |
| Chassis Base Dimensions..... | 9 $\frac{1}{2}$ inches x 7 $\frac{1}{2}$ inches x 2 $\frac{1}{2}$ inches | |
| Over-all Chassis Height..... | 7 $\frac{3}{16}$ inches | |
| Operating Controls..... | (1) Power Switch—Tone; (2) Tuning (large knob), Range Selector (small knob, left to right "A," "B," "C"); (3) Volume | |
| Tuning Drive Ratio..... | 20 to 1 | |

General Description

These receivers employ a three-band superheterodyne circuit as shown in the Schematic Circuit Diagram. Model 86T3 is an upright table model; Model 87T1 is a chest-type table model. Both employ 6-inch electrodynamic loudspeakers. Model 87T1 incorporates a "Magic Eye" tuning indicator. Features of design include magnetite-core adjusted

if transformers and low-frequency "A" oscillator tracking; automatic volume control; phonograph terminal board; aural-compensated volume control; continuous tone control; dust-proof electrodynamic loudspeakers; and an edge-illuminated straight-line dial.

Service Data

Loudspeaker.—Centering of the loudspeaker is made in the usual manner with three narrow celluloid or paper feelers after first removing the front dust cover. This may be removed by softening its cement with a light application of acetone, using care not to allow the acetone to flow into the air gap. A dust cover should be cemented in place with ambroid upon completion of adjustment.

Phonograph Attachment.—A terminal board is provided for connecting a phonograph into the audio amplifying

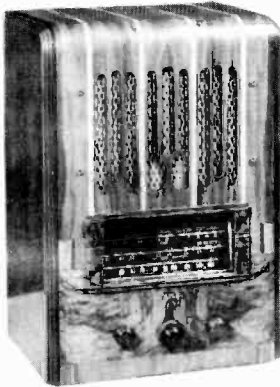

Model 86T3

circuit. RCA Victor Models R-93, R-93-A, R-93-2, or R-94 Record Players should be connected as follows: Open link between terminals 1 and 2 on terminal board. Connect yellow wire in Radio-Record switch cable to terminal 1, green to terminal 2, and shield extension to terminal 3. Tape unused red and blue leads separately. Connect a 2-conductor twisted cable between the Record Player binding posts and the screw terminals on Radio-Record switch.

Precautionary Lead Dress.—(1) Keep leads from C1 as short as possible. (2) Dress yellow and green leads from range selector to oscillator coil between front apron and range selector. Maintain original length and size of the following: (3) bus lead from antenna coil L1 to range selector and (4) lead from oscillator coil to chassis.



Model 87T1

Alignment Procedure

With the gang tuning-condenser plates in full-mesh position, adjust the pointer to the low-frequency (end) calibration mark on the dial scale. The pointer is soldered in place on the drive cable.

Perform alignment in proper order, tabulated below, starting with No. 1 and following all operations across, then No. 2, etc. Adjustment locations are shown on figures 1 and 2.

Cathode-ray alignment is preferable; the connections to the chassis are shown on figure 4. If an output indicator is used, connect it across the loudspeaker voice-coil and advance the receiver volume control to full-volume position.

Connect the "low" output terminal of the test oscillator to the receiver "G" (ground) terminal for all alignment opera-

tions. Regulate the output of the test oscillator so that minimum signal is applied to the receiver to obtain an observable output indication. This will avoid a-v-c action.

The term "Dummy antenna" means the device which must be connected between the "high" test-oscillator output and the point of connection to the receiver in order to obtain ideal alignment. "No signal, 550-750 kc" means that the receiver should be tuned to a point between 550 and 750 kc where no signal or interference is received from a station or local (heterodyne) oscillator.

For further details on alignment, refer to booklet "RCA Victor Receiver Alignment."

| Order of Alignment | Test Oscillator | | | Range Selector | Receiver Dial Setting | Circuit to Adjust | Adjustment Symbols | Adjust to Obtain |
|--------------------|------------------------|---------------|-------------------|----------------|-------------------------|-------------------|--------------------|------------------|
| | Connection to Receiver | Dummy Antenna | Frequency Setting | | | | | |
| 1 | 6K7 I-F Grid Cap | .001 Mfd. | 460 kc | "A" Left | No Signal 550-750 kc | 2nd I-F Trans. | L12 and L13 | Max. (peak) |
| 2 | 6A8 Det. Grid Cap | .001 Mfd. | 460 kc | "A" | No Signal 550-750 kc | 1st I-F Trans. | L10 and L11 | Max. (peak) |
| 3 | Ant. Term. | 300 Ohms | 6,000 kc | "B" Center | 6,000 kc | "B" Osc. | C11 | Max. (peak)* |
| 4 | Ant. Term. | 300 Ohms | 6,000 kc | "B" | 6,000 kc | "B" Ant. | C2 | Max. (peak)† |
| 5 | Ant. Term. | 300 Ohms | 20,000 kc | "C" Right | 20,000 kc | "C" Osc. | C7 | Max. (peak)‡ |
| 6 | Ant. Term. | 200 Mmfd. | 600 kc | "A" Left | 600 kc | "A" L-F Osc. | L8 | Max. (peak) |
| 7 | Ant. Term. | 200 Mmfd. | 1,500 kc | "A" | 1,500 kc | "A" H-F Osc. | C10 | Max. (peak) |
| 8 | Ant. Term. | 200 Mmfd. | 600 kc | "A" | 600 kc | "A" L-F Osc. | L8 | Max. (peak) |
| 9 | Ant. Term. | 200 Mmfd. | 1,500 kc | "A" | 1,500 kc | "A" H-F Osc. | C10 | Max. (peak) |

* Use minimum capacity peak if two peaks can be obtained.

† After this adjustment, check for image signal by shifting receiver dial to 5,080 kc.

‡ Use maximum capacity peak if two peaks can be obtained. After this adjustment, check for image signal by shifting receiver dial to 20,920 kc.

Note that the heterodyne oscillator tracks above the signal frequency on bands "A" and "B," and below the signal frequency on band "C."

Radiotron Cathode Current Readings

Measured with Milliammeter Connected at Tube Socket Cathode Terminals Under Conditions Similar to Those of Voltage Measurements

- (1) RCA-6A8—1st Det.—Osc..... 12.5 ma.
- (2) RCA-6K7—I-F Amp..... 7.2 ma.
- (3) RCA-6H6—2nd Det. and A.V.C.....
- (4) RCA-6F5—A-F Amp..... 0.27 ma.
- (5) RCA-6F6—Output..... 38.5 ma.
- (6) RCA-5W4—Rectifier..... 59 ma.**
- (7) RCA-6U5—Tuning Tube..... 1.2 ma.

** Cannot be measured at socket.

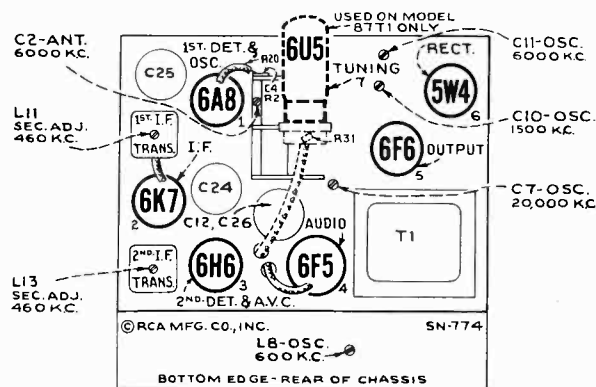

Figure 1—Radiotron, Component Part, and Trimmer Locations

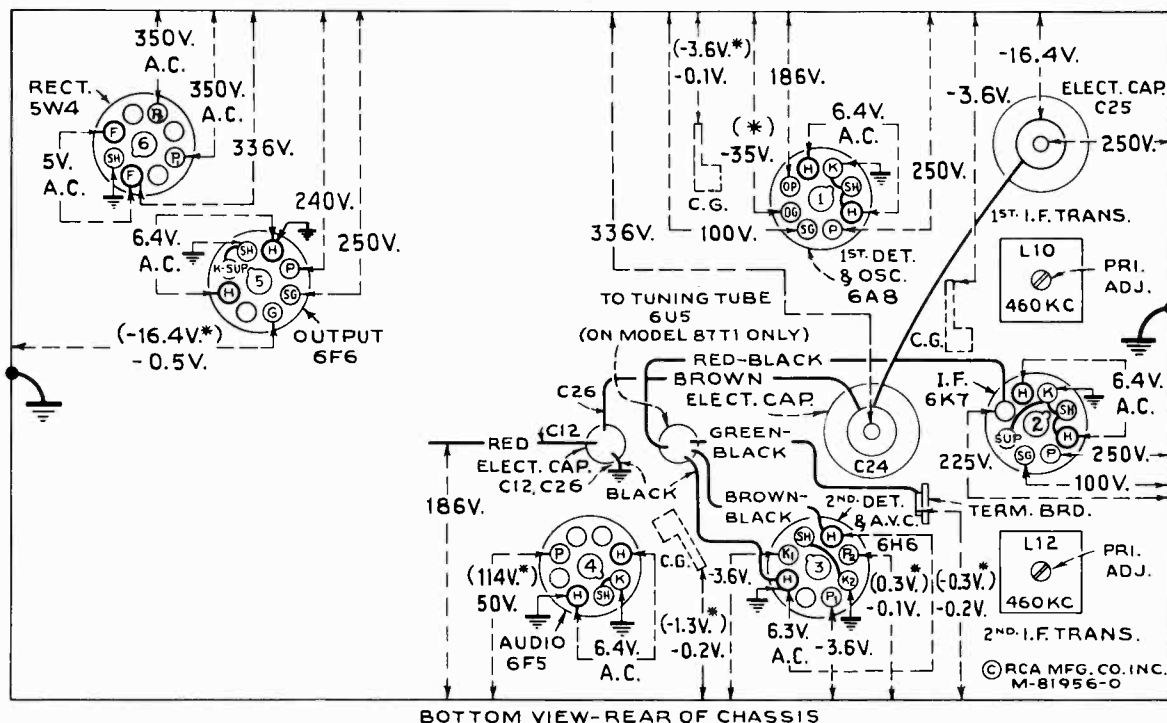

Figure 2—Radiotron Socket Voltages and Trimmer Locations

Measured at 115 volts, 60-cycle supply—Tuned to approximately 1,000 kc ("Standard Broadcast")—No signal being received—Volume control minimum—Tone control optional

Note: Two voltage values are shown for some readings. The value shown in parentheses with asterisk (*) indicates operating conditions without voltmeter loading. The other value (generally lower) is the actual measured voltage and differs from the value shown in parentheses because of the additional loading of the voltmeter through the high series circuit resistance.

Voltage values as specified should hold within $\pm 20\%$ when the receiver is normally operative at its rated line voltage. To duplicate the conditions under which the voltages were measured requires a 1,000-ohm-per-volt d-c meter, having ranges of 10, 50, 250 and 500 volts. Use the nearest range above the specified measured voltage. A-c voltages were measured with a corresponding a-c meter.

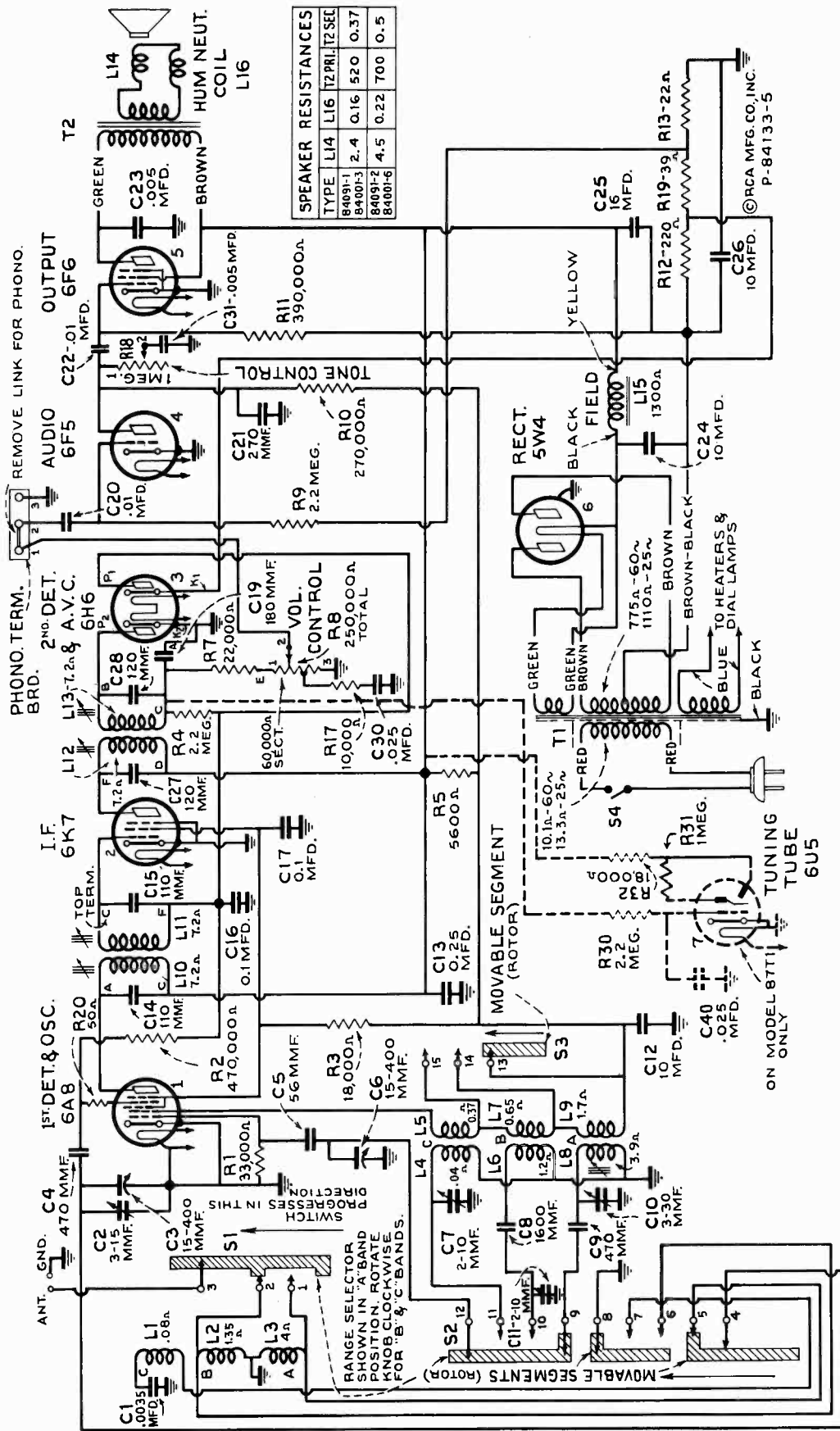

Figure 3—Schematic Circuit Diagram

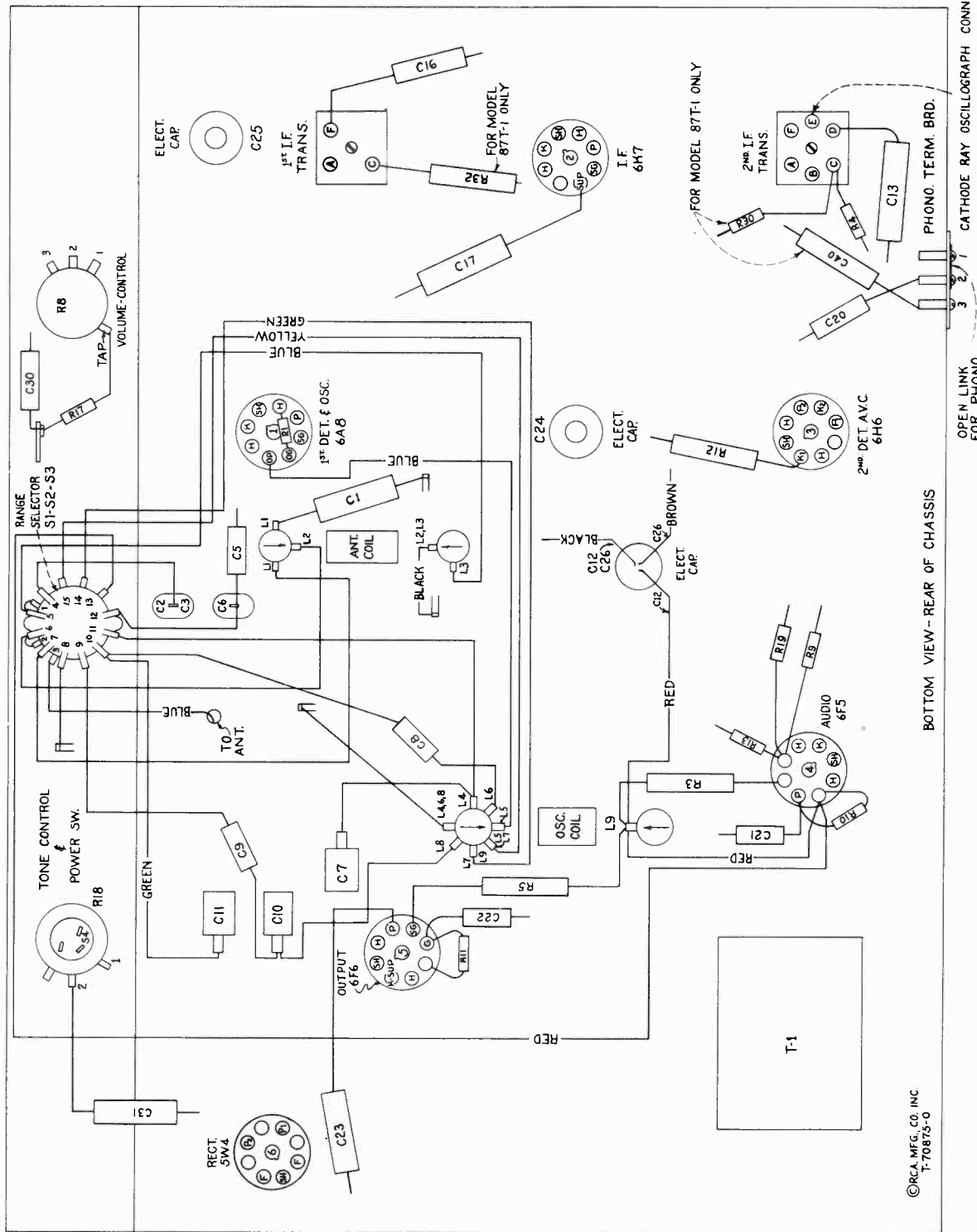

Figure 4—Component Part Location and R-F Wiring

©RCA MFG. CO. INC
T-70873-0

REPLACEMENT PARTS

Insist on genuine factory-tested parts, which are readily identified and may be purchased from authorized dealers.

| STOCK No. | DESCRIPTION | STOCK No. | DESCRIPTION |
|----------------------------|---|---------------------------------|--|
| RECEIVER ASSEMBLIES | | | |
| 14380 | Arm—Hub and arm for operating band indicator shutter—fastens on range switch shaft | 13005 | Resistor—390,000 ohms, carbon type, 1/10 watt (R11) |
| 14352 | Belt—Station selector drive belt | 11452 | Resistor—470,000 ohms, carbon type, 1/10 watt (R2) |
| 13216 | Board—Antenna and ground terminal board | 12013 | Resistor—1 meg., carbon type, 1/10 watt (R31) (Model 87T1 only) |
| 12717 | Board—Phonograph terminal board | 12679 | Resistor—2.2 meg., insulated, 1/2 watt (R4, R9) |
| 12607 | Cap—Top shield cap for hrst I.F. transformer | 11628 | Resistor—2.2 meg., carbon type, 1/2 watt (R30) (Model 87T1 only) |
| 12581 | Cap—Top shield cap for second I.F. transformer | 30582 | Retainer—Band-indicator disc retainer |
| 11350 | Cap—Grid contact cap | 14343 | Ring—Retaining ring for range switch shaft |
| 12723 | Capacitor—56 Mmfd. (C5) | 14350 | Screw—No. 8-32 x 3/16 in. square-head set screw for drum, Stock No. 30584, arm, Stock No. 14380, and pulley, Stock No. 30587 |
| 14262 | Capacitor—110 Mmfd. (C14, C15) | 14340 | Shaft—Drive pulley and knob shaft—fastens on range switch shaft |
| 12404 | Capacitor—120 Mmfd. (C27, C28) | 12008 | Shield—I.F. transformer shield can |
| 12406 | Capacitor—180 Mmfd. (C19) | 11196 | Socket—8-contact Radiotron socket |
| 12488 | Capacitor—270 Mmfd. (C21) | 14114 | Socket—Dial-lamp socket |
| 30433 | Capacitor—470 Mmfd. (C4, C9) | 13871 | Socket—Tuning-tube socket complete—less cable (Model 87T1 only) |
| 30592 | Capacitor—1,600 Mmfd. (C8) | 12007 | Spring—Retaining spring for core, Stock No. 12006 |
| 30303 | Capacitor—.0035 Mfd. (C1) | 30585 | Spring—Tension spring for pointer cord |
| 4838 | Capacitor—.005 Mfd. (C23, C31) | 30588 | Spring—Tension spring for idler pulley |
| 14393 | Capacitor—.01 Mfd. (C20, C22) | 30578 | Switch—Range switch (S1, S2) |
| 4870 | Capacitor—.025 Mfd. (C30, C40) (C40 — Model 87T1 only) | 30574 | Tone control and power switch (R18, S4) |
| 4839 | Capacitor—0.1 Mfd. (C16, C17) | 14376 | Transformer—First I.F. transformer (L10, L11, C14, C15) |
| 12484 | Capacitor—0.25 Mfd. (C13) | 14308 | Transformer—Second I.F. transformer (L12, L13, C19, C27, C28, R7) |
| 11203 | Capacitor—10 Mfd. (C12) | 30571 | Transformer—Power transformer, 105-125 volts, 25-60 cycle (T1) |
| 30577 | Capacitor Pack—Comprising two sections each 10 Mfd. (C24, C26) | 30617 | Transformer—Power transformer, 105-125 and 200-250 volts, 60-60 cycle (T1) |
| 5212 | Capacitor—16 Mfd. (C25) | 30575 | Volume Control (R8) |
| 4358 | Clamp—Mounting clamp for capacitor pack, Stock No. 30577 | REPRODUCER ASSEMBLIES | |
| 30578 | Coil—Antenna coil (L1, L2, L3) | 14614 | Cone—Reproducer cone and dust cap (for speaker marked 84091-1 or 84001-3) (L14) |
| 30579 | Coil—Oscillator coil (L4, L5, L6, L7, L8, L9) | 14934 | Cone—Reproducer cone and dust cap (for speaker marked 84091-2 or 84001-6) (L14) |
| 30573 | Condenser—2-gang variable tuning condenser (C2, C3, C6) | 14613 | Reproducer complete (marked 84001-3 or 6 but interchangeable with speaker marked 84091-1 or 2) |
| 30580 | Condenser—3-gang mica trimmer—two sections each 2-10 Mmfd., one section 3-30 Mmfd. (C7, C10, C11) | 14615 | Transformer—Output transformer (for speaker marked 84091-1 or 84001-3) (T2) |
| 30586 | Cord—Station-selector indicator pointer cord | 14935 | Transformer—Output transformer (for speaker marked 84091-2 or 84001-6) (T2) |
| 12800 | Core—Adjustable core and stud for oscillator coil | MISCELLANEOUS ASSEMBLIES | |
| 12006 | Core—Adjustable core and stud for I.F. transformer | 30595 | Bracket—Tuning-tube mounting bracket and clip (Model 87T1 only) |
| 30589 | Dial—Station-selector dial scale | 30593 | Escutcheon—Dial escutcheon and crystal (Model 86T3 only) |
| 30581 | Disc—Band indicator disc with celluloid window | 30594 | Escutcheon—Dial and tuning-tube escutcheon and crystal (Model 87T1 only) |
| 30572 | Drive—Vernier drive shaft and pinion gear for variable condenser | 14359 | Knob—Station selector knob |
| 30584 | Drum—Station-selector drive-cord drum with set screws | 14269 | Knob—Tone control, volume control, or range switch knob |
| 30583 | Indicator—Station-selector indicator pointer and holder assembly | 14267 | Screw—Chassis-mounting screw and washer assembly |
| 5226 | Lamp—Dial lamp | 14270 | Spring—Retaining spring for knob, Stock No. 14269 |
| 30587 | Pulley—Drive-belt pulley for condenser shaft | 4982 | Spring—Retaining spring for knob, Stock No. 14359 |
| 14636 | Pulley—Drive-belt idler pulley | | |
| 14525 | Resistor—22 ohms, carbon type, 1/2 watt (R13) | | |
| 30590 | Resistor—39 ohms, carbon type, 1/2 watt (R19) | | |
| 14653 | Resistor—50 ohms, flexible type, 1/10 watt (R20) | | |
| 30591 | Resistor—220 ohms, insulated wire wound, 1.1 watt (R12) | | |
| 11298 | Resistor—5,600 ohms, carbon type, 1 watt (R5) | | |
| 14559 | Resistor—10,000 ohms, insulated, 1/2 watt (R17) | | |
| 30151 | Resistor—18,000 ohms, insulated, 1 watt (R3, R32) (R32 — Model 87T1 only) | | |
| 14284 | Resistor—22,000 ohms, carbon type, 1/10 watt (R7) | | |
| 12454 | Resistor—35,000 ohms, insulated, 1/2 watt (R1) | | |
| 11323 | Resistor—270,000 ohms, carbon type, 1/2 watt (R10) | | |



RCA Victor

MODELS 86T4 and 86T44

Six-Tube, Three-Band, A-C, Superheterodyne Receivers

TECHNICAL INFORMATION AND SERVICE DATA

SERVICE DIVISION • RCA MANUFACTURING COMPANY, INC. • CAMDEN, N. J., U. S. A.

A Service of the Radio Corporation of America

Electrical Specifications

FREQUENCY OR WAVE-LENGTH RANGES

"Long Wave" (X). 145-350 kc (approx. 2,068-857 meters)
"Medium Wave" (A). 525-1,550 kc (approx. 571-193 meters)
"Short Wave" (C)..... 5.8-22 megacycles

Intermediate Frequency..... 460 kc

RADIOTRON COMPLEMENT

(1) RCA-6A7..... First Detector—Oscillator
(2) RCA-6D6..... Intermediate Amplifier
(3) RCA-75..... Second Detector, A-F Amp. and A.V.C.

Pilot Lamps (2)..... Mazda No. 46, 6.3 volts, 0.25 ampere

POWER SUPPLY RATINGS

Rating A..... 105-125 volts, 50-60 cycles, 75 watts
Rating B..... 105-125 volts, 25-60 cycles, 75 watts
Rating C..... 100-130/140-160/195-250 volts, 40-60 cycles, 75 watts

POWER OUTPUT RATING

Undistorted..... 2.5 watts
Maximum..... 4.5 watts

R-F ALIGNMENT FREQUENCIES

"Short Wave" (C)..... 20,000 kc (osc., det.)
"Medium Wave" (A)..600 kc (osc.), 1,500 kc (osc., det., ant.)
"Long Wave" (X)..... 175 kc (osc.), 350 kc (osc., det., ant.)

..... 460 kc

(4) RCA-42..... Audio Power Amplifier

(5) RCA-80..... Full-Wave Rectifier

(6) RCA-6G5..... "Magic Eye" Tuning Tube

..... Mazda No. 46, 6.3 volts, 0.25 ampere

LOUDSPEAKER

Type..... Electrodynamic

V.C. Impedance.... $\left\{ \begin{array}{l} \text{(RL-63F-1) 2.2—} \\ \text{(84091-1) 2.6—} \\ \text{(84091-2) 4.7—} \end{array} \right\}$ ohms at 400 cycles

Mechanical Specifications

| | 86T4 | 86T44 |
|------------------------------|--|-------------------------|
| Height..... | 20 $\frac{3}{8}$ inches | 11 $\frac{1}{2}$ inches |
| Width..... | 16 inches | 20 $\frac{1}{2}$ inches |
| Depth..... | 10 $\frac{1}{4}$ inches | 9 $\frac{5}{8}$ inches |
| Weight (Net)..... | 31 pounds | 27 pounds |
| Weight (Shipping)..... | 37 pounds | 33 pounds |
| Chassis Base Dimensions..... | 13 $\frac{1}{2}$ inches x 7 $\frac{3}{4}$ inches x 3 inches | |
| Over-all Chassis Height..... | 9 inches | |
| Operating Controls..... | (1) Volume; (2) Tuning (large inner knob), Range Selector (small outer knob, left to right "X," "A," "C"); (3) Power Switch—Tone | |
| Tuning Drive Ratio..... | 20 to 1 | |

General Description

These receivers are of the superheterodyne type and have many distinctive features. The circuit arrangement is shown in the Schematic Circuit Diagram. Their design include magnetite core adjustments for i-f transformers, low-frequency "X" and "A" oscillator tracking, and wave-trap;

pre-selector stage on "A" and "X" bands; aural compensated volume control; tone control; resistance-coupled audio system; phonograph terminal board; and a dust-proof electrodynamic loudspeaker.

Service Data

The various diagrams of this booklet contain such information as will be needed to isolate causes for defective operation if such develops. The ratings of the resistors, capacitors,

coils, etc., are indicated adjacent to the symbols signifying these parts on the diagrams. Identification titles such as R1, L1, C1, etc., provide reference between the illustrations and

Alignment Procedure

Calibrate the tuning dial by adjusting main dial pointer to the low-frequency (end) calibration mark on dial with the gang tuning-condenser plates in full-mesh position; then adjust the small (vernier) pointer to figure 0. These are friction adjustments.

Perform alignment in proper order, tabulated below, starting with No. 1 and following all operations across, then No. 2, etc. Adjustment locations are shown on figures 1 and 2.

Cathode-ray alignment is highly preferable; the connections to the chassis are shown on figure 4. If an output indicator is used, connect it across the loudspeaker voice-coil and advance the receiver volume control to full-volume position.

Connect the "low" output terminal of the test oscillator to the receiver "G" (ground) terminal for all alignment operations. Regulate the output of the test oscillator so that minimum signal is applied to the receiver to obtain an observable output indication. This will avoid a-v-c action.

The term "Dummy antenna" means the device which must be connected between the "high" test-oscillator output and the point of connection to the receiver in order to obtain ideal alignment. "No signal, 550-750 kc" means that the receiver should be tuned to a point between 550 and 750 kc (400-550 meters) where no signal or interference is received from a station or local (heterodyne) oscillator.

For further details on alignment, refer to booklet "RCA Victor Receiver Alignment."

| Order of Alignment | Test Oscillator | | | Receiver Dial Setting | Range Selector | Circuit to Adjust | Adjustment Symbols | Adjust to Obtain |
|--------------------|------------------------|---------------|-------------------|---|----------------|-------------------|--------------------|------------------|
| | Connection to Receiver | Dummy Antenna | Frequency Setting | | | | | |
| 1 | 6D6 I-F Grid Cap | .001 Mfd. | 460 kc | No Signal 550-750 kc (400-550 meters) | "A" Center | 2nd I-F Trans. | L15 and L16 | Max. (peak) |
| 2 | 6A7 Det. Grid Cap | .001 Mfd. | 460 kc | No Signal 550-750 kc (400-550 meters) | "A" | 1st I-F Trans. | L13 and L14 | Max. (peak) |
| 3 | Ant. Term. | 200 Mmfd. | 460 kc | No Signal 550-750 kc (400-550 meters) | "A" | Wave-trap | L1 | Minimum Output |
| 4 | Ant. Term. | 300 Ohms | 20,000 kc | 20 mc | "C" Right | "C" Osc. | C23 | Max. (peak)* |
| 5 | Ant. Term. | 300 Ohms | 20,000 kc | Rock Thru 20 mc | "C" | "C" Det. | C12 | Max. (peak)†‡ |
| 6 | Ant. Term. | 200 Mmfd. | 600 kc | 600 kc (500 meters) | "A" Center | "A" L-F Osc. | L10 | Max. (peak) |
| 7 | Ant. Term. | 200 Mmfd. | 1,500 kc | 1,500 kc (200 meters) | "A" | "A" H-F Osc. | C25 | Max. (peak) |
| 8 | Ant. Term. | 200 Mmfd. | 600 kc | Rock Thru 600 kc (500 meters) | "A" | "A" L-F Osc. | L10 | Max. (peak) |
| 9 | Ant. Term. | 200 Mmfd. | 1,500 kc | 1,500 kc (200 meters) | "A" | "A" H-F Osc. | C25 | Max. (peak) |
| 10 | Ant. Term. | 200 Mmfd. | 1,500 kc | 1,500 kc (200 meters) | "A" | "A" Det. | C13 | Max. (peak) |
| 11 | Ant. Term. | 200 Mmfd. | 1,500 kc | 1,500 kc (200 meters) | "A" | "A" Ant. | C4 | Max. (peak) |
| 12 | Ant. Term. | 200 Mmfd. | 175 kc | 175 kc (1715 meters) | "X" Left | "X" L-F Osc. | L11 | Max. (peak) |
| 13 | Ant. Term. | 200 Mmfd. | 350 kc | 350 kc (857 meters) | "X" | "X" H-F Osc. | C29 | Max. (peak) |
| 14 | Ant. Term. | 200 Mmfd. | 175 kc | Rock Thru 175 kc (1715 meters) | "X" | "X" L-F Osc. | L11 | Max. (peak) |
| 15 | Ant. Term. | 200 Mmfd. | 350 kc | 350 kc (857 meters) | "X" | "X" H-F Osc. | C29 | Max. (peak) |
| 16 | Ant. Term. | 200 Mmfd. | 350 kc | 350 kc (857 meters) | "X" | "X" Det. | C15 | Max. (peak) |
| 17 | Ant. Term. | 200 Mmfd. | 350 kc | 350 kc (857 meters) | "X" | "X" Ant. | C6 | Max. (peak) |

* Use minimum capacity peak if two peaks can be obtained.

† Use maximum capacity peak if two peaks can be obtained.

‡ After this adjustment, check for image signal by shifting receiver dial to 19,080 kc.

Replacement Parts List. The coils, transformer windings, and reactors are rated in terms of d-c resistance to permit continuity checks.

Precautionary Lead Dress.—Keep the following leads as short as possible: (1) Bus lead from C16 to S2, (2) bus lead from L8 to S2, (3) leads from C24 to L8 and to chassis. (4) Bus lead from L5 to S2 should be 2½ inches long between lugs and dressed away from S2, (5) bus lead from

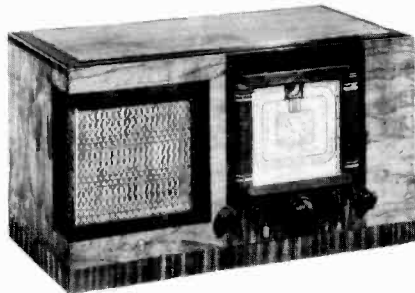

Model 86T44

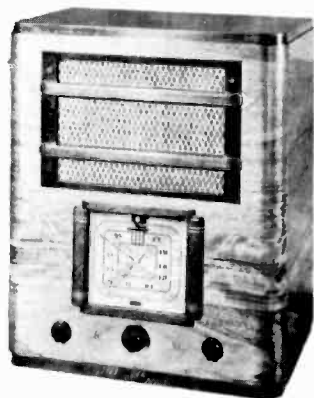

Model 86T4

C17 to S2 should be dressed away from adjacent parts, (6) leads should be dressed away from grid lug of 42 tube, (7) C11 lead to L5 should be 1 inch long and dressed between L5 and C4, C11 lead to ground should be short, (8) green lead between opposite lugs on S2 should be dressed away from S2, (9) excess antenna lead should be dressed above chassis, (10) blue lead from L7 to 6A7 oscillator plate lug should be dressed down and away from L8 lug and away from oscillator grid of 6A7, (11) green lead from L6 to S2 should be dressed away from bus connected between C17 and S2, (12) red lead from L6 tap to S2 should be dressed away from bus connected between C17 and S2. When necessary to replace bus leads, use only wire having same diameter as original.

Phonograph Attachment.—A terminal board is provided for connecting a phonograph into the audio amplifying circuit. RCA Victor Models R-93, R-93-A, R-93-2, or R-94 Record Players should be connected as follows: Remove link

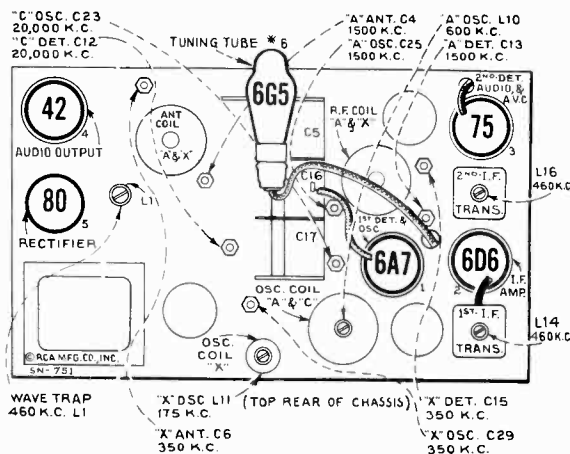

Figure 1—Radiotron, Coil, and Trimmer Locations

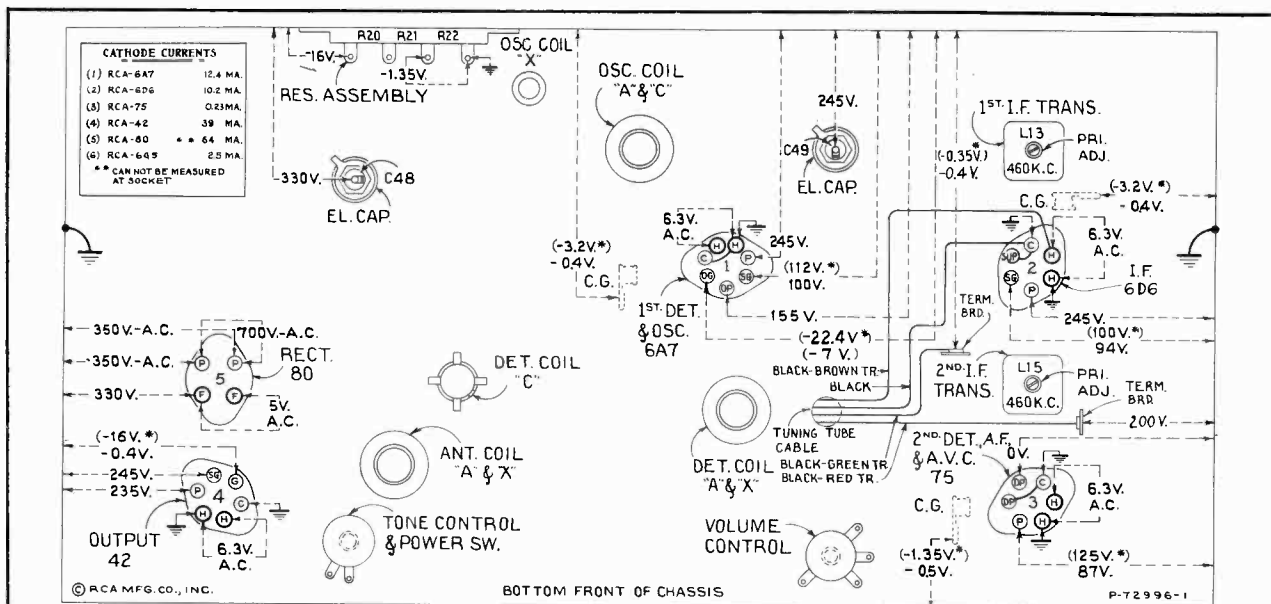
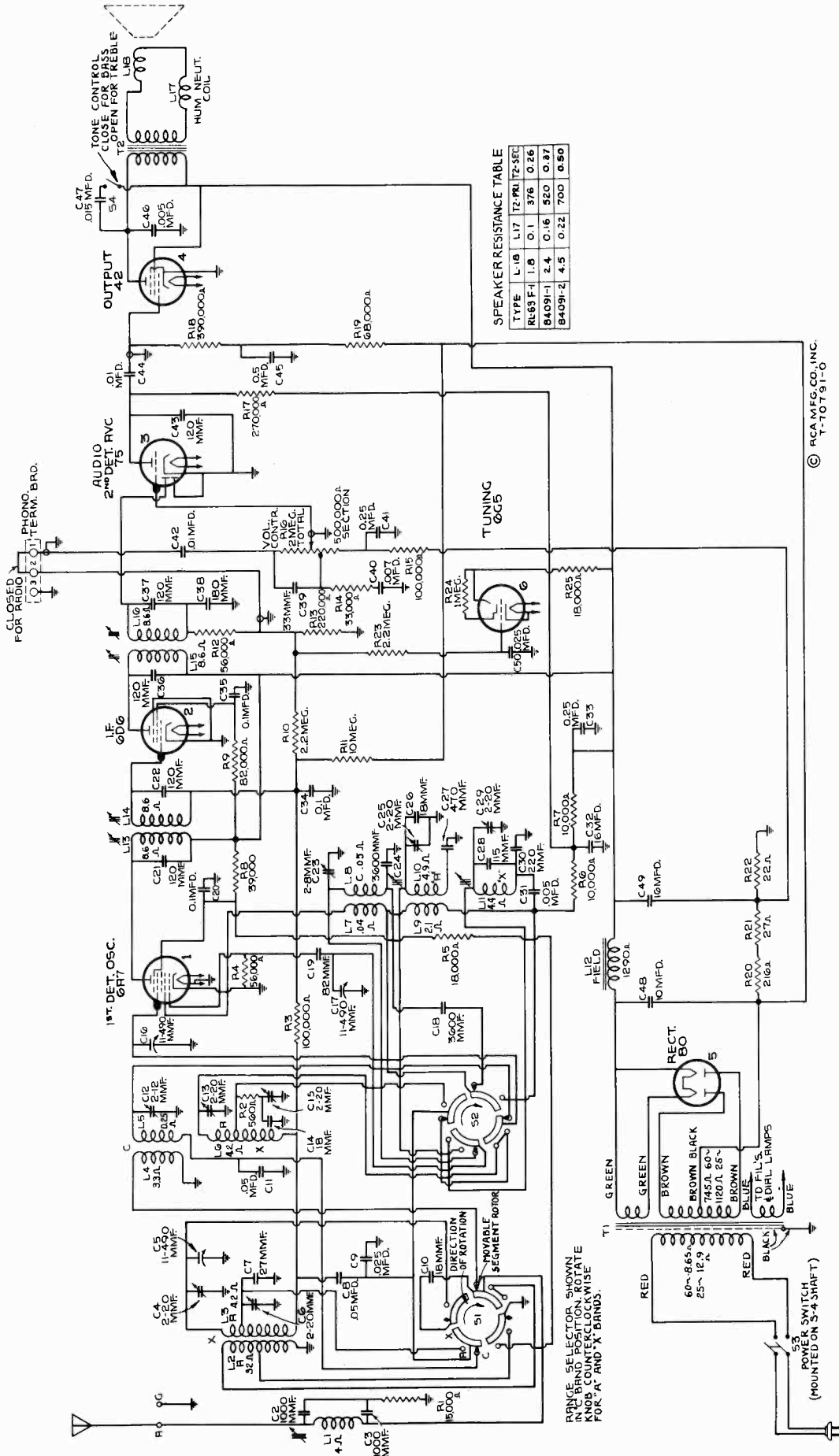

Figure 2—Radiotron Socket Voltages, Coil, and Trimmer Locations

Measured at 115 volts, 60-cycle supply—Tuned to approximately 1,000 kc or 300 meters "A" band—No signal being received—Volume control minimum

Note: Two voltage values are shown for some readings. The value shown in parentheses with asterisk (*) indicates operating conditions without voltmeter loading. The other value (generally lower) is the actual measured voltage and differs from the value shown in parentheses because of the additional loading of the voltmeter through the high series circuit resistance.

Voltage values as specified should hold within ±20% when the receiver is normally operative at its rated line voltage. To duplicate the conditions under which the voltages were measured requires a 1,000-ohm-per-volt d-c meter, having ranges of 10, 50, 250 and 500 volts. Use the nearest range above the specified measured voltage. A-c voltages were measured with a corresponding a-c meter.



SPEAKER RESISTANCE TABLE

| TYPE | L16 | L17 | TZ-PR1 | TZ-SEL |
|----------|-----|------|--------|--------|
| RL63 F-1 | 1.6 | 0.1 | 376 | 0.26 |
| 84091-1 | 2.4 | 0.16 | 520 | 0.37 |
| 84091-2 | 4.5 | 0.22 | 700 | 0.50 |

© RCA MFG. CO. INC.
T-70791-0

Figure 3—Schematic Circuit Diagram

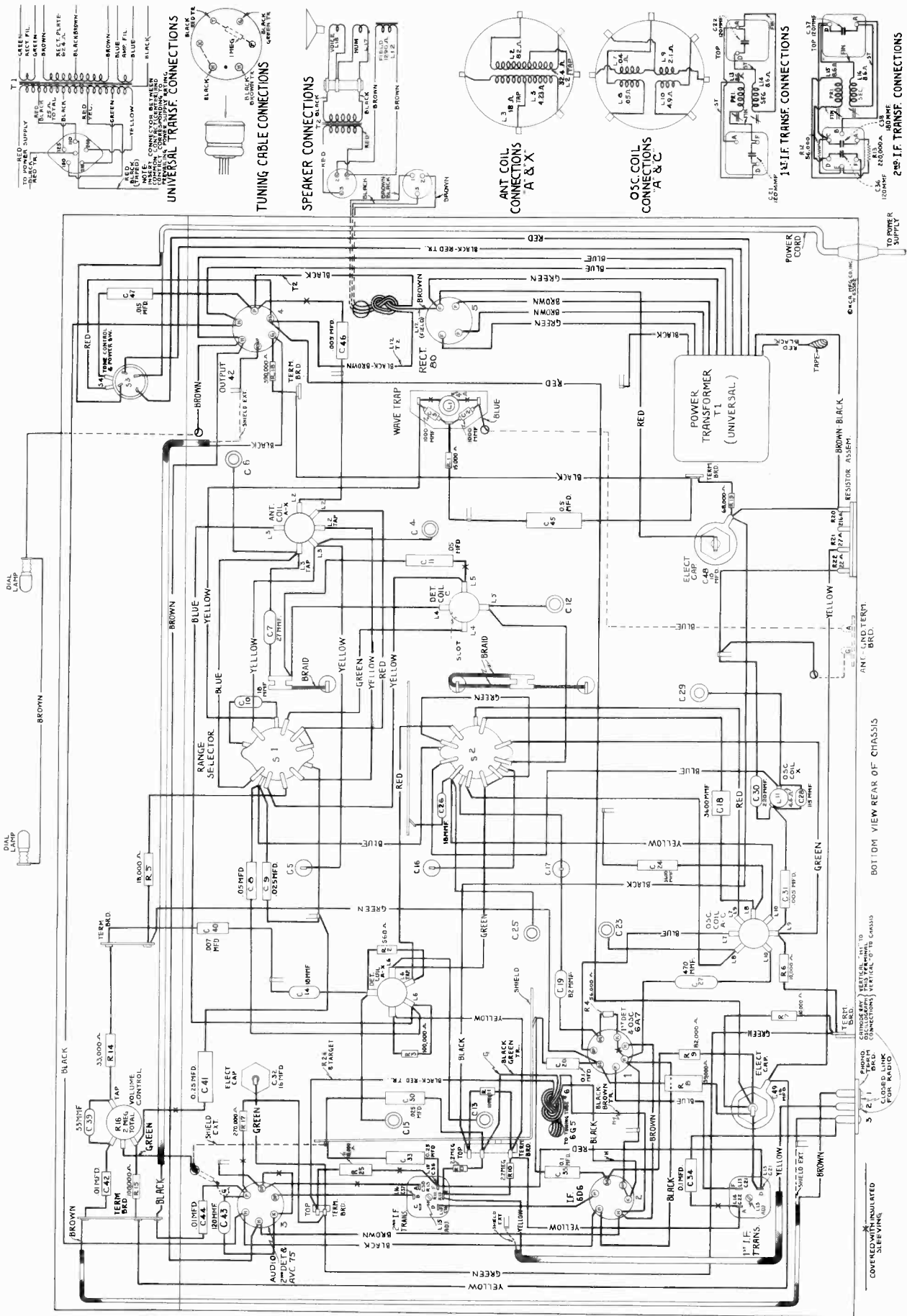

Figure 4—Chassis Wiring Diagram

between terminals 1 and 2 on terminal board. Connect green wire in Radio-Record switch cable to terminal 1, yellow to terminal 2, and shield extension to terminal 3. Tape unused red and blue leads separately. Connect a 2-conductor twisted cable between the Record Player binding posts and the screw terminals on Radio-Record switch.

Loudspeaker.—Centering of the loudspeaker is made in the usual manner with three narrow paper feelers after first removing the front dust cover. This may be removed by

softening its cement with a light application of acetone, using care that the acetone does not flow into the air gap. Speakers RL-63F-1 and 84091-1 have screws for the centering adjustment, while on speaker 84091-2, it is necessary to separate the glued centering disc from the housing, insert paper feelers in air gap, then apply cement to the centering disc, press down firmly, and leave the feelers in place until the cement dries. The dust cover should be cemented back in place with ambroid after completion of the adjustment.

REPLACEMENT PARTS

Insist on genuine factory tested parts, which are readily identified and may be purchased from authorized dealers.

| STOCK No. | DESCRIPTION | STOCK No. | DESCRIPTION |
|----------------------------|--|-----------------------------------|--|
| RECEIVER ASSEMBLIES | | | |
| 14542 | Arm—Band indicator operating arm and hub—less set screw, Stock No. 14350 | 13594 | Resistor—15,000 Ohms—Carbon type, 1/10 watt (R1) |
| 12038 | Band—Rubber band for tuning tube | 3219 | Resistor—18,000 Ohms—Carbon type, 1/2 watt (R5) |
| 14388 | Belt—Variable condenser drive belt | 14078 | Resistor—18,000 Ohms—Carbon type, 1 watt (R25) |
| 13216 | Board—Antenna and ground terminal board | 13735 | Resistor—33,000 Ohms—Carbon type, 1/2 watt (R14) |
| 12717 | Board—Phonograph terminal board | 13206 | Resistor—39,000 Ohms—Carbon type, 2 watt (R8) |
| 14338 | Bushing—Variable condenser mounting bushing and screw assembly | 5029 | Resistor—56,000 Ohms—Carbon type, 1/2 watt (R4) |
| 14394 | Cable—Tuning tube cable and socket | 11282 | Resistor—56,000 Ohms—Carbon type, 1/10 watt (R12) |
| 12607 | Cap—First I.F. transformer shield top | 12333 | Resistor—68,000 Ohms—Carbon type, 1/2 watt (R19) |
| 12581 | Cap—Second I.F. transformer shield top | 8064 | Resistor—82,000 Ohms—Carbon type, 1/2 watt (R9) |
| 12118 | Cap—Grid contact cap | 5145 | Resistor—100,000 Ohms—Carbon type, 1/2 watt (R3, R15) |
| 12884 | Capacitor—Adjustable trimmer (long) (C4, C6, C13, C15, C25, C29) | 11398 | Resistor—220,000 Ohms—Carbon type, 1/10 watt (R13) |
| 12714 | Capacitor—Adjustable trimmer (medium) (C12) | 12199 | Resistor—270,000 Ohms—Insulated, 1/2 watt (R17) |
| 12807 | Capacitor—Adjustable trimmer (short) (C23) | 13479 | Resistor—390,000 Ohms—Carbon type, 1/2 watt (R18) |
| 12722 | Capacitor—18 Mmfd. (C10, C14, C26) | 12013 | Resistor—1 Megohm—Carbon type, 1/10 watt (R24) |
| 13605 | Capacitor—27 Mmfd. (C7) | 12679 | Resistor—2.2 Megohm—Insulated, 1/2 watt (R10, R23) |
| 12948 | Capacitor—33 Mmfd. (C39) | 13601 | Resistor—10 Megohm—Insulated, 1/2 watt (R11) |
| 12813 | Capacitor—82 Mmfd. (C19) | 12004 | Resistor—Voltage divider—Comprising one 216 ohm, one 27 ohm and one 22 ohm sections (R20, R21, R22) |
| 13604 | Capacitor—115 Mmfd. (C28) | 14350 | Screw—No. 8-32 x 3/16 square head set screw for gear, Stock No. 14365, and drum, Stock No. 14345, and arm, Stock No. 14542 |
| 12404 | Capacitor—120 Mmfd. (C21, C22, C36, C37) | 12710 | Shield—Coil shield for Stock Nos. 13587 and 13588 |
| 12724 | Capacitor—120 Mmfd. (C43) | 12799 | Shield—Coil shield for Stock No. 12798 |
| 12406 | Capacitor—180 Mmfd. (C38) | 12883 | Shield—Coil shield for Stock No. 13590 |
| 13602 | Capacitor—220 Mmfd. (C30) | 12008 | Shield—I.F. transformer shield |
| 13603 | Capacitor—470 Mmfd. (C27) | 12798 | Shield—Oscillator coil and shield—"A" and "C" bands (L7, L8, L9, L10) |
| 13593 | Capacitor—1,000 Mmfd. (C2, C3) | 3682 | Shield—6A7, or 75 Radiotron shield |
| 12811 | Capacitor—3,600 Mmfd. (C18, C24) | 4233 | Shield—6D6 Radiotron shield |
| 4838 | Capacitor—.005 Mfd. (C31, C46) | 11383 | Shield—42 Radiotron shield |
| 5148 | Capacitor—.007 Mfd. (C40) | 14114 | Socket—Dial lamp socket |
| 13138 | Capacitor—.01 Mfd. (C42, C44) | 4794 | Socket—4-contact 80 Radiotron socket |
| 11315 | Capacitor—.015 Mfd. (C47) | 4786 | Socket—6-contact 42, 75 or 6D6 Radiotron socket |
| 13606 | Capacitor—.025 Mfd. (C9) | 4787 | Socket—7-contact 6A7 Radiotron socket |
| 4870 | Capacitor—.025 Mfd. (C50) | 12007 | Spring—Retaining spring for core, Stock Nos. 12006, 12664 and 12882 |
| 4886 | Capacitor—.05 Mfd. (C11) | 12907 | Spring—Tension spring for indicator drive gear, Stock No. 14365 |
| 13607 | Capacitor—.05 Mfd. (C8) | 14342 | Spring—Tension spring for idler, Stock No. 14341 |
| 4839 | Capacitor—.1 Mfd. (C20, C34, C35) | 14537 | Switch—Range switch (S1, S2) |
| 12484 | Capacitor—.25 Mfd. (C33, C41) | 14538 | Switch—Tone and power switch (S3, S4) |
| 12741 | Capacitor—.5 Mfd. (C45) | 12652 | Transformer—First I.F. transformer (L13, L14, C21, C22) |
| 11203 | Capacitor—10 Mfd. (C48) | 12653 | Transformer—Second I.F. transformer (L15, L16, C36, C37, C38, R12, R13) |
| 5212 | Capacitor—16 Mfd. (C49) | 13392 | Transformer—Power transformer—105-125 volts, 50-60 cycles (T1) |
| 14377 | Capacitor—16 Mfd. (C32) | 13566 | Transformer—Power transformer—105-125 volts, 25-60 cycles (T1) |
| 13587 | Coil—Antenna coil and shield—"X" and "A" bands (L2, L3) | 12646 | Transformer—Power transformer—100-130/140-160/195-250 volts, 50-60 cycles (T1) |
| 13589 | Coil—Antenna coil—"C" band only (L4, L5) | 13592 | Trap—Wave trap (L1) |
| 13590 | Coil—Oscillator coil and shield—"X" band only (L11) | 14335 | Volume Control (R16) |
| 12798 | Coil—Oscillator coil and shield—"A" and "C" bands (L7, L8, L9, L10) | 14379 | Washer—Felt washer for indicator pointer |
| 13588 | Coil—R.F. coil and shield—"X" and "A" bands (L6) | REPRODUCER ASSEMBLIES | |
| 14539 | Condenser—3-gang variable tuning condenser (C5, C16, C17) | Model 86T4 (Speaker No. RL-63F-1) | |
| 5119 | Connector—3-contact female connector for reproducer cable | 14356 | Board—3-contact reproducer terminal board |
| 12800 | Core—Adjustable core and stud assembly for Stock No. 12798 | 13866 | Cap—Cone center dust cap |
| 12882 | Core—Adjustable core and stud for Stock No. 13590 | 12012 | Coil—Field coil (L12) |
| 12006 | Core—Adjustable core and stud for Stock Nos. 12652 and 12653 | 11469 | Coil—Hum neutralizing coil (L17) |
| 12664 | Core—Adjustable core and stud for Stock No. 13592 | 12642 | Cone—Reproducer cone and dust cap (L18) |
| 14541 | Dial—Station selector dial scale, complete with tuning tube escutcheon (for European use only) | 5118 | Plug—3-contact male plug for reproducer |
| 14543 | Dial—Band indicator dial and mounting bracket | 14360 | Reproducer—Reproducer complete |
| 14544 | Dial—Station selector dial scale, complete with tuning tube escutcheon (for other than European use) | 14358 | Screw—Screw, washer and lockwasher to hold core in yoke |
| 14540 | Drive—Variable condenser vernier drive pinion gear and shaft | 14355 | Transformer—Output transformer (T2) |
| 14345 | Drum—Variable condenser drive belt drum, complete with set screws | 14357 | Washer—Spring washer to hold field coil |
| 14387 | Escutcheon—Tuning tube escutcheon | Model 86T44 (Speaker No. 84091-1) | |
| 11982 | Fastener—Dial scale fastener | 14616 | Coil—Reproducer field coil (L12, L17) |
| 30085 | Gear—Indicator drive gear and hub assembly and indicator pointer stem and gear assembly | 14614 | Cone—Reproducer cone and voice coil (L18) |
| 14341 | Idler—Station selector drive belt idler | 5118 | Plug—3-contact male plug |
| 14344 | Indicator—Station selector indicator pointer | 14613 | Reproducer—Complete |
| 14382 | Indicator—Vernier indicator pointer | 14615 | Transformer—Output transformer (T2) |
| 5226 | Lamp—Dial lamp | MISCELLANEOUS ASSEMBLIES | |
| 14028 | Nut—Jamb nut for Stock Nos. 12884, 12807 and 12714 | 14396 | Escutcheon—Station selector escutcheon and crystal |
| 14340 | Pulley—Station selector drive belt pulley and knob shaft | 14269 | Knob—Volume control, tone control or range switch knob |
| 14362 | Reflector—Dial reflector, lamp bracket and tuning tube mounting bracket and clamp | 14359 | Knob—Station selector knob |
| 14343 | Retainer—Drive shaft and pulley retainer—holds tuning knob shaft and pulley on range switch shaft | 11377 | Screw—Chassis mounting screw assembly |
| 11324 | Resistor—560 Ohms—Carbon type, 1/2 watt (R2) | 4982 | Spring—Retaining spring for knob, Stock No. 14359 |
| 3078 | Resistor—10,000 Ohms—Carbon type, 1/2 watt (R6, R7) | 14270 | Spring—Retaining spring for knob, Stock No. 14269 |



RCA Victor

MODEL 87K1

Seven-Tube, Three-Band, A-C, Superheterodyne Receiver

TECHNICAL INFORMATION AND SERVICE DATA

- 1937 No. 34 -

SERVICE DIVISION • RCA MANUFACTURING COMPANY, INC. • CAMDEN, N. J., U. S. A.

A Service of the Radio Corporation of America

Electrical Specifications

FREQUENCY RANGES

| | |
|-------------------------------|-----------------|
| "Standard Broadcast" (A)..... | 540-1,720 kc |
| "Medium Wave" (B)..... | 2,300-7,500 kc |
| "Short Wave" (C)..... | 7,500-22,000 kc |

R-F ALIGNMENT FREQUENCIES

| | |
|-----------------------------|--------------------------------|
| "Medium Wave" (B)..... | 6,000 kc (osc., ant.) |
| "Short Wave" (C)..... | 20,000 kc (osc.) |
| "Standard Broadcast" (A)... | 600 kc (osc.), 1,500 kc (osc.) |

Intermediate Frequency..... 460 kc

RADIOTRON COMPLEMENT

| | |
|------------------|----------------------------|
| (1) RCA-6A8..... | First Detector—Oscillator |
| (2) RCA-6K7..... | Intermediate Amplifier |
| (3) RCA-6H6..... | Second Detector and A.V.C. |

| | |
|------------------|-------------------------|
| (4) RCA-6F5..... | Audio Voltage Amplifier |
| (5) RCA-6F6..... | Audio Power Amplifier |
| (6) RCA-5W4..... | Full-Wave Rectifier |
| (7) RCA-6U5..... | Tuning Tube |

Pilot Lamps (3)..... Mazda No. 46, 6.3 volts, 0.25 ampere

POWER SUPPLY RATINGS

| | |
|---------------|---|
| Rating A..... | 105-125 volts, 50-60 cycles, 80 watts |
| Rating B..... | 105-125 volts, 25-60 cycles, 80 watts |
| Rating C..... | 105-125/200-250 volts, 50-60 cycles, 80 watts |

POWER OUTPUT

| | |
|------------------|-----------|
| Undistorted..... | 2.5 watts |
| Maximum..... | 4.5 watts |

LOUDSPEAKER

| | |
|-----------------------|------------------------|
| Type..... | 12-inch Electrodynamic |
| Impedance (v.c.)..... | 2.2 ohms at 400 cycles |

Mechanical Specifications

| | |
|------------------------------|--|
| Height..... | 41 inches |
| Width..... | 27½ inches |
| Depth..... | 14 ⁹ / ₁₆ inches |
| Net Weight..... | 60½ pounds |
| Shipping Weight..... | 76 pounds |
| Chassis Base Dimensions..... | 14½ inches x 7¾ inches x 3½ inches |
| Over-all Chassis Height..... | 8 inches |
| Operating Controls..... | (1) Volume (large knob), Power Switch—Tone (small knob); (2) Tuning (large knob), Range Selector (small knob, left to right "Electric," "A," "B," "C") |
| Tuning Drive Ratio..... | 20 to 1 |

General Description

This receiver employs a seven-tube, three-band superheterodyne circuit. Features of design include "Electric Tuning" with push-button operation; "cumulative-wound" antenna "A" band coil; magnetite-core adjusted i-f transformers and low-frequency "A" oscillator tracking; phonograph terminal

board; "Magic Eye" tuning tube; aural-compensated volume control; tone control; and an edge-illuminated straight-line dial. Model 87K1 incorporates a twelve-inch electrodynamic loudspeaker.

Circuit Arrangement

The circuit consists of a combined first-detector and oscillator stage, i-f amplifier stage, diode detector and automatic volume control stage, a-f amplifier stage, power amplifier

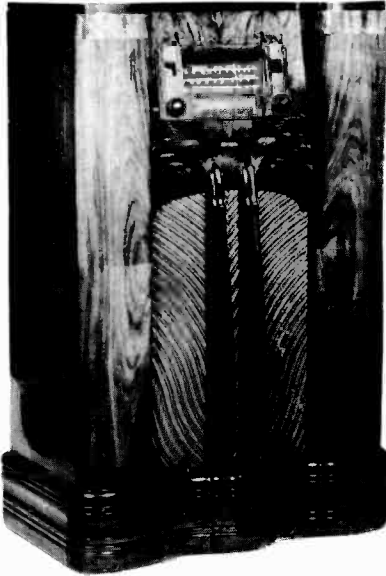

Model 87K1

stage, tuning indicator "Magic Eye," and a full-wave rectifier. The antenna coil is constructed with a special type winding ("cumulative") to provide increased sensitivity and selectivity on the "Standard Broadcast" band. There is a fixed-tuned wave trap for reducing 460 kc interference.

Electric tuning is accomplished in a simple, trouble-free manner without the use of rotating parts. There are six trimmers for tuning the single antenna coil and six magnetite-core adjusted oscillator coils. A desired station is tuned accurately, quickly, and silently by pressing a push-button which puts the pre-adjusted coil and trimmer into use. Oscillator frequency drift is reduced to a negligible amount by use of a temperature-compensating capacitor across the oscillator coils.

Service Data

Loudspeaker.—Centering of the loudspeaker is made in the usual manner with three narrow paper feelers after first removing the front dust cover. This may be removed by softening its cement with a light application of acetone, using care not to allow the acetone to flow into the air gap. The dust cover should be cemented back in place with ambroid upon completion of adjustment.

Phonograph Attachment.—A terminal board is provided for connecting a phonograph into the audio-amplifying circuit. RCA Victor Models R-93, R-93-A, R-93-2, or R-94 Record Players should be connected as follows: Remove the link from the phonograph terminal board. Connect green wire in Radio-Record switch cable to terminal 1; yellow to terminal 2; shield to terminal 3; and tape up the red and blue. Connect a 2-conductor twisted cable between the Record Player binding posts and the screw-terminals on Radio-Record switch. If additional volume is desired, connect an RCA Stock No. 9632 transformer between the 2-conductor twisted cable and the screw-terminals on Radio-Record switch as follows: Yellow and brown transformer leads and one side of twisted cable to ground screw-terminal on switch; black transformer lead to other side of twisted cable; and blue transformer lead to other screw-terminal on switch.

Precautionary Lead Dress.—Maintain original length and size of the following: (1) all leads from range selector to antenna and oscillator coils; (2) lead from oscillator coil to ground; (3) leads from gang condenser to range selector. (4) Keep filament leads twisted and dressed away from 6F5 grid lead. (5) Keep leads from C2 as short as possible.

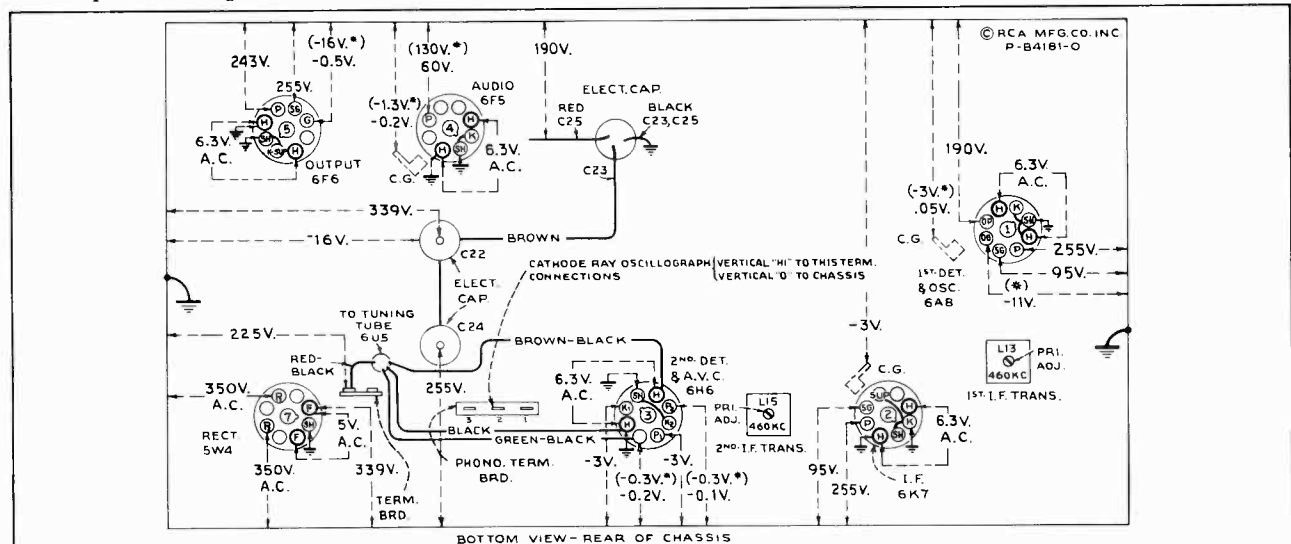

Figure 1—Radiotron Socket Voltages and Trimmer Locations

Measured at 115 volts, 60-cycle supply—Tuned to approximately 1,000 kc ("Standard Broadcast")—No signal being received—Volume control minimum—Tone control optional

Note: Two voltage values are shown for some readings. The value shown in parentheses with asterisk (*) indicates operating conditions without voltmeter loading. The other value (generally lower) is the actual measured voltage and differs from the value shown in parentheses because of the additional loading of the voltmeter through the high series circuit resistance.

Voltage values as specified should hold within $\pm 20\%$ when the receiver is normally operative at its rated line voltage. To duplicate the conditions under which the voltages were measured requires a 1,000-ohm-per-volt d-c meter, having ranges of 10, 50, 250 and 500 volts. Use the nearest range above the specified measured voltage. A-c voltages were measured with a corresponding a-c meter.

Radiotron Cathode Current Readings

Measured with Milliammeter Connected at Tube Socket
Cathode Terminals Under Conditions Similar to
Those of Voltage Measurements

- (1) RCA-6A8—1st Det.—Osc. 12 ma.
- (2) RCA-6K7—I-F Amp. 8 ma.
- (3) RCA-6H6—2nd Det.—A.V.C. — ma.
- (4) RCA-6F5—A-F Amp. 0.2 ma.
- (5) RCA-6F6—Output 41 ma.
- (6) RCA-5W4—Rectifier 63 ma.*
- (7) RCA-6U5—Tuning Tube 1.6 ma.

(*Cannot be measured at socket)

Alignment Procedure

Calibrate the tuning dial by adjusting dial pointer to the low-frequency (end) calibration mark on dial with the gang tuning-condenser plates in full-mesh position. The pointer is soldered in place on the drive cable.

Perform alignment in proper order, tabulated below, starting with No. 1 and following all operations across, then No. 2, etc. Adjustment locations are shown on figures 1 and 2.

Cathode-ray alignment is highly preferable; the connections to the chassis are shown on figure 1. If an output indicator is used, connect it across the loudspeaker voice-coil and advance the receiver volume control to full-volume position.

Connect the "low" output terminal of the test oscillator to the receiver "G" (ground) terminal for all alignment opera-

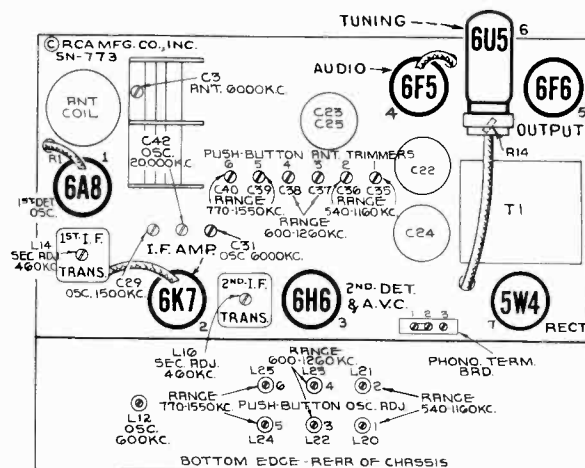

Figure 2—Radiotron, Component Part, and Trimmer Locations

tions. Regulate the output of the test oscillator so that minimum signal is applied to the receiver to obtain an observable output indication. This will avoid a-v-c action.

The term "Dummy antenna" means the device which must be connected between the "high" test-oscillator output and the point of connection to the receiver in order to obtain ideal alignment. "No signal, 550-750 kc" means that the receiver should be tuned to a point between 550 and 750 kc where no signal or interference is received from a station or local (heterodyne) oscillator. "Min. Eye" means minimum width of dark sector of "Magic Eye" or greatest deflection.

For further details on alignment, refer to booklet "RCA Victor Receiver Alignment."

| Order of Alignment | Test Oscillator | | | Range Selector | Receiver Dial Setting | Circuit to Adjust | Adjustment Symbols | Adjust to Obtain |
|--------------------|---|---------------|-------------------|----------------------|-----------------------|---------------------|--------------------|------------------|
| | Connection to Receiver | Dummy Antenna | Frequency Setting | | | | | |
| 1 | 6K7 I-F Grid Cap | .001 Mfd. | 460 kc | "Standard Broadcast" | No Signal 550-750 kc | 2nd I-F Trans. | L15 and L16 | Max. (peak) |
| 2 | 6A8 Det. Grid Cap | .001 Mfd. | 460 kc | "Standard Broadcast" | No Signal 550-750 kc | 1st I-F Trans. | L13 and L14 | Max. (peak) |
| 3 | Ant. Term. A | 300 Ohms | 6,000 kc | "Medium Wave" | 6 mc | "B" Osc. | C31 | Max. (peak) |
| 4 | Ant. Term. A | 300 Ohms | 6,000 kc | "Medium Wave" | 6 mc | "B" Ant. | C3 | Max. (peak) |
| 5 | Ant. Term. A | 300 Ohms | 20,000 kc | "Short Wave" | 20 mc | "C" Osc. | C42 | Max. (peak)* |
| 6 | Ant. Term. A | 200 Mmfd. | 600 kc | "Standard Broadcast" | 600 kc | "A" L-F Osc. | L12 | Max. (peak) |
| 7 | Ant. Term. A | 200 Mmfd. | 1,500 kc | "Standard Broadcast" | 1,500 kc | "A" H-F Osc. | C29 | Max. (peak) |
| 8 | Ant. Term. A | 200 Mmfd. | 600 kc | "Standard Broadcast" | 600 kc | "A" L-F Osc. | L12 | Max. (peak) |
| 9 | Ant. Term. A | 200 Mmfd. | 1,500 kc | "Standard Broadcast" | 1,500 kc | "A" H-F Osc. | C29 | Max. (peak) |
| 10 | Connect an antenna to receiver Ant. Term. A. See Electric Tuning Alignment described below. | | 540-1,160 kc | "Electric Tuning" | 540-1,160 kc | "A" Osc. 1 & Ant. 1 | L20 and C35 | Min. Eye |
| 11 | | | 540-1,160 kc | "Electric Tuning" | 540-1,160 kc | "A" Osc. 2 & Ant. 2 | L21 and C36 | Min. Eye |
| 12 | | | 600-1,260 kc | "Electric Tuning" | 600-1,260 kc | "A" Osc. 3 & Ant. 3 | L22 and C37 | Min. Eye |
| 13 | | | 600-1,260 kc | "Electric Tuning" | 600-1,260 kc | "A" Osc. 4 & Ant. 4 | L23 and C38 | Min. Eye |
| 14 | | | 770-1,550 kc | "Electric Tuning" | 770-1,550 kc | "A" Osc. 5 & Ant. 5 | L24 and C39 | Min. Eye |
| 15 | | | 770-1,550 kc | "Electric Tuning" | 770-1,550 kc | "A" Osc. 6 & Ant. 6 | L25 and C40 | Min. Eye |

* Use maximum capacity peak if two peaks can be obtained. Check for image signal by shifting receiver dial to 20.92 mc.

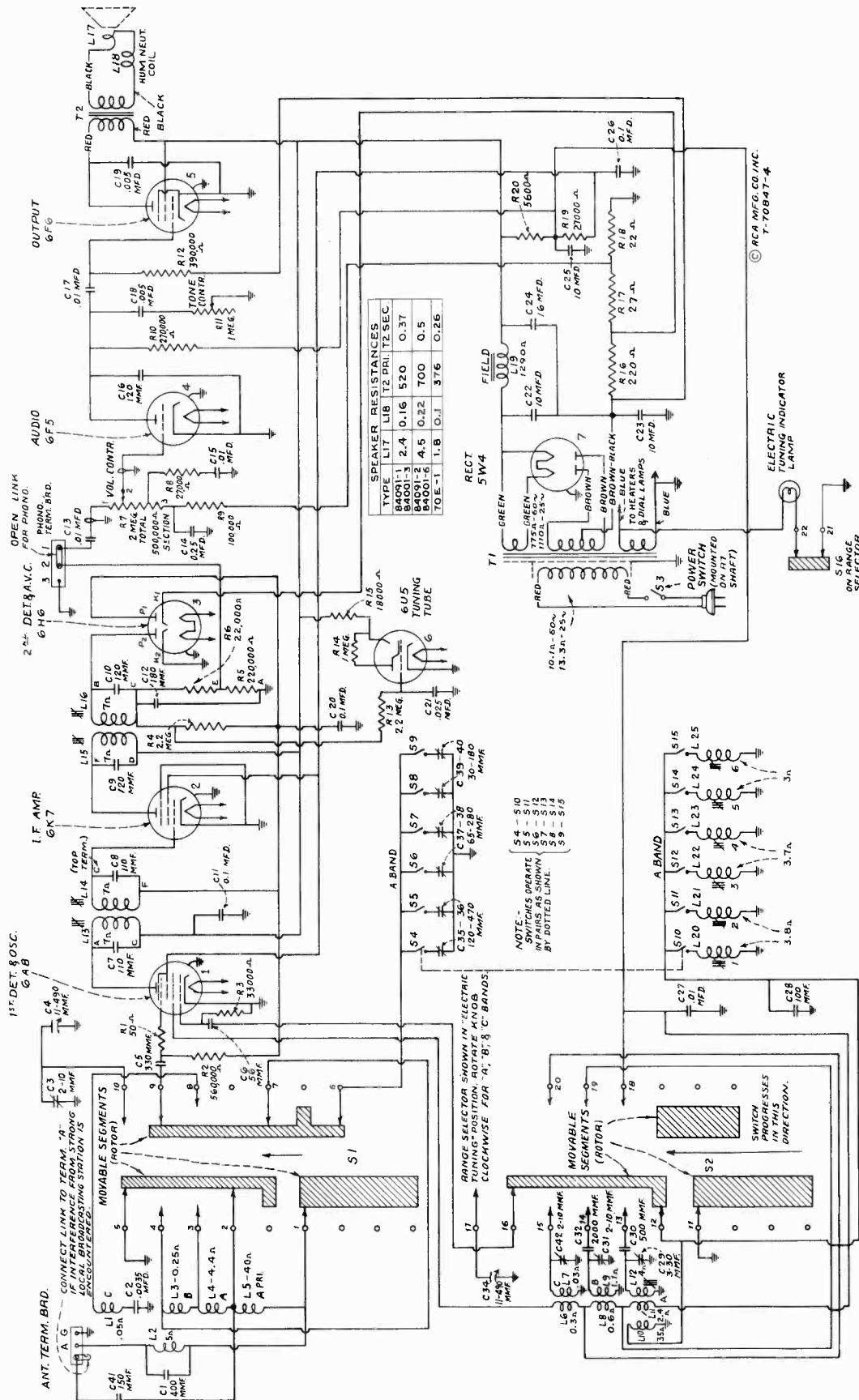
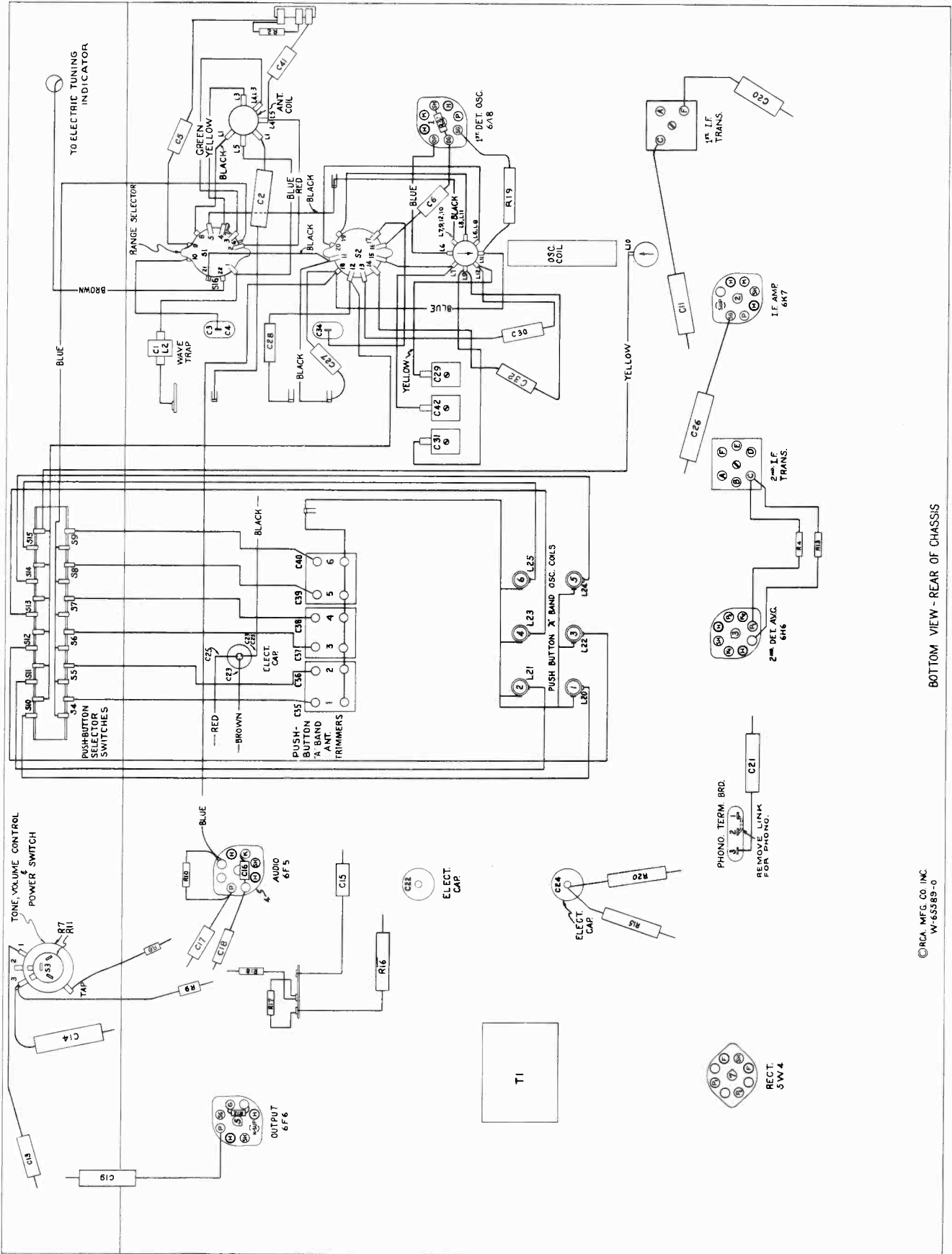

Figure 3—Schematic Circuit Diagram
 R19 was 18,000 ohms on some instruments. Replace with Stock No. 13477, 27,000 ohms.



BOTTOM VIEW - REAR OF CHASSIS

©RCA MFG. CO. INC. W-65589-0

Figure 4—Component Part Locations and R-F Wiring Diagram

Electric Tuning Alignment.—Select six "A" band stations to be tuned with push-buttons. It is usually preferable to choose stations not on the same network. For push-buttons 1 and 2, choose stations from 540 kc to 1,160 kc; for 3 and 4, stations from 600 kc to 1,260 kc; and for 5 and 6, stations from 770 kc to 1,550 kc. The push-buttons are numbered consecutively from left to right.

Allow the receiver to operate about five minutes before proceeding with "Electric Tuning" alignment.

To align so that push-button 1 will tune WJZ, e.g., first set "Range Selector" to "Standard Broadcast" position and manually tune WJZ at a dial setting near 760 kc. Then set "Range Selector" for "Electric Tuning," press push-button 1, and again tune WJZ for maximum output by carefully adjusting first L20 and then C35. If there is difficulty in

recognizing the desired station it should be borne in mind that clockwise rotation of trimmer and magnetite-core screws lowers the frequency to which the radio is tuned. Preliminary setting of the adjustments may be made with the use of a test oscillator. In any case final adjustment should be made on the desired station. Use "Magic Eye" indication of maximum output; tune for minimum width of dark sector of the eye. Proceed similarly, following the above table for the remaining push-buttons.

The first-detector trimmer adjustment will appear to be broad when tuning strong local signals because of a.v.c. action, so to obtain accurate adjustment on strong signals it will be necessary during adjustment to use an antenna only a few inches long. Use enough antenna to not more than half close the "Magic Eye."

REPLACEMENT PARTS

Insist on genuine factory-tested parts, which are readily identified and may be purchased from authorized dealers.

| STOCK No. | DESCRIPTION | STOCK No. | DESCRIPTION |
|--------------------------|--|---------------------------------|---|
| RECEIVER ASSEMBLY | | | |
| 30755 | Arm—Band indicator operating arm—fastens on range switch shaft | 16293 | Resistor—220 ohms, carbon type, 1 watt (R16) |
| 14384 | Belt—Drive belt | 11298 | Resistor—5,600 ohms, carbon type, 1 watt (R20) |
| 14623 | Board—Antenna and ground terminal board | 30151 | Resistor—18,000 ohms, insulated, 1 watt (R15) |
| 12717 | Board—Phonograph terminal board | 14284 | Resistor—22,000 ohms, carbon type, 1/10 watt (R6) |
| 30752 | Bracket—Tuning tube mounting bracket and clip | 11400 | Resistor—27,000 ohms, carbon type, 1/2 watt (R8) |
| 30754 | Cable—Band indicator operating cable | 12454 | Resistor—33,000 ohms, insulated, 1/2 watt (R3) |
| 11350 | Cap—Grid contact cap | 14560 | Resistor—100,000 ohms, insulated, 1/2 watt (R9) |
| 30766 | Cap—Rubber cap for tuning tube | 11398 | Resistor—220,000 ohms, carbon type, 1/10 watt (R5) |
| 30751 | Capacitor—Trimmer—Comprising two sections each 2-10 Mmfd. and one section 3-30 Mmfd. (C29, C31, C42) | 12199 | Resistor—270,000 ohms, insulated, 1/2 watt (R10) |
| 30750 | Capacitor—Dual trimmer, 30-180 Mmfd. each section (C39, C40) | 13005 | Resistor—390,000 ohms, carbon type, 1/10 watt (R12) |
| 12723 | Capacitor—56 Mmfd. (C6) | 11397 | Resistor—560,000 ohms, carbon type, 1/10 watt (R2) |
| 30764 | Capacitor—Dual trimmer, 65-280 Mmfd. each section (C37, C38) | 12013 | Resistor—1 Megohm, carbon type, 1/10 watt (R14) |
| 30769 | Capacitor—100 Mmfd. (C28) | 12679 | Resistor—2.2 Megohm, insulated, 1/2 watt (R4, R13) |
| 14262 | Capacitor—110 Mmfd. (C7, C8) | 30760 | Shaft—Tuning knob shaft and pulley |
| 12404 | Capacitor—120 Mmfd. (C9, C10) | 5119 | Socket—3-contact socket for speaker cable |
| 12724 | Capacitor—120 Mmfd. (C16) | 13871 | Socket—6-contact tuning tube socket |
| 30765 | Capacitor—Dual trimmer, 120-470 Mmfd. each section (C35, C36) | 11196 | Socket—8-contact Radiotron socket |
| 12725 | Capacitor—150 Mmfd. (C41) | 14114 | Socket—Dial lamp socket—open type |
| 12406 | Capacitor—180 Mmfd. (C12) | 14171 | Socket—Dial lamp socket—shell type |
| 12952 | Capacitor—330 Mmfd. (C5) | 30756 | Spring—Band indicator tension spring |
| 30768 | Capacitor—500 Mmfd. (C30) | 14342 | Spring—Idler pulley tension spring |
| 30767 | Capacitor—2,000 Mmfd. (C32) | 30585 | Spring—Indicator cord tension spring |
| 30303 | Capacitor—.0035 Mfd. (C2) | 30742 | Switch—Range switch (S1, S2, S16) |
| 4838 | Capacitor—.005 Mfd. (C18, C19) | 30744 | Switch—Tuning push button switch (S4, S5, S6, S7, S8, S9, S10, S11, S12, S13, S14, S15) |
| 14393 | Capacitor—.01 Mfd. (C13, C15, C17, C27) | 14376 | Transformer—First I.F. transformer (L13, L14, C7, C8) |
| 4870 | Capacitor—.025 Mfd. (C21) | 14283 | Transformer—Second I.F. transformer (L15, L16, C9, C10, C12, R5, R6) |
| 4839 | Capacitor—0.1 Mfd. (C11, C20, C26) | 30607 | Transformer—Power transformer 105-125 volts and 200-240 volts, 50-60 cycle (T1) |
| 12484 | Capacitor—0.25 Mfd. (C14) | 30571 | Transformer—Power transformer 105-125 volts, 25-60 cycle (T1) |
| 11203 | Capacitor—10 Mfd. (C25) | 13838 | Trap—Wave trap (L2, C1) |
| 30577 | Capacitor—Comprising two sections each 10 Mfd. (C22, C23) | REPRODUCER ASSEMBLIES | |
| 5212 | Capacitor—16 Mfd. (C24) | 13866 | Cap—Dust cap for cone center |
| 30745 | Coil—Antenna coil and shield A, B, and C bands (L1, L3, L4, L5) | 14354 | Coil—Field coil (L19) |
| 30749 | Coil—Oscillator coil A band (L20 or L21) | 11489 | Coil—Hum neutralizing coil (L16) |
| 30748 | Coil—Oscillator coil A band (L22 or L23) | 12667 | Cone—Reproducer cone and dust cap (L17) |
| 30747 | Coil—Oscillator coil A band (L24 or L25) | 5118 | Plug—3-contact male plug for reproducer |
| 30746 | Coil—Oscillator coil A, B, C bands (L6, L7, L8, L9, L10, L11, L12) | 14395 | Reproducer—complete |
| 30740 | Condenser—2-gang variable tuning condenser (C3, C4, C34) | 14358 | Screw—Screw, washer and lockwasher to hold core in yoke |
| 30743 | Control—Volume control, tone control, and power switch in one unit (R7, R11, S3) | 14355 | Transformer—Output transformer (T2) |
| 30763 | Cord—Indicator drive cord | 14357 | Washer—Spring washer to hold field coil |
| 30759 | Dial—Station selector dial scale | MISCELLANEOUS ASSEMBLIES | |
| 30753 | Disc—Band indicator disc with colored segment | 30778 | Button—Automatic station selector push button |
| 30741 | Drive—Variable condenser vernier drive shaft and pinion gear | 30780 | Cushion—Rubber cushion for automatic station selector button |
| 30587 | Drum—Drive belt drum—fastens on variable condenser vernier drive shaft | 30774 | Escutcheon—Station selector escutcheon complete with side panels and buttons |
| 30761 | Drum—Indicator cord drum—fastens on variable condenser rotor shaft | 30775 | Escutcheon—Station selector escutcheon center section only—less side panels and buttons |
| 14341 | Idler—Drive idler pulley, bracket and spring | 30776 | Escutcheon—Station selector escutcheon right and left hand sections only |
| 30762 | Indicator—Indicator pointer and slider | 30773 | Knob—Volume control knob |
| 5226 | Lamp—Dial lamp | 14269 | Knob—Range switch knob |
| 30757 | Pulley—Large size pulley for indicator cord—located at top left corner of dial bracket | 14359 | Knob—Station selector knob |
| 30758 | Pulley—Medium size pulley for indicator cord—located at top right side of dial bracket | 30772 | Knob—Tone control and power switch knob |
| 14697 | Pulley—Small size pulley for indicator cord—located at top right hand corner of dial bracket | 11210 | Screw—Chassis mounting screw and washer assembly |
| 14525 | Resistor—22 ohms, carbon type, 1/2 watt (R18) | 30779 | Shield—Celluloid shield for call letter cards |
| 11955 | Resistor—27 ohms, carbon type, 1/2 watt (R17) | 30777 | Shield—Finished metal shield and screws for automatic station selector button panel |
| 30771 | Resistor—50 ohms, flexible type, 2 1/2 watts (R1) | 30330 | Spring—Retaining spring for knob Stock No. 30772 |
| | | 14270 | Spring—Retaining spring for knobs Stock Nos. 30773 and 14269 |
| | | 4982 | Spring—Retaining spring for knob Stock No. 14359 |



RCA Victor

MODEL 88K

Eight-Tube, Three-Band, A-C, Superheterodyne Receiver

TECHNICAL INFORMATION AND SERVICE DATA

SERVICE DIVISION • RCA MANUFACTURING COMPANY, INC. • CAMDEN, N. J., U. S. A.

A Service of the Radio Corporation of America

Electrical Specifications

FREQUENCY RANGES

"Broadcast" (A)..... 530-1,720 kc
 "Medium Wave" (B)..... 2,100-6,800 kc
 "Short Wave" (C)..... 6,800-22,000 kc

Intermediate Frequency.....

R-F ALIGNMENT FREQUENCIES

"Broadcast" (A)..... 600 kc (osc.), 1,500 kc (osc.)
 "Medium Wave" (B)..... 6,000 kc (osc.)
 "Short Wave" (C)..... 20,000 kc (osc., det., ant.)

..... 460 kc

RADIOTRON COMPLEMENT

(1) RCA-6K7..... R-F Amplifier
 (2) RCA-6J7..... Heterodyne Oscillator
 (3) RCA-6L7..... First Detector
 (4) RCA-6K7..... Intermediate Amplifier

(5) RCA-6Q7..... Second Det., A-F Amp., and A.V.C.
 (6) RCA-6F6..... Power Output
 (7) RCA-6G5..... "Magic Eye" Tuning Tube
 (8) RCA-5W4..... Full-Wave Rectifier

Pilot Lamps (4)..... Mazda No. 46, 6.3 volts, 0.25 amp.

POWER SUPPLY RATINGS

Rating A..... 105-125 volts, 50-60 cycles, 90 watts
 Rating B..... 105-125 volts, 25-60 cycles, 90 watts
 Rating C..... 105-125/200-250 volts, 50-60 cycles, 90 watts

POWER OUTPUT

Undistorted..... 2.5 watts
 Maximum..... 4.5 watts

LOUDSPEAKER

Type..... 12-inch Electrodynamic
 Impedance (v.c.)..... 2.2 ohms at 400 cycles

Mechanical Specifications

Height 40 inches
 Width 26½ inches
 Depth 12⅞ inches
 Weight (net)..... 55½ pounds
 Weight (shipping)..... 68 pounds
 Chassis Base Dimensions..... 14⅞ inches x 9¾ inches x 3¼ inches
 Over-all Chassis Height..... 9¾ inches
 Operating Controls..... (1) Power Switch—Tone; (2) Tuning (large inner knob), Range Selector (small outer knob, left to right "A," "B," "C"); (3) Volume
 Tuning Drive Ratio 20 to 1

General Description

This receiver employs an eight-tube, three-band superheterodyne circuit, the arrangement of which is shown by the Schematic Circuit Diagram. Features of design include an r-f amplifier stage with "cumulative-wound" antenna transformer for high signal-to-noise ratio; magnetite-core i-f transformers and low-frequency oscillator tracking; full automatic

volume control; phonograph terminal board; "Magic Eye" tuning tube; 12-inch, dust-proof electrodynamic loudspeaker; plunger-type, air-dielectric trimming capacitors; aural-compensated audio volume control; two-point, high-frequency tone control; and a new sunburst dial with short-wave stations listed by name and illuminated band and tone indicators.

Copyright, 1937, RCA Manufacturing Co., Inc.

Trademarks "Radiotron," "Magic Eye"
Reg. U. S. Pat. Off. by RCA Mfg. Co., Inc.

Service Data

The various diagrams of this booklet contain such information as will be needed to isolate causes for defective operation if such develops. The ratings of the resistors, capacitors, coils, etc., are indicated adjacent to the symbols signifying these parts on the diagrams. Identification titles such as R1, L1, C1, etc., provide reference between the illustrations and Replacement Parts List. The coils, transformer windings, and reactors are rated in terms of d-c resistance to permit continuity checks.

Loudspeaker.—Centering of the loudspeaker is made in the usual manner with three narrow paper feelers after first removing the front dust cover. This may be removed by softening its cement with a light application of acetone, using care not to allow the acetone to flow into the air gap. The dust cover should be cemented back in place with ambroid upon completion of adjustment.

Phonograph Attachment.—A terminal board is provided for connecting a phonograph into the audio amplifying circuit. RCA Victor Models R-93, R-93-A, R-93-2, or R-94 Record Players should be connected as follows: Remove link between terminals 1 and 2 on terminal board. Connect green wire in Radio-Record switch cable to terminal 1, yellow to terminal 2, and shield extension to terminal 3. Tape unused

red and blue leads separately. Connect a 2-conductor twisted cable between the Record Player binding posts and the screw terminals on Radio-Record switch.

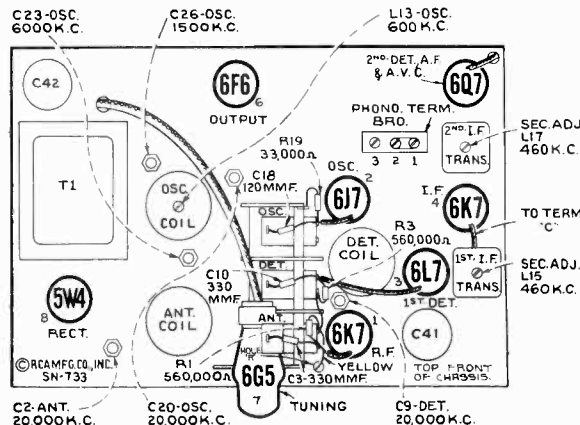

Figure 1—Radiotron, Coil, and Trimmer Locations

Alignment Procedure

Calibrate the tuning dial by adjusting main dial pointer to the low-frequency (end) calibration mark on dial with the gang tuning-condenser plates in full-mesh position; then adjust the small (vernier) pointer to "O." These are friction adjustments.

Perform alignment in proper order, tabulated below, starting with No. 1 and following all operations across, then No. 2, etc. Adjustment locations are shown on figures 1 and 2.

Cathode-ray alignment is highly preferable; the connections to the chassis are shown on figure 4. If an output indicator is used, connect it across the loudspeaker voice-coil and advance the receiver volume control to full-volume position.

Connect the "low" output terminal of the test oscillator to

the receiver "G" (ground) terminal for all alignment operations. Regulate the output of the test oscillator so that minimum signal is applied to the receiver to obtain an observable output indication. This will avoid a-v-c action.

The term "Dummy antenna" means the device which must be connected between the "high" test-oscillator output and the point of connection to the receiver in order to obtain ideal alignment. "No signal, 550-750 kc" means that the receiver should be tuned to a point between 550 and 750 kc where no signal or interference is received from a station or local (heterodyne) oscillator.

For further details on alignment, refer to booklet "RCA Victor Receiver Alignment."

| Order of Alignment | Test Oscillator | | | Range Selector | Receiver Dial Setting | Circuit to Adjust | Adjustment Symbols | Adjust to Obtain |
|--------------------|------------------------|---------------|-------------------|----------------|-----------------------|-------------------|--------------------|------------------|
| | Connection to Receiver | Dummy Antenna | Frequency Setting | | | | | |
| 1 | 6K7 I-F Grid Cap | .001 Mfd. | 460 kc | "A" Left | No Signal 550-750 kc | 2nd I-F Trans. | L16 and L17 | Max. (peak) |
| 2 | 6L7 Det. Grid Cap | .001 Mfd. | 460 kc | "A" | No Signal 550-750 kc | 1st I-F Trans. | L14 and L15 | Max. (peak) |
| 3 | Ant. Term. | 300 Ohms | 20,000 kc | "C" Right | 20,000 kc | "C" Osc. | C20 | Max. (peak) * |
| 4 | Ant. Term. | 300 Ohms | 20,000 kc | "C" | 20,000 kc | "C" Det. | C9 | Max. (peak) † |
| 5 | Ant. Term. | 300 Ohms | 20,000 kc | "C" | 20,000 kc | "C" Ant. | C2 | Max. (peak) ‡ |
| 6 | Ant. Term. | 300 Ohms | 6,000 kc | "B" Center | 6,000 kc | "B" Osc. | C23 | Max. (peak) * |
| 7 | Ant. Term. | 200 Mmfd. | 600 kc | "A" Left | 600 kc | "A" L-F Osc. | L13 | Max. (peak) |
| 8 | Ant. Term. | 200 Mmfd. | 1,500 kc | "A" | 1,500 kc | "A" H-F Osc. | C26 | Max. (peak) |
| 9 | Ant. Term. | 200 Mmfd. | 600 kc | "A" | 600 kc | "A" L-F Osc. | L13 | Max. (peak) |
| 10 | Ant. Term. | 200 Mmfd. | 1,500 kc | "A" | 1,500 kc | "A" H-F Osc. | C26 | Max. (peak) |

* Use minimum capacity peak if two peaks can be obtained.

† Use maximum capacity peak if two peaks can be obtained.

‡ After this adjustment, check for image signal by shifting receiver dial to 19,080 kc.

Precautionary Lead Dress.—(1) Keep leads to a-c switch dressed away from antenna coil and trimmer C2. (2) Keep all filament leads twisted. (3) Keep yellow lead from term. E of 2nd i-f trans. to phono. term. board as short as possible. (4) Keep leads of C21 as short as possible. (5) Dress shielded lead from volume control to phono. term. board against side of chassis and away from 6L7 socket. (6) Yellow lead from 6J7 oscillator cathode to dummy terminal on 6L7 socket must be dressed away from chassis base and from brown filament lead. (7) All molded capacitors should be dressed so that flat side is perpendicular to chassis base. (8) Yellow lead from cathode of 6J7 socket to term. 22 of S2 must be dressed under spaghetti on 6J7 socket jumper and pulled tight away from chassis. The following bus leads should be kept as short as possible and, when necessary, replaced only with wire having same diameter as original: (9) Lead from L11-L12-L13 to ground lance; (10) Lead from term. 13 of S3 to ground lance; (11) Lead from term. 9 of S3 to L6-L7; (12) Lead from L6 to C8; (13) Lead from C9 to C8; (14) Lead from term. 5 of S1 to ground lance; (15) Lead from L1-L2 to term. 4 of S1; (16) Lead from L1 to C1; (17) Lead from term. 21 of S2 to C19.

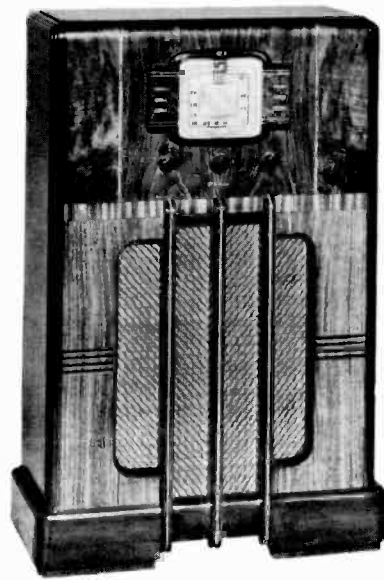

Model 88K

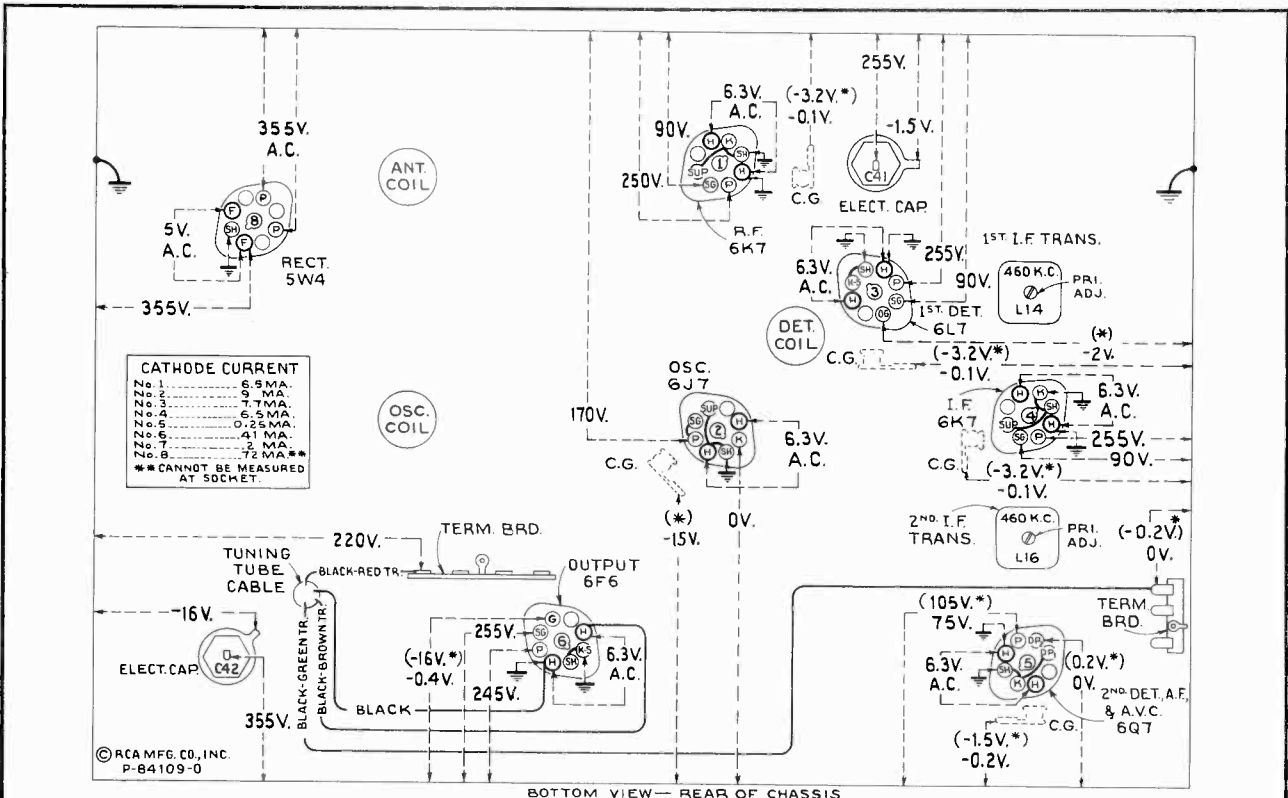

Figure 2—Radiotron Socket Voltages, Coil, and Trimmer Locations

Measured at 115 volts, 60-cycle supply—Tuned to approximately 1,000 kc ("Standard Broadcast")—No signal being received—Volume control minimum

Note: Two voltage values are shown for some readings. The value shown in parentheses with asterisk (*) indicates operating conditions without voltmeter loading. The other value (generally lower) is the actual measured voltage and differs from the value shown in parentheses because of the additional loading of the voltmeter through the high series circuit resistance.

Voltage values as specified should hold within $\pm 20\%$ when the receiver is normally operative at its rated line voltage. To duplicate the conditions under which the voltages were measured requires a 1,000-ohm-per-volt d-c meter, having ranges of 10, 50, 250, and 500 volts. Use the nearest range above the specified measured voltage. A-c voltages were measured with a corresponding a-c meter.

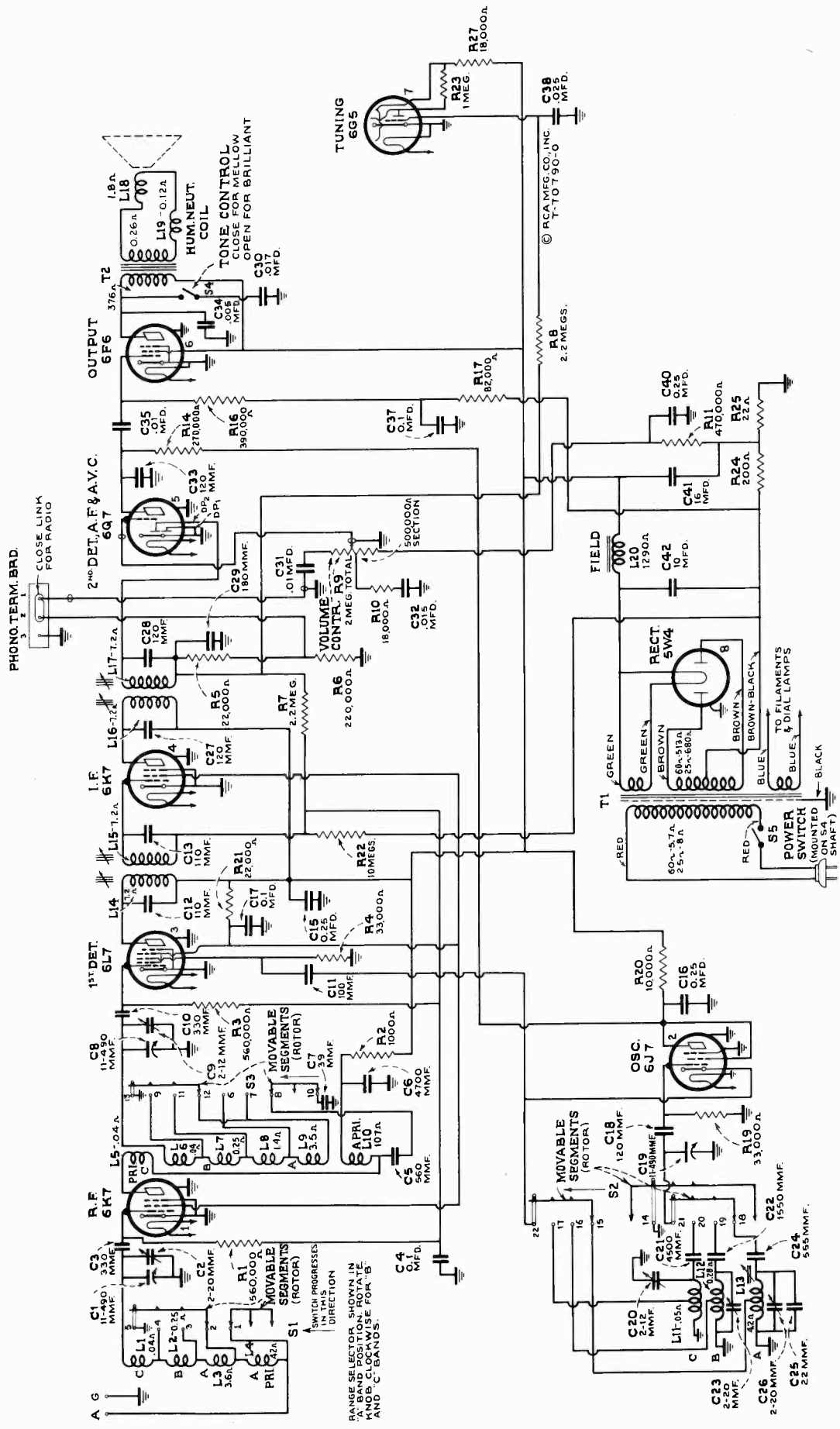

Figure 3—Schematic Circuit Diagram

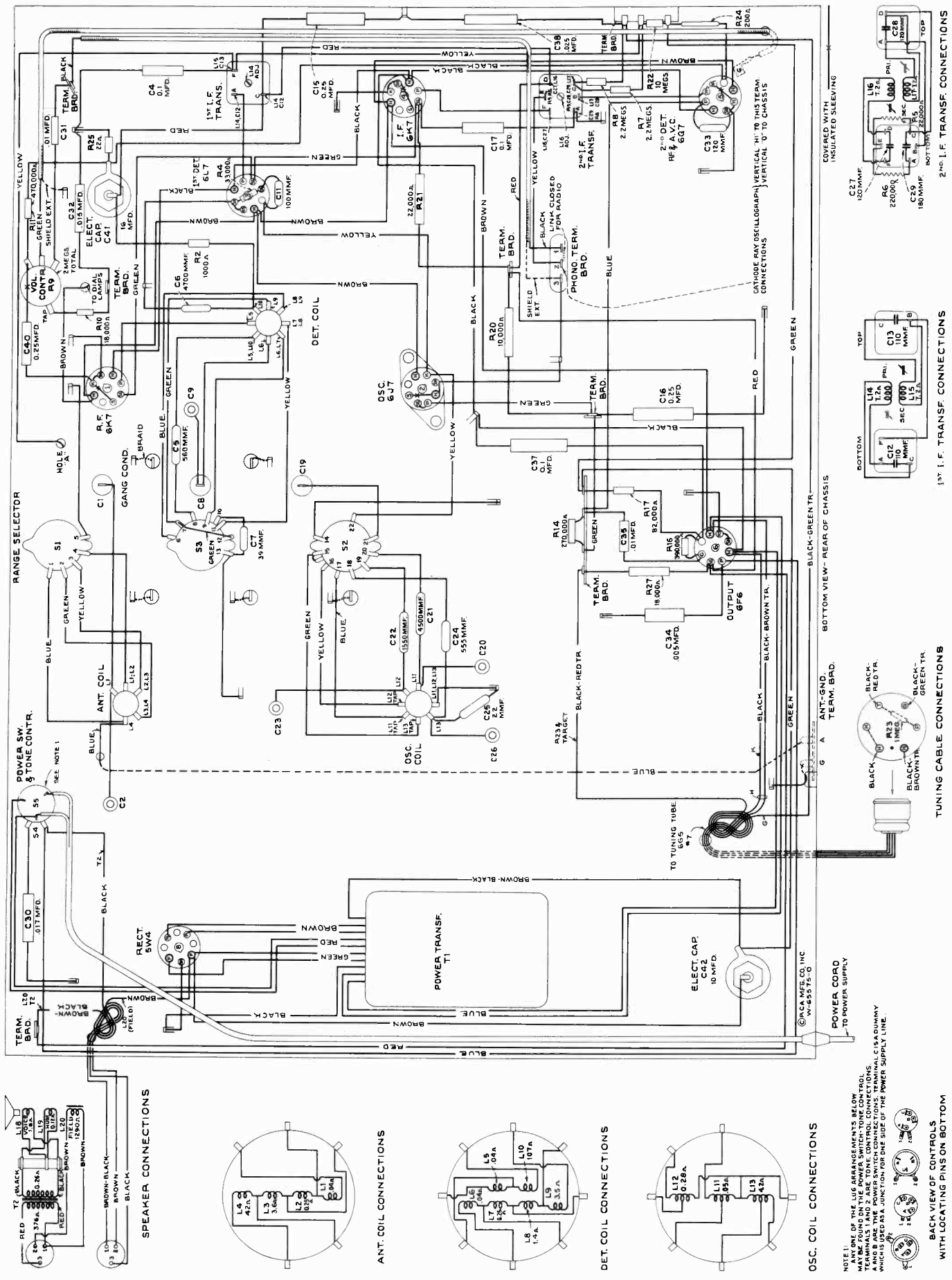

Figure 4—Chassis Wiring Diagram

REPLACEMENT PARTS

Insist on genuine factory tested parts, which are readily identified and may be purchased from authorized dealers.

| STOCK No. | DESCRIPTION | STOCK No. | DESCRIPTION |
|----------------------------|--|---|---|
| RECEIVER ASSEMBLIES | | | |
| 12038 | Band—Rubber band for tuning tube | 11175 | Resistor—18,000 Ohms, Carbon type, ¼ watt (R10) |
| 14384 | Belt—Variable condenser drive belt | 14078 | Resistor—18,000 Ohms, Carbon type, 1 watt (R27) |
| 14517 | Board—Antenna and ground terminal board | 14284 | Resistor—22,000 Ohms, Carbon type, 1/10 watt (R5) |
| 12717 | Board—Phonograph terminal board | 13669 | Resistor—22,000 Ohms, Carbon type, 2 watt (R21) |
| 14338 | Bushing—Variable condenser mounting bushing assembly | 11300 | Resistor—33,000 Ohms, Carbon type, 1/10 watt (R19) |
| 14524 | Cable—Band indicator cable approx. 6½-in. long | 13735 | Resistor—33,000 Ohms, Carbon type, ¼ watt (R4) |
| 14523 | Cable—Tone control indicator cable approx. 3-in. long | 11365 | Resistor—82,000 Ohms, Carbon type, ¼ watt (R17) |
| 14394 | Cable—Tuning tube cable and socket | 11398 | Resistor—220,000 Ohms, Carbon type, 1/10 watt (R6) |
| 12607 | Cap—First I-F transformer shield top | 11323 | Resistor—270,000 Ohms, Carbon type, ¼ watt (R14) |
| 12581 | Cap—Second I-F transformer shield top | 13005 | Resistor—390,000 Ohms, Carbon type, 1/10 watt (R16) |
| 11350 | Cap—Grid contact cap | 11172 | Resistor—470,000 Ohms, Carbon type, ¼ watt (R11) |
| 12884 | Capacitor—Adjustable trimmer (long) (C2, C23, C26) | 11397 | Resistor—560,000 Ohms, Carbon type, 1/10 watt (R1, R3) |
| 12714 | Capacitor—Adjustable trimmer (medium) (C9, C20) | 12013 | Resistor—1 Megohm, Carbon type, 1/10 watt (R23) |
| 14021 | Capacitor—22 Mmfd. (C25) | 11626 | Resistor—2.2 Megohm, Carbon type, ¼ watt (R7, R8) |
| 13545 | Capacitor—39 Mmfd. (C7) | 13732 | Resistor—10 Megohm, Carbon type, ¼ watt (R22) |
| 12720 | Capacitor—100 Mmfd. (C11) | 14343 | Retainer—Station selector knob shaft and pulley retainer |
| 14262 | Capacitor—110 Mmfd. (C12, C13) | 14350 | Screw—No. 8—32x3/16 square head set screw for hub and arm on tone or band indicator cable, drum Stock No. 14345, Gear Stock No. 30085 |
| 12404 | Capacitor—120 Mmfd. (C27, C28) | 14374 | Shield—Antenna or R-F coil shield |
| 12724 | Capacitor—120 Mmfd. (C18, C33) | 14375 | Shield—Oscillator coil shield |
| 12406 | Capacitor—180 Mmfd. (C29) | 12008 | Shield—First or second I-F transformer shield |
| 12952 | Capacitor—330 Mmfd. (C3, C10) | 11195 | Socket—5-contact 5W4 Radiotron socket |
| 12727 | Capacitor—655 Mmfd. (C24) | 11196 | Socket—8-contact 6F6, 6K7, 6J7, 6L7, or 6Q7 Radiotron socket |
| 12537 | Capacitor—660 Mmfd. (C5) | 14114 | Socket—Dial lamp socket |
| 12729 | Capacitor—1,650 Mmfd. (C22) | 12007 | Spring—Retaining spring for core Stock Nos. 12006 and 12800 |
| 12728 | Capacitor—4,500 Mmfd. (C21) | 12907 | Spring—Tension spring for indicator drive gear Stock No. 30085 |
| 12897 | Capacitor—4,700 Mmfd. (C6) | 14342 | Spring—Tension spring for idler Stock No. 14341 |
| 4838 | Capacitor—.005 Mfd. (C34) | 14371 | Switch—Low frequency tone and power switch (S4, S5) |
| 13138 | Capacitor—.01 Mfd. (C31, C35) | 14515 | Switch—Range switch (S1, S2, S3) |
| 11315 | Capacitor—.015 Mfd. (C32) | 14376 | Transformer—First I-F transformer (L14, L15, C12, C13) |
| 4752 | Capacitor—.017 Mfd. (C30) | 14283 | Transformer—Second I-F transformer (L16, L17, C27, C28, C29, R5, R6) |
| 4870 | Capacitor—.025 Mfd. (C38) | 14511 | Transformer—Power transformer, 105-125 volts, 50-60 cycles (T1) |
| 4839 | Capacitor—.01 Mfd. (C4, C17, C37) | 14512 | Transformer—Power transformer, 105-125 volts, 25-60 cycles (T1) |
| 5170 | Capacitor—.025 Mfd. (C15) | 14335 | Volume Control (R9) |
| 12484 | Capacitor—.025 Mfd. (C16, C40) | 14379 | Washer—Felt washer for indicator pointer |
| 11203 | Capacitor—.10 Mfd. (C42) | REPRODUCER ASSEMBLIES (RL-70E-1) | |
| 5212 | Capacitor—.16 Mfd. (C41) | 13866 | Cap—Dust cap for cone center |
| 14372 | Coil—Antenna coil and shield (L1, L2, L3, L4) | 12012 | Coil—Field coil (L20) |
| 14516 | Coil—Oscillator coil and shield (L11, L12, L13) | 11469 | Coil—Hum neutralizing coil (L19) |
| 14414 | Coil—R.F. coil and shield (L5, L6, L7, L8, L9, L10) | 12667 | Cone—Reproducer cone and dust cap (L18) |
| 14513 | Condenser—3-gang variable tuning condenser (C1, C8, C19) | 5118 | Connector—3-contact male plug for reproducer |
| 5119 | Connector—3-contact female connector for speaker cable | 14395 | Reproducer—Reproducer complete |
| 12006 | Core—Adjustable core and stud for Stock Nos. 14376 and 14283 | 14358 | Screw—Screw, washer and lockwasher to hold core in yoke |
| 12800 | Core—Adjustable core and stud for coil Stock No. 14516 | 14355 | Transformer—Output transformer (T2) |
| 14518 | Dial—Station selector dial scale complete with tuning tube escutcheon | 14357 | Washer—Spring washer to hold field coil |
| 14514 | Drive—Variable condenser vernier drive pinion gear and shaft | MISCELLANEOUS ASSEMBLIES | |
| 14345 | Drum—Variable condenser drive belt drum complete with set screws | 14527 | Escutcheon—Station selector escutcheon and crystal complete with tone and band indicating strips |
| 14387 | Escutcheon—Tuning tube escutcheon | 14529 | Index—Band indicating strip—mounts in station selector escutcheon |
| 11982 | Fastener—Dial scale fastener | 14528 | Index—Tone indicating strip—mounts in station selector escutcheon |
| 30085 | Gear—Indicator drive gear and hub assembly and indicator pointer stem and gear assembly | 14269 | Knob—Volume control, tone control, or range switch knob |
| 14341 | Idler—Station selector drive belt idler | 14359 | Knob—Station selector knob |
| 14519 | Indicator—Station selector indicator pointer | 11210 | Screw—Chassis mounting screw and washer assembly |
| 14520 | Indicator—Vernier indicator pointer | 14270 | Spring—Retaining spring for knob Stock No. 14269 |
| 5226 | Lamp—Dial lamp | 4982 | Spring—Retaining spring for knob Stock No. 14359 |
| 14028 | Nut—Jamb nut for adjustable trimmer capacitor Stock Nos. 12714 and 12884 | | |
| 12471 | Plate—6J7 Radiotron socket mounting plate and rubber cushions—less socket—Stock No. 11196 | | |
| 14340 | Pulley—Station selector drive belt pulley and knob shaft | | |
| 14522 | Reflector—Dial reflector and bracket complete with dial lamp brackets, tuning lamp bracket, and tone and band indicators | | |
| 14525 | Resistor—22 Ohms, Carbon type, ¼ watt (R25) | | |
| 14526 | Resistor—200 Ohms, Wire wound, 2½ watts (R24) | | |
| 5112 | Resistor—1,000 Ohms, Carbon type, ¼ watt (R2) | | |
| 8043 | Resistor—10,000 Ohms, Carbon type, 2 watt (R20) | | |



RCA Victor

MODELS 810K, 810K1, and 810T

Ten-Tube, Three-Band, A-C, Superheterodyne Receivers

TECHNICAL INFORMATION AND SERVICE DATA

-1937 No. 20-

SERVICE DIVISION • RCA MANUFACTURING COMPANY, INC. • CAMDEN, N. J., U. S. A.

A Service of the Radio Corporation of America

Electrical Specifications

FREQUENCY RANGES

"Broadcast" (A)..... 530-1,720 kc
 "Medium Wave" (B)..... 2,100-6,800 kc
 "Short Wave" (C)..... 6,800-22,000 kc

Intermediate Frequency..... 460 kc

R-F ALIGNMENT FREQUENCIES

"Short Wave" (C)..... 20,000 kc (osc., det., ant.)
 "Medium Wave" (B)..... 6,000 kc (osc.)
 "Broadcast" (A)..... 600 kc (osc.), 1,500 kc (osc.)

RADIOTRON COMPLEMENT

(1) RCA-6K7..... R-F Amplifier
 (2) RCA-6J7..... Heterodyne Oscillator
 (3) RCA-6L7..... First Detector
 (4) RCA-6K7..... Intermediate Amplifier
 (5) RCA-6H6..... Second Detector and A.V.C.

(6) RCA-6N7..... Phase Inverter A-F Amplifier
 (7) RCA-6F6..... Power Output
 (8) RCA-6F6..... Power Output
 (9) RCA-6G5..... "Magic Eye" Tuning Tube
 (10) RCA-5T4..... Full-Wave Rectifier

Pilot Lamps (4)..... Mazda No. 46, 6.3 volts, 0.25 amp.

POWER SUPPLY RATINGS

Rating A..... 105-125 volts, 50-60 cycles, 135 watts
 Rating B..... 105-125 volts, 25-60 cycles, 135 watts
 Rating C..... 100-130/140-160/195-250 volts, 40-60 cycles, 135 watts

POWER OUTPUT

Undistorted..... 10 watts
 Maximum..... 12.5 watts

LOUDSPEAKER

Type..... Electrodynamic
 Impedance (v.c.)..... 2.2 ohms at 400 cycles

Mechanical Specifications

| | 810K | 810K1 | 810T |
|------------------------------|--|--|--|
| Height | 42 inches..... | 42 inches..... | 20 ³ / ₄ inches |
| Width | 26 inches..... | 26 inches..... | 17 ³ / ₄ inches |
| Depth | 12 inches..... | 12 ¹ / ₂ inches..... | 11 ¹ / ₁₆ inches |
| Weight (net)..... | 57 pounds..... | 62 pounds..... | 33 pounds |
| Weight (shipping)..... | 74 pounds..... | 77 pounds..... | 40 pounds |
| Chassis Base Dimensions..... | 14 ³ / ₈ inches x 9 ³ / ₄ inches x 3 ³ / ₄ inches | | |
| Over-all Chassis Height..... | 9 ³ / ₄ inches | | |
| Operating Controls..... | (1) Power Switch—Tone; (2) Tuning (large inner knob), Range Selector (small outer knob, left to right "A," "B," "C"); (3) Volume | | |
| Tuning Drive Ratio | 20 to 1 | | |

General Description

These receivers employ a ten-tube, three-band, "Magic Brain," superheterodyne circuit, the arrangement of which is shown by the Schematic Circuit Diagram. Models 810K and 810K1 are console models, each employing a 12-inch electrodynamic loudspeaker. Model 810T is a table model employing an 8-inch electrodynamic loudspeaker. Features of design include an r-f amplifier stage, "cumulative-wound" antenna and r-f transformers for high signal-to-noise ratio; magnetite-core, i-f transformers and low-frequency oscillator

tracking; automatic volume control; phonograph terminal board; "Magic Eye" tuning tube; plunger-type, air-dielectric trimming capacitors; aural-compensated, audio-volume control; "Mellow-Brilliant" tone control; audio phase-inverter voltage amplifier; push-pull, power-output stage; improved dust-proof electrodynamic loudspeaker; and a new sunburst dial with short-wave stations listed by name and illuminated band and tone indicators. In addition, Model 810K1 has a cabinet incorporating the "Sonic-Arc" Magic Voice.

Copyright, 1937, RCA Manufacturing Co., Inc.

Trademarks "Radiotron," "Magic Eye," "Magic Brain," "Magic Voice" Reg. U. S. Pat. Off. by RCA Mfg. Co., Inc.

Service Data

The various diagrams of this booklet contain such information as will be needed to isolate causes for defective operation if such develops. The ratings of the resistors, capacitors, coils, etc., are indicated adjacent to the symbols signifying these parts on the diagrams. Identification titles such as R1, L1, C1, etc., provide reference between the illustrations and Replacement Parts List. The coils, transformer windings, and reactors are rated in terms of d-c resistance to permit continuity checks.

Loudspeaker.—Centering of the loudspeaker is made in the usual manner with three narrow paper feelers after first removing the front dust cover. This may be removed by softening its cement with a light application of acetone, using care not to allow the acetone to flow into the air gap. The dust cover should be cemented back in place with ambroid upon completion of adjustment.

Phonograph Attachment.—A terminal board is provided for connecting a phonograph into the audio amplifying circuit. RCA Victor Models R-93, R-93-A, R-93-2, or R-94 Record Players should be connected as follows: Remove link between terminals 1 and 2 on terminal board. Connect green wire in Radio-Record switch cable to terminal 1, yellow to terminal 2, and shield extension to terminal 3. Tape unused red and blue leads separately. Connect a 2-conductor twisted cable between the Record Player binding posts and the screw terminals on Radio-Record switch. If additional volume is desired, connect an RCA Stock No. 9632 transformer between the two-conductor twisted cable and the screw-

terminals on Radio-Record switch as follows: yellow and brown transformer leads and one side of twisted cable to ground screw-terminal on switch; black transformer lead to other side of twisted cable; and blue transformer lead to other screw-terminal on switch.

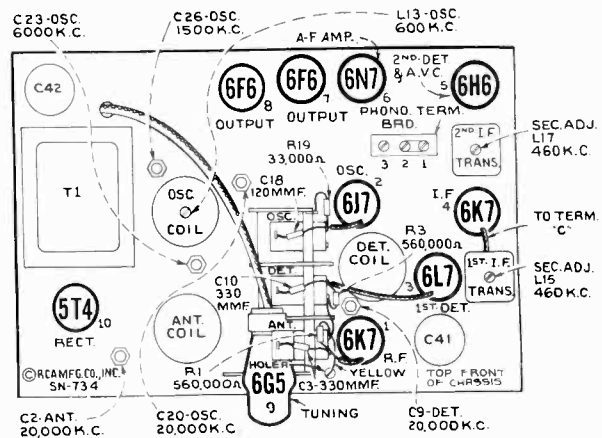

Figure 1—Radiotron, Coil, and Trimmer Locations

Alignment Procedure

Calibrate the tuning dial by adjusting main dial pointer to the low-frequency (end) calibration mark on dial with the gang tuning-condenser plates in full-mesh position; then adjust the small (vernier) pointer to "O." These are friction adjustments.

Perform alignment in proper order, tabulated below, starting with No. 1 and following all operations across, then No. 2, etc. Adjustment locations are shown on figures 1 and 2.

Cathode-ray alignment is highly preferable; the connections to the chassis are shown on figure 4. If an output indicator is used, connect it across the loudspeaker voice-coil and advance the receiver volume control to full-volume position.

Connect the "low" output terminal of the test oscillator to

the receiver "G" (ground) terminal for all alignment operations. Regulate the output of the test oscillator so that minimum signal is applied to the receiver to obtain an observable output indication. This will avoid a-v-c action.

The term "Dummy antenna" means the device which must be connected between the "high" test-oscillator output and the point of connection to the receiver in order to obtain ideal alignment. "No signal, 550-750 kc" means that the receiver should be tuned to a point between 550 and 750 kc where no signal or interference is received from a station or local (heterodyne) oscillator.

For further details on alignment, refer to booklet "RCA Victor Receiver Alignment."

| Order of Alignment | Test Oscillator | | | Range Selector | Receiver Dial Setting | Circuit to Adjust | Adjustment Symbols | Adjust to Obtain |
|--------------------|------------------------|---------------|-------------------|----------------|-------------------------|-------------------|--------------------|------------------|
| | Connection to Receiver | Dummy Antenna | Frequency Setting | | | | | |
| 1 | 6K7 I-F Grid Cap | .001 Mfd. | 460 kc | "A" Left | No Signal 550-750 kc | 2nd I-F Trans. | L16 and L17 | Max. (peak) |
| 2 | 6L7 Det. Grid Cap | .001 Mfd. | 460 kc | "A" | No Signal 550-750 kc | 1st I-F Trans. | L14 and L15 | Max. (peak) |
| 3 | Ant. Term. | 300 Ohms | 20,000 kc | "C" Right | 20,000 kc | "C" Osc. | C20 | Max. (peak) * |
| 4 | Ant. Term. | 300 Ohms | 20,000 kc | "C" | 20,000 kc | "C" Det. | C9 | Max. (peak) † |
| 5 | Ant. Term. | 300 Ohms | 20,000 kc | "C" | 20,000 kc | "C" Ant. | C2 | Max. (peak) ‡ |
| 6 | Ant. Term. | 300 Ohms | 6,000 kc | "B" Center | 6,000 kc | "B" Osc. | C23 | Max. (peak) * |
| 7 | Ant. Term. | 200 Mmfd. | 600 kc | "A" Left | 600 kc | "A" L-F Osc. | L13 | Max. (peak) |
| 8 | Ant. Term. | 200 Mmfd. | 1,500 kc | "A" | 1,500 kc | "A" H-F Osc. | C26 | Max. (peak) |
| 9 | Ant. Term. | 200 Mmfd. | 600 kc | "A" | 600 kc | "A" L-F Osc. | L13 | Max. (peak) |
| 10 | Ant. Term. | 200 Mmfd. | 1,500 kc | "A" | 1,500 kc | "A" H-F Osc. | C26 | Max. (peak) |

* Use minimum capacity peak if two peaks can be obtained.

† Use maximum capacity peak if two peaks can be obtained.

‡ After this adjustment, check for image signal by shifting receiver dial to 19,080 kc.



Model 810K1



Model 810T

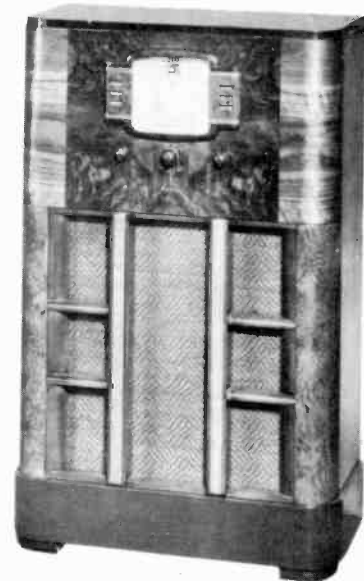

Model 810K

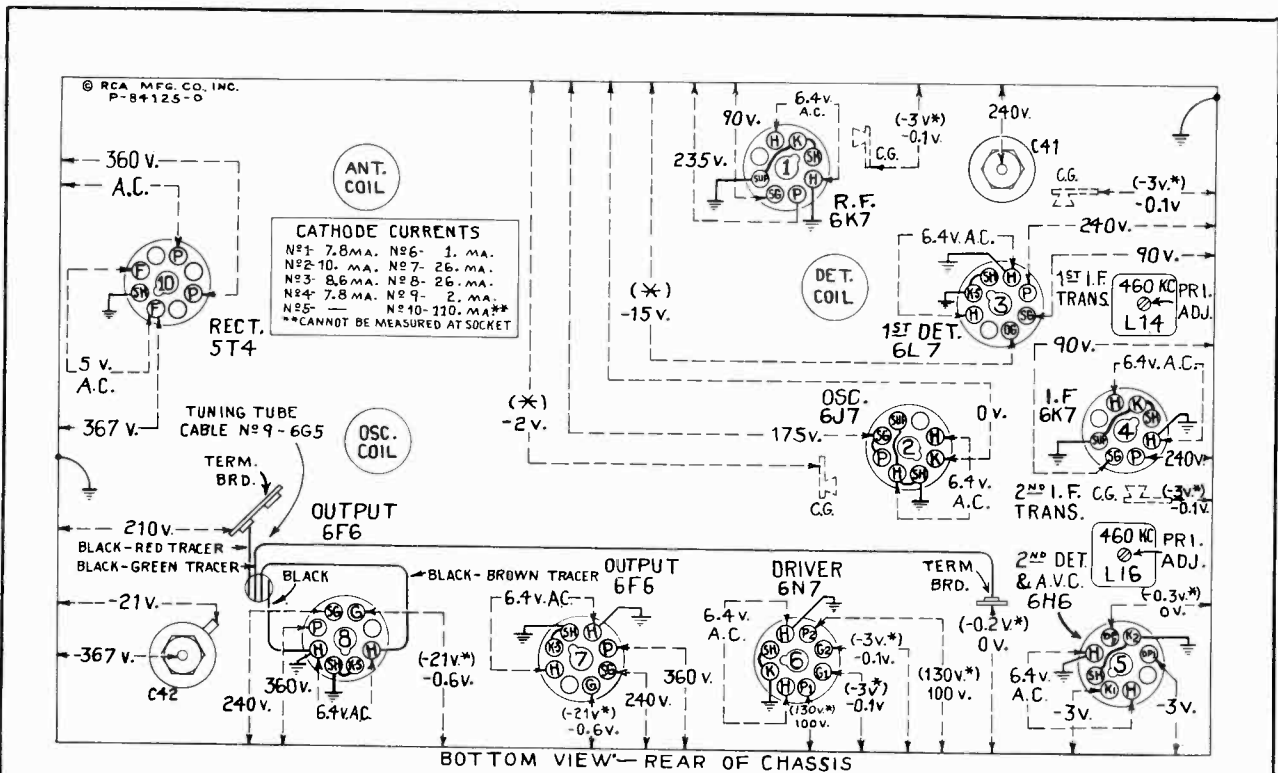

Figure 2—Radiotron Socket Voltages, Coil, and Trimmer Locations
 Measured at 115 volts, 60-cycle supply—Tuned to approximately 1,000 kc ("Standard Broadcast")—
 No signal being received—Volume control minimum

Note: Two voltage values are shown for some readings. The value shown in parentheses with asterisk (*) indicates operating conditions without voltmeter loading. The other value (generally lower) is the actual measured voltage and differs from the value shown in parentheses because of the additional loading of the voltmeter through the high series circuit resistance.

Voltage values as specified should hold within ±20% when the receiver is normally operative at its rated line voltage. To duplicate the conditions under which the voltages were measured requires a 1,000-ohm-per-volt d-c meter, having ranges of 10, 50, 250, and 500 volts. Use the nearest range above the specified measured voltage. A-c voltages were measured with a corresponding a-c meter.

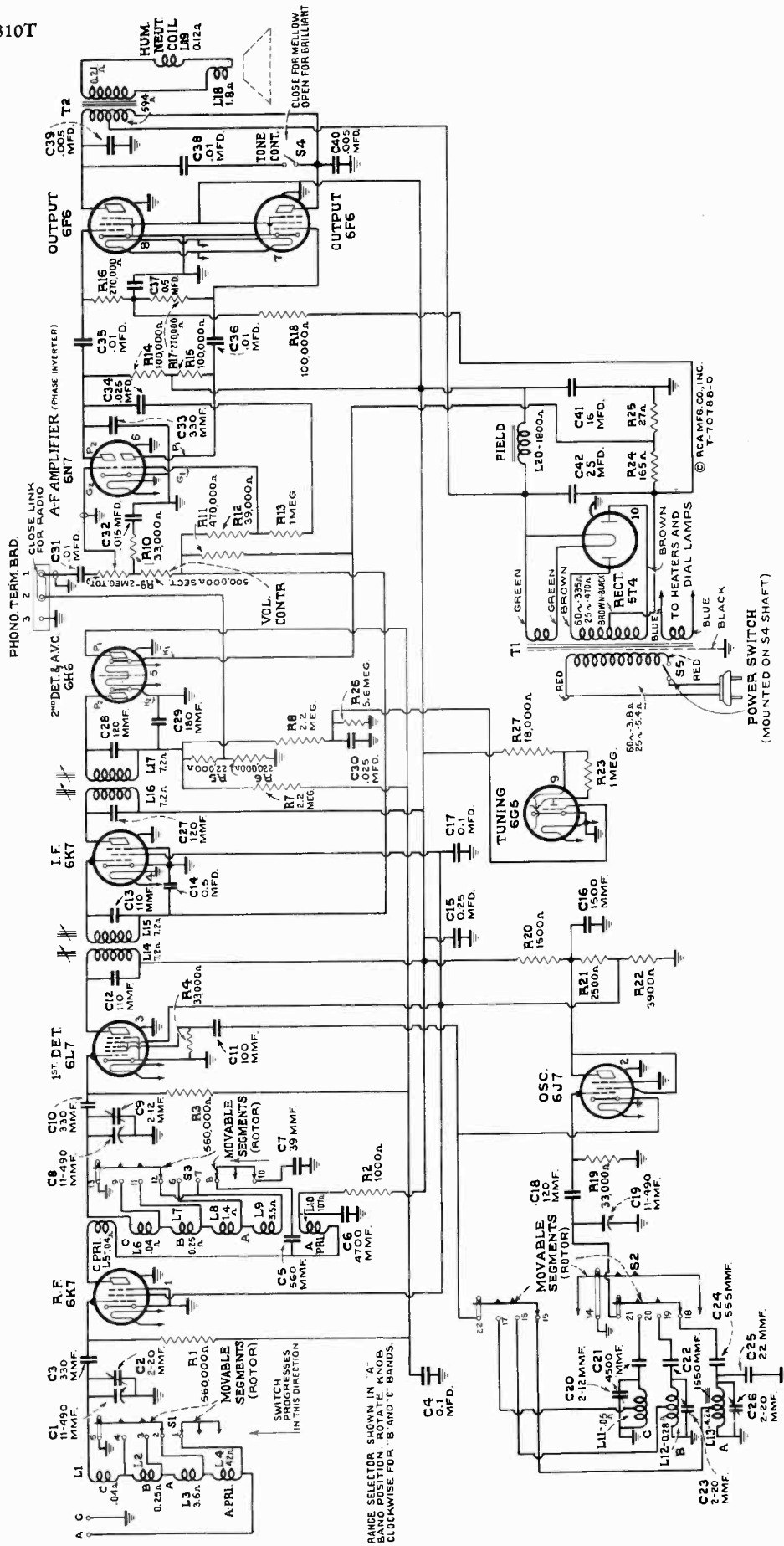

Figure 3—Schematic Circuit Diagram

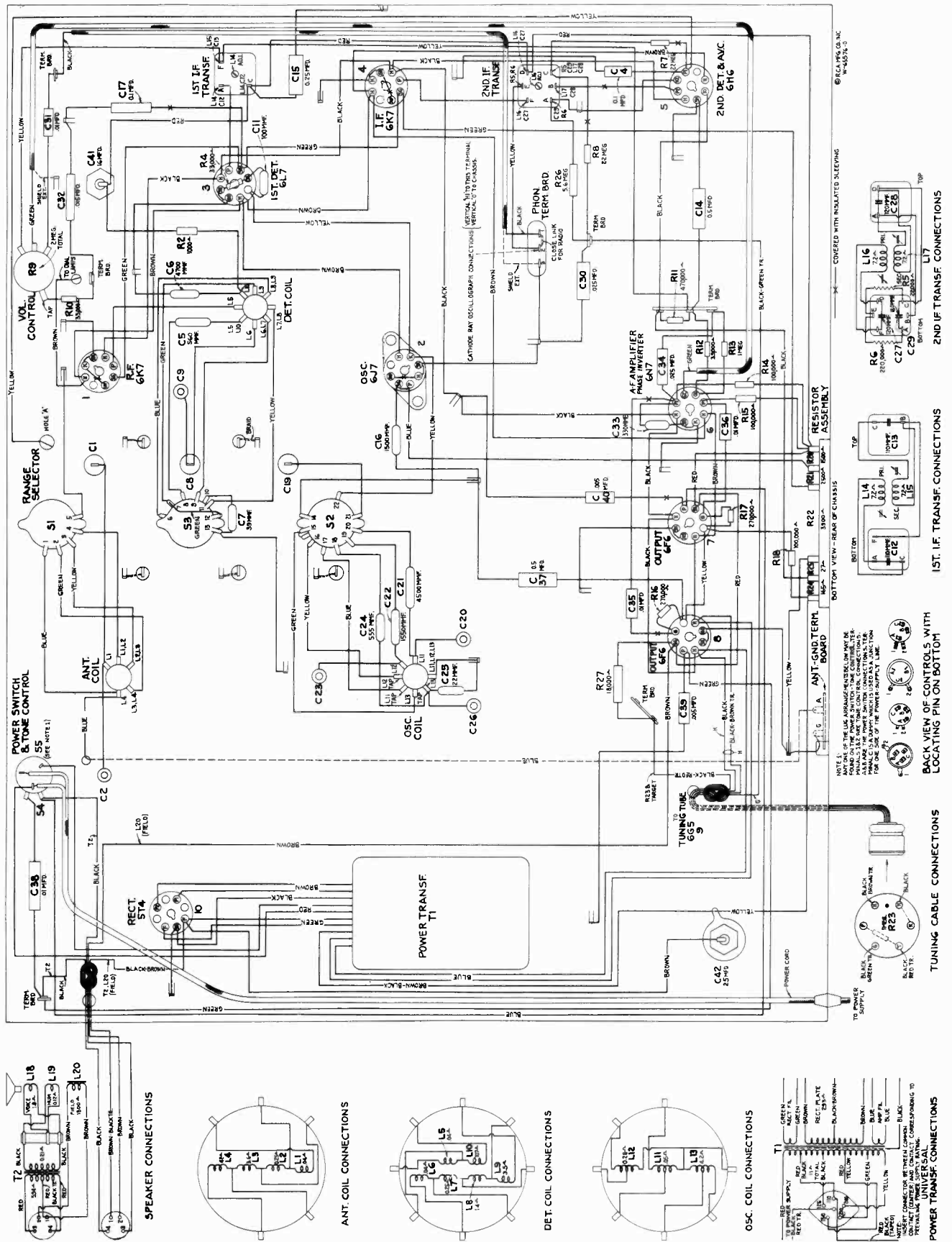
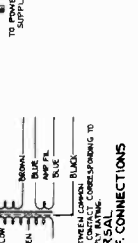
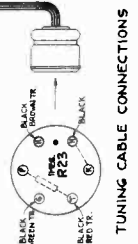
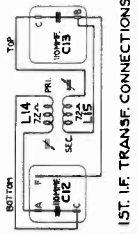
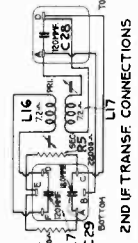

Figure 4—Chassis Wiring Diagram

COVERED WITH INSULATED SLEEPING



NOTE: THE U.S. ADVISORY CENTER HAS RECOMMENDED THAT THE POWER SWITCH-TIME CONTROLLER BOARD ON THE POWER SWITCH CONNECTIONS BE REPLACED BY THE POWER SWITCH CONNECTIONS BOARD FOR THE SIZE OF THE POWER SUPPLY LINE.

Precautionary Lead Dress.—(1) Keep leads to a-c switch dressed away from antenna coil and trimmer C2. (2) Keep all filament leads twisted. (3) Keep yellow lead from term. E of 2nd i-f trans. to phono. term. board as short as possible. (4) Keep leads of C21 as short as possible. (5) Dress shielded lead from volume control to phono. term. board against side of chassis and away from 6L7 socket. (6) Yellow lead from 6J7 oscillator cathode to dummy terminal on 6L7 socket must be dressed away from chassis base and from brown filament lead. (7) All molded capacitors should be dressed so that flat side is perpendicular to chassis base. (8) Yellow lead from cathode of 6J7 socket to term. 22 of S2 must be dressed under spaghetti on 6J7 socket jumper

and pulled tight away from chassis. The following bus leads should be kept as short as possible and, when necessary, replaced only with wire having same diameter as original: (9) Lead from L11-L12-L13 to ground lance; (10) Lead from term. 13 of S3 to ground lance; (11) Lead from term. 9 of S3 to L6-L7; (12) Lead from L6 to C8; (13) Lead from C9 to C8; (14) Lead from term. 5 of S1 to ground lance; (15) Lead from L1-L2 to term. 4 of S1; (16) Lead from L1 to C1; (17) Lead from term. 21 of S2 to C19. (18) Keep filament leads dressed away from grid prongs of 6N7. (19) Keep blue and green leads from plate prongs of output tubes twisted their entire length.

REPLACEMENT PARTS

Insist on genuine factory tested parts, which are readily identified and may be purchased from authorized dealers.

| STOCK No. | DESCRIPTION | STOCK No. | DESCRIPTION |
|----------------------------|--|---|---|
| RECEIVER ASSEMBLIES | | | |
| 12038 | Band—Rubber band for tuning tube | 11172 | Resistor—470,000 Ohms, Carbon type, 1/2 watt (R11) |
| 14384 | Belt—Variable condenser drive belt | 11397 | Resistor—560,000 Ohms, Carbon type, 1/10 watt (R1, R3) |
| 14517 | Board—Antenna and ground terminal board | 12013 | Resistor—1 Megohm, Carbon type, 1/10 watt (R23) |
| 12717 | Board—Phonograph terminal board | 13730 | Resistor—1 Megohm, Carbon type, 1/2 watt (R13) |
| 14338 | Bushing—Variable condenser mounting bushing assembly | 11628 | Resistor—2.2 Megohm, Carbon type, 1/2 watt (R7, R8) |
| 14524 | Cable—Band indicator cable approx. 6 1/2 in. long | 11668 | Resistor—5.6 Megohm, Carbon type, 1/2 watt (R26) |
| 14523 | Cable—Tone control indicator cable approx. 3 in. long | 14532 | Resistor—Voltage divider comprising one 1500 Ohm, one 2500 Ohm, one 3900 Ohm, one 27 Ohm and one 185 Ohm sections (R20, R21, R22, R24, R25) |
| 14394 | Cable—Tuning tube cable and socket | 14343 | Retainer—Station selector knob shaft and pulley retainer |
| 11350 | Cap—Grid contact cap | 14350 | Screw—No. 8-32 x 3/18 square head set screw for drum Stock No. 14345 gear Stock No. 30085 and hub and arm on band indicator cable |
| 12607 | Cap—First I.F. transformer shield top | 14374 | Shield—Antenna or R.F. coil shield |
| 12581 | Cap—Second I.F. transformer shield top | 12008 | Shield—First or Second I.F. transformer shield |
| 12884 | Capacitor—Adjustable trimmer (long) (C2, C23, C26) | 14375 | Shield—Oscillator coil shield |
| 12714 | Capacitor—Adjustable trimmer (Medium) (C9, C20) | 14114 | Socket—Dial lamp socket |
| 14021 | Capacitor—22 Mmfd. (C25) | 11195 | Socket—5 contact 5T4 Radiotron socket |
| 13545 | Capacitor—39 Mmfd. (C7) | 11196 | Socket—8 contact 6F6, 6H6, 6K7, 6L7, 6N7, or 6J7 Radiotron socket |
| 12720 | Capacitor—100 Mmfd. (C11) | 12907 | Spring—Tension spring for indicator drum gear Stock No. 30085 |
| 14262 | Capacitor—110 Mmfd. (C12, C13) | 14342 | Spring—Tension spring for idler Stock No. 14341 |
| 12404 | Capacitor—120 Mmfd. (C27, C28) | 12007 | Spring—Retaining spring for core Stock No. 12006 and No. 12800 |
| 12724 | Capacitor—120 Mmfd. (C18) | 14371 | Switch—Low frequency tone and power switch (S4, S5) |
| 12406 | Capacitor—180 Mmfd. (C29) | 14515 | Switch—Range switch (S1, S2, S3) |
| 12952 | Capacitor—330 Mmfd. (C3, C10, C33) | 14376 | Transformer—First I.F. transformer (L14, L15, C12, C13) |
| 12727 | Capacitor—555 Mmfd. (C24) | 14283 | Transformer—Second I.F. transformer (L16, L17, C27, C28, C29, R5, R6) |
| 12637 | Capacitor—560 Mmfd. (C5) | 11211 | Transformer—Power transformer 105-125 volts, 50-60 cycle (T1) |
| 13762 | Capacitor—1500 Mmfd. (C16) | 11212 | Transformer—Power transformer 105-125 volts, 25-60 cycle (T1) |
| 12729 | Capacitor—1560 Mmfd. (C22) | 11213 | Transformer—Power transformer 105-125/140-160/200-250 volts, 50-60 cycle (T1) |
| 12728 | Capacitor—4500 Mmfd. (C21) | 14335 | Volume Control—(R9) |
| 12897 | Capacitor—4700 Mmfd. (C6) | 14379 | Washer—Felt washer for indicator pointer |
| 4838 | Capacitor—.005 Mfd. (C39, C40) | REPRODUCER ASSEMBLIES | |
| 13138 | Capacitor—.01 Mfd. (C31, C35, C36) | MODEL 810T (RL-63-F2) | |
| 4937 | Capacitor—.01 Mfd. (C38) | 14356 | Board—3 contact reproducer terminal board |
| 11315 | Capacitor—.015 Mfd. (C32) | 13868 | Cap—Cone center dust cap |
| 4870 | Capacitor—.025 Mfd. (C30, C34) | 11234 | Coil—Field coil (L20) |
| 4839 | Capacitor—.01 Mfd. (C4, C17) | 11469 | Coil—Hum neutralizing coil (L19) |
| 12484 | Capacitor—.025 Mfd. (C15) | 12642 | Cone—Reproducer cone and dust cap (L18) |
| 12741 | Capacitor—.05 Mfd. (C14, C37) | 5039 | Plug—4 contact male plug for reproducer |
| 5212 | Capacitor—.16 Mfd. (C41) | 14533 | Reproducer—Reproducer complete |
| 14531 | Capacitor—.25 Mfd. (C42) | 14358 | Screw—Screw, washer, and lockwasher to hold core in yoke |
| 14372 | Coil—Antenna coil and shield (L1, L2, L3, L4) | 14534 | Transformer—Output transformer (T2) |
| 14516 | Coil—Oscillator coil and shield (L11, L12, L13) | 14357 | Washer—Spring washer to hold field coil |
| 14414 | Coil—R.F. coil and shield (L5, L6, L7, L8, L9, L10) | REPRODUCER ASSEMBLIES | |
| 14513 | Condenser—3 gang variable tuning condenser (C1, C8, C19) | MODELS 810K and 810K1 (RL-70-E2) | |
| 5040 | Connector—4 contact female connector for reproducer cable | 13866 | Cap—Dust cap for cone center |
| 12006 | Core—Adjustable core and stud for transformer Stock No. 14376 and Stock No. 14283 | 11234 | Coil—Field coil (L20) |
| 12800 | Core—Adjustable core and stud for coil Stock No. 14516 | 11469 | Coil—Hum neutralizing coil (L19) |
| 14518 | Dial—Station selector dial scale complete with tuning tube escutcheon | 12667 | Cone—Reproducer cone and dust cap (L18) |
| 14514 | Drive—Variable condenser vernier drive pinion gear and shaft | 5039 | Plug—4 contact male plug for reproducer |
| 14345 | Drum—Variable condenser drive belt drum complete with set screws | 14535 | Reproducer—Reproducer complete |
| 14387 | Escutcheon—Tuning tube escutcheon | 14358 | Screw—Screw, washer and lockwasher to hold core in yoke |
| 11982 | Fastener—Dial scale fastener | 14534 | Transformer—Output transformer (T2) |
| 30085 | Gear—Indicator drive gear and hub, and pointer stem and gear | 14357 | Washer—Spring washer to hold field coil |
| 14341 | Idler—Station selector drive belt idler | MISCELLANEOUS ASSEMBLIES | |
| 14519 | Indicator—Station selector indicator pointer | 14527 | Escutcheon—Station selector escutcheon and crystal complete with tone and band indicating strips |
| 14520 | Indicator—Vernier indicator pointer | 14528 | Index—Tone control indicating strip—mounts in station selector escutcheon |
| 5226 | Lamp—Dial lamp | 14529 | Index—Band indicating strip—mounts in station selector escutcheon |
| 14028 | Nut—Jamb nut for adjustable trimmer capacitor Stock No. 12714 and No. 12884 | 14359 | Knob—Station selector knob |
| 12471 | Plate—6J7 Radiotron socket mounting plate and rubber cushions—less socket | 14269 | Knob—Volume control, tone control or range switch knob |
| 14340 | Pulley—Station selector drive belt pulley and knob shaft | 11210 | Screw—Chassis mounting screw and washer assembly for console model |
| 14522 | Reflector—Dial reflector and bracket complete with dial lamp bracket, tuning tube bracket and tone and band indicators | 11377 | Screw—Chassis mounting screw and washer assembly for the table model |
| 14720 | Resistor—1000 Ohms, Carbon type, 1/2 watt (R2) | 4982 | Spring—Retaining spring for knob Stock No. 14359 |
| 14078 | Resistor—18,000 Ohms, Carbon type, 1 watt (R27) | 14270 | Spring—Retaining spring for knob Stock No. 14269 |
| 14284 | Resistor—22,000 Ohms, Carbon type, 1/10 watt (R5) | | |
| 11300 | Resistor—33,000 Ohms, Carbon type, 1/10 watt (R19) | | |
| 13735 | Resistor—33,000 Ohms, Carbon type, 1/2 watt (R4, R10) | | |
| 11322 | Resistor—39,000 Ohms, Carbon type, 1/2 watt (R12) | | |
| 5145 | Resistor—100,000 Ohms, Carbon type, 1/2 watt (R14, R15, R18) | | |
| 11398 | Resistor—220,000 Ohms, Carbon type, 1/10 watt (R6) | | |
| 11453 | Resistor—270,000 Ohms, Carbon type, 1/10 watt (R16, R17) | | |



RCA Victor

MODEL 810T4

Ten-Tube, Four-Band, A-C, Superheterodyne Receiver

TECHNICAL INFORMATION AND SERVICE DATA

SERVICE DIVISION • RCA MANUFACTURING COMPANY, INC. • CAMDEN, N. J., U. S. A

A Service of the Radio Corporation of America

Electrical Specifications

FREQUENCY RANGES

"Long Wave" (X)..... 2,000-850 meters (150-353 kc)
 "Medium Wave" (A)..... 565-180 meters (531-1,666 kc)
 "Short Wave 1" (B)..... 2.1-6.8 mc (143-44.1 meters)
 "Short Wave 2" (C)..... 6.8-22 mc (44.1-13.64 meters)

R-F ALIGNMENT FREQUENCIES

"Short Wave 2" (C)..... 20,000 kc (osc., det., ant.)
 "Short Wave 1" (B)..... 6,000 kc (osc.)
 "Medium Wave" (A)..... 600 kc (osc.), 1,500 kc (osc.)
 "Long Wave" (X)..... 166.7 kc (osc.), 353 kc (osc., det., ant.)

Intermediate Frequency..... 460 kc

RADIOTRON COMPLEMENT

(1) RCA-6K7..... R-F Amplifier
 (2) RCA-6J7..... Heterodyne Oscillator
 (3) RCA-6L7..... First Detector
 (4) RCA-6K7..... Intermediate Amplifier
 (5) RCA-6H6..... Second Detector and A.V.C.

(6) RCA-6N7..... Phase Inverter A-F Amplifier
 (7) RCA-6F6..... Power Output
 (8) RCA-6F6..... Power Output
 (9) RCA-6G5..... "Magic Eye" Tuning Tube
 (10) RCA-5U4G..... Full-Wave Rectifier

Pilot Lamps (5)..... Mazda No. 46, 6.3 volts, 0.25 amp.

POWER SUPPLY RATINGS

Rating A..... 105-125 volts, 50-60 cycles, 135 watts
 Rating B..... 105-125 volts, 25-60 cycles, 135 watts
 Rating C..... 100-130/140-160/195-250 volts, 40-60 cycles, 135 watts

POWER OUTPUT

Undistorted..... 10 watts
 Maximum..... 12.5 watts

LOUDSPEAKER

Type..... 8-inch Electrodynamic
 Impedance (v.c.)..... 2.2 ohms at 400 cycles

Mechanical Specifications

Height..... 20¹/₄ inches
 Width..... 17¹/₄ inches
 Depth..... 11¹³/₁₆ inches
 Weight (net)..... 33 pounds
 Weight (shipping)..... 43 pounds
 Chassis Base Dimensions..... 14⁷/₈ inches x 9³/₄ inches x 3¹/₄ inches
 Over-all Chassis Height..... 9³/₄ inches
 Operating Controls..... (1) Power Switch—Tone; (2) Tuning (large inner knob), Range Selector (small outer knob, left to right "X," "A," "B," "C"); (3) Volume
 Tuning Drive Ratio..... 20 to 1

General Description

This receiver employs a ten-tube, four-band, "Magic Brain," superheterodyne circuit, the arrangement of which is shown by the Schematic Circuit Diagram. Features of design include an r-f amplifier stage; "cumulative-wound" "A" antenna and r-f transformers for high signal-to-noise ratio; magnetite-core, i-f transformers and low-frequency "X" and "A" oscillator tracking; automatic volume control; phonograph terminal board; "Magic Eye" tuning tube; plunger-

type, air-dielectric trimming capacitors; aural-compensated, audio-volume control; "Bass-Mellow-Brilliant" tone control; audio phase-inverter voltage amplifier; push-pull, power-output stage; improved dust-proof electrodynamic loudspeaker; a new sunburst dial with short-wave stations listed by name and illuminated band and tone indicators; and the improved "Magic Voice."

Copyright, 1937, RCA Manufacturing Co., Inc.

Trademarks "Radiotron," "Magic Eye," "Magic Brain," "Magic Voice" Reg. U. S. Pat. Off. by RCA Manufacturing Co., Inc.

Alignment Procedure

Calibrate the tuning dial by adjusting main dial pointer to the low-frequency (end) calibration mark on dial with the gang tuning-condenser plates in full-mesh position; then adjust the small (vernier) pointer to "0." These are friction adjustments.

Perform alignment in proper order, tabulated below, starting with No. 1 and following all operations across, then No. 2, etc. Adjustment locations are shown on figures 1 and 2.

Cathode-ray alignment is highly preferable; the connections to the chassis are shown on figure 4. If an output indicator is used, connect it across the loudspeaker voice-coil and advance the receiver volume control to full-volume position.

Connect the "low" output terminal of the test oscillator to the receiver "G" (ground) terminal for all alignment operations. Regulate the output of the test oscillator so that minimum signal is applied to the receiver to obtain an observable output indication. This will avoid a-v-c action.

The term "Dummy antenna" means the device which must be connected between the "high" test-oscillator output and the point of connection to the receiver in order to obtain ideal alignment. "No signal, 545-400 meters" means that the receiver should be tuned to a point between 545 and 400 meters where no signal or interference is received from a station or local (heterodyne) oscillator. In extreme noisy locations, one end of C10 (top of gang) should be unsoldered during i-f alignment.

Conversion of kilocycles (kc) to meters for alignment frequencies is as follows: 20,000 kc (20 mc) = 15 meters; 6,000 kc (6 mc) = 50 meters; 1,500 kc = 200 meters; 600 kc = 500 meters; 460 kc = 652 meters; 353 kc = 850 meters; and 166.7 kc = 1,800 meters.

For further details on alignment, refer to booklet "RCA Victor Receiver Alignment."

| Order of Alignment | Test Oscillator | | | Range Selector | Receiver Dial Setting | Circuit to Adjust | Adjustment Symbols | Adjust to Obtain |
|--------------------|------------------------|---------------|-------------------|----------------|--------------------------|-------------------|--------------------|------------------|
| | Connection to Receiver | Dummy Antenna | Frequency Setting | | | | | |
| 1 | 6K7 I-F Grid Cap | .001 Mfd. | 460 kc | "Medium Wave" | No Signal 545-400 meters | 2nd I-F Trans. | L16 and L17 | Max. (peak) |
| 2 | 6L7 Det. Grid Cap | .001 Mfd. | 460 kc | "Medium Wave" | No Signal 545-400 meters | 1st I-F Trans. | L14 and L15 | Max. (peak) |
| 3 | Ant. Term. | 200 Mmfd. | 460 kc | "Medium Wave" | No signal 545-400 meters | Wave Trap | L24 | Minimum Output |
| 4 | Ant. Term. | 300 Ohms | 20,000 kc | "Short Wave 2" | 20 mc | "C" Osc. | C55 | Max. (peak)* |
| 5 | Ant. Term. | 300 Ohms | 20,000 kc | "Short Wave 2" | 20 mc | "C" Det. | C9 | Max. (peak)† |
| 6 | Ant. Term. | 300 Ohms | 20,000 kc | "Short Wave 2" | 20 mc | "C" Ant. | C2 | Max. (peak)‡ |
| 7 | Ant. Term. | 300 Ohms | 6,000 kc | "Short Wave 1" | 6 mc | "B" Osc. | C23 | Max. (peak)* |
| 8 | Ant. Term. | 200 Mmfd. | 600 kc | "Medium Wave" | 500 meters | "A" L-F Osc. | L13 | Max. (peak) |
| 9 | Ant. Term. | 200 Mmfd. | 1,500 kc | "Medium Wave" | 200 meters | "A" H-F Osc. | C26 | Max. (peak) |
| 10 | Ant. Term. | 200 Mmfd. | 600 kc | "Medium Wave" | 500 meters | "A" L-F Osc. | L13 | Max. (peak) |
| 11 | Ant. Term. | 200 Mmfd. | 1,500 kc | "Medium Wave" | 200 meters | "A" H-F Osc. | C26 | Max. (peak) |
| 12 | Ant. Term. | 200 Mmfd. | 166.7 kc | "Long Wave" | 1,800 meters | "X" L-F Osc. | L23 | Max. (peak) |
| 13 | Ant. Term. | 200 Mmfd. | 353 kc | "Long Wave" | 850 meters | "X" H-F Osc. | C46 | Max. (peak) |
| 14 | Ant. Term. | 200 Mmfd. | 353 kc | "Long Wave" | 850 meters | "X" Det. | C54 | Max. (peak) |
| 15 | Ant. Term. | 200 Mmfd. | 353 kc | "Long Wave" | 850 meters | "X" Ant. | C56 | Max. (peak) |
| 16 | Ant. Term. | 200 Mmfd. | 166.7 kc | "Long Wave" | 1,800 meters | "X" L-F Osc. | L23 | Max. (peak) |
| 17 | Ant. Term. | 200 Mmfd. | 353 kc | "Long Wave" | 850 meters | "X" H-F Osc. | C46 | Max. (peak) |

* Use minimum capacity peak if two peaks can be obtained.

† Use maximum capacity peak if two peaks can be obtained.

‡ After this adjustment, check for image signal by shifting receiver dial to 19,080 mc.

Service Data

The various diagrams of this booklet contain such information as will be needed to isolate causes for defective operation if such develops. The ratings of the resistors, capacitors, coils, etc., are indicated adjacent to the symbols signifying these parts on the diagrams. Identification titles such as R1, L1, C1, etc., provide reference between the illustrations and Replacement Parts List. The coils, transformer windings, and reactors are rated in terms of d-c resistance to permit continuity checks.

Loudspeaker.—Centering of the loudspeaker is made in the usual manner with three narrow celluloid or paper feelers after first removing the front dust cover. This may be removed by softening its cement with a light application of acetone, using care not to allow the acetone to flow into the air gap. The dust cover should be cemented back in place with ambroid upon completion of adjustment.

Phonograph Attachment.—A terminal board is provided for connecting a phonograph into the audio amplifying circuit. RCA Victor Models R-93, R-93-A, R-93-2, or R-94 Record Players should be connected as follows: Remove link between terminals 1 and 2 on terminal board. Connect green wire in Radio-Record switch cable to terminal 1, yellow to terminal 2, and shield extension to terminal 3. Tape unused red and blue leads separately. Connect a 2-conductor twisted cable between the Record Player binding posts and the screw terminals on Radio-Record switch. If additional volume is desired, connect an RCA Stock No. 9632 transformer between the two-conductor twisted cable and the screw terminals on Radio-Record switch as follows: yellow and brown transformer leads and one side of twisted cable to ground screw-terminal on switch; black transformer lead to other side of twisted cable; and blue transformer lead to other screw-terminal on switch.

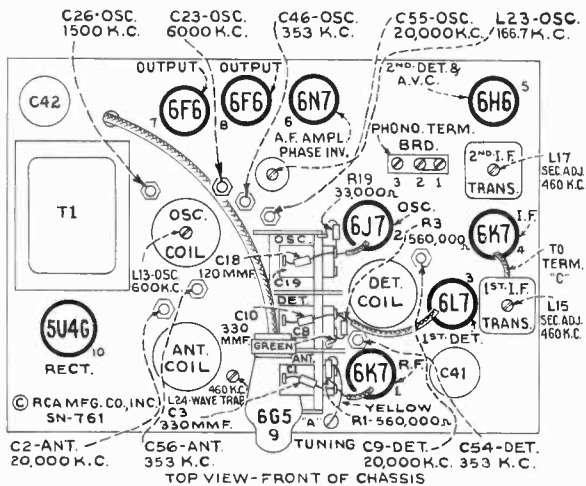
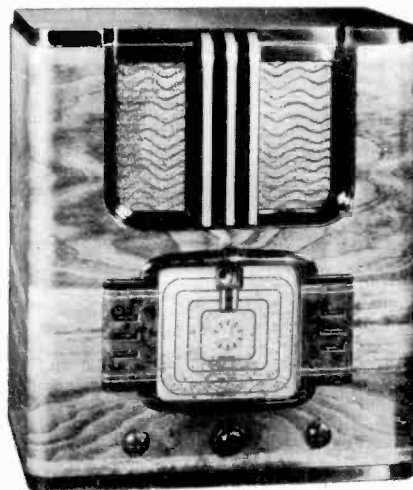

Figure 1—Radiotron, Coil, and Trimmer Locations



Model 810T4

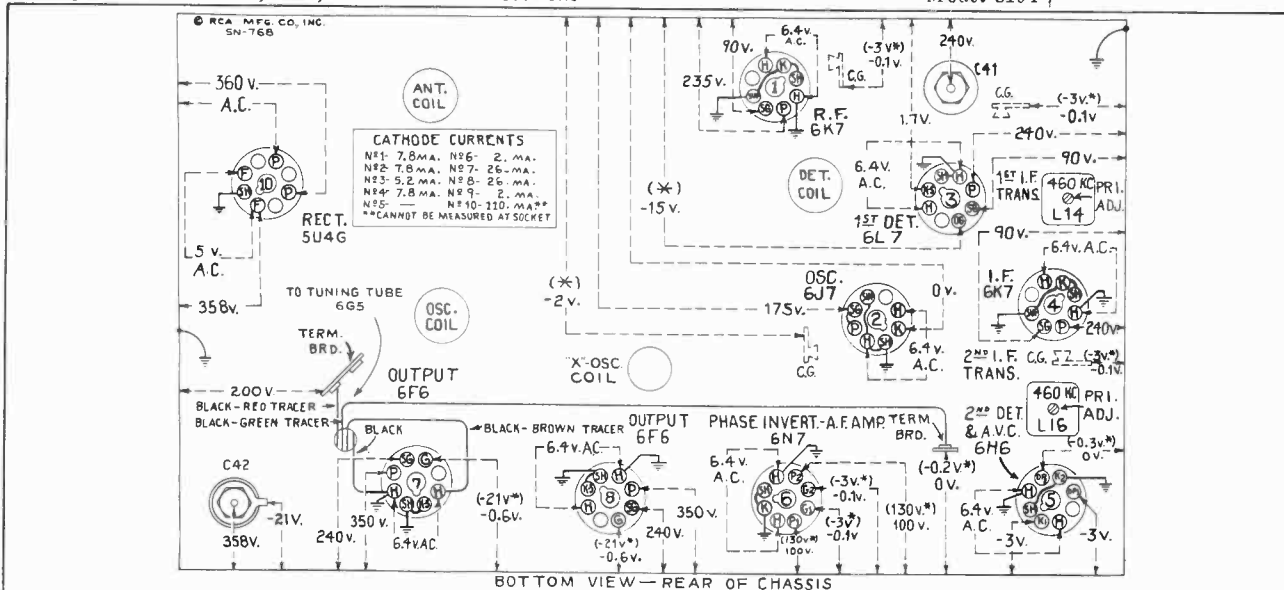

Figure 2—Radiotron Socket Voltages, Coil, and Trimmer Locations

Measured at 115 volts, 60-cycle supply—Tuned to approximately 1,000 kc or 300 meters, "A" band ("Medium Wave")—No signal being received—Volume control minimum

Note: Two voltage values are shown for some readings. The value shown in parentheses with asterisk (*) indicates operating conditions without voltmeter loading. The other value (generally lower) is the actual measured voltage and differs from the value shown in parentheses because of the additional loading of the voltmeter through the high series circuit resistance.

Voltage values as specified should hold within $\pm 20\%$ when the receiver is normally operative at its rated line voltage. To duplicate the conditions under which the voltages were measured requires a 1,000-ohm-per-volt d-c meter, having ranges of 10, 50, 250 and 500 volts. Use the nearest range above the specified measured voltage. A-c voltages were measured with a corresponding a-c meter.

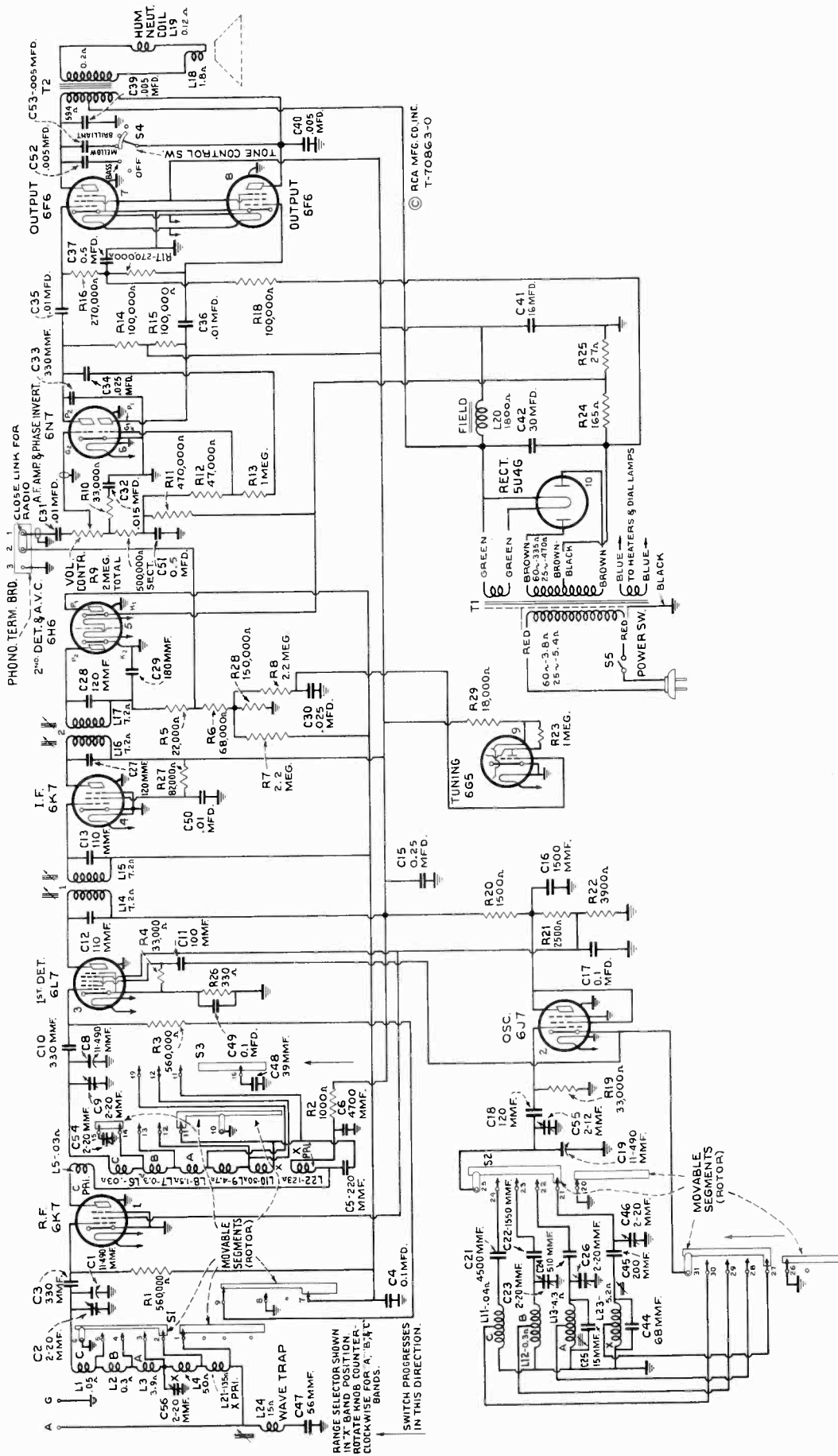

Figure 3—Schematic Circuit Diagram

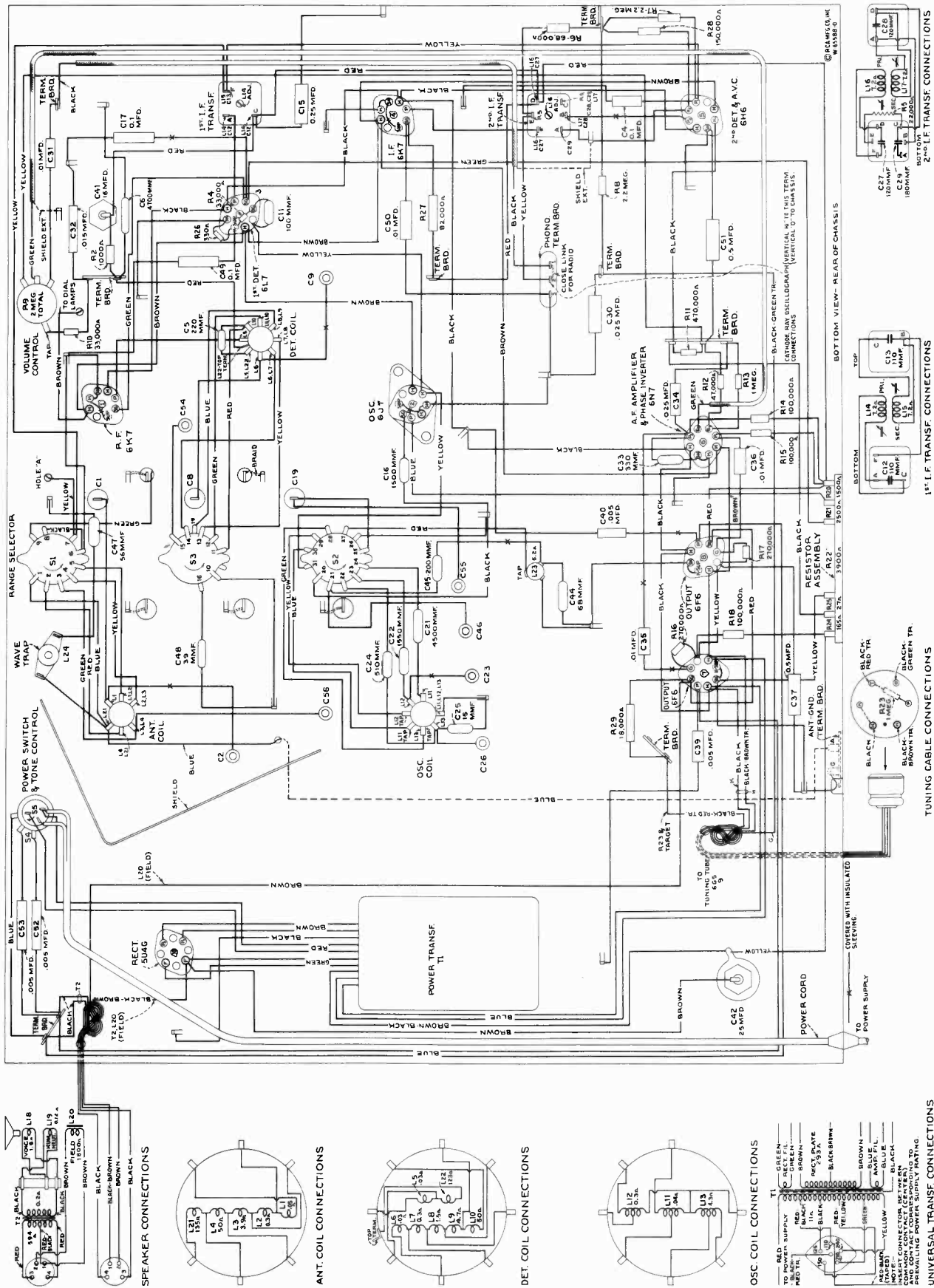

Figure 4—Chassis Wiring Diagram

Precautionary Lead Dress.—(1) Twist yellow, blue, and green leads from oscillator coil to S2. (2) Dress C45 and C21 away from C55. (3) Dress black lead from S2 to ground lance away from C55. (4) Dress yellow lead from 6J7 socket to S2 under bus on 6J7 socket. (5) Make lead from S3 to ground 2½ inches long and dress away from chassis. (6) Twist filament leads. (7) Dress shielded lead from C31 to phono. term. board away from 6L7 socket. (8) Dress yellow lead from term. "K" of 6J7 to C11 away from chassis and from brown filament lead. (9) Dress all molded capacitors perpendicular to chassis. (10) Dress fila-

ment leads away from terms. "G1" and "G2" of 6N7. (11) Twist blue leads from terms. "P" of 6F6's. Make the following as short as possible: (12) Lead from oscillator coils to ground. (13) Lead from S2 to C19. (14) Lead from detector coil to S3. (15) Lead from detector coil to C8. (16) Lead from S1 to chassis ground lance. (17) Lead from antenna coil to S1. (18) Lead from antenna coil to C1. (19) Yellow lead from 2nd i-f transformer to phono. term. board. When necessary to replace bus leads, use only wire having same diameter as original.

REPLACEMENT PARTS

Insist on genuine factory tested parts, which are readily identified and may be purchased from authorized dealers.

| STOCK No. | DESCRIPTION | STOCK No. | DESCRIPTION |
|----------------------------|---|---|---|
| RECEIVER ASSEMBLIES | | | |
| 12038 | Band—Rubber band for tuning tube | 14720 | Resistor—1,000 ohms, carbon type, ½ watt (R2) |
| 14384 | Belt—Variable condenser drive belt | 14078 | Resistor—18,000 ohms, carbon type, 1 watt (R29) |
| 14517 | Board—Antenna and ground terminal board | 14284 | Resistor—22,000 ohms, carbon type, 1/10 watt (R5) |
| 12717 | Board—Phonograph terminal board | 11300 | Resistor—33,000 ohms, carbon type, 1/10 watt (R19) |
| 14338 | Bushing—Variable condenser mounting bushing assembly | 13735 | Resistor—33,000 ohms, carbon type, ½ watt (R4, R10) |
| 14524 | Cable—Band indicator cable, approximately 6½ inches long | 11646 | Resistor—47,000 ohms, carbon type, ½ watt (R12) |
| 14523 | Cable—Tone control indicator cable, approximately 3 inches long | 12333 | Resistor—88,000 ohms, carbon type, ½ watt (R6) |
| 14394 | Cable—Tuning tube cable and socket | 8064 | Resistor—82,000 ohms, carbon type, ½ watt (R27) |
| 11350 | Cap—Grid contact cap | 11281 | Resistor—100,000 ohms, carbon type, 1/10 watt (R18) |
| 12607 | Cap—First I-F transformer shield top | 5145 | Resistor—100,000 ohms, carbon type, ½ watt (R14, R15) |
| 12581 | Cap—Second I-F transformer shield top | 5027 | Resistor—150,000 ohms, carbon type, ½ watt (R28) |
| 12884 | Capacitor—Adjustable trimmer (long) (C2, C9, C23, C26, C46, C54, C58) | 11453 | Resistor—270,000 ohms, carbon type, 1/10 watt (R16, R17) |
| 12714 | Capacitor—Adjustable trimmer (medium) (C55) | 11172 | Resistor—470,000 ohms, carbon type, ½ watt (R11) |
| 12896 | Capacitor—15 Mmfd. (C25) | 11397 | Resistor—560,000 ohms, carbon type, 1/10 watt (R1, R3) |
| 13545 | Capacitor—39 Mmfd. (C48) | 12013 | Resistor—1 megohm, carbon type, 1/10 watt (R23) |
| 12723 | Capacitor—56 Mmfd. (C47) | 13730 | Resistor—1 megohm, carbon type, ½ watt (R13) |
| 30233 | Capacitor—68 Mmfd. (C44) | 11626 | Resistor—2.2 megohms, carbon type, ½ watt (R7, R8) |
| 12720 | Capacitor—100 Mmfd. (C11) | 14532 | Resistor—Voltage divider—comprising one 1,500 ohm, one 2,500 ohm, one 3,900 ohm, one 27 ohm, and one 165 ohm sections (R20, R21, R22, R24, R25) |
| 14262 | Capacitor—110 Mmfd. (C12, C13) | 14343 | Retainer—Station selector knob shaft and pulley retainer |
| 12404 | Capacitor—120 Mmfd. (C27, C28) | 14350 | Screw—No. 8-32 x 3/16 square-head set-screw for drum, Stock No. 14346, gear, Stock No. 30085, and hub and arm on band indicator cable |
| 12724 | Capacitor—120 Mmfd. (C18) | 12799 | Shield—Antenna or R-F coil shield |
| 12406 | Capacitor—180 Mmfd. (C29) | 12008 | Shield—First or second I-F transformer shield |
| 30232 | Capacitor—200 Mmfd. (C45) | 14375 | Shield—Oscillator coil shield for Stock No. 14516 |
| 14546 | Capacitor—220 Mmfd. (C5) | 12883 | Shield—Oscillator coil shield for Stock No. 12881 |
| 12952 | Capacitor—330 Mmfd. (C3, C10, C33) | 14114 | Socket—Dial lamp socket |
| 30231 | Capacitor—510 Mmfd. (C24) | 11195 | Socket—5-contact 5U4G Radiotron socket |
| 13762 | Capacitor—1,500 Mmfd. (C16) | 11196 | Socket—8-contact 6F6, 6H6, 6K7, 6L7, 6J7, or 6N7 Radiotron socket |
| 12720 | Capacitor—1,550 Mmfd. (C22) | 12907 | Spring—Tension spring for indicator drum gear, Stock No. 30085 |
| 12728 | Capacitor—4,500 Mmfd. (C21) | 14342 | Spring—Tension spring for idler, Stock No. 14341 |
| 12897 | Capacitor—4,700 Mmfd. (C6) | 12007 | Spring—Retaining spring for core, Stock Nos. 12006 and 12800 |
| 4838 | Capacitor—005 Mfd. (C39, C40, C52, C53) | 30084 | Switch—High-frequency tone and power switch (S4, S5) |
| 13138 | Capacitor—01 Mfd. (C31, C35, C36, C50) | 30226 | Switch—Range switch (S1, S2, S3) |
| 11315 | Capacitor—015 Mfd. (C32) | 12654 | Trap—Wave trap (L24) |
| 4870 | Capacitor—025 Mfd. (C30, C34) | 14376 | Transformer—First I-F transformer (L14, L15, C12, C13) |
| 4859 | Capacitor—0.1 Mfd. (C4, C17, C49) | 14308 | Transformer—Second I-F transformer (L16, L17, C27, C28, C29, R5) |
| 12484 | Capacitor—0.25 Mfd. (C15) | 11212 | Transformer—Power transformer, 105-125 volts, 25-60 cycles (T1) |
| 12741 | Capacitor—0.5 Mfd. (C37, C51) | 11213 | Transformer—Power transformer, 105-250 volts, 50-60 cycles (T1) |
| 5212 | Capacitor—16 Mfd. (C41) | 14335 | Volume Control (R9) |
| 14531 | Capacitor—25 Mfd. (C42) | 14379 | Washer—Felt washer for indicator pointer |
| 30228 | Coil—Antenna coil and shield—A, B, C, and X bands (L1, L2, L3, L4, L21) | REPRODUCER ASSEMBLIES (RL-63F-2) | |
| 14516 | Coil—Oscillator coil and shield—A, B, and C bands (L11, L12, L13) | 14356 | Board—3-contact reproducer terminal board |
| 12881 | Coil—Oscillator coil and shield—X band only (L23) | 13866 | Cap—Cone center dust cap |
| 30229 | Coil—R-F coil and shield—A, B, C, and X bands (L5, L6, L7, L8, L9, L10, L22) | 11234 | Coil—Field coil (L20) |
| 14513 | Condenser—3-gang variable tuning condenser (C1, C8, C19) | 11469 | Coil—Hum neutralizing coil (L19) |
| 5040 | Connector—4-contact female connector for reproducer cable | 12642 | Cone—Reproducer cone and dust cap (L18) |
| 30567 | Connector—4-contact female connector with metal shell for reproducer cable in later production | 5039 | Plug—4-contact male plug for reproducer |
| 12006 | Core—Adjustable core and stud for transformer, Stock Nos. 14376 and 14308 | 14533 | Reproducer, complete |
| 12800 | Core—Adjustable core and stud for coil, Stock No. 14516 | 14358 | Screw—Screw, washer, and lockwasher to hold core in yoke |
| 30230 | Dial—Station selector dial scale, complete with tuning tube escutcheon | 14534 | Transformer—Output transformer (T2) |
| 14514 | Drive—Variable condenser vernier drive pinion gear and shaft | 14357 | Washer—Spring washer to hold field coil |
| 14345 | Drum—Variable condenser drive belt drum, complete with set screws | MISCELLANEOUS ASSEMBLIES | |
| 14387 | Escutcheon—Tuning tube escutcheon | 5040 | Connector—4-contact female connector for reproducer interconnecting cable in later production |
| 11982 | Fastener—Dial scale fastener | 30568 | Connector—4-contact male connector for reproducer interconnecting cable in later production |
| 30085 | Gear—Indicator drive gear and hub, and pointer stem and gear | 30234 | Escutcheon—Station selector escutcheon and crystal, complete with tone and band indicating strips |
| 14341 | Idler—Station selector drive belt idler | 14611 | Index—Tone control indicating strip—mounts in station selector escutcheon |
| 14519 | Indicator—Station selector indicator pointer | 30235 | Index—Band indicating strip—mounts in station selector escutcheon |
| 14382 | Indicator—Vernier indicator pointer | 14359 | Knob—Station selector knob |
| 5226 | Lamp—Dial lamp | 14269 | Knob—Volume control, tone control, or range switch knob |
| 14028 | Nut—Jamb nut for adjustable trimmer capacitor, Stock Nos. 12714 and 12884 | 11377 | Screw—Chassis mounting screw and washer assembly |
| 12471 | Plate—6J7 Radiotron socket mounting plate and rubber cushions—less socket | 4982 | Spring—Retaining spring for knob, Stock No. 14359 |
| 14340 | Pulley—Station selector drive belt pulley and knob shaft | 14270 | Spring—Retaining spring for knob, Stock No. 14269 |
| 30227 | Reflector—Dial reflector and bracket, complete with dial lamp bracket, tuning tube bracket and tone and band indicators | | |
| 13250 | Resistor—330 ohms, carbon type, ½ watt (R26) | | |



RCA Victor

MODEL 811K

Eleven-Tube, Three-Band, A-C, Superheterodyne Receiver

TECHNICAL INFORMATION AND SERVICE DATA

-1937 No. 24-

SERVICE DIVISION • RCA MANUFACTURING COMPANY, INC. • CAMDEN, N. J., U. S. A.

A Service of the Radio Corporation of America

Electrical Specifications

FREQUENCY RANGES

"Broadcast" (A)..... 530-1,720 kc
"Medium Wave" (B)..... 2,100-6,800 kc
"Short Wave" (C)..... 6,800-23,500 kc

Intermediate Frequency..... 460 kc

RADIOTRON COMPLEMENT

(1) RCA-6K7..... R-F Amplifier
(2) RCA-6L7..... First Detector
(3) RCA-6J7..... Heterodyne Oscillator
(4) RCA-6J7..... Oscillator Control
(5) RCA-6K7..... I-F Amplifier

Pilot Lamps (7)..... Mazda No. 46, 6.3 volts, 0.25 amp.

POWER SUPPLY RATINGS

Rating A..... 105-125 volts, 50-60 cycles, 140 watts
Rating B..... 105-125 volts, 25 cycles, 140 watts
Rating C..... 105-125/140-160/195-250 volts, 50-60 cycles, 140 watts

POWER OUTPUT

Undistorted..... 10 watts
Maximum..... 12½ watts

R-F ALIGNMENT FREQUENCIES

"Short Wave" (C)..... 20,000 kc (osc., det., ant.)
"Medium Wave" (B)..... 6,000 kc (osc.)
"Broadcast" (A)..... 600 kc (osc.), 1,500 kc (osc.)

(6) RCA-6H6..... Second Detector, A.V.C., and A.F.C.
(7) RCA-6N7..... Audio Phase Inverter
(8) RCA-6F6..... Power Output
(9) RCA-6P6..... Power Output
(10) RCA-5T4..... Full-Wave Rectifier
(11) RCA-6G5..... "Magic Eye" Tuning Tube

LOUDSPEAKER

Type..... 12-inch Electrodynamic
Impedance (v.c.)..... 2.2 ohms at 400 cycles

Mechanical Specifications

Height..... 42 inches
Width..... 28⅛ inches
Depth..... 15 inches
Weight (net)..... 79 pounds
Weight (shipping)..... 99 pounds
Chassis Base Dimensions..... 21 inches x 10½ inches x 3¼ inches
Over-all Chassis Height..... 11½ inches
Operating Controls..... (1) Power Switch—Speech-Music, (2) Volume, (3) Tuning, (4) Range Selector, (5) Manual-Electric-Remote, (6) Tone
Tuning Drive Ratios (manual)..... 10 to 1 and 50 to 1

General Description

This receiver employs an eleven-tube, three-band, "Magic Brain" superheterodyne circuit. Features of design include "Electric Tuning" with push-button operation; automatic frequency control; "cumulative-wound" antenna and detector coils; tuned r-f amplifier; magnetite-core adjusted i-f transformers and low-frequency "A" oscillator tracking; straight-line dial; automatic volume control; phonograph terminal

board; "Magic Eye" tuning tube; twelve-inch electrodynamic loudspeaker; plunger-type, air-dielectric trimming capacitors; aural-compensated volume control; tone control; "Music-Speech" switch; audio phase inverter; and push-pull power output stage. In addition, this model has a cabinet incorporating the "Sonic Arc" Magic Voice.

Copyright, 1937, RCA Manufacturing Co., Inc.

Trademarks "Radiotron," "Magic Eye," "Magic Voice," "Magic Brain" Reg. U. S. Pat. Off. by RCA Mfg. Co., Inc.

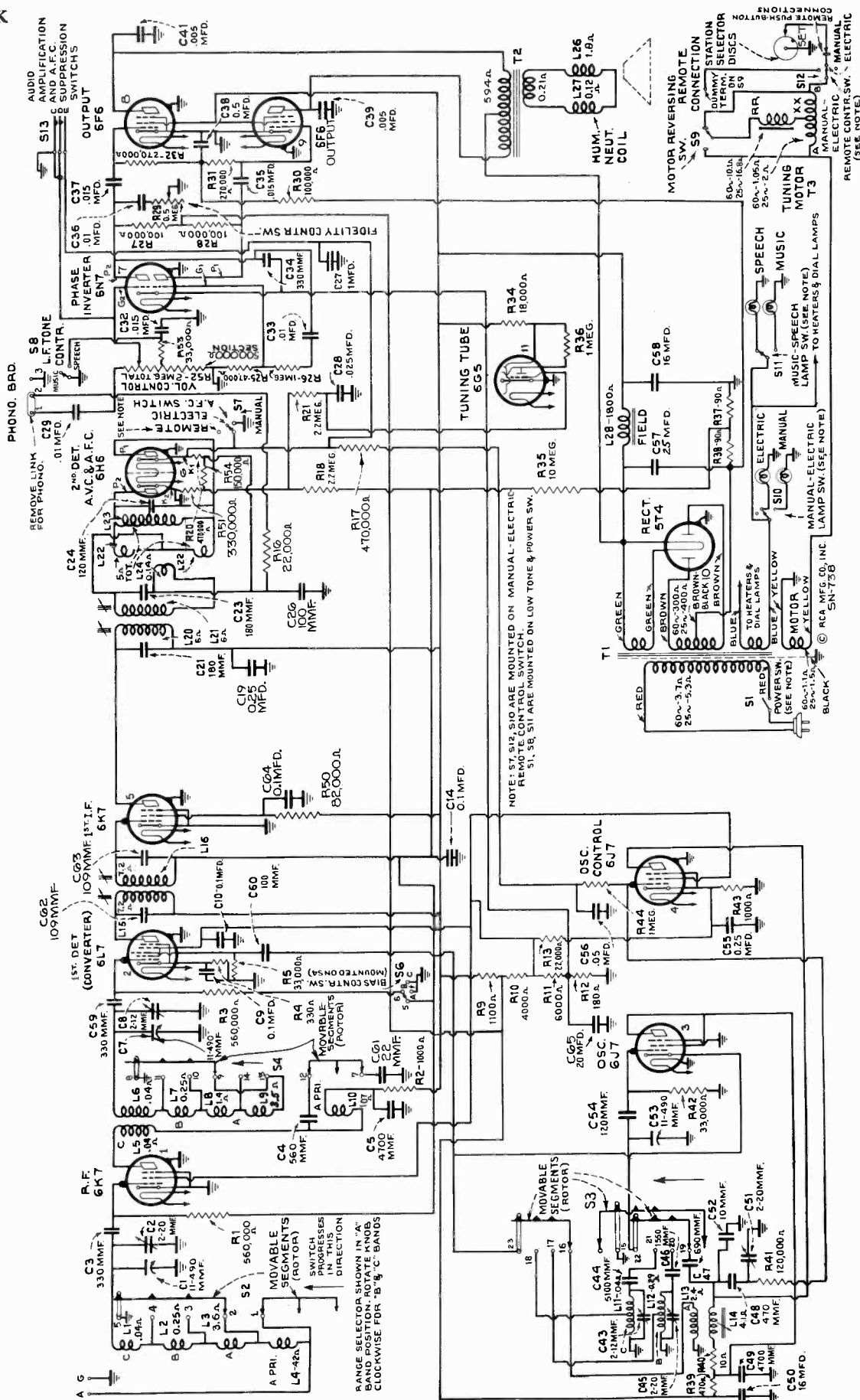

Figure 1—Schematic Circuit Diagram

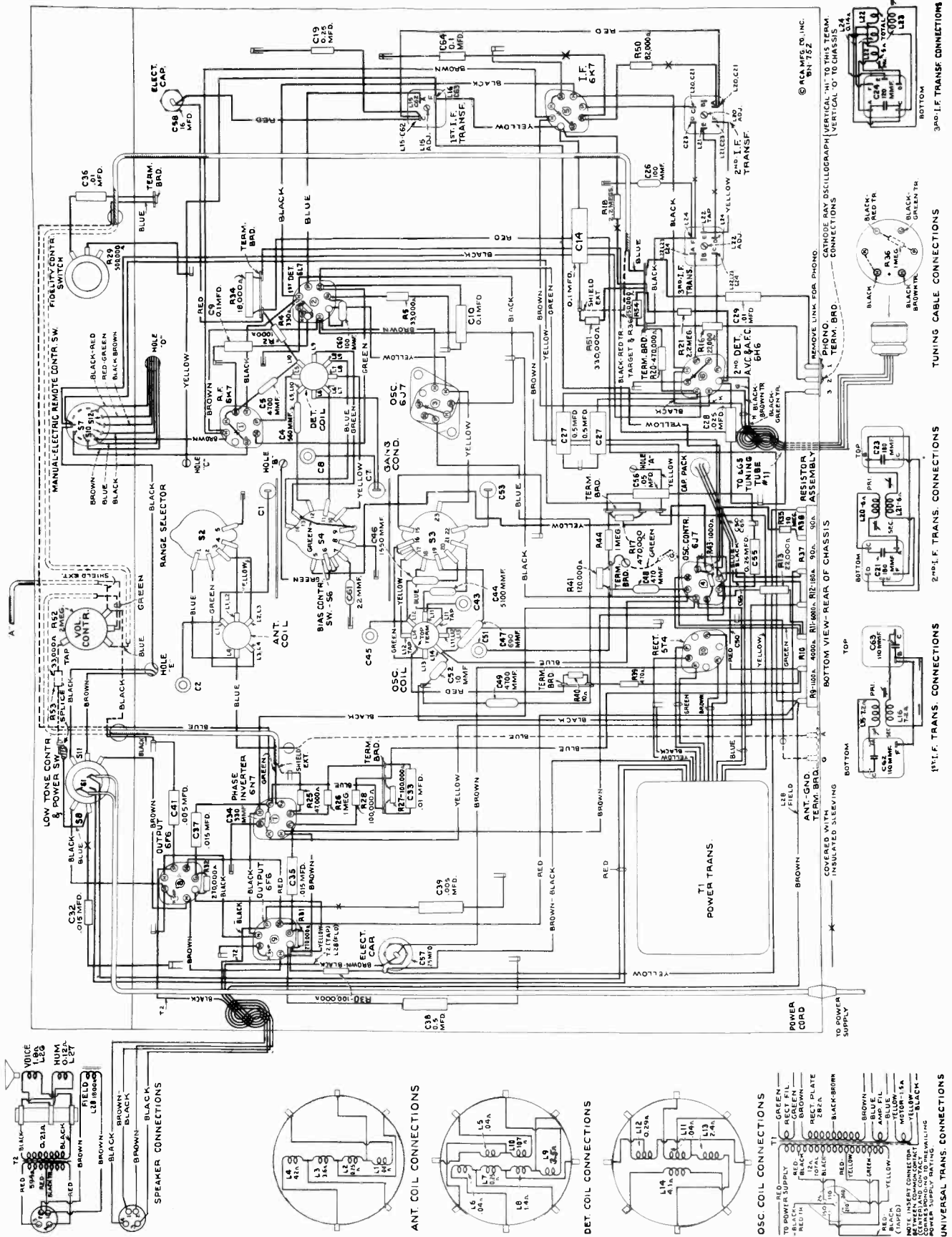
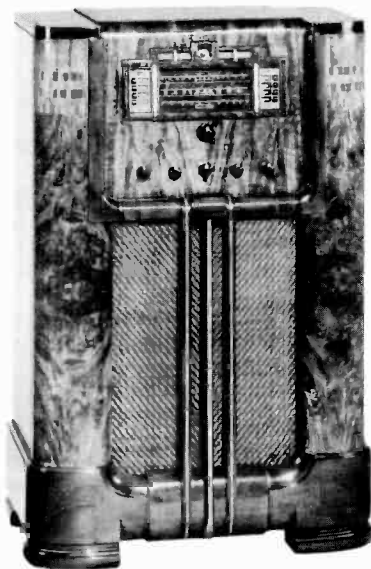

Figure 2—Chassis Wiring Diagram

Circuit Arrangement

The circuit consists of an r-f amplifier stage, first-detector (converter) stage, separate heterodyne-oscillator stage, oscillator control stage, i-f amplifier stage, diode-detector—automatic volume and frequency control stage, audio phase-inverter voltage-amplifier stage, push-pull pentode power-amplifier stage, tuning indicator "Magic Eye," and a full-wave rectifier stage.

The antenna and detector coils are constructed with a special type of winding ("cumulative") to provide increased sensitivity and selectivity on the "A" band. The "A," "B," and "C" sections on both coils are wound on single forms and are series connected. The range selector operates in such a manner that the correct portions are selected for the primary and secondary windings on each band. The "A,"



Model 811K

"B," and "C" oscillator sections are likewise wound on a single form but are connected so they operate separately. Undesirable interaction of unused windings with the tuned circuits is prevented by shorting out the proper sections with the range selector.

The intermediate-frequency amplifier consists of an RCA-6K7 tube in a transformer-coupled circuit. The windings of all i-f transformers are resonated by fixed capacitors and are adjusted by molded magnetite cores to tune to 460 kc.

The function of the automatic-frequency-control circuit is to automatically change the frequency of the heterodyne oscillator so that the correct i-f frequency is formed for the i-f amplifier. The circuit consists essentially of an i-f discriminator which, as the name implies, discriminates or furnishes control voltage of the correct polarity to an oscillator frequency-control tube for generated i-f carrier frequencies slightly above and below 460 kc, or the frequency to which the i-f amplifier is tuned.

The plate circuit of the RCA-6J7 oscillator control tube is caused to act as an apparent variable inductance in parallel with the "A" band oscillator tuned circuit of which coil L14 is a part. The series combination of resistor R41 and the oscillator control-tube grid to cathode capacitance is also in parallel with the oscillator tuned circuit. Since the resistance of R41 is many times greater than the reactance of the grid-

cathode capacitance, at the oscillator frequency, the r-f current through the combination will be practically in phase with the r-f voltage across the oscillator tuned circuit. However, the r-f voltage impressed across the grid-cathode capacitance section of the combination will lag the r-f voltage across the combination, or the tuned circuit, approximately 90 degrees. The grid-cathode r-f voltage will be amplified by the control tube but will be shifted an additional 180 degrees (grid and plate voltages of all tubes are always opposite in phase) so that the amplified r-f voltage appearing across the plate circuit will now lead the voltage across the combination or the tuned circuit by 90 degrees, or, in other words, the control tube is acting as an equivalent shunt inductance. The amount of this action is determined by the amplification of the tube, which in turn is governed by the grid-cathode bias voltage. In operation a residual bias is developed across the cathode resistor R43. The d-c control grid voltage is fed to the control grid from the discriminator circuit through resistor R44. If this voltage is negative with respect to ground, the amplification of the control tube will be decreased, the apparent plate circuit inductance of the tube increased, which will lower the frequency of the oscillator tube. The converse will occur when the grid voltage is positive with respect to ground.

The action of the discriminator circuit depends upon the fact that a 90-degree phase difference exists between the primary and secondary potentials of a double-tuned loosely-coupled transformer when the resonant frequency is applied and that this phase difference varies as the applied frequency varies; i.e., the maximum resultant response voltage across the primary and secondary windings connected in series will occur at a frequency either lower or higher in frequency than the frequency to which the individual windings are resonated, respectively depending on whether the windings are connected series aiding or opposing.

The discriminator, or third i-f transformer, consists of the primary winding, L24, which is a part of the second i-f transformer secondary tuned circuit (tuned to 460 kc) and the center-tapped secondary, L22. The upper and lower halves of L22 may be considered as two secondary coils, the upper series aiding and the lower series opposing the primary, L24. The magnetite core in L22 is inserted to inductively balance the two halves. The function of coil L23 (magnetite core adjusted), in parallel with L22, is to tune the secondary to 460 kc. Therefore, the maximum voltage will be applied to diode circuit P₂K₂, R51, and R54 when the i-f signal frequency is above 460 kc and to the diode circuit P₁K₁ and R20 when the i-f signal frequency is below 460 kc. Resistor sections R51-R54 and R20 are connected in series between ground and a point leading to the oscillator control tube grid.

D-c voltages, resulting from diode rectification, across section R51-R54 and section R20 are always in opposition, consequently the oscillator control-tube grid-bias voltage is a differential amount, depending upon the i-f signal strength and its frequency deviation from the nominal value of 460 kc. The polarity of this differential oscillator control-tube grid-bias, with respect to ground, depends on whether the i-f signal frequency is above or below 460 kc, but is always in the direction which will bring the generated i-f frequency nearer to 460 kc. A-f-c action is automatically eliminated for "manual" tuning by grounding diode cathode K₁ through switch S7. A-v-c voltage and audio signal components are developed across resistor section R51-R54.

The RCA-6N7 twin-triode tube is operated as a phase inverter to supply audio signal voltage 180-degrees out-of-phase between the control grids of the two RCA-6F6 power output tubes for push-pull operation. Audio signals applied to the upper triode control grid through volume control R52 are amplified and shifted 180-degrees in phase. A portion of this amplified signal is applied to the lower triode control grid, through capacitor C33 and resistors R26 and R25, where it is amplified to approximately the same level as that in the plate circuit of the upper triode but approximately 180-degrees out-of-phase.

Service Data

The various diagrams of this booklet contain such information as will be needed to isolate causes for defective operation if such develops. The ratings of the resistors, capacitors, coils, etc., are indicated adjacent to the symbols signifying these parts on the diagrams. Identification titles such as R1, L1, C1, etc., provide reference between the illustrations and Replacement Parts List. The coils, transformer windings, and reactors are rated in terms of d-c resistance to permit continuity checks.

Precautionary Lead Dress.—(1) Bus lead from oscillator coil directly to ground must be as short as possible for correct alignment, (2) bus lead from range switch S3 to oscillator section C53 of variable condenser should be 1½ inches long for correct alignment, (3) bus lead from detector coil to range switch S4 must be as short as possible for correct alignment, (4) bus lead from detector coil to detector section C7 of variable condenser should be 2½ inches long for correct alignment, (5) detector trimming capacitor C8 lead should connect directly to variable condenser C7, (6) bus lead from antenna section of range switch S2 to chassis ground lance must be as short as possible, (7) bus lead from antenna coil to range switch S2 should be 2¼ inches for correct alignment, (8) bus lead from antenna coil to antenna section C1 of variable condenser must be 3⅞ inches over-all with ½ inch bend at coil end for correct alignment, (9) filament leads should be dressed away from RCA-6N7 grids, pins Nos. 4 and 5, to reduce hum pickup, (10) resistors R41, R43, and R44 in the oscillator control tube circuit must be

kept free of other component parts for satisfactory operation of the a-f-c circuit, (11) capacitor C29 and resistor R16 leads from terminal board to the phonograph terminal board should be as short as possible and dressed away from other parts to reduce hum pickup, (12) filament leads should all be twisted to reduce hum pickup, (13) filament leads should be dressed away from the terminal board near the 3rd i-f transformer. (14) Lead from the range switch S3 to the oscillator cathode socket terminal should be dressed under bus wire on socket to hold this lead down close to chassis.

Phonograph Attachment.—A terminal board is provided for connecting a phonograph into the audio-amplifying circuit. RCA Victor Models R-93, R-93-A, R-93-2, or R-94 Record Players should be connected as follows: Remove the link from the phonograph terminal board. Connect green wire in Radio-Record switch cable to terminal 1; yellow to terminal 2; shield to terminal 3; and tape up the red and blue. Connect a 2-conductor twisted cable between the Record Player binding posts and the screw-terminals on Radio-Record switch. If additional volume is desired, connect an RCA Stock No. 9632 transformer between the 2-conductor twisted cable and the screw-terminals on Radio-Record switch as follows: Yellow and brown transformer leads and one side of twisted cable to ground screw-terminal on switch; black transformer lead to other side of twisted cable; and blue transformer lead to other screw-terminal on switch.

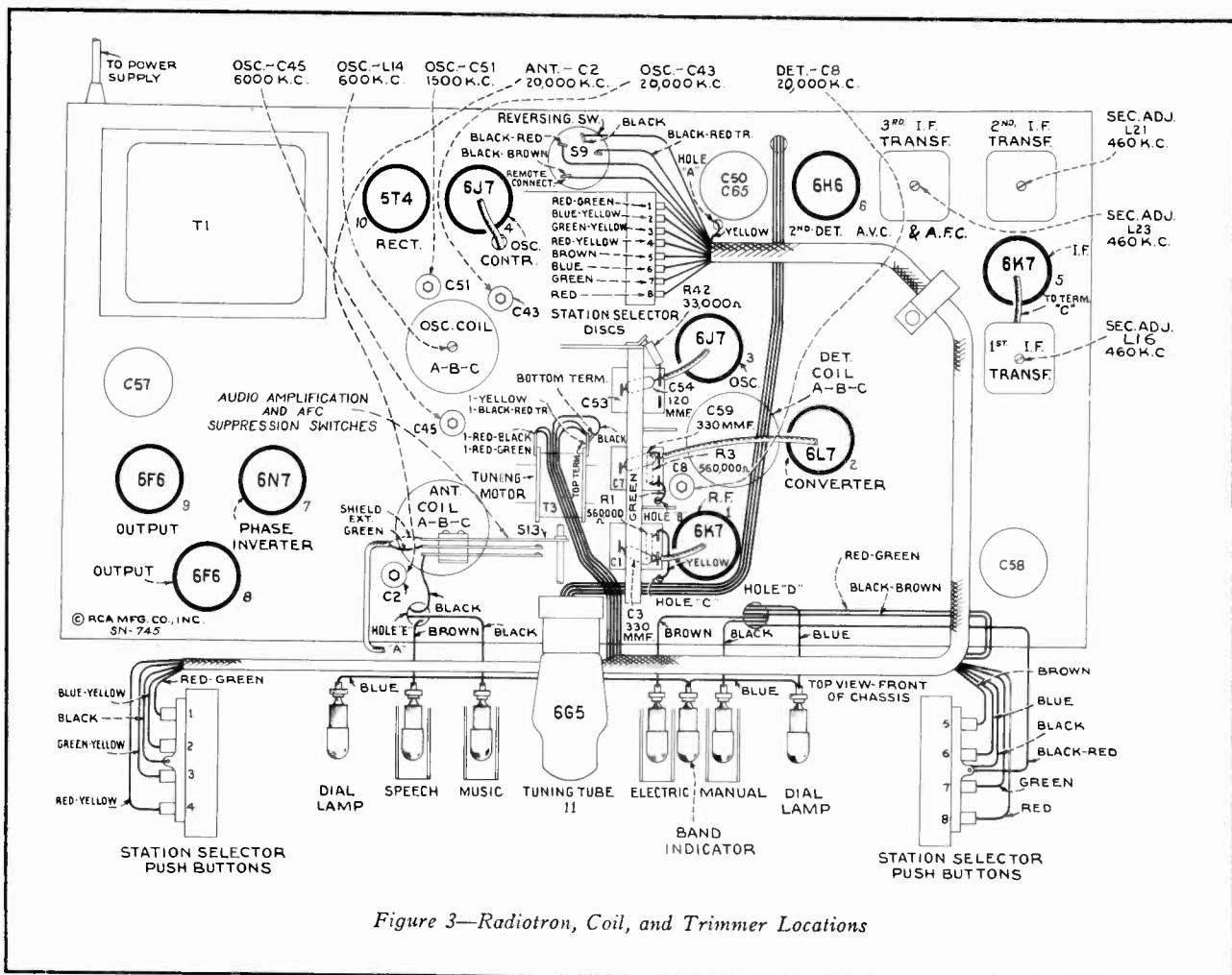

Figure 3—Radiotron, Coil, and Trimmer Locations

Loudspeaker.—Centering of the loudspeaker is made in the usual manner with three narrow paper feelers after first removing the front dust cover. This may be removed by softening its cement with a light application of acetone, using

care not to allow the acetone to flow into the air gap. The dust cover should be cemented back in place with ambroid upon completion of adjustment.

ALIGNMENT PROCEDURE

Calibrate the tuning dial by adjusting dial pointer to the left ends of horizontal calibration lines with the gang tuning-condenser plates in full-mesh position. This is a screw-driver adjustment.

The "Manual-Electric-Remote" switch should be turned to "Manual" (right) during alignment unless otherwise specified.

CAUTION.—The magnetite core screw L22 on the bottom of the 3rd i-f transformer has been accurately adjusted, for an exact electrical balance of coil L22 to center tap, during manufacture and should not be disturbed. However, if for any reason the adjustment has been moved from its original position, it will be necessary to mechanically adjust this screw until the end of the stud protrudes exactly 3/16 of an inch (six threads exposed) above the brass bushing prior to any alignment operations.

Perform alignment in proper order, tabulated below, starting with No. 1 and following all operations across, then No. 2, etc. A-f-c discriminator adjustments should follow r-f and i-f adjustments tabulated below. Adjustment locations are shown on figures 3 and 4.

Cathode-ray alignment is preferable; the connections to the chassis are shown on figure 2. If an output indicator is used, connect it across the loudspeaker voice-coil and advance the receiver volume control to full-volume position.

Connect the "low" output terminal of the test oscillator to the receiver chassis for all alignment operations. Regulate the output of the test oscillator so that minimum signal is applied to the receiver to obtain an observable output indication. This will avoid a-v-c action.

The term "Dummy antenna" means the device which must be connected between the "high" test-oscillator output and the point of connection to the receiver in order to obtain ideal alignment. "No signal, 550-750 kc" means that the receiver should be tuned to a point between 550 and 750 kc where no signal or interference is received from a station or local (heterodyne) oscillator.

For further details on alignment, refer to booklet "RCA Victor Receiver Alignment."

| Order of Alignment | Test Oscillator | | | Range-Selector | Receiver Dial Setting | Circuit to Adjust | Adjustment Symbols | Adjust to Obtain |
|--|---|---------------|-------------------|----------------|-----------------------|-------------------|--------------------|--------------------------------|
| | Connection to Receiver | Dummy Antenna | Frequency Setting | | | | | |
| 1 | — | — | — | — | — | 3rd I-F Trans. | L23 | Turn Extreme Counter-clockwise |
| 2 | 6K7 I-F Grid Cap | .001 Mfd. | 460 kc | "A" Left | No Signal 550-750 kc | 2nd I-F Trans. | L20 and L21 | Max. (peak) |
| 3 | 6L7 Det. Grid Cap | .001 Mfd. | 460 kc | "A" | No Signal 550-750 kc | 1st I-F Trans. | L15 and L16 | Max. (peak) |
| 4 | Ant. | 300 Ohms | 20,000 kc | "C" Right | 20,000 kc | "C" Osc. | C43 | Max. (peak)* |
| 5 | Ant. | 300 Ohms | 20,000 kc | "C" | Rock thru 20,000 kc | "C" Det. | C8 | Max. (peak)† |
| 6 | Ant. | 300 Ohms | 20,000 kc | "C" | 20,000 kc | "C" Ant. | C2 | Max. (peak)‡ |
| 7 | Ant. | 300 Ohms | 6,000 kc | "B" Center | 6,000 kc | "B" Osc. | C45 | Max. (peak)* |
| 8 | Ant. | 200 Mmfd. | 600 kc | "A" Left | 600 kc | "A" Osc. | L14 | Max. (peak) |
| 9 | Ant. | 200 Mmfd. | 1,500 kc | "A" | 1,500 kc | "A" Osc. | C51 | Max. (peak) |
| 10 | Ant. | 200 Mmfd. | 600 kc | "A" | 600 kc | "A" Osc. | L14 | Max. (peak) |
| 11 | Ant. | 200 Mmfd. | 1,500 kc | "A" | 1,500 kc | "A" Osc. | C51 | Max. (peak) |
| 12 | Proceed to A-F-C Discriminator Adjustments Outlined Below | | | | | | | |
| <p>* Use minimum capacity peak if two peaks can be obtained. † Use maximum capacity peak if two peaks can be obtained. ‡ After this adjustment, check for image signal by shifting receiver dial to 19,080 kc.</p> | | | | | | | | |

A-F-C Discriminator Adjustments.—These adjustments are rather critical and should be performed with extreme care. Improper adjustment may result in complete failure of the oscillator control tube to function or else may cause it to detune the oscillator instead of tuning it to the signal. It is assumed that the magnetite core adjusting screw L23 (top of

3rd i-f transformer) has been turned all the way out (extreme counter-clockwise) prior to the preceding tabulated adjustments. Adjustments are as follows: Remove spring "N" on link and arm assembly which connects the "Manual-Electric-Remote" switch shaft to the throw-out gear bracket. Connect antenna to receiver antenna "A" terminal. With the "Manual

Electric-Remote" switch in "Manual" (right) position, tune in a strong local station near 600 kc or the low-frequency end of the "A" band as accurately as possible by means of the tuning tube "Magic Eye." The most accurate adjustment will be obtained by adjusting the "vernier" tuning knob mid-way between the two points where the eye just appears to start to open. This will place the generated i-f carrier signal frequency exactly in the center of the i-f amplifier response curve (should be 460 kc if i-f amplifier was properly aligned) and is the frequency to which the a-f-c discriminator (3rd i-f transformer) should be tuned to resonance. Without disturbing any of the receiver adjustments, place the "high" test-oscillator lead about 3/4 of an inch from the grid cap lead of the RCA-6K7 i-f amplifier tube, adjust the test-oscillator output to maximum, turn test-oscillator "Modulation" off, and carefully zero-beat the test-oscillator frequency (approximately 460 kc) with the i-f carrier signal. Avoid placing the test-oscillator lead nearer to the grid cap lead than specified above, as doing so will tend to detune the i-f amplifier. It may be necessary to reduce the local station signal, during this operation, by shortening antenna lead or grounding antenna "A" terminal to chassis in order to increase the loudness of the beat note sufficiently for accurate zero-beat adjustment.

Throw "Manual-Electric-Remote" switch to "Electric" (center) position. A high whistle or beat note will now be heard. Turn the magnetite core screw L23 (top of 3rd i-f transformer) slowly clockwise. As this screw is turned, the beat note will first increase to a high audio frequency and will then decrease to a zero-beat and then increase in fre-

quency again. The point of exact zero-beat is the position for correct adjustment of the discriminator. Zero-beat should also still exist when the "Manual-Electric-Remote" switch is thrown back to "Manual" position. The adjustment is now

Radiotron Cathode Current Readings

Measured with Milliammeter Connected at Tube Socket Cathode Terminals Under Conditions Similar to Those of Voltage Measurements

| | |
|---|----------|
| (1) RCA-6K7—R-F Amp. | 8.5 ma. |
| (2) RCA-6L7—1st Det. | 7 ma. |
| (3) RCA-6J7—Osc. | 10 ma. |
| (4) RCA-6J7—Osc. Control..... | 1.2 ma. |
| (5) RCA-6K7—I-F Amp. | 8.5 ma. |
| (6) RCA-6H6—2nd Det., A.V.C. and A.F.C. | |
| (7) RCA-6N7—Phase Inverter..... | 1.8 ma. |
| (8) RCA-6F6—Output | 26 ma. |
| (9) RCA-6F6—Output | 26 ma. |
| (10) RCA-5T4—Rectifier | 112 ma.* |
| (11) RCA-6G5—Tuning Tube..... | 2.5 ma. |

(*Cannot be measured at socket)

complete and may be checked by slightly detuning the receiver above and below the local station frequency with the "Manual-Electric-Remote" in "Manual" position, switching to "Electric" position, and noting the oscillator pull-in. Replace spring "N."

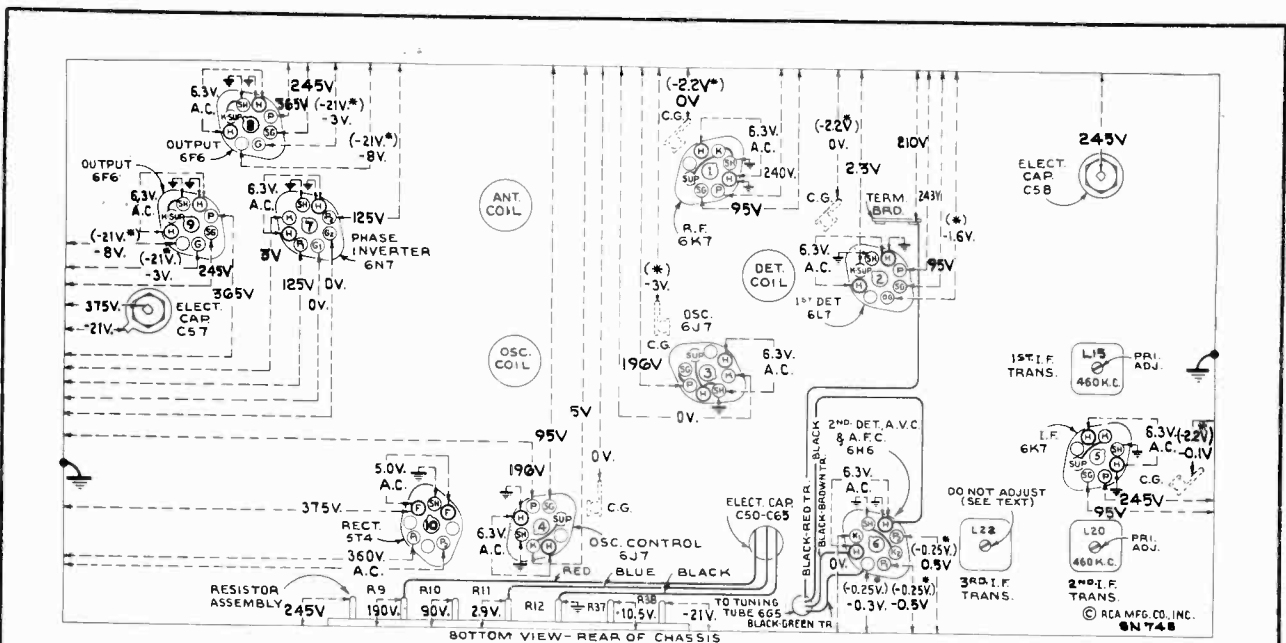
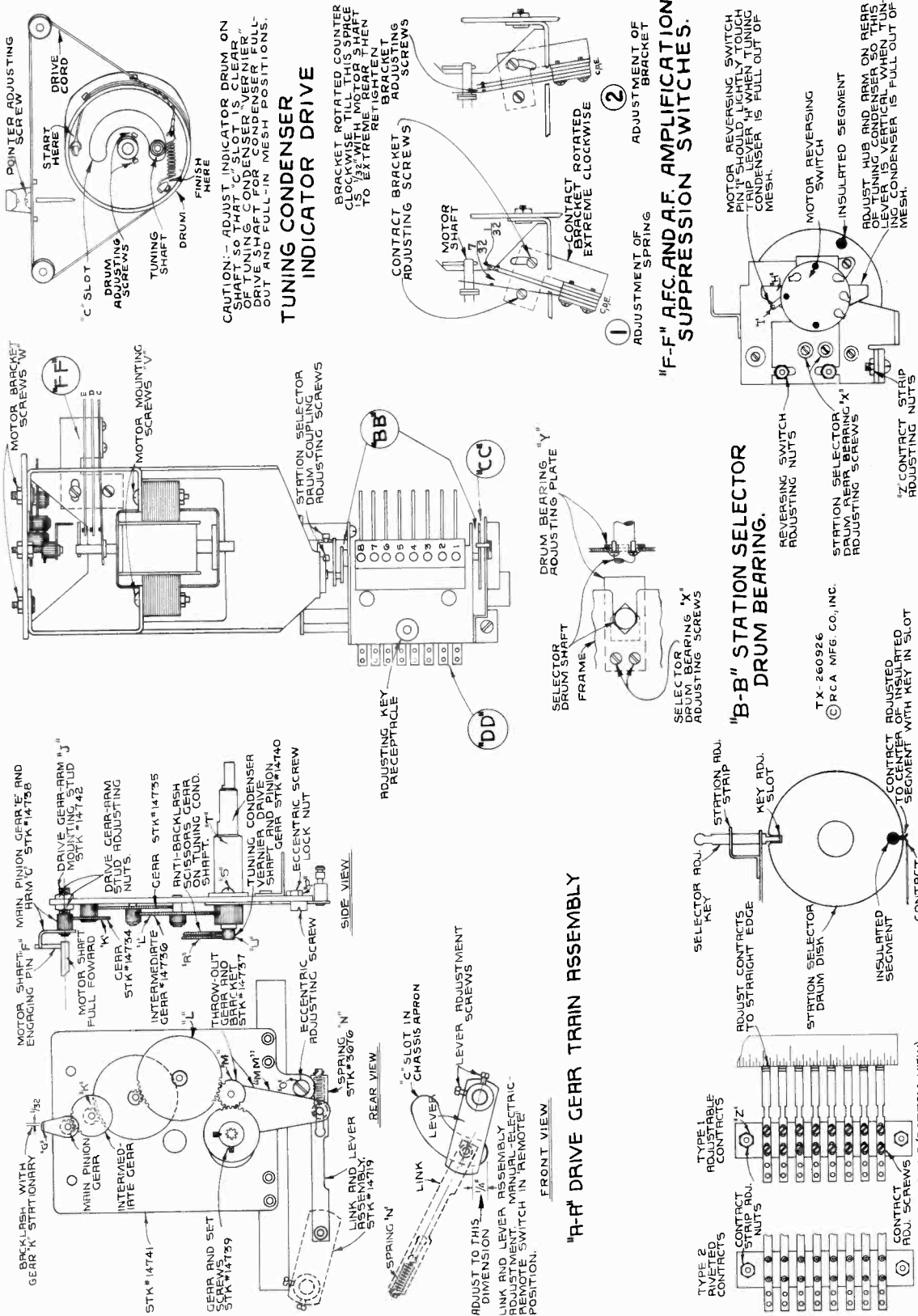

Figure 4—Radiotron Socket Voltages, Coil, and Trimmer Locations

Measured at 115 volts, 60-cycle supply—Tuned to approximately 1,000 kc ("Broadcast")—"Manual" control—No signal being received—Volume control minimum—Tone control optional

Note: Two voltage values are shown for some readings. The value shown in parentheses with asterisk (*) indicates operating conditions without voltmeter loading. The other value (generally lower) is the actual measured voltage and differs from the value shown in parentheses because of the additional loading of the voltmeter.

Voltage values as specified should hold within ±20% when the receiver is normally operative at its rated line voltage. To duplicate the conditions under which the voltages were measured requires a 1,000-ohm-per-volt d-c meter, having ranges of 10, 50, 250, and 500 volts. Use the nearest range above the specified measured voltage. A-c voltages were measured with a corresponding a-c meter.



"H" DRIVE GEAR TRAIN ASSEMBLY

"F-F" AFC AND AF AMPLIFICATION SUPPRESSION SWITCHES.

"B-B" STATION SELECTOR DRUM BEARING.

"C-C" MOTOR REVERSING SWITCH ADJUSTMENT.

"D-D" STATION SELECTOR DRUM CONTACT ADJUSTMENTS

Figure 5—"Electric Tuning" Mechanism Adjustments

ELECTRIC TUNING

Principle of Operation

The electric tuning mechanism consists essentially of a quick engaging and dis-engaging reversible electric motor, tuning condenser driving gear train, and eight mechanically interlocked (pushing one button releases all others) station selector push buttons respectively wired to eight adjustable station selector contactor discs (each with a motor stopping insulated segment) mounted on a drum which is direct-coupled to the gang tuning condenser shaft. The arrangement permits any one of eight pre-determined stations to be electrically tuned in by merely touching the correct push button.

The operation may be more readily understood by reference to figures 1, 5, and 6. When the motor is not energized, the armature is pushed to the rear or slightly out of the magnetic center by tension of contact spring "C" and the motor shaft is dis-engaged from the driving gear train. Pressing in any one of the eight push buttons will complete the motor circuit through a station selector contactor disc, assuming that the "Manual-Electric-Remote" switch is in "Electric" position and that the insulated segment in the contactor disc is not opposite its contactor. As the motor starts, the armature will be drawn forward, due to solenoid action, and the pin "F" on the end of its shaft will engage the arm "G" on the small main pinion gear, thereby driving the tuning mechanism. At the same time contact springs "E" and "D" will be grounded, causing suppression of audio amplification and automatic frequency control during the tuning cycle. The motor will continue to operate until the insulated segment in the selector disc breaks the motor circuit, whereupon spring "C" will instantly dis-engage the motor pin "F" from the arm "G" on the small pinion driving gear and open contacts "E" and "D." Pushing another button will cause the above mentioned cycle to be repeated except that the motor will be interrupted by the insulated segment on a corresponding disc. The discs are individually adjustable on a drum mechanism, providing a choice of eight "Electric Tuned" "Broadcast" stations. The arrangement of the motor is such that its rotation will continue in the same direction regardless of the number of "Electric" tuning cycles until the tuning condenser approaches either full-out or full-in of mesh, whereupon lever "H" trips switch S9 which reverses the direction of rotation. A throw-out idler gear is link-coupled to the "Manual-Electric-Remote" control to disconnect the motor drive gear train when the control is thrown to "Manual" position.

Mechanism Adjustments

The electric tuning mechanism is designed to be as simple in construction and as fool proof in operation as is possible. In order to maintain the accurate results possible with this device care must be taken in effecting any repairs or adjustments. Reference should be made to figure 5 and the following:

A-F-C and A-F Amplification Suppression Switches.—This switch assembly is located on the motor bracket and closes due to solenoid action of motor armature. The tension of the long contact spring "C" is important in bringing about quick dis-engagement of the motor and in permitting the motor to pull into mesh with the drive mechanism. Normal adjustment is attained when the short springs "D" and "E" are aligned exactly straight with contact points separated approximately 1/32 of an inch and with the spring "C" spaced approximately 7/32 of an inch from spring "D" at the point of contact. If necessary, in order to obtain positive pull-in and quick dis-engagement of the motor, the tension of spring "C" should be increased or decreased by bending. This action should be checked with the front apron of the chassis raised two inches higher than the rear. Contacts of the switch must be kept clean. Crocus cloth or a relay burnisher may be used for this purpose.

Motor Reversing Switch.—It is necessary to automatically stop and reverse the drive motor before the tuning condenser reaches the ends of its travel. Approximately 175 degrees of

sweep is required, and the reversal must take place above 1,700 kc and below 540 kc but not too near the limits of the scale. The coupling between the station selector drum and the tuning condenser shaft should be attached so that the reversing switch trip lever "H" is exactly vertical when the condenser is full-out of mesh. There should be 1/32 of an inch clearance between the end of the condenser shaft and the selector drum shaft. While the trip lever is in this position the reversing switch bracket should be adjusted by means of its elongated mounting holes until the switch pin "I" just lightly touches trip lever "H."

Main Pinion Gear.—Clearance between the small high-speed pinion gear "E" and the intermediate gear "K" determines the amount of mechanical noise produced. Correct adjustment will give approximately 1/32 of an inch movement of back lash at the end of pinion arm "G" when gear "K" is held stationary. Arm "G" must also be adjusted for correct mesh with motor shaft drive pin "F." With the motor shaft completely forward and pinion "E" tight against its front bearing, the pinion mounting stud "J" should be adjusted so that pin "F" meshes its full thickness with the rotating arm "G." An increase of this mesh will increase over travel on tuning while a decrease of mesh will decrease the over travel. The elongated hole in the front bracket allows sufficient movement of the mounting stud "J" to permit above mentioned gear mesh adjustment.

"Manual-Electric-Remote" Changeover.—(1) Link and lever adjustment—To properly line up the mechanical link between the switch shaft and throw-out gear bracket "MM," the set screws holding the link lever on the switch shaft must be loosened, the switch turned to the "Remote" position (extreme left) and the link lever revolved until the distance between the bottom of its link-connecting pin (extends through chassis apron) and the bottom of the "C" slot, in front apron of chassis, is exactly 1/4 of an inch. If this adjustment is not properly made, correct operation of "Electric" or "Remote" tuning will not result. (2) Throw-out Gear Adjustment—To obtain smooth operation on "Electric" or "Remote" positions it is important that the proper clearance is maintained between the throw-out gear "M" and the intermediate gear "L." With the "Manual-Electric-Remote" control thrown to "Remote" position (extreme left) adjust the mesh between these gears by means of the eccentric screw "O" and lock nut "P" on the throw-out gear bracket "MM" until there is approximately 1/64 of an inch backlash of gear "L" when gear "M" is held stationary.

Vernier Tuning.—In case it becomes necessary to remove tuning condenser drive shaft "T," it should be replaced by sliding anti-backlash gear "R" on condenser shaft apart so that compression amounting to one tooth on the gear is obtained in the springs. Adjust mesh of gear "R" with pinion gear "U" on vernier shaft before tightening screws "S" so that smooth tuning is obtained throughout the range.

Motor Alignment.—The motor shaft must be exactly aligned with the axis of the pinion gear with which it engages. This may be adjusted by loosening the mounting screws "V" of the motor and aligning shaft by sight. Correct alignment may be tested by slowly rotating motor and observing the relation between the pin "F" of the motor shaft and the arm "G" on the pinion. The relation of the two should remain the same throughout the revolution. Additional movement for adjustment may be obtained by the motor bracket screws "W" if necessary.

Station Selector Drum.—(1) Bearing Adjustment—The selector drum may be removed by unscrewing the two bearing adjusting screws "X" on the front and rear bearings and sliding shaft out of slots on frame. To replace drum, the reverse procedure should be followed holding bearing adjusting plates "Y" firmly against the shaft and tightening adjusting screws. (2) Contact adjustment—Two types of contact strips are used. They are designated on figure 5, as types 1 and 2, on which the individual contacts are respectively adjustable and fixed. On type 1, the individual contacts should be adjusted by setting the end contact springs near the mid-position of their travel and aligning the remaining springs to them by means of a straight edge. Either type of

contact strip should be adjusted to the selector drum by placing two selector adjusting keys in the station adjustment strip, positions 1 and 8, loosening contact strip adjusting nuts "Z" and shifting the contact strip until the end contacts are exactly centered on the respective disc insulating segments. More accurate adjustment may be made by silhouetting the point of contact with a piece of white paper held behind the contact. Adjustment will be facilitated by removing complete assembly from rear of tuning condenser by unscrewing the three mounting screws. Contacts and discs must be kept free of dirt, filings, and other extraneous matter.

Lubrication.—The dial pointer slide should be greased with petrolatum. This same lubrication should be applied lightly to all gear faces of the drive mechanism and sparingly with a cloth to the station selector discs. Any good household oil, such as "3-IN-ONE," is suitable for the motor shaft bearings. A light grade of engine oil should be used for all gear bearings. Medium viscosity engine oil, similar to "PYROIL" (B), should be applied between the thrust washers on the motor shaft. "CASTORDAG," a mixture of graphite and castor oil, is recommended for use at the selector drum end-bearing slots and at the bearings of cable pulleys.

Station Adjustment

Any eight stations may be chosen for "Electric" tuning. Remove the two escutcheon plates from the side of the dial, place proper call letter labels in the celluloid windows, and replace escutcheons. Turn the power on and proceed to set up the "Electric" tuning as follows:

1. Set Range Selector to "Broadcast."
2. Turn "Manual-Electric-Remote" control to "Electric."

3. Press push button No. 1 and wait until station pointer comes to rest.
4. Turn the "Manual-Electric-Remote" control to "Manual."
5. Remove adjusting key from receptacle on top of station selector drum mechanism.
6. Insert key in position marked, "1" in station adjustment strip and push the key all the way down to properly fit in slot in disc.
7. Tune the receiver very carefully by means of the manual tuning knob and the "Magic Eye," to station chosen for No. 1.
8. Remove key.
9. Turn the "Manual-Electric-Remote" control to "Electric."

Button No. 1 is now properly set for "Electric" tuning. Proceed similarly for the other seven push buttons, matching each station on the dial with the same number on the station adjustment strip. Repeat the above steps but place the key respectively in positions 2, 3, 4, etc., and in each case tune to the proper station. Now when you press a button the desired station will be tuned in electrically.

Note.—In the event that all the push-button switches are locked "in" at once, they may be released by pressing either the upper left-hand or the lower right-hand push buttons (Nos. 1 or 8) in farther than would ordinarily be required.

Armchair Control

When a Model G-8 armchair control is attached to the receiver as shown in figure 6 it duplicates the action of the push buttons on the front panel when the "Manual-Electric-Remote" control is turned to "Remote" position.

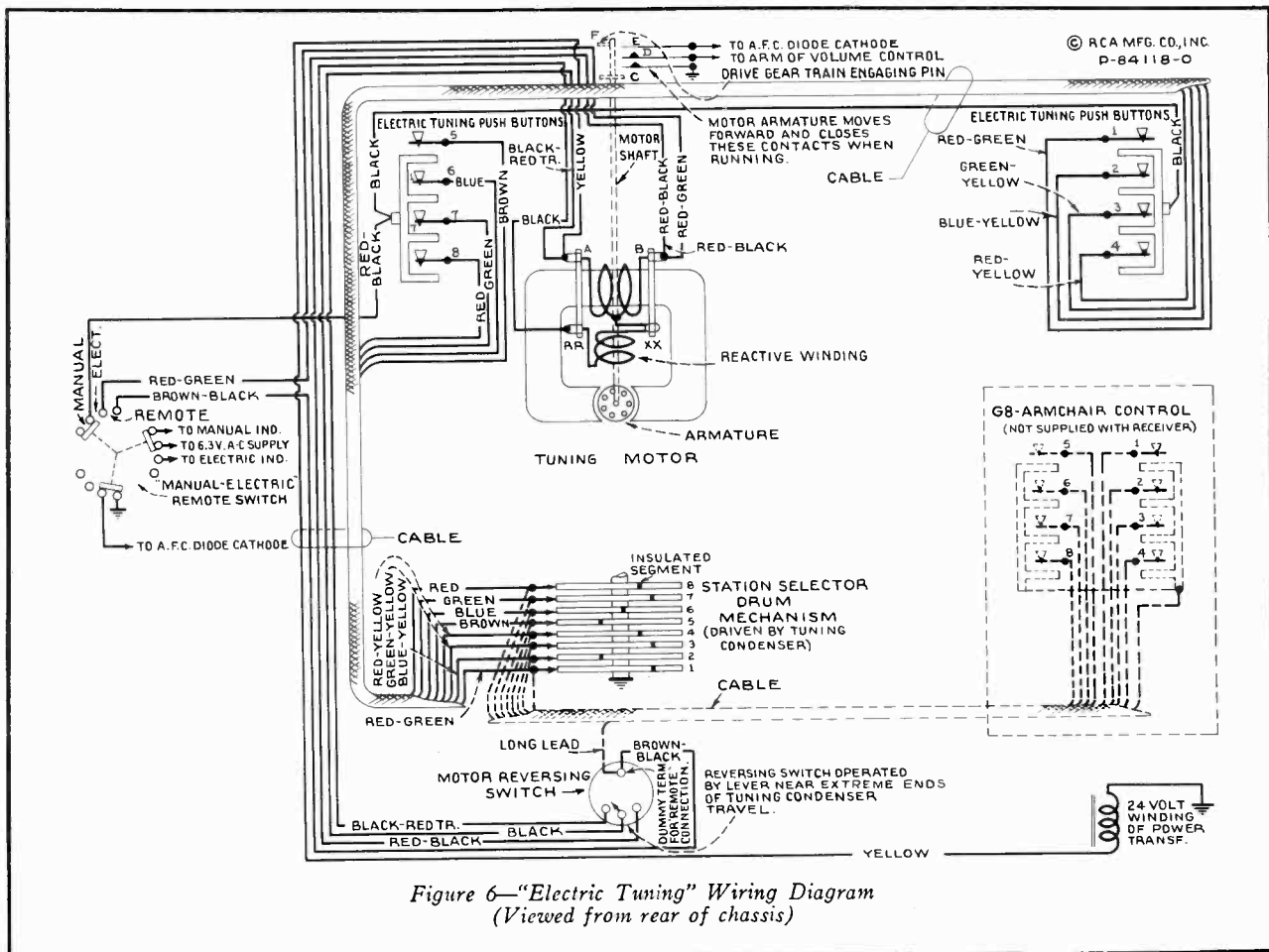

Figure 6—"Electric Tuning" Wiring Diagram (Viewed from rear of chassis)

REPLACEMENT PARTS

Insist on genuine factory tested parts, which are readily identified and may be purchased from authorized dealers.

| STOCK No. | DESCRIPTION | STOCK No. | DESCRIPTION |
|----------------------------|--|-----------|--|
| RECEIVER ASSEMBLIES | | | |
| 14701 | Arm—Hub and arm for operating band indicator shutter—located on range switch shaft | 14734 | Gear—Intermediate gear assembly—comprising one .749" O.D.—34 tooth—gear and one .291" O.D.—12 tooth pinion assembled |
| 14726 | Arm—Hub and arm complete with set screws—connects station selector drum to rear of tuning condenser shaft | 14735 | Gear—Intermediate gear assembly—comprising one 1.541" O.D.—72 tooth gear and one .291" O.D.—12 tooth pinion assembled |
| 14517 | Board—Antenna and ground terminal board | 14736 | Gear—Intermediate gear assembly—comprising one 1.541" O.D.—72 tooth gear and one hub assembled |
| 12717 | Board—Phonograph terminal board | 14737 | Gear—Throw-out gear and bracket |
| 5237 | Bushing—Variable condenser rubber mounting bushing | 14716 | Holder—Dial scale holder and reflector, complete with holding springs for band indicating shutter |
| 13656 | Button—Plug button for detector coil shield | 14715 | Indicator—Station selector indicator pointer and support |
| 14725 | Cable—Tuning tube cable and socket | 5226 | Lamp—Dial or indicating lamp |
| 12607 | Cap—Shield cap for first or second I.F. transformer | 14719 | Link—Link and lever assembly |
| 12581 | Cap—Shield cap for third I.F. transformer | 14730 | Motor—Tuning drive motor for 25-cycle models only (T3) |
| 11350 | Cap—Grid contact cap | 14729 | Motor—Tuning drive motor for 60-cycle models only (T3) |
| 12884 | Capacitor—Adjustable trimmer (long) (C2, C45, C51) | 14028 | Nut—Jamb nut for trimmer, Stock Nos. 12714 and 12884 |
| 12714 | Capacitor—Adjustable trimmer (med.) (C8, C43) | 12471 | Plate—Mounting plate for cushion socket—less socket |
| 13200 | Capacitor—10 Mmfd. (C52) | 14741 | Plate—Tuning condenser front plate and studs assembled for mounting drive gears |
| 14021 | Capacitor—22 Mmfd. (C61) | 14697 | Pulley—Indicator pointer cable pulley |
| 12720 | Capacitor—100 Mmfd. (C26, C60) | 13988 | Resistor—10 ohms—carbon type, ¼ watt (R40) |
| 14262 | Capacitor—109 Mfd. (C62, C63) | 11932 | Resistor—330 ohms—carbon type, 1/10 watt (R4) |
| 12404 | Capacitor—120 Mmfd. (C24) | 5030 | Resistor—470 ohms—carbon type, ¼ watt (R39) |
| 12724 | Capacitor—120 Mmfd. (C54) | 14720 | Resistor—1,000 ohms—carbon type, ¼ watt (R2, R43) |
| 14712 | Capacitor—180 Mmfd. (C21, C23) | 14078 | Resistor—18,000 ohms—carbon type, 1 watt (R34) |
| 12952 | Capacitor—330 Mmfd. (C3, C34, C59) | 11305 | Resistor—22,000 ohms—carbon type, ¼ watt (R16) |
| 13052 | Capacitor—470 Mmfd. (C48) | 14721 | Resistor—22,000 ohms—carbon type, ¼ watt (R13) |
| 14724 | Capacitor—560 Mmfd. (C4) | 11300 | Resistor—33,000 ohms—carbon type, 1/10 watt (R42) |
| 14723 | Capacitor—690 Mmfd. (C47) | 13735 | Resistor—33,000 ohms—carbon type, ¼ watt (R5) |
| 12729 | Capacitor—1,550 Mmfd. (C46) | 12454 | Resistor—33,000 ohms—insulated ¼ watt (R53) |
| 12897 | Capacitor—4,700 Mmfd. (C5, C49) | 11646 | Resistor—47,000 ohms—carbon type, ¼ watt (R25) |
| 14722 | Capacitor—5,100 Mmfd. (C44) | 11365 | Resistor—82,000 ohms—carbon type, ¼ watt (R50) |
| 4838 | Capacitor—.005 Mfd. (C39, C41) | 14560 | Resistor—100,000 ohms—insulated, ¼ watt (R27) |
| 13138 | Capacitor—.01 Mfd. (C29, C33) | 5145 | Resistor—100,000 ohms—carbon type, ¼ watt (R28, R30) |
| 14393 | Capacitor—.01 Mfd. (C36) | 12478 | Resistor—150,000 ohms—carbon type, 1/10 watt (R54) |
| 11315 | Capacitor—.015 Mfd. (C32, C35, C37) | 11453 | Resistor—270,000 ohms—carbon type, 1/10 watt (R31, R32) |
| 4870 | Capacitor—.025 Mfd. (C28) | 11297 | Resistor—330,000 ohms—carbon type, 1/10 watt (R51) |
| 4886 | Capacitor—.05 Mfd. (C56) | 11172 | Resistor—470,000 ohms—carbon type, ¼ watt (R17) |
| 4841 | Capacitor—.1 Mfd. (C9, C10, C14, C64) | 11452 | Resistor—470,000 ohms—carbon type, 1/10 watt (R20) |
| 5170 | Capacitor—.25 Mfd. (C19) | 11397 | Resistor—560,000 ohms—carbon type, 1/10 watt (R1, R3) |
| 4840 | Capacitor—.25 Mfd. (C55) | 12013 | Resistor—1 meg.—carbon type, 1/10 watt (R36) |
| 12741 | Capacitor—.5 Mfd. (C38) | 13730 | Resistor—1 meg.—carbon type, ¼ watt (R26, R44) |
| 5212 | Capacitor—16 Mfd. (C58) | 11628 | Resistor—2.2 meg.—carbon type, ¼ watt (R18, R21) |
| 14531 | Capacitor—25 Mfd. (C57) | 13732 | Resistor—10 meg.—carbon type, ¼ watt (R35) |
| 14829 | Capacitor Pack—Comprising one 16 Mfd. and one 20 Mfd. sections (C50, C65) | 14692 | Resistor—Voltage divider—comprising one 1,100 ohm, one 4,000 ohm, one 6,000 ohm, one 180 ohm and two 90 ohm sections (R9, R10, R11, R12, R37, R38) |
| 14372 | Coil—Antenna coil and shield (L1, L2, L3, L4) | 14695 | Rod—Tie rod for joining lockplate pawls on station selector push-button switches |
| 14414 | Coil—Detector coil and shield (L5, L6, L7, L8, L9, L10) | 4669 | Screw—No. 8-32 x 5/32 square head set screw for arm, Stock No. 14701, or link, Stock No. 14719, or drum, Stock No. 14693 |
| 14713 | Coil—Oscillator coil and shield (L11, L12, L13, L14) | 12418 | Screw—No. 8-32 x 3/16 milled head set screw for gear, Stock No. 14739 |
| 14727 | Condenser—3-gang variable tuning condenser, complete with gear train (C1, C7, C53) | 14848 | Selector—Station selector drum mechanism—comprising selector contactor discs, spring contacts, and motor reversing switch assembled in metal frame |
| 5040 | Connector—4-contact female connector for reproducer cable | 14374 | Shield—Antenna or detector coil shield |
| 14733 | Contact—Spring contact for engaging discs in station selector drum for type 1 contact assembly | 14375 | Shield—Oscillator coil shield |
| 30365 | Contact—Comprising 8 spring contacts assembled on insulating strip for engaging discs in station selector drum (type 2 contact assembly) | 12008 | Shield—I.F. transformer shield |
| 14699 | Cord—Indicator pointer drive cord | 14718 | Shutter—Band indicating shutter and arm assembly |
| 12006 | Core—Adjustable core and stud for I.F. transformer | | |
| 12800 | Core—Adjustable core and stud assembly for oscillator coil | | |
| 14717 | Dial—Station selector dial scale | | |
| 14740 | Drive—Tuning condenser vernier drive shaft and pinion gear | | |
| 14698 | Drum—Drum for indicator drive cord—fastens on tuning condenser shaft | | |
| 14731 | Drum—Station selector drum rotor—comprising 8 station selector contactor discs assembled on shaft | | |
| 14738 | Gear—Drive pinion gear and arm | | |
| 14739 | Gear—Drive gear and set screws—located on tuning condenser knob shaft | | |

REPLACEMENT PARTS—(Continued)

| STOCK No. | DESCRIPTION | STOCK No. | DESCRIPTION | |
|-----------|--|-----------|---|---|
| 14696 | Slider—Indicator pointer holder and spring | | REPRODUCER ASSEMBLIES (Speaker No. RL-70E2) | |
| 11195 | Socket—5-contact 5T4 Radiotron socket | | | |
| 11196 | Socket—8-contact 6K7, 6L7, 6J7, 6H6, 6F6 or 6N7 Radiotron socket | 13866 | | Cap—Dust cap for cone center |
| 14114 | Socket—Dial or indicating lamp socket | 11234 | | Coil—Field coil (L28) |
| 12007 | Spring—Retaining spring for core, Stock No. 12006 | 11469 | | Coil—Neutralizing coil (L27) |
| 3676 | Spring—Tension spring for link and lever, Stock No. 14719 | 12667 | | Cone—Reproducer cone, voice coil, center suspension and dust cap (L26) |
| 13638 | Spring—Tension spring for cord, Stock No. 14699 | 5039 | | Plug—4-contact male plug for reproducer |
| 14694 | Spring—Tension spring for lockplate pawl on station selector push-button switches | 14535 | | Reproducer, complete |
| 14742 | Stud—Mounting stud for gear and arm, Stock No. 14738 | 14534 | | Transformer—Output transformer (T2) |
| 14702 | Switch—"Manual - Electric - Remote" switch (S7, S10, S12) | 14357 | | Washer—Spring washer to hold field coil securely |
| 14705 | Switch—L.F. tone and power switch (S1, S8, S11) | | | MISCELLANEOUS ASSEMBLIES |
| 14732 | Switch—Motor reversing switch and mounting plate for station selector (S9) | 12038 | | Band—Rubber band for tuning tube |
| 14704 | Switch—Range switch (S2, S3, S4, S6) | 14744 | | Bracket—Tuning tube mounting bracket and clamp |
| 14728 | Switch—A-F-C and A-F amplication suppression switch (S13) | 14745 | | Button—Automatic station selector push button |
| 14693 | Switch—Station selector button switch—comprising four contacts and corresponding lockplates, completely assembled on insulating strips | 14747 | | Card—Call letter cards for station selector |
| 14764 | Tone Control—H.F. tone control (R29) | 14743 | | Escutcheon—Station selector and tuning tube escutcheon—complete with crystal, indicating cards, and buttons—less station indicating cards |
| 14828 | Transformer—First I.F. transformer (L15, L16, C62, C63) | 14749 | Indicator—"Electric-Manual" indicator screen | |
| 14765 | Transformer—Second I.F. transformer (L20, L21, C21, C23) | 14748 | Indicator—"Music-Speech" indicator screen | |
| 14709 | Transformer—Third I.F. transformer (L22, L23, L24, C24) | 14751 | Key—Key for use in setting "Electric Tuning" mechanism | |
| 14689 | Transformer—Power transformer, 105-125 volts, 50-60 cycle (T1) | 14359 | Knob—Large station selector knob | |
| 14690 | Transformer—Power transformer, 105-125 volts, 25-60 cycle (T1) | 14688 | Knob—Range switch knob | |
| 14691 | Transformer—Power transformer, 105-240 volts, 50-60 cycle (T1) | 14269 | Knob—Volume control, "Manual-Electric-Remote" switch, H.F. tone control, L.F. tone control or small station selector knob | |
| 13144 | Volume Control (R52) | 5210 | Screw—Chassis mounting screw and washer assembly | |
| | | 14746 | Shield—Celluloid shield for station call letter cards | |
| | | 4982 | Spring—Retaining spring for knob, Stock No. 14359 | |
| | | 14270 | Spring—Retaining spring for knob, Stock Nos. 14269 and 14688 | |

RCA VICTOR MODEL 811T

TECHNICAL INFORMATION AND SERVICE DATA

Model 811T is an eleven-tube, electric-tuning, table-type instrument employing a chassis similar to Model 811K. The reproducer is an 8-inch electrodynamic unit stamped RL-63F-2: the resistance and impedance values being the same as for reproducer RL-70E-2 used in Model 811K. All Service Data and Replacement Parts for Model 811K apply directly to Model 811T except use the Reproducer Replacement Parts listed below instead of those listed for Model 811K.

| <u>Stock No.</u> | <u>Description</u> |
|------------------|---|
| 14356 | Board--3-contact reproducer terminal board |
| 13866 | Cap--Cone-center dust cap |
| 11234 | Coil--Field coil (L28) |
| 11469 | Coil--Hum neutralizing coil (L27) |
| 12642 | Cone--Reproducer cone and dust cap (L26) |
| 5039 | Plug--4-contact male plug for reproducer |
| 14533 | Reproducer, complete |
| 14358 | Screw--Screw, washer, and lockwasher to hold core in yoke |
| 14534 | Transformer--Output transformer (T2) |
| 14357 | Washer--Spring washer to hold field coil |

Stock Nos. 12667 and 14535 are not used in Model 811T.

SERVICE DIVISION
RCA Manufacturing Company, Inc.
Camden, N. J., U. S. A.

RCA VICTOR MODELS 86T2, 87K2, and 87T2

TECHNICAL INFORMATION AND SERVICE DATA

MODEL 86T2 is a chest-type instrument identical to Model 86T3 except for cabinet styling. All Service Data and Replacement Parts for Model 86T3 apply directly to Model 86T2.

MODEL 87K2 is a console-type instrument identical to Model 87K1 except for cabinet styling. All Service Data and Replacement Parts for Model 87K1 apply directly to Model 87K2. The three additional Replacement Parts listed below apply to both models.

| <u>Stock No.</u> | <u>Description</u> |
|------------------|---|
| 30846 | Core--Inductance adjustment for instantenous tuning coils |
| 12007 | Spring--Retaining spring for core Stock No. 30846 |
| 30695 | Card--Station call-letter card for push buttons |

MODEL 87T2 is a table-type instrument employing a chassis identical to Model 87K1. All Service Data and Replacement Parts for Model 87K1 and the three additional parts listed above for Model 87K2 apply directly to Model 87T2 except: Use the Reproducer Replacement Parts listed below instead of those listed for Model 87K1.

| <u>Stock No.</u> | <u>Description</u> |
|------------------|---|
| 14614 | Cone--Reproducer cone and dust cap (L17) (for speaker marked 84091-1 or 84001-3) |
| 14934 | Cone--Reproducer cone and dust cap (L17) (for speaker marked 84091-2 or 84001-6) |
| 5118 | Plug--3-contact male plug for reproducer |
| 14613 | Reproducer complete (marked 84001-3 or 84001-6 but interchangeable with speaker marked 84091-1 or 84091-2 respectively) |
| 14615 | Transformer--Output transformer (T2) (for speaker marked 84091-1 or 84001-3) |
| 14935 | Transformer--Output transformer (T2) (for speaker marked 84091-2 or 84001-6) |

Stock Nos. 13866, 14354, 11469 12667, 14395, 14358, 14355, and 14357 for Model 87K1 Reproducer Assemblies are not used in Model 87T2.

SERVICE DIVISION
RCA Manufacturing Company, Inc.
Camden, N. J., U. S. A.



RCA Victor

MODEL 812K

Twelve-Tube, Three-Band, A-C, Superheterodyne Receiver

TECHNICAL INFORMATION AND SERVICE DATA

-1937 No. 18-

SERVICE DIVISION • RCA MANUFACTURING COMPANY, INC. • CAMDEN, N. J., U. S. A.

A Service of the Radio Corporation of America

Electrical Specifications

FREQUENCY RANGES

"Broadcast" (A)..... 530-1,720 kc
"Medium Wave" (B)..... 2,100-6,800 kc
"Short Wave" (C)..... 6,800-23,500 kc

Intermediate Frequency..... 460 kc

RADIOTRON COMPLEMENT

(1) RCA-6K7..... R-F Amplifier
(2) RCA-6L7..... First Detector
(3) RCA-6J7..... Heterodyne Oscillator
(4) RCA-6J7..... Oscillator Control
(5) RCA-6K7..... First I-F Amplifier
(6) RCA-6K7..... Second I-F Amplifier

R-F ALIGNMENT FREQUENCIES

"Short Wave" (C)..... 20,000 kc (osc., det., ant.)
"Medium Wave" (B)..... 6,000 kc (osc.)
"Broadcast" (A)..... 600 kc (osc.), 1,500 kc (osc.)

Pilot Lamps (7)..... Mazda No. 46, 6.3 volts, 0.25 amp.

POWER SUPPLY RATINGS

Rating A..... 105-125 volts, 50-60 cycles, 145 watts
Rating B..... 105-125 volts, 25 cycles, 145 watts
Rating C..... 105-125/140-160/195-250 volts, 50-60 cycles, 145 watts

POWER OUTPUT

Undistorted..... 10 watts
Maximum..... 12½ watts

LOUDSPEAKER

Type..... 12-inch Electrodynamic
Impedance (v.c.)..... 11½ ohms at 400 cycles

Mechanical Specifications

Height..... 42¹⁵/₁₆ inches
Width..... 28³/₄ inches
Depth..... 15⁵/₁₆ inches
Weight (net)..... 90 pounds
Weight (shipping)..... 118 pounds
Chassis Base Dimensions..... 21 inches x 10½ inches x 3¼ inches
Over-all Chassis Height..... 11½ inches
Operating Controls..... (1) Power Switch—Speech-Music, (2) Volume, (3) Tuning, (4) Range Selector, (5) Manual-Electric-Remote, (6) Fidelity
Tuning Drive Ratios (manual)..... 10 to 1 and 50 to 1

General Description

This receiver employs a twelve-tube, three-band, "Magic Brain" superheterodyne circuit. Features of design include "Electric Tuning" with push-button operation; automatic frequency control; "cumulative-wound" antenna and detector coils; tuned r-f amplifier; magnetite-core adjusted i-f transformers and low-frequency "A" oscillator tracking; two-stage i-f amplifier; automatic volume control; phonograph terminal

board; "Magic Eye" tuning tube; twelve-inch electrodynamic loudspeaker; plunger-type, air-dielectric trimming capacitors; two-point aural-compensated volume control; fidelity control; low-frequency tone control; audio phase inverter; and push-pull power output stage. In addition, this model has a cabinet incorporating the "Sonic Arc" Magic Voice.

Copyright, 1937, RCA Manufacturing Co., Inc.

Trademarks "Radiotron," "Magic Eye," "Magic Voice," "Magic Brain" Reg. U. S. Pat. Off. by RCA Mfg. Co., Inc.

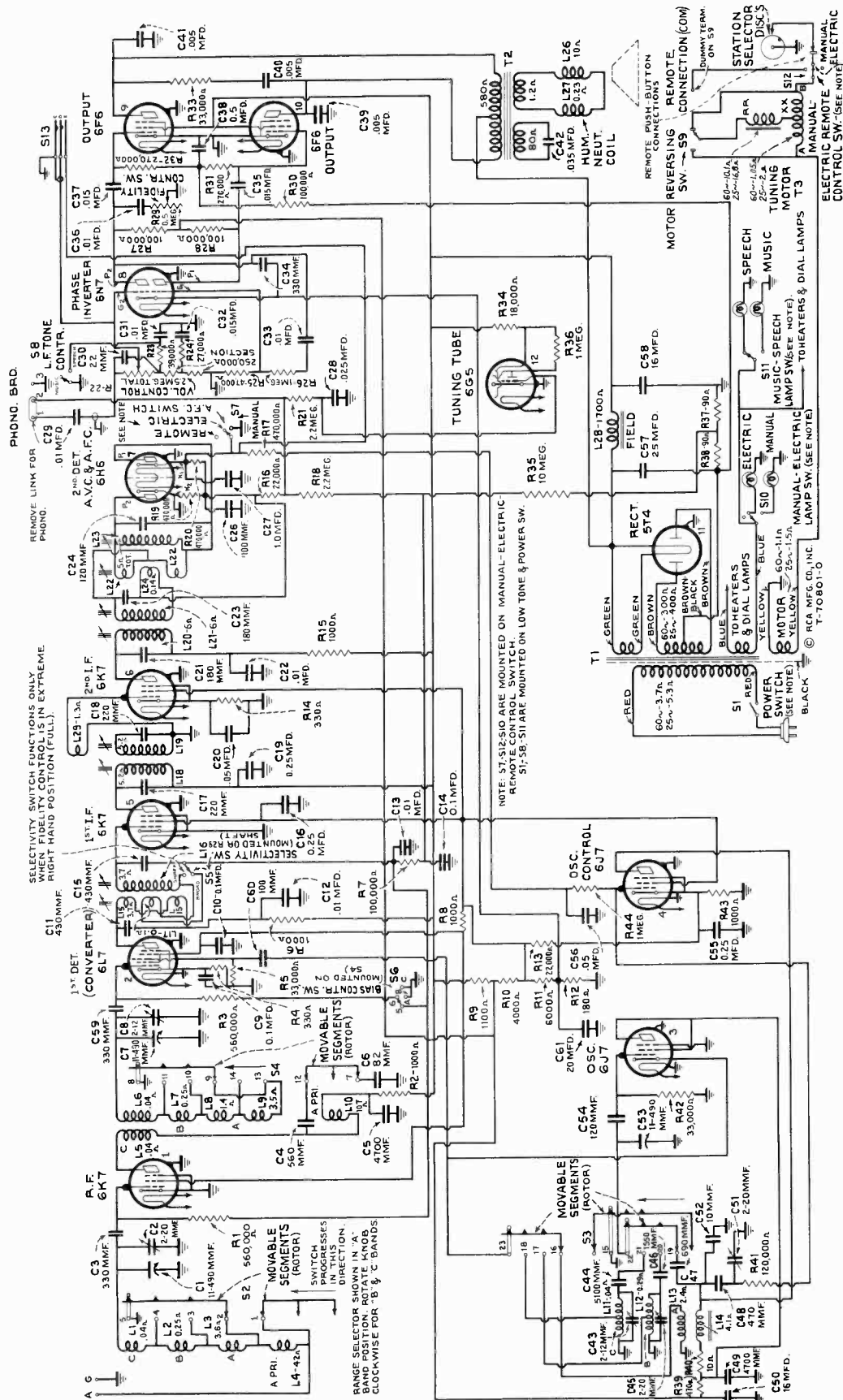

Figure 1—Schematic Circuit Diagram

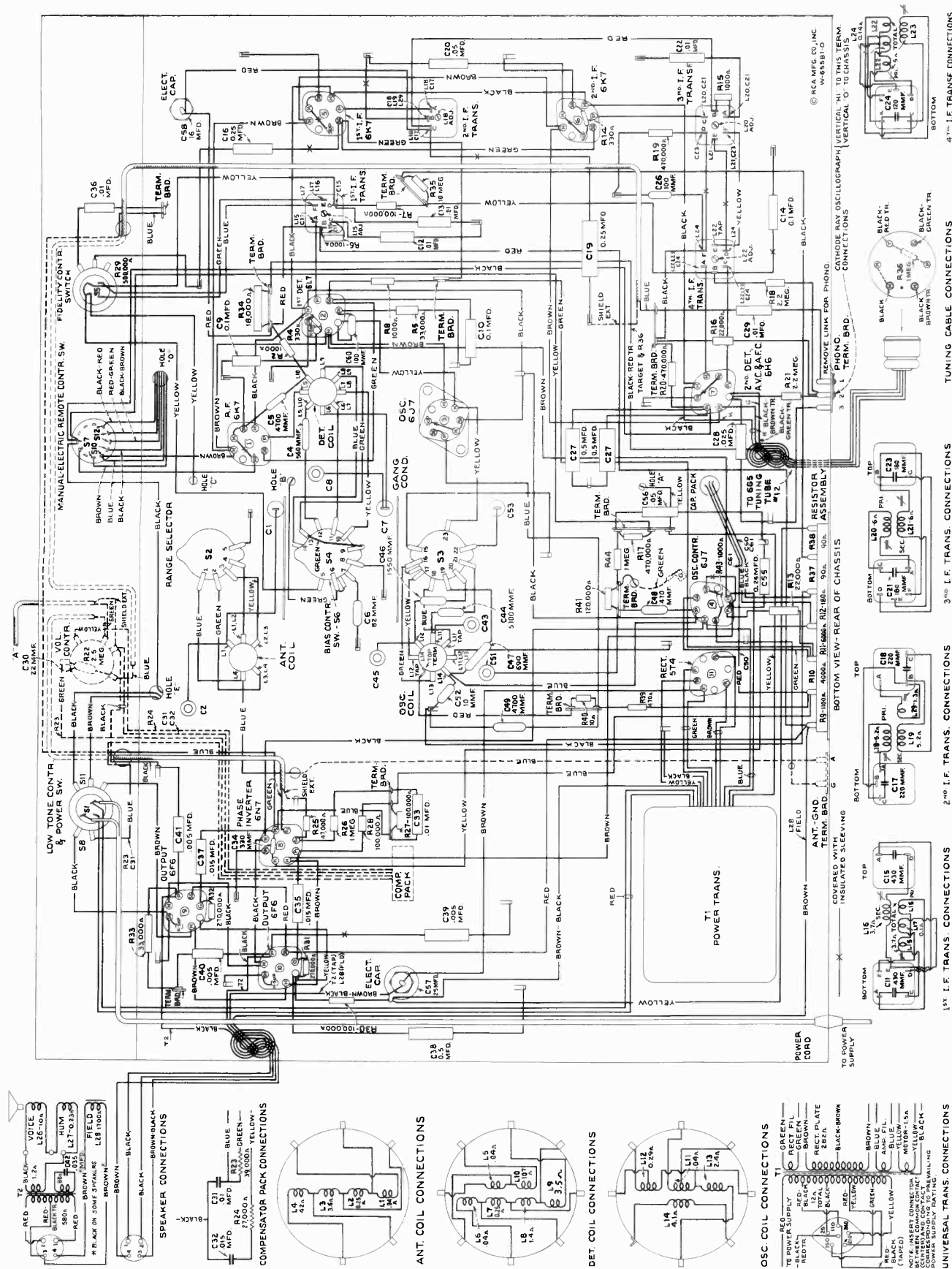

Figure 2—Chassis Wiring Diagram

1ST I.F. TRANS. CONNECTIONS

2ND I.F. TRANS. CONNECTIONS

3RD I.F. TRANS. CONNECTIONS

4TH I.F. TRANS. CONNECTIONS

TUNING CABLE CONNECTIONS

REAR VIEW OF CHASSIS

Circuit Arrangement

The circuit consists of an r-f amplifier stage, first-detector (converter) stage, separate heterodyne-oscillator stage, oscillator control stage, two i-f amplifier stages, diode-detector—automatic volume and frequency control stage, audio phase-inverter voltage-amplifier stage, push-pull pentode power-amplifier stage, tuning indicator "Magic Eye," and a full-wave rectifier stage.

The antenna and detector coils are constructed with a special type of winding ("cumulative") to provide increased sensitivity and selectivity on the "A" band. The "A," "B," and "C" sections on both coils are wound on single forms and are series connected. The range selector operates in such a manner that the correct portions are selected for the primary and secondary windings on each band. The "A,"

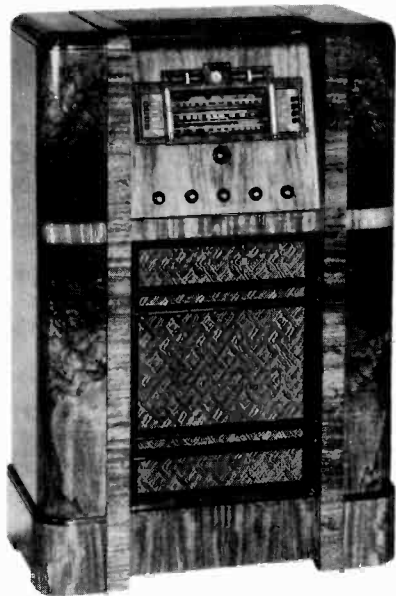

Model 812K

"B," and "C" oscillator sections are likewise wound on a single form but are connected so they operate separately. Undesirable interaction of unused windings with the tuned circuits is prevented by shorting out the proper sections with the range selector.

The intermediate-frequency amplifier consists of two RCA-6K7 tubes in a two-stage transformer-coupled circuit. The windings of all i-f transformers are resonated by fixed capacitors and are adjusted by molded magnetite cores to tune to 460 kc. A third winding, L17, in the first i-f transformer, closely coupled to the primary, L15, is placed in series with the main secondary L16 when the fidelity control switch S5 is thrown to "broad" position (see figure 1), thereby increasing the coupling between the primary and secondary circuits with a consequent broadening of the band width of the i-f amplifier, permitting higher fidelity reception.

The function of the automatic-frequency-control circuit is to automatically change the frequency of the heterodyne oscillator so that the correct i-f frequency is formed for the i-f amplifier. The circuit consists essentially of an i-f discriminator which, as the name implies, discriminates or furnishes control voltage of the correct polarity to an oscillator frequency-control tube for generated i-f carrier frequencies slightly above and below 460 kc, or the frequency to which the i-f amplifier is tuned.

The plate circuit of the RCA-6J7 oscillator control tube is caused to act as an apparent variable inductance in parallel with the "A" band oscillator tuned circuit of which coil L14 is a part. The series combination of resistor R41 and the oscillator control-tube grid to cathode capacitance is also in

parallel with the oscillator tuned circuit. Since the resistance of R41 is many times greater than the reactance of the grid-cathode capacitance, at the oscillator frequency, the r-f current through the combination will be practically in phase with the r-f voltage across the oscillator tuned circuit. However, the r-f voltage impressed across the grid-cathode capacitance section of the combination will lag the r-f voltage across the combination, or the tuned circuit, approximately 90 degrees. The grid-cathode r-f voltage will be amplified by the control tube but will be shifted an additional 180 degrees (grid and plate voltages of all tubes are always opposite in phase) so that the amplified r-f voltage appearing across the plate circuit will now lead the voltage across the combination or the tuned circuit by 90 degrees, or, in other words, the control tube is acting as an equivalent shunt inductance. The amount of this action is determined by the amplification of the tube, which in turn is governed by the grid-cathode bias voltage. In operation a residual bias is developed across the cathode resistor R43. The d-c control grid voltage is fed to the control grid from the discriminator circuit through resistor R44. If this voltage is negative with respect to ground, the amplification of the control tube will be decreased, the apparent plate circuit inductance of the tube increased, which will lower the frequency of the oscillator tube. The converse will occur when the grid voltage is positive with respect to ground.

The action of the discriminator circuit depends upon the fact that a 90-degree phase difference exists between the primary and secondary potentials of a double-tuned loosely-coupled transformer when the resonant frequency is applied and that this phase difference varies as the applied frequency varies; i.e., the maximum resultant response voltage across the primary and secondary windings connected in series will occur at a frequency either lower or higher in frequency than the frequency to which the individual windings are resonated, respectively depending on whether the windings are connected series aiding or opposing.

The discriminator, or fourth i-f transformer, consists of the primary winding, L24, which is a part of the third i-f transformer secondary tuned circuit (tuned to 460 kc) and the center-tapped secondary, L22. The upper and lower halves of L22 may be considered as two secondary coils, the upper series aiding and the lower series opposing the primary, L24. The magnetite core in L22 is inserted to inductively balance the two halves. The function of coil L23 (magnetite core adjusted), in parallel with L22, is to tune the secondary to 460 kc. Therefore, the maximum voltage will be applied to diode circuit P₂K₂ and R19 when the i-f signal frequency is above 460 kc and to the diode circuit P₁K₁ and R20 when the i-f signal frequency is below 460 kc. Resistors R19 and R20 are connected in series between ground and a point leading to the oscillator control tube grid.

D-c voltages, resulting from diode rectification, across R19 and R20 are always in opposition, consequently the oscillator control-tube grid-bias voltage is a differential amount, depending upon the i-f signal strength and its frequency deviation from the nominal value of 460 kc. The polarity of this differential oscillator control-tube grid-bias, with respect to ground, depends on whether the i-f signal frequency is above or below 460 kc, but is always in the direction which will bring the generated i-f frequency nearer to 460 kc. A-f-c action is automatically eliminated for "manual" tuning by grounding diode cathode K₁ through switch S7. A-v-c voltage and audio signal components are developed across resistor R19.

The RCA-6N7 twin-triode tube is operated as a phase inverter to supply audio signal voltage 180-degrees out-of-phase between the control grids of the two RCA-6F6 power output tubes for push-pull operation. Audio signals applied to the upper triode control grid through volume control R22 are amplified and shifted 180-degrees in phase. A portion of this amplified signal is applied to the lower triode control grid, through capacitor C33 and resistors R26 and R25, where it is amplified to approximately the same level as that in the plate circuit of the upper triode but approximately 180-degrees out-of-phase.

Service Data

The various diagrams of this booklet contain such information as will be needed to isolate causes for defective operation if such develops. The ratings of the resistors, capacitors, coils, etc., are indicated adjacent to the symbols signifying these parts on the diagrams. Identification titles such as R1, L1, C1, etc., provide reference between the illustrations and Replacement Parts List. The coils, transformer windings, and reactors are rated in terms of d-c resistance to permit continuity checks.

Precautionary Lead Dress.—(1) Bus lead from oscillator coil directly to ground must be as short as possible for correct alignment, (2) bus lead from range switch S3 to oscillator section C53 of variable condenser should be 1½ inches long for correct alignment, (3) bus lead from detector coil to range switch S4 must be as short as possible for correct alignment, (4) bus lead from detector coil to detector section C7 of variable condenser should be 2½ inches long for correct alignment, (5) detector trimming capacitor C8 lead should connect directly to variable condenser C7, (6) bus lead from antenna section of range switch S2 to chassis ground lance must be as short as possible, (7) bus lead from antenna coil to range switch S2 should be 2¼ inches for correct alignment, (8) bus lead from antenna coil to antenna section C1 of variable condenser must be 3⅞ inches over-all with ½ inch bend at coil end for correct alignment, (9) filament leads should be dressed away from RCA-6N7 grids, pins Nos. 4 and 5, to reduce hum pickup, (10) resistors R41, R43, and R44 in the oscillator control tube circuit must be

kept free of other component parts for satisfactory operation of the a-f-c circuit, (11) capacitor C29 and resistor R16 leads from terminal board to the phonograph terminal board should be as short as possible and dressed away from other parts to reduce hum pickup, (12) filament leads should all be twisted to reduce hum pickup, (13) filament leads should be dressed away from the terminal board near the 4th i-f transformer. (14) Lead from the range switch S3 to the oscillator cathode socket terminal should be dressed under bus wire on socket to hold this lead down close to chassis.

Phonograph Attachment.—A terminal board is provided for connecting a phonograph into the audio-amplifying circuit. RCA Victor Models R-93, R-93-A, R-93-2, or R-94 Record Players should be connected as follows: Remove the link from the phonograph terminal board. Connect green wire in Radio-Record switch cable to terminal 1; yellow to terminal 2; shield to terminal 3; and tape up the red and blue. Connect a 2-conductor twisted cable between the Record Player binding posts and the screw-terminals on Radio-Record switch. If additional volume is desired, connect an RCA Stock No. 9632 transformer between the 2-conductor twisted cable and the screw-terminals on Radio-Record switch as follows: Yellow and brown transformer leads and one side of twisted cable to ground screw-terminal on switch; black transformer lead to other side of twisted cable; and blue transformer lead to other screw-terminal on switch.

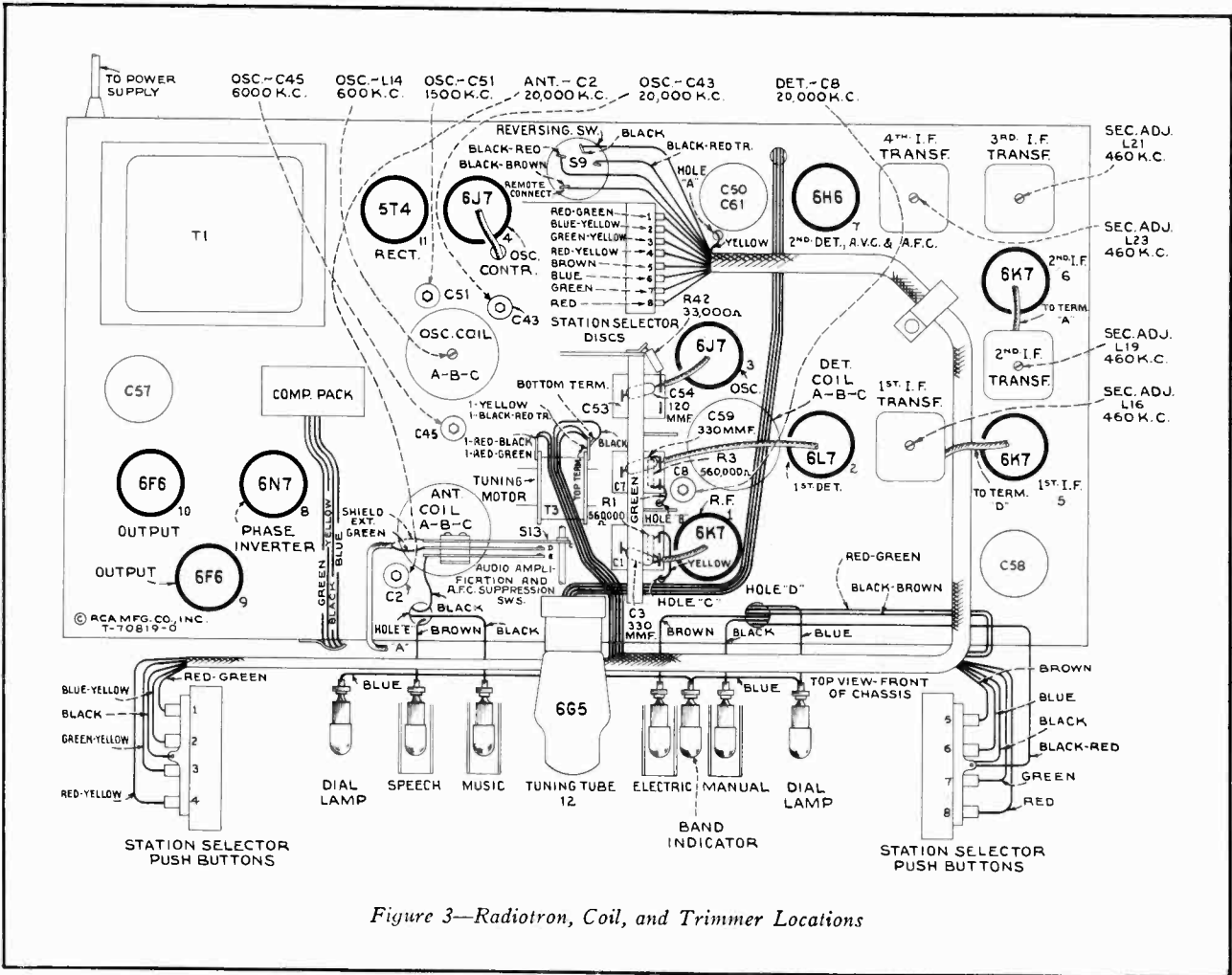

Figure 3—Radiotron, Coil, and Trimmer Locations

Loudspeaker.—Centering of the loudspeaker is made in the usual manner with three narrow paper feelers after first removing the front dust cover. This may be removed by softening its cement with a light application of acetone, using

care not to allow the acetone to flow into the air gap. The dust cover should be cemented back in place with ambroid upon completion of adjustment.

ALIGNMENT PROCEDURE

Calibrate the tuning dial by adjusting dial pointer to the left ends of horizontal calibration lines with the gang tuning-condenser plates in full-mesh position. This is a screw-driver adjustment.

The "Fidelity" control should be turned counter-clockwise during all alignment operations. The "Manual-Electric-Remote" switch should be turned to "Manual" (right) during alignment unless otherwise specified.

CAUTION.—The magnetite core screw L22 on the bottom of the 4th i-f transformer has been accurately adjusted, for an exact electrical balance of coil L22 to center tap, during manufacture and should not be disturbed. However, if for any reason the adjustment has been moved from its original position, it will be necessary to mechanically adjust this screw until the end of the stud protrudes exactly 3/16 of an inch (six threads exposed) above the brass bushing prior to any alignment operations.

Perform alignment in proper order, tabulated below, starting with No. 1 and following all operations across, then No. 2, etc. A-f-c discriminator adjustments should follow r-f

and i-f adjustments tabulated below. Adjustment locations are shown on figures 3 and 4.

Cathode-ray alignment is preferable; the connections to the chassis are shown on figure 2. If an output indicator is used, connect it across the loudspeaker voice-coil and advance the receiver volume control to full-volume position.

Connect the "low" output terminal of the test oscillator to the receiver chassis for all alignment operations. Regulate the output of the test oscillator so that minimum signal is applied to the receiver to obtain an observable output indication. This will avoid a-v-c action.

The term "Dummy antenna" means the device which must be connected between the "high" test-oscillator output and the point of connection to the receiver in order to obtain ideal alignment. "No signal, 550-750 kc" means that the receiver should be tuned to a point between 550 and 750 kc where no signal or interference is received from a station or local (heterodyne) oscillator.

For further details on alignment, refer to booklet "RCA Victor Receiver Alignment."

| Order of Alignment | Test Oscillator | | | Range-Selector | Receiver Dial Setting | Circuit to Adjust | Adjustment Symbols | Adjust to Obtain |
|---|---|---------------|-------------------|----------------|-------------------------|-------------------|--------------------|--------------------------------|
| | Connection to Receiver | Dummy Antenna | Frequency Setting | | | | | |
| 1 | — | — | — | — | — | 4th I-F Trans. | L23 | Turn Extreme Counter-clockwise |
| 2 | 6K7 2nd I-F Grid Cap | .001 Mfd. | 460 kc | "A" Left | No Signal 550-750 kc | 3rd I-F Trans. | L20 and L21 | Max. (peak) |
| 3 | 6K7 1st I-F Grid Cap | .001 Mfd. | 460 kc | "A" | No Signal 550-750 kc | 2nd I-F Trans. | L18 and L19 | Max. (peak) |
| 4 | 6L7 Det. Grid Cap | .001 Mfd. | 460 kc | "A" | No Signal 550-750 kc | 1st I-F Trans. | L15 and L16 | Max. (peak) |
| 5 | Ant. | 300 Ohms | 20,000 kc | "C" Right | 20,000 kc | "C" Osc. | C43 | Max. (peak)* |
| 6 | Ant. | 300 Ohms | 20,000 kc | "C" | Rock thru 20,000 kc | "C" Det. | C8 | Max. (peak)† |
| 7 | Ant. | 300 Ohms | 20,000 kc | "C" | 20,000 kc | "C" Ant. | C2 | Max. (peak)‡ |
| 8 | Ant. | 300 Ohms | 6,000 kc | "B" Center | 6,000 kc | "B" Osc. | C45 | Max. (peak)* |
| 9 | Ant. | 200 Mmfd. | 600 kc | "A" Left | 600 kc | "A" Osc. | L14 | Max. (peak) |
| 10 | Ant. | 200 Mmfd. | 1,500 kc | "A" | 1,500 kc | "A" Osc. | C51 | Max. (peak) |
| 11 | Ant. | 200 Mmfd. | 600 kc | "A" | 600 kc | "A" Osc. | L14 | Max. (peak) |
| 12 | Ant. | 200 Mmfd. | 1,500 kc | "A" | 1,500 kc | "A" Osc. | C51 | Max. (peak) |
| 13 | Proceed to A-F-C Discriminator Adjustments Outlined Below | | | | | | | |
| * Use minimum capacity peak if two peaks can be obtained. † Use maximum capacity peak if two peaks can be obtained. ‡ After this adjustment, check for image signal by shifting receiver dial to 19,080 kc. | | | | | | | | |

A-F-C Discriminator Adjustments.—These adjustments are rather critical and should be performed with extreme care. Improper adjustment may result in complete failure of the oscillator control tube to function or else may cause it to detune the oscillator instead of tuning it to the signal. It is assumed that the magnetite core adjusting screw L23 (top of

4th i-f transformer) has been turned all the way out (extreme counter-clockwise) prior to the preceding tabulated adjustments. Adjustments are as follows: Remove spring "N" on link and arm assembly which connects the "Manual-Electric-Remote" switch shaft to the throw-out gear bracket. Turn "Fidelity" control counter-clockwise. Connect antenna to re-

ceiver antenna "A" terminal. With the "Manual-Electric-Remote" switch in "Manual" (right) position, tune in a strong local station near 600 kc or the low-frequency end of the "A" band as accurately as possible by means of the tuning tube "Magic Eye." The most accurate adjustment will be obtained by adjusting the "vernier" tuning knob mid-way between the two points where the eye just appears to start to open. This will place the generated i-f carrier signal frequency exactly in the center of the i-f amplifier response curve (should be 460 kc if i-f amplifier was properly aligned) and is the frequency to which the a-f-c discriminator (4th i-f transformer) should be tuned to resonance. Without disturbing any of the receiver adjustments, place the "high" test-oscillator lead about 3/4 of an inch from the grid cap lead of the RCA-6K7, 1st i-f amplifier tube, adjust the test-oscillator output to maximum, turn test-oscillator "Modulation" off, and carefully zero-beat the test-oscillator frequency (approximately 460 kc) with the i-f carrier signal. Avoid placing the test-oscillator lead nearer to the grid cap lead than specified above, as doing so will tend to detune the i-f amplifier. It may be necessary to reduce the local station signal, during this operation, by shortening antenna lead or grounding antenna "A" terminal to chassis in order to increase the loudness of the beat note sufficiently for accurate zero-beat adjustment.

Throw "Manual-Electric-Remote" switch to "Electric" (center) position. A high whistle or beat note will now be heard. Turn the magnetite core screw L23 (top of 4th i-f transformer) slowly clockwise. As this screw is turned, the beat note will first increase to a high audio frequency and will then decrease to a zero-beat and then increase in fre-

quency again. The point of exact zero-beat is the position for correct adjustment of the discriminator. Zero-beat should also still exist when the "Manual-Electric-Remote" switch is thrown back to "Manual" position. The adjustment is now

Radiotron Cathode Current Readings

Measured with Milliammeter Connected at Tube Socket Cathode Terminals Under Conditions Similar to Those of Voltage Measurements

| | |
|--|----------|
| (1) RCA-6K7—R-F Amp. | 5.0 ma. |
| (2) RCA-6L7—1st Det. | 6.0 ma. |
| (3) RCA-6J7—Osc. | 8.5 ma. |
| (4) RCA-6J7—Osc. Control. | 1.2 ma. |
| (5) RCA-6K7—1st I-F Amp. | 6.0 ma. |
| (6) RCA-6K7—2nd I-F Amp. | 7.5 ma. |
| (7) RCA-6H6—2nd Det., A.V.C. and A.F.C. | — ma. |
| (8) RCA-6N7—Phase Inverter. | 1.8 ma. |
| (9) RCA-6F6—Output | 26 ma. |
| (10) RCA-6F6—Output | 26 ma. |
| (11) RCA-5T4—Rectifier | 118 ma.* |
| (12) RCA-6G5—Tuning Tube. | 2.5 ma. |

(*Cannot be measured at socket)

complete and may be checked by slightly detuning the receiver above and below the local station frequency with the "Manual-Electric-Remote" in "Manual" position, switching to "Electric" position, and noting the oscillator pull-in. Replace spring "N."

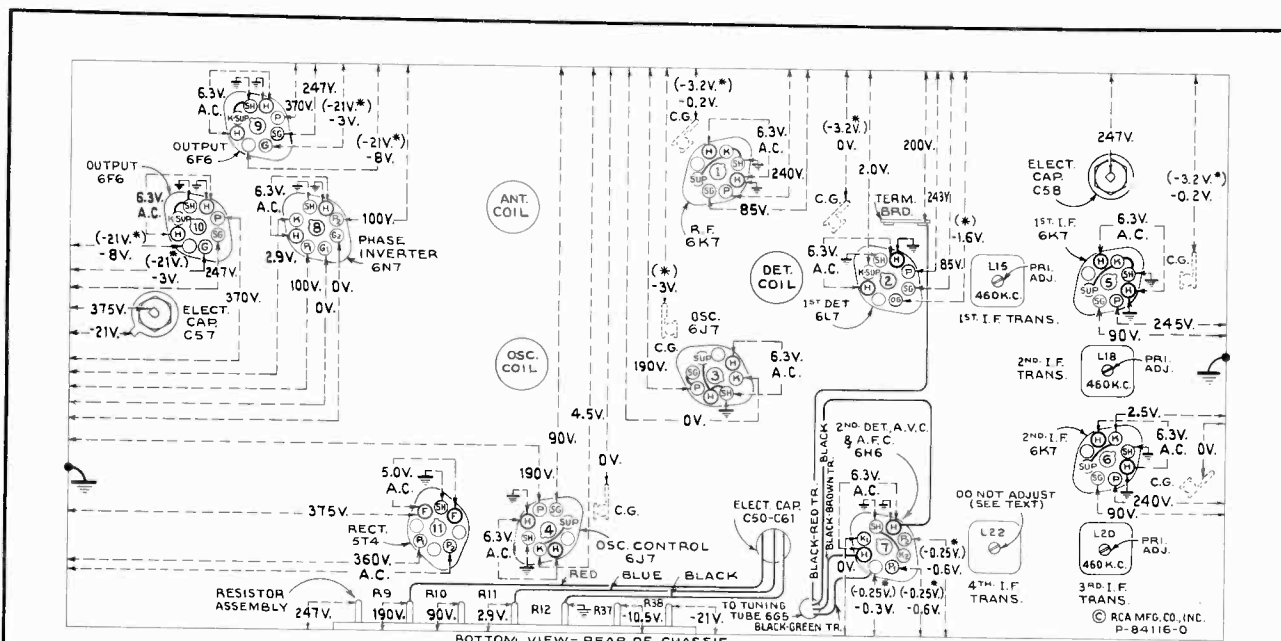

Figure 4—Radiotron Socket Voltages, Coil, and Trimmer Locations

Measured at 115 volts, 60-cycle supply—Tuned to approximately 1,000 kc ("Broadcast")—"Manual" control—No signal being received—Volume control minimum—Fidelity control optional

Note: Two voltage values are shown for some readings. The value shown in parentheses with asterisk (*) indicates operating conditions without voltmeter loading. The other value (generally lower) is the actual measured voltage and differs from the value shown in parentheses because of the additional loading of the voltmeter.

Voltage values as specified should hold within $\pm 20\%$ when the receiver is normally operative at its rated line voltage. To duplicate the conditions under which the voltages were measured requires a 1,000-ohm-per-volt d-c meter, having ranges of 10, 50, 250, and 500 volts. Use the nearest range above the specified measured voltage. A-c voltages were measured with a corresponding a-c meter.

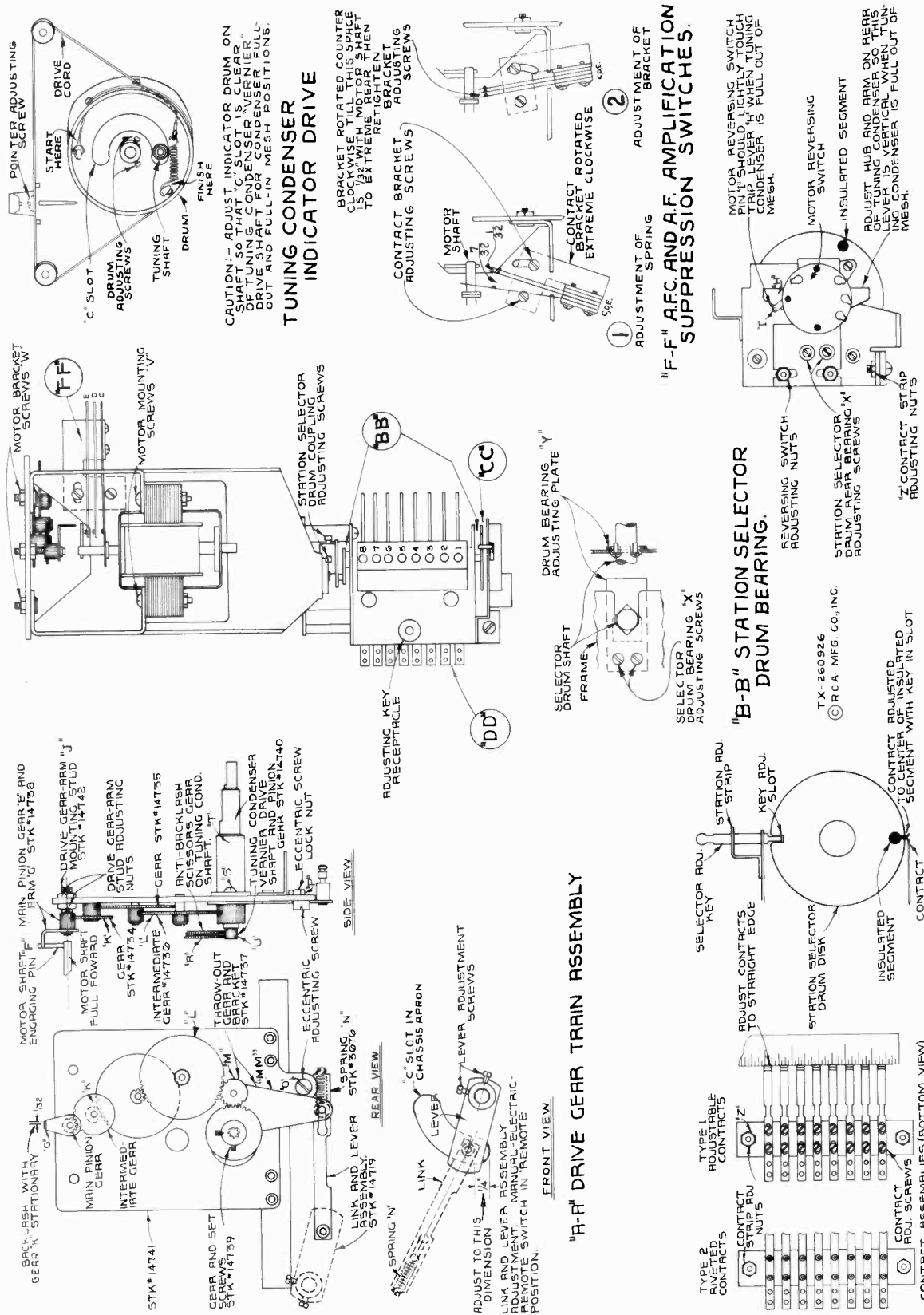

Figure 5—"Electric Tuning" Mechanism Adjustments

ELECTRIC TUNING

Principle of Operation

The electric tuning mechanism consists essentially of a quick engaging and dis-engaging reversible electric motor, tuning condenser driving gear train, and eight mechanically interlocked (pushing one button releases all others) station selector push buttons respectively wired to eight adjustable station selector contactor discs (each with a motor stopping insulated segment) mounted on a drum which is direct-coupled to the gang tuning condenser shaft. The arrangement permits any one of eight pre-determined stations to be electrically tuned in by merely touching the correct push button.

The operation may be more readily understood by reference to figures 1, 5, and 6. When the motor is not energized, the armature is pushed to the rear or slightly out of the magnetic center by tension of contact spring "C" and the motor shaft is dis-engaged from the driving gear train. Pressing in any one of the eight push buttons will complete the motor circuit through a station selector contactor disc, assuming that the "Manual-Electric-Remote" switch is in "Electric" position and that the insulated segment in the contactor disc is not opposite its contactor. As the motor starts, the armature will be drawn forward, due to solenoid action, and the pin "F" on the end of its shaft will engage the arm "G" on the small main pinion gear, thereby driving the tuning mechanism. At the same time contact springs "E" and "D" will be grounded, causing suppression of audio amplification and automatic frequency control during the tuning cycle. The motor will continue to operate until the insulated segment in the selector disc breaks the motor circuit, whereupon spring "C" will instantly dis-engage the motor pin "F" from the arm "G" on the small pinion driving gear and open contacts "E" and "D." Pushing another button will cause the above mentioned cycle to be repeated except that the motor will be interrupted by the insulated segment on a corresponding disc. The discs are individually adjustable on a drum mechanism, providing a choice of eight "Electric Tuned" "Broadcast" stations. The arrangement of the motor is such that its rotation will continue in the same direction regardless of the number of "Electric" tuning cycles until the tuning condenser approaches either full-out or full-in of mesh, whereupon lever "H" trips switch S9 which reverses the direction of rotation. A throw-out idler gear is link-coupled to the "Manual-Electric-Remote" control to disconnect the motor drive gear train when the control is thrown to "Manual" position.

Mechanism Adjustments

The electric tuning mechanism is designed to be as simple in construction and as fool proof in operation as is possible. In order to maintain the accurate results possible with this device care must be taken in effecting any repairs or adjustments. Reference should be made to figure 5 and the following:

A-F-C and A-F Amplification Suppression Switches.—

This switch assembly is located on the motor bracket and closes due to solenoid action of motor armature. The tension of the long contact spring "C" is important in bringing about quick dis-engagement of the motor and in permitting the motor to pull into mesh with the drive mechanism. Normal adjustment is attained when the short springs "D" and "E" are aligned exactly straight with contact points separated approximately 1/32 of an inch and with the spring "C" spaced approximately 7/32 of an inch from spring "D" at the point of contact. If necessary, in order to obtain positive pull-in and quick dis-engagement of the motor, the tension of spring "C" should be increased or decreased by bending. This action should be checked with the front apron of the chassis raised two inches higher than the rear. Contacts of the switch must be kept clean. Crocus cloth or a relay burnisher may be used for this purpose.

Motor Reversing Switch.—It is necessary to automatically stop and reverse the drive motor before the tuning condenser reaches the ends of its travel. Approximately 175 degrees of

sweep is required, and the reversal must take place above 1,700 kc and below 540 kc but not too near the limits of the scale. The coupling between the station selector drum and the tuning condenser shaft should be attached so that the reversing switch trip lever "H" is exactly vertical when the condenser is full-out of mesh. There should be 1/32 of an inch clearance between the end of the condenser shaft and the selector drum shaft. While the trip lever is in this position the reversing switch bracket should be adjusted by means of its elongated mounting holes until the switch pin "I" just lightly touches trip lever "H."

Main Pinion Gear.—Clearance between the small high-speed pinion gear "E" and the intermediate gear "K" determines the amount of mechanical noise produced. Correct adjustment will give approximately 1/32 of an inch movement of back lash at the end of pinion arm "G" when gear "K" is held stationary. Arm "G" must also be adjusted for correct mesh with motor shaft drive pin "F." With the motor shaft completely forward and pinion "E" tight against its front bearing, the pinion mounting stud "J" should be adjusted so that pin "F" meshes its full thickness with the rotating arm "G." An increase of this mesh will increase over travel on tuning while a decrease of mesh will decrease the over travel. The elongated hole in the front bracket allows sufficient movement of the mounting stud "J" to permit above mentioned gear mesh adjustment.

"Manual-Electric-Remote" Changeover.—(1) Link and lever adjustment—To properly line up the mechanical link between the switch shaft and throw-out gear bracket "MM," the set screws holding the link lever on the switch shaft must be loosened, the switch turned to the "Remote" position (extreme left) and the link lever revolved until the distance between the bottom of its link-connecting pin (extends through chassis apron) and the bottom of the "C" slot, in front apron of chassis, is exactly 1/4 of an inch. If this adjustment is not properly made, correct operation of "Electric" or "Remote" tuning will not result. (2) Throw-out Gear Adjustment—To obtain smooth operation on "Electric" or "Remote" positions it is important that the proper clearance is maintained between the throw-out gear "M" and the intermediate gear "L." With the "Manual-Electric-Remote" control thrown to "Remote" position (extreme left) adjust the mesh between these gears by means of the eccentric screw "O" and lock nut "P" on the throw-out gear bracket "MM" until there is approximately 1/64 of an inch backlash of gear "L" when gear "M" is held stationary.

Vernier Tuning.—In case it becomes necessary to remove tuning condenser drive shaft "T," it should be replaced by sliding anti-backlash gear "R" on condenser shaft apart so that compression amounting to one tooth on the gear is obtained in the springs. Adjust mesh of gear "R" with pinion gear "U" on vernier shaft before tightening screws "S" so that smooth tuning is obtained throughout the range.

Motor Alignment.—The motor shaft must be exactly aligned with the axis of the pinion gear with which it engages. This may be adjusted by loosening the mounting screws "V" of the motor and aligning shaft by sight. Correct alignment may be tested by slowly rotating motor and observing the relation between the pin "F" of the motor shaft and the arm "G" on the pinion. The relation of the two should remain the same throughout the revolution. Additional movement for adjustment may be obtained by the motor bracket screws "W" if necessary.

Station Selector Drum.—(1) Bearing Adjustment—The selector drum may be removed by unscrewing the two bearing adjusting screws "X" on the front and rear bearings and sliding shaft out of slots on frame. To replace drum, the reverse procedure should be followed holding bearing adjusting plates "Y" firmly against the shaft and tightening adjusting screws. (2) Contact adjustment—Two types of contact strips are used. They are designated on figure 5, as types 1 and 2, on which the individual contacts are respectively adjustable and fixed. On type 1, the individual contacts should be adjusted by setting the end contact springs near the mid-position of their travel and aligning the remaining springs to them by means of a straight edge. Either type of

contact strip should be adjusted to the selector drum by placing two selector adjusting keys in the station adjustment strip, positions 1 and 8, loosening contact strip adjusting nuts "Z" and shifting the contact strip until the end contacts are exactly centered on the respective disc insulating segments. More accurate adjustment may be made by silhouetting the point of contact with a piece of white paper held behind the contact. Adjustment will be facilitated by removing complete assembly from rear of tuning condenser by unscrewing the three mounting screws. Contacts and discs must be kept free of dirt, filings, and other extraneous matter.

Lubrication.—The dial pointer slide should be greased with petrolatum. This same lubrication should be applied lightly to all gear faces of the drive mechanism and sparingly with a cloth to the station selector discs. Any good household oil, such as "3-IN-ONE," is suitable for the motor shaft bearings. A light grade of engine oil should be used for all gear bearings. Medium viscosity engine oil, similar to "PYROIL" (B), should be applied between the thrust washers on the motor shaft. "CASTORDAG," a mixture of graphite and castor oil, is recommended for use at the selector drum end-bearing slots and at the bearings of cable pulleys.

Station Adjustment

Any eight stations may be chosen for "Electric" tuning. Remove the two escutcheon plates from the side of the dial, place proper call letter labels in the celluloid windows, and replace escutcheons. Turn the power on and proceed to set up the "Electric" tuning as follows:

1. Set Range Selector to "Broadcast."
2. Turn "Manual-Electric-Remote" control to "Electric."
3. Turn Fidelity control counter-clockwise.
4. Press push button No. 1 and wait until station pointer comes to rest.
5. Turn the "Manual-Electric-Remote" control to "Manual."
6. Remove adjusting key from receptacle on top of station selector drum mechanism.
7. Insert key in position marked, "1" in station adjustment strip and push the key all the way down to properly fit in slot in disc.
8. Tune the receiver very carefully by means of the manual tuning knob and the "Magic Eye," to station chosen for No. 1.
9. Remove key.
10. Turn the "Manual-Electric-Remote" control to "Electric."

Button No. 1 is now properly set for "Electric" tuning. Proceed similarly for the other seven push buttons, matching each station on the dial with the same number on the station adjustment strip. Repeat the above steps but place the key respectively in positions 2, 3, 4, etc., and in each case tune to the proper station. Now when you press a button the desired station will be tuned in electrically.

Armchair Control

When a Model G-8 armchair control is attached to the receiver as shown in figure 6 it duplicates the action of the push buttons on the front panel when the "Manual-Electric-Remote" control is turned to "Remote" position.

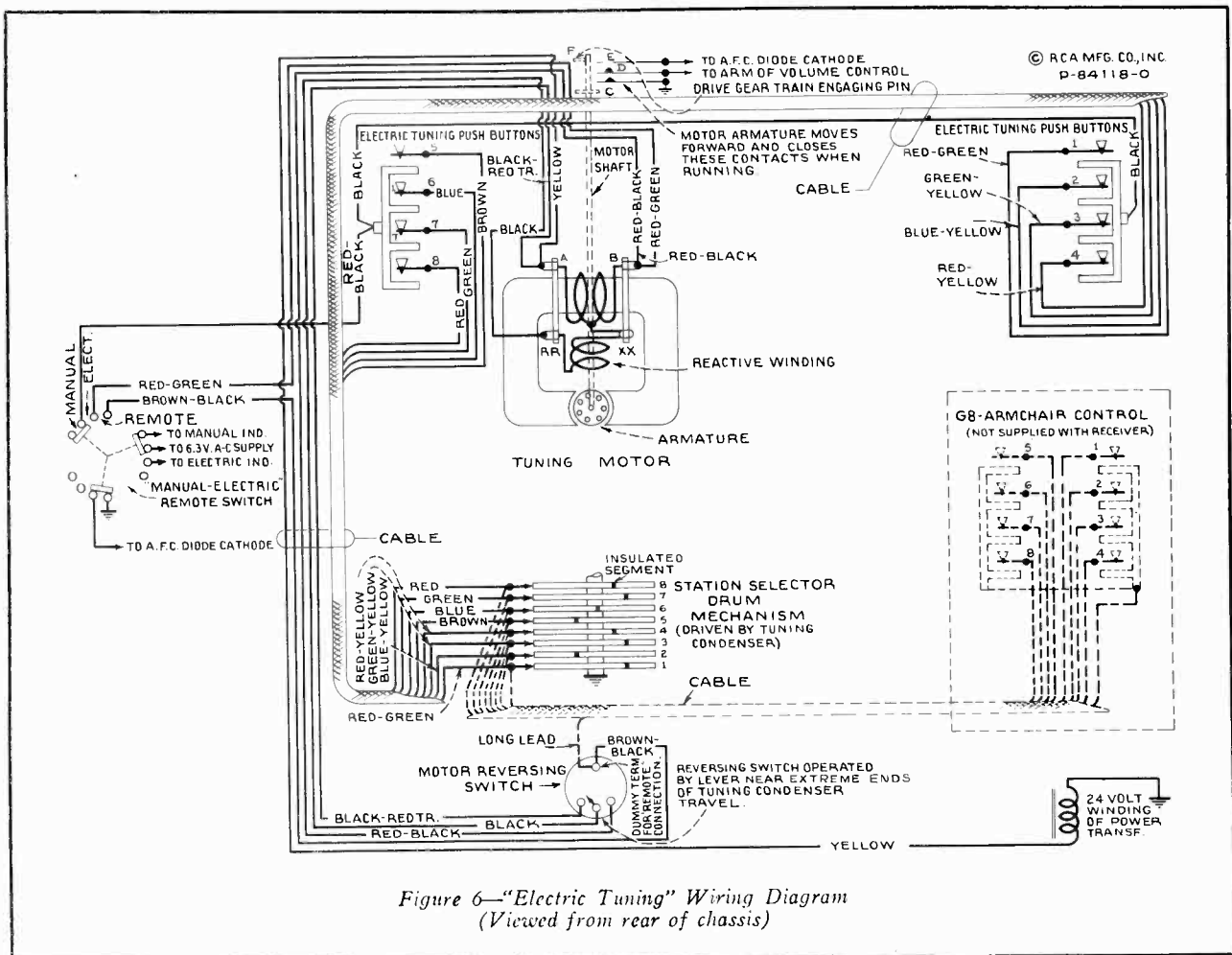

Figure 6—"Electric Tuning" Wiring Diagram
(Viewed from rear of chassis)

REPLACEMENT PARTS

Insist on genuine factory tested parts, which are readily identified and may be purchased from authorized dealers.

| STOCK No. | DESCRIPTION | STOCK No. | DESCRIPTION |
|----------------------------|--|-----------|--|
| RECEIVER ASSEMBLIES | | | |
| 14701 | Arm—Hub and arm for operating band indicator shutter—located on range switch shaft | 14738 | Gear—Drive pinion gear and arm |
| 14726 | Arm—Hub and arm complete with set screws—connects station selector drum to rear of tuning condenser shaft | 14739 | Gear—Drive gear and set screws—located on tuning condenser knob shaft |
| 14517 | Board—Antenna and ground terminal board | 14734 | Gear—Intermediate gear assembly—comprising one .749" O.D.—34 tooth—gear and one .291" O.D.—12 tooth pinion assembled |
| 12717 | Board—Phonograph terminal board | 14735 | Gear—Intermediate gear assembly—comprising one 1.541" O.D.—72 tooth gear and one .291" O.D.—12 tooth pinion assembled |
| 5237 | Bushing—Variable condenser rubber mounting bushing | 14736 | Gear—Intermediate gear assembly—comprising one 1.541" O.D.—72 tooth gear and one hub assembled |
| 13656 | Button—Plug button for detector coil shield | 14737 | Gear—Throw-out gear and bracket |
| 14725 | Cable—Tuning tube cable and socket | 14716 | Holder—Dial scale holder and reflector, complete with holding springs for band indicating shutter |
| 12607 | Cap—Shield cap for first or second I.F. transformer | 14715 | Indicator—Station selector indicator pointer and support |
| 12581 | Cap—Shield cap for third or fourth I.F. transformer | 5226 | Lamp—Dial or indicating lamp |
| 11350 | Cap—Grid contact cap | 14719 | Link—Link and lever assembly |
| 12884 | Capacitor—Adjustable trimmer (long) (C2, C45, C51) | 14730 | Motor—Tuning drive motor for 25-cycle models only (T3) |
| 12714 | Capacitor—Adjustable trimmer (med.) (C8, C43) | 14729 | Motor—Tuning drive motor for 60-cycle models only (T3) |
| 13200 | Capacitor—10 Mmfd. (C52) | 14028 | Nut—Jamb nut for trimmer, Stock Nos. 12714 and 12884 |
| 14021 | Capacitor—22 Mmfd. (C30) | 12471 | Plate—Mounting plate for cushion socket—less socket |
| 12813 | Capacitor—82 Mmfd. (C6) | 14741 | Plate—Tuning condenser front plate and studs assembled for mounting drive gears |
| 12720 | Capacitor—100 Mmfd. (C26, C60) | 14697 | Pulley—Indicator pointer cable pulley |
| 12404 | Capacitor—120 Mmfd. (C24) | 13988 | Resistor—10 ohms—carbon type, ½ watt (R40) |
| 12724 | Capacitor—120 Mmfd. (C54) | 11932 | Resistor—330 ohms—carbon type, 1/10 watt (R4) |
| 14712 | Capacitor—180 Mmfd. (C21, C23) | 13250 | Resistor—330 ohms—carbon type, ½ watt (R14) |
| 14711 | Capacitor—220 Mmfd. (C17, C18) | 5030 | Resistor—470 ohms—carbon type, ½ watt (R39) |
| 12952 | Capacitor—330 Mmfd. (C3, C34, C59) | 14720 | Resistor—1,000 ohms—carbon type, ½ watt (R2, R8, R43) |
| 14710 | Capacitor—430 Mmfd. (C11, C15) | 14837 | Resistor—1,000 ohms—carbon type, 1/10 watt (R6, R15) |
| 13052 | Capacitor—470 Mmfd. (C48) | 14078 | Resistor—18,000 ohms—carbon type, 1 watt (R34) |
| 14724 | Capacitor—560 Mmfd. (C4) | 11305 | Resistor—22,000 ohms—carbon type, ½ watt (R16) |
| 14723 | Capacitor—690 Mmfd. (C47) | 14721 | Resistor—22,000 ohms—carbon type, ½ watt (R13) |
| 12729 | Capacitor—1,550 Mmfd. (C46) | 5033 | Resistor—33,000 ohms—carbon type, 1 watt (R33) |
| 12897 | Capacitor—4,700 Mmfd. (C5, C49) | 11300 | Resistor—33,000 ohms—carbon type, 1/10 watt (R42) |
| 14722 | Capacitor—5,100 Mmfd. (C44) | 13735 | Resistor—33,000 ohms—carbon type, ½ watt (R5) |
| 4838 | Capacitor—.005 Mfd. (C39, C40, C41) | 11646 | Resistor—47,000 ohms—carbon type, ½ watt (R25) |
| 13138 | Capacitor—.01 Mfd. (C12, C13, C22, C29, C33) | 14560 | Resistor—100,000 ohms—insulated, ½ watt (R27) |
| 14393 | Capacitor—.01 Mfd. (C36) | 5145 | Resistor—100,000 ohms—carbon type, ½ watt (R7, R28, R30) |
| 11315 | Capacitor—.015 Mfd. (C35, C37) | 11453 | Resistor—270,000 ohms—carbon type, 1/10 watt (R31, R32) |
| 4870 | Capacitor—.025 Mfd. (C28) | 11172 | Resistor—470,000 ohms—carbon type, ½ watt (R17) |
| 4886 | Capacitor—.05 Mfd. (C20, C56) | 11452 | Resistor—470,000 ohms—carbon type, 1/10 watt (R19, R20) |
| 4839 | Capacitor—.1 Mfd. (C9, C10, C14) | 11397 | Resistor—560,000 ohms—carbon type, 1/10 watt (R1, R3) |
| 12484 | Capacitor—.25 Mfd. (C16, C19, C55) | 12013 | Resistor—1 meg.—carbon type, 1/10 watt (R36) |
| 12741 | Capacitor—.5 Mfd. (C38) | 13730 | Resistor—1 meg.—carbon type, ½ watt (R26, R44) |
| 5212 | Capacitor—16 Mfd. (C58) | 11626 | Resistor—2.2 meg.—carbon type, ½ watt (R18, R21) |
| 14531 | Capacitor—25 Mfd. (C57) | 13732 | Resistor—10 meg.—carbon type, ½ watt (R35) |
| 14714 | Capacitor Pack—Comprising one .015 Mfd. and one .010 Mfd. capacitor, one 27,000 ohm and one 39,000 ohm resistors (C31, C32, R23, R24) | 14692 | Resistor—Voltage divider—comprising one 1,100 ohm, one 4,000 ohm, one 6,000 ohm, one 180 ohm and two 90 ohm sections (R9, R10, R11, R12, R37, R38) |
| 14829 | Capacitor Pack—Comprising one 16 Mfd. and one 20 Mfd. sections (C50, C61) | 14695 | Rod—Tie rod for joining lockplate pawls on station selector push-button switches |
| 14372 | Coil—Antenna coil and shield (L1, L2, L3, L4) | 4669 | Screw—No. 8-32 x 5/32 square head set screw for arm, Stock No. 14701, or link, Stock No. 14719, or drum, Stock No. 14693 |
| 14414 | Coil—Detector coil and shield (L5, L6, L7, L8, L9, L10) | 12418 | Screw—No. 8-32 x 3/16 milled head set screw for gear, Stock No. 14739 |
| 14713 | Coil—Oscillator coil and shield (L11, L12, L13, L14) | 14848 | Selector—Station selector drum mechanism—comprising selector contactor discs, spring contacts, and motor reversing switch assembled in metal frame |
| 14727 | Condenser—3-gang variable tuning condenser, complete with gear train (C1, C7, C53) | 14374 | Shield—Antenna or detector coil shield |
| 5040 | Connector—4-contact female connector for reproducer cable | 14375 | Shield—Oscillator coil shield |
| 14733 | Contact—Spring contact for engaging discs in station selector drum for type 1 contact assembly | 12008 | Shield—I.F. transformer shield |
| 30365 | Contact—Comprising 8 spring contacts assembled on insulating strip for engaging discs in station selector drum (type 2 contact assembly) | 14718 | Shutter—Band indicating shutter and arm assembly |
| 14699 | Cord—Indicator pointer drive cord | | |
| 12006 | Core—Adjustable core and stud for I.F. transformer | | |
| 12800 | Core—Adjustable core and stud assembly for oscillator coil | | |
| 14717 | Dial—Station selector dial scale | | |
| 14740 | Drive—Tuning condenser vernier drive shaft and pinion gear | | |
| 14698 | Drum—Drum for indicator drive cord—fastens on tuning condenser shaft | | |
| 14731 | Drum—Station selector drum rotor—comprising 8 station selector contactor discs assembled on shaft | | |

REPLACEMENT PARTS—(Continued)

| STOCK No. | DESCRIPTION | STOCK No. | DESCRIPTION | | |
|-----------|--|-----------|---|--|---|
| 14696 | Slider—Indicator pointer holder and spring | | REPRODUCER ASSEMBLIES (Speaker No. RL76-1) | | |
| 11195 | Socket—5-contact 5T4 Radiotron socket | | | | |
| 11196 | Socket—8-contact 6K7, 6L7, 6J7, 6H6, 6F6 or 6N7 Radiotron socket | 14606 | | Cap—Dust cap for cone center | |
| 14114 | Socket—Dial or indicating lamp socket | 14603 | | Coil—Field coil (L28) | |
| 12007 | Spring—Retaining spring for core, Stock No. 12006 | 14604 | | Coil—Neutralizing coil (L27) | |
| 3676 | Spring—Tension spring for link and lever, Stock No. 14719 | 14602 | | Cone—Reproducer cone, voice coil, center suspension and dust cap (L26) | |
| 13638 | Spring—Tension spring for cord, Stock No. 14699 | 5039 | | Plug—4-contact male plug for reproducer | |
| 14694 | Spring—Tension spring for lockplate pawl on station selector push-button switches | 14600 | | Reproducer, complete | |
| 14742 | Stud—Mounting stud for gear and arm, Stock No. 14738 | 14601 | | Transformer—Output transformer (T2, C42) | |
| 14702 | Switch—"Manual - Electric - Remote" switch (S7, S10, S12) | 14357 | | Washer—Spring washer to hold field coil securely | |
| 14705 | Switch—L.F. tone and power switch (S1, S8, S11) | | | MISCELLANEOUS ASSEMBLIES | |
| 14732 | Switch—Motor reversing switch and mounting plate for station selector (S9) | 12038 | | | Band—Rubber band for tuning tube |
| 14704 | Switch—Range switch (S2, S3, S4, S6) | 14744 | | | Bracket—Tuning tube mounting bracket and clamp |
| 14728 | Switch—A-F-C and A-F amplification suppression switch (S13) | 14745 | | | Button—Automatic station selector push button |
| 14693 | Switch—Station selector button switch—comprising four contacts and corresponding lockplates, completely assembled on insulating strips | 14747 | | | Card—Call letter cards for station selector |
| 14703 | Tone Control—H.F. tone control (R29, S5) | 14743 | | | Escutcheon—Station selector and tuning tube escutcheon—complete with crystal, indicating cards, and buttons—less station indicating cards |
| 14706 | Transformer—First I.F. transformer (L15, L16, L17, C11, C15) | 14749 | | | Indicator—"Electric-Manual" indicator screen |
| 14707 | Transformer—Second I.F. transformer (L18, L19, L29, C17, C18) | 14748 | | | Indicator—"Music-Speech" indicator screen |
| 14708 | Transformer—Third I.F. transformer (L20, L21, C21, C23) | 14751 | | | Key—Key for use in setting "Electric Tuning" mechanism |
| 14709 | Transformer—Fourth I.F. transformer (L22, L23, L24, C24) | 14359 | | | Knob—Large station selector knob |
| 14689 | Transformer—Power transformer, 105-125 volts, 50-60 cycle (T1) | 14688 | Knob—Range switch knob | | |
| 14690 | Transformer—Power transformer, 105-125 volts, 25-60 cycle (T1) | 14269 | Knob—Volume control, "Manual-Electric-Remote" switch, H.F. tone control, L.F. tone control or small station selector knob | | |
| 14691 | Transformer—Power transformer, 105-240 volts, 50-60 cycle (T1) | 5210 | Screw—Chassis mounting screw and washer assembly | | |
| 12861 | Volume Control (R22) | 14746 | Shield—Celluloid shield for station call letter cards | | |
| | | 4982 | Spring—Retaining spring for knob, Stock No. 14359 | | |
| | | 14270 | Spring—Retaining spring for knob, Stock Nos. 14269 and 14688 | | |



RCA Victor

MODEL 813K

Thirteen-Tube, Five-Band, A-C, Superheterodyne Receiver

TECHNICAL INFORMATION AND SERVICE DATA

-1937 No. 31-

SERVICE DIVISION • RCA MANUFACTURING COMPANY, INC. • CAMDEN, N. J., U. S. A.

A Service of the Radio Corporation of America

Electrical Specifications

FREQUENCY RANGES

| | |
|-------------------------------|------------------|
| "Standard Broadcast" (A)..... | 530-1,720 kc |
| "49M." (49 Meters)..... | 5,970-6,240 kc |
| "31M." (31 Meters)..... | 9,410-9,690 kc |
| "25M." (25 Meters)..... | 11,680-11,920 kc |
| "19M." (19 Meters)..... | 15,090-15,380 kc |

R-F ALIGNMENT FREQUENCIES

| | |
|-----------------------------|--------------------------------|
| "31M." (31 Meters)..... | 9,600 kc (osc., det., ant.) |
| "25M." (25 Meters)..... | 11,700 kc (osc.) |
| "19M." (19 Meters)..... | 15,300 kc (osc.) |
| "49M." (49 Meters)..... | 6,100 kc (osc.) |
| "Standard Broadcast" (A) .. | 600 kc (osc.), 1,500 kc (osc.) |

Intermediate Frequency..... 460 kc

RADIOTRON COMPLEMENT

| | |
|------------------|-----------------------|
| (1) RCA-6K7..... | R-F Amplifier |
| (2) RCA-6L7..... | First Detector |
| (3) RCA-6J7..... | Heterodyne Oscillator |
| (4) RCA-6J7..... | Oscillator Control |
| (5) RCA-6K7..... | First I-F Amplifier |
| (6) RCA-6K7..... | Second I-F Amplifier |

| | |
|-------------------|-------------------------------------|
| (7) RCA-6H6..... | Second Detector, A.V.C., and A.F.C. |
| (8) RCA-6C5..... | First Audio Amplifier |
| (9) RCA-6F6..... | Audio Driver |
| (10) RCA-6F6..... | Power Output |
| (11) RCA-6F6..... | Power Output |
| (12) RCA-6G5..... | "Magic Eye" Tuning Tube |
| (13) RCA-5T4..... | Full-Wave Rectifier |

Pilot Lamps (9) Mazda No. 46, 6.3 volts, 0.25 amp.

POWER SUPPLY RATINGS

| | |
|----------------|--|
| Rating A | 105-125 volts, 50-60 cycles, 150 watts |
| Rating B | 105-125 volts, 25 cycles, 150 watts |
| Rating C | 100-130/140-160/195-250 volts, 50-60 cycles, 150 watts |

POWER OUTPUT

| | |
|-------------------|----------|
| Undistorted | 15 watts |
| Maximum | 20 watts |

LOUDSPEAKER

| | |
|-----------------------|-------------------------|
| Type..... | 12-inch Electrodynamic |
| Impedance (v.c.)..... | 11.5 ohms at 400 cycles |

Mechanical Specifications

| | |
|------------------------------|---|
| Height | 43 inches |
| Width | 28 $\frac{5}{8}$ inches |
| Depth | 16 $\frac{15}{16}$ inches |
| Weight (net) | 108 pounds |
| Weight (shipping) | 153 pounds |
| Chassis Base Dimensions..... | 22 $\frac{1}{8}$ inches x 12 $\frac{3}{8}$ inches x 4 $\frac{1}{8}$ inches |
| Over-all Chassis Height..... | 12 $\frac{3}{8}$ inches |
| Operating Controls..... | (1) Power Switch—Low Tone, (2) Volume, (3) Tuning, (4) Range Selector, (5) Manual-Electric-Remote, (6) Fidelity |

Tuning Drive Ratios (manual)..... 10 to 1 and 50 to 1

Copyright, 1937, RCA Manufacturing Co., Inc.

Trademarks "Radiotron," "Magic Eye," "Magic Voice," "Magic Brain" Reg. U. S. Pat. Off. by RCA Mfg. Co., Inc.

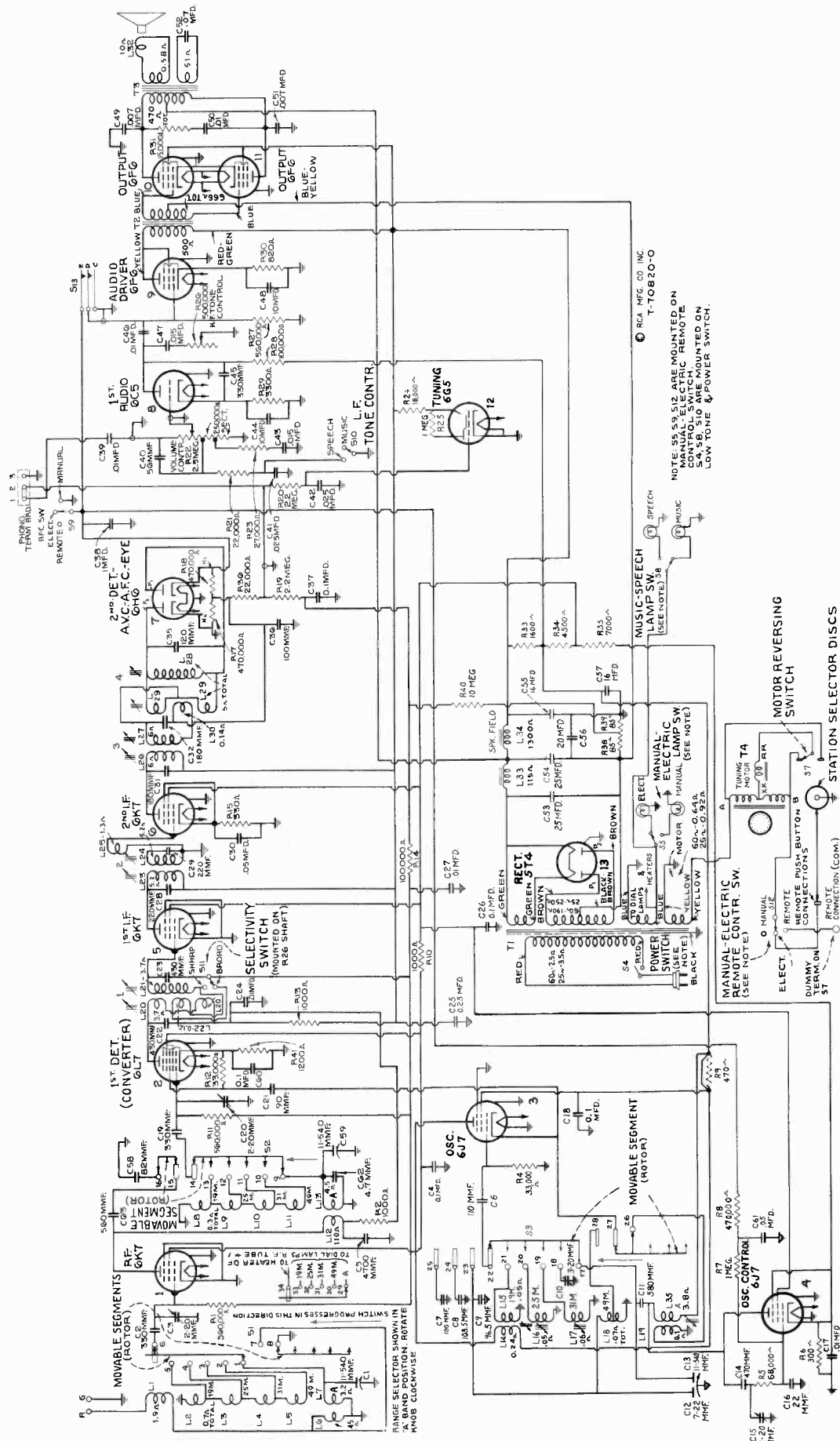

Figure 1—Schematic Circuit Diagram

NOTE: On later production, a 1.8-ohm resistor (R42) is connected in series with the indicator lamps. (See figure 2, between term. 34 of range selector and center term. of S5.) When servicing, this resistor (Stock No. 806647) should be installed.

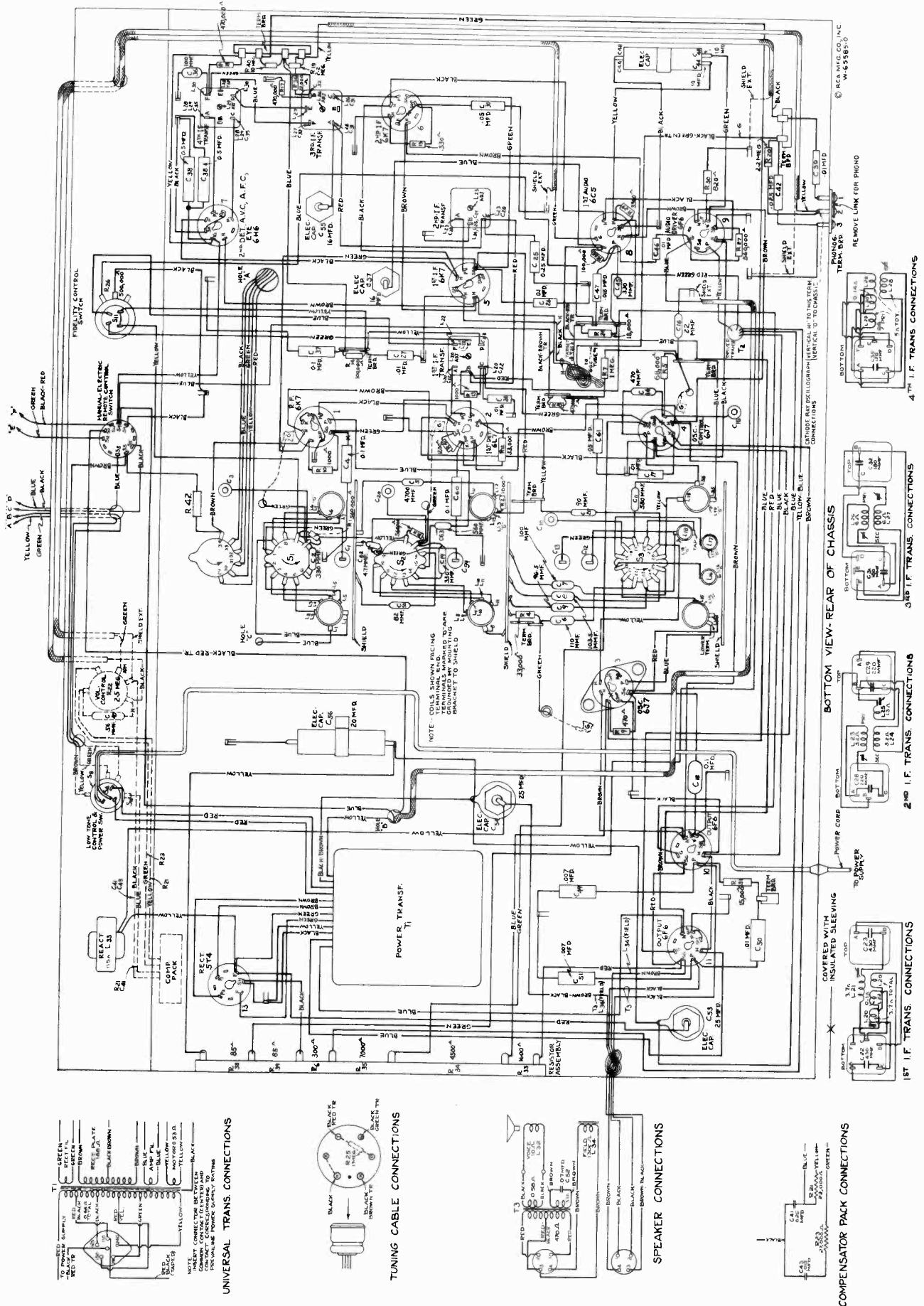

Figure 2—Chassis Wiring Diagram

General Description

This receiver employs a thirteen-tube, five-band, "Magic Brain" superheterodyne circuit. Features of design include "Electric Tuning" with push-button operation; automatic frequency control; spread-band, "Overseas" dial; "cumulative-wound" antenna and detector "A" band coils; tuned r-f amplifier; magnetite-core adjusted i-f transformers and low-frequency "A" oscillator tracking; two-stage i-f amplifier;

phonograph terminal board; "Magic Eye" tuning tube; twelve-inch electrodynamic loudspeaker; plunger-type, air-dielectric trimming capacitors; temperature-stabilized capacitors; two-point aural-compensated volume control; "Fidelity" control; "Music-Speech" control; and a driven push-pull power-output stage. In addition, this model has a cabinet incorporating the "Sonic Arc" Magic Voice.

Circuit Arrangement

The circuit consists of an r-f amplifier stage; first-detector (converter) stage; separate heterodyne-oscillator stage; oscillator-control stage; two i-f amplifier stages; diode detector, automatic-frequency and volume-control stage; audio voltage-amplifier stage; audio-driver stage; push-pull power-amplifier stage; tuning indicator "Magic Eye"; and a full-wave rectifier.

to automatically change the frequency of the heterodyne oscillator so that the correct i-f frequency is formed for the i-f amplifier. The circuit consists essentially of an i-f discriminator which, as the name implies, discriminates or furnishes control voltage of the correct polarity to an oscillator frequency-control tube for generated i-f carrier frequencies slightly above and below 460 kc, or the frequency to which the i-f amplifier is tuned.

The plate circuit of the RCA-6J7 oscillator-control tube is caused to act as an apparent variable inductance in parallel with the "A" band oscillator tuned circuit of which coil L35 is a part. The series combination of resistor R5 and the capacitor C16 is also in parallel with the oscillator tuned circuit. Since the resistance of R5 is many times greater than the reactance of C16, at the oscillator frequency, the r-f current through the combination will be practically in phase with the r-f voltage across the oscillator tuned circuit. However, the r-f voltage impressed across the C16 capacitance section of the combination, or from grid to cathode, will lag the r-f voltage across the combination, or the tuned circuit, approximately 90 degrees. The grid-cathode r-f voltage will be amplified by the control tube but will be shifted an additional 180 degrees (grid and plate voltages of all tubes are always opposite in phase) so that the amplified r-f voltage appearing across the plate circuit will now lead the voltage across the combination or the tuned circuit by 90 degrees, or, in other words, the control tube is acting as an equivalent shunt inductance. The amount of this action is determined by the amplification of the tube which, in turn, is governed by the grid-cathode bias voltage. In operation, a residual bias is developed across the cathode resistor R6. The d-c control-grid voltage is fed to the control grid from the discriminator circuit through resistor R7. If this voltage is negative with respect to ground, the amplification of the control tube will be decreased, the apparent plate-circuit inductance of the tube increased, which will lower the frequency of the oscillator tube. The converse will occur when the grid voltage is positive with respect to ground.

The action of the discriminator circuit depends upon the fact that a 90-degree phase difference exists between the primary and secondary potentials of a double-tuned loosely-coupled transformer when the resonant frequency is applied, and that this phase difference varies as the applied frequency varies, i.e., the maximum resultant response voltage across the primary and secondary windings connected in series will occur at a frequency either lower or higher in frequency than the frequency to which the individual windings are resonated, respectively, depending on whether the windings are connected series aiding or opposing.

The discriminator, or fourth i-f transformer, consists of the primary winding, L30, which is a part of the third i-f transformer secondary tuned circuit (tuned to 460 kc) and the center-tapped secondary, L29. The upper and lower halves of L29 may be considered as two secondary coils, the upper series aiding and the lower series opposing the primary, L30. The magnetite core in L29 is inserted to inductively balance the two halves. The function of coil L28 (magnetite core adjusted), in parallel with L29, is to tune the secondary to 460 kc. Therefore, the maximum voltage will be applied to diode circuit P₁K₁ and R18 when the i-f signal frequency is below 460 kc and to the diode circuit P₂K₂ and R17 when the i-f signal frequency is above 460 kc. Resistors R17 and R18 are connected in series between ground and a point leading to the oscillator control-tube grid.

D-c voltages, resulting from diode rectification, across R17 and R18 are always in opposition, consequently the oscillator control-tube grid-bias voltage is a differential amount, depending upon the i-f signal strength and its frequency deviation from the nominal value of 460 kc. The polarity of this



Model 813K

The antenna and first-detector coils are constructed with a special type of winding ("cumulative") to provide increased sensitivity and selectivity on the "Standard Broadcast" band. Special capacitors shunting the spread-band oscillator coils change in capacity with temperature variations to reduce oscillator frequency drift.

Spread-band tuning is accomplished electrically by shunting the low-capacity section of the oscillator variable capacitor with relatively large temperature-stabilized fixed capacitors for tuning the oscillator coil on the "19M," "25M," "31M," and "49M" bands. Antenna and first-detector coils are designed to be sufficiently broad-tuned to require no variable tuning over the narrow frequency range of the spread-bands.

The spread-band oscillator coils and the "Standard Broadcast" band oscillator, first-detector, and antenna coils are all wound on separate forms. The antenna and first-detector spread-band coils are tapped. Undesirable interaction between coils is avoided by shorting proper unused sections by means of the range selector.

The intermediate-frequency amplifier consists of two RCA-6K7 tubes in a two-stage transformer-coupled circuit. The windings of all i-f transformers are resonated by fixed capacitors and are adjusted by molded magnetite cores to tune to 460 kc. A third winding, L22, in the first i-f transformer, closely coupled to the primary, L20, is placed in series with the main secondary, L21, when the fidelity control switch S11 is thrown to "broad" position (see figure 1), thereby increasing the coupling between the primary and secondary circuits with a consequent broadening of the band width of the i-f amplifier, permitting higher fidelity reception.

The function of the automatic-frequency-control circuit is

differential oscillator control-tube grid-bias, with respect to ground, depends on whether the *i-f* signal frequency is above or below 460 kc, but is always in the direction which will

bring the generated *i-f* frequency nearer to 460 kc. A-f-c action is automatically eliminated for "manual" tuning by grounding diode cathode K_1 through switch S_9 .

Service Data

The various diagrams of this booklet contain such information as will be needed to isolate causes for defective operation if such develops. The ratings of the resistors, capacitors, coils, etc., are indicated adjacent to the symbols signifying these parts on the diagrams. Identification titles such as R1, L1, C1, etc., provide reference between the illustrations and Replacement Parts List. The coils, transformer windings, and reactors are rated in terms of d-c resistance to permit continuity checks.

Precautionary Lead Dress.—(1) Green bus leads from C1 to S1 and from C59 to S2 should be dressed away from nearby parts. (2) Green bus lead from C13 to S3 should be $2\frac{3}{4}$ inches long and dressed away from nearby parts. (3) Bus leads from C12 to L18 and from L18 to S3 should be as short as possible. (4) Red and blue leads from tube No. 3 to 19M. oscillator coil should be dressed away from coil. (5) Tube No. 3 grid lead should be 6-inches long and dressed away from grounded metal parts. (6) All leads behind oscillator coils should be dressed close to chassis. (7) "Magic Eye" cable should be clamped to dial bracket. (8) Filament leads should all be twisted. (9) Leads from C44 and C48 should be dressed close to chassis. (10) A-c leads near R22 should be dressed away from R22. (11) Leads from S11 to the first *i-f* transformer should be twisted and dressed away from chassis. (12) Capacitors C7, C8, and C9 should be dressed perpendicular to chassis and away from each other and grounded metal parts. (13) Motor-cable leads should be dressed away from pinion gear. (14) Blue bus lead from "A" detector coil to "P" of tube No. 1

should be dressed centrally between band-switch shield and air trimmer C20. The following should be dressed away from the chassis: (15) Yellow bus lead from "K" of tube No. 3 to S3. (16) Yellow bus lead from "OG" of tube No. 2. (17) Blue bus lead from C47 to R26.

Phonograph Attachment.—A terminal board is provided for connecting a phonograph into the audio-amplifying circuit. RCA Victor Models R-93, R-93-A, R-93-2, or R-94 Record Players should be connected as follows: Remove the link from the phonograph terminal board. Connect green wire in Radio-Record switch cable to terminal 1; yellow to terminal 2; shield to terminal 3; and tape up the red and blue. Connect a 2-conductor twisted cable between the Record Player binding posts and the screw-terminals on Radio-Record switch. If additional volume is desired, connect an RCA Stock No. 9632 transformer between the 2-conductor twisted cable and the screw-terminals on Radio-Record switch as follows: Yellow and brown transformer leads and one side of twisted cable to ground screw-terminal on switch; black transformer lead to other side of twisted cable; and blue transformer lead to other screw-terminal on switch.

Loudspeaker.—Two types of loudspeakers are used which will be referred to as types 1 and 2. In type 1 the cone centering diaphragm is cemented to a fixed ring, while in type 2 the centering diaphragm is cemented to an adjustable ring. Replacement of cone for either type is identical. Centering of cone for type 1 loudspeaker is made with three narrow celluloid or paper feelers after first removing the front dust

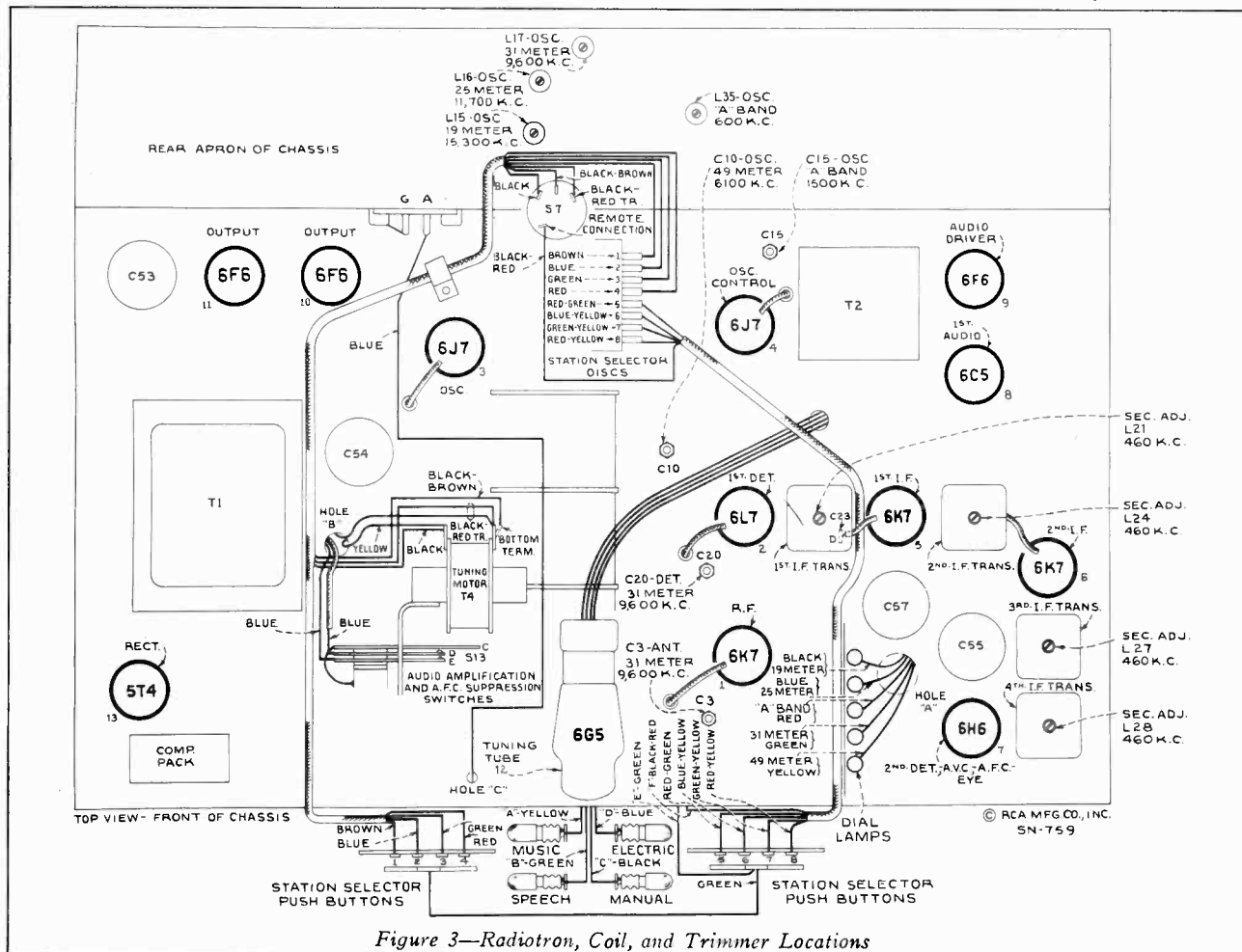

Figure 3—Radiotron, Coil, and Trimmer Locations

cover and cutting free the cone centering diaphragm. The dust cover may be removed by a light application of acetone, using care not to allow the acetone to flow into the air gap. The centering diaphragm should be cemented in place after placement of feelers. Sufficient time should be allowed for

the ambroid to set before removing feelers. Use ambroid to replace dust cover. Centering of cone for type 2 loudspeaker differs only in that it is not necessary to cut free the centering-diaphragm, adjustment being made in the usual manner by means of screws on the adjustable cone centering ring.

Alignment Procedure

Calibrate the tuning dial by adjusting dial pointer to the left ends of horizontal calibration lines with the gang tuning-condenser plates in full-mesh position. This is a screw-driver adjustment.

The "Fidelity" control should be turned counter-clockwise during all alignment operations. The "Manual-Electric-Remote" switch should be turned to "Manual" (clockwise) during alignment unless otherwise specified. The bottom shield-pan must be in place during spread-band alignment. Permit the set to operate at least five minutes before attempting alignment.

CAUTION.—The magnetite core screw L29 on the bottom of the 4th i-f transformer has been accurately adjusted, for an exact electrical balance of coil L29 to center tap, during manufacture and should not be disturbed. However, if for any reason the adjustment has been moved from its original position, it will be necessary to mechanically adjust this screw until the end of the stud protrudes exactly $\frac{1}{8}$ of an inch (four threads exposed) above the brass bushing prior to any alignment operations.

Perform alignment in proper order, tabulated below, starting with No. 1 and following all operations across, then No. 2, etc. A-f-c discriminator adjustments should follow r-f and i-f adjustments tabulated below. Adjustment locations

are shown on figures 3 and 6.

Cathode-ray alignment is preferable for adjustments 2, 3, and 4 due to the flat-top i-f characteristics; the connections to the chassis are shown on figure 2. If an output indicator is used, connect it across the loudspeaker voice-coil and advance the receiver volume control to full-volume position. The Magic Eye may be used as an output indicator for all other adjustments. It is preferable to replace the 6G5 tuning tube with a 6E5 during alignment.

Connect the "low" output terminal of the test oscillator to the receiver chassis for all alignment operations. Regulate the output of the test oscillator so that minimum signal is applied to the receiver to obtain an observable output indication. This will avoid a-v-c action and reduce possibility of error in spread-band adjustments.

The term "Dummy antenna" means the device which must be connected between the "high" test-oscillator output and the point of connection to the receiver in order to obtain ideal alignment. "No signal, 550-750 kc" means that the receiver should be tuned to a point between 550 and 750 kc where no signal or interference is received from a station or local (heterodyne) oscillator. "Min. Eye" means minimum width of dark sector of Magic Eye.

For further details on alignment, refer to booklet "RCA Victor Receiver Alignment."

| Order of Alignment | Test Oscillator | | | Range Selector | Receiver Dial Setting | Circuit to Adjust | Adjustment Symbols | Adjust to Obtain |
|--------------------|-----------------------------------|---------------|-------------------|----------------------|-------------------------|-------------------|--------------------|--------------------------------|
| | Connection to Receiver | Dummy Antenna | Frequency Setting | | | | | |
| 1 | _____ | _____ | _____ | _____ | _____ | 4th I-F Trans. | L28 | Turn Extreme Counter-clockwise |
| 2 | No. 6, 6K7 2nd I-F Grid Cap | .001 Mfd. | 460 kc | "Standard Broadcast" | No Signal 550-750 kc | 3rd I-F Trans. | L26 and L27 | Max. (peak) |
| 3 | No. 5, 6K7 1st I-F Grid Cap | .001 Mfd. | 460 kc | "Standard Broadcast" | No Signal 550-750 kc | 2nd I-F Trans. | L23 and L24 | Max. (peak) |
| 4 | No. 2, 6L7 Det. Grid Cap | .001 Mfd. | 460 kc | "Standard Broadcast" | No Signal 550-750 kc | 1st I-F Trans. | L20 and L21 | Max. (peak) |
| 5 | Ant. Term. | 300 Ohms | 1,600 kc a | "31M." | 9.6 mc | "31M." Osc. | L17 | Min. Eye b |
| 6 | Ant. Term. | 300 Ohms | 1,600 kc a | "31M." | 9.6 mc | "31M." Det. | C20 | Min. Eye |
| 7 | Ant. Term. | 300 Ohms | 1,600 kc a | "31M." | 9.6 mc | "31M." Ant. | C3 | Min. Eye |
| 8 | Ant. Term. | 300 Ohms | 1,300 kc a | "25M." | 11.7 mc | "25M." Osc. | L16 | Min. Eye c |
| 9 | Ant. Term. | 300 Ohms | 1,700 kc a | "19M." | 15.3 mc | "19M." Osc. | L15 | Min. Eye d |
| 10 | Ant. Term. | 300 Ohms | 6,000 kc e | "49M." | 6.0 mc | "49M." Osc. | C10 | Min. Eye f |
| 11 | Ant. Term. | 300 Ohms | 6,100 kc e | "49M." | 6.1 mc | "49M." Osc. | C10 | Min. Eye |
| 12 | Ant. Term. | 200 Mmfd. | 600 kc | "Standard Broadcast" | 600 kc | "A" L-F Osc. | L35 | Min. Eye |
| 13 | Ant. Term. | 200 Mmfd. | 1,500 kc | "Standard Broadcast" | 1,500 kc | "A" H-F Osc. | C15 | Min. Eye |

| Order of Alignment | Test Oscillator | | | Range Selector | Receiver Dial Setting | Circuit to Adjust | Adjustment Symbols | Adjust to Obtain |
|--|---|---------------|-------------------|----------------------|-----------------------|-------------------|--------------------|------------------|
| | Connection to Receiver | Dummy Antenna | Frequency Setting | | | | | |
| 14 | Ant. Term. | 200 Mmfd. | 600 kc | "Standard Broadcast" | 600 kc | "A" L-F Osc. | L35 | Min. Eye |
| 15 | Ant. Term. | 200 Mmfd. | 1,500 kc | "Standard Broadcast" | 1,500 kc | "A" H-F Osc. | C15 | Min. Eye |
| 16 | Proceed to A-F-C Discriminator Adjustments Outlined Below | | | | | | | |
| <p>a—Refer to "Spread-band Adjustments" below for Test Oscillator setting for adjustments 5, 6, 7, 8, and 9.</p> <p>b—Use minimum inductance peak (plunger out) if two peaks can be obtained. To check for correct harmonic, carefully set Test Oscillator to 1,200 kc using Crystal Calibrator. Signal should be indicated by "Magic Eye" in "31M." band near 9.6 mc.</p> <p>c—Use minimum inductance peak (plunger out) if two peaks can be obtained. To check for correct harmonic, carefully set Test Oscillator to 900 kc using Crystal Calibrator. Signal should be indicated by "Magic Eye" in "25M." band near 11.7 mc.</p> <p>d—Use minimum inductance peak (plunger out) if two peaks can be obtained. To check for correct harmonic, carefully set Test Oscillator to 900 kc using Crystal Calibrator. Signal should be indicated by "Magic Eye" in "19M." band near 15.3 mc.</p> <p>e—Refer to "Spread-band Adjustments" below for method of using the RCA Stock No. 9572 Crystal Calibrator for adjustments 10 and 11.</p> <p>f—Use minimum capacity peak if two peaks can be obtained from 1,000 kc harmonics.</p> | | | | | | | | |

Spread-band Adjustments.—Bottom shield-pan must be in place before attempting spread-band alignment. Alignment of the spread ("Overseas") bands requires special procedure since test oscillators used alone are not ordinarily sufficiently accurate for this purpose. The RCA Stock No. 9572 Crystal Calibrator affords a convenient and accurate alignment standard. Wrap a few turns of wire around the crystal calibrator and connect one free end to the antenna terminal of the receiver. Using the crystal calibrator to obtain the necessary accuracy, follow the tabulated alignment procedure for the "31M.", "25M.", and "19M." bands.

The "31M." band alignment, for example, is done as follows: Tune the receiver ("Standard broadcast" band) to the 1,000 kc crystal calibrator output with the crystal calibrator "Hi-Lo" switch in "Hi" position. Snap "Hi-Lo" switch to "Lo" and carefully tune receiver to 1,600 kc (the sixth 100 kc harmonic above 1,000 kc) for minimum "Magic Eye" opening (Min. Eye). Move crystal calibrator away from antenna wire, connect test oscillator, and carefully adjust test oscillator for minimum "Magic Eye" opening at a setting of approximately 1,600 kc. (If Stock No. 150 Test Oscillator is used, refer to second paragraph below.) Raise test-oscillator output to give sufficient harmonic output and use 6th harmonic (9,600 kc) for aligning in "31M." band at 9.6 mc. Align in the "25M." band at 11.7 mc (11,700 kc), the 9th harmonic of the test-oscillator 1,300 kc output. Align in the "19M." band at 15.3 mc (15,300 kc), the 9th harmonic of the test-oscillator 1,700 kc output. In each case select the peak giving minimum "Magic Eye" opening.

For the "49M." band, snap crystal calibrator "Hi-Lo" switch to "Hi", turn the range selector to "49M." band, and set receiver dial pointer to 6.0 mc. Adjust oscillator trimming capacitor C10 for minimum "Magic Eye" opening. Use the peak indicated by the alignment table. Snap "Hi-Lo" switch to "Lo" and locate 6,100 kc (the first 100 kc harmonic above 6,000 kc) by slightly readjusting C10 with the dial pointer set at 6.1 mc. This method insures selection of correct crystal-calibrator harmonic.

When aligning with the RCA Stock No. 150 Test Oscillator use the variable (unmodulated) oscillator† and "Magic Eye" indication of receiver output. Set test-oscillator dial 800 kc lower than the desired signal for the four lower frequency ranges and 800 kc higher than the desired signal for the two high ranges and use in same manner as TMV-97-C. Insert an open-circuit telephone plug in the test oscillator "Ext. Mod." jack, so the modulated fixed-frequency oscillator will be cut off, and align on the unmodulated variable oscil-

† The No. 150 Test Oscillator employs a fixed-frequency (800 kc), modulated oscillator and a variable, unmodulated oscillator. The scale is calibrated to the sum frequency for the two higher frequency ranges and to the difference frequency for the four lower frequency ranges.

lator signal, which will close the "Magic Eye" and evidence itself by a rushing noise in the speaker.

If the crystal calibrator signals are weak, disconnect test oscillator while using the crystal calibrator.

More accurate alignment in the spread-bands can be accomplished by making final slight adjustments using American, English, or German short-wave broadcasting stations of known frequency for frequency standards.

A-F-C Discriminator Adjustments.—These adjustments are rather critical and should be performed with extreme care. Improper adjustment may result in complete failure of the oscillator control tube to function or else may cause it to detune the oscillator instead of tuning it to the signal. It is assumed that the magnetite core adjusting screw L28 (top of 4th i-f transformer) has been turned all the way out (extreme counter-clockwise) during the preceding tabulated adjustments. Adjustments are as follows: Remove spring "N" on link and arm assembly which connects the "Manual-Electric-Remote" switch shaft to the throw-out gear bracket. Turn "Fidelity" control counter-clockwise. Connect antenna to receiver antenna terminal. With the "Manual-Electric-Remote" switch in "Manual" (right) position, tune in a strong local station near 600 kc or the low-frequency end of the "A" band as accurately as possible by means of the tuning tube "Magic Eye." The most accurate adjustment will be obtained by adjusting the "vernier" tuning knob mid-way between the two points where the eye just appears to start to open. This will place the generated i-f carrier signal frequency exactly in the center of the i-f amplifier response curve (should be 460 kc if i-f amplifier was properly aligned) and is the frequency to which the a-f-c discriminator (4th i-f transformer) should be tuned to resonance. Without disturbing any of the receiver adjustments, place the "high" test-oscillator lead about $\frac{3}{4}$ of an inch from the grid cap lead of the RCA-6K7, 1st i-f amplifier tube, adjust the test-oscillator output to maximum, turn test-oscillator "Modulation" off, and carefully zero-beat the test-oscillator frequency (approximately 460 kc) with the i-f carrier signal. Avoid placing the test-oscillator lead nearer to the grid-cap lead than specified above, as doing so will tend to detune the i-f amplifier. It may be necessary to reduce the local station signal, during this operation, by shortening antenna lead or grounding antenna "A" terminal to chassis in order to increase the loudness of the beat note sufficiently for accurate zero-beat adjustment.

Throw "Manual-Electric-Remote" switch to "Electric" (center) position. A high whistle or beat note will now be heard. Turn the magnetite core screw L28 (top of 4th i-f transformer) slowly clockwise. As this screw is turned, the beat note will first increase to a high audio frequency and will then decrease to a zero-beat and then increase in frequency again. The point of exact zero-beat is the position

© RCA MFG. CO., INC.
SN-754

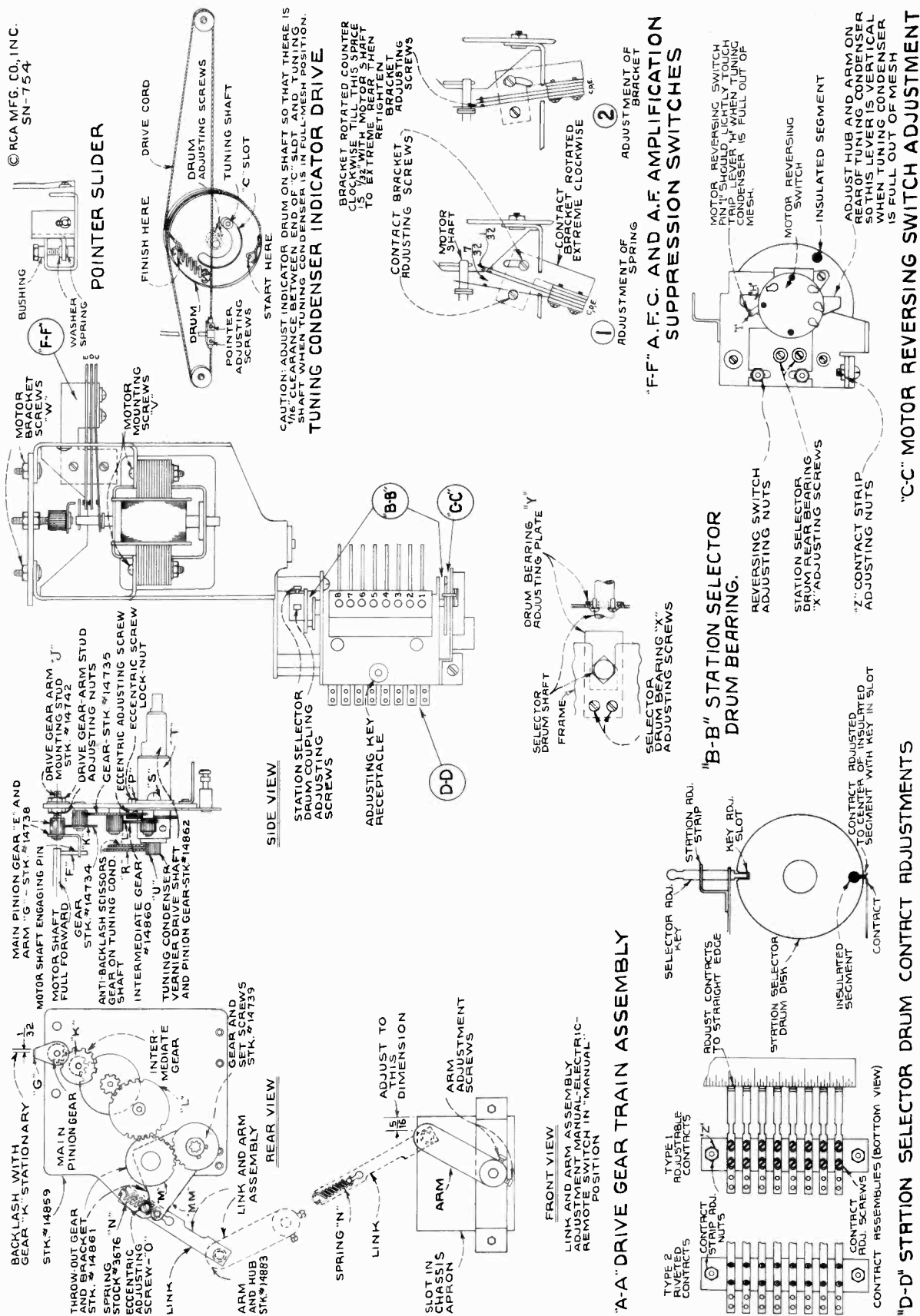

Figure 4—"Electric Tuning" Mechanism Adjustments

for correct adjustment of the discriminator. Zero-beat should also still exist when the "Manual-Electric-Remote" switch is thrown back to "Manual" position. The adjustment is now complete and may be checked by slightly detuning the re-

ceiver above and below the local station frequency with the "Manual-Electric-Remote" in "Manual" position, switching to "Electric" position, and noting the oscillator pull-in. Replace spring "N."

ELECTRIC TUNING

Principle of Operation

The electric tuning mechanism consists essentially of a quick engaging and dis-engaging reversible electric motor, tuning condenser driving gear train, and eight mechanically interlocked (pushing one button releases all others) station selector push buttons respectively wired to eight adjustable station selector contactor discs (each with a motor stopping insulated segment) mounted on a drum which is direct-coupled to the gang tuning condenser shaft. The arrangement permits any one of eight pre-determined stations to be electrically tuned in by merely touching the correct push button. If all eight buttons are inadvertently locked in, firmly pushing the right-hand button will release them.

The operation may be more readily understood by reference to figures 1, 4, and 5. When the motor is not energized, the armature is pushed to the rear or slightly out of the magnetic center by tension of contact spring "C" and the motor shaft is dis-engaged from the driving gear train. Pressing in any one of the eight push buttons will complete the motor circuit through a station selector contactor disc, assuming that the "Manual-Electric-Remote" switch is in "Electric" position and that the insulated segment in the contactor disc is not opposite its contactor. As the motor starts, the armature will be drawn forward, due to solenoid action, and the pin "F" on the end of its shaft will engage the arm "G" on the small main pinion gear, thereby driving the tuning mechanism. At the same time contact springs "E" and "D" will be grounded, causing suppression of audio amplification and automatic frequency control during the tuning cycle. The motor will continue to operate until the in-

ulated segment in the selector disc breaks the motor circuit, whereupon spring "C" will instantly dis-engage the motor pin "F" from the arm "G" on the small pinion driving gear and open contacts "E" and "D." Pushing another button will cause the above mentioned cycle to be repeated except that the motor will be interrupted by the insulated segment on a corresponding disc. The discs are individually adjustable on a drum mechanism, providing a choice of eight "Electric Tuned" "Broadcast" stations. The arrangement of the motor is such that its rotation will continue in the same direction regardless of the number of "Electric" tuning cycles until the tuning condenser approaches either full-out or full-in of mesh, whereupon lever "H" trips switch S7 which reverses the direction of rotation. A throw-out idler gear is link-coupled to the "Manual-Electric-Remote" control to disconnect the motor drive gear train when the control is thrown to "Manual" position.

Mechanism Adjustments

The electric tuning mechanism is designed to be as simple in construction and as fool proof in operation as is possible. In order to maintain the accurate results possible with this device care must be taken in effecting any repairs or adjustments. Reference should be made to figure 4 and the following:

A-F-C and A-F Amplification Suppression Switches.—

This switch assembly is located on the motor bracket and closes due to solenoid action of motor armature. The tension of the long contact spring "C" is important in bringing about quick dis-engagement of the motor and in permitting the

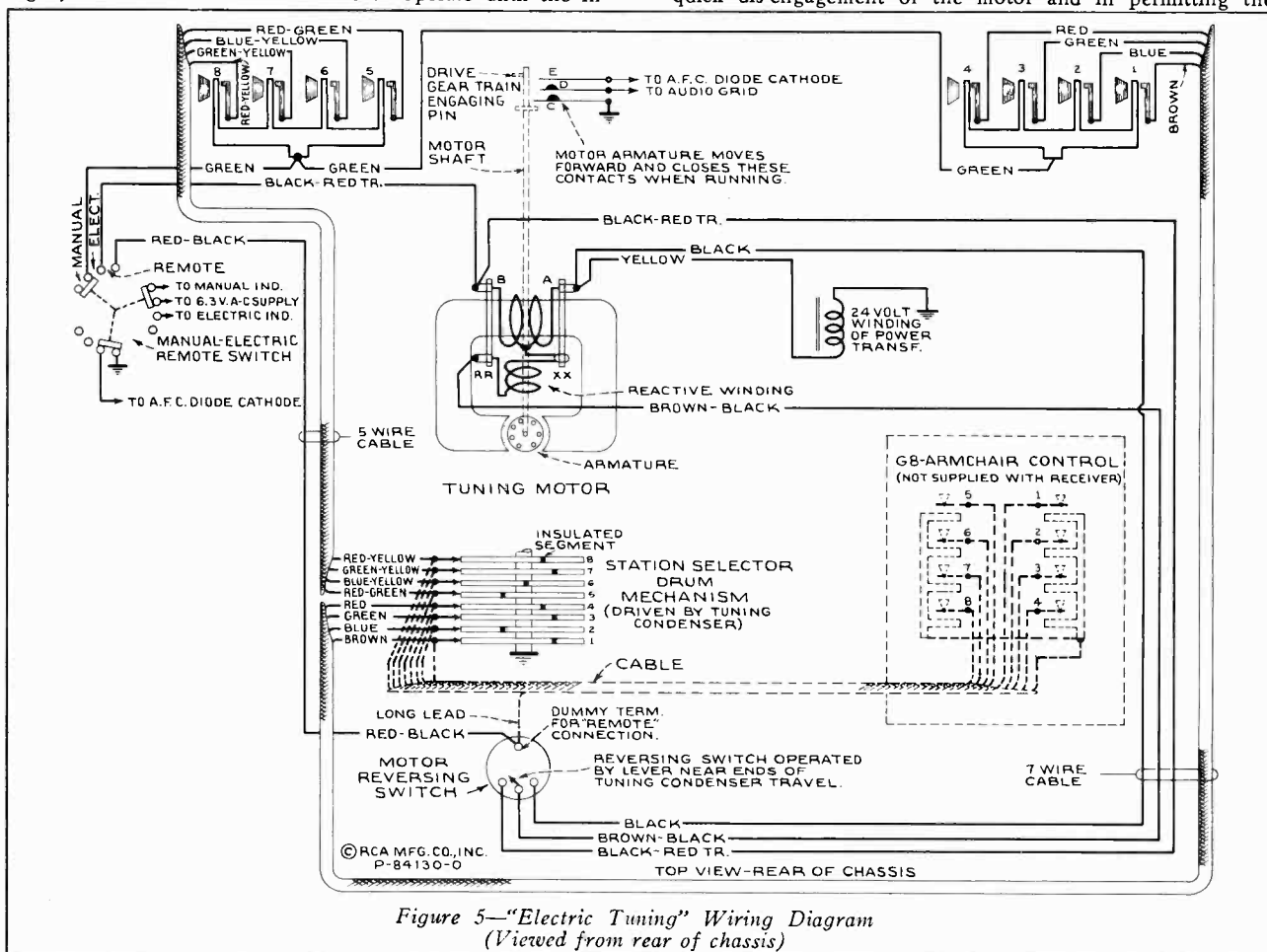

Figure 5—"Electric Tuning" Wiring Diagram
(Viewed from rear of chassis)

motor to pull into mesh with the drive mechanism. Normal adjustment is attained when the short springs "D" and "E" are aligned exactly straight with contact points separated approximately 1/32 of an inch and with the spring "C" spaced approximately 7/32 of an inch from spring "D" at the point of contact. If necessary, in order to obtain positive pull-in and quick dis-engagement of the motor, the tension of spring "C" should be increased or decreased by bending. This action should be checked with the front apron of the chassis raised two inches higher than the rear. Contacts of the switch must be kept clean. Crocus cloth or a relay burnisher may be used for this purpose.

Motor Reversing Switch.—It is necessary to automatically stop and reverse the drive motor before the tuning condenser reaches the ends of its travel. Approximately 175 degrees of sweep is required, and the reversal must take place above 1,700 kc and below 540 kc but not too near the limits of the scale. The coupling between the station selector drum and the tuning condenser shaft should be attached so that the reversing switch trip lever "H" is exactly vertical when the condenser is full-out of mesh. There should be 1/32 of an inch clearance between the end of the condenser shaft and the selector drum shaft. While the trip lever is in this position the reversing switch bracket should be adjusted by means of its elongated mounting holes until the switch pin "I" just lightly touches trip lever "H."

Main Pinion Gear.—Clearance between the small high-speed pinion gear "E" and the intermediate gear "K" determines the amount of mechanical noise produced. Correct adjustment will give approximately 1/32 of an inch movement of back lash at the end of pinion arm "G" when gear "K" is held stationary. Arm "G" must also be adjusted for correct mesh with motor shaft drive pin "F." With the motor shaft completely forward and pinion "E" tight against its front bearing, the pinion mounting stud "J" should be adjusted so that pin "F" meshes full thickness with the rotating arm "G." An increase of this mesh will increase over travel on tuning while a decrease of mesh will decrease

the over travel. The elongated hole in the front bracket allows sufficient movement of the mounting stud "J" to permit above mentioned gear mesh adjustment.

"Manual-Electric-Remote" Changeover.—(1) Link and arm adjustment—To properly line up the mechanical link between the switch shaft and throw-out gear bracket "MM," the set screws holding the link arm on the switch shaft must be loosened, the switch turned to the "Manual" position (extreme right) and the link lever revolved until the distance between the link-connecting pin (extends through chassis apron) and the right-hand (viewed from front) side of the slot, in front apron of chassis, is exactly 5/16 of an inch. If this adjustment is not properly made, correct operation of

Radiotron Cathode Current Readings

Measured with Milliammeter Connected at Tube Socket Cathode Terminals Under Conditions Similar to Those of Voltage Measurements

| | |
|---------------------------------|-----------|
| (1) RCA-6K7—R-F Amp..... | 9.0 ma. |
| (2) RCA-6L7—1st Det..... | 3.5 ma. |
| (3) RCA-6J7—Osc..... | 8.5 ma. |
| (4) RCA-6J7—Osc. Control..... | 1.8 ma. |
| (5) RCA-6K7—1st I-F Amp..... | 9.0 ma. |
| (6) RCA-6K7—2nd I-F Amp..... | 8.0 ma. |
| (7) RCA-6H6—2nd Det..... | — |
| (8) RCA-6C5—A-F Amp..... | 0.9 ma. |
| (9) RCA-6F6—Driver..... | 22 ma. |
| (10) RCA-6F6—Output..... | 25 ma. |
| (11) RCA-6F6—Output..... | 25 ma. |
| (12) RCA-6G5—Tuning Tube..... | 3.0 ma. |
| (13) RCA-5T4—Rectifier..... | 128 ma.** |

(* **Cannot be measured at socket)

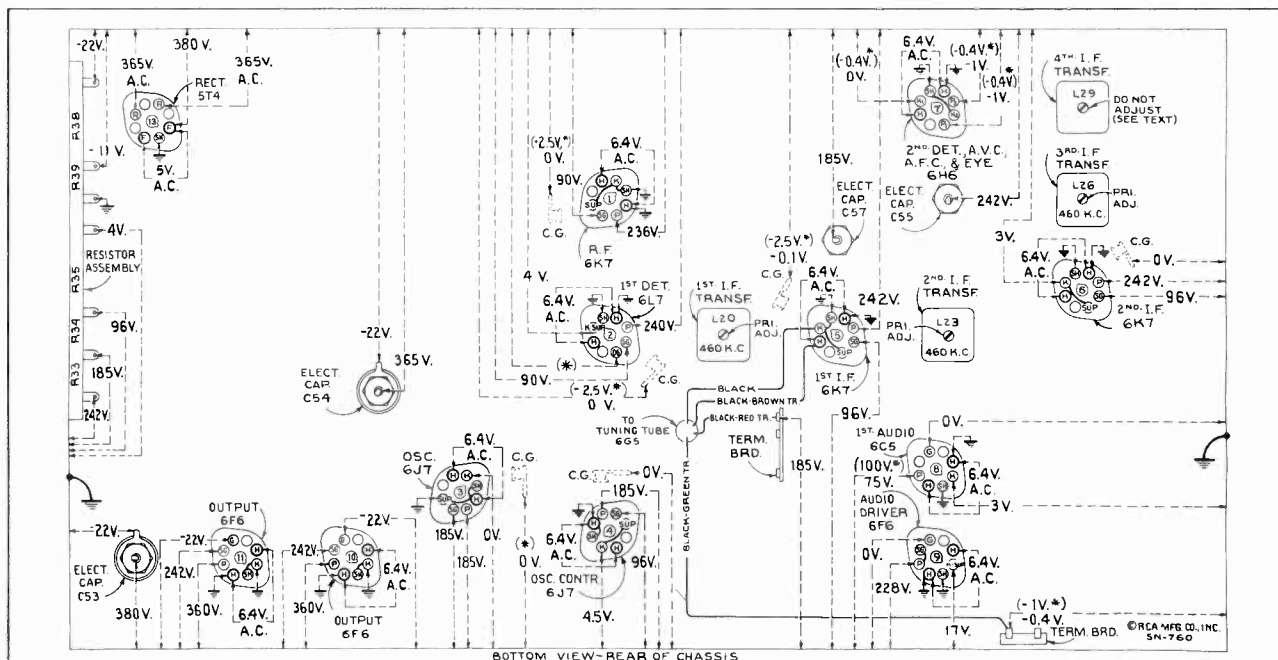

Figure 6—Radiotron Socket Voltages, Coil, and Trimmer Locations

Measured at 115 volts, 60-cycle supply—Tuned to approximately 1,000 kc ("Standard Broadcast")—"Manual" control—No signal being received—Volume control minimum—Fidelity control optional

Note: Two voltage values are shown for some readings. The value shown in parentheses with asterisk (*) indicates operating conditions without voltmeter loading. The other value (generally lower) is the actual measured voltage and differs from the value shown in parentheses because of the additional loading of the voltmeter.

Voltage values as specified should hold within $\pm 20\%$ when the receiver is normally operative at its rated line voltage. To duplicate the conditions under which the voltages were measured requires a 1,000-ohm-per-volt d-c meter, having ranges of 10, 50, 250 and 500 volts. Use the nearest range above the specified measured voltage. A-c voltages were measured with a corresponding a-c meter.

"Electric" or "Remote" tuning will not result. (2) Throw-out Gear Adjustment—To obtain smooth operation on "Electric" or "Remote" positions it is important that the proper clearance is maintained between the throw-out gear "M" and the intermediate gear "L." With the "Manual-Electric-Remote" control thrown to "Remote" position (extreme left) adjust the mesh between these gears by means of the eccentric screw "O" and lock nut "P," contacting the throw-out gear bracket "MM," until there is approximately 1/64 of an inch backlash of gear "L" when gear "M" is held stationary.

Vernier Tuning.—In case it becomes necessary to remove tuning condenser drive shaft "T," it should be replaced by sliding anti-backlash gear "R" on condenser shaft apart so that compression amounting to one tooth on the gear is obtained in the springs. Adjust mesh of gear "R" with pinion gear "U" on vernier shaft before tightening screws "S" so that smooth tuning is obtained throughout the range.

Motor Alignment.—The motor shaft must be exactly aligned with the axis of the pinion gear with which it engages. This may be adjusted by loosening the mounting screws "V" of the motor and aligning shaft by sight. Correct alignment may be tested by slowly rotating motor and observing the relation between the pin "F" of the motor shaft and the arm "G" on the pinion. The relation of the two should remain the same throughout the revolution. Additional movement for adjustment may be obtained by the motor bracket screws "W" if necessary.

Station Selector Drum.—(1) Bearing Adjustment—The selector drum may be removed by unscrewing the two bearing adjusting screws "X" on the front and rear bearings and sliding shaft out of slots on frame. To replace drum, the reverse procedure should be followed holding bearing adjusting plates "Y" firmly against the shaft and tightening adjusting screws. (2) Contact adjustment—Two types of contact strips are used. They are designated on figure 4, as types 1 and 2, on which the individual contacts are respectively adjustable and fixed. On type 1, the individual contacts should be adjusted by setting the end contact springs near the mid-position of their travel and aligning the remaining springs to them by means of a straight edge. Either type of contact strip should be adjusted to the selector drum by firmly placing two selector adjusting keys in the station adjustment strip, positions 1 and 8 (locking respective discs), loosening contact strip adjusting nuts "Z" and shifting the contact strip until the end contacts are exactly centered on the respective disc insulating segments. More accurate adjustment may be made by silhouetting the point of contact with a piece of white paper held behind the contact. Adjustment will be facilitated by removing complete assembly from rear of tuning condenser by unscrewing the three mounting screws. Contacts and discs must be kept free of dirt, filings, and other extraneous matter.

Lubrication.—The dial pointer slide should be greased with petrolatum. This same lubrication should be applied lightly to all gear faces of the drive mechanism and sparingly with a cloth to the station selector discs. Any good household oil, such as "3-IN-ONE," is suitable for the motor shaft bearings. A light grade of engine oil should be used for all gear bearings. Medium viscosity engine oil, similar to

"PYROIL" (B), should be applied between the thrust washers on the motor shaft. "CASTORDAG," a mixture of graphite and castor oil, is recommended for use at the selector drum end-bearing slots and at the bearings of cable pulleys.

Station Adjustment

Any eight stations may be chosen for "Electric" tuning. Remove the two escutcheon plates from the side of the dial, place proper call letter labels in the celluloid windows, and replace escutcheons. Turn the power on and proceed to set up the "Electric" tuning as follows:

1. Set Range Selector to "Standard Broadcast."
2. Turn "Manual-Electric-Remote" control to "Electric."
3. Turn Fidelity control counter-clockwise.
4. Press push button No. 1 (left) and wait until station pointer comes to rest.
5. Turn the "Manual-Electric-Remote" control to "Manual."
6. Remove adjusting key from receptacle on top of station selector drum mechanism.
7. Insert key in position marked "1" in station adjustment strip and push the key all the way down to properly fit in slot in disc.
8. Tune the receiver very carefully by means of the manual tuning knob and the "Magic Eye," to station chosen for No. 1.
9. Remove key.
10. Turn the "Manual-Electric-Remote" control to "Electric."

Button No. 1 is now properly set for "Electric" tuning. Proceed similarly for the other seven push buttons, matching each station on the dial with the same number on the station adjustment strip. Repeat the above steps but place the key respectively in positions 2, 3, 4, etc., and in each case tune to the proper station. Pressing the proper button will now cause the desired station to be tuned in electrically.

Armchair Control

When a Model G-8 armchair control is attached to the receiver as shown in figure 5 it duplicates the action of the push buttons on the front panel when the "Manual-Electric-Remote" control is turned to "Remote" position.

Service Hints

- a. Capacitor C18 should be carefully checked for leakage or short circuit in cases of intermittent operation or no operation. R9 should be shorted out and C18 replaced by Stock No. 4839, as shown by the Schematic Circuit Diagram figure 1, in the event of trouble in this circuit.
- b. Capacitor C5 should be checked for leakage or short circuit.
- c. Resistor R5 was 33,000 ohms in some instruments. Replace with Stock No. 12333.
- d. Capacitor C16 was 82 mmfd. in some instruments. Replace with Stock No. 14021.
- e. Capacitor C38 was two 0.5 mfd. in parallel on some instruments. Replace with Stock No. 30623.

REPLACEMENT PARTS

Insist on genuine factory tested parts which are readily identified and may be purchased from authorized dealers.

| STOCK No. | DESCRIPTION | STOCK No. | DESCRIPTION |
|----------------------------|---|-----------|---|
| RECEIVER ASSEMBLIES | | | |
| 14726 | Arm—Hub and arm complete with set screws—Connects station selector drum to rear of tuning condenser shaft | 12884 | Capacitor—Adjustable trimmer (long) (C3, C10, C15, C20) |
| 14883 | Arm—Arm and hub assembly located on "Manual-Electric-Remote" switch shaft | 14392 | Capacitor—4.7 Mmfd. (C62) |
| 14517 | Board—Antenna and ground terminal board | 14021 | Capacitor—22 Mmfd. (C16) |
| 12717 | Board—Phonograph terminal board | 12723 | Capacitor—56 Mmfd. (C40) |
| 14885 | Bracket—Left hand dial bracket and pulley assembly | 12813 | Capacitor—82 Mmfd. (C58) |
| 14884 | Bracket—Right hand dial bracket and pulley assembly | 14910 | Capacitor—90 Mmfd. (C21) |
| 14878 | Bracket—Tuning tube mounting bracket and clamp assembly | 14908 | Capacitor—96.5 Mmfd. (C9) |
| 5237 | Bushing—Variable condenser rubber mounting bushing assembly | 14906 | Capacitor—100 Mmfd. (C7) |
| 14919 | Cable—5 conductor push-button selector cable | 12720 | Capacitor—100 Mmfd. (C36) |
| 14918 | Cable—7 conductor tuning drive motor and push-button selector cable | 14907 | Capacitor—103.5 Mmfd. (C8) |
| 12607 | Cap—First or second I-F transformer shield cap | 14909 | Capacitor—110 Mmfd. (C6) |
| 12581 | Cap—Third or fourth I-F transformer shield cap | 12404 | Capacitor—120 Mmfd. (C35) |
| 11350 | Cap—Grid contact cap | 14712 | Capacitor—180 Mmfd. (C31, C32) |
| | | 14711 | Capacitor—220 Mmfd. (C28, C29) |
| | | 12952 | Capacitor—330 Mmfd. (C2, C19, C45) |
| | | 14710 | Capacitor—430 Mmfd. (C22, C23) |
| | | 13052 | Capacitor—470 Mmfd. (C14) |
| | | 14724 | Capacitor—560 Mmfd. (C63) |

REPLACEMENT PARTS (Continued)

| STOCK No. | DESCRIPTION | STOCK No. | DESCRIPTION |
|-----------|--|--------------------------------|--|
| 14911 | Capacitor—580 Mmfd. (C11) | 14875 | Resistor—Voltage divider comprising one 1600 ohm, one 4500 ohm, one 7,000 ohm, one 300 ohm and two 85 ohm sections (R6, R33, R34, R35, R38, R39) |
| 12897 | Capacitor—4700 Mmfd. (C5) | 14887 | Retainer—Indicator drive cord pulley retainer |
| 13033 | Capacitor—.007 Mfd. (C49, C51) | 14897 | Scale—19 meter glass dial strip |
| 4937 | Capacitor—.01 Mfd. (C50) | 14896 | Scale—25 meter glass dial strip |
| 13138 | Capacitor—.01 Mfd. (C17, C24, C27, C39, C46) | 14894 | Scale—31 meter glass dial strip |
| 11315 | Capacitor—.015 Mfd. (C47) | 14893 | Scale—49 meter glass dial strip |
| 4870 | Capacitor—.025 Mfd. (C42) | 30012 | Scale—"A" band glass dial strip |
| 4886 | Capacitor—.05 Mfd. (C30, C61) | 4669 | Screw—No. 8-32x5/32 square head set screw for drum Stock No. 14856, arm Stock No. 14726 and Stock No. 14883 |
| 4839 | Capacitor—.1 Mfd. (C4, C18, C26, C37, C60) | 12418 | Screw—No. 8-32x3/16 milled head screw for gear Stock No. 14739 |
| 5170 | Capacitor—.25 Mfd. (C25) | 14848 | Selector—Station selector drum mechanism—comprising selector contactor discs, spring contacts, and motor reversing switch assembled in metal frame |
| 30623 | Capacitor—1 Mfd. (C38) | 14882 | Shield—Chassis bottom shield |
| 5212 | Capacitor—16 Mfd. (C55) | 12735 | Sh cld—Dial lamp shield |
| 14377 | Capacitor—16 Mfd. (C57) | 12008 | Shield—I-F transformer shield can |
| 13611 | Capacitor—20 Mfd. (C56) | 14901 | Shield—Rubber shield for tuning tube |
| 14531 | Capacitor—25 Mfd. (C53, C54) | 14892 | Slide—Indicator pointer slider and spring assembly |
| 30017 | Capacitor Pack—Compensating capacitor pack comprising one .025 Mfd. and one .015 Mfd. capacitor, one 22,000 ohm and one 27,000 ohm resistor (C41, C43, R21, R23) | 11195 | Socket—5 contact 5T4 Radiotron socket |
| 14902 | Capacitor Pack—Comprising two sections 10 mfd. each (C44, C48) | 11196 | Socket—8 contact 6K7, 6J7, 6F6, 6H6, or 6C5, Radiotron socket |
| 14865 | Coil—"A" band antenna coil (L6, L7) | 14877 | Socket—8 contact 6J7 Radiotron impregnated socket for socket mounting plate Stock No. 12471 and 6K7 or 6L7 Radiotron |
| 14866 | Coil—Special band spread antenna coil (L1, L2, L3, L4, L5) | 14114 | Socket—Dial lamp socket |
| 14867 | Coil—"A" band detector coil (L12, L13) | 13638 | Spring—Drive cord tension spring |
| 14868 | Coil—Special band spread detector coil (L8, L9, L10, L11) | 12007 | Spring—Retaining spring for core Stock No. 12006 |
| 14869 | Coil—"A" band oscillator coil (L19, L35) | 3676 | Spring—Tension spring for link and arm Stock No. 14883 |
| 14873 | Coil—19 meter band oscillator coil (L14, L15) | 14694 | Spring—Tension spring for station selector push-button switch latch bar |
| 14872 | Coil—25 meter band oscillator coil (L16) | 14889 | Strap—Strap and bolt assembly used to hold glass dial strips in position |
| 14871 | Coil—31 meter band oscillator coil (L17) | 14899 | Strip—Bottom glass dial strip |
| 14870 | Coil—49 meter band oscillator coil (L18) | 14891 | Strip—Finish strip used between glass dial strips |
| 14858 | Condenser—3 gang variable tuning condenser complete with gear train (C1, C12, C13, C59) | 14898 | Strip—Top glass dial strip |
| 5040 | Connector—4 contact female connector for reproducer cable | 14742 | Stud—Mounting stud for gear and arm Stock No. 14738 |
| 30567 | Connector—4 contact female connector with metal shell for reproducer cable in later production | 14874 | Switch—"Manual-Electric-Remote" switch (S5, S9, S12) |
| 14733 | Contact—Spring contact for engaging discs in station selector drum for type 1 contact assembly | 14863 | Switch—"Power-Tone" (Music-Speech) switch (S4, S8, S10) |
| 30365 | Contact—Comprising 8 spring contacts assembled on insulating strip for engaging discs in station selector drum (type 2 contact assembly) | 14732 | Switch—Motor reversing switch and mounting plate for station selector (S7) |
| 14857 | Cord—Indicator drive cord | 14864 | Switch—Range switch (S1, S2, S3) |
| 12006 | Core—Adjustable core and stud for I-F transformers | 14728 | Switch—A-F-C and A-F amplification suppression switch (S13) |
| 14890 | Cushion—Black rubber dial cushion | 14904 | Switch—Station selector switch parts comprising one 4 point contact board, one 4 point conductor plate, insulator and lockplate |
| 14888 | Dial—Dial assembly, ready to mount on support brackets. Includes 7 glass dial strips and indicator slider assembled on metal frame | 14703 | Tone control—"Fidelity" control (R26, S11) |
| 14862 | Drive—Tuning condenser vernier drive shaft and pinion gear | 14706 | Transformer—First I-F transformer (L20, L21, L22, C22, C23) |
| 14856 | Drum—Drive cord drum complete with set screws | 14707 | Transformer—Second I-F transformer (L23, L24, L25, C28, C29) |
| 14731 | Drum—Station selector drum rotor—comprising 8 station selector contactor discs assembled on shaft | 14708 | Transformer—Third I-F transformer (L26, L27, C31, C32) |
| 14738 | Gear—Drive pinion gear and arm | 14709 | Transformer—Fourth I-F transformer (L28, L29, L30, C35) |
| 14739 | Gear—Drive gear and set screws—located on tuning condenser knob shaft | 14855 | Transformer—Driver transformer (T2) |
| 14734 | Gear—Intermediate gear assembly—comprising one .749-in. O.D., 34 tooth gear and one .291-in. O.D., 12 tooth pinion assembled | 14879 | Transformer—Power transformer 105-125 volts, 50-60 cycle (T1) |
| 14735 | Gear—Intermediate gear assembly—comprising one 1.541-in. O.D., 72 tooth gear and one .291-in. O.D., 12 tooth pinion assembled | 14880 | Transformer—Power transformer 105-125 volts, 25-60 cycle (T1) |
| 14860 | Gear—Intermediate gear assembly—comprising one 1.541-in. O.D., 72 tooth gear and hub assembled | 14881 | Transformer—Power transformer 100-130/140-160/195-250 volts, 50-60 cycle (T1) |
| 14861 | Gear—Throwout gear and bracket | 12861 | Volume Control (R22) |
| 14900 | Indicator—Station selector indicator pointer | REPRODUCER ASSEMBLIES (RL76-2) | |
| 5226 | Lamp—Dial Lamp | 14606 | Cap—Dust cap for cone center |
| 14729 | Motor—Tuning drive motor for 60 cycle models only (M-1) | 14922 | Coil—Reproducer field coil (L34) |
| 14730 | Motor—Tuning drive motor for 25 cycle models only (M-1) | 14602 | Cone—Reproducer cone, voice coil, center suspension and dust cap (L32) |
| 14859 | Plate—Tuning condenser front plate and studs assembled for mounting drive gears | 5039 | Plug—4 contact male plug for reproducer |
| 12471 | Plate—6J7 socket mounting plate assembly for cushion socket—less socket | 14920 | Reproducer—Complete |
| 14886 | Pulley—Indicator drive cord pulley—located on right or left hand dial bracket | 14921 | Transformer—Output transformer (T3, C52) |
| 14854 | Reactor—Filter reactor (L33) | 14957 | Washer—Spring washer to hold field coil securely |
| 30647 | Resistor—1.8 ohms, Resisto-fuse, 1 amp. (R42) | MISCELLANEOUS ASSEMBLIES | |
| 13250 | Resistor—330 ohms, carbon type, 1/2 watt (R15) | 14745 | Button—Station selector switch button |
| 30158 | Resistor—820 ohms, carbon type, 1/2 watt (R30) | 30361 | Card—Call letter cards for station selector |
| 5112 | Resistor—1000 ohms, carbon type, 1/2 watt (R10) | 5040 | Connector—4-contact female connector for reproducer inter-connecting cable in later production |
| 13030 | Resistor—1000 ohms, carbon type, 1/10 watt (R2, R13) | 30568 | Connector—4-contact male connector for reproducer inter-connecting cable in later production |
| 11283 | Resistor—1200 ohms, carbon type, 1/2 watt (R41) | 14925 | Crystal—Dial escutcheon crystal only |
| 13031 | Resistor—3300 ohms, carbon type, 1/10 watt (R29) | 14923 | Escutcheon—Dial and tuning tube escutcheon only—less crystal and buttons |
| 5114 | Resistor—15,000 ohms, carbon type, 1 watt (R31) | 14924 | Escutcheon—Dial and tuning tube escutcheon and crystal complete |
| 14078 | Resistor—18,000 ohms, carbon type, 1 watt (R24) | 14926 | Indicator—"Electric-Manual" indicating screen |
| 14284 | Resistor—22,000 ohms, carbon type, 1/10 watt (R36) | 14927 | Indicator—"Music-Speech" indicating screen |
| 12454 | Resistor—33,000 ohms, insulated, 1/2 watt (R4, R12) | 14751 | Key—Key for use in adjusting "Electric Tuning" |
| 12333 | Resistor—68,000 ohms, carbon type, 1/2 watt (R5) | 14359 | Knob—"Tuning" (large) control knob |
| 5145 | Resistor—100,000 ohms, carbon type, 1/2 watt (R14, R28) | 14688 | Knob—"Range Selector" knob |
| 11452 | Resistor—470,000 ohms, carbon type, 1/10 watt (R17, R18) | 14269 | Knob—"Power-Tone" (Music-Speech), "Volume", "Tuning" (small), "Manual-Electric-Remote", and "Fidelity" control knobs |
| 11172 | Resistor—470,000 ohms, carbon type, 1/2 watt (R8) | 5210 | Screw—Chassis mounting screw and washer assembly |
| 11397 | Resistor—560,000 ohms, carbon type, 1/10 watt (R1, R11, R27) | 14746 | Shield—Cellulo'd shield for station markers |
| 12013 | Resistor—1 Megohm, carbon type, 1/10 watt (R25) | 4982 | Spring—Retaining spring for knob Stock No. 14359 |
| 3033 | Resistor—1 Megohm, carbon type, 1/2 watt (R7) | 14270 | Spring—Retaining spring for knob Stock Nos. 14269 and 14688 |
| 11151 | Resistor—2.2 Megohm, carbon type, 1/2 watt (R20) | | |
| 5131 | Resistor—2.2 Megohm, carbon type, 1/10 watt (R19) | | |
| 13673 | Resistor—10 Megohm, carbon type, 1/2 watt (R40) | | |



RCA Victor

MODEL 816K

Sixteen-Tube, Seven-Band, AC, Superheterodyne Receiver

TECHNICAL INFORMATION AND SERVICE DATA

-1937 No. 28-

SERVICE DIVISION • RCA MANUFACTURING COMPANY, INC. • CAMDEN, N. J., U. S. A.

A Service of the Radio Corporation of America

Electrical Specifications

FREQUENCY RANGES

| | |
|-------------------------------|------------------|
| "Standard Broadcast" (A)..... | 530-1,720 kc |
| "M.W." Medium Wave (B)..... | 2,400-7,100 kc |
| "S.W." Short Wave (C)..... | 7,100-21,750 kc |
| "49M." (49 Meters)..... | 5,970-6,240 kc |
| "31M." (31 Meters)..... | 9,410-9,690 kc |
| "25M." (25 Meters)..... | 11,680-11,920 kc |
| "19M." (19 Meters)..... | 15,090-15,380 kc |

R-F ALIGNMENT FREQUENCIES

| | |
|-------------------------------|-----------------------------------|
| "49M." (49 Meters)..... | 6,100 kc (osc., det., ant.) |
| "31M." (31 Meters)..... | 9,600 kc (osc.) |
| "25M." (25 Meters)..... | 11,700 kc (osc.) |
| "19M." (19 Meters)..... | 15,300 kc (osc.) |
| "S.W." Short Wave (C)..... | 9,500 kc (osc.), 20,000 kc (osc.) |
| "M.W." Medium Wave (B)..... | 6,000 kc (osc.) |
| "Standard Broadcast" (A)..... | 600 kc (osc.), 1,500 kc (osc.) |

Intermediate Frequency..... 460 kc

RADIOTRON COMPLEMENT

| | |
|------------------|-------------------------------------|
| (1) RCA-6K7..... | R-F Amplifier |
| (2) RCA-6L7..... | First Detector |
| (3) RCA-6J7..... | Heterodyne Oscillator |
| (4) RCA-6J7..... | Oscillator Control |
| (5) RCA-6K7..... | First I-F Amplifier |
| (6) RCA-6K7..... | A-V-C, A-F-C, and Eye I-F Amplifier |
| (7) RCA-6K7..... | Second I-F Amplifier |
| (8) RCA-6H6..... | Second Detector |

| | |
|-------------------|-------------------------|
| (9) RCA-6H6..... | A.V.C., A.F.C., and Eye |
| (10) RCA-6C5..... | First Audio Amplifier |
| (11) RCA-6F6..... | Audio Driver |
| (12) RCA-6L6..... | Power Output |
| (13) RCA-6L6..... | Power Output |
| (14) RCA-6G5..... | "Magic Eye" Tuning Tube |
| (15) RCA-5T4..... | Half-wave Rectifier |
| (16) RCA-5T4..... | Half-wave Rectifier |

Pilot Lamps (11)..... Mazda No. 46, 6.3 volts, 0.25 amp.

POWER SUPPLY RATINGS

| | |
|---------------|--|
| Rating A..... | 105-125 volts, 50-60 cycles, 200 watts |
| Rating B..... | 105-125 volts, 25 cycles, 200 watts |
| Rating C..... | 100-130/140-160/195-250 volts, 50-60 cycles, 200 watts |

POWER OUTPUT

| | |
|------------------|----------|
| Undistorted..... | 25 watts |
| Maximum..... | 30 watts |

LOUDSPEAKER

| | |
|-----------------------|-------------------------|
| Type..... | 12-inch Electrodynamic |
| Impedance (v.c.)..... | 11.5 ohms at 400 cycles |

Mechanical Specifications

| | |
|-----------------------------------|--|
| Height..... | 43 inches |
| Width..... | 30 ³ / ₈ inches |
| Depth..... | 17 ³ / ₄ inches |
| Weight (net)..... | 124 pounds |
| Weight (shipping)..... | 168 pounds |
| Chassis Base Dimensions..... | 22 ¹ / ₈ inches x 12 ³ / ₈ inches x 4 ¹ / ₈ inches |
| Over-all Chassis Height..... | 12 ⁷ / ₈ inches |
| Operating Controls..... | (1) Power Switch—Speech-Music, (2) Volume, (3) Tuning, (4) Range Selector, (5) Manual-Electric-Remote, (6) Fidelity |
| Tuning Drive Ratios (manual)..... | 10 to 1 and 50 to 1 |

Copyright, 1937, RCA Manufacturing Co., Inc.

Trademarks "Radiotron," "Magic Eye," "Magic Voice," "Magic Brain" Reg. U. S. Pat. Off. by RCA Mfg. Co., Inc.

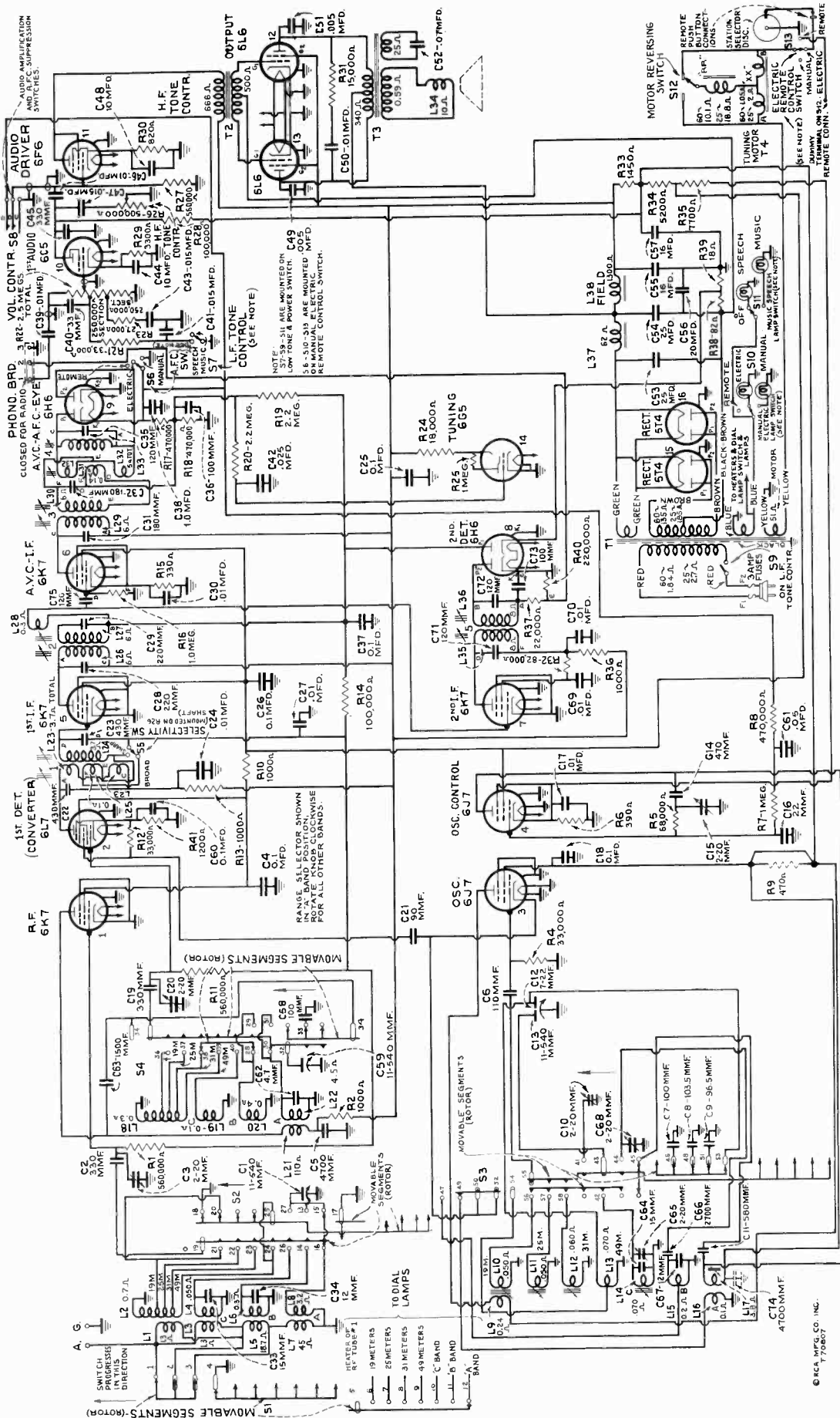

Figure 1—Schematic Circuit Diagram

© RCA, 1936

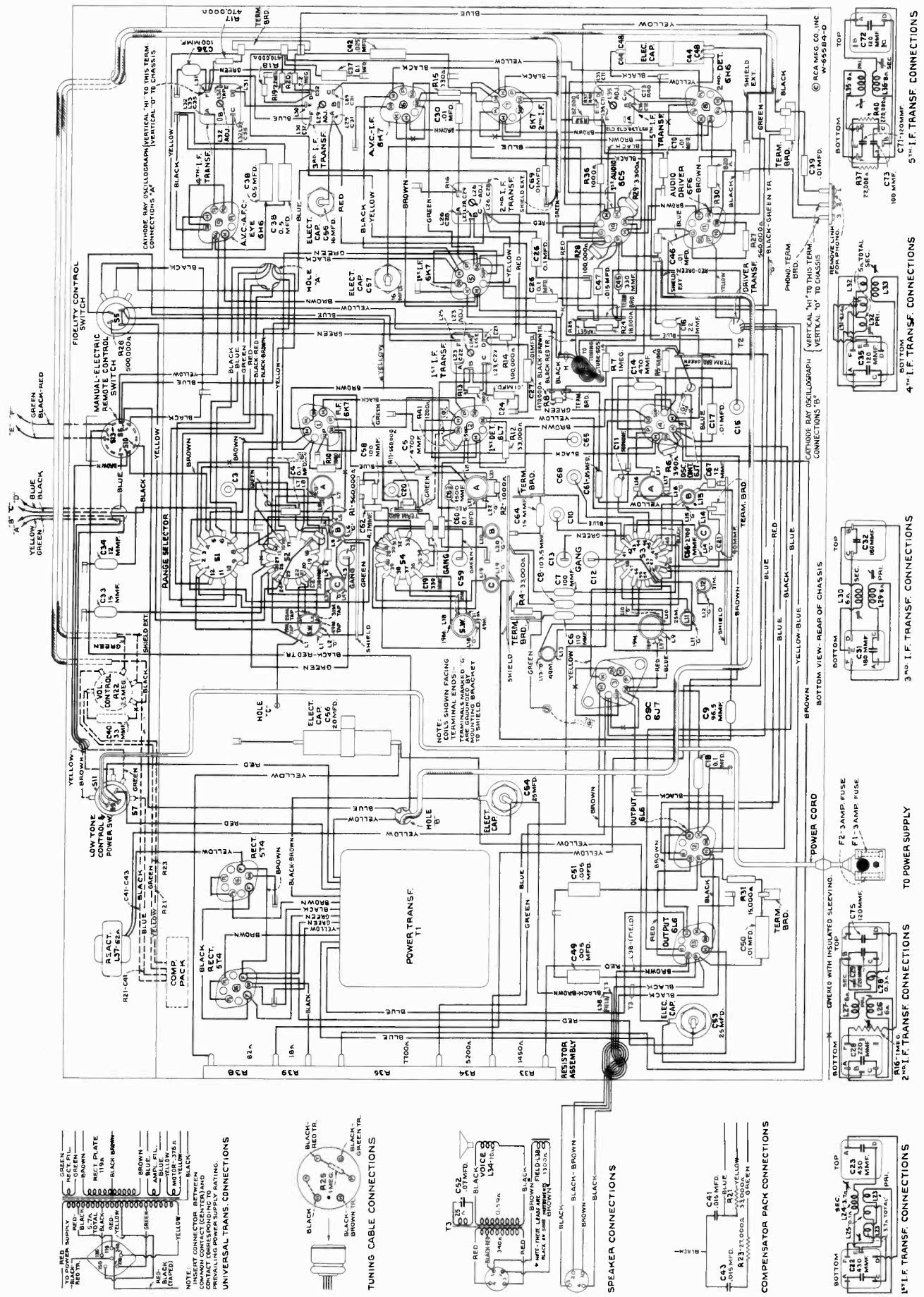
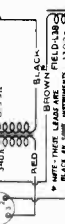
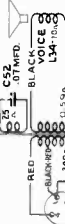
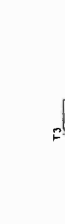
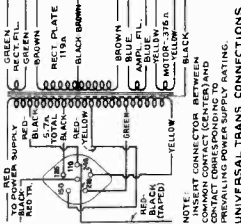

Figure 2—Chassis Wiring Diagram



General Description

This receiver employs a sixteen-tube, seven-band, "Magic Brain" superheterodyne circuit. Features of design include "Electric Tuning" with push-button operation; automatic frequency control; spread-band "Overseas" dial; "cumulative-wound" antenna and detector "A" band coils; tuned r-f amplifier; magnetite-core adjusted i-f transformers and low-frequency "A" and "C" oscillator tracking; two-stage signal i-f amplifier; parallel a-v-c., a-f-c., and "Magic Eye" i-f ampli-

fier; phonograph terminal board; "Magic Eye" tuning tube; twelve-inch electrodynamic loudspeaker; plunger-type, air-dielectric trimming capacitors; temperature-stabilized capacitors; two-point aural-compensated volume control; "Fidelity" control; "Music-Speech" control; and a driven push-pull power output stage. In addition, this model has a cabinet incorporating the "Sonic Arc" Magic Voice.

Circuit Arrangement

The circuit consists of an r-f amplifier stage, first-detector (converter) stage, separate heterodyne-oscillator stage, oscillator control stage, two signal i-f amplifier stages, diode detector stage, a parallel automatic-frequency-control and automatic-volume-control i-f amplifier stage, diode automatic-frequency and volume control stage, audio voltage-amplifier stage, audio driver stage, beam power tube push-pull power-amplifier stage, tuning indicator "Magic Eye," and a full-wave rectifier.

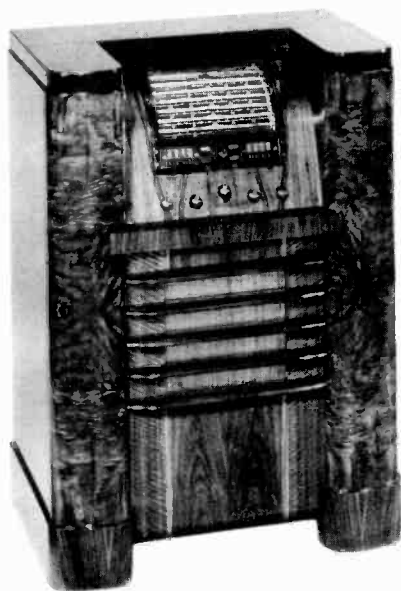

Model 816K

The antenna and first-detector coils are constructed with a special type of winding ("cumulative") to provide increased sensitivity and selectivity on the "Standard Broadcast" band. Special capacitors shunting the spread-band oscillator coils change in capacity with temperature variations to reduce oscillator frequency drift.

Spread-band tuning is accomplished electrically by shunting the low-capacity section of the oscillator variable capacitor with relatively large temperature-stabilized fixed capacitors for tuning the oscillator coil on the "19M," "25M," "31M," and "49M" bands. Antenna and first-detector coils are designed to be sufficiently broad-tuned to require no variable tuning over the narrow frequency range of the spread-bands.

The spread-band oscillator coils and the "Standard Broadcast," "M.W.," and "S.W." band oscillator, first detector, and antenna coils are all wound on separate forms. The antenna and first detector spread-band coils are tapped. Undesirable interaction between coils is avoided by shorting proper unused sections by means of the range selector.

The signal intermediate-frequency amplifier consists of two RCA-6K7 tubes in a two-stage transformer-coupled circuit. The windings of all i-f transformers are resonated by fixed capacitors and are adjusted by molded magnetite cores to tune to 460 kc. A third winding, L25, in the first i-f transformer, closely coupled to the primary, L23, is placed in series with the main secondary, L24, when the fidelity control switch S5 is thrown to "broad" position (see figure 1), thereby increasing the coupling between the primary and sec-

ondary circuits with a consequent broadening of the band width of the i-f amplifier, permitting higher fidelity reception. The grid of the automatic-volume-control i-f amplifier is supplied by winding L28.

The function of the automatic-frequency-control circuit is to automatically change the frequency of the heterodyne oscillator so that the correct i-f frequency is formed for the i-f amplifier. The circuit consists essentially of an i-f discriminator which, as the name implies, discriminates or furnishes control voltage of the correct polarity to an oscillator frequency-control tube for generated i-f carrier frequencies slightly above and below 460 kc, or the frequency to which the i-f amplifier is tuned.

The plate circuit of the RCA-6J7 oscillator control tube is caused to act as an apparent variable inductance in parallel with the "A" band oscillator tuned circuit of which coil L17 is a part. The series combination of resistor R5 and the capacitor C16 is also in parallel with the oscillator tuned circuit. Since the resistance of R5 is many times greater than the reactance of C16, at the oscillator frequency, the r-f current through the combination will be practically in phase with the r-f voltage across the oscillator tuned circuit. However, the r-f voltage impressed across the C16 capacitance section of the combination, or from grid to cathode, will lag the r-f voltage across the combination, or the tuned circuit, approximately 90 degrees. The grid-cathode r-f voltage will be amplified by the control tube but will be shifted an additional 180 degrees (grid and plate voltages of all tubes are always opposite in phase) so that the amplified r-f voltage appearing across the plate circuit will now lead the voltage across the combination or the tuned circuit by 90 degrees, or, in other words, the control tube is acting as an equivalent shunt inductance. The amount of this action is determined by the amplification of the tube, which in turn is governed by the grid-cathode bias voltage. In operation a residual bias is developed across the cathode resistor R6. The d-c control grid voltage is fed to the control grid from the discriminator circuit through resistor R7. If this voltage is negative with respect to ground, the amplification of the control tube will be decreased, the apparent plate circuit inductance of the tube increased, which will lower the frequency of the oscillator tube. The converse will occur when the grid voltage is positive with respect to ground.

The action of the discriminator circuit depends upon the fact that a 90-degree phase difference exists between the primary and secondary potentials of a double-tuned loosely-coupled transformer when the resonant frequency is applied and that this phase difference varies as the applied frequency varies, i.e., the maximum resultant response voltage across the primary and secondary windings connected in series will occur at a frequency either lower or higher in frequency than the frequency to which the individual windings are resonated, respectively depending on whether the windings are connected series aiding or opposing.

The discriminator, or fourth i-f transformer, consists of the primary winding, L31, which is a part of the third i-f transformer secondary tuned circuit (tuned to 460 kc) and the center-tapped secondary, L32. The upper and lower halves of L32 may be considered as two secondary coils, the upper series aiding and the lower series opposing the primary, L31. The magnetite core in L32 is inserted to inductively balance the two halves. The function of coil L33 (magnetite core adjusted), in parallel with L32, is to tune the secondary to 460 kc. Therefore, the maximum voltage will be applied to diode circuit P₁K₁ and R17 when the i-f signal frequency is below 460 kc and to the diode circuit P₂K₂ and R18 when the i-f signal frequency is above 460 kc. Resistors R17 and R18 are connected in series between ground and a point leading to the oscillator control tube grid.

D-c voltages, resulting from diode rectification, across R17 and R18 are always in opposition, consequently the oscillator control-tube grid-bias voltage is a differential amount, depending upon the i-f signal strength and its frequency deviation from the nominal value of 460 kc. The polarity of this differential oscillator control-tube grid-bias, with respect to

ground, depends on whether the i-f signal frequency is above or below 460 kc, but is always in the direction which will bring the generated i-f frequency nearer to 460 kc. A-f-c action is automatically eliminated for "manual" tuning by grounding diode cathode K₁ through switch S6.

Service Data

The various diagrams of this booklet contain such information as will be needed to isolate causes for defective operation if such develops. The ratings of the resistors, capacitors, coils, etc., are indicated adjacent to the symbols signifying these parts on the diagrams. Identification titles such as R1, L1, C1, etc., provide reference between the illustrations and Replacement Parts List. The coils, transformer windings, and reactors are rated in terms of d-c resistance to permit continuity checks.

Precautionary Lead Dress.—(1) Green bus lead from C1 to S2 should be 2¾ inches long, (2) green bus lead from C59 to S4 should be 2½ inches long, (3) green bus lead from C13 to S3 should be 2¾ inches long, (4) bare bus lead from C12 to S3 should be 1½ inches long, (5) blue and red leads from tube No. 3 to L9 should be dressed away from the coil, (6) tube No. 3 grid lead should be 6 inches long, (7) all leads to rear of oscillator coils should be dressed close to the chassis, (8) clamp "Magic Eye" cable to the dial bracket, (9) filament leads should all be twisted, (10) leads from C44 and C48 should be replaced dressed away from other leads, (11) twisted a-c leads near R22 should be dressed away from R22, (12) leads from S5 to the first i-f transformer should be twisted, (13) temperature-stabilizing capacitors marked 1A, 2A, and 3A should be

dressed perpendicular to chassis, (14) blue bus lead from L21 to tube No. 1 plate should be dressed away from shield plate on range selector assembly, (15) C36, C38, and K₂ of tube No. 9 should be grounded to the ground lances near corner of chassis. The following should be dressed away from chassis: (16) Yellow bus lead from cathode of tube No. 3 to S3, (17) yellow bus lead to OG of tube No. 2, (18) yellow bus lead from the 5th i-f transformer to phonograph terminal board, (19) blue bus lead from C47 to R26. When necessary to replace bus leads, use only wire having same diameter as original.

Phonograph Attachment.—A terminal board is provided for connecting a phonograph into the audio-amplifying circuit. RCA Victor Models R-93, R-93-A, R-93-2, or R-94 Record Players should be connected as follows: Remove the link from the phonograph terminal board. Connect green wire in Radio-Record switch cable to terminal 1; yellow to terminal 2; shield terminal 3; and tape up the red and blue. Connect a 2-conductor twisted cable between the Record Player binding posts and the screw-terminals on Radio-Record switch. If additional volume is desired, connect an RCA Stock No. 9632 transformer between the 2-conductor twisted cable and the screw-terminals on Radio-Record switch as follows: Yellow and brown transformer leads and one side of twisted cable to ground screw-terminal

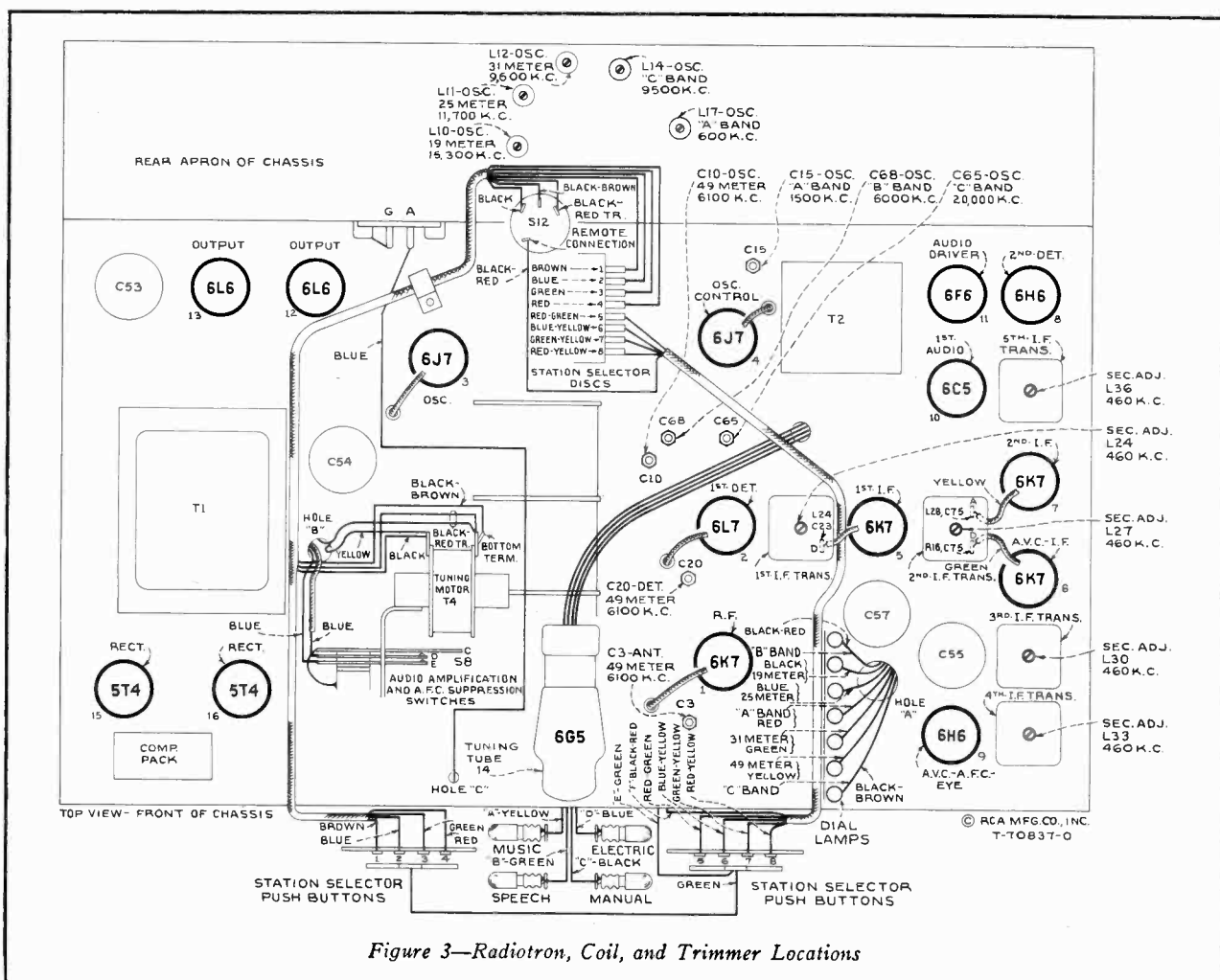

Figure 3—Radiotron, Coil, and Trimmer Locations

on switch; black transformer lead to other side of twisted cable; and blue transformer lead to other screw-terminal on switch.

Loudspeaker.—Two types of loudspeakers are used which will be referred to as types 1 and 2. In type 1 the cone centering diaphragm is cemented to a fixed ring, while in type 2 the centering diaphragm is cemented to an adjustable ring. Replacement of cone for either type is identical. Centering of cone for type 1 loudspeaker is made with three narrow celluloid or paper feelers after first removing the front dust

cover and cutting free the cone centering diaphragm. The dust cover may be removed by a light application of acetone, using care not to allow the acetone to flow into the air gap. The centering diaphragm should be cemented in place after placement of feelers. Sufficient time should be allowed for the ambroid to set before removing feelers. Use ambroid to replace dust cover. Centering of cone for type 2 loudspeaker differs only in that it is not necessary to cut free the centering diaphragm, adjustment being made in the usual manner by means of screws on the adjustable cone centering ring.

Alignment Procedure

Calibrate the tuning dial by adjusting dial pointer to the left ends of horizontal calibration lines with the gang tuning-condenser plates in full-mesh position. This is a screw-driver adjustment.

The "Fidelity" control should be turned counter-clockwise during all alignment operations. The "Manual-Electric-Remote" switch should be turned to "Manual" (clockwise) during alignment unless otherwise specified. The bottom shield pan must be in place during spread-band alignment. Permit the set to operate at least five minutes before attempting alignment.

CAUTION.—The magnetite core screw L32 on the bottom of the 4th i-f transformer has been accurately adjusted, for an exact electrical balance of coil L32 to center tap, during manufacture and should not be disturbed. However, if for any reason the adjustment has been moved from its original position, it will be necessary to mechanically adjust this screw until the end of the stud protrudes exactly $\frac{1}{8}$ of an inch (four threads exposed) above the brass bushing prior to any alignment operations.

Perform alignment in proper order, tabulated below, starting with No. 1 and following all operations across, then No. 2, etc. A-f-c discriminator adjustments should follow r-f and i-f adjustments tabulated below. Adjustment locations are shown on figures 3 and 6.

Cathode-ray alignment is preferable; the connections to the chassis are shown on figure 2. Cathode-ray connection "A" is used for adjustment of i-f transformers Nos. 1, 2, and 3 and connection "B" for adjustment of i-f transformer No. 5. If an output indicator is used, connect it across the loudspeaker voice-coil and advance the receiver volume control to full-volume position. The Magic Eye may be used as an output indicator for all adjustments except L35 and L36. It is preferable to replace the 6G5 tuning tube with a 6E5 during alignment.

Connect the "low" output terminal of the test oscillator to the receiver chassis for all alignment operations. Regulate the output of the test oscillator so that minimum signal is applied to the receiver to obtain an observable output indication. This will avoid a-v-c action and reduce possibility of error in spread-band adjustments.

The term "Dummy antenna" means the device which must be connected between the "high" test-oscillator output and the point of connection to the receiver in order to obtain ideal alignment. "No signal, 550-750 kc" means that the receiver should be tuned to a point between 550 and 750 kc where no signal or interference is received from a station or local (heterodyne) oscillator. "Min. Eye" means minimum width of dark sector of Magic Eye.

For further details on alignment, refer to booklet "RCA Victor Receiver Alignment."

| Order of Alignment | Test Oscillator | | | Range-Selector | Receiver Dial Setting | Circuit to Adjust | Adjustment Symbols | Adjust to Obtain |
|--------------------|----------------------------|---------------|-----------------------|----------------------|-----------------------|-----------------------|--------------------|--------------------------------|
| | Connection to Receiver | Dummy Antenna | Frequency Setting | | | | | |
| 1 | — | — | — | — | — | 4th I-F Trans. | L33 | Turn Extreme Counter-clockwise |
| 2 | No. 6 6K7 Eye I-F Grid Cap | .001 Mfd. | 460 kc | "Standard Broadcast" | No Signal 550-750 kc | 3rd I-F Trans. | L29 and L30 | Min. Eye |
| 3 | No. 5 6K7 1st I-F Grid Cap | .001 Mfd. | 460 kc | "Standard Broadcast" | No Signal 550-750 kc | 2nd I-F Trans. | L26 and L27 | Min. Eye |
| 4 | No. 2 6L7 Det. Grid Cap | .001 Mfd. | 460 kc | "Standard Broadcast" | No Signal 550-750 kc | 1st I-F Trans. | L23 and L24 | Min. Eye |
| 5 | No. 2 6L7 Det. Grid Cap | .001 Mfd. | 460 kc | "Standard Broadcast" | No Signal 550-750 kc | 5th I-F Trans. | L35 and L36 | Max. (peak) |
| 6 | Ant. Term. | 300 Ohms | 6,000 kc _a | "49M." | 6.0 mc | "49M." Osc. | C10 | Min. Eye _b |
| 7 | Ant. Term. | 300 Ohms | 6,100 kc | "49M." | 6.1 mc | "49M." Osc. | C10 | Min. Eye |
| 8 | Ant. Term. | 300 Ohms | 6,100 kc | "49M." | 6.1 mc | "49M." Det. | C20 | Min. Eye |
| 9 | Ant. Term. | 300 Ohms | 6,100 kc | "49M." | 6.1 mc | "49M." Ant. | C3 | Min. Eye |
| 10 | Ant. Term. | 300 Ohms | 1,200 kc _c | "31M." | 9.6 mc | "31M." Osc. | L12 | Min. Eye _d |
| 11 | Ant. Term. | 300 Ohms | 1,300 kc | "25M." | 11.7 mc | "25M." Osc. | L11 | Min. Eye _e |
| 12 | Ant. Term. | 300 Ohms | 1,700 kc | "19M." | 15.3 mc | "19M." Osc. | L10 | Min. Eye _f |
| 13 | Ant. Term. | 300 Ohms | 20,000 kc | "S.W." | 20 mc | "S.W." H-F Osc. ("C") | C65 | Min. Eye _g |
| 14 | Ant. Term. | 300 Ohms | 9,500 kc | "S.W." | 9.5 mc | "S.W." L-F Osc. ("C") | L14 | Min. Eye _h |

| Order of Alignment | Test Oscillator | | | Range-Selector | Receiver Dial Setting | Circuit to Adjust | Adjustment Symbols | Adjust to Obtain |
|--|---|---------------|-------------------|----------------------|-----------------------|-----------------------|--------------------|------------------|
| | Connection to Receiver | Dummy Antenna | Frequency Setting | | | | | |
| 15 | Ant. Term. | 300 Ohms | 20,000 kc | "S.W." | 20 mc | "S.W." H-F Osc. ("C") | C65 | Min. Eye |
| 16 | Ant. Term. | 300 Ohms | 6,000 kc | "M.W." | 6.0 mc | "M.W." Osc. ("B") | C68 | Min. Eye |
| 17 | Ant. Term. | 200 Mmfd. | 1,500 kc | "Standard Broadcast" | 1,500 kc | "A" H-F Osc. | C15 | Min. Eye |
| 18 | Ant. Term. | 200 Mmfd. | 600 kc | "Standard Broadcast" | 600 kc | "A" L-F Osc. | L17 | Min. Eye |
| 19 | Ant. Term. | 200 Mmfd. | 1,500 kc | "Standard Broadcast" | 1,500 kc | "A" H-F Osc. | C15 | Min. Eye |
| 20 | Proceed to A-F-C Discriminator Adjustments Outlined Below | | | | | | | |
| <p>a—Refer to "Spread-band Adjustments" below for method of using the RCA Stock No. 9572 Crystal Calibrator for adjustments 6, 7, 8, and 9.</p> <p>b—Use minimum capacity peak if two peaks can be obtained from 1,000 kc harmonics.</p> <p>c—Refer to "Spread-band Adjustments" below for Test Oscillator setting for adjustments 10, 11 and 12.</p> <p>d—To check for correct harmonic carefully set Test Oscillator to 1,600 kc using Crystal Calibrator. Signal should be indicated by "Magic Eye" in "31M." band near 9.6 mc.</p> <p>e—To check for correct harmonic carefully set Test Oscillator to 900 kc using Crystal Calibrator. Signal should be indicated by "Magic Eye" in "25M." band near 11.7 mc.</p> <p>f—To check for correct harmonic carefully set Test Oscillator to 900 kc using Crystal Calibrator. Signal should be indicated by "Magic Eye" in "19M." band near 15.3 mc.</p> <p>g—After this adjustment, check for image signal by shifting receiver dial to 19.08 mc. (19,080 kc).</p> <p>h—Check for image at 8.58 mc. (8,580 kc).</p> | | | | | | | | |

Spread-band Adjustments.—Alignment of the spread ("Overseas") bands requires special procedure since test oscillators used alone are not ordinarily sufficiently accurate for this purpose. The RCA Stock No. 9572 Crystal Calibrator affords a convenient and accurate alignment standard. Wrap a few turns of wire around the crystal calibrator and connect one free end to the antenna terminal of the receiver. Snap crystal calibrator "Hi-Lo" switch to "Hi" (1,000 kc), turn the range selector to "49M." band, and set receiver dial pointer to 6.0 mc. Adjust oscillator trimming capacitor C10 for minimum "Magic Eye" opening (Min. Eye). Use the peak indicated by the alignment table. Snap "Hi-Lo" switch to "Lo" (100 kc) and locate 6,100 kc (the first 100 kc harmonic above 6,000 kc) by slightly readjusting C10 with the dial pointer set at 6.1 mc. This method insures selection of correct crystal calibrator harmonic. Adjust 1st detector and antenna trimming capacitors, C20 and C3, for maximum output.

Follow the tabulated alignment procedure for the "31M.", "25M.", and "19M." bands. Use the crystal calibrator to obtain the necessary accuracy. For example, tune the receiver to the 1,000 kc crystal calibrator output with the crystal calibrator "Hi-Lo" switch in "Hi" position. Snap "Hi-Lo" switch to "Lo" and carefully tune receiver to 1,200 kc (the second 100 kc harmonic above 1,000 kc) for minimum "Magic Eye" opening. Move crystal calibrator away from antenna wire, connect test oscillator, and carefully adjust test oscillator for minimum "Magic Eye" opening at a setting of approximately 1,200 kc. Raise test-oscillator output to give sufficient harmonic output and use 8th harmonic (9,600 kc) for aligning in "31M." band at 9.6 mc. Align in the "25M." band at 11.7 mc, (11,700 kc), the 9th harmonic of the test-oscillator 1,300 kc output. Align in the "19M." band at 15.3 mc (15,300 kc), the 9th harmonic of the test-oscillator 1,700 kc output. In each case select the peak giving minimum "Magic Eye" opening.

When aligning with the RCA Stock No. 150 Test Oscillator use the variable (unmodulated) oscillator† and "Magic Eye" indication of receiver output. Set test-oscillator dial 800 kc lower than the desired signal for the four lower frequency ranges and 800 kc higher than the desired signal for the two high ranges and use in same manner as TMV97-C. Insert an open-circuit telephone plug in the test oscillator "Ext. Mod." jack, so the modulated fixed-frequency oscillator

† The No. 150 Test Oscillator employs a fixed-frequency (800 kc), modulated oscillator and a variable, unmodulated oscillator. The scale is calibrated to the sum frequency for the two higher frequency ranges and to the difference frequency for the four lower frequency ranges.

will be cut off, and align on the unmodulated variable oscillator signal, which will close the "Magic Eye" and evidence itself by a rushing noise in the speaker.

If the crystal calibrator signals are weak, disconnect test oscillator while using the crystal calibrator.

More accurate alignment in the spread-bands can be accomplished by making final slight adjustments using American, English, or German short-wave broadcasting stations of known frequency for frequency standards.

A-F-C Discriminator Adjustments.—These adjustments are rather critical and should be performed with extreme care. Improper adjustment may result in complete failure of the oscillator control tube to function or else may cause it to detune the oscillator instead of tuning it to the signal. It is assumed that the magnetite core adjusting screw L33 (top of 4th i-f transformer) has been turned all the way out (extreme counter-clockwise) during the preceding tabulated adjustments. Adjustments are as follows: Remove spring "N" on link and arm assembly which connects the "Manual-Electric-Remote" switch shaft to the throw-out gear bracket. Turn "Fidelity" control counter-clockwise. Connect antenna to receiver antenna terminal. With the "Manual-Electric-Remote" switch in "Manual" (right) position, tune in a strong local station near 600 kc or the low-frequency end of the "A" band as accurately as possible by means of the tuning tube "Magic Eye." The most accurate adjustment will be obtained by adjusting the "vernier" tuning knob mid-way between the two points where the eye just appears to start to open. This will place the generated i-f carrier signal frequency exactly in the center of the i-f amplifier response curve (should be 460 kc if i-f amplifier was properly aligned) and is the frequency to which the a-f-c discriminator (4th i-f transformer) should be tuned to resonance. Without disturbing any of the receiver adjustments, place the "high" test-oscillator lead about 3/4 of an inch from the grid cap lead of the RCA-6K7, 1st i-f amplifier tube, adjust the test-oscillator output to maximum, turn test-oscillator "Modulation" off, and carefully zero-beat the test-oscillator frequency (approximately 460 kc) with the i-f carrier signal. Avoid placing the test-oscillator lead nearer to the grid cap lead than specified above, as doing so will tend to detune the i-f amplifier. It may be necessary to reduce the local station signal, during this operation, by shortening antenna lead or grounding antenna "A" terminal to chassis in order to increase the loudness of the beat note sufficiently for accurate zero-beat adjustment.

Throw "Manual-Electric-Remote" switch to "Electric" (center) position. A high whistle or beat note will now be heard. Turn the magnetite core screw L33 (top of 4th i-f

RCA MFG. CO., INC.
SN-754

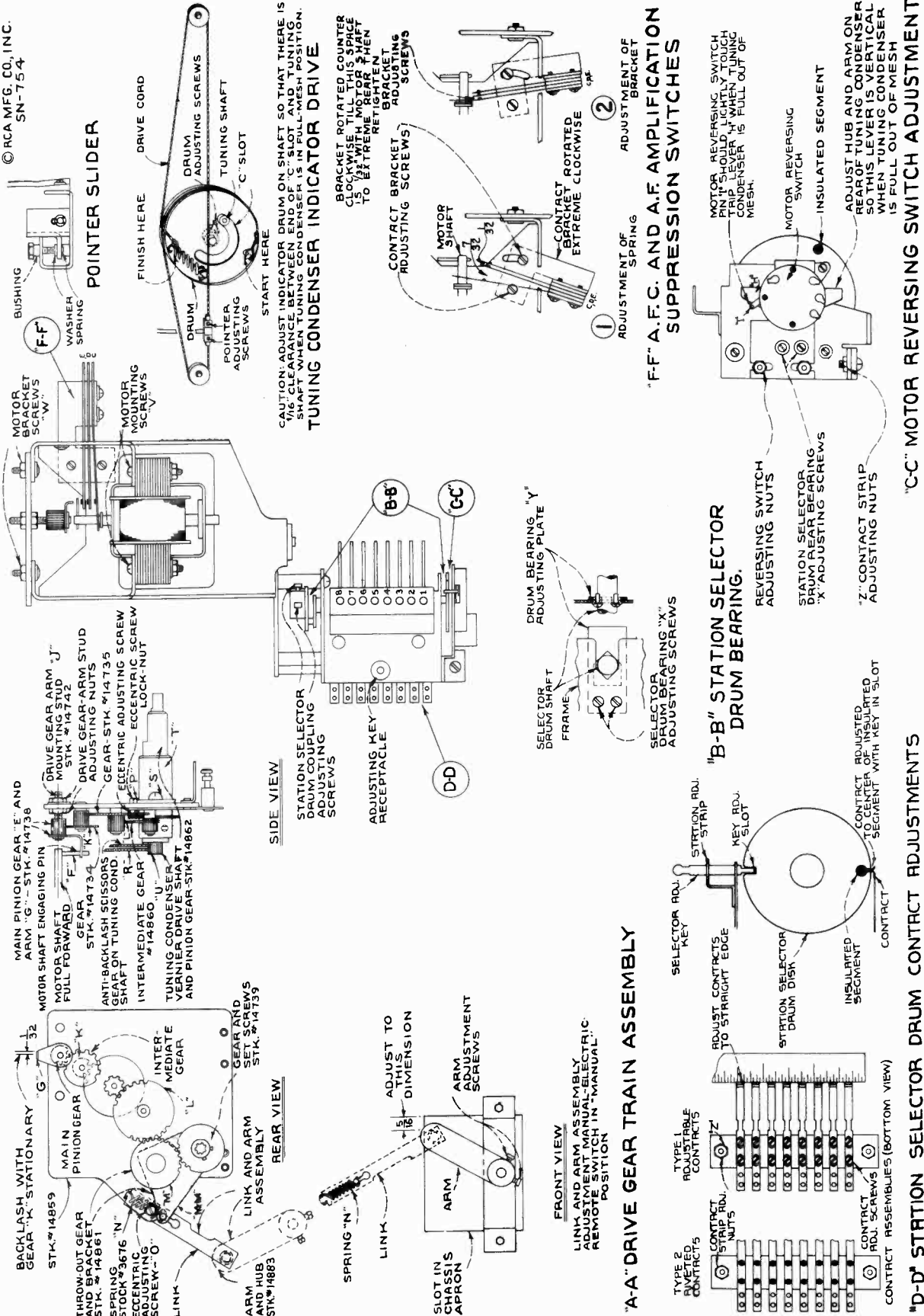

Figure 4—"Electric Tuning" Mechanism Adjustments

transformer) slowly clockwise. As this screw is turned, the beat note will first increase to a high audio frequency and will then decrease to a zero-beat and then increase in frequency again. The point of exact zero-beat is the position for correct adjustment of the discriminator. Zero-beat should also still exist when the "Manual-Electric-Remote" switch is

thrown back to "Manual" position. The adjustment is now complete and may be checked by slightly detuning the receiver above and below the local station frequency with the "Manual-Electric-Remote" in "Manual" position, switching to "Electric" position, and noting the oscillator pull-in. Replace spring "N."

ELECTRIC TUNING

Principle of Operation

The electric tuning mechanism consists essentially of a quick engaging and dis-engaging reversible electric motor, tuning condenser driving gear train, and eight mechanically interlocked (pushing one button releases all others) station selector push buttons respectively wired to eight adjustable station selector contactor discs (each with a motor stopping insulated segment) mounted on a drum which is direct-coupled to the gang tuning condenser shaft. The arrangement permits any one of eight pre-determined stations to be electrically tuned in by merely touching the correct push button. If all eight buttons are inadvertently locked in, firmly pushing the right-hand button will release them.

The operation may be more readily understood by reference to figures 1, 4, and 5. When the motor is not energized, the armature is pushed to the rear or slightly out of the magnetic center by tension of contact spring "C" and the motor shaft is dis-engaged from the driving gear train. Pressing in any one of the eight push buttons will complete the motor circuit through a station selector contactor disc, assuming that the "Manual-Electric-Remote" switch is in "Electric" position and that the insulated segment in the contactor disc is not opposite its contactor. As the motor starts, the armature will be drawn forward, due to solenoid action, and the pin "F" on the end of its shaft will engage the arm "G" on the small main pinion gear, thereby driving the tuning mechanism. At the same time contact springs "E" and "D" will be grounded, causing suppression of audio

amplification and automatic frequency control during the tuning cycle. The motor will continue to operate until the in-

Radiotron Cathode Current Readings

Measured with Milliammeter Connected at Tube Socket Cathode Terminals Under Conditions Similar to Those of Voltage Measurements

| | |
|--|----------|
| (1) RCA-6K7—R-F Amp..... | 6.2 ma. |
| (2) RCA-6L7—1st Det..... | 3.0 ma. |
| (3) RCA-6J7—Osc..... | 10.0 ma. |
| (4) RCA-6J7—Osc. Control..... | 1.2 ma. |
| (5) RCA-6K7—1st I-F Amp..... | 6.7 ma. |
| (6) RCA-6K7—A.V.C., A.F.C., Eye I-F Amp..... | 8.0 ma. |
| (7) RCA-6K7—2nd I-F Amp..... | 6.9 ma. |
| (8) RCA-6H6—2nd Det..... | — |
| (9) RCA-6H6—A.V.C., A.F.C., and Eye.. | — |
| (10) RCA-6C5—A-F Amp..... | 1.0 ma. |
| (11) RCA-6F6—Driver..... | 23.0 ma. |
| (12) RCA-6L6—Output..... | 51.5 ma. |
| (13) RCA-6L6—Output..... | 51.5 ma. |
| (14) RCA-6G5—Tuning Tube..... | 2.2 ma. |
| (15) RCA-5T4—Rectifier..... | 90 ma.** |
| (16) RCA-5T4—Rectifier..... | 90 ma.** |

(**Cannot be measured at socket)

ulated segment in the selector disc breaks the motor circuit, whereupon spring "C" will instantly dis-engage the motor pin-

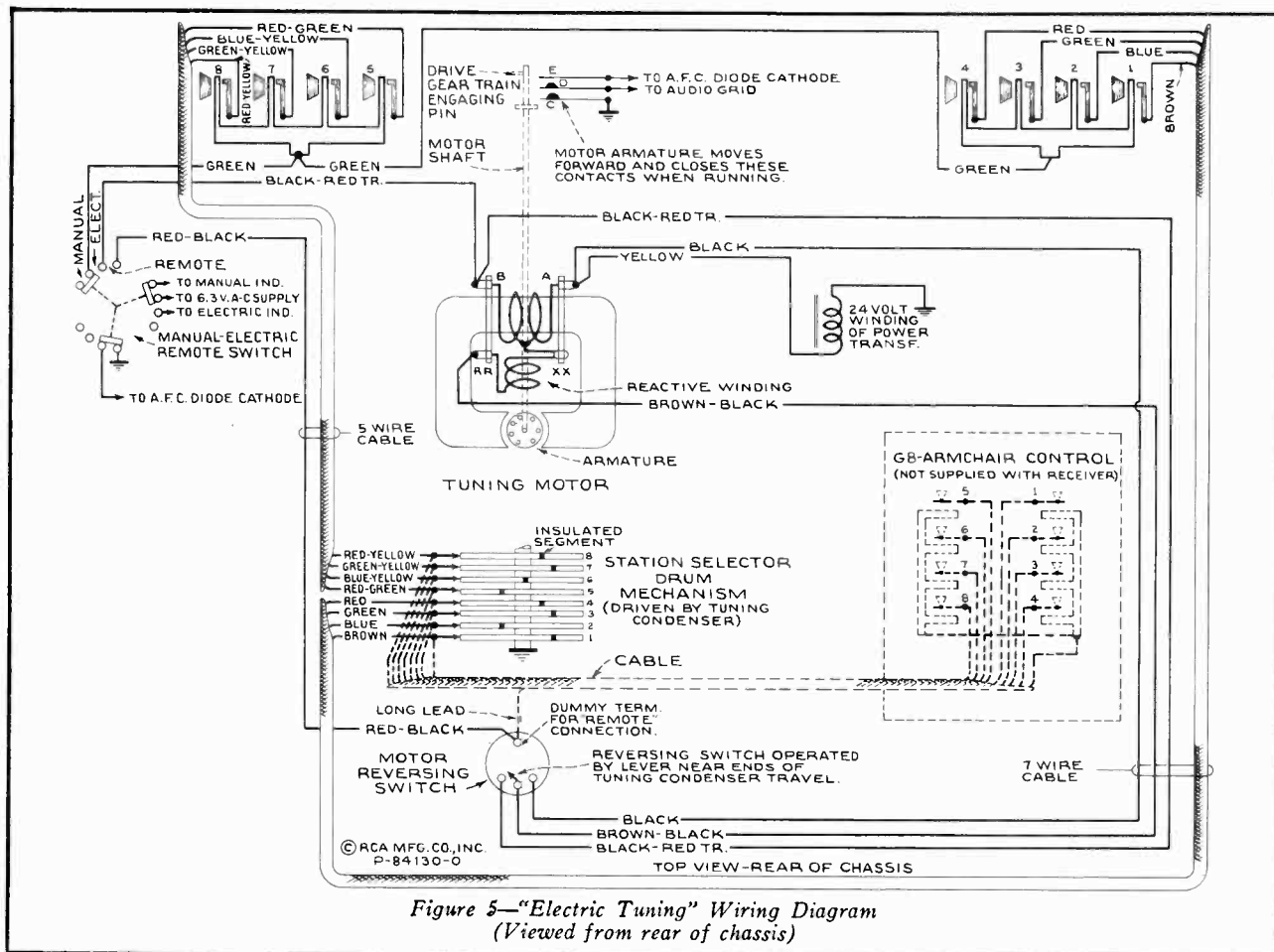

Figure 5—"Electric Tuning" Wiring Diagram (Viewed from rear of chassis)

"F" from the arm "G" on the small pinion driving gear and open contacts "E" and "D." Pushing another button will cause the above mentioned cycle to be repeated except that the motor will be interrupted by the insulated segment on a corresponding disc. The discs are individually adjustable on a drum mechanism, providing a choice of eight "Electric Tuned" "Broadcast" stations. The arrangement of the motor is such that its rotation will continue in the same direction regardless of the number of "Electric" tuning cycles until the tuning condenser approaches either full-out or full-in of mesh, whereupon lever "H" trips switch S12 which reverses the direction of rotation. A throw-out idler gear is link-coupled to the "Manual-Electric-Remote" control to disconnect the motor drive gear train when the control is thrown to "Manual" position.

Mechanism Adjustments

The electric tuning mechanism is designed to be as simple in construction and as fool proof in operation as is possible. In order to maintain the accurate results possible with this device care must be taken in effecting any repairs or adjustments. Reference should be made to figure 4 and the following:

A-F-C and A-F Amplification Suppression Switches.—This switch assembly is located on the motor bracket and closes due to solenoid action of motor armature. The tension of the long contact spring "C" is important in bringing about quick disengagement of the motor and in permitting the motor to pull into mesh with the drive mechanism. Normal adjustment is attained when the short springs "D" and "E" are aligned exactly straight with contact points separated approximately 1/32 of an inch and with the spring "C" spaced approximately 7/32 of an inch from spring "D" at the point of contact. If necessary, in order to obtain positive pull-in and quick disengagement of the motor, the tension of spring "C" should be increased or decreased by bending. This action should be checked with the front apron of the chassis raised two inches higher than the rear. Contacts of the switch must be kept clean. Crocus cloth or a relay burnisher may be used for this purpose.

Motor Reversing Switch.—It is necessary to automatically stop and reverse the drive motor before the tuning condenser

reaches the ends of its travel. Approximately 175 degrees of sweep is required, and the reversal must take place above 1,700 kc and below 540 kc but not too near the limits of the scale. The coupling between the station selector drum and the tuning condenser shaft should be attached so that the reversing switch trip lever "H" is exactly vertical when the condenser is full-out of mesh. There should be 1/32 of an inch clearance between the end of the condenser shaft and the selector drum shaft. While the trip lever is in this position the reversing switch bracket should be adjusted by means of its elongated mounting holes until the switch pin "I" just lightly touches trip lever "H."

Main Pinion Gear.—Clearance between the small high-speed pinion gear "E" and the intermediate gear "K" determines the amount of mechanical noise produced. Correct adjustment will give approximately 1/32 of an inch movement of back lash at the end of pinion arm "G" when gear "K" is held stationary. Aim "G" must also be adjusted for correct mesh with motor shaft drive pin "F." With the motor shaft completely forward and pinion "E" tight against its front bearing, the pinion mounting stud "J" should be adjusted so that pin "F" meshes full thickness with the rotating arm "G." An increase of this mesh will increase over travel on tuning while a decrease of mesh will decrease the over travel. The elongated hole in the front bracket allows sufficient movement of the mounting stud "J" to permit above mentioned gear mesh adjustment.

"Manual-Electric-Remote" Changeover.—(1) Link and arm adjustment—To properly line up the mechanical link between the switch shaft and throw-out gear bracket "MM," the set screws holding the link arm on the switch shaft must be loosened, the switch turned to the "Manual" position (extreme right) and the link lever revolved until the distance between the link-connecting pin (extends through chassis apron) and the right-hand (viewed from front) side of the slot, in front apron of chassis, is exactly 5/16 of an inch. If this adjustment is not properly made, correct operation of "Electric" or "Remote" tuning will not result. (2) Throw-out Gear Adjustment—To obtain smooth operation on "Electric" or "Remote" positions it is important that the proper clearance is maintained between the throw-out gear "M" and the intermediate gear "L." With the "Manual-Electric-Re-

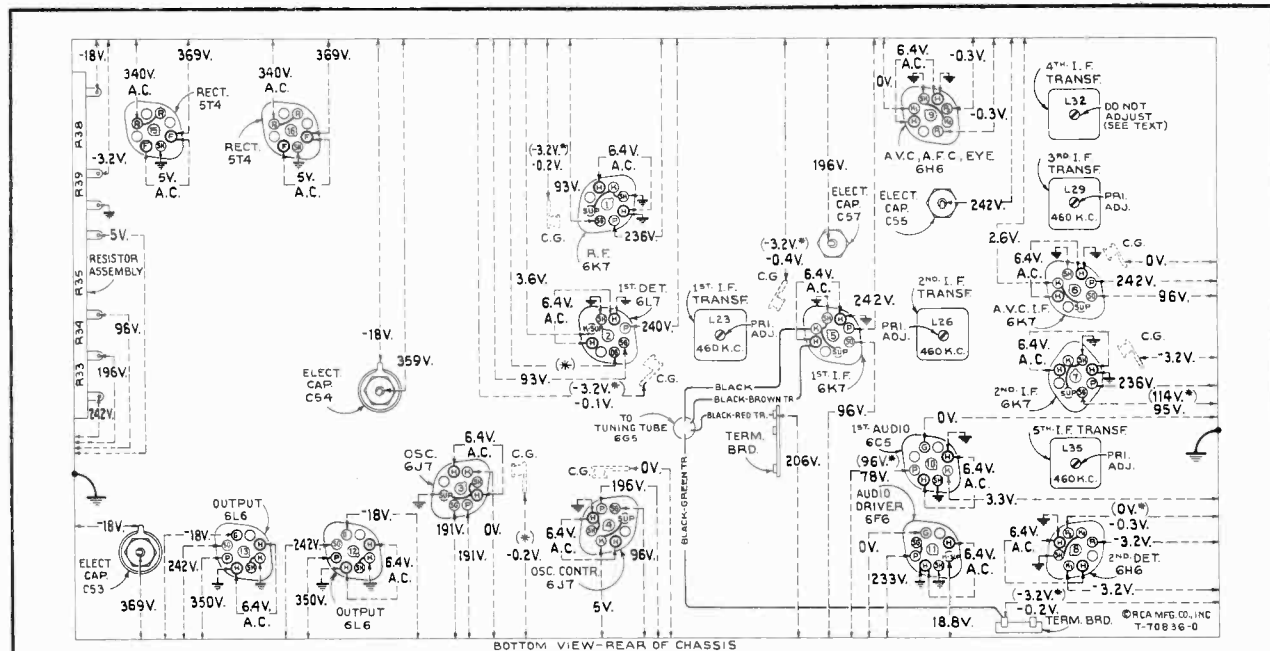

Figure 6—Radiotron Socket Voltages, Coil, and Trimmer Locations
 Measured at 115 volts, 60-cycle supply—Tuned to approximately 1,000 kc ("Standard Broadcast")—"Manual" control—
 No signal being received—Volume control minimum—Fidelity control optional

Note: Two voltage values are shown for some readings. The value shown in parentheses with asterisk () indicates operating conditions without voltmeter loading. The other value (generally lower) is the actual measured voltage and differs from the value shown in parentheses because of the additional loading of the voltmeter.*

Voltage values as specified should hold within $\pm 20\%$ when the receiver is normally operative at its rated line voltage. To duplicate the conditions under which the voltages were measured requires a 1,000-ohm-per-volt d-c meter, having ranges of 10, 50, 250 and 500 volts. Use the nearest range above the specified measured voltage. A-c voltages were measured with a corresponding a-c meter.

mote" control thrown to "Remote" position (extreme left) adjust the mesh between these gears by means of the eccentric screw "O" and lock nut "P," contacting the throw-out gear bracket "MM," until there is approximately 1/64 of an inch backlash of gear "L" when gear "M" is held stationary.

Vernier Tuning.—In case it becomes necessary to remove tuning condenser drive shaft "T," it should be replaced by sliding anti-backlash gear "R" on condenser shaft apart so that compression amounting to one tooth on the gear is obtained in the springs. Adjust mesh of gear "R" with pinion gear "U" on vernier shaft before tightening screws "S" so that smooth tuning is obtained throughout the range.

Motor Alignment.—The motor shaft must be exactly aligned with the axis of the pinion gear with which it engages. This may be adjusted by loosening the mounting screws "V" of the motor and aligning shaft by sight. Correct alignment may be tested by slowly rotating motor and observing the relation between the pin "F" of the motor shaft and the arm "G" on the pinion. The relation of the two should remain the same throughout the revolution. Additional movement for adjustment may be obtained by the motor bracket screws "W" if necessary.

Station Selector Drum.—(1) Bearing Adjustment—The selector drum may be removed by unscrewing the two bearing adjusting screws "X" on the front and rear bearings and sliding shaft out of slots on frame. To replace drum, the reverse procedure should be followed holding bearing adjusting plates "Y" firmly against the shaft and tightening adjusting screws. (2) Contact adjustment—Two types of contact strips are used. They are designated on figure 4, as types 1 and 2, on which the individual contacts are respectively adjustable and fixed. On type 1, the individual contacts should be adjusted by setting the end contact springs near the mid-position of their travel and aligning the remaining springs to them by means of a straight edge. Either type of contact strip should be adjusted to the selector drum by firmly placing two selector adjusting keys in the station adjustment strip, positions 1 and 8 (locking respective discs), loosening contact strip adjusting nuts "Z," and shifting the contact strip until the end contacts are exactly centered on the respective disc insulating segments. More accurate adjustment may be made by silhouetting the point of contact with a piece of white paper held behind the contact. Adjustment will be facilitated by removing complete assembly from rear of tuning condenser by unscrewing the three mounting screws. Contacts and discs must be kept free of dirt, filings, and other extraneous matter.

Lubrication.—The dial pointer slide should be greased with petrolatum. This same lubrication should be applied lightly to all gear faces of the drive mechanism and sparingly with a cloth to the station selector discs. Any good household oil, such as "3-IN-ONE," is suitable for the motor shaft bearings. A light grade of engine oil should be used for all gear bearings. Medium viscosity engine oil, similar to "PYROIL" (B), should be applied between the thrust washers on the motor shaft. "CASTORDAG," a mixture

of graphite and castor oil, is recommended for use at the selector drum end-bearing slots and at the bearings of cable pulleys.

Station Adjustment

Any eight stations may be chosen for "Electric" tuning. Remove the two escutcheon plates from the side of the dial, place proper call letter labels in the celluloid windows, and replace escutcheons. Turn the power on and proceed to set up the "Electric" tuning as follows:

1. Set Range Selector to "Standard Broadcast."
2. Turn "Manual-Electric-Remote" control to "Electric."
3. Turn Fidelity control counter-clockwise.
4. Press push button No. 1 (left) and wait until station pointer comes to rest.
5. Turn the "Manual-Electric-Remote" control to "Manual."
6. Remove adjusting key from receptacle on top of station selector drum mechanism.
7. Insert key in position marked "1" in station adjustment strip and push the key all the way down to properly fit in slot in disc.
8. Tune the receiver very carefully by means of the manual tuning knob and the "Magic Eye," to station chosen for No. 1.
9. Remove key.
10. Turn the "Manual-Electric-Remote" control to "Electric."

Button No. 1 is now properly set for "Electric" tuning. Proceed similarly for the other seven push buttons, matching each station on the dial with the same number on the station adjustment strip. Repeat the above steps but place the key respectively in positions 2, 3, 4, etc., and in each case tune to the proper station. Pressing the proper button will now cause the desired station to be tuned in electrically.

Armchair Control

When a Model G-8 armchair control is attached to the receiver as shown in figure 5 it duplicates the action of the push buttons on the front panel when the "Manual-Electric-Remote" control is turned to "Remote" position.

Service Hints

- a. Capacitors C18 and C74 should be carefully checked for leakage or short circuit in cases of intermittent operation or no operation. C74 should be eliminated from the circuit, R9 should be shorted out, and C18 replaced by Stock No. 4839, as shown by the Schematic Circuit Diagram figure 1, in the event of trouble in this circuit.
- b. Capacitor C5 should be checked for leakage or short circuit.
- c. Resistor R5 was 33,000 ohms in some instruments. Replace with Stock No. 12333.
- d. Capacitor C16 was 82 mmfd. in some instruments. Replace with Stock No. 14021.

REPLACEMENT PARTS

Insist on genuine factory-tested parts, which are readily identified and may be purchased from authorized dealers.

| STOCK No. | DESCRIPTION | STOCK No. | DESCRIPTION |
|----------------------------|---|-----------|--|
| RECEIVER ASSEMBLIES | | | |
| 14726 | Arm—Hub and arm complete with set screws—Connects station selector drum to rear of tuning condenser shaft | 30016 | Capacitor—12 Mmfd. (C34) |
| 14883 | Arm—Arm and hub assembly located on "Manual-Electric-Remote" switch shaft | 12896 | Capacitor—15 Mmfd. (C64) |
| 14517 | Board—Antenna and ground terminal board | 30015 | Capacitor—15 Mmfd. (C33) |
| 12717 | Board—Phonograph terminal board | 14021 | Capacitor—22 Mmfd. (C16) |
| 14885 | Bracket—Left hand dial bracket and pulley assembly | 12948 | Capacitor—33 Mmfd. (C40) |
| 14884 | Bracket—Right hand dial bracket and pulley assembly | 14910 | Capacitor—90 Mmfd. (C21) |
| 14878 | Bracket—Tuning tube mounting bracket and clamp assembly | 14908 | Capacitor—98.5 Mmfd. (C9) |
| 5237 | Bushing—Variable condenser rubber mounting bushing assembly | 14906 | Capacitor—100 Mmfd. (C7) |
| 14919 | Cable—5 conductor push-button selector cable | 12720 | Capacitor—100 Mmfd. (C36, C58) |
| 14918 | Cable—7 conductor tuning drive motor and push-button selector cable | 14960 | Capacitor—100 Mmfd. (C73) |
| 12607 | Cap—First or second I-F transformer shield cap | 14907 | Capacitor—103.5 Mmfd. (C8) |
| 12581 | Cap—Third, fourth or fifth I-F transformer shield cap | 14909 | Capacitor—110 Mmfd. (C6) |
| 11350 | Cap—Grid contact cap | 12404 | Capacitor—120 Mmfd. (C35, C71, C72, C75) |
| 12884 | Capacitor—Adjustable trimmer (long) (C3, C10, C15, C20, C65, C68) | 14712 | Capacitor—180 Mmfd. (C31, C32) |
| 14392 | Capacitor—4.7 Mmfd. (C62) | 14711 | Capacitor—220 Mmfd. (C28, C29) |
| 13002 | Capacitor—12 Mmfd. (C67) | 12952 | Capacitor—330 Mmfd. (C2, C19, C45) |
| | | 14710 | Capacitor—430 Mmfd. (C22, C23) |
| | | 13052 | Capacitor—470 Mmfd. (C14) |
| | | 14911 | Capacitor—580 Mmfd. (C11) |
| | | 18140 | Capacitor—1500 Mmfd. (C63) |
| | | 30160 | Capacitor—2700 Mmfd. (C66) |
| | | 12897 | Capacitor—4700 Mmfd. (C5) |
| | | 4838 | Capacitor—.005 Mfd. (C49, C51) |
| | | 4937 | Capacitor—.01 Mfd. (C50) |

REPLACEMENT PARTS (Continued)

| STOCK No. | DESCRIPTION | STOCK No. | DESCRIPTION |
|-----------|--|--------------------------------|---|
| 13138 | Capacitor—.01 Mfd. (C17, C24, C27, C30, C39, C46, C89, C70) | 14887 | Retainer—Indicator drive cord pulley retainer |
| 11315 | Capacitor—.015 Mfd. (C47) | 30014 | Scale—19 meter glass dial strip |
| 4870 | Capacitor—.025 Mfd. (C42) | 30013 | Scale—25 meter glass dial strip |
| 4886 | Capacitor—.05 Mfd. (C61) | 30011 | Scale—31 meter glass dial strip |
| 4839 | Capacitor—.01 Mfd. (C4, C18, C25, C26, C37, C60) | 30010 | Scale—49 meter glass dial strip |
| 5212 | Capacitor—16 Mfd. (C55) | 14962 | Scale—"C" band glass dial strip |
| 14377 | Capacitor—16 Mfd. (C57) | 14961 | Scale—"B" band glass dial strip |
| 13611 | Capacitor—20 Mfd. (C56) | 30285 | Scale—"A" band glass dial strip |
| 14531 | Capacitor—25 Mfd. (C53, C54) | 4669 | Screw—No. 8-32x5/32 square head set screw for drum Stock No. 14866, arm Stock No. 14726 and Stock No. 14883 |
| 30053 | Capacitor Pack—Compensating capacitor pack comprising two .015 mfd. capacitors, one 27,000 ohm and one 33,000 ohm resistors (C41, C43, R21, R23) | 12418 | Screw—No. 8-32x3/16 milled head screw for gear Stock No. 14739 |
| 14902 | Capacitor Pack—Comprising two sections 10 mfd. each (C44, C48) | 14848 | Selector—Station selector drum mechanism—comprising selector contactor disc's, spring contacts, and motor reversing switch assembled in metal frame |
| 14948 | Coil—"A" band antenna coil (L7, L8) | 14882 | Shield—Chassis bottom shield |
| 14949 | Coil—"B" band antenna coil (L5, L6) | 12735 | Shield—Dial lamp shield |
| 14950 | Coil—"C" band antenna coil (L3, L4) | 12008 | Shield—I-F transformer shield can |
| 14951 | Coil—Special band spread antenna coil (L1, L2) | 14901 | Shield—Rubber shield for tuning tube |
| 14887 | Coil—"A" band detector coil (L21, L22) | 14892 | Slide—Indicator pointer slider and spring assembly |
| 14952 | Coil—"B" band detector coil (L20) | 11195 | Socket—5 contact 5T4 Radiotron socket |
| 14953 | Coil—"C" band detector coil (L19) | 11196 | Socket—8 contact 6K7, 6L6, 6J7, 6F6, 6H6, or 6C5 Radiotron socket |
| 14954 | Coil—Special band spread detector coil (L18) | 14877 | Socket—8 contact 6J7 Radiotron impregnated socket for socket mounting plate Stock No. 12471 and 6K7 or 6L7 Radiotron |
| 14869 | Coil—"A" band oscillator coil (L16, L17) | 14114 | Socket—Dial lamp socket |
| 14955 | Coil—"B" band oscillator coil (L15) | 13638 | Spring—Drive cord tension spring |
| 14956 | Coil—"C" band oscillator coil (L14) | 12007 | Spring—Retaining spring for core Stock No. 12006 |
| 14873 | Coil—19 meter band oscillator coil (L9, L10) | 3676 | Spring—Tension spring for link and arm Stock No. 14883 |
| 14872 | Coil—25 meter band oscillator coil (L11) | 14694 | Spring—Tension spring for station selector push-button switch latch bar |
| 14871 | Coil—31 meter band oscillator coil (L12) | 14889 | Strap—Strap and bolt assembly used to hold glass dial strips in position |
| 14957 | Coil—49 meter band oscillator coil (L13) | 14891 | Strip—Finish strip used between glass dial strips |
| 14858 | Condenser—3 gang variable tuning condenser complete with gear train (C1, C12, C13, C59) | 14742 | Stud—Mounting stud for gear and arm Stock No. 14738 |
| 5040 | Connector—4 contact female connector for reproducer cable | 14874 | Switch—"Manual-Electric-Remote" switch (S6, S10, S13) |
| 14733 | Contact—Spring contact for engaging discs in station selector drum for type 1 contact assembly | 14863 | Switch—L-F tone and power switch (S7, S9, S11) |
| 30365 | Contact—Comprising 8 spring contacts assembled on insulating strip for engaging discs in station selector drum (type 2 contact assembly) | 14732 | Switch—Motor reversing switch and mounting plate for station selector (S12) |
| 14857 | Cord—Indicator drive cord | 14947 | Switch—Range switch (S2, S3, S4) |
| 12006 | Core—Adjustable core and stud for I-F transformers | 14728 | Switch—A-F-C and A-F amplification suppression switch (S8) |
| 14890 | Cushion—Black rubber dial cushion | 14904 | Switch—Station selector switch parts comprising one 4 point contact board, one 4 point conductor plate, insulator and lockplate |
| 14862 | Drive—Tuning condenser vernier drive shaft and pinion gear | 14703 | Tone control—H-F tone control (R26, S5) |
| 14856 | Drum—Drive cord drum complete with set screws | 14706 | Transformer—First I-F transformer (L23, L24, L25, C22, C23) |
| 14731 | Drum—Station selector drum rotor—comprising 8 station selector contactor discs assembled on shaft | 14958 | Transformer—Second I-F transformer (L26, L27, L28, C28, C29, C75, R16) |
| 10907 | Fuse—3 Amp. (F1) | 14708 | Transformer—Third I-F transformer (L29, L30, C31, C32) |
| 14738 | Gear—Drive pinion gear and arm | 14709 | Transformer—Fourth I-F transformer (L31, L32, L33, C35) |
| 14739 | Gear—Drive gear and set screws—located on tuning condenser knob shaft | 14959 | Transformer—Fifth I-F transformer (L35, L36, C71, C72, C73, R37, R40) |
| 14734 | Gear—Intermediate gear assembly—comprising one .749-in. O.D., 34 tooth gear and one .291-in. O.D., 12 tooth pinion assembled. | 14855 | Transformer—Driver transformer (T2) |
| 14735 | Gear—Intermediate gear assembly—comprising one 1.541-in. O.D., 72 tooth gear and one .291-in. O.D., 12 tooth pinion assembled. | 14944 | Transformer—Power transformer 105-125 volts, 50-60 cycle (T1) |
| 14860 | Gear—Intermediate gear assembly—comprising one 1.541-in. O.D., 72 tooth gear and hub assembled | 14945 | Transformer—Power transformer 105-125 volts, 25-60 cycle (T1) |
| 14861 | Gear—Throwout gear and bracket | 30156 | Transformer—Power transformer 100-130/140-160/195-250 volts, 50-60 cycle (T1) |
| 14900 | Indicator—Station selector indicator pointer | 12861 | Volume Control (R22) |
| 5226 | Lamp—Dial lamp | REPRODUCER ASSEMBLIES (RL76-3) | |
| 14729 | Motor—Tuning drive motor for 60 cycle models only (M-1) | 14806 | Cap—Dust cap for cone center |
| 14730 | Motor—Tuning drive motor for 25 cycle models only (M-1) | 14922 | Coil—Reproducer field coil (L38) |
| 14859 | Plate—Tuning condenser front plate and studs assembled for mounting drive gears | 14802 | Cone—Reproducer cone, voice coil, center suspension and dust cap (L34) |
| 12471 | Plate—6J7 socket mounting plate assembly for cushion socket—less socket | 5039 | Plug—4 contact male plug for reproducer |
| 30557 | Plug—Power cord plug less fuses Stock No. 10907 | 30131 | Reproducer—Complete |
| 14886 | Pulley—Indicator drive cord pulley—located on right or left hand dial bracket | 14992 | Transformer—Output transformer (T3, C52) |
| 14946 | Reactor—Filter reactor (L37) | 14357 | Washer—Spring washer to hold field coil securely |
| 13250 | Resistor—330 ohms, carbon type, 1/2 watt (R15) | MISCELLANEOUS ASSEMBLIES | |
| 11355 | Resistor—390 ohms, carbon type, 1/2 watt (R6) | 14745 | Button—Station selector switch button |
| 30158 | Resistor—820 ohms, carbon type, 1/2 watt (R30) | 30361 | Card—Call letter cards for station selector |
| 19035 | Resistor—1000 ohms, carbon type, 1/10 watt (R2, R13) | 14925 | Crystal—Dial escutcheon crystal only |
| 14720 | Resistor—1000 ohms, carbon type, 1/2 watt (R10, R36) | 14923 | Escutcheon—Dial and tuning tube escutcheon only—less crystal and buttons |
| 14993 | Resistor—1200 ohms, carbon type, 1/10 watt (R41) | 14924 | Escutcheon—Dial and tuning tube escutcheon and crystal complete |
| 13031 | Resistor—3300 ohms, carbon type, 1/10 watt (R29) | 14926 | Indicator—"Electric-Manual" indicating screen |
| 5114 | Resistor—15,000 ohms, carbon type, 1 watt (R31) | 14927 | Indicator—"Music-Speech" indicating screen |
| 14078 | Resistor—18,000 ohms, carbon type, 1 watt (R24) | 14751 | Key—Key for use in adjusting "Electric Tuning" |
| 14284 | Resistor—22,000 ohms, carbon type, 1/10 watt (R37) | 14359 | Knob—Large station selector knob |
| 12454 | Resistor—33,000 ohm, insulated, 1/2 watt (R4, R12) | 14688 | Knob—Range switch knob |
| 12333 | Resistor—68,000 ohms, carbon type, 1/2 watt (R5) | 14269 | Knob—Volume control, "Manual-Electric-Remote" switch, H-F tone control, L-F tone control or small station selector knob |
| 11365 | Resistor—82,000 ohms, carbon type, 1/2 watt (R32) | 5210 | Screw—Chassis mounting screw and washer assembly |
| 5145 | Resistor—100,000 ohms, carbon type, 1/2 watt (R14, R28) | 14746 | Shield—Celluloid shield for station markers |
| 11398 | Resistor—220,000 ohms, carbon type, 1/10 watt (R40) | 4982 | Spring—Retaining spring for knob Stock No. 14359 |
| 11452 | Resistor—470,000 ohms, carbon type, 1/10 watt (R17, R18) | 14270 | Spring—Retaining spring for knob Stock Nos. 14269 and 14688 |
| 11172 | Resistor—470,000 ohms, carbon type, 1/2 watt (R8) | | |
| 11397 | Resistor—560,000 ohms, carbon type, 1/10 watt (R1, R27) | | |
| 5035 | Resistor—560,000 ohms, carbon type, 1/2 watt (R11) | | |
| 12013 | Resistor—1 Megohm, carbon type, 1/10 watt (R25) | | |
| 3033 | Resistor—1 Megohm, carbon type, 1/2 watt (R7) | | |
| 12200 | Resistor—1 Megohm, insulated, 1/2 watt (R16) | | |
| 12679 | Resistor—2.2 Megohm, insulated, 1/2 watt (R19, R20) | | |
| 14876 | Resistor—Voltage divider comprising one 1450 ohm, one 5200 ohm, one 7700 ohm, one 18 ohm and one 82 ohm sections (R33, R34, R35, R38, R39) | | |



RCA Victor

MODEL 86X

Six-Tube, Two-Band, AC-DC, Superheterodyne Receiver

TECHNICAL INFORMATION AND SERVICE DATA

-1937 No. 27-

SERVICE DIVISION • RCA MANUFACTURING COMPANY, INC. • CAMDEN, N. J., U. S. A.

A Service of the Radio Corporation of America

Electrical Specifications

FREQUENCY RANGES

"Broadcast" (A)..... 540-1,720 kc
"Short Wave" (C)..... 5,800-18,000 kc

Intermediate Frequency..... 460 kc

RADIOTRON COMPLEMENT

(1) RCA-6A7..... First Detector—Oscillator
(2) RCA-6D6..... Intermediate Amplifier
(3) RCA-75..... Second Det., A-F Amp. and A.V.C.

R-F ALIGNMENT FREQUENCIES

"Broadcast" (A)..... 600 kc (osc.)
"Short Wave" (C)..... 15,000 kc (osc., ant.)

Pilot Lamp (1) Mazda No. 40, 6.3 volts, 0.15 ampere

POWER SUPPLY RATINGS

A-C Rating..... 105-125 volts, 50-100 cycles, 58 watts
POWER OUTPUT—(125 volt, A-C supply)

Undistorted..... 0.5 watt
Maximum..... 1.2 watts

D-C Rating..... 105-125 volts, 58 watts
POWER OUTPUT—(125 volt, D-C supply)

Undistorted..... 0.4 watt
Maximum..... 1.0 watt

LOUDSPEAKER

Type..... 6-inch Electrodynamic

Impedance (V.C.)..... $\left\{ \begin{array}{l} (84003-3) \text{ 2.6 ohms} \\ (84003-4) \text{ 3.4 ohms} \end{array} \right\}$ at 400 cycles

Mechanical Specifications

Height 8 $\frac{3}{4}$ inches

Width 12 $\frac{19}{16}$ inches

Depth 7 $\frac{1}{4}$ inches

Weight (Net) 11 pounds

Weight (Shipping) 13 pounds

Chassis Base Dimensions..... 11 $\frac{3}{8}$ inches x 5 $\frac{3}{4}$ inches x 2 $\frac{1}{4}$ inches

Over-all Chassis Height..... 6 $\frac{7}{8}$ inches

Operating Controls..... (1) Power Switch—Volume, (2) Range Selector ("A" left, "C" right), (3) Tuning

Tuning Drive Ratio..... 12 to 1

General Description

This receiver employs an ac-dc superheterodyne circuit, the arrangement of which is shown on figure 2. Its design includes magnetite-core adjusted i-f transformers, automatic

volume control, resistance-coupled audio system, and a six-inch electrodynamic loudspeaker.

Service Data

CAUTION: The chassis is connected to one side of the power supply. Avoid contact of chassis or parts to external ground when servicing.

The various diagrams of this booklet contain such information as will be needed to isolate causes for defective operation if such develops. The ratings of the resistors, ca-

pacitors, coils, etc., are indicated adjacent to the symbols signifying these parts on the diagrams. Identification titles such as R1, L1, C1, etc., provide reference between the illustrations and Replacement Parts List. The coils, transformer windings, and reactors are rated in terms of d-c resistance to permit continuity checks.

Precautionary Lead Dress—(1) Dress power line leads to the on-off switch away from grid connection terminal on volume control to reduce hum pick-up. (2) Keep leads of capacitor C3 as short as possible. (3) Bus lead from range

RCA-6A7 grid-cap lead (50-ohm resistor R18) to top of tuning capacitor C2 should be dressed properly to prevent shorts and should be maintained flexible to prevent acoustic howl.

Loudspeaker—Centering of the loudspeaker voice coil is made in the usual manner with three narrow paper feelers.

Operation on 25-Cycle A-C Supply—For 25-cycle operation, install RCA Stock No. 14767 capacitor pack and clamp under chassis below speaker and make connections as shown dotted on figure 3. Use a No. 6-32 machine screw for anchoring clamp in hole provided.

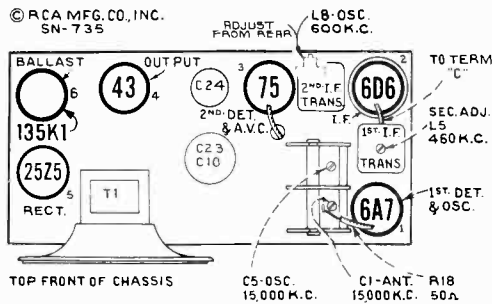
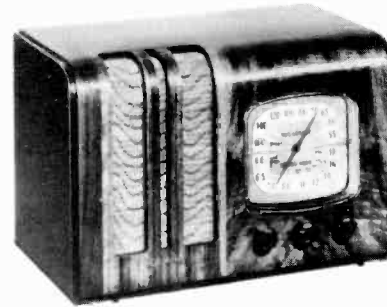

Figure 1—Radiotron, Coil, and Trimmer Locations

selector (ter. 6) to oscillator coil tap L6L8 should be maintained 3 1/2 inches long for proper alignment. (4) Capacitor C25 should be dressed free of adjacent parts to maintain correct alignment at high-frequency end of "A" band. (5) Bus lead from range selector (ter. 3) to antenna coil L1 should be maintained 2 1/4 inches long for proper alignment. (6) The



Model 86X

Alignment Procedure

Calibrate the tuning dial by adjusting dial pointer to the center horizontal line with the gang tuning-condenser plates in full-mesh position. This is a screw-driver adjustment.

Perform alignment in proper order, tabulated below, starting with No. 1 and following all operations across, then No. 2, etc. Adjustment locations are shown on figures 1 and 4.

Cathode-ray alignment is preferable; the connections to the chassis are shown on figure 3. If an output indicator is used, connect it across the loudspeaker voice-coil and advance the receiver volume control to full-volume position.

Connect the "low" output terminal of the test oscillator to the receiver chassis for all alignment operations. Regulate

the output of the test oscillator so that minimum signal is applied to the receiver to obtain an observable output indication. This will avoid a-v-c action.

The term "Dummy antenna" means the device which must be connected between the "high" test-oscillator output and the point of connection to the receiver in order to obtain ideal alignment. "No signal, 550-750 kc" means that the receiver should be tuned to a point between 550 and 750 kc where no signal or interference is received from a station or local (heterodyne) oscillator.

For further details on alignment, refer to booklet "RCA Victor Receiver Alignment."

| Order of Alignment | Test Oscillator | | | Range-Selector | Receiver Dial Setting | Circuit to Adjust | Adjustment Symbols | Adjust to Obtain |
|--------------------|------------------------|---------------|-------------------|----------------|---------------------------|-------------------|--------------------|------------------|
| | Connection to Receiver | Dummy Antenna | Frequency Setting | | | | | |
| 1 | 6D6 I-F Grid Cap | .001 Mfd. | 460 kc | "A" Left | No Signal 550-750 kc | 2nd I-F Trans. | L9 | Max. (peak) |
| 2 | 6A7 Det. Grid Cap | .001 Mfd. | 460 kc | "A" Left | No Signal 550-750 kc | 1st I-F Trans. | L4 and L5 | Max. (peak) |
| 3 | Ant. Lead (blue) | 300 Ohms | 15,000 kc | "C" Right | 15,000 kc | "C" Osc. | C5 | Max. (peak)† |
| 4 | Ant. Lead (blue) | 300 Ohms | 15,000 kc | "C" Right | Rock Through 15,000 kc | "C" Ant. | C1 | Max. (peak)*‡ |
| 5 | Ant. Lead (blue) | 200 Mmfd. | 600 kc | "A" Left | 600 kc | "A" Osc. | L8 | Max. (peak) |

† Use maximum capacity peak if two peaks can be obtained.

* Use minimum capacity peak if two peaks can be obtained.

‡ After this adjustment, check for image signal by shifting receiver dial to 15,920 kc.

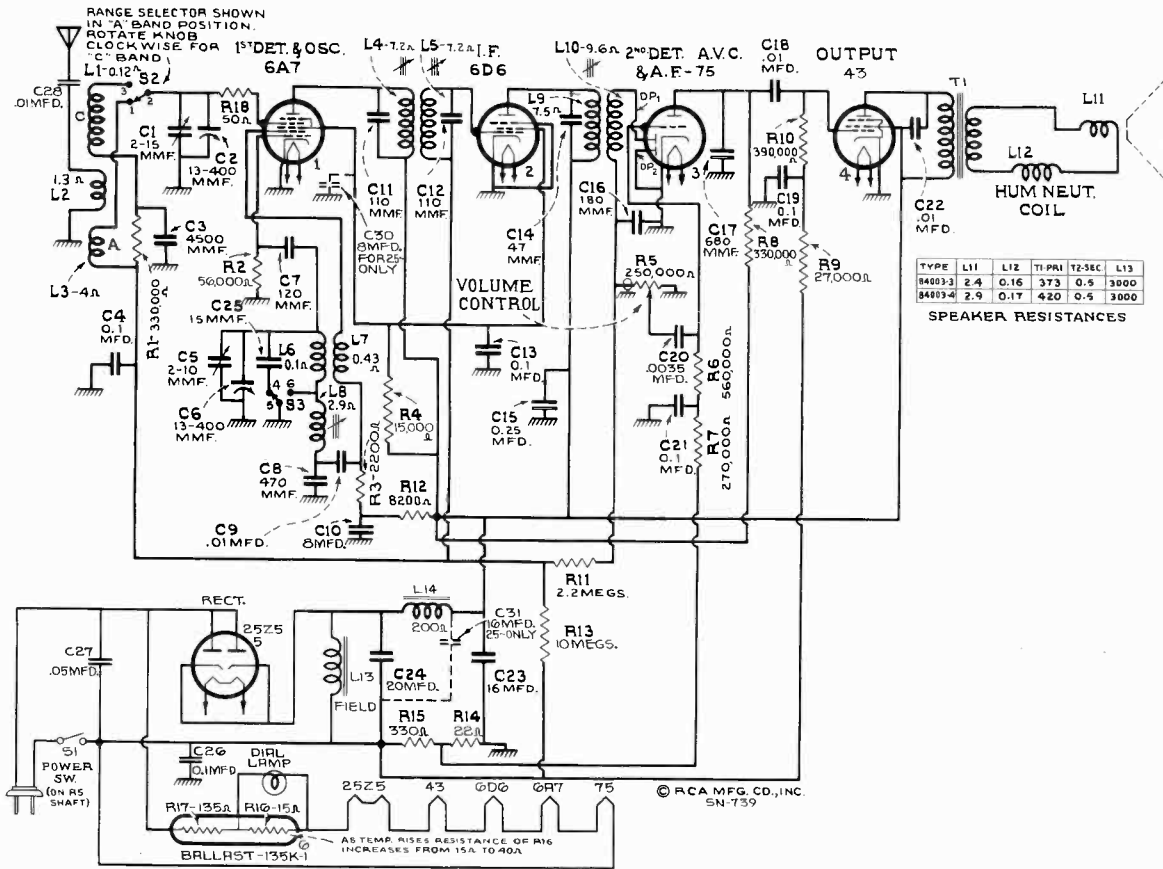

Figure 2—Schematic Circuit Diagram
(On some instruments, C17 is 150 Mmfd. Replace with Stock No. 14498.)

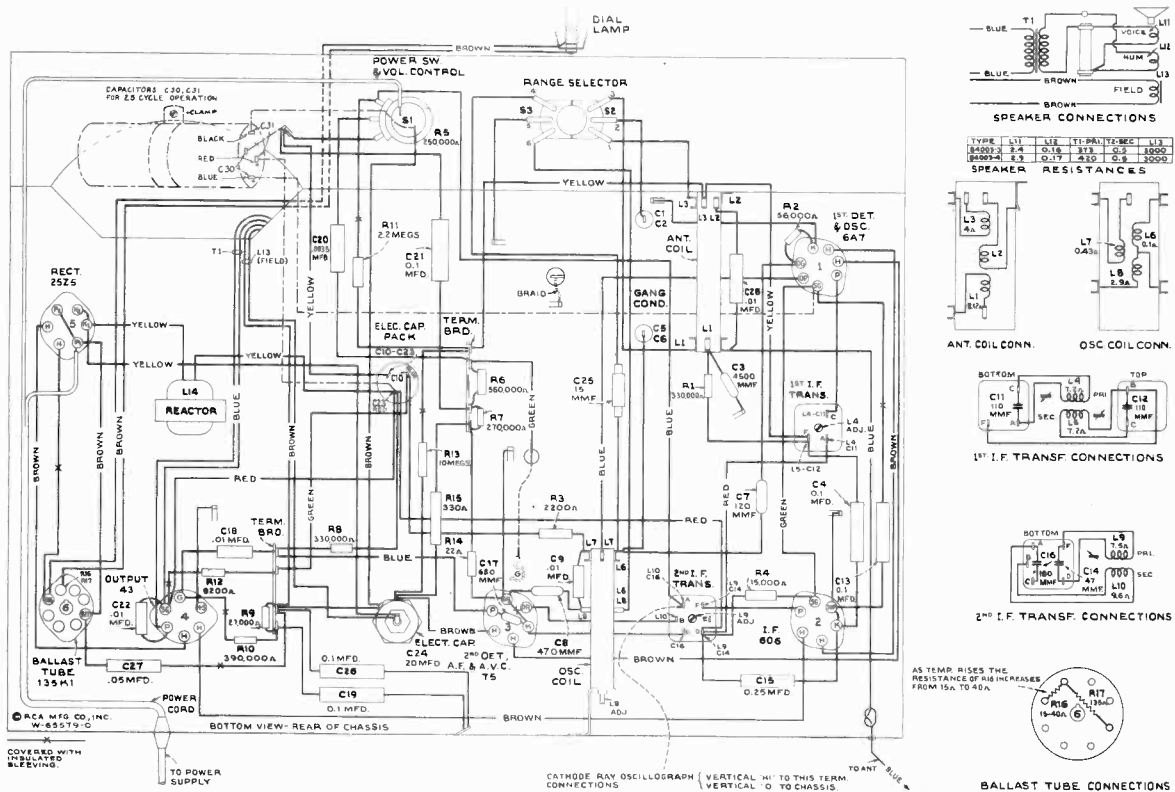

Figure 3—Chassis Wiring Diagram

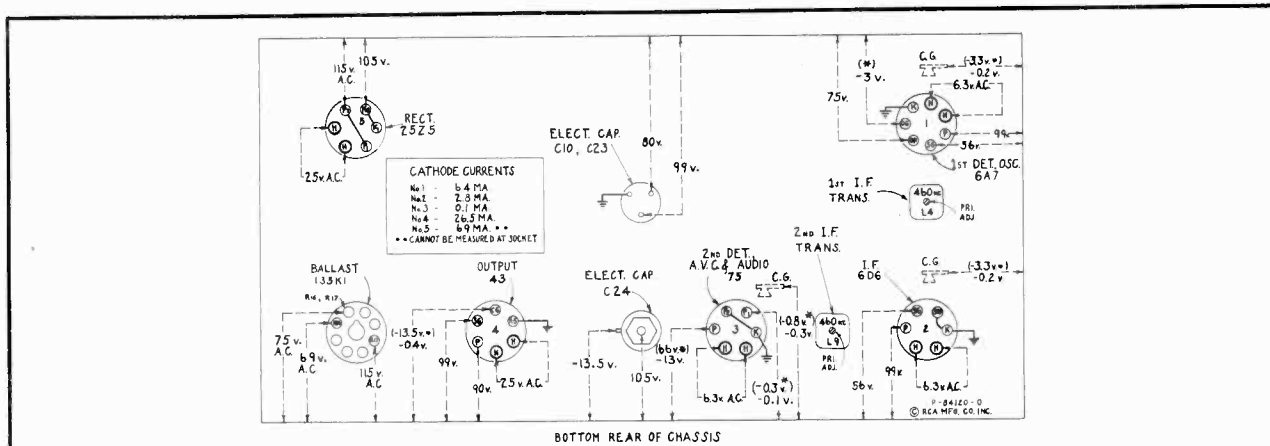

Figure 4—Radiotron Socket Voltages, Coil, and Trimmer Locations

Measured at 115 volts, 60-cycle supply—For 115-volt d-c supply approximately 10% lower, except heater voltage which remains the same—Tuned to approximately 1,000 kc (“Standard Broadcast”)—No signal being received—Volume control minimum.

Note: Two voltage values are shown for some readings. The value shown in parentheses with asterisk (*) indicates operating conditions without voltmeter loading. The other value (generally lower) is the actual measured voltage and differs from the value shown in parentheses because of the additional loading of the voltmeter through the high series circuit resistance.

Voltage values as specified should hold within ±20% when the receiver is normally operative at its rated line voltage. To duplicate the conditions under which the voltages were measured requires a 1,000-ohm-per-volt d-c meter, having ranges of 10, 50, 250 and 500 volts. Use the nearest range above the specified measured voltage. A-c voltages were measured with a corresponding a-c meter.

REPLACEMENT PARTS

Insist on genuine factory-tested parts, which are readily identified and may be purchased from authorized dealers.

| STOCK No. | DESCRIPTION | STOCK No. | DESCRIPTION |
|----------------------------|---|---------------------------------|--|
| RECEIVER ASSEMBLIES | | | |
| 14634 | Belt—Variable condenser drive belt | 11400 | Resistor—27,000 Ohms—Carbon type, ½ watt (R9) |
| 14632 | Bracket—Dial mounting bracket | 5029 | Resistor—58,000 Ohms—Carbon type, ½ watt (R2) |
| 5237 | Bushing—Variable condenser rubber mounting bushing | 11323 | Resistor—270,000 Ohms—Carbon type, ½ watt (R7) |
| 12118 | Cap—Grid contact cap | 13733 | Resistor—330,000 Ohms—Carbon type, ½ watt (R1, R8) |
| 12896 | Capacitor—15 Mmfd. (C25) | 13479 | Resistor—300,000 Ohms—Carbon type, ½ watt (R10) |
| 12405 | Capacitor—47 Mmfd. (C14) | 5035 | Resistor—560,000 Ohms—Carbon type, ½ watt (R6) |
| 14262 | Capacitor—110 Mmfd. (C11, C12) | 12679 | Resistor—2.2 Megohm—Insulated, ½ watt (R11) |
| 12724 | Capacitor—120 Mmfd. (C7) | 13601 | Resistor—10 Megohm—Insulated, ½ watt (R13) |
| 12406 | Capacitor—180 Mmfd. (C16) | 14649 | Resistor—Ballast resistor tube type No. 135K1 (R16, R17) |
| 30396 | Capacitor—470 Mmfd. (C8) | 5129 | Ring—Radiotron shield ring |
| 14498 | Capacitor—680 Mmfd. (C17) | 4389 | Screw—No. 6—32x3/16 headless set screw for pulley No. 14639 |
| 30245 | Capacitor—.0045 Mfd. (C3) | 14638 | Shaft—Station selector knob shaft and pulley |
| 5005 | Capacitor—.0035 Mfd. (C20) | 12008 | Shield—First I.F. transformer shield |
| 4858 | Capacitor—.01 Mfd. (C28) | 12408 | Shield—Second I.F. transformer shield |
| 13138 | Capacitor—.01 Mfd. (C9, C18, C22) | 11265 | Shield—Radiotron shield |
| 4836 | Capacitor—.05 Mfd. (C27) | 14650 | Socket—Dial lamp socket |
| 4839 | Capacitor—.01 Mfd. (C26) | 4786 | Socket—6-contact 6D6, 25Z5, 43 or 75 Radiotron socket |
| 4841 | Capacitor—.01 Mfd. (C4, C13, C19, C21) | 4787 | Socket—7-contact 6A7 Radiotron socket |
| 4840 | Capacitor—.025 Mfd. (C15) | 11196 | Socket—8-contact ballast resistor socket |
| 14643 | Capacitor—20 Mfd. (C24) | 14637 | Spring—Idle pulley tension spring |
| 14644 | Capacitor Pack—Comprising one 16 Mfd. and one 8 Mfd. section (C10, C23) | 12007 | Spring—Retaining spring for core Stock Nos. 12006 and 14648 |
| 14767 | Capacitor Pack—Comprising one 16 Mfd. and one 8 Mfd. section and one clamp (for 25 cycle operation only) (C30, C31) | 14640 | Switch—Range switch (S2, S3) |
| 14646 | Coil—Antenna coil (L1, L2, L3) | 14376 | Transformer—First I.F. transformer (L4, L5, C11, C12) |
| 14647 | Coil—Oscillator coil (L6, L7, L8) | 14642 | Transformer—Second I.F. transformer (L9, L10, C14, C16) |
| 14633 | Condenser—2 gang variable tuning condenser (C1, C2, C5, C6) | 14645 | Volume Control and power switch (R5, S1) |
| 14618 | Core—Adjustable core and stud for Oscillator coil | 14682 | Cone—Reproducer cone (L11) for speaker marked 84003-3 |
| 12006 | Core—Adjustable core and stud for I.F. transformer | 14936 | Cone—Reproducer cone (L11) for speaker marked 84003-4 |
| 14631 | Dial—Station selector dial | 14681 | Reproducer Complete |
| 14651 | Drive—Variable condenser vernier drive and pinion gear | 14683 | Transformer—Output transformer (T1) for speaker marked 84003-3 |
| 14635 | Indicator—Station selector indicator pointer | 14937 | Transformer—Output transformer (T1) for speaker marked 84003-4 |
| 4340 | Lamp—Dial lamp | MISCELLANEOUS ASSEMBLIES | |
| 14636 | Pulley—Idle pulley—less spring | 14654 | Escutcheon—Station selector escutcheon and crystal knob |
| 14639 | Pulley—Variable condenser drive pulley—located on condenser shaft | 12673 | Knob—Station selector, volume control or range switch knob |
| 14641 | Reactor—Filter reactor (L14) | 14267 | Screw—Chassis mounting screw and washer |
| 14525 | Resistor—22 Ohms—Carbon type, ½ watt (R14) | 4119 | Screw—No. 8—32x1/4 headless set screw for knob Stock No. 12673 |
| 14653 | Resistor—50 Ohms—Flexible type, 1/10 watt (R18) | | |
| 14652 | Resistor—330 Ohms—Wire wound, 1 watt (R15) | | |
| 5159 | Resistor—2,200 Ohms—Carbon type, ½ watt (R3) | | |
| 14296 | Resistor—8,200 Ohms—Carbon type, ½ watt (R12) | | |
| 12759 | Resistor—15,000 Ohms—Carbon type, ½ watt (R4) | | |



RCA Victor

MODEL 86X4

Six-Tube, Three-Band, AC-DC, Superheterodyne Receiver

TECHNICAL INFORMATION AND SERVICE DATA

SERVICE DIVISION • RCA MANUFACTURING COMPANY, INC. • CAMDEN, N. J., U. S. A.

A Service of the Radio Corporation of America

Electrical Specifications

FREQUENCY OR WAVE-LENGTH RANGES

"Long Wave" (X).....140-400 kc (2,140-750 meters)
"Medium Wave" (A)..... 540-1,600 kc (555-188 meters)
"Short Wave" (C).....5,800-18,000 kc (5.8-18 mc)

R-F ALIGNMENT FREQUENCIES

"Short Wave" (C)..... 15,000 kc (osc., ant.)
"Medium Wave" (A)..... 600 kc (osc.), 1,500 kc (osc.)
"Long Wave" (X)..... 166.7 kc (osc.), 353 kc (osc.)

Intermediate Frequency..... 460 kc

RADIOTRON COMPLEMENT

(1) RCA-6A8..... First Detector—Oscillator
(2) RCA-6D6..... Intermediate Amplifier
(3) RCA-6Q7G.. Second Detector, A-F Amp., and A.V.C.

(4) RCA-25L6..... Power Output
(5) RCA-25Z5..... Half-Wave Rectifier
(6) RCA-260K1A..... Ballast for 220 volts
or RCA-135K1A..... Ballast for 110 volts

Pilot Lamp (1)..... Mazda No. 40, 6.3 volts, 0.15 amp.

POWER SUPPLY RATINGS

A-C Rating..... 105-125 volts, 25-100 cycles, 55 watts
200-250 volts, 25-100 cycles, 100 watts
D-C Rating..... 105-125 volts, 50 watts
200-250 volts, 95 watts

POWER OUTPUT

Undistorted..... 1.6 watts
Maximum..... 2.75 watts

LOUDSPEAKER

Type..... 6-inch Permanent-Magnet Dynamic
Impedance (V.C.)..... 2.4 ohms at 400 cycles

Mechanical Specifications

Height 10 $\frac{1}{2}$ inches
Width 14 $\frac{15}{16}$ inches
Depth 7 $\frac{1}{4}$ inches
Weight (Net) 14 $\frac{1}{2}$ pounds
Weight (Shipping)..... 17 $\frac{1}{2}$ pounds
Chassis Base Dimensions..... 11 $\frac{7}{16}$ inches x 5 $\frac{3}{4}$ inches x 2 $\frac{1}{4}$ inches
Over-all Chassis Height..... 8 $\frac{3}{4}$ inches
Operating Controls..... (1) Power Switch—Volume, (2) Tone Control, (3) Range Selector ("X" left, "A" center, "C" right), (4) Tuning
Tuning Drive Ratio..... 12 to 1

General Description

This receiver employs an ac-dc superheterodyne circuit, the arrangement of which is shown on figure 3. Its design includes magnetite-core adjusted i-f transformers, and "X" and

"A" oscillator coils, automatic volume control, tone control, resistance-coupled audio system, and a six-inch permanent-magnet dynamic loudspeaker.

Copyright, 1937, RCA Manufacturing Co., Inc.

Trademark "Radiotron"
Reg. U. S. Pat. Off. by RCA Mfg. Co., Inc.

Service Data

CAUTION: The chassis is connected to one side of the power supply. Avoid contact of chassis or parts to external ground when servicing.

The various diagrams of this booklet contain such information as will be needed to isolate causes for defective

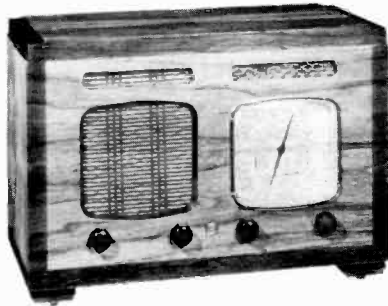

Model 86X4

operation if such develops. The ratings of the resistors, capacitors, coils, etc., are indicated adjacent to the symbols signifying these parts on the schematic diagram. Identification titles such as R1, L1, C1, etc., provide reference between the illustrations and Replacement Parts List. The coils, transformer windings, and reactors are rated in terms of d-c resistance to permit continuity checks.

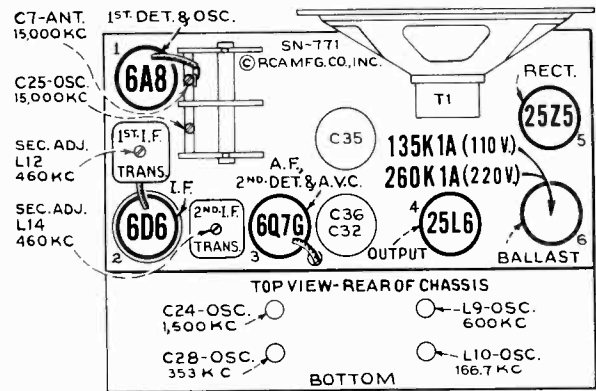

Figure 1—Radiotron, Coil, and Trimmer Locations

Phonograph Attachment.—A terminal board is provided for connecting a phonograph into the audio amplifying circuit. RCA Victor Models R-93, R-93-A, R-93-2, or R-94 Record Players should be connected as follows: Open link between terminals 1 and 2 on terminal board. Connect green wire in Radio-Record switch cable to terminal 1, yellow to terminal 2, and shield extension to terminal 3. Tape unused

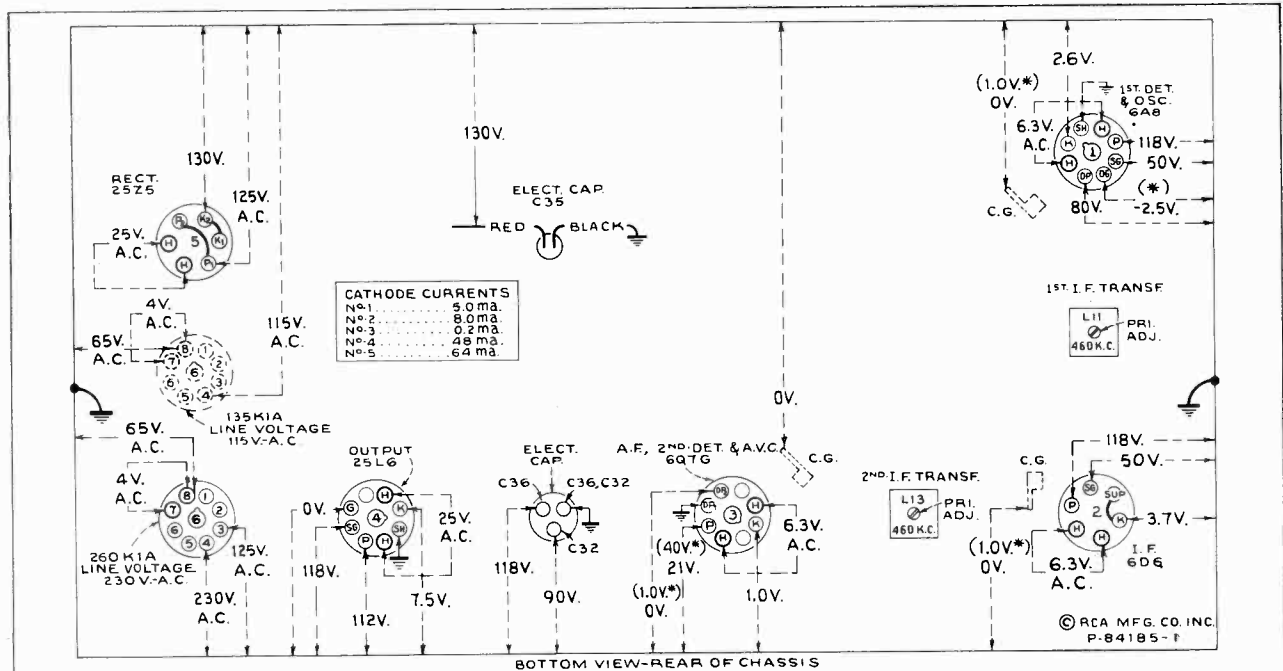

Figure 2—Radiotron Socket Voltages, Coil, and Trimmer Locations

Measured at 230 volts, 60 cycle supply; or 115 volts, 60 cycle supply—For 230 volts d-c, voltages are same—For 115 volts d-c, all voltages except line and heaters about 20% lower—Tuned to approximately 1,000 kc (300 meters) "Medium Wave"—No signal being received—Volume control minimum—Tone control optional.

Note: Two voltage values are shown for some readings. The value shown in parentheses with asterisk () indicates operating conditions without voltmeter loading. The other value (generally lower) is the actual measured voltage and differs from the value shown in parentheses because of the additional loading of the voltmeter through the high series circuit resistance.*

Voltage values as specified should hold within $\pm 20\%$ when the receiver is normally operative at its rated line voltage. To duplicate the conditions under which the voltages were measured requires a 1,000-ohm-per-volt d-c meter, having ranges of 10, 50, 250 and 500 volts. Use the nearest range above the specified measured voltage. A-c voltages were measured with a corresponding a-c meter.

red and blue leads separately. Connect a 2-conductor twisted cable between the Record Player binding posts and the screw terminals on Radio-Record switch.

CAUTION: Disconnect receiver power cord before making phonograph connections. Tape shield extension on Radio-Record cable so it cannot make metallic connection with receiver chassis ground.

Precautionary Lead Dress.—(1) All bus leads in r-f assembly should be kept as short as possible. When necessary to replace bus leads, use only wire having same diameter. (2) Dress capacitor, connected from tone-control switch to

terminal board, away from capacitor, connected to center terminal of volume control, and away from exposed green shielded lead running to phono. term. board. (3) Dress green lead, connected from volume control to 2nd i-f transformer, as close to chassis as possible. (4) Dress capacitor, connected from 25L6 socket to red lug on electrolytic-capacitor, away from phono. term. board. (5) Brown and green leads from speaker must be twisted, dressed along chassis and away from exposed green shielded lead and lug running to phono. term. board. (6) Dress green lead, connected between 6A8 and 6D6 sockets, away from pin No. 5 of 6A8 socket.

Alignment Procedure

Calibrate the tuning dial by adjusting dial pointer to the center horizontal line with the gang tuning-condenser plates in full-mesh position. This is a screw-driver adjustment.

Perform alignment in proper order, tabulated below, starting with No. 1 and following all operations across, then No. 2, etc. Adjustment locations are shown on figures 1 and 2.

Cathode-ray alignment is highly preferable; the connections to the chassis are shown on figure 4. If an output indicator is used, connect it across the loudspeaker voice-coil and advance the receiver volume control to full-volume position.

Connect the "low" output terminal of the test oscillator to the receiver chassis for all alignment operations. Regulate the output of the test oscillator so that minimum signal is applied to the receiver to obtain an observable output indication. This will avoid a-v-c action.

The term "Dummy antenna" means the device which must be connected between the "high" test-oscillator output and the point of connection to the receiver in order to obtain ideal alignment. "No signal, 550-750 kc" means that the receiver should be tuned to a point between 550 and 750 kc (400-550 meters) where no signal or interference is received from a station or local (heterodyne) oscillator.

Conversion of kilocycles (kc) to meters for alignment frequencies is as follows: 15,000 kc (20 mc) = 20 meters; 1,500 kc = 200 meters; 600 kc = 500 meters; 460 kc = 652 meters; 353 kc = 850 meters; and 166.7 kc = 1,800 meters.

For further details on alignment, refer to booklet "RCA Victor Receiver Alignment."

| Order of Alignment | Test Oscillator | | | Range Selector | Receiver Dial Setting | Circuit to Adjust | Adjustment Symbols | Adjust to Obtain |
|--------------------|------------------------|---------------|----------------------------|----------------|---|-------------------|--------------------|------------------|
| | Connection to Receiver | Dummy Antenna | Frequency Setting | | | | | |
| 1 | 6D6 I-F Grid Cap | .001 Mfd. | 460 kc | "A" Center | No Signal 550-750 kc (400-550 meters) | 2nd I-F Trans. | L13 and L14 | Max. (peak) |
| 2 | 6A8 Det. Grid Cap | .001 Mfd. | 460 kc | "A" Center | No Signal 550-750 kc (400-550 meters) | 1st I-F Trans. | L11 and L12 | Max. (peak) |
| 3 | Ant. Lead (blue) | 300 Ohms | 15,000 kc (20 meters) | "C" Right | 15 mc | "C" Osc. | C25 | Max. (peak)† |
| 4 | Ant. Lead (blue) | 300 Ohms | 15,000 kc (20 meters) | "C" Right | Rock Through 15 mc | "C" Ant. | C7 | Max. (peak)* |
| 5 | Ant. Lead (blue) | 200 Mmfd. | 600 kc (500 meters) | "A" Center | 600 kc (500 meters) | "A" L-F Osc. | L9 | Max. (peak)‡ |
| 6 | Ant. Lead (blue) | 200 Mmfd. | 1,500 kc (200 meters) | "A" Center | 1,500 kc (200 meters) | "A" H-F Osc. | C24 | Max. (peak) |
| 7 | Ant. Lead (blue) | 200 Mmfd. | 600 kc (500 meters) | "A" Center | 600 kc (500 meters) | "A" L-F Osc. | L9 | Max. (peak) |
| 8 | Ant. Lead (blue) | 200 Mmfd. | 1,500 kc (200 meters) | "A" Center | 1,500 kc (200 meters) | "A" H-F Osc. | C24 | Max. (peak) |
| 9 | Ant. Lead (blue) | 200 Mmfd. | 166.7 kc (1,800 meters) | "X" Left | 166.7 kc (1,800 meters) | "X" L-F Osc. | L10 | Max. (peak) |
| 10 | Ant. Lead (blue) | 200 Mmfd. | 353 kc (850 meters) | "X" Left | 353 kc (850 meters) | "X" H-F Osc. | C28 | Max. (peak) |
| 11 | Ant. Lead (blue) | 200 Mmfd. | 166.7 kc (1,800 meters) | "X" Left | 166.7 kc (1,800 meters) | "X" L-F Osc. | L10 | Max. (peak) |
| 12 | Ant. Lead (blue) | 200 Mmfd. | 353 kc (850 meters) | "X" Left | 353 kc (850 meters) | "X" H-F Osc. | C28 | Max. (peak) |

† Use maximum capacity peak if two peaks can be obtained.

* Use minimum capacity peak if two peaks can be obtained. After this adjustment, check for image signal by shifting receiver dial to 15,920 kc.

‡ "X" H-F Osc. trimmer C28 must be at least three turns out during this adjustment.

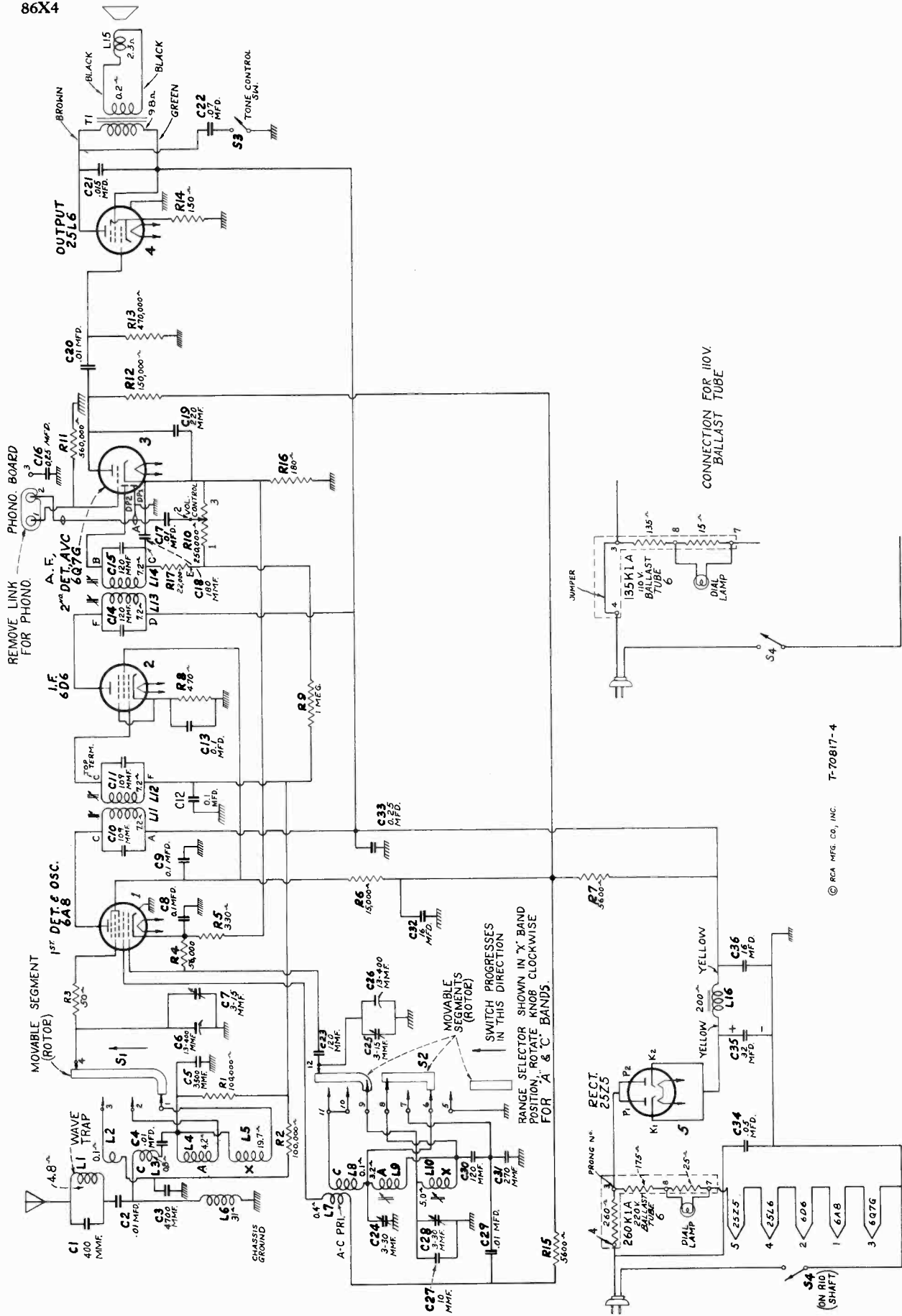
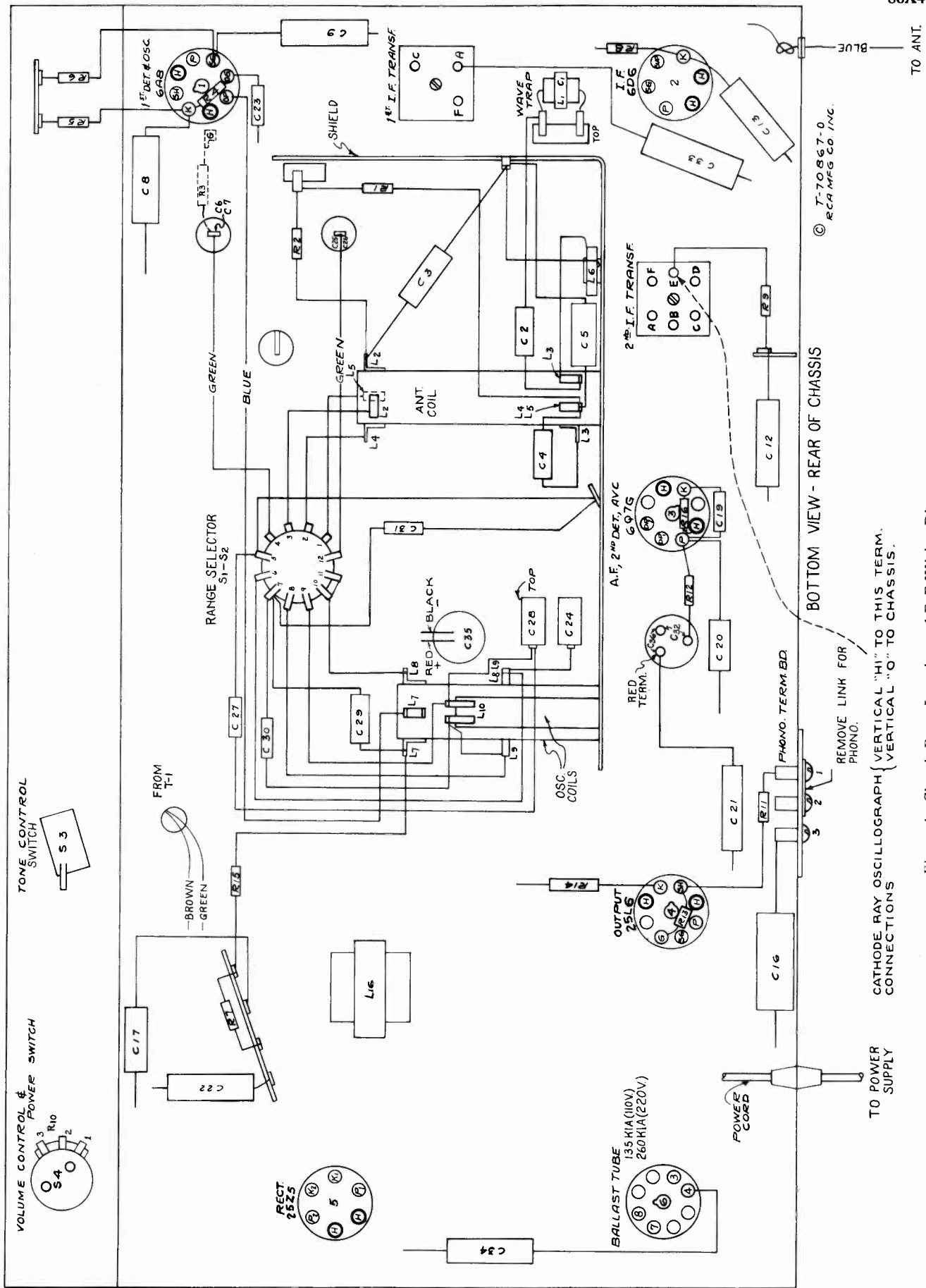

Figure 3—Schematic Circuit Diagram



© T-70867-0
RCA MFG CO. INC.

Figure 4—Chassis Parts Location and R-F Wiring Diagram

CATHODE RAY OSCILLOGRAPH { VERTICAL "HI" TO THIS TERM.
VERTICAL "O" TO CHASSIS.

TO POWER SUPPLY

TO ANT.

REPLACEMENT PARTS

Insist on genuine factory tested parts, which are readily identified and may be purchased from authorized dealers.

| STOCK No. | DESCRIPTION | STOCK No. | DESCRIPTION |
|----------------------------|---|---|---|
| RECEIVER ASSEMBLIES | | | |
| 14634 | Belt—Variable condenser drive belt | 14653 | Resistor—50 ohms, flexible type, 1/10 watt (R3) |
| 14632 | Bracket—Dial mounting bracket | 30301 | Resistor—150 ohms, carbon type, 1/2 watt (R14) |
| 5237 | Bushing—Variable condenser rubber mounting | 30545 | Resistor—180 ohms, insulated, 1/2 watt (R16) |
| 11350 | Cap—Small grid-contact cap | 13250 | Resistor—330 ohms, carbon type, 1/2 watt (R5) |
| 30295 | Capacitor—Adjustable dual trimmer (C24, C28) | 30546 | Resistor—470 ohms, insulated, 1/2 watt (R8) |
| 13200 | Capacitor—10 Mmfd. (C27) | 13714 | Resistor—5,600 ohms, insulated, 1/2 watt (R7, R15) |
| 14262 | Capacitor—109 Mmfd. (C10, C11) | 3998 | Resistor—15,000 ohms, carbon type, 1/2 watt (R6) |
| 12404 | Capacitor—120 Mmfd. (C14, C15) | 14284 | Resistor—22,000 ohms, carbon type, 1/10 watt (R17) |
| 12724 | Capacitor—120 Mmfd. (C23, C30) | 12286 | Resistor—56,000 ohms, insulated, 1/2 watt (R4) |
| 12406 | Capacitor—180 Mmfd. (C18) | 5145 | Resistor—100,000 ohms, carbon type, 1/2 watt (R1, R2) |
| 12694 | Capacitor—220 Mmfd. (C19) | 5027 | Resistor—150,000 ohms, carbon type, 1/2 watt (R12) |
| 30302 | Capacitor—270 Mmfd. (C31) | 12285 | Resistor—470,000 ohms, insulated, 1/2 watt (R13) |
| 30303 | Capacitor—.0035 Mfd. (C5) | 5035 | Resistor—560,000 ohms, carbon type, 1/2 watt (R11) |
| 30304 | Capacitor—.0047 Mfd. (C3) | 13730 | Resistor—1 megohm, carbon type, 1/2 watt (R9) |
| 4858 | Capacitor—.01 Mfd. (C2) | 4389 | Screw—No. 6-32 x 3/16-inch headless set-screw for drive pulley, Stock No. 14639 |
| 14393 | Capacitor—.01 Mfd. (C4, C17, C20, C29) | 14638 | Shaft—Station selector knob shaft and pulley |
| 11315 | Capacitor—.015 Mfd. (C21) | 12008 | Shield—I-F transformer shield can |
| 4886 | Capacitor—.05 Mfd. (C34) | 12581 | Shield—I-F transformer shield cap |
| 14626 | Capacitor—.07 Mfd. (C22) | 11265 | Shield—Radiotron shield |
| 4839 | Capacitor—0.1 Mfd. (C8, C9, C12, C13) | 4786 | Socket—6-contact 6D6 or 25Z5 Radiotron socket |
| 12484 | Capacitor—0.25 Mfd. (C16) | 11196 | Socket—8-contact 6A8, 6Q7G, 25L6 Radiotron or ballast resistor tube socket |
| 4840 | Capacitor—0.25 Mfd. (C33) | 14650 | Socket—Dial lamp socket |
| 30298 | Capacitor Pack—Comprising 2 sections each 16 Mfd. (C32, C36) | 14637 | Spring—Idler pulley tension spring |
| 30297 | Capacitor—32 Mfd. (C35) | 12007 | Spring—Retaining spring for core, Stock Nos. 14648, 12664 and 12006 |
| 30292 | Coil—Antenna coil—X, A, and C bands (L2, L3, L4, L5) | 30291 | Switch—Range switch (S1, S2) |
| 30293 | Coil—Oscillator coil—A and C Bands only (L7, L8, L9) | 30299 | Switch—Tone control switch (S3) |
| 30294 | Coil—Oscillator coil—X band only (L10) | 14376 | Transformer—First I-F transformer (L11, L12, C10, C11) |
| 30296 | Coil—Choke coil (L6) | 14308 | Transformer—Second I-F transformer (L13, L14, C14, C15, C18, R17) |
| 14633 | Condenser—2-gang variable tuning condenser (C6, C7, C25, C26) | 13838 | Trap—Wave trap (L1, C1) |
| 14648 | Core—Adjustable core and stud for coil, Stock No. 30293 | 14645 | Volume control and power switch (R10, S4) |
| 12664 | Core—Adjustable core and stud for coil, Stock No. 30294 | REPRODUCER ASSEMBLIES (Speaker No. 84106-1) | |
| 12006 | Core—Adjustable core and stud for i-f transformers | 30306 | Cone—Reproducer cone, complete, centered in metal cone housing—less transformer (L15) |
| 30289 | Dial—Station selector dial scale and holder (for European use only) | 30305 | Reproducer, complete |
| 30397 | Dial—Station selector dial scale and holder (for other than European use) | 30307 | Transformer—Output transformer (T1) |
| 14651 | Drive—Variable condenser vernier drive and pinion gear | MISCELLANEOUS ASSEMBLIES | |
| 30290 | Indicator—Station selector indicator pointer | 14654 | Escutcheon—Station selector escutcheon and crystal |
| 4340 | Lamp—Dial lamp | 30373 | Knob—Range switch knob |
| 14636 | Pulley—Drive belt idler pulley—less spring | 12673 | Knob—Station selector, volume control or tone control knob |
| 14639 | Pulley—Variable condenser drive pulley—located on condenser shaft | 30308 | Screw—Chassis mounting screw and washer assembly |
| 14641 | Reactor—Filter reactor (L16) | 4119 | Screw—No. 8-32 x 1/4-inch headless cup-point set-screw for knob, Stock Nos. 12673 and 30373 |
| 30300 | Resistor—Ballast resistor tube, type 260K-1A, for 220-volt operation | | |
| MI-8115 | Resistor—Ballast resistor tube, type 135K-1A, for 110-volt operation | | |



RCA Victor

MODELS 87EY, 87X, and 87Y

Seven-Tube, Three-Band, AC-DC, Superheterodyne Receivers

TECHNICAL INFORMATION AND SERVICE DATA

-1937 No. 21-

SERVICE DIVISION • RCA MANUFACTURING COMPANY, INC. • CAMDEN, N. J., U. S. A.

A Service of the Radio Corporation of America

Electrical Specifications

FREQUENCY RANGES

"Broadcast" (A)..... 530-1,720 kc
 "Medium Wave" (B)..... 2,100-6,800 kc
 "Short Wave" (C)..... 6,800-22,000 kc
 Intermediate Frequency

R-F ALIGNMENT FREQUENCIES

"Short Wave" (C)..... 20,000 kc (osc.)
 "Medium Wave" (B)..... 6,000 kc (osc., ant.)
 "Broadcast" (A)..... 600 kc (osc.), 1,500 kc (osc.)

RADIOTRON COMPLEMENT

(1) RCA-6A8..... First Detector—Oscillator
 (2) RCA-6K7..... Intermediate Amplifier
 (3) RCA-6H6..... Second Detector and A.V.C.
 (4) RCA-6J7..... Audio Voltage Amplifier

(5) RCA-25L6..... Audio Power Output
 (6) RCA-25Z5..... Half-Wave Rectifier
 (7) RCA-95K2..... Ballast

Pilot Lamps (2)..... Mazda No. 40, 6.3 volts, 0.15 amp.

POWER SUPPLY RATINGS

A-C Rating..... 105-125 volts, 25-100 cycles, 55 watts
 D-C Rating..... 105-125 volts, 50 watts

POWER OUTPUT (125-volt, a-c supply)

| | | |
|-------------------|-----------|-----------|
| | 87EY, 87Y | 87X |
| Undistorted | 1.9 watts | 1.7 watts |
| Maximum | 3.0 watts | 2.8 watts |

POWER OUTPUT (125-volt, d-c supply)

| | | |
|-------------------|-----------|-----------|
| | 87EY, 87Y | 87X |
| Undistorted | 1.3 watts | 1.2 watts |
| Maximum | 2.1 watts | 1.9 watts |

Loudspeaker (Permanent-Magnet Dynamic)..... Impedance (v.c.) 2.2 ohms at 400 cycles

Mechanical Specifications

| | 87EY | 87X | 87Y |
|------------------------------|--|-------------------------|-------------------------|
| Height | 23 $\frac{1}{8}$ inches | 11 $\frac{1}{8}$ inches | 39 inches |
| Width | 26 $\frac{3}{4}$ inches | 18 $\frac{1}{4}$ inches | 24 $\frac{1}{4}$ inches |
| Depth | 14 $\frac{3}{8}$ inches | 8 $\frac{1}{8}$ inches | 12 inches |
| Weight (net) | 54 pounds | 19 pounds | 48 pounds |
| Weight (shipping) | 63 pounds | 23 pounds | 61 pounds |
| Chassis Base Dimensions..... | 15 $\frac{1}{4}$ inches x 6 $\frac{1}{2}$ inches x 2 $\frac{3}{4}$ inches | | |
| Over-all Chassis Height..... | 9 inches | | |
| Operating Controls..... | (1) Power Switch—Tone; (2) Tuning (large inner knob), Range Selector (small outer knob, left to right "A," "B," "C"); (3) Volume | | |
| Tuning Drive Ratio..... | 20 to 1 | | |

General Description

These receivers employ a conventional three-band, ac-dc superheterodyne circuit; the arrangement of which is shown by the Schematic Circuit Diagram. Model 87EY is an arm-chair model and Model 87Y is a console model, each employing a sensitive, 12-inch, permanent-magnet-dynamic loud-

speaker. Model 87X is a chest-type table model employing a sensitive, 6-inch, permanent-magnet-dynamic loudspeaker.

The extensive tuning range afforded by the three tuning bands includes the "Standard broadcast" band and the important short-wave international broadcast bands of 49,

31, 25, 19, 16, and 13 meters along with channels assigned for police, aviation, and amateur communication.

Features of design include magnetite-core adjustments for i-f transformers and low-frequency "A" oscillator tracking; "cumulative-wound" antenna transformer for high signal-to-

noise ratio; antenna wave-trap; full automatic volume control; phonograph terminal board; aural-compensated audio volume control; two-point, high-frequency tone control; dust-proof, permanent-magnet-dynamic loudspeaker; and a new sunburst dial with band indicator and short-wave stations listed by name.

Service Data

Caution: Avoid contact of grid caps, tuning condenser, or other receiver component parts to external ground when servicing.

The various diagrams of this booklet contain such information as will be needed to isolate causes for defective operation if such develops. The ratings of the resistors, capacitors, coils, etc., are indicated adjacent to the symbols signifying these parts on the diagrams. Identification titles such as R1, L1, C1, etc., provide reference between the illustrations and Replacement Parts List. The coils, transformer windings, and reactors are rated in terms of d-c resistance to permit continuity checks.

Precautionary Lead Dress.—(1) Dress power cord away from audio circuits. (2) Keep filament leads away from C24. (3) Keep bus lead from term. 8 of S1-S2 to ground lance as short as possible. (4) Bus lead from term. 12 of S1-S2 to C27-C28 thence to C10 should be 4 7/8 inches long. (5) Bus lead from term. 4 of S1-S2 to L2-L3 should be 2 1/2 inches long. (6) Bus lead from L2 to C8-C9 should be 3 7/8 inches long and dressed over bus lead from antenna coil to range switch. (7) Bus lead from term. 7 of S1-S2 to L12-L14 should be 2 1/4 inches long. (8) Keep bus lead from term. E of 2nd i-f trans. to term. 2 on phono. board as short as

possible. (9) Keep leads of C10, C29, and C34 as short as possible. When replacing bus leads, use wire having same diameter as original.

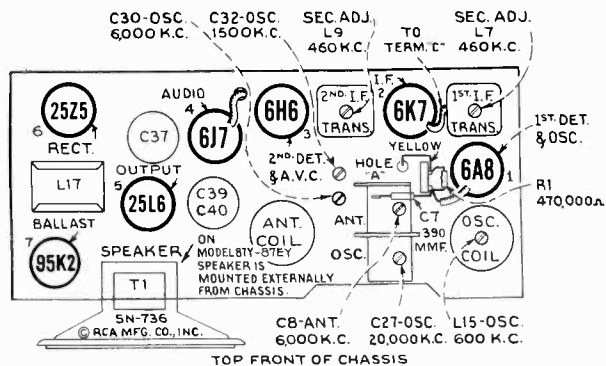

Figure 1—Radiotron, Coil, and Trimmer Locations

Alignment Procedure

Calibrate the tuning dial by adjusting main dial pointer to the low-frequency (end) calibration mark on dial with the gang tuning-condenser plates in full-mesh position; then adjust the small (vernier) pointer to "O." These are friction adjustments.

Perform alignment in proper order, tabulated below, starting with No. 1 and following all operations across, then No. 2, etc. Adjustment locations are shown on figures 1 and 2.

Cathode-ray alignment is highly preferable; the connections to the receiver circuits are shown on figure 4. If an output indicator is used, connect it across the loudspeaker voice-coil and advance the receiver volume control to full-volume position.

Connect the "low" output terminal of the test oscillator to the positive (+) side of C38 (same point as "low" vertical input to cathode-ray oscillograph) for all alignment operations. Regulate the output of the test oscillator so that minimum signal is applied to the receiver to obtain an observable output indication. This will avoid a-v-c action.

The term "Dummy antenna" means the device which must be connected between the "high" test-oscillator output and the point of connection to the receiver in order to obtain ideal alignment. "No signal, 550-750 kc" means that the receiver should be tuned to a point between 550 and 750 kc where no signal or interference is received from a station or local (heterodyne) oscillator.

For further details on alignment, refer to booklet "RCA Victor Receiver Alignment."

| Order of Alignment | Test Oscillator | | | Range Selector | Receiver Dial Setting | Circuit to Adjust | Adjustment Symbols | Adjust to Obtain |
|--------------------|------------------------|---------------|-------------------|----------------|-----------------------|-------------------|--------------------|------------------|
| | Connection to Receiver | Dummy Antenna | Frequency Setting | | | | | |
| 1 | 6K7 I-F Grid Cap | .001 Mfd. | 460 kc | "A" Left | No Signal 550-750 kc | 2nd I-F Trans. | L8 and L9 | Max. (peak) |
| 2 | 6A8 Det. Grid Cap | .001 Mfd. | 460 kc | "A" | No Signal 550-750 kc | 1st I-F Trans. | L6 and L7 | Max. (peak) |
| 3 | Ant. Term. | 300 Ohms | 20,000 kc | "C" Right | 20,000 kc | "C" Osc. | C27 | Max. (peak)*† |
| 4 | Ant. Term. | 300 Ohms | 6,000 kc | "B" Center | 6,000 kc | "B" Osc. | C30 | Max. (peak)* |
| 5 | Ant. Term. | 300 Ohms | 6,000 kc | "B" | 6,000 kc | "B" Ant. | C8 | Max. (peak) |
| 6 | Ant. Term. | 200 Mmfd. | 600 kc | "A" Left | 600 kc | "A" L-F Osc. | L15 | Max. (peak) |
| 7 | Ant. Term. | 200 Mmfd. | 1,500 kc | "A" | 1,500 kc | "A" H-F Osc. | C32 | Max. (peak) |
| 8 | Ant. Term. | 200 Mmfd. | 600 kc | "A" | 600 kc | "A" L-F Osc. | L15 | Max. (peak) |
| 9 | Ant. Term. | 200 Mmfd. | 1,500 kc | "A" | 1,500 kc | "A" H-F Osc. | C32 | Max. (peak) |

*Use minimum capacity peak if two peaks can be obtained.

†After this adjustment, check for image signal by shifting receiver dial to 19,080 kc.



Model 87EY



Model 87X

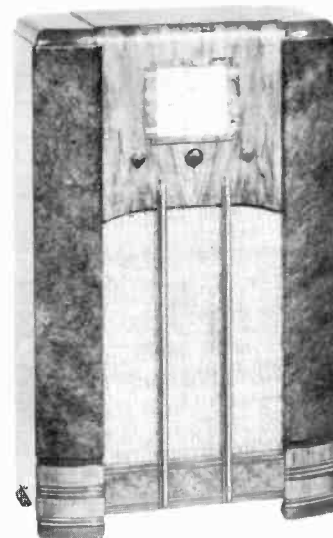

Model 87Y

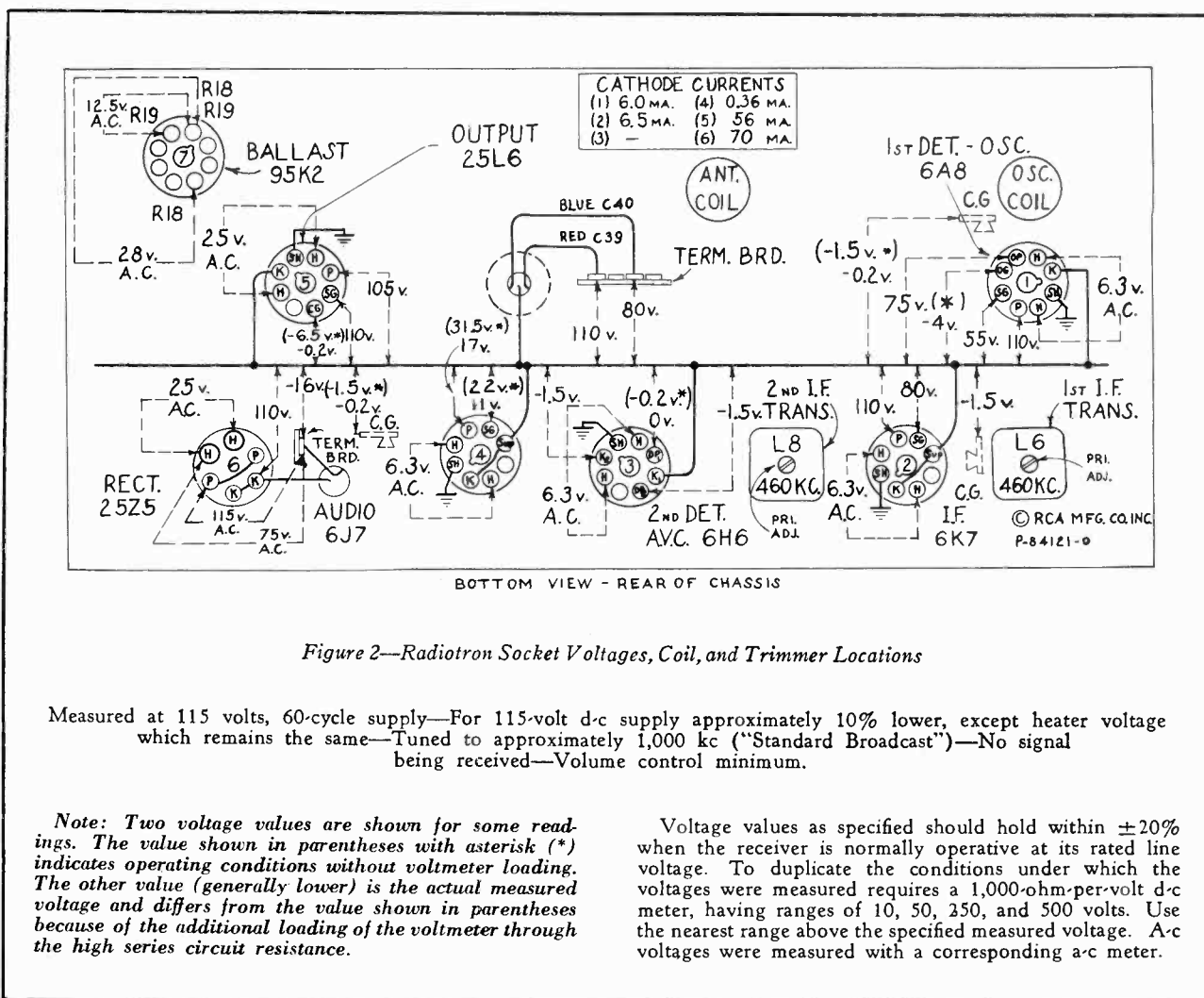

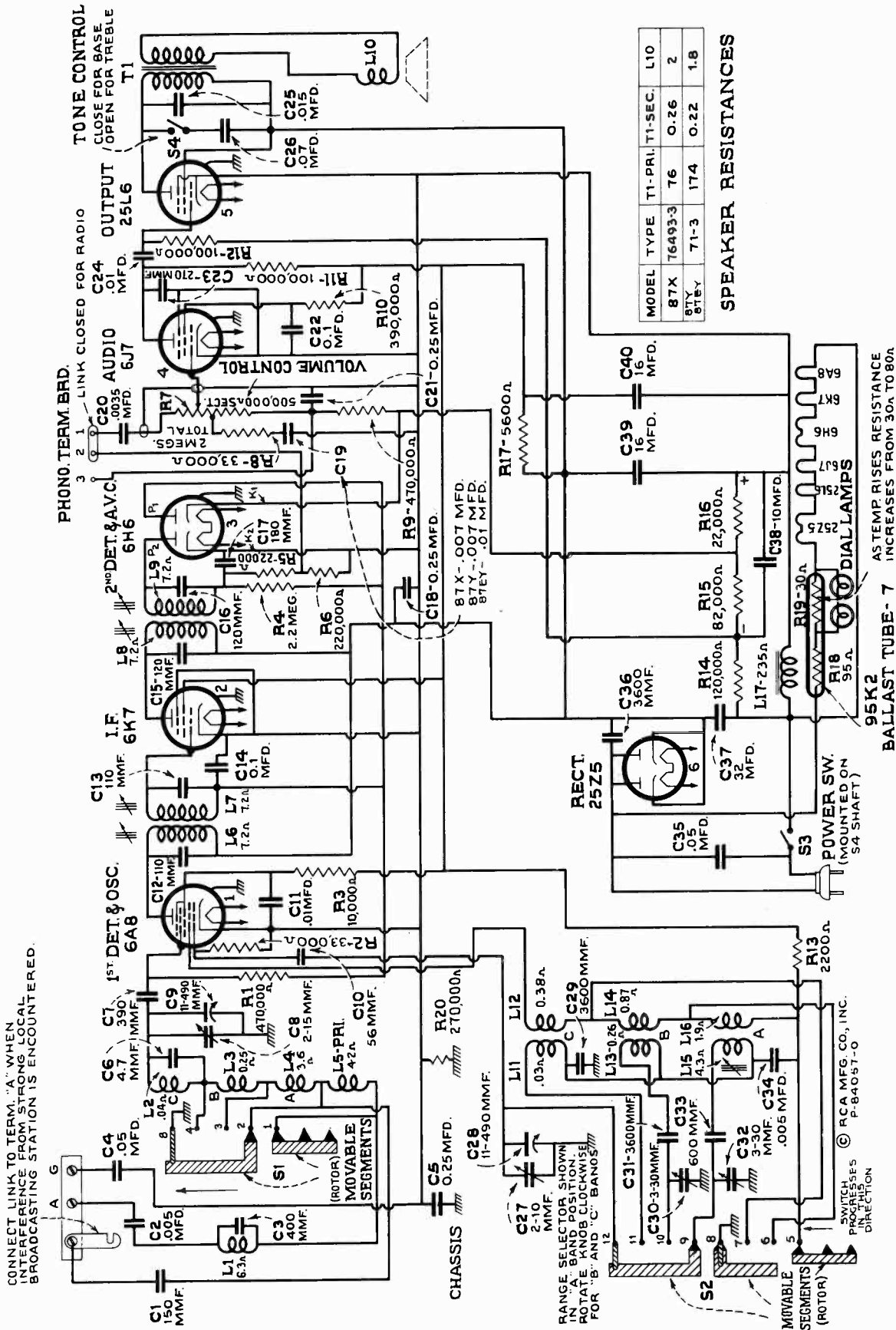
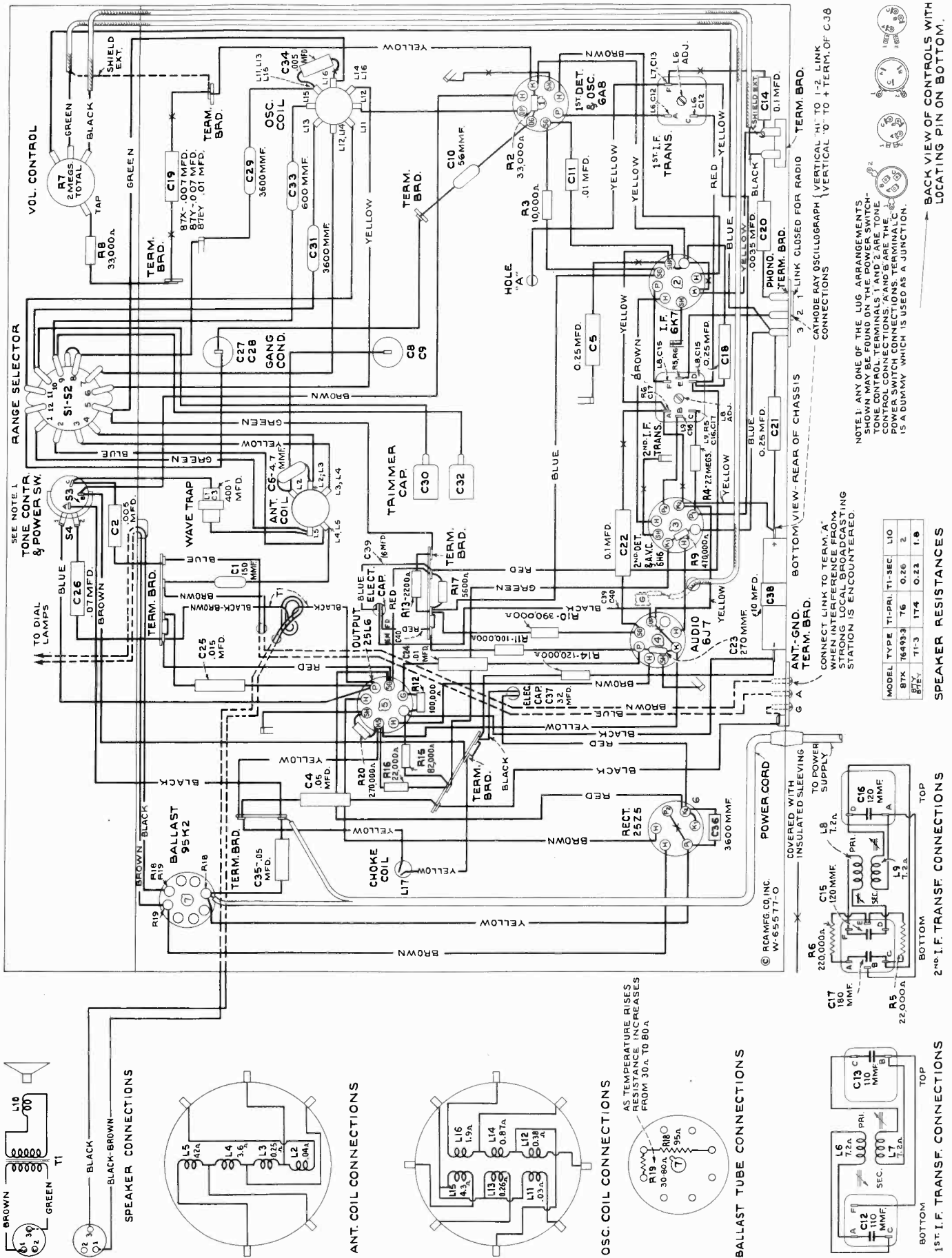

Figure 3—Schematic Circuit Diagram

On some instruments, R15 is 68,000 ohms and R16 is 33,000 ohms.



NOTE 1: ANY ONE OF THE LUG ARRANGEMENTS SHOWN MAY BE FOUND ON THE POWER SWITCH-TONE CONTROL. TERMINALS 1 AND 2 ARE TONE CONTROL. TERMINALS 3 AND 4 ARE TONE POWER SWITCH CONNECTIONS. TERMINAL 5 IS A DUMMY WHICH IS USED AS A JUNCTION.

| MODEL TYPE | T1-PR1 | T1-SEC | L10 |
|------------|--------|--------|----------|
| 87X | 76 | 0.26 | 2 |
| 87Y | 11-3 | 17.4 | 0.23 1.8 |

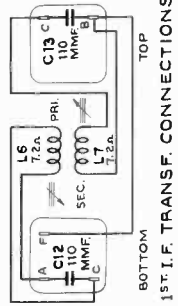
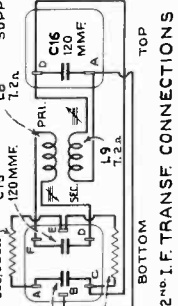

Figure 4—Chassis Wiring Diagram

Phonograph Attachment.—A terminal board is provided for connecting a phonograph into the audio amplifying circuit. RCA Victor Models R-93, R-93-A, R-93-S, R-93-2, or R-94 Record Players should be connected as follows: Remove link between terminals 1 and 2 on terminal board. Connect green wire in Radio-Record switch cable to terminal

1, yellow to terminal 2, and shield extension to terminal 3. Tape unused red and blue leads separately. Connect a 2-conductor twisted cable between the Record Player binding posts and the screw terminals on Radio-Record switch. When employing the R-93-S, the 0.1 mfd. capacitor contained in the R-93-S should be shorted out.

REPLACEMENT PARTS

Insist on genuine factory-tested parts, which are readily identified and may be purchased from authorized dealers.

| STOCK No. | DESCRIPTION | STOCK No. | DESCRIPTION |
|----------------------------|---|--|---|
| RECEIVER ASSEMBLIES | | | |
| 14380 | Arm—Band indicator operating arm and hub—less set screw Stock No. 14350 | 13718 | Resistor—2,200 Ohms—Insulated, ¼ watt (R13) |
| 14388 | Belt—Variable condenser drive belt | 11647 | Resistor—5,600 Ohms—Carbon type, ¼ watt (R17) |
| 14623 | Board—Antenna and ground terminal board | 13736 | Resistor—10,000 Ohms—Carbon type, ¼ watt (R3) |
| 12717 | Board—Phonograph terminal board | 14284 | Resistor—22,000 Ohms—Carbon type, 1/10 watt (R5) |
| 14338 | Bushing—Variable condenser mounting bushing and screw assembly | 11305 | Resistor—22,000 Ohms—Carbon type, ¼ watt (R16) |
| 12607 | Cap—First I-F transformer shield top | 12454 | Resistor—33,000 Ohms—Insulated, ¼ watt (R2) |
| 12581 | Cap—Second I-F transformer shield top | 11300 | Resistor—33,000 Ohms—Carbon type, 1/10 watt (R8) |
| 11350 | Cap—Grid contact cap | 14023 | Resistor—82,000 Ohms—Insulated, ¼ watt (R15) |
| 12110 | Cap—Radiotron shield cap | 11281 | Resistor—100,000 Ohms—Carbon type, 1/10 watt (R12) |
| 14383 | Capacitor—Adjustable dual trimmer (C30, C32) | 14560 | Resistor—100,000 Ohms—Insulated, ¼ watt (R11) |
| 14392 | Capacitor—4.7 Mmfd. (C8) | 13734 | Resistor—120,000 Ohms—Carbon type, ¼ watt (R14) |
| 12723 | Capacitor—56 Mmfd. (C10) | 11398 | Resistor—220,000 Ohms—Carbon type, 1/10 watt (R6) |
| 14262 | Capacitor—110 Mmfd. (C12, C13) | 11323 | Resistor—270,000 Ohms—Carbon type, ¼ watt (R20) |
| 12404 | Capacitor—120 Mmfd. (C15, C16) | 13479 | Resistor—390,000 Ohms—Carbon type, ¼ watt (R10) |
| 12725 | Capacitor—150 Mmfd. (C1) | 11452 | Resistor—470,000 Ohms—Carbon type, 1/10 watt (R1) |
| 12406 | Capacitor—180 Mmfd. (C17) | 12285 | Resistor—470,000 Ohms—Insulated, ¼ watt (R9) |
| 14625 | Capacitor—270 Mmfd. (C23) | 12679 | Resistor—2.2 Megohm—Insulated, ¼ watt (R4) |
| 13894 | Capacitor—390 Mmfd. (C7) | 30284 | Resistor—Ballast resistor tube type No. 95K2 (R18, R19) |
| 14391 | Capacitor—600 Mmfd. (C33) | 14350 | Screw—No. 8-32x3/16 square head set screw for gear Stock No. 30085 and drum Stock No. 14345 and arm Stock No. 14380 |
| 12811 | Capacitor—3,600 Mmfd. (C28, C31, C36) | 14374 | Shield—Antenna coil shield |
| 5005 | Capacitor—0.035 Mfd. (C20) | 12008 | Shield—First or Second I.F. transformer shield |
| 4838 | Capacitor—0.005 Mfd. (C2, C34) | 14375 | Shield—Oscillator coil shield |
| 5148 | Capacitor—0.007 Mfd. (C19) (Models 87X and 87Y only) | 14171 | Socket—Dial lamp socket |
| 13138 | Capacitor—0.01 Mfd. (C11) | 4786 | Socket—6-contact 25Z5 Radiotron socket |
| 14393 | Capacitor—0.01 Mfd. (C19, C24) (C19, .01 Mfd. used in Model 87EY only) | 11196 | Socket—8-contact 6A8, 6K7, 6J7, 6H6, or 25L6 Radiotron socket |
| 11315 | Capacitor—0.15 Mfd. (C25) | 12007 | Spring—Retaining spring for core Stock No. 12006 and Stock No. 12800 |
| 4886 | Capacitor—0.05 Mfd. (C4, C35) | 12907 | Spring—Tension spring for indicator drive gear Stock No. 30085 |
| 14626 | Capacitor—0.07 Mfd. (C26) | 14342 | Spring—Tension spring for idler Stock No. 14341 |
| 4839 | Capacitor—0.1 Mfd. (C14, C22) | 14370 | Switch—Range switch (S1, S2) |
| 12484 | Capacitor—0.25 Mfd. (C5, C18, C21) | 14371 | Switch—Tone control switch and power switch (S3, S4) |
| 14624 | Capacitor—10 Mfd. (C38) | 14376 | Transformer—First I.F. transformer (L6, L7, C12, C13) |
| 14621 | Capacitor—32 Mfd. (C37) | 14283 | Transformer—Second I.F. transformer (L8, L9, C15, C16, C17, R5, R6) |
| 14622 | Capacitor Pack—2 sections each 16 Mfd. (C39, C40) | 13838 | Trap—Wave trap complete (L1, C3) |
| 14372 | Coil—Antenna coil and shield (L2, L3, L4, L5) | 14335 | Volume Control (R7) |
| 14373 | Coil—Oscillator coil and shield (L11, L12, L13, L14, L15, L16) | 14379 | Washer—Felt washer for indicator pointer |
| 14363 | Condenser—2 gang variable tuning condenser (C8, C9, C27, C28) | REPRODUCER ASSEMBLIES MODEL 87X (76493-3) | |
| 5119 | Connector—3-contact female connector for reproducer cable | 14685 | Cone—Reproducer cone (L10) |
| 12800 | Core—Adjustable core and stud assembly for coil Stock No. 14373 | 5118 | Plug—3-contact male plug for reproducer |
| 12006 | Core—Adjustable core and stud for Stock No. 14378 and Stock No. 14283 | 14684 | Reproducer—Complete |
| 14381 | Dial—Station selector dial scale | 14686 | Transformer—Output transformer (T1) |
| 14389 | Dial—Band indicator dial and mounting bracket assembly (Models 87X and 87Y only) | REPRODUCER ASSEMBLIES (RL-71-3) MODEL 87Y and 87EY | |
| 30127 | Dial—Band indicator dial and mounting bracket assembly (Model 87EY only) | 12667 | Cone—Reproducer cone and dust cap |
| 14364 | Drive—Variable condenser vernier pinion gear and shaft | 5118 | Plug—3-contact male plug for reproducer |
| 14345 | Drum—Variable condenser drive belt drum complete with set screws | 14627 | Reproducer—Complete |
| 11982 | Fastener—Station selector dial scale fastener | 14628 | Transformer—Output transformer (T1) |
| 30085 | Gear—Indicator drive gear and hub assembly and indicator pointer stem and gear assembly complete | MISCELLANEOUS ASSEMBLIES | |
| 14341 | Idler—Station selector drive belt idler | 14396 | Escutcheon—Station selector escutcheon and crystal |
| 14344 | Indicator—Station selector indicator pointer | 14359 | Knob—Station selector knob |
| 14382 | Indicator—Vernier indicator pointer | 14269 | Knob—Volume control, tone control or range switch knob |
| 4340 | Lamp—Dial lamp | 4560 | Screw—Chassis mounting screw and washer assembly (Model 87EY only) |
| 14340 | Pulley—Station selector drive belt pulley and knob shaft | 11210 | Screw—Chassis mounting screw and washer assembly (Model 87Y only) |
| 14620 | Reactor—Filter reactor (L17) | 11377 | Screw—Chassis mounting screw and washer assembly (Model 87X only) |
| 14361 | Reflector—Dial reflector and lamp bracket assembly | 4982 | Spring—Retaining spring for knob Stock No. 14359 |
| 14343 | Retainer—Drive shaft and pulley retainer—holds tuning knob shaft and pulley on range switch shaft | 14270 | Spring—Retaining spring for knob Stock No. 14269 |



RCA Victor

MODEL 812X

Twelve-Tube, Four-Band, AC-DC, Superheterodyne Receiver

TECHNICAL INFORMATION AND SERVICE DATA

SERVICE DIVISION • RCA MANUFACTURING COMPANY, INC. • CAMDEN, N. J., U. S. A.

A Service of the Radio Corporation of America

Electrical Specifications

FREQUENCY RANGES

"Long Wave" (X)..... 2,000-850 meters (150-353 kc)
 "Medium Wave" (A)..... 565-180 meters (531-1,666 kc)
 "Short Wave 1" (B)..... 2.1-6.8 mc (143-44.1 meters)
 "Short Wave 2" (C)..... 6.8-22 mc (44.1-13.64 meters)

R-F ALIGNMENT FREQUENCIES

"Short Wave 2" (C)..... 20,000 kc (osc., det., ant.)
 "Short Wave 1" (B)..... 6,000 kc (osc.)
 "Medium Wave" (A)..... 600 kc (osc.), 1,500 kc (osc.)
 "Long Wave" (X)..... 166.7 kc (osc.), 353 kc (osc., det., ant.)

Intermediate Frequency..... 460 kc

RADIOTRON COMPLEMENT

(1) RCA-6K7..... R-F Amplifier
 (2) RCA-6L7..... First Detector
 (3) RCA-6J7..... Heterodyne Oscillator
 (4) RCA-6K7..... Intermediate Amplifier
 (5) RCA-6H6..... Second Detector and A.V.C.
 (6) RCA-6F5..... Audio Amplifier

(7) RCA-6F5..... Audio Amplifier
 (8) RCA-25A6..... Power Output
 (9) RCA-25A6..... Power Output
 (10) RCA-6G5..... "Magic Eye" Tuning Tube
 (11) RCA-25Z5..... Half-Wave Rectifier
 (12) RCA-25Z5..... Half-Wave Rectifier

Pilot Lamps (2)..... Mazda No. 40, 6.3 volts, 0.15 amp.

POWER SUPPLY RATINGS

A-C Rating..... 200-250 volts, 40-60 cycles, 220 watts
 D-C Rating..... 200-250 volts, 195 watts

LOUDSPEAKER

Type..... 8-inch Electrodynamic
 Impedance (v.c.)..... 2.2 ohms at 400 cycles

POWER OUTPUT

| | | |
|------------------|---------------|------------|
| Undistorted..... | A-C Rating | D-C Rating |
| Maximum..... | 5 watts..... | 4 watts |
| | 7½ watts..... | 5½ watts |

Mechanical Specifications

Height..... 20⅞ inches
 Width..... 16⅞ inches
 Depth..... 12 inches
 Net Weight..... 35½ pounds
 Shipping Weight..... 45½ pounds
 Chassis Base Dimensions..... 14⅞ inches x 9⅞ inches x 3⅞ inches
 Over-all Chassis Height..... 9⅞ inches
 Operating Controls..... (1) Power Switch—Tone; (2) Tuning (large inner knob), Range Selector (small outer knob, left to right "X," "A," "B," "C"); (3) Volume
 Tuning Drive Ratio..... 30 to 1

General Description

This receiver employs a twelve-tube, four-band, "Magic Brain," superheterodyne circuit, the arrangement of which is shown by the Schematic Circuit Diagram. Features of design include an r-f amplifier stage; cumulative-wound "A" antenna and r-f transformers for high signal-to-noise ratio; magnetite-core, i-f transformers and low-frequency "X" and "A" oscillator tracking; automatic volume control; phono-

graph terminal board; "Magic Eye" tuning tube; plunger-type, air-dielectric trimming capacitors; aural-compensated, audio-volume control; tone control; audio phase-inverter voltage amplifier; push-pull, power-output stage; improved dust-proof electrodynamic loudspeaker; a new sunburst dial with short-wave stations listed by name and illuminated band indicator; and the improved "Magic Voice."

Copyright, 1937, RCA Manufacturing Co., Inc.

Trademarks "Radiotron," "Magic Eye," "Magic Brain," "Magic Voice" Reg. U. S. Pat. Off. by RCA Manufacturing Co., Inc.

Alignment Procedure

Calibrate the tuning dial by adjusting main dial pointer to the low-frequency (end) calibration mark on dial with the gang tuning-condenser plates in full-mesh position; then adjust the small (vernier) pointer to "0." These are friction adjustments.

Perform alignment in proper order, tabulated below, starting with No. 1 and following all operations across, then No. 2, etc. Adjustment locations are shown on figures 1 and 2.

Cathode-ray alignment is highly preferable; the connections to the chassis are shown on figure 4. If an output indicator is used, connect it across the loudspeaker voice-coil and advance the receiver volume control to full-volume position.

Connect the "low" output terminal of the test oscillator to the chassis for all alignment operations. Regulate the output of the test oscillator so that minimum signal is applied to the receiver to obtain an observable output indication. This will avoid a-v-c action.

The term "Dummy antenna" means the device which must be connected between the "high" test-oscillator output and the point of connection to the receiver in order to obtain ideal alignment. "No signal, 545-400 meters" means that the receiver should be tuned to a point between 545 and 400 meters where no signal or interference is received from a station or local (heterodyne) oscillator. In extreme noisy locations, one end of C15 (top of gang) should be unsoldered during i-f alignment.

Conversion of kilocycles (kc) to meters for alignment frequencies is as follows: 20,000 kc (20 mc) = 15 meters; 6,000 kc (6 mc) = 50 meters; 1,500 kc = 200 meters; 600 kc = 500 meters; 460 kc = 652 meters; 353 kc = 850 meters; and 166.7 kc = 1,800 meters.

For further details on alignment, refer to booklet "RCA Victor Receiver Alignment."

| Order of Alignment | Test Oscillator | | | Range Selector | Receiver Dial Setting | Circuit to Adjust | Adjustment Symbols | Adjust to Obtain |
|--------------------|------------------------|---------------|-------------------|----------------|--------------------------|-------------------|--------------------|------------------|
| | Connection to Receiver | Dummy Antenna | Frequency Setting | | | | | |
| 1 | 6K7 I-F Grid Cap | .001 Mfd. | 460 kc | "Medium Wave" | No Signal 545-400 meters | 2nd I-F Trans. | L16 and L17 | Max. (peak) |
| 2 | 6L7 Det. Grid Cap | .001 Mfd. | 460 kc | "Medium Wave" | No Signal 545-400 meters | 1st I-F Trans. | L14 and L15 | Max. (peak) |
| 3 | Ant. Term. | 200 Mmfd. | 460 kc | "Medium Wave" | No Signal 545-400 meters | Wave Trap | L6 | Minimum Output |
| 4 | Ant. Term. | 300 Ohms | 20,000 kc | "Short Wave 2" | 20 mc | "C" Osc. | C45 | Max. (peak)* |
| 5 | Ant. Term. | 300 Ohms | 20,000 kc | "Short Wave 2" | 20 mc | "C" Det. | C10 | Max. (peak)† |
| 6 | Ant. Term. | 300 Ohms | 20,000 kc | "Short Wave 2" | 20 mc | "C" Ant. | C4 | Max. (peak)‡ |
| 7 | Ant. Term. | 300 Ohms | 6,000 kc | "Short Wave 1" | 6 mc | "B" Osc. | C38 | Max. (peak)* |
| 8 | Ant. Term. | 200 Mmfd. | 600 kc | "Medium Wave" | 500 meters | "A" L-F Osc. | L20 | Max. (peak) |
| 9 | Ant. Term. | 200 Mmfd. | 1,500 kc | "Medium Wave" | 200 meters | "A" H-F Osc. | C40 | Max. (peak) |
| 10 | Ant. Term. | 200 Mmfd. | 600 kc | "Medium Wave" | 500 meters | "A" L-F Osc. | L20 | Max. (peak) |
| 11 | Ant. Term. | 200 Mmfd. | 1,500 kc | "Medium Wave" | 200 meters | "A" H-F Osc. | C40 | Max. (peak) |
| 12 | Ant. Term. | 200 Mmfd. | 166.7 kc | "Long Wave" | 1,800 meters | "X" L-F Osc. | L21 | Max. (peak) |
| 13 | Ant. Term. | 200 Mmfd. | 353 kc | "Long Wave" | 850 meters | "X" H-F Osc. | C43 | Max. (peak) |
| 14 | Ant. Term. | 200 Mmfd. | 353 kc | "Long Wave" | 850 meters | "X" Det. | C9 | Max. (peak) |
| 15 | Ant. Term. | 200 Mmfd. | 353 kc | "Long Wave" | 850 meters | "X" Ant. | C6 | Max. (peak) |
| 16 | Ant. Term. | 200 Mmfd. | 166.7 kc | "Long Wave" | 1,800 meters | "X" L-F Osc. | L21 | Max. (peak) |
| 17 | Ant. Term. | 200 Mmfd. | 353 kc | "Long Wave" | 850 meters | "X" H-F Osc. | C43 | Max. (peak) |

* Use minimum capacity peak if two peaks can be obtained.

† Use maximum capacity peak if two peaks can be obtained.

‡ After this adjustment, check for image signal by shifting receiver dial to 19,080 mc.

Service Data

CAUTION: The chassis is connected to one side of the power supply. Avoid contact of chassis or parts to external ground when servicing.

The various diagrams of this booklet contain such information as will be needed to isolate causes for defective operation if such develops. The ratings of the resistors, capacitors, coils, etc., are indicated adjacent to the symbols signifying these parts on the schematic diagram. Identification titles such as R1, L1, C1, etc., provide reference between the illustrations and Replacement Parts List. The coils, transformer windings, and reactors are rated in terms of d-c resistance to permit continuity checks.

Loudspeaker.—Centering of the loudspeaker is made in the usual manner with three narrow celluloid or paper feelers after first removing the front dust cover. This may be removed by softening its cement with a light application of acetone, using care not to allow the acetone to flow into the air gap. The dust cover should be cemented back in place with ambroid upon completion of adjustment.

Phonograph Attachment.—A terminal board is provided for connecting a phonograph into the audio amplifying circuit. RCA Victor Models R-93, R-93-A, R-93-2, or R-94 Record Players should be connected as follows: Remove link between terminals 1 and 2 on terminal board. Connect green

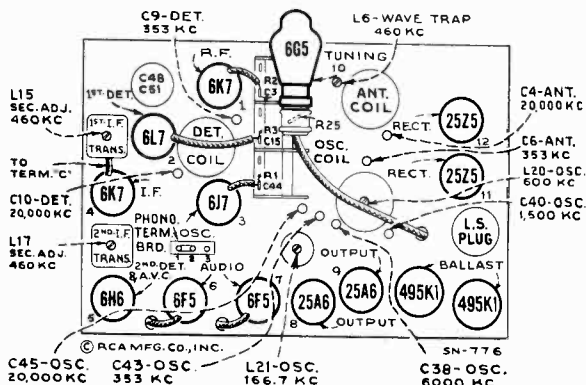
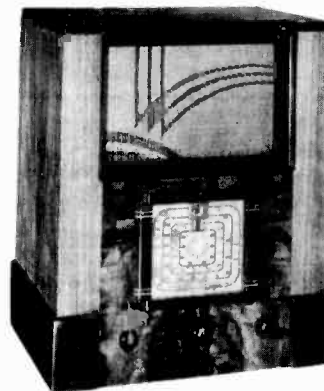

Figure 1—Radiotron, Component Part, and Trimmer Locations



Model 812X

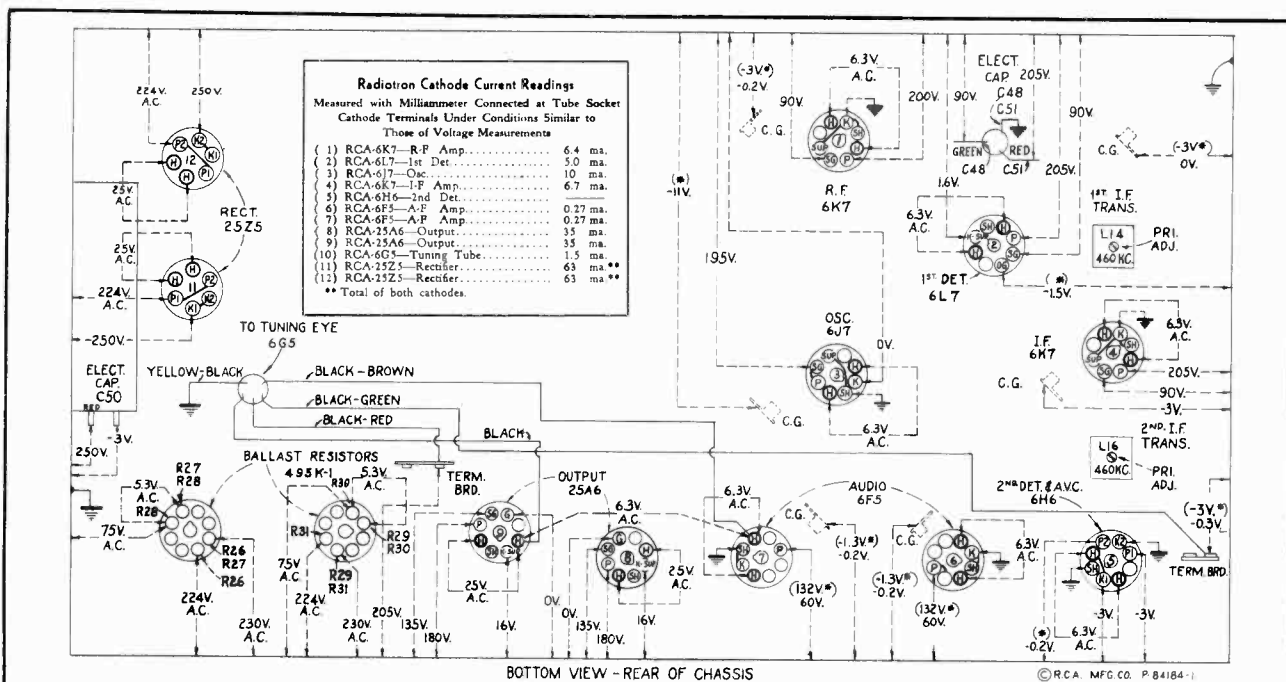

Figure 2—Radiotron Socket Voltages and Trimmer Locations

Measured at 230 volts, 60-cycle supply—For 230-volt d-c supply approximately 15% lower, except heater voltages, which remain the same—Tuned to approximately 1,000 kc or 300 meters, "A" band ("Medium Wave")—No signal being received—Volume control minimum—Tone control optional.

Note: Two voltage values are shown for some readings. The value shown in parentheses with asterisk (*) indicates operating conditions without voltmeter loading. The other value (generally lower) is the actual measured voltage and differs from the value shown in parentheses because of the additional loading of the voltmeter.

Voltage values as specified should hold within $\pm 20\%$ when the receiver is normally operative at its rated line voltage. To duplicate the conditions under which the voltages were measured requires a 1,000-ohm-per-volt d-c meter, having ranges of 10, 50, 250 and 500 volts. Use the nearest range above the specified measured voltage. A-c voltages were measured with a corresponding a-c meter.

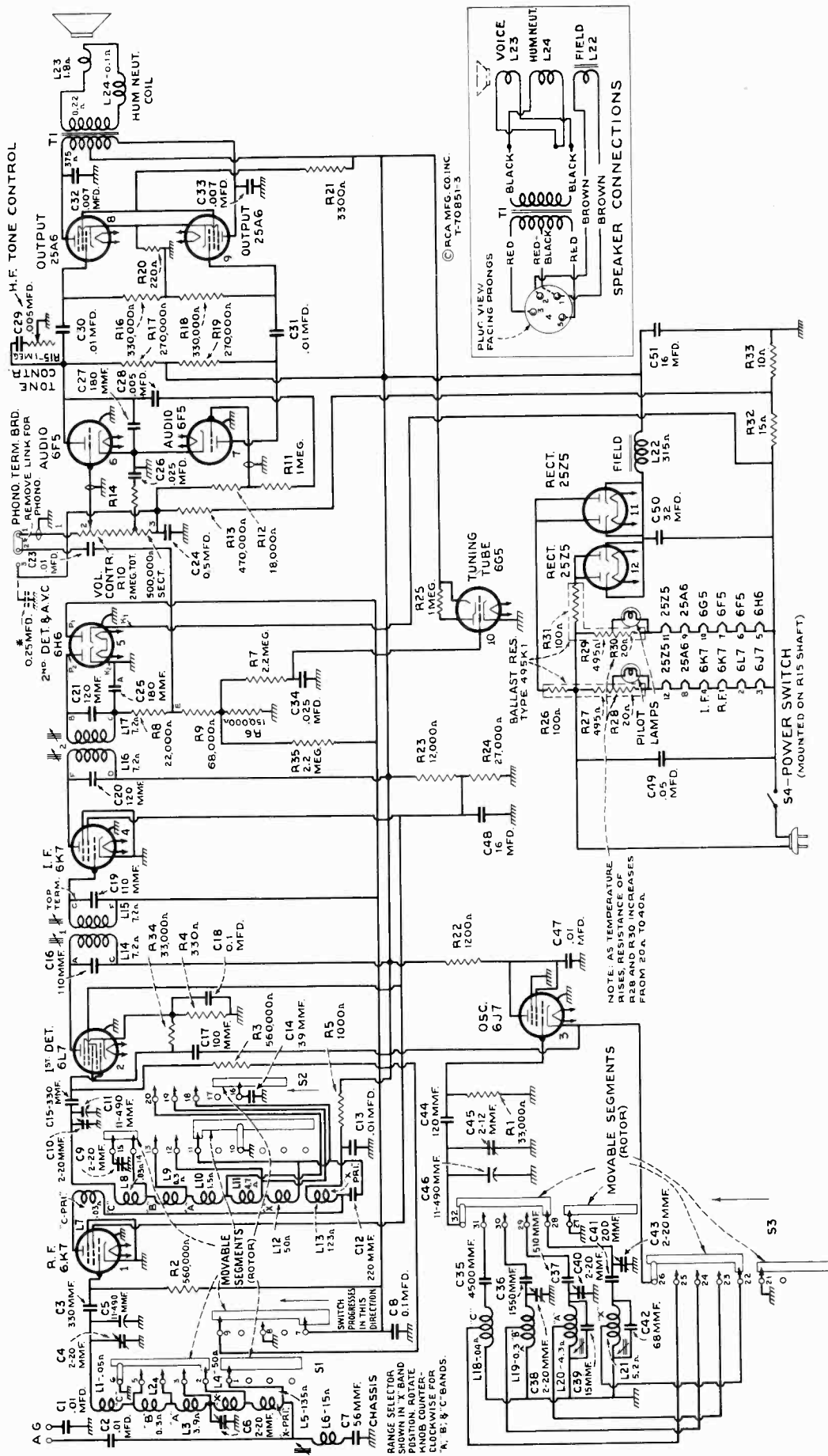
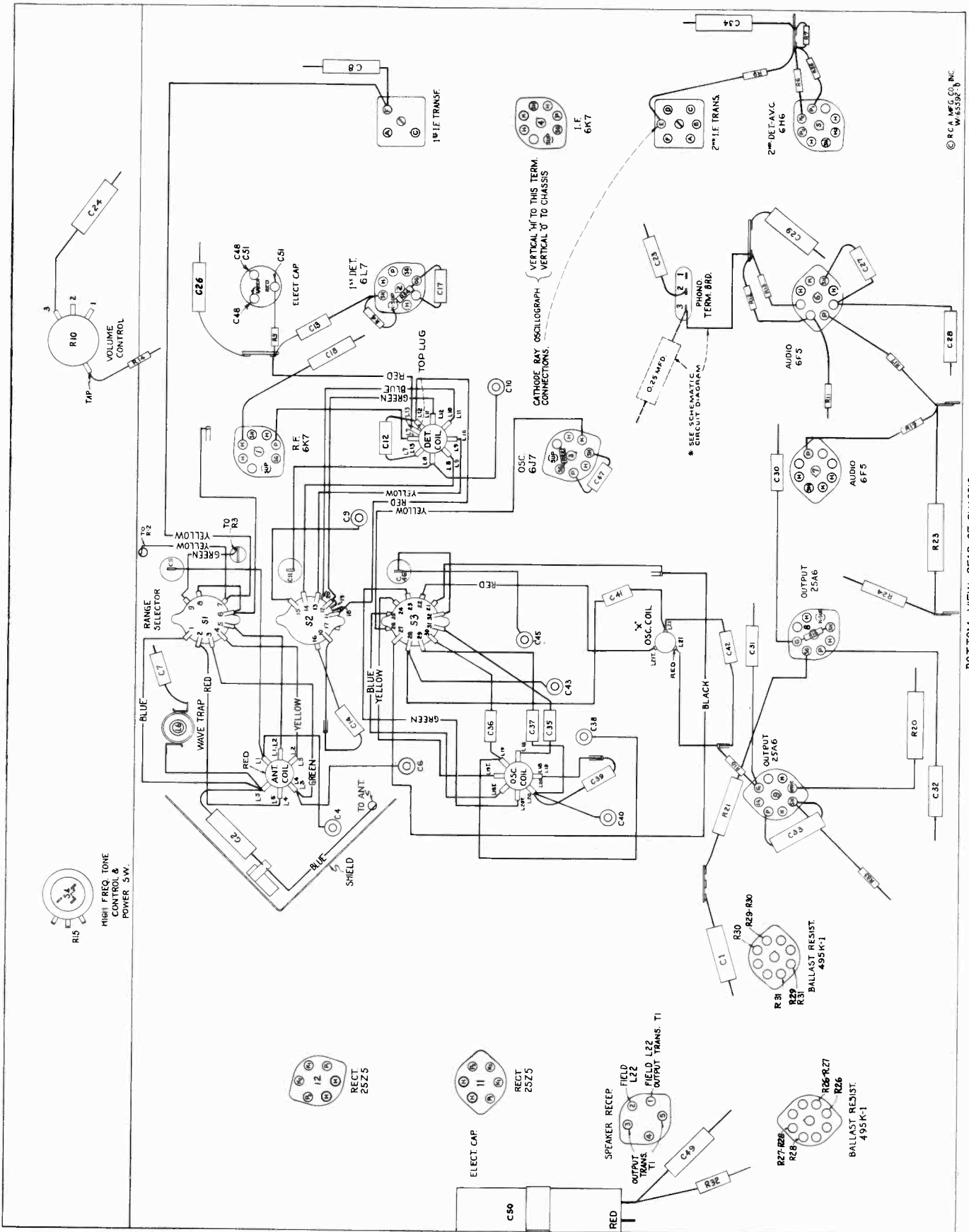

Figure 3—Schematic Circuit Diagram

* Some instruments have this capacitor and do not have jumper from terminal 3 of phono. term. board to junction of R12 and R13. In service remove capacitor and connect jumper from term. 3 to junction of R12 and R13.



BOTTOM VIEW - REAR OF CHASSIS

Figure 4—Component Part Locations and R-F Wiring Diagram

wire in Radio-Record switch cable to terminal 1, yellow to terminal 2, and shield extension to terminal 3. Tape unused red and blue leads separately. Connect a 2-conductor twisted cable between the Record Player binding posts and the screw terminals on Radio-Record switch. If additional volume is desired, connect an RCA Stock No. 9632 transformer between the two-conductor twisted cable and the screw-terminals on Radio-Record switch as follows: yellow and brown transformer leads and one side of twisted cable to ground screw-terminal on switch; green transformer lead to other side of twisted cable; and red transformer lead to other screw-terminal on switch.

CAUTION: Disconnect receiver power cord before making phonograph connections. Tape shield extension on Radio-Record cable so it cannot make metallic connection with receiver chassis ground.

Precautionary Lead Dress.—(1) Twist yellow, blue, and green leads from oscillator coil to range selector. Dress the

following away from the short trimmer: (2) capacitor from "X" oscillator coil to range selector; (3) black lead from rear section of range selector to ground lance. (4) Dress yellow lead from 6J7 socket under bus lead on the socket. (5) Dress shielded lead from volume control to phonograph terminal board away from 6L7 socket. (6) Dress yellow leads from 6J7 socket away from chassis and brown filament leads. (7) Dress all molded capacitors with flat side perpendicular to chassis. (8) Dress C35 and C36 apart and away from air trimmers. (9) Maintain length and size of lead from center section of range selector to ground and dress away from chassis. Do not change length or wire size of the following: (10) lead from oscillator coil (L18, L19, L20) to ground; (11) lead from rear section of range selector to rear section of tuning condenser; (12) lead from detector coil to center section of tuning condenser; (13) lead from front section of range selector to ground lance; (14) bus lead from antenna coil to range selector; and (15) lead from antenna coil to front section of tuning condenser.

REPLACEMENT PARTS

Insist on genuine factory tested parts, which are readily identified and may be purchased from authorized dealers.

| STOCK No. | DESCRIPTION | STOCK No. | DESCRIPTION |
|----------------------------|---|---------------------------------|---|
| RECEIVER ASSEMBLIES | | | |
| 14542 | Arm—Band indicator operating arm and hub—less set-screw Stock No. 4669 | 13988 | Resistor—10 ohms, carbon type, 1/4 watt (R33) |
| 12038 | Band—Rubber band for tuning tube | 12014 | Resistor—15 ohms, carbon type, 1/4 watt (R32) |
| 30605 | Belt—Drive belt | 13218 | Resistor—220 ohms, carbon type, 2 watt (R20) |
| 13216 | Board—Antenna and ground terminal board | 13250 | Resistor—330 ohms, carbon type, 1/4 watt (R4) |
| 12717 | Board—Phonograph terminal board | 14837 | Resistor—1,000 ohms, carbon type, 1/10 watt (R5) |
| 13658 | Button—Plug button for R.F. coil shield | 30104 | Resistor—1,200 ohms, carbon type, 1/4 watt (R22) |
| 12607 | Cap—First I.F. transformer top shield cap | 5147 | Resistor—3,300 ohms, carbon type, 1 watt (R21) |
| 12581 | Cap—Second I.F. transformer top shield cap | 8073 | Resistor—12,000 ohms, carbon type, 2 watt (R23) |
| 11350 | Cap—Grid contact cap | 13045 | Resistor—18,000 ohms, insulated, 1/4 watt (R12) |
| 12884 | Capacitor—Adjustable trimmer (long) (C4, C6, C9, C10, C38, C40, C43) | 14284 | Resistor—22,000 ohms, carbon type, 1/10 watt (R8, R14) |
| 12714 | Capacitor—Adjustable trimmer (medium) (C45) | 8085 | Resistor—27,000 ohms, carbon type, 1/4 watt (R24) |
| 12896 | Capacitor—15 Mmfd. (C39) | 11300 | Resistor—33,000 ohms, carbon type, 1/10 watt (R1, R34) |
| 13545 | Capacitor—39 Mmfd. (C14) | 12010 | Resistor—68,000 ohms, carbon type, 1/10 watt (R9) |
| 12723 | Capacitor—58 Mmfd. (C7) | 12478 | Resistor—150,000 ohms, carbon type, 1/10 watt (R6) |
| 13057 | Capacitor—68 Mmfd. (C42) | 11323 | Resistor—270,000 ohms, carbon type, 1/4 watt (R17, R19) |
| 12720 | Capacitor—100 Mmfd. (C17) | 13733 | Resistor—330,000 ohms, carbon type, 1/4 watt (R16, R18) |
| 14262 | Capacitor—110 Mmfd. (C18, C19) | 11452 | Resistor—470,000 ohms, carbon type, 1/10 watt (R13) |
| 12404 | Capacitor—120 Mmfd. (C20, C21) | 11397 | Resistor—560,000 ohms, carbon type, 1/10 watt (R2, R3) |
| 12724 | Capacitor—120 Mmfd. (C44) | 12200 | Resistor—1 meg., insulated, 1/4 watt (R11) |
| 12406 | Capacitor—180 Mmfd. (C25) | 12013 | Resistor—1 meg., carbon type, 1/10 watt (R25) |
| 13003 | Capacitor—180 Mmfd. (C27) | 5131 | Resistor—2.2 meg., carbon type, 1/10 watt (R7, R35) |
| 30232 | Capacitor—200 Mmfd. (C41) | 14343 | Retainer—Retaining ring for range switch shaft—holds station selector knob shaft and pulley |
| 12694 | Capacitor—220 Mmfd. (C12) | 4669 | Screw—No. 8-32 x 5/32-in. square head set screw for arm Stock No. 14542 |
| 12952 | Capacitor—330 Mmfd. (C3, C15) | 14350 | Screw—No. 8-32 x 3/16-in. square head set screw for gear Stock No. 30085—drum Stock No. 14345 |
| 30608 | Capacitor—510 Mmfd. (C37) | 4814 | Socket—5-contact Radiotron socket |
| 12729 | Capacitor—1,550 Mmfd. (C36) | 4786 | Socket—6-contact Radiotron socket |
| 12728 | Capacitor—4,500 Mmfd. (C35) | 11198 | Socket—8-contact Radiotron socket |
| 4838 | Capacitor—.005 Mfd. (C28, C29) | 14171 | Socket—Dial lamp socket |
| 5148 | Capacitor—.007 Mfd. (C32, C33) | 13871 | Socket—Tuning tube socket |
| 4858 | Capacitor—.01 Mfd. (C1, C2, C13) | 30609 | Socket—Pilot lamp socket and lead assembly |
| 14393 | Capacitor—.01 Mfd. (C23, C30, C31, C47) | 14342 | Spring—Tension spring for idler Stock No. 14341 |
| 4870 | Capacitor—.025 Mfd. (C26, C34) | 30226 | Switch—Range switch (S1, S2, S3) |
| 4886 | Capacitor—.05 Mfd. (C49) | 30574 | Tone control and power switch (R15, S4) |
| 4839 | Capacitor—.1 Mfd. (C8, C18) | 14376 | Transformer—First I.F. transformer (L14, L15, C16, C19) |
| 12741 | Capacitor—.5 Mfd. (C24) | 14308 | Transformer—Second I.F. transformer (L16, L17, C20, C21, R8) |
| 30597 | Capacitor Pack—2 sections each 16 Mfd. (C48, C51) | 12654 | Trap—Wave trap (L6) |
| 30598 | Capacitor—32 Mfd. (C50) | 30596 | Volume Control (R10) |
| 30228 | Coil—Antenna coil and shield (A-B-C-X) (L1, L2, L3, L4, L5) | 14379 | Washer—Felt washer for indicator pointer |
| 14516 | Coil—Oscillator coil and shield (A-B-C) (L18, L19, L20) | REPRODUCER ASSEMBLIES | |
| 12881 | Coil—Oscillator coil and shield (X) (L21) | Speaker RL-63H-2 | |
| 30229 | Coil—R.F. coil and shield (A-B-C-X) (L7, L8, L9, L10, L11, L12, L13) | 14356 | Board—3-contact reproducer terminal board |
| 14513 | Condenser—3-gang variable tuning condenser (C5, C11, C46) | 13866 | Cap—Cone center dust cap |
| 30600 | Dial—Station selector dial scale and tuning tube escutcheon for European use | 30613 | Coil—Field coil (L22) |
| 30601 | Dial—Station selector dial scale and tuning tube escutcheon for other than European use | 11469 | Coil—Hum neutralizing coil (L24) |
| 14514 | Drive—Vernier drive shaft and pinion gear for variable condenser | 12642 | Cone—Reproducer cone and dust cap (L23) |
| 14345 | Drum—Variable condenser drive belt drum complete with set screws | 30611 | Connector—4-prong male plug |
| 11982 | Fastener—Dial scale fastener | 30610 | Reproducer complete |
| 30085 | Gear—Indicator drive gear and hub and indicator stem and gear assemblies | 14358 | Screw—Screw, washer and lockwasher to hold core in yoke |
| 14341 | Idler—Drive belt idler pulley, bracket and spring | 30612 | Transformer—Output transformer (T1) |
| 30603 | Indicator—Band indicator and bracket | 14357 | Washer—Spring washer to hold field coil |
| 14344 | Indicator—Station selector indicator pointer (long) | MISCELLANEOUS ASSEMBLIES | |
| 14382 | Indicator—Station selector indicator pointer (vernier) | 11823 | Cord—Power cord and plug for back cover of cabinet |
| 4340 | Lamp—Dial lamp | 14398 | Escutcheon—Station selector escutcheon and crystal |
| 14028 | Nut—Jamb nut for adjustable trimmer capacitor | 14359 | Knob—Station selector knob |
| 12471 | Plate—Metal plate and rubber cushions for cushion socket | 30606 | Knob—Volume control, tone control, or range switch knob |
| 11979 | Plug—2-prong male plug for chassis power leads | 12993 | Screw—No. 8-32 x 3/8-in. cone-pointed set-screw for knob Stock No. 30608 |
| 30602 | Pulley—Drive belt pulley and knob shaft | 4982 | Spring—Retaining spring for knob Stock No. 14359 |
| 30599 | Resistor—Ballast resistor tube type 495K1 (2 used) (R26, R27, R28) (R29, R30, R31) | | |



RCA Victor

MODELS 84BT and 84BT6

Four-Tube, Single-Band, Battery Operated, Superheterodyne Receivers

TECHNICAL INFORMATION AND SERVICE DATA

SERVICE DIVISION • RCA MANUFACTURING COMPANY, INC. • CAMDEN, N. J., U. S. A.

A Service of the Radio Corporation of America

Electrical Specifications

| | | | |
|---|--|--------------------------|-----------------------------------|
| Frequency Range..... | 530—1,720 kc | Alignment Frequency..... | 1,500 kc (osc., ant.) |
| Intermediate Frequency..... | | | 460 kc |
| RADIOTRON COMPLEMENT (MODEL 84BT) | | (MODEL 84BT6) | |
| (1) RCA-1C6..... | First Detector—Oscillator | (1) RCA-6A7..... | First Detector—Oscillator |
| (2) RCA-1A4..... | Intermediate Amplifier | (2) RCA-6D6..... | Intermediate Amplifier |
| (3) RCA-1F6..... | Second Det., A-F Amp., and A.V.C. | (3) RCA-75..... | Second Det., A-F Amp., and A.V.C. |
| (4) RCA-1F4..... | Power Output | (4) RCA-42..... | Power Output |
| Pilot Lamp..... | 84BT, (1) Mazda 2.0 volts, .06 amp.; 84BT6, (1) Mazda No. 40, 6.3 volts, 0.15 amp. | | |
| BATTERIES REQUIRED | | | |
| 84BT...."A", one plug-in, 2½-volt Air Cell, or one 2-volt storage battery; "B", three 45-volt, heavy-duty, plug-in type B batteries; "C", one 4½-volt C battery tapped at 1½ volts. | | | |
| 84BT6...."A", one 6-volt storage battery; "B", none required; "C", three bias cells (Stock No. 12681). | | | |
| CURRENT CONSUMPTION | | MODEL 84BT | MODEL 84BT6 |
| "A" at 2 volts..... | 0.42 ampere..... | | |
| "A" at 6 volts..... | | | 2.95 amperes |
| "B" at 135 volts..... | 25 ma..... | | (Supplied from vibrator) |
| Fuse Rating..... | ½ amp..... | | 5 amps. |
| POWER OUTPUT | | | |
| Undistorted..... | 0.3 watt..... | | 0.5 watt |
| Maximum..... | 0.5 watt..... | | 0.8 watt |
| LOUDSPEAKER | | | |
| Type: permanent-magnet dynamic Diameter: 6 inches Voice coil impedance: 2¼ ohms at 400 cycles. | | | |

Mechanical Specifications

| | | |
|---------------------------------|-----------------|-------------------------------------|
| | MODEL 84BT | MODEL 84BT6 |
| Height..... | 16½ inches..... | 16½ inches |
| Width..... | 11¾ inches..... | 11¾ inches |
| Depth..... | 6¼ inches..... | 6¼ inches |
| Weight (net)..... | 9 pounds..... | 13½ pounds |
| Weight (shipping)..... | 12 pounds..... | 17 pounds |
| Chassis Base Dimensions..... | | 9⅞ inches x 5⅝ inches x 2 inches |
| Over-all Height of Chassis..... | | 6¾ inches |
| Operating Controls..... | | (1) Tuning, (2) Power Switch—Volume |
| Tuning Drive Ratio..... | | 5 to 1 |

General Description

These receivers each employ a four-tube superheterodyne circuit; the arrangement of which are shown by figures 3 and 5. Model 84BT obtains its plate supply from "B" batteries and its filament supply from either a 2-volt storage battery or a 2½-volt Air Cell. Model 84BT6 obtains its plate supply from a compact, built-in, vibrator power-supply unit which, in turn, is operated from a 6-volt storage

battery. This same battery also supplies heater voltage for the tubes.

Features of design include magnetite-core i-f transformers; automatic volume control; diode detection; resistance coupled audio system; sensitive, six-inch, permanent-magnet, dynamic loudspeaker with dust screen; low current drain; and a big, easy-to-read, illuminated dial.

Copyright, 1937, RCA Manufacturing Co., Inc.

Trademark "Radiotron"
Reg. U. S. Pat. Off. by RCA Mfg. Co., Inc.

84BT
84BT6

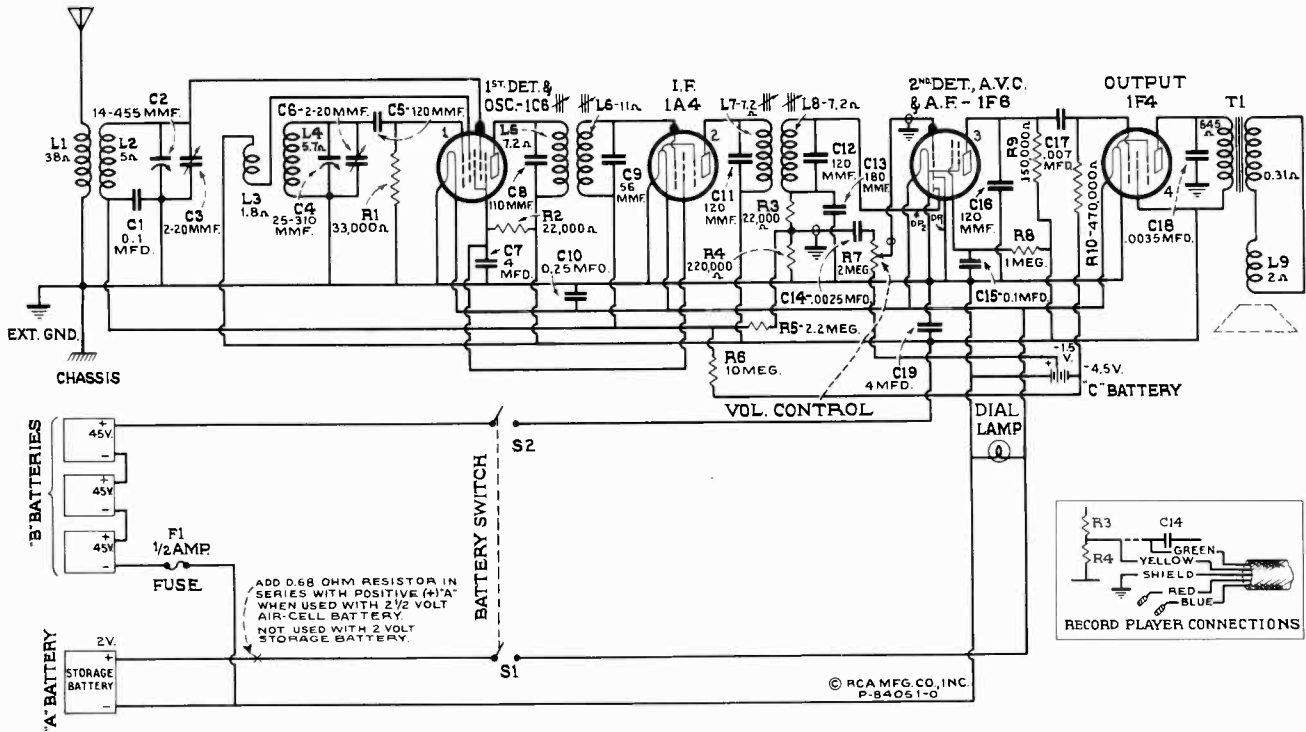

Figure 3—Schematic Circuit Diagram (Model 84BT)

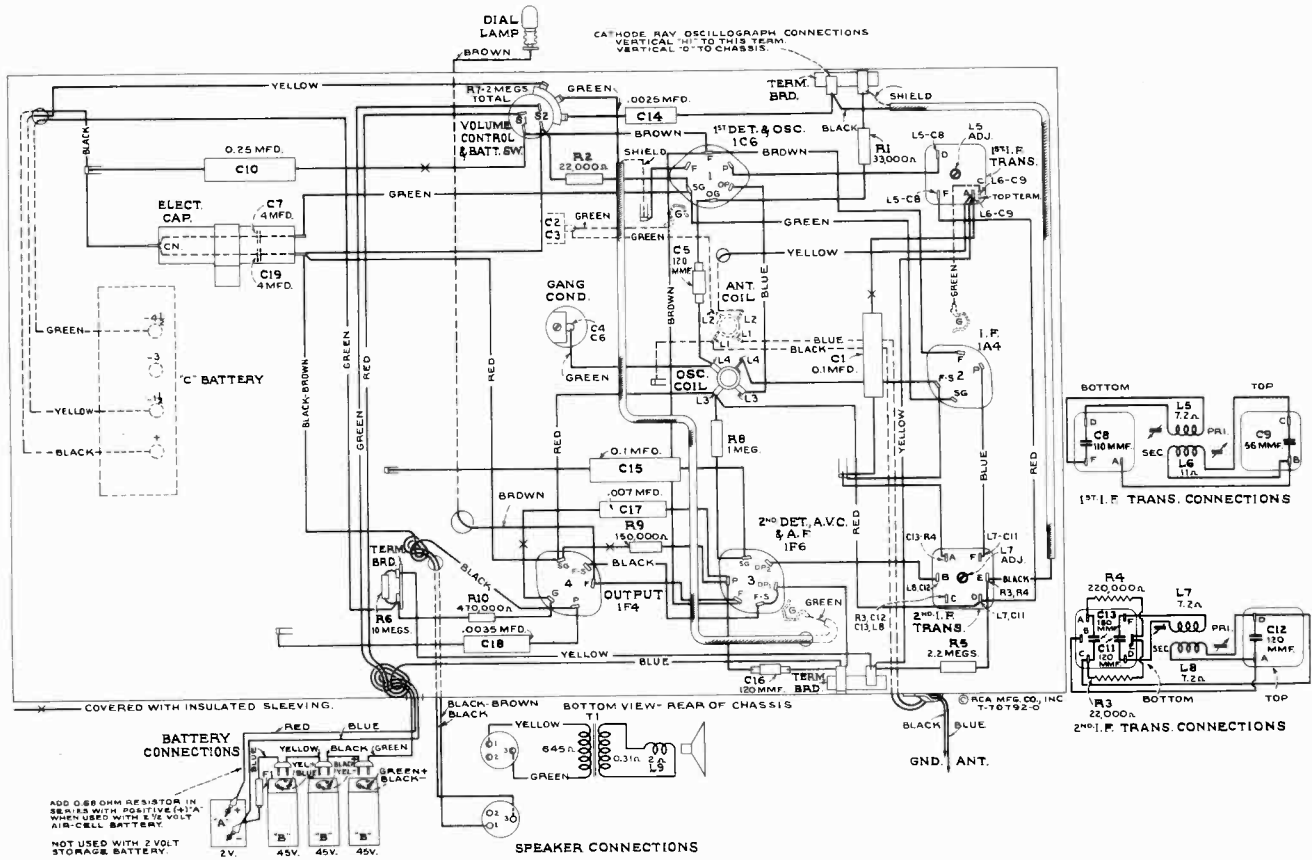

Figure 4—Chassis Wiring Diagram (Model 84BT)

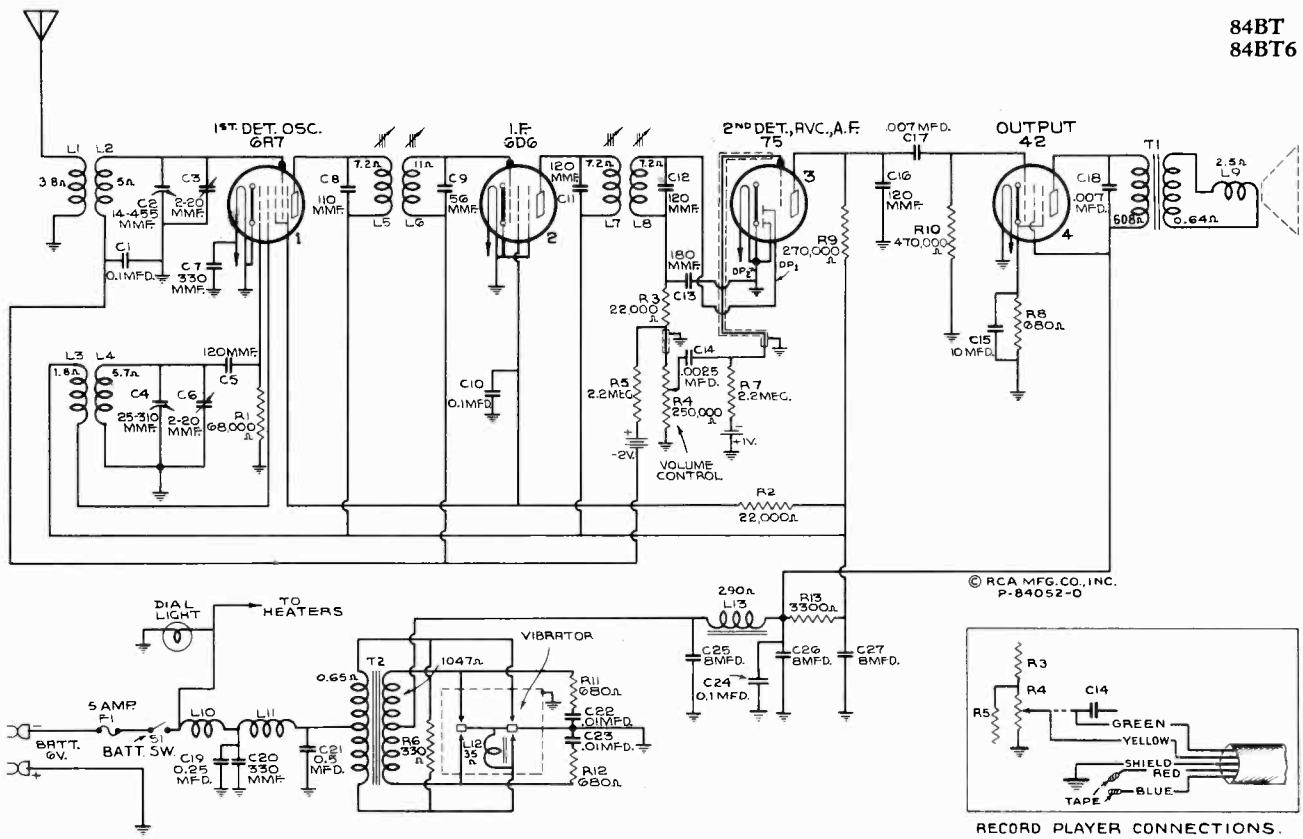

Figure 5—Schematic Circuit Diagram (Model 84BT6)

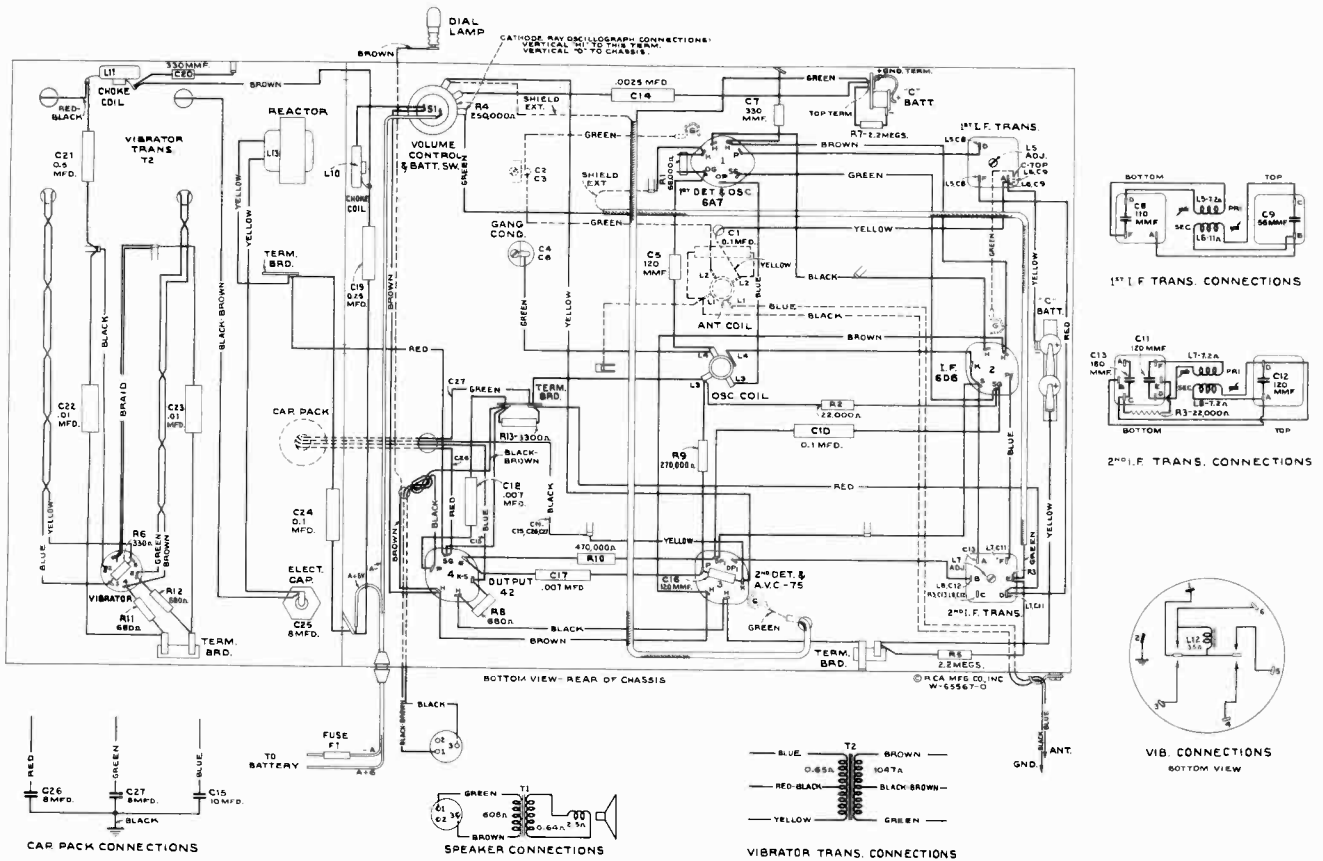
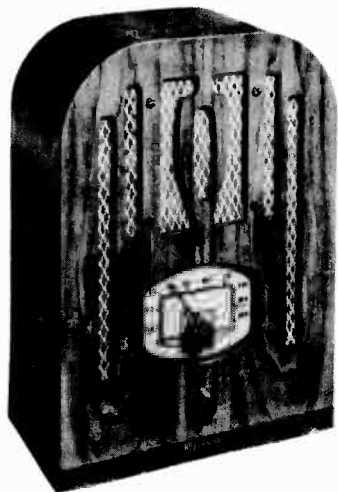

Figure 6—Chassis Wiring Diagram (Model 84BT6)

Service Data

The various diagrams of this booklet contain such information as will be needed to isolate causes for defective operation if such develops. The ratings of the resistors, capacitors, coils, etc., are indicated adjacent to the symbols signifying these parts on the diagrams. Identification titles such as R1, L1, C1, etc., provide reference between the illustrations and Replacement Parts List. The coils, transformer windings, and reactors are rated in terms of d-c resistance to permit continuity checks.



Model 84BT or 84BT6

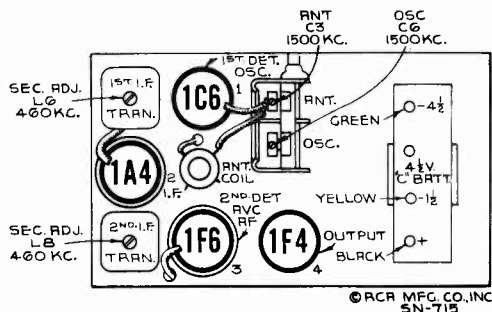

Figure 1—Radiotron and Trimmer Locations (Model 84BT)

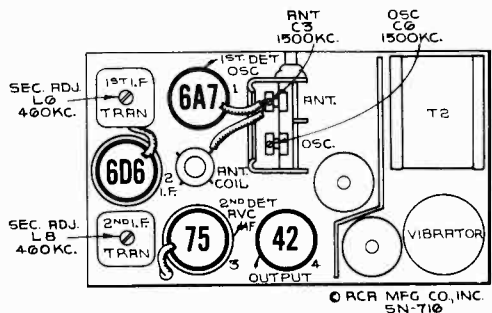

Figure 2—Radiotron and Trimmer Locations (Model 84BT6)

Alignment Procedure

Calibrate the tuning dial by adjusting dial pointer to the low-frequency (end) calibration mark on dial scale with the gang tuning-condenser plates in full-mesh position. This is a friction adjustment.

Perform alignment in proper order, tabulated below, starting with No. 1 and following all operations across, then No. 2, etc. Adjustment locations are shown on figures 1, 2, and 7.

Cathode-ray alignment is preferable; the connections to the chassis are shown on figures 4 and 6. If an output indicator is used, connect it across the loudspeaker voice-coil and advance the receiver volume control to full-volume position.

Connect the "low" output terminal of the test oscillator to the receiver chassis for all alignment operations. Regulate the output of the test oscillator so that minimum signal is applied to the receiver to obtain an observable output indication. This will avoid a-v-c action.

The term "Dummy antenna" means the device which must be connected between the "high" test-oscillator output and the point of connection to the receiver in order to obtain ideal alignment. "No signal, 550-750 kc" means that the receiver should be tuned to a point between 550 and 750 kc where no signal or interference is received from a station or local (heterodyne) oscillator.

For further details on alignment, refer to booklet "RCA Victor Receiver Alignment."

| Order of Alignment | Test Oscillator | | | Receiver Dial Setting | Circuit to Adjust | Adjustment Symbols | Adjust to Obtain |
|--------------------|-------------------------|---------------|-------------------|-----------------------|-------------------|--------------------|------------------|
| | Connection to Receiver | Dummy Antenna | Frequency Setting | | | | |
| 1 | I-F Amp. Grid Cap | .001 Mfd. | 460 kc | No Signal 550-750 kc | 2nd I-F Trans. | L7 and L8 | Max. (peak) |
| 2 | 1st Det. -Osc. Grid Cap | .001 Mfd. | 460 kc | No Signal 550-750 kc | 1st I-F Trans. | L5 and L6 | Max. (peak) |
| 3 | Ant. Lead | 200 Mmfd. | 1,500 kc | 1,500 kc | "A" Osc. | C6* | Max. (peak) |
| 4 | Ant. Lead | 200 Mmfd. | 1,500 kc | 1,500 kc | "A" Ant. | C3 | Max. (peak) |

* C6 is in two sections. Tighten section on bottom of gang (under chassis) for maximum capacity before adjusting top section.

Loudspeaker.—Centering of the loudspeaker is made in the usual manner with three narrow paper feelers after first removing the front dust cover. This may be removed by softening its cement with a light application of acetone, using care not to allow the acetone to flow into the air gap. The dust cover should be cemented back in place with ambroid upon completion of adjustment.

Bias Cells (Model 84BT6 only).—The bias cells are used only for the purpose of supplying bias potential and should never be measured with an ordinary voltmeter or other device which draws any current. A simple check on the cells may be made by connecting a milliammeter in the plate circuit of the tubes biased by these cells (6A7 or 6D6, 2 cells; 75, 1 cell). Measure the plate current with the cells in the circuit, then carefully remove the cells and substitute a voltage equivalent to the rated cell voltage. If the first reading obtained (with bias cells) is more than 40% from the latter reading (with known voltage), the bias cells should

be replaced. This 40% difference is equivalent to a change of approximately 25% battery voltage.

Precautionary Lead Dress (Model 84BT6 only).—(1) Green lead from antenna coil to antenna section of tuning condenser should be dressed as far as possible from tube No. 1 (6A7). (2) Dress brown and green twisted leads (vibrator transformer T2 to vibrator socket) under capacitor C21. (3) Dress brown-black lead (T2 to C25) away from red lead which connects terminal in vibrator compartment to "SG" of tube No. 4 (42). (4) Keep all other leads in vibrator compartment as close to chassis base as possible.

Synchronous Vibrator—Rectifier (Model 84BT6 only).—The synchronous vibrator—rectifier used in the power system is constructed with a plug-in base so as to be easily removed or replaced after first removing the two nuts holding the shield can in place. Its adjustments have been accurately made during manufacture by means of special equipment. In cases of excessive interference or otherwise faulty operation, a renewal should be installed.

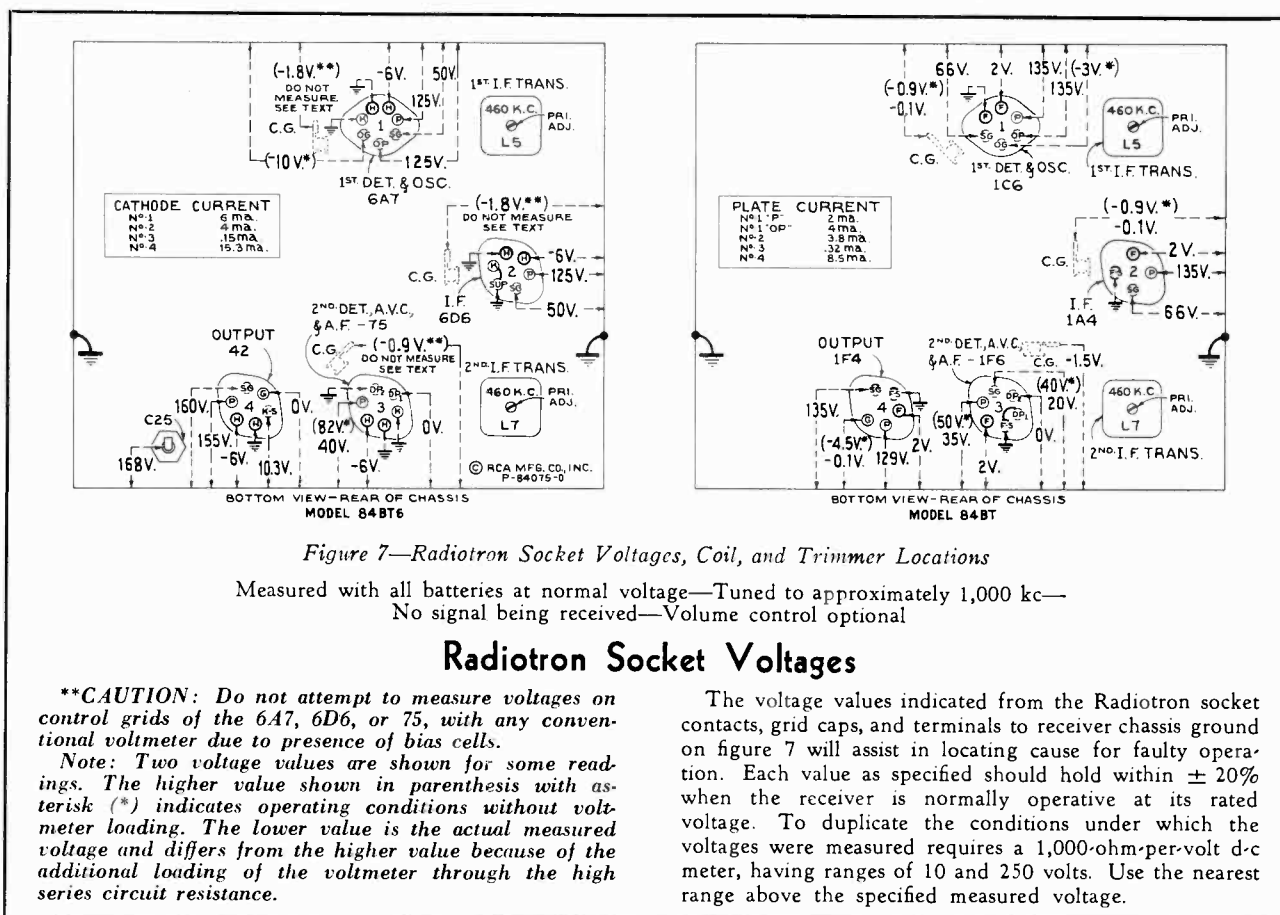

Radiotron Socket Voltages

****CAUTION:** Do not attempt to measure voltages on control grids of the 6A7, 6D6, or 75, with any conventional voltmeter due to presence of bias cells.

Note: Two voltage values are shown for some readings. The higher value shown in parenthesis with asterisk (*) indicates operating conditions without voltmeter loading. The lower value is the actual measured voltage and differs from the higher value because of the additional loading of the voltmeter through the high series circuit resistance.

The voltage values indicated from the Radiotron socket contacts, grid caps, and terminals to receiver chassis ground on figure 7 will assist in locating cause for faulty operation. Each value as specified should hold within $\pm 20\%$ when the receiver is normally operative at its rated voltage. To duplicate the conditions under which the voltages were measured requires a 1,000-ohm-per-volt d-c meter, having ranges of 10 and 250 volts. Use the nearest range above the specified measured voltage.

REPLACEMENT PARTS

Insist on genuine factory-tested parts, which are readily identified and may be purchased from authorized dealers

| STOCK No. | DESCRIPTION | STOCK No. | DESCRIPTION |
|----------------------------|--|-----------|---|
| RECEIVER ASSEMBLIES | | | |
| 4289 | Body—Fuse connector body (Model 84BT6 only) | 4629 | Cap—Radiotron shield cap |
| 14286 | Bracket—Dial lamp bracket | 12629 | Capacitor—56 Mmfd. (C9) |
| 14288 | Cable—3-conductor battery cable approximately 60 inches long, complete with fuse and battery clips (Model 84BT only) | 14262 | Capacitor—110 Mmfd. (C8) |
| 12607 | Cap—First I-F transformer shield cap | 12404 | Capacitor—120 Mmfd. (C11, C12) |
| 12581 | Cap—Second I-F transformer shield cap | 12724 | Capacitor—120 Mmfd. (C5, C16) |
| 12118 | Cap—Grid contact cap | 12406 | Capacitor—180 Mmfd. (C13) |
| 4288 | Cap—Fuse connector male cap (Model 84BT6 only) | 14320 | Capacitor—330 Mmfd. (C7, C20) (Model 84BT6 only) |
| | | 5107 | Capacitor—.0025 Mfd. (C14) |
| | | 5005 | Capacitor—.0035 Mfd. (C18) (Model 84BT only) |
| | | 5148 | Capacitor—.007 Mfd. (C17) (Model 84BT only) |
| | | 5196 | Capacitor—.007 Mfd. (C17, C18) (Model 84BT6 only) |

REPLACEMENT PARTS—(Continued)

| STOCK No. | DESCRIPTION | STOCK No. | DESCRIPTION |
|-----------|--|-----------|--|
| 11654 | Capacitor—.01 Mfd. (C22, C23) (Model 84BT6 only) | 13673 | Resistor—10 megohms, carbon type, $\frac{1}{2}$ watt (R6) (Model 84BT only) |
| 4841 | Capacitor—.01 Mfd. (Model 84BT, C1, C15) (Model 84BT6, C1, C10, C24) | 14315 | Shield—Chassis end shield complete with bias cell holder—For end opposite vibrator (Model 84BT6 only) |
| 4840 | Capacitor—.025 Mfd. (Model 84BT, C10) (Model 84BT6, C19) | 14318 | Shield—Chassis end and bottom shield for vibrator end of chassis (Model 84BT6 only) |
| 12741 | Capacitor—.05 Mfd. (C21) (Model 84BT6 only) | 12008 | Shield—First or second I-F transformer shield can |
| 14287 | Capacitor—Pack comprising two sections each $\frac{1}{4}$ Mfd. (C7, C19) (Model 84BT only) | 14317 | Shield—Vibrator shield can (Model 84BT6 only) |
| 13046 | Capacitor—.8 Mfd. (C25) (Model 84BT6 only) | 3682 | Shield—1A4, 1F6, 6D6, or 75 Radiotron shield |
| 14210 | Capacitor Pack—Comprising one 10 Mfd. and two 8 Mfd. sections (C15, C26, C27) (Model 84BT6 only) | 14114 | Socket—Dial lamp socket |
| 12681 | Cell—Bias cell (Model 84BT6 only) | 4794 | Socket—4-contact 1A4 Radiotron socket (Model 84BT only) |
| 14289 | Clip—2 battery clips, one marked "+" and one unmarked | 4814 | Socket—5-contact 1F4 Radiotron socket (Model 84BT only) |
| 14285 | Coil—Antenna coil (L1, L2) | 4786 | Socket—6-contact 1C6, 1F6, 6D6, 42, or 75 Radiotron socket |
| 14257 | Coil—Oscillator coil (L3, L4) | 14312 | Socket—6-contact vibrator socket, less rubber mounting (Model 84BT6 only) |
| 12179 | Coil—Vibrator choke coil (L10, L11) (Model 84BT6 only) | 4787 | Socket—7-contact 6A7 Radiotron socket (Model 84BT6 only) |
| 14256 | Condenser—2-gang variable tuning condenser (C2, C3, C4, C6) | 4284 | Spring—Fuse connector spring (Model 84BT6 only) |
| 5119 | Connector—3-contact female connector for speaker cable | 12007 | Spring—Retaining spring for core Stock No. 12006 |
| 14314 | Cord—Power cord complete with fuse and clips (Model 84BT6 only) | 14261 | Transformer—First I-F transformer (L5, L6, C8, C9) |
| 12006 | Core—Adjustable core and stud for first or second I-F transformers | 14283 | Transformer—Second I-F transformer (L7, L8, C11, C12, C13, R3, R4) (Model 84BT only) |
| 14264 | Dial—Station selector dial and holder assembly | 14308 | Transformer—Second I-F transformer (L7, L8, C11, C12, C13, R4) (Model 84BT6 only) |
| 4286 | Ferrule—Fuse connector ferrule and bushing (Model 84BT6 only) | 14311 | Transformer—Vibrator transformer (T2) (Model 84BT6 only) |
| 3748 | Fuse— $\frac{1}{2}$ ampere (F1) (Model 84BT only) | 14309 | Vibrator complete (L12) (Model 84BT6 only) |
| 5140 | Fuse—5 ampere (F1) (Model 84BT6 only) | 14282 | Volume control and power switch (R7, S1) (Model 84BT only) |
| 14316 | Holder—Bias cell holder (2 cells) (Model 84BT6 only) | 14307 | Volume control and power switch (R4, S1) (Model 84BT6 only) |
| 14319 | Holder—Bias cell holder (1 cell) (Model 84BT6 only) | 4285 | Washer—Fuse connector insulating washer (Model 84BT6 only) |
| 14263 | Indicator—Station selector indicator pointer | | REPRODUCER ASSEMBLIES (76474-3) (Model 84BT only) |
| 4290 | Insulator—Fuse connector body insulator (Model 84BT6 only) | 14303 | Cone—Reproducer cone centered in metal housing complete with dust cap, less output transformer and plug (L9) |
| 4348 | Lamp—Dial lamp (Model 84BT only) | 5118 | Plug—3-contact male plug for reproducer |
| 4340 | Lamp—Dial lamp (Model 84BT6 only) | 9802 | Reproducer complete |
| 14313 | Mounting—Vibrator socket mounting comprising 2 rubber washers, 2 screws, 2 eyelets, 2 washers, 2 lock-washers, and 2 nuts (Model 84BT6 only) | 14304 | Transformer—Output transformer (T1) |
| 12818 | Reactor—Filter reactor (L13) (Model 84BT6 only) | | REPRODUCER ASSEMBLIES (76494-2) (Model 84BT6 only) |
| 8063 | Resistor—330 ohms, carbon type, $\frac{1}{2}$ watt (R6) (Model 84BT6 only) | 14305 | Cone—Reproducer cone complete with dust cap (L9) |
| 5031 | Resistor—680 ohms, carbon type, $\frac{1}{2}$ watt (R8, R11, R12) (Model 84BT6 only) | 5118 | Plug—3-contact male plug for reproducer |
| 12330 | Resistor—3,300 ohms, carbon type, $\frac{1}{2}$ watt (R13) (Model 84BT6 only) | 9803 | Reproducer complete |
| 11305 | Resistor—22,000 ohms, carbon type, $\frac{1}{2}$ watt (R2) | 14306 | Transformer—Output transformer (T1) |
| 14284 | Resistor—22,000 ohms, carbon type, 1/10 watt (R3) | | MISCELLANEOUS ASSEMBLIES |
| 11364 | Resistor—33,000 ohms, carbon type, $\frac{1}{2}$ watt (R1) (Model 84BT only) | 14268 | Crystal—Station selector crystal |
| 12333 | Resistor—68,000 ohms, carbon type, $\frac{1}{2}$ watt (R1) (Model 84BT6 only) | 14269 | Knob—Station selector or volume control knob |
| 5023 | Resistor—150,000 ohms, carbon type, $\frac{1}{2}$ watt (R9) (Model 84BT only) | 14299 | Resistor—0.68 ohm flexible wire wound ballast resistor (Model 84BT only) |
| 11398 | Resistor—220,000 ohms, carbon type, 1/10 watt (R4) (Model 84BT only) | 14298 | Screw—Chassis mounting screw and washer assembly |
| 11323 | Resistor—270,000 ohms, carbon type, $\frac{1}{2}$ watt (R9) | 14270 | Spring—Retaining spring for knob Stock No. 14269 |
| 11172 | Resistor—470,000 ohms, carbon type, $\frac{1}{2}$ watt (R10) | | |
| 3033 | Resistor—1 megohm, carbon type, $\frac{1}{2}$ watt (R8) (Model 84BT only) | | |
| 11626 | Resistor—2.2 megohms, carbon type, $\frac{1}{2}$ watt (Model 84BT, R5) (Model 84BT6, R5, R7) | | |

NOTE: On later production Model 84BT6, an RCA-41 output tube is used in place of the RCA-42. All circuit and specification data remain the same except the "A" current consumption at 6 volts which is 2.65 amperes.



RCA Victor

MODELS 85BK and 85BT

Five-Tube, Three-Band, Battery Operated, Superheterodyne Receivers

TECHNICAL INFORMATION AND SERVICE DATA

SERVICE DIVISION • RCA MANUFACTURING COMPANY, INC. • CAMDEN, N. J., U. S. A.

A Service of the Radio Corporation of America

Electrical Specifications

| | | | |
|--|---------------------------|-----------------------------|-----------------------------------|
| FREQUENCY RANGES | | R-F ALIGNMENT FREQUENCIES | |
| "Standard Broadcast" (A)..... | 530—1,720 kc | "Short Wave" (C)..... | 20,000 kc (osc.) |
| "Medium Wave" (B)..... | 2,100—6,800 kc | "Medium Wave" (B)..... | 6,000 kc (osc., ant.) |
| "Short Wave" (C)..... | 6,800—22,000 kc | "Standard Broadcast" (A)... | 600 kc (osc.), 1,500 kc (osc.) |
| Intermediate Frequency..... | | | 460 kc |
| RADIOTRON COMPLEMENT | | (3) RCA-1F6..... | Second Det., A-F Amp., and A.V.C. |
| (1) RCA-1C6..... | First Detector—Oscillator | (4) RCA-30..... | Audio Driver |
| (2) RCA-1A4..... | Intermediate Amplifier | (5) RCA-19..... | Push-Pull Power Output |
| Pilot Lamps (2)..... | | | Mazda 2.0 volts, .06 ampere |
| BATTERIES REQUIRED | | | |
| "A," one plug-in, 2½-volt Air Cell, or one 2-volt storage battery; "B," three 45-volt, heavy-duty, plug-in type B batteries; | | | |
| "C," one 7½-volt C battery tapped at —1½, —3, and —4½ volts, and three bias cells (Stock No. 12681). | | | |
| CURRENT CONSUMPTION | | | |
| "A" at 2 volts (pilot lamps off)..... | | | 0.56 ampere |
| "A" at 2 volts (pilot lamps on)..... | | | 0.68 ampere |
| "B" at 135 volts..... | | | 19 milliamperes |
| Fuse Rating..... | | | ½ ampere |
| POWER OUTPUT | | LOUDSPEAKER | |
| Undistorted..... | 1.2 watts | Type..... | Permanent-Magnet Dynamic |
| Maximum..... | 2.2 watts | Voice Coil Impedance..... | 2.2 ohms at 400 cycles |

Mechanical Specifications

| | MODEL 85BK | MODEL 85BT |
|---------------------------------|---|------------|
| Height..... | 39 inches | 20¼ inches |
| Width..... | 24¼ inches | 13⅜ inches |
| Depth..... | 12 inches | 9⅛ inches |
| Weight (net)..... | 46½ pounds | 19½ pounds |
| Weight (shipping)..... | 59½ pounds | 24 pounds |
| Chassis Base Dimensions..... | 12 inches x 7 inches x 2½ inches | |
| Over-all Height of Chassis..... | 8¾ inches | |
| Operating Controls..... | (1) Volume; (2) Tuning (large inner knob) Range Selector (small outer knob); (3) Power Switch—Tone | |
| Tuning Drive Ratio..... | 20 to 1 | |

General Description

Each of these receivers employs a similar chassis, the superheterodyne circuit arrangement of which is shown by figure 2. Model 85BK is a console model employing an 8-inch, permanent-magnet dynamic loudspeaker while Model 85BT is a table model employing an 8-inch, permanent-magnet dynamic

loudspeaker. Features of design include magnetite-core i-f transformers and low-frequency "A"-oscillator tracking; automatic volume control; resistance-coupled, first-audio stage and transformer-coupled, audio-driver stage to a push-pull, class-B, audio-output stage; phonograph terminal board; two-point,

Copyright, 1937, RCA Manufacturing Co., Inc.

Trademark "Radiotron"
Reg. U. S. Pat. Off. by RCA Mfg. Co., Inc.

high-frequency tone control; super-sensitive, permanent-magnet dynamic loudspeaker with dust screen; low current drain; and a large, easy-to-read, illuminated dial with save-a-drain pilot lamp switch combined with the tuning control.

These receivers may be easily converted to 6-volt operation by employing an RCA Victor CV-8 Pak-O-Powr which, with

a 6-volt storage battery, replaces the "A" and "B" batteries listed under "Batteries required."

The three tuning ranges cover the "Standard broadcast" band and the important short-wave bands at 49, 31, 25, 19, 16, and 13 meters along with channels assigned for police, aviation, and amateur communication.

Service Data

The various diagrams of this booklet contain such information as will be needed to isolate causes for defective operation if such develops. The ratings of the resistors, capacitors, coils, etc., are indicated adjacent to the symbols signifying these parts on the diagrams. Identification titles such as R1, L1, C1, etc., provide reference between the illustrations and Replacement Parts List. The coils, transformer windings, and reactors are rated in terms of d-c resistance to permit continuity checks.

Precautionary Lead Dress.—(1) Twisted leads from filament switch to power plug must be dressed against bottom of end shield and fastened with tape. (2) Keep leads of C18 as short as possible. (3) Lead from L1 to C5-C6 should be 3¼ inches long. (4) Lead from L1-L2 to range switch should be 1⅞ inches long. (5) Keep lead from range switch to C10-C11 as short as possible. (6) Keep lead from range switch to L6 as short as possible. (7) Yellow lead from 2nd i-f transformer to phonograph terminal board must be dressed away from other wiring.

Phonograph Attachment.—A terminal board is provided for connecting a phonograph into the audio amplifying circuit. RCA Victor Model R-93-S Record Player should be connected as follows: Remove link between terminals 1 and 2 on terminal board. Connect green wire in Radio-

Record switch cable to terminal 1, yellow to terminal 2, and shield extension to terminal 3. Tape unused red and blue leads separately. Connect a 2-conductor twisted cable between the Record Player binding posts and the screw terminals on Radio-Record switch.

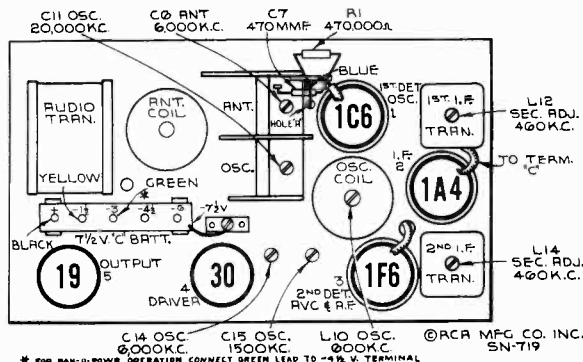

Figure 1—Radiotron, Coil, and Trimmer Locations

Alignment Procedure

Calibrate the tuning dial by adjusting main dial pointer to the low-frequency (end) calibration mark on dial with the gang tuning-condenser plates in full-mesh position; then adjust the small (vernier) pointer to "O." These are friction adjustments.

Perform alignment in proper order, tabulated below, starting with No. 1 and following all operations across, then No. 2, etc. Adjustment locations are shown on figures 1 and 4.

Cathode-ray alignment is highly preferable; the connections to the chassis are shown on figure 3. If an output indicator is used, connect it across the loudspeaker voice-coil and advance the receiver volume control to full-volume position.

Connect the "low" output terminal of the test oscillator to

the receiver "G" (ground) terminal for all alignment operations. Regulate the output of the test oscillator so that minimum signal is applied to the receiver to obtain an observable output indication. This will avoid a-v-c action.

The term "Dummy antenna" means the device which must be connected between the "high" test-oscillator output and the point of connection to the receiver in order to obtain ideal alignment. "No signal, 550-750 kc" means that the receiver should be tuned to a point between 550 and 750 kc where no signal or interference is received from a station or local (heterodyne) oscillator.

For further details on alignment, refer to booklet "RCA Victor Receiver Alignment."

| Order of Alignment | Test Oscillator | | | Receiver Dial Setting | Circuit to Adjust | Adjustment Symbols | Adjust to Obtain |
|--------------------|------------------------|---------------|-------------------|-----------------------|-------------------|--------------------|------------------|
| | Connection to Receiver | Dummy Antenna | Frequency Setting | | | | |
| 1 | 1A4 I-F Grid Cap | .001 Mfd. | 460 kc | No Signal 550-750 kc | 2nd I-F Trans. | L13 & L14 | Max. (peak) |
| 2 | 1C6 Det. Grid Cap | .001 Mfd. | 460 kc | No Signal 550-750 kc | 1st I-F Trans. | L11 & L12 | Max. (peak) |
| 3 | Ant. Term. | 300 Ohms | 20,000 kc | 20,000 kc | "C" Osc. | C11 | Max. (peak)*‡ |
| 4 | Ant. Term. | 300 Ohms | 6,000 kc | 6,000 kc | "B" Osc. | C14 | Max. (peak)* |
| 5 | Ant. Term. | 300 Ohms | 6,000 kc | 6,000 kc | "B" Ant. | C6 | Max. (peak) |
| 6 | Ant. Term. | 200 Mmfd. | 600 kc | 600 kc | "A" L-F Osc. | L10 | Max. (peak) |
| 7 | Ant. Term. | 200 Mmfd. | 1,500 kc | 1,500 kc | "A" H-F Osc. | C15 | Max. (peak) |
| 8 | Ant. Term. | 200 Mmfd. | 600 kc | Rock thru 600 kc | "A" L-F Osc. | L10 | Max. (peak) |
| 9 | Ant. Term. | 200 Mmfd. | 1,500 kc | Rock thru 1,500 kc | "A" H-F Osc. | C15 | Max. (peak) |

* Use minimum capacity peak if two peaks can be obtained.

‡ After this adjustment, check for image signal by shifting receiver dial to 19,080 kc.



Model 85BK

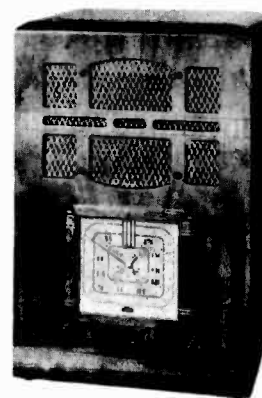

Model 85BT

Loudspeaker.—Centering of the loudspeaker is made in the usual manner with three narrow paper feelers after first removing the front dust cover. This may be removed by softening its cement with a light application of acetone, using care not to allow the acetone to flow into the air gap. The dust cover should be cemented back in place with ambroid upon completion of adjustment.

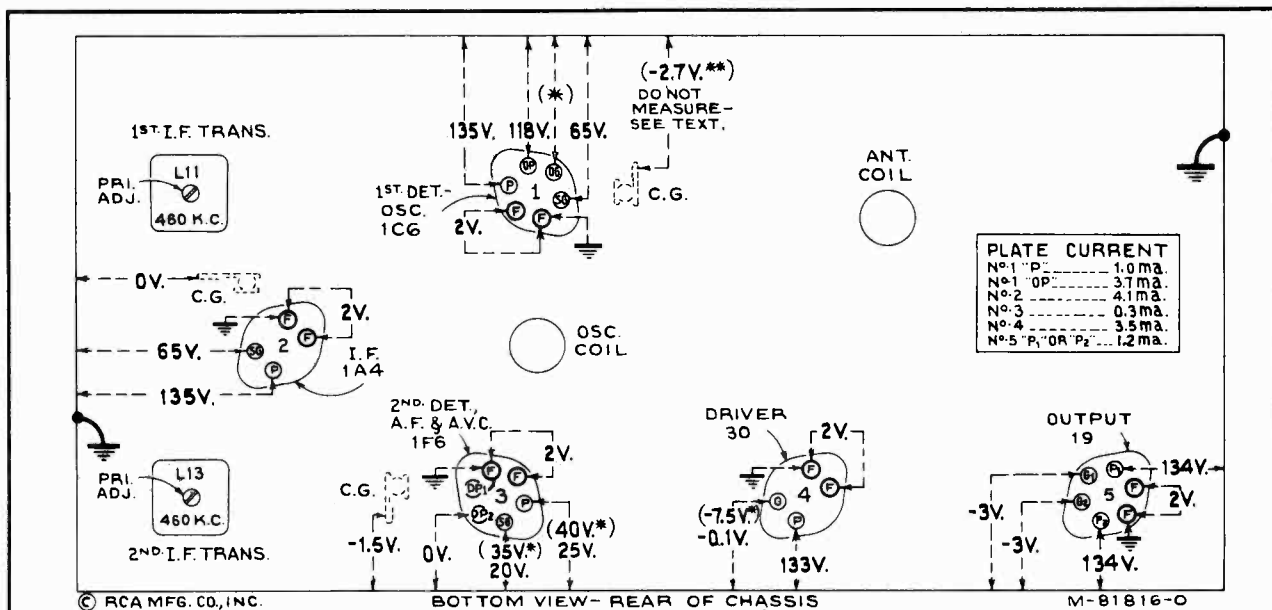

Figure 4—Radiotron Socket Voltages, Coil, and Trimmer Locations

Measured with all batteries at normal voltage—Tuned to approximately 1,000 kc—
No signal being received—Volume control minimum

Radiotron Socket Voltages

****CAUTION:** Do not attempt to measure voltage on control grid of the 1C6 with any conventional voltmeter due to presence of bias cells.

Note: Two voltage values are shown for some readings. The higher value shown in parenthesis with asterisk (*) indicates operating conditions without voltmeter loading. The lower value is the actual measured voltage and differs from the higher value because of the additional loading of the voltmeter through the high series circuit resistance.

The voltage values indicated from the Radiotron socket contacts, grid caps, and terminals to receiver chassis ground on figure 4 will assist in locating cause for faulty operation. Each value as specified should hold within $\pm 20\%$ when the receiver is normally operative at its rated voltage. To duplicate the conditions under which the voltages were measured requires a 1,000-ohm-per-volt d-c meter, having ranges of 10 and 250 volts. Use the nearest range above the specified measured voltage.

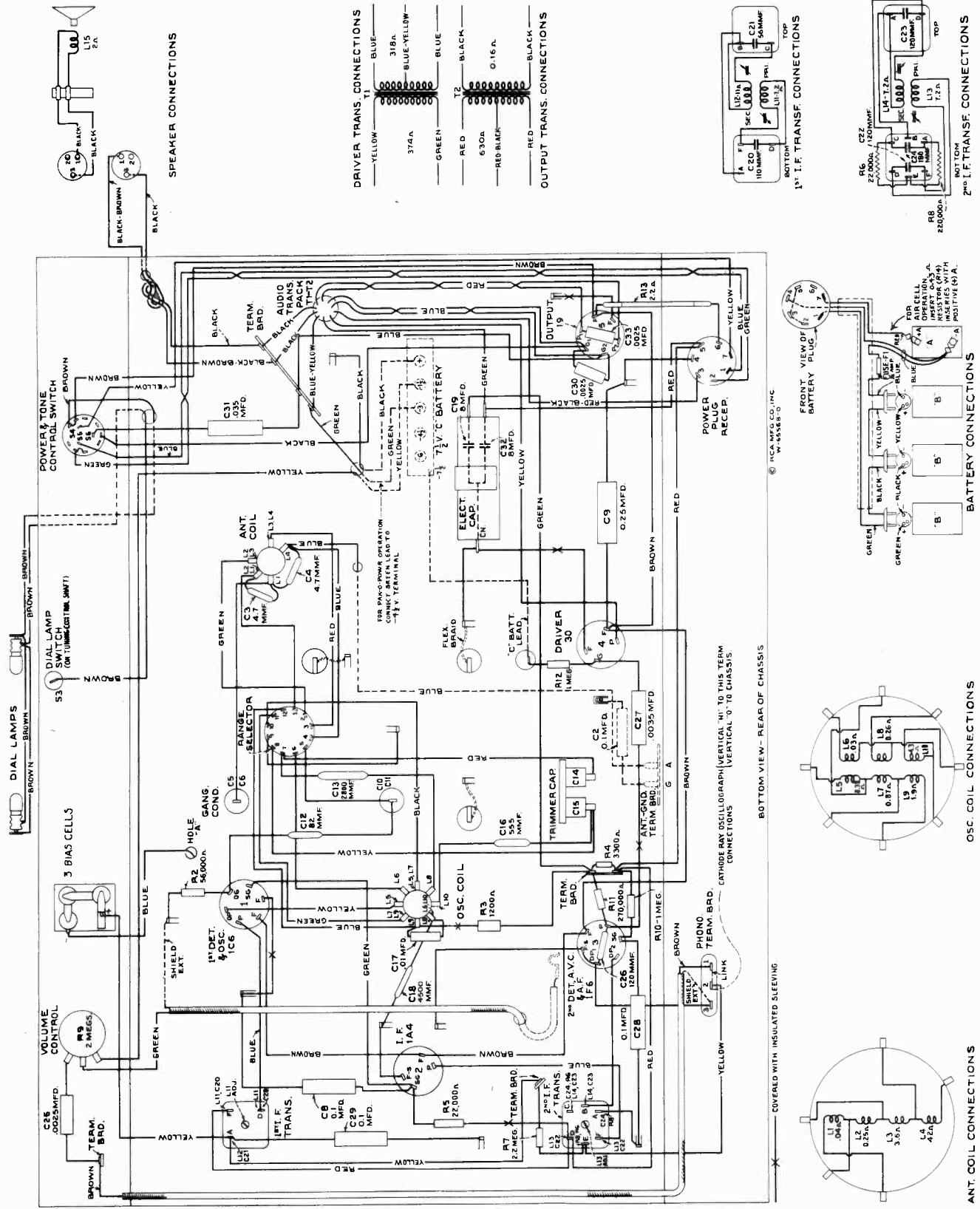

Figure 3—Chassis Wiring Diagram

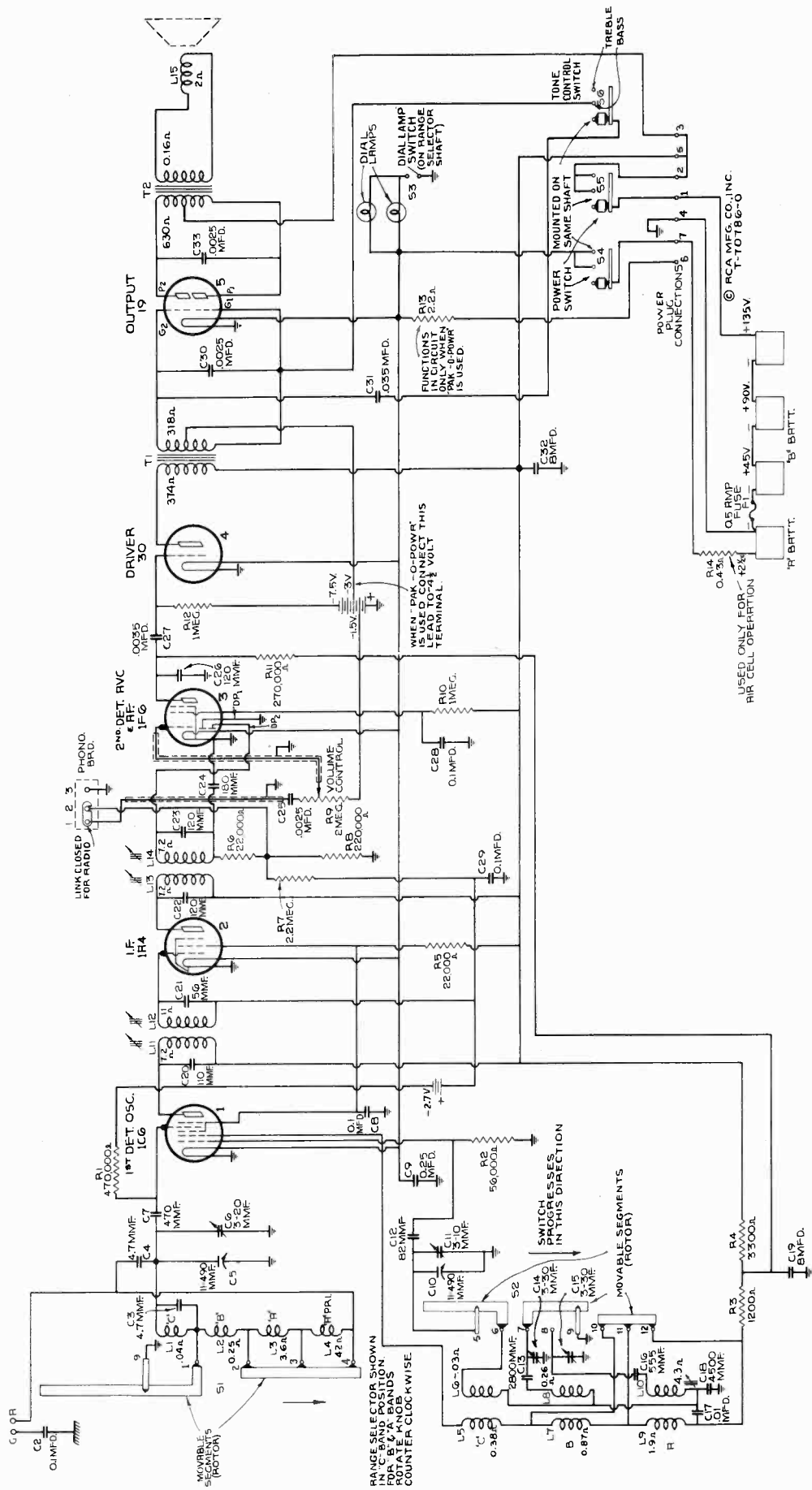

Figure 2—Schematic Circuit Diagram

Bias Cells.—Three bias cells are used only for the purpose of supplying bias potential to the 1C6 first-detector—oscillator tube. These cells should never be measured with an ordinary voltmeter or other device which draws any current. A simple check on these cells may be made by connecting a milliammeter in the plate circuit of the 1C6 tube and noting the plate current reading. Then carefully remove the cells and substitute a battery potential of 2.7 volts in their place and note the new reading on the milliammeter. If the first reading obtained (with bias cells) is more than 40% from the latter reading (with 2.7-volt battery), the bias cells should be replaced. This 40% difference is equivalent to a change of approximately 25% battery voltage.

Operation With CV-8 Pak-O-Powr.—These receivers may readily be operated from an RCA CV-8 Pak-O-Powr, in which case, a six-volt storage battery replaces the "A" and "B" batteries listed under "Batteries required." When using the CV-8, one cell (2 volts) of the storage battery supplies filament voltage to the tubes, while the other two cells (4 volts) supplies power for the CV-8. When installing, the seven prong CV-8 receptacle plugs into the seven prong

plug on the rear apron of the receiver chassis and the four battery leads clip on terminals of the storage battery as follows: Red to + 6 V.; Blue to + 4 V.; Yellow to + 4 V.; and brown (fused lead) to -V. The two four-volt leads (Blue and Yellow) should make separate connections to the same battery strap to avoid vibrator buzz which might otherwise result if these two leads are joined together or touch each other. Observe extreme care that proper connections are made to the battery, as a wrong connection will burn out the tubes. The green lead (originally connected to - 3 v. on the "C" battery) should be shifted to the - 4.5 volt tap. The other "C" battery connections remain unchanged.

The following changes under "Electrical specifications" become effective when employing the CV-8; "A" battery current drain at 6 volts, 1.65 amperes. Fuse rating, 5 amperes. Undistorted output, 1.3 watts. Maximum output, 1.8 watts. Under "Service data," the following voltages apply to the RCA-19 power-output tube. Either plate to chassis, 180 volts. Either grid to chassis, -4 1/2 volts. Plate current (either plate), 1.6 ma.

When servicing, the CV-8 chassis should be insulated from the receiver chassis to avoid vibrator buzz.

REPLACEMENT PARTS

Insist on genuine factory tested parts, which are readily identified and may be purchased from authorized dealers.

| STOCK No. | DESCRIPTION | STOCK No. | DESCRIPTION | |
|----------------------------|---|---------------------------------|--|--|
| RECEIVER ASSEMBLIES | | | | |
| 14388 | Belt—Variable condenser drive belt | 5029 | Resistor—56,000 ohms, carbon type, 1/2 watt (R2) | |
| 13216 | Board—Antenna and ground terminal board | 11398 | Resistor—220,000 ohms, carbon type, 1/10 watt (R8) | |
| 12717 | Board—Phonograph terminal board | 11453 | Resistor—270,000 ohms, carbon type, 1/10 watt (R11) | |
| 14338 | Bushing—Variable condenser mounting bushing and screw assembly | 11452 | Resistor—470,000 ohms, carbon type, 1/10 watt (R1) | |
| 12607 | Cap—First I.F. transformer shield top | 12200 | Resistor—1 megohm, insulated, 1/2 watt (R12) | |
| 12581 | Cap—Second I.F. transformer shield top | 13730 | Resistor—1 megohm, carbon type, 1/2 watt (R10) | |
| 12118 | Cap—Grid contact cap | 12679 | Resistor—2.2 megohm, insulated, 1/2 watt (R7) | |
| 14383 | Capacitor—Adjustable dual trimmer (C14, C15) | 14406 | Resistor—2.2 ohms, flexible type, 3 watts (R13) | |
| 14392 | Capacitor—4.7 Mmfd. (C3, C4) | 14350 | Screw—No. 8-32x3/16 square head set screw for gear Stock No. 30085 and drum Stock No. 14345 | |
| 12629 | Capacitor—56 Mmfd. (C21) | 14374 | Shield—Antenna coil shield | |
| 12813 | Capacitor—82 Mmfd. (C12) | 13311 | Shield—Chassis end shield and rubber mounting foot assembly | |
| 14262 | Capacitor—110 Mmfd. (C20) | 12008 | Shield—I.F. transformer shield | |
| 12404 | Capacitor—120 Mmfd. (C22, C23) | 14375 | Shield—Oscillator coil shield | |
| 12724 | Capacitor—120 Mmfd. (C26) | 3682 | Shield—Radiotron shield | |
| 12406 | Capacitor—180 Mmfd. (C24) | 14171 | Socket—Dial lamp socket | |
| 13052 | Capacitor—470 Mmfd. (C7) | 4794 | Socket—4-contact 1A4 or 30 Radiotron socket | |
| 12727 | Capacitor—555 Mmfd. (C8) | 4786 | Socket—6-contact 1C8, 1F8 or 19 Radiotron socket | |
| 14407 | Capacitor—2,800 Mmfd. (C13) | 12007 | Spring—Retaining spring for core Stock No. 12006 | |
| 12728 | Capacitor—4,500 Mmfd. (C18) | 12907 | Spring—Tension spring for indicator drive gear Stock No. 30085 | |
| 5107 | Capacitor—.0025 Mfd. (C25, C30, C33) | 14342 | Spring—Tension spring for idler Stock No. 14341 | |
| 5005 | Capacitor—.0035 Mfd. (C27) | 14402 | Switch—Range switch (S1, S2) | |
| 13138 | Capacitor—.01 Mfd. (C17) | 14401 | Switch—Tone control switch and power switch (S3, S4, S5, S6) | |
| 5196 | Capacitor—.035 Mfd. (C31) | 12803 | Transformer—Audio transformer pack (T1, T2) | |
| 4841 | Capacitor—.01 Mfd. (C2, C8, C28, C29) | 14261 | Transformer—First I.F. transformer (L11, L12, C20, C21) | |
| 4840 | Capacitor—.025 Mfd. (C9) | 14283 | Transformer—Second I.F. transformer (L13, L14, C22, C23, C24, R6, R8) | |
| 5170 | Capacitor—.025 Mfd. (C25, C30, C33) | 14400 | Volume Control (R9) | |
| 14403 | Capacitor Pack—Comprising two sections each 8 Mfd. (C19, C32) | 14379 | Washer—Felt washer for indicator pointer | |
| 12681 | Cell—Bias cell | 12642 | REPRODUCER ASSEMBLIES (RL-73-1) | |
| 14372 | Coil—Antenna coil and shield (L1, L2, L3, L4) | 5118 | Cone—Reproducer cone and dust cap (L15) | |
| 14373 | Coil—Oscillator coil and shield (L5, L6, L7, L8, L9, L10) | 9712 | Plug—3-contact male connector for reproducer | |
| 14397 | Condenser—2-gang variable condenser (C5, C6, C10, C11) | | Reproducer complete | |
| 5119 | Connector—3-contact female connector for reproducer cable | MISCELLANEOUS ASSEMBLIES | | |
| 12800 | Core—Adjustable core and stud assembly for coil Stock No. 14373 | 4289 | Body—Fuse holder female body | |
| 12006 | Core—Adjustable core and stud for I.F. transformer | 4286 | Bushing—Fuse holder bushing and ferrule | |
| 14399 | Dial—Station selector dial scale | 14408 | Cable—Battery cable complete with fuse, fuse holder, one 7-contact female connector, three 2-contact male connectors and two battery clips | |
| 14398 | Drive—Variable condenser vernier drive pinion gear and shaft | 4288 | Cap—Fuse holder male cap | |
| 14345 | Drum—Variable condenser drive belt drum complete with set screws | 14289 | Clip—Battery clips, one marked "+" and one unmarked | |
| 30085 | Gear—Indicator drive gear and hub assembly and pointer stem and gear assembly | 12827 | Connector—2-contact male connector for battery cable | |
| 14405 | Holder—Bias cell holder | 14409 | Connector—7-contact connector for battery cable | |
| 14341 | Idler—Station selector drive belt idler | 14396 | Escutcheon—Station selector escutcheon and crystal | |
| 14344 | Indicator—Station selector indicator pointer | 3748 | Fuse—1/2 ampere (F1) | |
| 14382 | Indicator—Vernier indicator pointer | 4290 | Insulator—Fuse holder insulating sleeve | |
| 4348 | Lamp—Dial lamp | 14359 | Knob—Station selector knob | |
| 14404 | Plug—7-contact male plug located on rear apron of chassis for battery cable | 14289 | Knob—Volume control, tone control or range switch knob | |
| 14340 | Pulley—Station selector drive belt pulley and knob shaft | 14410 | Resistor—0.43 ohms, flexible resistor, 1/2 watt complete with clip (R14) | |
| 14361 | Reflector—Dial reflector and lamp bracket assembly | 11210 | Screw—Chassis mounting screw and washer assembly— for Model 85BK | |
| 14343 | Retainer—Drive shaft and pulley retainer—holds tuning knob shaft and pulley on range switch shaft | 11377 | Screw—Chassis mounting screw and washer assembly— for Model 85BT | |
| 11283 | Resistor—1,200 ohms, carbon type, 1/2 watt (R3) | 4284 | Spring—Fuse holder tension spring | |
| 13737 | Resistor—3,300 ohms, carbon type, 1/2 watt (R4) | 4982 | Spring—Retaining spring for knob Stock No. 14359 | |
| 14284 | Resistor—22,000 ohms, carbon type, 1/10 watt (R6) | 14270 | Spring—Retaining spring for knob Stock No. 14269 | |
| 11305 | Resistor—22,000 ohms, insulated, 1/2 watt (R5) | 4285 | Washer—Fuse holder insulating washer | |



RCA Victor

MODEL 85BT6

Five-Tube, Two-Band, A-C/Battery-Operated, Superheterodyne Receiver

TECHNICAL INFORMATION AND SERVICE DATA

-1937 No. 32-

SERVICE DIVISION • RCA MANUFACTURING COMPANY, INC. • CAMDEN, N. J., U. S. A.

A Service of the Radio Corporation of America

Electrical Specifications

| | | | |
|-----------------------------|---------------------------|--|---------------------------------------|
| FREQUENCY RANGES | | R-F ALIGNMENT FREQUENCIES | |
| "Broadcast" (A)..... | 540-1,720 kc | "Short Wave" (C)..... | 15,000 kc (osc., ant.) |
| "Short Wave" (C)..... | 5,800-18,000 kc | "Broadcast" (A)..... | 600 kc (osc.), 1,500 kc (osc.) |
| Intermediate Frequency..... | | | 460 kc |
| RADIOTRON COMPLEMENT | | (3) RCA-6Q7-G.... Second Det., A-F Amp. and A.V.C. | |
| (1) RCA-6A8-G..... | First Detector—Oscillator | (4) RCA-6K6-G..... | Audio Power Amplifier |
| (2) RCA-6K7-G..... | Intermediate Amplifier | (5) RCA-5Y3-G..... | Full-Wave Rectifier |
| Pilot Lamp (1)..... | | | Mazda No. 40, 6.3 volts, 0.15 ampere |
| POWER SUPPLY RATINGS | | | |
| Rating A..... | | | 105-125 volts, 50-60 cycles, 45 watts |
| Storage Battery..... | | | 6 volts, 2.95 amperes |
| Fuse Rating (Vibrator)..... | | | 5 amperes |
| POWER OUTPUT | BATTERY POWER | A-C POWER | LOUDSPEAKER |
| Undistorted..... | 0.85 watt | 1.2 watts | Type..... |
| Maximum..... | 1.5 watts | 2.0 watts | Voice coil impedance..... |
| | | | 6-inch Permanent-magnet Dynamic |
| | | | 2.6 ohms at 400 cycles |

Mechanical Specifications

| | |
|--|--|
| Height..... | 10 ³ / ₈ inches |
| Width..... | 16 ⁹ / ₁₆ inches |
| Depth..... | 8 ¹ / ₂ inches |
| Weight (Net)..... | 21 ¹ / ₂ pounds |
| Weight (Shipping)..... | 24 ¹ / ₂ pounds |
| Chassis Base Dimensions..... | 11 ⁷ / ₁₆ inches x 5 ³ / ₄ inches x 2 ¹ / ₄ inches |
| Vibrator Power-supply Unit Dimensions..... | 7 inches x 3 ⁵ / ₈ inches x 6 ⁵ / ₈ inches |
| Over-all Chassis Height..... | 8 ¹ / ₄ inches |
| Operating Controls..... | (1) Power Switch—Volume, (2) Range Selector ("A" left, "C" right), (3) Tuning |
| Tuning Drive Ratio..... | 12 to 1 |

General Description

This receiver employs five tubes in a two-band superheterodyne circuit. The design includes magnetite-core adjusted i-f transformers and low-frequency "A" oscillator tracking, automatic volume control, resistance-coupled audio amplifier, and a six-inch permanent-magnet dynamic loudspeaker. It is designed for convenient use either as a conventional a-c

operated receiver (a-c power-supply cable-connector) or as a storage-battery operated receiver (vibrator power-supply unit with cable-connector); the transition from one type of operation to the other being made by merely exchanging cable-connector connections to the male connector on the rear of the receiver chassis.

Service Data

The various diagrams of this booklet contain such information as will be needed to isolate causes for defective operation if such develops. The ratings of the resistors, capacitors, coils, etc., are indicated adjacent to the symbols signifying these parts on the schematic diagram. Identification titles



Model 85BT6

such as R1, L1, C1, etc., provide reference between the illustrations and Replacement Parts List. The coils, transformer windings, and reactors are rated in terms of d-c resistance to permit continuity checks.

Precautionary Lead Dress.—(1) Dress brown twisted leads to power switch away from bias cell and a-f leads to volume

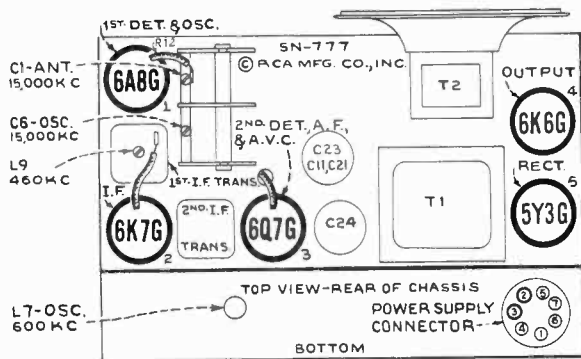

Figure 1—Radiotron and Trimmer Locations

control. (2) Dress light-blue lead, connected from 6A8-G socket to oscillator coil, away from all other leads and chassis. (3) Dress 6A8-G grid-cap lead (R12) to prevent shorts and keep flexible. (4) Dress all leads to antenna coil away from trimming capacitor C26 and from bus lead, connected from oscillator coil to gang condenser. (5) Dress blue antenna lead through the loop of C4 which is mounted on end of antenna coil. Do not change length of the following leads: (6) C9 to chassis; (7) Blue lead from L3 to range selector; (8) Bus lead from oscillator coil to gang condenser. Keep

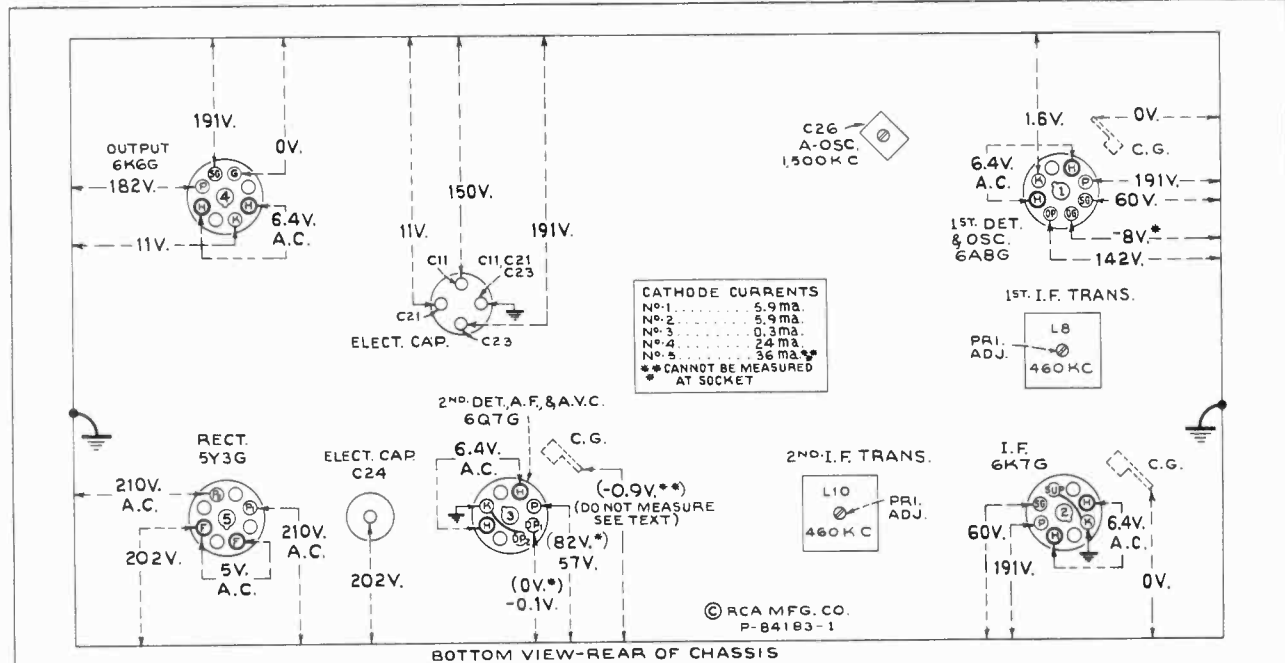

Figure 2—Radiotron Socket Voltages and Trimmer Locations

Measured at 115 volts, 60-cycle supply—Values approximately 5% lower when vibrator power-supply unit is used—Tuned to approximately 1,000 kc ("Broadcast")—No signal being received—Volume control minimum

**** CAUTION:** Do not attempt to measure voltage on control grid of the 6Q7-G with any conventional voltmeter due to presence of bias cell.

Note: Two voltage values are shown for some readings. The higher value shown in parentheses with asterisk (*) indicates operating conditions without voltmeter loading. The lower value is the actual measured voltage and differs from the higher value because of the additional loading of the voltmeter.

Voltage values as specified should hold within $\pm 20\%$ when the receiver is normally operative at its rated line voltage. To duplicate the conditions under which the voltages were measured requires a 1,000-ohm-per-volt d-c meter, having ranges of 10, 50, 250 and 500 volts. Use the nearest range above the specified measured voltage. A-c voltages were measured with a corresponding a-c meter.

the following as short as possible: (9) Leads to C26; (10) Bus lead from oscillator coil to range selector. In the vibrator power-supply unit: (11) Dress small leads from transformer to vibrator socket terminals 3 and 4 close to base and twist twice. (12) Twist large leads from transformer to vibrator socket terminals 2 and 5. (13) Dress C2 as near to bottom cover as possible.

Phonograph Attachment.—See Schematic Circuit Diagram, figure 3.

CAUTION.—Disconnect plug from a-c power source, or battery clips from storage battery, before attaching either cable-connector to the male connector on the rear of the chassis.

110-Volt A-C Operation.—When the a-c power-supply cable-connector is attached to the male connector on the rear of the chassis; a-c power is supplied to the primary circuit of transformer T1 through terms. 3 and 7. Terms. 1 and 6 are jumpered together, in cable-connector, thereby connecting the tube heaters and dial lamp to the heater winding of T1. Terms. 2, 4, and 5 are not used.

6-Volt Battery Operation.—When the vibrator power-supply unit cable-connector is attached to the male connector on the rear of the chassis, the high side of the

battery (-) is connected to receiver "On-Off" switch S4 through term. 3. The other side of S4 connects to term. 4 which in turn is jumpered to term. 1, in cable connector, thereby supplying battery power to the vibrator circuit and to the tube heaters and dial lamp through term. 1. Battery ground return (+) connection is made through term. 2. "B+" voltage from vibrator is connected to the receiver filter input through term. 5. The 5Y3-G rectifier tube circuit is inoperative for this type of operation. Terms. 6 and 7 are not used.

Bias Cell.—The bias cell is used only for the purpose of supplying bias potential to the triode section of the 6Q7-G tube. This cell should never be measured with an ordinary voltmeter, or other device, which draws any current. A simple check on this cell may be made by temporarily shunting the 270,000-ohm plate resistor R7 (mounted on 6Q7-G socket) with a 20,000-ohm resistor, connecting a milliammeter in the plate circuit of the 6Q7-G tube, and noting the plate current reading. Then carefully remove the bias cell and substitute a battery potential of 0.9-volt in its place and note the new reading of the milliammeter. If the first reading obtained (with bias cell) differs from the latter reading (with 0.9-volt battery supply) by more than 20% of the latter reading, the bias cell should be replaced. This 20% is equivalent to a change of approximately 25% battery voltage.

Alignment Procedure

Calibrate the tuning dial by adjusting dial pointer to the center horizontal line with the gang tuning-condenser plates in full-mesh position. This is a screw-driver adjustment.

Perform alignment in proper order, tabulated below, starting with No. 1 and following all operations across, then No. 2, etc. Adjustment locations are shown on figures 1 and 2.

Cathode-ray alignment is preferable; the connections to the chassis are shown on figure 4. If an output indicator is used, connect it across the loudspeaker voice-coil and advance the receiver volume control to full-volume position.

Connect the "low" output terminal of the test oscillator to the receiver chassis for all alignment operations. Regulate

the output of the test oscillator so that minimum signal is applied to the receiver to obtain an observable output indication. This will avoid a-v-c action.

The term "Dummy antenna" means the device which must be connected between the "high" test-oscillator output and the point of connection to the receiver in order to obtain ideal alignment. "No signal, 550-750 kc" means that the receiver should be tuned to a point between 550 and 750 kc where no signal or interference is received from a station or local (heterodyne) oscillator.

For further details on alignment, refer to booklet "RCA Victor Receiver Alignment."

| Order of Alignment | Test Oscillator | | | Range Selector | Receiver Dial Setting | Circuit to Adjust | Adjustment Symbols | Adjust to Obtain |
|--------------------|------------------------|---------------|-------------------|----------------|-----------------------|-------------------|--------------------|------------------|
| | Connection to Receiver | Dummy Antenna | Frequency Setting | | | | | |
| 1 | 6K7-G I-F Grid Cap | .001 Mfd. | 460 kc | "A" Left | No Signal 550-750 kc | 2nd I-F Trans. | L10 | Max. (peak) |
| 2 | 6A8-G Det. Grid Cap | .001 Mfd. | 460 kc | "A" Left | No Signal 550-750 kc | 1st I-F Trans. | L8 and L9 | Max. (peak) |
| 3 | Ant. Lead (blue) | 300 Ohms | 15,000 kc | "C" Right | 15,000 kc | "C" Osc. | C6 | Max. (peak)† |
| 4 | Ant. Lead (blue) | 300 Ohms | 15,000 kc | "C" Right | Rock Thru 15,000 kc | "C" Ant. | C1 | Max. (peak)*‡ |
| 5 | Ant. Lead (blue) | 200 Mmfd. | 600 kc | "A" Left | 600 kc | "A" L-F Osc. | L7 | Max. (peak) |
| 6 | Ant. Lead (blue) | 200 Mmfd. | 1,500 kc | "A" Left | 1,500 kc | "A" H-F Osc. | C26 | Max. (peak) |
| 7 | Ant. Lead (blue) | 200 Mmfd. | 600 kc | "A" Left | 600 kc | "A" L-F Osc. | L7 | Max. (peak) |
| 8 | Ant. Lead (blue) | 200 Mmfd. | 1,500 kc | "A" Left | 1,500 kc | "A" H-F Osc. | C26 | Max. (peak) |

† Use maximum capacity peak if two peaks can be obtained.

* Use minimum capacity peak if two peaks can be obtained.

‡ After this adjustment, check for image signal by shifting receiver dial to 15,920 kc.

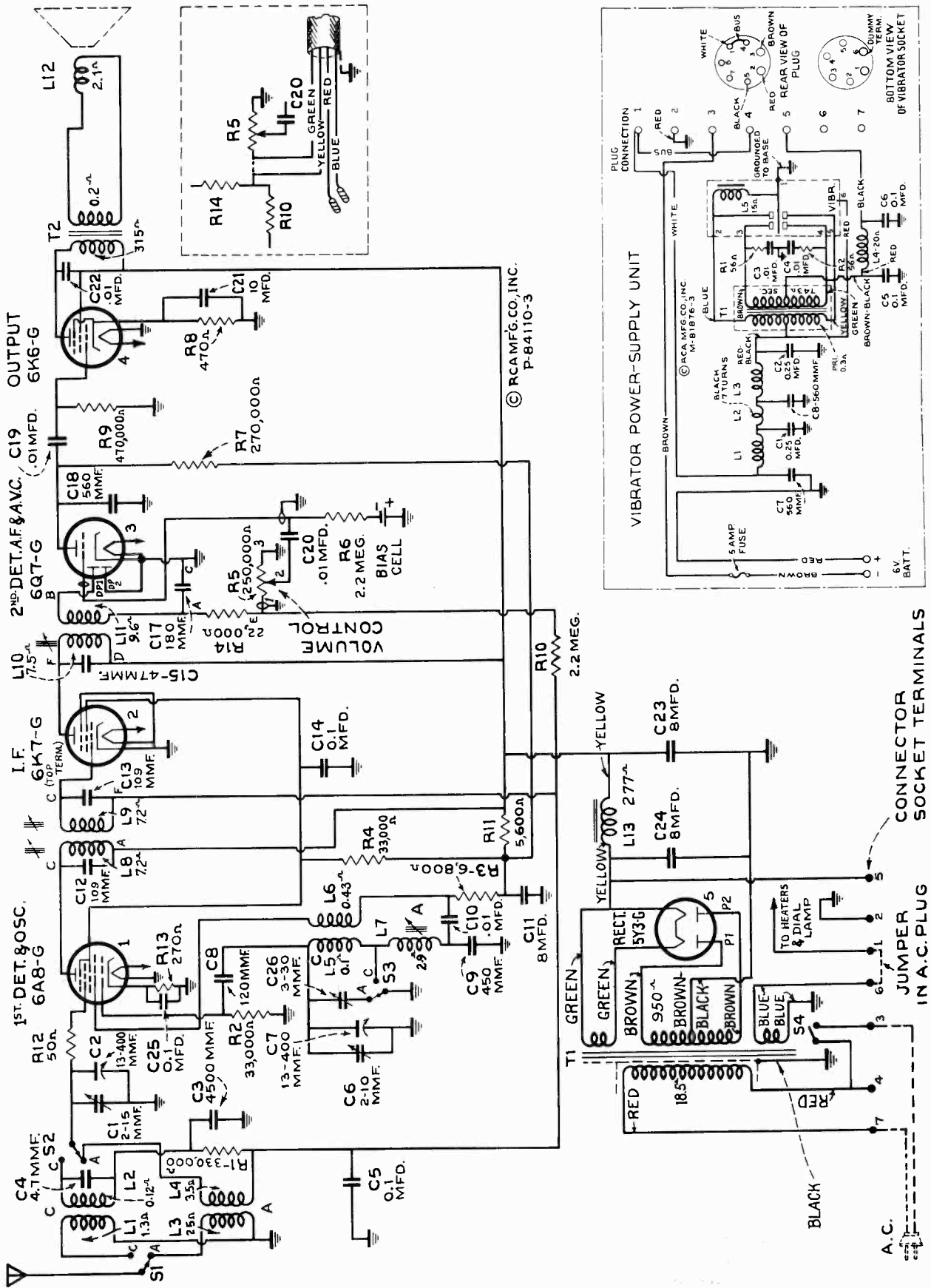

Figure 3—Schematic Circuit Diagram

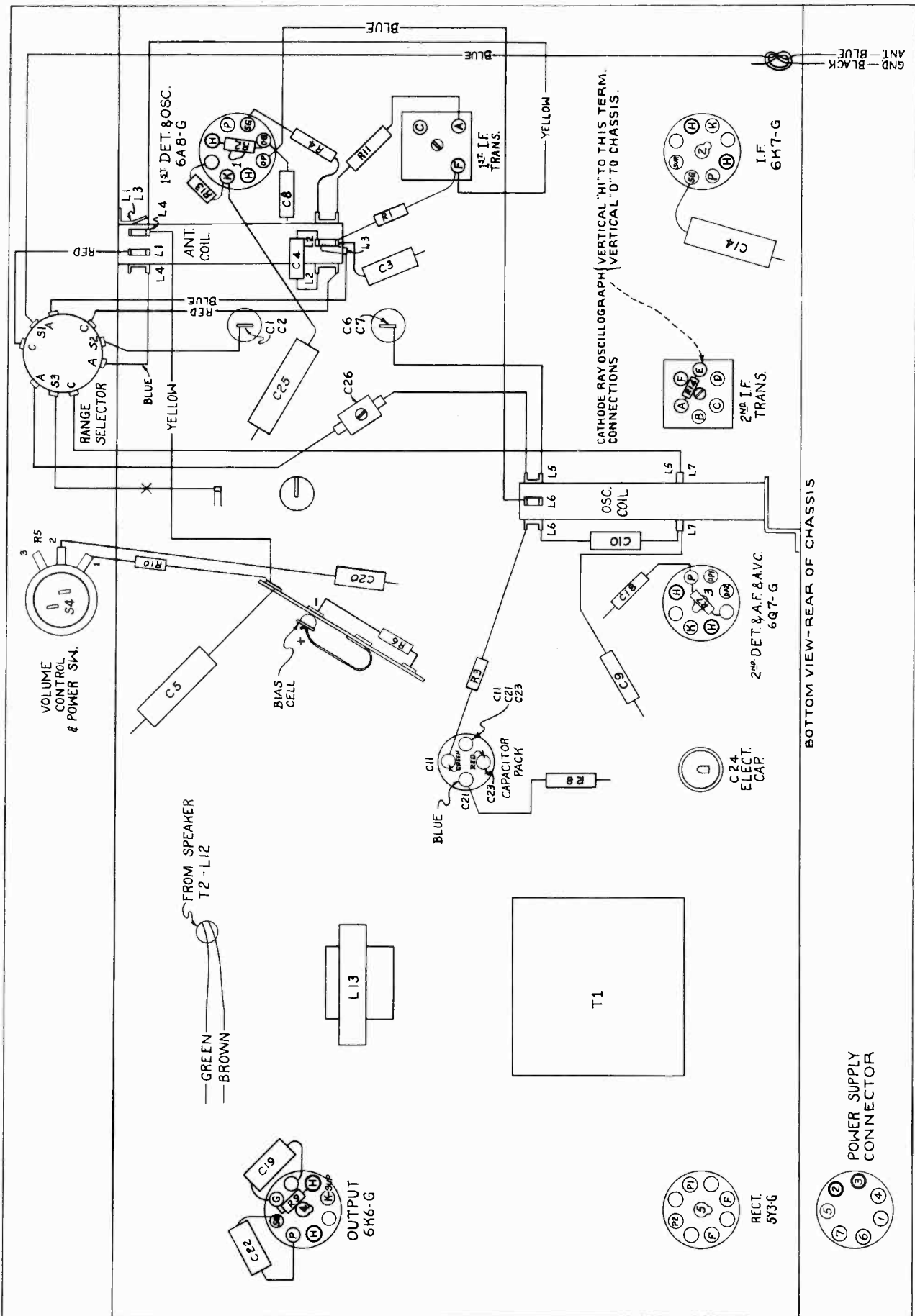

Figure 4—Chassis Parts Location and R-F Wiring Diagram

© RCA MFG. CO., INC.
T-70866-0

REPLACEMENT PARTS

Insist on genuine factory tested parts which are readily identified and may be purchased from authorized dealers.

| STOCK No. | DESCRIPTION | STOCK No. | DESCRIPTION |
|----------------------------|--|---|--|
| RECEIVER ASSEMBLIES | | | |
| 14634 | Belt—Variable condenser drive belt | 12679 | Resistor—2.2 megohms, insulated, ½ watt (R6, R10) |
| 14632 | Bracket—Dial mounting bracket | 5129 | Ring—Radiotron shield ring |
| 5237 | Bushing—Variable condenser rubber mounting bushing | 4389 | Screw—No. 6-32 x 3/16-inch headless set-screw for drive pulley, Stock No. 14639 |
| 11360 | Cap—Grid contact cap | 14638 | Shaft—Station selector knob shaft and pulley |
| 30661 | Capacitor—Adjustable trimmer (3-30 Mmfd.) (C26) | 5037 | Shield—Radiotron shield |
| 14392 | Capacitor—4.7 Mmfd. (C4) | 14658 | Socket—Dial lamp socket |
| 12405 | Capacitor—47 Mmfd. (C15) | 11196 | Socket—Radiotron socket |
| 14262 | Capacitor—110 Mmfd. (C12, C13) | 14637 | Spring—Idler pulley tension spring |
| 12724 | Capacitor—120 Mmfd. (C8) | 30655 | Switch—Range switch (S1, S2, S3) |
| 12812 | Capacitor—450 Mmfd. (C9) | 14378 | Transformer—First I.F. transformer (L8, L9, C12, C13) |
| 13699 | Capacitor—470 Mmfd. (C17) | 14642 | Transformer—Second I.F. transformer (L10, L11, C15, C17) |
| 12537 | Capacitor—560 Mmfd. (C18) | 30656 | Transformer—Power transformer, 105-125 volts, 50-80 cycles (T1) |
| 12728 | Capacitor—4,500 Mmfd. (C3) | 30658 | Volume control and power switch (R25, S4) |
| 14393 | Capacitor—.01 Mfd. (C10, C19, C20, C22) | REPRODUCER ASSEMBLIES (84140-1) | |
| 4838 | Capacitor—0.1 Mfd. (C5, C14, C25) | 30664 | Cone—Reproducer cone and voice coil mounted and centered in metal housing (L12) |
| 11263 | Capacitor—5 Mfd. (C11) | 30662 | Reproducer, complete |
| 30657 | Capacitor Pack—Comprising two sections each 8 Mfd. and one section 10 Mfd. (C21, C23, C24) | 30663 | Transformer—Output transformer (T2) |
| 12681 | Cell—Bias cell | VIBRATOR POWER UNIT ASSEMBLIES | |
| 4358 | Clamp—Capacitor pack mounting clamp for Stock No. 30657 | 14724 | Capacitor—560 Mmfd. (C7, C8) |
| 30659 | Coil—Antenna coil (L1, L2, L3, L4) | 11654 | Capacitor—.01 Mfd. (C3, C4) |
| 14647 | Coil—Oscillator coil (L5, L6, L7) | 4839 | Capacitor—0.1 Mfd. (C5, C6) |
| 14633 | Condenser—2-gang variable tuning condenser (C1, C2, C6, C7) | 12484 | Capacitor—0.25 Mfd. (C1, C2) |
| 14631 | Dial—Station selector dial and holder | 14289 | Clip—Battery clips for vibrator battery cable |
| 14651 | Drive—Variable condenser vernier drive and pinion gear | 12179 | Coil—Choke coil (L1, L3) |
| 30660 | Holder—Bias cell holder | 12819 | Coil—Choke coil and terminal board assembly (L4) |
| 14635 | Indicator—Station selector indicator pointer | 5140 | Fuse—5-amp. (F1) |
| 4340 | Lamp—Dial lamp | 13220 | Resistor—56 ohms, carbon type, ½ watt (R1, R2) |
| 14404 | Plug—7-contact male plug for rear apron of chassis | 30667 | Socket—7-contact female socket for vibrator to chassis power cable |
| 14636 | Pulley—Idler pulley—less spring | 30665 | Transformer—Vibrator power transformer (T1) |
| 14639 | Pulley—Variable condenser drive pulley—located on condenser shaft | 30666 | Vibrator (L5) |
| 12818 | Reactor—Filter reactor (L13) | MISCELLANEOUS ASSEMBLIES | |
| 14653 | Resistor—50 ohms, flexible type (R12) | 14654 | Escutcheon—Station selector escutcheon and crystal |
| 13454 | Resistor—270 ohms, carbon type, ½ watt (R13) | 30668 | Cord—A.C. power cord and plug for 110-volt operation |
| 30499 | Resistor—470 ohms, insulated, ½ watt (R8) | 12673 | Knob—Station selector, range switch, or volume control knob |
| 5175 | Resistor—5,600 ohms, carbon type, ½ watt (R11) | 4119 | Screw—No. 8-32 x ¼-inch headless cup-pointed set-screw for knob, Stock No. 12673 |
| 12265 | Resistor—6,800 ohms, insulated, ½ watt (R3) | | |
| 13998 | Resistor—22,000 ohms, insulated, ½ watt (R14) | | |
| 8072 | Resistor—33,000 ohms, carbon type, ½ watt (R4) | | |
| 12454 | Resistor—33,000 ohms, insulated, ½ watt (R2) | | |
| 12199 | Resistor—270,000 ohms, insulated, ½ watt (R7) | | |
| 13733 | Resistor—330,000 ohms, carbon type, ½ watt (R1) | | |
| 12285 | Resistor—470,000 ohms, insulated, ½ watt (R9) | | |



RCA Victor

MODELS 86BK and 86BT

Six-Tube, Three-Band, Battery Operated, Superheterodyne Receivers

TECHNICAL INFORMATION AND SERVICE DATA

SERVICE DIVISION • RCA MANUFACTURING COMPANY, INC. • CAMDEN, N. J., U. S. A.

A Service of the Radio Corporation of America

Electrical Specifications

FREQUENCY RANGES

"Standard Broadcast" (A)..... 530—1,720 kc
"Medium Wave" (B)..... 2,100—6,800 kc
"Short Wave" (C)..... 6,800—22,000 kc

Intermediate Frequency..... 460 kc

RADIOTRON COMPLEMENT

(1) RCA-1A4..... R-F Amplifier
(2) RCA-1C6..... First Detector—Oscillator
(3) RCA-1A4..... Intermediate Amplifier

R-F ALIGNMENT FREQUENCIES

"Short Wave" (C)..... 20,000 kc (osc., det., ant.)
"Medium Wave" (B)..... 6,000 kc (osc.)
"Standard Broadcast" (A)... 600 kc (osc.), 1,500 kc (osc.)

Pilot Lamps (2)..... Mazda 2.0 volts, .06 ampere

BATTERIES REQUIRED

"A," one plug-in, 2½-volt Air Cell, or one 2-volt storage battery; "B," three 45-volt, heavy-duty, plug-in type B batteries; "C," one 7½-volt C battery tapped at —1½, —3, and —4½ volts, and three bias cells (Stock No. 12681).

CURRENT CONSUMPTION

"A" at 2 volts (pilot lamps off)..... 0.62 ampere
"A" at 2 volts (pilot lamps on)..... 0.74 ampere
"B" at 135 volts..... 21 milliamperes
Fuse Rating..... ½ ampere

POWER OUTPUT

Undistorted 1.2 watts
Maximum 2.2 watts

LOUDSPEAKER

Type..... Permanent-Magnet Dynamic
Voice Coil Impedance..... 2.2 ohms at 400 cycles

Mechanical Specifications

| | MODEL 86BK | MODEL 86BT |
|---------------------------------|---|------------|
| Height | 39 inches | 20½ inches |
| Width | 24¼ inches | 16 inches |
| Depth | 12 inches | 10¼ inches |
| Weight (net)..... | 49 pounds | 23½ pounds |
| Weight (shipping)..... | 62 pounds | 29 pounds |
| Chassis Base Dimensions..... | 13½ inches x 7¾ inches x 3 inches | |
| Over-all Height of Chassis..... | 9 inches | |
| Operating Controls..... | (1) Volume; (2) Tuning (large inner knob) Range Selector (small outer knob); (3) Power Switch—tone | |
| Tuning Drive Ratio..... | 20 to 1 | |

General Description

Each of these receivers employs a similar chassis, the superheterodyne circuit arrangement of which is shown by figure 2. Model 86BK is a console model employing a 12-inch, permanent-magnet, dynamic loudspeaker while Model 86BT is a table model employing an 8-inch, permanent-magnet, dynamic loudspeaker. Features of design include an r-f amplifier stage for high signal-to-noise ratio and high sensitivity; new, plunger-type, air trimmers; magnetite-core

i-f transformers and low-frequency "A" oscillator tracking; automatic volume control; aural-compensated audio volume control; resistance-coupled, first-audio stage and transformer-coupled, audio-driver stage to a push-pull, class-B, audio-output stage; phonograph terminal board; two-point, high-frequency tone control; super-sensitive, permanent-magnet, dynamic loudspeaker with dust screen; low current drain; and a large, easy-to-read, illuminated dial with vernier pointer

Copyright, 1937, RCA Manufacturing Co., Inc.

Trademark "Radiotron"
Reg. U. S. Pat. Off. by RCA Mfg. Co., Inc.

and save-a-drain pilot lamp switch combined with the tuning control.

These receivers may be easily converted to 6-volt operation by employing an RCA Victor CV-8 Pak-O-Powr which, with a 6-volt storage battery, replaces the "A" and "B" batteries

Service Data

The various diagrams of this booklet contain such information as will be needed to isolate causes for defective operation if such develops. The ratings of the resistors, capacitors, coils, etc., are indicated adjacent to the symbols signifying these parts on the diagrams. Identification titles such as R1, L1, C1, etc., provide reference between the illustrations and Replacement Parts List. The coils, transformer windings, and reactors are rated in terms of d-c resistance to permit continuity checks.

Precautionary Lead Dress.—(1) Twisted leads from filament switch to power plug must be dressed against bottom of end shield and fastened with tape. (2) Lead from term. No. 6 of S3 to chassis must be as short as possible and to same chassis lance as C15-C34. (3) Keep lead from term. No. 9 of S3 to L7-L8 as short as possible. (4) Keep lead from L7 to C11 as short as possible. (5) Keep lead from C10 to C11 as short as possible. (6) Keep leads of C41 as short as possible. (7) Keep lead from term. No. 20 of S2 to C13 as short as possible.

Phonograph Attachment.—A terminal board is provided for connecting a phonograph into the audio amplifying circuit. RCA Victor Model R-93-S Record Player should be connected as follows: Remove link between terminals

listed under "Batteries required".

The three tuning ranges cover the "Standard broadcast" band and the important short-wave bands at 49, 31, 25, 19, 16, and 13 meters along with channels assigned for police, aviation, and amateur communication.

1 and 2 on terminal board. Connect green wire in Radio-Record switch cable to terminal 1, yellow to terminal 2, and shield extension to terminal 3. Tape unused red and blue leads separately. Connect a 2-conductor twisted cable between the Record Player binding posts and the screw terminals on Radio-Record switch.

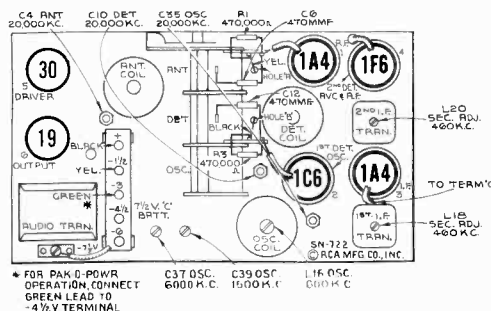

Figure 1—Radiotron, Coil, and Trimmer Locations

Alignment Procedure

Calibrate the tuning dial by adjusting main dial pointer to the low-frequency (end) calibration mark on dial with the gang tuning-condenser plates in full-mesh position; then adjust the small (vernier) pointer to "O." These are friction adjustments.

Perform alignment in proper order, tabulated below, starting with No. 1 and following all operations across, then No. 2, etc. Adjustment locations are shown on figures 1 and 4.

Cathode-ray alignment is highly preferable; the connections to the chassis are shown on figure 3. If an output indicator is used, connect it across the loudspeaker voice-coil and advance the receiver volume control to full-volume position.

Connect the "low" output terminal of the test oscillator to

the receiver "G" (ground) terminal for all alignment operations. Regulate the output of the test oscillator so that minimum signal is applied to the receiver to obtain an observable output indication. This will avoid a-v-c action.

The term "Dummy antenna" means the device which must be connected between the "high" test-oscillator output and the point of connection to the receiver in order to obtain ideal alignment. "No signal, 550-750 kc" means that the receiver should be tuned to a point between 550 and 750 kc where no signal or interference is received from a station or local (heterodyne) oscillator.

For further details on alignment, refer to booklet "RCA Victor Receiver Alignment."

| Order of Alignment | Test Oscillator | | | Receiver Dial Setting | Circuit to Adjust | Adjustment Symbols | Adjust to Obtain |
|--------------------|------------------------|---------------|-------------------|-----------------------|-------------------|--------------------|------------------|
| | Connection to Receiver | Dummy Antenna | Frequency Setting | | | | |
| 1 | 1A4 I-F Grid Cap | .001 Mfd. | 460 kc | No Signal 550-750 kc | 2nd I-F Trans. | L19 and L20 | Max. (peak) |
| 2 | 1C6 Det. Grid Cap | .001 Mfd. | 460 kc | No Signal 550-750 kc | 1st I-F Trans. | L17 and L18 | Max. (peak) |
| 3 | Ant. Term. | 300 Ohms | 20,000 kc | 20,000 kc | "C" Osc. | C35 | Max. (peak) * |
| 4 | Ant. Term. | 300 Ohms | 20,000 kc | 20,000 kc | "C" Det. | C10 | Max. (peak) † |
| 5 | Ant. Term. | 300 Ohms | 20,000 kc | 20,000 kc | "C" Ant. | C4 | Max. (peak) ‡ |
| 6 | Ant. Term. | 300 Ohms | 6,000 kc | Rock Thru 6,000 kc | "B" Osc. | C37 | Max. (peak) * |
| 7 | Ant. Term. | 200 Mmfd. | 600 kc | 600 kc | "A" L-F Osc. | L16 | Max. (peak) |
| 8 | Ant. Term. | 200 Mmfd. | 1,500 kc | 1,500 kc | "A" H-F Osc. | C39 | Max. (peak) |
| 9 | Ant. Term. | 200 Mmfd. | 600 kc | Rock Thru 600 kc | "A" L-F Osc. | L16 | Max. (peak) |
| 10 | Ant. Term. | 200 Mmfd. | 1,500 kc | Rock Thru 1,500 kc | "A" H-F Osc. | C39 | Max. (peak) |

* Use minimum capacity peak if two peaks can be obtained.

† Use maximum capacity peak if two peaks can be obtained.

‡ After this adjustment, check for image signal by shifting receiver dial to 19,080 kc.

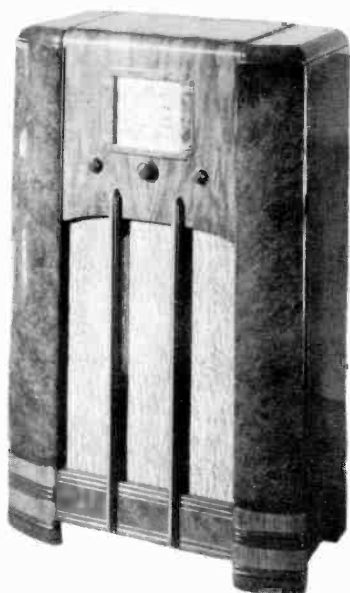

Model 86BK

Loudspeaker.—Centering of the loudspeaker is made in the usual manner with three narrow paper feelers after first removing the front dust cover. This may be removed by softening its cement with a light application of acetone, using care not to allow the acetone to flow into the air gap. The dust cover should be cemented back in place with ambroid upon completion of adjustment.

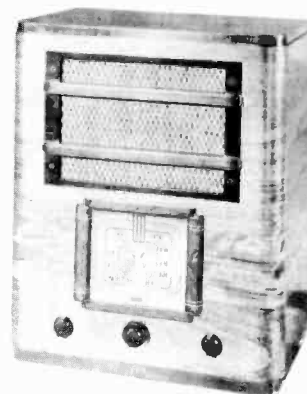

Model 86BT

Bias Cells.—Three bias cells are used only for the purpose of supplying bias potential to the 1C6 first-detector—oscillator tube. These cells should never be measured with an ordinary voltmeter or other device which draws any current. A simple check on these cells may be made by connecting a milliammeter in the plate circuit of the 1C6 tube and noting the plate current reading. Then carefully remove the cells and substitute a battery potential of 2.7 volts in their place and note the new reading on the milliammeter. If the first reading obtained (with bias cells) is more than 40% from the latter reading (with 2.7-volt battery), the bias cells should be replaced. This 40% difference is equivalent to a change of approximately 25% battery voltage.

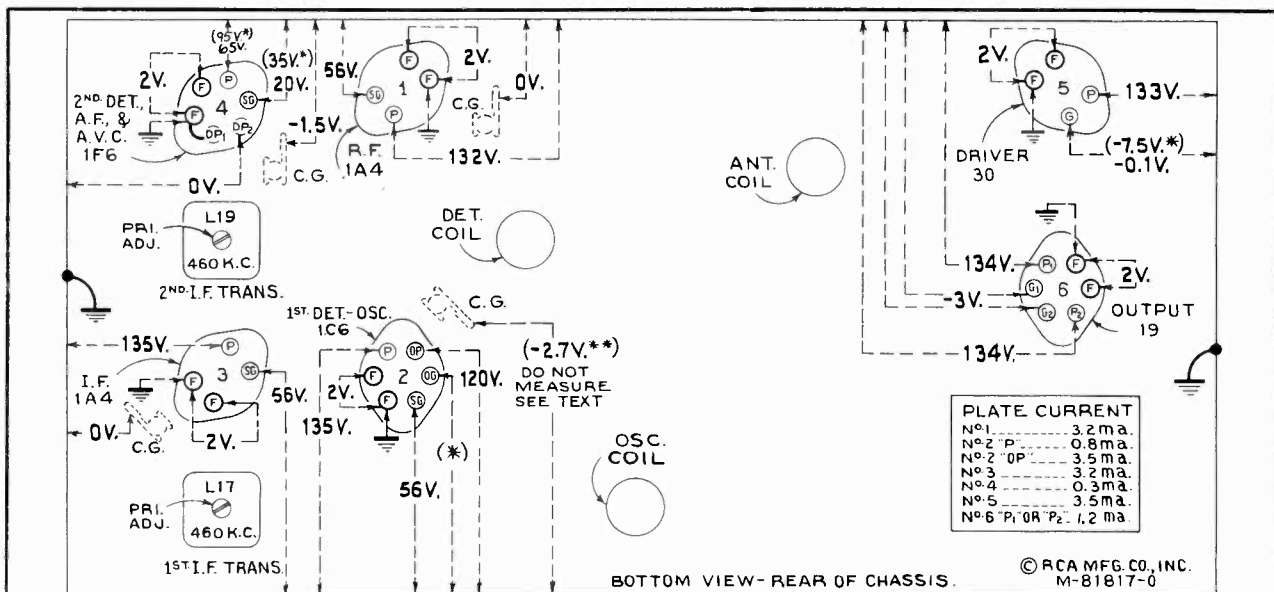

Figure 4—Radiotron Socket Voltages, Coil, and Trimmer Locations
Measured with all batteries at normal voltage—Tuned to approximately 1,000 kc—
No signal being received—Volume control minimum

****CAUTION:** Do not attempt to measure voltage on control grid of the 1C6 with any conventional voltmeter due to presence of bias cells.

Note: Two voltage values are shown for some readings. The higher value shown in parenthesis with asterisk (*) indicates operating conditions without voltmeter loading. The lower value is the actual measured voltage and differs from the higher value because of the additional loading of the voltmeter through the high series circuit resistance.

The voltage values indicated from the Radiotron socket contacts, grid caps, and terminals to receiver chassis ground on figure 4 will assist in locating cause for faulty operation. Each value as specified should hold within $\pm 20\%$ when the receiver is normally operative at its rated voltage. To duplicate the conditions under which the voltages were measured requires a 1,000-ohm-per-volt d-c meter, having ranges of 10 and 250 volts. Use the nearest range above the specified measured voltage.

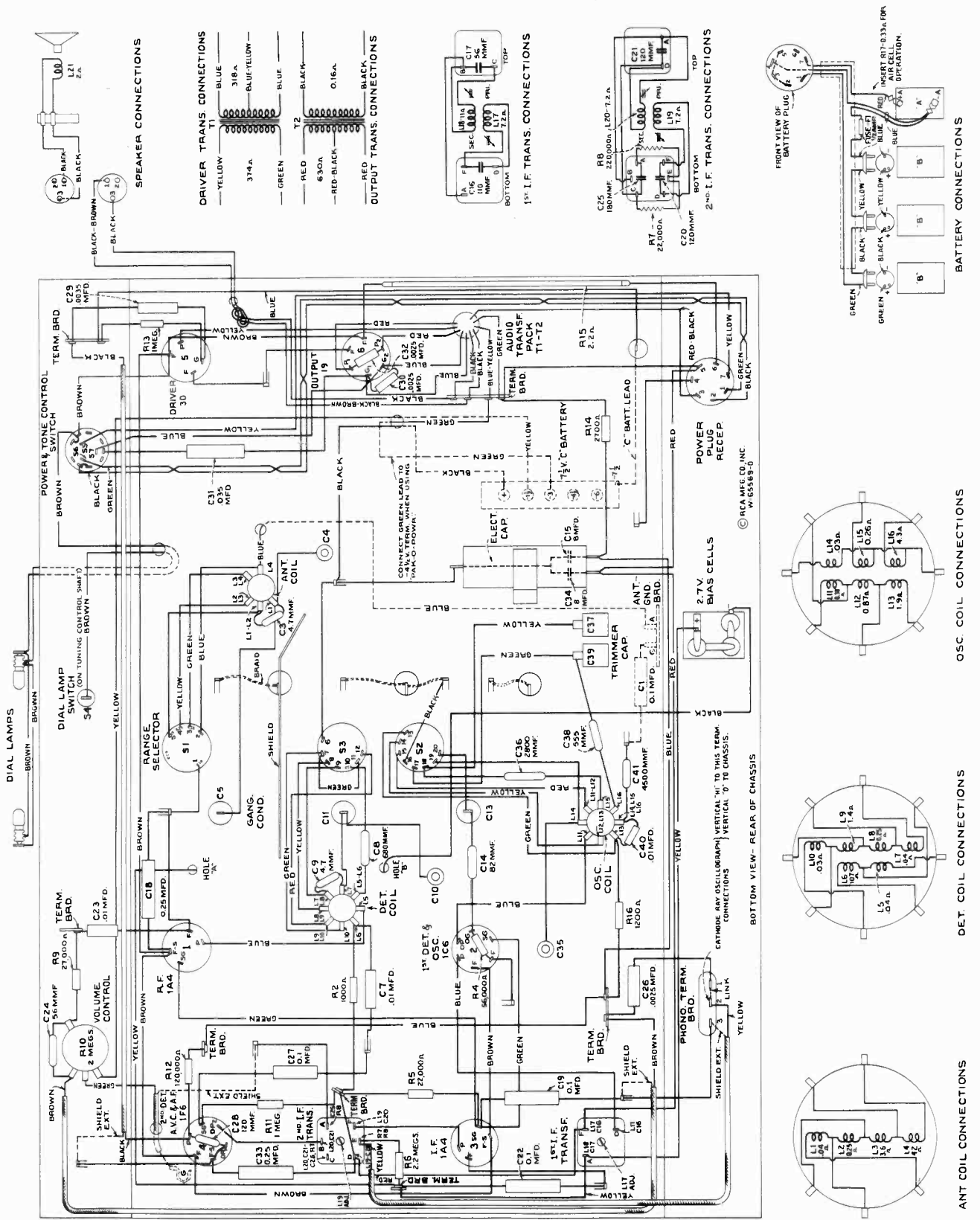

Figure 3—Chassis Wiring Diagram

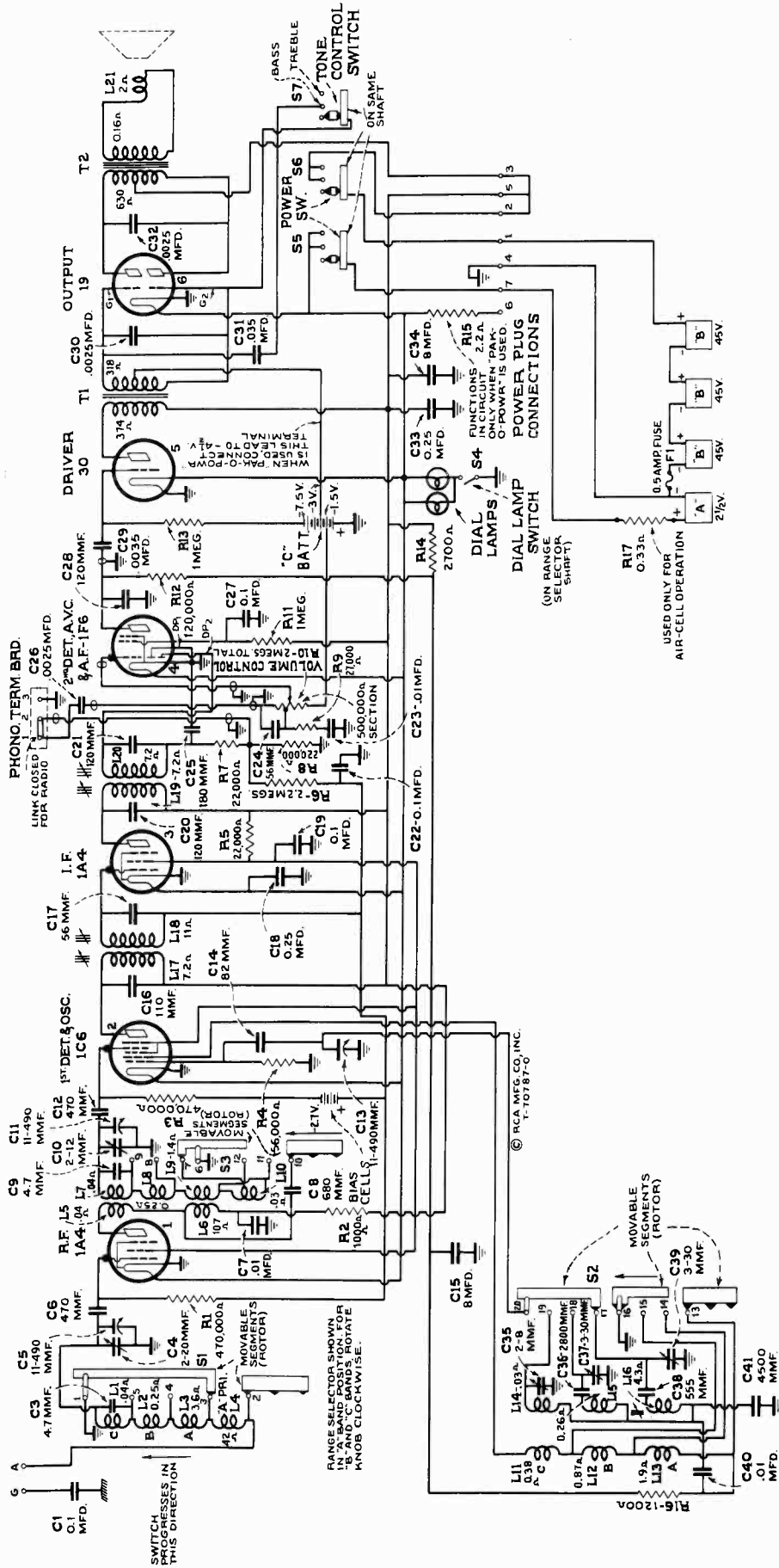

Figure 2—Schematic Circuit Diagram

Operation With CV-8 Pak-O-Powr.—These receivers may readily be operated from an RCA CV-8 Pak-O-Powr, in which case, a six-volt storage battery replaces the "A" and "B" batteries listed under "Batteries required." When using the CV-8, one cell (2 volts) of the storage battery supplies filament voltage to the tubes, while the other two cells (4 volts) supplies power for the CV-8. When installing, the seven prong CV-8 receptacle plugs into the seven prong plug on the rear apron of the receiver chassis and the four battery leads clip on terminals of the storage battery as follows: Red to + 6 V.; Blue to + 4 V.; Yellow to + 4 V.; and brown (fused lead) to —V. The two four-volt leads (Blue and Yellow) should make separate connections to the same battery strap to avoid vibrator buzz which might otherwise result if these two leads are joined together or touch each other. Observe extreme care that proper con-

nections are made to the battery, as a wrong connection will burn out the tubes. The green lead (originally connected to — 3 v. on the "C" battery) should be shifted to the — 4.5 volt tap. The other "C" battery connections remain unchanged.

The following changes under "Electrical specifications" become effective when employing the CV-8; "A" battery current drain at 6 volts, 1.65 amperes. Fuse rating, 5 amperes. Undistorted output, 1.3 watts. Maximum output, 1.8 watts. Under "Service data," the following voltages apply to the RCA-19 power-output tube. Either plate to chassis, 180 volts. Either grid to chassis, — 4½ volts. Plate current (either plate), 1.6 ma.

When servicing, the CV-8 chassis should be insulated from the receiver chassis to avoid vibrator buzz.

REPLACEMENT PARTS

Insist on genuine factory tested parts, which are readily identified and may be purchased from authorized dealers.

| STOCK No. | DESCRIPTION | STOCK No. | DESCRIPTION |
|----------------------------|---|---|--|
| RECEIVER ASSEMBLIES | | | |
| 14388 | Belt—Variable condenser drive belt | 14390 | Resistor—27,000 ohms, carbon type, 1/10 watt (R9) |
| 12/17 | Board—Phonograph terminal board | 12286 | Resistor—56,000 ohms, insulated, ¼ watt (R4) |
| 13216 | Board—Antenna and ground terminal board | 13734 | Resistor—120,000 ohms, carbon type, ¼ watt (R12) |
| 14338 | Bushing—Variable condenser mounting bushing and screw assembly | 11398 | Resistor—220,000 ohms, carbon type, 1/10 watt (R8) |
| 12607 | Cap—First I.F. transformer shield top | 11452 | Resistor—470,000 ohms, carbon type, 1/10 watt (R1, R3) |
| 12581 | Cap—Second I.F. transformer shield top | 13730 | Resistor—1 megohm, carbon type, ¼ watt (R11, R13) |
| 12118 | Cap—Grid contact cap | 11626 | Resistor—2.2 megohm, carbon type, ¼ watt (R6) |
| 14392 | Capacitor—4.7 Mmfd. (C3, C9) | 14343 | Retainer—Drive shaft and pulley retainer |
| 12629 | Capacitor—56 Mmfd. (C17) | 14350 | Screw—No. 8-32x3/16 square head set screw for gear Stock No. 30085 and drum Stock No. 14345 |
| 12723 | Capacitor—56 Mmfd. (C24) | 12008 | Shield I.F. transformer shield can |
| 12813 | Capacitor—82 Mmfd. (C14) | 14374 | Shield—R.F. or antenna coil shield |
| 14262 | Capacitor—110 Mmfd. (C16) | 14375 | Shield—Oscillator coil shield |
| 12724 | Capacitor—120 Mmfd. (C28) | 3682 | Shield—Radiotron shield |
| 12404 | Capacitor—120 Mmfd. (C20, C21) | 4794 | Socket—4-contact 1A4 or 30 Radiotron socket |
| 12406 | Capacitor—180 Mmfd. (C25) | 4786 | Socket—6-contact 1C6, 1F6 or 19 Radiotron socket |
| 13052 | Capacitor—470 Mmfd. (C6, C12) | 14171 | Socket—Dial lamp socket |
| 12727 | Capacitor—555 Mmfd. (C38) | 12907 | Spring—Tension spring for indicator drive gear Stock No. 30085 |
| 14417 | Capacitor—680 Mmfd. (C8) | 14342 | Spring—Tension spring for idler Stock No. 14341 |
| 14407 | Capacitor—2,800 Mmfd. (C36) | 12007 | Spring—Retaining spring for core Stock No. 12006 |
| 12728 | Capacitor—4,500 Mmfd. (C41) | 14413 | Switch—Range switch (S1, S2) |
| 5005 | Capacitor—.0035 Mfd. (C29) | 14401 | Switch—Tone control switch and power switch (S4, S5, S6, S7) |
| 5107 | Capacitor—.0025 Mfd. (C26, C30, C32) | 14261 | Transformer—First I.F. transformer (L17, L18, C16, C17) |
| 5196 | Capacitor—.035 Mfd. (C31) | 14283 | Transformer—Second I.F. transformer (L19, L20, C20, C21, C25, R7, R8) |
| 13138 | Capacitor—.01 Mfd. (C7, C23, C40) | 12803 | Transformer—Audio transformer pack (T1, T2) |
| 4841 | Capacitor—0.1 Mfd. (C1, C19, C22, C27) | 14379 | Washer—Felt washer for indicator pointer |
| 4840 | Capacitor—0.25 Mfd. (C18, C33) | 14335 | Volume Control (R10) |
| 14383 | Capacitor—Adjustable dual trimmer (C37, C39) | REPRODUCER ASSEMBLIES | |
| 12884 | Capacitor—Adjustable trimmer (long) (C4) | CONSOLE MODEL (Speaker No. RL71-1) | |
| 12714 | Capacitor—Adjustable trimmer (medium) (C10) | 12667 | Cone—Reproducer cone and dust cap (L21) |
| 12807 | Capacitor—Adjustable trimmer (short) (C35) | 5118 | Plug—3-contact male connector for reproducer |
| 14403 | Capacitor—Pack comprising two sections each 8 Mfd. (C15, C34) | 9713 | Reproducer—Complete |
| 12681 | Cell—Bias cell | TABLE MODEL (Speaker No. RL73-1) | |
| 14372 | Coil—Antenna coil and shield (L1, L2, L3, L4) | 12642 | Cone—Reproducer cone and dust cap (L21) |
| 14373 | Coil—Oscillator coil and shield (L11, L12, L13, L14, L15, L16) | 5118 | Plug—3-contact male connector for reproducer |
| 14414 | Coil—R.F. coil and shield (L5, L6, L7, L8, L9, L10) | 9712 | Reproducer—Complete |
| 14411 | Condenser—3-gang variable tuning condenser (C5, C11, C13) | MISCELLANEOUS ASSEMBLIES | |
| 5119 | Connector—3-contact female connector for reproducer cable | 4289 | Body—Fuse holder female body |
| 12006 | Core—Adjustable core and stud for I.F. transformers | 4286 | Bushing—Fuse holder bushing and ferrule |
| 12800 | Core—Adjustable core and stud assembly for oscillator coil | 14408 | Cable—Battery cable complete with fuse, fuse holder, one 7-contact female connector, three 2-contact male connectors and two battery clips |
| 14416 | Dial—Station selector dial scale | 4288 | Cap—Fuse holder male cap |
| 14412 | Drive—Variable condenser vernier drive shaft and pinion gear | 14289 | Clip—Battery clips, one marked "+" and one unmarked |
| 14345 | Drum—Variable condenser drive belt drum complete with set screws | 12827 | Connector—2-contact male connector for battery cable |
| 14415 | Foot—Chassis mounting foot and bracket assembly | 14409 | Connector—7-contact female connector for battery cable |
| 30085 | Gear—Indicator drive gear and hub assembly and pointer stem and gear assembly | 14396 | Escutcheon—Station selector escutcheon and crystal |
| 14405 | Holder—Bias cell holder | 3748 | Fuse—¼ ampere (F1) |
| 14341 | Idler—Station selector drive belt idler | 14269 | Knob—Volume control, tone control or range switch knob |
| 14344 | Indicator—Station selector indicator pointer | 14359 | Knob—Station selector knob |
| 14382 | Indicator—Vernier indicator pointer | 4290 | Insulator—Fuse holder insulating sleeve |
| 4348 | Lamp—Dial lamp | 14418 | Resistor—0.33 ohms flexible resistor—¼ watt, complete with clip (R17) |
| 14028 | Nut—Jamb nut for air trimmer capacitors | 11210 | Screw—Chassis mounting screw and washer for Model 86BK |
| 14404 | Plug—7-contact male plug located on rear apron of chassis for battery cable | 11377 | Screw—Chassis mounting screw and washer for Model 86BT |
| 14340 | Pulley—Station selector drive belt pulley and knob shaft | 4284 | Spring—Fuse holder tension spring |
| 14361 | Reflector—Dial reflector and lamp bracket assembly | 4982 | Spring—Retaining spring for knob Stock No. 14359 |
| 14406 | Resistor—2.2 ohms, flexible type, 3 watt (R15) | 14270 | Spring—Retaining spring for knob Stock No. 14269 |
| 5112 | Resistor—1,000 ohms, carbon type, ¼ watt (R2) | 4285 | Washer—Fuse holder insulating washer |
| 11283 | Resistor—1,200 ohms, carbon type, ¼ watt (R16) | | |
| 5144 | Resistor—2,700 ohms, carbon type, ¼ watt (R14) | | |
| 11505 | Resistor—22,000 ohms, carbon type, ¼ watt (R5) | | |
| 14284 | Resistor—22,000 ohms, carbon type, 1/10 watt (R7) | | |

RCA VICTOR MODEL CV-8 PAK-O-POWR

TECHNICAL INFORMATION AND SERVICE DATA

Battery Required: One 6-volt storage battery tapped at +4 volts (4 volts for CV-8 and 2 volts for receiver tubes).

Current Drain: 1.65 amperes to supply 4 ma. at 180 volts and 18 ma. at 135 volts.

Fuse Rating: 5 amperes

Height, 6-5/8 inches Width, 7 inches Depth, 3 1/2 inches

Weight (net), 7 1/2 pounds Weight (shipping), 8 3/4 pounds

The RCA Victor Model CV-8 Pak-O-Powr is a compact, self-contained, power-conversion unit which operates from a 6-volt storage battery and supplies all "A" and "B" power required to operate RCA Victor Receiver Models 85BK, 85BT, 86BK, or 86BT.

Four clip-leads extend from the cable for connection to the storage battery. Two leads, the Brown (-) and Yellow (+4 v.), supply power for the CV-8 vibrator; while the remaining two leads, Blue (+4 v.) and Red (+6 v.), supply 2 volts for the receiver-tube filaments. It is important that the battery leads be connected correctly, as a wrong connection of the Red and/or Blue leads will burn out the tubes. Refer to the Wiring Diagram, figure 2, for proper connections and also note that the two 4-volt leads, Blue and Yellow, should make separate connections to the same battery strap to avoid vibrator buzz. The four pairs of twisted leads must each be twisted their full length to avoid vibrator buzz. The seven-contact female receptacle plugs into the power plug on the rear of the receiver chassis. The battery cable supplied with the receiver is not required.

The seven plug connections are as follows: No. 1, battery side of vibrator switch. No. 2, vibrator side of vibrator switch. No. 3 +180 volts for power-output tube. No. 4, receiver chassis ground. No. 5, +135 volts for all tubes except power output. No. 6, jumper to No. 4. No. 7, battery side of filament switch.

To check the CV-8 when a receiver is not available, resistors may be used for loading as follows: a 56,000-ohm, 1-watt resistor from contacts 3 to 2, and an 8,200-ohm, 3-watt resistor from contacts 5 to 2. Under such conditions, the voltage from contacts 3 to 2 should be 180 volts and from contacts 5 to 2 should be 135 volts. It will be necessary to connect a jumper from contacts 1 to 2 to turn the CV-8 on.

When operating or servicing, the CV-8 chassis should be insulated from the receiver chassis to avoid vibrator buzz.

REPLACEMENT PARTS

| <u>Stock No.</u> | <u>Description</u> |
|------------------|---|
| 4289 | Body--Fuse holder female body |
| 4286 | Bushing--Fuse holder bushing and ferrule |
| 14423 | Cable--Battery cable complete, connects battery to vibrator to receiver |
| 4288 | Cap--Fuse holder male cap |
| 11654 | Capacitor--0.01 mfd.(C3, C4) |
| 4841 | Capacitor--0.1 mfd. (C6) |
| 4840 | Capacitor--0.25 mfd. (C1, C2) |

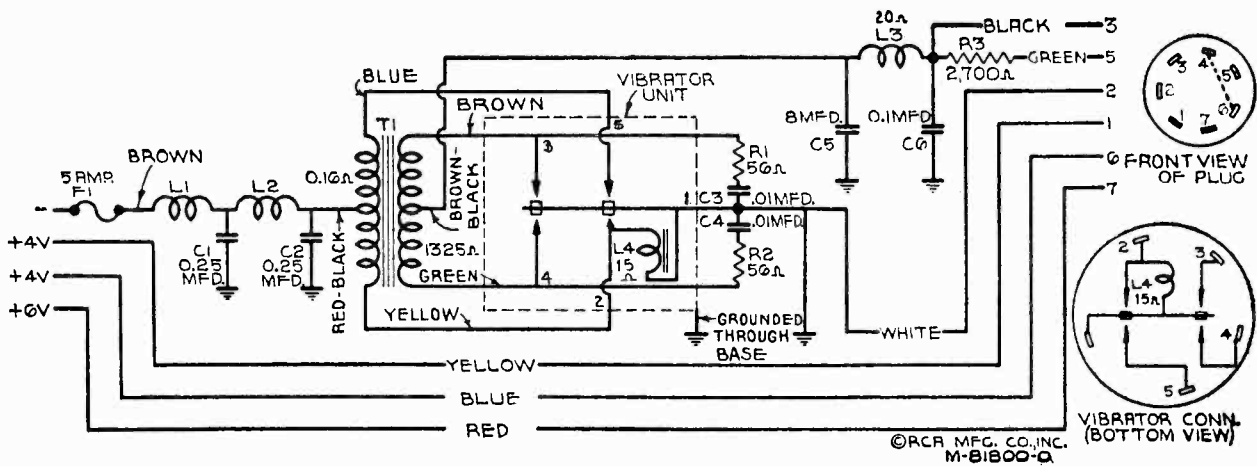

Figure 1. - Schematic Circuit Diagram

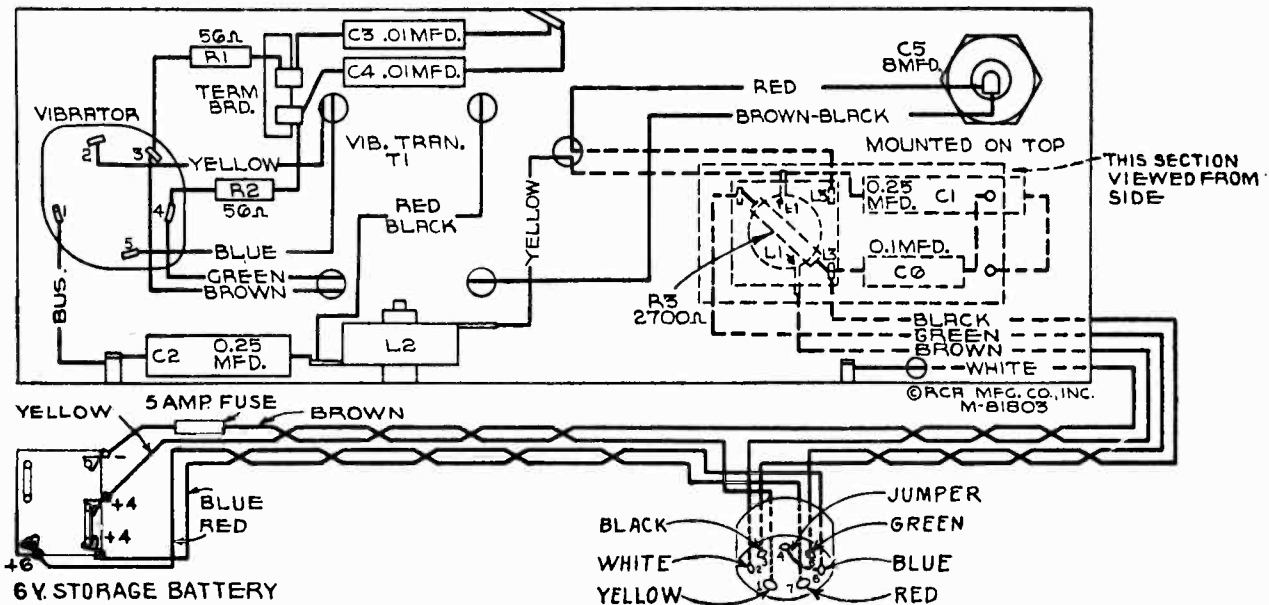

Figure 2. - Chassis Wiring Diagram

Stock No.

Description

| | |
|-------|--|
| 13046 | Capacitor--8 mfd. (C5) |
| 14289 | Clip--Two battery clips, one marked "+" and one unmarked |
| 12819 | Coil--Choke coil and terminal board assembly (L3) |
| 12179 | Coil--Choke coil (L1, L2) |
| 5140 | Fuse--5 ampere (F1) |
| 4290 | Insulator--Fuse holder insulating sleeve |
| 14419 | Mounting--Rubber mounting for vibrator chassis |
| 14409 | Plug--7-contact female plug for battery cable |
| 13220 | Resistor--56 ohms, carbon type, 1/4 watt (R1, R2) |
| 14421 | Resistor--2700 ohms, insulated, 1 watt (R3) |
| 4284 | Spring--Fuse holder tension spring |
| 14420 | Transformer--Vibrator transformer (T1) |
| 14422 | Vibrator--Plug-in vibrator unit (L4) |
| 4285 | Washer--Fuse holder insulating washer |

SERVICE DIVISION
RCA Manufacturing Company, Inc.
Camden, N. J., U. S. A.



RCA Victor

MODELS U-101 and U-103

Five-Tube, Two-Band, A-C, Radio-Phonographs

TECHNICAL INFORMATION AND SERVICE DATA

-1937 No. 25-

SERVICE DIVISION • RCA MANUFACTURING COMPANY, INC. • CAMDEN, N. J., U. S. A.

A Service of the Radio Corporation of America

Electrical Specifications

FREQUENCY RANGES

"Broadcast" (A)..... 540-1,720 kc
"Short Wave" (C)..... 5,800-18,000 kc
Intermediate Frequency.....

R-F ALIGNMENT FREQUENCIES

"Broadcast" (A)..... 600 kc (osc.)
"Short Wave" (C)..... 15,000 kc (osc., ant.)
..... 460 kc

RADIOTRON COMPLEMENT

(1) RCA-6A7 First Detector—Oscillator
(2) RCA-6D6 Intermediate Amplifier
Pilot Lamp (1)

(3) RCA-75 Second Det., A-F Amp. and A.V.C.
(4) RCA-42 Audio Power Amplifier
(5) RCA-80 Full-Wave Rectifier
..... Mazda No. 46, 6.3 volts, 0.25 ampere

POWER SUPPLY RATINGS

| Model U-101 | Radio Only | Total |
|--|------------|----------|
| A-6.. 105-125 volts, 60 cycles..... | 75 watts.. | 80 watts |
| A-5.. 105-125 volts, 50 cycles..... | 75 watts.. | 80 watts |
| B-2.. 105-125 volts, 25 cycles..... | 80 watts.. | 85 watts |
| C-6.. 105-125/200-250 volts, 60 cycles.. | 75 watts.. | 80 watts |
| C-5.. 105-125/200-250 volts, 50 cycles.. | 75 watts.. | 80 watts |

| Model U-103 | Radio Only | Total |
|--|------------|-----------|
| A-6.. 105-125 volts, 60 cycles..... | 75 watts.. | 100 watts |
| A .. 105-125 volts, 50-60 cycles..... | 75 watts.. | 105 watts |
| B-2.. 105-125 volts, 25 cycles..... | 80 watts.. | 105 watts |
| C-6.. 105-125/200-250 volts, 60 cycles.. | 75 watts.. | 100 watts |
| C .. 105-125/200-250 volts, 50-60 cycles | 75 watts.. | 105 watts |

POWER OUTPUT RATING

Undistorted 2.5 watts
Maximum 4.5 watts

LOUDSPEAKER

Type Electrodynamic
V.C. Impedance..... 2.2 ohms at 400 cycles

PHONOGRAPH

| | Model U-101 | Model U-103 |
|----------------------|--------------|------------------|
| Type..... | Manual..... | Automatic-Manual |
| Turntable Speed..... | 78 r.p.m.... | 78 r.p.m. |

Type of Pickup..... High-impedance magnetic
Pickup Impedance..... 1,400 ohms at 1,000 cycles

Mechanical Specifications

| | Model U-101 | Model U-103 |
|------------------------------|---|---------------------------------------|
| Height | 13 ³ / ₁₆ inches | 34 inches |
| Width | 19 ⁷ / ₈ inches | 26 ³ / ₈ inches |
| Depth | 14 ³ / ₈ inches | 14 ⁷ / ₈ inches |
| Over-all Chassis Height..... | 6 ¹ / ₂ inches | 7 ¹ / ₂ inches |
| Weight (Net)..... | 38 pounds | 63 pounds |
| Weight (Shipping) | 45 pounds | 81 pounds |
| Chassis Base Dimensions..... | 11 ³ / ₈ inches x 5 ³ / ₄ inches x 2 ¹ / ₄ inches | |
| Operating Controls..... | (1) Power Switch-Volume, (2) Range Selector ("A" left, "C" right), (3) Tuning, (4) Radio-Phono. | |
| Tuning Drive Ratio..... | 12 to 1 | |

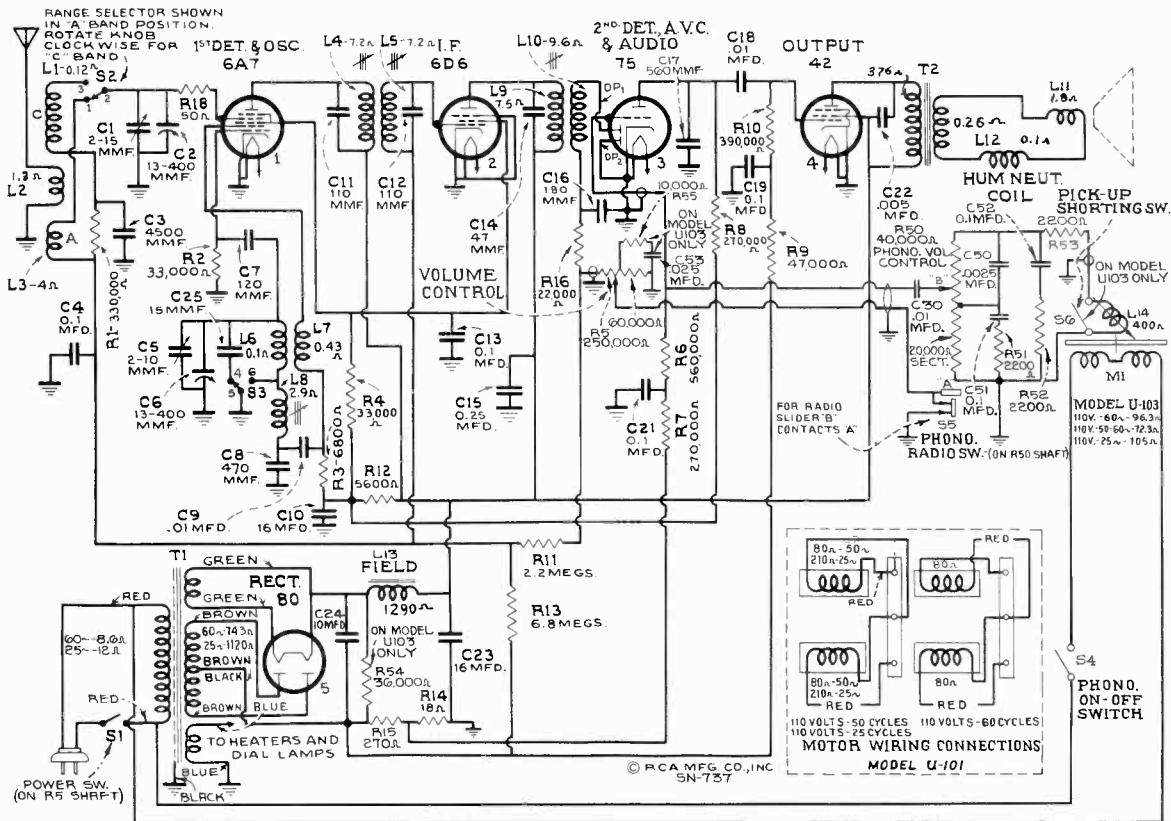

Figure 1—Schematic Circuit Diagram

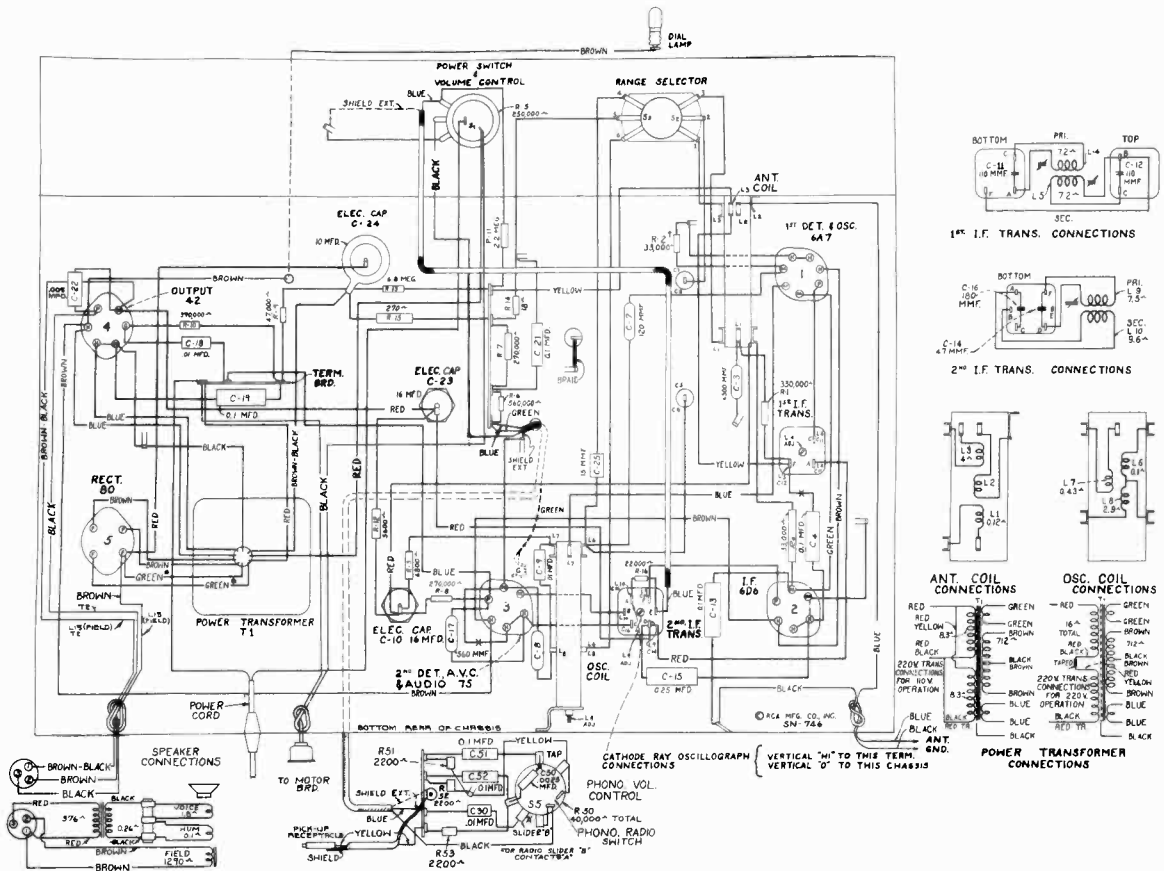

Figure 2—Chassis Wiring Diagram
(Model U-101)

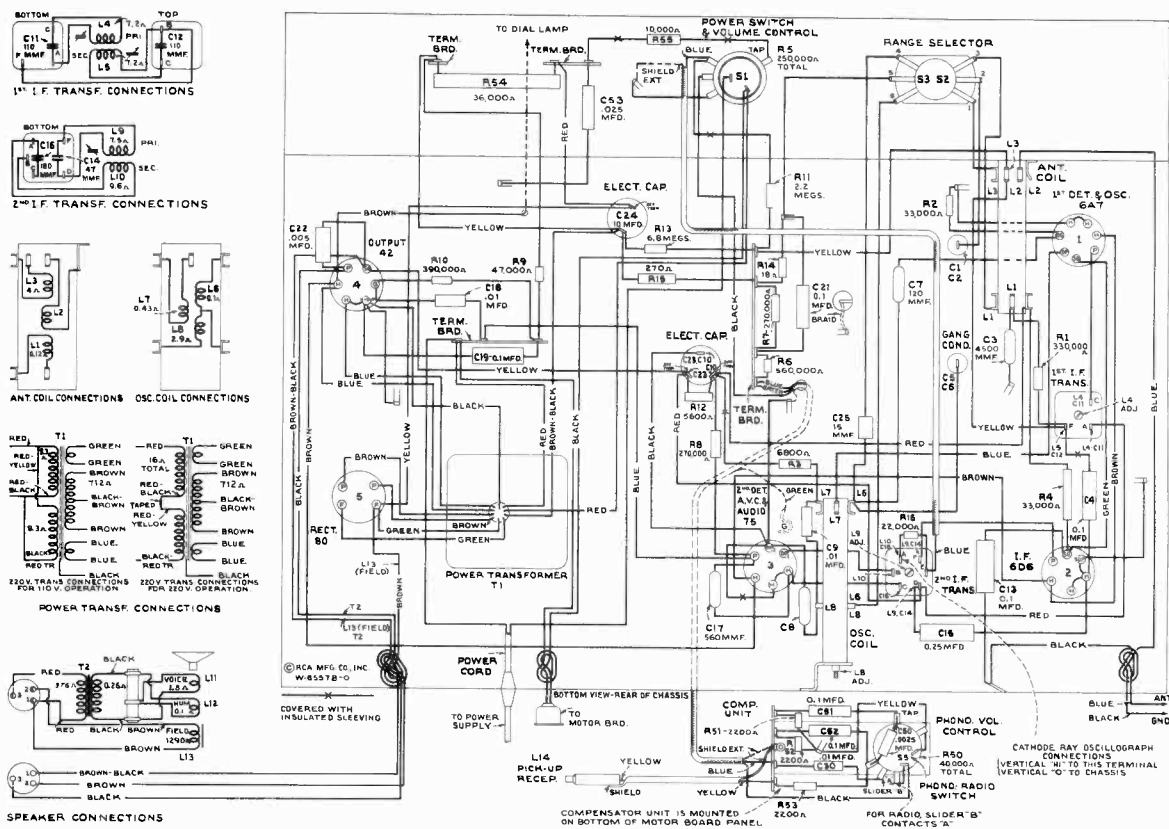

Figure 3—Chassis Wiring Diagram (Model U-103)

General Description

The Model U-103 combination instrument consists of a five-tube superheterodyne receiver and an automatically operated phonograph combined in console-type cabinet. Its design includes magnetic-core adjusted i-f transformers, automatic volume control, resistance-coupled audio system, phonograph compensation pack, self-starting constant-speed motor, improved magnetic pickup, and a twelve-inch dust-proof electrodynamic loudspeaker. The phonograph mechanism

will change seven 10-inch records or repeat 12-inch records automatically. It may be operated manually if desired.

The Model U-101 instrument consists of a similar radio receiver combined with a manually operated phonograph in a table-type cabinet. The loudspeaker is an eight-inch dust-proof electrodynamic unit. The motor is of the synchronous induction type. The circuit arrangement of both receivers is shown on figure 1.

Service Data

The various diagrams of this booklet contain such information as will be needed to isolate causes for defective operation if such develops. The ratings of the resistors, capacitors, coils, etc., are indicated adjacent to the symbols signifying these parts on the diagrams. Identification titles such as R1, L1, C1, etc., provide reference between the illustrations and Replacement Parts List. The coils, transformer windings, and reactors are rated in terms of d-c resistance to permit continuity checks.

Precautionary Lead Dress—(1) Dress power line leads to the on-off switch away from grid connection terminal on volume control to reduce hum pickup. (2) Keep leads of capacitor C3 as short as possible. (3) Bus leads from range selector (ter. 6) to oscillator coil tap L6L8 should be maintained 3½ inches long for proper alignment. (4) Capacitor C25 should be dressed free of adjacent parts to maintain correct alignment at high-frequency end of "A" band. (5) Bus lead from range selector (ter. 3) to antenna coil L1 should be maintained 2¼ inches long for proper alignment. (6) The RCA-6A7 grid-cap lead (50-ohm resistor R18) to top of tuning capacitor C2 should be dressed properly to prevent shorts and should be maintained flexible to prevent acoustic howl.

Loudspeaker.—Centering of the loudspeaker is made in the usual manner with three narrow paper feelers after first removing the front dust cover. This may be removed by softening its cement with a light application of acetone, using

care not to allow the acetone to flow into the air gap. The dust cover should be cemented back in place with ambroid upon completion of adjustment.

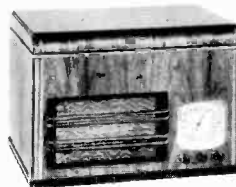

Model U-101

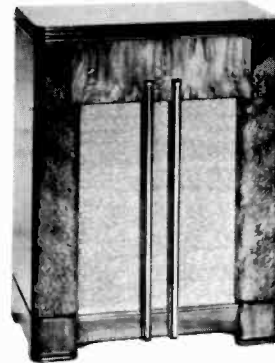

Model U-103

Phonograph Mechanism (Model U-101)

This phonograph motor is of the synchronous type. Under normal operating conditions, service difficulties should be

ADJUST THE REST POSITION OF THE MAIN LEVER BY MEANS OF THE NUT D ON THE BUMPER BRACKET. THE DETENT LEVER MUST CLEAR THE REVOLVING CRAM 1/16" IN THE REAREST POSITION. ALSO NOTE THAT THE PIN "F" AT LEAST 1/16" WHEN THE ABOVE CONDITIONS EXIST.

TO ADJUST THE LANDING POSITION OF THE NEEDLE FROM THE CENTER OF THE TURNABLE SPINDLE, THE TRIP LEVER WITH THE STOP PIN "M" AND THE LOCATING LEVER MUST BE CONTACTING THE LOCATING LEVER. TIGHTEN THE BLUNT SCREW "H" ON TONE ARM SUPPORT AND RUN DEVICE THROUGH CYCLE AS A CHECK. WHEN CORRECT ADJUSTMENT IS OBTAINED, THE CONE POINTED SCREW "H" (STK*14195) ON TONE ARM SUPPORT.

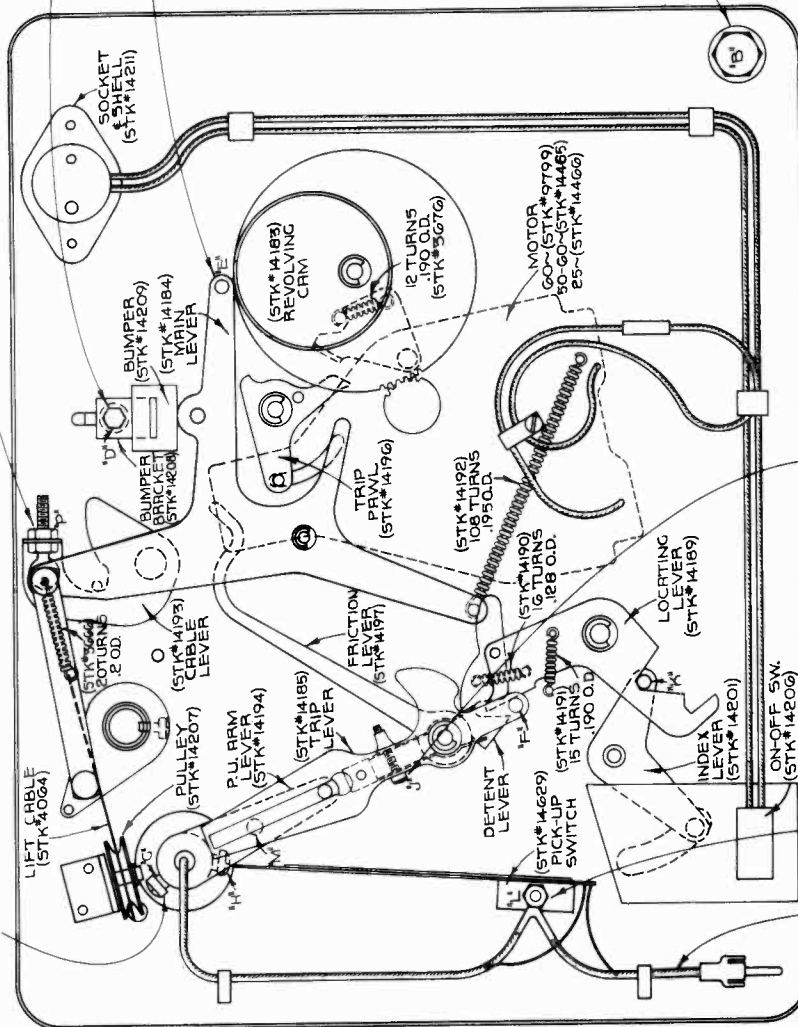

ADJUST THE LOWEST REST POSITION OF THE NEEDLE POINT "A" IN A PLANE 1/16" BELOW THE PLANE OF THE TOP OF THE TURNABLE BY MEANS OF SCREW "H".

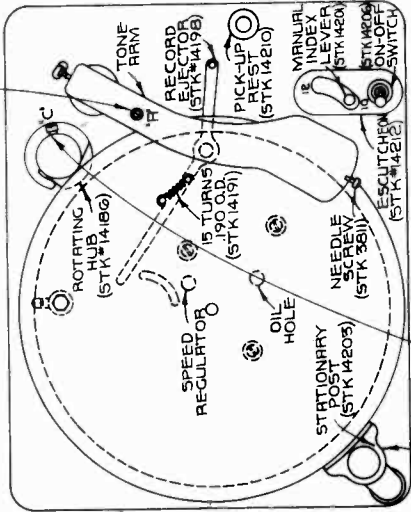

TO ADJUST RECORD POSTS SO THAT IT RESTS ON THE LOWER SHELF OF THE ROT. HUB, MOVE STATIONARY RECORD POST TO A POSITION WHERE IT IS CONCENTRICALLY MOUNTED WITH RECORD BOARD AND THE BEVELED SHELF FRONTED BY MOTOR BOARD WITH RECORD TIGHTEN HEARON SCREW OF ROTATING HUB. ADJUST SCREW "C" (STK*14188) STILL ON LOWER BEVELED TONGUE ON THE SEPARATING CRAM. CLEAR THE RECORD BY 1/8" IN THESE ADJUSTMENTS SHOULD BE MADE ONLY WHEN THE COMPLETE UNIT IS RESTING ON THE FOUR MOTOR BOARD BUSHINGS.

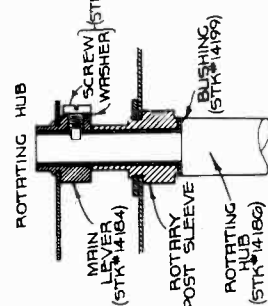
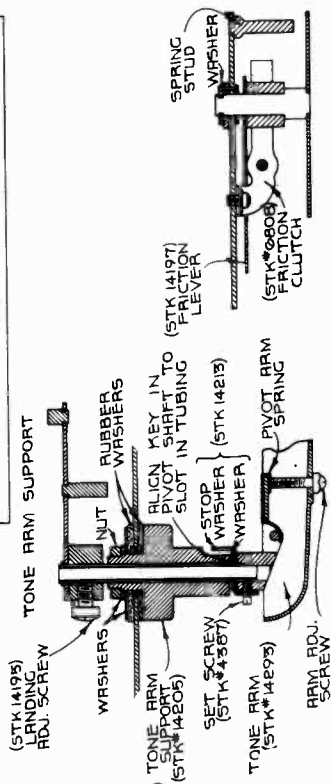
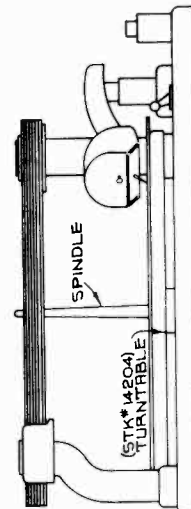

ADJUST TRIP LEVER SCREW "J" (STK*4059) UNTIL FRICTION WILL JUST FORCE FRICTION LEVER TO MOVE TRIP PAWL.

TO ADJUST PICK-UP SHORTING SWITCH SET PICK-UP NEEDLE 2" FROM CENTER OF SPINDLE. ADJUST NUT "L" SO THAT THE BLADE ON SWITCH IS JUST CONTACTING PIN "M".

Figure 4—Automatic Record Changer Adjustments (Model U-103)

© RCA MFG. CO. INC. T-70887-0

negligible. Occasionally, however, certain adjustments may be required. These adjustments are illustrated and explained in figure 7. Refer to figure 1 for motor coil connections.

Automatic Record Mechanism (Model U-103)

The record changing mechanism is designed to be simple and fool-proof. Certain adjustments may be required occasionally. The adjustments are illustrated and explained in figures 4 and 5.

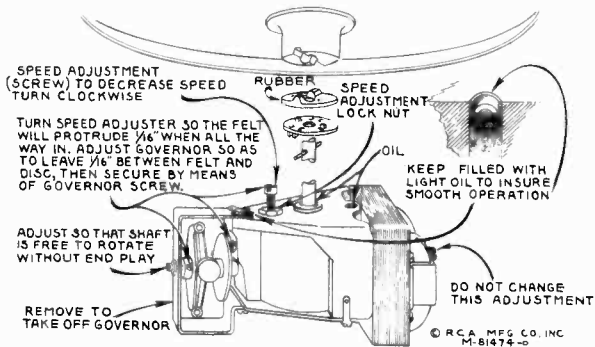

Figure 5—Details of Motor
(Model U-103)

It is important when servicing the automatic mechanism, to have it placed on a level support. It is also important to refrain from forcing the mechanism if there is a tendency to bind or jam, since bent levers and possible broken parts may result.

CAUTION.—Do not leave records stacked on the record holder posts, when not in use, as they are liable to warp, particularly so in warm climates.

MAGNETIC PICKUP

The pickup used in the phonograph unit is of an improved design. The horseshoe magnet is rigidly welded to the pole pieces and is irremovable. There is a centering spring attached to the armature to maintain proper adjustment and to provide a limiting effect on the movement of the armature. The frequency response is substantially uniform over a wide range. Service operations which may be necessary on the pickup are as follows:

Centering Armature.—Refer to figure 6 showing the pickup inner structure. The armature is shown in its proper relation to the magnet pole pieces, i. e., exactly centered. Whenever this centering adjustment has been disturbed it will be necessary to remove the pickup mechanism from the tone arm by removing the needle holding screw and the two mounting screws from the front of the tone arm, holding the pickup assembly to keep it from dropping. Unsolder the two leads from the lugs on the terminal board at the rear of the pickup. Insert a small rod or nail into the armature needle hole and replace the needle holding screw, tightening it to hold the rod securely. If the armature clamping screws A and B have not been disturbed, screws C should be loosened which will permit the armature to be moved from side to side, the rod acting as a lever to perform this operation. The proper adjustment is obtained when the armature is moved to the extreme position on each side (the movement being

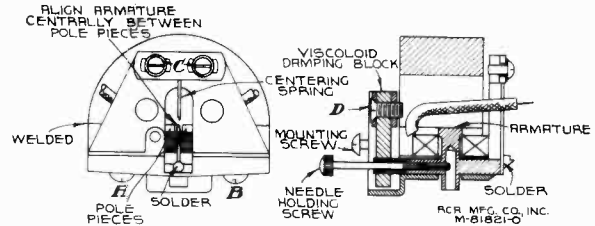

Figure 6—Details of Pickup

limited by the armature striking the pole pieces) and then brought to the mid position between these two extremes. Screws C should then be tightened. The armature position should then be central between the pole pieces and at right angles to them. With a little practice, the correct adjustment of the armature will be obtained. The air gap between the pole pieces and the armature should be kept free from dust, filings, and other foreign material which would obstruct the movement of the pickup armature.

Damping Block.—The viscoloid damping block which is attached to the front end of the armature shank serves as a mechanical filter to eliminate undesirable resonances and to cause the frequency response to be uniform. Should it be necessary to replace this damping block, the pickup mechanism should be removed from the tone arm as explained above. Remove screw D and the damping block from the pickup assembly. Make sure that the shaft of the armature which contacts the viscoloid is clean. Then insert the new damping block so that it occupies the same position as that of the original

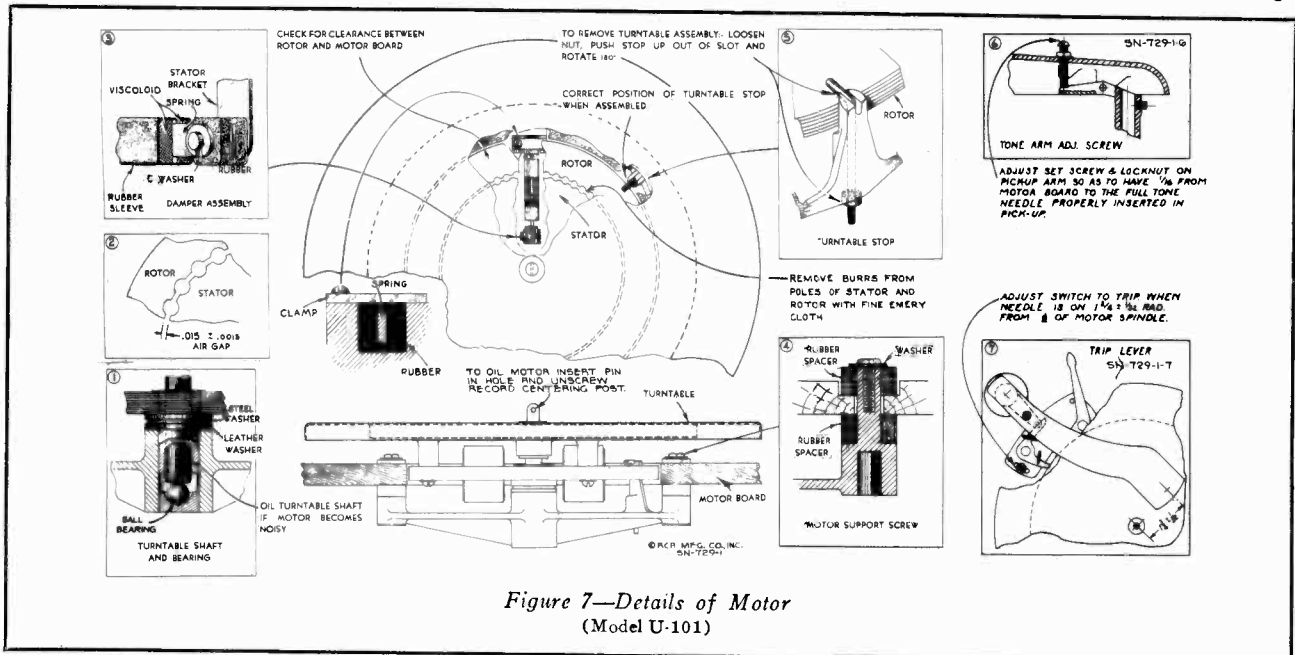

Figure 7—Details of Motor
(Model U-101)

nal block, and is in correct vertical alignment with the armature. The hole in the block is somewhat smaller than the diameter of the armature in order to permit a snug fit. With the damping block properly aligned on the armature, screw D with its washer should then be replaced. Heat should be applied to the armature (viscoloid side) so that the damping block will fuse at the point of contact and become rigidly attached to the armature. A special-tip soldering iron, constructed as shown in figure 8 will be found very useful in performing this operation. The iron should be applied only long enough to slightly melt the block, causing a small bulge on both sides.

Replacing Coil.—Whenever there is defective operation due to an open or shorted pickup coil, this coil should be replaced. Remove the pickup mechanism and terminal board as described above. Remove screws A and B and the magnet assembly. Remove the bakelite coil support (with coil at-

tached) and insert the new coil support assembly in its place, after which replace the magnet assembly and center the armature as described above, then re-assemble the remainder of the unit.

Magnetizing.—In case it becomes necessary to re-magnetize the unit, first remove the pickup mechanism from the tone arm, and then remove the magnet assembly. Place the mag-

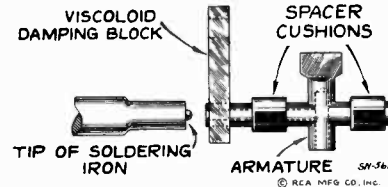

Figure 8—Special Soldering-Iron Tip

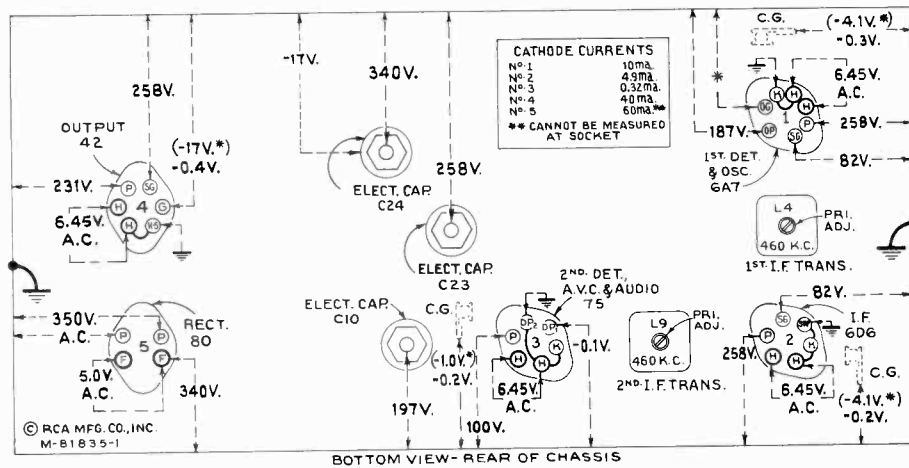

Figure 9—Radiotron Socket Voltages, Coil, and Trimmer Locations (Model U-101)

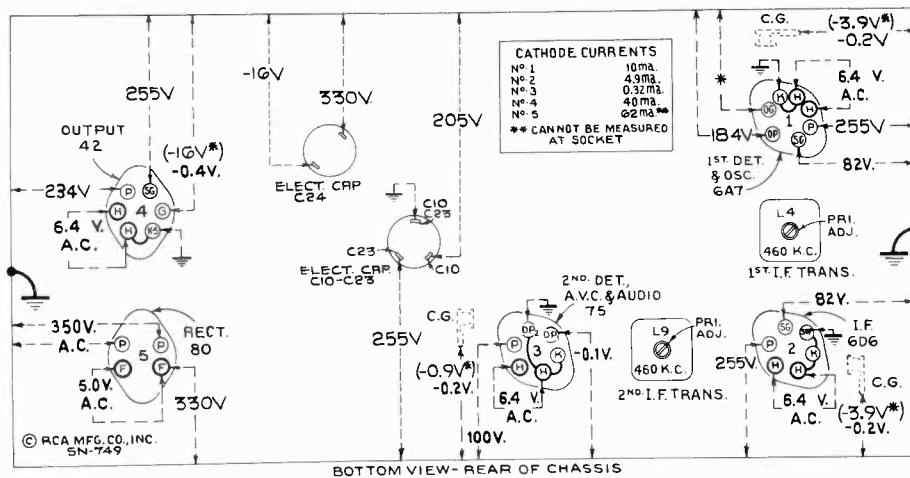

Figure 10—Radiotron Socket Voltages, Coil, and Trimmer Locations (Model U-103)

Measured at 115 volts, 60-cycle supply—Tuned to approximately 1,000 kc ("Broadcast")—No signal being received—Volume control minimum

Note: Two voltage values are shown for some readings. The value shown in parentheses with asterisk () indicates operating conditions without voltmeter loading. The other value (generally lower) is the actual measured voltage and differs from the value shown in parentheses because of the additional loading of the voltmeter through the high series circuit resistance.*

Voltage values as specified should hold within $\pm 20\%$ when the receiver is normally operative at its rated line voltage. To duplicate the conditions under which the voltages were measured requires a 1,000-ohm-per-volt d-c meter, having ranges of 10, 50, 250, and 500 volts. Use the nearest range above the specified voltage. A-c voltages were measured with a corresponding a-c meter.

net assembly on the poles of a standard pickup magnetizer such as the RCA Stock No. 9549 Pickup Magnetizer and charge the magnet in accordance with the instructions accom-

panying the magnetizer. It is preferable to check the polarity of the pickup magnet and to remagnetize it so that the same polarity is maintained.

Alignment Procedure

Calibrate the tuning dial by adjusting dial pointer to the center horizontal line with the gang tuning-condenser plates in full-mesh position. This is a screw-driver adjustment.

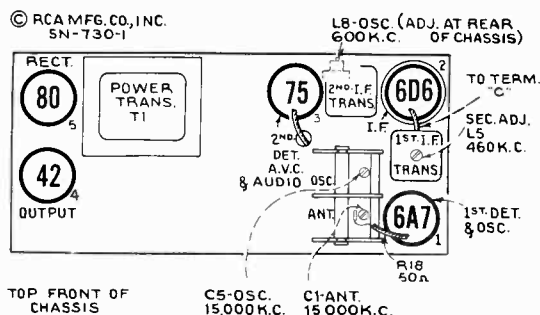

Figure 11—Radiotron, Coil, and Trimmer Locations

Perform alignment in proper order, tabulated below, starting with No. 1 and following all operations across, then No. 2, etc. Adjustment locations are shown on figures 9, 10, and 11.

Cathode-ray alignment is preferable; the connections to the chassis are shown on figures 2 and 3. If an output indicator is used, connect it across the loudspeaker voice-coil and advance the receiver volume control to full-volume position.

Connect the "low" output terminal of the test oscillator to the receiver chassis for all alignment operations. Regulate the output of the test oscillator so that minimum signal is applied to the receiver to obtain an observable output indication. This will avoid a-v-c action.

The term "Dummy antenna" means the device which must be connected between the "high" test-oscillator output and the point of connection to the receiver in order to obtain ideal alignment. "No signal, 550-750 kc" means that the receiver should be tuned to a point between 550 and 750 kc where no signal or interference is received from a station or local (heterodyne) oscillator.

For further details on alignment, refer to booklet "RCA Victor Receiver Alignment."

| Order of Alignment | Test Oscillator | | | Range-Selector | Receiver Dial Setting | Circuit to Adjust | Adjustment Symbols | Adjust to Obtain |
|--------------------|------------------------|---------------|-------------------|----------------|------------------------|-------------------|--------------------|------------------|
| | Connection to Receiver | Dummy Antenna | Frequency Setting | | | | | |
| 1 | 6D6 I-F Grid Cap | .001 Mfd. | 460 kc | "A" Left | No Signal 550-750 kc | 2nd I-F Trans. | L9 | Max. (peak) |
| 2 | 6A7 Det. Grid Cap | .001 Mfd. | 460 kc | "A" Left | No Signal 550-750 kc | 1st I-F Trans. | L4 and L5 | Max. (peak) |
| 3 | Ant. Lead (blue) | 300 Ohms | 15,000 kc | "C" Right | 15,000 kc | "C" Osc. | C5 | Max. (peak)† |
| 4 | Ant. Lead (blue) | 300 Ohms | 15,000 kc | "C" Right | Rock Through 15,000 kc | "C" Ant. | C1 | Max. (peak)*‡ |
| 5 | Ant. Lead (blue) | 200 Mmfd. | 600 kc | "A" Left | 600 kc | "A" Osc. | L8 | Max. (peak) |

† Use maximum capacity peak if two peaks can be obtained.

* Use minimum capacity peak if two peaks can be obtained.

‡ After this adjustment, check for image signal by shifting receiver dial to 15,920 kc.

REPLACEMENT PARTS

Insist on genuine factory tested parts which are readily identified and may be purchased from authorized dealers.

| STOCK No. | DESCRIPTION | STOCK No. | DESCRIPTION |
|----------------------------|--|-----------|---|
| RECEIVER ASSEMBLIES | | | |
| 14634 | Belt—Variable condenser drive belt | 14377 | Capacitor—16 Mfd. (C10)—Model U101 only |
| 14632 | Bracket—Dial mounting bracket | 14813 | Capacitor Pack—Comprising two 16 Mfd. sections (C10, C23)—Model U103 only |
| 5237 | Bushing—Variable condenser rubber mounting bushing | 14648 | Coil—Antenna coil (L1, L2, L3) |
| 14802 | Cable—2-conductor shielded compensation cable complete with grid contact cap | 14647 | Coil—Oscillator coil (L6, L7, L8) |
| 12118 | Cap—Grid contact cap | 14633 | Condenser—2-gang variable tuning condenser (C1, C2, C5, C6) |
| 12896 | Capacitor—15 Mmfd. (C25) | 14783 | Connector—2-contact female for motor power cable |
| 12405 | Capacitor—47 Mmfd. (C14) | 5119 | Connector—3-contact female for speaker cable |
| 14262 | Capacitor—110 Mmfd. (C11, C12) | 14648 | Core—Adjustable core and stud for oscillator coil |
| 12724 | Capacitor—120 Mmfd. (C7) | 12006 | Core—Adjustable core and stud for I.F. transformer |
| 12406 | Capacitor—180 Mmfd. (C16) | 14631 | Dial—Station selector dial |
| 30396 | Capacitor—470 Mmfd. (C8) | 14651 | Drive—Variable condenser vernier drive and pinion gear |
| 14724 | Capacitor—560 Mmfd. (C17) | 14635 | Indicator—Station selector indicator pointer |
| 12728 | Capacitor—4,500 Mmfd. (C3) | 5228 | Lamp—Dial lamp |
| 4868 | Capacitor—.005 Mfd. (C22) | 14638 | Pulley—Idler pulley—less spring |
| 13138 | Capacitor—.01 Mfd. (C9, C18) | 14639 | Pulley—Variable condenser drive pulley—located on condenser shaft |
| 4870 | Capacitor—.025 Mfd. (C53) | 14660 | Resistor—18 ohms, insulated, ½ watt (R14) |
| 4839 | Capacitor—.01 Mfd. (C4, C13, C19, C21) | 14653 | Resistor—50 ohms, flexible type, 1/10 watt (R18) |
| 12484 | Capacitor—.025 Mfd. (C15) | 13819 | Resistor—270 ohms, wire wound, 1.1 watt (R15) |
| 14814 | Capacitor—10 Mfd. (C24) | 5175 | Resistor—5,600 ohms, carbon type, ½ watt (R12) |
| 5212 | Capacitor—16 Mfd. (C23)—Model U101 only | | |

REPLACEMENT PARTS (Continued)

| STOCK No. | DESCRIPTION | STOCK No. | DESCRIPTION |
|-----------|--|-----------|--|
| 14659 | Resistor—6,800 ohms, carbon type, 1/2 watt (R3) | 14232 | Cap—Turntable spindle cap |
| 14559 | Resistor—10,000 ohms, insulated, 1/2 watt (R55)—Model U103 only | 14223 | Coil—Stator assembly—comprising coils and laminations—105-125 volts, 60 cycle |
| 11305 | Resistor—22,000 ohms, carbon type, 1/2 watt (R16) | 14224 | Coil—Stator assembly—comprising coils and laminations—105-125 volts, 50 cycle |
| 13735 | Resistor—33,000 ohms, carbon type, 1/2 watt (R2) | 14225 | Coil—Stator assembly—comprising coils and laminations—105-125 volts, 25 cycle |
| 5033 | Resistor—33,000 ohms, carbon type, 1 watt (R4) | 14228 | Damper—Motor damper assembly comprising one damper, one damper plate, one screw and one "C" washer |
| 5206 | Resistor—36,000 ohms, wire wound, 20 watt (R54)—Model U103 only | 14806 | Motor—105-125 volts, 60 cycle (M1) |
| 11646 | Resistor—47,000 ohms, carbon type, 1/2 watt (R9) | 14807 | Motor—105-125 volts, 50 cycle (M1) |
| 11323 | Resistor—270,000 ohms, carbon type, 1/2 watt (R7, R8) | 14808 | Motor—105-125 volts, 25 cycle (M1) |
| 13733 | Resistor—330,000 ohms, carbon type, 1/2 watt (R1) | 14227 | Shield—Terminal board shield and nuts |
| 13479 | Resistor—390,000 ohms, carbon type, 1/2 watt (R10) | 14229 | Stop—Turntable stop, lockwasher and nut—prevents removal of turntable |
| 5035 | Resistor—560,000 ohms, carbon type, 1/2 watt (R6) | 14809 | Turntable—Turntable assembly complete with rotor laminations—60 cycle operation |
| 12679 | Resistor—2.2 meg., insulated, 1/2 watt (R11) | 14810 | Turntable—Turntable assembly complete with rotor laminations—50 cycle operation |
| 14661 | Resistor—6.8 meg., insulated, 1/2 watt (R13) | 14811 | Turntable—Turntable assembly complete with rotor laminations—25 cycle operation |
| 5129 | Ring—Radiotron shield ring | 14812 | Turntable—10-in. turntable plate only |
| 4389 | Screw—No. 6-32x3/16 headless set screw for pulley No. 14639 | 4083 | Washer—Leather washer for turntable bearing |
| 14638 | Shaft—Station selector knob shaft and pulley | 14230 | Washer—Metal washer for turntable bearing |
| 12008 | Shield—First I.F. transformer shield | 14231 | Washer—Metal shim washer for turntable bearing |
| 12408 | Shield—Second I.F. transformer shield | | MOTOR ASSEMBLIES |
| 14658 | Shield—Radiotron shield | | MODEL U-103 |
| 4794 | Socket—Dial lamp socket | 14215 | Governor—Governor complete for motor Stock No. 9799, No. 14465 and No. 14466 |
| 4794 | Socket—4-contact 80 Radiotron socket | 14466 | Motor—105-125 volts, 25 cycle (M1) |
| 4786 | Socket—6-contact 6D6 or 42 or 75 Radiotron socket | 14465 | Motor—105-125 volts, 50-60 cycle (M1) |
| 4787 | Socket—7-contact 6A7 Radiotron socket | 9799 | Motor—105-125 volts, 60 cycle (M1) |
| 14637 | Spring—Idler pulley tension spring | 14214 | Screw—Motor mounting screw and spacer assembly |
| 12007 | Spring—Retaining spring for core stock No. 12006 and No. 14648 | | PICKUP AND ARM ASSEMBLIES |
| 14640 | Switch—Range switch (S2, S3) | | MODEL U-101 |
| 14378 | Transformer—First I.F. transformer (L4, L5, C11, C12) | 14291 | Armature—Pickup armature |
| 14642 | Transformer—Second I.F. transformer (L9, L10, C14, C16) | 11732 | Coil—Pickup coil (L14) |
| 14655 | Transformer—Power transformer, 105-125 volts, 50-60 cycle (T1) | 14292 | Damper—Pickup damper assembly—comprising one damper, one clamp and one screw |
| 14656 | Transformer—Power transformer, 105-125 volts, 25-60 cycle (T1) | 14933 | Pickup and Arm complete |
| 14657 | Transformer—Power transformer, 100-125/200-250 volts, 50-60 cycle (T1) | 3811 | Screw—Needle holding screw |
| 14828 | Volume Control—and power switch (R5, S1) | | PICKUP AND ARM ASSEMBLIES |
| | OPERATING MECHANISM ASSEMBLIES | | MODEL U-103 |
| 14199 | Bushing—Record separator rotating shaft bushing | 14291 | Armature—Pickup armature assembly |
| 14183 | Cam—Cam and gear assembly | 4084 | Cable—Pickup lift cable |
| 6808 | Clutch—Trip lever friction clutch | 11732 | Coil—Pickup coil (L14) |
| 14197 | Finger—Friction finger assembly | 14292 | Damper—Pickup damper block complete with clamp and screw |
| 14186 | Hub—Rotating hub and record separator complete with set screw | 14290 | Pickup and Arm complete |
| 14189 | Lever—Locating lever assembly | 3811 | Screw—Needle holding screw |
| 14184 | Lever—Main lever and link assembly | 4387 | Screw—No. 6-32x4-in. headless set screw for pickup arm pivot shaft |
| 14201 | Lever—Manual index lever assembly | | REPRODUCER ASSEMBLIES (RL63F-1) |
| 14193 | Lever—Pickup lift cable lever | | MODEL U-101 |
| 14194 | Lever—Pickup arm lever complete with set screws | 14358 | Board—3-contact reproducer terminal board |
| 14198 | Lever—Reject lever assembly | 13866 | Cap—Cone center dust cap |
| 14185 | Lever—Trip lever and friction clutch assembly | 12012 | Coil—Field coil (L13) |
| 14196 | Pawl—Trip pawl assembly | 11469 | Coil—Hum neutralizing coil (L12) |
| 4563 | Screw—Cable lever screw and two locknuts | 12642 | Cone—Reproducer cone and dust cap (L11) |
| 4059 | Screw—Trip lever clutch tension adjustment screw | 5118 | Plug—3-contact male plug for reproducer |
| 14200 | Screw—No. 8-32 special hex head screw and lockwasher for record separator shaft mounting | 14360 | Reproducer—Complete |
| 14195 | Screw—No. 10-32x5/16 fillister-head, cone-pointed set screw for pickup arm lever | 14358 | Screw—Screw, washer and lockwasher to hold core in yoke |
| 14188 | Screw—No. 10-32x7/16 fillister-head, cone-pointed set screw for rotating hub | 14355 | Transformer—Output transformer (T2) |
| 14187 | Shaft—Rotating shaft for record separator | 14357 | Washer—Spring washer to hold field coil |
| 3676 | Spring—Cam pawl tension spring | | REPRODUCER ASSEMBLIES (RL70E-1) |
| 3666 | Spring—Lift cable tension spring | | MODEL U-103 |
| 14190 | Spring—Locating lever pawl tension spring | 13866 | Cap—Dust cap for cone center |
| 14191 | Spring—Locating lever or reject lever tension spring | 14354 | Coil—Field coil (L13) |
| 14192 | Spring—Main lever tension spring | 11469 | Coil—Hum neutralizing coil (L12) |
| | MOTORBOARD ASSEMBLIES | 12667 | Cone—Reproducer cone and dust cap (L11) |
| | MODEL U-101 | 5118 | Plug—3-contact male plug for reproducer |
| 14803 | Brake—Turntable brake and motor switch | 14395 | Reproducer—Complete |
| 14805 | Connector—2-contact male connector for motor and switch leads | 14358 | Screw—Screw, washer and lockwasher to hold core in yoke |
| 3261 | Rest—Pickup rest | 14355 | Transformer—Output transformer (T2) |
| 14235 | Screw—Motor mounting screw and washer | 14357 | Washer—Spring washer to hold field coil |
| 30100 | Springs—Tension springs for brake Stock No. 14803—comprising 1 long and 1 short spring | | MISCELLANEOUS ASSEMBLIES |
| 14804 | Switch—Motor switch (S4)—located on turntable brake Stock No. 14803 | 11762 | Box—Needle box—for Model U-101 only |
| | MOTORBOARD ASSEMBLIES | 4391 | Box—Needle box—for Model U-103 only |
| | MODEL U-103 | 14817 | Cable—Shielded pickup cable complete with female connector—compensator end |
| 14208 | Bracket—Bumper bracket and bumper complete | 5107 | Capacitor—.0025 Mfd. (C50) |
| 14209 | Bumper—Rubber bumper | 13138 | Capacitor—.01 Mfd. (C30) |
| 14830 | Cable—Shielded cable 13-in. long complete with single contact male connector—connects pickup shorting switch to input transformer or compensator | 4841 | Capacitor—0.1 Mfd. (C51, C52) |
| 11704 | Damper—Turntable damper and damper plate | 14654 | Escutcheon—Station selector escutcheon and crystal |
| 14212 | Escutcheon—Manual index lever and switch escutcheon | 12673 | Knob—Station selector, range switch, radio volume control or phonograph volume control knob |
| 14203 | Post—Record post—located on front left hand corner of motorboard | 13716 | Resistor—2,200 ohms, insulated, 1/2 watt (R51, R52, R53) |
| 14210 | Rest—Pickup arm rest | 14267 | Screw—Chassis mounting screw and washer—for Model U101 only |
| 14207 | Roller—Pickup lift cable roller and bracket | 13573 | Screw—Chassis mounting screw and washer—for Model U103 only |
| 14211 | Socket—Motorboard socket and shell | 14816 | Screw—Motorboard mounting screw and spacer—for Model U103 only |
| 14205 | Support—Pickup arm mounting spacer, washers and nut | 4119 | Screw—No. 8-32 headless set screw for knob Stock No. 12673 |
| 14206 | Switch—Motor toggle switch (S4) | 14815 | Volume Control—Phonograph volume control and radio-record switch (R50, S5) |
| 14629 | Switch—Pickup shorting switch (S6) | | |
| 14204 | Turntable Complete | | |
| 14213 | Washer—Pickup arm stop washer and spacing washer | | |
| | MOTOR ASSEMBLIES | | |
| | MODEL U-101 | | |
| 10194 | Ball—Steel ball bearing | | |
| 14233 | Base—Motor base and bearing assembly | | |



RCA Victor

MODELS U-105 and U-107

Ten-Tube, Three-Band, A-C, Radio-Phonographs

TECHNICAL INFORMATION AND SERVICE DATA

-1937 No. 30-

SERVICE DIVISION • RCA MANUFACTURING COMPANY, INC. • CAMDEN, N. J., U. S. A.

A Service of the Radio Corporation of America

Electrical Specifications

FREQUENCY RANGES

"Broadcast" (A)..... 530-1,720 kc
 "Medium Wave" (B)..... 2,100-6,800 kc
 "Short Wave" (C)..... 6,800-22,000 kc

Intermediate Frequency..... 460 kc

RADIOTRON COMPLEMENT

(1) RCA-6K7..... R-F Amplifier
 (2) RCA-6J7..... Heterodyne Oscillator
 (3) RCA-6L7..... First Detector
 (4) RCA-6K7..... Intermediate Amplifier
 (5) RCA-6H6..... Second Detector and A.V.C.

R-F ALIGNMENT FREQUENCIES

"Short Wave" (C)..... 20,000 kc (osc., det., ant.)
 "Medium Wave" (B)..... 6,000 kc (osc.)
 "Broadcast" (A)..... 600 kc (osc.), 1,500 kc (osc.)

..... 460 kc

Pilot Lamps

(4) Radio..... Mazda No. 46, 6.3 volts, 0.25 amp.
 (1) Front Cabinet (U-105 only)..... Mazda No. 40, 6.3 volts, 0.15 amp.
 (1) Phono Compartment (U-107 only)..... Mazda No. 40, 6.3 volts, 0.15 amp.

POWER SUPPLY RATINGS

Model U-105

| | | |
|--|------------|-----------|
| A-6...105-125 volts, 60 cycles..... | Radio only | Total |
| A...105-125 volts, 50-60 cycles..... | 135 watts | 165 watts |
| B-2...105-125 volts, 25 cycles..... | 135 watts | 165 watts |
| C-6...105-130/140-160/200-250 volts, 60 cycles..... | 135 watts | 165 watts |
| C...105-130/140-160/200-250 volts, 50-60 cycles..... | 135 watts | 165 watts |

Model U-107

| | | |
|---|------------|-----------|
| A-6...105-125 volts, 60 cycles..... | Radio only | Total |
| A-5...105-125 volts, 50 cycles..... | 135 watts | 165 watts |
| B-2...105-125 volts, 25 cycles..... | 135 watts | 170 watts |
| C-6...105-130/140-160/200-250 volts, 60 cycles..... | 135 watts | 165 watts |
| C-5...105-130/140-160/200-250 volts, 50 cycles..... | 135 watts | 170 watts |

POWER OUTPUT

Undistorted..... 10 watts
 Maximum..... 12.5 watts

LOUDSPEAKER

Type..... Electrodynamic
 Impedance (v.c.)..... 11.5 ohms at 400 cycles

PHONOGRAPH

| | | |
|-----------------------|------------------------------|--------------------------------|
| Type..... | Model U-105 | Model U-107 |
| Record Capacity..... | Automatic-Manual | Automatic-Manual |
| Turntable Speed..... | Eight 10-inch | Eight 10-inch or Seven 12-inch |
| Type of Pickup..... | 78 R.P.M. | 78 R.P.M. |
| Pickup Impedance..... | Low-impedance magnetic | Crystal |
| | 96 ohms at 1,000 cycles..... | 80,000 ohms at 1,000 cycles |

Mechanical Specifications

| | | |
|------------------------------|---------------------------------------|---|
| | Model U-105 | Model U-107 |
| Height..... | 34 inches | 43 inches |
| Width..... | 36 ³ / ₄ inches | 31 ¹ / ₈ inches |
| Depth..... | 15 ⁷ / ₈ inches | 19 ⁵ / ₈ inches |
| Weight (net)..... | 96 pounds | 136 pounds |
| Weight (shipping)..... | 122 pounds | 199 pounds |
| Chassis Base Dimensions..... | | 14 ⁷ / ₈ inches x 9 ³ / ₄ inches x 3 ¹ / ₄ inches |
| Over-all Chassis Height..... | | 9 ³ / ₄ inches |

OPERATING CONTROLS

Radio Panel..... (1) Tone—Power (switch), (2) Tuning (large inner knob), (3) Range Selector (small outer knob, left to right "A," "B," "C"), (4) Phono.—Volume (radio).
 Phono. Compartment. { (U-105)..... (1) Turntable Switch, (2) Index Lever, (3) Record Ejector, (4) Phono. Volume
 { (U-107)..... (1) Turntable Switch, (2) Index Lever, (3) Phono. Volume
 Tuning Drive Ratio..... 20 to 1

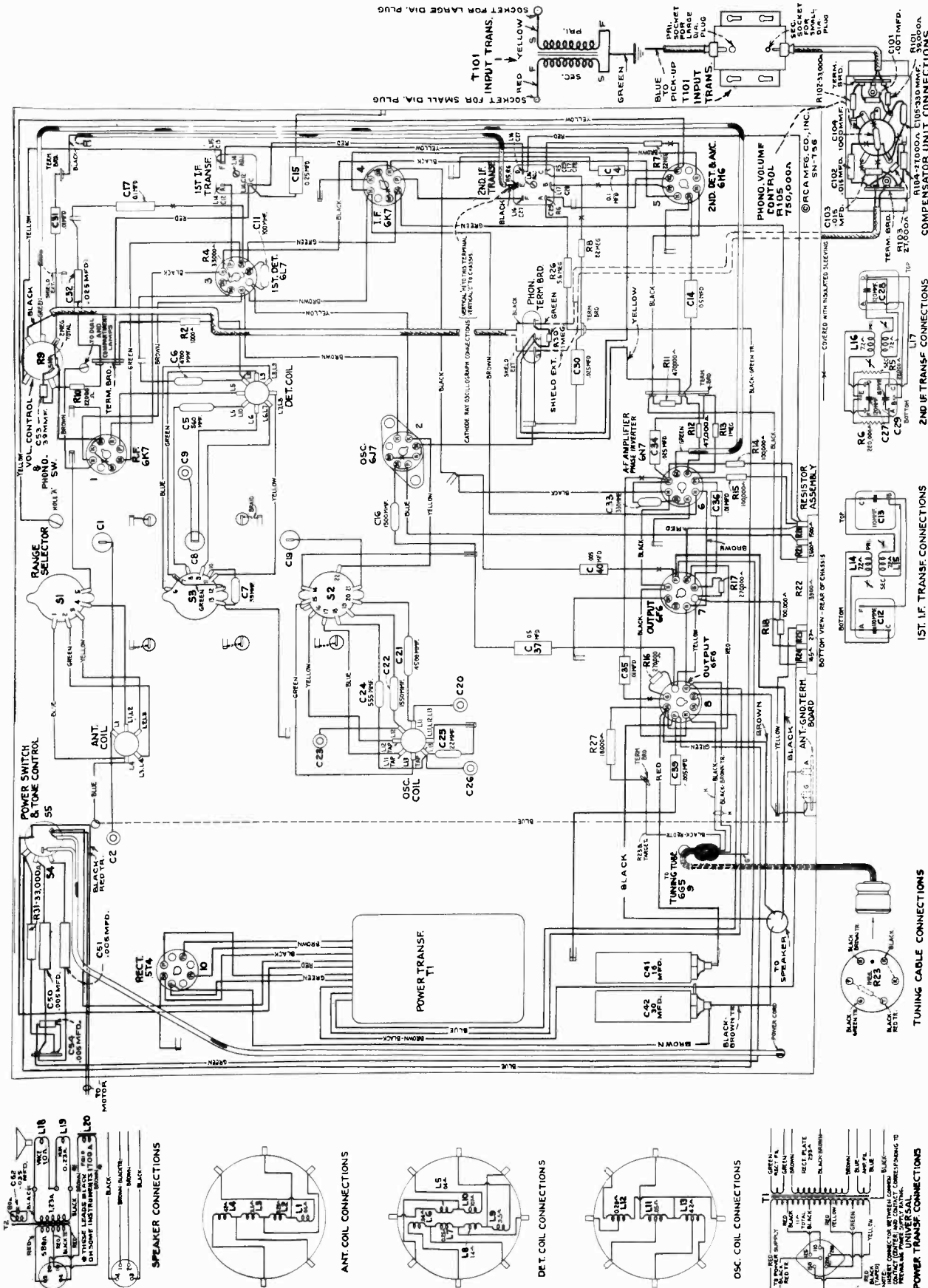

Figure 2—Chassis Wiring Diagram (Model U-106)

General Description

The Model U-107 combination instrument consists of a ten-tube, three-band, "Magic Brain," superheterodyne receiver and an automatically operated phonograph combined in a console-type cabinet. Features of design include an r-f amplifier stage, "cumulative-wound" antenna and r-f transformers for high signal-to-noise ratio in "A" Band; magnetite-core adjusted i-f transformers and low-frequency "A" oscillator tracking; automatic volume control; plunger-type, air-dielectric trimming capacitors; "Magic Eye" tuning tube; aural-compensated radio and phonograph audio-volume controls; three-point tone control; audio phase-inverter voltage

amplifier; push-pull power-output stage; crystal pickup; improved super-sensitive dust-proof electrodynamic loudspeaker; and the "Sonic-Arc" Magic Voice. The record changer may be operated automatically or manually on both 10-inch and 12-inch records.

The Model U-105 combination instrument consists of a similar radio receiver combined with a smaller automatically operated phonograph. This record changer will change seven 10-inch records or repeat 12-inch records automatically. It may be operated manually if desired.

Service Data

The various diagrams of this booklet contain such information as will be needed to isolate causes for defective operation if such develops. The ratings of the resistors, capacitors, coils, etc., are indicated adjacent to the symbols signifying these parts on the diagrams. Identification titles such as R1,



Model U-105

L1, C1, etc., provide reference between the illustrations and Replacement Parts List. The coils, transformer windings, and reactors are rated in terms of d-c resistance to permit continuity checks.

Loudspeaker.—Two types of loudspeakers are used which will be referred to as types 1 and 2. In type 1 the cone centering diaphragm is cemented to a fixed ring, while in type 2 the centering diaphragm is cemented to an adjustable ring. Replacement of cone for either type is identical. Centering of cone for "type 1" loudspeaker is made with three narrow celluloid or paper feelers after first removing the front dust cover and cutting free the cone centering diaphragm. The dust cover may be removed by a light application of acetone, using care not to allow the acetone to flow into the air gap. The centering diaphragm should be cemented in place after placement of feelers. Sufficient time should be allowed for the ambroid to set before removing feelers. Use ambroid to replace dust cover. Centering of cone for "type 2" loudspeaker differs only in that it is not necessary to cut free the centering diaphragm, adjustment being made in the usual manner by means of screws on the adjustable cone centering ring.

Precautionary Lead Dress.—(1) Keep leads to a-c switch dressed away from antenna coil and trimmer C2. (2) Keep all filament leads twisted. (3) Dress shield lead from term. E of 2nd i-f transformer to term. board against side of chassis and away from 6L7 socket. (4) Dress shielded lead from 6N7 socket to volume control against side of chassis and away from 6L7 socket. (5) Shielded lead from phono. term. board to volume control must be dressed under bus connected between 6L7 and term. A of first i-f transformer. (6) Keep leads of C21 as short as possible. (7) Yellow lead from 6J7 oscillator cathode to dummy terminal on 6L7 socket must be dressed away from chassis base and from brown filament lead. (8) All molded capacitors should be dressed so that flat side is perpendicular to chassis base. (9) Yellow lead

from cathode of 6J7 socket to term. 22 of S2 must be dressed under spaghetti on 6J7 socket jumper and pulled tight away from chassis. The following bus leads should be kept as short as possible and, when necessary, replaced only with wire having same diameter as original: (10) Lead from L11-L12-L13 to ground lance; (11) Lead from term. 13 of S3 to ground lance; (12) Lead from term. 9 of S3 to L6-L7; (13) Lead from L6 to C8; (14) Lead from C9 to C8; (15) Lead from term. 5 of S1 to ground lance; (16) Lead from L1-L2 to term. 4 of S1; (17) Lead from L1 to C1; (18) Lead from term. 21 of S2 to C19. (19) Keep filament leads dressed away from grid prongs of 6N7. (20) Keep blue and green leads from plate prongs of output tubes twisted their entire length.

Pickup (Model U-107)

An adjustment is provided to compensate for possible reduced sensitivity of the crystal pickup with age. Adjustment requires the use of a 1,000-ohm-per-volt a-c voltmeter (rec-

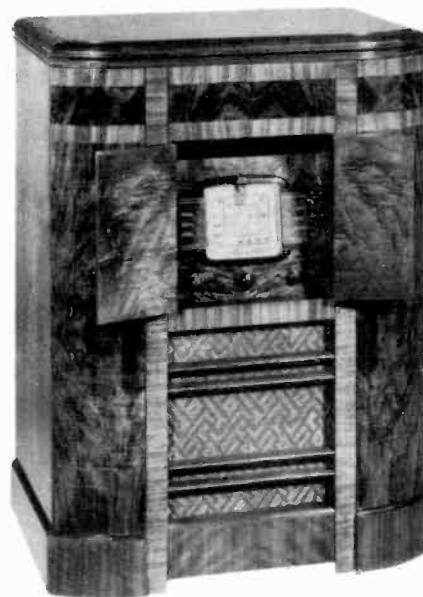

Model U-107

tifier type, 10-volt range), a 1-meg. resistor, and an RCA Victor Technical Purpose frequency record (Cat. No. 84519-A or 84505-B). Disconnect the green lead from terminal "1" (terminal board marked "1," "2," and "3" located on top right-hand side of chassis), connect the 1-meg. resistor between green lead and terminal "1," connect the voltmeter across loudspeaker voice coil, turn "Phonograph Volume" and "Power-Tone" controls extreme clockwise, turn "Phono-Volume" (radio) control extreme counter-clockwise, and adjust R114 ("Pickup Voltage Adjuster," mounted under right-hand end of motor-board) until either of the above-mentioned frequency records gives a voltage reading of 6.8 volts using 400-cycle section of record. R114 should also be adjusted if pickup is replaced.

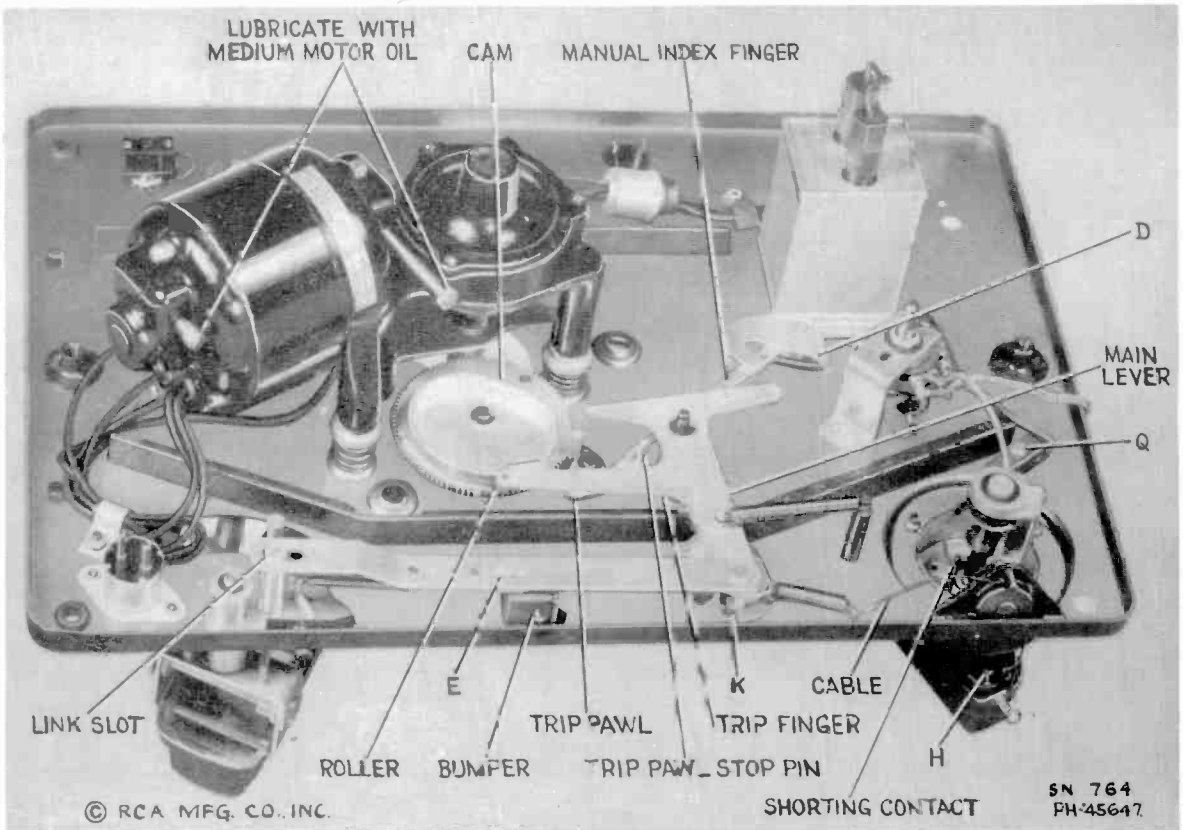
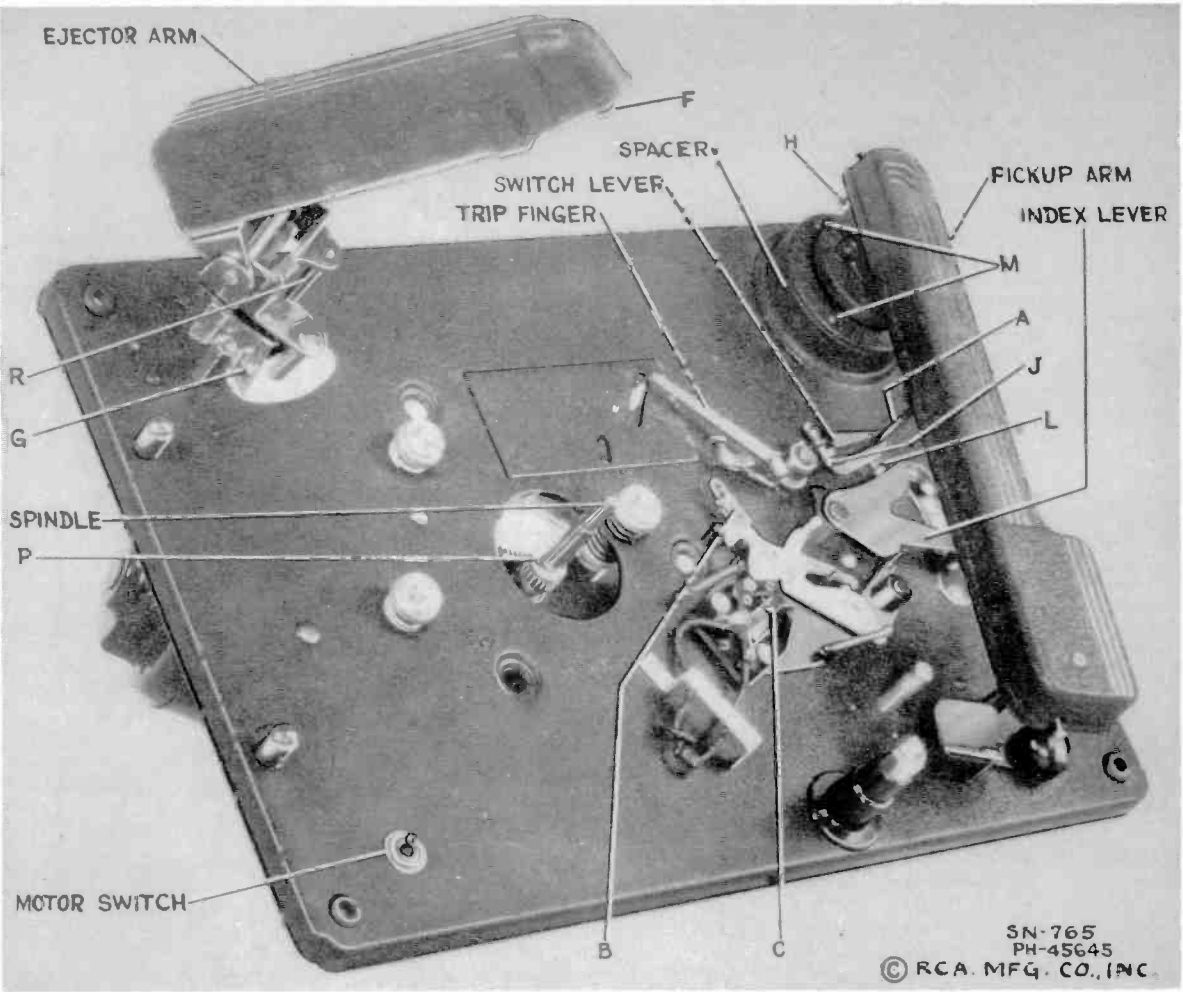

Figure 4—Automatic Record Changer Adjustments
(Model U-107)

Automatic Record Changer (Model U-107)

Under normal operating conditions, service requirements on this mechanism should be negligible. Occasionally, however, certain adjustments may be necessary. It is important to refrain from forcing the mechanism if there is a tendency to bind or jam, when operating or adjusting, since bent levers and possibly broken parts may result.

Record Changer Adjustments.—Mount motor-board on a level support. Remove turntable and cover at right of turntable. Adjustment locations are designated on figure 4 as A, B, etc. The adjustments are explained under corresponding symbols below. Perform adjustments in the following order:

A.—Trip rod "A" should be engaged in "Switch Lever" slot. Adjust trip rod "A" to obtain about 1/8 of an inch clearance from motor-board.

B.—Adjust "B" to the position shown.

C.—With "Index Lever" in "Manual" position, "Pickup Arm" rotated to extreme left, and switch tripped to open contacts "C," adjust contact points "C" by bending the stiff contact arm until points are opened 10 to 30 thousandths of an inch.

D.—With "Index Lever" in "Manual" position, release set screw "D" and force "Manual Index Finger" as far as it will go towards "Trip Pawl Stop Pin." Tighten set screw.

E.—Adjust at "E" to provide approximately 1/32 of an inch between outer end of "Link Slot" and screw when rubber "Bumper" is in contact with stop bracket.

F. and G.—Remove rubber silencer at "F" and adjust "F" and "G" so ejector tip "F" is in line with "Spindle." Longitudinal movement, with respect to "Ejector Arm," may be effected by loosening hex. head at "F." Lateral movement of "Ejector Arm" may be effected by adjustment "G."

H.—Adjust "H" so under side of pickup head can be raised 2 1/2 inches above motor-board.

J.—Adjust screw "J" until friction will just force "Trip Finger" to move "Trip Pawl" when "Index Lever" is in "12" inch position.

N.—Adjust needle pressure by turning screw under center of "Pickup Arm" so that a force of 72 grams (2.5 ounces) is required to lift needle from record. Hook scale under needle screw to measure force.

K.—Adjustment "N" must be performed prior to this adjustment. With a 12-inch record on turntable, turn on "Motor Switch," place "Index Lever" to "12" position and adjust "K" so that "Cable" tension will allow needle to lower slowly on start of record at completion of eject cycle. Turn "Motor Switch" off after eject cycle is completed and check to see that "Cable" is slightly loose when "Pickup Arm" is moved against "Spindle." Replace turntable and put a needle in "Pickup."

L.—Adjust "L" so needle will drop into center of smooth portion at the start of a 12-inch record when "Index Lever" is in "12" inch position and "Pickup Arm" is to extreme right.

M.—Loosen three screws "M" and rotate "Spacer" until pointer on "Spacer" is in line with screw to right of "Pickup Arm."

P.—Adjust turntable height by insertion or removal of thrust washers at "P" so ejector tip "F" will not eject bottom 12-inch record but will eject second from bottom record.

Q.—Adjust position of shorting switch at "Q" so switch closes when needle is just outside a 12-inch record.

R.—Adjust screw "R" upward just enough so that with one record on turntable and ejector tip "F" resting on record surface, there is 1/32 of an inch clearance between screw "R" and "Ejector Arm."

Record Changer Service Hints.—A general perusal of the following possible troubles which may be experienced with this mechanism, together with the adjustment or adjustments to be applied for same, will enable one to ascertain that which pertains to the instrument at hand:

- 1.—"Ejector Arm" goes through normal cycle but does not eject records. Adjust "F" and "G." See that "Spindle" slides freely.
- 2.—Ejects bottom record. Lower turntable by removing thrust washers at "P."

- 3.—Ejects records properly down to second from bottom of pile. Raise turntable by placing thrust washers at "P."
- 4.—Eject cycle does not start after needle reaches eccentric groove. Adjust "J" (turn screw clockwise).
- 5.—Eject cycle starts before eccentric record groove is reached. Adjust "J" (turn screw counter-clockwise). Set "Index Lever" to "12" inch or "10" inch position **after** starting to play record. Do not jar motor-board during automatic operation.
- 6.—Lateral movement of "Pickup Arm" has no control over starting and stopping. Adjust clearance of rod "A." See that rod "A" engages in slot of "Switch Lever."
- 7.—Fails to eject top record of a pile because "Ejector Arm" strikes record in returning to center at end of eject cycle. Adjust screw "R" upward to provide greater incline so that roller in "Ejector Arm" will roll back during cycle.
- 8.—Pickup strikes record during eject cycle. Adjust "K" and "H."
- 9.—Starts playing record several grooves in from beginning or needle misses record entirely. Adjust "L."
- 10.—Needle falls on smooth portion at start of record but does not move into playing groove. Adjust "M." Check to see that motor-board is level.
- 11.—Automatic stop does not operate after needle reaches eccentric groove. Adjust "B" and "C."
- 12.—Motor does not re-start when "Pickup" is returned to rest position. Adjust "C." See that switch mechanism parts move freely and springs are functioning.
- 13.—Starts eject cycle although set for "Manual" operation. Adjust "D."
- 14.—Noise in loudspeaker while changing needles. Clean "Shorting Contact" and adjust "Q."
- 15.—"Wow" in record reproduction.—Instrument should be warmed to about 65° F. Ejector tip should be centered and free to rotate (adjustments "F" and "G"). There should be no solid particles on gear teeth or in grease; no tendency to bind. Turntable plate should be in dynamic balance and "Spindle" should be straight. Proper lubrication is important.

Lubrication.—Clean motor gear-box thoroughly before re-greasing. Apply less than a tablespoonful of a grease, such as "Cities Service No. 7035-A1" or "Koolmotor Universal Trojan No. 1," directly on gears, taking care to get none in rotor bearings. Put medium motor oil (S.A.E. No. 30) in the oil holes. Cover main gear and cam of automatic mechanism with a light grease such as "Socony-Vacuum No. 2." Any good household oil, such as "3-IN-ONE" is suitable for the ejector-tip "F" bearing.

Pickup (Model U-105)

The pickup used in the phonograph unit is of an improved design. The horseshoe magnet is rigidly welded to the pole pieces and is irremovable. There is a centering spring attached to the armature to maintain proper adjustment and to provide a limiting effect on the movement of the armature. The frequency response is substantially uniform over a wide range. Service operations which may be necessary on the pickup are as follows:

Centering Armature.—Refer to figure 5 showing the pickup inner structure. The armature is shown in its proper relation to the magnet pole pieces, i. e., exactly centered. Whenever this centering adjustment has been disturbed it will be necessary to remove the pickup mechanism from the tone arm by removing the needle holding screw and the two mounting screws from the front of the tone arm, holding the pickup assembly to keep it from dropping. Unsolder the two leads from the lugs on the terminal board at the rear of the pickup. Insert a small rod or nail into the armature needle hole and replace the needle holding screw, tightening it to hold the rod securely. If the armature clamping screws A and B have not been disturbed, screws C should be loosened which will permit the armature to be moved from side to side, the rod acting as a lever to perform this operation. The proper adjustment is obtained when the armature is moved to the extreme position on each side (the movement being limited by the armature striking the pole pieces) and then brought to the mid position between these two extremes.

Screws C should then be tightened. The armature position should then be central between the pole pieces and at right angles to them. With a little practice, the correct adjustment of the armature will be obtained. The air gap between the pole pieces and the armature should be kept free from dust, filings, and other foreign material which would obstruct the movement of the pickup armature.

Damping Block.—The viscoloid damping block which is attached to the front end of the armature shank serves as a mechanical filter to eliminate undesirable resonances and to cause the frequency response to be uniform. Should it be

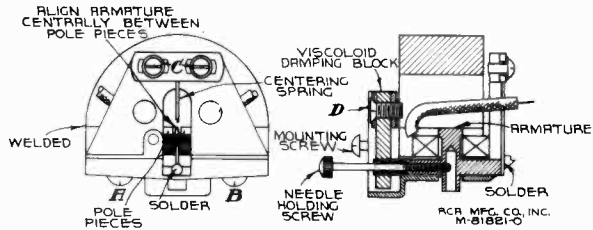

Figure 5—Details of Pickup (Model U-105)

necessary to replace this damping block, the pickup mechanism should be removed from the tone arm as explained above. Remove screw D and the damping block from the pickup assembly. Make sure that the shaft of the armature which

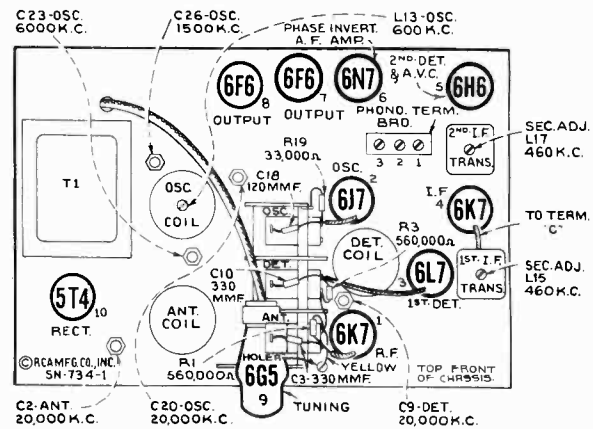

Figure 6—Radiotron, Coil, and Trimmer Locations

contacts the viscoloid is clean. Then insert the new damping block so that it occupies the same position as that of the original block, and is in correct vertical alignment with the armature. The hole in the block is somewhat smaller than the diameter of the armature in order to permit a snug fit. With the damping block properly aligned on the armature, screw D with its washer should then be replaced. Heat should be applied to the armature (viscoloid side) so that the damping

Alignment Procedure

Calibrate the tuning dial by adjusting main dial pointer to the low-frequency (end) calibration mark on dial with the gang tuning-condenser plates in full-mesh position; then adjust the small (vernier) pointer to "0." These are friction adjustments.

Perform alignment in proper order, tabulated below, starting with No. 1 and following all operations across, then No. 2, etc. Adjustment locations are shown on figures 6 and 9.

Cathode-ray alignment is highly preferable; the connections to the chassis are shown on figures 2 and 3. If an output indicator is used, connect it across the loudspeaker voice-coil and advance the receiver volume control to full-volume position.

Connect the "low" output terminal of the test oscillator to the receiver "G" (ground) terminal for all alignment operations. Regulate the output of the test oscillator so that minimum signal is applied to the receiver to obtain an observable output indication. This will avoid a-v-c action.

The term "Dummy antenna" means the device which must be connected between the "high" test-oscillator output and the point of connection to the receiver in order to obtain ideal alignment. "No signal, 550-750 kc" means that the receiver should be tuned to a point between 550 and 750 kc where no signal or interference is received from a station or local (heterodyne) oscillator.

For further details on alignment, refer to booklet "RCA Victor Receiver Alignment."

| Order of Alignment | Test Oscillator | | | Range Selector | Receiver Dial Setting | Circuit to Adjust | Adjustment Symbols | Adjust to Obtain |
|--------------------|------------------------|---------------|-------------------|----------------|-----------------------|-------------------|--------------------|------------------|
| | Connection to Receiver | Dummy Antenna | Frequency Setting | | | | | |
| 1 | 6K7 I-F Grid Cap | .001 Mfd. | 460 kc | "A" Left | No Signal 550-750 kc | 2nd I-F Trans. | L16 and L17 | Max. (peak) |
| 2 | 6L7 Det. Grid Cap | .001 Mfd. | 460 kc | "A" | No Signal 550-750 kc | 1st I-F Trans. | L14 and L15 | Max. (peak) |
| 3 | Ant. Term. | 300 Ohms | 20,000 kc | "C" Right | 20,000 kc | "C" Osc. | C20 | Max. (peak) * |
| 4 | Ant. Term. | 300 Ohms | 20,000 kc | "C" | 20,000 kc | "C" Det. | C9 | Max. (peak) † |
| 5 | Ant. Term. | 300 Ohms | 20,000 kc | "C" | 20,000 kc | "C" Ant. | C2 | Max. (peak) ‡ |
| 6 | Ant. Term. | 300 Ohms | 6,000 kc | "B" Center | 6,000 kc | "B" Osc. | C23 | Max. (peak) * |
| 7 | Ant. Term. | 200 Mmfd. | 600 kc | "A" Left | 600 kc | "A" L-F Osc. | L13 | Max. (peak) |
| 8 | Ant. Term. | 200 Mmfd. | 1,500 kc | "A" | 1,500 kc | "A" H-F Osc. | C26 | Max. (peak) |
| 9 | Ant. Term. | 200 Mmfd. | 600 kc | "A" | 600 kc | "A" L-F Osc. | L13 | Max. (peak) |
| 10 | Ant. Term. | 200 Mmfd. | 1,500 kc | "A" | 1,500 kc | "A" H-F Osc. | C26 | Max. (peak) |

* Use minimum capacity peak if two peaks can be obtained.

† Use maximum capacity peak if two peaks can be obtained.

‡ After this adjustment, check for image signal by shifting receiver dial to 19,080 kc.

block will fuse at the point of contact and become rigidly attached to the armature. A special-tip soldering iron, constructed as shown in figure 7 will be found very useful in performing this operation. The iron should be applied only long enough to slightly melt the block, causing a small bulge on both sides.

Replacing Coil.—Whenever there is defective operation due to an open or shorted pickup coil, this coil should be replaced. Remove the pickup mechanism and terminal board as described above. Remove screws A and B and the magnet assembly. Remove the bakelite coil support (with coil attached) and insert the new coil support assembly in its place, after which replace the magnet assembly and center the armature as described above, then re-assemble the remainder of the unit.

Magnetizing.—In case it becomes necessary to re-magnetize the unit, first remove the pickup mechanism from the tone arm, and then remove the magnet assembly. Place the magnet assembly on the poles of a standard pickup magnetizer such as the RCA Stock No. 9549 Pickup Magnetizer and charge the magnet in accordance with the instructions accom-

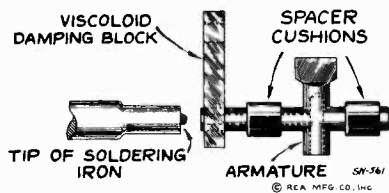

Figure 7—Special Soldering-Iron Tip

panying the magnetizer. It is preferable to check the polarity of the pickup magnet and to remagnetize it so that the same polarity is maintained.

Automatic Record Mechanism (Model U-105)

This record changing mechanism is designed to be simple and fool-proof. Certain adjustments may be required occasionally. The adjustments are illustrated and explained in figures 8 and 10.

It is important, when servicing the automatic mechanism, to have it placed on a level support. It is also important to

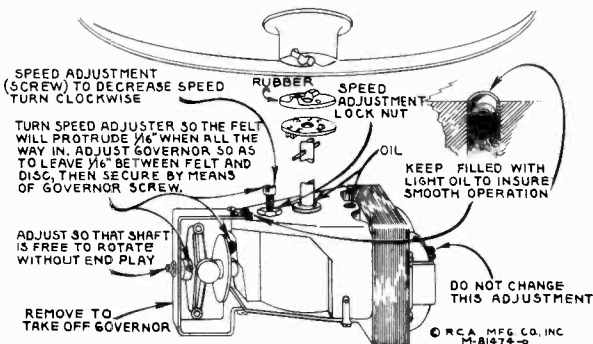

Figure 8—Details of Motor
(Model U-105)

refrain from forcing the mechanism if there is a tendency to bind or jam, since bent levers and possible broken parts may result.

CAUTION.—Do not leave records stacked on the record holder posts, when not in use, as they are liable to warp, particularly so in warm climates.

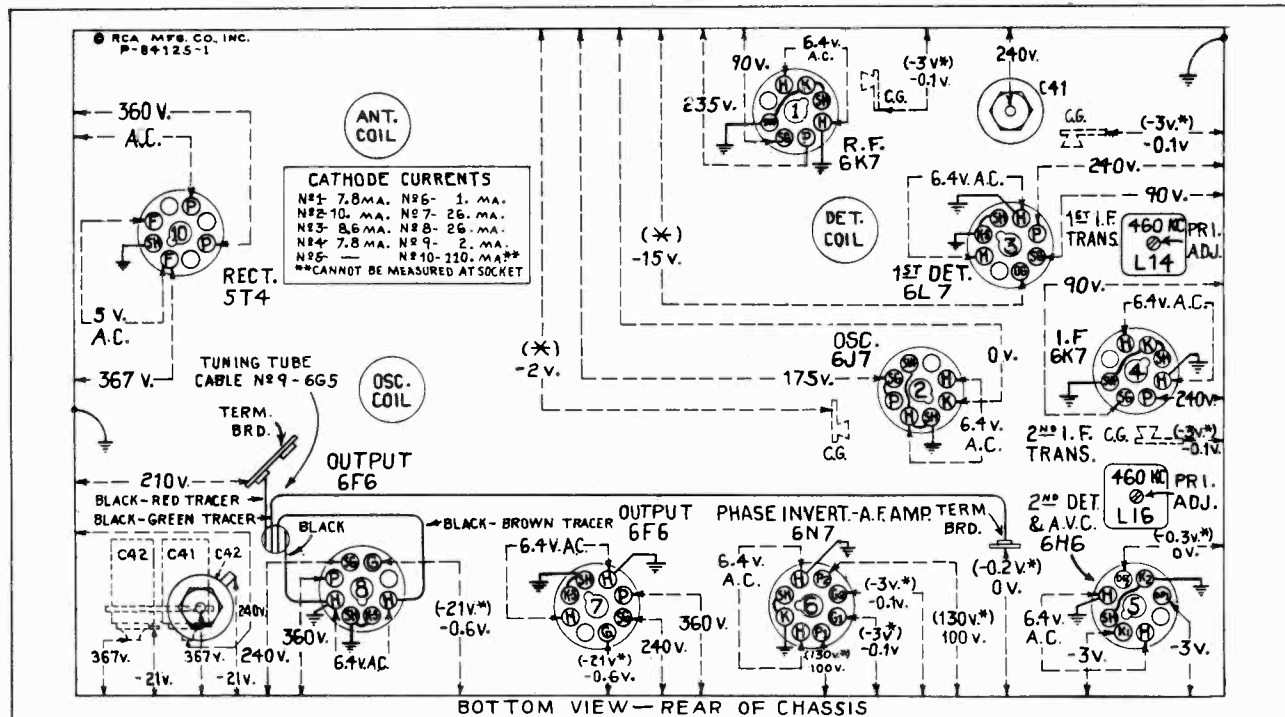

Figure 9—Radiotron Socket Voltages, Coil, and Trimmer Locations

Measured at 115 volts, 60-cycle supply—Tuned to approximately 1,000 kc ("Broadcast")—
No signal being received—Volume control minimum

Note: Two voltage values are shown for some readings. The value shown in parentheses with asterisk () indicates operating conditions without voltmeter loading. The other value (generally lower) is the actual measured voltage and differs from the value shown in parentheses because of the additional loading of the voltmeter through the high series circuit resistance.*

Voltage values as specified should hold within $\pm 20\%$ when the receiver is normally operative at its rated line voltage. To duplicate the conditions under which the voltages were measured requires a 1,000-ohm-per-volt d-c meter, having ranges of 10, 50, 250 and 500 volts. Use the nearest range above the specified measured voltage. A-c voltages were measured with a corresponding a-c meter.

TO ADJUST THE LANDING POSITION OF THE NEEDLE FIRST LOCATE NEEDLE POINT FROM CENTER OF THE LEVER TRIP LEVER AGAINST THE STOP PIN AND THE TRIP LEVER TRIP LEVER CONTACTING THE LOCATING LEVER TIGHTEN THE BLIND SCREW ON TONE ARM SUPPORT AND RUN DEVICE THROUGH CYCLE AS A CHECK WHEN CORRECT ADJUSTMENT IS OBTAINED TIGHTEN CONE POINT SCREW "H" (STK*14195) ON TONE ARM SUPPORT.

ADJUST THE RISE OF THE TONE ARM SO THAT THE NEEDLE POINT RISES $3/16$ " ABOVE THE CRIBLE LEVER. THIS ADJUSTMENT IS MADE BY MEANS OF THE SCREW AND LOCK NUTS "P" (STK*4563) ON THE CRIBLE LEVER.

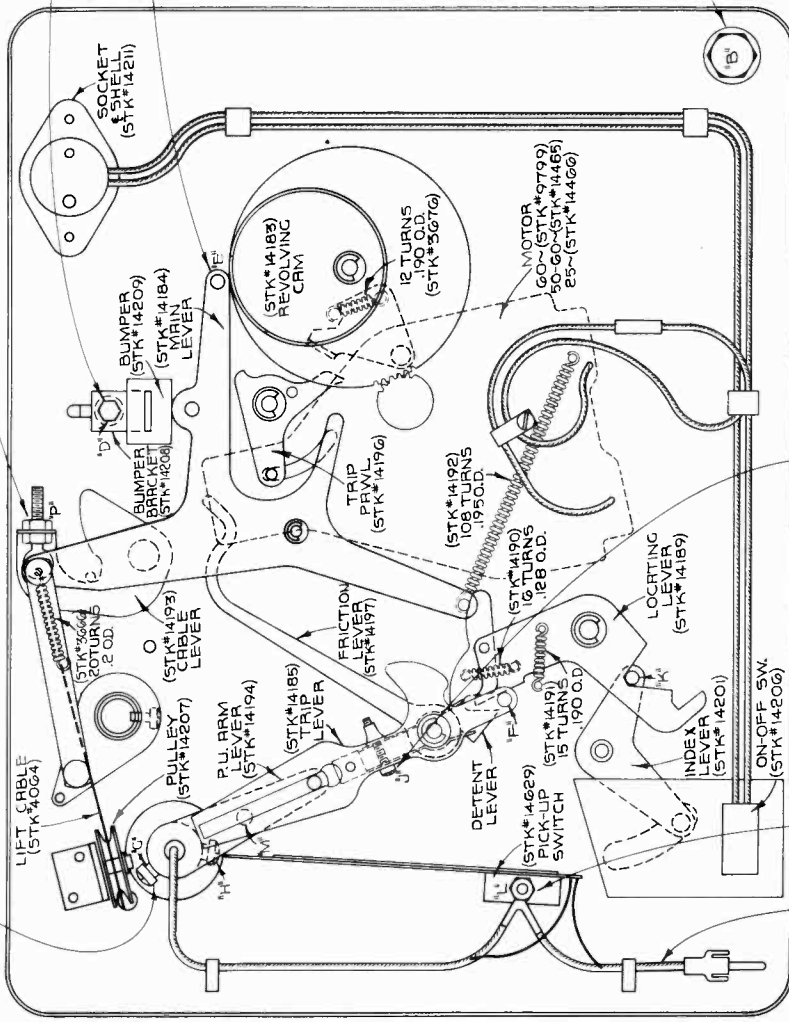

ADJUST THE REST POSITION OF THE MAIN LEVER BY ON THE BUMPER BRACKET SO THAT THE CRAM ROLLER CLEARS THE REVOLVING CRM $1/64$ " IN THE NEAREST POSITION. ALSO NOTE THAT THE DETENT LEVER LEANS THE ABOVE CONDITIONS EXIST.

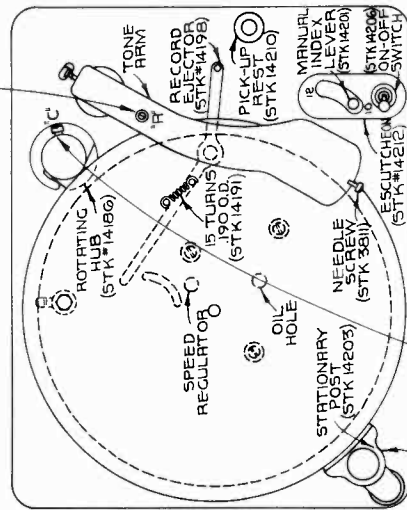

TO ADJUST RECORD POSTS: PLACE RECORD IN POSITION OVER SPINDLE SO THAT IT RESTS ON THE LOWER SHELF OF THE ROT. HUB. MOVE STATIONARY RECORD POST TO POSITION WHERE RECORDS UNDER THE RECORDING HEADS CAN BE REPRODUCED. TIGHTEN HEXAGON SCREW "B" ROTATED UNDER MOTOR BOARD WITH RECORD STILL ON LOWER SHELF OF ROTATING HUB ADJUST SCREW "C" (STK*14188) SO THAT THE BEVELED TONGUE ON THE SEPARATING CRAM CLEARS THE RECORD BY $1/8$ "- $1/2$ ". THESE ADJUSTMENTS SHOULD BE MADE ONLY WHEN THE COMPLETE UNIT IS RESTING ON THE FOUR MOTOR BOARD BUSHINGS.

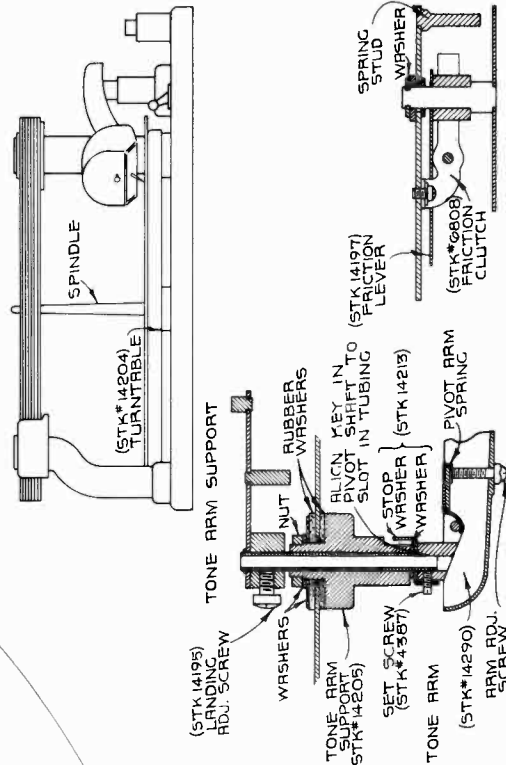

ADJUST TRIP LEVER SCREW "J" (STK*4059) UNTIL FRICTION WILL JUST FORCE FRICTION LEVER TO MOVE TRIP PAWL.

TO ADJUST PICK-UP SHORTING SWITCH SET PICK-UP NEEDLE "G" FROM CENTER OF SPINDLE. ADJUST NUT "L" SO THAT THE BLADE ON SWITCH IS JUST CONTACTING PIN "M"

Figure 10—Automatic Record Changer Adjustments (Model U-105)

© RCA MFG. CO., INC. T-10626-0

REPLACEMENT PARTS

Insist on genuine factory tested parts, which are readily identified and may be purchased from authorized dealers.

| STOCK No. | DESCRIPTION | STOCK No. | DESCRIPTION |
|----------------------------|---|---|--|
| RECEIVER ASSEMBLIES | | | |
| 12038 | Band—Rubber band for tuning tube | 14375 | Shield—Oscillator coil shield |
| 14384 | Belt—Variable condenser drive belt | 12008 | Shield—First or second I.F. transformer shield |
| 14618 | Board—Antenna and ground terminal board (Model U-105 only) | 14114 | Socket—Dial lamp socket |
| 14517 | Board—Antenna and ground terminal board (Model U-107 only) | 14171 | Socket—Pilot lamp socket |
| 12717 | Board—Phonograph terminal board | 11195 | Socket—5-contact 5T4 Radiotron socket |
| 14338 | Bushing—Variable condenser mounting bushing assembly | 11488 | Socket—2-contact female for compartment lamp cable—Model U-107 |
| 14524 | Cable—Band indicator cable, approximately 8½ in. long | 11196 | Socket—8-contact 6F6, 6H6, 6K7, 6L7, 6N7, or 6J7 Radiotron socket |
| 14523 | Cable—Tone control indicator cable, approximately 3 in. long | 12907 | Spring—Tension spring for indicator gear, Stock No. 30085 |
| 14394 | Cable—Tuning tube cable and socket | 14342 | Spring—Tension spring for idler, Stock No. 14341 |
| 11350 | Cap—Grid contact cap | 12007 | Spring—Retaining spring for core, Stock Nos. 12006 and 12800 |
| 12607 | Cap—First I.F. transformer shield top | 14599 | Switch—High-frequency tone and power switch (S4, S5) |
| 12581 | Cap—Second I.F. transformer shield top | 14516 | Switch—Range switch (S1, S2, S3) |
| 12884 | Capacitor—Adjustable trimmer (long) (C2, C23, C26) | 14376 | Transformer—First I.F. transformer (L14, L15, C12, C13) |
| 12714 | Capacitor—Adjustable trimmer (medium) (C9, C20) | 14283 | Transformer—Second I.F. transformer (L16, L17, C27, C28, C29, R5, R6) |
| 14021 | Capacitor—22 Mmfd. (C25) | 11211 | Transformer—Power transformer, 105-125 volts, 50-60 cycles (T1) |
| 13545 | Capacitor—39 Mmfd. (C7, C53) | 11212 | Transformer—Power transformer, 105-125 volts, 25-60 cycles (T1) |
| 12720 | Capacitor—100 Mmfd. (C11) | 11213 | Transformer—Power transformer, 105-250 volts, 50-60 cycles (T1) |
| 14262 | Capacitor—110 Mmfd. (C12, C13) | 14597 | Volume Control—Radio volume control and Radio-Record switch (R9, S10) |
| 12404 | Capacitor—120 Mmfd. (C27, C28) | 14379 | Washer—Felt washer for indicator pointer |
| 12724 | Capacitor—120 Mmfd. (C18) | REPRODUCER ASSEMBLIES (Speaker RL76-1) | |
| 12406 | Capacitor—180 Mmfd. (C29) | 14606 | Cap—Dust cap for cone center |
| 12952 | Capacitor—330 Mmfd. (C3, C10, C33) | 14603 | Coil—Field coil (L20) |
| 12727 | Capacitor—555 Mmfd. (C24) | 14604 | Coil—Hum neutralizing coil (L19) |
| 12537 | Capacitor—560 Mmfd. (C5) | 14602 | Cone—Reproducer cone and dust cap (L18) |
| 12898 | Capacitor—1,500 Mmfd. (C16) | 5039 | Plug—4-contact male plug for reproducer |
| 12729 | Capacitor—1,550 Mmfd. (C22) | 14600 | Reproducer—Reproducer, complete |
| 12728 | Capacitor—4,500 Mmfd. (C21) | 14358 | Screw—Screw, washer, and lockwasher to hold core in yoke |
| 12897 | Capacitor—4,700 Mmfd. (C6) | 14601 | Transformer—Output transformer (T2, C52) |
| 4838 | Capacitor—.005 Mfd. (C39, C40, C50, C51, C54) | 14357 | Washer—Spring washer to hold field coil |
| 13138 | Capacitor—.01 Mfd. (C31, C35, C36) | OPERATING MECHANISM ASSEMBLIES (Model U-105 only) | |
| 4870 | Capacitor—.025 Mfd. (C30, C32, C34) | 14199 | Bushing—Record separator rotating shaft bushing |
| 4841 | Capacitor—.01 Mfd. (C4, C17) | 14183 | Cam—Cam and gear assembly |
| 5170 | Capacitor—.025 Mfd. (C15) | 6808 | Clutch—Trip lever friction clutch |
| 12741 | Capacitor—.05 Mfd. (C14, C37) | 14197 | Finger—Friction finger assembly |
| 5212 | Capacitor—.16 Mfd. (C+1) | 14186 | Hub—Rotating hub and record separator, complete with set screw |
| 14531 | Capacitor—.25 Mfd. (C+2) | 14189 | Lever—Locating lever assembly |
| 14372 | Coil—Antenna coil and shield (L1, L2, L3, L4) | 14184 | Lever—Main lever and link assembly |
| 14516 | Coil—Oscillator coil and shield (L11, L12, L13) | 14201 | Lever—Manual index lever assembly |
| 14414 | Coil—R.F. coil and shield (L5, L6, L7, L8, L9, L10) | 14193 | Lever—Pickup lift cable lever |
| 14513 | Condenser—3-gang variable condenser (C1, C8, C19) | 14194 | Lever—Pickup arm lever, complete with set screws |
| 14783 | Connector—2-contact female connector for compartment lamp cable or motor power cable | 14198 | Lever—Reject lever assembly |
| 5040 | Connector—4-contact female connector for reproducer cable | 14185 | Lever—Trip lever and friction clutch assembly |
| 12006 | Core—Adjustable core and stud for transformer, Stock Nos. 14376 and 14283 | 14196 | Pawl—Trip pawl assembly |
| 12800 | Core—Adjustable core and stud for coil, Stock No. 14516 | 4563 | Screw—Cable lever screw and two locknuts |
| 14596 | Dial—Station selector dial scale, complete with tuning tube escutcheon (Model U-105 only) | 14200 | Screw—No. 8-32 special hex-head screw and lockwasher for record separator shaft mounting |
| 14518 | Dial—Station selector dial scale, complete with tuning tube escutcheon (Model U-107 only) | 4059 | Screw—Trip lever clutch tension adjustment screw |
| 14514 | Drive—Variable condenser vernier drive pinion gear and shaft | 14188 | Screw—No. 10-32 x 7/16 fillister-head, cone-pointed set screw for rotating hub |
| 14345 | Drum—Variable condenser drive belt drum, complete with set screws | 14195 | Screw—No. 10-32 x 5/16 fillister-head, cone-pointed set screw for pickup arm lever |
| 14387 | Escutcheon—Tuning tube escutcheon | 14187 | Shaft—Rotating shaft for record separator |
| 11982 | Fastener—Dial scale fastener | 3676 | Spring—Cam pawl tension spring |
| 30085 | Gear—Indicator drive gear and hub, and pointer stem and gear | 3666 | Spring—Lift cable tension spring |
| 14341 | Idler—Station selector drive belt idler | 14190 | Spring—Locating lever pawl tension spring |
| 14519 | Indicator—Station selector indicator pointer | 14191 | Spring—Locating lever or reject lever tension spring |
| 14520 | Indicator—Vernier indicator pointer | 14192 | Spring—Main lever tension spring |
| 5226 | Lamp—Dial or pilot lamp | OPERATING MECHANISM ASSEMBLIES (Model U-107 only) | |
| 14028 | Nut—Jamb nut for adjustable trimmer capacitor, Stock Nos. 12714 and 12884 | 14754 | Cam—Cam and gear assembly |
| 12471 | Plate—6J7 Radiotron socket mounting plate and rubber cushions—less socket, Stock No. 11196 | 6808 | Clutch—Trip lever friction clutch |
| 14340 | Pulley—Station selector drive belt pulley and knob shaft | 14756 | Cover—Metal cover for trip lever and friction finger assembly |
| 14598 | Reflector—Dial reflector and bracket, complete with dial lamp bracket, tuning tube bracket, and tone and band indicators | 6809 | Finger—Manual index lever finger assembly |
| 5112 | Resistor—1,000 ohms, carbon type, ¼ watt (R2) | 3670 | Finger—Friction finger assembly |
| 14078 | Resistor—18,000 ohms, carbon type, 1 watt (R27) | 11554 | Lever—Manual index lever—less pin |
| 14284 | Resistor—22,000 ohms, carbon type, 1/10 watt (R5) | 14755 | Lever—Main lever and link assembly |
| 11305 | Resistor—22,000 ohms, carbon type, ¼ watt (R10) | 14914 | Lever—Pickup lift cable lever |
| 11300 | Resistor—33,000 ohms, carbon type, 1/10 watt (R19) | 11555 | Lever—Trip lever and friction clutch assembly |
| 13735 | Resistor—33,000 ohms, carbon type, ¼ watt (R4) | 30624 | Pawl—Trip pawl assembly |
| 5033 | Resistor—33,000 ohms, carbon type, 1 watt (R31) | 3672 | Pin—Manual index lever pin |
| 11646 | Resistor—47,000 ohms, carbon type, ¼ watt (R12) | 13635 | Plate—Eject arm actuating plate assembly |
| 5145 | Resistor—100,000 ohms, carbon type, ¼ watt (R14, R15, R18) | 4564 | Screw—Manual index lever finger set screw |
| 11398 | Resistor—220,000 ohms, carbon type, 1/10 watt (R6) | 4059 | Screw—Trip lever clutch tension adjustment screw |
| 11453 | Resistor—270,000 ohms, carbon type, 1/10 watt (R16, R17) | 4566 | Screw—Special screw used to fasten main lever and link assembly bushing |
| 11172 | Resistor—470,000 ohms, carbon type, ¼ watt (R11) | 13637 | Spacer—Pickup arm mounting spacer |
| 11397 | Resistor—560,000 ohms, carbon type, 1/10 watt (R1, R3) | 13638 | Spring—Actuating spring |
| 12013 | Resistor—1 megohm, carbon type, 1/10 watt (R23, R30) | 4565 | Spring—Manual index lever finger tension spring |
| 13730 | Resistor—1 megohm, carbon type, ¼ watt (R13) | 4061 | Spring—Main spring lever tension spring or pickup arm cable tension spring |
| 11626 | Resistor—2.2 megohms, carbon type, ¼ watt (R7, R8) | 2893 | Spring—Trip lever latch plate tension spring |
| 11668 | Resistor—5.6 megohms, carbon type, ¼ watt (R26) | 3676 | Spring—Cam and gear pawl tension spring |
| 14532 | Resistor—Voltage divider—comprising one 1,500-ohm, one 2,500-ohm, one 3,900-ohm, one 27-ohm, and one 165-ohm sections (R20, R21, R22, R24, R25) | 14916 | Spring—Pickup lift lever spring |
| 14343 | Retainer—Station selector knob shaft and pulley retainer | 4125 | Spring—Eject arm horizontal action tension spring |
| 14350 | Screw—No. 8-32 x 3/16 square head set screw for drum, Stock No. 14345, and gear, Stock No. 30085 | 13636 | Stud—Pickup arm lift cable stud and nut |
| 14374 | Shield—Antenna or R.F. coil shield | 2917 | Washer—Spring washer—"U" type |

REPLACEMENT PARTS (Continued)

| STOCK No. | DESCRIPTION | STOCK No. | DESCRIPTION |
|--|---|---|--|
| EJECT ARM ASSEMBLIES (Model U-107 only) | | 14205 | Support—Pickup arm mounting spacer, washers, and nut |
| 14753 | Arm—Eject arm, complete | 14206 | Switch—Motor toggle switch (S101) |
| 11533 | Ball—1/16-in.-diameter steel ball | 14629 | Switch—Pickup shorting switch (S102) |
| 10129 | Ball—3/16-in.-diameter steel ball | 14204 | Turntable, complete |
| 11529 | Bearing—Ejector tip bearing and nut | 14213 | Washer—Pickup arm stop washer and spacing washer |
| 11538 | Bracket—Eject arm bracket | MOTOR BOARD ASSEMBLIES (Model U-107 only) | |
| 11537 | Collar—Eject arm shaft collar and set screw | 11881 | Base—Phonograph compartment lamp socket and base |
| 11536 | Cushion—Counter balance roller cushion—located inside of eject arm | 14760 | Cup—Used-needle cup |
| 4055 | Post—Vertical adjustment post—located on eject arm bracket | 12051 | Capacitor—2 Mfd., complete with 2-contact male connector for use with motor, Stock Nos. 9650 or 9651 only (C115) |
| 3729 | Roller—Eject arm counter balance roller—located inside of eject arm | 13101 | Capacitor—4 Mfd., complete with 2-contact male connector for use with motor, Stock No. 9735 only (C115) |
| 4580 | Screw—No. 6-32 x 3/16-in. square-head set screw for eject arm collar | 4674 | Connector—2-contact male connector for Stock Nos. 12051, 13101 or phono. compartment lamp leads |
| 11534 | Screw—No. 8-36 x 7/32-in. special screw for eject arm tip center adjustment | 14211 | Connector—2-contact male connector for motor cable |
| 11535 | Shaft and Collar—Eject arm vertical action shaft and collar assembly | 11488 | Connector—2-contact female connector for motor leads |
| 11528 | Silencer—Ejector tip silencer | 14762 | Damper—Turntable damper |
| 4067 | Spring—Ejector arm bracket spring | 11553 | Escutcheon—Index escutcheon engraved "Manual—12—10" |
| 11531 | Spring—Ejector tip spring | 14688 | Knob—Needle rest knob |
| 11530 | Tip—Ejector tip with tip center, adjusting screw and cap | 4340 | Lamp—Phonograph compartment lamp—6.3 volts |
| 11539 | Yoke—Eject arm yoke assembly | 3764 | Nut—Cap nut for motor board suspension assembly |
| PICKUP AND ARM ASSEMBLIES (Model U-105 only) | | 30565 | Resistor—500 ohms, 8 watts, for use with motor, Stock No. 9735 only (R118) |
| 14291 | Armature—Pickup armature assembly | 14761 | Rest—Pickup rest |
| 4064 | Cable—Pickup lift cable | 14825 | Roller—Pickup arm cable guide roller—comprising bracket, roller, and guide pin |
| 14672 | Coil—Pickup coil (L101) | 11711 | Shade—Phonograph compartment lamp shade |
| 14292 | Damper—Pickup damper block, complete with clamp and screw | 14758 | Spacer—Pickup arm mounting spacer |
| 14293 | Pickup and Arm, complete | 14270 | Spring—Retaining spring for knob, Stock No. 14758 |
| 3811 | Screw—Needle holding screw | 4565 | Spring—Tension spring for needle rest |
| 4387 | Screw—No. 6-32 x 1/4-in. headless set screw for pickup arm pivot shaft | 3763 | Suspension Spring—Suspension spring, washer, and bolt assembly for motor board—comprising one bolt, two cup washers, two springs, two "C" washers, and one cap nut |
| PICKUP AND ARM ASSEMBLIES (Model U-107 only) | | 4671 | Switch—Operating switch, toggle type (S112) |
| 10941 | Ball—Steel ball for pivot shaft bearing | 30157 | Switch—Pickup shorting switch (S110) |
| 3204 | Cable—Pickup lift cable | 14759 | Turntable, complete |
| 30101 | Cable—Shielded pickup cable—connects pickup unit to shorting switch | MISCELLANEOUS ASSEMBLIES (Model U-105 only) | |
| 12850 | Damper—Pickup arm pivot shaft damper—comprising one upper rubber damper and bearing, one lower rubber damper and one lower bearing | 4391 | Box—Used-needle box |
| 14820 | Mechanism—Pickup mechanism, complete with needle screw | 14607 | Cable—Shielded compensation cable, complete with male plug |
| 14818 | Pickup and Arm, complete | 13103 | Cap—Pilot lamp cap |
| 12546 | Plug—Pivot shaft bearing plug | 12952 | Capacitor—330 Mmfd. (C105) |
| 14823 | Rod—Pickup arm brake trip rod | 12635 | Capacitor—1,000 Mmfd. (C104) |
| 14822 | Screw—Needle screw | 5148 | Capacitor—.007 Mfd. (C101) |
| 14824 | Screw—Pickup mechanism terminal screw | 11315 | Capacitor—.015 Mfd. (C102, C103) |
| 14913 | Spring—Pickup arm tension spring | 14610 | Escutcheon—Station selector escutcheon and crystal, complete with tone and band indicating strips |
| 14821 | Support—Pickup mechanism support | 14611 | Index—Tone control indicating strip—mounts in station selector escutcheon |
| MOTOR ASSEMBLIES (Model U-105 only) | | 14529 | Index—Band indicating strip—mounts in station selector escutcheon |
| 14215 | Governor—Governor, complete for motor, Stock Nos. 9799 and 14465 | 14359 | Knob—Station selector knob |
| 14465 | Motor—105-125 volts, 50-60 cycles (M-101) | 14269 | Knob—Volume control, tone control, or range switch knob |
| 9799 | Motor—105-125 volts, 60 cycles (M-101) | 11807 | Receptacle—New-needle card holder |
| 14214 | Screw—Motor mounting screw and spacer assembly | 11400 | Resistor—27,000 ohms, carbon type, 1/2 watt (R103, R104) |
| MOTOR ASSEMBLIES (Model U-107 only) | | 13735 | Resistor—33,000 ohms, carbon type, 1/2 watt (R102) |
| 9735 | Motor—105-125 volts, 25 cycles (M-110) | 11322 | Resistor—39,000 ohms, carbon type, 1/2 watt (R101) |
| 9651 | Motor—105-125 volts, 50 cycles (M-110) | 4560 | Screw—Chassis mounting screw and washer assembly |
| 9650 | Motor—105-125 volts, 60 cycles (M-110) | 4982 | Spring—Retaining spring for knob, Stock No. 14359 |
| 12050 | Suspension Spring—Motor mounting spring, washer, and stud assembly—comprising six springs, six cup washers, three spring washers, and three studs | 14270 | Spring—Retaining spring for knob, Stock No. 14269 |
| AUTOMATIC SWITCH ASSEMBLIES (Model U-107 only) | | 3763 | Suspension Spring—Motor board suspension springs, stud, washer, and nut assembly |
| 3994 | Cover—Motor switch cover | 14809 | Transformer—Phonograph input transformer (T101) |
| 10184 | Plate—Automatic brake latch plate | 14608 | Volume Control—Phonograph volume control (R105) |
| 10174 | Springs—Automatic brake springs | MISCELLANEOUS ASSEMBLIES (Model U-107 only) | |
| 6805 | Switch Assembly—Automatic switch, complete | 12488 | Capacitor—270 Mmfd. (C110) |
| 3322 | Switch—Motor switch (S111) | 13762 | Capacitor—1,500 Mmfd. (C111) in 25 cycle model only |
| MOTOR BOARD ASSEMBLIES (Model U-105 only) | | 14393 | Capacitor—.01 Mfd. (C114) |
| 14208 | Bracket—Bumper bracket and bumper, complete | 11315 | Capacitor—.015 Mfd. (C111, C112, C113)—C111 .015 Mfd. in 50 and 60 cycle models only |
| 14209 | Bumper—Rubber bumper | 30099 | Control—Pickup control (R114) |
| 14630 | Cable—Shielded cable, 22 inches long, complete with single contact male connector—connects pickup shorting switch to input transformer or compensator | 14610 | Escutcheon—Station selector escutcheon and crystal |
| 11704 | Damper—Turntable damper and damper plate | 14269 | Knob—Radio or phonograph volume control, tone control, or range switch knob |
| 14212 | Escutcheon—Manual index lever and switch escutcheon | 14359 | Knob—Station selector knob |
| 14203 | Post—Record post—located on front left-hand corner of motor board | 14529 | Index—Band indicator card—mounts in station selector escutcheon |
| 14210 | Rest—Pickup arm rest | 14611 | Index—Tone indicator card—mounts in station selector escutcheon |
| 14207 | Roller—Pickup lift cable roller and bracket | 11807 | Receptacle—New-needle card holder |
| 14211 | Socket—Motor board socket and shell | 12738 | Resistor—27,000 ohms, insulated, 1/2 watt (R111, R115) —R115 27,000 ohms in 50 cycle model only |
| | | 12454 | Resistor—33,000 ohms, insulated, 1/2 watt (R110) |
| | | 12288 | Resistor—56,000 ohms—insulated 1/2 watt (R115) in 25 cycle model only |
| | | 14560 | Resistor—100,000 ohms, insulated, 1/2 watt (R113) |
| | | 12210 | Screw—Chassis mounting screw and washer assembly |
| | | 3763 | Suspension Spring—Motor board suspension bolt spring washers and nut |
| | | 30098 | Volume Control—Phonograph volume control (R112) |



RCA Victor

MODEL U-109

Sixteen-Tube, Three-Band, A-C, Radio-Phonograph

TECHNICAL INFORMATION AND SERVICE DATA

-1937 No. 29-

SERVICE DIVISION • RCA MANUFACTURING COMPANY, INC. • CAMDEN, N. J., U. S. A.

A Service of the Radio Corporation of America

Electrical Specifications

FREQUENCY RANGES

"Broadcast" (A)..... 530-1,720 kc
 "Medium Wave" (B)..... 2,100-6,800 kc
 "Short Wave" (C)..... 6,800-23,500 kc

R-F ALIGNMENT FREQUENCIES

"Short Wave" (C)..... 20,000 kc (osc., det., ant.)
 "Medium Wave" (B)..... 6,000 kc (osc.)
 "Broadcast" (A)..... 600 kc (osc.), 1,500 kc (osc.)

Intermediate Frequency..... 460 kc

RADIOTRON COMPLEMENT

(1) RCA-6K7..... R-F Amplifier
 (2) RCA-6L7..... First Detector
 (3) RCA-6J7..... Heterodyne Oscillator
 (4) RCA-6J7..... Oscillator Control
 (5) RCA-6K7..... First I-F Amplifier
 (6) RCA-6K7..... Second I-F Amplifier
 (7) RCA-6H6..... Second Detector, A.V.C., and A.F.C.
 (8) RCA-6C5..... First Audio Amplifier

(9) RCA-6G5..... "Magic Eye" Tuning Tube
 (10) RCA-6L7..... Volume Expander
 (11) RCA-6F5..... Expander Amplifier
 (12) RCA-6H6..... Expander Rectifier
 (13) RCA-6C5..... Audio Driver
 (14) RCA-2A3..... Power Output
 (15) RCA-2A3..... Power Output
 (16) RCA-5Z3..... Full-Wave Rectifier

Pilot Lamps..... { (7) Radio..... Mazda No. 46, 6.3 volts, 0.25 amp.
 (1) Phono Compartment. Mazda No. 40, 6.3 volts, 0.15 amp.

POWER RATINGS

| | | Radio Only | Total |
|------------------|---|----------------|-----------|
| Rating A-6..... | 105-125 volts, 60 cycles..... | 190 watts..... | 220 watts |
| Rating A-5..... | 105-125 volts, 50 cycles..... | 190 watts..... | 220 watts |
| Rating B-2..... | 105-125 volts, 25 cycles..... | 190 watts..... | 220 watts |
| Rating C-6..... | 100-130/140-160/200-250 volts, 60 cycles..... | 190 watts..... | 220 watts |
| Rating C-5..... | 100-130/140-160/200-250 volts, 50 cycles..... | 190 watts..... | 220 watts |
| Fuse Rating..... | | | 3 amperes |

PHONOGRAPH

Type..... Automatic Record Ejector
 Record Capacity..... Eight 10-inch or seven 12-inch
 Turntable Speed..... 78 r.p.m.
 Type of Pickup..... Crystal
 Pickup Impedance..... 80,000 ohms at 1,000 cycles

POWER OUTPUT

Undistorted..... 12 watts
 Maximum..... 15 watts

LOUDSPEAKER

Type..... 12-inch Electrodynamic
 Impedance (v.c.)..... 11½ ohms at 400 cycles

Mechanical Specifications

Height..... 43 inches
 Width..... 35⁵/₈ inches
 Depth..... 22⁷/₁₆ inches
 Weight (net)..... 209 pounds
 Weight (shipping)..... 297 pounds
 Chassis Base Dimensions..... (Amplifier) 16¹/₄ x 7¹/₂ x 2⁷/₈ inches (Radio) 21 x 10¹/₂ x 3¹/₄ inches
 Over-all Chassis Height..... (Amplifier) 8 inches (Radio) 11¹/₂ inches
 Operating Controls.. { Radio Panel..... (1) Phono — Music-Speech, (2) Volume — Power, (3) Tuning, (4) Range
 Selector, (5) Manual-Electric-Remote, (6) Fidelity
 Phono Compartment.. (1) Phonograph Volume, (2) Dynamic Amplifier, (3) Motor Switch, (4) Index
 Tuning Drive Ratios (manual)..... 10 to 1 and 50 to 1

Copyright, 1937, RCA Manufacturing Co., Inc.

Trademarks "Radiotron," "Magic Eye," "Magic Voice," "Magic Brain" Reg. U. S. Pat. Off. by RCA Mfg. Co., Inc.

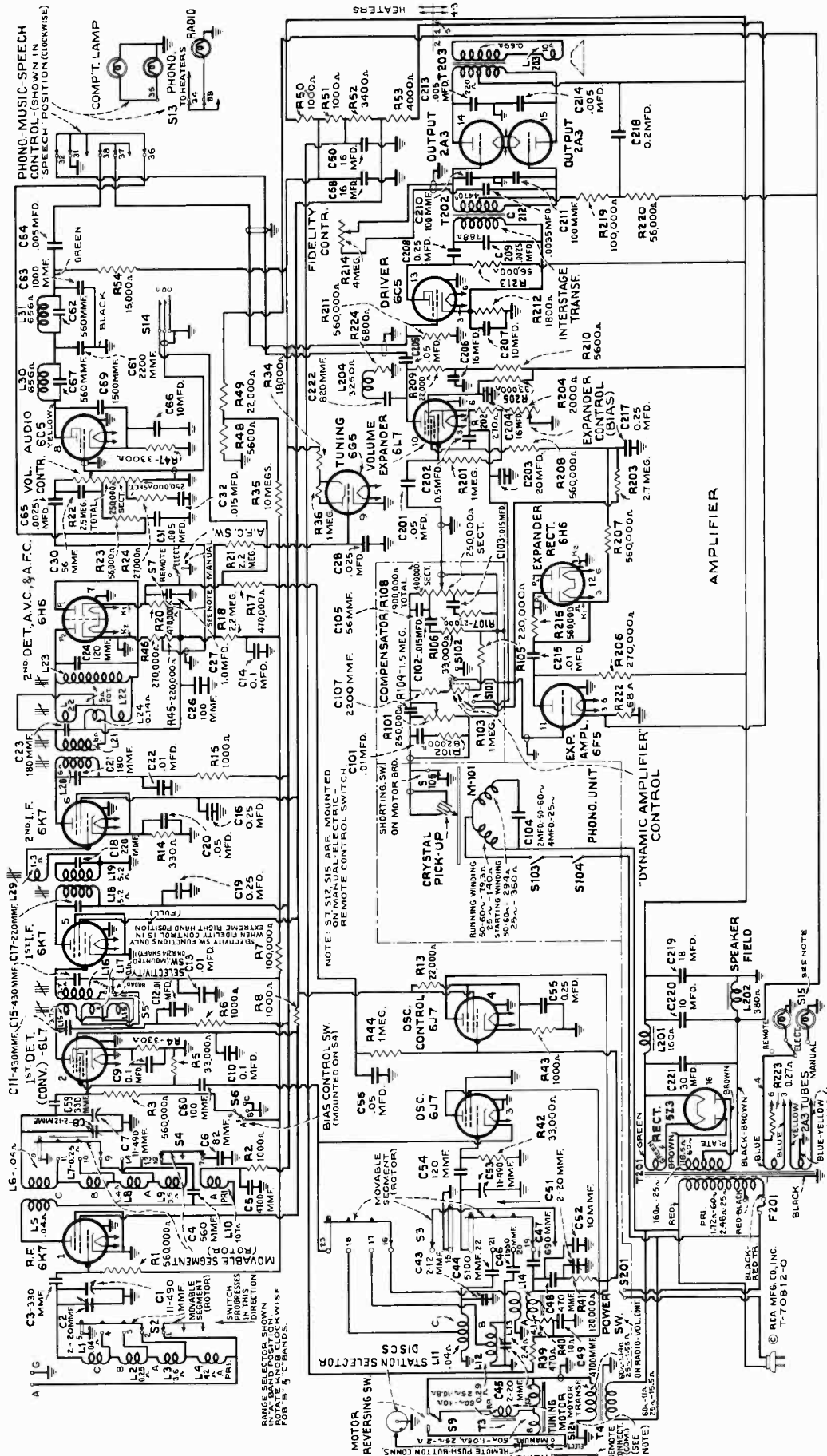

Figure 1—Schematic Circuit Diagram

General Description

The Model U-109 Radio-Phonograph Combination employs the latest developments in the art of record and radio reproduction. Features of design effected in the radio receiver include "Electric Tuning" with push-button operation; automatic frequency control; "cumulative-wound" antenna and detector coils; tuned r-f amplifier; magnetite-core adjusted i-f transformers and low-frequency "A" oscillator tracking; two-stage i-f amplifier; automatic volume control; "Magic Eye" tuning tube; plunger-type, air-dielectric trimming capacitors, two-point aural-compensated volume con-

trol; "Fidelity" control; "Music-Speech" control; and push-pull triode power output stage. Features of design pertinent to phonograph operation include a crystal pickup with top-loading needle socket; improved dynamic expander; automatic operation with either 10-inch or 12-inch records; and a separate two-point aural compensated volume control. A super-sensitive 12-inch electrodynamic loudspeaker with a high-frequency tone diffuser is used. In addition, this model has a cabinet incorporating the "Magic Voice".

Circuit Arrangement

The radio receiver circuit consists of an r-f amplifier stage, first-detector (converter) stage, separate heterodyne-oscillator stage, oscillator control stage, two i-f amplifier stages, diode-detector—automatic volume and frequency control stage, audio voltage-amplifier stage, tuning indicator "Magic Eye," audio driver stage, push-pull triode power-amplifier stage, and a full-wave rectifier. The phonograph circuit consists of a volume expander stage, expander amplifier stage, expander rectifier, audio driver stage, push-pull power amplifier stage, and full-wave rectifier.



Model U-109

The antenna and detector coils are constructed with a special type of winding ("cumulative") to provide increased sensitivity and selectivity on the "A" band. The "A," "B," and "C" sections on both coils are wound on single forms and are series connected. The range selector operates in such a manner that the correct portions are selected for the primary and secondary windings on each band. The "A," "B," and "C" oscillator sections are likewise wound on a single form but are connected so they operate separately. Undesirable interaction of unused windings with the tuned circuits is prevented by shorting out the proper sections with the range selector.

The intermediate-frequency amplifier consists of two RCA-6K7 tubes in a two-stage transformer-coupled circuit. The windings of all i-f transformers are resonated by fixed capacitors and are adjusted by molded magnetite cores to tune to 460 kc. A third winding, L17, in the first i-f transformer, closely coupled to the primary, L15, is placed in series with the main secondary L16 when the fidelity control switch S5 is thrown to "broad" position (see figure 1), thereby increasing the coupling between the primary and secondary circuits with a consequent broadening of the band width of the i-f amplifier, permitting higher fidelity reception.

The function of the automatic-frequency-control circuit is to automatically change the frequency of the heterodyne oscillator so that the correct i-f frequency is formed for the i-f amplifier. The circuit consists essentially of an i-f discriminator which, as the name implies, discriminates or furnishes control voltage of the correct polarity to an oscillator frequency-control tube for generated i-f carrier frequencies slightly above and below 460 kc, or the frequency to which the i-f amplifier is tuned.

The plate circuit of the RCA-6J7 oscillator control tube is caused to act as an apparent variable inductance in parallel with the "A" band oscillator tuned circuit of which coil L14 is a part. The series combination of resistor R41 and the oscillator control-tube grid to cathode capacitance is also in parallel with the oscillator tuned circuit. Since the resistance of R41 is many times greater than the reactance of the grid-cathode capacitance, at the oscillator frequency, the r-f current through the combination will be practically in phase with the r-f voltage across the oscillator tuned circuit. However, the r-f voltage impressed across the grid-cathode capacitance section of the combination will lag the r-f voltage across the combination, or the tuned circuit, approximately 90 degrees. The grid-cathode r-f voltage will be amplified by the control tube but will be shifted an additional 180 degrees (grid and plate voltages of all tubes are always opposite in phase) so that the amplified r-f voltage appearing across the plate circuit will now lead the voltage across the combination or the tuned circuit by 90 degrees, or, in other words, the control tube is acting as an equivalent shunt inductance. The amount of this action is determined by the amplification of the tube, which in turn is governed by the grid-cathode bias voltage. In operation a residual bias is developed across the cathode resistor R43. The d-c control grid voltage is fed to the control grid from the discriminator circuit through resistor R44. If this voltage is negative with respect to ground, the amplification of the control tube will be decreased, the apparent plate circuit inductance of the tube increased, which will lower the frequency of the oscillator tube. The converse will occur when the grid voltage is positive with respect to ground.

The action of the discriminator circuit depends upon the fact that a 90-degree phase difference exists between the primary and secondary potentials of a double-tuned loosely-coupled transformer when the resonant frequency is applied and that this phase difference varies as the applied frequency varies; i.e., the maximum resultant response voltage across the primary and secondary windings connected in series will occur at a frequency either lower or higher in frequency than the frequency to which the individual windings are resonated, respectively depending on whether the windings are connected series aiding or opposing.

The discriminator, or fourth i-f transformer, consists of the primary winding, L24, which is a part of the third i-f transformer secondary tuned circuit (tuned to 460 kc) and the center-tapped secondary, L22. The upper and lower halves of L22 may be considered as two secondary coils, the upper series opposing and the lower series aiding the primary, L24. The magnetite core in L22 is inserted to inductively balance the two halves. The function of coil L23 (magnetite core adjusted), in parallel with L22, is to tune the secondary to 460 kc. Therefore, the maximum voltage will be applied to diode circuit P₂K₂, R46, and R45 when the i-f signal frequency is above 460 kc and to the diode circuit P₁K₁ and R20 when the i-f signal frequency is below 460 kc. Resistor sections R46-R45 and R20 are connected in series between ground and a point leading to the oscillator control tube grid.

D-c voltages, resulting from diode rectification, across section R46-R45 and section R20 are always in opposition, consequently the oscillator control-tube grid-bias voltage is a differential amount, depending upon the i-f signal strength and its frequency deviation from the nominal value of 460 kc. The polarity of this differential oscillator control-tube grid-bias, with respect to ground, depends on whether the i-f signal frequency is above or below 460 kc, but is always in the direction which will bring the generated i-f frequency nearer to 460 kc. A-f-c action is automatically eliminated for "manual" tuning by grounding diode cathode K₁ through switch S7. A-v-c voltage and audio signal components are developed across resistor section R46-R45. The audio component is taken from R46.

The dynamic volume expander is used with the phonograph so that greater volume-range reproduction may be realized from disc recordings. The gain is varied by means

of the volume expander in direct proportion to the average intensity of the recorded sound. To accomplish this, the expander control R103 in series with R104 and R105 is placed in shunt with the phonograph volume control R108, and the arm of the expander control is connected to the control grid of the RCA-6F5 expander amplifier. The audio voltage applied to this tube is amplified and applied to diode plate P1 of the RCA-6H6 expander rectifier through capacitor C215. The rectified current develops a voltage across resistor R215 which is applied to the No. 3 grid of the RCA-6L7 volume expander and varies the amplification of this tube so that the gain will be increased for loud passages and decreased for soft passages. The volume expander circuit is arranged so that there is no appreciable change of gain, with an average record, between the minimum expansion (second dot) and "Off" positions of the "Dynamic Amplifier" control.

Service Data

The various diagrams of this booklet contain such information as will be needed to isolate causes for defective operation if such develops. The ratings of the resistors, capacitors, coils, etc., are indicated adjacent to the symbols signifying these parts on the diagrams. Identification titles such as R1, L1, C1, etc., provide reference between the illustrations and Replacement Parts List. The coils, transformer windings, and reactors are rated in terms of d-c resistance to permit continuity checks.

Precautionary Lead Dress.—(1) Bus lead from oscillator coil directly to ground must be as short as possible for correct alignment, (2) bus lead from range switch S3 to oscillator section C53 of variable condenser should be 1½ inches long for correct alignment, (3) bus lead from detector coil to range switch S4 must be as short as possible for correct

alignment, (4) bus lead from detector coil to detector section C7 of variable condenser should be 2½ inches long for correct alignment, (5) detector trimming capacitor C8 lead should connect directly to variable condenser C7, (6) bus lead from antenna section of range switch S2 to chassis ground lance must be as short as possible, (7) bus lead from antenna coil to range switch S2 should be 2¼ inches for correct alignment, (8) bus lead from antenna coil to antenna section C1 of variable condenser must be 3¾ inches over all with ½ inch bend at coil end for correct alignment, (9) resistors R13, R41, R43, and R44 in the oscillator control tube circuit must be kept free of other component parts for satisfactory operation of the a-f-c circuit, (10) filament leads should all be twisted to reduce hum pickup, (11) filament leads should be dressed away from the terminal

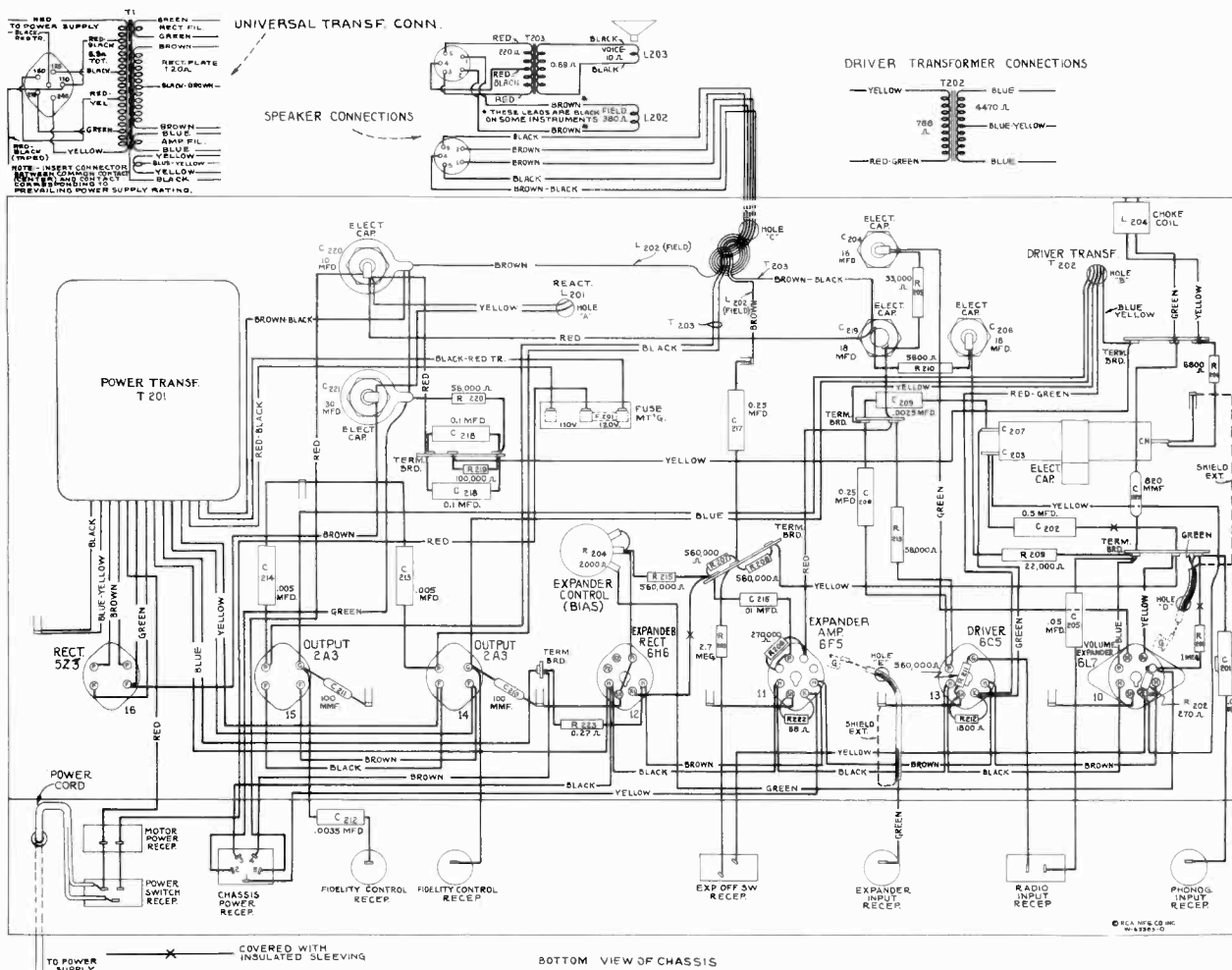
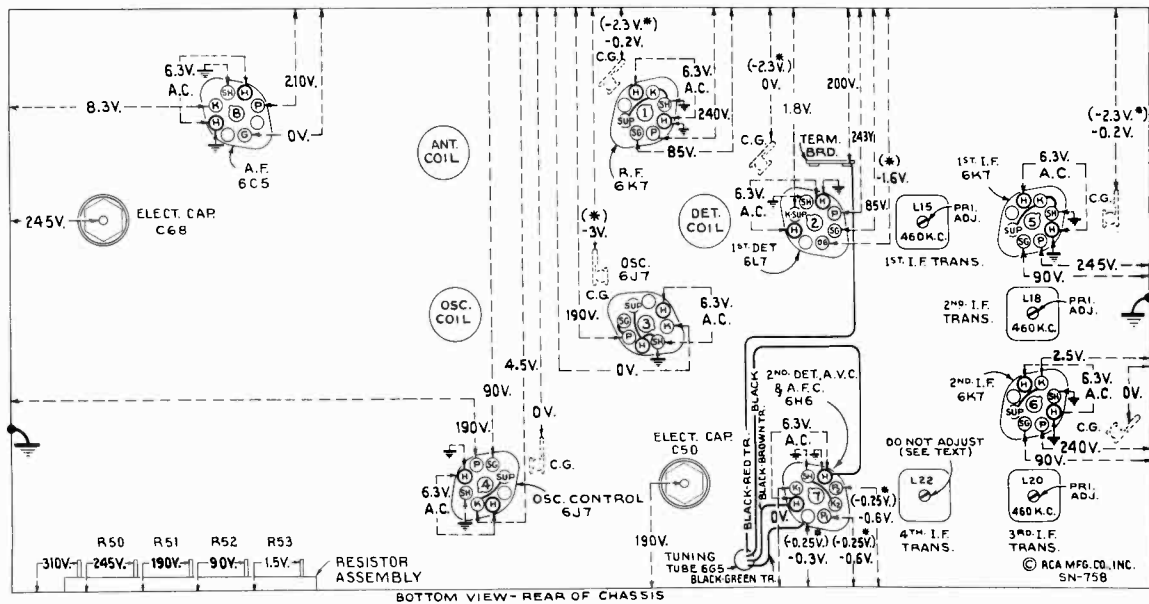

Figure 3—Power Amplifier Chassis Wiring Diagram

board near the 4th i-f transformer, (12) lead from the range switch S3 to the oscillator cathode socket terminal should be dressed under bus wire on socket to hold this lead down close to chassis.

Loudspeaker.—Two types of loudspeakers are used which will be referred to as types 1 and 2. In type 1 the cone centering diaphragm is cemented to a fixed ring, while in type 2 the centering diaphragm is cemented to an adjust-

able ring. Replacement of cone in either type is identical. Centering of cone for type 1 loudspeaker is made with three narrow celluloid or paper feelers after first removing the front dust cover and cutting free the cone centering diaphragm. The dust cover may be removed by a light application of acetone, using care not to allow the acetone to flow into the air gap. The centering diaphragm should be cemented in place after placement of feelers. Sufficient time



Receiver

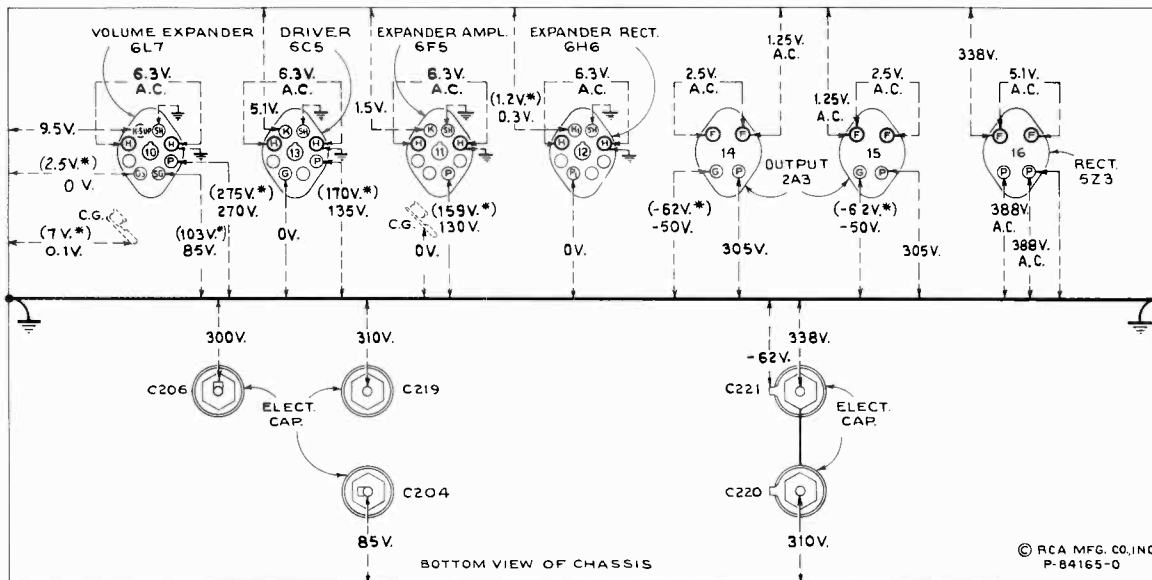

Power Amplifier

Figure 4—Radiotron Socket Voltages, Coil, and Trimmer Locations

Measured at 115 volts, 60-cycle supply—Tuned to approximately 1,000 kc ("Broadcast")—"Manual" control—No signal being received—Both volume controls minimum—"Dynamic Amplifier" control "off"—Speech-Music—Phono. and Fidelity controls optional.

Note: Two voltage values are shown for some readings. The value shown in parentheses with asterisk () indicates operating conditions without voltmeter loading. The other value (generally lower) is the actual measured voltage and differs from the value shown in parentheses because of the additional loading of the voltmeter.*

Voltage values as specified should hold within $\pm 20\%$ when the receiver is normally operative at its rated line voltage. To duplicate the conditions under which the voltages were measured requires a 1,000-ohm-per-volt d-c meter, having ranges of 10, 50, 250 and 500 volts. Use the nearest range above the specified measured voltage. A-c voltages were measured with a corresponding a-c meter.

should be allowed for the ambroid to set before removing feelers. Use ambroid to replace dust cover. Centering of cone for type 2 loudspeaker differs only in that it is not necessary to cut free the centering diaphragm, adjustment being made in the usual manner by means of screws on the adjustable cone centering ring.

Dynamic Amplifier Adjustment

It is essential that correct voltages and currents exist at the RCA-6L7 volume expander stage in order that the expanding function may take place in the proper manner. A screw-driver adjustment is accordingly provided to regulate the RCA-6L7 control grid No. 3 bias to the correct operating value. Two methods of adjustment are applicable. Either method requires a normal voltage of 310 volts across the filter output (electrolytic capacitor C220 to chassis). The one to be preferred (a) requires the use of an RCA Stock No. 9633 Beat-Frequency Oscillator or the equivalent, a 22-ohm resistor, two 120-ohm resistors, and a 1,000-ohm-per-volt a-c voltmeter (rectifier type) having ranges of 1, 5, and 10 volts. The less accurate method (b) requires the use of an RCA Stock No. 12353 Split-Plate Adapter, and a suitable d-c milliammeter. Both of these procedures are outlined below. It is necessary to turn the "Phono-Music-Speech" control to "Phono" position (clockwise) during this adjustment.

CAUTION: Before using either method, be sure that power-supply fuse is in proper position for the line voltage.

(a) **Preferred Method.**—Turn power switch off. Connect one 22-ohm and two 120-ohm resistors in series between the beat-frequency oscillator terminals (upper "250" and "CT") with the 22-ohm resistor connected to "CT." Calibrate the beat-frequency oscillator, adjust it to 1,000 cycles, and reduce its output. Connect the 1,000-ohm-per-volt a-c voltmeter (1-volt range) to the beat-frequency oscillator terminals (upper "250" and "CT"). Remove male plugs on "Phono Input Cable" and "Exp.-Off Switch Cable" from the apron of the dynamic amplifier (see figure 10). Connect a lead

through a 0.1 mfd. capacitor from the grid cap of the RCA-6L7 (tube No. 10, grid-cap lead in place) to the junction of the 22-ohm and 120-ohm resistors. Connect beat-frequency oscillator terminal "CT" to the dynamic amplifier chassis.

Adjust beat-frequency oscillator output until the voltmeter reads exactly 1.0 volt. Remove the voltmeter leads from beat-frequency oscillator terminals without disturbing oscillator adjustments. Set the voltmeter to its 5-volt range and connect it across the loudspeaker voice coil.

Set the "Dynamic Amplifier" control to extreme counter-clockwise position and "Fidelity" control to extreme clockwise position. Turn on power switch and allow a few minutes for the instrument to become stabilized. Adjust the expander-bias control R204 (screw-driver adjustment top-center amplifier chassis, see figure 7) until the voltmeter reads 2.4 volts.

To check the operation of the volume expander, first change the voltmeter to its 10-volt range (leaving meter attached to voice coil) and then connect a lead from the junction of the two 120-ohm resistors to the grid cap of the RCA-6F5 expander amplifier (grid-cap lead removed). The voltmeter should now read from 6 to 9 volts if the expander is operating properly.

After replacing the "Exp.-Off Switch Cable"—plug in amplifier, turning "Dynamic Amplifier" control to "Off" position, removing lead from junction of the two 120-ohm resistors, and replacing the grid-cap lead on the RCA-6F5 tube, the voltmeter should read approximately 4 volts.

(b) **Alternate Method.**—Turn power switch off. Place RCA Stock No. 12353 Split-Plate Adapter under the RCA-6L7 volume expander. Connect a suitable d-c milliammeter to the adapter. Turn both the "Phonograph Volume" and "Dynamic Amplifier" controls to their extreme counter-clockwise positions and remove "Exp.-Off Switch Cable"—plug from apron of the dynamic amplifier (see figure 10). Turn on power switch and allow a few minutes for the instrument to become stabilized. Adjust "Expander Bias" control R204 to give one milliampere of plate current with no signal input to the dynamic amplifier.

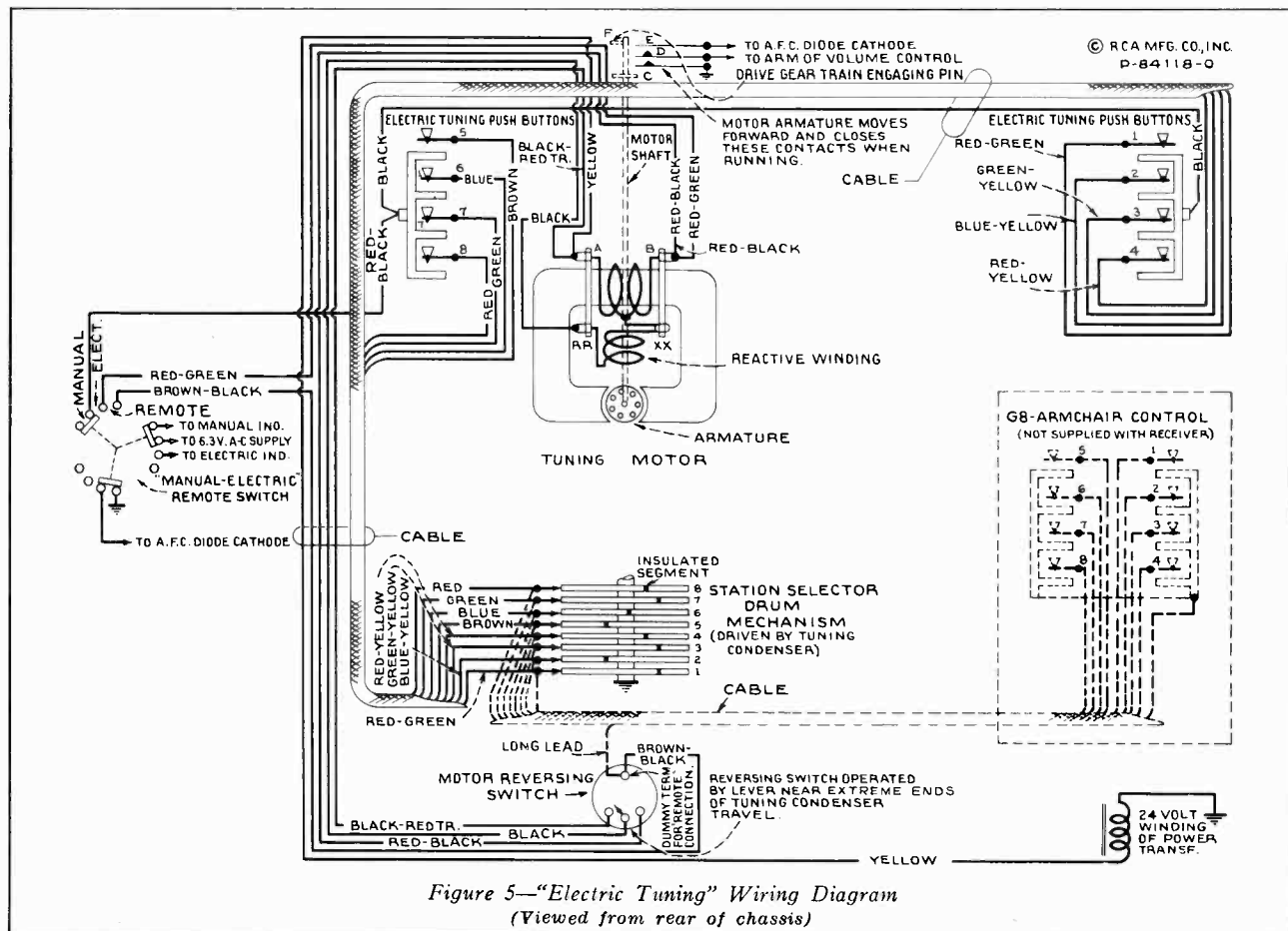

Figure 5—"Electric Tuning" Wiring Diagram
(Viewed from rear of chassis)

ALIGNMENT PROCEDURE

Calibrate the tuning dial by adjusting dial pointer to the left ends of horizontal calibration lines with the gang tuning-condenser plates in full-mesh position. This is a screw-driver adjustment.

The "Manual-Electric-Remote" switch should be turned to "Manual" (clockwise) during alignment unless otherwise specified.

CAUTION.—The magnetite core screw L22 on the bottom of the 4th i-f transformer has been accurately adjusted, for an exact electrical balance of coil L22 to center tap, during manufacture and **should not be disturbed**. However, if for any reason the adjustment has been moved from its original position, it will be necessary to mechanically adjust this screw until the end of the stud protrudes exactly $\frac{1}{8}$ of an inch (four threads exposed) above the brass bushing prior to any alignment operations.

Perform alignment in proper order, tabulated below, starting with No. 1 and following all operations across, then No. 2, etc. A-f-c discriminator adjustments should follow r-f

and i-f adjustments tabulated below. Adjustment locations are shown on figures 4 and 6.

Cathode-ray alignment is preferable; the connections to the chassis are shown on figure 2. If an output indicator is used, connect it across the loudspeaker voice-coil and advance the receiver volume control to full-volume position.

Connect the "low" output terminal of the test oscillator to the receiver chassis for all alignment operations. Regulate the output of the test oscillator so that minimum signal is applied to the receiver to obtain an observable output indication. This will avoid a-v-c action.

The term "Dummy antenna" means the device which must be connected between the "high" test-oscillator output and the point of connection to the receiver in order to obtain ideal alignment. "No signal, 550-750 kc" means that the receiver should be tuned to a point between 550 and 750 kc where no signal or interference is received from a station or local (heterodyne) oscillator.

For further details on alignment, refer to booklet "RCA Victor Receiver Alignment."

| Order of Alignment | Test Oscillator | | | Range-Selector | Receiver Dial Setting | Circuit to Adjust | Adjustment Symbols | Adjust to Obtain |
|--------------------|---|---------------|-------------------|----------------|-----------------------|-------------------|--------------------|--------------------------------|
| | Connection to Receiver | Dummy Antenna | Frequency Setting | | | | | |
| 1 | — | — | — | — | — | 4th I-F Trans. | L23 | Turn Extreme Counter-clockwise |
| 2 | 6K7 I-F Grid Cap | .001 Mfd. | 460 kc | "A" Left | No Signal 550-750 kc | 3rd I-F Trans. | L20 and L21 | Max. (peak) |
| 3 | 6K7 I-F Grid Cap | .001 Mfd. | 460 kc | "A" | No Signal 550-750 kc | 2nd I-F Trans. | L18 and L19 | Max. (peak) |
| 4 | 6L7 Det. Grid Cap | .001 Mfd. | 460 kc | "A" | No Signal 550-750 kc | 1st I-F Trans. | L15 and L16 | Max. (peak) |
| 5 | Ant. | 300 Ohms | 20,000 kc | "C" Right | 20,000 kc | "C" Osc. | C43 | Max. (peak)* |
| 6 | Ant. | 300 Ohms | 20,000 kc | "C" | Rock thru 20,000 kc | "C" Det. | C8 | Max. (peak)† |
| 7 | Ant. | 300 Ohms | 20,000 kc | "C" | 20,000 kc | "C" Ant. | C2 | Max. (peak)‡ |
| 8 | Ant. | 300 Ohms | 6,000 kc | "B" Center | 6,000 kc | "B" Osc. | C45 | Max. (peak)* |
| 9 | Ant. | 200 Mmfd. | 600 kc | "A" Left | 600 kc | "A" Osc. | L14 | Max. (peak) |
| 10 | Ant. | 200 Mmfd. | 1,500 kc | "A" | 1,500 kc | "A" Osc. | C51 | Max. (peak) |
| 11 | Ant. | 200 Mmfd. | 600 kc | "A" | 600 kc | "A" Osc. | L14 | Max. (peak) |
| 12 | Ant. | 200 Mmfd. | 1,500 kc | "A" | 1,500 kc | "A" Osc. | C51 | Max. (peak) |
| 13 | Proceed to A-F-C Discriminator Adjustments Outlined Below | | | | | | | |

* Use minimum capacity peak if two peaks can be obtained.
 † Use maximum capacity peak if two peaks can be obtained.
 ‡ After this adjustment, check for image signal by shifting receiver dial to 19,080 kc.

A-F-C Discriminator Adjustments.—These adjustments are rather critical and should be performed with extreme care. Improper adjustment may result in complete failure of the oscillator control tube to function or else may cause it to detune the oscillator instead of tuning it to the signal. It is assumed that the magnetite core adjusting screw L23 (top of 4th i-f transformer) has been turned all the way out (extreme counter-clockwise) during the preceding tabulated adjustments. Adjustments are as follows: Remove spring "N" on link and arm assembly which connects the "Manual-Electric-Remote" switch shaft to the throw-out gear bracket. Turn "Fidelity" control counter-clockwise. Connect antenna

to receiver antenna "A" terminal. With the "Manual-Electric-Remote" switch in "Manual" (clockwise) position, tune in a strong local station near 600 kc or the low-frequency end of the "A" band as accurately as possible by means of the tuning tube "Magic Eye." The most accurate adjustment will be obtained by adjusting the "vernier" tuning knob mid-way between the two points where the eye just appears to start to open. This will place the generated i-f carrier signal frequency exactly in the center of the i-f amplifier response curve (should be 460 kc if i-f amplifier was properly aligned) and is the frequency to which the a-f-c discriminator (4th i-f transformer) should be tuned to resonance. Without dis-

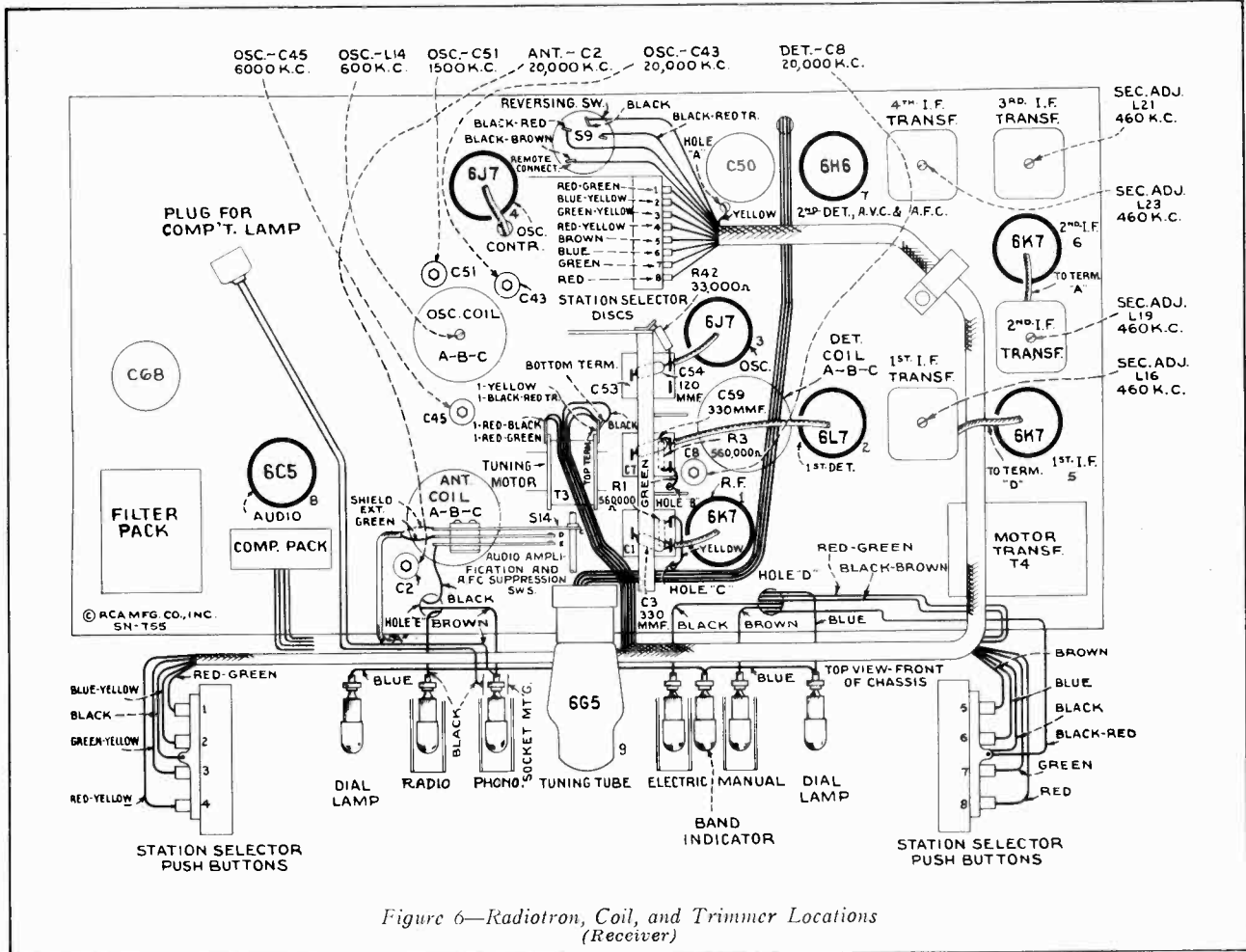

Figure 6—Radiotron, Coil, and Trimmer Locations (Receiver)

turbing any of the receiver adjustments, place the "high" test-oscillator lead about 3/4 of an inch from the grid cap lead of the RCA-6K7, 1st i-f amplifier tube, adjust the test-oscillator output to maximum, turn test-oscillator "Modulation" off, and carefully zero-beat the test-oscillator frequency (approximately 460 kc) with the i-f carrier signal. Avoid placing the test-oscillator lead nearer to the grid cap lead

grounding antenna "A" terminal to chassis in order to increase the loudness of the beat note sufficiently for accurate zero-beat adjustment.

Throw "Manual-Electric-Remote" switch to "Electric" (center) position. A high whistle or beat note will now be

Radiotron Cathode Current Readings

Measured with Milliammeter Connected at Tube Socket Cathode Terminals Under Conditions Similar to Those of Voltage Measurements

| | |
|--|-----------|
| (1) RCA-6K7—R-F Amp. | 5.0 ma. |
| (2) RCA-6L7—1st Det. | 6.0 ma. |
| (3) RCA-6J7—Osc. | 8.5 ma. |
| (4) RCA-6J7—Osc. Control | 1.2 ma. |
| (5) RCA-6K7—1st I-F Amp. | 6.0 ma. |
| (6) RCA-6K7—2nd I-F Amp. | 7.5 ma. |
| (7) RCA-6H6—2nd Det., A.V.C. and A.F.C. | — ma. |
| (8) RCA-6C5—1st A-F Amp. | 2.5 ma. |
| (9) RCA-6G5—Tuning Tube. | 2.5 ma. |
| (10) RCA-6L7—Volume Expander | 9.5 ma. |
| (11) RCA-6F5—Expander Amp. | 0.6 ma. |
| (12) RCA-6H6—Expander Rectifier | — ma. |
| (13) RCA-6C5—A-F Driver. | 2.9 ma. |
| (14) RCA-2A3—Output | 43 ma. |
| (15) RCA-2A3—Output | 43 ma. |
| (16) RCA-5Z3—Rectifier | 168 ma.** |

(** Cannot be measured at socket)

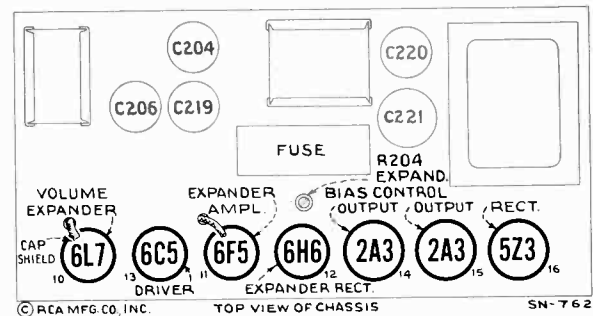

Figure 7—Radiotron Locations (Power Amplifier)

than specified above, as doing so will tend to detune the i-f amplifier. It may be necessary to reduce the local station signal, during this operation, by shortening antenna lead or

heard. Turn the magnetite core screw L23 (top of 4th i-f transformer) slowly clockwise. As this screw is turned, the beat note will first increase to a high audio frequency and will then decrease to a zero-beat and then increase in frequency again. The point of exact zero-beat is the position for correct adjustment of the discriminator. Zero-beat should also still exist when the "Manual-Electric-Remote" switch is thrown back to "Manual" position. The adjustment is now complete and may be checked by slightly detuning with the "Manual-Electric-Remote" in "Manual" position, switching to "Electric" position, and noting the oscillator pull-in. Replace spring "N."

ELECTRIC TUNING

Principle of Operation

The electric tuning mechanism consists essentially of a quick engaging and dis-engaging reversible electric motor, tuning condenser driving gear train, and eight mechanically interlocked (pushing one button releases all others) station selector push buttons respectively wired to eight adjustable station selector contactor discs (each with a motor stopping insulated segment) mounted on a drum which is direct-coupled to the gang tuning condenser shaft. The arrangement permits any one of eight pre-determined stations to be electrically tuned in by merely touching the correct push button.

The operation may be more readily understood by reference to figures 1, 5, and 8. When the motor is not energized, the armature is pushed to the rear or slightly out of the magnetic center by tension of contact spring "C" and the motor shaft is dis-engaged from the driving gear train. Pressing in any one of the eight push buttons will complete the motor circuit through a station selector contactor disc, assuming that the "Manual-Electric-Remote" switch is in "Electric" position and that the insulated segment in the contactor disc is not opposite its contactor. As the motor starts, the armature will be drawn forward, due to solenoid action, and the pin "F" on the end of its shaft will engage the arm "G" on the small main pinion gear, thereby driving the tuning mechanism. At the same time contact springs "E" and "D" will be grounded, causing suppression of audio amplification and automatic frequency control during the tuning cycle. The motor will continue to operate until the insulated segment in the selector disc breaks the motor circuit, whereupon spring "C" will instantly dis-engage the motor pin "F" from the arm "G" on the small pinion driving gear and open contacts "E" and "D." Pushing another button will cause the above mentioned cycle to be repeated except that

the motor will be interrupted by the insulated segment on a corresponding disc. The discs are individually adjustable on a drum mechanism, providing a choice of eight "Electric Tuned" "Broadcast" stations. The arrangement of the motor is such that its rotation will continue in the same direction regardless of the number of "Electric" tuning cycles until the tuning condenser approaches either full-out or full-in of mesh, whereupon lever "H" trips switch S9 which reverses the direction of rotation. A throw-out idler gear is link-coupled to the "Manual-Electric-Remote" control to disconnect the motor drive gear train when the control is thrown to "Manual" position.

Mechanism Adjustments

The electric tuning mechanism is designed to be as simple in construction and as fool proof in operation as is possible. In order to maintain the accurate results possible with this device care must be taken in effecting any repairs or adjustments. Reference should be made to figure 8 and the following:

A-F-C and A-F Amplification Suppression Switches.— This switch assembly is located on the motor bracket and closes due to solenoid action of motor armature. Before attempting switch adjustment, loosen "Tilt Compensating Spring" adjusting screws (rear of tuning-motor bracket) and move spring to extreme travel away from motor armature shaft. The tension of the long contact spring "C" is important in bringing about quick dis-engagement of the motor and in permitting the motor to pull into mesh with the drive mechanism. Normal adjustment is attained when the short springs "D" and "E" are aligned exactly straight with contact points separated approximately 1/32 of an inch and with the spring "C" spaced approximately 7/32 of an inch from spring "D" at the point of contact. If necessary, in order to obtain positive pull-in

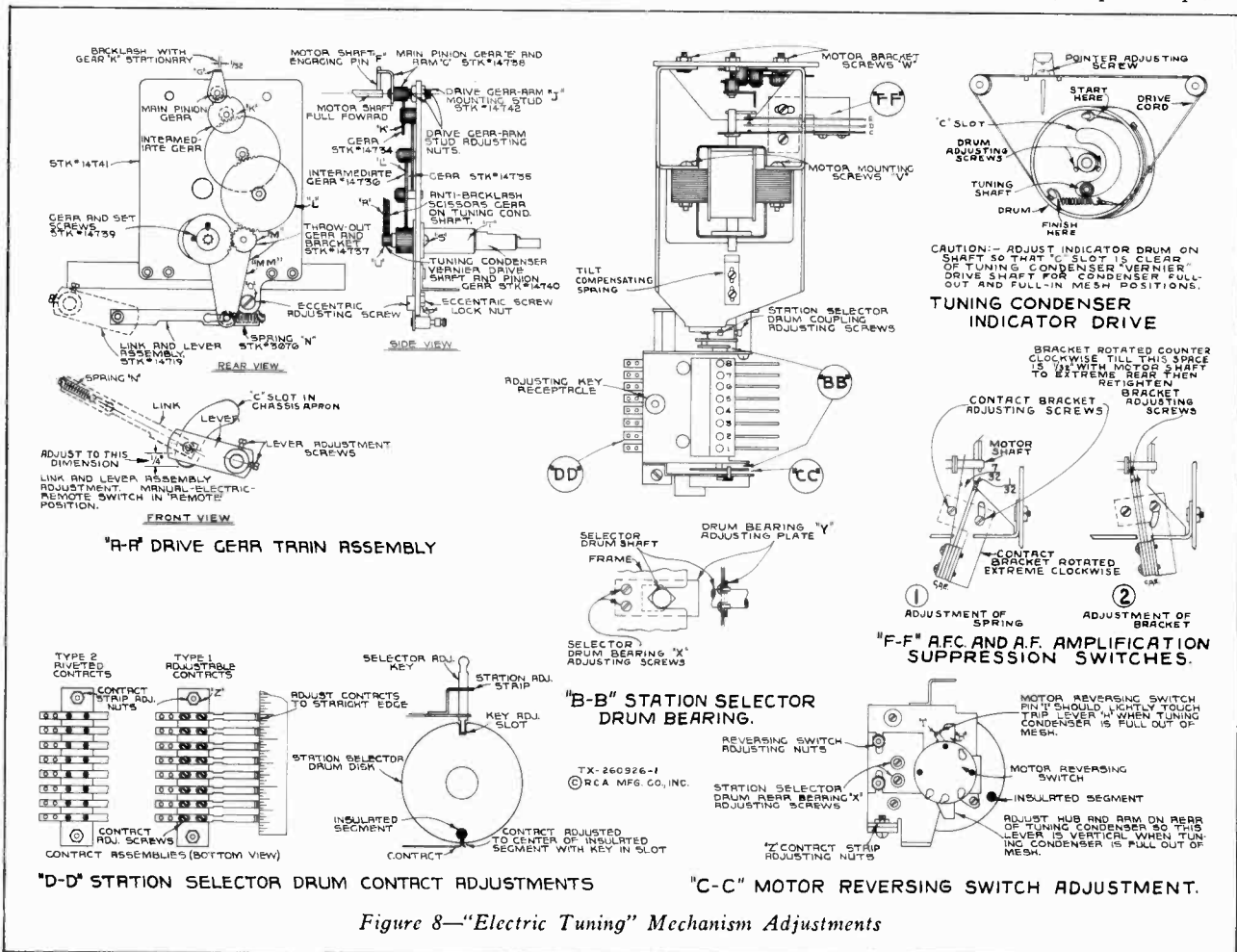

Figure 8—"Electric Tuning" Mechanism Adjustments

and quick dis-engagement of the motor, the tension of spring "C" should be increased or decreased by bending. This action should be checked with the front apron of the chassis raised two inches higher than the rear. Contacts of the switch must be kept clean. Crocus cloth or a relay burnisher may be used for this purpose.

Tilt Compensating Spring.—The function of this spring is to compensate for the force of gravity, acting to the rear, on the tuning motor armature when the chassis is tilted as mounted in cabinet. The "Tilt Compensating Spring" is located on the rear of the tuning-motor bracket. After completion of adjustment "A-F-C and A-F Amplification Suppression Switches," raise the front apron of chassis six inches higher than the rear, and then adjust spring by means of its elongated mounting holes until the pin "F" on the motor shaft will pull in and remain in mesh with the arm "G" on the pinion when a push button is pressed. This adjustment should be made with the lowest power-supply voltage that will be encountered at the installation.

Motor Reversing Switch.—It is necessary to automatically stop and reverse the drive motor before the tuning condenser reaches the ends of its travel. Approximately 175 degrees of sweep is required, and the reversal must take place above 1,700 kc and below 540 kc but not too near the limits of the scale. The coupling between the station selector drum and the tuning condenser shaft should be attached so that the reversing switch trip lever "H" is exactly vertical when the condenser is full-out of mesh. There should be 1/32 of an inch clearance between the end of the condenser shaft and the selector drum shaft. While the trip lever is in this position the reversing switch bracket should be adjusted by means of its elongated mounting holes until the switch pin "I" just lightly touches trip lever "H."

Main Pinion Gear.—Clearance between the small high-speed pinion gear "E" and the intermediate gear "K" determines the amount of mechanical noise produced. Correct adjustment will give approximately 1/32 of an inch movement of back lash at the end of pinion arm "G" when gear "K" is held stationary. Arm "G" must also be adjusted for correct mesh with motor shaft drive pin "F." With the motor shaft completely forward and pinion "E" tight against its front bearing, the pinion mounting stud "J" should be adjusted so that pin "F" meshes its full thickness with the rotating arm "G." An increase of this mesh will increase over travel on tuning while a decrease of mesh will decrease the over travel. The elongated hole in the front bracket allows sufficient movement of the mounting stud "J" to permit above mentioned gear mesh adjustment.

"Manual-Electric-Remote" Changeover.—(1) Link and lever adjustment—To properly line up the mechanical link between the switch shaft and throw-out gear bracket "MM," the set screws holding the link lever on the switch shaft must be loosened, the switch turned to the "Remote" position (extreme left) and the link lever revolved until the distance between the bottom of its link-connecting pin (extends through chassis apron) and the bottom of the "C" slot, in front apron of chassis, is exactly 1/4 of an inch. If this adjustment is not properly made, correct operation of "Electric" or "Remote" tuning will not result. (2) Throw-out Gear Adjustment—To obtain smooth operation on "Electric" or "Remote" positions it is important that the proper clearance is maintained between the throw-out gear "M" and the intermediate gear "L." With the "Manual-Electric-Remote" control thrown to "Remote" position (extreme left) adjust the mesh between these gears by means of the eccentric screw "O" and lock nut "P" on the throw-out gear bracket "MM" until there is approximately 1/64 of an inch backlash of gear "L" when gear "M" is held stationary.

Vernier Tuning.—In case it becomes necessary to remove tuning condenser drive shaft "T," it should be replaced by sliding anti-backlash gear "R" on condenser shaft apart so that compression amounting to one tooth on the gear is obtained in the springs. Adjust mesh of gear "R" with pinion gear "U" on vernier shaft before tightening screws "S" so that smooth tuning is obtained throughout the range.

Motor Alignment.—The motor shaft must be exactly aligned with the axis of the pinion gear with which it engages. This may be adjusted by loosening the mounting screws "V" of the motor and aligning shaft by sight. Correct alignment may be tested by slowly rotating motor and observing the relation between the pin "F" of the motor shaft and the arm "G" on the pinion. The relation of the two should

remain the same throughout the revolution. Additional movement for adjustment may be obtained by the motor bracket screws "W" if necessary.

Station Selector Drum.—(1) Bearing Adjustment—The selector drum may be removed by unscrewing the two bearing adjusting screws "X" on the front and rear bearings and sliding shaft out of slots on frame. To replace drum, the reverse procedure should be followed holding bearing adjusting plates "Y" firmly against the shaft and tightening adjusting screws. (2) Contact adjustment—Two types of contact strips are used. They are designated on figure 8, as types 1 and 2, on which the individual contacts are respectively adjustable and fixed. On type 1, the individual contacts should be adjusted by setting the end contact springs near the mid-position of their travel and aligning the remaining springs to them by means of a straight edge. Either type of contact strip should be adjusted to the selector drum by placing two selector adjusting keys in the station adjustment strip, positions 1 and 8, loosening contact strip adjusting nuts "Z" and shifting the contact strip until the end contacts are exactly centered on the respective disc insulating segments. More accurate adjustment may be made by silhouetting the point of contact with a piece of white paper held behind the contact. Adjustment will be facilitated by removing complete assembly from rear of tuning condenser by unscrewing the three mounting screws. Contacts and discs must be kept free of dirt, filings, and other extraneous matter.

Lubrication.—The dial pointer slide should be greased with petrolatum. This same lubrication should be applied lightly to all gear faces of the drive mechanism and sparingly with a cloth to the station selector discs. Any good household oil, such as "3-IN-ONE," is suitable for the motor shaft bearings. A light grade of engine oil should be used for all gear bearings. Medium viscosity engine oil, similar to "PYROL" (B), should be applied between the thrust washers on the motor shaft. "CASTORDAG," a mixture of graphite and castor oil, is recommended for use at the selector drum end-bearing slots and at the bearings of cable pulleys.

Station Adjustment

Any eight stations may be chosen for "Electric" tuning. Remove the two escutcheon plates from the side of the dial, place proper call letter labels in the celluloid windows, and replace escutcheons. Turn the power on and proceed to set up the "Electric" tuning as follows:

1. Set Range Selector to "Broadcast."
2. Turn "Manual-Electric-Remote" control to "Electric."
3. Turn Fidelity control counter-clockwise.
4. Press push button No. 1 and wait until station pointer comes to rest.
5. Turn the "Manual-Electric-Remote" control to "Manual."
6. Remove adjusting key from receptacle on top of station selector drum mechanism.
7. Insert key in position marked, "1" in station adjustment strip and push the key all the way down to properly fit in slot in disc.
8. Tune the receiver very carefully by means of the manual tuning knob and the "Magic Eye," to station chosen for No. 1.
9. Remove key.
10. Turn the "Manual-Electric-Remote" control to "Electric."

Button No. 1 is now properly set for "Electric" tuning. Proceed similarly for the other seven push buttons, matching each station on the dial with the same number on the station adjustment strip. Repeat the above steps but place the key respectively in positions 2, 3, 4, etc., and in each case tune to the proper station. Now when you press a button the desired station will be tuned in electrically.

Note.—In the event that all the push-button switches are locked "in" at once, they may be released by pressing either the upper left-hand or the lower right-hand push buttons (Nos. 1 or 8) in farther than would ordinarily be required.

Armchair Control

When a Model G-8 armchair control is attached to the receiver as shown in figure 5 it duplicates the action of the push buttons on the front panel when the "Manual-Electric-Remote" control is turned to "Remote" position.

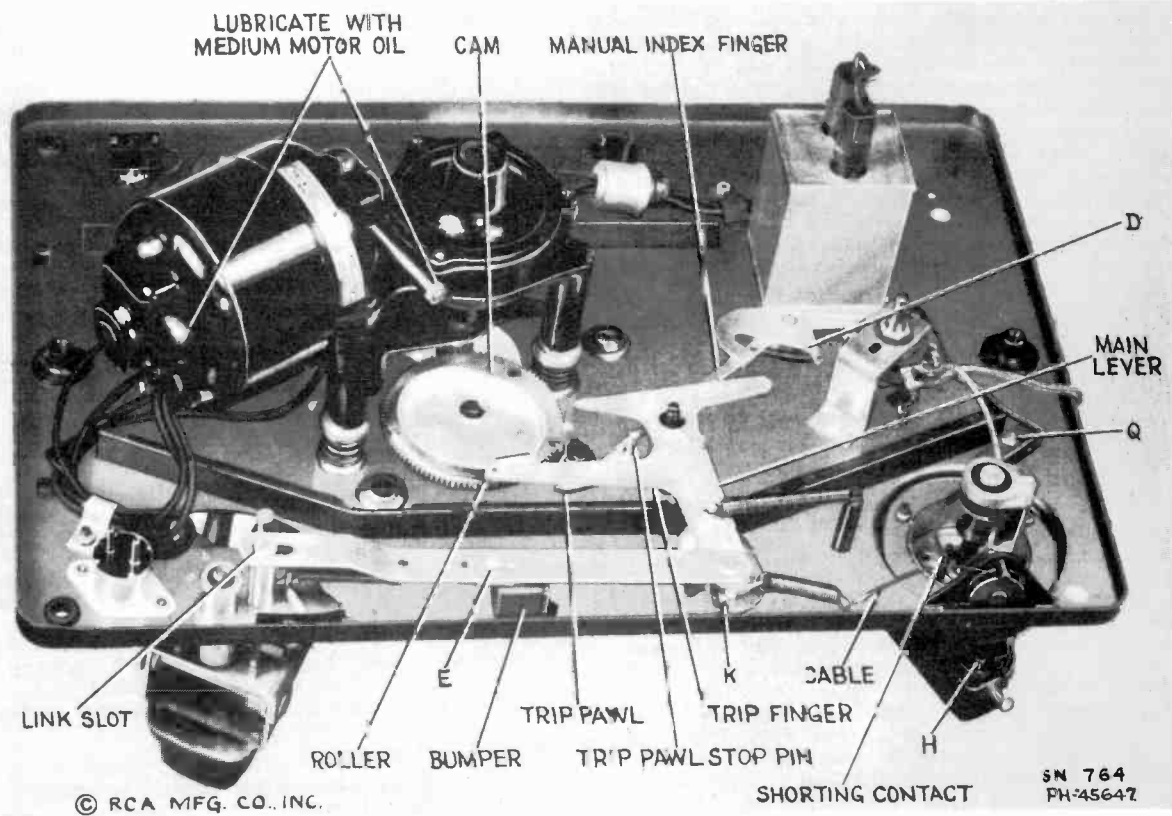
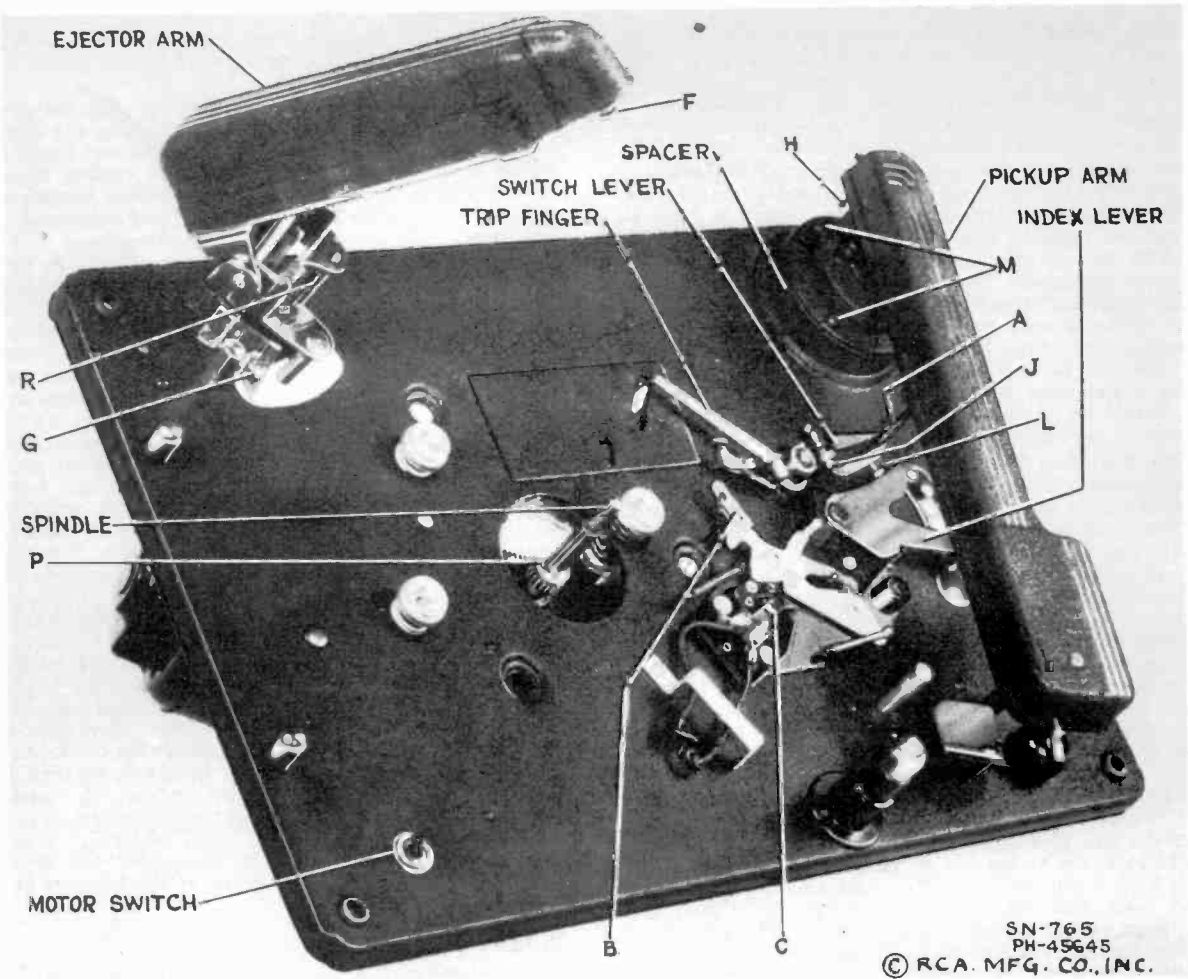

Figure 9—Automatic Record Changer Adjustments
(Top and bottom views)

AUTOMATIC RECORD CHANGER

The record changing mechanism is designed to be simple and fool-proof. Under normal operating conditions, service difficulties should be negligible. Occasionally, however, certain adjustments may be required. It is important to refrain from forcing the mechanism if there is a tendency to bind or jam, since bent levers and possibly broken parts may result.

Record Changer Adjustments

Mount motor-board on a level support. Remove turntable and cover at right of turntable. Adjustment locations are designated on figure 9 as A, B, etc. The adjustments are explained under corresponding symbols below. Perform adjustments in the following order:

A.—Trip rod "A" should be engaged in "Switch Lever" slot. Adjust trip rod "A" to obtain about $\frac{1}{8}$ of an inch clearance from motor-board.

B.—Adjust "B" to the position shown.

C.—With "Index Lever" in "Manual" position, "Pickup Arm" rotated to extreme left, and switch tripped to open contacts "C," adjust contact points "C" by bending the stiff contact arm until points are opened 10 to 30 thousandths of an inch.

D.—With "Index Lever" in "Manual" position, release set screw "D" and force "Manual Index Finger" as far as it will go towards "Trip Pawl Stop Pin." Tighten set screw.

E.—Adjust at "E" to provide approximately $\frac{1}{32}$ of an inch between outer end of "Link Slot" and screw when rubber "Bumper" is in contact with stop bracket.

F. and G.—Remove rubber silencer at "F" and adjust "F" and "G" so ejector tip "F" is in line with "Spindle." Longitudinal movement, with respect to "Ejector Arm," may be effected by loosening hex. head at "F." Lateral movement of "Ejector Arm" may be effected by adjustment "G."

H.—Adjust "H" so under side of pickup head can be raised $2\frac{1}{2}$ inches above motor-board.

J.—Adjust screw "J" until friction will just force "Trip Finger" to move "Trip Pawl" when "Index Lever" is in "12" inch position.

N.—Adjust needle pressure by turning screw under center of "Pickup Arm" so that a force of 72 grams (2.5 ounces) is required to lift needle from record. Hook scale under needle screw to measure force.

K.—Adjustment "N" must be performed prior to this adjustment. With a 12-inch record on turntable, turn on "Motor Switch," place "Index Lever" to "12" position and adjust "K" so that "Cable" tension will allow needle to lower slowly on start of record at completion of eject cycle. Turn "Motor Switch" off after eject cycle is completed and check to see that "Cable" is slightly loose when "Pickup Arm" is moved against "Spindle." Replace turntable and put a needle in "Pickup."

L.—Adjust "L" so needle will drop into center of smooth portion at the start of a 12-inch record when "Index Lever" is in "12" inch position and "Pickup Arm" is to extreme right.

M.—Loosen three screws "M" and rotate "Spacer" until pointer on "Spacer" is in line with screw to right of "Pickup Arm."

P.—Adjust turntable height by insertion or removal of thrust washers at "P" so ejector tip "F" will not eject bottom 12-inch record but will eject second from bottom record.

Q.—Adjust position of shorting switch at "Q" so switch closes when needle is just outside a 12-inch record.

R.—Adjust screw "R" upward just enough so that with one record on turntable and ejector tip "F" resting on record surface, there is $\frac{1}{32}$ of an inch clearance between screw "R" and "Ejector Arm."

Record Changer Service Hints

1.—"Ejector Arm" goes through normal cycle but does not eject records. Adjust "F" and "G." See that "Spindle" slides freely.

2.—Ejects bottom record. Lower turntable by removing thrust washers at "P."

3.—Ejects records properly down to second from bottom of pile. Raise turntable by placing thrust washers at "P."

4.—Eject cycle does not start after needle reaches eccentric groove. Adjust "J" (turn screw clockwise).

5.—Eject cycle starts before eccentric record groove is reached. Adjust "J" (turn screw counter-clockwise). Set "Index Lever" to "12" inch or "10" inch position after starting to play record. Do not jar motor-board during automatic operation.

6.—Lateral movement of "Pickup Arm" has no control over starting and stopping. Adjust clearance of rod "A." See that rod "A" engages in slot of "Switch Lever."

7.—Fails to eject top record of a pile because "Ejector Arm" strikes record in returning to center at end of eject cycle. Adjust screw "R" upward to provide greater incline so that roller in "Ejector Arm" will roll back during cycle.

8.—Pickup strikes record during eject cycle. Adjust "K" and "H."

9.—Starts playing record several grooves in from beginning or needle misses record entirely. Adjust "L."

10.—Needle falls on smooth portion at start of record but does not move into playing groove. Adjust "M." Check to see that motor-board is level.

11.—Automatic stop does not operate after needle reaches eccentric groove. Adjust "B" and "C."

12.—Motor does not re-start when "Pickup" is returned to rest position. Adjust "C." See that switch mechanism parts move freely and springs are functioning.

13.—Starts eject cycle although set for "Manual" operation. Adjust "D."

14.—Noise in loudspeaker while changing needles. Clean "Shorting Contact" and adjust "Q."

15.—"Wow" in record reproduction.—Instrument should be warmed to about 65° F. Ejector tip should be centered and free to rotate (adjustments "F" and "G"). There should be no solid particles on gear teeth or in grease; no tendency to bind. Turntable plate should be in dynamic balance and "Spindle" should be straight. Proper lubrication is important.

Lubrication.—Clean motor gear-box thoroughly before re-greasing. Apply less than a tablespoonful of a grease, such as "Cities Service No. 7035-A1" or "Koolmotor Universal Trojan No. 1," directly on gears taking care to get none in rotor bearings. Put medium motor oil (S.A.E. No. 30) in the oil holes. Cover main gear and cam of automatic mechanism with a light grease such as "Socony-Vacuum No. 2." Any good house-hold oil, such as "3-IN-ONE" is suitable for the ejector-tip "F" bearing.

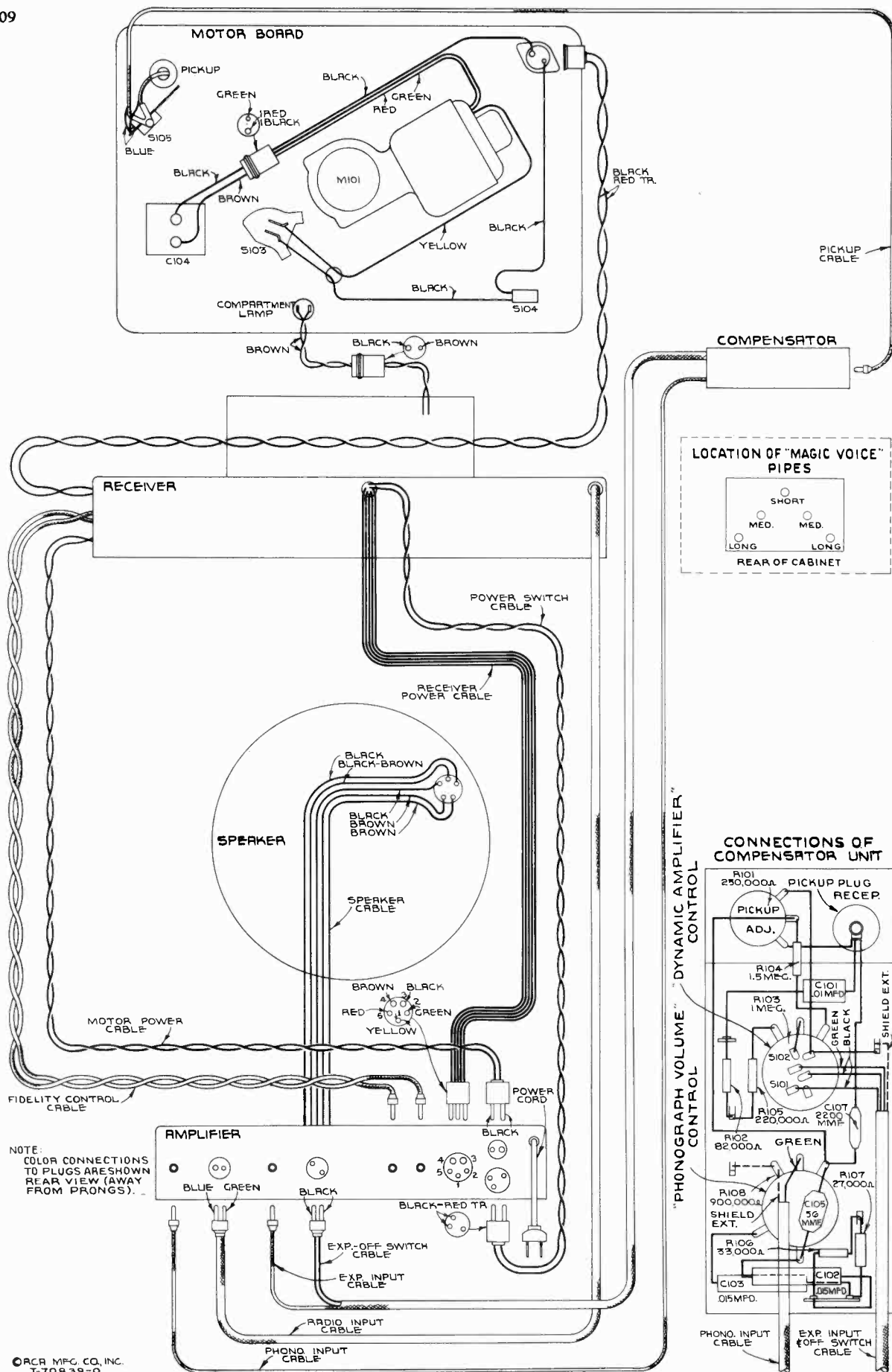

Figure 10—Assembly Wiring Diagram

REPLACEMENT PARTS

U-109

Insist on genuine factory tested parts, which are readily identified and may be purchased from authorized dealers.

| STOCK No. | DESCRIPTION | STOCK No. | DESCRIPTION |
|----------------------------|--|-----------------------------|---|
| RECEIVER ASSEMBLIES | | | |
| 14701 | Arm—Hub and arm for operating band indicator shutter—located on range switch shaft | 11300 | Resistor—33,000 ohms, carbon type, 1/10 watt (R42) |
| 14726 | Arm—Hub and arm, complete with set screws—connects station selector drum to rear of tuning condenser shaft | 13735 | Resistor—33,000 ohms, carbon type, 1/2 watt (R5) |
| 14517 | Board—Antenna and ground terminal board | 5145 | Resistor—100,000 ohms, carbon type, 1/2 watt (R7) |
| 5237 | Bushing—Variable condenser rubber mounting bushing | 30552 | Resistor—120,000 ohms, special, carbon type, 1/2 watt (R41) |
| 13656 | Button—Plug button for detector coil shield | 5158 | Resistor—220,000 ohms, carbon type, 1/2 watt (R45) |
| 14725 | Cable—Tuning tube cable and socket | 11323 | Resistor—270,000 ohms, carbon type, 1/2 watt (R46) |
| 12607 | Cap—Shield cap for first or second I.F. transformer | 11172 | Resistor—470,000 ohms, carbon type, 1/2 watt (R17, R20) |
| 12581 | Cap—Shield cap for third or fourth I.F. transformer | 11397 | Resistor—560,000 ohms, carbon type, 1/10 watt (R1, R3) |
| 11350 | Cap—Grid contact cap | 12013 | Resistor—1 megohm, carbon type, 1/10 watt (R36) |
| 12884 | Capacitor—Adjustable trimmer (long) (C2, C45, C51) | 13730 | Resistor—1 megohm, carbon type, 1/2 watt (R44) |
| 12714 | Capacitor—Adjustable trimmer (medium) (C8, C43) | 11626 | Resistor—2.2 megohms, carbon type, 1/2 watt (R18, R21) |
| 13200 | Capacitor—10 Mmfd. (C52) | 13732 | Resistor—10 megohms, carbon type, 1/2 watt (R35) |
| 12723 | Capacitor—56 Mmfd. (C30) | 14845 | Resistor—Voltage divider—comprising two 1,000 ohm, one 3,400 ohm and one 4,000 ohm sections (R50, R51, R52, R53) |
| 12813 | Capacitor—82 Mmfd. (C6) | 14695 | Rod—Tie rod for joining lockplate pawls on station selector push-button switches |
| 12720 | Capacitor—100 Mmfd. (C26, C60) | 4669 | Screw—No. 8-32 x 5/32 square head set screw for arm, Stock No. 14701, or link, Stock No. 14719, or drum, Stock No. 14693 |
| 12404 | Capacitor—120 Mmfd. (C24) | 12418 | Screw—No. 8-32 x 3/16 milled head set screw for gear, Stock No. 14739 |
| 12724 | Capacitor—120 Mmfd. (C54) | 14848 | Selector—Station selector drum mechanism—comprising station-selector contactor discs, spring contacts and motor reversing switch assembled in metal frame |
| 14712 | Capacitor—180 Mmfd. (C21, C23) | 14374 | Shield—Antenna or detector coil shield |
| 14711 | Capacitor—220 Mmfd. (C17, C18) | 14375 | Shield—Oscillator coil shield |
| 12952 | Capacitor—330 Mmfd. (C3, C59) | 12008 | Shield—I.F. transformer shield |
| 14710 | Capacitor—430 Mmfd. (C11, C15) | 14718 | Shutter—Band indicating shutter and arm assembly |
| 13052 | Capacitor—470 Mmfd. (C48) | 14696 | Slider—Indicator pointer holder and spring |
| 14724 | Capacitor—560 Mmfd. (C4) | 11488 | Socket—2-contact female socket for compartment lamp power cable |
| 14723 | Capacitor—690 Mmfd. (C47) | 11196 | Socket—8-contact 6K7, 6L7, 6J7, 6H6 or 6C5 Radiotron socket |
| 13762 | Capacitor—1,500 Mmfd. (C69) | 14114 | Socket—Dial or indicating lamp socket |
| 12729 | Capacitor—1,550 Mmfd. (C46) | 12007 | Spring—Retaining spring for core, Stock No. 12006 |
| 12897 | Capacitor—4,700 Mmfd. (C5, C49) | 3676 | Spring—Tension spring for link and lever, Stock No. 14719 |
| 14722 | Capacitor—5,100 Mmfd. (C44) | 13638 | Spring—Tension spring for cord, Stock No. 14699 |
| 13608 | Capacitor—.0025 Mfd. (C65) | 14694 | Spring—Tension spring for lockplate pawl on station selector push-button switches |
| 4838 | Capacitor—.005 Mfd. (C64) | 14742 | Stud—Mounting stud for gear and arm, Stock No. 14738 |
| 30103 | Capacitor Pack—Comprising one .005 Mfd., one .015 Mfd. capacitors, one 27,000 ohm and one 56,000 ohm resistors (C31, C32, R23, R24) | 14702 | Switch—"Manual-Electric-Remote" switch (S7, S12, S15) |
| 13138 | Capacitor—.01 Mfd. (C12, C13, C22) | 14844 | Switch—"Phono-Music-Speech" switch (S13) |
| 4870 | Capacitor—.025 Mfd. (C28) | 14732 | Switch—Motor reversing switch and mounting plate for station selector (S9) |
| 4886 | Capacitor—.05 Mfd. (C20, C56) | 14704 | Switch—Range switch (S2, S3, S4, S6) |
| 4839 | Capacitor—.1 Mfd. (C9, C10, C14) | 14728 | Switch—A-F-C and A-F amplification suppression switch (S14) |
| 12484 | Capacitor—.25 Mfd. (C16, C19, C55) | 14693 | Switch—Station selector button switch—comprising four contacts and corresponding lockplates, completely assembled on insulating strips |
| 12682 | Capacitor—.10 Mfd. (C66) | 14836 | Tone Control—"Fidelity" control (R214, S5) |
| 14773 | Capacitor—.16 Mfd. (C50, C68) | 14706 | Transformer—First I.F. transformer (L15, L16, L17, C11, C15) |
| 14372 | Coil—Antenna coil and shield (L1, L2, L3, L4) | 14707 | Transformer—Second I.F. transformer (L18, L19, L29, C17, C18) |
| 14414 | Coil—Detector coil and shield (L5, L6, L7, L8, L9, L10) | 14708 | Transformer—Third I.F. transformer (L20, L21, C21, C23) |
| 14713 | Coil—Oscillator coil and shield (L11, L12, L13, L14) | 14709 | Transformer—Fourth I.F. transformer (L22, L23, L24, C24) |
| 14727 | Condenser—3-gang variable tuning condenser, complete with gear train (C1, C7, C53) | 14834 | Transformer—Tuning motor transformer, 105-125 volts, 50-60 cycle (T4) |
| 14733 | Contact—Spring contact for engaging discs in station selector drum ("type 1" contact assembly) | 30102 | Transformer—Tuning motor transformer, 105-125 volts, 25-60 cycle (T4) |
| 30365 | Contact—Comprising eight spring contacts assembled on insulating strip for engaging discs in station selector drum ("type 2" contact assembly) | 14835 | Volume Control—Radio volume control and power switch (R22, S201) |
| 14699 | Cord—Indicator pointer drive cord | AMPLIFIER ASSEMBLIES | |
| 12006 | Core—Adjustable core and stud for I.F. transformers | 14272 | Bracket—Expander control mounting bracket |
| 12800 | Core—Adjustable core and stud assembly for oscillator coil | 12511 | Cap—Grid contact cap |
| 14717 | Dial—Station selector dial scale | 12110 | Cap—Top shield cap for 6L7 Radiotron |
| 14740 | Drive—Tuning condenser vernier drive shaft and pinion gear | 12720 | Capacitor—100 Mmfd. (C210, C211) |
| 14698 | Drum—Drum for indicator drive cord—fastens on tuning condenser shaft | 14831 | Capacitor—820 Mmfd. (C222) |
| 14731 | Drum—Station selector drum rotor—comprising eight station-selector contactor discs assembled on shaft | 5107 | Capacitor—.0025 Mfd. (C209) |
| 13612 | Filter Pack—Comprising two 0.43 Henry chokes, two 560 Mmfd., one 2,200 Mmfd. and one 1,000 Mmfd. capacitors (L30, L31, C61, C62, C63, C67) | 5005 | Capacitor—.0035 Mfd. (C212) |
| 14738 | Gear—Drive pinion gear and arm | 4838 | Capacitor—.005 Mfd. (C213, C214) |
| 14739 | Gear—Drive gear and set screws—located on tuning condenser knob shaft | 13138 | Capacitor—.01 Mfd. (C215) |
| 14734 | Gear—Intermediate gear assembly—comprising one .749" O.D.—34 tooth-gear and one .291" O.D.—12 tooth pinion assembled | 4886 | Capacitor—.05 Mfd. (C205) |
| 14735 | Gear—Intermediate gear assembly—comprising one 1.541" O.D.—72 tooth-gear and one .291" O.D.—12 tooth pinion assembled | 4518 | Capacitor—.05 Mfd. (C201) |
| 14736 | Gear—Intermediate gear assembly—comprising one 1.541" O.D.—72 tooth-gear and one hub assembled | 4839 | Capacitor—.01 Mfd. (C218, two in parallel) |
| 14737 | Gear—Throw-out gear and bracket | 12484 | Capacitor—.025 Mfd. (C208, C217) |
| 14716 | Holder—Dial scale holder and reflector, complete with holding springs for band indicating shutter | 12741 | Capacitor—.05 Mfd. (C202) |
| 14715 | Indicator—Station selector indicator pointer and support | 11203 | Capacitor—10 Mfd. (C220) |
| 5226 | Lamp—Dial or indicating lamp | 5212 | Capacitor—16 Mfd. (C204, C206) |
| 14719 | Link—Link and lever assembly | 11496 | Capacitor—18 Mfd. (C219) |
| 14730 | Motor—Tuning drive motor for 25 cycle models only (M1) | 14273 | Capacitor—Pack comprising one 20 mfd. and one 10 mfd. sections (C203, C207) |
| 14729 | Motor—Tuning drive motor for 60 cycle models only (M1) | 14531 | Capacitor—25 Mfd. (C221) |
| 14028 | Nut—Jamb nut for trimmers, Stock Nos. 12714 and 12884 | 11320 | Coil—Choke coil (L204) |
| 12471 | Plate—Mounting plate for cushion socket—less socket | 5240 | Cover—Fuse mounting cover |
| 14741 | Plate—Tuning condenser front plate and studs assembled for mounting drive gears | 12468 | Expander Control (R204) |
| 14697 | Pulley—Indicator pointer cable pulley | 10907 | Fuse—3 amp. (F201) |
| 13988 | Resistor—10 ohms, carbon type, 1/2 watt (R40) | 5239 | Mounting—Fuse mounting—110 volt |
| 11932 | Resistor—330 ohms, carbon type, 1/10 watt (R4) | 12471 | Plate—6L7 socket mounting plate assembly—less socket, Stock No. 11196 |
| 13250 | Resistor—330 ohms, carbon type, 1/2 watt (R14) | 12466 | Reactor—Filter reactor (L201) |
| 5030 | Resistor—470 ohms, carbon type, 1/2 watt (R39) | 14795 | Resistor—0.27 ohms, resisto-fuse, 1.2 ampere (R223) |
| 14837 | Resistor—1,000 ohms, carbon type, 1/10 watt (R6, R15, R43) | 14281 | Resistor—68 ohms, insulated, 1/2 watt (R222) |
| 14720 | Resistor—1,000 ohms, carbon type, 1/2 watt (R2, R8) | 13454 | Resistor—270 ohms, insulated, 1/2 watt (R202) |
| 13737 | Resistor—3,300 ohms, carbon type, 1/2 watt (R47) | 12194 | Resistor—1,800 ohms, insulated, 1/2 watt (R212) |
| 11647 | Resistor—5,600 ohms, carbon type, 1/2 watt (R48) | 11298 | Resistor—5,600 ohms, carbon type, 1 watt (R210) |
| 5114 | Resistor—15,000 ohms, carbon type, 1 watt (R41) | 11726 | Resistor—6,800 ohms, carbon type, 1/2 watt (R224) |
| 14078 | Resistor—18,000 ohms, carbon type, 1 watt (R34) | 11332 | Resistor—22,000 ohms, carbon type, 1 watt (R209) |
| 14721 | Resistor—22,000 ohms, carbon type, 1/2 watt (R13, R49) | 12487 | Resistor—33,000 ohms, carbon type, 2 watt (R205) |
| | | 12875 | Resistor—56,000 ohms, carbon type, 1 watt (R213) |

REPLACEMENT PARTS (Continued)

| STOCK No. | DESCRIPTION | STOCK No. | DESCRIPTION |
|-----------|--|-----------|---|
| 5029 | Resistor—56,000 ohms, carbon type, 1/4 watt (R220) | | |
| 5145 | Resistor—100,000 ohms, carbon type, 1/4 watt (R219) | 9735 | MOTOR ASSEMBLIES |
| 11323 | Resistor—270,000 ohms, carbon type, 1/4 watt (R208) | 9851 | Motor—105-125 volts—25 cycles (M101) |
| 5035 | Resistor—580,000 ohms, carbon type, 1/4 watt (R211) | 9850 | Motor—105-125 volts—50 cycles (M101) |
| 12486 | Resistor—580,000 ohms, insulated, 1/4 watt (R207, R208, R215) | 12050 | Motor—105-125 volts—60 cycles (M101) |
| 12200 | Resistor—1 megohm, insulated, 1/4 watt (R201) | | Suspension Spring—Motor mounting spring, washer and stud assembly—comprising six springs, six cup washers, three spring washers and three studs |
| 14752 | Resistor—2.7 megohms, insulated, 1/4 watt (R203) | | |
| 14275 | Socket—2-contact female socket for phonograph motor power supply | | MOTOR BOARD ASSEMBLIES |
| 14276 | Socket—2-contact female socket for "expander-off" switch | 11881 | Base—Phonograph compartment lamp socket and base |
| 14280 | Socket—2-contact female socket and clinching plate for radio input | 14819 | Cable—Shielded pickup cable—connects shorting switch to compensator pack |
| 14277 | Socket—3-contact female socket for power switch or tuning motor power supply | 12051 | Capacitor—2 Mfd., complete with 2-contact male connector for use with motor, Stock Nos. 9850 or 9851 only (C104) |
| 4794 | Socket—4-contact 2A3 or 5Z3 Radiotron socket | 13101 | Capacitor—4 Mfd., complete with 2-contact male connector for use with motor Stock No. 9735 only (C104) |
| 14278 | Socket—5-contact female socket for chassis power supply | 4674 | Connector—2-contact male connector for Stock Nos. 12051, 13101 or phono compartment lamp leads |
| 11197 | Socket—6-contact 6C5 Radiotron socket | 14211 | Connector—2-contact male connector for motor cable |
| 11198 | Socket—7-contact 6H6 Radiotron socket | 11488 | Connector—2-contact female connector for motor leads |
| 11196 | Socket—8-contact 6L7 or 6F5 Radiotron socket | 14760 | Cup—Used-needle cup |
| 14274 | Socket—Single contact female socket and plate for phonograph or expander input | 14762 | Damper—Turntable damper |
| 14278 | Socket—Single contact socket and plate for tone control | 11553 | Escutcheon—Index escutcheon engraved "Manual—12—10" |
| 13984 | Transformer—Interstage driver transformer (T202) | 14888 | Knob—Needle rest knob |
| 14271 | Transformer—Power transformer, 105-125 volts, 50-60 cycle (T201) | 4340 | Lamp—Phonograph compartment lamp—6.3 volts |
| 14846 | Transformer—Power transformer, 105-125 volts, 25-60 cycle (T201) | 3764 | Nut—Cap nut for motor board suspension |
| 30130 | Transformer—Power transformer, 100-130/140-160/165-250 volts, 50-60 cycle (T201) | 14761 | Rest—Pickup rest |
| | EJECT ARM ASSEMBLIES | 14825 | Roller—Pickup arm cable guide roller—comprising bracket, roller and guide pin |
| 14753 | Arm—Eject arm, complete | 11711 | Shade—Phonograph compartment lamp shade |
| 11533 | Ball—1/16-inch diameter steel ball | 14758 | Spacer—Pickup arm mounting spacer |
| 10129 | Ball—3/16-inch diameter steel ball | 14270 | Spring—Retaining spring for knob, Stock No. 14758 |
| 11529 | Bearing—Ejector tip bearing and nut | 4565 | Spring—Tension spring for needle rest |
| 11538 | Bracket—Eject arm bracket | 3763 | Suspension Spring—Suspension spring, washer and bolt assembly for motor board—comprising one bolt, two cup washers, two springs, two "C" washers, and one cap nut |
| 11537 | Collar—Eject arm shaft collar and set screw | 30157 | Switch—Pickup shorting switch (S105) |
| 11536 | Cushion—Counter balance roller cushion—located inside of eject arm | 4871 | Switch—Operating switch—toggle switch (S104) |
| 4055 | Post—Vertical adjustment post—located on eject arm bracket | 14759 | Turntable, complete |
| 3729 | Roller—Eject arm counter balance roller—located inside of eject arm | | REPRODUCER ASSEMBLIES |
| 4580 | Screw—No. 6—32-3/16-inch square head set screw for eject arm collar | | Speaker RL76-4 |
| 11534 | Screw—No. 8—38-7/32-inch special screw for eject arm tip center adjustment | 14806 | Cap—Dust cap for cone center |
| 11535 | Shaft and Collar—Eject arm vertical action shaft and collar assembly | 14785 | Coil—Field coil (L202) |
| 11528 | Silencer—Ejector tip silencer | 14802 | Cone—Reproducer cone and dust cap (L203) |
| 4087 | Spring—Ejector arm bracket spring | 14847 | Diffuser—Reproducer diffuser |
| 11531 | Spring—Ejector tip spring | 14788 | Plug—5-contact male plug for reproducer |
| 11530 | Tip—Ejector tip with tip center, adjusting screw and cap | 14784 | Reproducer, complete |
| 11539 | Yoke—Eject arm yoke assembly | 14358 | Screw—Screw, washer and lockwasher to hold core in yoke |
| | PICKUP AND ARM ASSEMBLIES | 12568 | Transformer—Output transformer (T203) |
| 10941 | Ball—Steel ball for pivot shaft bearing | 14357 | Washer—Spring washer to hold field coil |
| 3204 | Cable—Pickup lift cable | | MISCELLANEOUS ASSEMBLIES |
| 30101 | Cable—Shielded pickup cable—connects pickup unit to shorting switch | 12038 | Band—Rubber band for tuning tube |
| 12850 | Damper—Pickup arm pivot shaft damper—comprising one upper rubber damper and bearing, one lower rubber damper and one lower bearing | 14744 | Bracket—Tuning tube mounting bracket and clamp |
| 14820 | Mechanism—Pickup mechanism, complete with needle screw | 14745 | Button—Station selector push-button |
| 14818 | Pickup and arm, complete | 14789 | Cable—Shielded phonograph volume control cable, complete with male plug—compensation unit to amplifier |
| 12548 | Plug—Pivot shaft bearing plug | 14790 | Cable—Shielded expander control cable, complete with two male plugs—compensation unit to amplifier |
| 14823 | Rod—Pickup arm brake trip rod | 12723 | Capacitor—56 Mmfd. (C105) |
| 14822 | Screw—Needle screw | 14393 | Capacitor—.01 Mfd. (C101) |
| 14824 | Screw—Pickup mechanism terminal | 11315 | Capacitor—.015 Mfd. (C102, C103) |
| 14913 | Spring—Pickup arm tension spring | 14747 | Card—Call letter cards for station selector |
| 14821 | Support—Pickup mechanism support | 14840 | Escutcheon—Station selector and tuning tube escutcheon, complete with crystal, indicating cards and buttons—less station indicating cards |
| | OPERATING MECHANISM | 30570 | Escutcheon—Right- and left-hand side panels for electric tuning buttons—less buttons, call letter cards, retainers, and metal front plates—for use with station selector dial escutcheon |
| 14754 | Cam—Cam and gear assembly | 30569 | Escutcheon—Station selector dial and tuning tube escutcheon and crystal, complete with "Radio-Phono" and "Electric-Manual" indicating screens—less right- and left-hand side panels for electric tuning buttons |
| 6808 | Clutch—Trip lever friction clutch | 14787 | Expander Control and Switch (R103, S101, S102) |
| 14756 | Cover—Metal cover for trip lever and friction finger assembly | 14749 | Indicator—"Electric-Manual" indicator screen |
| 8809 | Finger—Manual index lever finger assembly | 14841 | Indicator—"Radio-Phono" indicator screen |
| 9870 | Finger—Friction finger assembly | 14751 | Key—Key for use in setting "Electric Tuning" mechanism |
| 11554 | Lever—Manual index lever—less pin | 14269 | Knob—Phono—Music-Speech, Volume—Power, Tuning (small), Manual-Electric-Remote, Fidelity, Phonograph Volume, and Dynamic Amplifier Control Knobs |
| 14755 | Lever—Main lever and link assembly | 14888 | Knob—Range selector knob |
| 14914 | Lever—Pickup lift cable lever | 14359 | Knob—Tuning knob (large) |
| 11555 | Lever—Trip lever and friction clutch assembly | 14788 | Knob—Tuning knob (large) |
| 30624 | Pawl—Trip pawl assembly | 11807 | Pickup Control (R101) |
| 3872 | Pin—Manual index lever pin | 12738 | Receptacle—Needle card holder |
| 13635 | Plate—Eject arm actuating plate assembly | 12454 | Resistor—27,000 ohms, insulated, 1/4 watt (R107) |
| 4564 | Screw—Manual index lever finger set screw | 14023 | Resistor—33,000 ohms, insulated, 1/4 watt (R108) |
| 4059 | Screw—Trip lever clutch tension adjustment screw | 12264 | Resistor—82,000 ohms, insulated, 1/4 watt (R102) |
| 4566 | Screw—Special screw used to fasten main lever and link assembly bushing | 12201 | Resistor—220,000 ohms, insulated, 1/4 watt (R105) |
| 13637 | Spacer—Pickup arm mounting spacer | 11829 | Resistor—1.5 megohms, insulated, 1/4 watt (R104) |
| 13638 | Spring—Actuating spring | | Roller—Record pocket slide roller—comprising one rubber roller, one metal roller and two washers |
| 4566 | Spring—Manual index lever finger tension spring | 11377 | Screw—Amplifier mounting screw and washer |
| 4061 | Spring—Main spring lever tension spring or pickup lift cable spring | 5210 | Screw—Chassis mounting screw and washer |
| 2893 | Spring—Trip lever latch plate tension | 14748 | Shield—Celluloid shield for station call letter cards |
| 3676 | Spring—Cam and gear pawl tension spring | 14274 | Socket—Pickup cable socket and plate on compensation unit |
| 14916 | Spring—Pickup lift lever spring | 14270 | Spring—Retaining spring for knobs, Stock Nos. 14888 and 14269 |
| 4125 | Spring—Eject arm horizontal action tension spring | 4982 | Spring—Retaining spring for knob, Stock No. 14359 |
| 13636 | Stud—Pickup arm lift cable stud and nut | 3763 | Suspension Spring—Motor board suspension bolt, springs, cup washers and cap nut |
| 2917 | Washer—Spring washer—"U" type | 14833 | Volume Control—Phonograph volume control (R108) |
| | AUTOMATIC SWITCH ASSEMBLIES | | |
| 3994 | Cover—Motor switch cover | | |
| 10184 | Plate—Automatic brake latch plate | | |
| 10174 | Springs—Automatic brake springs | | |
| 8805 | Switch Assembly—Automatic switch, complete | | |
| 3322 | Switch—Motor switch (S103) | | |



RCA Victor

MODEL 88U

Eight-Tube, Three-Band, A-C, Radio-Phonograph

TECHNICAL INFORMATION AND SERVICE DATA

SERVICE DIVISION • RCA MANUFACTURING COMPANY, INC. • CAMDEN, N. J., U. S. A.

A Service of the Radio Corporation of America

Electrical Specifications

| | | | |
|-----------------------------|--|---------------------------|-----------------------------------|
| FREQUENCY RANGES | | R-F ALIGNMENT FREQUENCIES | |
| "Broadcast" (A)..... | 530-1,720 kc | "Broadcast" (A)..... | 600 kc (osc.), 1,500 kc (osc.) |
| "Medium Wave" (B)..... | 2,100-6,800 kc | "Medium Wave" (B)..... | 6,000 kc (osc.) |
| "Short Wave" (C)..... | 6,800-22,000 kc | "Short Wave" (C)..... | 20,000 kc (osc., det., ant.) |
| Intermediate Frequency..... | 460 kc | | |
| RADIOTRON COMPLEMENT | | | |
| (1) RCA-6K7..... | R-F Amplifier | (5) RCA-6Q7..... | Second Det., A-F Amp., and A.V.C. |
| (2) RCA-6J7..... | Heterodyne Oscillator | (6) RCA-6F6..... | Power Output |
| (3) RCA-6L7..... | First Detector | (7) RCA-6G5..... | "Magic Eye" Tuning Tube |
| (4) RCA-6K7..... | Intermediate Amplifier | (8) RCA-5Y3G..... | Full-Wave Rectifier |
| Pilot Lamps (4)..... | Mazda No. 46, 6.3 volts, 0.25 amp. | | |
| POWER SUPPLY RATING | | | |
| Radio Only..... | 105-125/200-250 volts, 50-60 cycles, 90 watts | | |
| Total..... | 105-125/200-250 volts, 50-60 cycles, 120 watts | | |
| POWER OUTPUT | | | |
| Undistorted..... | 2.5 watts | Type..... | 12-inch Electrodynamic |
| Maximum..... | 4.5 watts | Impedance (v.c.)..... | 11.5 ohms at 400 cycles |
| PHONOGRAPH | | | |
| Type..... | Manual | Type of Pickup..... | Magnetic |
| Turntable Speed..... | 78 r.p.m. (adjustable) | Pickup Impedance..... | 96 ohms at 1,000 cycles |

Mechanical Specifications

| | |
|------------------------------|--|
| Height..... | 43½ inches |
| Width..... | 26½ inches |
| Depth..... | 15⅞ inches |
| Weight (net)..... | 80 pounds |
| Weight (shipping)..... | 147 pounds |
| Chassis Base Dimensions..... | 14⅞ inches x 9¾ inches x 3¼ inches |
| Over-all Chassis Height..... | 9¾ inches |
| Operating Controls..... | (1) Power Switch—Tone; (2) Tuning (large inner knob), Range Selector (small outer knob, left to right "A," "B," "C"); (3) Radio Volume—Phono Radio Transfer; (4) Phono Volume (on motor board) |
| Tuning Drive Ratio..... | 20 to 1 |

General Description

The Model 88U combination instrument consists of an eight-tube superheterodyne receiver and a phonograph combined in a console-type cabinet. Features of design include an r-f amplifier stage with "cumulative-wound" "A" antenna and r-f transformers for high signal-to-noise ratio; magnetite-core adjusted i-f transformers and low-frequency "A" oscillator tracking; automatic volume control; "Magic Eye" tun-

ing tube; 12-inch, dust-proof, high-efficiency, electrodynamic loudspeaker; plunger-type, air-dielectric trimming capacitors; aural-compensated audio volume control; two-point, high-frequency tone control; and a new sunburst dial with short-wave stations listed by name and illuminated band and tone indicators.

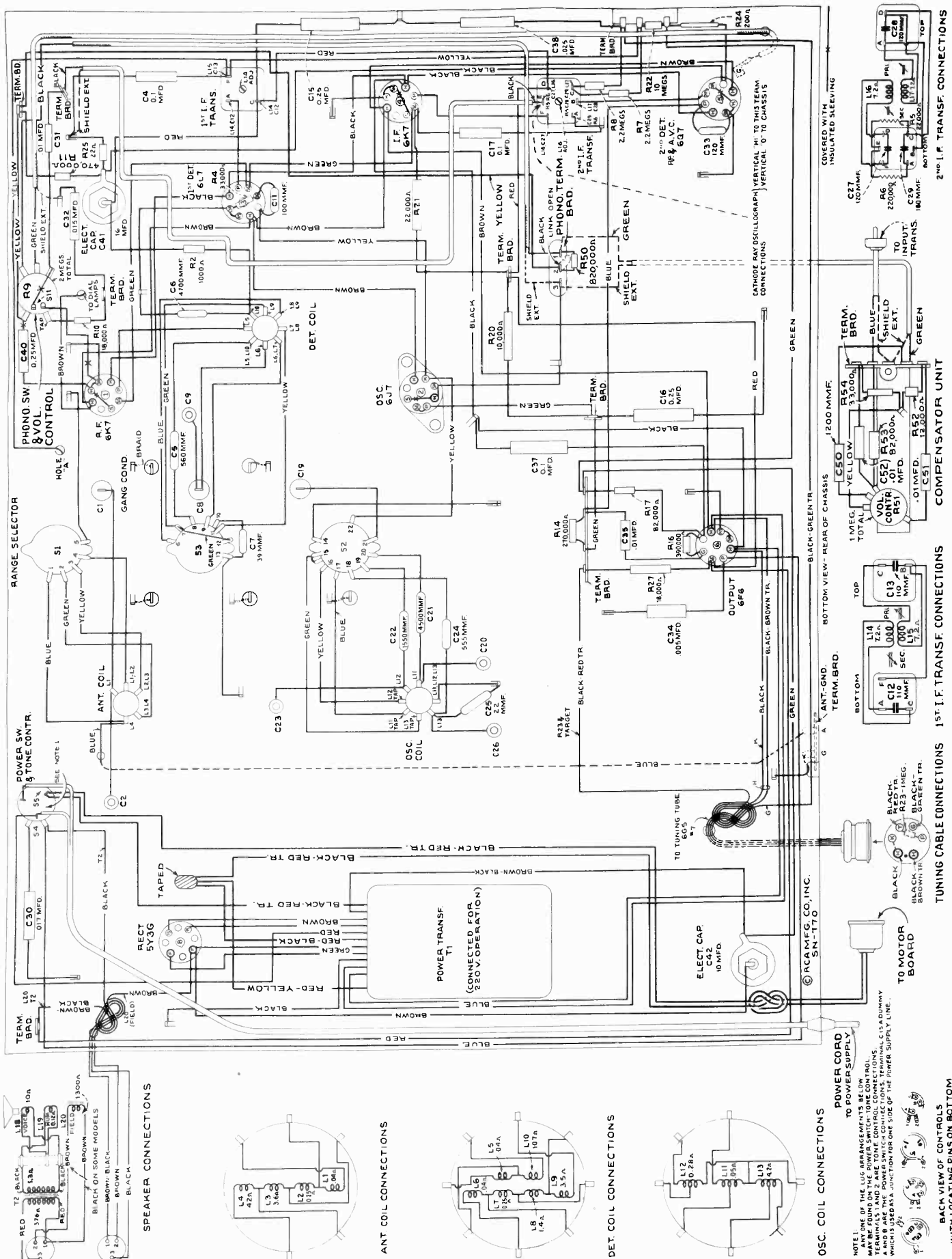

Figure 1—Chassis Wiring Diagram

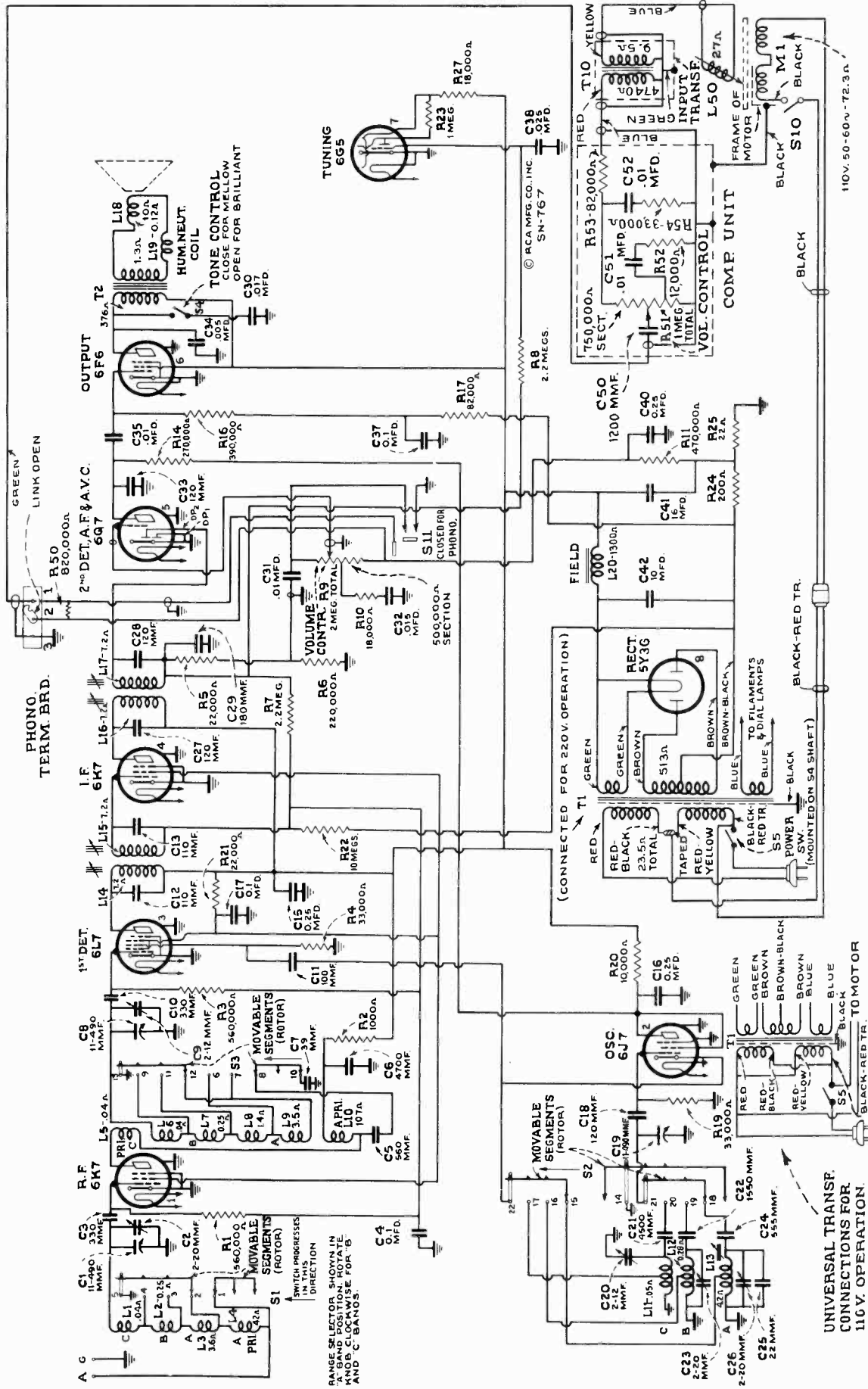

Figure 2—Schematic Circuit Diagram

Service Data

The various diagrams of this booklet contain such information as will be needed to isolate causes for defective operation if such develops. The ratings of the resistors, capacitors, coils, etc., are indicated adjacent to the symbols signifying these parts on the diagrams. Identification titles such as R1, L1, C1, etc., provide reference between the illustrations and Replacement Parts List. The coils, transformer windings, and reactors are rated in terms of d-c resistance to permit continuity checks.

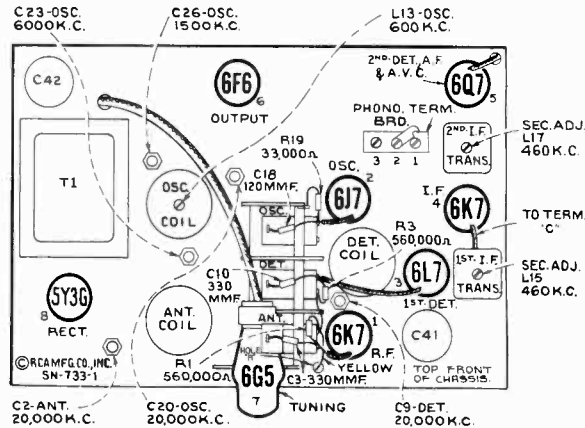
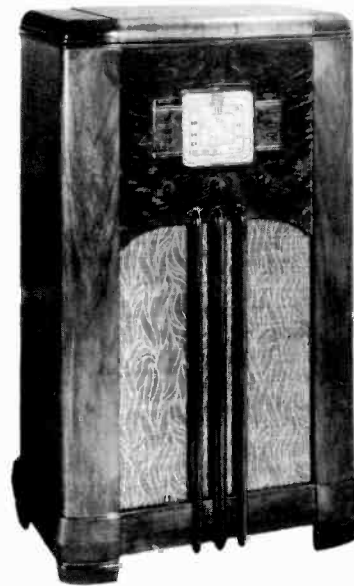

Figure 3—Radiotron, Coil, and Trimmer Locations



Model 88U

Alignment Procedure

Calibrate the tuning dial by adjusting main dial pointer to the low-frequency (end) calibration mark on dial with the gang tuning-condenser plates in full-mesh position; then adjust the small (vernier) pointer to "0." These are friction adjustments.

Perform alignment in proper order, tabulated below, starting with No. 1 and following all operations across, then No. 2, etc. Adjustment locations are shown on figures 3 and 4.

Cathode-ray alignment is highly preferable; the connections of the chassis are shown on figure 1. If an output indicator is used, connect it across the loudspeaker voice-coil and advance the receiver volume control to full-volume position.

Connect the "low" output terminal of the test oscillator to

the receiver "G" (ground) terminal for all alignment operations. Regulate the output of the test oscillator so that minimum signal is applied to the receiver to obtain an observable output indication. This will avoid a-v-c action.

The term "Dummy antenna" means the device which must be connected between the "high" test-oscillator output and the point of connection to the receiver in order to obtain ideal alignment. "No signal, 550-750 kc" means that the receiver should be tuned to a point between 550 and 750 kc where no signal or interference is received from a station or local (heterodyne) oscillator.

For further details on alignment, refer to booklet "RCA Victor Receiver Alignment."

| Order of Alignment | Test Oscillator | | | Range Selector | Receiver Dial Setting | Circuit to Adjust | Adjustment Symbols | Adjust to Obtain |
|--------------------|------------------------|---------------|-------------------|----------------|-----------------------|-------------------|--------------------|------------------|
| | Connection to Receiver | Dummy Antenna | Frequency Setting | | | | | |
| 1 | 6K7 I-F Grid Cap | .001 Mfd. | 460 kc | "A" Left | No Signal 550-750 kc | 2nd I-F Trans. | L16 and L17 | Max. (peak) |
| 2 | 6L7 Det. Grid Cap | .001 Mfd. | 460 kc | "A" | No Signal 550-750 kc | 1st I-F Trans. | L14 and L15 | Max. (peak) |
| 3 | Ant. Term. | 300 Ohms | 20,000 kc | "C" Right | 20,000 kc | "C" Osc. | C20 | Max. (peak)* |
| 4 | Ant. Term. | 300 Ohms | 20,000 kc | "C" | 20,000 kc | "C" Det. | C9 | Max. (peak)† |
| 5 | Ant. Term. | 300 Ohms | 20,000 kc | "C" | 20,000 kc | "C" Ant. | C2 | Max. (peak)‡ |
| 6 | Ant. Term. | 300 Ohms | 6,000 kc | "B" Center | 6,000 kc | "B" Osc. | C23 | Max. (peak)* |
| 7 | Ant. Term. | 200 Mmfd. | 600 kc | "A" Left | 600 kc | "A" L-F Osc. | L13 | Max. (peak) |
| 8 | Ant. Term. | 200 Mmfd. | 1,500 kc | "A" | 1,500 kc | "A" H-F Osc. | C26 | Max. (peak) |
| 9 | Ant. Term. | 200 Mmfd. | 600 kc | "A" | 600 kc | "A" L-F Osc. | L13 | Max. (peak) |
| 10 | Ant. Term. | 200 Mmfd. | 1,500 kc | "A" | 1,500 kc | "A" H-F Osc. | C26 | Max. (peak) |

* Use minimum capacity peak if two peaks can be obtained.

† Use maximum capacity peak if two peaks can be obtained.

‡ After this adjustment, check for image signal by shifting receiver dial to 19,080 kc.

Loudspeaker.—The ring to which the cone-centering diaphragm is cemented must be freed from its mounting before centering or replacing the cone. Center the cone by inserting three narrow, snugly fitting celluloid or paper feelers between voice coil and magnet pole after removing front dust cover. The dust cover may be removed by a light application of acetone. Carefully keep any foreign particles out of the air gap. The centering diaphragm should be firmly remounted before removing feelers and replacing the dust cover. Use ambroid for any cementing required.

Precautionary Lead Dress.—(1) Keep leads to a-c switch dressed away from antenna coil and trimmer C2. (2) Keep all filament leads twisted. (3) Keep leads of C31 as short as possible. (4) Keep leads of C21 as short as possible. (5) Dress shielded lead from volume control to phono. term. board against side of chassis away from 6L7 socket. (6) Yellow lead from 6J7 oscillator cathode to dummy terminal on 6L7 socket must be dressed away from chassis base and from brown filament lead. (7) All molded capacitors should be dressed so that flat side is perpendicular to chassis base. (8) Yellow lead from cathode of 6J7 socket to term. 22 of S2 must be dressed under spaghetti on 6J7 socket jumper and pulled tight away from chassis. The following bus leads should be kept as short as possible and, when necessary, replaced only with wire having same diameter as original: (9) Lead from L11-L12-L13 to ground lance; (10) Lead from term. 13 of S3 to ground lance; (11) Lead from term. 9 of S3 to L6-L7; (12) Lead from L6 to C8; (13) Lead from C9 to C8; (14) Lead from term. 5 of S1 to ground lance; (15) Lead from L1-L2 to term. 4 of S1; (16) Lead from L1 to C1; (17) Lead from term. 21 of S2 to C19.

Magnetic Pickup

The pickup used in the phonograph unit is of an improved design. The horseshoe magnet is rigidly welded to the pole pieces and is irremovable. There is a centering spring attached to the armature to maintain proper adjustment and to provide a limiting effect on the movement of the armature. The response is substantially uniform over a wide range of frequencies. Service operations which may be necessary on the pickup are as follows:

Centering Armature.—Refer to figure 5 showing the pickup inner structure. The armature is shown in its proper relation to the magnet pole pieces, i. e., exactly centered. Whenever this centering adjustment has been disturbed it will be necessary to remove the pickup mechanism from the tone arm by removing the needle holding screw and the two mounting screws from the front of the tone arm, holding the pickup assembly to keep it from dropping. Unsolder the two leads from the lugs on the terminal board at the rear of the pickup. Insert a small rod or nail into the armature needle hole and replace the needle holding screw, tightening it to hold the rod securely. If the armature clamping screws A and B have not been disturbed, screws C should be loosened which will permit the armature to be moved from side to side, the rod acting as a lever to perform this operation. Proper adjustment is obtained when the armature is moved to the extreme position on each side (the movement being limited by the armature striking the pole pieces) and then brought to the mid position between these two extremes. Screws C should then be tightened. The armature position should then be central between the pole pieces and at right angles

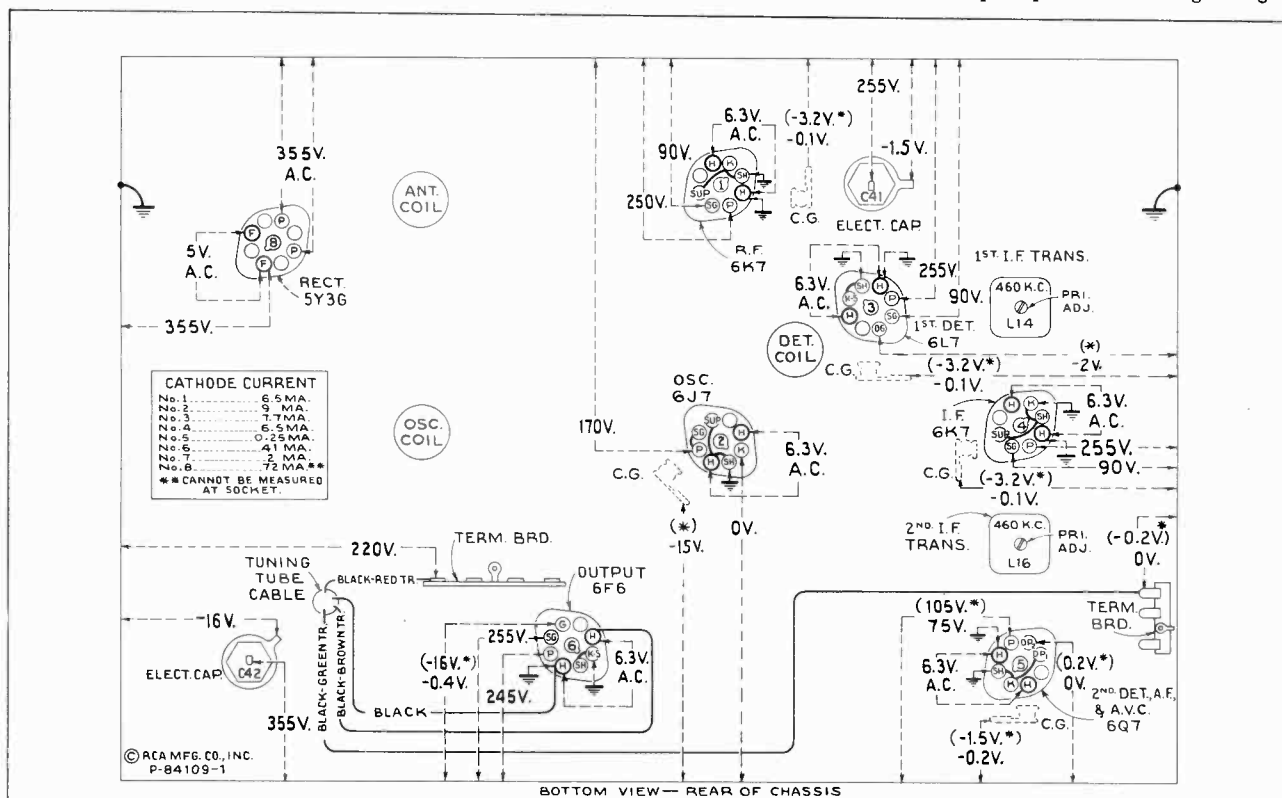

Note: Two voltage values are shown for some readings. The value shown in parentheses with asterisk (*) indicates operating conditions without voltmeter loading. The other value (generally lower) is the actual measured voltage and differs from the value shown in parentheses because of the additional loading of the voltmeter through the high series circuit resistance.

Voltage values as specified should hold within $\pm 20\%$ when the receiver is normally operative at its rated line voltage. To duplicate the conditions under which the voltages were measured requires a 1,000-ohm-per-volt d-c meter, having ranges of 10, 50, 250 and 500 volts. Use the nearest range above the specified measured voltage. A-c voltages were measured with a corresponding a-c meter.

to them. With a little practice, the correct adjustment of the armature will be obtained. The air gap between the pole pieces and the armature should be kept free from dust, filings, and other foreign material which would obstruct the movement of the pickup armature.

Damping Block.—The viscoloid damping block which is attached to the front end of the armature shank serves as a mechanical filter to eliminate undesirable resonances and to cause the frequency response to be uniform. Should it be necessary to replace this damping block, the pickup mechanism should be removed from the tone arm as explained above.

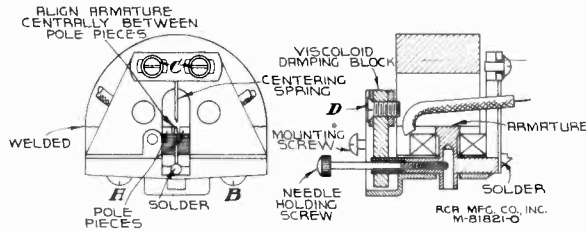

Figure 5—Details of Pickup

Remove screw D and the damping block from the pickup assembly. Make sure that the shaft of the armature which contacts the viscoloid is clean. Then insert the new damping block so that it occupies the same position as that of the original block, and is in correct vertical alignment with the armature. The hole in the block is somewhat smaller than the diameter of the armature in order to permit a snug fit. With the damping block properly aligned on the armature, screw D with its washer should then be replaced. Heat should be applied to the armature (viscoloid side) so that the damping block will fuse at the point of contact and become rigidly attached to the armature. A soldering iron with the tip filed slim and round will be found very useful in performing this operation. The iron should be applied only long enough to slightly melt the block, causing a small bulge on both sides.

Replacing Coil.—Whenever there is defective operation due to an open or shorted pickup coil, this coil should be replaced. Remove the pickup mechanism and terminal board as described above. Remove screws A and B and the magnet assembly. Remove the bakelite coil support (with coil attached) and insert the new coil support assembly in its place, after which replace the magnet assembly and center the armature as described above, then re-assemble the remainder of the unit.

Magnetizing.—In case it becomes necessary to re-magnetize the unit, first remove the pickup mechanism from the tone arm, and then remove the magnet assembly. Place the magnet assembly on the poles of a standard pickup magnetizer

such as the RCA Stock No. 9549 Pickup Magnetizer and charge the magnet in accordance with the instructions accompanying the magnetizer. It is preferable to check the polarity of the pickup magnet and to remagnetize it so that the same polarity is maintained.

Motorboard and Motor

The adjustments for tone-arm height and automatic stop-switch position are shown in figure 6.

The phonograph motor is of the governor induction type and designed to be simple and foolproof. Occasionally, how-

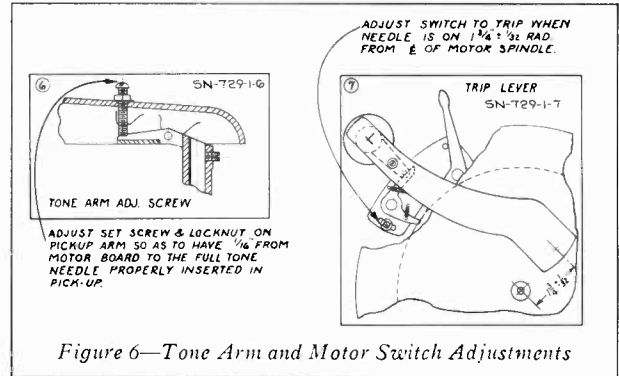

Figure 6—Tone Arm and Motor Switch Adjustments

ever, certain adjustments may be required. These adjustments are illustrated and explained in figure 7. Apply a few drops of light machine oil in the three holes provided and around the motor spindle every six months to ensure smooth operation.

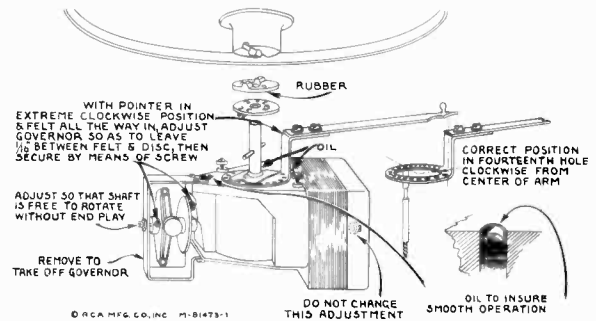

Figure 7—Details of Motor

REPLACEMENT PARTS

Insist on genuine factory tested parts, which are readily identified and may be purchased from authorized dealers.

| STOCK No. | DESCRIPTION | STOCK No. | DESCRIPTION |
|----------------------------|---|-----------|---|
| RECEIVER ASSEMBLIES | | | |
| 12038 | Band—Rubber band for tuning tube | 12406 | Capacitor—180 Mmfd. (C29) |
| 14384 | Belt—Variable condenser drive belt | 12952 | Capacitor—330 Mmfd. (C3, C10) |
| 14517 | Board—Antenna and ground terminal board | 12727 | Capacitor—555 Mmfd. (C24) |
| 12717 | Board—Phonograph terminal board | 12537 | Capacitor—560 Mmfd. (C5) |
| 14338 | Bushing—Variable condenser mounting bushing assembly | 12729 | Capacitor—1,550 Mmfd. (C22) |
| 14524 | Cable—Band indicator cable approx. 6 1/2-in. long | 12728 | Capacitor—4,500 Mmfd. (C21) |
| 14523 | Cable—Tone control indicator cable approx. 3-in. long | 12897 | Capacitor—4,700 Mmfd. (C6) |
| 14394 | Cable—Tuning tube cable and socket | 4838 | Capacitor—.005 Mfd. (C34) |
| 12607 | Cap—First I-F transformer shield top | 13138 | Capacitor—.01 Mfd. (C31, C35) |
| 12581 | Cap—Second I-F transformer shield top | 11315 | Capacitor—.015 Mfd. (C32) |
| 11350 | Cap—Grid contact cap | 4752 | Capacitor—.017 Mfd. (C30) |
| 12884 | Capacitor—Adjustable trimmer (long) (C2, C23, C26) | 4870 | Capacitor—.025 Mfd. (C38) |
| 12714 | Capacitor—Adjustable trimmer (medium) (C9, C20) | 4841 | Capacitor—.01 Mfd. (C4, C17, C37) |
| 14021 | Capacitor—22 Mmfd. (C25) | 5170 | Capacitor—.025 Mfd. (C15) |
| 13545 | Capacitor—39 Mmfd. (C7) | 4840 | Capacitor—.025 Mfd. (C16, C40) |
| 12720 | Capacitor—100 Mmfd. (C11) | 11240 | Capacitor—10 Mfd. (C42) |
| 14262 | Capacitor—110 Mmfd. (C12, C13) | 5212 | Capacitor—16 Mfd. (C41) |
| 12404 | Capacitor—120 Mmfd. (C27, C28) | 14372 | Coil—Antenna coil and shield (L1, L2, L3, L4) |
| 12724 | Capacitor—120 Mmfd. (C18, C33) | 14516 | Coil—Oscillator coil and shield (L11, L12, L13) |

REPLACEMENT PARTS (Continued)

| STOCK No. | DESCRIPTION | STOCK No. | DESCRIPTION |
|-----------|---|--|--|
| 14414 | Coil—R.F. coil and shield (L5, L6, L7, L8, L9, L10) | 14283 | Transformer—Second I-F transformer (L16, L17, C27, C28, C29, R5, R6) |
| 14513 | Condenser—3-gang variable tuning condenser (C1, C8, C19) | 14994 | Transformer—Power transformer, 105-250 volts, 50-60 cycles (T1) |
| 14783 | Connector—2-contact female connector for motor power cable | 14597 | Volume Control—Radio volume control and radio-record switch (R9, S11) |
| 5119 | Connector—3-contact female connector for speaker cable | 14379 | Washer—Felt washer for indicator pointer |
| 12006 | Core—Adjustable core and stud for Stock Nos. 14376 and 14283 | MOTORBOARD ASSEMBLIES | |
| 12800 | Core—Adjustable core and stud for coil Stock No. 14516 | 14803 | Brake—Turntable brake and motor switch |
| 30288 | Dial—Station selector dial scale complete with tuning tube escutcheon | 14805 | Connector—2-contact male connector for motor and switch leads |
| 14514 | Drive—Variable condenser vernier drive pinion gear and shaft | 13575 | Escutcheon—Motor speed regulator escutcheon |
| 14345 | Drum—Variable condenser drive belt drum complete with set screws | 14328 | Governor—Motor governor complete |
| 14387 | Escutcheon—Tuning tube escutcheon | 14912 | Motor—105-125 volts, 50-60 cycle (M1) |
| 11982 | Fastener—Dial scale fastener | 13583 | Regulator—Motor speed regulator arm and pointer |
| 30085 | Gear—Indicator drive gear and hub assembly and indicator pointer stem and gear assembly | 13261 | Rest—Pickup rubber rest |
| 14341 | Idler—Station selector drive belt idler | 14799 | Screw—Motor mounting screw, lockwasher, washer, and spacer |
| 14519 | Indicator—Station selector indicator pointer | 30100 | Springs—Tension springs for brake Stock No. 14803—comprising one long and one short spring |
| 14520 | Indicator—Vernier indicator pointer | 14804 | Switch—Motor switch—located on brake Stock No. 14803 (S10) |
| 5226 | Lamp—Dial lamp | PICKUP AND ARM ASSEMBLIES | |
| 14028 | Nut—Jamb nut for adjustable trimmer capacitor Stock Nos. 12714 and 12884 | 14291 | Armature—Pickup armature assembly |
| 12471 | Plate—6J7 Radiotron socket mounting plate and rubber cushions—less socket—Stock No. 11196 | 14930 | Coil—Pickup coil (L50) |
| 14340 | Pulley—Station selector drive belt pulley and knob shaft | 14292 | Damper—Pickup damper assembly—comprising one damper, one damper clamp, and one screw |
| 14522 | Reflector—Dial reflector and bracket, complete with dial lamp brackets, tuning lamp bracket, and tone and band indicators | 14929 | Pickup and Arm complete |
| 14525 | Resistor—22 Ohms, Carbon type, 1/2 watt (R25) | 3811 | Screw—Needle holding screw |
| 14526 | Resistor—200 Ohms, Wire wound, 2 1/2 watt (R24) | REPRODUCER ASSEMBLIES (Speaker RL76A1) | |
| 5112 | Resistor—1,000 Ohms, Carbon type, 1/2 watt (R2) | 14606 | Cap—Dust cap for cone center |
| 8043 | Resistor—10,000 Ohms, Carbon type, 2 watt (R20) | 14922 | Coil—Field coil (L20) |
| 11175 | Resistor—18,000 Ohms, Carbon type, 1/2 watt (R10) | 14604 | Coil—Hum neutralizing coil (L19) |
| 14078 | Resistor—18,000 Ohms, Carbon type, 1 watt (R27) | 14602 | Cone—Reproducer cone and dust cap (L18) |
| 14284 | Resistor—22,000 Ohms, Carbon type, 1/10 watt (R5) | 5118 | Plug—3-contact male plug for reproducer |
| 13668 | Resistor—22,000 Ohms, Carbon type, 2 watt (R21) | 14995 | Reproducer—Reproducer complete |
| 11300 | Resistor—33,000 Ohms, Carbon type, 1/10 watt (R19) | 14358 | Screw—Screw, washer, and lockwasher to hold core in yoke |
| 13735 | Resistor—33,000 Ohms, Carbon type, 1/2 watt (R4) | 14996 | Transformer—Output transformer (T2) |
| 11365 | Resistor—82,000 Ohms, Carbon type, 1/2 watt (R17) | 14357 | Washer—Spring washer to hold field coil |
| 11398 | Resistor—220,000 Ohms, Carbon type, 1/10 watt (R6) | MISCELLANEOUS ASSEMBLIES | |
| 11323 | Resistor—270,000 Ohms, Carbon type, 1/2 watt (R14) | 30428 | Capacitor—1,200 Mmfd. (C50) |
| 13005 | Resistor—390,000 Ohms, Carbon type, 1/10 watt (R16) | 13138 | Capacitor—.01 Mfd. (C51, C52) |
| 11172 | Resistor—470,000 Ohms, Carbon type, 1/2 watt (R11) | 11762 | Cup—Used needle cup |
| 11397 | Resistor—560,000 Ohms, Carbon type, 1/10 watt (R1, R3) | 11704 | Damper—Turntable rubber damper and damper plate |
| 11284 | Resistor—820,000 Ohms, Carbon type, 1/2 watt (R50) | 14527 | Escutcheon—Station selector escutcheon and crystal |
| 12013 | Resistor—1 Megohm, Carbon type, 1/10 watt (R23) | 14528 | Index—Tone control indicating strip—mounts in station selector escutcheon |
| 11626 | Resistor—2.2 Megohm, Carbon type, 1/2 watt (R7, R8) | 14529 | Index—Band change indicating strip—mounts in station selector escutcheon |
| 13732 | Resistor—10 Megohm, Carbon type, 1/2 watt (R22) | 14359 | Knob—Station selector knob |
| 14343 | Retainer—Station selector knob shaft and pulley retainer | 14269 | Knob—Radio or phonograph volume control, tone control or range switch knob |
| 14350 | Screw—No. 8—32x3/16 square head set screw for hub and arm on tone or band indicator cable, drum Stock No. 14345, Gear Stock No. 30085 | 30128 | Resistor—12,000 Ohms, insulated, 1/2 watt (R52) |
| 14374 | Shield—Antenna or R-F coil shield | 12454 | Resistor—33,000 Ohms, insulated, 1/2 watt (R54) |
| 14376 | Shield—Oscillator coil shield | 14023 | Resistor—82,000 Ohms, insulated, 1/2 watt (R53) |
| 12008 | Shield—First or second I-F transformer shield | 11210 | Screw—Chassis mounting screw and washer assembly |
| 11195 | Socket—5-contact 5Y3G Radiotron socket | 30249 | Screw—Motorboard mounting screw, spring, spacer, and washer assembly |
| 11196 | Socket—8-contact 6F6, 6K7, 6J7, or 6Q7 Radiotron socket | 14609 | Transformer—Phonograph input transformer (T10) |
| 14114 | Socket—Dial lamp socket | 14801 | Turntable—Turntable complete |
| 12007 | Spring—Retaining spring for core Stock Nos. 12006 and 12800 | 30129 | Volume Control—Phonograph volume control (R51) |
| 12907 | Spring—Tension spring for indicator drive gear Stock No. 30085 | | |
| 14342 | Spring—Tension spring for idler Stock No. 14341 | | |
| 14371 | Switch—Low frequency tone and power switch (S4, S5) | | |
| 14515 | Switch—Range switch (S1, S2, S3) | | |
| 14376 | Transformer—First I-F transformer (L14, L15, C12, C13) | | |



RCA Victor

MODELS 67M, 67M1, 67M2, and 67M3

Six-Tube, Superheterodyne Automobile Receivers

TECHNICAL INFORMATION AND SERVICE DATA

SERVICE DIVISION • RCA MANUFACTURING COMPANY, INC. • CAMDEN, N. J., U. S. A.

A Service of the Radio Corporation of America

Electrical Specifications

MODEL 67M

RADIOTRON COMPLEMENT

- (1) RCA-6D6 R-F Amplifier
- (2) RCA-6A8 First Detector—Oscillator
- (3) RCA-6K7 I-F Amplifier
- (4) RCA-6B7 Second Det., A-F Amp., and A.V.C.
- (5) RCA-42 Power Output
- (6) RCA-84 Full-Wave Rectifier

MODELS 67M1, 67M2 and 67M3

- (1) RCA-6D6 R-F Amplifier
- (2) RCA-6A8 First Detector—Oscillator
- (3) RCA-6K7 I-F Amplifier
- (4) RCA-85 Second Det., A-F Amp., and A.V.C.
- (5) RCA-6C5 Audio Driver
- (6) RCA-6A6 Push-Pull Power Output

Tuning Range (all models) 540 to 1,600 kc

POWER-OUTPUT RATINGS

Maximum 3½ Watts 9 Watts
 Undistorted 2¼ Watts 6 Watts

LOUDSPEAKER

Type (all models) Electrodynamic
 Voice-Coil Impedance (all models) 3¼ Ohms at 400 Cycles

POWER-SUPPLY RATINGS

Supply Voltage (all models) 6.3 Volts (Storage Battery)
 Current Drain 67M, 7.1 Amperes; 67M1, 7.5 Amperes; 67M2, 7.5 Amperes; 67M3, 9 Amperes
 Fuse Protection (all models) 15 Amperes
 Pilot Lamp (all models) Mazda No. 44, 6.3 Volts, 0.25 Ampere

Alignment Frequencies (all models) I. F., 260 kc; Oscillator Coil, 600 kc and 1,400 kc;
 Detector Coil, 1,400 kc; Antenna Coil, 1,400 kc

Mechanical Specifications

RECEIVER CASE DIMENSIONS (all models)

Height 7 Inches Width 10 Inches Depth 7½ Inches

OPERATING CONTROLS

Model 67M (1) Power Switch—Volume, (2) Tuning
 Model 67M1 (1) Power Switch—Volume, (2) High-Frequency Tone, (3) Tuning
 Models 67M2 and 67M3 (1) Power Switch—Volume, (2) High-Frequency Tone, (3) Tuning, (4) Sensitivity

Tuning-Drive Ratio (all models) 16 to 1

SPEAKER CASE DIMENSIONS

Dash Speaker, Models 67M2 and 67M3 Diameter, 9½ Inches; Depth, 5 Inches
 Header Speaker, Model 67M3 Diameter, 8¾ Inches Maximum; Depth, 2 Inches

WEIGHTS

Net (Receiver and Speaker(s)) 67M, 20 Pounds; 67M1, 22 Pounds; 67M2, 29 Pounds; 67M3, 33 Pounds
 Shipping 67M, 23 Pounds; 67M1, 25 Pounds; 67M2, 34 Pounds; 67M3, 39 Pounds

Copyright, 1937, RCA Manufacturing Co., Inc.

Trademark "Magic Voice"
Reg. U. S. Pat. Off. by RCA Mfg. Co., Inc.

General Description

These four receivers are designed and constructed to provide marked improvement in performance, operation, and ease of installation. Correct arrangement of parts, adequate shielding, and the ingenious insertion of filters at proper points in the circuits insure minimum disturbances from apparatus associated with the electrical circuits of the automobile and from outside sources. The receivers are compactly housed in substantial metal cases. Removable covers permit ready access to the under- and top-sides of the chassis. Flexible shafts interconnect the operating head to the controlled devices within the receiver housing. A description of each model follows:

Model 67M is a six-tube, single-unit receiver having the loudspeaker contained in the same housing with the receiver chassis. An RCA-42, operating as a Class A power amplifier, delivers a maximum output of $3\frac{1}{2}$ watts. The power supply consists of an interrupter (vibrator) and an RCA-84 full-wave rectifier in conjunction with a step-up power transformer and filter circuit. Features of design include an r-f amplifier; magnetite-core i-f and antenna transformers; full automatic-volume control; ignition-suppression filters in both the antenna- and power-input circuits; and a resistance-capacitance coupled audio system.

Model 67M1 is a six-tube, single-unit receiver having the loudspeaker contained in the same housing with the receiver chassis. An RCA-6A6, operating in a push-pull, Class B power-output stage, delivers a maximum output of 9 watts. Features of design include an r-f amplifier; magnetite-cores in the i-f, detector, and antenna transformers; full automatic-volume control; ignition-suppression filters in both the antenna- and power-input circuits; aurally compensated volume control; continuously variable, high-frequency tone control (mounted on receiver housing); and a resistance-capacitance coupled audio-driver stage. A three-contact receptacle is provided on the side of the receiver case for plugging-in an additional (external) speaker if desired.

Model 67M2 is a two-unit receiver utilizing a chassis, similar to Model 67M1, and a dash-type loudspeaker contained in a separate cylindrical housing. In addition to the features mentioned for Model 67M1, a sensitivity control is incorporated which permits the listener to alter the receiver sensitivity to suit reception conditions.

Model 67M3 is a three-unit receiver having a chassis and dash loudspeaker similar to Model 67M2, but with the addition of a second (header) loudspeaker. A speaker-selector switch permits both speakers to be operated simultaneously or either speaker to be operated separately.

With the two- and three-unit types, "Magic Voice" reproduction will only be obtained from the dash speakers when acoustic-equalizing holes are drilled in the firewall behind the speaker and the speaker mounted flush against the firewall. The rubber ring should be installed between the speaker and firewall.



Model 67M3—Upper photograph (includes both speakers)

Model 67M2—Upper photograph (includes dash [right] speaker only)

Model 67M1—Center photograph

Model 67M—Lower photograph

Circuit Description

Model 67M

This receiver employs six Radiotrons in a conventional superheterodyne circuit consisting of an r-f amplifier stage; a combination first-detector—oscillator stage; an i-f amplifier stage; a combination second-detector—audio-amplifier—a-v-c stage; a power-output stage; and a full-wave rectifier power-supply stage.

The antenna-input circuit includes a low-pass filter network, C1, L1, and C2, for the purpose of reducing ignition interference and other such high-frequency disturbances picked up by the antenna. The antenna transformer L3 is of the magnetite-core type, which provides high signal-to-noise ratio. The amplified r-f signal is applied to grid No. 4 of the RCA-6A8 first-detector tube. This same tube is also used for the local (heterodyne) oscillator—grid No. 1 acting as the oscillator grid while grid No. 2 acts as the oscillator plate. The output of this stage (260 kc) is fed through the i-f amplifier (consisting of two magnetite-core i-f transformers and an RCA-6K7) to one of the diode plates of the second detector, an RCA-6B7. The d-c component of the rectified

signal develops voltage across the volume control R8. This voltage is applied as a-v-c bias voltage to the r-f, first-detector, and i-f tubes through suitable resistance-capacitance filters. The output of the pentode section of the RCA-6B7, used for voltage amplification, is resistance-capacitance coupled to the RCA-42 power-output Radiotron; thence to the loudspeaker through output transformer T2. Improved fidelity results from degeneration employed in the power-output stage.

The power-supply circuit contains a vibrator, step-up power transformer, and a full-wave rectifier, an RCA-84, along with adequate capacity and choke filtering. Special filters are inserted in the "hot" A-input lead to provide filtering of ignition interference or other high-frequency disturbances which may be present in the car's wiring.

Models 67M1, 67M2, and 67M3

These three receivers employ similar chassis. Six Radiotrons are used in a conventional superheterodyne circuit consisting of an r-f amplifier stage; a combination

first-detector—oscillator stage; an i-f amplifier stage; a combination second-detector—audio-voltage-amplifier—a-v-c stage; an audio-driver stage; and a push-pull power-output stage.

The antenna-input circuit includes a low-pass filter network, C1, L1, and C2, for the purpose of reducing ignition interference and other high-frequency disturbances picked up by the antenna. The additional filter inductance L2 is used for the purpose of shunting out low-frequency interference such as power-line hum pickup. The antenna and r-f transformers are of the magnetite-core type which provides high signal-to-noise ratio. The amplified r-f signal is applied to grid No. 4 of the RCA-6A8 first-detector tube. This same tube is also used for the local (heterodyne) oscillator—grid No. 1 acting as the oscillator grid while grid No. 2 acts as the oscillator plate. The output of this stage (260 kc) is fed through the i-f amplifier (consisting of two magnetite-core i-f transformers and an RCA-6K7) to diode plate DP2 of the RCA-85 second detector. The d-c component of the rectified signal develops voltage across resistors R20 and R21. The audio component of the voltage developed across R21 is applied to the volume control through capacitor C23. The arm of this volume control is connected to the grid of the triode section of the RCA-85, thus giving a means of continuously varying the voltage input to the audio amplifier.

The a-v-c diode of the RCA-85 is coupled through capacitor C25 to the primary of the second i-f transformer. Due to the rectifying action of this diode, current flows

through resistor R13. The d-c voltage developed across this resistor is used for automatically regulating the control-grid bias of the r-f, first-detector, and i-f tubes; the voltage being applied through suitable resistance-capacitance filters.

A sensitivity switch S2 (Models 67M2 and 67M3 only) permits the sensitivity of the receiver to be altered to suit reception conditions. When this switch is closed, R22 is shorted which returns resistor R13 direct to chassis-ground. Under such condition, the residual bias on the r-f, first-detector, and i-f tubes is approximately 7 volts; the voltage developed across the cathode resistors of these tubes. When this switch is opened, resistor R13 returns to the junction of R22 and R10, which is approximately 4 volts positive with respect to ground. The effective residual bias for the controlled tubes under such conditions is approximately 3 volts, providing normal sensitivity of the receiver.

The output of the RCA-85 is resistance-capacitance coupled to the audio-driver stage, an RCA-6C5; thence to the Class B, push-pull, power-output stage, an RCA-6A6, through transformer T1. The output of this stage is transformer coupled to the electrodynamic loud-speaker(s).

The power supply consists of a synchronous vibrator-rectifier and a step-up power transformer along with adequate capacity and choke filtering. Special filters are inserted in the "hot" A-input lead to provide filtering of ignition interference and other high-frequency disturbances which may be present in the car's wiring.

Service Data

NOTE: When installing these receivers in automobiles having high-capacity (400 mmfd. or greater) antennas, the .01 mfd. antenna-coupling capacitor C-3 should be replaced by a 470 mmfd. capacitor, Stock No. 14082. The 1936 models of Chrysler, DeSoto, and Dodge are examples of cars with such antennas.

The various diagrams in this booklet contain such information as will be needed to locate cause for faulty operation if such develops. Figures 1 and 2 show the schematic and wiring diagrams for Model 67M; while Figures 3 and 4 show the schematic and wiring diagrams for Models 67M1, 67M2, and 67M3. It will be noted from the two latter diagrams that the tone control for Model 67M1 is mounted on the receiver case and the speaker contained in the receiver case with an additional 3-contact socket provided for an external speaker, if desired. Also, it will be noted that Models 67M2 and 67M3 have two sockets on the receiver case—the 3-contact one is for the loudspeaker cable while the 4-contact one is for the tone-control and sensitivity-switch cable.

Loudspeakers

Centering of the loudspeaker voice-coil is made in the usual manner, with three narrow-paper feelers after first removing the front paper dust-cover. This may be removed by softening its cement with a light application of acetone, using care not to let the acetone flow down into the air-gap. Visual inspection of the suspension arrangement on the speaker will show the screws to loosen for this adjusting operation. The dust-cover may be cemented back in place with ambroid cement upon completion of adjustments. Reference to Figure 10 shows that pin jacks plug into the speaker terminal board on Model 67M1; while Model 67M2 employs a 3-contact plug attached to the set-end of the speaker cable. Model 67M3 has pin jacks on the set-end of both speaker cables. These pin jacks plug into the terminal board on the speaker-selector switch. The switch cable has a 3-contact plug for connecting to the receiver loud-speaker socket. Caution should be observed, when connecting speaker cables, to see that the color dots on the terminal board corresponds to the color of the speaker wires inserted in the corresponding pin jacks.

Final Tuning-Dial Adjustment

Final adjustment of the dial pointer should be made after the receiver is installed in the car and the control cables connected. Rotate the tuning-control knob counterclockwise until the gang-tuning condenser reaches its low-frequency stop. Remove the dial-lamp socket from the control head. Insert a small screwdriver through the dial-lamp hole so that it engages the dial-adjusting screwhead. Rotate this screw until the dial pointer coincides with the last dial mark at the low-frequency end of the scale. This is a friction adjustment. This adjustment may also be made by setting the dial pointer to the known frequency of a station accurately tuned in; preferably near the high-frequency end of the band.

Tuning-Condenser Drive and Flexible Shafts

Smooth control should be obtained over the entire tuning range of the variable condenser. If irregularity is present, check the action of the gear mechanism for binding or backlash at every point within the tuning range. A bind may be due to improper mesh between the worm and the large gears on the condenser shaft. To correct such a condition, loosen the screws holding the gear plate and adjust the mesh of the gears to a position which gives smooth operation. Gear backlash is prevented by the small compression spring between the two large gears on the rotor shaft. The flexible control cables plug into the receiver case. When removing these cables, a sideways pull should be exerted to avoid undue strain on the cable mechanism. A slight amount of grease applied to the inner (drive) cable will ensure smooth operation.

Interrupter—Vibrator

The mechanical interrupter or synchronous vibrator-rectifier used in the power system is constructed with a plug-in base so as to be easily removed from the receiver. Its adjustment has been set during manufacture by means of special equipment. In cases of faulty operation, a renewal should be installed.

The synchronous vibrator-rectifier used in Models 67M1, 67M2, and 67M3 has a symmetrical plug-in base so as to give correct output-voltage polarity on an auto-

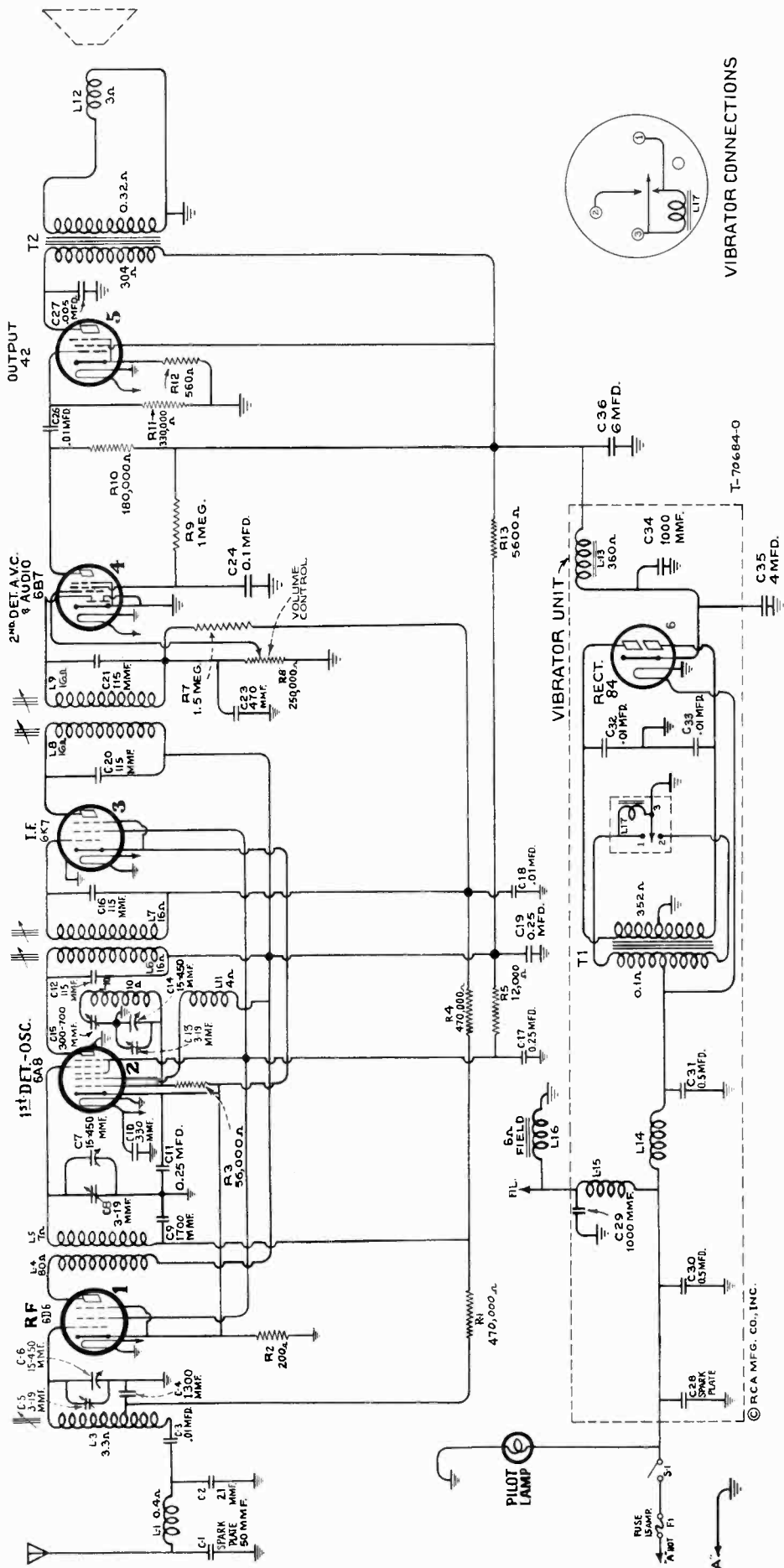

Figure 1—Schematic Circuit Diagram (Model 67M)

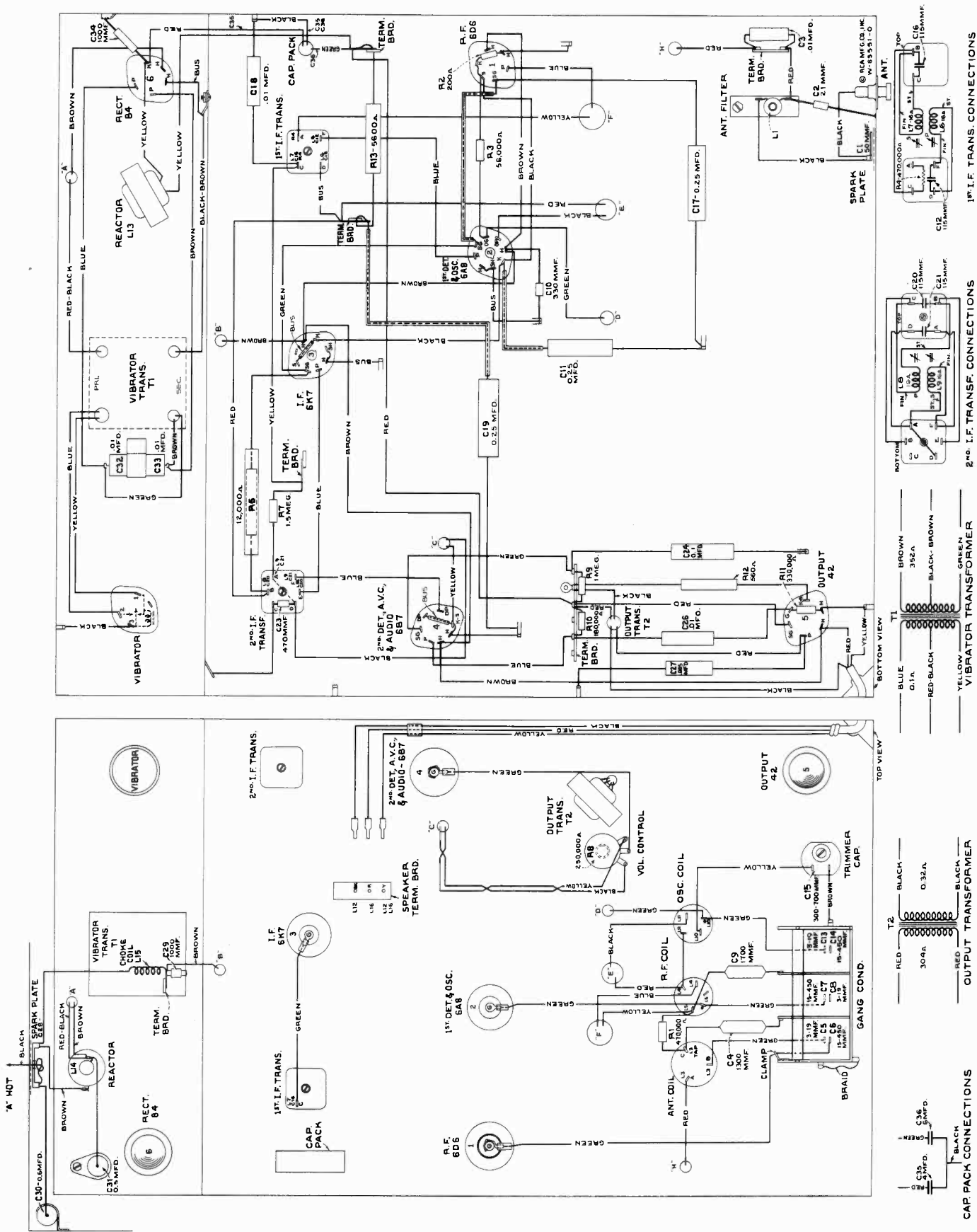

Figure 2—Chassis Wiring Diagram (Model 67M)

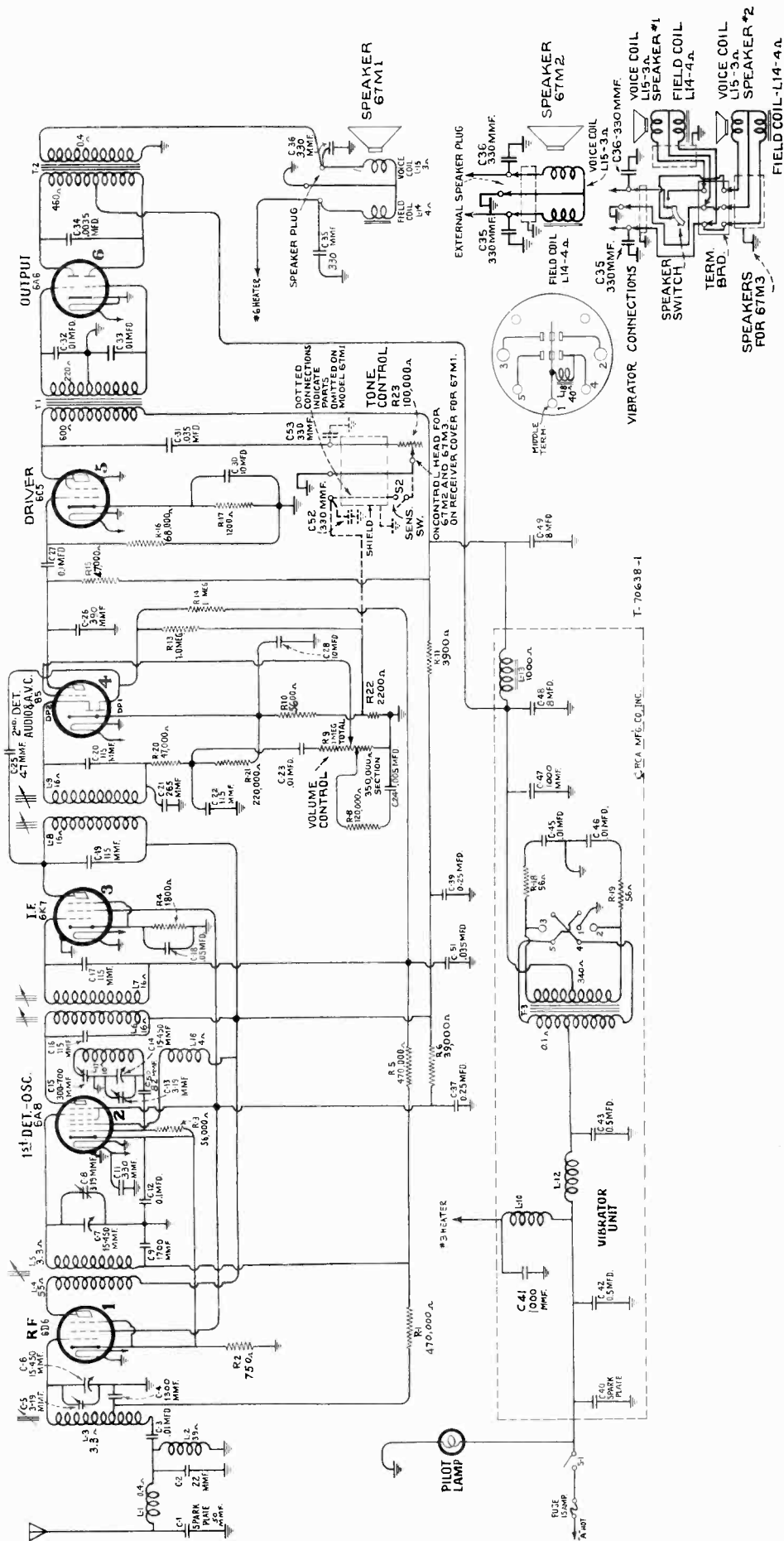

Figure 3—Schematic Circuit Diagram (Models 67M1, 67M2, and 67M3)

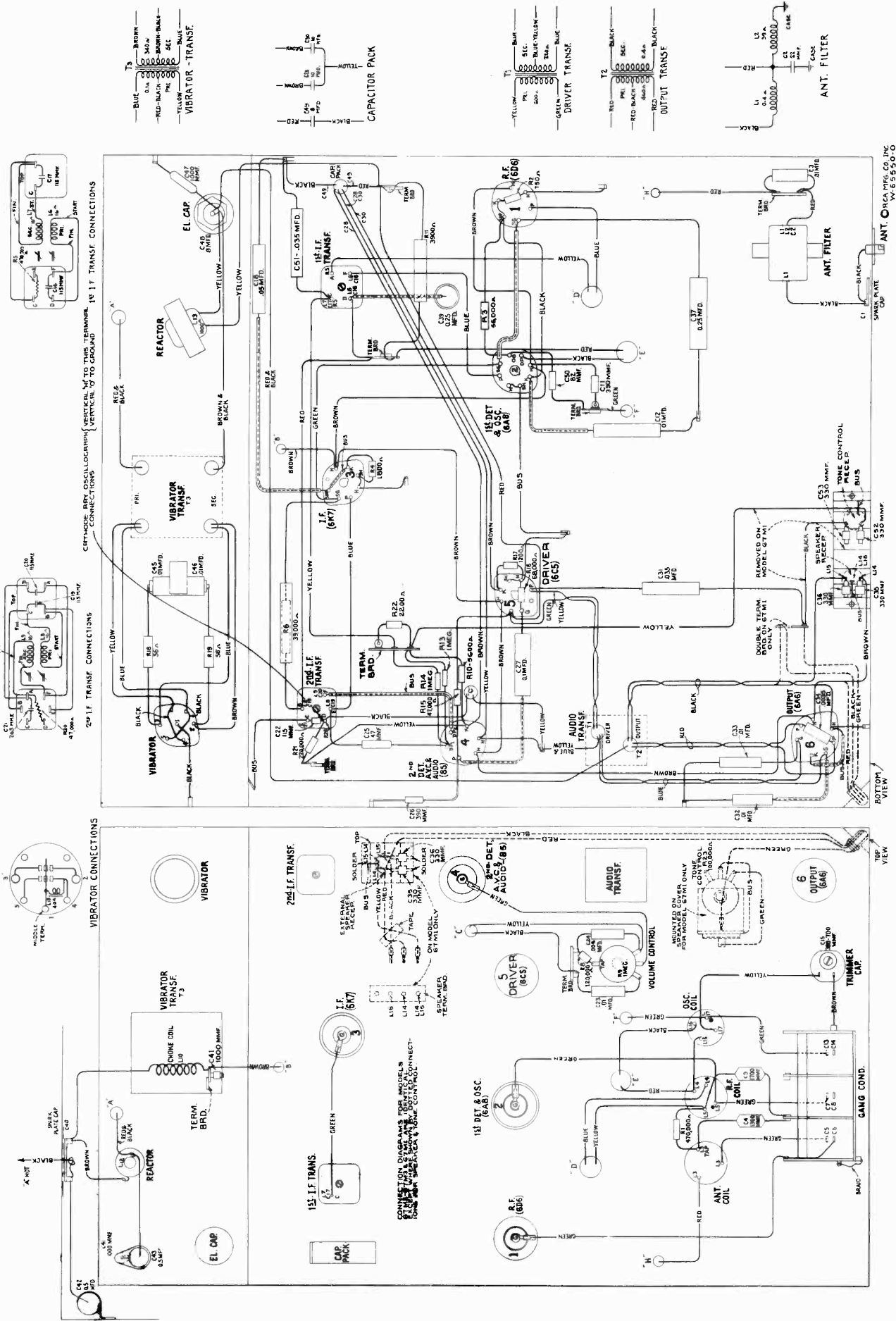
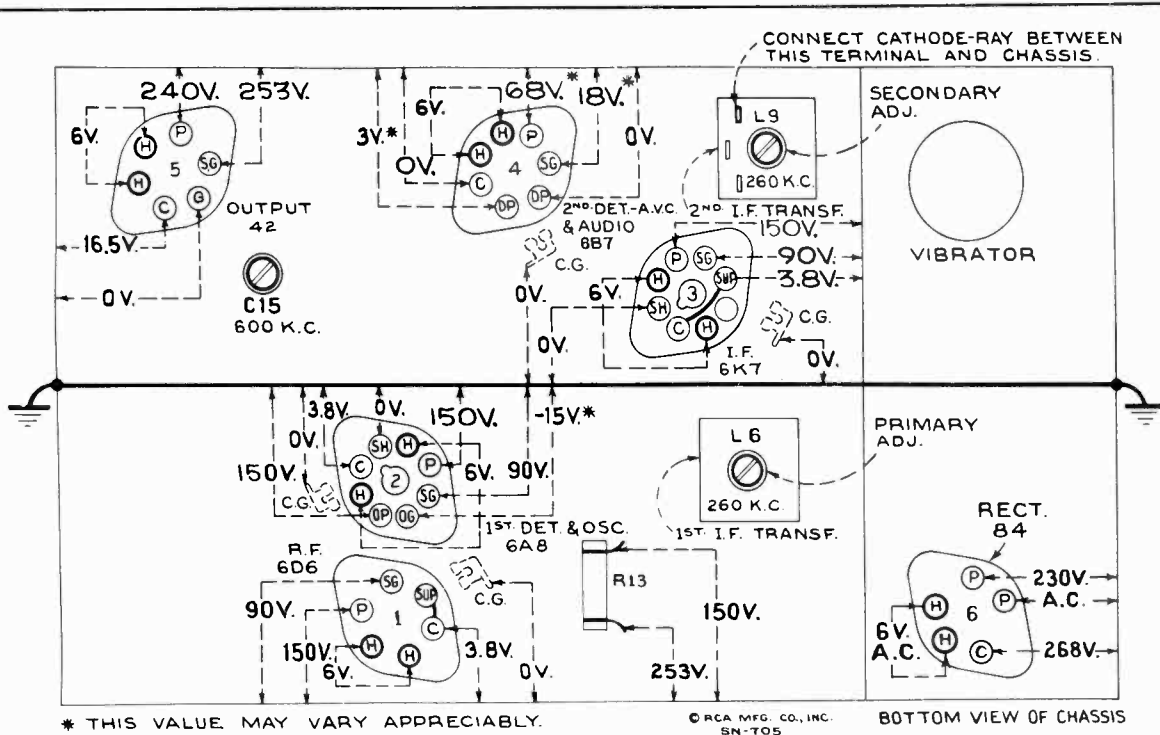

Figure 4—Chassis Wiring Diagram (Models 67M1, 67M2, and 67M3)

ORCA MFG. CO. INC. W-6550-0



* THIS VALUE MAY VARY APPRECIABLY. © RCA MFG. CO., INC. SN-705 BOTTOM VIEW OF CHASSIS

Figure 5—Radiotron Socket Voltages and Trimmer Locations (Model 67M)
(Measured at 6.3 volts battery supply—Volume control minimum—No signal input.)

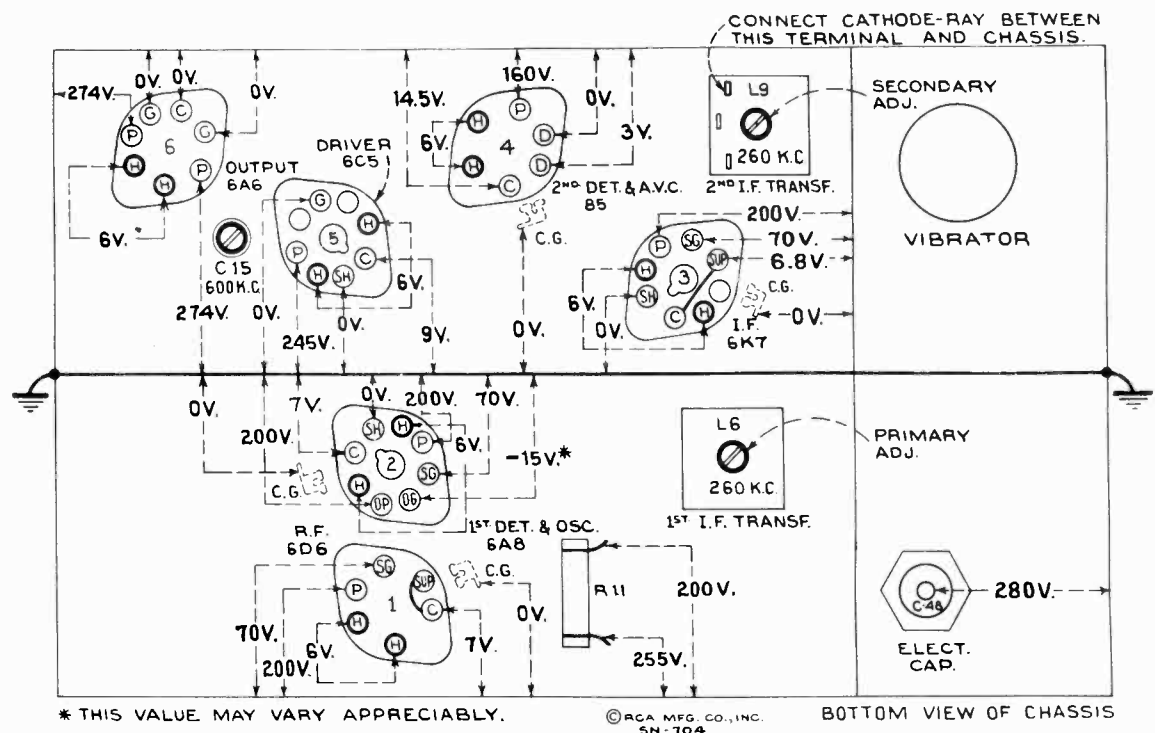

* THIS VALUE MAY VARY APPRECIABLY. © RCA MFG. CO., INC. SN-704 BOTTOM VIEW OF CHASSIS

Figure 6—Radiotron Socket Voltages and Trimmer Locations (Models 67M1, 67M2, and 67M3)
(Measured at 6.3 volts battery supply—Volume control minimum—No signal input—Sensitivity control (Models 67M2 and 67M3) at minimum sensitivity position.)

To duplicate the conditions under which the above voltages were measured requires a 1,000-ohm-per-volt a-c/d-c meter having ranges of 10, 50, 250, and 500 volts. Use the nearest range above the indicated voltage value. Each value should hold within $\pm 20\%$ when the receiver is normally operative at rated battery voltage.

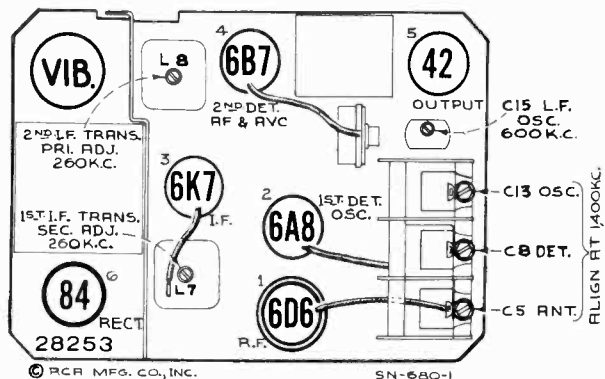

Figure 7—Radiotron and Trimmer Locations (Model 67M)

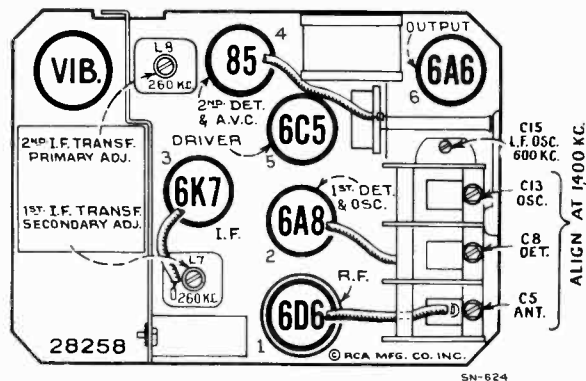

Figure 8—Radiotron and Trimmer Locations (Models 67M1, 67M2, and 67M3)

ALIGNMENT PROCEDURE

Calibrate the tuning-dial pointer to the low-frequency dial mark as outlined under "Final tuning-dial adjustment."

Perform alignment in proper order tabulated below, starting with No. 1 and following all operations across, then No. 2, etc.

Cathode-ray alignment is preferable; the connections to the chassis are shown on Figures 5 and 6. If an output indicator is used, connect it across the loudspeaker voice-coil and advance the receiver volume control to full-volume position.

Connect the "low" output terminal of the test oscillator to the receiver chassis for all alignment operations. Regulate the output of the test oscillator so that minimum signal is applied to the receiver to obtain an observable output indication. This will avoid a-v-c action.

On Models 67M2 and 67M3, the sensitivity control

should be placed in its clockwise (maximum sensitivity) position.

If capacitor C-3, in the receiver, has been changed to 470 mmfd., use a "dummy antenna" of .001 mfd. instead of 175 mmfd. for r-f alignment.

The terms "Set end antenna cable" means test oscillator signal should be applied to the receiver at the connector on the short antenna cable extending from the receiver chassis. "Dummy antenna" means the device which must be connected between the "high" test-oscillator output and the point of connection to the receiver in order to obtain ideal alignment. "No signal, 550-750 kc" means that the receiver should be tuned to a point between 550 and 750 kc where no signal is received from a station or the local (heterodyne) oscillator.

For further details on alignment, refer to booklet "RCA Victor Receiver Alignment."

| Order of Alignment | Test Oscillator | | | Receiver Dial Setting | Circuit to Adjust | Adjustment Symbols | Adjust to Obtain | Adjustment Location | |
|--------------------|------------------------|---------------|-------------------|-----------------------|-------------------|--------------------|------------------|---------------------|--------------|
| | Connection to Receiver | Dummy Antenna | Frequency Setting | | | | | 67M | 67M1, M2, M3 |
| 1 | 6K7 i-f Grid Cap | .001 Mfd. | 260 kc | No signal 550-750 kc | 2nd i-f Trans. | L9 and L8 | Max. (peak) | Figs. 5-7 | Figs. 6-8 |
| 2 | 6A8 Det. Grid Cap | .001 Mfd. | 260 kc | No signal 550-750 kc | 1st i-f Trans. | L7 and L6 | Max. (peak) | Figs. 5-7 | Figs. 6-8 |
| 3 | Set End Ant. Cable | 175 Mmfd. | 600 kc | 600 kc | L-F Osc. | C15 | Max. (peak) | Fig. 7 | Fig. 8 |
| 4 | Set End Ant. Cable | 175 Mmfd. | 1,400 kc | 1,400 kc | H-F Osc. | C13 | Max. (peak) | Fig. 7 | Fig. 8 |
| 5 | Set End Ant. Cable | 175 Mmfd. | 1,400 kc | 1,400 kc | Det. | C8 | Max. (peak) | Fig. 7 | Fig. 8 |
| 6 | Set End Ant. Cable | 175 Mmfd. | 1,400 kc | 1,400 kc | Ant. | C5 | Max. (peak) | Fig. 7 | Fig. 8 |
| 7 | Set End Ant. Cable | 175 Mmfd. | 600 kc | Rock thru 600 kc | L-F Osc. | C15 | Max. (peak) | Fig. 7 | Fig. 8 |
| 8 | Set End Ant. Cable | 175 Mmfd. | 1,400 kc | 1,400 kc | H-F Osc. | C13 | Max. (peak) | Fig. 7 | Fig. 8 |
| 9 | Set End Ant. Cable | 175 Mmfd. | 1,400 kc | 1,400 kc | Det. | C8 | Max. (peak) | Fig. 7 | Fig. 8 |
| 10 | Set End Ant. Cable | 175 Mmfd. | 1,400 kc | 1,400 kc | Ant. | C5 | Max. (peak) | Fig. 7 | Fig. 8 |

mobile with either positive- or negative-"A" ground. For installation with positive ground, insert vibrator so positive (+) symbol is nearest label on vibrator-compartment partition; for negative-"A" ground, insert with negative (-) symbol nearest chassis.

The interrupter used in Model 67M does not require reversing, since the rectifier tube automatically supplies proper polarity on either polarity ground.

Radiotrons

Deterioration of tubes and their approach to failure is usually evidenced by noisy or intermittent operation, loss of sensitivity, and distorted tone quality. When suspected as faulty, the tubes should be removed from the receiver and checked with standard tube-testing apparatus. It is not feasible to test the tubes while in the receiver, due to measurement inaccuracies which would result from the effects of the circuits.

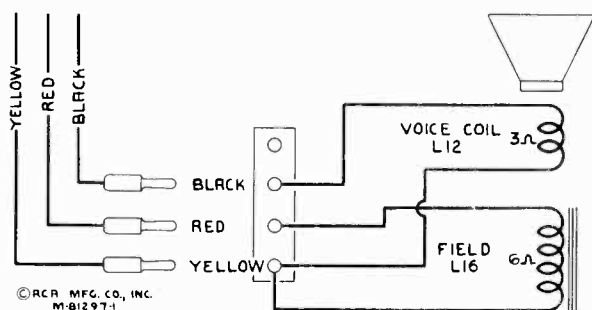

Figure 9—Loudspeaker Schematic and Wiring (Model 67M)

Receiver Housing

The screws holding the receiver chassis to the case must all be in place and tightly installed, inasmuch as they appreciably affect the ground resistance of the assembly and will, consequently, have a bearing on the amount of ignition noise received.

Volume Control and Power Switch

This adjustment is made by turning the volume-control knob fully clockwise and then fully counterclockwise. This places the friction-clutch mechanism on the volume control in proper alignment.

Service Hint (Model 67M only)

Noise pickup or mushy reception on demonstration or test antennas in the vicinity of a-c circuits may be eliminated by connecting a 5 millihenry r-f choke (Stock No. 12177) between the antenna connector and receiver case. This may be either inside or outside the receiver case.

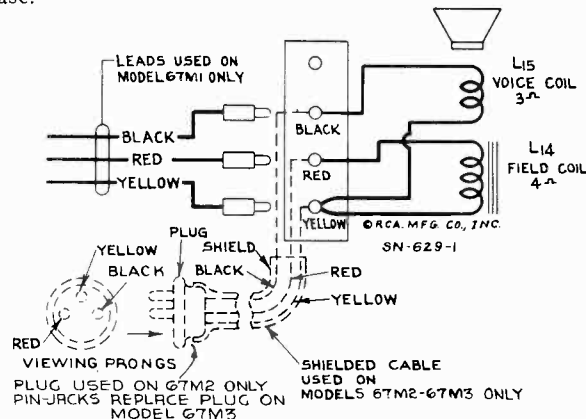

Figure 10—Loudspeaker Schematic and Wiring (Models 67M1, 67M2, and 67M3)

REPLACEMENT PARTS

Insist on genuine factory tested parts, which are readily identified and may be purchased from authorized dealers

| Stock No. | DESCRIPTION | Stock No. | DESCRIPTION |
|---|--|-----------|---|
| RECEIVER ASSEMBLIES MODEL 67M ONLY | | | |
| 13542 | Bracket—Chassis mounting bracket and stud assembly | 12006 | Core—Adjustable core and stud for Stock Nos. 13419 and 13693 |
| 12118 | Cap—Grid contact cap for glass tubes—Package of 5 | 12168 | Coupling—Station selector flexible shaft coupling |
| 12511 | Cap—Grid contact cap for metal tubes—Package of 5 | 13691 | Filter—Antenna filter (L1) |
| 13629 | Capacitor—Adjustable capacitor (C15) | 13372 | Gear—Large gear located on tuning condenser shaft |
| 13700 | Capacitor—22 mfd. (C2) | 13373 | Gear—Worm gear for tuning condenser |
| 11998 | Capacitor—115 Mmfd. (C15, C16, C20, C21) | 13694 | Guide—Volume control shaft guide |
| 13432 | Capacitor—330 Mmfd. (C10) | 12485 | Pin—Contact pin for speaker leads—Package of 5 |
| 13699 | Capacitor—470 Mmfd. (C23) | 13696 | Reactor—Filter reactor, iron core (L13) |
| 12762 | Capacitor—1,000 Mmfd. (C29, C34) | 13697 | Resistor—200 ohms, insulated, 1/4 watt—Package of 5 (R2) |
| 13701 | Capacitor—1,300 Mmfd. (C4) | 11845 | Resistor—560 ohms, carbon type, 1 watt—Package of 5 (R12) |
| 13702 | Capacitor—1,700 Mmfd. (C9) | 8097 | Resistor—5,600 ohms, carbon type, 2 watts (R13) |
| 4838 | Capacitor—.005 Mfd. (C27) | 3066 | Resistor—12,000 ohms, carbon type, 1 watt—Package of 5 (R5) |
| 4858 | Capacitor—.01 Mfd. (C3, C18, C26) | 12286 | Resistor—56,000 ohms, insulated, 1/4 watt—Package of 5 (R3) |
| 4839 | Capacitor—.1 Mfd. (C24) | 13698 | Resistor—180,000 ohms, insulated, 1/4 watt—Package of 5 (R10) |
| 5019 | Capacitor—.5 Mfd. (C31) | 12452 | Resistor—330,000 ohms, insulated, 1/4 watt—Package of 5 (R11) |
| 4840 | Capacitor—.25 Mfd. (C11, C17) | 12285 | Resistor—470,000 ohms, insulated, 1/4 watt—Package of 5 (R1) |
| 12484 | Capacitor—.25 Mfd. (C19) | 11452 | Resistor—470,000 ohms, carbon type, 1/10 watt—Package of 5 (R4) |
| 13687 | Capacitor—Pack, comprising one 4 Mfd. and one 6 Mfd. sections (C35, C36) | 12200 | Resistor—1 megohm, insulated, 1/4 watt—Package of 5 (R9) |
| 13695 | Capacitor—Pack, comprising 2 sections each .01 Mfd. (C32, C33) | | |
| 13685 | Coil—Antenna coil and shield (L3) | | |
| 12235 | Coil—Choke coil (L14) | | |
| 12225 | Coil—Oscillator coil less shield (L10, L11) | | |
| 13684 | Coil—R. F. coil less shield (L4, L5) | | |
| 13371 | Condenser—3-gang variable tuning condenser (C5, C6, C7, C8, C13, C14) | | |

REPLACEMENT PARTS (Continued)

| Stock No. | DESCRIPTION | | Stock No. | DESCRIPTION |
|-----------|---|--|-----------|---|
| 12287 | Resistor—1.5 megohms, insulated, ¼ watt—Package of 5 (R7) | | 13714 | Resistor—5,600 ohms, insulated, ¼ watt—Package of 5 (R10) |
| 5129 | Ring—Radiotron shield ring—Package of 5 | | 5176 | Resistor—39,000 ohms, carbon type, 1 watt (R6) |
| 3584 | Ring—Retaining ring for R. F. or oscillator coil—Package of 5 | | 5132 | Resistor—47,000 ohms, carbon type, 1/10 watt—Package of 5 (R20) |
| 3623 | Shield—R. F. or oscillator coil shield | | 12412 | Resistor—47,000 ohms, insulated, ¼ watt—Package of 5 (R15) |
| 12218 | Shield—Radiotron shield | | 12286 | Resistor—56,000 ohms, insulated, ¼ watt—Package of 5 (R3) |
| 12008 | Shield—Transformer shield for Stock Nos. 13419 and 13693 | | 13715 | Resistor—68,000 ohms, insulated, ¼ watt—Package of 5 (R16) |
| 4814 | Socket—5-contact 84 Radiotron socket | | 12355 | Resistor—120,000 ohms, carbon type, 1/10 watt—Package of 5 (R8) |
| 4786 | Socket—6-contact 6D6 or 42 Radiotron socket | | 12264 | Resistor—220,000 ohms, insulated, ¼ watt—Package of 5 (R21) |
| 4787 | Socket—7-contact 6B7 Radiotron socket | | 11452 | Resistor—470,000 ohms, carbon type, 1/10 watt—Package of 5 (R5) |
| 12227 | Socket—8-contact 6A8 or 6K7 Radiotron socket | | 12285 | Resistor—470,000 ohms, insulated, ¼ watt—Package of 5 (R1) |
| 13686 | Socket—Vibrator socket | | 12200 | Resistor—1 megohm, insulated, ¼ watt—Package of 5 (R13, R14) |
| 12007 | Spring—Retaining spring for core, Stock No. 12006—Package of 10 | | 5129 | Ring—Radiotron shield ring—Package of 5 |
| 13419 | Transformer—First I. F. transformer (L6, L7, C15, C16, R4) | | 3584 | Ring—Retaining ring for oscillator coil—Package of 5 |
| 13693 | Transformer—Second I. F. transformer (L8, L9, C20, C21) | | 12008 | Shield—I. F. transformer shield for Stock Nos. 12229 and 13419 |
| 13692 | Transformer—Output transformer (T2) | | 3623 | Shield—Oscillator coil shield |
| 13690 | Transformer—Vibrator transformer (T1) | | 12218 | Shield—Radiotron shield |
| 13688 | Vibrator—Complete (L17) | | 4786 | Socket—6-contact 6D6 or 85 Radiotron socket |
| 13420 | Volume control (R8) | | 12241 | Socket—6-contact vibrator socket |
| | RECEIVER ASSEMBLIES | | 12243 | Socket—7-contact 6A6 Radiotron socket |
| | MODELS 67M1, 67M2, AND 67M3 ONLY | | 12227 | Socket—8-contact 6A8, 6C5, or 6K7 Radiotron socket |
| 13789 | Bracket—Chassis mounting bracket and stud assembly (67M2, 67M3 only) | | 12007 | Spring—Retaining spring for core, Stock No. 12006—Package of 10 |
| 13543 | Bracket—Chassis mounting bracket and stud assembly (67M1 only) | | 12230 | Transformer—Audio transformer pack comprising driver and output transformers (T1, T2) |
| 12118 | Cap—Grid contact cap for glass tubes—Package of 5 | | 13419 | Transformer—First I. F. transformer (L6, L7, C16, C17, R5) |
| 12511 | Cap—Grid contact cap for metal tubes—Package of 5 | | 12229 | Transformer—Second I. F. transformer (L8, L9, C19, C20, C21, R20) |
| 13689 | Capacitor—Adjustable capacitor (C15) | | 12231 | Transformer—Vibrator transformer (T3) |
| 13141 | Capacitor—47 Mmfd. (C25) | | 12236 | Vibrator—Complete (L18) |
| 12813 | Capacitor—82 Mmfd. (C50) | | 13711 | Volume control (R9) |
| 13433 | Capacitor—115 Mmfd. (C22) | | | REPRODUCER ASSEMBLIES |
| 11998 | Capacitor—115 Mmfd. (C16, C17, C19, C20) | | | MODEL 67M ONLY |
| 12761 | Capacitor—265 Mmfd. (C21) | | 13703 | Cone—Reproducer cone and dust cap (L12) |
| 13432 | Capacitor—330 Mmfd. (C11, C35, C36, C52, C53) (C52, C53 used in 67M2 and 67M3 only) | | 9772 | Reproducer complete Note No. 1—Field coil (L16) cannot be replaced separately. |
| 12764 | Capacitor—390 Mmfd. (C26) | | | REPRODUCER ASSEMBLIES |
| 12762 | Capacitor—1,000 Mmfd. (C41, C47) | | | MODEL 67M1 ONLY |
| 13701 | Capacitor—1,300 Mmfd. (C4) | | 12482 | Board—Reproducer terminal board |
| 13717 | Capacitor—1,700 Mmfd. (C9) | | 12450 | Coil—Field coil (L14) |
| 5005 | Capacitor—.0035 Mfd. (C34) | | 12451 | Cone—Reproducer cone complete (L15) |
| 4868 | Capacitor—.005 Mfd. (C24) | | 9687 | Reproducer—Reproducer complete |
| 5196 | Capacitor—.035 Mfd. (C31, C51) | | | REPRODUCER ASSEMBLIES |
| 4858 | Capacitor—.01 Mfd. (C3, C23, C32, C33) | | | DASH SPEAKER |
| 4836 | Capacitor—.05 Mfd. (C18) | | | MODELS 67M2 AND 67M3 ONLY |
| 11414 | Capacitor—.01 Mfd. (C27) | | 13794 | Cable—3-conductor shielded reproducer cable, approximately 18 inches long, complete with 3-contact male connector (67M2 only) |
| 4841 | Capacitor—.01 Mfd. (C12) | | 13798 | Cable—3-conductor shielded reproducer cable, approximately 24 inches long, complete with 3-contact pins (67M3 only) |
| 5019 | Capacitor—.05 Mfd. (C43) | | 13795 | Coil—Reproducer field coil (L14) |
| 12237 | Capacitor—0.25 Mfd. (C39) | | 13796 | Cone—Reproducer cone and dust cap (L15) |
| 12484 | Capacitor—0.25 Mfd. (C37) | | 11984 | Connector—3-contact male connector for reproducer cable (67M2 only) |
| 12234 | Capacitor—.8 Mfd. (C48) | | 13793 | Housing—Reproducer housing complete, less speaker unit and cable |
| 12238 | Capacitor pack—Comprising one .8 Mfd. and two 10 Mfd. sections (C28, C30, C49) | | 9774 | Reproducer—Speaker unit only, less case, cable and mounting parts |
| 13695 | Capacitor pack—Comprising two sections each .01 Mfd. (C45, C46) | | 13797 | Screw—Reproducer housing screw—Package of 5 |
| 13685 | Coil—Antenna coil and shield (L3) | | | REPRODUCER ASSEMBLIES |
| 12235 | Coil—Choke coil (L12) | | | HEADER SPEAKER |
| 12225 | Coil—Oscillator coil less shield (L16, L17) | | | MODEL 67M3 ONLY |
| 13712 | Coil—R. F. coil and shield (L4, L5) | | 9705 | Clip—Spring clip used to hold speaker unit in baffle pan—Package of 3 |
| 13371 | Condenser—3-gang variable tuning condenser (C5, C6, C7, C8, C13, C14) | | 9708 | Cone—Reproducer cone and dust cap (L15) |
| 12006 | Core—Adjustable core and stud for Stock Nos. 12229 and 13419 | | 9775 | Reproducer—Speaker unit only, less trimmer ring, baffle pan and grille cloth, and cable |
| 12168 | Coupling—Tuning control flexible shaft coupling | | 9701 | Ring—Trimmer ring with baffle pan and grille cloth |
| 12239 | Filter—Antenna filter (L1, L2, C2) | | 9706 | Screw—Mounting screw used to fasten speaker unit in car—Package of 2 |
| 13372 | Gear—Large drive gear for tuning condenser shaft | | 9709 | Screen—Wire screen for speaker unit |
| 13373 | Gear—Worm gear and mounting bracket for tuning condenser | | 9707 | Nut—Wing nut used to fasten speaker unit in car—Package of 2 |
| 13694 | Guide—Volume control flexible shaft guide | | | |
| 12483 | Pin—Contact pin for speaker leads—Package of 5 (67M1 only) | | | |
| 12485 | Pin—Contact pin for tone control lead—Package of 5 (67M1 only) | | | |
| 13111 | Reactor—Filter reactor (L13) | | | |
| 5034 | Resistor—56 ohms, carbon type, ½ watt—Package of 5 (R18, R19) | | | |
| 13713 | Resistor—750 ohms, insulated, ¼ watt—Package of 5 (R2) | | | |
| 12267 | Resistor—1,200 ohms, insulated, ¼ watt—Package of 5 (R17) | | | |
| 12194 | Resistor—1,800 ohms, insulated, ¼ watt—Package of 5 (R4) | | | |
| 13716 | Resistor—2,200 ohms, insulated, ¼ watt—Package of 5 (R22) | | | |
| 13229 | Resistor—3,900 ohms, carbon type, 2 watts (R11) | | | |

REPLACEMENT PARTS (Continued)

| Stock No. | DESCRIPTION | Stock No. | DESCRIPTION |
|--|---|-----------|---|
| CONTROL BOX AND FLEXIBLE SHAFT ASSEMBLIES | | | |
| MODELS 67M AND 67M1 ONLY | | | |
| 13719 | Box—Control box, tuning section only, less knob, flexible shaft and dial scale | 4291 | Clip—"A" lead ammeter clip—Package of 10 |
| 13720 | Box—Control box, volume control shaft and switch section only, less knob and flexible shaft | 13710 | Connector—Antenna lead connector assembly located on receiver housing |
| 13718 | Dial—Station selector dial | 13705 | Cover—Receiver housing top cover, less speaker grille (67M only) |
| 11765 | Lamp—Control box dial lamp—Package of 5 | 13723 | Cover—Receiver housing top cover, less speaker grille (67M1 only) |
| 13925 | Shaft—Tuning control flexible shaft, approximately 24½ inches long | 13802 | Cover—Receiver housing top cover (67M2 and 67M3 only) |
| 13926 | Shaft—Volume control flexible shaft, approximately 24¾ inches long | 13706 | Cover—Receiver housing bottom cover (67M and 67M1 only) |
| | Note No. 1—Knobs, escutcheon, and mounting parts are included in kits to be supplied by dealer for particular car in which installation is to be made. | 13803 | Cover—Receiver housing bottom cover (67M2 and 67M3 only) |
| | Note No. 2—If complete control box only is required, order one each of Stock No. 13719 and Stock No. 13720. | 13808 | Escutcheon—Speaker switch escutcheon for Model 67M3 only |
| CONTROL BOX AND FLEXIBLE SHAFT ASSEMBLIES | | 13707 | Fastener—Receiver housing top cover fastener—Package of 10 |
| MODELS 67M2 AND 67M3 ONLY | | 4286 | Ferrule—Ferrule and bushing for "A" lead connector—Package of 10 |
| 13790 | Box—Control box, tuning and sensitivity switch section only, less tuning control knob and dial scale | 5023 | Fuse—"A" lead fuse, 15 amp.—Package of 5 |
| 13791 | Box—Control box, volume control, tone control and operating switch section, less volume control knob | 13709 | Grille—Speaker grille assembly (67M only) |
| 13792 | Cable—3-conductor shielded sensitivity and tone control cable, approximately 26 inches long, complete with 4-contact male connector | 13725 | Grille—Speaker grille less screen (67M1 only) |
| 13718 | Dial—Station selector dial scale | 13704 | Housing—Receiver housing complete less speaker grille (67M only) |
| 11765 | Lamp—Dial lamp—Package of 5 | 13722 | Housing—Receiver housing complete less speaker grille (67M1 only) |
| 13925 | Shaft—Tuning control flexible shaft, approximately 24½ inches long | 13801 | Housing—Receiver housing complete (67M2 and 67M3 only) |
| 13926 | Shaft—Volume control flexible shaft, approximately 24¾ inches long | 4290 | Insulator—Fuse connector insulating sleeve—Package of 10 |
| | Note No. 1—Knobs, escutcheons, and mounting parts are included in kits to be supplied by dealer for particular car in which installation is to be made. | 13727 | Knob—Tone control knob—Package of 5 (67M1 only) |
| | Note No. 2—If complete control box only is required, order one each of Stock Nos. 13790 and 13791. | 4325 | Knob—Speaker switch knob for Model 67M3 only—Package of 5 |
| MISCELLANEOUS ASSEMBLIES | | 12445 | Lead—"A" lead (set end), approximately 8 inches long, complete with section of connector |
| ALL MODELS | | 7766 | Lead—"A" lead (ammeter end) complete with female section of fuse connector and ammeter clip |
| 4289 | Body—"A" lead fuse connector female body—Package of 10 | 13721 | Plate—Receiver nameplate and mounting screws (67M1 only) |
| 13724 | Button—Plug button to cover external speaker socket in receiver housing (67M1 only) | 13805 | Plate—RCA monogram for receiver housing (67M2 and 67M3 only) |
| 13708 | Cable—Shielded antenna lead-in, approximately 36 inches long, complete with 2 male connectors | 13806 | Ring—Rubber ring for dash speaker mounting (67M2 and 67M3 only) |
| 13809 | Cable—3-conductor shielded speaker switch cable, approximately 22 inches long, complete with 3-contact male connector (for Model 67M3 only) | 13726 | Screen—Speaker grille cloth and screen (67M1 only) |
| 13810 | Cable—3-conductor shielded reproducer cable, approximately 90 inches long, complete with contact pins, for header speaker in Model 67M3 only | 12252 | Screw—No. 8 self-tapping, hex head screw, used on receiver housing—Package of 10 |
| 4288 | Cap—Male connector cap for "A" lead—Package of 10 | 12447 | Screw—Speaker mounting screw assembly, comprising one screw, one lockwasher, and one nut—Package of 4 (67M only) |
| 4293 | Capacitor—Ammeter capacitor | 12248 | Socket—3-contact socket and bracket assembly for external speaker (67M1 only) |
| 5025 | Capacitor—Generator capacitor | 12502 | Socket—Pin-type socket and bracket for tone control lead (67M1 only) |
| 13109 | Capacitor—0.5 Mfd. (C42 for 67M1, 67M2, 67M3 only) (C30 for 67M only) | 13804 | Socket—Socket and bracket assembly, comprising one 3-contact socket for reproducer cable and one 4-contact socket for tone and sensitivity cable, both mounted on supporting bracket (67M2 and 67M3 only) |
| | | 4284 | Spring—Tension spring for "A" lead connector—Package of 10 |
| | | 12448 | Stud—Receiver mounting stud assembly, comprising one stud, one washer, one lockwasher, one nut |
| | | 12254 | Stud—Dash speaker mounting stud assembly, comprising one stud, one spacer, two lockwashers and one nut (67M2 and 67M3 only) |
| | | 5024 | Suppressor—Distributor suppressor |
| | | 13807 | Switch—Dash mounting speaker switch and bracket assembly, less knob and cable (67M3 only) |
| | | 12249 | Tone control (R23) (67M1 only) |
| | | 4285 | Washer—Insulating washer for "A" lead connector—Package of 10 |



RCA Victor

RECORD PLAYERS

MODELS R-93-A, R-93-2, R-93-S, and R-94

and

SUPPLEMENT to MODEL R-93

TECHNICAL INFORMATION AND SERVICE DATA

SERVICE DIVISION • RCA MANUFACTURING COMPANY, INC. • CAMDEN, N. J., U. S. A.

A Service of the Radio Corporation of America

Introduction

The RCA Victor Record Players Models R-93 (third production), R-93-A (first and second production), R-93-2 Deluxe, R-93-S, and R-94 Deluxe are designed to provide record reproduction to the owner of a radio receiver by utilizing the audio amplifier system and loudspeaker of the radio receiver. Methods of connecting these record players to the radio receiver are outlined in the Model R-93 Service Notes (third edition) and in this booklet. Model R-93 (first and second production) is listed in the "Specifications" tabulation of this booklet, for convenient reference.

Note

1. (Applies to Model R-93-S only). It is necessary to short the 0.1 mfd. blocking capacitor C1 in Model R-93-S (see figure 6) for cases in which the control grid d-c bias, or cathode current flow, would be removed or prevented by this capacitor when the record player switch is thrown to "Phono" position. C1 is provided to permit operation on battery receivers without shorting bias batteries, etc. Cases in which it is necessary to short C1 are indicated in "RCA Victor Receivers—Details of Lead Connections" of this booklet.

2. (Record Player Switch Jumpers)—Some record player switches do not have jumpers J1 and J2 (see figure 3) attached. When the switch is so connected and turned to phonograph position, the voltage developed by the pickup is fed into the radio receiver through the green wire and shield, and at the same time the yellow wire is connected to shield. The jumpers J1 and J2 permit the yellow lead to kill radio by connection to shield. The jumpers should be removed where the yellow lead connects in such a position as to short bias batteries, etc. Check the switch to be used for the method chosen and use the jumpers accordingly. Correct jumper connections are indicated in "RCA Victor Receivers—Details of Lead Connections" of this booklet.

To prevent confusion, replacement parts lists are provided separately in this booklet for Models R-93 (third production), R-93-A (first and second production), R-93-2 Deluxe (first production), R-93-S (first production), and R-94 Deluxe (first production), respectively, and should be consulted whenever making replacements to these various models.

Description and Service Data

MODEL R-93

(Third Production)

(Walnut, Red, White, Black)

The Model R-93 (third production) in colors of Walnut, Red, White, or Black are similar electrically to the original R-93 (first and second production) but may be identified mechanically by the curved tone arm. The original Model R-93 had a straight tone arm. Refer to Model R-93 Service Notes (third edition) Phonograph Motor Service Data (second production motors) for motor details and adjustments.

MAGNETIC PICKUP

The pickup used in the phonograph unit is of an improved design. The horseshoe magnet is rigidly welded to the pole pieces and is irremovable. There is a centering spring attached to the armature to maintain proper adjustment and to

provide a limiting effect on the movement of the armature. The frequency response is substantially uniform over a wide range. Service operations which may be necessary on the pickup are as follows:

CENTERING ARMATURE

Refer to figure 1 showing the pickup inner structure. The armature is shown in its proper relation to the magnet pole pieces, i. e., exactly centered. Whenever this centering adjustment has been disturbed it will be necessary to remove the pickup mechanism from the tone arm by removing the needle holding screw and the two mounting screws from the front of the tone arm, holding the pickup assembly to keep it from dropping. Unsolder the two leads from the lugs on the terminal board at the rear of the pickup. Insert a small rod or nail into the armature needle hole and replace the needle holding screw, tightening it to hold the rod securely. If the armature clamping screws A and B have not been disturbed, screw or screws C should be loosened which will per-

mit the armature to be moved from side to side, the rod acting as a lever to perform this operation. The proper adjustment is obtained when the armature is moved to the extreme position on each side (the movement being limited by

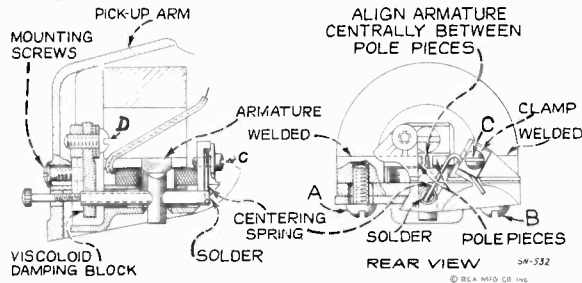

Figure 1—Details of Pickup
[Models R-93 (3rd prod.), R-93-A (1st prod.), R-93-2 Deluxe (1st prod.), and R-93-S (1st prod.)]

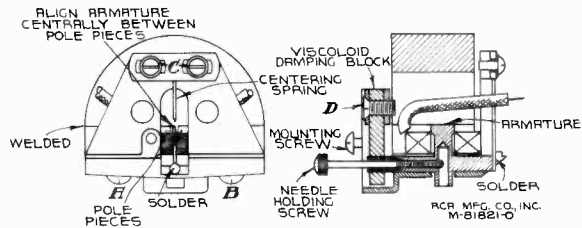

Figure 2—Details of Pickup
[Models R-93-A (2nd prod.) and R-94 Deluxe (1st prod.)]

the armature striking the pole pieces) and then brought to the mid position between these two extremes. Screw or screws C should then be tightened. The armature position should then be central between the pole pieces and at right angles to them. With a little practice, the correct adjustment of the armature will be obtained. The air gap between the pole pieces and the armature should be kept free from dust, filings, and other foreign material which would obstruct the movement of the pickup armature.

DAMPING BLOCK

The viscoloid damping block which is attached to the front end of the armature shank serves as a mechanical filter to eliminate undesirable resonances and to cause the frequency response to be uniform. Should it be necessary to replace this damping block, the pickup mechanism should be removed from the tone arm as explained above. Remove screw D and the damping block from the pickup assembly. Make sure that the shaft of the armature which contacts the viscoloid is clean. Then insert the new damping block so that it occupies the same position as that of the original block, and is in correct vertical alignment with the armature. The hole in the block is somewhat smaller than the diameter of the armature in order to permit a snug fit. With the damping block properly aligned on the armature, screw D with its washer should then be replaced. Heat should be applied to the armature (viscoloid side) so that the damping block will fuse at the point of contact and become rigidly attached to the armature. A special-tip soldering iron, constructed as shown in Model R-93 Service Notes (third edition) figure 8, will be found very useful in performing this operation. The iron should be applied only long enough to slightly melt the block, causing a small bulge on both sides.

REPLACING COIL

Whenever there is defective operation due to an open or shorted pickup coil, this coil should be replaced. Remove the pickup mechanism and terminal board as described above. Remove screws A and B and the magnet assembly. Remove the bakelite coil support (with coil attached) and insert the new coil support assembly in its place, after which replace the magnet assembly and center the armature as described above, then re-assemble the remainder of the unit. Only

rosin core solder should be used for soldering the coil leads and pickup leads to the pickup terminal board. This same type of solder should be used when necessary for soldering the centering spring to the armature.

MAGNETIZING

Loss of magnetization will not usually occur when the pickup has received normal care because the magnet and pole pieces are one unit and the magnetic circuit remains practically closed at all times. When the pickup has been mishandled, subjected to a strong a-c field, jolted, or dropped, there may be an appreciable loss of magnetic strength, in which case it will be necessary to remagnetize the entire structure. To do this, it will be necessary to first remove the pickup mechanism from the tone arm, and then remove the magnet assembly. Place the magnet assembly on the poles of a standard pickup magnetizer such as the RCA Stock No. 9549 Pickup Magnetizer and charging the magnet in accordance with the instructions accompanying the magnetizer. It is preferable to check the polarity of the pickup magnet and to remagnetize it so that the same polarity is maintained.

MODEL R-93-A

(First and Second Production)
(Walnut)

The cabinet of the Model R-93-A is similar to that of the Model R-93 Walnut finish. This model incorporates an acoustic compensated volume control, see figure 3. Model R-93-A (first production) and Model R-93-A (second production) differ only in the pickup construction, the essential difference being in the armature centering spring and spring clamps. Reference to pickup details, figures 1 and 2 will reveal the fact that the armature centering spring is respec-

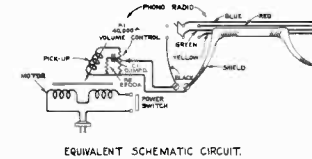

Figure 3—Wiring Diagram and Equivalent Schematic Circuit
[Models R-93-A (1st and 2nd prod.) and R-94 Deluxe (1st prod.)]

tively "V" and "T" shaped for the Model R-93-A (first and second productions). Refer to "Model R-93 (third production)" and figures 1 and 2 for pickup adjustments.

The motor differs slightly in construction and mounting details from that used in the Model R-93 (second production). Refer to figure 4 for motor details. Refer to Model R-93 Service Notes (third edition) for motor coil connections.

MODEL R-93-2 DE LUXE

(Walnut)

Model R-93-2 Deluxe is finished in walnut and is electrically identical to Model R-93 (third production), however, the cabinet is larger in size and has a hinged lid which may be closed while playing the records. The turntable is 10 inches in diameter. The motor differs slightly in construction from that used in the Model R-93 (second production). Refer to figure 5 for motor details and to Model R-93 Service Notes (third edition) for motor coil connections.

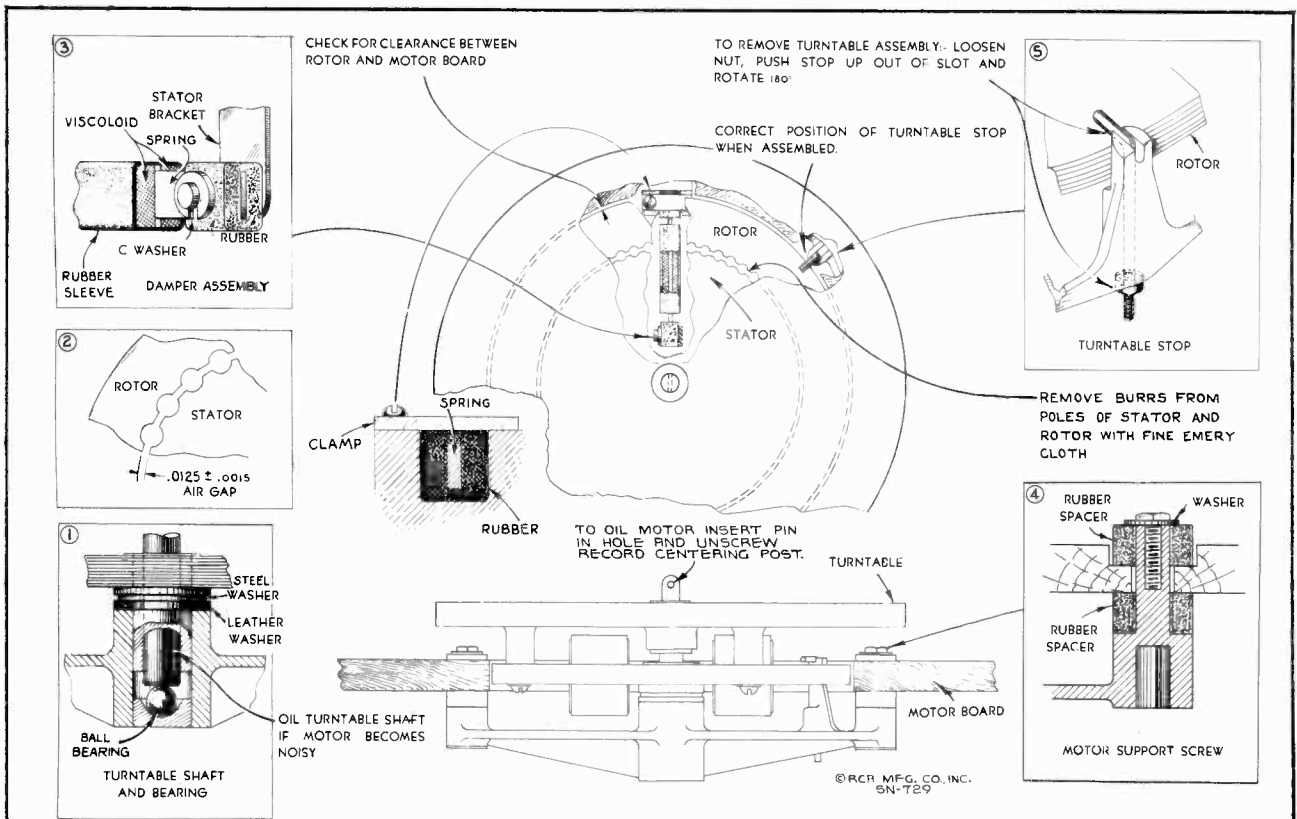

Figure 4—Details of Motor
[Model R-93-A (1st and 2nd prod.)]

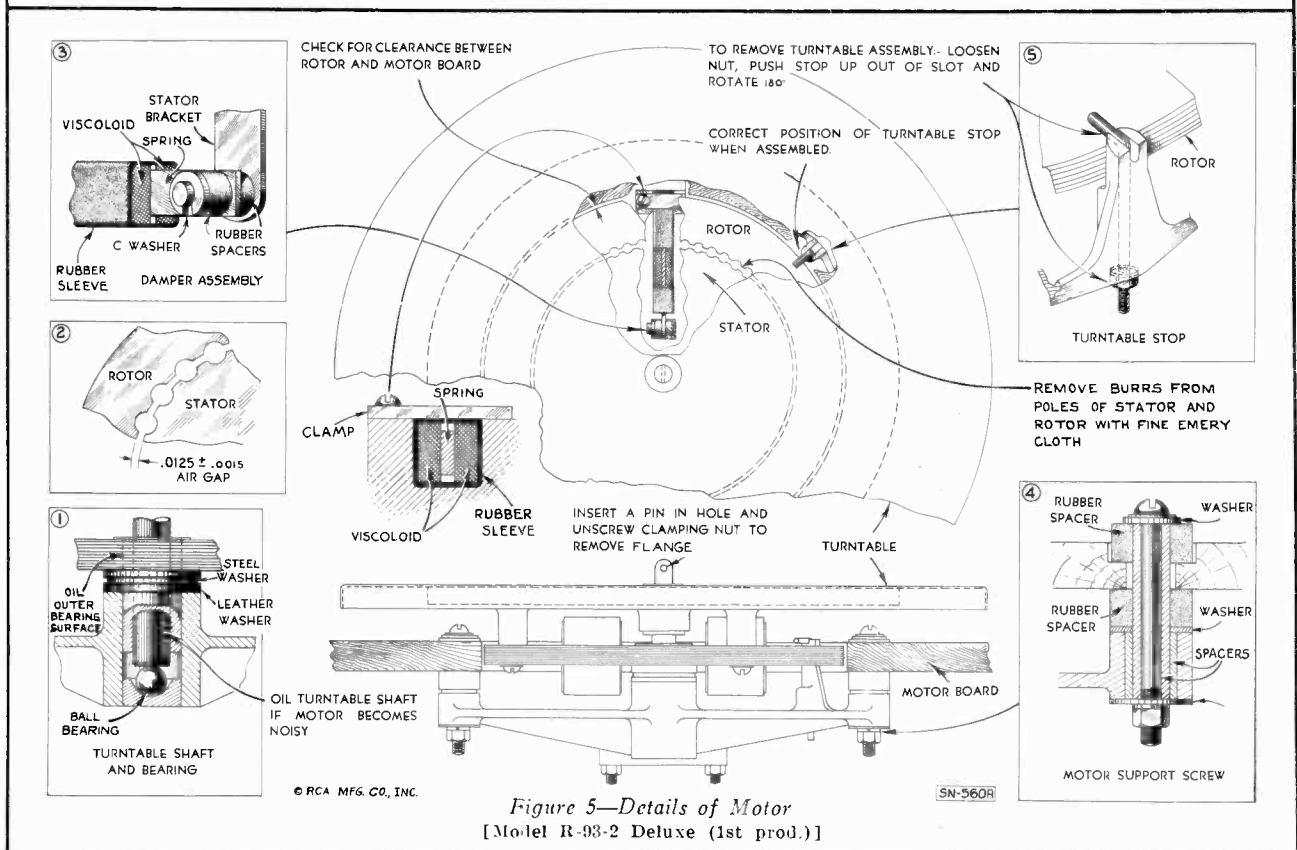

Figure 5—Details of Motor
[Model R-93-2 Deluxe (1st prod.)]

MODEL R-93-S (Walnut)

Model R-93-S has a spring wound motor and is primarily intended for use with battery receivers. The pickup and tonearm are identical to those described in "Model R-93 (third production)," therefore the adjustments will be the

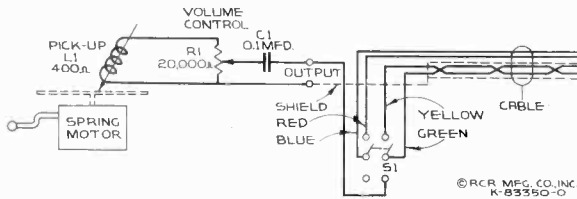

Figure 6—Schematic Circuit Diagram
[Model R-93-S (1st prod.)]

same. Reference to the Schematic diagram figure 6 will show a capacitor C1 in series with one of the leads to the binding posts. The purpose of C1 is to permit operation on battery receivers without shorting bias batteries, etc. Observe Note 1 under "Introduction" when making connections to radio receivers.

MOTOR

The drive motor is of simple design and substantial construction. It should require little or no service if properly maintained. Attention to lubrication of the moving parts and occasional cleaning of the mechanism will go far to prevent faulty operation. Should it become necessary to repair the motor, the following procedure should be applied referring to figure 7:

REMOVING MOTOR FROM CABINET—Remove the winding key. To dismount the motor, unscrew the spindle cap with a screwdriver and remove turntable, slightly tapping the spindle while exerting an upward lift on the turntable. Remove the bottom cover from the cabinet. Loosen the screw holding the speed regulating lever and remove the latter. The four nuts holding motor to motor board should then be loosened to permit removal of motor assembly.

Caution—Allow the motor mechanism to run down completely before attempting adjustment, repairs, or replacement.

REPLACING MAIN SPRING—In case of main spring failure the entire spring barrel and gear should be replaced. Remove spring barrel spindle screw by unscrewing to right. Remove the "C" washer and two pillar screws holding bottom plate. Remove plate and intermediate spindle shaft. Replace main spring barrel, intermediate spindle shaft, and bottom plates.

WINDING SHAFT SPRING—This spring functions as a friction ratchet. It may be removed by first removing pin holding winding gear on shaft, removing shaft, and then the screw holding the spring.

GOVERNOR ADJUSTMENTS—The mesh of the worm and fibre gears is adjusted by rotation of the eccentric spindle bearings. The adjustments should be made so that the worm meshes properly with the fibre gear and rotates freely without

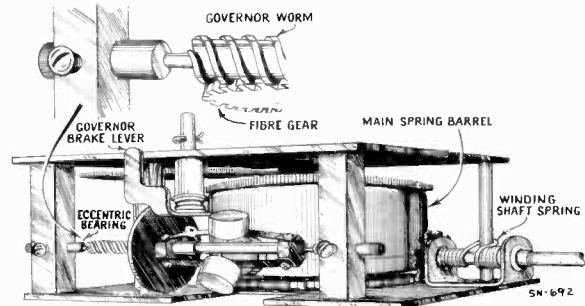

Figure 7—Details of Motor
[Model R-93-S (1st prod.)]

binding. The bearings should be accurately aligned with each other. The minimum of spindle end play which permits smooth operation should be used.

SPEED REGULATOR LEVEL—After assembly, adjust the speed regulator until the turntable rotates at 78 r.p.m.; then loosen the speed regulator screw and set pointer to center of speed indicator scale; tighten screw and re-check turntable speed.

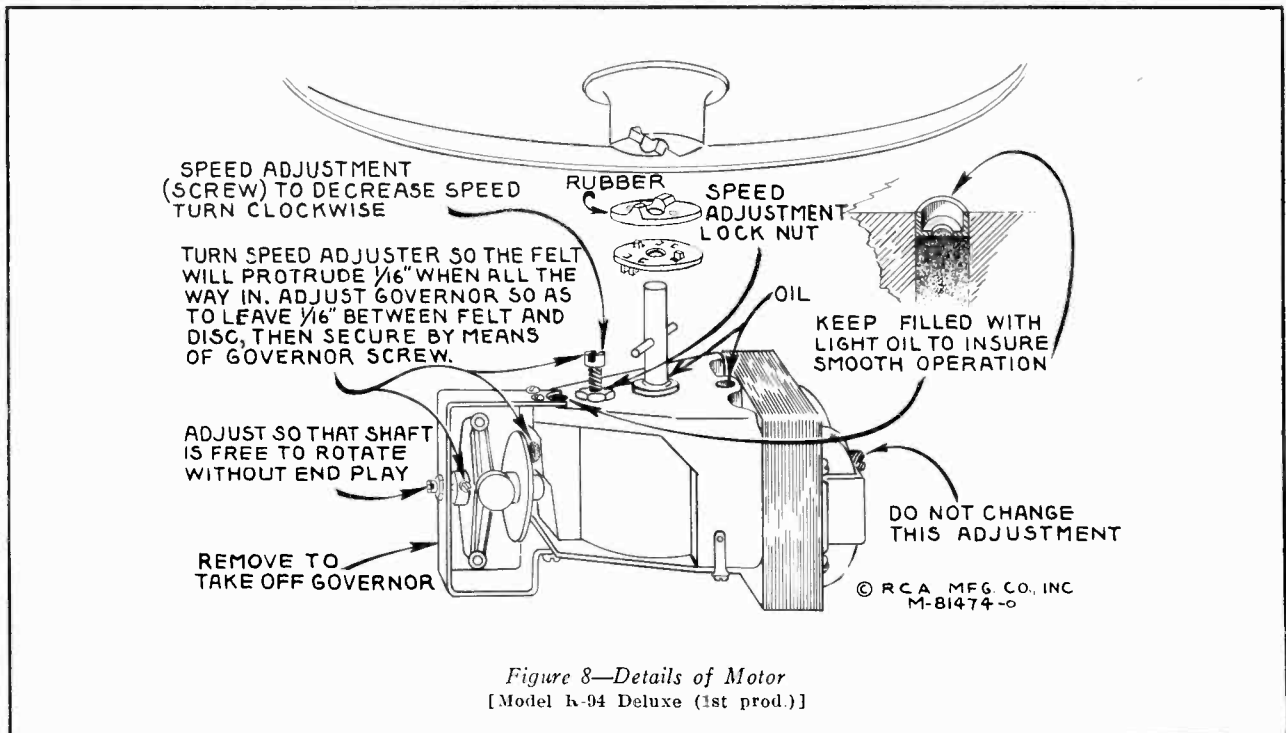

Figure 8—Details of Motor
[Model R-94 Deluxe (1st prod.)]

LUBRICATION—All moving parts of the motor should be thoroughly cleaned and lubricated every six months to prevent excess wear and improper operation. A small amount of grease should be applied to the worm gear of the governor, the gear of the winding shaft, and on the small pinion gear. All other points should be lubricated with a drop of light oil. All motor parts should be covered with a light film of oil to prevent rusting.

MODEL R-94 DE LUXE

(Walnut)

The Model R-94 Deluxe cabinet is finished in walnut and has a hinged lid which may be closed while playing the

records. This model incorporates an acoustic compensated volume control, see figure 3. An improved type of pickup is used, the construction of which is illustrated in figure 2. Refer to "Model R-93 (third production)" and figure 2 for pickup adjustments.

MOTOR—The phonograph motor is of the governor induction type and is designed to be simple and foolproof. Occasionally, however, certain adjustments may be required. These adjustments are illustrated and explained in figure 8. Application of oil to the felt pad which rubs against the governor disc will insure smooth operation.

Specifications

| Model | Cabinet Finish | Production | Tone Arm Style | Voltage | Freq. Cyc. | Power Consumption Watts | Motor Coil Res. Ohms Total | Type of Motor | Turntable Speed R.P.M. | Pickup Impedance 1000 cycles | Volume Control Resistance Ohms | Dimensions Inches | | | Weights | | |
|---------------|-----------------|------------------|----------------|---------|------------|-------------------------|----------------------------|------------------------------------|------------------------|------------------------------|--------------------------------|-------------------|-------|-------|-----------------------|-----|----------|
| | | | | | | | | | | | | Height | Width | Depth | Turntable Dia. Inches | Net | Shipping |
| R-93 | Walnut | Third | Curved | 105— | 60 | 5 | 200 | Synchronous (Manual Starting) | 78 | 1,400 | 20,000 | 5 | 11 | 8 | 7 | 8½ | 10 |
| | | | | 125 | 50 | 5 | 200 | | | | | | | | | | |
| R-93 | Red White Black | Third | Curved | 105— | 60 | 5 | 200 | Synchronous (Manual Starting) | 78 | 1,400 | 20,000 | 5 | 11 | 8 | 7 | 8½ | 10 |
| | | | | 105— | 50 | 5 | 200 | | | | | | | | | | |
| | | | | 105— | 25 | 5 | 660 | | | | | | | | | | |
| | | | | 200— | 50 | 5 | 1,040 | | | | | | | | | | |
| R-93 | Walnut | Second | Straight | 105— | 60 | 5 | 200 | Synchronous (Manual Starting) | 78 | 1,400 | 20,000 | 5 | 11 | 8 | 7 | 8½ | 10 |
| | | | | 105— | 50 | 5 | 200 | | | | | | | | | | |
| | | | | 105— | 25 | 5 | 660 | | | | | | | | | | |
| R-93 | Walnut | First | Straight | 105— | 60 | 5 | 218 | Synchronous (Manual Starting) | 78 | 1,400 | 20,000 | 5 | 11 | 8 | 7 | 8½ | 10 |
| | | | | 105— | 50 | 5 | 218 | | | | | | | | | | |
| | | | | 105— | 25 | 5 | 960 | | | | | | | | | | |
| | | | | 200— | 50 | 5 | 1,270 | | | | | | | | | | |
| R-93-A | Walnut | First and Second | Curved | 105— | 60 | 5 | 160 | Synchronous (Manual Starting) | 78 | 1,400 | 40,000 Tapped for Compensation | 5½ | 11¼ | 9 | 7 | 10 | 12 |
| | | | | 105— | 50 | 5 | 160 | | | | | | | | | | |
| | | | | 105— | 25 | 5 | 420 | | | | | | | | | | |
| | | | | 200— | 50 | 5 | 700 | | | | | | | | | | |
| R-93-2 Deluxe | Walnut | First | Curved | 105— | 60 | 5 | 200 | Synchronous (Manual Starting) | 78 | 1,400 | 20,000 | 5½ | 13¼ | 13½ | 10 | 14 | 18 |
| | | | | 105— | 50 | 5 | 200 | | | | | | | | | | |
| | | | | 105— | 25 | 5 | 660 | | | | | | | | | | |
| | | | | 200— | 50 | 5 | 1,040 | | | | | | | | | | |
| R-93-S | Walnut | First | Curved | — | — | — | — | Spring Wound | 78 Adjustable | 1,400 | 20,000 | 5½ | 12¼ | 10½ | 9 | 10 | 13 |
| R-94 Deluxe | Walnut | First | Curved | 105— | 60 | 25 | 100 | Governor Induction (Self-Starting) | 78 Adjustable | 1,400 | 40,000 Tapped for Compensation | 7¼ | 15½ | 13½ | 9 | 14 | 18 |
| | | | | 105— | 50 | 25 | 70 | | | | | | | | | | |
| | | | | 200— | 50 | 25 | 290 | | | | | | | | | | |
| | | | | 250 | 60 | — | — | | | | | | | | | | |

RCA VICTOR RECEIVERS—DETAILS OF LEAD CONNECTIONS

| MODEL | METHOD OF CONNECTION | GREEN | YELLOW | RED | BLUE | SHIELD | SWITCH |
|---|----------------------|----------------------|------------------------------|------------------|-------------------------------------|--------------------------------------|--------|
| 5BT, 5T, 5T1, 5T4, 5T5, 5T6, 5T7, 5T8, 6K, 6K1, 6T, 6T5, 8BK, 8BK6, 8BT, 8BT6, 8K11, 8T2, 8T11 | 2. Term. Board | 1 | 2 | Tape | Tape | 3 | † |
| 6BK, 6BK6, 6BT, 6BT6 | 2. Term. Board | 1 | 2 | Tape | Tape | 3 | †† |
| 7K, 7T, 7X, 7X1, 8K, 8K1, 8T, 8T10 | 2. Term. Board | 1 | 2 | Tape | Tape | 3 | †§ |
| 6K2, 6K3, 6K10, 6T2, 6T10, 7K1 | 2. Term. Board | 2 | 1 | Tape | Tape | 3 | † |
| T9-7, T9-8 | 2. Term. Board | 2 | 3 | Tape | Tape | 1 | † |
| 9K, 9K1, 9K2, 9K3, 9K10, 9T, 10K, 10K1, 10K11, 10T, 10T11, 13K, 15K | 2. Term. Board | 2 | 1 | 4 | 3 | 3 | †† |
| C6-12, C7-14, C8-19, C8-20, T6-11, T7-12, T8-18, T9-10 | 4. Grid Clip | Grid Cap Tube | Grid Clip | Tape | Tape | Chassis | †§ |
| C11-3, C13-3, C15-4 | 5. Adapter | 1st Audio Cathode | Cathode Socket Contact | I-F Cathode * | I-F Cathode Socket Contact | Chassis | ††§ |
| C6-8, T6-7 | 5. Adapter | Grid Cap Tube | Grid Clip | Tape | Tape | Both Adapter Cathode Terms. | †§ |

† Add Jumpers J1 and J2 to Phono-Radio Switch if not present.

†† Remove Jumpers J1 and J2 to Phono-Radio Switch if present.

§ Short 0.1 Mfd. Capacitor (C1) in R-93-S Record-Player.

* Use a second adapter.

REPLACEMENT PARTS

Insist on genuine factory tested parts, which are readily identified and may be purchased from authorized dealers.

| STOCK No. | DESCRIPTION | STOCK No. | DESCRIPTION |
|-----------|---|-----------|---|
| | MOTOR ASSEMBLIES [Model R-93 (third production) Walnut] | 11733 | Coil—Stator assembly—comprising coil and lamination—110 volts, 60 cycle |
| | | 11734 | Coil—Stator assembly—comprising coil and lamination—110 volts, 50 cycle |
| 10194 | Ball—Steel ball bearing | 11735 | Coil—Stator assembly—comprising coil and lamination—110 volts, 25 cycle |
| 11740 | Base—Motor base and bearing assembly | 13081 | Coil—Stator assembly—comprising coil and lamination—220 volts, 50 cycle |
| 11733 | Coil—Stator assembly—comprising coil and laminations—105-125 volt, 60 cycle operation | 11748 | Damper—Motor damper assembly—comprising one damper, one damper plate, one screw, two rubber washers, and one "C" washer |
| 11734 | Coil—Stator assembly—comprising coil and laminations—105-125 volt, 50 cycle operation | 9721 | Motor—110 volts, 60 cycle motor with red turntable (M1) |
| 11748 | Damper—Motor damper assembly—comprising one damper, one damper plate, one screw, two rubber washers, and one "C" washer | 9725 | Motor—110 volts, 60 cycle motor with white turntable (M1) |
| 11873 | Motor—105-125 volts—60 cycle motor (M1) | 9729 | Motor—110 volts, 60 cycle motor with black turntable (M1) |
| 11874 | Motor—105-125 volts—50 cycle motor (M1) | 9722 | Motor—110 volts, 50 cycle motor with red turntable (M1) |
| 4456 | Motor Accessories—comprising three nuts, one shield and one screw | 9726 | Motor—110 volts, 50 cycle motor with white turntable (M1) |
| 11876 | Turntable—Turntable assembly complete— with rotor laminations—60 cycle operation | 9730 | Motor—110 volts, 50 cycle motor with black turntable (M1) |
| 11875 | Turntable—Turntable assembly complete— with rotor laminations—50-cycle operation | 9723 | Motor—110 volts, 25 cycle motor with red turntable (M1) |
| 4083 | Washer—Leather washer | 9727 | Motor—110 volts, 25 cycle motor with white turntable (M1) |
| 4084 | Washer—Metal washer | 9731 | Motor—110 volts, 25 cycle motor with black turntable (M1) |
| | MOTOR ASSEMBLIES [Model R-93 (third production) Red-White-Black] | | |
| 10194 | Ball—Steel ball bearing | | |
| 11740 | Base—Motor base and bearing assembly | | |

REPLACEMENT PARTS—(Continued)

Insist on genuine factory tested parts, which are readily identified and may be purchased from authorized dealers.

| STOCK No. | DESCRIPTION | STOCK No. | DESCRIPTION |
|-----------|--|-----------|--|
| 9724 | Motor—220 volts, 50 cycle motor with red turntable (M1) | 7943 | Barrel—Spring barrel—complete with winding gear and drive gear |
| 9728 | Motor—220 volts, 50 cycle motor with white turntable (M1) | 7945 | Gear—Intermediate gear, pinion and shaft |
| 9732 | Motor—220 volts, 50 cycle motor with black turntable (M1) | 7938 | Gear—Winding gear, sleeve and shaft |
| 13072 | Turntable—Red turntable—complete with rotor lamination—60 cycle operation | 7940 | Governor Assembly—Comprising governor, spindle, disc, collar, governor balls and springs assembled |
| 13075 | Turntable—White turntable—complete with rotor lamination—60 cycle operation | 7226 | Grease—Motor grease—1 pint can |
| 13078 | Turntable—Black turntable—complete with rotor lamination—60 cycle operation | 7228 | Lubricant—Spring lubricant—1 pint can |
| 13073 | Turntable—Red turntable—complete with rotor lamination—50 cycle operation | 7931 | Motor—Motor complete with spindle cap |
| 13076 | Turntable—White turntable—complete with rotor lamination—50 cycle operation | 7227 | Oil—Motor oil—1 pint can |
| 13079 | Turntable—Black turntable assembly—complete with rotor lamination—50 cycle operation | 7941 | Plate—Motor top plate assembly |
| 13074 | Turntable—Red turntable assembly—complete with rotor lamination—25 cycle operation | 7944 | Shaft—Regulator shaft—complete with friction lever and pad with cotter pin |
| 13077 | Turntable—White turntable assembly—complete with rotor lamination—25 cycle operation | 7939 | Spindle—Turntable spindle—complete with two gears |
| 13080 | Turntable—Black turntable assembly—complete with rotor lamination—25 cycle operation | 7957 | Spring—Main spring for motor |
| 4083 | Washer—Leather spacing washer | 7942 | Spring—Winding shaft spring |
| 4084 | Washer—Metal spacing washer | | |
| | MOTOR ASSEMBLIES | | |
| | [Model R-93-A (first and second production) Walnut] | | |
| 10194 | Ball—Steel ball bearing | 14328 | Governor—Complete motor governor assembly |
| 14233 | Base—Motor base and bearing assembly | 14325 | Motor—105-125 volts—60 cycle (MI) |
| 14232 | Cap—Turntable spindle cap | 14326 | Motor—105-125 volts—50-60 cycle (MI) |
| 14223 | Coil—Stator assembly—comprising coils and laminations—105-125 volts, 60 cycle | 14327 | Motor—200-250 volts—50-60 cycle (MI) |
| 14224 | Coil—Stator assembly—comprising coils and laminations—105-125 volts, 50 cycle | | |
| 14225 | Coil—Stator assembly—comprising coils and laminations—105-125 volts, 25 cycle | | |
| 14226 | Coil—Stator assembly—comprising coils and laminations—220 volts, 50 cycle | | |
| 14228 | Damper—Motor damper assembly—comprising one damper, one damper plate, one screw and one "C" washer | | |
| 14216 | Motor—105-125 volts—60 cycle (MI) | | |
| 14217 | Motor—105-125 volts—50 cycle (MI) | | |
| 14218 | Motor—105-125 volts—25 cycle (MI) | | |
| 14219 | Motor—220 volt—50 cycle (MI) | | |
| 14227 | Shield—Terminal board shield and nuts | | |
| 14229 | Stop—Turntable stop, lockwasher and nut—prevents removal of turntable | | |
| 14220 | Turntable—Turntable assembly—complete with rotor laminations—60 cycle operation | | |
| 14221 | Turntable—Turntable assembly—complete with rotor laminations—50 cycle operation | | |
| 14222 | Turntable—Turntable assembly—complete with rotor laminations—25 cycle operation | | |
| 4083 | Washer—Leather washer for turntable bearing | | |
| 14230 | Washer—Metal washer for turntable bearing | | |
| 14231 | Washer—Metal shim washer for turntable bearing | | |
| | MOTOR ASSEMBLIES | | |
| | [Model R-93-2 Deluxe (first production) Walnut] | | |
| 10194 | Ball—Steel ball bearing | 3812 | Armature—Pickup armature |
| 11740 | Base—Motor base and bearing assembly | 4462 | Cable—Pickup cable |
| 11735 | Coil—Stator assembly—Comprising coils and laminations—110 volts, 25 cycles | 11732 | Coil—Pickup coil and support (L1) |
| 11734 | Coil—Stator assembly—comprising coils and laminations—110 volts, 50 cycles | 5091 | Cushion—Pickup armature cushion |
| 11733 | Coil—Stator assembly—comprising coils and laminations—110 volts, 60 cycles | 4543 | Damper—Pickup damper block—complete with damper plate, washer and screw |
| 13081 | Coil—Stator assembly—comprising coils and laminations—220 volts, 50 cycles | 12329 | Pickup and arm assembly—complete |
| 11748 | Damper—Motor damper assembly—comprising one damper, one damper plate, one screw, two rubber washers and one "C" washer | 4387 | Screw—Pickup arm set screw—used to fasten arm to pivot shaft |
| 9733 | Motor—110 volts—25 cycles (MI) | 11951 | Screw—Pickup needle holding screw |
| 12083 | Motor—110 volts—50 cycles (MI) | | |
| 12082 | Motor—110 volts—60 cycles (MI) | | |
| 9734 | Motor—220 volts—50 cycles (MI) | | |
| 13084 | Turntable—Turntable assembly—complete with rotor laminations—25 cycle operation | | |
| 12049 | Turntable—Turntable assembly—complete with rotor laminations—50 cycle operation | | |
| 12048 | Turntable—Turntable assembly—complete with rotor laminations—60 cycle operation | | |
| 4083 | Washer—Leather spacing washer | | |
| 4084 | Washer—Metal spacing washer | | |
| | MOTOR ASSEMBLIES | | |
| | [Model R-93-S (first production) Walnut] | | |
| 7937 | Ball and Spring—Governor ball and spring assembly | | |

REPLACEMENT PARTS—(Continued)

Insist on genuine factory tested parts, which are readily identified and may be purchased from authorized dealers.

| STOCK No. | DESCRIPTION | STOCK No. | DESCRIPTION |
|---|--|-----------|---|
| PICKUP AND ARM ASSEMBLIES | | | |
| [Model R-94 Deluxe (first production) Walnut] | | | |
| 14291 | Armature—Pickup armature assembly | 4458 | Post—Binding post |
| 11732 | Coil—Pickup coil (L1) | 3261 | Rest—Pickup rest |
| 14292 | Damper—Pickup damper block—complete with clamp and screw | 11869 | Screw—Motor mounting screw assembly—comprising one screw, one upper spacer, one lower spacer, two rubber washers, three metal washers, one lockwasher and one nut |
| 14329 | Pickup and Arm—Complete | 4119 | Screw—No. 8-32 x 1/4-inch headless set screw for knob, Stock No. 3829 |
| 4387 | Screw—No. 6-32x1/4-in. headless set screw for pickup arm pivot shaft | 4460 | Switch—Radio-Record switch (S2) |
| 3811 | Screw—Needle holding screw | 4502 | Volume Control and switch (R1, S1) |
| 14213 | Washer—Pickup arm stop washer | | |
| CABINET ASSEMBLIES | | | |
| [Model R-93 (third production) Walnut] | | | |
| X325 | Bottom—Lower section of wood cabinet | 4461 | Cable—5-conductor Radio-Record switch cable |
| X324 | Cover—Upper section of wood cabinet | 4841 | Capacitor—0.1 Mfd. (C1) |
| CABINET ASSEMBLIES | | | |
| [Model R-93 (third production) Red-White-Black] | | | |
| X314 | Bottom—Lower section of red cabinet | 3829 | Knob—Radio-Record switch knob |
| X316 | Bottom—Lower section of white cabinet | 3961 | Knob—Volume control knob |
| X318 | Bottom—Lower section of black cabinet | 4458 | Post—Binding post |
| X315 | Cover—Top section of red cabinet | 3261 | Rest—Pickup rest |
| X317 | Cover—Top section of white cabinet | 12195 | Resistor—2,200 Ohms, insulated, 1/2 watt (R2) |
| X319 | Cover—Top section of black cabinet | 14235 | Screw—Motor mounting screw assembly—comprising one screw, one metal washer and two rubber washers |
| CABINET ASSEMBLIES | | | |
| [Model R-93-A (first and second production) Walnut] | | | |
| X356 | Bottom—Lower section of wood cabinet | 4119 | Screw—No. 8-32x1/4-in. headless screw for knob Stock No. 3829 |
| X357 | Cover—Upper section of wood cabinet | 4460 | Switch—Radio-Record switch (S2) |
| CABINET ASSEMBLIES | | | |
| [Model R-93-2 Deluxe (first production) Walnut] | | | |
| X321 | Bottom—Lower section of cabinet—less hinges and lid support | 4502 | Volume Control and Switch (R1, S1) |
| X320 | Cover—Lid section of cabinet—less hinges and lid support | | |
| 13085 | Hinge—Cabinet hinge and screws | | |
| 13086 | Support—Cabinet lid support and screws | | |
| CABINET ASSEMBLIES | | | |
| [Model R-93-S (first production) Walnut] | | | |
| X322 | Bottom—Lower section of wood cabinet | 4459 | Bracket—Volume control mounting bracket |
| X323 | Cover—Top section of wood cabinet | 4461 | Cable—5-conductor Radio-Record switch cable |
| CABINET ASSEMBLIES | | | |
| [Model R-94 Deluxe (first production) Walnut] | | | |
| X370 | Bottom—Lower section of cabinet—less hinges and lid support | 3829 | Knob—Radio-Record switch knob |
| X371 | Cover—Lid section of cabinet—less hinges and lid support | 3961 | Knob—Volume control knob |
| 13085 | Hinge—Cabinet lid hinge and screws | 7935 | Leather—Friction leather for turntable brake |
| 13086 | Support—Cabinet lid support and screws | 7936 | Nut—Motor mounting nut assembly—comprising one nut, two washers, one lockwasher, one rubber cushion |
| MISCELLANEOUS ASSEMBLIES | | | |
| [Model R-93 (third production) Walnut] | | | |
| 4459 | Bracket—Volume control mounting bracket | 4458 | Post—Binding post |
| 4461 | Cable—5-conductor Radio-Record switch cable | 13090 | Regulator—Motor speed regulator and plate |
| 3829 | Knob—Radio-Record switch knob | 3261 | Rest—Pickup rest |
| 3961 | Knob—Volume control knob | 4119 | Screw—No. 8-32x1/4-in. headless set screw for knob Stock No. 3829 |
| 4458 | Post—Binding post | 7934 | Spring—Coil spring for turntable brake |
| 3261 | Rest—Pickup rest | 4460 | Switch—Radio-Record switch (S1) |
| 11869 | Screw—Motor mounting screw assembly—comprising one screw, three metal washers, two rubber washers, one lockwasher, one nut and two spacers | 13088 | Turntable—Complete |
| 4119 | Screw—No. 8-32 x 1/4-in. headless set screw for knob, Stock No. 3829 | 13092 | Volume Control (R1) |
| 4460 | Switch—Radio-Record switch (S2) | | |
| 4502 | Volume Control and switch (R1, S1) | | |
| MISCELLANEOUS ASSEMBLIES | | | |
| [Model R-93 (third production) Red-White-Black] | | | |
| 4459 | Bracket—Volume control mounting bracket | 4461 | 5-conductor switch cable |
| 4461 | Cable—5-conductor Radio-Record switch cable | 4841 | Capacitor—0.1 Mfd. (C1) |
| 3829 | Knob—Radio-Record switch knob | 11704 | Damper—Turntable damper and damper plate |
| 3961 | Knob—Volume control knob | 3961 | Knob—Volume control and switch knob |
| 4458 | Post—Binding post | 3829 | Knob—Radio-Record switch knob |
| 3261 | Rest—Pickup rest | 4458 | Post—Binding post |
| 13716 | Resistor—2,200 Ohms, insulated, 1/2 watt (R2) | 3261 | Rest—Pickup rest |
| 13573 | Screw—Motor mounting screw assembly—comprising one screw, one spacer, one washer and one lockwasher | 4119 | Screw—No. 8-32x1/4-in. headless set screw for knob Stock No. 3829 |
| 4119 | Screw—No. 8-32x1/4-in. headless set screw for knob Stock No. 3829 | 4460 | Switch—Radio-Record switch (S2) |
| 14204 | Turntable—Complete | 14204 | Turntable—Complete |
| 13082 | Knob—Volume control knob—for white finish models | 14234 | Volume Control and Power Switch (R1, S1) |



RCA Victor

MODELS R-96 and R-97

Three-Tube, A-C, Electric Phonographs

TECHNICAL INFORMATION AND SERVICE DATA

-1937 No. 23-

SERVICE DIVISION • RCA MANUFACTURING COMPANY, INC. • CAMDEN, N. J., U. S. A.

A Service of the Radio Corporation of America

Electrical Specifications

| | | |
|--|---|--|
| RADIOTRON COMPLEMENT | | (2) RCA-42..... Power Output |
| (1) RCA-6C6..... Audio Voltage Amplifier | | (3) RCA-80..... Rectifier |
| POWER SUPPLY RATINGS | | |
| Rating A-6 | 105-125 volts, 60 cycles, 90 watts | |
| Rating A | 105-125 volts, 50-60 cycles, 90 watts | |
| Rating B-2 | 105-125 volts, 25 cycles, 90 watts | |
| Rating C-6 | 105-125/200-250 volts, 60 cycles, 90 watts | |
| Rating C-5 | 105-125/200-250 volts, 50-60 cycles, 90 watts | |
| POWER OUTPUT | | LOUDSPEAKER |
| Undistorted..... 2.5 watts | | Type..... 8-inch Electrodynamic |
| Maximum..... 4.5 watts | | Impedance (V.C.)..... 2.2 ohms at 400 cycles |
| MOTOR-BOARD | | |
| Type | R-96 | R-97 |
| Turntable Speed (adjustable)..... | Manual | Automatic-Manual |
| Pickup | 78 r.p.m..... | 78 r.p.m. |
| Pickup Impedance | High-impedance Magnetic | |
| | 1,400 ohms at 1,000 cycles | |

Mechanical Specifications

| | | |
|------------------------------|---|---------------------------------------|
| | R-96 | R-97 |
| Height | 13 ⁵ / ₁₆ inches | 15 ⁷ / ₈ inches |
| Width | 17 ⁷ / ₁₆ inches | 18 ¹ / ₈ inches |
| Depth | 14 ³ / ₁₆ inches | 14 ¹ / ₈ inches |
| Weight (Net) | 30 pounds | 49 pounds |
| Weight (Shipping) | 36 pounds | 55 pounds |
| Chassis Base Dimensions..... | 9 ³ / ₄ inches x 5 ¹ / ₂ inches x 2 inches | 6 ⁵ / ₈ inches |
| Over-all Chassis Height..... | | |
| Operating Controls..... | (1) Volume [right-front], (2) Power-Tone [right-rear], (3) Turntable Switch, (4) Index [R-97 only], (5) Record Reject [R-97 only] | |

General Description

The Model R-97 Electric Phonograph consists of a three-tube audio amplifier, an eight-inch dust-proof electrodynamic loudspeaker, and an automatic record changer combined in a hinged-top table-type cabinet. Its design includes a phonograph compensation pack, resistance-coupled audio system, self-starting constant-speed motor, improved magnetic pickup, and a tone control. The phonograph mechanism will play a

series of eight 10-inch records (changes seven) or repeat 12-inch records. It may be operated manually if desired.

The Model R-96 Electric Phonograph is identical to Model R-97 electrically, has a manually operated turntable, and a slightly different cabinet design.

The circuit arrangement of either instrument is shown on figure 8.

Service Data

The various diagrams of this booklet contain such information as will be needed to isolate causes for defective operation if such develops. The ratings of the resistors, capacitors, coils, etc., are indicated adjacent to the symbols signifying these parts on the diagrams. Identification titles such as R1,



Model R-97

L1, C1, etc., provide reference between the illustrations and Replacement Parts List. The coils, transformer windings, and reactors are rated in terms of d-c resistance to permit continuity checks.

AUTOMATIC RECORD CHANGER (Model R-97)

The record changing mechanism is designed to be simple and fool-proof. Certain adjustments may be required occasionally. The adjustments are illustrated and explained in figures 1 and 7.

It is important when servicing the automatic mechanism, to have it placed on a level support. It is also important to refrain from forcing the mechanism if there is a tendency to bind or jam, since bent levers and possible broken parts may result.

CAUTION.—Do not leave records stacked on the record holder posts, when not in use, as they are liable to warp, particularly so in warm climates.

MOTOR ADJUSTMENTS

The phonograph motors are of the governor induction type and are designed to be simple and foolproof. Occasionally, however, certain adjustments may be required. These

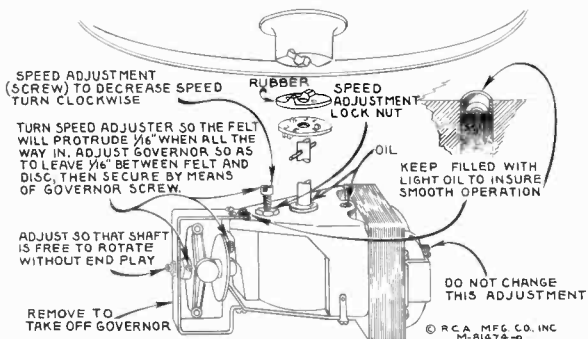

Figure 1—Details of Motor

adjustments are illustrated and explained in figure 1. Application of oil to the felt pad which rubs against the governor disc will insure smooth operation.

MAGNETIC PICKUP

The pickup used is of an improved design. The horseshoe magnet is rigidly welded to the pole pieces and is irremovable. There is a centering spring attached to the armature to maintain proper adjustment and to provide a limiting effect on the movement of the armature. The frequency response is substantially uniform over a wide range. Service operations which may be necessary on the pickup are as follows:

Centering Armature.—Refer to figure 2 showing the pickup inner structure. The armature is shown in its proper relation to the magnet pole pieces, i. e., exactly centered. When-



Model R-96

ever this centering adjustment has been disturbed it will be necessary to remove the pickup mechanism from the tone arm by removing the needle holding screw and the two mounting screws from the front of the tone arm, holding the pickup assembly to keep it from dropping. Unsolder the two leads from the lugs on the terminal board at the rear

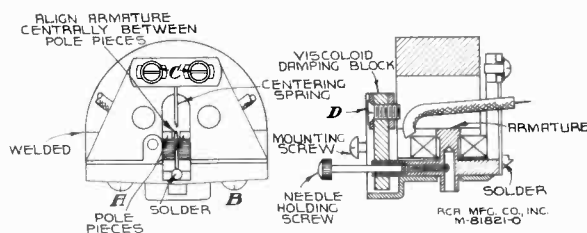

Figure 2—Details of Pickup

of the pickup. Insert a small rod or nail into the armature needle hole and replace the needle holding screw, tightening it to hold the rod securely. If the armature clamping screws A and B have not been disturbed, screws C should be loosened which will permit the armature to be moved from side to side, the rod acting as a lever to perform this operation. The proper adjustment is obtained when the armature is moved to the extreme position on each side (the movement being limited by the armature striking the pole pieces) and then brought to the mid position between these two extremes. Screws C should then be tightened. The armature position should then be central between the pole pieces and at right angles to them. With a little practice, the correct adjustment of the armature will be obtained. The air gap between the pole pieces and the armature should be kept free from dust, filings, and other foreign material which would obstruct the movement of the pickup armature.

Damping Block.—The viscoloid damping block which is attached to the front end of the armature shank serves as a mechanical filter to eliminate undesirable resonances and to

cause the frequency response to be uniform. Should it be necessary to replace this damping block, the pickup mechanism should be removed from the tone arm as explained above. Remove screw D and the damping block from the pickup assembly. Make sure that the shaft of the armature

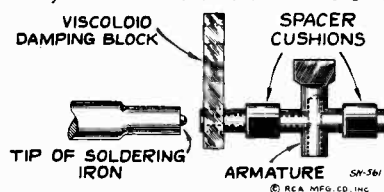

Figure 3—Special Soldering-Iron Tip

which contacts the viscoloid is clean. Then insert the new damping block so that it occupies the same position as that of the original block, and is in correct vertical alignment with the armature. The hole in the block is somewhat smaller than the diameter of the armature in order to permit a snug fit. With the damping block properly aligned on the armature, screw D with its washer should then be replaced. Heat should be applied to the armature (viscoloid side) so that the damping block will fuse at the point of contact and become rigidly attached to the armature. A special-tip soldering iron, constructed as shown in figure 3, will be found very useful in performing this operation. The iron should be applied only long enough to slightly melt the block, causing a small bulge on both sides.

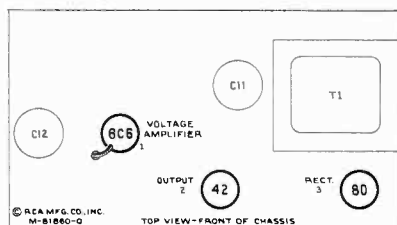

Figure 4—Radiotron Locations

Replacing Coil.—Whenever there is defective operation due to an open or shorted pickup coil, this coil should be

replaced. Remove the pickup mechanism and terminal board as described above. Remove screws A and B and the magnet assembly. Remove the bakelite coil support (with coil attached) and insert the new coil support assembly in its place, after which replace the magnet assembly and center the armature as described above, then re-assemble the remainder of the unit. Only rosin core solder should be used for soldering the coil leads and pickup leads to the pickup terminal board. This same type of solder should be used when necessary for soldering the centering spring to the armature.

Magnetizing.—Loss of magnetization will not usually occur when the pickup has received normal care because the magnet and pole pieces are one unit and the magnetic circuit remains practically closed at all times. When the pickup has been mishandled, subjected to a strong a-c field, jolted, or

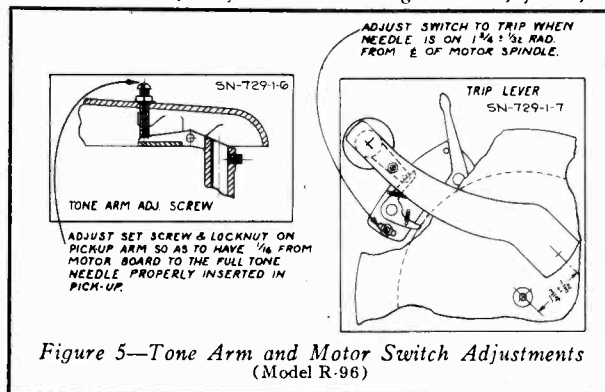

Figure 5—Tone Arm and Motor Switch Adjustments (Model R-96)

dropped, there may be an appreciable loss of magnetic strength, in which case it will be necessary to remagnetize the entire structure. To do this, it will be necessary to first remove the pickup mechanism from the tone arm, and then remove the magnet assembly. Place the magnet assembly on the poles of a standard pickup magnetizer such as the RCA Stock No. 9549 Pickup Magnetizer and charge the magnet in accordance with the instructions accompanying the magnetizer. It is preferable to check the polarity of the pickup magnet and to remagnetize it so that the same polarity is maintained.

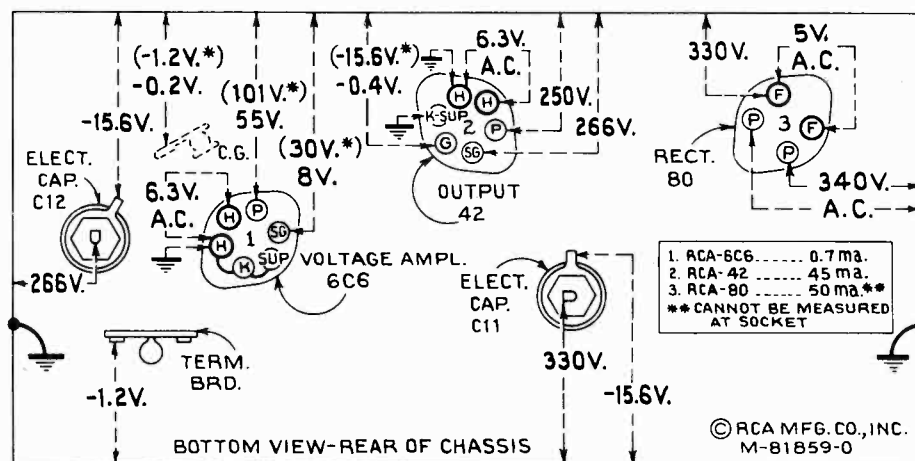

Figure 6—Radiotron Socket Voltages

Measured at 115 volts, 60-cycle supply—Volume control minimum

Note: Two voltage values are shown for some readings. The value shown in parentheses with asterisk (*) indicates operating conditions without voltmeter loading. The other value (generally lower) is the actual measured voltage and differs from the value shown in parentheses because of the additional loading of the voltmeter.

Voltage values as specified should hold within $\pm 20\%$ when instrument is normally operative at its rated line voltage. To duplicate the conditions under which the voltages were measured requires a 1,000-ohm-per-volt d-c meter, having ranges of 10, 50, 250, and 500 volts. Use the nearest range above the specified measured voltage. A-c voltages were measured with a corresponding a-c meter.

ADJUST THE RISE OF THE TONE ARM SO THAT THE NEEDLE POINT RISES $1/16$ " ABOVE THE TOP OF THE TURNABLE DURING CYCLE. THIS ADJUSTMENT IS MADE BY TURNING THE SCREW AND LOCK NUTS ON THE CABLE LEVER.

ADJUST THE REST POSITION OF THE MAIN LEVER BY MEANS OF THE NUT ON THE BUMPER BRACKET SO THAT THE CAM ROLLER CLEARS THE REVOLVING CAM $1/8$ " IN THE NEAREST POSITION. AT LEAST $1/16$ " WHEN THE ABOVE CONDITIONS EXIST.

TO ADJUST THE REST POSITION OF THE NEEDLE POINT RISE $1/16$ " ABOVE THE TURNABLE SPINDLE. THE LEVER CONTACTING THE TRIP LEVER MUST BE TIGHTENED TO THE POINT WHERE CORRECT ADJUSTMENT IS OBTAINED THROUGH THE POINTED SCREW ON TONE ARM SUPPORT.

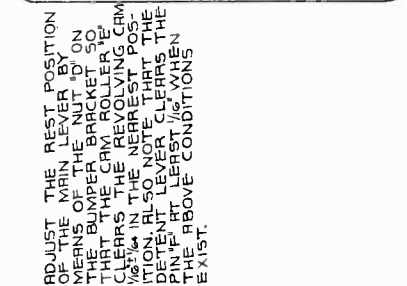
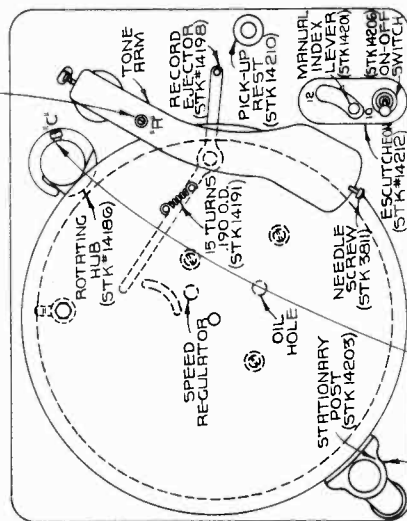

TO ADJUST RECORD POSTS: OVER SPINDLE SO THAT IT RESTS ON THE LOWER SHELF OF THE TONER HUB. STATIONARY RECORD POST TO ROTATION WHERE IT IS CONCEALED UNDER THE RECORD BOARD. TIGHTEN HEXAGON SCREW "B" LOCATED UNDER MOTOR BOARD, WITH RECORD STILL ON LOWER SHELF OF ROTATING HUB ADJUST SCREW "C" (STK*14186) SO THAT THE BEVELED TONGUE ON THE SEPARATING ARM CLEARS THE RECORD BY $1/8$ ". THESE ADJUSTMENTS SHOULD BE MADE ONLY WHEN THE COMPLETE UNIT IS RESTING ON THE FOUR MOTOR BOARD BUSHINGS.

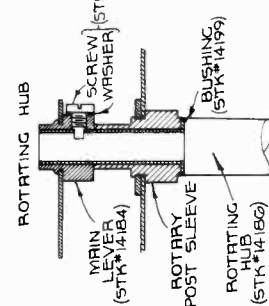
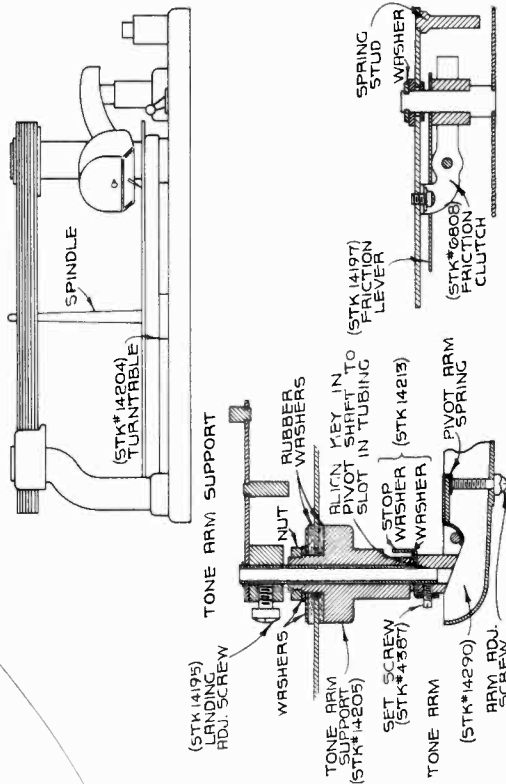
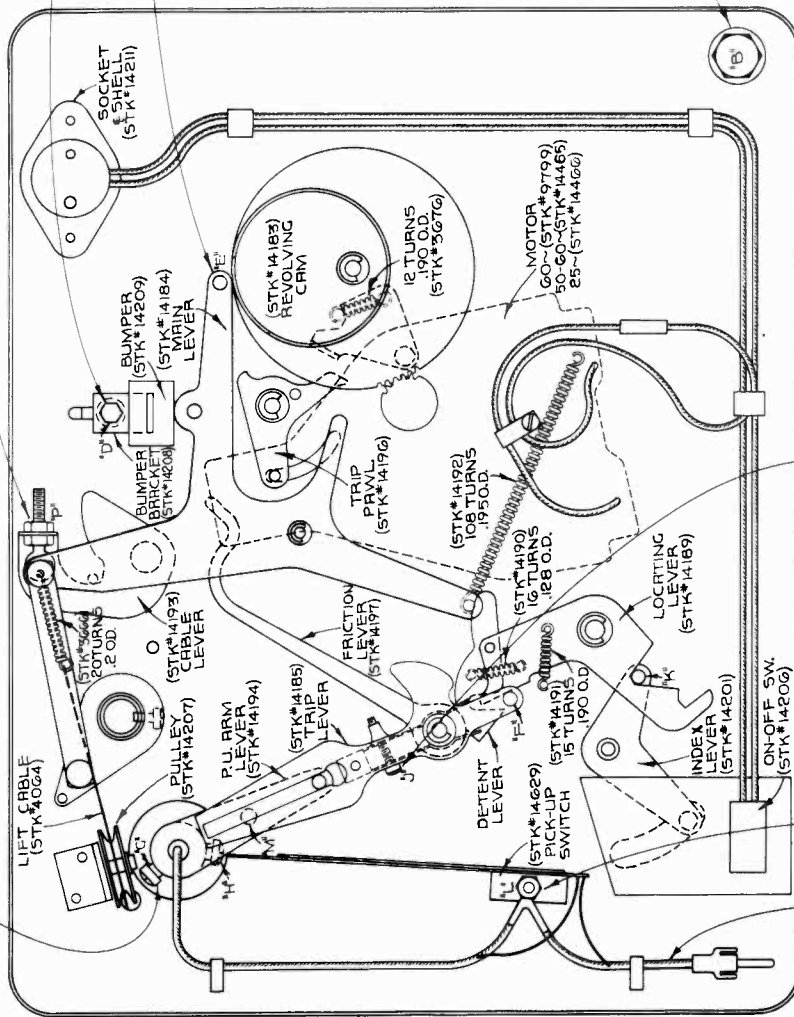

ADJUST TRIP LEVER SCREW "J" (STK*4059) UNTIL FRICTION WILL JUST FORCE FRICTION LEVER TO MOVE TRIP PAWL.

TO ADJUST PICK-UP NEEDLE G FROM CENTER OF SPINDLE, ADJUST NUT "L" SO THAT THE BLADE ON SWITCH IS JUST CONTACTING PIN "M"

Figure 7—Automatic Record Changer Adjustments (Model R-97)

© RCA MFG. CO. INC. T-70827-0

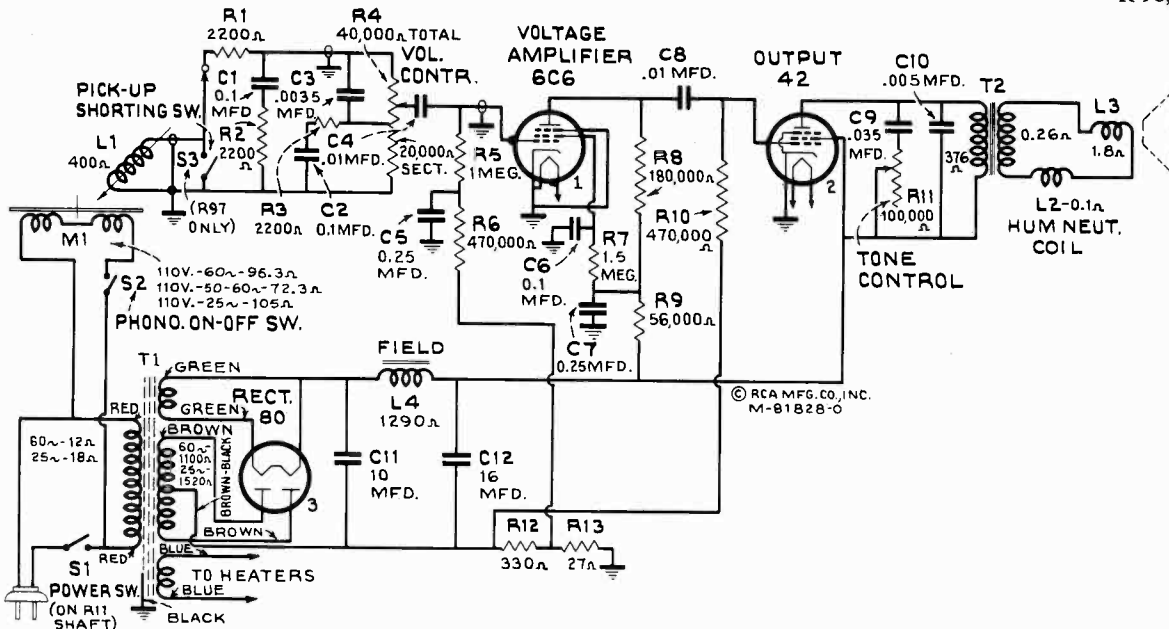

Figure 8—Schematic Circuit Diagram

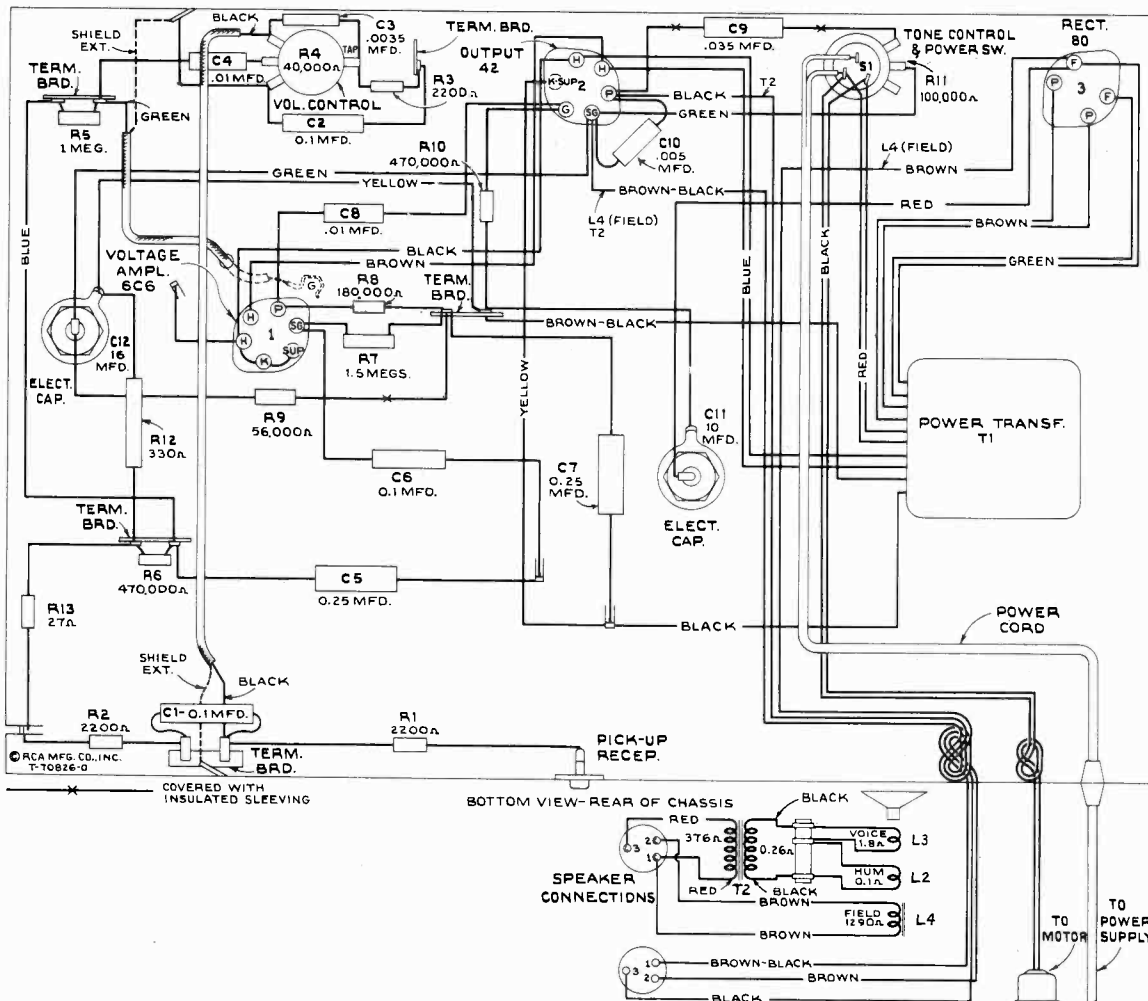

Figure 9—Chassis Wiring Diagram

LOUDSPEAKER

Centering of the loudspeaker is made in the usual manner with three narrow paper feelers after first removing the front dust cover. This may be removed by softening its cement

with a light application of acetone, using care not to allow the acetone to flow into the air gap. The dust cover should be cemented back in place with ambroid upon completion of adjustment.

REPLACEMENT PARTS

Insist on genuine factory tested parts, which are readily identified and may be purchased from authorized dealers.

| STOCK No. | DESCRIPTION | STOCK No. | DESCRIPTION |
|---|--|---|---|
| AMPLIFIER ASSEMBLIES | | MOTORBOARD ASSEMBLIES (Model R-97) | |
| 12118 | Cap—Grid contact cap | 14208 | Bracket—Bumper bracket and bumper complete |
| 5005 | Capacitor—.0035 Mfd. (C3) | 14209 | Bumper—Rubber bumper |
| 4838 | Capacitor—.005 Mfd. (C10) | 14830 | Cable—Shielded cable 13" long complete with single contact male connector—connects pickup shorting switch to input transformer or compensator |
| 18138 | Capacitor—.01 Mfd. (C4, C8) | 14212 | Escutcheon—Manual index lever and switch escutcheon |
| 12670 | Capacitor—.035 Mfd. (C9) | 14203 | Post—Record post—located on front left hand corner of motorboard |
| 4839 | Capacitor—0.1 Mfd. (C1, C2, C6) | 14210 | Rest—Pickup arm rest |
| 5170 | Capacitor—0.25 Mfd. (C7) | 14207 | Roller—Pickup lift cable roller and bracket |
| 12484 | Capacitor—0.25 Mfd. (C5) | 14211 | Socket—Motorboard socket and shell |
| 11203 | Capacitor—10 Mfd. (C11) | 14205 | Support—Pickup arm mounting spacer, washers and nut |
| 5212 | Capacitor—16 Mfd. (C12) | 14206 | Switch—Motor toggle switch (S2) |
| 14783 | Connector—2-contact female connector for motor power cable | 14629 | Switch—Pickup shorting switch (S3) |
| 5119 | Connector—3-contact female connector for reproducer cable | 14204 | Turntable—Complete |
| 11955 | Resistor—27 Ohms—Carbon type, $\frac{1}{4}$ watt (R13) | 14213 | Washer—Pickup arm stop washer and spacing washer |
| 11670 | Resistor—330 Ohms—Carbon type, 1 watt (R12) | MOTOR ASSEMBLIES (Model R-97) | |
| 5159 | Resistor—2,200 Ohms—Carbon type, $\frac{1}{4}$ watt (R1, R2, R3) | 14215 | Governor—Governor complete with motor Stock Nos. 9799, 14465 and 14466 |
| 5029 | Resistor—56,000 Ohms—Carbon type, $\frac{1}{4}$ watt (R9) | 14466 | Motor—105-125 volts, 25 cycle (M1) |
| 14943 | Resistor—180,000 Ohms—Carbon type, $\frac{1}{4}$ watt (R8) | 14465 | Motor—105-125 volts, 50-60 cycle (M1) |
| 11172 | Resistor—470,000 Ohms—Carbon type, $\frac{1}{4}$ watt (R6, R10) | 9799 | Motor—105-125 volts, 60 cycle (M1) |
| 13730 | Resistor—1 Meg.—Carbon type, $\frac{1}{4}$ watt (R5) | 14214 | Screw—Motor mounting screw and spacer assembly |
| 4241 | Resistor—1.5 Meg.—Carbon type, $\frac{1}{4}$ watt (R7) | PICKUP AND ARM ASSEMBLIES (For Model R-96 only) | |
| 4233 | Shield—6C6 Radiotron shield | 14291 | Armature—Pickup armature |
| 14278 | Socket—Single contact female pickup cable socket | 11732 | Coil—Pickup coil (L1) |
| 4794 | Socket—4-contact 80 Radiotron socket | 14292 | Damper—Pickup damper assembly—comprising one damper, one clamp and one screw |
| 4786 | Socket—6-contact 6C6 or 42 Radiotron socket | 14931 | Pickup and Arm Complete |
| 14797 | Tone Control and power switch (R11, S1) | 3811 | Screw—Needle holding screw |
| 14796 | Transformer—Power transformer—105-125 volts, 50-60 cycles (T1) | PICKUP AND ARM ASSEMBLIES (For Model R-97 only) | |
| 14843 | Transformer—Power transformer—105-125 volts, 25-60 cycles (T1) (Model R97 only) | 14291 | Armature—Pickup armature assembly |
| 14798 | Volume Control (R4) | 4064 | Cable—Pickup lift cable |
| MOTORBOARD ASSEMBLIES (Model R-96) | | 11732 | Coil—Pickup coil (L1) |
| 14803 | Brake—Turntable brake and motor switch | 14292 | Damper—Pickup damper block complete with clamp and screw |
| 3261 | Rest—Pickup rest | 14290 | Pickup and Arm Complete |
| 30248 | Screw—Motor mounting screw, washer, rubber washers, clamp plate and spacer assembly | 3811 | Screw—Needle holding screw |
| 30100 | Springs—Tension springs for brake Stock No. 14803 comprising 1 long and 1 short spring | 4387 | Screw—No. 8-32 \times $\frac{1}{4}$ " headless set screw for pickup arm pivot shaft |
| 14804 | Switch—Motor switch (S2)—located on turntable brake Stock No. 14803 | REPRODUCER ASSEMBLIES (RL-63-F1) | |
| MOTOR ASSEMBLIES (Model R-96) | | 14356 | Board—3-contact reproducer terminal board |
| 11703 | Governor—Complete motor governor, governor shaft and gear assembly | 13866 | Cap—Cone center dust cap |
| 14800 | Motor—105-125 volts, 60 cycle (M1) | 12012 | Coil—Field coil (L4) |
| OPERATING MECHANISM ASSEMBLIES (Model R-97) | | 11469 | Coil—Hum coil (L2) |
| 14199 | Bushing—Record separator rotating shaft bushing | 12642 | Cone—Reproducer cone and dust cap (L3) |
| 14183 | Cam—Cam and gear assembly | 5118 | Plug—3-contact male plug for reproducer |
| 6808 | Clutch—Trip lever friction clutch | 14360 | Reproducer—Reproducer complete |
| 14197 | Finger—Friction finger assembly | 14358 | Screw—Screw, washer and lockwasher to hold core in yoke |
| 14186 | Hub—Rotating hub and record separator complete with set screw | 14355 | Transformer—Output transformer (T2) |
| 14189 | Lever—Locating lever assembly | 14357 | Washer—Spring washer to hold field coil |
| 14201 | Lever—Manual index lever assembly | MISCELLANEOUS ASSEMBLIES | |
| 14184 | Lever—Main lever and link assembly | 4391 | Box—Needle box for Model R-97 only |
| 14194 | Lever—Pickup arm lever complete with set screws | 11762 | Box—Needle box for Model R-96 only |
| 14193 | Lever—Pickup lift cable lever | 11704 | Damper—Turntable damper and damper plate |
| 14198 | Lever—Reject lever assembly | 12673 | Knob—Volume control or tone control and power switch knob |
| 14185 | Lever—Trip lever and friction clutch assembly | 14267 | Screw—Amplifier chassis mounting screw and washer |
| 14196 | Pawl—Trip pawl assembly | 30249 | Screw—Motorboard mounting screw, spring, spacer, washer, lockwasher, and rubber washer assembly for Model R-96 only |
| 4583 | Screw—Cable lever screw and two locknuts | 30250 | Screw—Motorboard mounting screw, spring, washers and rubber washer assembly for Model R-97 only |
| 4059 | Screw—Trip lever clutch tension adjustment screw | 4119 | Screw—No. 8-32 headless set screw for knob Stock No. 12673 |
| 14200 | Screw—No. 8-32 special hex head screw and lockwasher for record separator shaft mounting | 14801 | Turntable—Complete for Model R-96 only |
| 14188 | Screw—No. 10-32 \times 7/16 fillister-head cone-pointed set screw for rotating hub | | |
| 14195 | Screw—No. 10-32 \times 5/16 fillister-head cone-pointed set screw for pickup arm lever | | |
| 14187 | Shaft—Rotating shaft for record separator | | |
| 3676 | Spring—Cam pawl tension spring | | |
| 3668 | Spring—Lift cable tension spring | | |
| 14190 | Spring—Locating lever pawl tension spring | | |
| 14191 | Spring—Locating lever or reject lever tension spring | | |
| 14192 | Spring—Main lever tension spring | | |

RCA VICTOR MODEL R-99 (Second Production) HIGH-FIDELITY ELECTROLA

TECHNICAL INFORMATION AND SERVICE DATA

The RCA Victor Model R-99 (second production) is identical to the original model except for slight modifications. These modifications are as follows: new design of input transformer T2, compensation pack, and volume control R4; RCA-6L7 audio volume expander tube grid resistor R5 changed in value from 330,000-ohm to 1 meg.; a 56,000-ohm resistor R24 is used in place of the former plate reactor L5; new design of interstage transformer T3; capacitors C12 and C13 have changed in value from 270 mmfd. to 100 mmfd.; change in power cable; and a slight re-arrangement of parts. Model R-99 (second production) may be identified by reference to the assembly wiring diagram figure 1 where it may be seen that the input transformer T2 and the compensation pack are built in one unit ("input pack") with cable connections to the pickup and to the volume control. In the original model the input transformer and the compensation pack were constructed as separate units with a cable connection between them. Model R-99 (second production) amplifier chassis may be identified by the 56,000-ohm resistor R24 which is connected between the RCA-6C5 audio-driver tube plate terminal and an adjacent terminal board.

Service data for Model R-99 (first production) is directly applicable to the instrument except for the data contained herein.

Cathode Current Reading—RCA-6C5 driver tube—2.8 ma.

Resistance Measurements (Referring to figure 5 Service data for Model R-99 first production)—Resistance from grid "G" of RCA-6C5 control amplifier tube to chassis should be, with "Dynamic" expander control positions,—"Min" 0-ohm —"Center" 0.5 meg.—"Max" 50,000-ohm; from grid cap of RCA-6L7 audio volume expander tube to chassis should be 1-meg; and from plate "P" of RCA-6C5 driver tube to center terminal of capacitor C24 should be 62,000-ohms.

Voltage Measurements (Referring to figure 7 Service Data for Model R-99 first production)—Voltage values from diode plate "P₂" and the diode cathode "C₂" of the RCA-6H6 Diode tube to chassis should be (7.3V.*), 0.35V; from plate "P" and from cathode "C" of the RCA-6C5 driver tube to chassis should be 145V. and 4.8V. respectively.

Dynamic Amplifier Adjustments

It is essential that the correct voltages and currents exist at the RCA-6L7 audio expander stage in order that the expanding function may take place in the proper manner. A screw driver adjustment is accordingly provided to regulate the RCA-6L7 control grid No. 3 to the correct operating value. Two methods of adjustment are applicable. Either method requires a normal voltage of 300-volts across the filter output (resistor R22). The one to be preferred (a) requires the use of the RCA Stock No. 9633 Beat Frequency Oscillator or the equivalent, a 100-ohm resistor, a 200-ohm resistor, and a 1,000-ohm-per-volt a-c voltmeter (rectifier-type) having a "low" range of 1.0 volt and a "high" range of 250 volts or greater. The less accurate method (b) requires the use of a RCA Stock No. 12353 Split Plate Adapter, and a suitable d-c milliammeter. **CAUTION:** Before using either method, be sure that power-supply fuse is in proper position for the line voltage.

(a) **Preferred Method.**—Turn power switch (left front) off. Connect the 200-ohm and the 100-ohm resistors in series between the beat-frequency oscillator terminals (upper "250" and "CT") with the 100-ohm resistor connected to "CT". Calibrate the beat-frequency oscillator, adjust it to 1,000 cycles and reduce its output. Connect the 1,000-ohm-per-volt a-c voltmeter (1-volt range) to the beat-frequency oscillator terminals (upper "250" and "CT"). Remove the "M" plug from the "F" receptacle on the shielded cable running between the "input pack" and the "volume control" (see figure 1). Connect beat-frequency oscillator terminal "CT" to the shield on the "M" plug. Connect the junction of the 200-ohm and the 100-ohm resistors to the small pin (marked blue on diagram) on the "M" plug.

Adjust beat-frequency oscillator output until the voltmeter reads exactly 1.0 volt. Remove the voltmeter leads from the beat-frequency oscillator terminals without disturbing any of the oscillator adjustments. Place the voltmeter to its 250-volt or greater range and connect it between the plate prongs of the two RCA-2A3 power-output tubes. Connections to the tube prongs may be made by stripping approximately $\frac{1}{2}$ inch of insulation from the ends of two short leads of rubber-covered wire, wrapping one bare end around each plate prong (being careful not to allow the bare ends to short on the chassis when the tubes are placed in their sockets), and connecting the voltmeter to these leads. **CAUTION:** Do not touch these plate connections after the power is turned on since the potential at these points is rather high and carelessness might result in a serious shock.

Set the expander "Dynamic" control (center front) to its extreme counter-clockwise position. Set the phonograph volume control (right front) to its extreme clockwise posi-

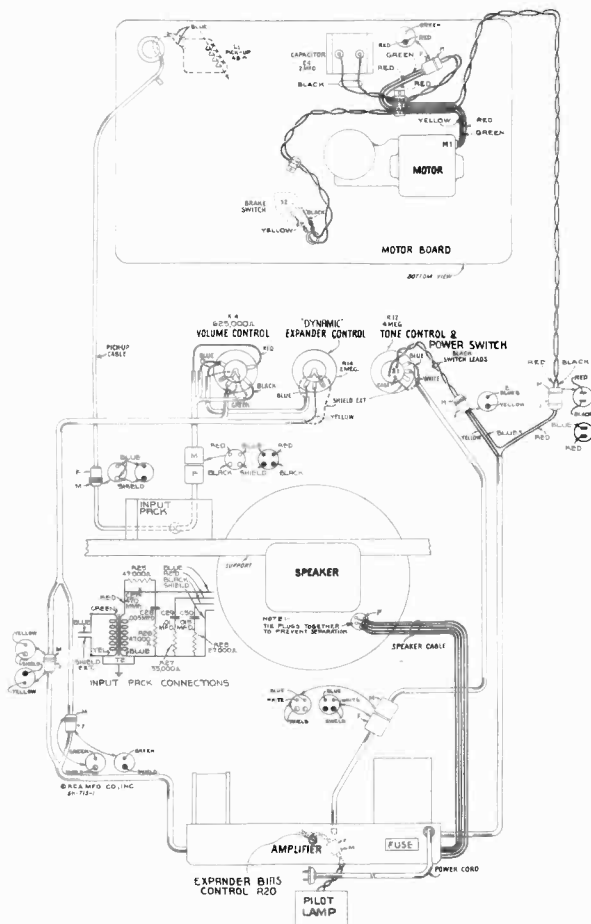
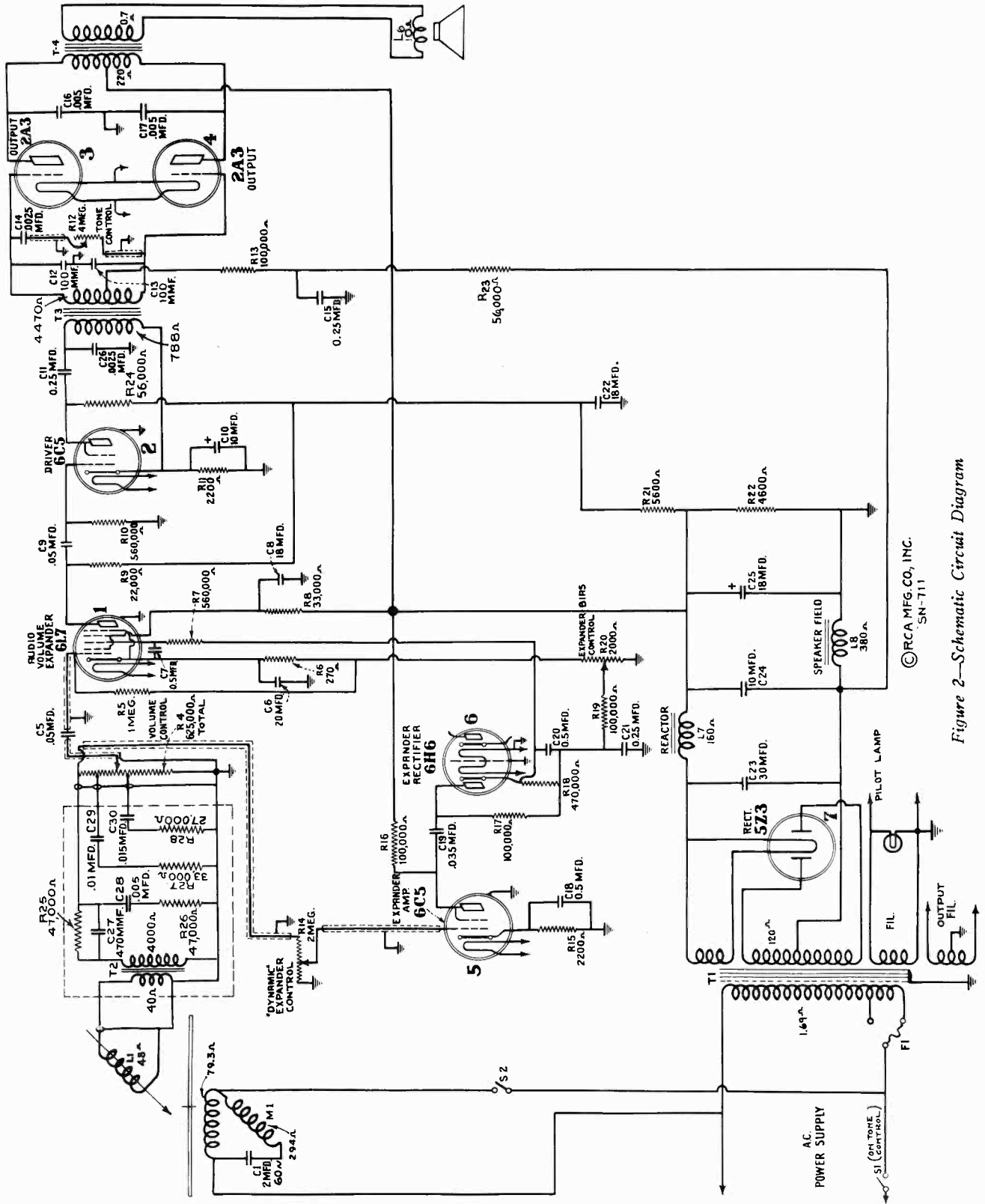

Figure 1—Assembly Wiring

tion. Turn on power switch (left front) and rotate this control to its extreme clockwise position, allowing it to remain in this position for all adjustments. Allow a few minutes for the instrument to become stabilized. Adjust the expander bias control R20, on rear apron of amplifier (see figure 1), until the voltmeter reads 195 volts. Turn phonograph volume control to extreme counter-clockwise position.



© RCA MFG. CO., INC.
SN-711

Figure 2—Schematic Circuit Diagram

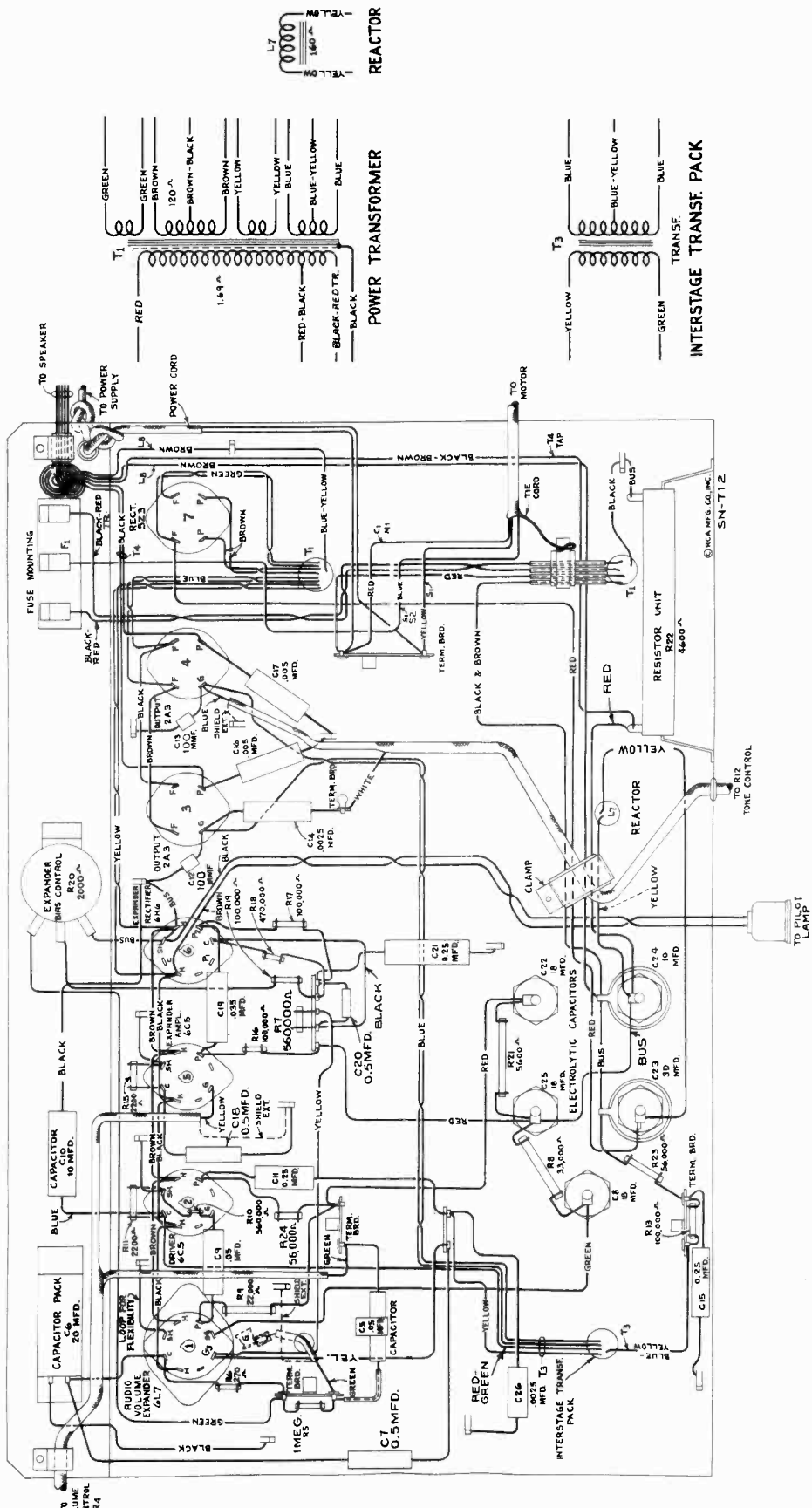

Figure 3—Chassis Wiring Diagram

Transfer lead from the junction of the 200-ohm and the 100-ohm resistors to the beat-frequency oscillator (upper "250") terminal without disturbing any of the oscillator adjustments. Adjust phonograph volume control (right front) until the voltmeter reads 50 volts. Turn the expander "Dynamic" control (center front) to its extreme clockwise position allowing maximum expansion to take place. The voltmeter should now read not less than 150 volts if the expander circuit is operating correctly. Failure to do so indicates a defect in the system and the usual service procedure should be followed.

(b) **Alternate Method.**—Turn power switch (left front) off. Place RCA Stock No. 12353 Split Plate Adapter under the RCA-6L7. Connect a suitable d-c milliammeter to the adapter. Turn both the phonograph volume control (right front) and the expander "Dynamic" control (center front) to their extreme counter-clockwise positions. Turn on power switch (left front) and allow a few minutes for the instrument to become stabilized. Adjust expander bias control R20, on rear apron of amplifier (see figure 1), to give 1.0 milliamperes of plate current with no signal input to the dynamic amplifier.

REPLACEMENT PARTS

Insist on genuine factory tested parts, which are readily identified and may be purchased from authorized dealers.

| STOCK No. | DESCRIPTION | STOCK No. | DESCRIPTION |
|---------------------------------------|---|------------------------------------|---|
| AMPLIFIER ASSEMBLIES | | PICKUP AND ARM ASSEMBLIES | |
| 12511 | Cap—Grid contact cap | 12542 | Arm—Pickup arm, complete less pickup unit |
| 12110 | Cap—Top shield cap for 6L7 Radiotron | 11548 | Back—Pickup back |
| 5107 | Capacitor—.0025 Mfd. (C14, C26) | 10941 | Ball—Pickup arm pivot shaft bearing |
| 4838 | Capacitor—.005 Mfd. (C16, C17) | 12543 | Bracket—Pickup arm spring adjusting bracket and screw |
| 5196 | Capacitor—.035 Mfd. (C19) | 12541 | Coil—Pickup coil (L1) |
| 4886 | Capacitor—.05 Mfd. (C9) | 3521 | Cover—Pickup back cover with mounting screws |
| 4518 | Capacitor—.05 Mfd. (C5) | 11708 | Cover—Pickup front cover |
| 5170 | Capacitor—.25 Mfd. (C11) | 12850 | Damper—Comprising one upper damper and bushing assembly, one lower bushing and one lower bearing |
| 12484 | Capacitor—.25 Mfd. (C15, C21) | 3390 | Escutcheon—Pickup arm escutcheon and rivets |
| 12741 | Capacitor—.5 Mfd. (C7, C18, C20) | 14115 | Mechanism—Pickup mechanism comprising one armature and spring assembly, one armature clamp and one armature damper |
| 11203 | Capacitor—10 Mfd. (C24) | 12538 | Pickup—Pickup unit, complete |
| 12472 | Capacitor—10 Mfd. (C10) | 12546 | Plug—Pickup arm pivot shaft plug |
| 5212 | Capacitor—18 Mfd. (C8, C22) | 12545 | Rod—Pickup arm trip rod and nut |
| 11496 | Capacitor—18 Mfd. (C25) | 11549 | Screw—Pickup front cover screw |
| 12470 | Capacitor—20 Mfd. (C6) | 12539 | Screw—Pickup needle screw |
| 12467 | Capacitor—30 Mfd. (C23) | 3387 | Screw—Screw, nut and washer for mounting pickup to arm |
| 12720 | Capacitor—100 Mmfd. (C12, C13) | 12544 | Spring—Pickup arm adjusting spring |
| 11272 | Clamp—Volume control or speaker cable clamp | MOTORBOARD ASSEMBLIES | |
| 5240 | Cover—Fuse cover | 12051 | Capacitor—2 Mfd. motor capacitor, complete with cable and 2-contact male connector (C1) |
| 12468 | Expander—Control (R20) | 6122 | Clamp—Brake switch cable clamp |
| 10907 | Fuse—3-ampere fuse (F1) | MOTOR ASSEMBLIES | |
| 5239 | Mounting—Fuse mounting | 9693 | Motor—105-125 volts, 50 cycles (M1) |
| 12471 | Plate—6L7 socket mounting plate assembly, less socket | 9692 | Motor—105-125 volts, 60 cycles (M1) |
| 12466 | Reactor—Filter reactor (L7) | 12551 | Suspension Spring—Motor mounting spring, washer and stud assembly—comprising 6 springs, 6 cup washers, 3 spring washers and 3 studs |
| 13494 | Resistor—270 ohms, insulated, ½ watt (R6) | AUTOMATIC SWITCH ASSEMBLIES | |
| 13716 | Resistor—2,200 ohms, insulated, ½ watt (R11, R15) | 3944 | Cover—Automatic switch cover and screw |
| 12469 | Resistor—4,600 ohms, wire wound (R22) | 10184 | Plate—Automatic brake trip latch plate with mounting screws |
| 11298 | Resistor—5,600 ohms, carbon type, 1 watt (R21) | 12550 | Springs—Automatic brake springs |
| 11332 | Resistor—22,000 ohms, carbon type, 1 watt (R9) | 12549 | Switch—Automatic brake and switch, complete |
| 12487 | Resistor—33,000 ohms, carbon type, 2 watt (R8) | 3322 | Switch—Switch only for automatic brake (S2) |
| 12286 | Resistor—56,000 ohms, insulated, ½ watt (R23) | REPRODUCER ASSEMBLIES | |
| 12875 | Resistor—56,000 ohms, carbon type, 1 watt (R24) | 8059 | Board—Reproducer terminal board |
| 14560 | Resistor—100,000 ohms, insulated, ½ watt (R13, R16, R17, R19) | 8060 | Bracket—Output transformer mounting bracket |
| 12285 | Resistor—470,000 ohms, insulated, ½ watt (R18) | 8058 | Clamp—Cone rim clamp |
| 12486 | Resistor—560,000 ohms, insulated, ½ watt (R7, R10) | 12566 | Coil—Field coil, magnet and cone housing (L8) |
| 12200 | Resistor—1 Meg., insulated, ½ watt (R5) | 12474 | Cone—Reproducer cone (L6) |
| 4794 | Socket—4-contact 5Z3 or 2A3 Radiotron socket | 12569 | Diffuser—Reproducer sound diffuser |
| 11197 | Socket—6-contact 6C5 Radiotron socket | 9694 | Reproducer—Reproducer, complete |
| 11198 | Socket—7-contact 6H6 or 6L7 Radiotron socket | 12568 | Transformer—Output transformer (T4) |
| 13964 | Transformer—Interstage transformer (T3) | MISCELLANEOUS ASSEMBLIES | |
| 12463 | Transformer—Power transformer, 110-120 volt, 50-60 cycle (T1) | 12557 | Bolt—Motorboard suspension bolt and spring assembly, consisting of 1 bolt, 1 C washer, 2 cup washers, 1 bottom spring, 1 top spring, 1 lockwasher and 1 cap nut |
| MISCELLANEOUS CABLES AND PLUGS | | 5211 | Bolt—Reproducer mounting bolt assembly |
| 12547 | Cable—2-conductor shielded pickup cable, 25 inches long, complete less female connector, Stock No. 11488 | 3430 | Box—Used needle box |
| 13992 | Cable—Power cable, approximately 23½ inches long, complete with two female connectors | 13103 | Cap—Indicator lamp cap |
| 12563 | Cable—Shielded input cable, approximately 9 inches long, complete with 4-contact male connector | 12561 | Cap—Turntable spindle cap |
| 12564 | Cable—Shielded tone control cable, approximately 20½ inches long, with 4-contact male connector | 6122 | Clamp—Volume control and pickup cables clamp |
| 12490 | Cable—Shielded tone control cable, approximately 14 inches long, complete with female connector | 4420 | Clamp—Volume control cable clamp |
| 12562 | Cable—Shielded volume control cable, approximately 28 inches long, complete with 2 male connectors | 11580 | Cover—Indicator lamp cover |
| 12491 | Cable—Shielded volume control cable, approximately 17 inches long, complete with 2 female connectors | 12559 | Cover—Reproducer cover |
| 12492 | Cable—Speaker cable, approximately 40 inches long, complete with female connectors | 12552 | Cover—Turntable cover |
| 4674 | Connector—2-contact male connector for volume control cable, input transformer cable, compensator cable, motor leads, tone control switch leads and indicator lamp cable (socket end) | 11347 | Expander Control (R14) |
| 11488 | Connector—2-contact female connector for pickup cable, Stock No. 12547, power cable Stock No. 13992, or indicator lamp cable (chassis end) | 5226 | Knob—Expander, tone and switch or volume control knob |
| 4577 | Connector—2-contact male connector for motorboard power leads | 3396 | Lamp—Indicator lamp |
| 12565 | Connector—4-contact male tone control and input cable connector | 11210 | Receptacle—Needle receptacle |
| 12567 | Connector—5-contact male connector plug for reproducer housing | 11573 | Screw—Amplifier mounting screw assembly |
| 4573 | Connector—2-contact female connector with oblong openings for power cable, Stock No. 13992 | 11349 | Socket—Indicator lamp socket |
| 12493 | Connector—Speaker cable 5-contact female connector | 12553 | Spring—Retaining spring for knob, Stock No. 11347 |
| 12494 | Connector—Tone control or compensator cable 4-contact female connector | 14027 | Tone control and switch (R12, S1) |
| | | 13965 | Transformer—Input transformer pack, complete (T2, C27, C28, C29, C30, R25, R26, R27, R28) |
| | | 14026 | Turntable—Complete |
| | | | Volume Control (R4) |

RCA VICTOR PORTABLE VICTROLA

MODEL 0-11

SERVICE DATA

Motor.—The drive motor is of simple design and substantial construction. It should require little or no service if properly maintained. Attention to lubrication of the moving parts and occasional cleaning of the mechanism will go far to prevent faulty operation. Should it become necessary to repair the motor, the following procedure should be applied: **CAUTION.**—**Allow the motor mechanism to run down completely before attempting adjustment, repairs, or replacements.**

Removing Motor from Cabinet.—Remove the winding key. To dismount the motor, unscrew the spindle cap with a screwdriver and remove turntable, slightly tapping the spindle while exerting an upward lift on the turntable. Remove the seven screws holding the motor board and the two screws holding lid support to cabinet and lift motor board assembly from case. Loosen the screw holding the speed-regulating lever and remove the latter. The three screws holding motor to motor board should then be loosened to permit removal of motor assembly.

Replacing Main Spring Barrel.—In case of main spring failure, the entire spring barrel and gear should be replaced. Remove the spring-barrel spindle screw by **unscrewing to right**. Remove the C washer and two pillar screws holding bottom plate. Remove bottom plate, intermediate spindle shaft, and spring barrel. Reassemble parts in reverse sequence.

Winding Shaft Spring.—This spring functions as a friction ratchet. It may be removed as follows: remove pin holding winding worm on shaft; remove winding shaft; then remove screw holding spring. Replace in reverse sequence.

Governor Adjustments.—The mesh of the worm and fiber gears is adjusted by rotation of the eccentric spindle bearings. The adjustments should be made so that the worm meshes properly with the fiber gear and rotates freely without binding. The bearings should be

accurately aligned with each other. The minimum of spindle end-play which permits smooth operation should be used.

Speed Regulator Lever.—After assembly, adjust the speed regulator until the turntable rotates at 78 r. p. m.; loosen the speed regulator screw and set pointer to center of speed indicator scale; tighten screw and recheck turntable speed.

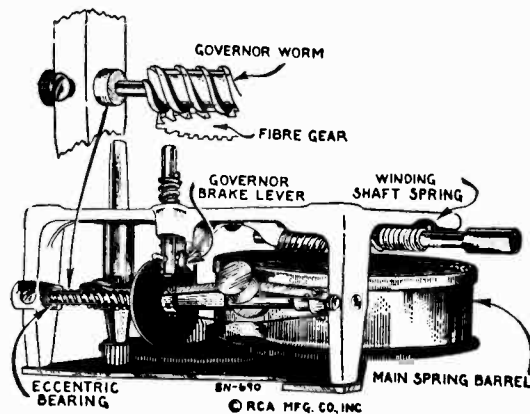

Lubrication.—All moving parts of the motor should be thoroughly cleaned and lubricated every six months to prevent excess wear and to assure proper operation. A small amount of grease should be applied to the worm gear of the governor, the gear of the winding shaft, and on the small pinion gear. All other points, including regulator friction pad, should be lubricated with light oil. All motor parts should be covered with a light film of oil to prevent rusting.

REPLACEMENT PARTS

| Stock No. | DESCRIPTION | Stock No. | DESCRIPTION |
|-----------|---|-----------|--|
| 13849 | Arm—Tone arm less sound box | 13854 | Motor—Spring motor complete |
| 13850 | Brake—Turntable brake complete | 13865 | Screw—Needle holding screw |
| 13845 | Cap—Turntable spindle cap | 13860 | Shaft—Winding key shaft and socket—Less winding gear |
| 13852 | Cup—Needle cup | 30368 | Sound box |
| 13847 | Escutcheon—Speed regulator escutcheon | 13856 | Spindle—Motor spindle and two gears assembled |
| 13855 | Gear—Intermediate drive gear and shaft | 13851 | Spring—Turntable brake spring |
| 13858 | Gear—Winding worm gear—Located on winding key shaft | 13835 | Spring—Mainspring, spring barrel and drive gear |
| 13859 | Gear—Winding gear—Located on spring barrel shaft | 13873 | Turntable—Complete with black cover |
| 13857 | Governor—Governor assembly complete | 13844 | Turntable—Complete with brown cover |
| 13846 | Indicator—Speed regulator arm and pointer | 14181 | Turntable—Complete with blue cover |
| 13861 | Key—Winding key | 13862 | Weight—Governor weight and spring |

SERVICE DIVISION
RCA Manufacturing Co., Inc.
 CAMDEN, N. J., U. S. A.

—1937 No. 22—

Copyright, 1937, RCA Manufacturing Co., Inc.

First Edition.
 Trademark "Victrola"
 Reg. U. S. Pat. Off. by RCA Mfg. Co., Inc.

RCA VICTOR PORTABLE VICTROLA

MODEL 0-15

SERVICE DATA

Motor.—The drive motor is of simple design and substantial construction. It should require little or no service if properly maintained. Attention to lubrication of the moving parts and occasional cleaning of the mechanism will go far to prevent faulty operation. Should it become necessary to repair the motor, the following procedure should be applied: **CAUTION.**—Allow the motor mechanism to run down completely before attempting adjustment, repairs, or replacements.

Removing Motor from Cabinet.—Remove the winding key. To dismount the motor, unscrew the spindle cap with a screwdriver and remove turntable, slightly tapping the spindle while exerting an upward lift on the turntable. Remove the five screws holding the motor board and the two screws holding lid support to cabinet and lift motor board assembly from case. Loosen the screw holding the speed-regulating lever and remove the latter. The three screws holding motor to motor board should then be loosened to permit removal of motor assembly.

Replacing Main Spring Barrel.—In case of main spring failure, the entire spring barrel and gear should be replaced. Remove the spring-barrel spindle screw by **unscrewing to right**. Remove the C washer and two pillar screws holding bottom plate. Remove bottom plate, intermediate spindle shaft, and spring barrel. Reassemble parts in reverse sequence.

Winding Shaft Spring.—This spring functions as a friction ratchet. It may be removed as follows: remove pin holding winding worm on shaft; remove winding shaft; then remove screw holding spring. Replace in reverse sequence.

Governor Adjustments.—The mesh of the worm and fiber gears is adjusted by rotation of the eccentric spindle bearings. The adjustments should be made so that the worm meshes properly with the fiber gear and rotates freely without binding. The bearings should be

accurately aligned with each other. The minimum of spindle end-play which permits smooth operation should be used.

Speed Regulator Lever.—After assembly, adjust the speed regulator until the turntable rotates at 78 r. p. m.; loosen the speed regulator screw and set pointer to center of speed indicator scale; tighten screw and recheck turntable speed.

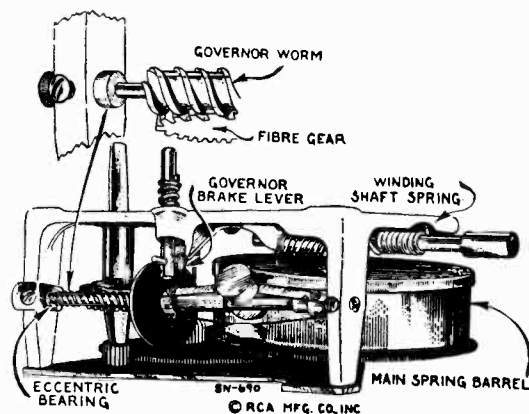

Lubrication.—All moving parts of the motor should be thoroughly cleaned and lubricated every six months to prevent excess wear and to assure proper operation. A small amount of grease should be applied to the worm gear of the governor, the gear of the winding shaft, and on the small pinion gear. All other points, including regulator friction pad, should be lubricated with light oil. All motor parts should be covered with a light film of oil to prevent rusting.

REPLACEMENT PARTS

| Stock No. | DESCRIPTION | Stock No. | DESCRIPTION |
|-----------|---|-----------|--|
| 30087 | Arm—Tone arm less sound box | 30094 | Key—Winding key |
| 30088 | Brake—Turntable brake complete | 13854 | Motor—Spring motor complete |
| 30089 | Cap—Turntable spindle cap | 13865 | Screw—Needle holding screw |
| 30090 | Cover—Needle cup hinged cover | 13860 | Shaft—Winding key shaft and socket—Less winding gear |
| 30091 | Cup—Needle cup | 30095 | Sound box |
| 30092 | Escutcheon—Speed regulator escutcheon | 13856 | Spindle—Motor spindle and two gears assembled |
| 13855 | Gear—Intermediate drive gear and shaft | 13851 | Spring—Turntable brake spring |
| 13858 | Gear—Winding worm gear—Located on winding key shaft | 13835 | Spring—Mainspring, spring barrel and drive gear |
| 13859 | Gear—Winding gear—Located on spring barrel shaft | 30096 | Turntable—Complete with brown cover |
| 13857 | Governor—Governor assembly complete | 13862 | Weight—Governor weight and spring |
| 30093 | Indicator—Speed regulator arm and pointer | | |

SERVICE DIVISION
RCA Manufacturing Co., Inc.
 CAMDEN, N. J., U. S. A.

First Edition.

Trademark "Victrola"
 Reg. U. S. Pat. Off. by RCA Mfg. Co., Inc.

INSTRUCTION BOOK

FOR THE

ACR - 111

PART I - INTRODUCTION

1. General

This new, sixteen-tube, RCA Amateur Communications Receiver is built for rack and for table mounting and covers a frequency range of from 540 to 30,000 kc. It embodies the most up-to-date circuits and construction, including RCA metal tubes, electrical band spread, beat-frequency oscillator, crystal filter, noise suppressor, noise limiter, sensitivity and automatic-volume controls, standby switch, loudspeaker, and phone jack. The advanced degree of sensitivity and selectivity of the instrument together with its frequency stability and reliability open to the operator a field of reception covering all communications in the more important ranges.

This book should be studied carefully to learn how to make full use of the ACR-111 and keep it in its optimum operating condition.

2. Special Features

An inspection of the schematic circuit diagram and the wiring diagrams make clear the many developments incorporated in this model. See Fig.4, 5 and 6.

Metal tubes provide effective shielding as well as minimum terminal spacing and short connecting circuits with their attendant advantages. The eleven labeled controls, including the phone jack, are all on the front panel, thus giving complete front panel operation. The two large diameter tuning knobs with crank handles are comfortable and convenient to the hand and facilitate rapidity and ease of tuning. In conjunction with the vernier drive and electrical band spread system, fine tuning adjustments are easily made. An AVC Switch allows one to dispense with the use of the Automatic-Volume-Control when desired.

The Crystal Filter in the first i-f stage provides single-signal reception with an unusually high degree of selectivity, and the adjustable Selectivity Control is a means of obtaining various degrees of selectivity with or without a rejection dip. The Electron-Ray-Tube Indicator fulfills the dual function of measuring signal input and aiding in precise tuning.

The Noise Suppressor is a valuable aid in reducing interfering noises and thus enabling the operator to obtain reception of maximum strength and fidelity and minimum interference. It is used in conjunction with the Signal Input Control.

A Noise Limiter is incorporated in the circuit by means of the second diode of the second detector (RCA 6H6) tube. This device reduces peak noises due to excessive signals or bursts of static which load the anode beyond a certain bias value.

The Selector Dial brings each scale separately into the dial opening by a turn of the Range Selector knob and gives clear vision tuning calibrations for the range in use only. In addition the vernier scale beneath provides for calibration spread, and the readings of both tuning and calibration spread scales may be entered in the station log for future reference when it is again desired to receive the same station.

The Beat Oscillator is equipped with two controls, (1) an "On-Off" switch and (2) a Heterodyne Control with magnetite-core tuning which effectively governs the pitch. The shield enclosing the entire beat-oscillator circuit enables the listener to operate the set with freedom from undesirable beat notes due to harmonics.

The Loudspeaker is a separate unit attached to the chassis by means of a cable with a seven-prong plug-in connection. It is assembled on a small wooden mounting in which holes are provided for fastening to a large baffle when high-quality reproduction is required.

Each receiver is carefully tested and calibrated before leaving the factory.

PART II - ELECTRICAL SPECIFICATIONS

3. Tuning Ranges

| Band | Range Megacycles | Services |
|------|---------------------|-------------------------------------|
| A | 0.54 to 1.6 | Standard Broadcast |
| B | 1.6 to 4.0 | Amateur, Police, Aviation |
| C | 3 to 8 | Amateur, Aviation, S-W Broadcast |
| D | 6 to 16 | Amateur, S-W Broadcast |
| E | 12 to 30 | Amateur, S-W Broadcast |

4. Circuit Data and Power Rating

Circuit - Superheterodyne with beat-frequency oscillator for CW reception, noise suppressor, noise limiter, crystal filter, automatic volume control, electron-ray tuning indicator, calibrated signal input (sensitivity) control, electrical band spread, and class A pentode output system.

Intermediate Frequency - 460 kc.

Power Output - 5 watts (undistorted); 8 watts maximum.

Loudspeaker - (separate unit) - Electro-dynamic 8-inch (voice-coil impedance 2-1/4 ohms at 400 cycles).

Tubes -

- 2 RCA-6K7 - Radio Frequency Amplifiers
- 1 RCA-6J7 - First Detector
- 1 RCA-6J7 - Oscillator
- 2 RCA-6K7 - Intermediate-Frequency Amplifiers
- 1 RCA-6H6 - Second Detector and Noise Limiter
- 2 RCA-6C5 - Audio-Voltage Amplifiers
- 2 RCA-6F6 - Power Output Tubes
- 1 RCA-5Z3 - Full-Wave Rectifier
- 1 RCA-6J7 - Beat-Frequency Oscillator
- 1 RCA-6R7 - Automatic Volume Control
- 1 RCA-6J7 - Noise Suppressor
- 1 RCA-6E5 - Tuning Indicator

See diagram label on shield on chassis for locations of tubes and grid leads.

Power Supply Ratings - Check with rating symbol on chassis.

| Symbol | Voltage | Frequency (cycles) |
|--------|---------------------------|-----------------------|
| A | 105-125 | 50-60 |
| B | 105-125 | 25-60 |
| C | 100-130; 140-160; 195-250 | 40-60 |

As shipped from the factory, rating C receivers are connected for 225-250 volts unless prominently specified otherwise on the chassis. Such receivers may be converted for operation at 100-117, 117-130, 140-160 or 195-225 volts when required.

Power Consumption - 120 watts.

5. Antenna

A most important factor in good reception is the antenna. Both "noise reducing" and "directional" properties as well as definite "length" to suit the signal frequency are essential antenna requirements for best reception. A three-terminal board with the terminals marked "A1", "A2", and "G" is provided on the rear of the chassis for connections to antenna and ground. The "G" terminal should always be connected to a good external ground.

For maximum performance in any one or two amateur bands, one of the antenna systems illustrated below is recommended. Essential parts, such as cross-over insulators (Stock No. 4327), transmission lines (Stock Nos. 12429 and 12430) and receiver coupling transformers (Stock No. 12424) may be purchased from your dealer.

When it is undesirable to use a coupling transformer between the receiver and transmission line, the two sides of the transmission line may be connected to "A1" and "A2", the connecting link between "A2" and "G" being then removed.

The correct length (L) in feet for each arm of the doublet for maximum signal input at any particular frequency in kilocycles may be computed from the following formula:

$$L = \frac{233,700}{f}$$

where L = length of each doublet arm in feet
and f = frequency in kilocycles.

Example - It is desired to install an antenna for reception of 7,150 kc signals.

The correct length of each arm of the doublet is

$$L = \frac{233,700}{7,150} = 32.6 \text{ feet}$$

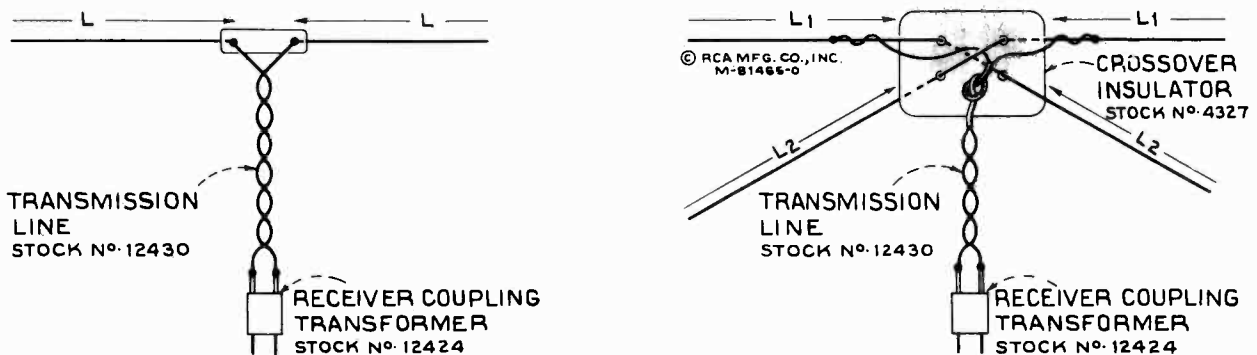

Figure 3—Doublet Antenna

SINGLE DOUBLET ANTENNA

| | | | |
|--------------|---------------|------------|---------------|
| L = 130 feet | for 160 Meter | (1,900 kc) | Band |
| L = 65 " | " " | 80 " | (3,800 kc) " |
| L = 33 " | " " | 40 " | (7,150 kc) " |
| L = 16 " | " " | 20 " | (14,200 kc) " |
| L = 8 " | " " | 10 " | (28,000 kc) " |

DOUBLE DOUBLET ANTENNA

| | | |
|---------------|---------------|--------|
| L1 = 130 feet | for 160 Meter | Band |
| L1 = 65 " | " " | 80 " " |
| L1 = 33 " | " " | 40 " " |
| L1 = 16 " | " " | 20 " " |
| L2 = 65 " | " " | 80 " " |
| L2 = 33 " | " " | 40 " " |
| L2 = 16 " | " " | 20 " " |
| L2 = 8 " | " " | 10 " " |

PART III - OPERATION

6. Controls

All controls are located upon the front panel and are identified by adjacent markings.

(a) Tuning and Band Spread - The two large knobs to the right and left of the dial are respectively the "Main" and "Band Spread" tuning knobs. The latter covers a range of 10 percent ($\pm 5\%$) of the main dial scale reading.

(b) Volume - The Volume Control is the knob to the left below the "Band Spread" tuning knob. It is connected in the audio-frequency circuit, and the receiver output level is increased with clockwise rotation.

(c) Power and Fidelity - The Power Switch is combined with the Fidelity Control, the power being off in the counter-clockwise position.

The Fidelity Control provides attenuation of the higher frequencies. Full-range reproduction is obtained with the knob turned clockwise. Turning counter-clockwise introduces a capacitance in the secondary circuit of the driver transformer, which attenuates the high-frequency response and aids in the reduction of disturbing background noises.

(d) Range - The Range Selector in the center of the panel below the dial selects any one of the five scales of which the frequency limits are tabulated under "Part II Electrical Specifications". Turn the Range Selector knob to bring the required scale into the dial opening.

(e) Electron-Ray-Tuning Tube - The green illuminated Electron-Ray-Indicator Tube (RCA-6E5) at the left of the dial near the top of the front panel is a visible guide to precise tuning. The deflection of the electron stream by the signal voltage causes a narrowing of the darker sector. Maximum deflection, (i.e., when the area of the light sector is at a maximum) indicates that the receiver is tuned to exact resonance.

(f) Selectivity Control - This introduces the crystal filter into the i-f circuit for single-signal reception of CW telegraph or telephone transmission. Crystal phasing is performed by means of an air-trimmer capacitor. Near the midway position marked "Max." the crystal circuit is balanced and maximum selectivity is obtained. This setting is characterized by minimum background noise. In the extreme clockwise position the crystal is short-circuited by means of the crystal switch. Other positions broaden the crystal selectivity curve on one side of resonance and cause a rejection dip on the other side. They are useful for phone reception through severe interference.

(g) Beat Frequency - The Beat Frequency knob at the extreme lower left is a heterodyne control governing the Beat Oscillator output frequency. When set at its zero mid-position the Beat Oscillator frequency will approximate zero beat with the receiver tuned accurately to an incoming signal. The

calibration figures on either side of the zero position indicate the approximate frequency in kilocycles of the beat produced by the combination of the Beat Frequency Oscillator and the received signal tuned to exact resonance.

(h) **Signal Input** - The Signal Input Control is calibrated from 1 to 10,000 on a logarithmic scale. It is used in conjunction with the Electron-Ray-Indicator to obtain the approximate value in microvolts of any signal delivered to the receiver. This is accomplished by tuning the receiver to resonance by means of the Electron-Ray-Indicator and then rotating the Signal Input knob fully counter-clockwise to reduce the voltage on the Electron-Ray tube. Then by slowly rotating this control clockwise, a point causing only a slight deflection ($1/64$ inch) in the dark sector in the Electron-Ray-Indicator, will be obtained. The Signal Input scale reading will then be the approximate signal input value to the receiver, in microvolts. For code reception the correct setting will be at the point where the Electron-Ray-Indicator just begins to flicker.

The absolute accuracy of Signal Input values depends upon the sensitivity of the receiver. This in turn depends on proper alignment, condition of tubes, value of line voltage and similar factors. Relative readings, however, between stations of different signal strengths give a correct comparison. Signal Input readings are also useful for reporting to the transmission station for making tests on different types of antennas, for discovering improvements in transmitters at distant locations, and for making charts of signal strength variations.

Note: Multiply the readings by 5 for obtaining values on band "E" operation.

(i) **AVC - CW Selector** - This is a five position switch on the right of the dial and by means of this knob the operator may set the receiver for Modulated or CW reception, either with or without Automatic Volume Control, according to requirements. On normal CW reception with the control turned to "CW AVC ON" the time constants of the AVC circuits will be such that they will hold during intervals between characters. For slow-speed CW reception, however, the time constant will not hold and the switch should be turned to "CW AVC OFF" and the Signal Input Control used for adjusting the output level. Furthermore the central point is a "Standby" position which keeps the filaments of all tubes heated ready for immediate reception. This is indicated by means of the Standby Light at the top right hand side of the front panel.

(j) **Noise Suppressor** - The Noise Suppression Control is for reducing peaks of noise to a minimum. When used in conjunction with the Signal Input or Sensitivity Control and the Fidelity Control, the Noise Suppressor becomes a very important and valuable device for reducing interfering noises that may impair the intelligibility of radio reception. It is of particular value in minimizing interference caused by the ignition systems of airplanes and automobiles, dial telephones, and similar electrical apparatus. Interference from rotating electrical machinery however is not eliminated by this device.

With a station properly tuned in by the use of the Electron-Ray-Tuning-Indicator, then if the Noise Suppression knob is slowly rotated in a clockwise direction a point of noticeable distortion of the signal will eventually be reached. (If the signal is too strong it may be necessary to reduce the strength by means of the Signal Input Control in order to obtain a point of noticeable distortion on the Noise Suppression Control.) The knob should then be turned very slowly counter-clockwise until the signal becomes clear. This point is the correct setting for the Noise Suppression Control for that particular signal.

This control is also effective for inter-carrier Noise Suppression and its use in this capacity requires the following procedure in order to obtain reception with full strength, maximum fidelity and minimum interference:

- (1) Reduce Signal Input Control as low as possible, meanwhile keeping receiver output at the desired level by means of the Volume Control.
- (2) Set receiver at a point where no signal is being received.
- (3) Adjust Noise Suppression Control till background noise is just audible.
- (4) Tune in desired signal again.

This adjustment of the receiver is of particular value for intermittent signals or when it is desired to standby on a certain channel, the background output of the receiver being extremely low on "no signal" and yet allowing full volume on "signal"

(k) **Phones** - The Phone Jack is to the left of the front panel. When a phone plug is inserted in this jack, it simultaneously connects a resistance load across the secondary of the output transformer in place of the voice coil of the electro-dynamic loudspeaker. It also connects the phones across the plate circuit of the output tube, a blocking condenser being used to isolate the d-c voltage. The loudspeaker field which is employed as a filter for the rectifier stage, still forms an active part of the circuit when using headphones. By inserting the phone plug part way in the jack both headphone and loudspeaker signals may be obtained. The loudspeaker is connected to the chassis by means of a cable and plug.

7. Dial

The Selector Dial provides for each major band a single clearly calibrated scale in the upper dial opening. Each scale is clearly marked in megacycles. The small lower dial opening gives calibration spread for accurate logging. The mechanism is illustrated in Figure 11.

8. Tuning

The two r-f amplifiers (6K7), first detector (6J7) and oscillator (6J7) are tuned by two four-gang variable capacitors and controlled from two knobs.

The right hand knob controls the main tuning capacitor and the left hand knob the band spread capacitor. The band spread capacitor is connected in the circuit to cover a uniform percentage of band spread regardless of the frequency to which the receiver is tuned. Frequency readings on the dial scale obtained by rotation of the Main Tuning knob are only accurate when the Band Spread Control is at zero - turned fully to right.

The Tuning limits for each of the five ranges are given under "Part II - Electrical Specifications". To tune the receiver for desired reception of modulated signals proceed as follows:

- (a) Turn Power Switch "On".
- (b) Turn Range Selector to bring the desired scale into the Selector Dial opening.
- (c) Set AVC - CW Control to "MOD. AVC ON".
- (d) Advance Signal Input Control fully clockwise for maximum sensitivity.
- (e) Advance Volume Control clockwise until background noise is heard.
- (f) Set Band Spread Control at zero - fully clockwise - and then rotate Main Tuning Control to a point just below desired frequency, such as at the low end of an Amateur Band. Now tune in signal with Band Spread Control. Turn slowly counter-clockwise, observe the Calibration Spread scale to obtain station location and then watch the Electron-Ray-Tuning-Indicator for point of resonance.
- (g) Decrease volume as necessary and set Fidelity Control for preferred quality of reproduction. Full tone range reproduction is obtained with the knob set to its extreme clockwise position.
- (h) Silent Tuning may be obtained by reducing the volume until no signal is heard, and then tuning by means of the visual indications of the Electron-Ray Tube.
- (i) Weak Modulated Signals - The Beat Oscillator may be used to advantage in locating weak, modulated signals. For this purpose it should be tuned exactly to the intermediate frequency of the receiver by turning the Beat Frequency Control to "0" so that an audio-frequency note of ascending pitch will be obtained on each side of resonance of the incoming signal when the AVC - CW Selector is turned to "CW AVC OFF". Any carrier will then be tuned to exact resonance when the Frequency Control is adjusted for

"zero beat" and weak signals will be located almost as well as those of greater strength because of the heterodyne "whistle" produced while passing through resonance. After proper adjustment has been made, turn AVC - CW Selector to "MOD. AVC ON".

(j) CW Signals - For CW (code) reception, the tuning procedure is the same as for modulated signals except that the Beat Oscillator performs a definite rather than incidental function. The Beat Frequency Control is set, not at zero, but slightly to either side so as to provide an audio-frequency beat note when the receiver is tuned to resonance with any carrier. Adjust the pitch with the Beat Frequency Control knob. Turn AVC - CW Selector to "CW AVC OFF" when receiving slow speed CW transmission.

(k) If the interference is objectionable during reception, the Noise Suppression Control should be adjusted, as described under "Controls" Section 6, to its "correct setting" for that signal.

(l) Selectivity - The value of the Crystal Selectivity Control is most evident on CW reception. Its importance should not be forgotten in phone reception and for identification of weak stations which are normally lost in the background noise. The curves (Figure 13) should be studied carefully before operating the Selectivity Control.

The following suggestions also may be of value:

Locate the desired frequency or station with control at "Crystal OFF," i.e., in its position of minimum selectivity, then adjust to obtain the desired degree of selectivity.

Tuning is extremely critical with control in the "Max." position and in consequence the movement of the Band Spread knob should be very slow and deliberate.

9. Performance

Average performance data for the ACR-111 is shown in the following table. Slight variations either above or below the values given, may be encountered due to practical manufacturing tolerances.

Noise Equivalent - (microvolts CW) - "Noise Equivalent" is a coined term to express the input in microvolts through the normal input circuit, which would be required to produce an output equal to the receiver noise output.

Selectivity - The Selectivity curve for the average ACR-111 receiver is shown in Figure 13(a).

| Range | Frequency Megacycles | Noise Equivalent Microvolts (CW) | Image Ratio | Sensitivity Input Microvolts(1 w.output) |
|-------|-------------------------|-------------------------------------|-------------|---|
| A | 0.6 | 2 | 250,000 | 10 |
| | 1.5 | 2 | 100,000 | 10 |
| B | 1.7 | 1.0 | 150,000 | 5 |
| | 4.0 | 0.85 | 40,000 | 3.5 |
| C | 4 | 1.2 | 3,000 | 5 |
| | 7 | 0.96 | 2,000 | 3.5 |
| D | 7 | 1.1 | 3,000 | 4.5 |
| | 14 | 0.86 | 400 | 3.5 |
| E | 14 | 0.9 | 200 | 15 |
| | 28 | 1.0 | 10 | 8 |

PART IV - SERVICE

10. General

The various diagrams of this booklet contain information for understanding the arrangement performance, and servicing requirements of the ACR-111. The ratings of all resistors, capacitors, coils, etc., are indicated adjacent to the symbols signifying these parts on the diagrams. The coils, reactors and transformer windings are rated in terms of their d-c resistances only. Ratings of less than 1 ohm are generally omitted. Identification titles such as R₃, L₂, C₁, etc., are provided for reference between the illustrations and replacement parts.

Adjustment and service convenience has been a controlling factor in the layout of the chassis parts and wiring. The assembly of these various elements is such that the number of conductors is minimized, with all important connections being readily accessible. Trimming adjustments are located at accessible points.

11. Circuit Arrangement

A schematic diagram of the complete circuit is shown in Figure 4, a wiring diagram illustrating the wiring layout of the radio chassis and front panel controls is detailed in Figure 5, and of the r-f tuner unit in Figure 6. The loudspeaker wiring diagram and connections to chassis are shown in Figure 12, and the wiring of the Universal Transformer for rating "C" receivers in Figure 7. The circuit is based on the superheterodyne principle. It consists of two r-f amplifier stages, a first-detector (converter) stage, a separate oscillator stage, a crystal filter stage, two i-f amplifier stages, a diode-detector and noise limiter stage, an automatic-volume control stage, an audio voltage-amplifier stage, a noise suppressor stage, an audio driver stage, a power-amplifier stage, a beat frequency oscillator stage, and a full-wave rectifier.

A doublet antenna, when connected to the proper input terminals of the receiver, is coupled to the control grid of the first RCA-6K7 r-f amplifier tube through the tuned r-f transformer consisting of L2, L4, L6, L8, L10, C40, C41, and C42. C2, C3, C4, C5, and C6 are plunger type air-trimmer capacitors for the respective bands - A, B, C, D, and E. The variable tuning capacitors, C41 and C42, are of the split-stator type and are controlled from the main tuning knob. The band spread capacitor, C40, is connected in series with C41, the combination being in parallel with C42 - the main tuning capacitor. Thus a variable capacitance is effectively placed in series with C40, and its value bears a definite ratio to that of C42, the effective capacitance range of C40 being approximately a constant percentage of that of C42, irrespective of its setting.

The range switch in the "A" position shorts out C40, effectively paralleling C41 and C42.

Separate coils are used for each band, and all primary windings not in use are short-circuited, as well as all secondaries for lower frequencies.

The range switching of the r-f and detector circuits is similar to that of the antenna circuits.

Separate windings are employed in the oscillator stage for each position of the range selector. The inherent stability of this circuit provides minimum frequency drift which is especially advantageous for high-frequency reception. The locally generated signal is capacitance coupled to the cathode of the RCA-6J7 first-detector.

I-F Amplifier - The intermediate-frequency amplifier consists of two RCA-6K7 tubes in a two-stage, transformer-coupled circuit. The windings of all three i-f transformers are resonated by a combination of fixed capacitors, and adjustable molded-magnetite cores (both primary and secondary) tune to 460 kc. The crystal filter is introduced between the first i-f transformer secondary (L39) and the control grid of RCA-6K7 first i-f amplifier tube by means of the crystal switch S-11, Figure 4.

Detector and Noise Limiter - The signal, as obtained from the output of the last i-f stage, is detected by an RCA-6H6 twin-diode tube (No. 1 diode), the useful audio-frequency (a-f) and direct-current (d-c) components appearing across resistor R22. The No. 2 diode of this same Radiotron is effectively placed in shunt with R22, with its anode biased approximately 20 volts negative with respect to the cathode, by means of the bleeder resistor R44. Excessive signals, or bursts of static, of magnitude great enough to cause the voltage across R22 to exceed approximately 20 volts will cause the No. 2 diode to draw current, or present a low impedance across R22, thereby acting as a noise limiter.

Audio System - The control grid of the RCA-6C5 first audio amplifier is connected directly to R22, the tube functioning as a diode-biased voltage-amplifier. The output of this tube is resistance-capacitance coupled to the

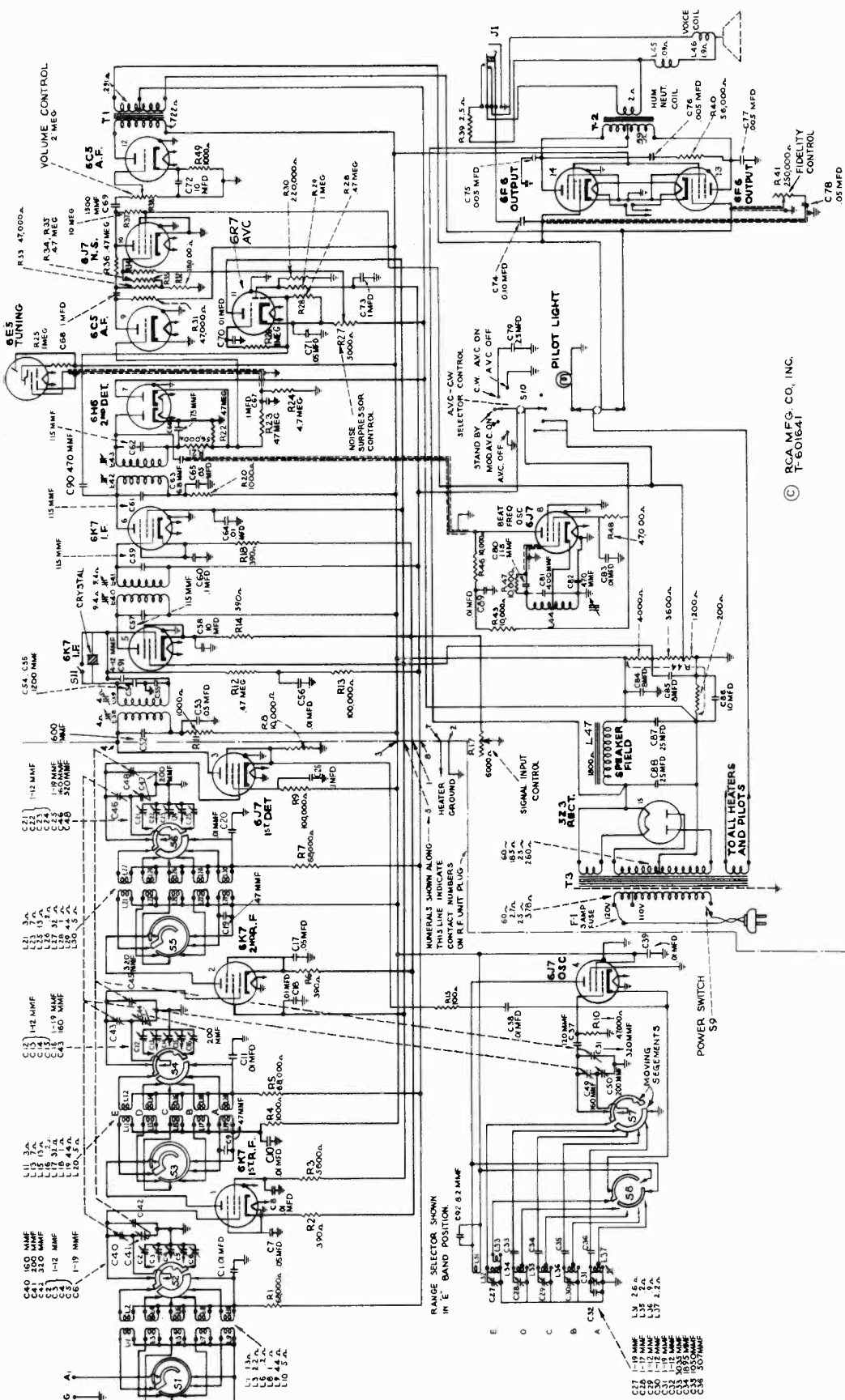

© RCA MFG. CO., INC.
T-601G41

Figure 4—Schematic Diagram

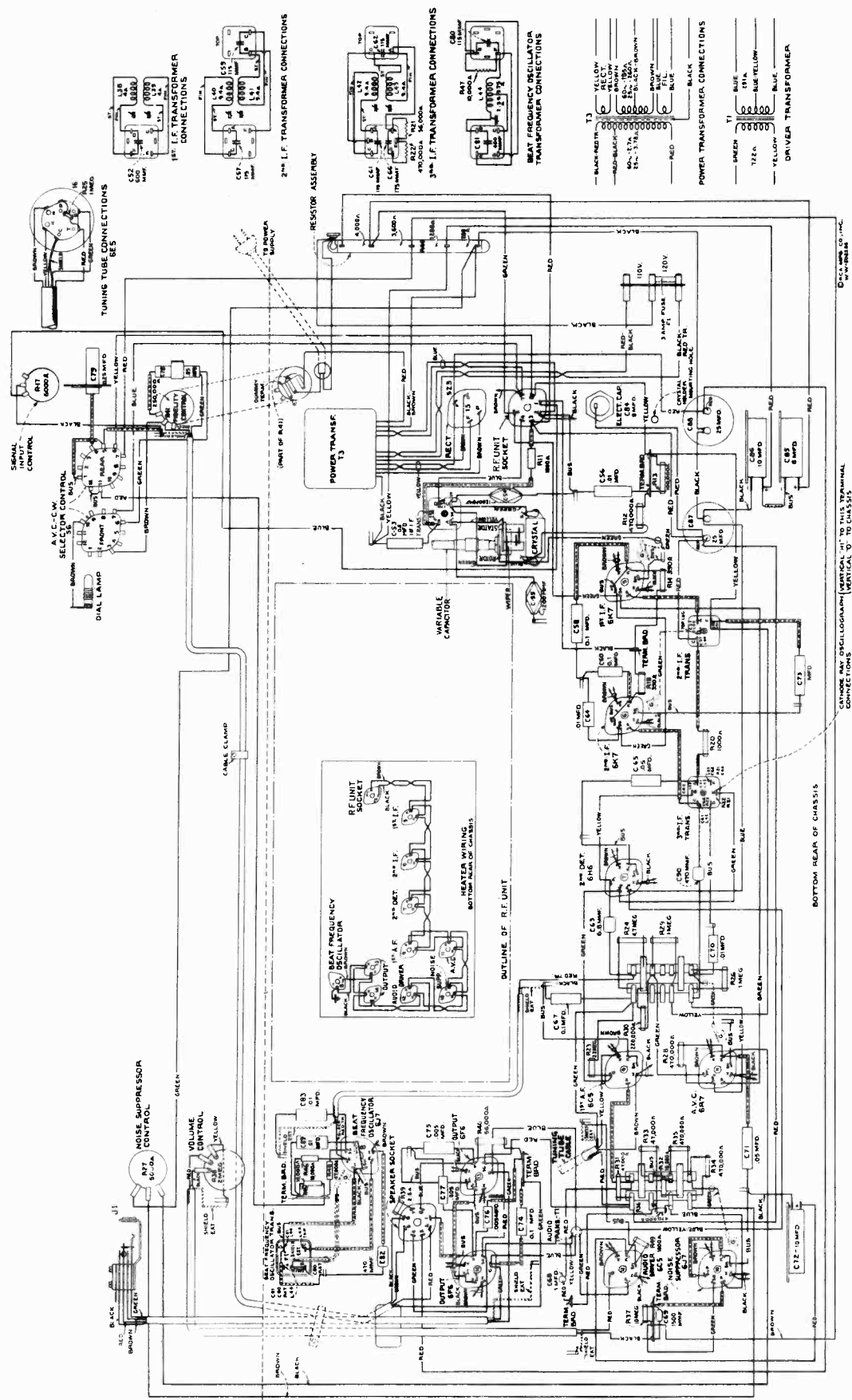

Figure 5—Wiring Diagram

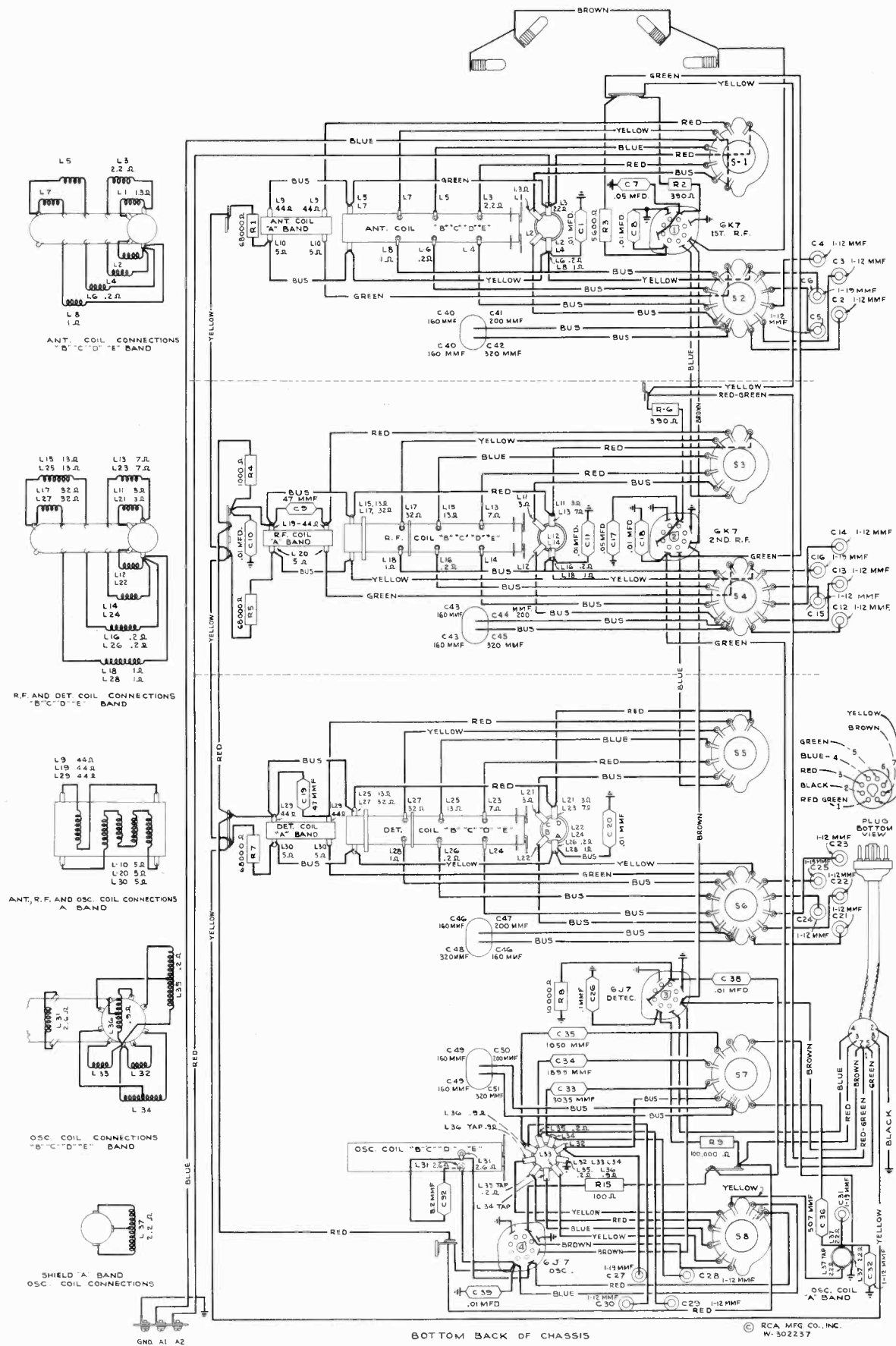

Figure 6—Tuner Unit Wiring Diagram

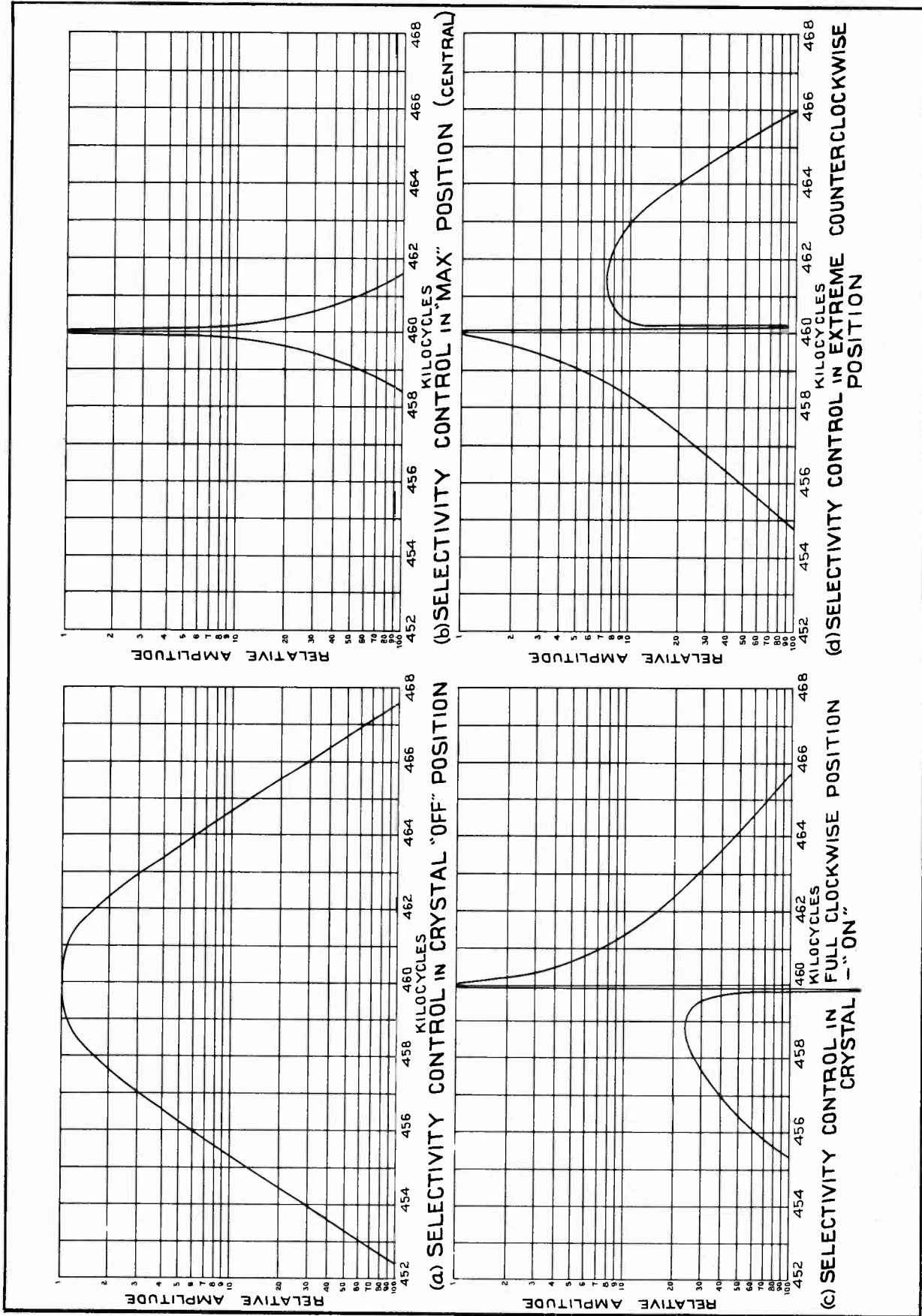

Figure 13—Selectivity Control Curves—Crystal Filter

control grid of the RCA-6C5 audio-driver, potentiometer R38 functioning as the volume control. The output of the driver stage is transformer coupled, through T1, to the control grids of the RCA-6F6 push-pull, power-output tubes. The output of this stage is transformer coupled, through T2, to the voice coil of the electro-dynamic loudspeaker. Insertion of a telephone plug in the headphone jack J1 disconnects the voice coil from the secondary of T2 and substitutes a dummy resistor R39 in its place. The tip and sleeve of the plug are connected across the input circuit of one of the RCA-6F6 power tubes, through capacitor C74, for headphone reception.

The "Fidelity" or tone control comprises the combination of capacitor C78 and variable resistor R41 shunting the secondary of T1.

Automatic Volume Control - The operation of the RCA-6R7 Automatic Volume Control Tube and associated circuits is as follows:

Under conditions of no signal, the cathode current flowing through resistor R27 develops a voltage across R27 of approximately 29 volts. This is in opposition to the approximate 20 volts drop across the bleeder resistor R44, thereby making the cathode approximately 9 volts positive with respect to chassis-ground, or to the anode DP-1. When signals are present, a portion of the i-f voltage is applied to anode DP-2, through Capacitor C90, for rectification. The d-c voltage which develops across resistor R28 is applied to the control grid of the RCA-6R7 through a resistance-capacitance filter, making the grid more negative with respect to cathode, in turn reducing the cathode current or voltage drop across R27, and consequently making the cathode less positive with respect to anode DP-1 than under the condition of no signal. Sufficient signal will cause the cathode to become negative with respect to diode DP-1; current will then flow through this circuit causing a voltage drop across R30, which is applied as automatic control-grid bias to the r-f, first-detector, and i-f tubes through suitable resistance-capacitance filters.

Noise Suppressor - The Noise Suppressor consists of an RCA-6J7 whose plate circuit effectively shunts the input circuit of the audio-driver stage, and a means of making the shunting plate impedance very high for desired signals, and very low for undesired noise impulses of short duration and amplitude greater than the desired signal. The plate impedance will be very high for control-grid bias values sufficient to cause plate-current cut-off, and low for bias values which will permit plate current to flow. The audio signal appearing across resistor R37, and consequently across the RCA-6C5 audio driver input circuit will, therefore, depend upon the ratio of the plate impedance of the Noise Suppressor Tube to the resistance of R36, the series combination being essentially a voltage-dividing network. When the plate impedance is high, the ratio will be high, and practically the total audio voltage appearing across resistors R32 and R33 will appear across the plate circuit. The converse will occur with a low plate-impedance. In operation, the bias is adjusted just below the point of plate current cut-off by means of the movable arm on R27. Noise impulses of short duration, tending to make the grid more positive, will cause the plate impedance to be low during these impulses with a consequent reduction of input to the audio driver during these intervals.

Beat Frequency Oscillator - The frequency generated by the Beat Frequency beat-oscillator (457 to 463 kc) for CW reception is applied to the No. 1 diode plate of the RCA-6H6 second-detector through capacitor C63. This frequency mixes with the incoming intermediate frequency to produce an audio-frequency note which can be readily heard in the loudspeaker or phones. The movable magnetite-core, adjusted by the Beat Frequency Control, provides a variable inductance which acts as a vernier control for adjustment of the oscillator frequency over the required a-f range on either side of the intermediate-frequency signal. The plate and screen-grid voltage supply to this oscillator is turned on and off by means of the AVC - CW selector switch.

AVC - CW Selector - A five-position switch selects the type of reception and controls the Beat Oscillator and AVC circuits. The secondary of the audio transformer T1 is short-circuited in the "Standby" position.

Electron-Ray-Tuning-Indicator - An RCA-6E5 cathode-ray tuning tube is used as a means of visually indicating when the receiver is accurately tuned to the incoming signal. This tube consists of an amplifier section and a cathode-ray section built in the same glass envelope. A portion of the voltage developed across resistor R22 is used to actuate the grid of the amplifier section. Maximum voltage is applied to this grid when the receiver is tuned to resonance with an incoming carrier. This condition is evidenced by minimum width of the dark sector on the fluorescent screen.

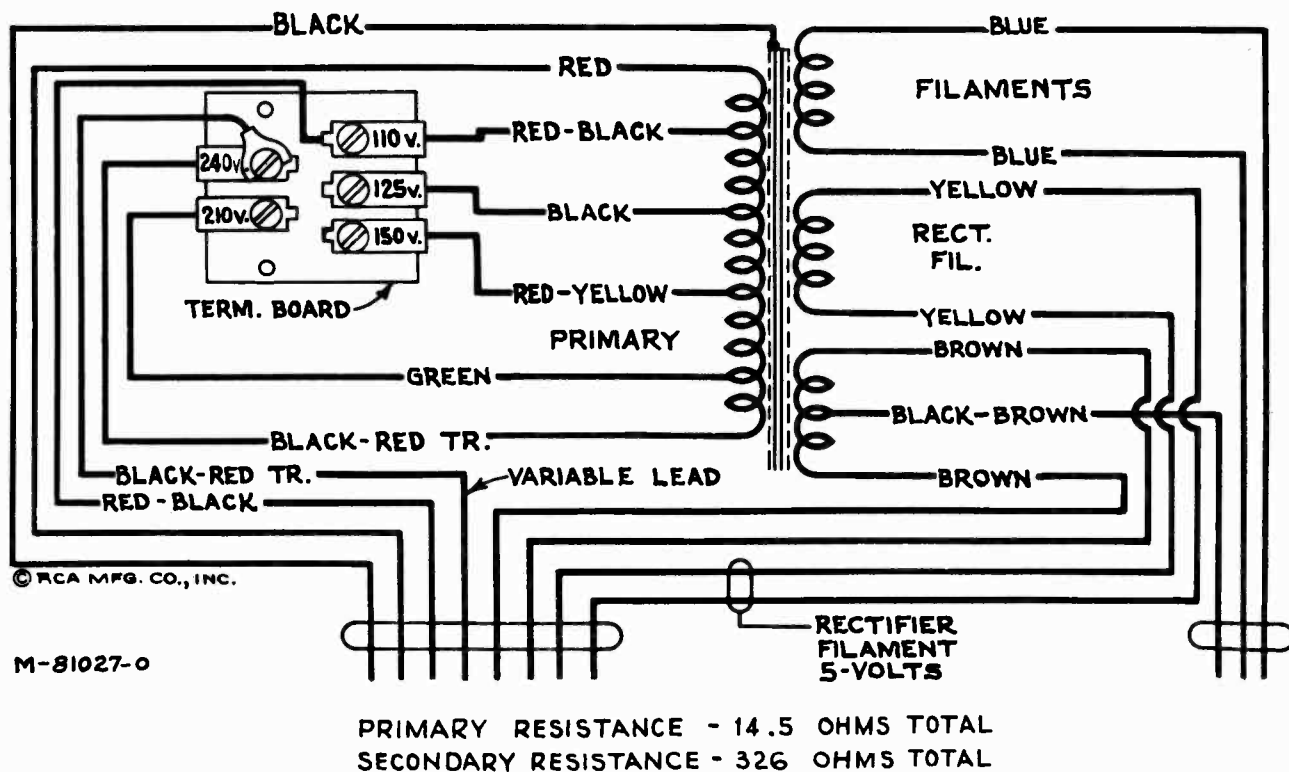

Figure 7—Universal Transformer

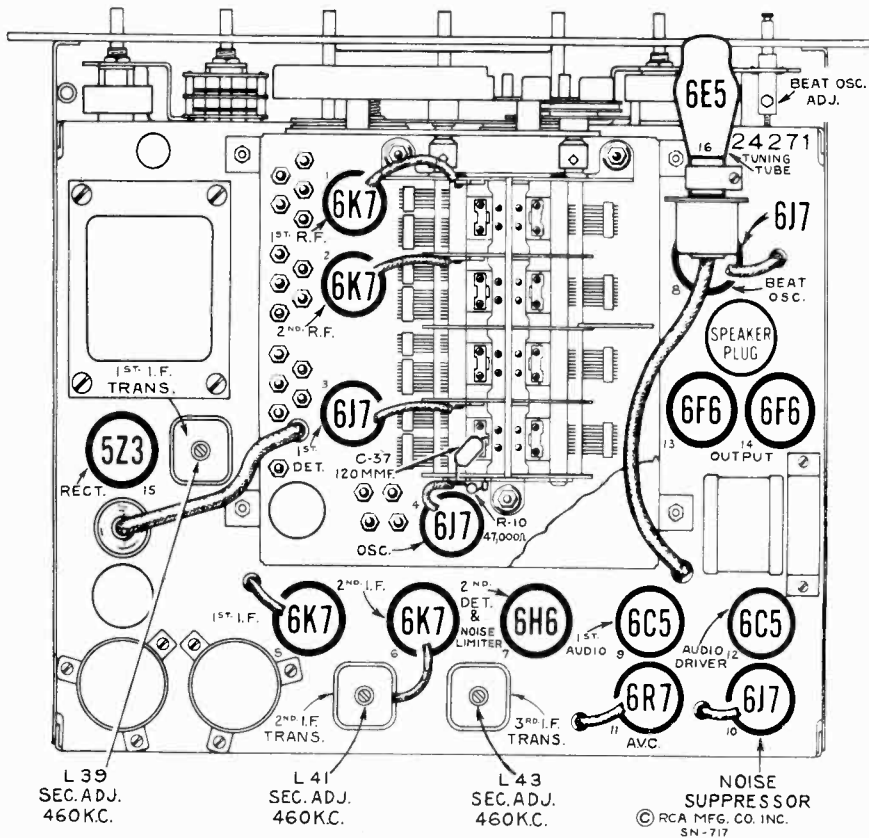

Figure 8—Radiotron and I-F Trimmer Locations

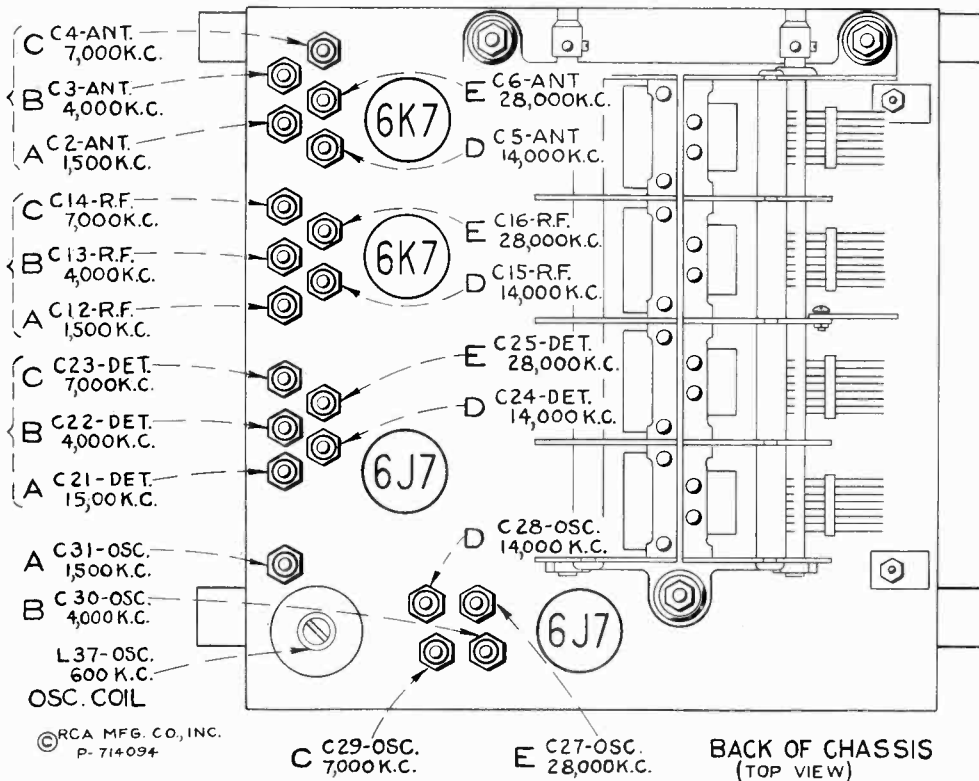

Figure 9—R-F Trimmer Locations

12. Alignment

Before aligning the r-f circuits, make receiver dial adjustments as outlined under "Selector Dial" (Figure 11).

In performing services on the oscillator, detector, and r-f circuits, the leads should be restored to their original positions, since the lead-dress is important for proper operation and dial calibration.

Perform alignment in proper order tabulated below, starting with No. 1 and following all operations across, then No. 2, etc. Adjustment locations are shown by Figures 8, 9 and 10. Holes are provided in the left side of the lower r-f unit shield to enable a tuning check with the RCA Stock No. 6679 Tuning Wand.

The RCA Stock No. 12636 Adjusting Tool has been designed for loosening and retightening lock-nut and for making the plunger adjustment on the plunger-type air-dielectric trimming capacitors.

Cathode-ray alignment is preferable; the connections to the chassis are shown on Figure 5. If an output indicator is used, connect it across the loudspeaker voice coil and advance the receiver volume control to full-volume position. Turn AVC - CW Selector to "MOD. AVC OFF"; Signal Input clockwise. Turn Noise Suppression control to extreme counter-clockwise position. Adjust Signal Input control to "100". Set AVC - CW Selector to "MOD. AVC OFF".

Connect the "Low" output terminal of the test oscillator to the receiver chassis for all alignment operations. Regulate the output of the test oscillator so that the signal applied to the receiver is the minimum which will permit an accurate output observation.

The term "Dummy Antenna" means that device which must be connected between the "High" test oscillator output and the point of connection to the receiver in order to obtain ideal alignment. "No signal, 550-750 kc" means that the receiver should be tuned to a point between 550 and 750 kc where no signal or interference is received from a station or local (heterodyne) oscillator. "Dial setting for image check" means that after alignment is performed following across in proper sequence, the receiver dial should be shifted to the setting specified, without making any other changes, except possibly increasing test oscillator output, at which point image signal should be received. If the image is not received at this dial setting, but at a point approximately 1840 kc below this point in the case of (12) or 1840 kc above this point in the case of (16), it will indicate that the oscillator has been improperly adjusted.

For further details on alignment, refer to booklet "RCA Victor Receiver Alignment" obtainable through your RCA Victor dealer.

| Order of Alignment | Crystal Filter Control | Test Oscillator | | | Receiver Dial Setting | Circuit to Adjust | Adjustment Symbols | Adjust to Obtain | Dial Setting for Image Check |
|--------------------|--------------------------|------------------------|---------------|--------------------------------|-----------------------|-------------------|--------------------|--------------------------|------------------------------|
| | | Connection to Receiver | Dummy Antenna | Frequency Setting | | | | | |
| 1 | "OFF" | 6J7 Det. Grid Cap | 0.001 mfd | 460 kc | No signal 550-750 kc | 3rd i-f Trans. | L43 & L42 | Max. (peak) | — |
| 2 | "OFF" | 6J7 Det. Grid Cap | 0.001 mfd | 460 kc | No signal 550-750 kc | 2nd i-f Trans. | L41 & L40 | Max. (peak) | — |
| 3 | "OFF" | 6J7 Det. Grid Cap | 0.001 mfd | 460 kc | No signal 550-750 kc | 1st i-f Trans. | L39 & L38 | Max. (peak) | — |
| 4 | "ON" Mid-Position "MAX." | 6J7 Det. Grid Cap | 0.001 mfd | Shift Slightly for Max. Output | No signal 550-750 kc | — | — | Max. (peak) | — |
| 5 | "ON" Mid-Position "MAX." | 6J7 Det. Grid Cap | 0.001 mfd | Final Setting of Above | No signal 550-750 kc | 3rd i-f Trans. | L43 & L42 | Max. (peak) | — |
| 6 | "ON" Mid-Position "MAX." | 6J7 Det. Grid Cap | 0.001 mfd | Final Setting of Above | No signal 550-750 kc | 2nd i-f Trans. | L41 & L40 | Max. (peak) | — |
| 7 | "ON" Mid-Position "MAX." | 6J7 Det. Grid Cap | 0.001 mfd | Final Setting of Above | No signal 550-750 kc | 1st i-f Trans. | L39 & L38 | Max. (peak) | — |
| 8 | "OFF" | 6J7 Det. Grid Cap | 0.001 mfd | Final Setting of Above | No signal 550-750 kc | — | — | Check for Max. Output | — |
| 9 | "OFF" | 6K7 and r-f Grid Cap | 300 ohm | 28,000 kc | 28,000 kc | "E" Osc. | C27 | Max. (peak) ⁺ | — |
| 10 | "OFF" | 6K7 and r-f Grid Cap | 300 ohm | 28,000 kc | Rock Thru 28,000 kc | "E" Det. | C25 | Max. (peak)* | — |
| 11 | "OFF" | "A1" Ant. Post | 300 ohm | 28,000 kc | Rock Thru 28,000 kc | "E" R-F | C16 | Max. (peak)* | — |
| 12 | "OFF" | "A1" Ant. Post | 300 ohm | 28,000 kc | Rock Thru 28,000 kc | "E" Ant. | C6 | Max. (peak)* | 28,020 kc |
| 13 | "OFF" | 6K7 and r-f Grid Cap | 300 ohm | 14,000 kc | 14,000 kc | "D" Osc. | C28 | Max. (peak)* | — |
| 14 | "OFF" | 6K7 and r-f Grid Cap | 300 ohm | 14,000 kc | Rock Thru 14,000 kc | "D" Det. | C24 | Max. (peak) ⁺ | — |
| 15 | "OFF" | "A1" Ant. Post | 300 ohm | 14,000 kc | Rock Thru 14,000 kc | "D" R-F | C15 | Max. (peak) ⁺ | — |
| 16 | "OFF" | "A1" Ant. Post | 300 ohm | 14,000 kc | Rock Thru 14,000 kc | "D" Ant. | C5 | Max. (peak) ⁺ | 13,080 kc |

+ Use Maximum Capacity Peak If Two Peaks Can Be Found.

* Use Minimum Capacity Peak If Two Peaks Can Be Found.

| Order of Alignment | Crystal Filter Control | Test Oscillator | | | Receiver Dial Setting | Circuit to Adjust | Adjustment Symbols | Adjust to Obtain | Dial Setting For Image Check |
|--------------------|------------------------|------------------------|---------------|-------------------|-----------------------|-------------------|--------------------|------------------|------------------------------|
| | | Connection to Receiver | Dummy Antenna | Frequency Setting | | | | | |
| 17 | "OFF" | 6K7 and r-f Grid Cap | 300 ohm | 7,000 kc | 7,000 kc | "C" Osc. | C29 | Max. (peak)* | |
| 18 | "OFF" | 6K7 and r-f Grid Cap | 300 ohm | 7,000 kc | Rock Thru 7,000 kc | "C" Det. | C23 | Max. (peak)+ | |
| 19 | "OFF" | "A1" Ant. Post | 300 ohm | 7,000 kc | Rock Thru 7,000 kc | "C" R-F | C14 | Max. (peak)+ | |
| 20 | "OFF" | "A1" Ant. Post | 300 ohm | 7,000 kc | Rock Thru 7,000 kc | "C" Ant. | C4 | Max. (peak)+ | |
| 21 | "OFF" | 6K7 and r-f Grid Cap | 300 ohm | 4,000 kc | 4,000 kc | "B" Osc. | C30 | Max. (peak)* | |
| 22 | "OFF" | 6K7 and r-f Grid Cap | 300 ohm | 4,000 kc | Rock Thru 4,000 kc | "B" Det. | C22 | Max. (peak)+ | |
| 23 | "OFF" | "A1" Ant. Post | 300 ohm | 4,000 kc | Rock Thru 4,000 kc | "B" R-F | C13 | Max. (peak)+ | |
| 24 | "OFF" | "A1" Ant. Post | 300 ohm | 4,000 kc | Rock Thru 4,000 kc | "B" Ant. | C3 | Max. (peak)+ | |
| 25 | "OFF" | 6K7 and r-f Grid Cap | 300 ohm | 600 kc | 600 kc | "A" L-F Osc. | L37 | Max. (peak) | |
| 26 | "OFF" | 6K7 and r-f Grid Cap | 300 ohm | 1,500 kc | 1,500 kc | "A" H-F Osc. | C31 | Max. (peak) | |
| 27 | "OFF" | 6K7 and r-f Grid Cap | 300 ohm | 1,500 kc | 1,500 kc | "A" Det. | C21 | Max. (peak) | |
| 28 | "OFF" | 6K7 and r-f Grid Cap | 300 ohm | 600 kc | Rock Thru 600 kc | "A" L-F Osc. | L37 | Max. (peak) | |
| 29 | "OFF" | 6K7 and r-f Grid Cap | 300 ohm | 1,500 kc | 1,500 kc | "A" H-F Osc. | C31 | Max. (peak) | |
| 30 | "OFF" | 6K7 and r-f Grid Cap | 300 ohm | 1,500 kc | 1,500 kc | "A" Det. | C21 | Max. (peak) | |
| 31 | "OFF" | "A1" Ant. Post | 300 ohm | 1,500 kc | 1,500 kc | "A" R-F | C12 | Max. (peak) | |
| 32 | "OFF" | "A1" Ant. Post | 300 ohm | 1,500 kc | 1,500 kc | "A" Ant. | C2 | Max. (peak) | |

+ Use Maximum Capacity Peak If Two Peaks Can Be Found.

* Use Minimum Capacity Peak If Two Peaks Can Be Found.

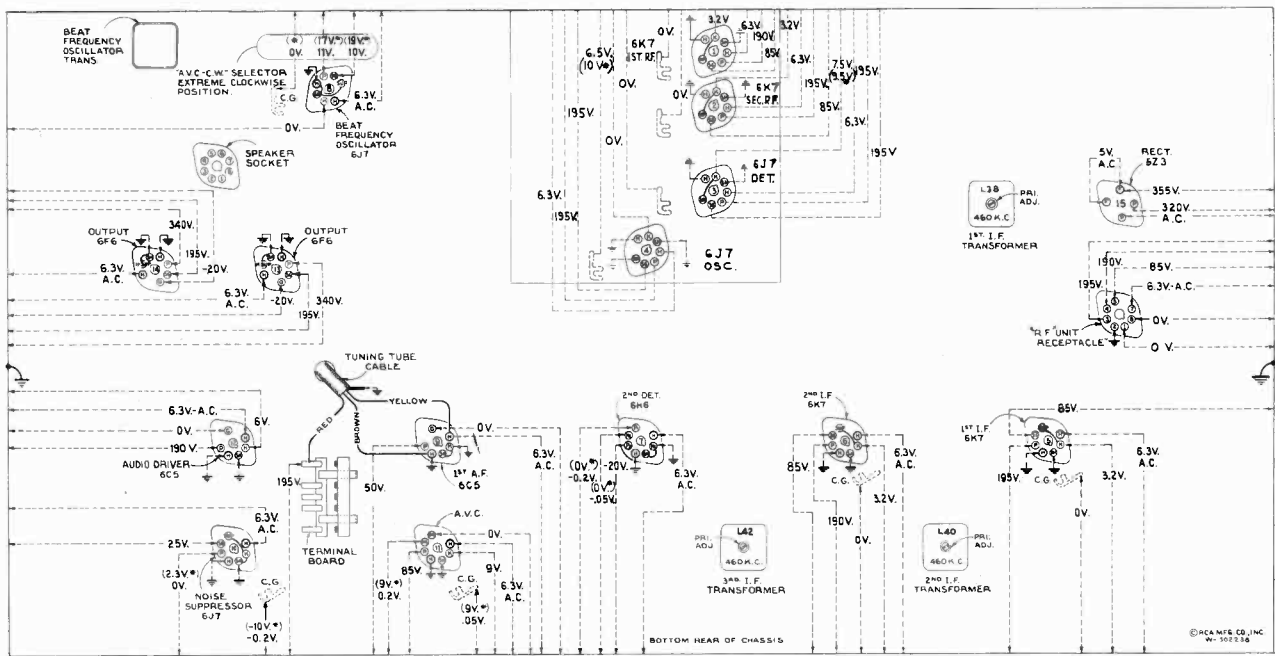

Figure 10—Radiotron Socket, Voltages, Coil and I-F Trimmer Locations

Measured at 115 volts, 60 cycle supply--Tuned to approximately 1000 kc--No signal being received--"Signal Input" control clockwise--"Noise Suppressor" control counterclockwise--"AVC Selector" to "Mod. AVC OFF"--"Volume" control counterclockwise--"Fidelity" and "Beat Frequency" controls optional.

Note: Two voltage values are shown for some readings. The value shown in parentheses with asterisk() indicates operating conditions without voltmeter loading. The other value (generally lower) is the actual measured voltage and differs from the value shown in parentheses because of the additional loading of the voltmeter through the high series circuit resistance.*

The voltage values indicated from the Radiotron socket contacts, grid caps, resistors, and terminals to receiver chassis ground on Figure 10 will assist in locating cause of faulty operation. Each value as specified should hold within $\pm 20\%$ when the receiver is normally operative at its rated line voltage. Variations in excess of this limit will usually be indicative of trouble in the basic circuits. To duplicate the conditions under which the voltages were measured requires a 1000 ohm-per-volt d-c meter, having ranges of 10, 50, 250, and 500 volts. Use the nearest range above the specified measured voltage. A-c voltages were measured with a corresponding a-c meter.

13. Heterodyne Control Setting

Connect a source of unmodulated carrier of the i-f frequency from the grid of the RCA-6J7 first-detector to ground. Turn AVC off, crystal filter to maximum selectivity, sensitivity control to maximum, audio volume control partially on and beat oscillator on.

Rotate the Heterodyne Control knob to left or right until the heterodyne beat is heard.

Change the frequency of the unmodulated carrier from the test oscillator *very carefully* for maximum deflection on the electron-ray-tube indicator. Reduce the signal input if necessary so that the electron-ray-tube does not completely close. The test oscillator is now adjusted to the same frequency as the crystal filter.

Set the Heterodyne Control knob at its zero position and note whether the heterodyne beat is at zero frequency. If not, proceed as follows:

- (a) Rotate the Heterodyne Control knob to obtain zero beat.
- (b) Loosen the knob set screw and turn loosened knob on shaft to its "0" or vertical position.
- (c) Tighten up set screw.

The Heterodyne Control is now adjusted to zero beat at the frequency of the crystal filter.

In the event that the frequency drift is such that the zero beat position of the knob is at or beyond the figure "2" on either side, or outside field of rotation, the following adjustment is necessary:

- (a) Turn knob until the set-screw-stop on the knob control shaft, behind the front panel, is approximately vertical, then loosen stop with screw driver.
- (b) Turn core stud to obtain zero beat. Use a pair of padded long-nose pliers to rotate the core stud in order to avoid injuring thread.
- (c) Turn set-screw-stop over to left (facing front panel) to its mid-position, and adjust knob control shaft to allow 1/32 to 1/16 inch clearance between front panel and adjacent surface of knob.
- (d) Tighten set-screw-stop with pliers to grip core stud, then swing stop to vertical and tighten securely with screw driver.
- (e) Proceed as first described for setting knob accurately to zero position at zero beat.

Note: Do not pull control shaft loose from bearing bracket when adjusting core stud.

14. Selector Dial

Figure 11 illustrates the relation of the various parts of the dial mechanism when in its "B" position with the range switch likewise turned to the same range position. In re-assembling the dial after repairs, see that the gears are meshed in accordance with the diagram, at the same time noting that the range switch is in its "B" position and the lever attached to the range-switch shaft placed in the position shown.

To adjust the dial mechanism, set the range-switch to its "B" position. Place a straight-edge across the center of the dial so that its edge is even with the lower (end) marking at both the low-frequency and high-frequency ends of the dial. Under such conditions the straight-edge should be paralleled with the top of the chassis base. If the straight-edge is not parallel with the top of the chassis base, loosen the nut on the rear of the roller link pivot stud and move the stud up or down until the link roller moves the dial to the desired position so that the end calibration marks obtain the position mentioned above. Tighten the nut on the roller link pivot stud.

Set the gang-tuning condenser to its maximum capacity position. Adjust the dial pointer to the low-frequency (end) mark on the "B" range scale. This is a friction adjustment.

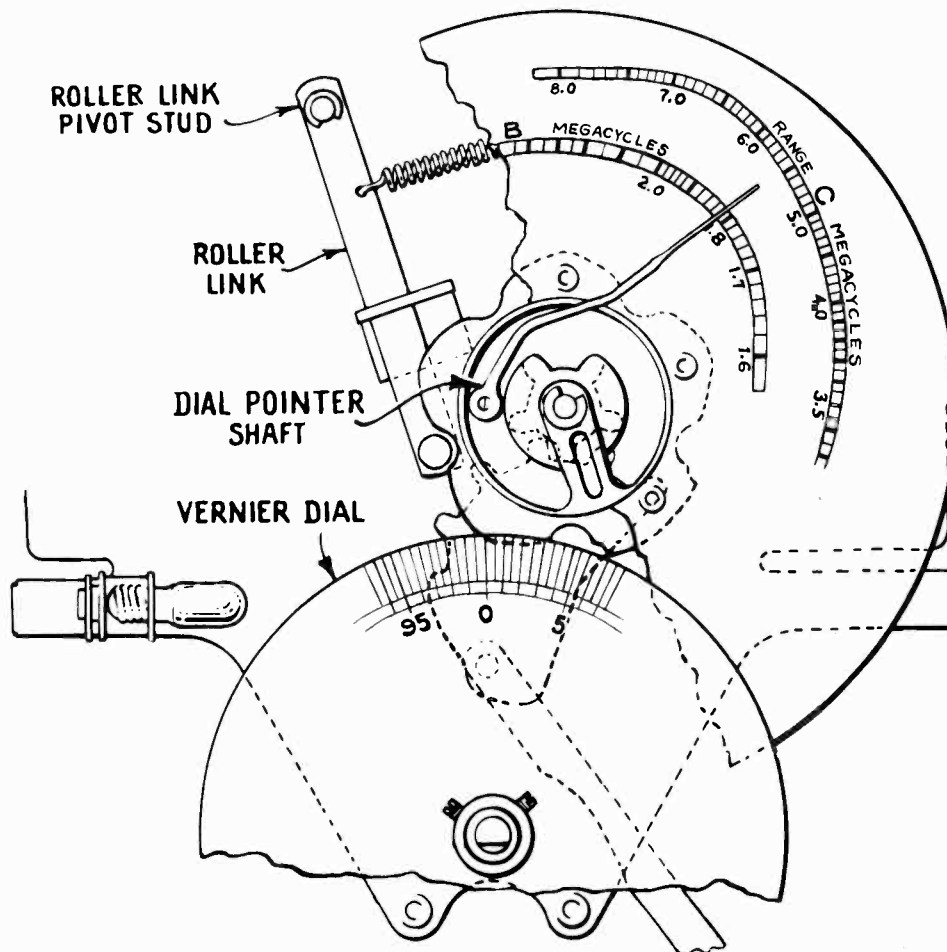

Figure 11—Selector Dial Mechanism

15. Loudspeaker

Centering of the loudspeaker voice coil is made with three narrow paper feelers after first removing the front paper dust cover. This may be removed by softening its cement with a very light application of acetone using care not to allow the acetone to flow down into the air gap. The dust cover should be cemented back in place with ambroid upon completion of adjustment.

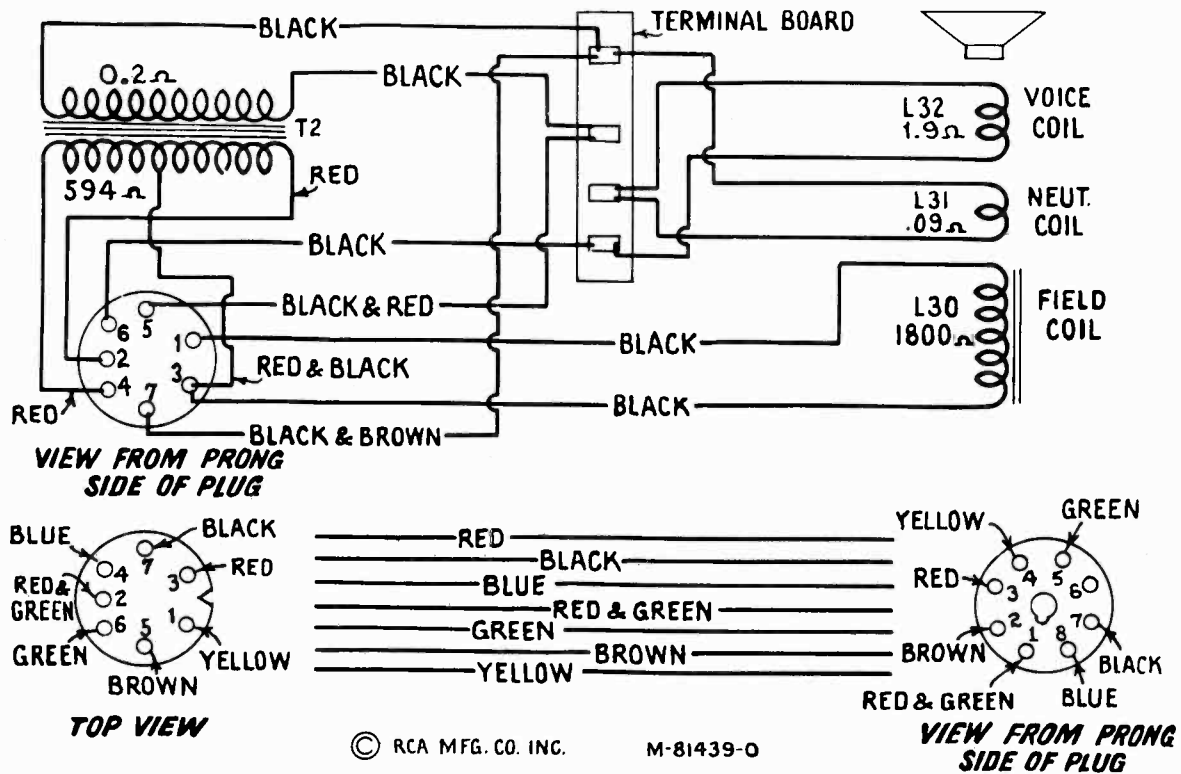

Figure 12—Loudspeaker Wiring

16
REPLACEMENT PARTS
MODEL ACR-111

Insist on genuine factory tested parts, which are readily identified and may be purchased from authorized dealers.

| Stock No. | Description | Stock No. | Description |
|-----------|--|-----------|---|
| | RECEIVER ASSEMBLIES | | |
| 4427 | Bracket - Mounting bracket for beat oscillator control shaft, volume control, fidelity control, sensitivity control, selector switch or suppressor control | 12261 | Resistor - 390 ohms - Insulated 1/4 watt (R14, R18) |
| 13024 | Cable - Tuning tube cable and socket | 11937 | Resistor - 2.5 ohms - wire sound 5 watts (R39) |
| 12110 | Cap - Beat frequency oscillator coil shield top | 12311 | Resistor - 1000 ohms - Insulated 1/4 watt (R11, R20, R49) |
| 12581 | Cap - First or third i-f transformer shield top | 13302 | Resistor - 10,000 ohms - Carbon type 1/10 watt (R47) |
| 12607 | Cap - Second i-f transformer shield top | 12288 | Resistor - 10,000 ohms - Insulated 1/4 watt (R45, R46) |
| 11350 | Cap - Grid contact cap | 13045 | Resistor - 18,000 ohms - Insulated 1/4 watt (R32) |
| 13053 | Capacitor - 6.8 mmfd (C63) | 12412 | Resistor - 47,000 ohms - Insulated 1/4 watt (R33, R48) |
| 11998 | Capacitor - 115 mmfd (C57, C59, C61, C62) | 12573 | Resistor - 47,000 ohms - Carbon type 1/2 watt (R31) |
| 12404 | Capacitor - 120 mmfd (C80) | 11282 | Resistor - 56,000 ohms - Carbon type 1/10 watt (R21) |
| 12406 | Capacitor - 180 mmfd (C66) | 13049 | Resistor - 56,000 ohms - Insulated 1 watt (R40) |
| 13301 | Capacitor - 390 mmfd (C81) | 12263 | Resistor - 100,000 ohms - Insulated 1/4 watt (R13) |
| 13052 | Capacitor - 470 mmfd (C82, C90) | 12264 | Resistor - 220,000 ohms - Insulated 1/4 watt (R30) |
| 12104 | Capacitor - 560 mmfd (C52) | 11452 | Resistor - 470,000 ohms - Carbon type 1/10 watt (R22) |
| 13054 | Capacitor - 1200 mmfd (C54, C55) | 12285 | Resistor - 470,000 ohms - Insulated 1/4 watt (R12, R23, R28, R34, R35, R36) |
| 12898 | Capacitor - 1500 mmfd (C69) | 12013 | Resistor - 1 megohm - Carbon type 1/10 watt (R25) |
| 4838 | Capacitor - .005 mfd (C75, C76, C77) | 12200 | Resistor - 1 megohm - Insulated 1/4 watt (R26, R29) |
| 4518 | Capacitor - .05 mfd (C78) | 13044 | Resistor - 4.7 megohm - Insulated 1/4 watt (R24) |
| 4836 | Capacitor - .05 mfd (C71) | 13050 | Resistor - 10 megohm - Insulated 1/4 watt (R37) |
| 4886 | Capacitor - .05 mfd (C53, C65) | 13037 | Resistor - Voltage divider comprising one 4000 ohm, one 3600 ohm, one 1200 ohm and one 200 ohm sections (R44) |
| 4858 | Capacitor - .01 mfd (C56, C64, C70, C83, C89) | 13038 | Sensitivity Control - (R17) |
| 4839 | Capacitor - 0.1 mfd (C58, C60, C67, C73, C74) | 14427 | Screw - #8-32 x 1/2 headless, cup point set screw for shaft Stock #12105 |
| 13048 | Capacitor - 0.25 mfd (C79) | 4119 | Screw - #8-32 x 1/4 headless, cup point set screw for coupling Stock #12107 collar Stock #14429 and gear Stock #14468 |
| 12141 | Capacitor - 1 mfd (C68) | 12105 | Shaft - Extension shaft for beat oscillator coil adjustment |
| 13041 | Capacitor - 8 mfd (C85) | 14428 | Shaft - Extension shaft for crystal phasing condenser |
| 13046 | Capacitor - 8 mfd (C84) | 14469 | Shaft - Band change knob shaft complete with one "C" washer, one spring washer, and two flat washers |
| 13040 | Capacitor - 10 mfd (C72, C86) | 13300 | Shield - Coil shield for Stock #13299 |
| 13036 | Capacitor - 25 mfd (C87, C88) | 16711 | Shield - Complete beat oscillator circuit bottom shield |
| 13299 | Coil - Beat frequency oscillator coil and shield (L44, C80, C81, R47) | 12008 | Shield - I-F transformer shield for Stock #12095, 12096, and 12097 |
| 14429 | Collar - Retaining collar for crystal phasing condenser extension shaft complete with set screw | 14114 | Socket - Dial lamp and stand-by lamp socket |
| 12089 | Condenser - Crystal phasing variable condenser and switch (C91, S11) | 4794 | Socket - 4 contact 5Z3 Radiotron socket |
| 12085 | Core - Adjustable core and stud for Stock #13299 | 11197 | Socket - 6 contact 6C5 Radiotron socket |
| 12006 | Core - Adjustable core and stud for Stock #12095, 12096, and 12097 | | |
| 12107 | Coupling - Crystal phasing condenser extension shaft flexible coupling | | |
| 12108 | Crystal - Filter crystal and case | | |
| 10907 | Fuse - 3 ampere (F1) | | |
| 14468 | Gear - Gear located on band change knob shaft complete with set screws | | |
| 12128 | Jack - Phone jack (J1) | | |
| 5226 | Lamp - Dial lamp | | |
| 3376 | Mounting - Fuse mounting board for 110 volt models - less fuse | | |
| 4604 | Mounting - Fuse mounting board for 250 volt models - less fuse | | |
| 14467 | Plate - Mounting plate and bearing for band change knob shaft - located on front apron of chassis | | |

| Stock No. | Description | Stock No. | Description |
|-----------|---|-----------|---|
| 11198 | Socket - 7 contact 6F6, 6H6, 6J7, 6K7 Radiotron or r-f unit power supply socket | 14439 | Resistor - 100 ohms - Insulated 1/4 watt (R15) |
| 11196 | Socket - 8 contact speaker cable socket | 12261 | Resistor - 390 ohms - Insulated 1/4 watt (R2, R6) |
| 11381 | Socket - Tuning tube socket and cover | 12311 | Resistor - 1000 ohms - Insulated 1/4 watt (R4) |
| 12106 | Spring - Tension spring for beat oscillator adjustment shaft | 13714 | Resistor - 5600 ohms - Insulated 1/4 watt (R3) |
| 12007 | Spring - Retaining spring for core Stock #12006 | 12288 | Resistor - 10,000 ohms - Insulated 1/4 watt (R8) |
| 13042 | Suppressor Control - (R27) | 12412 | Resistor - 47,000 ohms - Insulated 1/4 watt (R10) |
| 13043 | Switch - AVC - CW selector switch (S10) | 13715 | Resistor - 68,000 ohms - Insulated 1/4 watt (R1, R5, R7) |
| 14134 | Tone Control and Power Switch - (R41, S9) | 14438 | Resistor - 100,000 ohms - Insulated 1/2 watt (R9) |
| 12095 | Transformer - First i-f transformer (L38, L39, C52) | 12883 | Shield - Oscillator coil shield |
| 13035 | Transformer - Interstage driver transformer (T1) | 11280 | Socket - 7 contact det. 6J7 or r-f 6K7 Radiotron socket |
| 12096 | Transformer - Second i-f transformer (L40, L41, C57, C59) | 11278 | Socket - 7 contact osc. 6J7 Radiotron socket |
| 12097 | Transformer - Third i-f transformer (L42, L43, C61, C62, C66, R21, R22) | 12007 | Spring - Retaining spring for core Stock #12882 |
| 11880 | Transformer - Power transformer 105-125 volts 50-60 cycle (T3) | 14436 | Switch - Range switch (S1, S2, S3, S4, S5, S6, S7, S8) |
| 11887 | Transformer - Power transformer 105-125 volts 25-60 cycle (T3) | | |
| 11251 | Transformer - Power transformer 105-250 volts 50-60 cycle (T3) | | |
| 13039 | Volume Control - (R38) | | |
| | R-F UNIT ASSEMBLIES | | DRIVE ASSEMBLIES |
| 12806 | Board - Antenna and ground terminal board | 14451 | Belt - Vernier dial drive belt |
| 5237 | Bushing - Variable tuning condenser mounting bushing assembly | 14452 | Belt - Main or vernier tuning knob drive belt |
| 14430 | Cable - R-F unit power supply cable complete with 8 contact male connector | 14444 | Dial - Band indicating dial and cam assembly |
| 11350 | Cap - Grid contact cap | 14478 | Dial - Vernier dial and disc assembly complete with set screws |
| 12884 | Capacitor - Adjustable trimmer (long) (C6, C16, C25, C27, C31) | 14446 | Disc - Indicator pointer drive disc complete with set screws |
| 12714 | Capacitor - Adjustable trimmer (medium) (C2, C3, C4, C5, C12, C13, C14, C15, C21, C22, C23, C24, C28, C29, C32) | 14464 | Drive - Variable tuning condenser dials and drive assembly complete |
| 14392 | Capacitor - 4.7 mmfd (C32) | 14475 | Gear - 5 tooth segment gear and connecting link for operating band indicating dial |
| 13001 | Capacitor - 8.2 mmfd (C92) | 14476 | Gear - Segment gear located on range switch shaft complete with set screw |
| 13141 | Capacitor - 47 mmfd (C9, C19) | 14449 | Idler - Drive belt idler pulley assembly - less spring |
| 12724 | Capacitor - 120 mmfd (C37) | 12908 | Indicator - Station selector indicator pointer |
| 14443 | Capacitor - 570 mmfd (C36) | 8051 | Link - Band indicating dial link and roller complete with spring |
| 14442 | Capacitor - 1050 mmfd (C35) | 14447 | Pulley - Tuning knob shaft and pulley |
| 14441 | Capacitor - 1895 mmfd (C34) | 14470 | Pulley - Vernier dial drive belt pulley and drive disc located on left hand tuning condenser shaft complete with set screws |
| 14440 | Capacitor - 3035 mmfd (C33) | 14472 | Pulley - Drive belt pulley located on vernier dial shaft - complete with set screws |
| 4836 | Capacitor - .05 mfd (C7, C17) | 14473 | Pulley - Large pulley for drive belt complete with friction discs - drives station indicator pointer drive disc |
| 11799 | Capacitor - .01 mfd (C1, C11, C20) | 14474 | Pulley - Large pulley for drive belt complete with friction discs - drives vernier tuning condenser drive disc and pulley |
| 13138 | Capacitor - .01 mfd (C8, C10, C18, C38, C39) | 14445 | Screen - Dial lamp shield |
| 4839 | Capacitor - 0.1 mfd (C26) | 12993 | Screw - #8-32 x 3/8 headless set screw for disc Stock #14446 |
| 14431 | Coil - Antenna coil B, C, D and E bands (L1, L2, L3, L4, L5, L6, L7, L8) | 4119 | Screw - #8-32 x 1/4 headless cup point set screw for shaft Stock #14448 |
| 14434 | Coil - Antenna r-f or detector coil "A" band (R-F - L19, L20) (DET - L29, L30) (ANT - L9, L10) | | Shaft Stock #14471 and pulley Stock #14470 and gear Stock #14476 |
| 14433 | Coil - Oscillator coil - B, C, D and E bands (L31, L32, L33, L34, L35, L36) | 4387 | Screw - #6-32 x 1/4 headless set screw for pulley Stock 14472 |
| 14435 | Coil - Oscillator coil and shield - "A" band only (L37) | | |
| 14432 | Coil - R-F or detector coil - B, C, D and E bands (R-F - L11, L12, L13, L14, L15, L16, L17, L18) (DET - L21, L22, L23, L24, L25, L26, L27, L28) | | |
| 14437 | Condenser - 8 gang variable tuning condenser (two 4 gang sections assembled C40, C41, C42, C43, C44, C45, C46, C48, C49, C50, C51) | | |
| 12882 | Core - Adjustable core and stud for oscillator coil | | |
| 14028 | Nut - Jamb nut for adjustable trimmer capacitors | | |

| Stock No. | Description | Stock No. | Description |
|--------------------------|---|-----------|--|
| 5042 | Screw - #8-32 x 1/8 headless set screw for vernier dial Stock #14478 | 13542 | Connector - 7 contact female connector for speaker cable |
| 14448 | Shaft - Indicator pointer shaft complete with set screws. | 16836 | Connector - 8 contact male connector for speaker cable |
| 14471 | Shaft - Shaft and socket complete with set screws - connects pulley Stock #14470 to shaft of left hand tuning condenser | 13066 | Disc - Colored disc and mask for stand-by escutcheons |
| 8052 | Spring - Tension spring for link Stock #8051 | 14456 | Escutcheon - Tuning tube and stand-by light escutcheon for Table Model |
| 14450 | Spring - Tension spring for idler | 14457 | Escutcheon - Tuning tube and stand-by light escutcheon and crystal for Rack Model |
| 14453 | Spring - Friction drive disc tension spring | 13064 | Escutcheon - Station selector dial escutcheon for Rack Model |
| 14454 | Spring - Vernier dial shaft tension spring | 14458 | Escutcheon - Station selector dial escutcheon and crystal for Table Model |
| 14477 | Stud - Hex head stud for attaching link to gear Stock #14476 | 14460 | Escutcheon - Oscillator control, volume control, band spread, range switch, tuning selectivity and fidelity, knob escutcheon |
| REPRODUCER ASSEMBLIES | | 14461 | Escutcheon - Phone jack and suppressor control knob escutcheon |
| 13063 | Board - Reproducer terminal board | 14462 | Escutcheon - Stand-by switch and sensitivity control knob escutcheon |
| 12640 | Bracket - Output transformer mounting bracket and clamp | 12595 | Knob - Station selector knob for Rack Model |
| 11234 | Coil - Reproducer field coil (L47) | 14459 | Knob - Station selector knob for Table Model |
| 11233 | Coil - Reproducer neutralizing coil (L45) | 16803 | Knob - Oscillator control, volume control, suppressor control, sensitivity control, tone control, power switch, range switch, or selector switch, knob and pointer |
| 12642 | Cone - Reproducer cone and dust cap (L46) | 12993 | Screw - #8-32 x 3/8 headless, cup point set screw for tuning knob |
| 13062 | Connector - 7 contact male connector for speaker leads | 14463 | Shield - Complete r-f unit top shield |
| 9720 | Reproducer Complete | | |
| 11229 | Transformer - Output transformer (T2) | | |
| 11886 | Washer - Spring washer to hold field coil securely | | |
| MISCELLANEOUS ASSEMBLIES | | | |
| 14455 | Cable - 7 conductor speaker cable approximately 72" long complete with 1 male and 1 female connectors | | |

INSTRUCTION BOOK

for the
ACR-155

PART I—INTRODUCTION

1. General

This new, moderately-priced, nine-tube RCA Amateur Communications Receiver covers a frequency range of from 520 to 22,000 kilocycles. It embodies the most up-to-date circuits and construction, including RCA metal tubes, beat-frequency oscillator, sensitivity and automatic-volume controls, standby switch, loudspeaker, and phone jack. The sensitivity and selectivity of the instrument together with its frequency stability and reliability open to the operator a field of reception covering all communications in the more important ranges.

This book should be studied carefully to learn how to make full use of the ACR-155 and keep it in its optimum operating condition.

2. Special Features

An inspection of the schematic circuit diagram (Fig. 9, page 12) and the wiring diagrams (Figs. 10 and 11, pages 13 and 14) make clear the many developments incorporated in this new model.

Metal Tubes provide effective shielding as well as minimum terminal spacing and short connecting circuits with their attendant advantages. The nine labeled *controls*, including the phone jack, are all on the front panel, thus giving complete front panel op-

eration. The large diameter *Tuning* knob is comfortable and convenient to the hand and facilitates ease of tuning. In conjunction with the 100:1 vernier drive, fine tuning adjustments are easily made. The crank handle permits the operator to rapidly tune to any point within the range. Other knobs are of the bar type plainly labeled for their particular functions. An *AVC Switch* allows one to dispense with the use of the *Automatic-Volume Control* when desired.

The *Selector Dial* brings each scale separately into the dial opening by a turn of the *Range Selector* knob and gives clear vision calibrations for the range in use only. The calibration-spreader scale beneath provides readings that may be entered in the station log for future reference when it is again desired to receive the same station.

The *Beat Oscillator* is equipped with two controls, an "On-Off" toggle switch and a *Heterodyne Control* with magnetite-core tuning which effectively governs the pitch. The shield enclosing the entire beat-oscillator circuit enables the listener to operate the set with freedom from undesirable beat notes due to harmonics.

Each receiver is carefully tested and calibrated before leaving the factory.

PART II—ELECTRICAL SPECIFICATIONS

3. Tuning Ranges

| Range | Kilocycles | Megacycles | Meters | Major Transmissions |
|-------|--------------|------------|-----------|---|
| A | 520-1,720 | 0.52-1.72 | 577-174 | Standard Broadcast—Police |
| B | 1,720-6,300 | 1.72-6.30 | 174-47.5 | 100 and 80 m. Amateur—Police—Aviation |
| C | 6,300-22,000 | 6.30-22 | 47.5-13.7 | 40 and 20 m. Amateur—Police—S-W Broadcast |

4. Circuit Data

Circuit.—Superheterodyne with beat-frequency oscillator for C-W reception, optional automatic-volume control, class A output system and wave-trap.

Intermediate Frequency.—460 kilocycles.

Power Output.—2 watts (undistorted); 4.5 watts maximum.

Loudspeaker.—Dust proof, electrodynamic, 6-inch. (Voice-coil impedance 3.2 ohms at 400 cycles) with Hum-Neutralizing Coil.

Tubes.—

- 1 RCA-6K7—Radio-Frequency Amplifier.
- 1 RCA-6L7—First Detector.
- 1 RCA-6J7—Oscillator.
- 1 RCA-6K7—Intermediate-Frequency Amplifier.
- 1 RCA-6H6—Second Detector and A.V.C.
- 1 RCA-6F5—Audio-Voltage Amplifier.
- 1 RCA-6F6—Power Output.
- 1 RCA-5W4—Full-Wave Rectifier.
- 1 RCA-6J7—Beat-Frequency Oscillator.

See diagram on label inside cabinet for locations of tubes and grid leads.

Power Supply Ratings.—Check with rating symbol on chassis.

| Symbol | Voltage | Frequency (cycles) |
|--------|---------------------------|--------------------|
| A | 105-125 | 50-60 |
| B | 105-125 | 25-60 |
| C | 100-130; 140-160; 195-250 | 40-60 |

As shipped from the factory, rating C receivers are connected for 225-250 volts unless prominently specified otherwise on the chassis. Such receivers may be converted for operation at 100-117, 117-130, 140-160 or 195-225 volts when required.

Power Consumption.—110 watts.

5. Antenna

A most important factor in good reception is the antenna. Both "noise reducing" and "directional" properties as well as definite "length" to suit the signal frequency are essential antenna requirements for best reception. A two-terminal board with the terminals marked "A" and "G" is provided on the rear of the chassis for connections to antenna and ground. The "G" terminal should always be connected to a good external ground.

The RCA "Spiderweb" antenna system (Stock No. 9685) is designed to give maximum signal input to the receiver over the greatest possible range of frequencies. This antenna is recommended for best overall results when it is desired to operate the re-

ceiver on a number of different frequencies. The antenna is completely assembled and soldered at the factory, and therefore is simple to install and neat in appearance when erected. The transmission line should be connected to the terminals "A" and "G" on the chassis.

However, for maximum performance in any one or two amateur bands, one of the antenna systems illustrated below is recommended. Essential parts, such as crossover insulators (Stock No. 4327), transmission lines (Stock No. 12430) and receiver coupling transformers (Stock No. 12424) may be purchased from your dealer.

The correct length (L) in feet for each arm of the doublet for maximum signal input at any particular frequency in kilocycles may be computed from the following formula:

$$L = \frac{233,700}{f}$$

where L = length of each doublet arm in feet and f = frequency in kilocycles.

Example.—It is desired to install an antenna for reception of 7,150 kilocycle signals.

The correct length of each arm of the doublet is

$$L = \frac{233,700}{7,150} = 32.6 \text{ feet.}$$

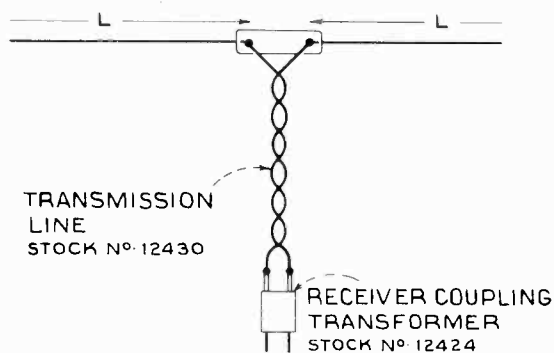

| L = 130 FEET FOR 160 METER (1,900 K.C.) BAND. | | | |
|---|---|----|-------------------|
| L = 65 | " | 80 | " (3,800 K.C.) " |
| L = 33 | " | 40 | " (7,150 K.C.) " |
| L = 16 | " | 20 | " (14,200 K.C.) " |

SINGLE DOUBLET ANTENNA

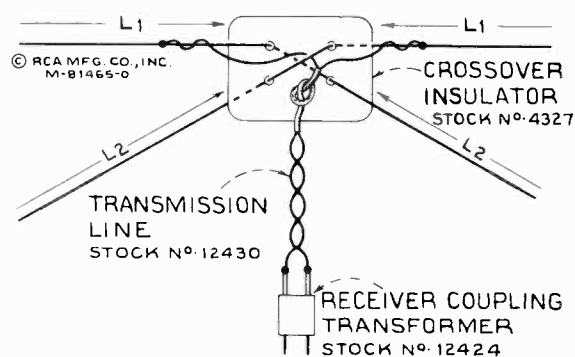

| L1 = 130 FT. FOR 160 M. BAND. L2 = 65 FT. FOR 80 M. BAND. | | | |
|---|---|----|----------------------|
| L1 = 65 | " | 80 | " L2 = 33 " " 40 " " |
| L1 = 33 | " | 40 | " L2 = 16 " " 20 " " |

DOUBLE DOUBLET ANTENNA

M-81465

Figure 4—Doublet Antennas

PART III—OPERATION

6. Controls

All controls are located upon the front panel and are identified by adjacent markings.

(a) **Tuning.**—In the center of the front panel, just beneath the dial, is the large *Tuning* knob with crank handle.

(b) **Volume.**—The Volume Control is the first knob to the left of the "Tuning" knob. It is connected in the audio-frequency circuit, and the receiver output level is increased with clockwise rotation.

(c) **Power and Stand-by.**—The Power Switch is combined with the Stand-by Switch, and this control has three positions. Turned fully clockwise to "Stand-by" all plate and screen-grid supply voltages are disconnected, but the filament supply remains "on" to keep the receiver "warmed up" and ready for instant operation. At its center position the receiver is "on" and turned fully counterclockwise the receiver is "off."

(d) **Range.**—The Range Selector to the right of the "Tuning" control selects any one of the three scales of which the frequency limits are tabulated under "Electrical Specifications—Tuning Range—Section 3." Turn the Range Selector knob to bring the required scale into the dial opening.

(e) **Tone.**—The Tone Control provides attenuation of the higher frequencies. Full-range reproduction is obtained with the knob turned clockwise. The counterclockwise position introduces a capacitance in the primary circuit of the output transformer, which attenuates the high-frequency response. This setting aids in the reduction of disturbing background noises.

(f) **Beat Oscillator.**—The Beat-Frequency Oscillator controls consist of:

(1) A toggle switch on the extreme left of the panel, which serves to interrupt screen- and plate-supply voltages to the beat-frequency oscillator tube, but leaves the filament heated continuously so that the tube is ready for instant use at any time.

(2) A Heterodyne Control knob, which governs the beat-oscillator output frequency over a limited range by means of a magnetite-core adjustment within the beat-oscillator tuning coil.

The beat-frequency oscillator provides for the reception of continuous-wave (c-w) telegraph signals. It also may be used to locate modulated signals by the "birdie" method, in cases where the signal strength is very low.

(g) **Sensitivity and AVC.**—The last knob to the right of the panel provides:

(1) Automatic-volume control in the fully clockwise position. When turned counterclockwise it eliminates AVC action in order to obtain the best reception of slow-speed code transmission by the reduction of "thumping."

(2) Continuously-variable sensitivity control which functions progressively as an auxiliary volume control when the AVC is turned "off," the sensitivity being decreased as the knob is turned counterclockwise.

(h) **Phone Jack.**—A phone jack for the connection of headphones is located at the extreme right of the front panel.

7. Dial

The selector dial provides for each band a single clearly calibrated scale in the upper dial opening. Each scale is clearly marked in megacycles. Meter markings for assigned communication bands are also indicated.

The small lower dial opening gives calibration spread for accurate logging.

8. Tuning

The r-f amplifier (6K7), first detector (6L7) and oscillator (6J7) are tuned by a three-gang variable capacitor and so controlled from a single knob. The Tuning limits for each of the three ranges are given under "Electrical Specification," page 5. To tune the receiver for desired reception of modulated signals proceed as follows:

(a) Turn *Power Switch* "on."

(b) Turn *Range Selector* to bring the desired scale into the *Selector Dial* opening.

(c) Set *AVC Switch* in its fully clockwise position—AVC "on."

(d) Set *Beat-Oscillator Switch* at "off."

(e) Advance *Volume Control* clockwise, until background noise is heard.

(f) Rotate *Tuning* knob to tune in the required station as indicated by the pointer readings on the *Selector Dial* scale.

(g) Adjust *Volume* to suit and set *Tone Control* to give best rendition of the program being received. Full-Tone Range reproduction is obtained with the knob turned fully clockwise. Counterclockwise positions eliminate high tones and reduce static interference.

(h) **Weak Modulated Signals.**—The beat oscillator may be used to advantage in locating weak, modulated signals. It should be tuned for this purpose exactly to the intermediate frequency of the receiver so that an audio-frequency note of ascending pitch will be obtained on each side of every incoming carrier. To adjust the beat oscillator in this manner, simply tune the receiver accurately to any carrier of suitable strength, then turn the *Beat-Oscillator Switch* "on" and rotate the Heterodyne Control until "zero beat" is obtained. It follows then, of course, that any other carrier will be tuned to exact resonance when the gang or tuning capacitor is adjusted for "zero beat" and that weak signals will be tuned almost as well as those of greater strength because of the heterodyne "whistle" produced while passing through resonance.

(i) **C-W Signals.**—For c-w (code) reception, the tuning procedure is the same as for modulated signals except that the beat oscillator performs a definite rather than incidental function. It is set not at the intermediate frequency, but slightly *above* or *below* so as to provide an audio-frequency beat note when the receiver is tuned to resonance with any carrier.

The gang capacitor, therefore, should be adjusted to the center of the carrier by listening to the "swish" before turning "on" the Beat-Oscillator Switch. Always adjust the pitch with the heterodyne knob—never by means of the tuning control knob. Turn AVC off when receiving slow-speed c-w transmission.

9. Performance

Average performance data for the ACR-155 is shown in the following table. Slight variations,

| Range | Frequency | Noise Equivalent C-W | Image Ratio | Modulated Signal to Noise Ratio (1 Watt Output; Maximum Sensitivity) | Sensitivity Input for 1 Watt Output |
|-------|------------|-------------------------|-----------------|---|---|
| | Kilocycles | Microvolts | | Microvolts | Microvolts |
| A | 550 | 0.80 | 60,000 1,500 | 2.00 | 9.0 |
| | 1,500 | 1.50 | | 1.40 | 6.0 |
| B | 2,000 | 1.40 | 3,000 150 | 4.45 | 30.0 |
| | 6,000 | 2.00 | | 4.00 | 15.0 |
| C | 6,300 | 1.60 | 250 20 | 10.00 | 35.0 |
| | 20,000 | 2.00 | | 10.00 | 13.0 |

PART IV—SERVICE

10. General

The various diagrams of this booklet contain information for understanding the arrangement, performance, and servicing requirements of the ACR-155. The ratings of all resistors, capacitors, coils, etc., are indicated adjacent to the symbols signifying these parts on the diagrams. The coils, reactors and transformer windings are rated in terms of their d-c resistances only. Ratings of less than one ohm are generally omitted. Identification titles such as R3, L2, C1, etc., are provided for reference between the illustrations and replacement parts. Design features include improved plunger-type air-dielectric adjustable trimming capacitors in the antenna, detector, and oscillator-coil circuits; tuned r-f amplifier; high-efficiency first detector (converter) with separate oscillator; magnetite-core adjusted i-f transformers, low-frequency oscillator tracking, and wave-trap; automatic-volume control; sensitivity control; selector dial; beat oscillator and heterodyne control; and a dustproof electrodynamic loudspeaker.

Adjustment and service convenience has been a controlling factor in the layout of the chassis parts and wiring. The assembly of these various elements is such that the number of conductors is minimized, with all important connections being readily accessible. Trimming adjustments are located at accessible points. The tuning knob is on a hundred to one dial drive ratio, permitting ease of tuning, especially in the "B" and "C" ranges.

11. Circuit Arrangement

A schematic diagram of the complete circuit is shown in Figure 9, a wiring diagram illustrating the wiring layout of the radio chassis and front panel controls is detailed in Figure 10 and of the r-f tuner

either above or below the values given, may be encountered due to practical manufacturing tolerances.

Noise Equivalent (microvolts c-w).—"Noise Equivalent" is a coined term to express the input in microvolts through the normal input circuit, which would be required to produce an output equal to the receiver noise output.

Selectivity.—The Selectivity curve for the average ACR-155 receiver is shown on page 21, Figure 16.

unit in Figure 11. The loudspeaker wiring diagram and connections to chassis are shown in Figure 15, and the wiring of the Universal Transformer for rating "C" receivers in Figure 5. The circuit is based on the superheterodyne principle. It consists of an r-f amplifier stage, a first-detector (converter) stage, a separate oscillator stage, an i-f amplifier stage, a diode-detector—automatic-volume-control stage, an audio voltage-amplifier stage, a power-amplifier stage, a beat-frequency oscillator stage, and a full-wave rectifier.

A "Spiderweb" antenna system, or a doublet antenna, when connected to the input terminals of the receiver, is coupled to the control grid of the RCA-6K7 r-f amplifier tube through the tuned r-f transformer consisting of L5, L4, L3, and L2. A

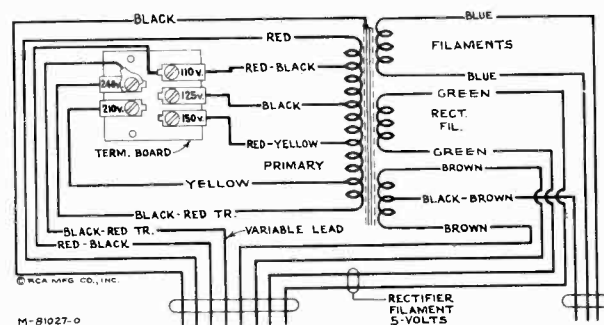

Figure 5—Universal Transformer

unique method of switching is used. In the 0.52 to 1.72 mc "A" range, L5 becomes the primary with L4, L3, and L2 as secondary. In the 1.72 to 6.3 mc "B" range, L4 becomes the primary with L3 and L2 as secondary (L5 shorted out). In the 6.3 to 22 mc

"C" range, L3 becomes the primary with L2 as secondary (L5, L4, and tap on L4 shorted out). The tap on L4 is provided to prevent interaction with L3 and L2 when operating receiver in the "C" range. This method of switching reduces the total number of coils and leads, and results in having a low-loss primary and secondary winding for each range with high efficiency of operation.

The range switching of the detector circuits is similar to that of the antenna circuits. Coils L9 and L13 are always connected in series with the plate circuit of the RCA-6K7 r-f amplifier tube. In the 0.52 to 1.72 mc "A" range L12, L11, and L10 are connected in series as the secondary circuit. The ground of the coil system is now at the lower end of L12. L13 is used as the primary and is resonated at the proper frequency by the combined capacitors C18 and C19 which shunt this coil. In the 1.72 to 6.30 mc "B" range, L11 and L10 are connected in series as the secondary. The ground of the coil system is now between L12 and L11. L12 is used as the primary and is resonated at the proper frequency by capacitor C18 which is in shunt with this coil. Capacitor C19 transfers the r-f energy from the plate circuit to the primary L12. In the 6.3 to 22 mc "C" range, L10 is the secondary. The ground of the coil system is now between L11 and L10. L11 is used as the primary and is resonated to the proper frequency by capacitor C18. In addition, L9 acts as a high-frequency primary which resonates at about 20 mc and improves the gain at the high-frequency end of the "C" range. Coil L12 is shorted by the range selector.

Separate windings are employed in the oscillator stage for each position of the range selector. The inherent stability of this circuit provides minimum frequency drift which is especially advantageous for high-frequency reception. The locally generated signal is capacitance coupled to control grid No. 3 of the RCA-6L7 first detector.

I-F Amplifier

The intermediate-frequency amplifier consists of an RCA-6K7 in a transformer-coupled circuit. The windings of these transformers are resonated with fixed capacitors, and are adjusted by molded magnetite cores (both primary and secondary) to tune to 460 kc.

Detector, A.V.C., and Sensitivity

The modulated signal as obtained from the output of the i-f stage is detected by an RCA-6H6 twin-diode tube (P2 diode). The audio frequency secured by this process is transferred to the a-f system for amplification and final reproduction. The d-c voltage which results from detection of the signal is used for automatic-volume control. This voltage,

which develops across resistors R10 and R11, is applied as automatic control-grid bias to the r-f, first-detector, and i-f tubes. The P1 diode of the RCA-6H6 is used to supply residual bias to the controlled tubes under conditions of little or no signal, when AVC switch S6 is "on." This diode, under such conditions, draws current which flows through resistors R9, R10, and R11, thereby maintaining the desired operating bias on such tubes. On application of signal energy above a certain level, however, the auxiliary bias-diode P1 ceases to draw current and the diode P2 takes over the biasing function.

The AVC action is eliminated with the switch S6 turned counterclockwise from its extreme position, the Sensitivity Control (resistor R26) being then connected in the circuit. This resistor or potentiometer, which shunts a portion of the bleeder circuit, is used for manually regulating the grid bias voltage on the r-f, detector, and i-f tubes. The bias-voltage is increased as the sensitivity control is turned counterclockwise. The position of greatest sensitivity is adjacent to the AVC switch.

Audio System

The manual volume control consists of a potentiometer R13 in the audio circuit between the output of the detector-diode and the input grid of the RCA-6F5 audio-voltage-amplifier tube.

The output of the voltage amplifier is resistance-capacitance coupled to the control grid of the RCA-6F6 power-output tube. The output of this stage is transformer coupled to the voice coil of the electrodynamic speaker.

A telephone jack is provided on this receiver for the insertion of headphones. The insertion of the phone plug simultaneously short-circuits the voice coil of the electrodynamic loudspeaker and connects the phones through a small capacitor across the plate circuit of the power output stage. Since the loudspeaker field is employed as a filter for the rectifier stage, the unit still forms an active part of the circuit when using headphones.

The Tone Control comprises a switch S7 and a capacitor C39 shunting the plate circuit of the output tube. When the switch is closed the capacitor C39 is connected to ground, thus providing maximum attenuation of the higher audio frequencies.

Beat Oscillator.—The Beat-Frequency Oscillator consists of a RCA-6J7 tube in a stabilized Hartley circuit. Its frequency may be varied slightly above or below the i-f frequency of the receiver (460 kc) by means of the molded magnetite core in oscillator coil L20 (Heterodyne Control). The output of the oscillator is coupled through the capacitor C33 to detector diode No. 2 to provide a beat note with the i-f signal. This oscillator may be turned "off" or "on" as desired by means of the switch S8.

12. Alignment

There are ten adjustments required for the alignment of the oscillator, first-detector, and antenna-tuned circuits; one adjustment for the wave-trap; and four adjustments for the i-f system. Nine of these fifteen adjustments are made with plunger-type air-

trimming capacitors and require the use of an RCA Stock No. 12636 Adjusting Tool. Each of these capacitors has a lock nut for securing the plunger in place after adjustment. The remaining six adjustments are made by means of screws attached to

molded magnetite cores. These cores change the inductance of the particular coils in which they are inserted to provide exact alignment. All of these adjustments are accurately made during manufacture and should remain in proper alignment unless affected by abnormal conditions of climate or otherwise changed. Loss of sensitivity, improper tone quality, and poor selectivity are the usual indications of improper alignment. Such conditions will usually exist simultaneously. Correct performance of this receiver can only be obtained when these adjustments have been properly made with the use of adequate and reliable test equipment. The manufacturer of this receiver has such test equipment available for sale through its distributors and dealers.

This receiver requires a more or less involved method of alignment. However, if the following directions are carefully applied in the sequence given, normal performance of the instrument will be obtained.

In performing services on the oscillator, detector, and r-f circuits, the leads should be restored to their original positions, since the lead-dress is important for proper operation and dial calibration.

For alignment, the test-oscillator frequency should be quite accurate. A convenient and reliable means of accurately checking the frequency of test oscillators, receivers, etc., is the **RCA Stock No. 9572 Crystal Calibrator**.

Holes are provided in the top of the r-f and antenna coil cans to enable a tuning check with the **RCA Stock No. 6679 Tuning Wand**. The hole in the top of the detector coil can has a cinch button which must be removed before insertion of the tuning wand. When the brass end of the wand is inserted in the coil, the inductance of the coil is decreased. If this results in an increase of output, the respective air-trimmer capacitance should be decreased (plunger pulled out). If inserting the iron end of the tuning wand causes an increase in output, resulting from an increase of inductance of the coil, the respective air-trimmer capacitance should be increased (plunger pushed in). If the range of the air trimmer is not sufficient to give the desired results, the lead-dress may be changed in the particular circuit being aligned so as to cause the circuit to resonate within the range of the trimmer. An increase in the capacity-to-ground of the circuit will be required if the iron

end of the tuning wand causes an increase of signal output when the air-trimmer plunger is full-in, while a decrease in the capacity-to-ground will be required if the brass end of the tuning wand causes an increase in signal output when the air-trimmer plunger is full-out.

Two methods of alignment are applicable—one requires use of the cathode-ray oscillograph, and the other requires a voltmeter or glow-type output indicator. The cathode-ray alignment method is advantageous in that the indication provided is in the form of a wave-image which represents the resonance characteristics of the circuit being tuned. This method is preferred because of the i-f characteristics of this receiver. This type of alignment is possible through use of apparatus such as the **RCA Stock No. 9558 Frequency Modulator** and the **RCA Stock No. 9545 Cathode-Ray Oscillograph**. If this equipment is not available, an approximate alignment may be performed by the output-indicator method with an instrument such as the **RCA Stock No. 4317 Neon Glow Indicator** attached across the loudspeaker voice coil. Alignment by this method is similar to the cathode-ray method outlined below except that the receiver volume control should be at maximum, the trimmers adjusted to peak response (with the exception of the wave-trap) and the test-oscillator sweeping operations omitted. For all i-f adjustments, the "Ant" output of the test oscillator should then be connected to the grid cap (grid lead in place) of the RCA-6L7 first-detector tube, through a 0.001 mfd. capacitor. Either of these methods require the use of a reliable test oscillator such as the **RCA Stock No. 9595**.

Alignment Frequencies

| Band M. C. | Oscillator —K. C. | Osc., Det., Ant. —K. C. |
|------------|----------------------|----------------------------|
| 0.52-1.72 | 600 | 1,500 |
| 1.72-6.30 | — | 6,000 |
| 6.30-22 | — | 20,000 |

Intermediate Frequency—460 kc

Cathode-Ray Alignment

Make alignment apparatus connections shown in Figure 7. Remove the plug of the frequency-modulator cable from the test-oscillator jack. Connect the receiver chassis to a good external ground. Connect oscillograph "Vertical" input terminals as indicated on Figure 10. Set oscillograph power switch to "On" and adjust "Intensity" and "Focus" controls to give a clearly defined spot, or line, on the screen. Set oscillograph "Ampl. A" switch to "On," "Vertical gain" control full-clockwise, "Ampl. B" switch to "Timing," "Range" switch to No. 2 position, and "Timing" switch to "Int." Place the "Sync." control, "Freq." control, and "Horizontal gain" control to about their mid-positions. For each of the following adjustments, the test-oscillator output must be regulated so that the image obtained on the oscillograph screen will be of the minimum size for accurate observation. The receiver volume-control setting is optional. The beat-frequency oscillator must be turned off and the sensitivity set at maximum.

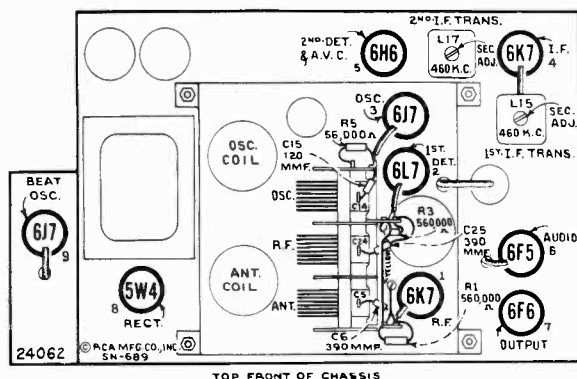

Figure 6—Radiotron and I-F Trimmer Locations

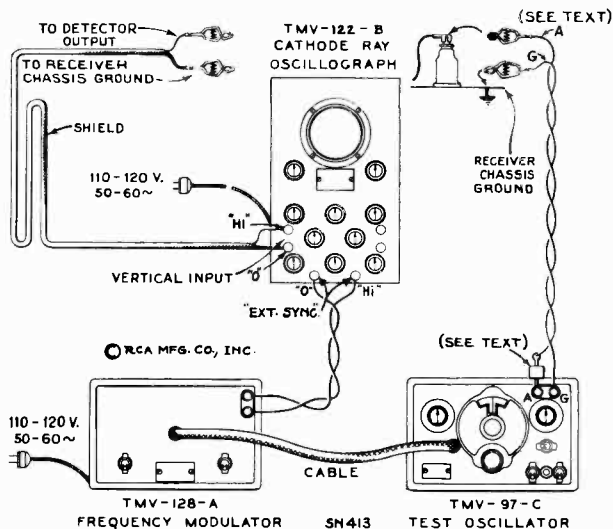

Figure 7—Alignment Apparatus Connections

I-F Adjustments

(a) Turn range selector to its "A" range position, and tune receiver to a position of no extraneous signals near 600 kc. Connect the "Ant." output of the test oscillator to the grid cap of RCA-6K7 i-f tube (with grid lead in place) through a .001 mfd. capacitor, with "Gnd." to receiver chassis. Tune the test oscillator to 460 kc and place its modulation switch to "On" and its output switch to "Hi."

(b) Turn on the receiver and test oscillator. Increase the output of the test oscillator until a deflection is noticeable on the oscillograph screen. The figures obtained represent several waves of the detected signal, the amplitude of which may be observed as an indication of output. Cause the wave-image formed (400-cycle waves) to be spread completely across the screen by adjusting the "Horizontal gain" control. The image should be synchronized and made to remain motionless by adjusting the "Sync." and "Freq." controls.

(c) Adjust the two magnetite-core screws L17 and L16 (see Figures 6 and 13) of the second i-f transformer to produce maximum vertical deflection of the oscillographic image. This adjustment places the transformer in exact resonance with the 460 kc signal.

(d) The sweeping operation should follow, using the frequency modulator. Shift the oscillograph "Timing" switch to "Ext." Insert plug of frequency-modulator cable in test-oscillator jack. Turn the test-oscillator modulation switch to "Off." Turn on the frequency modulator and place its sweep-range switch to "Hi."

(e) Increase the frequency of the test oscillator by slowly turning its tuning control until two separate, distinct, and similar waves appear on the screen. If only one wave appears, increase the "Freq." control on the oscillograph to obtain two waves. These waves will be identical in shape, totally disconnected, and appear in reversed positions. They will have a common base line, which is discontinuous. Adjust the

"Freq." and "Sync." controls of the oscillograph to make them remain motionless on the screen. Continue increasing the test-oscillator frequency until these forward and reverse curves move together and overlap, with their highest points exactly coincident. This condition will be obtained at a test-oscillator setting of approximately 575 kc.

(f) With the images established as in (e), re-adjust the two magnetite-core screws L17 and L16 on the second i-f transformer so that they cause the curves on the oscillograph screen to exactly coincide throughout their lengths and have maximum amplitude.

(g) Without altering the adjustments of the apparatus, shift the "Ant." output of the test oscillator to the input of the i-f system, i.e., to the RCA-6L7 first-detector grid cap, through a .001 mfd. capacitor (with grid lead in place). Regulate the test-oscillator output so that the amplitude of the oscillographic image is approximately the same as used for adjustment (f) above.

(h) The two first i-f transformer magnetite-core screws L15 and L14 (one on top and one on bottom) should then be adjusted so that they cause the forward and reverse curves to become coincident throughout their lengths and have maximum amplitude. The composite wave obtained in this manner represents the resonance characteristic of the total i-f system. Lack of symmetry or irregularity of the resultant image will indicate the presence of a defect in the i-f system.

R-F Adjustments

Make receiver dial adjustments as outlined by "Selector dial," Figure 14. Alignment must be made in sequence of "Wave-trap," "C" range, "B" range and "A" range.

"Wave-Trap" Adjustment

(a) Connect the "Ant." output of the test oscillator to the receiver antenna terminal "A" through a 200 mmfd. (important) capacitor. Remove the plug

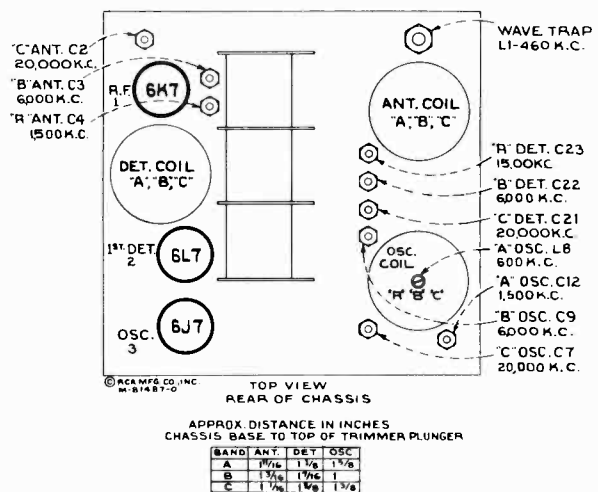

Figure 8—R-F Trimmer Locations

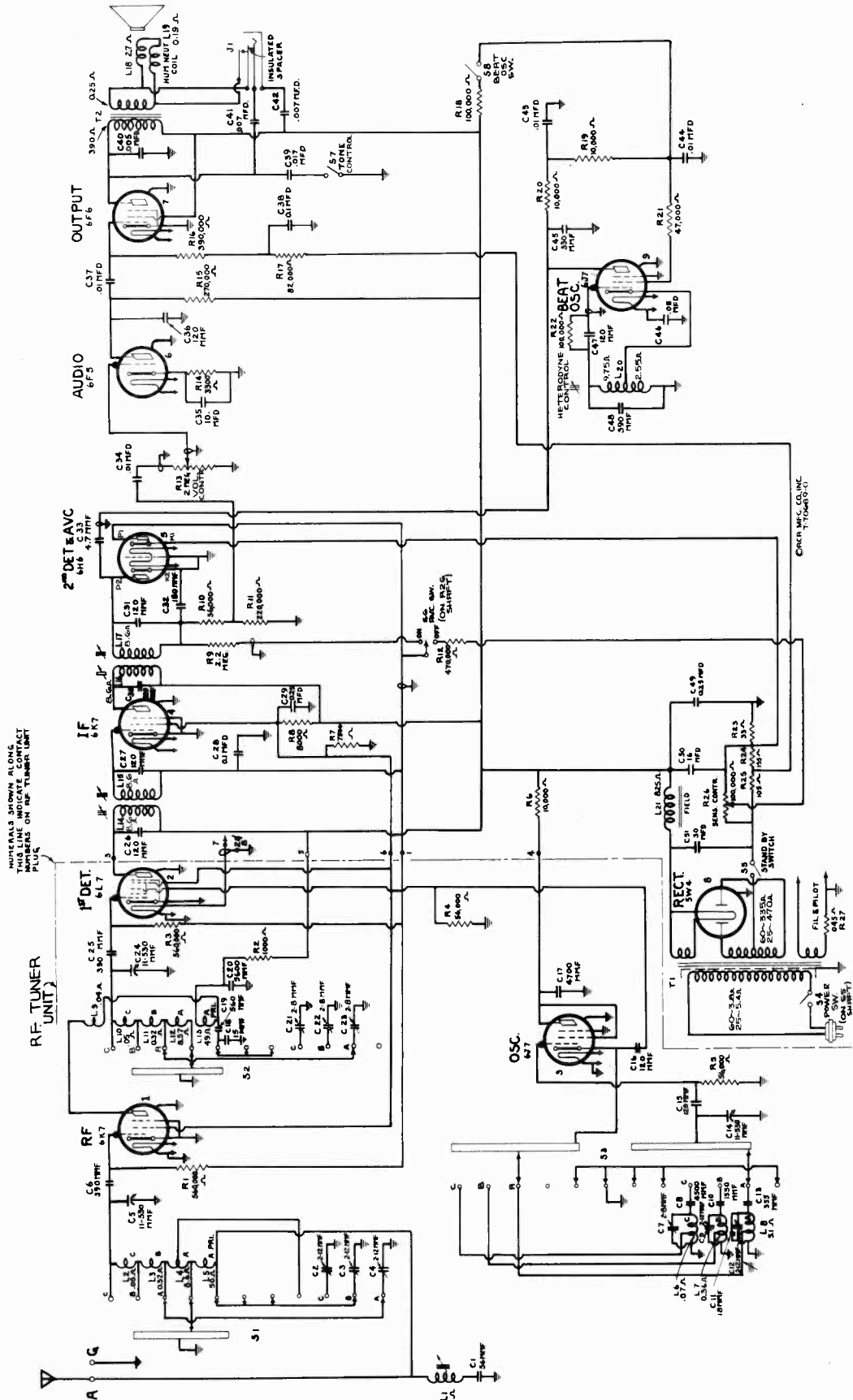

Figure 9—Schematic Diagram

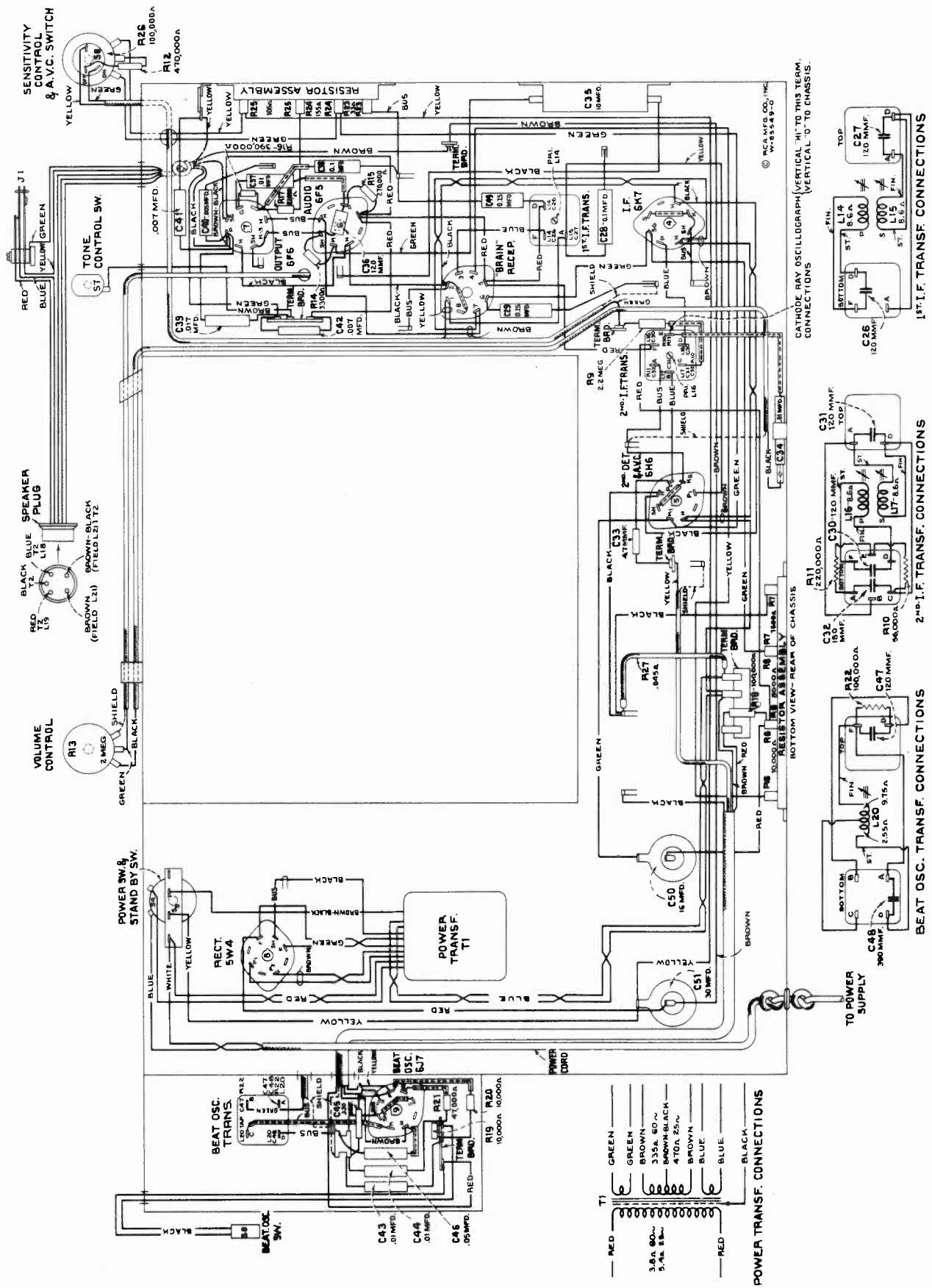
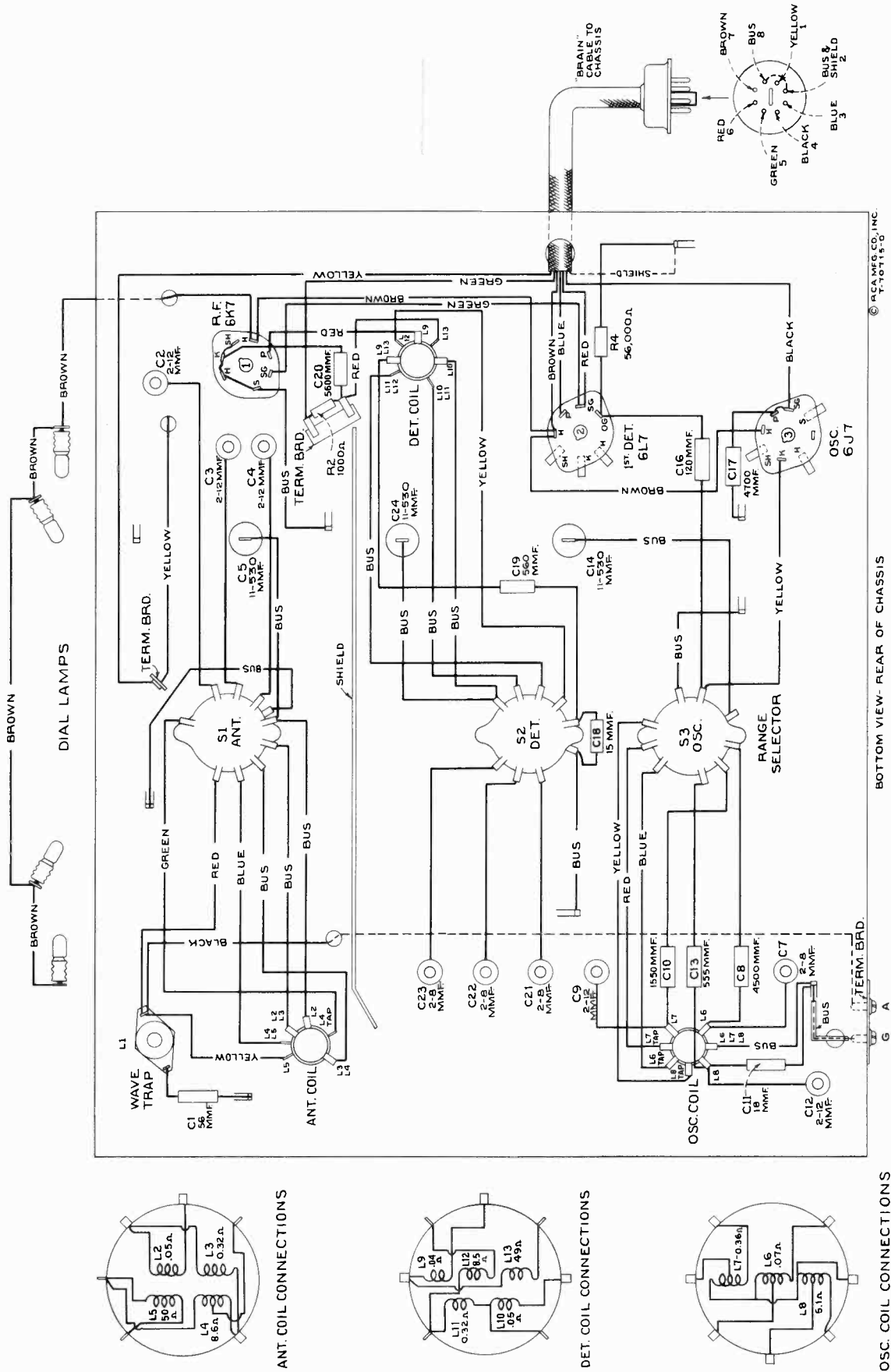

Figure 10—Wiring Diagram



© RCA MFG. CO. INC.
T-707115-0

BOTTOM VIEW- REAR OF CHASSIS

Figure 11—R-F Tuner Unit Wiring Diagram

OSC. COIL CONNECTIONS

of the frequency-modulator cable from the test-oscillator jack. Turn test-oscillator modulation switch to "On." Shift the oscillograph "Timing" switch to "Int." Place receiver range selector in its "A" range position. Set the receiver dial to a position of no extraneous signals near 600 kc. Tune the test oscillator to 460 kc. Adjust the wave-trap magnetite-core screw L1 to the point which causes minimum amplitude of output (maximum suppression of signal) as shown by the waves on the oscillograph. An increase of the test-oscillator output may be necessary before this point of minimum amplitude, obtained by correct adjustment of wave-trap screw, becomes apparent on oscillograph screen.

6.3 to 22 mc "C" Range

(b) Connect the "Ant." output of the test oscillator to the antenna terminal "A" of the receiver through a 300-ohm resistor. Set the receiver range selector to its "C" range position and its dial pointer to 20,000 kc. Adjust the test oscillator to 20,000 kc. Adjust oscillator air-trimmer C7 until maximum (peak) output is reached. Two peaks may be found with this circuit. The peak with minimum capacitance (plunger near out) should be used. Tighten lock nut. Adjust detector air-trimmer C21 until maximum (peak) output is reached, while

slightly rocking the gang tuning condenser back and forth through the signal. Two peaks may be found with this circuit. The peak with maximum capacitance (plunger near in) should be used. Tighten lock nut. Adjust antenna air-trimmer C2 until maximum (peak) output is reached while slightly rocking the gang tuning condenser back and forth through the signal. Two peaks may be found with this circuit. The peak with maximum capacitance (plunger near in) should be used. Tighten lock nut. Check the image frequency by changing the receiver dial setting to 19,080 kc. The image signal should be received at this position indicating that the adjustment of C7 has been correctly made. No adjustments should be made while checking for the image signal.

1.72 to 6.3 mc "B" Range

(c) Place receiver range selector to its "B" range position with its dial pointer set to 6,000 kc. Tune the test oscillator to 6,000 kc. Adjust oscillator air-trimmer C9 to produce maximum (peak) output as shown by the waves on the oscillograph. Two peaks may be found with this circuit. The peak with minimum capacitance (plunger near out) should be used. Tighten lock nut. Adjust the detector air-trimmer C22 for maximum (peak) output while slightly rocking the gang tuning condenser back and

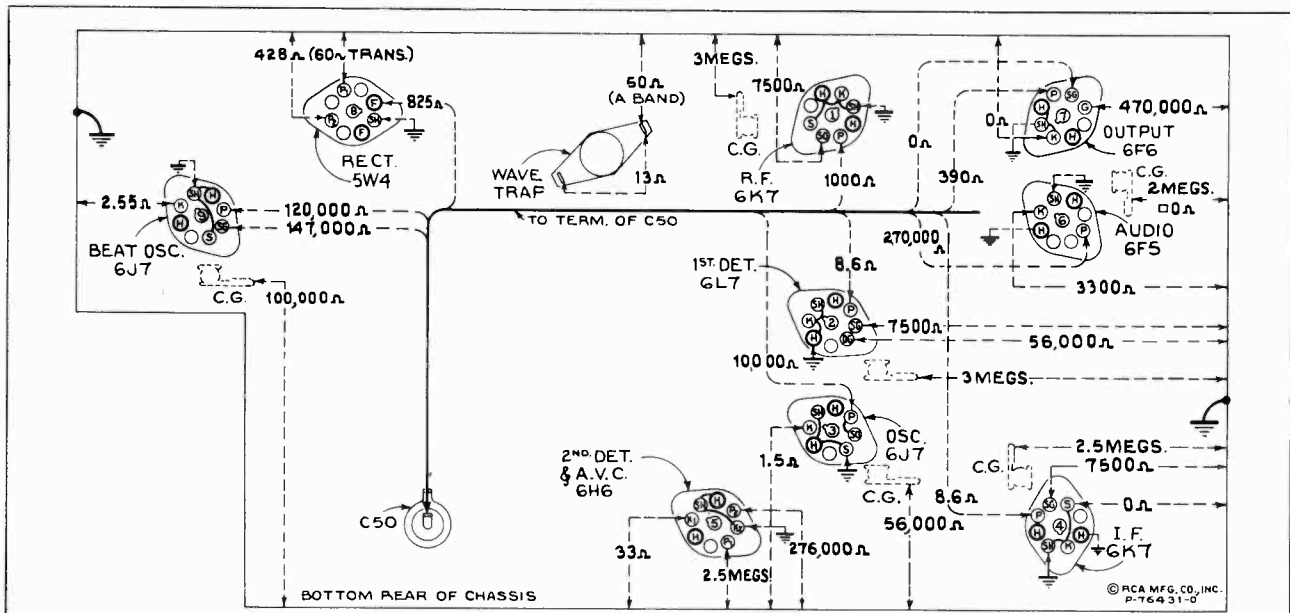

Figure 12—Resistance Diagram

Power supply disconnected at receptacle—"Power and Stand-by" switch in center position—Radiotrons in sockets—Tuning condenser in full-mesh—Range selector in "A" range position—Volume control maximum—Tone control optional—AVC switch "on"—Beat-oscillator switch "on"

The resistance values shown between Radiotron socket contacts, grid caps, resistors, and terminals to receiver chassis-ground or other pertinent point on Figure 12, permit a rapid continuity check of the circuits. The use of this diagram in conjunction with the Schematic Circuit Diagram, Figure 9, and Wiring Diagrams, Figures 10 and 11, will permit the location of certain troubles which might otherwise be difficult to ascertain. Each value as specified should hold within $\pm 20\%$. Variations in ex-

cess of this limit will usually be indicative of trouble in circuit under test. In all cases of measuring the resistance between points of the circuit and ground, it will be necessary to connect the negative terminal of the resistance meter to chassis-ground. If the polarity of the resistance meter is not known, it may be readily ascertained by connecting a d-c voltmeter of indicated polarity across the terminals of the device.

forth through the signal. Two peaks may be found with this circuit. The peak with maximum capacitance (plunger near in) should be used. Tighten lock nut. Adjust antenna air-trimmer C3 to produce maximum (peak) output. Tighten lock nut.

0.52 to 1.72 mc "A" Range

(d) Remove the 300-ohm resistor from between the test-oscillator "Ant." post and receiver antenna terminal "A" and insert a 200 mmfd. capacitor in its place. Place receiver range selector to its "A" range position with receiver dial pointer set to 600 kc. Tune the test oscillator to 600 kc. Adjust oscillator magnetite-core screw L8 (top of oscillator coil can) for maximum (peak) output as shown by the waves on the oscillograph screen.

(e) Set receiver dial pointer to 1,500 kc. Tune test oscillator to 1,500 kc (1,500-3,100 kc range) and increase its output to produce a registration on the oscillograph screen. Carefully adjust the oscillator, detector, and antenna air-trimmers C12, C23, and C4, respectively, to produce maximum (peak) output as shown by the waves on the oscillograph screen. Shift the oscillograph "Timing" switch to "Ext."

Place the frequency modulator sweep-range switch to its "Lo" position and insert plug of the frequency-modulator cable in test oscillator jack. Turn test-oscillator modulation switch to "Off." Re-tune the test oscillator (increase frequency) until the forward and reverse waves show on the oscillograph screen and coincide at their highest points. This will occur at a test-oscillator setting of approximately 1,680 kc. Adjust trimmers C12, C23, and C4 again, setting each to the point at which the images have maximum amplitude and coincide.

Radiotron Cathode Current Readings

Measured with Milliammeter Connected at Tube Socket Cathode Terminals under Conditions Similar to Those of Voltage Measurements

| | |
|------------------------------|----------|
| (1) RCA-6K7—R-F | 7.85 ma. |
| (2) RCA-6L7—1st Det. (Conv.) | 7.75 ma. |
| (3) RCA-6J7—Osc. | 5.0 ma. |
| (4) RCA-6K7—I.F. | 7.3 ma. |
| (5) RCA-6H6—2nd Det.—A.V.C. | — |
| (6) RCA-6F5—A.F. | 0.4 ma. |
| (7) RCA-6F6—Power | 42 ma. |
| (8) RCA-5Z4—Rect. | 92 ma.* |
| (9) RCA-6J7—Beat Osc. | 1.6 ma. |

(*Cannot be measured at socket.)

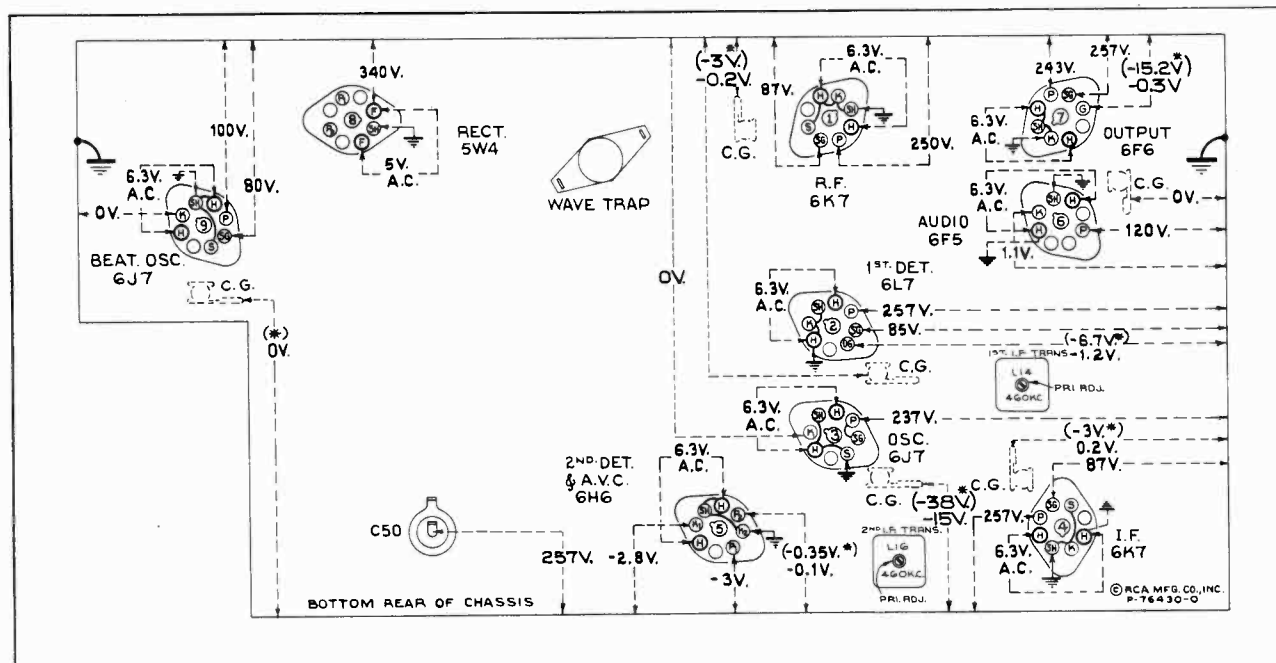

Figure 13—Radiotron Socket Voltages, Coil, and I-F Trimmer Locations

Measured at 115 volts, 60-cycle supply—"Power and Stand-by" switch in central position—Tuned to approximately 1,000 kc—No signal being received—Volume control minimum—Beat-oscillator "off"—Sensitivity control maximum (AVC off)—Tone control optional

Note: Two voltage values are shown for some readings. The higher value shown in parenthesis with asterisk (*) indicates operating conditions without voltmeter loading. The lower value is the actual measured voltage and differs from the higher value because of the additional loading of the voltmeter through the high series circuit resistance.

The voltage values indicated from the Radiotron socket contacts, grid caps, resistors, and terminals to receiver

chassis-ground on Figure 13 will assist in locating cause for faulty operation. Each value as specified should hold within $\pm 20\%$ when the receiver is normally operative at its rated line voltage. Variations in excess of this limit will usually be indicative of trouble in the basic circuits. To duplicate the conditions under which the voltages were measured requires a 1,000-ohm-per-volt d-c meter, having ranges of 10, 50, 250, 500, and 1,000 volts. Use the nearest range above the specified measured voltage. A-c voltages were measured with a corresponding a-c meter.

(f) Remove the plug of the frequency-modulator cable from the test-oscillator jack. Turn test-oscillator modulation switch to "On." Set oscillograph "Timing" switch to "Int." Tune test oscillator to 200 kc (200-400 kc range). Tune receiver for maximum response to this signal at a dial reading of approximately 600 kc. The third harmonic of the 200 kc signal is used for this adjustment. Shift oscillograph "Timing" switch to "Ext." Insert the plug of the frequency-modulator cable in test-oscillator jack. Turn test-oscillator modulation switch to "Off." Re-tune the test oscillator (increase frequency) until the forward and reverse waves show on the oscillograph screen. This will occur at a test-oscillator setting of approximately 230 kc. Disregarding the fact that the two images may or may not come together, adjust the oscillator magnetite-core screw L8 (top of oscillator coil can) to produce maximum (peak) amplitude of the images. Shift the oscillograph "Timing" switch to "Int." Remove the plug of the frequency-modulator cable from the test-oscillator jack. Turn the test-oscillator modulation switch to "On." Repeat adjustments in (e) above to compensate for any changes caused by the adjustment of L8 core, tightening lock nuts on C12, C23, and C4, respectively, after each is adjusted.

13. Selector Dial

Figure 14 illustrates the relation of the various parts of the dial mechanism when in its "A" position (0.52 to 1.72 mc) with the range switch likewise turned to the same range position. In re-assembling the dial after repairs, see that the gears are meshed in

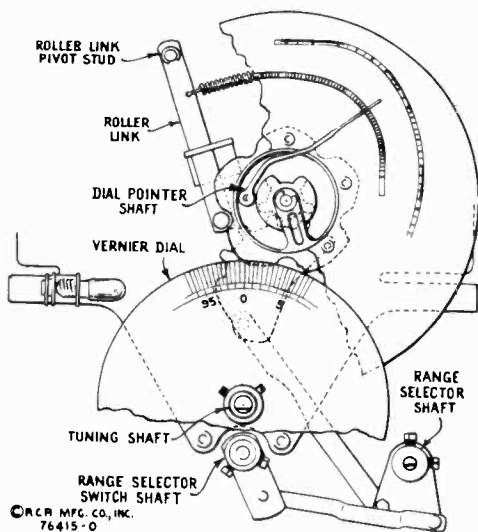

Figure 14—Selector Dial Change Mechanism

accordance with the diagram, at the same time noting that the range switch is in its "A" position and the lever attached to the range-switch shaft placed in the position shown.

To adjust the dial mechanism, set the range switch to its "A" position (0.52 to 1.72 mc). Place a straight-edge across the center of the dial so that its edge is even with the lower (end) marking at both the low-frequency and high-frequency ends of the dial. Under such conditions the straight-edge should be parallel with the top of the chassis base. If the straight-edge is not parallel with the top of the chassis base, loosen the nut on the rear of the roller link pivot stud and move the stud up or down until the link roller moves the dial to the desired position so that the end calibration marks obtain the position mentioned above. Tighten the nut on the roller link pivot stud.

Set the gang tuning condenser to its maximum capacity position. Adjust the dial pointer to the low-frequency (end) mark on the 0.52 to 1.72 "A" range scale. This is a friction adjustment.

With the gang tuning condenser plates still in full mesh, loosen the two set screws on the vernier-dial hub. Rotate the vernier dial until the "0" marking is in a vertical plane above the center of the shaft. Tighten set screws.

14. Loudspeaker

Centering of the loudspeaker voice coil is made with three narrow paper feelers after first removing the front paper dust cover. This may be removed

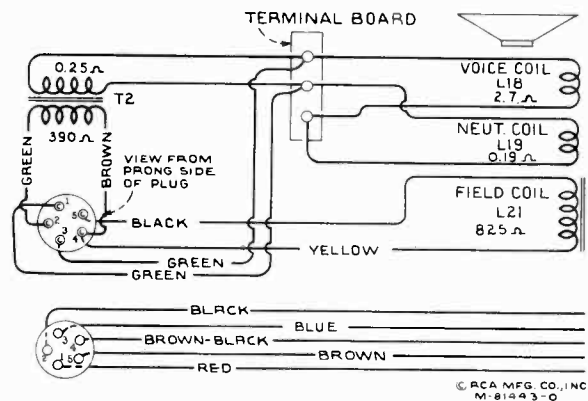

Figure 15—Loudspeaker Wiring

by softening its cement with a very light application of acetone using care not to allow the acetone to flow down into the air gap. The dust cover should be cemented back in place with ambroid upon completion of adjustment.

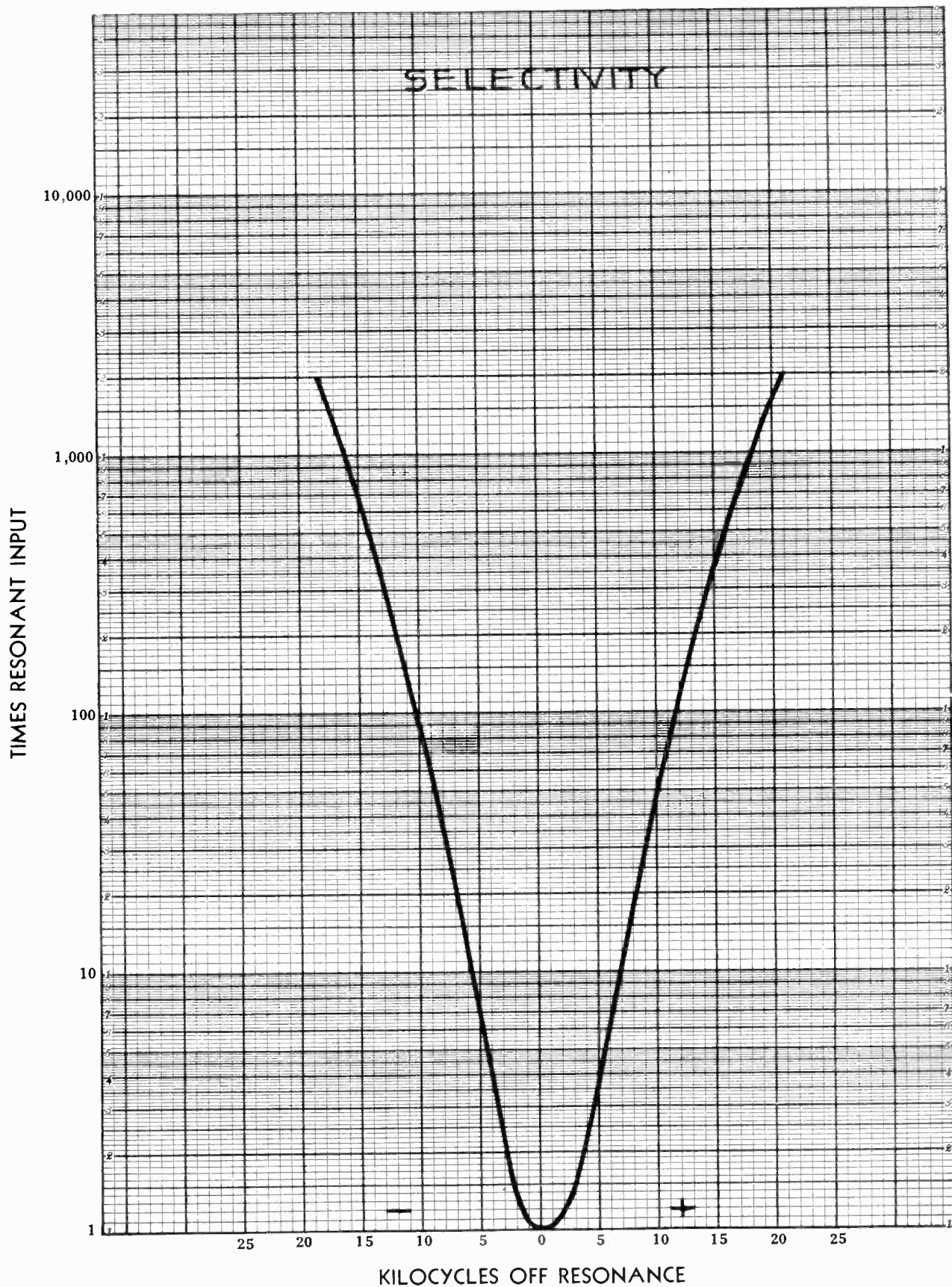

Figure 16—Selectivity Curve

REPLACEMENT PARTS

Insist on genuine factory tested parts, which are readily identified and may be purchased from authorized dealers

| Stock No. | DESCRIPTION | Stock No. | DESCRIPTION |
|----------------------------|---|-----------|--|
| RECEIVER ASSEMBLIES | | | |
| 4427 | Bracket—Volume control, tone control or sensitivity control mounting bracket | 11453 | Resistor—270,000 ohms, carbon type, 1/10 watt—Package of 5 (R15) |
| 13890 | Cable—2-conductor shielded sensitivity control cable, approximately 13¼ inches long | 13005 | Resistor, 390,000 ohms, carbon type, 1/10 watt—Package of 5 (R16) |
| 13891 | Cable—4-conductor shielded beat oscillator power supply and input cable, approximately 18½ inches long | 12285 | Resistor—470,000 ohms, insulated, ¼ watt—Package of 5 (R12) |
| 12511 | Cap—Grid contact cap—Package of 5 | 12412 | Resistor—2.2 megohms, insulated, ¼ watt—Package of 5 (R9) |
| 13888 | Capacitor—4.7 Mmfd. (C33) | 13882 | Resistor—Voltage divider, comprising one 10,000-ohm, one 8,000-ohm and one 7,500-ohm sections (R6, R7, R8) |
| 12724 | Capacitor—120 Mmfd. (C36) | 13883 | Resistor—Voltage divider, comprising one 33-ohm, one 155-ohm and one 105-ohm sections (R23, R24, R25) |
| 12404 | Capacitor—120 Mmfd. (C26, C27, C30, C31, C47) | 4669 | Screw—No. 8-32 x 5/32 set screw for link, Stock No. 12858—Package of 10 |
| 12406 | Capacitor—180 Mmfd. (C32) | 3903 | Screw—No. 8-32 x 3/16 headless set screw for dial, Stock No. 12870—Package of 20 |
| 12952 | Capacitor—330 Mmfd. (C45) | 13885 | Screw—No. 8-32 x 5/8 headless set screw for beat oscillator coil shaft, Stock No. 12105—Package of 10 |
| 13301 | Capacitor—390 Mmfd. (C48) | 13881 | Sensitivity control and A.V.C. switch (R26, S6) |
| 5148 | Capacitor—.007 Mfd. (C42) | 12105 | Shaft—Extension shaft for beat oscillator coil adjustment |
| 13033 | Capacitor—.007 Mfd. (C41) | 13884 | Shaft—Range selector knob shaft and hub |
| 4838 | Capacitor—.005 Mfd. (C40) | 13300 | Shield—Coil shield for Stock No. 12084 |
| 4624 | Capacitor—.01 Mfd. (C34) | 12607 | Shield—First I. F. transformer shield top |
| 4858 | Capacitor—.01 Mfd. (C37, C43, C44) | 12008 | Shield—I. F. transformer shield for Stock Nos. 12652 and 12653 |
| 11451 | Capacitor—.017 Mfd. (C39) | 12581 | Shield—Second I. F. transformer shield top |
| 4836 | Capacitor—.05 Mfd. (C46) | 11195 | Socket—5-contact 5W4 Radiotron socket |
| 4841 | Capacitor—.01 Mfd. (C28, C38) | 11198 | Socket—7-contact 6F5, 6J7, 6K7 or 6H6 Radiotron socket |
| 4840 | Capacitor—0.25 Mfd. (C29) | 11196 | Socket—8-contact 6F6 Radiotron or R. F. unit power socket |
| 5170 | Capacitor—0.25 Mfd. (C49) | 11222 | Socket—Upper right or lower left-hand dial lamp socket (facing front of receiver) |
| 12682 | Capacitor—10 Mfd. (C35) | 13095 | Socket—Upper left or lower right-hand dial lamp socket (facing front of receiver) |
| 5212 | Capacitor—16 Mfd. (C50) | 12007 | Spring—Retaining spring for core, Stock No. 12006—Package of 10 |
| 12467 | Capacitor—30 Mfd. (C51) | 12106 | Spring—Retaining spring for shaft, Stock No. 12105—Package of 5 |
| 12084 | Coil—Beat oscillator coil and shield (L20, C47, C48, R22) | 12986 | Stud—Stud, nut and lockwasher for assembling range switch link to band dial link—Package of 5 |
| 12493 | Connector—5-contact female connector for speaker cable | 13879 | Switch—Stand-by and power switch (S4, S5) |
| 12006 | Core—Adjustable core and stud for Stock Nos. 12652 and 12653 | 13886 | Switch—S.P.S.T. beat oscillator switch (S8) |
| 12085 | Core—Adjustable core and stud assembly for beat oscillator coil, comprising one core, one stud, one spacer, one spring and one washer | 13880 | Tone control (S7) |
| 12870 | Dial—Vernier (or band spreader) dial scale and disc assembly | 12652 | Transformer—First I. F. transformer (L14, L15, C26, C27) |
| 12866 | Foot—Chassis mounting bracket and foot assembly—Package of 2 | 12653 | Transformer—Second I. F. transformer (L16, L17, C30, C31, C32, R10, R11) |
| 13889 | Jack—Phone jack (J1) | 11211 | Transformer—Power transformer, 100-120 volts, 50-60 cycles (T1) |
| 5226 | Lamp—Dial lamp—Package of 5 | 11212 | Transformer—Power transformer, 100-120 volts, 25-50 cycles (T1) |
| 12868 | Link—Range switch and band indicator operating hub and link assembly, complete with set screws—connects range selector knob shaft to range switch | 11213 | Transformer—Power transformer, 100-250 volts, 50-60 cycles (T1) |
| 13887 | Resistor—.045 ohms, flexible type—Package of 5 (R27) | 12087 | Volume control (R13) |
| 13031 | Resistor—3,300 ohms, carbon type, 1/10 watt—Package of 5 (R14) | | |
| 13302 | Resistor—10,000 ohms, carbon type, 1/10 watt—Package of 5 (R19, R20) | | |
| 5132 | Resistor—47,000 ohms, carbon type, 1/10 watt—Package of 5 (R21) | | |
| 11282 | Resistor—56,000 ohms, carbon type, 1/10 watt—Package of 5 (R10) | | |
| 11365 | Resistor—82,000 ohms, carbon type, ¼ watt—Package of 5 (R17) | | |
| 11281 | Resistor—100,000 ohms, carbon type, 1/10 watt—Package of 5 (R22) | | |
| 5145 | Resistor—100,000 ohms, carbon type, ¼ watt—Package of 5 (R18) | | |
| 11398 | Resistor—220,000 ohms, carbon type, 1/10 watt—Package of 5 (R11) | | |

REPLACEMENT PARTS (Continued)

| Stock No. | DESCRIPTION | Stock No. | DESCRIPTION |
|-----------|---|-----------|---|
| | MAGIC BRAIN UNIT ASSEMBLIES | | |
| 13216 | Board—Antenna and ground terminal board | 13898 | Drive—Variable tuning condenser drive complete, including mounting bracket, planetary drive, band dial scale and indicator—less vernier dial, Stock No. 12870 and link, Stock No. 12868 |
| 5237 | Bushing—Variable tuning condenser mounting bushing assembly—Package of 3 | 12906 | Gear—Anti-lash drive gear, complete |
| 13656 | Button—Plug button for Stock No. 13654 | 12910 | Gear—Sector gear and link assembly for band selector |
| 12886 | Cable—Shielded power cable, approximately 4 inches long, complete with 8-contact male connector | 12908 | Indicator—Station selector indicator pointer |
| 12511 | Cap—Grid contact cap—Package of 5 | 8051 | Link—Link and roller assembly, complete with spring |
| 12884 | Capacitor—Adjustable trimmer (C12) | 12911 | Screen—Dial lamp screen and light diffuser |
| 12714 | Capacitor—Adjustable trimmer (C2, C3, C4, C7, C9, C23) | 4669 | Screw—Set screw for indicator shaft, Stock No. 13900, and gear, Stock No. 12906—Package of 10 |
| 12807 | Capacitor—Adjustable trimmer (C21, C22) | 13896 | Shaft—Direct drive shaft and pinion gear for planetary drive |
| 12896 | Capacitor—15 Mmfd. (C18) | 13900 | Shaft—Indicator shaft |
| 12722 | Capacitor—18 Mmfd. (C11) | 16713 | Shaft—Vernier drive shaft for planetary drive |
| 12723 | Capacitor—56 Mmfd. (C1) | 13897 | Spring—Tension spring for drive shaft, Stock No. 13896—Package of 10 |
| 12724 | Capacitor—120 Mmfd. (C15, C16) | 12903 | Spring—Tension spring for planetary drive bearing—Package of 10 |
| 13894 | Capacitor—390 Mmfd. (C6, C25) | 12907 | Spring—Tension spring for gear, Stock No. 12906—Package of 10 |
| 12727 | Capacitor—555 Mmfd. (C13) | 8052 | Spring—Tension spring for link, Stock No. 8051—Package of 5 |
| 12537 | Capacitor—560 Mmfd. (C19) | | REPRODUCER ASSEMBLIES |
| 12729 | Capacitor—1,550 Mmfd. (C10) | 13901 | Coil—Reproducer field coil (L21) |
| 12728 | Capacitor—4,500 Mmfd. (C8) | 13902 | Cone—Reproducer cone and dust cap (L18) |
| 12897 | Capacitor—4,700 Mmfd. (C17) | 12567 | Connector—5-contact male connector for reproducer |
| 13895 | Capacitor—5,600 Mmfd. (C20) | 9779 | Reproducer—Complete |
| 12708 | Coil—Antenna coil and shield (L2, L3, L4, L5) | 13903 | Transformer—Output transformer (T2) |
| 13654 | Coil—Detector coil and shield (L9, L10, L11, L12, L13) | | MISCELLANEOUS ASSEMBLIES |
| 12709 | Coil—Oscillator coil and shield (L6, L7, L8) | 13905 | Escutcheon—Station selector escutcheon and crystal assembly |
| 13892 | Condenser—3-gang variable tuning condenser (C5, C14, C24) | 13914 | Foot—Rubber foot assembly for cabinet—Package of 4 |
| 12887 | Connector—8-contact male connector and cover for power cable, Stock No. 12886 | 13908 | Knob—Heterodyne control knob—Package of 5 |
| 12664 | Core—Adjustable core and stud for Stock No. 12654 | 13909 | Knob—Station selector knob |
| 12800 | Core—Adjustable core and stud for Stock No. 12709 | 13907 | Knob—Power stand-by, volume control, range selector, tone control or sensitivity switch knob—Package of 5 |
| 13893 | Range switch (S1, S2, S3) | 13911 | Plate—Beat oscillator, heterodyne control, power stand-by and volume control knob marker plates |
| 5112 | Resistor—1,000 ohms, carbon type, ¼ watt—Package of 5 (R2) | 13912 | Plate—Range selector, tone control, sensitivity switch and head phone marker plate |
| 11282 | Resistor—56,000 ohms, carbon type, 1/10 watt—Package of 5 (R4, R5) | 13913 | Plate—RCA monogram plate |
| 11397 | Resistor—560,000 ohms, carbon type, 1/10 watt—Package of 5 (R1, R3) | 13906 | Screen—Screen and grille cloth for front panel grilles |
| 12710 | Shield—Coil shield for Stock No. 12709 | 12125 | Screw—No. 8-32 x 5/16-inch set screw for knob, Stock No. 13908—Package of 10 |
| 12799 | Shield—Coil shield for Stock Nos. 12708 and 13654 | 13910 | Screw—No. 8-32 x 1/2-inch set screw for knob, Stock No. 13909—Package of 10 |
| 11198 | Socket—7-contact 6K7 Radiotron socket | 11349 | Spring—Retaining spring for knob, Stock No. 13907—Package of 5 |
| 11279 | Socket—7-contact 6L7 Radiotron socket | | |
| 12885 | Socket—8-contact 6J7 Radiotron socket | | |
| 12007 | Spring—Retaining spring for core, Stock No. 12664—Package of 10 | | |
| 12654 | Trap—Wave-trap complete (L1) | | |
| | DRIVE ASSEMBLIES | | |
| 10705 | Ball—5/32-inch diameter steel ball for planetary drive—Package of 20 | | |
| 10941 | Ball—1/8-inch diameter steel ball for planetary drive bearing—Package of 20 | | |
| 12904 | Bushing—Plate and bushing assembly for planetary drive mounting | | |
| 13899 | Dial—Band indicating dial and cam assembly | | |



RCA Victor

RECEIVER ALIGNMENT

Supplementing

TECHNICAL INFORMATION AND SERVICE DATA

-1937 No. 26-

SERVICE DIVISION • RCA MANUFACTURING COMPANY, INC. • CAMDEN, N. J., U. S. A.

A Service of the Radio Corporation of America

INTRODUCTION

For convenience and brevity, RCA Victor Alignment Procedure is being presented in tabular form as a part of the Technical Information and Service Data supplied for each radio receiver. It is essential that these instructions be rigidly adhered to and all adjustments made in the order listed. The brief instructions which precede the tabulated Alignment Procedure are supplemented in the following general discussion.

Part 1—Superheterodyne—I-F Alignment.

Every superheterodyne receiver uses an intermediate-frequency (*i-f*) amplifier having characteristics which largely govern the selectivity of the receiver. The *i-f* amplifier characteristics are determined principally by the design and adjustment of the *i-f* transformers. It is, therefore, necessary that the *i-f* amplifier be correctly adjusted to provide a symmetrical selectivity curve. These adjustments may be in the form of movable magnetite cores placed within the coils or adjustable trimmers connected across the coils. During alignment, it is necessary only to adjust these magnetite cores or trimmers, as specified in Technical Information and Service Data, to obtain the best operation.

In some receivers, a quartz-crystal filter is included as part of the *i-f* amplifier system. In such designs, the crystal provides far greater selectivity than is otherwise available. During alignment of such an *i-f* amplifier, the most important point is to align the *i-f* amplifier transformers to exactly the natural periodic frequency of the crystal.

Some receivers use a double *i-f* amplifier. This consists of two *i-f* channels whose inputs are in parallel. One channel (usually the more selective of the two) amplifies the signal and feeds into the second detector. The other channel feeds the *a-v-c* tube. It is important that both channels be aligned to exactly the same frequency. The output indicator or Cathode Ray Oscillograph, as the case may be, must be connected to the channel under alignment.

Parts 19 and 20 below describe the use of RCA Stock No. 9595 Test Oscillator (TMV-97-C) and RCA Stock No. 9558 Frequency Modulator (TMV-128-A) and tell how to find the correct Test Oscillator dial setting with Frequency Modulator plugged in, for any specified alignment frequency. This calibration, when made on an *i-f* amplifier, should always be made on one that does not have a flat-topped or double-peaked characteristic. Once this calibration is found, the test equipment will produce accurate results when used to align either flat-topped or double-peaked *i-f* amplifiers.

Some receivers employ automatic-frequency-control (*a-f-c*) circuits. Such receivers require very accurate alignment of these circuits before the *a-f-c* "pull-in" action will be correct and equal on both sides of the signal being received. The Technical Information and Service Data covering such receivers gives detailed procedure for making these adjustments.

Part 2—R-F Alignment. Image Response.

Every superheterodyne receiver incorporates a local oscillator, the output of which mixes with the incoming signal from the antenna. The local oscillator does not operate at the same frequency as the incoming signal which is to be received. The acceptance (resonant) frequency of the *i-f* amplifier establishes the difference frequency required; 175 kc and 460 kc are commonly used. In most RCA Victor receivers the local oscillator operates at a frequency higher than the incoming signal frequency. However, on certain bands of some receivers, the oscillator operates at a frequency lower than the incoming signal frequency. When the local oscillator output mixes with the incoming signal, the two predominating resultant frequencies produced are the *sum* and the *difference* of the two frequencies. Most superheterodyne receivers are designed in such a way that the *difference* frequency is the same as the *i-f* amplifier resonant frequency. Modulation of the incoming signal will be present as modulation of input to the *i-f* amplifier.

Figure 1 shows the frequency-range chart for the RCA Victor Model 5T5 receiver. The intermediate frequency is 460 kc. The A band range is 530 kc to 1,900 kc. The C band range is 5,800 kc to 21,600 kc. The design is such that the local oscillator in the receiver operates at a frequency higher than the incoming signal frequency. Let us consider the case of an incoming signal at a frequency of 10,000 kc with the receiver tuned to this frequency. The local oscillator is now operating at 10,460 kc to produce a difference frequency of 460 kc, which is the resonant frequency of the *i-f* amplifier. An unwanted signal at 10,920 kc will also be accepted by the *i-f* amplifier since this particular frequency also differs from the frequency of the local oscillator by 460 kc. Thus, it is possible to receive two signals of different frequencies at the same dial setting. Likewise, if the radio receiver is tuned to a frequency of 9,080 kc, the local oscillator will produce a 460 kc beat with the original wanted signal which was at 10,000 kc. Therefore, it is possible to receive a given signal at two different settings of the receiver dial. This unwanted signal is known as the image, and in all superheterodyne receivers exists at a frequency which differs from the wanted signal frequency by twice the intermediate frequency. Image response depends upon many things in-

Copyright, 1937, RCA Manufacturing Co., Inc.

FREQUENCY RANGE CHART FOR RCA VICTOR 5T5 RECEIVER

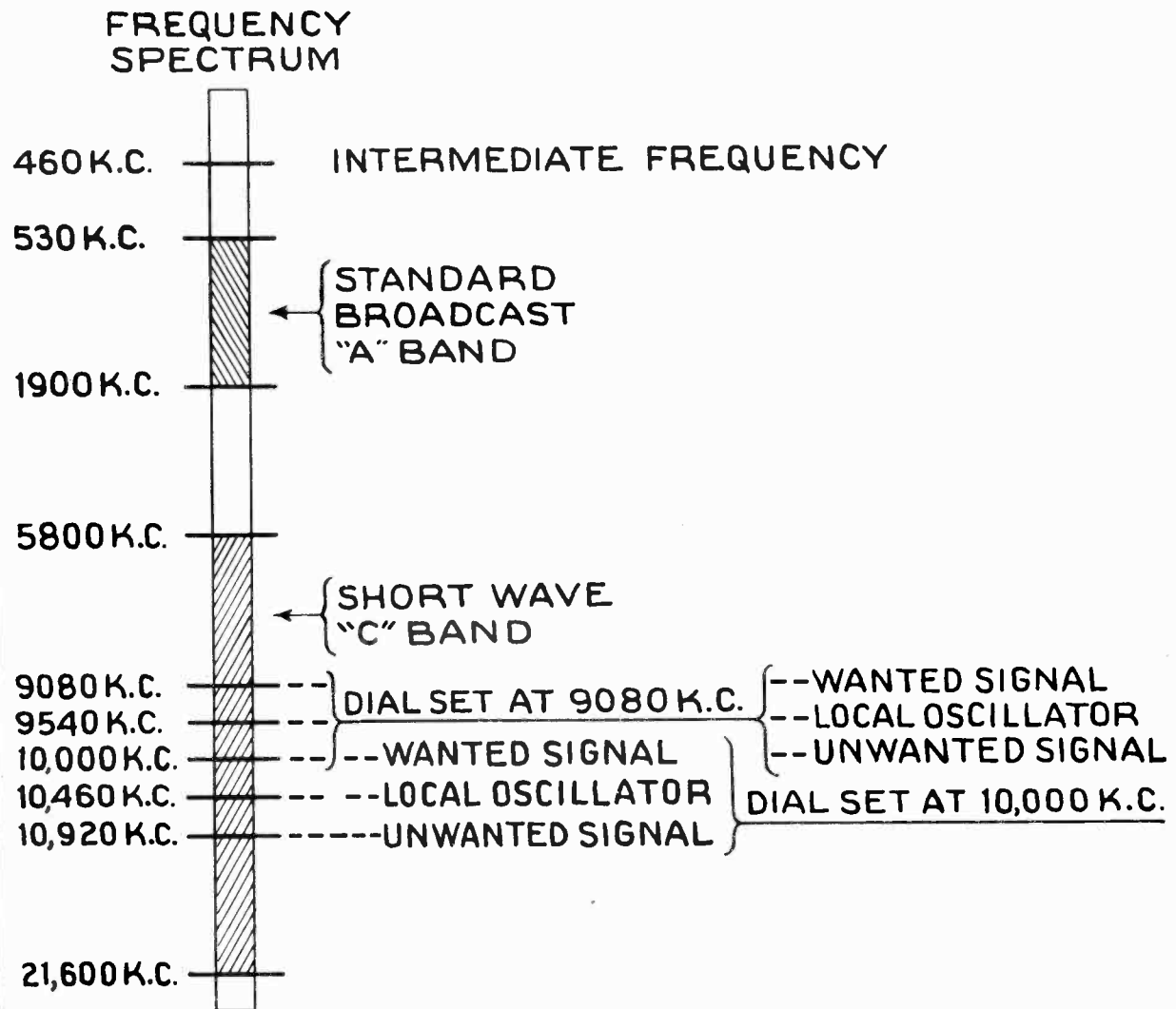

Figure 1

herent in the receiver design such as number of tuned circuits, degree of coupling, shielding, etc.

When aligning the short-wave band of a receiver, the oscillator trimmer usually has sufficient range so the local oscillator can be tuned over rather wide limits. It is thus often possible to tune the local oscillator to either a higher or lower frequency than the incoming signal. The receiver

alignment information contained in Technical Information and Service Data specifies which of these settings to use. It is important that the correct oscillator-trimmer setting be employed; otherwise the receiver sensitivity will be below normal over some portions of that particular band since the tuned circuits will not track.

Some receivers employ "band-spread" circuits as an aid to

short-wave reception. Such circuits spread short-wave stations further apart on the dial than is usual for the standard-broadcast band. Because of this fact, a slight error in dial calibration will be very noticeable and may result in a portion of the short-wave broadcast band not falling within the tuning range of the receiver. Alignment of such short-wave bands requires greater accuracy of calibration than can usually be obtained with test equipment now in general use for radio service work. Sufficient accuracy for alignment of such bands requires special alignment procedure which is covered in detail in Technical Information and Service Data for these receivers. Where reception conditions permit, it is satisfactory to tune in a short-wave station of known frequency falling within the frequency range of the particular band under alignment, and then make alignment adjustments to that particular band until the receiver has maximum sensitivity and correct dial calibration.

Part 3—Usual Effects of Misalignment of R-F or I-F Stages.

The most commonly observed effects of misaligned r-f or i-f stages are loss of sensitivity; either over the entire receiver range, or on certain bands, or a portion of certain bands; loss of selectivity, often characterized by the selectivity being noticeably unequal on the two sides of the point of best reception; inaccurate dial readings; and change in fidelity of the receiver. Loss of fidelity will be apparent as change of audio-characteristic balance with either high- or low-audio frequencies being reduced. If the i-f amplifier is not tuned to the specified frequency, the oscillator and other tuned circuits will not track. The dial readings will then be incorrect and portions of all bands will have low sensitivity. Misaligned i-f amplifiers in receivers using a-f-c circuits will usually result in incorrect or unequal "pull-in" action.

Part 4—Preliminaries to Alignment.

Before the various aligning adjustments are made, the radio receiver should be functioning normally in all other respects. Trouble-shooting, if necessary, should precede the final alignment.

The dressing of leads, as specified in Technical Information and Service Data, is very important and should always be checked since the capacity from certain leads to ground is often a part of the tuned circuits and will change as the leads are moved closer to, or further away from, other leads or the chassis.

Receiving signals at the correct setting of the dial scale depends upon having the proper relation between tuning condenser setting and dial scale. There will usually be a mark at the low-frequency end of the scale for pointer setting with the condenser fully meshed. The adjustment is made by rotating the pointer to the desired position with the shaft stationary, or in some cases by moving the scale, shifting a stationary index, or other relative change. Reference to Technical Information and Service Data for the receiver will give more specific information. It is important that this be checked before alignment of the separate bands. Pointer or dial setting is necessary because the scales are not linear with frequency and all scales are pre-calibrated for maximum accuracy.

Part 5—Connection of Test Oscillator to Radio Receiver. Use of Dummy Antenna.

The radio receiver ground terminal should usually be connected to the "0" or "Gnd." terminal of the Test Oscillator and preferably also connected to an external ground. Some ac-dc receivers require different connections as described in Part 14 below. The "Ant." or "High" terminal of the Test Oscillator output must be connected to the antenna post or other points in the radio receiver as specified in Alignment Procedure. The use of a fixed condenser, or resistor, in series with this Test Oscillator lead, is specified in some instances. Such a condenser or resistor, known as a "Dummy Antenna," provides the proper input loading to the receiver. The condenser or resistor, as the case may be, should be connected at the point where the Test Oscillator lead joins the radio set, and should not be connected at the Test

Oscillator. Grid caps should be left connected to the tubes to provide d-c bias unless otherwise specified. In any case that requires removal of the grid cap, the "Dummy Antenna" will consist of a resistor. Shielded leads should be used; RCA Stock No. 9797 Cable Assembly is a convenient set of such leads for all these connections.

When the Test Oscillator is connected to the grid circuit of the first-detector tube (usually for alignment of the first i-f transformer) it is often necessary to set the receiver range switch to the "A band" (standard broadcast) position in order to get sufficient signal from the Test Oscillator into the i-f amplifier to permit proper alignment.

RCA Test Oscillators have rather low-impedance output circuits. When using some other types of Oscillators, which have high-impedance output circuits, to align high-gain i-f amplifiers, there is a possibility of i-f regeneration. If such is the case, the resonance curve will be unusually narrow in width and high in amplitude. This condition can be eliminated by shunting a 200-ohm resistor directly across the Oscillator output terminals. If the Oscillator output controls are calibrated in terms of voltage output, this resistor will, of course, change the calibration.

Part 6—Connections of Output Meter to Radio Receiver.

The RCA Stock No. 4317 (TMV-121-A) Neon Output Indicator or any one of many different types of Output Meters can be employed during alignment. Such indicators, or meters, should be connected across either the primary or secondary of the output transformer. It is best to leave the loudspeaker voice coil connected to the radio receiver when using an Output Meter. In general, the RCA Output Indicator gives best results when connected across the voice coil of the loudspeaker, although on some types of receivers it will give satisfactory results when connected to the primary of the output transformer.

Part 7—Connections of Cathode Ray Oscillograph to Different Types of Second-Detector Circuits.

Figures 2, 3, and 4 show, in simplified form, the three most commonly used second-detector circuits. Figure 2 shows a diode-detector circuit. Figure 3 shows a power detector resistance-capacitance coupled to the audio amplifier. Figure 4 shows a power detector using impedance-capacitance or transformer coupling to the audio amplifier. For simplicity, only the essential elements in these circuits are shown. On

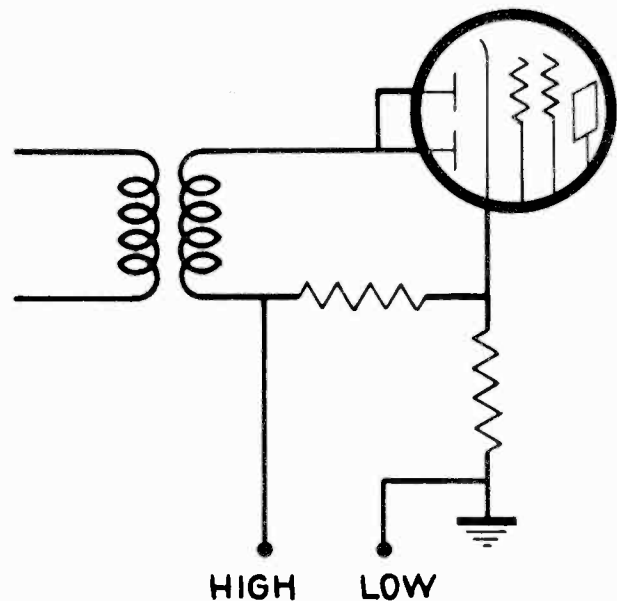

Figure 2

RECEIVER ALIGNMENT

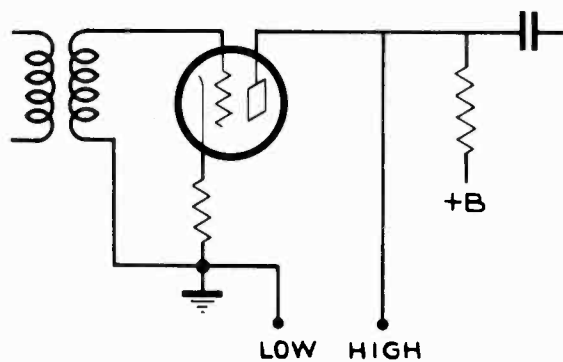
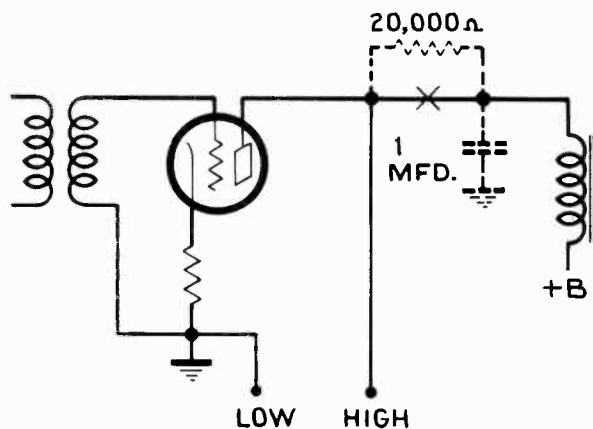

Figure 3



Open plate circuit at point marked "X". Connect resistor and condenser as shown by dotted lines

Figure 4

each of the three diagrams, points of connection are indicated by "Low" and "High." The "Low" point should be connected to the "0" or "Gnd" Cathode Ray Oscillograph terminal; the "High" point should be connected to the vertical "High" terminal. Most of the Service Notes on radio receivers, released by RCA Manufacturing Company since 1934, have had connections for Cathode Ray Oscillographs marked on the circuit diagrams. On many of these receivers the point of connection is conveniently located on the Phonograph Terminal Board. Some a-c-dc receivers require different connections as described in Part 14 below.

Part 8—Aligning the Tuned Circuits.

Tuning adjustment with trimmers or adjustable magnetite cores is accomplished while applying a modulated signal, of the specified frequency, to the input of the stage being adjusted. Either Oscillograph or Output Meter indication, of the amplitude of audio-frequency output, of the radio receiver, shows when tuning is correct. In some cases, the Oscillograph also shows the selectivity characteristic. The various tuned circuits are aligned by adjusting each in this manner. During all alignment adjustments, the output of the Test Oscillator must be kept as low as possible to prevent a-v-c action from taking place and making all adjustments seem very broad.

The tool used for tuning must have a minimum of metal so it will cause little or no tuning reaction. If removing the tool, after making an adjustment, reduces the output appreciably, a slight compensating mistuning will correct the error and produce maximum output when the tool is removed. Sometimes fine adjustments of mica compression trimmers can be made easily by tapping the trimmer screw with a wooden rod.

Part 9—Rocking Adjustments in Alignment.

Provision is usually made in the oscillator circuits of super-heterodynes for a tracking adjustment at the low-frequency end of X and A bands. This consists of a variable oscillator-trimming condenser or magnetite core. Tuning frequencies specified in the Alignment Procedure Table for making these adjustments should be followed carefully because the design of the tuned circuits is such that only this procedure will produce correct dial calibration. For maximum sensitivity at the low-frequency end of the band, this should be a rocking adjustment. To make a rocking adjustment, change the setting of the specified oscillator trimmer slightly, then tune the gang condenser for maximum output regardless of dial setting, and note the exact reading of the output indicator. Next, repeat this procedure and note if the output reading so obtained is greater, or less, than the first one. If the second reading is greater than the first, continue this process while changing the oscillator-trimmer adjustment in the same direction until the highest possible output reading is obtained. If the second reading is less than the first, continue this process while changing the oscillator-trimmer adjustment in the opposite direction until the highest possible output reading is obtained.

When using a frequency-sweeping device and Cathode Ray Oscillograph connected to show the resonance curve of the circuit being aligned, rocking is unnecessary because the final result is the same regardless of whether a receiver is sweep-tuned about a fixed Test Oscillator frequency or a Test Oscillator sweep-tuned about a fixed receiver frequency.

In such cases, adjustment should be made for maximum amplitude of the resonance curves. In some receivers, the same maximum amplitude is obtainable throughout part of the trimmer adjustment range. When such is the case, the maximum amplitude setting which produces most accurate dial calibration should be used.

The dial setting so obtained will ordinarily be close to correct. This procedure increases the receiver sensitivity by effectively tuning the local oscillator circuit simultaneously with the r-f and first-detector stages at the low-frequency end of the band. Simultaneous adjustment is necessary to maintain correct tracking. An adjustment at the low-frequency end of a band should be followed by readjustment at the high-frequency end because each tuning adjustment affects the other.

Alignment at high frequencies (above broadcast-band frequencies) can sometimes be improved by similar rocking. This becomes effective when there is interaction among the various tuned circuits. In such cases, it is preferable to adjust the local-oscillator trimmer first, and then adjust the r-f and first detector trimmers while rocking. When the interaction is particularly bad, repeating these adjustments several times will often produce an increase in sensitivity.

Part 10—Frequency Sweeping in I-F Amplifier Alignment.

Many i-f amplifiers have a sharp, single-peak selectivity characteristic because i-f coupling transformers are under-coupled. When improved fidelity is desired, i-f coupling transformers may be over-coupled with the result of a flat-topped selectivity characteristic and extended high-frequency audio range. Some i-f amplifiers do employ over-coupling and have, therefore, a double-peaked or flat-topped selectivity characteristic. Any amplitude indicating device such as **RCA Stock No. 4317 Neon Output Indicator (TMV-121-A)** or any conventional output meter can be used when aligning i-f amplifiers having single-peaked characteristics. *A more satisfactory method using a frequency-sweeping device and Cathode Ray Oscillograph is desirable in any case and necessary for double-peaked or flat-topped characteristics.* The frequency-sweeping alignment method makes it possible to tune the mid-frequency point of the flat-topped or double-peaked characteristic to the desired alignment frequency, and maintain practically symmetrical side-bands. It is also of great value in checking an i-f amplifier having a variable-width selectivity characteristic. If the intermediate frequency is 460 kc and the sweep range 20 kc, the sweeping device varies

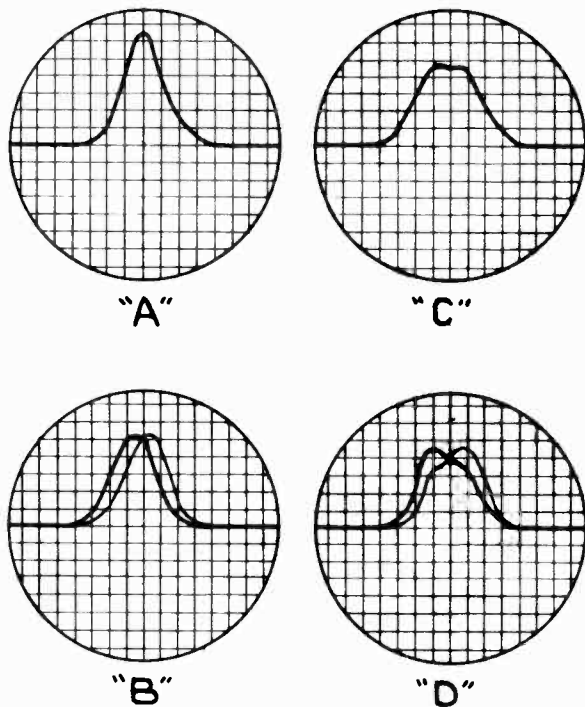

- A—Correct pattern showing a sharp selectivity curve with proper i-f alignment.
- B—Incorrect pattern showing result of i-f alignment at a frequency slightly different from the Test Oscillator output frequency.
- C—Correct pattern showing a broad selectivity curve with proper i-f alignment.
- D—Incorrect pattern showing result of slight misalignment of i-f transformers.

Figure 5

the Test Oscillator output frequency from 450 kc to 470 kc and back to 450 kc linearly with time. The cycle is repeated so rapidly that a Cathode Ray Oscillograph connected to the second detector of the receiver, when properly synchronized, shows two selectivity curves—one like the mirror image of the other. Figure 5 shows these patterns as they appear on the oscillograph screen. The i-f amplifier alignment is correct when the two images are made to coincide throughout and have maximum amplitude.

Part 11—Use of Crystal Calibrator to Check Calibration of Test Oscillators.

One of the easiest methods of checking the calibration of a Test Oscillator against the RCA Stock No. 9572 Crystal Calibrator (TMV-133-A) requires the use of an all-wave radio receiver which will tune to the frequencies at which it is desired to check calibration. A few turns of wire should be wrapped around the case of the Crystal Calibrator and connected to the antenna and ground posts of the radio receiver. The Crystal Calibrator may be used, as supplied by the factory, without external B batteries, and is simply plugged into the power line in the usual way. Hum signals will now be heard in the radio receiver at dial settings 100 kc or 1,000 kc apart, depending on the position of the "Hi-Lo" switch on the Crystal Calibrator. If, for example, it is desired to check a calibration at 5,000 kc, set

the "Hi-Lo" switch to the "Hi" position and tune the radio-receiver dial exactly to its fifth harmonic (5,000 kc) signal. Next, remove the Crystal Calibrator and connect the Test Oscillator to the radio receiver, and tune the Test Oscillator dial in the region of 5,000 kc until its signal is heard with maximum intensity in the receiver. At this point the Test Oscillator is delivering a signal of exactly 5,000 kc. A notation should now be made of the dial scale reading on the Test Oscillator and marked that this particular reading represents exactly 5,000 kc. This same procedure may be followed to find exact calibration for any frequency which is a multiple of 100 or 1,000 kc.

To check the Test Oscillator at frequencies which are not multiples of 100 or 1,000 kc, tune the receiver to a frequency which is a harmonic of the wanted check point on the Test Oscillator and which falls on some multiple of 100 or 1,000 kc. Suppose it is desired to check at 175 kc. The Test Oscillator dial is set to 175 kc and its fourth harmonic, which is 700 kc, is checked—using the Crystal Calibrator and radio receiver as outlined above.

Part 12—Wave-Trap Adjustment.

Wave-traps may consist of either a parallel-resonant circuit in series with the antenna of the receiver, or a series-resonant circuit connected from antenna to ground. They will be found in many RCA Victor receivers, especially following the models of 1935. The resonant frequency of the wave-trap is adjusted during manufacture to the same frequency as the i-f amplifier, to prevent signals at or near this frequency from causing interference.

When aligning a receiver, the wave-trap should always be adjusted to the same frequency as the i-f amplifier unless the exact frequency of the local interfering signal is known. In this case the wave-trap should be adjusted exactly to this interfering frequency. To make this adjustment, it is necessary to increase the Test Oscillator output considerably, since the wave-trap attenuates the signal. However, care must be taken not to use too strong a signal as this would cause a-v-c action in the receiver and make the wave-trap appear to tune broadly.

Part 13—Tuning Wand.

The RCA Stock No. 6679 Tuning Wand is very useful in checking any tuned circuit during alignment. When the test equipment is connected ready for aligning, insert first one end and then the other, of the tuning wand, inside the coil to be checked and observe the effects of each on the receiver output. If each end of the tuning wand produces a decrease in output, the circuit is correctly tuned and needs no further adjustment. If the brass sleeve end of the tuning wand produces an increase of output, the circuit must be retuned to a higher frequency; and if the iron core end of the tuning wand produces an increase of output, the circuit must be retuned to a lower frequency.

Both r-f and i-f circuits are usually tuned by either magnetite cores or trimming condensers.

Part 14—AC-DC Receivers. AC-DC Test Equipment.

Some ac-dc receivers employ internal connections between receiver wiring and chassis in such a manner that connections from Test Oscillator, Cathode Ray Oscillograph, and external ground, must not be made directly to chassis frame in the usual manner. When such is the case, the Technical Information and Service Data covering that particular receiver will specify the proper point in the circuit to which the Test Oscillator and Cathode Ray Oscillograph must be connected. At such times NO EXTERNAL GROUND CONNECTION SHOULD BE USED. If test equipment for ac-dc operation is used, there is a possibility of direct connection existing through the power line between the test equipment and receiver circuits. When such is the case, the test equipment must be isolated from direct connection to the receiver by the use of suitable fixed condensers (0.1 mf or larger) in all leads which connect the test equipment to the receiver circuits.

RECEIVER
ALIGNMENT

Part 15—RCA Alignment Equipment.

- Stock No. 9595 Test Oscillator—TMV-97-C.
- Stock No. 9558 Frequency Modulator—TMV-128-A.
- Stock No. 9545 Cathode Ray Oscillograph—TMV-122-B.
- Stock No. 9572 Crystal Calibrator—TMV-133-A.
- Stock No. 150 Test Oscillator.
- Stock No. 151 Cathode Ray Oscillograph.
- Stock No. 4317 Neon Output Indicator—TMV-121-A.
- Stock No. 9797 Cable Assembly.
- Stock No. 12636 Air-Trimner Wrench.
- Stock No. 11890 Fibre Screw Driver.
- Stock No. 6679 Tuning Wand.
- Stock No. 4160 Aligning Wrench.
- Stock No. 3792 Resistor, 300 ohms.
- Stock No. 12635 Capacitor, .001 mf.
- Stock No. 12694 Capacitor, 220 mmf.

(This capacitor is suitable for use wherever a capacitor of 200 mmf. is specified in alignment procedure.)

- Stock No. 12270 Capacitor, 80 mmf.

NOTE: When using the RCA Stock No. 12636 Air-Trimner Wrench, care must be taken not to disturb the adjustment of the Air-Trimner Capacitor while tightening its lock nut. The lock nut should be tightened while the test equipment is still connected to the radio receiver, so that any change in capacity which might result from the tightening will be immediately observed. The chassis should not be moved until the lock nuts are tightened.

The instruction books supplied with RCA test equipment such as Cathode Ray Oscillographs, Test Oscillators, Frequency Modulators, Crystal Calibrators, etc., describe the construction and operation of these instruments and will be found very helpful.

The following publications contain valuable information relative to receiver alignment and will be found helpful. Obviously, the list is not inclusive, but it will guide the reader to other references.

GHIRARDI, ALFRED A., *Modern Radio Servicing*. Radio and Technical Publishing Co., New York.

RCA MANUFACTURING CO., INC., *RCA Victor Service Notes*.

RIDER, JOHN F., *The Cathode-Ray Tube at Work*. John F. Rider, Publisher, New York.

Part 16—Connecting and Operating Different Combinations of RCA Test Equipment for Aligning.

Below are shown connection diagrams for different combinations of RCA Test Equipment, any of which can be used to align RCA Victor receivers (and also other types). In using any of these combinations, connect the test equipment as shown in the diagram and adjust it to the frequency specified in Technical Information and Service Data, then adjust the receiver trimmers or magnetite cores, as the case may be, in the manner prescribed.

Below each of the following connection diagrams will be found data on how to adjust and operate the test equipment.

Part 17—Use of RCA Stock No. 150 or RCA Stock No. 9595 Test Oscillator (TMV-97-C) and RCA Stock No. 4317 Neon Output Indicator.

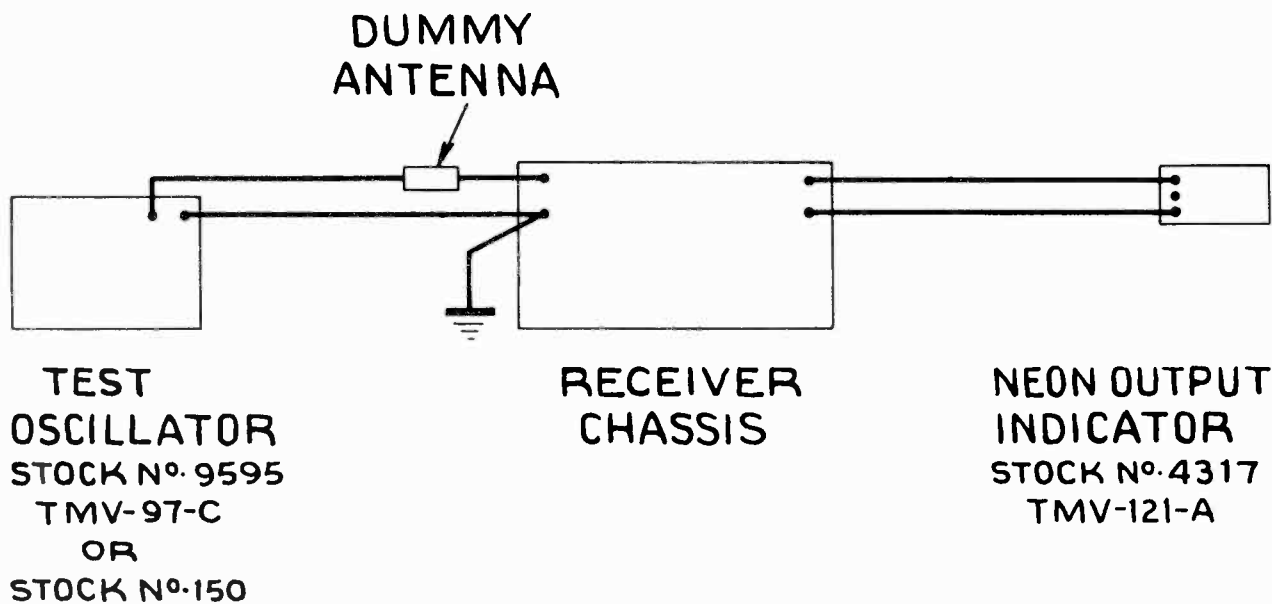

Figure 6

When using the RCA Stock No. 9595 Test Oscillator (TMV-97-C), or RCA Stock No. 150 Test Oscillator, and RCA Stock No. 4317 Neon Output Indicator (TMV-121-A), make connections to receiver chassis and Dummy Antenna

as specified for alignment in Technical Information and Service Data. Such connections are shown in figure 6 and described in Parts 5 and 6 above.

Part 18—Use of RCA Stock No. 150 Test Oscillator and RCA Stock No. 151 Cathode Ray Oscillograph.

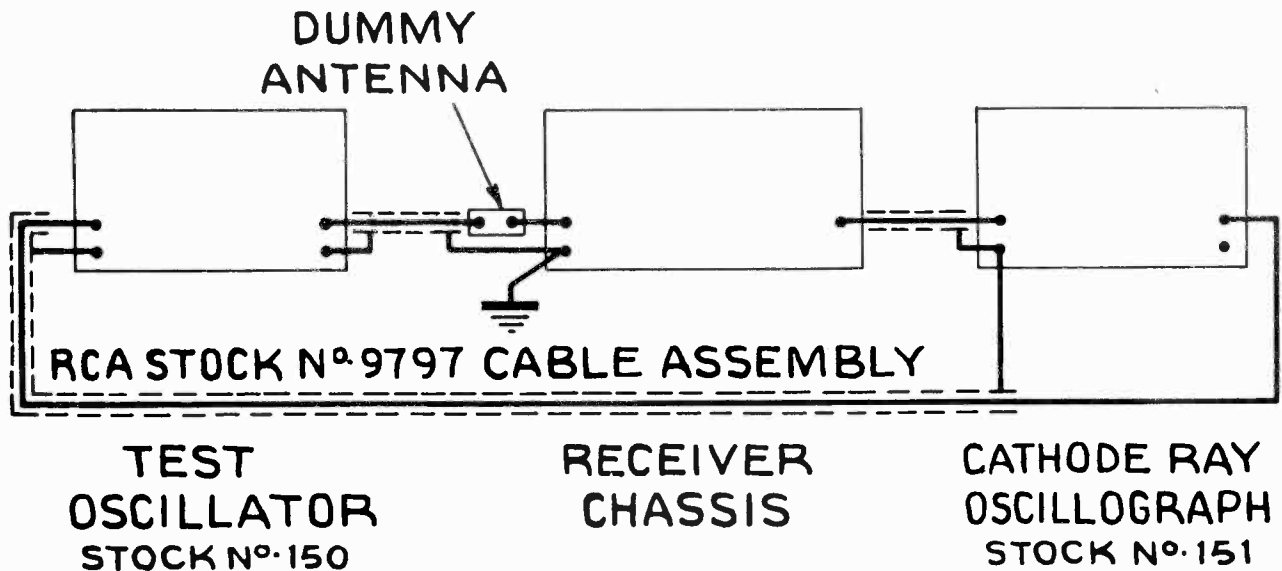

Figure 7

When using the RCA Stock No. 150 Test Oscillator and RCA Stock No. 151 Cathode Ray Oscillograph, make connections to receiver chassis and Dummy Antenna as specified for alignment in Technical Information and Service Data. Connect the test equipment as shown in figure 7, and adjust it as follows:

Test Oscillator:

- SWEEP KC—Between 20 and 40.
- DIAL—Specified alignment frequency.
- RANGE KC—Range within which specified frequency falls.
- POWER switch—ON.
- MODULATION switch—FREQ.
- Output controls FINE and COURSE—Low as possible and still keep screen filled with image.

Cathode Ray Oscillograph:

- INTENSITY } Adjust to give clear, sharply
- FOCUS } defined image on screen.
- CENTERING—V } Adjust to center image
- CENTERING—H } on screen.
- AMP. V switch—ON.
- AMP. H switch—TIMING.
- GAIN (under intensity control)—Maximum clockwise.
- FREQUENCY—Approximately 55.
- SYNC. control—Approximately two-thirds clockwise.
- RANGE—1.
- GAIN (under focus control)—Approximately 65.

Two separate, distinct, and similar waves should now appear on the screen. If only one wave appears, increase the "Frequency" control on the Oscillograph to obtain two waves. These waves will be identical in shape, totally disconnected, and appear in reversed positions. They will have a common base line which is discontinuous. Adjust the "Frequency" and "Sync." controls of the Oscillograph to make them remain motionless on the screen. Turning the Test

Oscillator dial slightly should cause them to move back and forth across the screen. However, before making any alignment adjustments, the Test Oscillator dial must be adjusted to the specified alignment frequency.

The circuit being aligned (to which the Test Oscillator output was originally connected) must now have its trimmers or magnetite cores adjusted so that the two waves on the Oscillograph screen coincide throughout and have maximum amplitude.

In most receivers, the trimmer which tunes the local oscillator for the high-frequency band (usually around 12,000 kc and higher) has sufficient capacity to tune it over a rather wide range of frequencies. The RCA Stock No. 150 Test Oscillator, because of its beat-frequency principle, produces on the two high-frequency bands (frequencies from 7,000 kc to 32,000 kc) the frequency to which the dial is calibrated and also another frequency 1,600 kc lower. Thus, it is sometimes possible to produce the desired resonance curve on the screen at four different settings of the receiver's local-oscillator trimmer. Two of these points represent the correct tuning, and the image, for the frequency of the Test Oscillator shown on its dial. The other two represent the correct tuning, and the image for the additional frequency coming from the Test Oscillator which is 1,600 kc lower than the one shown on its dial. When this condition exists, the local-oscillator trimmer in the receiver must be set to one of the two highest frequencies. If the alignment information specifies adjustment to the highest-frequency (minimum-capacity) peak, use the highest-frequency peak obtainable on the trimmer. If it specifies adjustment to the lowest-frequency (maximum-capacity) peak, use the peak next lower in frequency to the highest-frequency one obtainable. This is the correct procedure in all cases where the intermediate frequency used in the receiver is less than 800 kc, and when the fundamental (not a harmonic) frequency delivered by the Test Oscillator is being used.

When using this Test Oscillator, it is important to keep its output controls at the lowest possible setting in order to avoid unwanted beat notes and harmonics which may otherwise be present.

Part 19—Use of RCA Stock No. 9595 Test Oscillator (TMV-97-C), RCA Stock No. 9558 Frequency Modulator (TMV-128-A), and RCA Stock No. 9545 Cathode Ray Oscillograph.

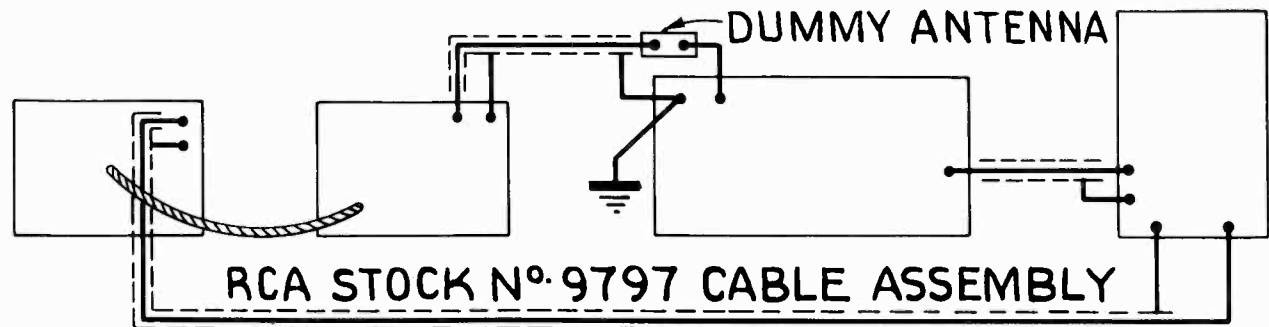

| | | | |
|--|---|-----------------------------|---|
| FREQUENCY MODULATOR STOCK N° 9558 TMV-128-A | TEST OSCILLATOR STOCK N° 9595 TMV-97-C | RECEIVER CHASSIS | CATHODE RAY OSCILLOGRAPH STOCK N° 9545 TMV-122-B |
|--|---|-----------------------------|---|

Figure 8

When using the RCA Stock No. 9595 Test Oscillator (TMV-97-C), and RCA Stock No. 9558 Frequency Modulator (TMV-128-A), and RCA Stock No. 9545 Cathode Ray Oscillograph (TMV-122-B), it is necessary to determine the correct Test Oscillator dial setting with Frequency Modulator plugged in, for any given frequency, in order that the sweep range will center about that particular frequency. Make connections to receiver chassis and Dummy Antenna as specified in Technical Information and Service Data. Connect the test equipment as shown in figure 8, and adjust it as follows:

Frequency Modulator:

Disconnect by removing plug-in cable from Test Oscillator (not from Frequency Modulator).

Test Oscillator:

- RANGE KC—Range within which specified frequency falls.
- DIAL—Specified alignment frequency.
- HI-LO control switch { Low as possible and still keep
- OUTPUT control knob { screen filled with image.
- Modulation switch—MOD.
- Power switch—ON.

Cathode Ray Oscillograph:

- INTENSITY { Adjust to give clear, sharply
- FOCUS { defined image on screen.
- AMPL. A—ON.
- RANGE switch—2.
- AMPL. B—TIMING.
- SYNC. control—Approximately 5.
- FREQ. control—Approximately 7.
- VERTICAL GAIN—Maximum clockwise.
- SYNC. switch—INT.
- HORIZONTAL GAIN—Approximately 5.

With the test equipment controls adjusted as indicated above, align the circuit in question for maximum (peak) amplitude as indicated on the Oscillograph screen. Then change only the test equipment settings noted below leaving the other controls as they were:

Frequency Modulator:

- Power switch—ON.
- HI-LO switch—HI. See text below.
- Cable—Plugged into Test Oscillator.

Test Oscillator:

- RANGE KC } See text below.
- DIAL }
- Modulation switch—OFF.

Cathode Ray Oscillograph:

- FREQ. control—Approximately 8.
- SYNC. switch—EXT.

Increase the frequency of the Test Oscillator by slowly turning its tuning control until two separate, distinct, and similar waves appear on the screen. If only one wave appears, increase the "Freq." control on the Oscillograph to obtain two waves. These waves will be identical in shape, totally disconnected, and appear in reversed positions. They will have a common base line which is discontinuous. Adjust the "Freq." and "Sync." controls of the Oscillograph to make them remain motionless on the screen. Continue increasing the Test Oscillator frequency until these forward and reverse curves move together and overlap, *with their highest points exactly coincident*. For some frequencies, this will necessitate moving the "Range-kc" switch on the Test Oscillator to the next higher-frequency position, and may also necessitate throwing the "Hi-Lo" switch on the Frequency Modulator to the "Lo" position. In still other cases, it may be necessary to tune the Test Oscillator to a lower frequency and increase its output, thereby using one of its harmonics instead of the fundamental frequency. The equipment is now producing a test signal which is sweeping around the specified alignment frequency to which the Test Oscillator was originally adjusted, and this specified frequency is exactly in the middle of the range of sweep.

The circuit being aligned (to which the Test Oscillator output was originally connected) must now have its trimmers or magnetite cores adjusted so that the *two curves on the Oscillograph screen coincide throughout and have maximum amplitude*.

It is desirable to write down the final switch and dial settings of the Frequency Modulator and Test Oscillator for future reference. If this is done, much future work can be eliminated since then it will only be necessary to adjust the test equipment to these final settings, and it will be ready for use in aligning any circuit which must be aligned to that particular frequency.

The Frequency Modulator method of sweeping is generally used only for frequencies below 2,000 kc. At higher frequencies, the Frequency Modulator is not used and alignment adjustments are made for peak amplitude only as shown on the Oscillograph screen.

Part 20—Use of RCA Stock No. 9595 Test Oscillator (TMV-97-C), RCA Stock No. 9558 Frequency Modulator (TMV-128-A), and RCA Stock No. 151 Cathode Ray Oscillograph.

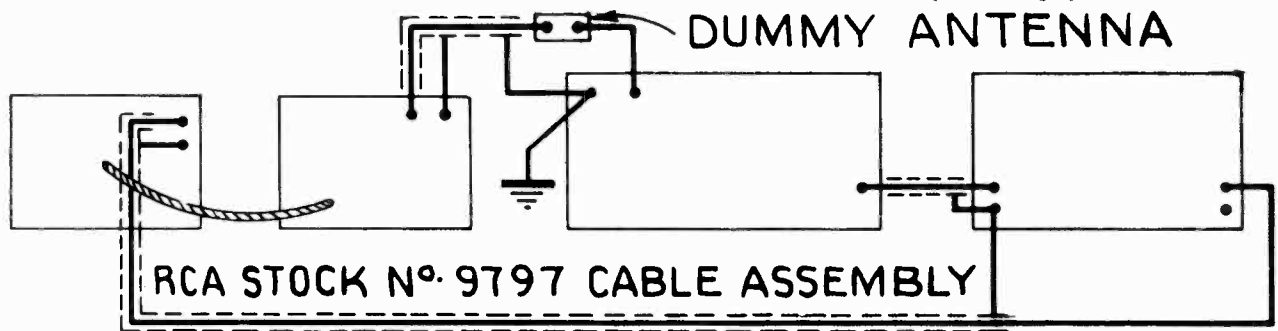

| | | | |
|--------------------------------|----------------------------|-----------------------------|-------------------------------------|
| FREQUENCY MODULATOR | TEST OSCILLATOR | RECEIVER CHASSIS | CATHODE RAY OSCILLOGRAPH |
| STOCK N° 9558 | STOCK N° 9595 | | STOCK N° 151 |
| TMV-128-A | TMV-97-C | | |

Figure 9

When using the RCA Stock No. 9595 Test Oscillator (TMV-97-C), and RCA Stock No. 9558 Frequency Modulator (TMV-128-A), and RCA Stock No. 151 Cathode Ray Oscillograph, it is necessary to determine the correct Test Oscillator dial setting with Frequency Modulator plugged in, for any given frequency, in order that the sweep range will center about that particular frequency. Make connections to receiver chassis and Dummy Antenna as specified for alignment in Technical Information and Service Data. Connect the test equipment as shown in figure 9, and adjust it as follows:

Frequency Modulator:

Disconnect by removing plug-in cable from Test Oscillator (not from Frequency Modulator).

Test Oscillator:

RANGE KC—Range within which specified frequency falls.
DIAL—Specified alignment frequency.
HI-LO control switch } Low as possible and still keep
OUTPUT control knob } screen filled with image.
Modulation switch—MOD.
Power switch—ON.

Cathode Ray Oscillograph:

INTENSITY } Adjust to give clear, sharply
FOCUS } defined image on screen.
CENTERING—V } Adjust to center image on
CENTERING—H } screen.
AMP. V switch—ON.
AMP. H switch—TIMING.
GAIN (under intensity control)—Maximum clockwise.
FREQUENCY—Approximately 15.
SYNC. control—Maximum clockwise.
RANGE—1.
GAIN (under focus control)—70.
Wire from Frequency Modulator disconnected from
HORIZ. HIGH binding post.
Connect jumper between HORIZ. HIGH and SYNC.
HIGH binding posts.

With the test equipment controls adjusted as indicated above, align the circuit in question for maximum (peak) amplitude as indicated on the Oscillograph screen. Then change only the test equipment settings noted below leaving the other controls as they were:

Frequency Modulator:

Power switch—ON.
HI-LO switch—HI. See text below.
Cable—Plugged into Test Oscillator.

Test Oscillator:

RANGE KC }
DIAL } See text below.
Modulation switch—OFF.

Cathode Ray Oscillograph:

SYNC. control—Approximately one-half clockwise.
Remove jumper between HORIZ. HIGH and SYNC.
HIGH binding posts.
Connect wire from HORIZ. HIGH binding post to
Frequency Modulator.

Increase the frequency of the Test Oscillator by slowly turning its tuning control until two separate, distinct, and similar waves appear on the screen. If only one wave appears, increase the "Frequency" control on the Oscillograph to obtain two waves. These waves will be identical in shape, totally disconnected, and appear in reversed positions. They will have a common base line which is discontinuous. Adjust the "Frequency" and "Sync." controls of the Oscillograph to make them remain motionless on the screen. Continue increasing the Test Oscillator frequency until these forward and reverse curves move together and overlap, with their highest points exactly coincident. For some frequencies, this will necessitate moving the "Range-kc" switch on the Test Oscillator to the next higher-frequency position, and may also necessitate throwing the "Hi-Lo" switch on the Frequency Modulator to the "Lo" position. In still other cases, it may be necessary to tune the Test Oscillator to a lower frequency and increase its output, thereby using one of its harmonics instead of the fundamental frequency. The equipment is now producing a test signal which is sweeping around the specified alignment frequency to which the Test Oscillator was originally adjusted, and this specified frequency is exactly in the middle of the range of sweep.

The circuit being aligned (to which the Test Oscillator output was originally connected) must now have its trimmers or magnetite cores adjusted so that the two curves on the Oscillograph screen coincide throughout and have maximum amplitude.

It is desirable to write down the final switch and dial settings of the Frequency Modulator and Test Oscillator for future reference. If this is done, much future work can be eliminated since then it will only be necessary to adjust the test equipment to these final settings, and it will be ready for use in aligning any circuit which must be aligned to that particular frequency.

The Frequency Modulator method of sweeping is generally used only for frequencies below 2,000 kc. At higher frequencies, the Frequency Modulator is not used and alignment adjustments are made for peak amplitude only as shown on the Oscillograph screen.

Part 21—Use of RCA Stock No. 150 Test Oscillator and RCA Stock No. 9545 Cathode Ray Oscillograph (TMV-122-B).

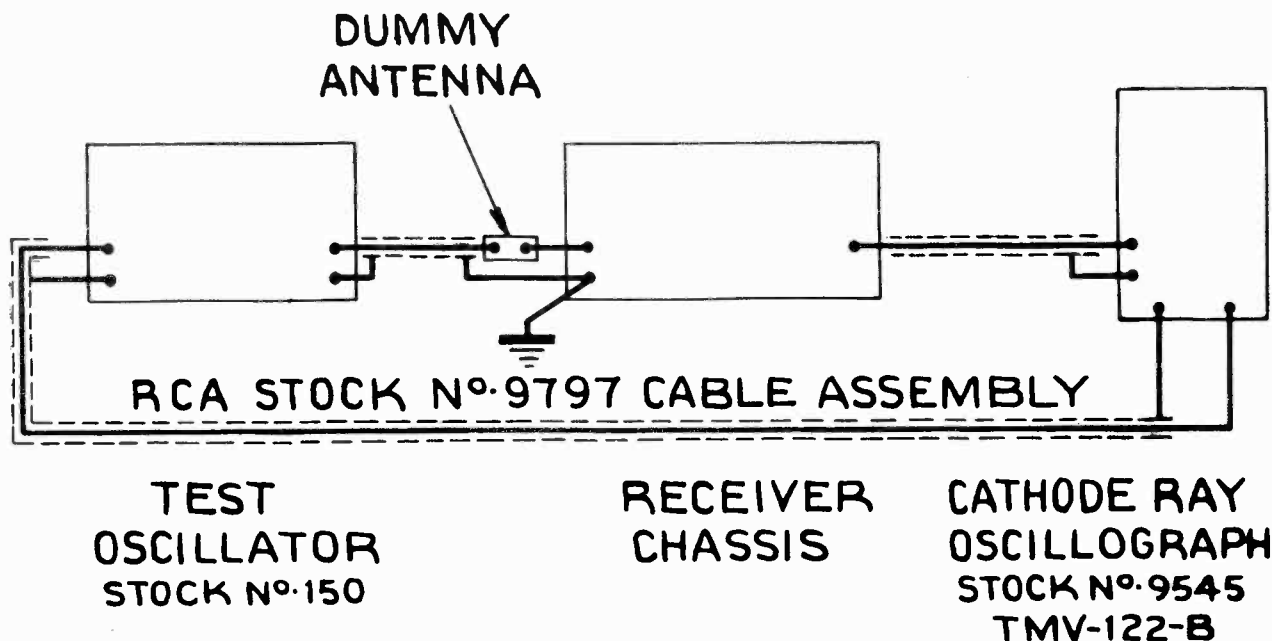

Figure 10

When using the RCA Stock No. 150 Test Oscillator and RCA Stock No. 9545 Cathode Ray Oscillograph (TMV-122-B), make connections to receiver chassis and Dummy Antenna as specified for alignment in Technical Information and Service Data. Connect the equipment as shown in figure 10, and adjust it as follows:

Test Oscillator:

- SWEEP KC—Between 20 and 40.
- DIAL—Specified alignment frequency.
- RANGE KC—Range within which specified frequency falls.
- POWER switch—ON.
- MODULATION switch—FREQ.
- Output controls FINE and COURSE—Low as possible and still keep screen filled with image.

Cathode Ray Oscillograph:

- INTENSITY } Adjust to give clear, sharply
- FOCUS } defined image on screen.
- AMPL. A—ON.
- RANGE switch—3.
- AMPL. B—TIMING.
- SYNC. control—Maximum clockwise.
- FREQ. control—Approximately 8.
- VERTICAL GAIN—Maximum clockwise.
- SYNC. switch—EXT.
- HORIZONTAL GAIN—Approximately 4.

Two separate, distinct, and similar waves should now appear on the screen. If only one wave appears, increase the "Freq." control on the Oscillograph to obtain two waves. These waves will be identical in shape, totally disconnected, and appear in reversed positions. They will have a common base line which is discontinuous. Adjust the "Freq." and "Sync." controls of the Oscillograph to make them remain motionless on the screen. Turning the Test Oscillator dial slightly should cause them to move back and forth across

the screen. However, before making any alignment adjustments, the Test Oscillator dial must be adjusted to the specified alignment frequency.

The circuit being aligned (to which the Test Oscillator output was originally connected) must now have its trimmers or magnetite cores adjusted so that the two waves on the Oscillograph screen coincide throughout and have maximum amplitude.

In most receivers, the trimmer which tunes the local oscillator for the high-frequency band (usually around 12,000 kc and higher) has sufficient capacity to tune it over a rather wide range of frequencies. The RCA Stock No. 150 Test Oscillator, because of its beat-frequency principle, produces on the two high-frequency bands (frequencies from 7,000 kc to 32,000 kc) the frequency to which the dial is calibrated and also another frequency 1,600 kc lower. Thus, it is sometimes possible to produce the desired resonance curve on the screen at four different settings of the receiver's local-oscillator trimmer. Two of these points represent the correct tuning, and the image, for the frequency of the Test Oscillator shown on its dial. The other two represent the correct tuning, and the image, for the additional frequency coming from the Test Oscillator which is 1,600 kc lower than the one shown on its dial. When this condition exists, the local-oscillator trimmer in the receiver must be set to one of the two highest frequencies. If the alignment information specifies adjustment to the highest-frequency (minimum-capacity) peak, use the highest-frequency peak obtainable on the trimmer. If it specifies adjustment to the lowest-frequency (maximum-capacity) peak, use the peak next lower in frequency to the highest-frequency one obtainable. This is the correct procedure in all cases where the intermediate frequency used in the receiver is less than 800 kc, and when the fundamental (not a harmonic) frequency delivered by the Test Oscillator is being used.

When using this Test Oscillator it is important to keep its output controls at the lowest possible setting in order to avoid unwanted beat notes and harmonics which may otherwise be present.

INSTRUCTIONS

RCA VICTOR ARMCHAIR CONTROL Model G8

FROM YOUR ARMCHAIR you will be gratified with the value of your new tuning unit by the added ease of changing from one to another of your favorite broadcasting stations on your new RCA Victor Radio Receiver.

THE DEALER who sold you the Armchair control will, in most cases, install it on your radio and be glad to instruct you in its use. If the owner makes the attachment he should first read carefully the whole of this booklet.

THE G-8 ARMCHAIR CONTROL is a small ornamental cabinet that may be placed on the arm of a chair or on an end table and there used to tune your radio. On the top are eight push buttons and windows for station letters similar to those on your radio receiver dial. With the radio switched on, the pressing of one of the buttons tunes in the corresponding station.

THE FOOLPROOF DESIGN of the G-8 Armchair Control is such that if you press two or

the Electric Tuning and Armchair Control will not cause damage to receiver or control unit. The RCA Victor Radio Receivers, Models 811K, 812K, 813K, 816K and the Phonograph Radio U-109, as also other forthcoming RCA Victor products with "Electric Tuning," may be equipped with the Armchair Control.

Description

The G-8 Armchair Control Kit consists of:

A complete Control Box assembled with cover and 25 feet of flat 9-wire cable attached.

A Cable Clamp with insulating strip and screws for anchoring the cable on your radio receiver.

A sheet on which are printed the call letters of United States, Canadian and Mexican broadcast stations.

The ends of the wires extending from the cable are of different lengths to facilitate connections to the Electric Tuning Unit on the chassis in the back of the Radio Receiver.

The procedure is as follows:

1. Turn the radio off.
2. Cut out the call letters of the eight chosen stations, which must be the same as those used on your radio Electric Tuning Dial. Arrange them in order. The sequence must be the same as on the dial for each of the two rows of four on left and right.
3. Place the Armchair Unit on a table with the cable extending from the left end, remove the cover, and then the two escutcheon plates from the sides. Each plate is held by two screws. Take out the celluloid windows and the dummy labels, replacing the latter with the proper station call letters. Be sure the two dial correspond to the two rows on the radio dial. Replace the celluloid windows and the escutcheons, and also the metal cover.
4. Note the eight brass terminals, like piano keys, on the bottom of the Electric Tuning Unit on your radio. They correspond to the numbered holes in the station adjustment strip at the top of the unit, and these in turn with the push buttons numbered in the sketch.

Now take the end of the 9-wire flat cable, separate the wires in order of length and ar-

range in place as shown in sketch, the shortest wire nearest you and the longest central wire pulled out for attachment to the special terminal on the reversing switch as shown. The shortest wire is for attachment to the terminal corresponding to "1," the second to "2," etc.

5. Anchor the cable in place with the clamp, leaving sufficient slack inside the cabinet for making connections. Place the insulation and clamp over the cable and tighten up the screws securely.

6. Solder the eight wires to the eight terminals in order as explained in above paragraphs.

7. Solder the longest ninth central wire to the point on the circular reversing switch, as shown in the sketch.

You can now tune in stations on your Armchair Control as with the push buttons on the radio dial.

If at any time you wish to change one of the stations, be sure to make the same change in the station call letters on Armchair Control as on the Electric Tuning Dial of your radio receiver.

REPLACEMENT PARTS

| Stock No. | Description |
|-----------|---|
| 14850 | Bar—Tie bar for connecting push button lock plates. |
| 14851 | Box—Control box case only—less buttons, switches, cable and top and bottom covers. |
| 14745 | Button—Station selector push button. |
| 14853 | Cable—9-conductor flat cable, approximately 25 feet long. |
| 14747 | Card—Station call letter cards. |
| 14852 | Cover—Control box top cover. |
| 14746 | Shield—Celluloid shield for station markers. |
| 14694 | Spring—Tension spring for push button lock plate. |
| 14693 | Switch—Station selector button switch, comprising 4 contacts and 1 lock plate completely assembled on insulating strip. |

Refer to Figure 6 of 811K Service Data for Schematic of G-8.

Extra lengths of control cable should not be used where power-line voltages are low. The voltage drop in the cable circuit, due to the added resistance, will reduce the power of the drive motor and prevent correct operation.

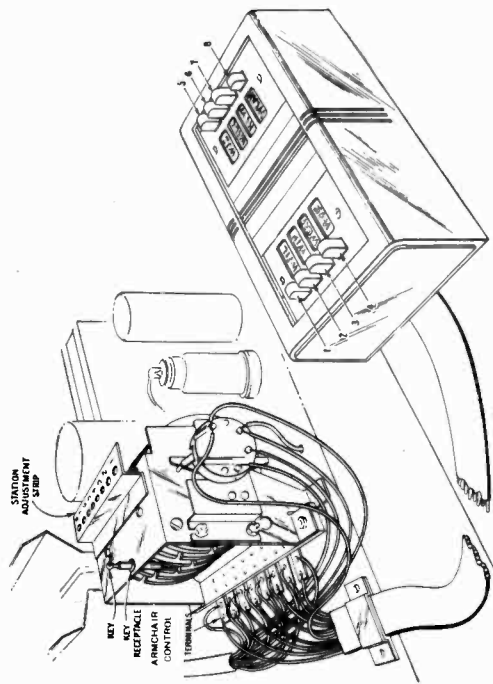

more buttons down at one time you can release them by pressing another one that is not down. If all eight are pressed and remain down then an extra push on No. 1 or No. 8 (see illustration) will release the others. Operating any controls on the radio receiver to conflict with

Installation

The accompanying illustration shows you the back of your receiver with the Armchair Control installed. To make the connections you will only need soldering equipment.

INSTALLATION INSTRUCTIONS

RCA "MAGIC WAVE" ANTENNA KIT Stock No. 9812

Maximum performance from your radio receiver is obtained only when installation of this antenna is made in accordance with the following instructions. Read these carefully. It is best to have the antenna installed by your RCA Victor dealer, whom you should consult in all cases of doubt or difficulty.

The "Magic Wave" Antenna Kit is designed for reception of radio frequencies between 500 and 23,000 kilocycles. It gives noise reduction over the complete range, and is most efficient on the standard broadcast band and the international short-wave broadcast bands. Interfering electrical disturbances reaching the receiver by way of the power supply system

are eliminated or reduced in their effects on the receiver sound output when using this antenna kit. Radiated disturbances caused by electrical appliances, oil burners, power line leaks, etc., are eliminated or reduced in their effect on the receiver, when the antenna and external ground are located remote from the source of interference.

DESCRIPTION

The "Magic Wave" Antenna Kit consists of: (1) Antenna Wire. One coil 60 feet long. (2) Antenna Coupling Unit. An enclosed weatherproof transformer with mounting strap. The Antenna Wire, the Antenna Ground Wire and the Transmission Line are attached to this transformer.

(3) Transmission Line. One coil, 45 feet long, of black, twisted, two-wire insulated cable, covered with weatherproof lining.

(4) Receiver Coupling Unit. Stock No. 9813. A shielded transformer with transmission line terminals and receiver set terminals. The ground terminal serves as mounting bracket.

(5) Ground Wire. One coil, 5 feet long, of

flexible wire for grounding the Antenna Coupling Unit.

(6) Insulators. Five porcelain insulators for suspension of wires, etc.

(7) Ground Clamp. For ground connection of Antenna Coupling Unit.

Additional requirements not supplied with the kit include:

Poles, etc.—Necessary supports for suspending the Antenna Wire. Note: A special type of vertical Antenna as suggested in these instructions may be used instead of the Antenna Wire supplied, or you may have an Antenna already installed which is satisfactory for connection to the Antenna Coupling Unit.

Ground Device.—Metal stake, wire screen or other good external ground.

LOCATION

Preliminary to the installation, the type, location and direction of the antenna has to be decided upon. Several different types of antennas are shown in the illustrations. Choose the one best suited to your requirements. Antenna wires must be well clear of roofs, buildings, trees and all other surfaces or objects, particularly those made of metal. The

higher the elevation the more effective the antenna.

The antenna should be remote from trolley wires, main automobile highways, telephone lines, power lines, household electrical appliances and other sources of production of electrical interference. The further away the antenna is from "noise production" the better.

INSTALLATION

Standard Antenna

A typical installation of the Wire ("L" Type Antenna is shown in Figure 1. It is recommended as the most convenient for homes, although any ordinary good antenna already in service may be used in place of the antenna wire furnished with the RCA "Magic Wave"

25319-1



Figure 3—Home Installation with Pole Antenna and Underground Transmission Line

Self-Supporting Vertical Antenna

This is shown in Figure 2 (a) and Photograph Figure 4. It is recommended for home installation when neat appearance is desired. The transmission line may be run underground to house, thereby leaving no visible antenna wires. The pole should be located remote from the house and electrical wiring, as shown in Figure 3, in order to obtain maximum noise reduction.

Requirement—

Three sections of galvanized iron water pipe, or equivalent of other suitable metal.

- (1) 8 feet of 1/2 inch (top).
- (2) 10 feet of 3/4 inch (middle).
- (3) 12 feet of 1 inch (bottom).

Two pipe-reducing couplings, one from 1-inch to 3/4-inch pipe and one from 3/4-inch to 1/2-inch pipe.

Two 2 x 4 wooden posts, each 6 to 8 feet long, cross-cut or otherwise treated for preservation.

Two bolts, 3/8 inch or larger x 6 inches, with nuts and washers for securing nuts to wooden supports.

One ground pipe, 1-inch diameter, 5 feet long. One extra ground clamp for antenna.

Erect, as indicated in Figure 2 (a). The Transmission Line may be above or below ground. If above ground it must be kept away from pole after leaving the Antenna Coupling Unit. The metal pole acts as the antenna and should be connected to the Antenna Coupling Unit in place of the Antenna Wire supplied with the kit. The pole should rest about one foot above ground between the wooden posts, which act as insulators.

Apartment House Vertical Antenna

Recommended for Apartment Houses and Office Buildings.

Requirements—

Two or three sections of pipe with reducing couplings as specified for Self-Supporting Vertical Antenna, Figure 2 (a), together with suitable wooden insulating and support block. Erect as indicated in Figure 2 (b).

Apartment House "L" Type Antenna

Recommended for Apartment Houses and Office Buildings.

Requirements—

Wooden or metal pole, 10 feet to 30 feet long. Guy wires and staples for anchoring pole. Erect as indicated in Figure 2 (c).

Note: A good antenna already installed may be used.

Antenna Coupling Unit

Mount the Antenna Coupling Unit close to the external ground, low down on pole base or wall, by means of the strap extending at the ends. Use screws for attachment. The ground wire should be as short as possible and the unit should, therefore, be mounted in close proximity to the metal "ground."

Transmission Line

Check the approximate length of Transmission Line required, and, if necessary, splice on additional lengths of cable. This is obtainable from your dealer. Attach Transmission Line to

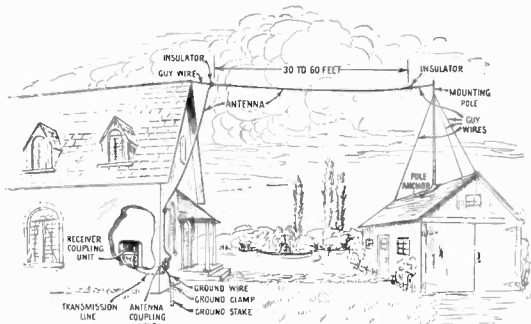

Figure 1—Typical Installation

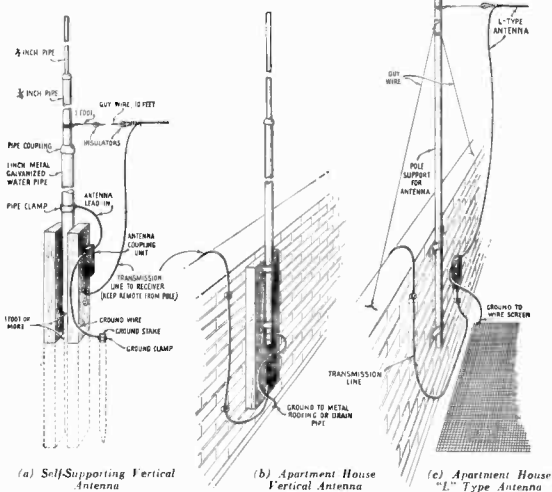

Figure 2—Optional Antenna Installations

2

wall or other exterior surface with nail-on knobs, in such a manner as to avoid possible damage to the insulation or to the line from effects of swaying, wind and weather. Then thread through hole in wall and carry to receiver. Any surplus length may be cut off. In the interior of the house, the Transmission Line may be attached to walls with insulated staples.

The Transmission Line may be above or below ground. In the former case, it should be kept away from the antenna or antenna lead-in after leaving the Antenna Coupling Unit. For long lines exposed to weather and for underground lines we recommend our special heavy submarine-insulated Transmission Line, Stock No. 12430, 90 feet long, or Stock No. 12429, 45 feet long. This is obtainable from your dealer, for use in place of the line supplied with the kit. For extra lengths used for internal wiring, we recommend our Stock No. 9816 (same as supplied with kit). The total length of the Transmission Line is not critical, and it may be cut at any convenient point. Both types of Transmission Line may be used in the same installation.

Receiver Coupling Unit

The "Ant" (pigtail lead) and "Gnd" (ground mounting bracket) terminals of the Receiver Coupling Unit are attached in such a manner that they will fit the antenna and ground "A" and "C" or "Ant" and "Gnd" terminals on your Radio Receiver Chassis. Mount Receiver Coupling Unit in place on receiver, being sure to use the connectors provided, as very short connections from the unit to the receiver are essential to good performance. The two wires of the Transmission Line should be connected to the two screw terminals at the top of the Receiver Coupling Unit.

Note—Some RCA Receivers have three terminals on the back of the chassis, marked A2, A1, and G. The "Ant" terminal of the Receiver Coupling Unit should be attached to A1, and the "Gnd" terminal, which supports the unit, should be connected to "G." The A2 terminal is not used with the "Magic Wave" Antenna Installation.

Grounds

(a) External.—The ground connection of the Antenna Coupling Unit is very important. The ground lead should be short and preferably not over five feet in length. The wire provided should be firmly attached, by means of the ground clamp supplied, to a metal stake or pipe driven four feet or more into the soil. A copper wire similar to the antenna wire, buried in a trench 6 inches deep and 15 feet long, makes a good ground. Do not use the same trench as for a buried Transmission Line. For apartment houses where the antenna is erected on the roof, use preferably a soldered connection to the metal roofing; a second choice is a 15 to 30-foot insulated wire, or a 12-foot square copper screen secured to the surface of the roof. For an installation where none of the above ground terminations are feasible, use an extended ground lead, twisted around the Transmission Line, for a distance of 15 feet from the Antenna Coupling Unit.

(b) Internal.—The ground from the Receiver Coupling Unit is optional, but sometimes advisable for best noise reduction. Attach a ground wire to the "Gnd" (or G) terminal of the receiver and carry to water pipe or radiator. A clean metallic connection should be made, using a proper ground clamp.

AUXILIARY COUPLING UNIT FOR FOUR RECEIVERS

A new RCA Distribution Transformer, Stock No. 9814, is available from your dealer for attachment to the Transmission Line. Two, three, or four sets of leads from this transformer feed separate Receiver Coupling Units, Stock No.

9813, at separate receivers, so that reception on several receivers may be obtained simultaneously from one antenna. Ask your dealer for details.

REPLACEMENT PARTS

| Stock No. | Description |
|-----------|---|
| 9813 | Transformer—Receiver coupling unit. |
| 9816 | Transmission Line—Standard, 45 feet long. |
| 12429 | Transmission Line—Special, for underground and exposed locations, 45 feet long. |
| 12430 | Transmission Line—Special, for underground and exposed locations, 90 feet long. |
| 9814 | Transformer—Special distribution auxiliary coupling unit. |

INSTALLATION INSTRUCTIONS FOR SPECIAL DISTRIBUTION TRANSFORMER STOCK 9814 AND RCA MAGIC WAVE ANTENNA SYSTEM STOCK 9812 FOR MULTIPLE OUTLET INSTALLATIONS

INTRODUCTION - By use of special distribution transformer, Stock 9814, the RCA Magic Wave Antenna System may be used to supply signals to as many as sixteen receivers, giving noise reduction on standard and international short wave bands to all receivers. Tuning of one receiver does not affect any of the other receivers connected to the same antenna.

This system meets the requirements of small apartment houses, radio dealers, homes with more than one radio, etc.

INSTALLATION - Figure 1 shows the installation of one distribution transformer which provides for operation of four receivers or less.

Figure 2 shows the installation of five distribution transformers providing for operation of sixteen receivers. For twelve receivers four distribution transformers are required, for eight receivers three transformers, etc. Each receiver requires a Receiver Coupling Transformer, Stock 9813.

Stock 9816 transmission line is recommended for wiring between transformers, or 12429 or 12430 may also be used. Transmission lines may be run in metal conduit if desired although this is not necessary. Two or more lines may be run in the same conduit but not with other electrical wiring.

NOTE: Signal voltage to each receiver in Figure 1 installation is reduced to about 1/2 the voltage of a single outlet installation. For Figure 2 the voltage is reduced to about 1/4 of the voltage of a single outlet installation. The higher efficiency antenna shown in Figure 2 is recommended for installations feeding a large number of outlets.

FIGURE 1

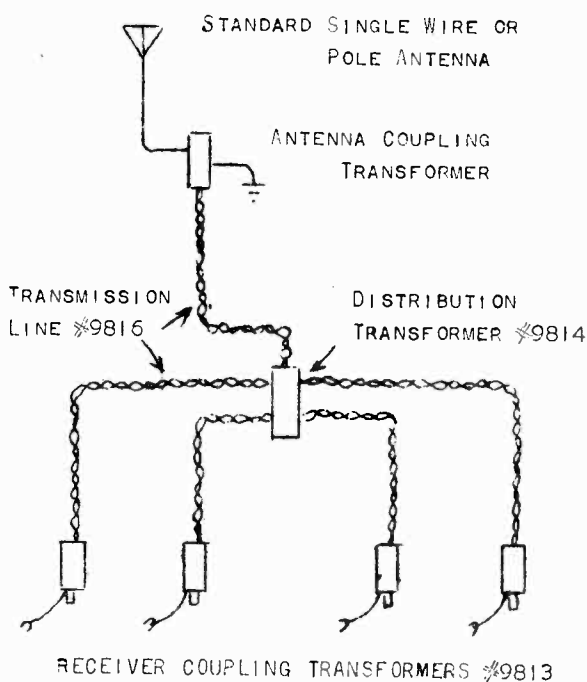
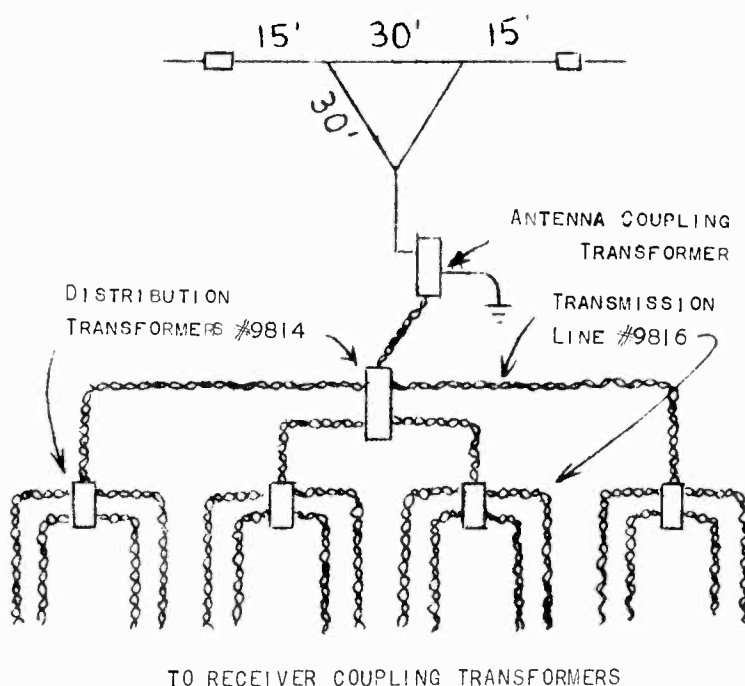

FIGURE 2



INSTALLATION INSTRUCTIONS

for the
RCA SPIDER WEB ANTENNA SYSTEM
Stock Nos. 9685 and 9689

General

The demand for an effective, easily installed, reliable antenna system to give adequate reception with the modern multiband receivers has necessitated research and development work which has resulted in the production of the RCA Spider Web Antenna. This antenna is a combination of carefully balanced doublets with transformers and transmission line skillfully assembled and completely soldered at the factory, thus reducing the work for erection to a minimum.

The Stock No. 9685 Kit as supplied, effectively brings in all signals from 140 to 23,000 k. c. (4 bands). However, to those who desire to cover the ultra high frequency band (23 to 70 megacycles) the Stock No. 9689 Auxiliary Kit is available at a nominal cost. The Auxiliary Kit consists of a pair of short dipoles assembled complete with insulators, and with the necessary loading coils soldered in place, all ready to add to the main spider web network.

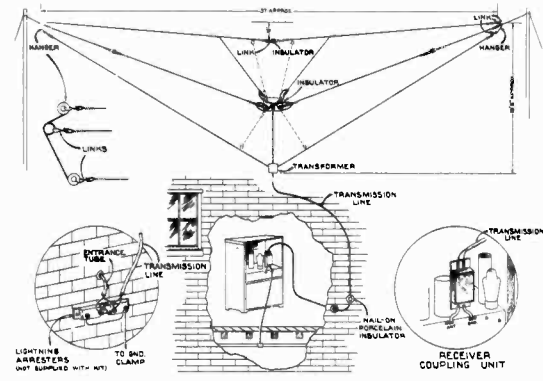

Figure 1—Spider Web Antenna System

Description

The Stock No. 9685 Antenna Kit consists of:

- (1) A complete antenna network assembled with transformer, insulator, line, and connections as shown in Figure 2.
- (2) Two specially designed hangers for attachment and proper spacing of antenna wires.

- (3) Seven special attachment links for attaching antenna and suspension wires to hangers.
- (4) Antenna Receiver Coupling Transformer having two terminals for attachment of transmission line and two terminals with links for attachment to receiver.

(6) Suspension.—Attach one end of the suspension or strain wire or rope to the support and the other end to the mid-loop of one of the hangers, and secure in place on mast or other support.

(7) Estimate and check length of other suspension line (if metal, it should be throughout in length not greater than 16 feet separated by insulators), and then attach one end to second hanger and string antenna in place to second support with rope and pulley or other convenient means. Allow slack as suggested under "Location."

(8) Transmission Line.—Attach transmission line to wall or other exterior surface with nail-on knobs or other insulating devices, in such a manner as to avoid future damage to the insulation or to the line from effects of swaying, wind and weather. There should be a slight tension in the transmission line to prevent antenna from severe swaying in the wind. Secure lead-in porcelain tube insulator in place through wall, thread transmission line through tube and carry to receiver. Any surplus length of transmission line may be wound into a coil and secured with tape or strap. The transmission line may be attached to interior walls with insulated tapes.

Note.—The transmission line must not be allowed to pull the antenna to one side towards support so that it hangs with the center line more than slightly deflected from the vertical. A transmission line at an angle of 45° or more in the plane of the antenna wires will do this. It will then be necessary to straighten up the installation so that it hangs symmetrically. This may be accomplished by stretching a strong, light rope from a point on the transmission line just below the transformer to a convenient anchorage, so that the short length of transmission line between crossover insulator and transformer becomes approximately vertical.

A pull at right angles to plane of suspension does not affect the performance of the Stock No. 9685. But with the "D" hand Auxiliary (No. 9689) attached, the symmetrical placement of the four short antenna wires about a axis, as near vertical as possible, is an essential to best performance. Any deflection must therefore be remedied in the manner described above.

(9) Strip the ends of the leads of the transmission line and attach to the two upper unmarked terminals on the Coupling Transformer.

(10) Receiver Coupling Transformer.—Attach the links to the "Ant" and "Gnd" terminals of the Coupling Transformer in such manner that they will fit the "Ant" and "Gnd" terminals or clips on the Radio Receiver chassis. Mount Coupling Transformer in place on receiver, being sure to use the links provided, as very short connections are essential to good performance.

Note.—New RCA receivers have three terminals on the back of the chassis, marked A2, A1, and C. The "Ant" terminal of the Coupling Transformer should be attached to A1 and

the "Gnd" terminal and ground wire to G. The A2 terminal is not used with the Spider Web Antenna installation.

(11) Ground.—Attach a ground wire to the "Gnd" (or G) terminal or clip of the receiver and carry to water pipe or metal stake driven 5 to 8 feet into the soil. A clean metallic connection should be made, using a proper ground clamp.

(12) Lightning Arrester.—Where local ordinance requires, a lightning arrester may be installed preferably on the outside wall at the point at which the transmission line enters the building. The two transmission line wires, stripped at entrance points, are to be connected as shown in Figure 1.

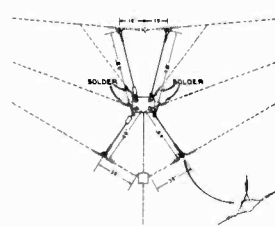

Figure 3—Auxiliary Antenna

(13) Auxiliary Antenna, Stock No. 9689.—To attach the Auxiliary Antenna wires, which are provided in a separate package containing four coils with insulators and choke or loading coils assembled, proceed as follows:

(a) Locate the points on the top and bottom main antenna wires to which the auxiliary wires are to be attached. These points are 18 inches from the center insulator for the top wires and 30 inches from the transformer on bottom wires. (See Figure 3.)

(b) Unwind one of the auxiliary coils that has the loading or choke coil attached, and lay it out in place with insulator end at the attachment point at left on the top main wire, and the other end at the crossover insulator. Take one of the tie wires, place it in groove round insulator and coil it firmly and securely round the main wire on both sides of insulator. It is recommended that these connections be soldered. Loop the other end of the auxiliary antenna wire through the top left hole of the crossover insulator so that the choke is one inch from the corner of the crossover insulator. Wrap the end of the wire one turn around itself and then several turns tightly around the main network antenna wire at this point, and solder in place.

(c) Unwind the other auxiliary coil with choke attached, lay out with insulator at attachment point at left on bottom main wire, and other end at crossover insulator. Attach

Additional requirements not supplied with the kit are:

- (1) One or more Nylon Porcelain Knob Insulators for carrying transmission line on side of building or other supporting surface.
- (2) One Porcelain-tube Lead-in Insulator or equivalent for entrance of transmission line into building.
- (3) One Ground Wire with Ground Clamp for connecting ground wire to water pipe or to stake driven 5 to 8 feet into the soil.
- (4) Lightning Arrester.—When demanded by local ordinance.
- (5) Two Antenna Poles and Rope for suspension. The poles should be at least 12 feet high, but will not be necessary if other suitable supports are available.

The auxiliary kit (Stock No. 9689) for ultra short-wave reception consists of:

- (1) Two antenna wire coils, each approximately 5 feet long and equipped with insulator.
- (2) Two antenna wire coils, each approximately 5 feet long and equipped with choke coil and insulator.
- (3) Four tie wires for attaching insulators in place on main network.

Location

Preliminary to the installation the location and direction of the antenna has to be decided upon. The following requirements must be given consideration in order to provide the best reception.

(1) Antenna wires must be well clear of roof and other surfaces or objects, particularly of metal. In the open, when the sides of buildings, trees or masts are used for suspension, the antenna wires should be free from all possible obstruction. Higher elevations will usually be found more advantageous. It is preferable to string the antenna at about the same height above ground at each support.

(2) The direction of the antenna wires should be such that the span is at right angles to the line of direction of the location of any station whose short-wave signal in particular it is desired to receive. However, the antenna should not parallel trolley wires, main automobile highways, telephone lines, power lines, and other sources of electrical wave production, but should point towards such causes of electrical disturbance in the immediate vicinity.

(3) A clear run of 38 feet between supporting points is required to allow for the strain or suspension wires or ropes and their attachment to rigid supports. Allowance must also be made for sag in the antenna wires. The mid-portion of the uppermost wires should be about 18 inches below the level of the top of the hangers. If pulled up too tight the wires are apt to break with added strain due to snow, ice, and wind in severe winter weather. Furthermore, the antenna, due to its design, will not hang properly if the sag is not approximately 18 inches.

When attached to swaying mast or tree it is advisable to use a pulley and rope with weight attached, or a coiled spring on the suspension line to relieve the tension and prevent breakage of the antenna wires in cases of stress.

(4) The path of the transmission line should be planned with locations for the nail-on insulators and the entrance into the building by means of the lead-in tube insulator.

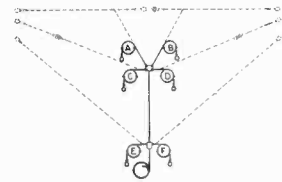

Figure 2—Antenna Laid Out Before Installation

Installation

If masts or other supports necessitating guy wires are used the wires should not be in lengths greater than 16 feet without interruption by means of insulators. Such insulators can be obtained from dealers, for building up long lengths of guy wires. The same also applies to strain wires from hangers to supporting points.

The following steps are advised as the simplest and best sequence for installation, and the avoidance of possible entanglement of the network.

- (1) Lay out antenna, as shown in Figure 2, on flat surface in convenient proximity to supports.
- (2) Remove shipping tape and carefully unwind coils A and B (Figure 2), keeping wire straight and free from twists. Make connection with special link, to top insulator of each hanger, as each wire is uncoiled. Make connection with special link, at center, with loop on coil A to insulator on coil B.
- (3) Unwind coils C and D (Figure 2), keeping wire straight and free from twist. Make connection with special link to center loop of each hanger as each wire is uncoiled.
- (4) Unwind coils E and F (Figure 2), keeping wire straight and free from twist. Make connection with special link to bottom insulator of each hanger as each wire is uncoiled.
- (5) Check the approximate length of transmission line required, and, if necessary, splice on additional lengths of same type of cable. This is obtainable from your dealer in lengths of 45 feet. These lengths should not be cut, but any excess should be coiled, taped and secured in a convenient location. If an auxiliary ultra short-wave antenna is being used it should now be connected in place on the main network as described in paragraph 13.

to main network as in paragraph (h) above, but with the choke coil two inches from the corner of the crossover insulator.

(d) Unwind and attach the other auxiliary coils on the right hand side of the main network in a similar manner to the two former.

Note.—The auxiliary installation should hang as near vertically as possible, as explained in paragraph 8 Note.

Service

Although easy to install, it may be preferable to have an experienced radio service engineer make the installation. A request to your dealer or service engineer should be made, and he will take care of the complete installation at a nominal charge.

Antenna Information

With the advent of "all-wave" radio receivers, the antenna installation has become a fundamental, rather than an incidental, problem. Short waves are used primarily because of their ability to travel great distances with relatively low transmitting power. Upon reaching the receiver, therefore, these waves are, in general, far weaker and fade much more severely than those from stations in the standard broadcast band (540 to 1,600 kilocycles). Obviously, the antenna must perform very efficiently in the short-wave spectrum; it must be able to transfer signals to the receiver with negligible loss or reliable results will be practically impossible.

Short-wave broadcasting covers a very wide frequency range, being segregated by international agreement into seven principal narrow bands located approximately at 11, 13, 16, 19, 25, 31, and 49 meters. There are also experimental bands between 5 and 10 meters. For any given length, an antenna will favor certain frequencies and tend to reject others. A system comprising a series of carefully bal-

anced doublets, however, admirably serves the purpose of covering the required wide range.

The Stock No. 9685 incorporates three distinct doublet-type antennas, and when the Stock No. 9689 is added, five. The doublets are of different lengths, being tuned to different frequencies. They are cross-connected, so that each compensates for weak points of the other at various intervening frequencies. Signals intercepted by the doublets are fed to the receiver through a balanced, twisted-pair lead-in or transmission line and a specially constructed receiver-coupling transformer. The length of the transmission line and coupling ratio of the transformer are correct, to afford proper electrical matching for greatest energy transfer.

While natural static is almost negligible in the short-wave spectrum, man-made interference is often very severe. Such interference usually is of local origin radiated by the house wiring or by external electrical apparatus, such as the ignition systems of passing automobiles. It is "picked up" by the ordinary antenna lead-in as well as the antenna proper. Doublet antennas, however, are particularly advantageous from a standpoint of noise reduction, since the transmission line does not form an active part of the system, but serves merely to transfer signals from the doublets to the receiver. In this system, complete rejection of signals "picked up" along the transmission line is achieved by means of a special shield in the receiver-coupling transformer.

There is yet another consideration involved. With an all-wave receiver, the antenna must not sacrifice performance in the standard broadcast and other low-frequency bands in order to obtain good short-wave reception. At frequencies below 4,000 kilocycles, therefore, this antenna system is converted to one approximating the conventional "T-type" arrangement, so that the transmission line acts as a part of the effective length. This change-over is performed automatically by an electrical filter circuit built integral with the receiver-coupling transformer.

Replacement Parts

| Stock No. | DESCRIPTION | Stock No. | DESCRIPTION |
|-----------|---|-----------|---|
| 12425 | Hanger—Antenna hanger complete with insulators..... | 12427 | Link—Connecting link—used at insulators—Package of 5..... |
| 4327 | Insulator—Antenna crossover insulator..... | 12424 | Transformer—Receiver coupling transformer..... |
| 12426 | Insulator—Antenna insulator—Package of 5..... | 12429 | Transmission Line—Special lead in cable—45 feet long..... |
| 4783 | Link—Coupling link—coupler receiver transformer for receiver chassis—Package of 10..... | 12430 | Transmission Line—Special lead in cable—90 feet long..... |

INSTRUCTIONS

for
INSTALLING AND ADJUSTING
the
RCA UNIVERSAL WAVE-TRAP
Stock No. 13467

The RCA Universal Wave-Trap is designed for use on radio receivers in localities where unusual interference is caused by intense signals from local transmitting stations. This interference is generally encountered in smaller types of superheterodyne receivers, and occasionally in the older models of all types of receivers, and is evidenced in one or more of the following forms:

- (1) "Whistles," "Beat Notes" or "Birdies" occurring while tuning to, or during reception of a station broadcast.
- (2) "Cross-Modulation" or the superimposing of a local station broadcast on the carrier waves of other stations which are being received.
- (3) "Long Wave" or "Code Interference"

heard over certain sections of, or over the entire tuning range of the receiver.

(4) "Blanketing" by an excessively strong local station which interferes with reception from desired stations, due to broad tuning.

The RCA Universal Wave-Trap will eliminate or at least greatly reduce these forms of interference within the standard broadcast range. The Wave-Trap may be continuously tuned over a range of from 435 to 1,700 kilocycles and will produce an attenuation of approximately 30 decibels (32:1 voltage ratio) to any signal to which it is tuned. This amount of attenuation reduces the strength of the interfering station to a point where it will not affect reception from other stations and will yet permit reception from the interfering station when desired.

Installation

A typical installation of the RCA Universal Wave-Trap is shown in the accompanying illustration. On one side of the unit are two screw-type terminals marked "A" (antenna) and "C" (ground) for connection to the external antenna system. On the other side are three screw-type terminals marked numerically and one soldering-type terminal for connection to the receiver. Two metallic links are provided to facilitate mounting the Wave-Trap to the antenna and ground terminals on radio chassis having suitable terminal arrangements.

Mounting

The Wave-Trap may be attached by links to receiver terminals, by lugs to the shelf or by lugs to the wall of the cabinet, as shown in Figure 1. Any one of the mounting methods may be used.

- (1) **Link Mounting**, with links from trap to antenna and ground terminals of receiver as on RCA radios with two or three terminals.

23195

In recent RCA Victor receivers there will be found one of three different arrangements for the antenna and ground terminals. Some earlier models utilize two spring slips, whereas all later models are equipped with either two or three screw-type terminals. Whether clips or terminals, however, the spacing is the same and the metallic links will fit equally well on either. Models with two spring clips or two screw-type terminals will be considered herein as identical and references made to the receiver antenna and ground terminals only, irrespective of their actual markings. For models with three terminals, the "A1" and "C" terminals correspond respectively to the customary antenna and ground terminals, the "A2" terminal affording connection to the built-in antenna coupler used with the RCA "RK-40A" Antenna System.

The mounting arrangement and connections for the RCA Universal Wave-Trap will differ fundamentally only with respect to the type of

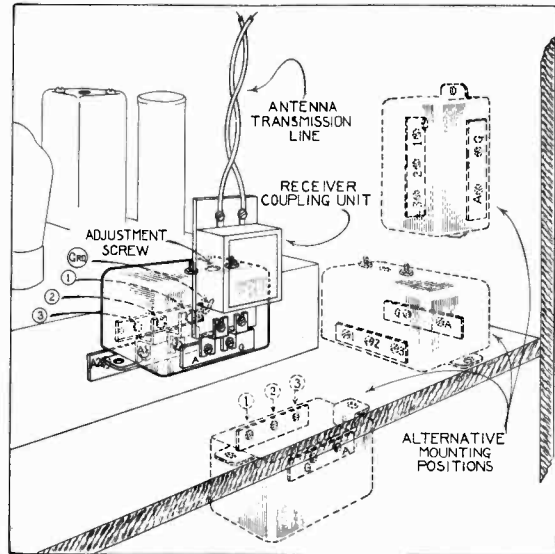

Figure 1—Typical Installation and Mounting Positions

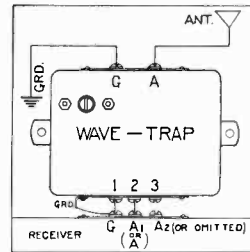

Figure 2—Single-Wire Antenna

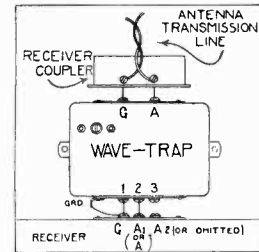

Figure 3—"Spider-Web" or "RK-40" Antenna

Adjustment

The Wave-Trap must be tuned to the frequency of the interfering signal. Screwdriver adjustment is provided by a variable air-dielectric capacitor C2, Figure 5, having a slotted shaft accessible through the shield-base of the trap. Adjustments, corresponding to the type of interference encountered are:

- (1) "Whistles," "Beat Notes" or "Birdies."—This condition is caused by excessive signals from two local stations whose assigned frequencies differ by the amount of the receiver i-f (460 kc on present RCA radios). It will therefore be necessary to determine the troublesome stations and to tune the Wave-Trap to one of them. This is accomplished by first tuning the receiver to the strongest interfering station and adjusting the Wave-Trap by means of the slotted shaft until its signal is reduced to minimum intensity.
- (2) "Cross-Modulation."—Tune the receiver to a desired weak station and listen care-

fully, during pauses of program, in order to determine identity of the interfering station. Check its frequency, tune in the receiver to the interfering station, and then adjust the Wave-Trap by means of the slotted shaft until the signal is reduced to minimum intensity.

- (3) "Long Wave" or "Code Interference."—This is produced by one or more stations each having an assigned frequency in the vicinity of the i-f of the receiver (460 kc on present RCA radios). Tune the receiver to a point in its range where the interference is plainly audible and then adjust the Wave-Trap to give maximum suppression of the interfering signal.
- (4) "Broad Tuning."—Tune the receiver accurately to the assigned frequency of the interfering station and then adjust the Wave-Trap to reduce its intensity to a minimum.

Special Applications

- (1) **Use of Two Wave-Traps.**—In extreme cases of interference, two Wave-Traps may be used. Connect the three-terminal strip of one Wave-Trap to the receiver, as previously instructed, and the two-terminal strip of the second Wave-Trap to the antenna, as previously instructed. Inter-connect the two Wave-Traps so that the terminal "1" on the one is connected to the terminal "1" on the other, and the terminal "A" to terminal "2". This places the trap circuits in series. Connect the soldering-lug on each trap to the ground terminal of the receiver. Both traps may be tuned to the same interfering signals or each trap to a different interfering signal.

- (2) **Lowering of Range.**—The range of the Wave-Trap may be lowered by the use of a ca-

pacitor of the required size to reduce the range limits to include a particular interfering frequency. This additional capacitor should be connected in parallel with the variable air capacitor of the Wave-Trap and its capacitance will be in accordance with the following information:

| Size of Capacitor microfarads | Approximate Range Kilocycles |
|----------------------------------|---------------------------------|
| 50 | 400 to 720 |
| 100 | 350 to 550 |
| 200 | 300 to 400 |
| 500 | 220 to 250 |

The attenuation of the Wave-Trap will be somewhat lower with the higher capacity shunting condensers.

antenna system employed. Connections for the conventional single-wire (inverted L) type antenna and for the three RCA all-wave antenna systems are described individually and shown in the accompanying diagrams. Special links may be obtained from your dealer when necessary.

Single-Wire Antenna.—Mount the Wave-Trap using the links to connect No. 1 and No. 2 terminals on the trap to the ground and antenna terminals respectively on the radio chassis. Use the "A1" terminal as the antenna post in RCA Victor receivers equipped with a three-terminal board. Connect the antenna lead-in and the external ground soldering lug to the "A" and "C" terminals respectively on the trap. (See Fig. 2.)

RCA "RK-40" Antenna.—Attach the Wave-Trap to the radio chassis with the links connected as described for the single-wire antenna. Then mount the receiver-coupling unit of the "RK-40" system upon the "A" and "C" terminals of the trap, using the two metallic links furnished with the antenna system. Connect the external ground soldering lug to the ground terminal on the receiver. (See Fig. 3.)

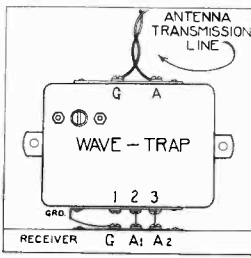

Figure 4—"RK-40A" Antenna

RCA "RK-40A" Antenna.—As mentioned in a foregoing paragraph, this antenna system can be used only with RCA Victor receivers equipped with the built-in antenna coupler, such receivers being identified by a three-terminal board on the radio chassis. Mount the Wave-Trap with the links connecting No. 2 and No. 3 terminals on the trap to the "A1" and "A2" terminals respectively on the radio chassis. From the transmission line (lead-in) of the antenna system, connect the black wire to the "A" terminal on the trap and the red wire to the adjacent "C" terminal. Attach the external ground soldering lug to the "C" terminal on the receiver. (See Fig. 4.)

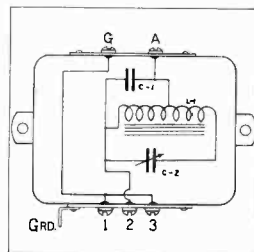

Figure 5—Schematic Diagram

- (2) **Shelf Mounting**, with the Wave-Trap attached to the chassis shelf, by means of the mounting lugs provided on the trap, in a location as close as possible to the receiver terminals. Connections are made with a short two-color twisted pair replacing the links used in method 1.

- (3) **Cabinet Mounting**, with the Wave-Trap attached to the inside of the cabinet, by means of the mounting lugs, in a location as close as possible to the receiver terminals. Connections are made with a short two-color twisted pair replacing the links used in method 1.

3

INSTRUCTIONS

for the

RCA "EARPHONE ADAPTER"

Stock No. 9715

Application

The RCA "Earphone Adapter" provides a convenient means for connecting an RCA Sonotone hearing aid to the radio set in the home. A rapidly increasing number of modern motion picture theatres equipped with RCA Sonotone attest the popularity of this new aid for the hard-of-hearing. Through RCA, the same Sonotone hearing aids used in such theatres installations are now sold separately by your local dealer for home radio use.

RCA Sonotone hearing aids (see Figures 2a, 2b and 2c) are of two types, operating respectively on principles of bone conduction and air conduction. Bone conduction is a recently developed technique wherein a tiny vibrator is employed to transmit sound to the auditory organs through the bones of the head rather than through the drumskin of the ear. Many people who have been totally deaf for years are enabled to hear clearly again with the RCA Sonotone bone-conduction device. This type of hearing aid is available in both comfortable head-band and attractive lorgnette handle models, while the air-conduction type (for persons with merely sub-normal hearing) is available only in the lorgnette-handle model. All models are equipped with a volume control in the connecting cord for convenient personal adjustment.

Installation of the Earphone Adapter does not deprive other members of the household of their radio privileges. Three alternative forms of radio operation are possible: (1) "Sonotone" alone, (2) "Sonotone" and loudspeaker together, and (3) loudspeaker alone. The first and second of these arrangements are obtained respectively by inserting the plug on the "Sonotone" cord either (1) fully or (2) half-way into the adapter, while for the third arrangement, the plug is removed entirely. Operation of a Sonotone hearing aid is extremely simple, consisting only of inserting the plug and adjusting the volume control in the connecting cord.

In addition to its primary purpose, the "Earphone Adapter" also may be used by persons with normal hearing for radio reception by headphones instead of loudspeaker. Many hotels and apartment houses require that radios shall be turned off at eleven or twelve o'clock at night, although the use of headphones after that time would be permissible. Any pair of standard headphones (see Figure 2d), with a total impedance preferably not over 40 ohms, will serve for this application.

Installation

Although there is nothing complicated or hazardous about installing the RCA "Earphone Adapter," you may prefer to have the work done by your dealer or service engineer. All connections to the radio set are made at the loudspeaker, the terminals of which are usually readily accessible. Installation is possible on an extremely wide variety of radio models, irrespective of make or circuit arrangement. To satisfy requirements of performance and safe operation, however, it is essential that the loudspeaker be of the dynamic type, either electrodynamic or permanent-magnet dynamic. Such loudspeakers have been used, with very few exceptions, in recent years by all radio manufacturers.

The actuating or voice coil in dynamic-type loudspeakers is of low impedance (corresponding closely to that of the RCA Sonotone), and is energized through a transformer which effectively isolates it from the chassis supply voltages. In radio sets equipped with magnetic-type loudspeakers, installation of the "Earphone Adapter" is not recommended since exactly the opposite conditions will be found. Speakers of the latter type have a very high-impedance winding, usually directly connected to the power stage on the radio chassis.

One other restriction should be observed. This concerns the power-supply requirements of the radio set and excludes those models designed for "Universal" (A.C. or D.C.) operation. In "Universal" sets, it is common practice to ground the radio chassis and loudspeaker directly to one side of the power line. A definite shock hazard therefore might exist, regardless of the type of loudspeaker employed, were the "Earphone Adapter" installed.

A typical installation of the RCA "Earphone Adapter" is shown in Figure 1. The adapter box is intended to be attached to the radio cabinet at the rear, in a position convenient for inserting the plug of the RCA Sonotone hearing aid or headphones. This box may be located on either side of the cabinet, although the mounting plate should be reversed when attached to the left-hand side (viewing front), so that the label will be below the plug receptacle. The mounting plate is secured to the box by means of two machine screws which can be removed easily for reversing the plate. Two wood screws are furnished separately for fastening the assembly to the cabinet.

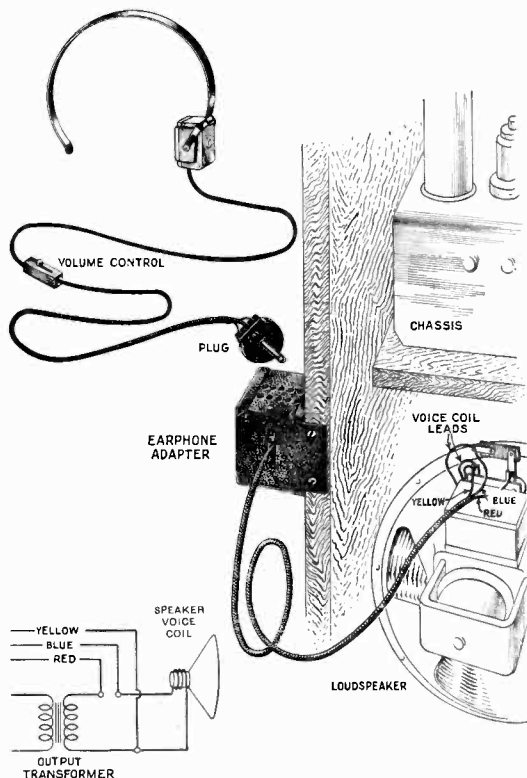

Figure 1—Typical Installation

Connections—A three-conductor cable extends from the rear of the "Earphone Adapter" for connection to the radio loudspeaker. The three cable wires are color coded for easy identification and should be connected as shown in the schematic diagram of Figure 1. First, disconnect one end of the loudspeaker voice coil from the output transformer secondary winding, then attach the adapter cable wires as follows:

- (1) Red wire to open end of output transformer secondary.
- (2) Blue wire to open end of voice coil.
- (3) Yellow wire to connection between opposite end of voice coil and output transformer secondary.

NOTE—It is unimportant which end of the voice coil is detached from the output transformer when making the above connections. In the event that one end of that circuit is grounded (which possibility should be checked initially), open the opposite end if possible. If the grounded end of the circuit must be used, make certain to detach the voice coil so that it will be isolated from ground.

These connections, considered from a diagrammatic viewpoint, are exactly alike for all receivers. Different radio models, however, employ different mechanical parts, and the actual arrangement of wiring for the "Earphone Adapter" therefore will require individual attention in each case. In general, little difficulty should be experienced since all connections are made at the speaker terminals and the radio chassis need not be removed.

The physical location of the output transformer in the radio set is immaterial. If this transformer is on the radio chassis, the speaker voice coil leads will be found connected to insulated terminals on the speaker frame, and it will be necessary merely to disconnect one of the transformer leads. In most cases, even where the output transformer is mounted upon the loudspeaker frame, a similar method of construction is employed and equal ease of connection will exist. With the output transformer on the speaker, however, there is a possibility that the voice coil leads will be found connected directly to terminals on the transformer, necessitating removal of a voice-coil (instead of a transformer) lead.

If one of the voice-coil leads must be removed, it should be anchored to an insulated terminal rather than spliced directly to the adapter cable wire. Such leads usually are very fragile and often are uninsulated, rendering provision of anchorage necessary or highly desirable. A small, double-terminal, insulated board is provided with the "Earphone Adapter" for this purpose. Use either terminal on this board for mounting, soldering to any convenient terminal on the output transformer or to the loudspeaker frame, and connect the loose voice-coil lead to the other terminal. It probably will be found advantageous in many cases to utilize this terminal board in a similar manner where one of the transformer leads can be removed and thereby avoid direct splicing to the adapter cable.

Operation

With the RCA "Earphone Adapter" installed, operation of the radio set will be no different from before. The volume control in the connecting cord of the RCA Sonotone receiver is the only additional adjustment involved, this control allowing convenient personal adjustment of volume independent of the requirement of other listeners using the radio loudspeaker. A separate volume control is, of course, unnecessary with standard headphones when used as suggested for late evening radio reception.

NOTE—If the radio is equipped with a low-frequency tone control, an improvement in response from the Sonotone receiver (or headphones) often can be realized by setting that control for "minimum tone." A tone control of this type is found in the MUSIC-SPEECH switches of many recent RCA Victor models, the SPEECH position affording best reception on the Sonotone or headphones.

Using the RCA Sonotone alone: Insert the plug all the way into the adapter box and set the Sonotone volume control at maximum loudness. Upon tuning in any broadcast program, adjust the radio volume control to a point where the loudness of reproduction is slightly greater than desired. Reduce the volume to the desired level by means of the Sonotone volume control, thus leaving a suitable range of adjustment to compensate for fading or a change of program affecting the signal strength.

Using the RCA Sonotone with the Radio Loudspeaker: Insert the plug half-way into the adapter box and set the Sonotone volume control at minimum loudness. Upon tuning in any broadcast program, adjust the radio volume control to the satisfaction of those listening to the loudspeaker. Then move the Sonotone volume control to a setting where the desired loudness of reproduction from the Sonotone hearing aid is obtained. If the Sonotone volume is insufficient with the cord control fully advanced (as may occur when a low room volume is being furnished by the loudspeaker), adjust the radio volume control as necessary to provide the required volume increase. This, of course, will be accompanied by a corresponding increase of room volume from the loudspeaker.

Using Standard Headphones: The RCA "Earphone Adapter" can be used to accommodate standard headphones as well as an RCA Sonotone hearing aid. As noted heretofore in these instructions, such headphones should be low in impedance for best results—preferably not over 40 ohms total. Insertion of the plug in the adapter box to operate headphones alone or in conjunction with the radio loudspeaker is exactly the same as for the RCA Sonotone hearing aid.

Using the Radio Loudspeaker alone: Independent operation of the radio loudspeaker is attained simply by leaving the plug on the RCA Sonotone hearing aid or headphones disconnected from the adapter box.

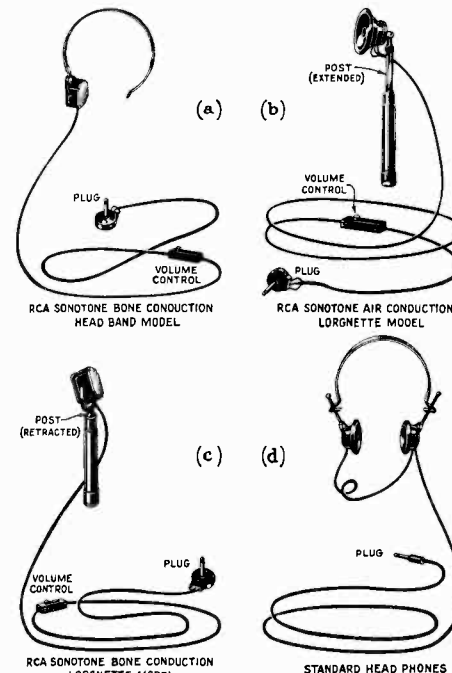

Figure 2—Sonotone Hearing Aids

Replacement Parts

| Stock No. | Description |
|-----------|---|
| 12851 | Switch Complete with insulating washers, mounting washers and nut |
| 12852 | Cable Adapted cable, 20 1/2 inches long (approximate) |
| 12853 | Resistor 5 ohms, wire wound |
| 12854 | Board Two-contact terminal board |

-INSTALLATION INSTRUCTIONS-

for the

RCA 395 Antenna

General

The demand for the simplest effective type of antenna to meet the requirements of "all-wave" radio receivers covering the long, standard and short wave bands has caused the development of this low priced antenna kit. Two supports 42 feet or more apart to give an elevation to the antenna wires of at least 10 feet above a roof or about 30 feet above the ground are the necessary requirements for installing

this aerial. Its two antenna wires are effective in picking up communications at frequencies varying from 140 to 23,000 kilocycles or more, covering the bands listed as "X", "A", "B" and "C" in RCA publications. This means that reception is obtainable on the 49, 31, 25, 19, 16 and 13 meter international broadcasting bands as well as on the long and standard wave broadcasts.

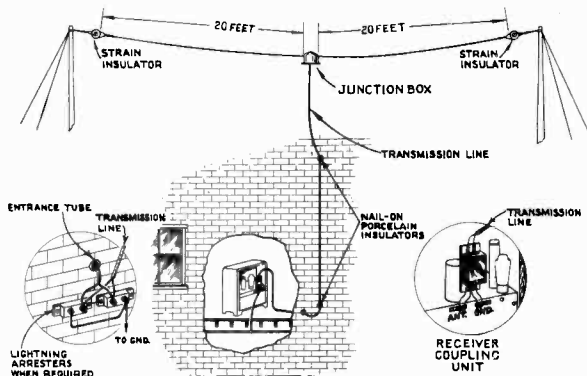

Description

The complete kit consists of the following parts:

1. Antenna Assembly comprising—
 - (a) Two Antenna Wire Coils each 20 feet long with Strain Insulator attached.
 - (b) Transmission Line Coil of special two conductor insulated cable 60 ft. long.
 - (c) Hermetically Sealed Junction Box to which the two antenna wires and the transmission line are connected.
2. Receiver Coupling Unit with two Links for attachment to Antenna and Ground terminals or clips on radio receiver.
3. Two Nail-on Porcelain Knob Insulators for carrying transmission line on side of building or other supporting surface.
4. Ground Clamp for attachment of ground wire to water pipe or to stake driven 5 to 8 feet into the soil.

25087-4

INSTRUCTIONS

for the

RCA CATHODE RAY TUNING KIT

Stock No. 9688

Maximum performance from your radio receiver and correct tuning indication is obtained only when installation of the Cathode Ray Tube is made in accordance with the following instructions. Read these carefully. Have the tuning unit installed by your RCA dealer whom you should also consult in all cases of doubt or difficulty.

The RCA Cathode Ray Tuning Kit is a new aid to exact tuning in radio receivers. It shows visually the ideal tuning point for best reception ("resonance") on each individual signal. In addition, it makes possible silent tuning, which means that the station you select may be precisely tuned-in before the volume

control is turned up. This visible tuning indicator in kit form is prepared for installation on radio receivers equipped with standard diode automatic volume control. The installation should be made by a competent service engineer.

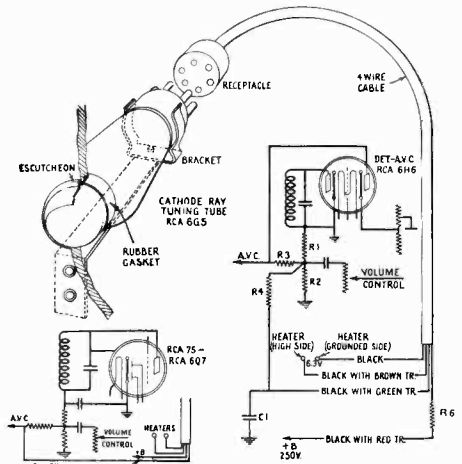

Figure 1—Cathode Ray Tuning Tube and Connections

25116-0

Location

Preliminary to the installation, the location and direction of the antenna has to be decided upon. The following requirements must be given consideration in order to provide for best reception.

1. Antenna wires should have at least 10 feet clear space above roof or other surface and from any metal parts of buildings or other objects. They should preferably be no less than 30 feet above the ground. This latter requirement refers to installations strung to buildings, trees or masts in the open.
2. The direction of the antenna wires should be such that the span is at right angles to the line of direction of the location of any particular station whose short-wave signals it is desired to receive. However, the antenna should not parallel trolley wires, main automobile

highways, telephone lines, power lines, and other sources of electrical wave production, but should point towards such causes of electrical disturbance in the immediate vicinity. It is preferable to string the antenna at the same height at each support.

3. A clear run of at least 42 feet between supporting points is required to allow for the strain wires and their attachment to rigid supports. Allowance must also be made for sag in the antenna wires. If pulled too tightly they are apt to break with the added strain due to snow, ice and wind in severe winter weather.
4. The path of the transmission line should be planned with locations for the nail-on insulators and the entrance into the building by means of a lead-in tube or other insulator.

Installation

The following steps are suggested as the simplest and best sequence for installation.

1. Layout antenna in convenient proximity to supports. Remove shipping straps and unwind both coils and transmission line.
2. Check the approximate length of transmission line required and if necessary splice on additional lengths of similar cable. This is obtainable from your dealer.
3. Suspension—Attach the suspension or strain wire or rope from one support to the strain insulator on one of the 20 foot antenna wires and secure in place.
4. String antenna in place to second support by means of rope and pulley or other means. Leave sufficient slack to prevent excessive strain in the antenna wire.
5. Transmission Line—Attach transmission line to wall or other exterior surface, with nail-on knobs or other insulators in such a manner as to avoid future damage to the insulation or to the line from effects of swaying, wind and weather. Carry through wall and attach to receiver. Any surplus length of transmission line may be wound into a coil and secured with the original shipping straps, or the cable may be cut off to the required length. The transmission line may be attached to interior walls with insulated staples.
6. Strip the ends of the leads of the trans-

mission line and attach to the two terminals on the Coupling Unit.

7. Receiver Coupling Unit—Attach the links to the "Ant" and "Gnd" terminals of the Coupling Unit in such manner that they will fit the "Ant" and "Gnd" terminals or clips on the Radio Receiver chassis. Mount Coupling Unit in place on receiver.

NOTE: Some RCA Radio Receivers are equipped with a three-terminal board on the back of the chassis. The terminals are marked A2, A1 and G. In this case the transmission line leads should be connected directly to the A2 and A1 terminals. The receiver coupling unit is not required.

8. Ground—Attach a ground wire to the "Gnd" or "G" terminal or clip of the Receiver and carry to water pipe or metal stake driven 5 to 8 feet into the soil. A clean metallic connection should be made using the ground clamp provided.

9. Lightning Arresters—Where local ordinance requires, a lightning arrester may be installed preferably on the outside wall at the point at which the transmission line enters the building. The two Transmission Line wires, stripped at entrance point are to be connected as shown in the accompanying sketch. A single unit three terminal lightning arrester may be used.

Service

Although easy to install it may be preferable to have an experienced radio service engineer make the installation. A request to your

dealer or service engineer should be made and he will take care of the complete installation at a nominal charge.

Replacement Parts

| Stock No. | Description |
|-----------|--|
| 9816 | Transmission line—additional length for long spans—45 ft. |
| 12855 | Receiver Coupling Unit and Links—for replacement purposes. |

Operation

The Tuning Kit is particularly effective on strong signals such as standard broadcasts.

To tune with the Cathode Ray Kit, first proceed in accordance with the operating instructions for your receiver. Then watch the Cathode Ray Tuning Tube as you rotate the Tuning Control knob backward and forward. The station is perfectly tuned in when the darker illuminated area is at its narrowest.

Silent tuning may be obtained by turning the Volume Control knob down, rotating Tuning Control to approximate scale reading for station, and then making final adjustments slowly and carefully to bring the dark green area to a minimum. Turn up the Volume Control to give the required volume of program.

Description

The Cathode Ray Tuning Kit, as sold, consists of the following items:

- (a) One RCA-6G5 Electron-Ray Tube.
- (b) One Eye-Type Escutcheon.
- (c) One Cable and Socket Assembly with resistor.
- (d) One Mounting Bracket and Clamp.
- (e) Two Mounting Screws.
- (f) Two Front Panel Washers.
- (g) Nuts and Washers for Panel Attachment.
- (h) Two Wood Screws—for use as mounting screws when practicable.
- (i) One Rubber Gasket for Securing Top of Tube in Escutcheon.
- (j) One Resistor (R5), approximately 18,000 ohms.

Auxiliary equipment may be required to suit your particular receiver, and this may be obtained from your distributor. It includes:

- (a) Resistor—One of approximately two megohms (R-4).
- (b) Capacitor—One of 0.025 microfarad (C1).
- (c) Transformer for use where 2-volt instead of 6.3-volt tubes are used on receiver.

The tube mounting bracket may be attached to cabinet or chassis, or the tuning tube may be mounted on a separate panel or in an ornamental box according to particular taste and convenience.

Installation

For installation and attachment to the cabinet panel of any radio receiver, it will be necessary to drill the cabinet and then make several soldered connections to the chassis.

The complete procedure is as follows:

- (a) Choose location for mounting the RCA-6G5 tube and cable, giving due consideration to ample space for mounting bracket, and freedom of cable from tuning control, grid raps, loudspeaker, and other receiver parts.

- (b) Remove chassis complete from receiver.

(c) Locate accurately the center points for the bracket and Cathode Ray Tube. Drill a hole, 1 1/2 inch diameter, for the escutcheon, and two holes, 3/8-inch diameter, for bracket mounting screws. If the wood screws are used for mounting these two holes will not be necessary.

(d) Insert the escutcheon in place in the 1 1/2-inch hole. It is advisable to make a few center punched indentations on the slotted flange to hold the escutcheon firmly to the cabinet.

(e) Assemble the bracket on the cabinet.

(f) Insert end of RCA-6G5 Radiotron with rubber gasket in place in the escutcheon in correct position for "casting shadow" in lower part of "eye". This means that the arrow on the base of the tube must point to left when looking at back. Then assemble Radiotron in bracket.

(g) Locate AVC-Detector-tube socket on chassis and decide positions for the cable tube and soldered attachments of the four cable connections; also location for mounting resistor and capacitor, if required.

(h) Drill a 3/8-inch hole in chassis, thread cable through and make the required soldered connections (see illustration).

1. The black heater lead is soldered to the ground side of the 6.3-volt filament supply, or to a separate 6.3-volt transformer when filament supply of receiver is 2.5 volts. (If a separate transformer is used, the center tap of the secondary winding, or one side of filament supply winding, must be grounded.)

2. The black with brown tracer lead is soldered to the other side of the filament supply.

3. The black with red tracer lead is soldered to a convenient point of 200-250-volt plate supply (B) in 1/4, 1/2 or 1 circuit.

4. The black with green tracer lead is connected in the AVC circuit, as shown in the illustration.

5. When the -B voltage exceeds 250 volts under any condition of power line voltage, the Resistor R5 is connected in series with the -B, black with red tracer, lead, as shown in the diagram.

6. When necessary, to reduce excessive flicker, the Resistor R4 and Capacitor C1 are connected in the circuit as shown in the diagram.

It is advisable to arrange with your RCA dealer for a service engineer to make the installation on your receiver, adjust it to your requirements and demonstrate its use and value.

Service

Ineffective operation should be called to the attention of your dealer or service engineer who has installed the kit on your receiver. In certain cases an improvement for clearer indication for particular stations may be made. Remember to keep your receiver in good operating condition by having your dealer or service engineer make periodical examinations.

—INSTRUCTIONS—

for the

RCA Universal Output Transformer

(Stock Nos. 7852 and 7853)

Modern radio receivers almost without exception contain a dynamic-type loudspeaker which receives electrical energy from a single-ended or push-pull power output stage. The plate-circuit impedance of the power tube or tubes is relatively high while the loudspeaker voice coil offers a very low impedance.

Therefore, transformer coupling between these parts must be employed in order to provide correct matching for greatest energy transfer.

In receiver design, it is accepted practice to build a special output transformer for each specific application and dealers obviously have been obliged to stock a large variety of units in order to make replacements without undue delay. This new "universal" or general-purpose output transformer now makes that procedure unnecessary. It can be adapted to satisfactorily match practically any combination of dynamic loudspeaker and power stage in common usage.

The "universal" output transformer consists of a mid-tapped primary to accommodate either a single-ended or push-pull power stage and a multi-tapped secondary affording a selection of fifteen different ratios for optimum matching. All terminals are numbered plainly and in accordance with the schematic diagram on opposite side. Numbers 1, 2 and 3 designate the primary start, mid-tap and finish respectively while numbers 4 to 9 indicate the various secondary points in sequence from start to finish. The number of turns between each pair of terminals as shown on the schematic diagram permits ready computation of the voltage ratio avail-

able with any arrangement of connections. Thus, for example, the ratio between Terminals 1 and 3 (primary) and Terminals 5 and 8 (secondary) is equal to $2700 / (28 + 33\frac{1}{2} + 38)$ or approximately 27 to 1.

Always use the full primary winding whether the power stage is single-ended or push-pull. In the former case, connect the plate of the power stage to Terminal 1, and the plate voltage (+B) supply to Terminal 2. For push-pull circuits, connect the plate elements to Terminals 1 and 3, and the "+B" supply to Terminal 2.

The choice of secondary terminals can be determined easily by reference to the "Matching" chart. Voice-coil impedances are shown horizontally and primary load impedances vertically. Adjacent to the vertical scale are given the type numbers of all well-known power amplifiers, thus indicating their correct load impedances both singly and push-pull. Simply locate the diagonal line nearest the intersection of those values on the horizontal and vertical scales which correspond to the existing impedances. Connect the loudspeaker voice coil to that pair of terminals whose numbers appear on this diagonal line.

Example—Let us assume that the power amplifier Type 2A5 is working into a loudspeaker with a voice-coil impedance of four ohms. From the chart, it will be seen that secondary Terminals 5 and 7 should be used if the power stage is single-ended, while Terminals 8 and 9 are proper for a push-pull arrangement.

Loudspeaker voice coils usually offer a fairly-constant low impedance at all frequencies within the central portion of the response range. With

increasing frequency above 1000 cycles, the impedance rises rather rapidly and in some reproducers, a sharp resonant peak exists in the region of 100 cycles where the impedance becomes many

times its mid-range value. Impedance ratings when listed designate the mid-range value which generally is from 10 to 20 per cent higher than the d-c resistance.

Obviously, maximum undistorted output will be obtained at frequencies where the voice-coil impedance is at an optimum value for the transformer ratio employed. When matching to the mid-range impedance is correct, best results will be insured in that range. Similarly, if matched to a higher than rated impedance, the mid-range output will be somewhat decreased but an improvement in response will occur at the higher frequen-

cies and also at the lower frequencies if the reproducer contains a resonant peak as noted in the foregoing paragraph. Such an effect is of course desirable to compensate for the decreased sensitivity of the human ear, and in some cases for a loss in output of the amplifier, at the extremities of the audio-frequency range.

In view of these considerations, it should be evident that the use of secondary terminals strictly in accordance with the chart is not always advantageous. Two alternatives usually are possible—maximum volume or best quality of reproduction. Where the first alternative is most important, no deviation from the chart is recommended. If ample undistorted output is available however, attention should be given to the improvement of tone quality, substituting those terminals represented by the next diagonal toward the right-hand side of the chart. With such connections, some sacrifice in volume is to be expected since matching to the mid-range impedance of the voice coil is incorrect.

This transformer will operate safely on plate voltages up to 500 at primary currents not exceeding 55 milli-amperes. It is available in two forms differing only in mechanical details. Stock No. 7852 is entirely open and fitted with a mounting bracket whereas Stock No. 7853 is submerged in insulating compound within a metallic case.

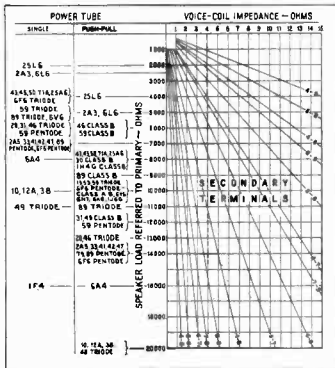

Figure 1—"Matching" Chart

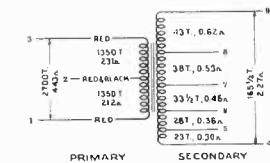

Figure 2—Schematic Diagram

times its mid-range value. Impedance ratings when listed designate the mid-range value which generally is from 10 to 20 per cent higher than the d-c resistance.

Obviously, maximum undistorted output will be obtained at frequencies where the voice-coil impedance is at an optimum value for the transformer ratio employed. When matching to the mid-range impedance is correct, best results will be insured in that range. Similarly, if matched to a higher than rated impedance, the mid-range output will be somewhat decreased but an improvement in response will occur at the higher frequen-

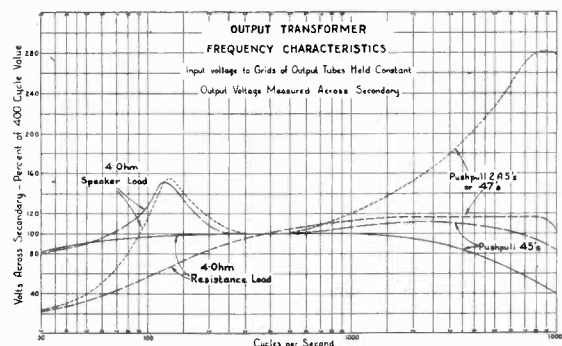

Figure 3—Typical Frequency-Response Curves

—INSTRUCTIONS—

for the

RCA Universal Audio Transformer

Stock Number 9632

This universal interstage audio transformer consists of a primary and secondary winding, both with mid-taps, assembled on a laminated iron core and semi-enclosed in metal case. Its overall dimensions are 2 x 2 3/8 x 2 1/2 inches including lugs.

It is designed as a coupling unit for operation from

(a) The plate of any general purpose triode such as: RCA-01-A, RCA-26, RCA-27, RCA-30, RCA-37, RCA-55, RCA-56, RCA-70, RCA-85 or RCA-4C5, or (b) The plates of any two of the above, acting as pushpull triodes.

to (a) The grid of a single class A amplifier tube, or (b) The grids of two class A amplifier tubes connected in pushpull.

The schematic diagram Figure 1 illustrates the functions and layout of this transformer together with windings and their total ohmic resistances, and leads with their color coding. It also indicates connections to tube terminals.

Further information with regard to this unit is as follows:

Turns ratio—Primary to secondary—1:3, overall.

Current—Primary winding—maximum—10 milliamperes D. C.

Frequency Characteristics—See Figure 3.—Three curves are given illustrating the operating characteristics of the transformer under different conditions. The response at the lower frequencies, when the transformer operates from a single plate, may be improved by connecting the transformer in the circuit according to the diagram, Figure 2. This shows a parallel feed circuit by means of which the D. C. is blocked out of the primary winding resulting in the curve B of Figure 3. A similar improvement in low frequency response, without any reduction in gain, may be obtained by replacing the resistor R-1 with a reactor of 100 henrys.

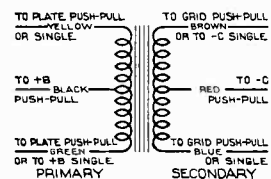

Primary Resistance—1400 ohms
Secondary Resistance—5800 ohms

Fig. 1—Schematic Diagram

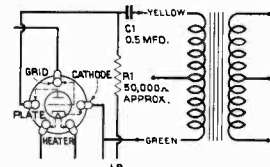

NOTE: THE RESISTOR R1 MAY BE REPLACED WITH A 100 HENRY REACTOR.

Figure 2—Diagram for Parallel Feed Circuit

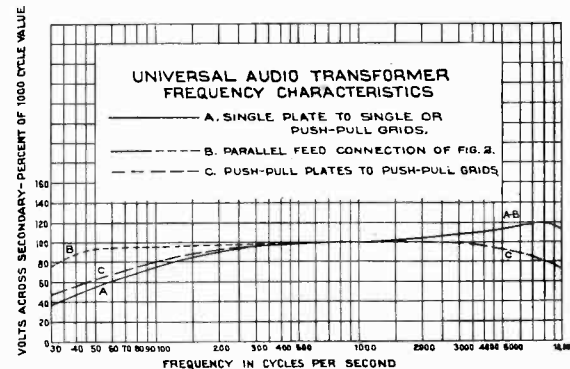

Figure 5—Characteristic Curves

**INSTRUCTIONS
FOR THE
RCA EXTENSION SPEAKER**

STOCK NO. 9695

Maximum performance from your Radio Receiver is obtained only when installation of the Extension Speaker is made in accordance with the following instructions. Read these carefully. It is best to have the unit installed by your RCA dealer whom you should consult in all cases of doubt or difficulty.

The RCA Extension Speaker may be attached to your Radio Receiver in order to improve sound distribution or to enable a broadcast program to be heard in two different rooms.

DESCRIPTION

The unit consists of a permanent magnet loudspeaker and RCA Universal Output Transformer mounted with switch in a small ornamental cabinet. A two wire cable is required for connections from the Extension Speaker cabinet to your Radio Receiver. Different lengths of cable are available from your dealer to satisfy your particular requirements.

CONNECTIONS

Before making connections it is necessary to know the "Voice Coil Impedance" of the loudspeaker on your Radio Receiver. Your RCA dealer will supply you with this information.

All connections should be soldered.

1 - Connect the two leads from one end of the cable to the secondary terminals of the output transformer in your receiver, where the two transformer leads run to the loudspeaker.

2 - Connect one of the two leads from the other end of the cable to the free switch terminal at the back of the switch inside the Extension Speaker Cabinet.

3 - Connect the second cable lead and the free end of the lead from the other terminal of the switch, to the numbered Output Transformer Terminals in accordance with the following table. The additional instructions enclosed (25044-2) for the RCA Universal Output Transformer will guide you in making these connections. Either wire may be connected to either transformer terminal.

NOTE:
The primary terminals of the Output Transformer Nos. 1, 2 & 3 (Fig. 2) are taped up and not used in this application.

Receiver Loudspeaker
Voice Coil Impedance
(From Your Dealer)
Ohms

- | | |
|----|---------|
| 1 | 8 and 9 |
| 2 | 5 and 7 |
| 3 | 6 and 8 |
| 4 | 7 and 9 |
| 6 | 5 and 8 |
| 8 | 6 and 9 |
| 10 | 4 and 8 |
| 12 | 5 and 3 |
| 15 | 4 and 9 |

Extension Speaker
Output Transformer
Terminals

The Extension Speaker will now give sound reproduction equal in volume to that from the Speaker of your Radio Receiver. The switch turns your new unit "on" or "off."

MODIFIED SOUND OUTPUT

It may be desirable to obtain less or greater volume from your Extension Speaker than from your Main Speaker. This may be done in two ways.

1 - The Extension Speaker, as shipped, has the "Voice Coil" leads, connected to terminals 6 and 8 on the Output Transformer. These may be changed, to vary the sound volume ratio; for instance, when attached to terminals 8 and 9 a ratio of 3 to 1 is obtained.

2 - The easier and more advisable method of changing the Sound Volume ratio is to make the connections of cable lead and switch lead (See connections, paragraph 3) to a different pair of Output Transformer Terminals.

Example: - The Voice Coil Impedance of the Radio Receiver Loudspeaker is found to be 6 ohms. For equal volume ratio the cable and switch leads should be attached to terminals 5 and 8 according to the table. For less volume from Extension Speaker connect to 6 and 9 or 4 and 8, etc., till the most satisfactory position is found. For greater volume from Extension Speaker connect to 7 and 9 or 6 and 8, etc.

The ratio of sound volume in the two speakers may be estimated from ohmic values. When computing ratio of sound volume from ohmic values, the installer must take into consideration the resistance of the connecting cable; for instance, the resistance of 50 feet of cable, two conductor, each 10 strands of 30 g. wire, is approximately 1 ohm.

RCA MANUFACTURING CO., INC.
Camden, N. J., U.S.A.

25220-1

25220-1

RECEIVER CHASSIS LAYOUTS

RCA VICTOR INSTRUMENTS — 1937-8 LINE

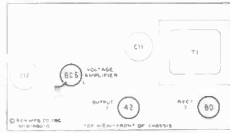

R-96, R-97

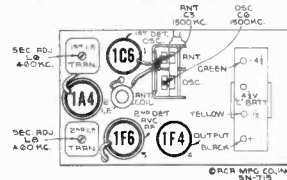

84BT

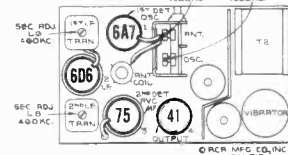

84BT6

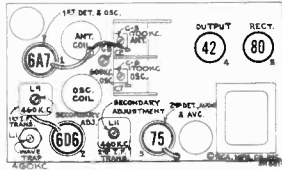

5T1

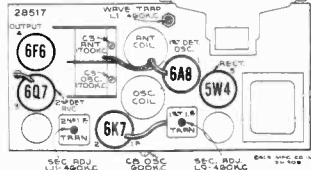

5T6, 5T7, 5T8

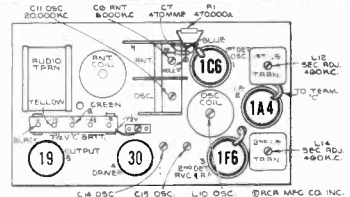

85BK, 85BT

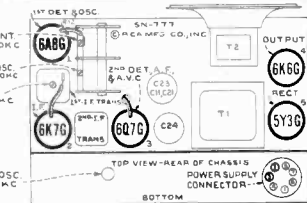

85BT6

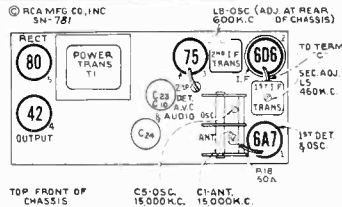

85E, U-102E

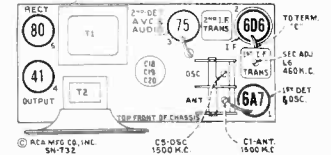

(Speaker separate on 85T2)

85T, 85T2

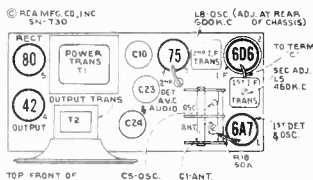

(Speaker separate on 85K)

85K, 85T1

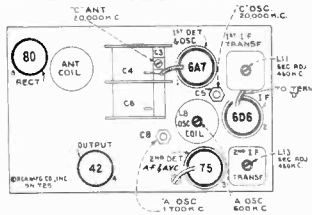

85T5

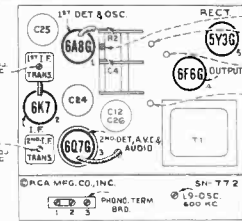

85T8

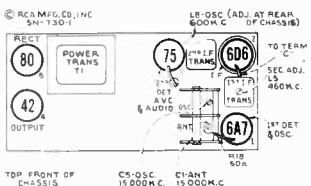

U-101, U-103

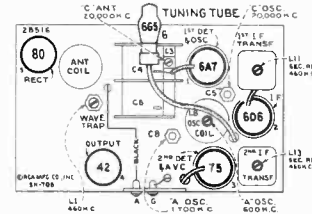

6T5

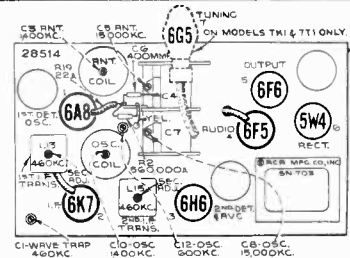

6K3, 7T1, 7K1

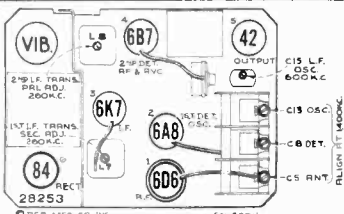

67M

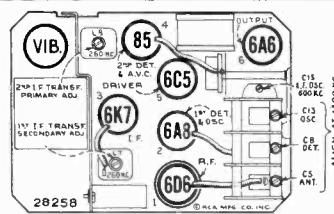

67M1, 67M2, 67M3

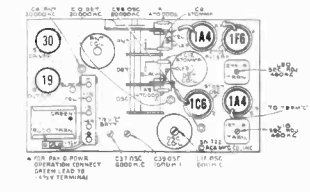

86BK, 86BT

RECEIVER CHASSIS LAYOUTS - CONTINUED

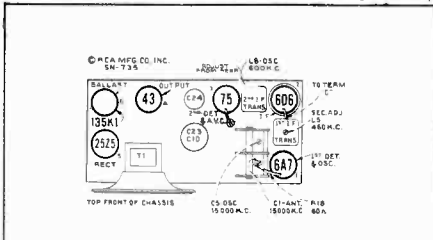

86X

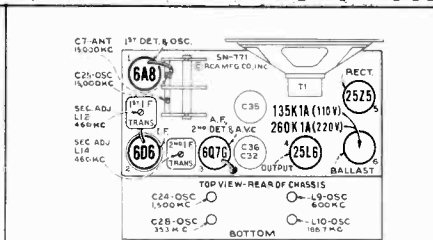

86X4

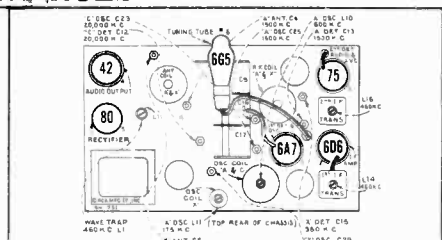

86T4, 86T44

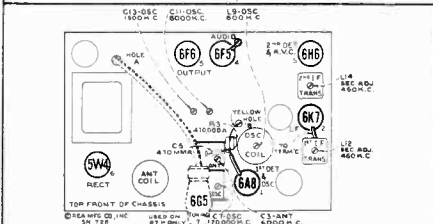

86E, 86K, 86K7, 87K

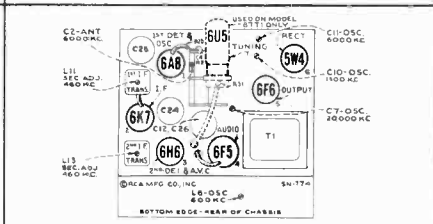

86T2, 86T3, 87T1

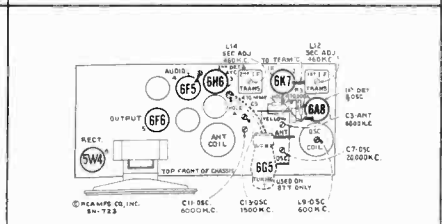

86T, 86T1, 87T

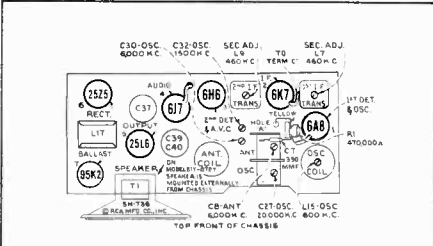

87EY, 87X, 87Y

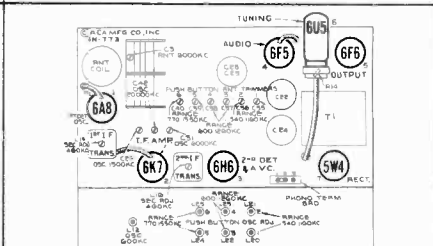

87KI, 87K2, 87T2

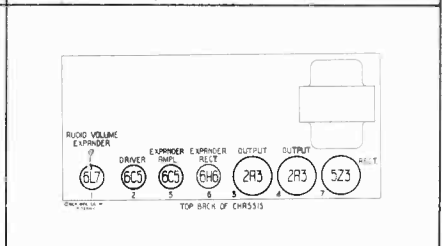

R-99

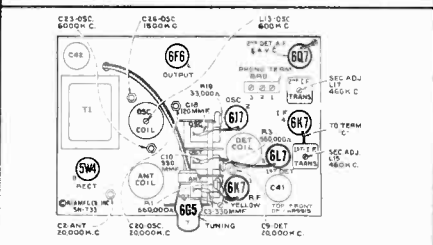

88K

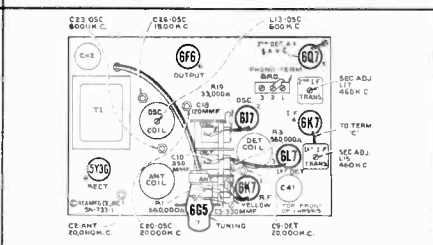

88U, 88U2

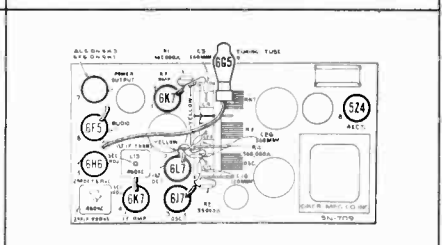

9K1, 9K3

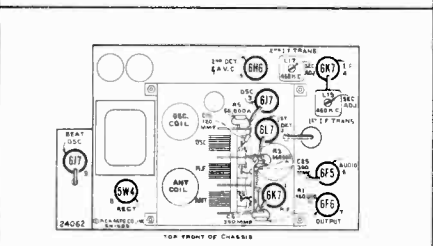

ACR-155

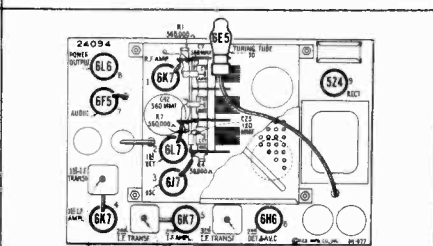

10K1, 10T

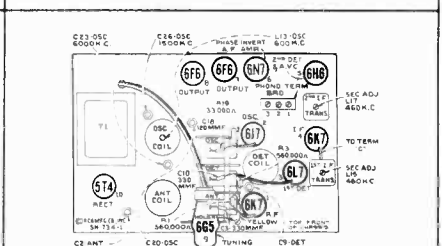

U-105, U-107, 810K, 810KI, 810T

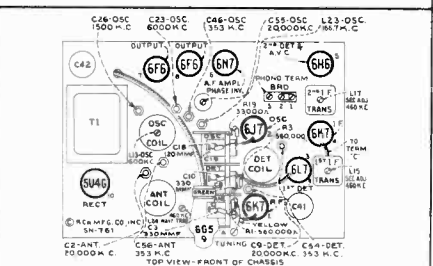

810T4

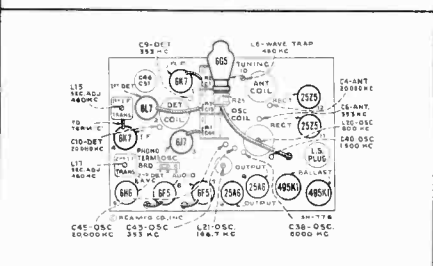

812X

RECEIVER CHASSIS LAYOUTS - CONTINUED

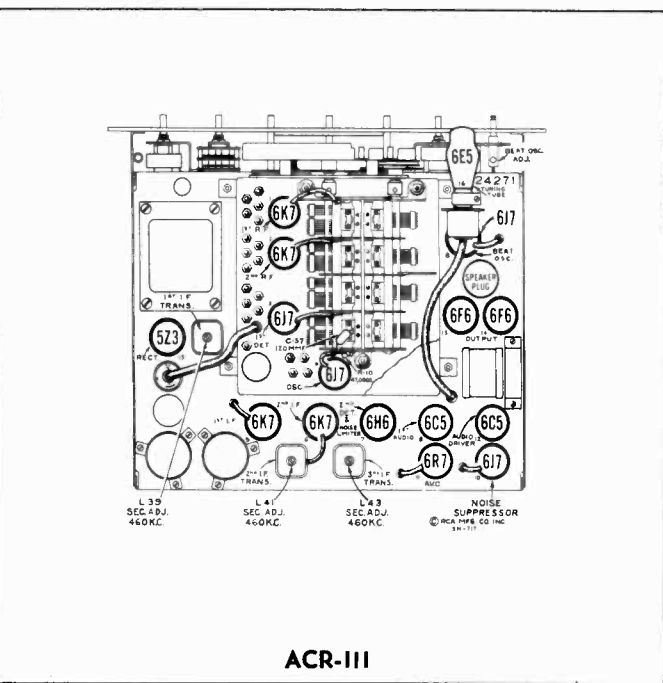
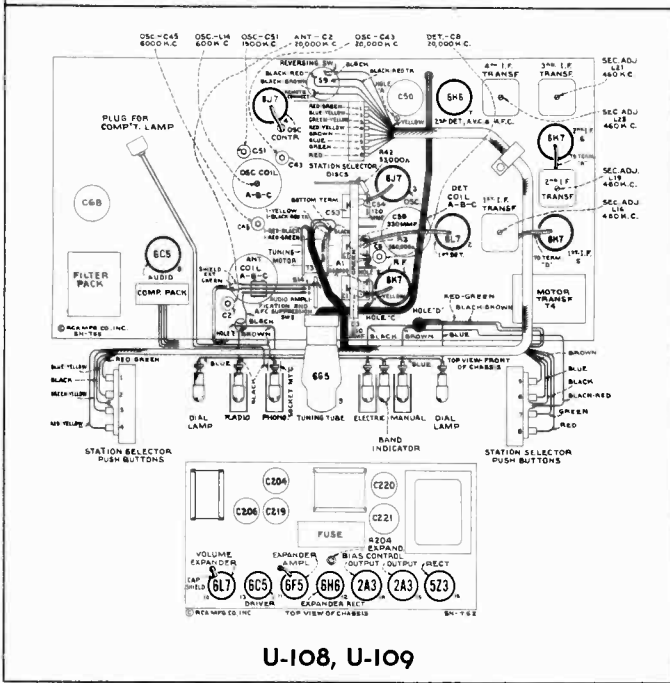
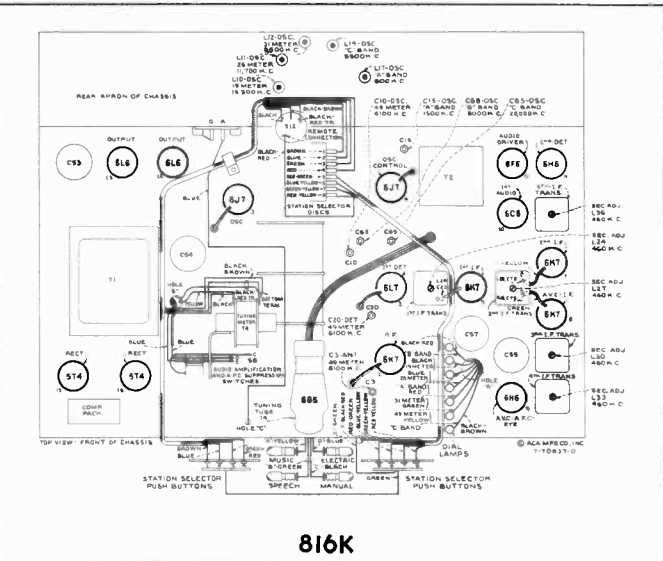
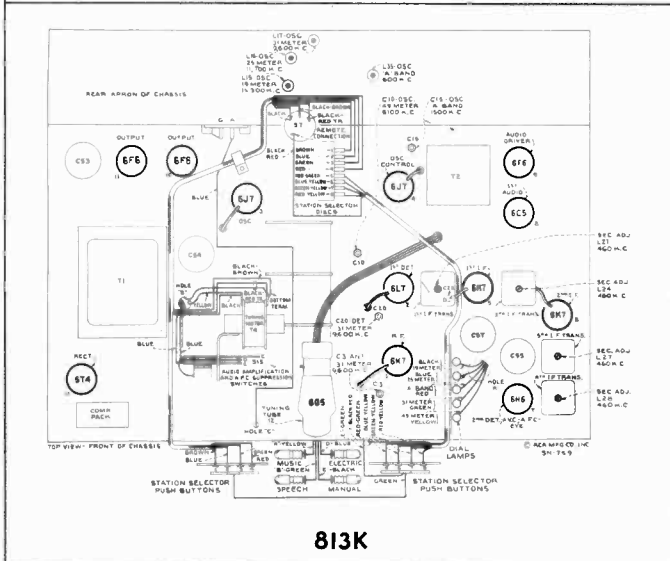
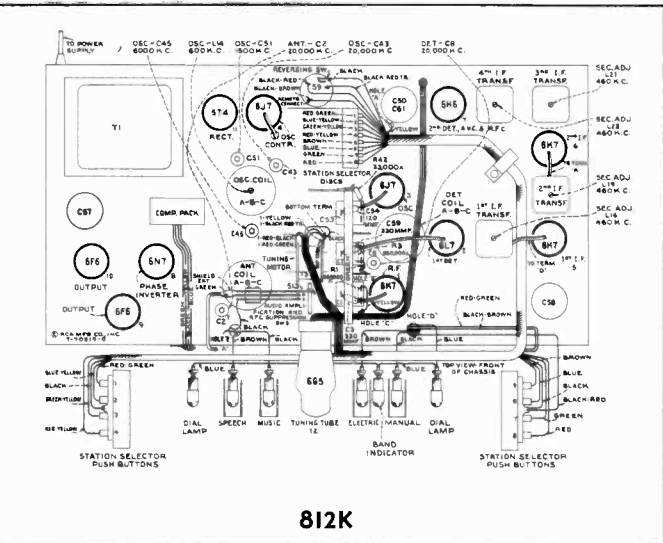
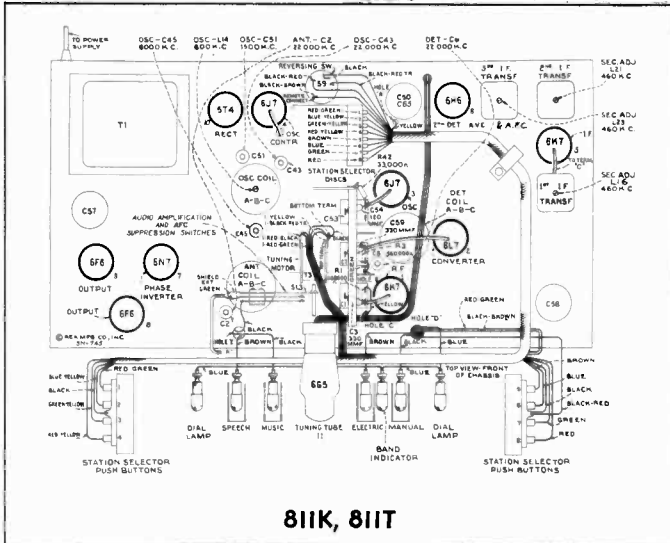

A MODELS 5T6, 5T7, 5T7-0, and 5T8

The small, black, insulated 1.8 ohm resistor (R16), which connects from the "hot" side of the 5P6 heater circuit to the terminal strip directly behind the volume control, should be replaced on all chassis passing through service shops for repair. The replacement resistor, Stook #14301 is a wire-wound type, with the resistance element enclosed in a ceramic tube. This resistor is in series with the pilot lamps and serves to reduce voltage.

B MODEL 5T7-0

This instrument has a chassis and speaker identical with those of Model 5T7. The cabinet finish is plain maple instead of blonde maple as on the 5T7. All electrical and mechanical service data of 5T7 are directly applicable to 5T7-0.

C MODELS 9K, 9K1 and 9K3

A blocking action which prevents reception over a section of the low-frequency end of the scale is generally curable by replacement of the 6L7 first-detector tube. Should this not be effective, reduce the 8J7 oscillator grid leak from 56,000 ohms to 33,000 ohms. The 56,000-ohm resistor of the 6L7 injector-grid circuit should also be lowered to 33,000 ohms. The value of the oscillator grid-coupling capacitor is very critical and no replacements other than stock #12724 should be used.

D MODEL 85K

A limited number of instruments have the loudspeaker mounted in such a manner that one of the mounting studs is directly in line with the output transformer. In some cases, this stud may protrude to the extent of striking the transformer winding and the circuit will be shorted, resulting in low over-all sensitivity or weak output. The condition should be corrected, where necessary, by removing the speaker and revolving it approximately 45 degrees to a new mounting position, so that the transformer does not fall opposite a stud.

E MODELS 85T and 85T-2

On some chassis, where it is necessary to replace the stock #14669 capacitor pack, several thicknesses of fish paper or its equivalent is required between the mounting clamp and the capacitor unit in order to obtain a secure assembly. When replacing this pack, it is advisable to install a 56,000-ohm, 1-watt resistor (Stook #12875) from the oscillator coil terminal L-4 (plus B) to the chassis. This resistor will improve surge conditions in any localities where they are abnormal.

F MODEL 85T1

Resistor R-13, which forms part of the divider system supplying residual bias to the first detector and I-F stages, must be of the correct value. In receivers where sensitivity is poor, variation of value of this part should be checked as a likely cause. If measurement apparatus available does not extend to 6.8 megohms, the resistor should be replaced with a standard Stook #14661 unit. Removing R-13 from the circuit entirely will be permissible where a slight excess of sensitivity can be tolerated.

Unstable performance at the high frequency end of the "C" band may be due to super-regenerative action in the oscillator-detector circuits. Careful re-alignment of the "C" band circuits will correct most cases of this trouble, however, it may be necessary to replace the oscillator resistor R-2. This resistor should have 33,000 ohms resistance. The "C" band circuits must be aligned at 16,000 Kc, with the heterodyne oscillator stage tracking 460 Kc below the signal frequency.

G RCA REPLACEMENT POWER TRANSFORMER - STOCK #30607
 Rating:- 100/130 and 200/260 Volts, 40 - 60 Cycles

Stook #30607 is an extra-duty transformer, designed to give good service under adverse conditions of high line voltage, low frequency limits, and high ambient temperature. This transformer is supplied for Service Replacement purposes on various five and six tube instruments, superseding the following types:-

| Stook No. | Used In Models | Stook No. | Used In Models |
|-----------|-----------------------------|-----------|--------------------|
| 13392 | 5U, 5T5, 5T4, 85T5 | 14655 | 85T1, U-101, U-103 |
| 13393 | " " " " | 14657 | " " " " |
| 12644 | 5T, 5T6, 5T7, 5T8, 5T1, 5T5 | 14668 | 85T |
| 13869 | 5T5 | 14668 | " |

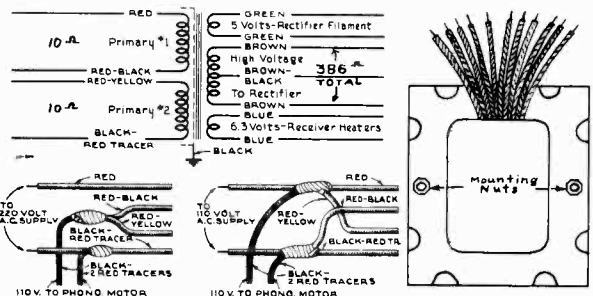

MOUNTING - Two types of mounting are provided; the type to be used depending on the particular chassis base arrangement. The mounting lugs are to be employed in most applications. When screw mounting is necessary, break off the mounting lugs by bending; remove the two nuts shown above; place the transformer in position and replace the nuts on the underside of the chassis base so as to secure the transformer.

CONNECTIONS - For use on 100-130 volts power supply; splice RED to RED-YELLOW and RED-BLACK to BLACK with RED TRACER.
 For use on 200-260 volts power supply; splice RED-BLACK to RED-YELLOW.

All leads are approximately 15 inches long and must be cut to the proper length.

H MODEL 87K1 - ADDITIONAL REPLACEMENT PARTS

- 30695 Card -- Station call letter card
- 30846 Core -- Adjustable core and stud for "A" band oscillator coils
- 13477 Resistor -- 27,000 ohm, carbon type, 1 watt (R19)
- 12007 Spring -- Retaining spring for core Stook #30846

J CAPACITOR REPLACEMENT - Stook #12897

Occasional difficulty may develop on receivers employing the Stook #12897, 4700 mmfd, molded-capacitor in high-voltage circuits. Failure is generally in the form of low leakage resistance, or complete short circuit. The effect on receiver performance may be exhibited as erratic operation, insensitivity, or lack of oscillation and signals on "A" band. It is to be recommended that this capacitor be replaced on all chassis which require service for any of these reasons. Replacement and later production capacitors of the stock #12897 type are rated at 500 volts, and are tested at a sustained voltage of 900 volts, A-C. Instruments having this unit are:-

| Model | Symbol | Circuit Location | Model | Symbol | Circuit Location |
|--------|--------|------------------|-------|--------|------------------|
| 88K | C-6 | Plate R-F | 816K | C-5 | Plate R-F |
| | | | | C-18 | Screen Osc. |
| 810-T | C-6 | Plate R-F | | C-74 | Plate AFC |
| 810K | C-6 | Plate R-F | U-106 | C-6 | Plate R-F |
| 810-KL | C-6 | Plate R-F | | | |
| 811K | C-5 | Plate R-F | U-107 | C-6 | Plate R-F |
| | C-49 | Plate AFC | | | |
| 812-K | C-5 | Plate R-F | U-109 | C-5 | Plate R-F |
| | C-49 | Plate AFC | | C-49 | Plate AFC |
| 813-K | C-5 | Plate R-F | | | |
| | C-18 | Screen Osc. | | | |

K MODEL 88K - 110-220 VOLT POWER TRANSFORMER

Stook No. 14994 is a 110-220 volt, split primary, 60-60 cycle power transformer, which may be used for replacement in Model 88K, when it is necessary to adopt this instrument to 220 volt operation. The wiring color code and d-c resistance values are shown in Service Note for Model 88U.

L MODEL 810K1 - ADDITIONAL REPLACEMENT PARTS

- 5040 Connector -- 4 contact female for reproducer interconnecting cable.
- 30667 Connector -- 4-contact female with metal shell for reproducer cable.
- 30668 Connector -- 4-contact male with metal shell for reproducer interconnecting cable.

M PUSH BUTTON RELEASE - ELECTRIC TUNING

Provisions are incorporated on the Electric Tuning control buttons for simple release where the entire group of eight have been pushed in and are latched.

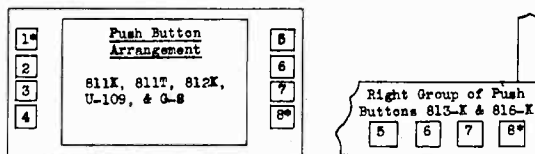

When all eight buttons are latched due to error or tampering, it is only necessary to push either the number 1 or number 8 button on the 811K, 811T, 812K, U-109 or G-8 type; while on the 813-K and 816-K, push the number 8 button. These buttons are asterisked in the above diagrams. In pushing the indicated buttons they must be forced slightly (more than required for tuning) so as to actuate the auxiliary release lever.

CLUTCH PIN ON ELECTRIC TUNING MOTORS

The small clutch pin, which is fitted to the end of electric tuning motor shaft, and engages with the gear mechanism may be obtained separately as a replacement by ordering stock #30262. Five pins are supplied in each package.

A CONTINUOUS OPERATION - ELECTRIC TUNING DRIVE

The mechanical drive mechanism of the Electric Tuning Instruments is not rated for continuous operation over sustained periods. Tests and demonstrations which require constant running should therefore be avoided. Temperature rise of the motor coils, wear of contact fingers, wear of gears, and wear of bearings are likely consequence of abnormal operation. Under conditions of regular operation, wear and mechanical deterioration of parts will not become excessive within several years of usage.

ARCING CONTACTS - ELECTRIC TUNING DRIVE

Noisy reception due to an arcing condition at the selector disc contacts should be remedied by the following procedure:

- (1) Thoroughly clean all excess grease and dirt from the selector discs. It is necessary to clean between the discs as well as on their edges. Carbona or an equivalent cleaning fluid may be used if necessary.
- (2) Clean and polish spring contacts with a plain cloth or crocus cloth.
- (3) Complete cleaning and polish the periphery of each disc with crocus cloth. Make sure the insulating segment is smooth and clean.
- (4) Moisten a cloth with a very slight amount of Vaseline or Petrolatum and apply sparingly to discs. Wipe off excess, so that only a film remains.
- (5) Check adjustment of contact springs.
- (6) Check instrument for operation.

B 40-CYCLE OPERATION - MODELS 811K, 811T, 812K, 813K, 816K

These instruments may be operated on 40-cycles, 115-volt, A-C circuits by making the following modifications:-

- (A) Standard 105-125 volt, 50-60 cycle instruments (Rating A) to be altered as follows for 105-125 volt, 40-cycle operation:
 - (1) Replace power transformer with either the 25 cycle, or the Universal type (105-240 volts) specified in Service Notes for particular instrument concerned.
 - (2) Insert a 5 ohm, 25 watt resistor in series with one of the "yellow" leads of the power transformer secondary winding which supplies drive motor current.
- (B) Where the instrument available is 105-125 volts, 25 cycles (Rating B) -
 - (1) Change Electric Tuning motor to 60 cycle type.
 - (2) Add resistor as in (2) of "A" above.

C ADDITIONAL REPLACEMENT PARTS - MODELS 811K, 811T, 812K

R-34, 18,000 ohm tuning tube plate resistor is omitted on some instruments.

- 30623 Capacitor -- 1.0 mfd. (C27)
- 30567 Connector -- 4-contact female with metal shell for reproducer cable.
- 30552 Resistor -- 120,000 ohms, special carbon type, 1/4 watt (R41)
- 5040 Connector-- 4-contact female for reproducer interconnecting cable.
- 30568 Connector-- 4-contact male with metal shell for reproducer interconnecting cable
- 30569 Escutcheon - Station selector dial and tuning tube escutcheon and crystal complete with "Speech-Music" and "Electric-Manual" indicating screens - less right and left-hand side panels for buttons.
- 30570 Escutcheon - Right and left-hand side panels - less buttons, call letter cards, retainers, celluloid shields, and metal front plates.
- 30670 Screws - Screws for attaching metal retainer plate on escutcheon side panels.
- 30675 Retainer - Metal retainer plate for Electric Tuning Buttons on escutcheon side panels.

OSCILLATOR STOPPAGE OR INTERMITTENCY - MODELS 811K, 811T, 812K

Where trouble develops on these receivers due to lack of oscillation on "A" band, or intermittent variation of sensitivity, capacitors C-5 and C-49 should be carefully checked for leakage or short circuit. A d-c voltage in the order of 500 should be applied to these parts as a check for breakdown.

D DIAL CALIBRATION - MODELS 813K and 816K

Abnormal variations of dial readings on the 49, 31, 25, or 19 meterspread bands, from the correct frequency, may be caused in some instances by insecure contact at various points in the oscillator circuit. The following points should be carefully checked should this type of trouble be exhibited:-

- (1) Poor or intermittent contact of the oscillator section of the range switch. The rotary disc may be loose on the shaft causing

insecure and irregular connection. A metal or wooden wedge should be driven between the disc and the shaft to make the two rigid with each other.

- (2) Intermittent contact of the metal sleeves or spacers on the support rods of the band switch will upset the ground circuit and produce frequency variations. These should be tightly pinched with a pair of pliers at their ends in order to provide solid contact with the assembly rods.
- (3) The connection between the feet of the band switch shield partitions and the chassis must be secure. Soldering of the shield to the chassis is effective in eliminating variations of ground circuit at this point.
- (4) Vibration of rear end shield partition of the band switch may be causing trouble. A strip of felt, mounted on the chassis shelf directly below the rear partition, to prevent its vibration, will be of considerable advantage.
- (5) Variation of r-f potential of band switch shaft and consequent change of circuit constants may be minimized by grounding the inner end of the shaft with a flexible pigtail to the chassis.

OSCILLATOR CAPACITORS - MODELS 813K and 816K

The 100 mmfd. molded Lucite capacitors which connect in parallel with the bandspread oscillator tuning condenser for short-wave operation, are specially designed to have a negative thermal coefficient of capacity to compensate for variations in other parts of the oscillator circuit with temperature changes. These capacitors are therefore, not inter-changeable with ordinary types and replacements should always be of the particular RCA stock number specified in the Replacement Parts Lists. Care must be exercised in replacing these parts, to avoid twisting the leads excessively and allowing too much heat to be applied when soldering.

ADDITION OF RESISTOR - MODELS 813K and 816K

Resistor, Stock #30647, 1.8 ohms, with a five ampere maximum current rating, is now specified for use in the circuit supplying the "Music-Speech" and "Manual - Electric - Remote" indicating lamps. This part should be installed on all chassis of Models 813K and 816K requiring service in the field. It may be conveniently added to the circuit in place of the "brown" lead which connects from the front section of the range switch to the "Manual-Electric-Remote" switch.

E ADDITIONAL REPLACEMENT PARTS - MODEL 816K

- 30623 Capacitor - 1.0 mfd. (C28)
- 30647 Resistor - 1.8 ohm resisto-fuse, 1 amp. (R42)
- 30567 Connector - 4-contact female with metal shell for reproducer cable (on some models only)
- 5040 Connector - 4-contact female for reproducer interconnecting cable (on some models only)
- 30568 Connector - 4-contact male with metal shell for reproducer interconnecting cable (on some models only)

F ADDITIONAL REPLACEMENT PARTS - MODEL 84BT

- 14827 Drive - Vernier Drive

On some instruments, speaker marked 76474-1 is employed. The following Replacement Parts apply to this unit:

- 30236 Cone - Cone and dust cap (L9)
- 5118 Plug - 3-contact male plug
- 30237 Transformer- Output transformer (T1)

BLOCKING OF MODEL 84BT

Should any blocking tendencies be noted on this receiver, the 1P4 tube should be exchanged. Blocking which is produced by the 1P4 tube is particularly noticeable when the battery switch is turned off and immediately turned on again. Wear on the contact of the battery switch may bring this action about when the receiver is first turned on. In such cases, it is advisable to replace the switch, and at the same time, investigate the condition of the 1P4 tube as well as the "B" batteries.

G 84BT6 TUBE COMPLEMENT

Some receivers of this type employ a '42 output tube. Present specifications call for an RCA-41 in the output stage and it is recommended that this tube be used for replacement on all receivers. The '41 fits the '42 socket, no circuit changes are necessary, and performance does not change. Battery drain changes to 2.65 amperes.

H ADAPTING BATTERY RECEIVERS TO 32 VOLTS - MODELS 85BT, 85BK, 86BT, and 86BK WITH CV-8 PAK-O-PWR

These 6-volt vibrator type receivers may be operated in conjunction with 32-volt farm lighting systems by using a standard 6-volt, medium-duty battery for direct supply to the receiver, and charging this battery from the 32-volt circuit thru a current limiting device such as a standard 32-volt lamp. With such an arrangement, connections to the receiver will be kept standardized, performance will not be hampered by possible hum interference, and positive protection will be afforded against harmful voltage variations.

The sketch below shows the proper connections. Accessories required are:- One 60-watt, 32-volt lamp; one socket for this lamp; one double-pole switch having five-ampere capacity; one medium-duty 6-volt storage battery; and necessary wiring.

(Continued on next page)

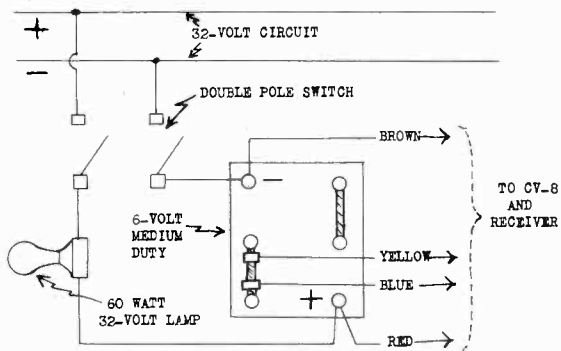

CHARGING - With a 60 watt, 32 volt lamp used in the charging circuit as shown, it will be necessary to charge the battery by closing the double-pole switch approximately as many hours as the receiver is used. The receiver should not be in operation while charging. Due to variations in batteries, their phases of life, etc. a slower or faster charge rate may be required. In the former case, a 50-watt lamp is recommended, and for the latter, a 75 watt should be used. Periodic hydrometer measurement of specific gravity will indicate the necessity for a higher or lower rate of charging.

A REPLACEMENT PART CHANGES - MODEL U-101

12675 Base - Pickup arm base and pivot shaft.

On 50-cycle instruments, C30 is 1,500 mmfd. and C51 is .07 mfd. These capacitors are on the compensator unit. Stock No. 13138, .01 mfd. (C30) and Stock No. 4841, 0.1 mfd. (C51) are used in 60 and 25 cycle instruments only.

13762 Capacitor - 1,500 mmfd. (C30) (50-cycle only)
14626 Capacitor - .07 mfd. (C51) (50-cycle only)

MODEL U-101 - SECOND PRODUCTION

This model may be readily identified by the rubber mountings and metal spider used to support the motor turntable.

Replacement parts listed for Model U101 are directly applicable to this model except as listed below-

MOTOR ASSEMBLIES

| Stock No. | Description |
|-----------|---|
| 30393 | Cap - Turntable spindle cap |
| 30385 | Motor - 110 volts - 50 cycle |
| 30386 | Motor - 110 volts - 50 cycle |
| 30387 | Motor - 110 volts - 25 cycle |
| 30388 | Rotor - Rotor assembly complete - comprising laminations, turntable, spindle and spindle cap - for 60 cycle operation. |
| 30389 | Rotor - Rotor assembly complete - comprising laminations, turntables, spindle and spindle cap - for 50 cycle operation. |
| 30390 | Rotor - Rotor assembly complete - comprising laminations, turntable, spindle and spindle cap - for 25 cycle operation. |
| 30392 | Spacer- Comprising one spindle and three rotor spider rubber spacers. |
| 30391 | Turntable - Turntable plate and cover only. |

Stock Nos. 14232, 14806, 14807, 14808, 14809, 14810, 14811, and 14812 are not used on Model U-101 Second Production.

B ADDITIONAL REPLACEMENT PART - MODEL U-105

11730 Cable - Pickup Cable and Connector

C PHONOGRAPH RUMBLE - Model U-107

In any instances where a rumble or low-frequency vibration causes interference in the reproduction of records, the same can be satisfactorily minimized by spacing the loudspeaker baffle board 3/8 inches away from the cabinet. Small metal or wood spacers may be used for this purpose, employing one over each mounting screw.

D ADDITIONAL REPLACEMENT PARTS - MODELS U-108 and U-109

| | | |
|-------|-----------|---|
| 12488 | Capacitor | - 270 mmfd. (C107) |
| 30623 | Capacitor | - 1.0 mfd. (C27) |
| 14781 | Plug | - 5-contact male for chassis power cable |
| 14793 | Plug | - 2-contact male for motor power cable |
| 14779 | Plug | - 2-contact male for radio input cable |
| 14782 | Plug | - 2-contact and guide pin male for power switch cable |
| 30693 | Plug | - 2-contact male for expander input cable |
| 30841 | Spring | - Tilt compensating spring for tuning motor |

C107 in the compensator unit has been changed from 2200 mmfd. to 270 mmfd. Replacements should be made with Stock No. 12488. All Models U-108 have this change incorporated.

E MODEL U-108 TECHNICAL INFORMATION AND SERVICE DATA

All data published in Model U-109 Service Notes are directly applicable to Model U-108, with the following exceptions:-

- (1) Stock #14830 Pickup Cable and Male Plug and Stock #14278 Pickup Cable Female Socket replace Stock #14819 and Stock #14274 respectively.
- (2) Capacitor C-107, Stock 12951, 2200 mmfd. has been changed to 270 mmfd. replacement Stock #12488.
- (3) Cabinet Styling of model U-108 is different from model U-109.

F MODELS U-108 and U-109 - FREQUENCY RESPONSE

Revised Adjustment Procedure - Pickup Voltage Control

Dealers' and servicemen's attention should be brought to the need for properly adjusting the pickup voltage control during the installation of Models U-108 and U-109. This control is identified in the schematic as R-101. It is located on "Phonograph Input and Compensator Pack" and is accessible from the rear of the cabinet. The following circuit change and revised adjustment procedure should be effected on U-108 and U-109 instruments when installed and particularly in cases where insufficient low-frequency response is apparent. Adjustment method #1 is definitely better than the alternate methods, and should be employed whenever feasible.

G CIRCUIT CHANGE - MODEL U-109 ONLY

Remove 2200 mmfd. capacitor C-107 (Stock #12951, marked M-523) from compensator circuit and substitute in its place a 270 mmfd., Stock #12488 capacitor.

Adjustment of Pickup Voltage Control

Preferred Method #1.

- Connect an a-c rectifier type voltmeter having either 5 or 10 volt range across voice-coil of loudspeaker.
- Set phonograph volume control to position of the highest compensation tap (junction C-106 & C-102) - using continuity meter to check this setting.
- Turn tone control to position of maximum high frequency response.
- Turn "Dynamic Expander" control to its minimum-off position (full counter-clockwise).
- While playing RCA Victor Technical Purpose record #84506-B, on 400 cycle section, adjust pickup voltage control to give 1.6 volts amplifier output as indicated across speaker voice-coil.

Alternate Method #2.

- Connect an a-c rectifier type voltmeter having range above 200 volts (1000 ohms per volt) in shunt with a 5000-ohm (5 watts or more) resistor and then between plate and plate of the amplifier output stage.
- Turn the phonograph volume control to its maximum position.
- Set the tone control to position of maximum high-frequency response.
- Turn the "Dynamic Expander" control to its minimum-off position.
- While playing RCA Victor Technical Purpose record #84506-B, on 400 cycle section, adjust pickup voltage control to give 164 volts amplifier output, as indicated from plate to plate of the output stage.

Alternate Method #3.

- Advance phonograph volume control exactly 1/2 turn from its minimum position (180 degrees rotation from off).
- While playing RCA Victor Record #4319-B, Thunder and Lightning (Unter Donner und Blitz), adjust pickup voltage control until average (moderate) output volume (consistent with pleasing tone balance) is obtained, as indicated by careful listening.

Dynamic Amplifier Adjustment

After performing the above adjustments, the dynamic amplifier "bias control" should be set as prescribed under "Dynamic Amplifier Adjustment" in the Service Notes on Model U-109. Record #4319-B should be played and the relative degree of expansion on its heavy passages observed. The "bias control" may be varied - on a cut-and-try basis - until the desired or normal amount of expansion is indicated by listening. This method should always be avoided whenever the standard Service Note adjustment is possible.

H MODELS 88U and 88U2 - REMOVAL OF RESISTOR

R27, 18,000-ohm tuning tube plate resistor is omitted on some instruments; the plate being connected directly to the screen grid of the output tube socket.

J MODEL 88U2 TECHNICAL INFORMATION AND SERVICE DATA

Model 88U2 is identical to Model 88U except for cabinet styling. All Service Data for Model 88U applies directly to Model 88U2.

A MODELS R-95, R-95-A, and R-94 - VOLUME AND FIDELITY INCREASE

The pickup unit of these Duo Junior instruments is designed to be adaptable to a great variety of receiver inputs, and to provide the best average of output and fidelity that may be obtained over such a wide range of application. On some installations, where the ultimate in output and fidelity is desired, it is possible to gain considerable improvement in performance by installation of a Stock #9632 transformer between the Radio-Phono" changeover switch and the Duo output. This transformer gives a decided stepup in voltage, and enables the Duo volume control to be operated at a lower point so that the full benefit is derived from the tone compensation. The #9632 transformer should be connected as shown in the diagram above, and its placement should be such that it is not in an interfering magnetic field from a power transformer, reactor, wiring or motor. All other connections are to be made per standard instructions. Shielding should be placed over the primary and secondary leads if such is found necessary. If the bias of the receiver audio input stage is affected by the transformer winding, a .06 mfd. in series with the "blue" lead will correct the condition. The "green" and "red" leads of the transformer should be taped up separately and not used.

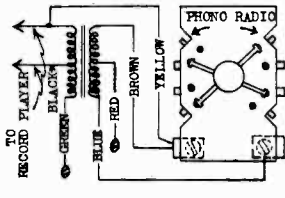

B MECHANICAL VIBRATION AND HUM - Models R-95-A and U-101

Hum produced by the drive motor of the R-95-A and U-101 may occasionally be amplified by mechanical resonance of the table or radio cabinet used for supporting the instrument. Where this condition causes interference to proper reproduction, the motor should be carefully lubricated and adjusted in accordance with Service Note instructions. A felt or sponge-rubber pad beneath the instrument will also effectively reduce the hum. Whenever the hum is of abnormal intensity due to the combination or accumulation of causes, such as high line voltage, resonant support, excessive amplifier gain, and unusual low-frequency response; the addition of a 300-ohm, 5-watt resistor in series with the motor coils is recommended for the 106-125 volt, 60 cycle motors. A 500-ohm, 5-watt resistor in series with the motor coils is recommended for the 106-125 volt, 25 cycle motors.

C MODEL R-99 WEAK AND DISTORTING

The output transformer mounted on the loudspeaker unit should be inspected in all cases of puzzling trouble on the R-99, to see that it is not sagged and touching against the top of one of the filter electrolytic capacitors. If this condition has developed, the speaker field and bias of the output stage may be shorted out. Bend the transformer mounting bracket so that there is ample safe clearance.

D SERVICE SUGGESTIONS ON MODEL O-11 MOTOR

1. To reduce the mechanical noise, loosen the two screws which hold the governor shaft bearing and adjust the eccentric bearings so as to obtain a desirable running clearance between the worm and gear. As this adjustment is made, you will readily notice that the noise is affected to a considerable extent.
2. The proper method of adjusting the governor is in the setting of the felt brake or the sliding of the governor into the desired position on the shaft. There is a set screw in the governor collar which holds the governor securely to the shaft and this must be loosened before the governor can be moved in either direction.
3. The points of lubrication are between the bearings and shafts of gears. Although no oil is provided, it is advisable to introduce a drop or two of 10-W oil between the bearings and shafts.
4. This has reference to the principal sources of speed variation and recommended adjustments. We can only say that the speed variation is caused by an incorrect setting of the brake felt or of the governor and this is fairly well covered under No. 2. We have found that the graphite grease in the spring barrel occasionally causes a variation in speed and this is overcome usually by winding the motor and letting it run down once or twice. The graphite grease seldom affects the speed after a motor has been in use for some little time.

E DIAL DRIVE SLIPPAGE - Model ACR-111

Slipping of the dial drive mechanisms, on any instruments so affected, may be centered either in the friction drive disc assembly or in the idler of the belt system. The recommended methods of repair are:-

- (1) Install new Stock #14453 friction drive-disc tension spring. The later springs of this type have a fewer number of turns and are of different hardness. Excessive grease on the friction disc will accentuate slippage, hence it should be carefully cleaned with carbon tetrachloride or equivalent.
- (2) The idler gear spring should be replaced, using stock #14450. This spring has been modified to have 30 turns instead of the original 45. Reduction of the number of turns, as indicated, will of course be satisfactory where replacements are not readily available. The idler should be carefully examined to certify that it is not binding on its bushing.

F RESISTOR CHANGE - AMATEUR RECEIVER ACR-165

The filament series resistor shown in Service Diagrams as R-27 (.045 ohms, Stock #13887) is being omitted on receivers of late production. A jumper lead is being substituted in its place. Please arrange to effect this same modification on any receivers requiring service.

TRIMMER CAPACITOR CHANGES - MODEL ACR-165

Plunger-type air trimmers C21, C22, and C23 have been changed from 2-8 mmfd. to 2-12 mmfd. Stock No. 12714, and C9 has been changed from 2-12 mmfd. to 2-20 mmfd. (Stock No. 12864). These trimmers should only be changed if a definite peak cannot be obtained during alignment.

DIAL SLIPPAGE - MODEL ACR-165

Two washers, one a plain flat type, and the other, a spring type, are used between the tuning knob and the larger shaft of the drive. These are held in place by means of a rubber band during shipment. In order to obtain smooth and positive tuning, install the knob after removal of the rubber band, so that there is compression in the phosphor bronze spring washer. Avoid jamming the knob too tight against the washers. The spring washer should be nearest the knob. If a slippage condition is apparent on this drive, the washers should be checked to see that they are in place. Should it be necessary to replace them, use:- One Plain Flat Washer to fit 1/4 inch shaft, 1/2 inch outside diameter, .040 inch thick; and one Phosphor Bronze Spring Washer to fit 1/4 inch shaft, 7/16 inch outside diameter, .010 inch thick and raised approximately 1/16 inches.

MODEL ACR-155 DIAL DRIVE MECHANISM

STOCK #13898

When installing Stock #13898 replacement drive mechanism, it is essential that a definite method of procedure be used in order that smooth action will be obtained. Assuming that the original drive mechanism has been disassembled from the tuning condenser and chassis, it should be replaced in accordance with the following:

- (1) Remove the pointer and main dial scale from assembly.
- (2) Mount drive assembly to gang condenser - tighten the three nuts on mounting studs. Tighten shaft coupling set screws slightly. Remove packing wedge (sheet metal) from between condenser shaft coupling and mechanism mounting brackets.
- (3) With gang condenser in the full-closed position and the sector gear turned anti-clockwise tight against the top center stud, tighten the two set screws on the gang condenser main shaft coupling. Place a .020" feeler between the front plate of the mechanism and the front hub of the sector gear, and another .020" feeler between the gang end plate and the gang condenser shaft coupling. The mesh of the tuning pinion and large sector gear will be approximate at this stage.
- (4) Loosen the three mounting nuts on condenser end plate slightly and adjust the mechanism up or down until the proper gear mesh is obtained and the dial works freely. Retighten nuts and remove feelers.
- (5) To test drive - gang should be turned through a complete cycle using vernier control. If slippage occurs at any point - adjustment #4 is not ideal and should be repeated.
- (6) Replace dial and pointer and line them up according to Service Notes, Section 13.

CAUTION: The double section sector gear is designed to minimize gear backlash and it is important that there be one tooth displacement between them to maintain compression in the coil springs. This adjustment is made during manufacture and the mechanism is clamping by a wedge between the main shaft coupling and main bracket. Do not fail to remove this wedge, after the mechanism is mounted.

G MAGIC WAVE ANTENNA

The length of the grounding lead of the antenna transformer is very important and it should be maintained as short as possible on all installations. Approximately five feet of ground lead (yellow) is supplied in the antenna kit. This should be cut down to the minimum length required for making a solid ground. Extension of this lead should be avoided. It will generally be found better to lower the elevation of one end of the antenna to obtain a short ground connection rather than increasing the length of the ground lead to gain elevation. Antenna locations should, therefore, be chosen with consideration of remoteness from noise sources, and facility of obtaining a short transformer ground.

In using less than four receivers on the stock #9814 branch transformer, the unused output terminals should be left open circuited and should not be loaded nor connected to a line.

Lightning arrestors are not supplied with the new RCA Magic Wave Antenna kit. Where they are required by local ordinance, or if installation is desired for other reason, the doublet type, or two arrestors should be used. An arrestor arrangement should be connected between each side of the transmission line and ground at the point where the line enters the building.

SPECIAL ADVANTAGES OF STOCK #9812 MAGIC WAVE ANTENNA

The characteristic band-pass action of the Magic Wave Antenna between 500 kc and 23,000 kc, and its ability to isolate coupling between the receiver power supply and antenna, render the system particularly useful in localities where certain unusual interference problems may exist. Types of interference in this category that may be reduced through use of the Magic Wave Antenna are as follows:-

- (1) Cross Modulation - Abnormal r-f signals from local stations may often times be present on the power circuits to which the receiver is attached, and will be introduced by mutual coupling through the antenna capacitance to the receiver input, causing

stray modulation effects. Since the Magic Wave Antenna is designed so as to efficiently eliminate capacity coupling between the receiver and transmission line, and between the transmission circuit and the antenna transformer primary, the unwanted signal from the power circuit is eliminated. The ground lead of the antenna coupling transformer must be kept to a minimum length, in severe cases of this interference. The addition of a power circuit filter, with a separate and short return to a good ground will provide additional improvement where needed.

- (2) **Long Wave Code** - Coastal communication stations operating at frequencies near to the I-F of the particular receiver involved will be definitely attenuated by the Magic Wave Antenna. The amount of reduction on signals in the I-f range, 450-470 kc amounting to approximately 6 to 1. Where the antenna is used as a means of minimizing this type of interference, the standard 60 foot section supplied, should not be lengthened. Further improvement, in extreme cases, is of course obtainable with standard RCA Wave Traps.
- (3) **Image Response** - Signal frequencies above 23,000 kc can not readily cause the image response on "C" band where the Magic Wave Antenna is used, due to the high frequency cut-off of the system and resultant attenuation in that range.
- (4) **General** - Installations of broadcast receivers on shipboard can be benefited by use of the Magic Wave Antenna, in that cross-modulation and shock excitation effects of the ship's transmitters operating at 500 kc and below, will be suppressed.

Due to an intermediate band-elimination range of the Magic Wave System between approximately 2000 kc and 4000 kc; image and cross-modulation interference from stations within this range can, in many cases, be corrected by employing this antenna alone.

A I-F WAVE TRAP ADJUSTMENT

In areas where interference is experienced from code stations operating in the range of 450-470 kc, additional reduction of such interference may be obtained by adjusting the wave trap contained in the receiver to the frequency of the interfering station instead of to 460 kc, the I-F of the receiver. Each receiver installed in affected areas should be accordingly adjusted by the dealer during installation, after having determined the exact operating frequency of the disturbing station by consulting the owners or operators of the station. Effect of wave trap adjustment on battery receivers is increased by use of a short direct (low impedance) ground lead to earth.

B UNIVERSAL WAVE TRAP - RANGE EXTENSION

Many demands have been received for a wave trap similar to the stock #13467 type with tuning to include the 160 meter Amateur band. This facility is possible by a simple alteration of the present #13467 trap, which permits adjustment for attenuation of any signal in the range from approximately 1200 kc to 2500 kc. To effect such an increase in range, interconnect the lug of terminal "A" to the stator of the variable capacitor, by adding a jumper lead between the points. The connection at the stator may be soldered (carefully) to the stator plates support rod as shown by the diagram below.

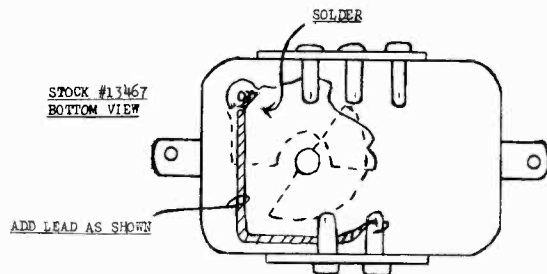

The addition of the jumper, short circuits a portion of the inductance and thus increases the range. Attenuation characteristics remain substantially equivalent to the standard range.

Two particular uses of the trap with extended tuning will be for reducing interfering signals from local Police transmitters on the 2500 kc band, and from local Amateur transmitters on the 2000 kc band. On the former, the interference will generally be due to overloading of the receiver or cross-modulation. The Amateur interference may in addition to overloading and cross-modulation, show up in the broadcast band as an image. The image interference range on receivers with 450-470 kc I-F will be approximately between 860 kc and 1100 kc on the broadcast scale.

Adjustment of the #13467 trap is quite critical, and it is necessary to tune the condenser by very slow rotation. A listening indication of proper adjustment is not usually satisfactory, particularly on receivers with AVC. It is, therefore, desirable to use an oscillator, tuned to the frequency of the known interfering signal, and a visual output indicator to show the point of maximum reduction during the adjustment. Otherwise, the antenna should be reduced during the operation to a short length of wire so that the signal will be below the AVC threshold and the minimum point will be perceptible by ear.

A further increase of range to include frequencies up to approximately 6000 kc may be effected by removing the fixed moulded capacitor from the circuit after addition of the jumper lead. This permits adjustment for the Aircraft bands and the 4000 kc (80 meter) Amateur band.

C PARTS IDENTIFICATION

The numerals stamped on various parts of RCA receiver assemblies are for manufacturing use only and should not be interpreted as stock or catalog numbers. Always order replacement parts by the Stock Numbers supplied in service lists, and in the event this number is unavailable, order by careful description of the part desired, including the factory markings.

ELECTROLYTIC CAPACITORS - WET TYPE

It is highly important that cartons containing replacement electrolytic capacitors be stored upright in a standing position. This is essential in order to prevent slow leakage of electrolyte through the venting outlet if the unit is left inverted or lying on its side for an appreciable time.

All instruments in shipment or in storage should likewise be kept with their top sides upward. Shipping cases and cartons are marked "This End Up" as an instruction for proper storage. This should be definitely followed.

The average type of wet electrolytic will freeze at temperatures of plus 15 degrees Fahrenheit and below. It is advisable, therefore, to refrain from storing or installing receivers under such conditions. Freezing is generally not harmful unless the receiver is operated before allowing the capacitors to thaw.

STOCK #5212 ELECTROLYTIC CAPACITOR

This unit is a regulating type of capacitor, designed to stabilize surge voltages during period required for tubes to heat when the receiver is first tuned "On". It is therefore not replaceable with ordinary electrolytic having similar voltage and capacity ratings. For every replacement use only Stock #5212.

RECTIFIER 524 REPLACEMENTS

The new RCA-5T4 metal type rectifier may be used for replacement on RCA Victor receivers employing the 524. The arrangement of pin connections is such that the 5T4 can be plugged directly into the 524 socket without requiring circuit changes. In using the 5T4, somewhat better service will be obtained due to its increased power handling capacity.

The 5T4 tube will be secured in its socket by special packing or shipped in a separate container on future instruments of the new line. This same packing should be incorporated when re-packing and shipping is necessary in the field.

OSCILLATOR ALIGNMENT - 600 KC

Receivers of the new 1937-38 line are being peaked on the low frequency end of "A" band at a dial reading of exactly 600 kc during factory alignment. The tuning condenser is not rooked for this operation but the 600 kc series trimmer is adjusted for maximum with the dial set for 600 kc and the test oscillator set at the same frequency.

A slight improvement in selectivity and sensitivity in the vicinity of 600 kc can be obtained, if this requirement exists in any locality, by careful realignment of the 600 kc oscillator trimmer while rocking the tuning condenser. Trimmer adjustments at the 1500 kc end of the dial should be re-checked if this is done.

D STOCK NO. 9800 - JUNIOR AUTOMATIC RECORD CHANGER

For adjustments and Replacement Parts on this Record Changer refer to Service Data on Record Changer Mechanism used in Model U-103.

E STOCK NO. 9820 - DE LUXE AUTOMATIC RECORD CHANGER

For adjustments and Replacement Parts on this Record Changer refer to Service Data on Record Changer Mechanism used in Model U-109.

F RADIO-PHONOGRAPH COMBINATIONS

It is inadvisable to transport or move phonograph instruments with the turntable plate in place on the spindle, since a jolt will be apt to bend the spindle or turntable and result in excessive "wow". The motor should always be clamped solidly to the motor board when the instrument is handled; this being extremely important due to close mesh between the fixed automatic main gear and the pinion on the spindle of the flexibly mounted motor. Any binding or burr produced by a jolt on the teeth of the pinion or gear, will contribute to "wow" content.

REPAIRING PICKUP UNIT

If inspection or tests indicate that a pickup of the type employed on Models 9U, 9U2, D22, etc., is unstable due to loose solder at the point where the centering spring is attached to the armature, careful repair should be effected as follows:-

- (1) Remove armature from pickup assembly and thoroughly clean parts to be soldered.
- (2) Obtain a soldering iron of approximate 100 watt capacity; adjust or modify it so that the point is short and stubby in order to concentrate the heat.

(Continued on next page)

- Apply an acid flux to the junction of spring and armature, and solder as hurriedly as possible to prevent the heat from spreading. Solder consisting of 50% tin and 50% lead should be used. See that it flows between the spring and the walls of the hole in the armature.

WARNING- This repair requires that a quick, clean, solid joint be made in the minimum of time. Excess heating will affect the resilience of the spring, therefore avoid application of the iron for too long an interval.

PHONOGRAPH WOW REDUCTION

Abnormal wow in record reproduction does not always originate in the mechanism of the drive motor, but in many cases is the sum of several contributing causes. It is therefore proper service practice, when overhauling phonographs, to determine the major source or sources of wow in a routine manner, and applying the correction accordingly. The following items should be examined in the order given:-

- Temperature** - Instruments which have been stored or left idle for a protracted period at temperatures below that of an average comfortable room (65°) should not be tested or demonstrated until they are warmed up to the temperature of the room. After several hours of operation or if left standing idle at normal temperature for about a day, wow due to low lubricant temperature should not be present.
- Turntable Plate** - Inspect this part to see that it is in approximate dynamic balance and does not have excessive vertical wobble. Should the reinforcing ring attached to the under-side of some turntables, be mounted off-center in respect to the spindle axis, wows will be produced due to poor balance. Revolving the turntable 1/2 turn on the spindle will often improve wow.
- Record Wow and Eccentricity** - Wow may be inherent to the recording being observed - this of course cannot be remedied by changing the playing mechanism. Other records should be tested for comparison. Worn, enlarged, or mis-shaped spindle holes in records will cause the record to lie on the plate with its axis off-center and wow will result. The average clearance between the record and spindle should not be more than approximately .006 - .007 inches.
- Ejector Arm** - The tip of the record ejector arm employed on automatic record changers similar to those of Models D 22-1, 9U, 15U, etc. must be properly centered over the motor spindle in the playing position; otherwise, the record will tend to shift between the axis of the tip and the axis of the spindle, and excessive wow will result.
- Automatic Gear** - The main gear of the automatic mechanism and the pinion of the motor spindle should be carefully inspected. There should be no tendency to bind, nor any burrs on their teeth. Also, inspect for dirt or metal particles in the grease used; clean and re-grease the gears if necessary.
- Pickup Centering** - If the pickup armature is seriously off-center, an effect will be reproduced which may sound similar to wow. Always check the centering of the pickup.
- Drive Motor** - The rotor and spindle thrust adjustments should not be changed from that established at the factory. Proper lubrication of all bearings is very important. A good light grade of clean engine oil should be used on all shaft bearings approximately every six months. Gear systems are usually packed with grease which does not require attention for considerable time. When necessary to replace the gear grease, use a type having good clinging qualities, as well as good high and low temperature viscosity. Use as little as is necessary to obtain satisfactory lubrication of the gears. Gear grease should not be allowed to accumulate in the rotor shaft bearings.

A REPLACEMENT MOUNTING STUD STOCK #31023 For Automatic Record Changer Cam and Gear Assembly

Stock #31023 cam and gear mounting stud is being made available for service replacement use on the large automatic record changer mechanisms such as are employed on Models 331, 341, 381, D11-2, D22-1, 9U, 9U2, 15-U, U-106, U-107, U-108, U-109, etc. The stud, illustrated below, will facilitate and simplify repairs necessary where the original part has become loosened in its mounting; due to the fact that it is mountable by means of a nut and washer.

Installation and Adjustment

- Remove entire motor assembly from the motor board.
- Remove cam and gear from stud.
- Extract original stud from board, using pin punch.

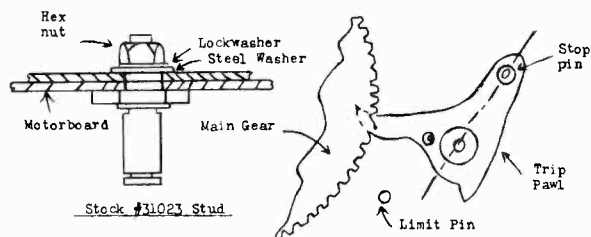

- Straighten motor board being sure it is normally flat in vicinity of stud mounting hole.
- Install new stud with nut and washers provided. It must be perfectly square or perpendicular to the motor board.
- Re-install cam and gear. Revolve the gear so as to carry mechanism thru a change cycle several times and note the engagement of roller on main link and the cam of the main gear. Bend the trip pawl stop pin toward or away from the lever so as to vary the roller engagement as required. The bend should be in the direction of the center line between pawl mounting stud and stop pin. The roller must be prevented from striking the edge or inside of the cam and causing a bind.
- If pin which limits movement of the trip pawl is sheared off from the motor board - replace it with a standard 8-32 screw, using locknuts to secure it to the board.
- Replace motor and adjust its position to give a free-running mesh between the pinion and the automatic main gear.
- Cover the main gear and cam with light grease such as "Socony-Vacuum No. 2."

B FLEXIBLE OCTAL-SOCKET ADAPTOR

A flexible socket adaptor, which may be used in conjunction with any octal base tube for reduction of microphonics, is available in stock as #14617. This adaptor plugs directly into the tube socket and provides an excellent shock-proof or insulative mount for the tube. It can be used to advantage in expander amplifiers to minimize howl (6L7) in short-wave oscillator stages (6J7) to reduce howling tendencies on the 13, 16, and 19 meter bands, and in any other octal-tube position which is critical to microphonism.

STOCK #11218 DRIVER TRANSFORMER

Replacement units of stock #11218 driver transformer have been recently modified in construction, so that the primary d-c resistance now equals 1350 ohms, and the total secondary resistance equals 2000 ohms. These same units also have an extra lead, which is color coded RED - GREEN. This lead has a definite purpose in reversing any electrolysis that may occur in high humidity regions, so that the life of the transformer is prolonged. The extra lead is internally connected to the core of the transformer, and should be connected externally, during installation of the unit, to the GREEN primary lead or to a point of plus "B" potential.

LOUDSPEAKER DUST CAPS

The dust caps appearing on speaker cones of the 1937-38 line receivers are employed principally to facilitate production by protecting the air gap from the many metal particles which may be attracted to the unit during its assembly and installation on the receiver. When it is necessary to remove the cap in servicing the speaker, it is not strictly required that it be replaced. These caps are however, being stocked, in case it is considered desirable by the individual serviceman to replace them. Ordering data are:-

- Stock #13866 - For use on Speakers Marked RL-70 and RL-63 - Cap Diameter 1-7/16"
- Stock #13867 - For use on Speakers Marked RL-69 Cap Diameter - 2-1/16"

Ambroid or Household cement may be used to re-insert the caps into the cone. The cement should not be allowed to run down into the air gap. See that sufficient cement is applied without an excess being used.

WRENCH FOR SLAB SET SCREW ON CONDENSER DRIVES

A set screw having a "slab" or rectangular shaped head is being employed at various points on tuning drive mechanisms. This type of screw is particularly advantageous in being small, thus requiring less clearance; and at the same time, rugged, which permits it to be tightened securely in a permanent manner without danger of breakage. A service wrench, which has been designed to fit this screw, is being made available in Service Parts Stock. This part may be ordered as RCA Stock #30369 - Wrench for Vernier Drive Set Screw.



TOPTENNA MOLDED COUPLINGS

The molded bakelite screw cap which secures the Stock #9792 Toptenna forward section to the cowl coupling, is carried in stock as #14673. This part may be ordered for replacement use in repairing any breakages that might occur in service.

REVISED ALIGNMENT PROCEDURE - MODEL 160 - ELECTRONIC SWEEP OSCILLATOR

- Adjustment of Fixed Frequency Oscillator** - The 6F7 oscillator stage must be adjusted to operate exactly at 800 kc in all positions of the "CW-AMP-FREQ." switch.
 - Adjust tap of resistor R-10 to give 2.75 volts between the cathode of the Frequency Control tube (6C6) and ground.
 - Advance "Range KC" Control to #6 position and set variable capacitor to its minimum capacitance position (full out of mesh).

(Continued on next page)

- (3) Tune in the 8th harmonic (800 kc) of an RCA Stock #9572 Crystal Calibrator on a broadcast receiver.
 - (4) Connect the test oscillator output to receiver antenna-ground terminals.
 - (5) Set oscillator "Modulation" Control on "FREQ" and reduce the "Sweep KC" (R-1) control to its zero position or turned completely counter-clockwise.
 - (6) Adjust trimmer C-28 to produce zero beat signal in receiver output.
 - (7) Without otherwise disturbing oscillator or receiver, shift "Modulation" Control to "CW", and adjust compensating capacitor C-17 to restore the zero beat. If proper zero beat adjustment is not within the range of C-17, it will be necessary to slightly re-adjust the bias resistor R-10 - see (1). If zero beat requires less indicated capacitance in C-17, then the bias voltage should be increased slightly. If more indicated capacitance is required on C-17, the bias voltage must be decreased slightly. The alignment steps (2), (3), (4), (5), (6) and (7) must then be repeated.
- B. Adjustment of Variable Frequency Oscillator - Trimmers are provided in the variable oscillator circuits for alignment at the high frequency end of each tuning range. These must be properly adjusted in respect to frequency and correct dial setting. The following procedure will establish correct alignment of the variable oscillator at the proper points; while the 800 kc oscillator is kept inoperative so as to avoid beat signals and harmonics that may be confusing otherwise. The oscillator and crystal calibrator must be operating into a receiver which will tune to 1,100 kc, 1,800 kc, 3,300 kc, 7,800 kc, 13,000 kc and 31,000 kc.**
- (1) Adjust the dial so that the index mark is exactly opposite the continuous radial line at the low frequency end of the scales when the capacitor is in full mesh.
 - (2) Ground the top control grid of the 6A7 variable oscillator. This removes the 800 kc signal from the Mixer Stage leaving only the variable oscillator signal in the output.
 - (3) Band #1 - Tune the receiver to the 11th harmonic of the Crystal Calibrator at 1100 kc. Set the oscillator to the 300 kc dial reading. Adjust trimmer C-36 to produce zero beat.
 - (4) Band #2 - Tune the receiver to the 18th harmonic of the Crystal Calibrator at 1800 kc. Set the oscillator to a reading of 1000 kc. Adjust trimmer C-35 to give zero beat.
 - (5) Band #3 - Tune the receiver to the 33rd harmonic of the Crystal Calibrator at 3300 kc. Set the oscillator to 2500 kc on the dial. Adjust trimmer C-34 to give zero beat.
 - (6) Band #4 - Tune the receiver to the 78th harmonic of the Crystal Calibrator at 7800 kc. Set the oscillator to 7000 kc on the dial. Adjust C-33 to give zero beat.
 - (7) Band #5 - Tune the receiver to the 13th harmonic of the Crystal Calibrator at 13,000 kc. Set the oscillator to 13,800 kc on the dial. Adjust C-32 to give zero beat.
 - (8) Band #6 - Tune the receiver to the 31st harmonic of the Crystal Calibrator at 31,000 kc. Set the oscillator to 31,800 kc on the dial. Adjust C-31 to give zero beat.
- C. Adjustment of Sweep Control - The bias adjustment R-10 determines the symmetry of frequency sweep and also affects the tuning of the 800 kc fixed frequency oscillator. The correct setting of this adjustment is to a value of 2.75 volts, however, due to slight variations in characteristics of the 6C6 tubes a slightly lower or higher value may be required to give: - (a) equal range of sweep above and below the normal frequency, and (b) proper control range for capacitor C-17.**
- Check of the symmetry can be made by placing the Oscillator in operation at 580 kc. (or some other frequency where the receiver dial is graduated in 5 kc markings) with "Modulation" in the "Freq." position. The signal should be tuned on a broadcast receiver with an Oscillograph connected and adjusted to show the typical forward and reverse curves. Tuning the receiver above and below 580 kc will cause the curves to disappear or merge into a straight horizontal line. The points on the receiver dial at which the curve disappears should be at approximate equal kc from the 580 kc reference point. If seriously poor symmetry is indicated, R-10 should be readjusted, and if necessary, exchange the 6C6 Frequency Control tube. If R-10 is varied, it is imperative to re-check the alignment of the Fixed Frequency Oscillator as in A.

A ADDITIONAL REPLACEMENT PARTS - MODELS 67M, 67M1, 67M2, and 67M3

- 14619 Knob--Metal wing knob (Models 67M2 and 67M3 only)
 14763 Pointer--Dial pointer disc (all models)

RADIO TUBE CHART

| TYPE | NAME | BASE | SOCKET CONNECTIONS | DIMENSIONS MAXIMUM OVERALL LENGTH x DIAMETER | CATHODE TYPE # | RATING | | | | USE Values to right give operating conditions and characteristics for indicated typical use | PLATE SUPPLY VOLTS | GRID BIAS # | SCREEN SUPPLY VOLTS | SCREEN CURRENT MA. | PLATE CURRENT MA. | A-C PLATE RESISTANCE OHMS | TRANS- CONDUCTANCE (GRID- PLATE) µMHOS | AMPLIFI- CATION FACTOR | LOAD FOR STATED POWER OUTPUT OHMS | POWER OUT- PUT WATTS | TYPE | | | | |
|---------|--|-----------------------------|--------------------|---|-------------------|-----------------------|---------|-------|--------|---|---|--------------------------------|---------------------------|--------------------------|-------------------------|--|---|------------------------------|--|-------------------------------|---------|-------|---------|------------|------------|
| | | | | | | FILAMENT OR HEATER | | PLATE | SCREEN | | | | | | | | | | | | | VOLTS | AMPERES | MAX. VOLTS | MAX. VOLTS |
| | | | | | | VOLTS | AMPERES | VOLTS | VOLTS | | | | | | | | | | | | | | | | |
| 00-A | DETECTOR TRIODE | MEDIUM 4-PIN Bayonet | 4D | 4 1/8" x 1 1/8" | D-C FILAMENT | 5.0 | 0.25 | 45 | — | GRID/LEAK DETECTOR | 45 | Grid Return to (-) Filament | | 1.5 | 30000 | 666 | 20 | — | — | 00-A | | | | | |
| 01-A | DETECTOR- AMPLIFIER | MEDIUM 4-PIN Bayonet | 4D | 4 1/8" x 1 1/8" | D-C FILAMENT | 5.0 | 0.25 | 135 | — | CLASS A AMPLIFIER | 90 135 | - 4.5 - 9.0 | — | 2.5 3.0 | 11000 10000 | 725 800 | 8.0 8.0 | — | — | 01-A | | | | | |
| 1A4 | SUPER-CONTROL R-F AMPLIFIER PENTODE | SMALL 4-PIN | 4M | 4 1/2" x 1 1/8" | D-C FILAMENT | 2.0 | 0.06 | 180 | 67.5 | CLASS A AMPLIFIER | For other characteristics, refer to Type 1D3-G. | | | | | | | | | | 1A4 | | | | |
| 1A6 | PENTAGRID CONVERTER | SMALL 8-PIN | 8L | 4 1/2" x 1 1/8" | D-C FILAMENT | 2.0 | 0.06 | 180 | 67.5 | CONVERTER | For other characteristics, refer to Type 1D7-G. | | | | | | | | | | 1A6 | | | | |
| 1B4 | R-F AMPLIFIER PENTODE | SMALL 4-PIN | 4M | 4 1/2" x 1 1/8" | D-C FILAMENT | 2.0 | 0.06 | 180 | 67.5 | CLASS A AMPLIFIER | For other characteristics, refer to Type 1E5-G. | | | | | | | | | | 1B4 | | | | |
| 1B5/25S | DUPLEX-DIODE TRIODE | SMALL 8-PIN | 8M | 4 1/8" x 1 1/8" | D-C FILAMENT | 2.0 | 0.06 | 135 | — | TRIODE UNIT AS AMPLIFIER | For other characteristics, refer to Type 1H6-G. | | | | | | | | | | 1B5/25S | | | | |
| 1C6 | PENTAGRID CONVERTER | SMALL 8-PIN | 8L | 4 1/2" x 1 1/8" | D-C FILAMENT | 2.0 | 0.12 | 180 | 67.5 | CONVERTER | For other characteristics, refer to Type 1C7-G. | | | | | | | | | | 1C6 | | | | |
| 1C7-G | PENTAGRID CONVERTER | SMALL SHELL OCTAL 8-PIN | G-7Z | 4 1/8" x 1 1/8" | D-C FILAMENT | 2.0 | 0.12 | 180 | 67.5 | CONVERTER | 135 180 | - 3.0 min. | 67.5 67.5 | 2.0 2.0 | 1.3 1.5 | 550000 750000 | Anode-Grid (#2): 180 v max. volts, 2.3 ma. Oscillator-Grid (#1) Resistor = Conversion Conductance, 325 micromhos. | | — | — | 1C7-G | | | | |
| 1D5-G | SUPER-CONTROL R-F AMPLIFIER PENTODE | SMALL SHELL OCTAL 7-PIN | G-5V | 4 1/8" x 1 1/8" | D-C FILAMENT | 2.0 | 0.06 | 180 | 67.5 | CLASS A AMPLIFIER | 90 180 | - 3.0 min. | 67.5 67.5 | 0.9 0.8 | 2.2 2.3 | 600000 1000000 | 720 750 | 425 750 | — | — | 1D5-G | | | | |
| 1D7-G | PENTAGRID CONVERTER | SMALL SHELL OCTAL 8-PIN | G-7Z | 4 1/8" x 1 1/8" | D-C FILAMENT | 2.0 | 0.06 | 180 | 67.5 | CONVERTER | 135 180 | - 3.0 min. | 67.5 67.5 | 2.5 2.4 | 1.2 1.3 | 400000 500000 | Anode-Grid (#2): 180 v max. volts, 2.3 ma. Oscillator-Grid (#1) Resistor = Conversion Conductance, 300 micromhos. | | — | — | 1D7-G | | | | |
| 1E5-G | R-F AMPLIFIER PENTODE | SMALL SHELL OCTAL 7-PIN | G-5V | 4 1/8" x 1 1/8" | D-C FILAMENT | 2.0 | 0.06 | 180 | 67.5 | CLASS A AMPLIFIER | 90 180 | - 3.0 - 3.0 | 67.5 67.5 | 0.7 0.6 | 1.6 1.7 | 1000000 1500000 | 600 650 | 550 1000 | — | — | 1E5-G | | | | |
| 1E7-G | TWIN PENTODE POWER AMPLIFIER PENTODE | SMALL SHELL OCTAL 8-PIN | G-8C | 4 1/8" x 1 1/8" | D-C FILAMENT | 2.0 | 0.24 | 135 | 135 | CLASS A AMPLIFIER | 135 | - 7.5 | 135 | — | — | Power Output is for one tube at stated plate-to-plate load. | | 24000 | 0.65 | 1E7-G | | | | | |
| 1F4 | POWER AMPLIFIER PENTODE | MEDIUM 5-PIN | 5K | 4 1/8" x 1 1/8" | D-C FILAMENT | 2.0 | 0.12 | 135 | 135 | CLASS A AMPLIFIER | For other characteristics, refer to Type 1F5-G. | | | | | | | | | | 1F4 | | | | |
| 1F5-G | POWER AMPLIFIER PENTODE | MEDIUM SHELL OCTAL 7-PIN | G-4X | 4 1/8" x 1 1/8" | D-C FILAMENT | 2.0 | 0.12 | 135 | 135 | CLASS A AMPLIFIER | 90 135 | - 3.0 - 4.5 | 135 | 2.6 | 8.0 | 240000 200000 | 1400 1700 | 340 340 | 20000 16000 | 0.12 0.34 | 1F5-G | | | | |

| TYPE | NAME | BASE | SOCKET CONNECTIONS | DIMENSIONS MAXIMUM OVERALL LENGTH X DIAMETER | CATHODE TYPE # | RATING | | | USE Values to right give operating conditions and characteristics for indicated typical use | PLATE SUPPLY VOLTS | GRID BIAS VOLTS | SCREEN SUPPLY VOLTS | SCREEN CURRENT MA. | PLATE CURRENT MA. | A-C PLATE RESISTANCE OHMS | TRANS-CONDUCTANCE (OHMS) (μMHO) | AMPLIFICATION FACTOR | LOAD FOR STATED POWER OUTPUT OHMS | POWER OUTPUT WATTS | TYPE |
|--------|-------------------------------------|--------------------------|--------------------|--|----------------|--------------------|---------|------------|---|--------------------|-----------------|---------------------|--------------------|-------------------|---------------------------|---------------------------------|----------------------|-----------------------------------|--------------------|--------|
| | | | | | | FILAMENT OR HEATER | PLATE | SCREEN | | | | | | | | | | | | |
| | | | | | | VOLTS | AMPERES | MAX. VOLTS | MAX. VOLTS | | | | | | | | | | | |
| 1F6 | DUPLEX-DIODE PENTODE | SMALL 9-PIN | 9W | 4 1/2" x 1 1/8" | D-C FILAMENT | 2.0 | 0.06 | 180 | 67.5 | | | | | | | | | | | 1F6 |
| 1F7-G | DUPLEX-DIODE PENTODE | SMALL SHELL OCTAL 8-PIN | 0-7AD | 4 1/2" x 1 1/8" | D-C FILAMENT | 2.0 | 0.06 | 180 | 67.5 | | | | | | | | | | | 1F7-G |
| 1H4-G | DETECTOR-AMPLIFIER | SMALL SHELL OCTAL 7-PIN | 0-4S | 4 1/2" x 1 1/8" | D-C FILAMENT | 2.0 | 0.06 | 180 | | | | | | | | | | | | 1H4-G |
| 1H6-G | DUPLEX-DIODE TRIODE | SMALL SHELL OCTAL 8-PIN | 0-7AA | 4 1/2" x 1 1/8" | D-C FILAMENT | 2.0 | 0.06 | 135 | | | | | | | | | | | | 1H6-G |
| 1J6-G | TWIN-TRIODE AMPLIFIER | SMALL SHELL OCTAL 8-PIN | 0-7AB | 4 1/2" x 1 1/8" | D-C FILAMENT | 2.0 | 0.24 | 135 | | | | | | | | | | | | 1J6-G |
| 1-Y | HALF-WAVE RECTIFIER | SMALL 4-PIN | 4G | 4 1/2" x 1 1/8" | HEATER | 6.3 | 0.3 | | | | | | | | | | | | | 1-Y |
| 2A3 | POWER AMPLIFIER TRIODE | MEDIUM 4-PIN | 4D | 5 1/2" x 2 1/8" | FILAMENT | 2.5 | 2.5 | 250 | | | | | | | | | | | | 2A3 |
| 2A5 | POWER AMPLIFIER PENTODE | MEDIUM 8-PIN | 8B | 4 1/2" x 1 1/8" | HEATER | 2.5 | 1.75 | | | | | | | | | | | | | 2A5 |
| 2A6 | DUPLEX-DIODE HIGH-IMPEDANCE TRIODE | SMALL 8-PIN | 8G | 4 1/2" x 1 1/8" | HEATER | 2.5 | 0.8 | 250 | | | | | | | | | | | | 2A6 |
| 2A7 | PENTAGRID CONVERTER | SMALL 7-PIN | 7C | 4 1/2" x 1 1/8" | HEATER | 2.5 | 0.8 | 250 | 100 | | | | | | | | | | | 2A7 |
| 2B7 | DUPLEX-DIODE PENTODE | SMALL 7-PIN | 7D | 4 1/2" x 1 1/8" | HEATER | 2.5 | 0.8 | 250 | 125 | | | | | | | | | | | 2B7 |
| 5T4 | FULL-WAVE RECTIFIER | LARGE WAFER OCTAL 8-PIN | 8T | 4 1/2" x 1 1/8" | FILAMENT | 5.0 | 2.0 | | | | | | | | | | | | | 5T4 |
| 5U4-G | FULL-WAVE RECTIFIER | MEDIUM SHELL OCTAL 8-PIN | 0-8T2 | 5 1/8" x 2 1/8" | FILAMENT | 5.0 | 3.0 | | | | | | | | | | | | | 5U4-G |
| 5V4-G | FULL-WAVE RECTIFIER | MEDIUM SHELL OCTAL 8-PIN | 0-8L1 | 4 1/2" x 1 1/8" | HEATER | 5.0 | 2.0 | | | | | | | | | | | | | 5V4-G |
| 5W4 | FULL-WAVE RECTIFIER | SMALL WAFER OCTAL 8-PIN | 8T | 3 1/2" x 1 1/8" | FILAMENT | 5.0 | 1.5 | | | | | | | | | | | | | 5W4 |
| 5X4-G | FULL-WAVE RECTIFIER | MEDIUM SHELL OCTAL 8-PIN | 0-8Q | 5 1/8" x 2 1/8" | FILAMENT | 5.0 | 3.0 | | | | | | | | | | | | | 5X4-G |
| 5Y3-G | FULL-WAVE RECTIFIER | MEDIUM SHELL OCTAL 8-PIN | 0-8T1 | 4 1/2" x 1 1/8" | FILAMENT | 5.0 | 2.0 | | | | | | | | | | | | | 5Y3-G |
| 5Y4-G | FULL-WAVE RECTIFIER | MEDIUM SHELL OCTAL 8-PIN | 0-8Q | 4 1/2" x 1 1/8" | FILAMENT | 5.0 | 2.0 | | | | | | | | | | | | | 5Y4-G |
| 5Z3 | FULL-WAVE RECTIFIER | MEDIUM 4-PIN | 4C | 5 1/2" x 2 1/8" | FILAMENT | 5.0 | 3.0 | | | | | | | | | | | | | 5Z3 |
| 6A4/LA | POWER AMPLIFIER TRIODE | SMALL WAFER OCTAL 8-PIN | 8L | 3 1/2" x 1 1/8" | HEATER | 5.0 | 2.0 | | | | | | | | | | | | | 6A4/LA |
| 6A6 | TWIN-TRIODE AMPLIFIER | MEDIUM 8-PIN | 8B | 4 1/2" x 1 1/8" | FILAMENT | 6.3 | 0.3 | 180 | 180 | | | | | | | | | | | 6A6 |
| 6A6 | TWIN-TRIODE AMPLIFIER | MEDIUM 7-PIN # | 7B | 4 1/2" x 1 1/8" | HEATER | 6.3 | 0.8 | 300 | | | | | | | | | | | | 6A6 |
| 6A7 | PENTAGRID CONVERTER | SMALL 7-PIN | 7C | 4 1/2" x 1 1/8" | HEATER | 6.3 | 0.3 | 250 | 100 | | | | | | | | | | | 6A7 |
| 6A8 | PENTAGRID CONVERTER | SMALL WAFER OCTAL 8-PIN | 8A | 3 1/2" x 1 1/8" | HEATER | 6.3 | 0.3 | 250 | 100 | | | | | | | | | | | 6A8 |
| 6A8-G | PENTAGRID CONVERTER | SMALL SHELL OCTAL 8-PIN | 0-8A1 | 4 1/2" x 1 1/8" | HEATER | 6.3 | 0.3 | 250 | 100 | | | | | | | | | | | 6A8-G |
| 6AC5-G | HIGH-MU POWER AMPLIFIER TRIODE | SMALL SHELL OCTAL 8-PIN | 0-8Q1 | 4 1/2" x 1 1/8" | HEATER | 6.3 | 0.4 | 250 | | | | | | | | | | | | 6AC5-G |
| 6B7 | DUPLEX-DIODE PENTODE | SMALL 7-PIN | 7D | 4 1/2" x 1 1/8" | HEATER | 6.3 | 0.3 | 250 | 125 | | | | | | | | | | | 6B7 |
| 6B8 | DUPLEX-DIODE PENTODE | SMALL WAFER OCTAL 8-PIN | 8E | 3 1/2" x 1 1/8" | HEATER | 6.3 | 0.3 | 250 | 125 | | | | | | | | | | | 6B8 |
| 6B8-G | DUPLEX-DIODE PENTODE | SMALL SHELL OCTAL 8-PIN | 0-8E1 | 4 1/2" x 1 1/8" | HEATER | 6.3 | 0.3 | 250 | 125 | | | | | | | | | | | 6B8-G |
| 6C5 | DETECTOR-AMPLIFIER TRIODE | SMALL WAFER OCTAL 8-PIN | 8Q | 2 1/2" x 1 1/8" | HEATER | 6.3 | 0.3 | 250 | | | | | | | | | | | | 6C5 |
| 6C5-G | DETECTOR-AMPLIFIER TRIODE | SMALL SHELL OCTAL 8-PIN | 0-8Q1 | 4 1/2" x 1 1/8" | HEATER | 6.3 | 0.3 | 250 | | | | | | | | | | | | 6C5-G |
| 6C6 | TRIPLE-GRID DETECTOR AMPLIFIER | SMALL 8-PIN | 8F | 4 1/2" x 1 1/8" | HEATER | 6.3 | 0.3 | 250 | 100 | | | | | | | | | | | 6C6 |
| 6D6 | TRIPLE-GRID SUPER-CONTROL AMPLIFIER | SMALL 8-PIN | 8F | 4 1/2" x 1 1/8" | HEATER | 6.3 | 0.3 | 250 | 100 | | | | | | | | | | | 6D6 |
| 6D8-G | PENTAGRID CONVERTER | SMALL SHELL OCTAL 8-PIN | 0-8A1 | 4 1/2" x 1 1/8" | HEATER | 6.3 | 0.15 | 250 | 100 | | | | | | | | | | | 6D8-G |
| 6E5 | ELECTRON-RAY TUBE | SMALL 8-PIN | 8R | 4 1/2" x 1 1/8" | HEATER | 6.3 | 0.3 | 250 | | | | | | | | | | | | 6E5 |
| 6F5 | HIGH-MU TRIODE | SMALL WAFER OCTAL 8-PIN | 8M | 3 1/2" x 1 1/8" | HEATER | 6.3 | 0.3 | 250 | | | | | | | | | | | | 6F5 |
| 6F5-G | HIGH-MU TRIODE | SMALL SHELL OCTAL 8-PIN | 0-8M1 | 4 1/2" x 1 1/8" | HEATER | 6.3 | 0.3 | 250 | | | | | | | | | | | | 6F5-G |
| 6F6 | POWER AMPLIFIER PENTODE | SMALL WAFER OCTAL 7-PIN | 7S | 3 1/2" x 1 1/8" | HEATER | 6.3 | 0.7 | 250 | | | | | | | | | | | | 6F6 |
| 6F6-G | POWER AMPLIFIER PENTODE | MEDIUM SHELL OCTAL 7-PIN | 0-7S | 4 1/2" x 1 1/8" | HEATER | 6.3 | 0.7 | | | | | | | | | | | | | 6F6-G |
| 6F7 | TRIODE PENTODE | SMALL 7-PIN | 7E | 4 1/2" x 1 1/8" | HEATER | 6.3 | 0.3 | 250 | 100 | | | | | | | | | | | 6F7 |
| 6G5 | ELECTRON-RAY TUBE | SMALL 8-PIN | 8R | 4 1/2" x 1 1/8" | HEATER | 6.3 | 0.3 | 250 | | | | | | | | | | | | 6G5 |
| 6H6 | TWIN DIODE | SMALL WAFER OCTAL 8-PIN | 7Q | 1 1/2" x 1 1/8" | HEATER | 6.3 | 0.3 | | | | | | | | | | | | | 6H6 |
| 6H6-G | TWIN DIODE | SMALL SHELL OCTAL 7-PIN | 0-7Q1 | 4 1/2" x 1 1/8" | HEATER | 6.3 | 0.3 | | | | | | | | | | | | | 6H6-G |
| 6J5 | DETECTOR AMPLIFIER TRIODE | SMALL SHELL OCTAL 8-PIN | 8Q | 2 1/2" x 1 1/8" | HEATER | 6.3 | 0.3 | 250 | | | | | | | | | | | | 6J5 |
| 6J5-G | DETECTOR AMPLIFIER TRIODE | SMALL SHELL OCTAL 8-PIN | 0-8Q | 4 1/2" x 1 1/8" | HEATER | 6.3 | 0.3 | 250 | | | | | | | | | | | | 6J5-G |
| 6J7 | TRIPLE-GRID DETECTOR AMPLIFIER | SMALL WAFER OCTAL 7-PIN | 7R | 3 1/2" x 1 1/8" | HEATER | 6.3 | 0.3 | 250 | 125 | | | | | | | | | | | 6J7 |
| 6J7-G | TRIPLE-GRID DETECTOR AMPLIFIER | SMALL SHELL OCTAL 7-PIN | 0-7R1 | 4 1/2" x 1 1/8" | HEATER | 6.3 | 0.3 | 250 | 125 | | | | | | | | | | | 6J7-G |
| 6K5-G | HIGH-MU TRIODE | SMALL SHELL OCTAL 7-PIN | 0-8U | 4 1/2" x 1 1/8" | HEATER | 6.3 | 0.3 | 250 | | | | | | | | | | | | 6K5-G |
| 6K6-G | POWER AMPLIFIER PENTODE | SMALL SHELL OCTAL 7-PIN | 0-7S | 4 1/2" x 1 1/8" | HEATER | 6.3 | 0.4 | 250 | 250 | | | | | | | | | | | 6K6-G |

| TYPE | NAME | BASE | SOCKET CONNECTIONS | DIMENSIONS MAXIMUM OVERALL LENGTH x DIAMETER | CATHODE TYPE # | RATING | | | | USE Values to right give operating conditions and characteristics for indicated typical use | PLATE SUPPLY VOLTS | GRID BIAS VOLTS | SCREEN SUPPLY VOLTS | SCREEN CURRENT MA. | PLATE CURRENT MA. | A-C PLATE RESISTANCE OHMS | TRANS-CONDUCTANCE (GRID-PLATE) μMhos | AMPLIFICATION FACTOR | LOAD RESISTANCE OUTPUT OHMS | POWER OUTPUT WATTS | TYPE | |
|-------|-------------------------------------|--------------------------|--------------------|--|----------------|--------------------|---------|--------------------------|--------------------------|--|--------------------------|--|--------------------------|----------------------------|--------------------------------|---------------------------|--------------------------------------|----------------------|--|------------------------------|------------------------------|-----|
| | | | | | | FILAMENT OR HEATER | | PLATE MAX. VOLTS | SCREEN MAX. VOLTS | | | | | | | | | | | | | |
| | | | | | | VOLTS | AMPERES | | | | | | | | | | | | | | | |
| 6K7 | TRIPLE-GRID SUPER-CONTROL AMPLIFIER | SMALL WAFER OCTAL 7-PIN | 7R | 3 1/2" x 1 1/8" | HEATER | 6.3 | 0.3 | 250 | 125 | CLASS A AMPLIFIER | 90 250 | - 3.0 min. | 90 | 1.3 2.6 | 5.4 10.5 | 315000 60000 | 1275 1650 | 900 400 | | | 6K7 | |
| 6K7-G | TRIPLE-GRID SUPER-CONTROL AMPLIFIER | SMALL SHELL OCTAL 7-PIN | G-7R: | 4 1/2" x 1 1/8" | HEATER | 6.3 | 0.3 | 250 | 125 | MIXER IN SUPERHETERODYNE AMPLIFIER MIXER | 250 | -10.0 | 100 | | | | | | | | 6K7-G | |
| 6L5-G | DETECTOR AMPLIFIER TRIODE | SMALL SHELL OCTAL 8-PIN | Q-4Q: | 4 1/2" x 1 1/8" | HEATER | 6.3 | 0.15 | 250 | | CLASS A AMPLIFIER | 135 | - 5.0 | | | 3.5 | 11300 | 1500 | 17 | | | 6L5-G | |
| 6L6 | BEAM POWER AMPLIFIER | SMALL WAFER OCTAL 7-PIN | 7AC | 4 1/8" x 1 1/8" | HEATER | 6.3 | 0.9 | 375 375 400 400 | 250 250 300 300 | SINGLE-TUBE CLASS A1 AMPLIFIER PUSH-PULL CLASS A1 AMPLIFIER PUSH-PULL CLASS AB1 AMPLIFIER PUSH-PULL CLASS AB1 AMPLIFIER | 250 250 400 400 | -14.0 Self-bias Self-bias Self-bias | 250 250 300 300 | 5.0 5.4 10.0 10.0 | 72.0 75.0 120.0 120.0 | 11300 9000 | 1500 1900 | 17 17 | | 3500 2500 5000 5000 | 6.5 6.5 14.5† 13.8† | 6L6 |
| 6L6-G | BEAM POWER AMPLIFIER | MEDIUM SHELL OCTAL 7-PIN | Q-7AC: | 5 1/8" x 2 1/8" | HEATER | 6.3 | 0.9 | | | AMPLIFIER | 400 | -25.0 | 300 | 6.0 | 102.0 | | | | | | 6L6-G | |
| 6L7 | PENTAGRID MIXER AMPLIFIER | SMALL WAFER OCTAL 7-PIN | 7T | 3 1/2" x 1 1/8" | HEATER | 6.3 | 0.3 | 250 | 150 | MIXER IN SUPERHETERODYNE CLASS A AMPLIFIER | 250 | - 3.0 | 100 | 7.1 | 2.4 | | | | | | 6L7 | |
| 6L7-G | PENTAGRID MIXER AMPLIFIER | SMALL SHELL OCTAL 7-PIN | Q-7T: | 4 1/2" x 1 1/8" | HEATER | 6.3 | 0.3 | | | MIXER AMPLIFIER | 250 | - 3.0 | 100 | 6.5 | 5.3 | 800000 | 1100 | 880 | | | 6L7-G | |
| 6N5 | ELECTRON-RAY TUBE | SMALL 8-PIN | 8R | 4 1/8" x 1 1/8" | HEATER | 6.3 | 0.15 | 135 | | VISUAL INDICATOR | 250 | - 5.0 | | | 6.0 | 11300 | 3100 | 35 | 20000 | exceeds | 6N5 | |
| 6N7 | TWIN-TRIODE AMPLIFIER | SMALL WAFER OCTAL 8-PIN | 8B | 3 1/2" x 1 1/8" | HEATER | 6.3 | 0.8 | 300 | | CLASS A AMPLIFIER (As Driver) | 250 294 | - 5.0 - 6.0 | 300 | 7.0 | 11000 | 3200 | 35 | or more | 8.0 | 4.0 | 6N7 | |
| 6N7-G | TWIN-TRIODE AMPLIFIER | MEDIUM SHELL OCTAL 8-PIN | G-8B: | 4 1/2" x 1 1/8" | HEATER | 6.3 | 0.8 | 300 | | AMPLIFIER | 300 | 0 | | | | | | | 8000 | 10.0 | 6N7-G | |
| 6Q7 | DUPLEX-DIODE HIGH-MU TRIODE | SMALL WAFER OCTAL 7-PIN | 7V | 3 1/2" x 1 1/8" | HEATER | 6.3 | 0.3 | 250 | | TRIODE UNIT AS CLASS A AMPLIFIER | 100 250 | - 1.5 - 3.0 | | | 0.35 1.1 | 87500 38000 | 800 1200 | 70 70 | | | 6Q7 | |
| 6Q7-G | DUPLEX-DIODE HIGH-MU TRIODE | SMALL SHELL OCTAL 7-PIN | Q-7V: | 4 1/2" x 1 1/8" | HEATER | 6.3 | 0.3 | 250 | | TRIODE UNIT AS AMPLIFIER | 90W 300W | Self-bias, 4400 ohms Self-bias, 3000 ohms | | | | | | | Gain per stage = 32 Gain per stage = 45 | | 6Q7-G | |

| | | | | | | | | | | | | | | | | | | | | | | |
|-------|-------------------------------------|--------------------------|--------|-----------------|--------------|------|-------|------------|------------|--|-------------|--|------------|-------------|--------------|------------------|--------------|-------------|--|---------------|--|-------|
| 6R7 | DUPLEX-DIODE TRIODE | SMALL WAFER OCTAL 7-PIN | 7V | 3 1/2" x 1 1/8" | HEATER | 6.3 | 0.3 | 250 | | TRIODE UNIT AS CLASS A AMPLIFIER | 90W 300W | Self-bias, 4400 ohms Self-bias, 3800 ohms | | | | | | | Gain per stage = 10 Gain per stage = 10 | | 6R7 | |
| 6R7-G | DUPLEX-DIODE TRIODE | SMALL SHELL OCTAL 7-PIN | Q-7V: | 4 1/2" x 1 1/8" | HEATER | 6.3 | 0.3 | 250 | | TRIODE UNIT AS AMPLIFIER | | | | | | | | | | | 6R7-G | |
| 6S7-G | TRIPLE-GRID SUPER-CONTROL AMPLIFIER | SMALL SHELL OCTAL 7-PIN | Q-7R: | 4 1/2" x 1 1/8" | HEATER | 6.3 | 0.15 | 250 | 100 | CLASS A AMPLIFIER | 135 | - 3.0 min. | 100 | 0.9 2.0 | 3.7 8.5 | 1250 1750 | 850 1100 | | | | 6S7-G | |
| 6T7-G | DUPLEX-DIODE HIGH-MU TRIODE | SMALL SHELL OCTAL 7-PIN | Q-7V: | 4 1/2" x 1 1/8" | HEATER | 6.3 | 0.15 | 250 | | TRIODE UNIT AS CLASS A AMPLIFIER | 135 | - 1.5 - 3.0 | | | 0.9 1.2 | 65000 62000 | 1000 1650 | 65 65 | | | 6T7-G | |
| 6U5 | ELECTRON-RAY TUBE | SMALL 8-PIN | 8R | 4 1/8" x 1 1/8" | HEATER | 6.3 | 0.3 | 250 | | VISUAL INDICATOR | 250 | - 5.0 | | | 6.0 | 11300 | 3100 | 35 | 20000 | exceeds | 6U5 | |
| 6U7-G | TRIPLE-GRID SUPER-CONTROL AMPLIFIER | SMALL SHELL OCTAL 7-PIN | G-7R: | 4 1/2" x 1 1/8" | HEATER | 6.3 | 0.3 | 250 | 100 | CLASS A AMPLIFIER MIXER IN SUPERHETERODYNE | 100 250 | - 3.0 min. | 100 | 2.2 2.0 | 8.0 8.2 | 250000 800000 | 1500 1600 | 375 1280 | | | 6U7-G | |
| 6V6-G | BEAM POWER AMPLIFIER | MEDIUM SHELL OCTAL 7-PIN | Q-7AC: | 4 1/8" x 1 1/8" | HEATER | 6.3 | 0.45 | 250 300 | 250 300 | SINGLE-TUBE CLASS A AMPLIFIER CLASS AB1 AMPLIFIER | 250 300 | -12.5 -20.0 | 250 300 | 4.5 5.0 | 45.0 70.0 | | | | | 5000 10000 | 4.25 8.5† | 6V6-G |
| 6X5 | FULL-WAVE RECTIFIER | SMALL WAFER OCTAL 8-PIN | 8S | 3 1/2" x 1 1/8" | HEATER | 6.3 | 0.6 | | | | | | | | | | | | 350 Volts, RMS 75 Milliamperes | | 6X5 | |
| 6X5-G | FULL-WAVE RECTIFIER | SMALL SHELL OCTAL 8-PIN | Q-8S: | 4 1/2" x 1 1/8" | HEATER | 6.3 | 0.6 | | | | | | | | | | | | | | 6X5-G | |
| 6Y6-G | BEAM POWER AMPLIFIER | MEDIUM SHELL OCTAL 7-PIN | Q-7AC: | 4 1/8" x 1 1/8" | HEATER | 6.3 | 1.25 | 135 | 135 | SINGLE-TUBE CLASS A1 AMPLIFIER | 135 | -13.5 | 135 | 3.0 | 58.0 | | | | 2000 | 3.6 | | 6Y6-G |
| 6Z5-G | FULL-WAVE RECTIFIER | SMALL SHELL OCTAL 8-PIN | Q-8S: | 4 1/2" x 1 1/8" | HEATER | 6.3 | 0.3 | | | | | | | | | | | | 350 Volts, RMS 35 Milliamperes | | 6Z5-G | |
| 10 | POWER AMPLIFIER TRIODE | MEDIUM 4-PIN (Bayonet) | 4D | 5 1/2" x 2 1/8" | FILAMENT | 7.5 | 1.25 | 425 | | CLASS A AMPLIFIER | 350 425 | -32.0 -40.0 | | | 16.0 18.0 | 5150 5000 | 1550 1600 | 8.0 8.0 | 11000 10200 | 0.9 1.6 | 10 | |
| 11 | DETECTOR AMPLIFIER TRIODE | MEDIUM 4-PIN (Bayonet) | 4D | 4 1/2" x 1 1/8" | D-C FILAMENT | 1.1 | 0.25 | 135 | | CLASS A AMPLIFIER | 90 | - 4.5 | | | 2.5 | 15500 | 425 | 6.6 | | | 11 | |
| 12 | DETECTOR AMPLIFIER TRIODE | MEDIUM 4-PIN (Bayonet) | 4D | 4 1/2" x 1 1/8" | D-C FILAMENT | 1.1 | 0.25 | 135 | | CLASS A AMPLIFIER | 135 | -10.5 | | | 3.0 | 15000 | 440 | 6.6 | | | 12 | |
| 1223 | HALF-WAVE RECTIFIER | SMALL 4-PIN | 4D | 4 1/8" x 1 1/8" | HEATER | 12.6 | 0.3 | | | | | | | | | | | | 250 Volts, RMS 60 Milliamperes | | 1223 | |
| 15 | R-F AMPLIFIER PENTODE | SMALL 8-PIN | 8P | 4 1/2" x 1 1/8" | HEATER | 2.0 | 0.22 | 135 | 67.5 | CLASS A AMPLIFIER | 67.5 | - 1.5 | 67.5 | 0.3 | 1.85 | 630000 | 710 | 450 | | | 15 | |
| 19 | TWIN-TRIODE AMPLIFIER | SMALL 8-PIN | 8C | 4 1/8" x 1 1/8" | D-C FILAMENT | 2.0 | 0.26 | 135 | | CLASS B AMPLIFIER | 135 | - 1.5 | 67.5 | 0.3 | 1.85 | 800000 | 750 | 600 | | | 19 | |
| 20 | POWER AMPLIFIER TRIODE | TAPERED MEDIUM 4-PIN | 4D | 4 1/2" x 1 1/8" | D-C FILAMENT | 3.3 | 0.132 | 135 | | CLASS A AMPLIFIER | 90 | -16.5 | | | 3.0 | 8000 | 415 | 3.3 | 9500 | 0.045 | 20 | |
| 22 | R-F AMPLIFIER TETRODE | MEDIUM 4-PIN | 4K | 5 1/2" x 1 1/8" | D-C FILAMENT | 3.3 | 0.132 | 135 | 67.5 | SCREEN-GRID R-F AMPLIFIER | 135 | - 1.5 | 45 | 0.6* | 1.7 | 725000 | 375 | 270 | | | 22 | |
| 24-A | R-F AMPLIFIER TETRODE | MEDIUM 8-PIN | 8E | 5 1/2" x 1 1/8" | HEATER | 2.5 | 1.75 | 275 | 90 | SCREEN-GRID R-F AMPLIFIER BIAS DETECTOR | 180 250 | - 3.0 approx. | 90 | 1.7* 4.5 | 4.0 4.0 | 400000 600000 | 1000 2050 | 400 630 | | | Plate current to be adjusted to 0.1 milliamperes with no signal. | 24-A |

| | | | | | | | | | | | | | | | | | | | | | | |
|--------|-------------------------------------|--------------------------|--------|-----------------|--------------|------|------|-----|------|--|------------|------------------|------|------|------------|--------------|-------------|------------|------------------------------------|-------|--|----|
| 25A6 | POWER AMPLIFIER PENTODE | SMALL WAFER OCTAL 7-PIN | 7S | 3 1/2" x 1 1/8" | HEATER | 25.0 | 0.3 | 180 | 135 | CLASS A AMPLIFIER | 95 | -15.0 -20.0 | 95 | 4.0 | 20.0 | 45000 | 2000 | 90 | 4500 | 0.9 | 25A6 | |
| 25A6-G | POWER AMPLIFIER PENTODE | MEDIUM SHELL OCTAL 7-PIN | G-7S: | 4 1/2" x 1 1/8" | HEATER | 25.0 | 0.3 | 180 | 135 | CLASS A AMPLIFIER | 180 | - 15.0 | 135 | 7.5 | 38.0 | 40000 | 2500 | 100 | | | 25A6-G | |
| 25B6-G | POWER AMPLIFIER PENTODE | MEDIUM SHELL OCTAL 7-PIN | G-7S: | 4 1/2" x 1 1/8" | HEATER | 25.0 | 0.3 | 95 | 95 | CLASS A AMPLIFIER | 95 | -15.0 | 95 | 4.0 | 45.0 | 4000 | | | 2000 | 1.75 | 25B6-G | |
| 25L6 | BEAM POWER AMPLIFIER | SMALL WAFER OCTAL 7-PIN | 7AC | 3 1/2" x 1 1/8" | HEATER | 25.0 | 0.3 | 110 | 110 | SINGLE-TUBE CLASS A AMPLIFIER | 110 | - 7.5 | 110 | 4.0 | 49.0 | 10000 | 8700 | 82 | 1500 | 2.1 | 25L6 | |
| 25L6-G | BEAM POWER AMPLIFIER | MEDIUM SHELL OCTAL 7-PIN | Q-7AC: | 4 1/2" x 1 1/8" | HEATER | 25.0 | 0.3 | 110 | 110 | SINGLE-TUBE CLASS A AMPLIFIER | 110 | - 7.5 | 110 | 4.0 | 49.0 | 10000 | 8700 | 82 | 2000 | 2.2 | 25L6-G | |
| 25Z5 | RECTIFIER-DOUBLER | SMALL 8-PIN | 8E | 4 1/8" x 1 1/8" | HEATER | 25.0 | 0.3 | | | VOLTAGE DOUBLER MAXIMUM A-C VOLTAGE PER PLATE MAXIMUM D-C OUTPUT CURRENT | | | | | | | | | 125 Volts, RMS 100 Milliamperes | | 25Z5 | |
| 25Z6 | RECTIFIER-DOUBLER | SMALL WAFER OCTAL 7-PIN | 7Q | 3 1/2" x 1 1/8" | HEATER | 25.0 | 0.3 | | | VOLTAGE DOUBLER MAXIMUM A-C VOLTAGE PER PLATE MAXIMUM D-C OUTPUT CURRENT | | | | | | | | | 125 Volts, RMS 85 Milliamperes | | 25Z6 | |
| 25Z6-G | RECTIFIER-DOUBLER | SMALL SHELL OCTAL 7-PIN | Q-7Q: | 4 1/2" x 1 1/8" | HEATER | 25.0 | 0.3 | | | VOLTAGE DOUBLER MAXIMUM A-C VOLTAGE PER PLATE MAXIMUM D-C OUTPUT CURRENT | | | | | | | | | 250 Volts, RMS 85 Milliamperes | | 25Z6-G | |
| 26 | AMPLIFIER TRIODE | MEDIUM 4-PIN | 4D | 4 1/2" x 1 1/8" | FILAMENT | 1.5 | 1.05 | 180 | | CLASS A AMPLIFIER | 90 180 | - 7.0 -14.5 | | | 2.9 6.2 | 8900 7300 | 933 1150 | 8.3 8.3 | | | 26 | |
| 27 | DETECTOR AMPLIFIER TRIODE | MEDIUM 8-PIN | 8A | 4 1/8" x 1 1/8" | HEATER | 2.5 | 1.75 | 275 | | CLASS A AMPLIFIER BIAS DETECTOR | 135 250 | - 9.0 -21.0 | | | 4.5 5.2 | 9000 9250 | 1000 | 9.0 | | | Plate current to be adjusted to 0.2 milliamperes with no signal. | 27 |
| 30 | DETECTOR AMPLIFIER TRIODE | SMALL 4-PIN | 4D | 4 1/8" x 1 1/8" | D-C FILAMENT | 2.0 | 0.06 | 180 | | AMPLIFIER | 135 | -21.5 | | | 8.0 | 4100 | 925 | 3.8 | 7000 | 0.185 | 30 | |
| 31 | POWER AMPLIFIER TRIODE | SMALL 4-PIN | 4D | 4 1/8" x 1 1/8" | D-C FILAMENT | 2.0 | 0.13 | 180 | | CLASS A AMPLIFIER | 135 | -30.0 | | | 12.3 | 3600 | 1050 | 3.0 | 5700 | 0.375 | 31 | |
| 32 | R-F AMPLIFIER TETRODE | MEDIUM 4-PIN | 4K | 5 1/2" x 1 1/8" | D-C FILAMENT | 2.0 | 0.06 | 180 | 67.5 | SCREEN-GRID R-F AMPLIFIER BIAS DETECTOR | 135 180 | - 3.0 approx. | 67.5 | 0.4* | 1.7 | 950000 | 640 | 610 | | | Plate current to be adjusted to 0.2 milliamperes with no signal. | 32 |
| 33 | POWER AMPLIFIER PENTODE | MEDIUM 8-PIN | 8K | 4 1/2" x 1 1/8" | D-C FILAMENT | 2.0 | 0.26 | 180 | 180 | CLASS A AMPLIFIER | 180 | -18.0 | 180 | 5.0 | 22.0 | 55000 | 1700 | 90 | 6000 | 1.4 | 33 | |
| 34 | SUPER-CONTROL R-F AMPLIFIER PENTODE | MEDIUM 4-PIN | 4M | 5 1/2" x 1 1/8" | D-C FILAMENT | 2.0 | 0.06 | 180 | 67.5 | SCREEN-GRID R-F AMPLIFIER | 135 180 | - 3.0 min. | 67.5 | 1.0 | 2.8 | 600000 | 600 | 360 | | | 34 | |
| 35 | SUPER-CONTROL R-F AMPLIFIER TETRODE | MEDIUM 8-PIN | 8E | 5 1/2" x 1 1/8" | HEATER | 2.5 | 1.75 | 275 | 90 | SCREEN-GRID R-F AMPLIFIER | 180 250 | - 3.0 min. | 90 | 2.5* | 6.5 | 300000 | 1020 | 620 | | | 35 | |

| TYPE | NAME | BASE | SOCKET CONNECTIONS | DIMENSIONS OVERALL LENGTH X DIAMETER | CATHODE TYPE # | RATING | | | USE Values to right give operating conditions and characteristics for indicated typical use | PLATE SUPPLY VOLTS | GRID BIAS # VOLTS | SCREEN SUPPLY VOLTS | SCREEN CURR. MA. | PLATE CURR. MA. | A-C PLATE RESISTANCE OHMS | TRANS-CONDUCTANCE (GRID-PLATE) μ MMS | AMPLIFICATION FACTOR | LOAD FOR STATED POWER OUTPUT OHMS | POWER OUTPUT WATTS | TYPE |
|---|-------------------------------------|----------------------|--------------------|--------------------------------------|----------------|--------------------|---------|------------|---|--------------------|-----------------------|---------------------|------------------|-----------------|---------------------------|--|----------------------|-----------------------------------|---------------------|--------|
| | | | | | | FILAMENT OR HEATER | PLATE | SCREEN | | | | | | | | | | | | |
| | | | | | | VOLTS | AMPERES | MAX. VOLTS | | | | | | | | | | | | |
| 36 | R-F AMPLIFIER TETRODE | SMALL 8-PIN | 5E | 4 1/2" x 1 1/8" | HEATER | 6.3 | 0.3 | 250 | 90 | 100 | -1.5 | 55 | 1.7* | 1.8 | 550000 | 850 | 470 | 595 | 36 | |
| 37 | DETECTOR & AMPLIFIER TRIODE | SMALL 8-PIN | 5A | 4 1/8" x 1 1/8" | HEATER | 6.3 | 0.3 | 250 | --- | 100 | -5.0 | 55 | --- | 3.2 | 550000 | 1080 | 595 | --- | 37 | |
| 38 | POWER AMPLIFIER PENTODE | SMALL 8-PIN | 5F | 4 1/2" x 1 1/8" | HEATER | 6.3 | 0.3 | 250 | 250 | 100 | -6.0 | 100 | 1.2 | 7.0 | 140000 | 875 | 120 | 15000 | 0.27 | 38 |
| 39/44 | SUPER-CONTROL R-F AMPLIFIER PENTODE | SMALL 8-PIN | 5F | 4 1/2" x 1 1/8" | HEATER | 6.3 | 0.3 | 250 | 90 | 100 | -3.0 | 90 | 1.6 | 5.6 | 375000 | 960 | 360 | 10000 | 2.50 | 39/44 |
| 40 | VOLTAGE AMPLIFIER TRIODE | MEDIUM 6-PIN Bayonet | 4D | 4 1/2" x 1 1/2" | D-C FILAMENT | 5.0 | 0.25 | 180 | --- | 135 | -3.0 | --- | --- | 0.2 | 150000 | 200 | 30 | --- | --- | 40 |
| 41 | POWER AMPLIFIER PENTODE | SMALL 8-PIN | 5H | 4 1/2" x 1 1/8" | HEATER | 6.3 | 0.4 | 250 | 250 | 100 | -1.5 | --- | --- | 0.2 | 150000 | 200 | 30 | --- | --- | 41 |
| For other characteristics, refer to Type 6K6-G. | | | | | | | | | | | | | | | | | | | | |
| 42 | POWER AMPLIFIER PENTODE | MEDIUM 6-PIN | 6B | 4 1/2" x 1 1/2" | HEATER | 6.3 | 0.7 | 315 | 315 | 250 | -16.5 | 250 | 6.5 | 34.0 | 80000 | 2600 | 190 | 7000 | 3.0 | 42 |
| 43 | POWER AMPLIFIER PENTODE | MEDIUM 6-PIN | 6B | 4 1/2" x 1 1/2" | HEATER | 25.0 | 0.3 | 180 | 135 | 180 | -31.5 | --- | --- | 31.0 | 1650 | 2125 | 3.5 | 2700 | 0.83 | 43 |
| 45 | POWER AMPLIFIER TRIODE | MEDIUM 6-PIN | 4D | 4 1/2" x 1 1/2" | FILAMENT | 2.5 | 1.5 | 275 | --- | 180 | -56.0 | --- | --- | 36.0 | 1700 | 2050 | 3.5 | 4600 | 2.0 | 45 |
| 46 | DUAL-GRID POWER AMPLIFIER | MEDIUM 8-PIN | 5C | 5 1/2" x 2 1/8" | FILAMENT | 2.5 | 1.75 | 250 | --- | 275 | Self-bias, 775 ohms | --- | --- | 72.0 | --- | --- | --- | 5060 | 12.0† | 46 |
| 47 | POWER AMPLIFIER PENTODE | MEDIUM 8-PIN | 6R | 5 1/2" x 2 1/8" | FILAMENT | 2.5 | 1.75 | 250 | 250 | 400 | 0 | --- | --- | 12.0 | --- | --- | --- | 5800 | 20.0† | 47 |
| 48 | POWER AMPLIFIER TETRODE | MEDIUM 8-PIN | 6A | 5 1/2" x 2 1/8" | D-C HEATER | 30.0 | 0.4 | 125 | 100 | 96 | -19.0 | 96 | 9.0 | 52.0 | --- | 3800 | --- | 1500 | 2.0 | 48 |
| 49 | DUAL-GRID POWER AMPLIFIER | MEDIUM 8-PIN | 5C | 4 1/2" x 1 1/2" | D-C FILAMENT | 2.0 | 0.12 | 135 | --- | 125 | -20.0 | 100 | 9.5 | 56.0 | --- | 3900 | --- | 1500 | 2.5 | 49 |
| 50 | POWER AMPLIFIER TRIODE | MEDIUM 6-PIN Bayonet | 4D | 6 1/2" x 2 1/8" | FILAMENT | 7.5 | 1.25 | 450 | --- | 180 | -33.0 | --- | --- | 22.0 | 2380 | 2350 | 5.6 | 6400 | 1.25 | 50 |
| 53 | TWIN-TRIODE AMPLIFIER | MEDIUM 7-PIN# | 7B | 4 1/2" x 1 1/2" | HEATER | 2.5 | 2.0 | 300 | --- | 300 | -54.0 | --- | --- | 35.0 | 2000 | 1900 | 3.8 | 4600 | 1.6 | 53 |
| For other characteristics, refer to Type 6N7. | | | | | | | | | | | | | | | | | | | | |
| 55 | DUPLEX-DIODE TRIODE | SMALL 8-PIN | 6G | 4 1/2" x 1 1/8" | HEATER | 2.5 | 1.0 | 250 | --- | --- | --- | --- | --- | --- | --- | --- | --- | --- | --- | 55 |
| 56 | SUPER-TUNE AMPLIFIER DETECTOR | SMALL 8-PIN | 5A | 4 1/8" x 1 1/8" | HEATER | 2.5 | 1.0 | 250 | --- | --- | --- | --- | --- | --- | --- | --- | --- | --- | --- | 56 |
| 57 | TRIPLE-GRID AMPLIFIER | SMALL 8-PIN | 6F | 4 1/2" x 1 1/8" | HEATER | 2.5 | 1.0 | 250 | 100 | --- | --- | --- | --- | --- | --- | --- | --- | --- | --- | 57 |
| 58 | TRIPLE-GRID SUPER-CONTROL AMPLIFIER | SMALL 8-PIN | 6F | 4 1/2" x 1 1/8" | HEATER | 2.5 | 1.0 | 250 | 100 | --- | --- | --- | --- | --- | --- | --- | --- | --- | --- | 58 |
| 59 | TRIPLE-GRID POWER AMPLIFIER | MEDIUM 7-PIN# | 7A | 5 1/2" x 2 1/8" | HEATER | 2.5 | 2.0 | 250 | 250 | 250 | -28.0 | --- | --- | 26.0 | 2300 | 2600 | 6.0 | 5000 | 1.25 | 59 |
| 71-A | POWER AMPLIFIER TRIODE | MEDIUM 6-PIN Bayonet | 4D | 4 1/2" x 1 1/2" | FILAMENT | 5.0 | 0.25 | 180 | --- | 90 | -19.0 | --- | --- | 10.0 | 2010 | 1750 | 3.0 | 3000 | 0.125 | 71-A |
| 75 | DUPLEX-DIODE HIGH-MU TRIODE | SMALL 8-PIN | 6G | 4 1/2" x 1 1/8" | HEATER | 6.3 | 0.3 | 250 | --- | 90 | Self-bias, 11000 ohms | --- | --- | 20.0 | 1750 | 1700 | 3.0 | 4800 | 0.790 | 75 |
| 76 | SUPER-TUNE AMPLIFIER DETECTOR | SMALL 8-PIN | 5A | 4 1/8" x 1 1/8" | HEATER | 6.3 | 0.3 | 250 | --- | 300 | Self-bias, 3500 ohms | --- | --- | 5.0 | 9500 | 1450 | 13.8 | --- | Gain per stage = 53 | 76 |
| 77 | TRIPLE-GRID DETECTOR | SMALL 8-PIN | 6F | 4 1/2" x 1 1/8" | HEATER | 6.3 | 0.3 | 250 | 100 | 100 | -5.0 | 60 | 0.4 | 1.7 | 650000 | 1100 | 715 | --- | Gain per stage = 9 | 77 |
| 78 | TRIPLE-GRID SUPER-CONTROL AMPLIFIER | SMALL 8-PIN | 6F | 4 1/2" x 1 1/8" | HEATER | 6.3 | 0.3 | 250 | 125 | --- | --- | --- | --- | 2.3 | 1500000 | 1250 | 1500 | --- | Gain per stage = 10 | 78 |
| 79 | TWIN-TRIODE AMPLIFIER | SMALL 8-PIN | 6H | 4 1/2" x 1 1/8" | HEATER | 6.3 | 0.6 | 250 | --- | 180 | 0 | --- | --- | --- | --- | --- | --- | 7000 | 5.5 | 79 |
| 80 | FULL-WAVE RECTIFIER | MEDIUM 6-PIN | 4C | 4 1/2" x 1 1/2" | FILAMENT | 5.0 | 2.0 | --- | --- | --- | --- | --- | --- | --- | --- | --- | --- | 1400 | 5.5 | 80 |
| 81 | HALF-WAVE RECTIFIER | MEDIUM 6-PIN Bayonet | 4B | 6 1/2" x 2 1/8" | FILAMENT | 7.5 | 1.25 | --- | --- | --- | --- | --- | --- | --- | --- | --- | --- | 400 | Milliamperes | 81 |
| 82 | FULL-WAVE RECTIFIER | MEDIUM 6-PIN | 4C | 4 1/2" x 1 1/2" | FILAMENT | 2.5 | 3.0 | --- | --- | --- | --- | --- | --- | --- | --- | --- | --- | 1400 | 5.5 | 82 |
| 83 | FULL-WAVE RECTIFIER | MEDIUM 6-PIN | 4C | 5 1/2" x 2 1/8" | FILAMENT | 5.0 | 3.0 | --- | --- | --- | --- | --- | --- | --- | --- | --- | --- | 1400 | 5.5 | 83 |
| 83-V | FULL-WAVE RECTIFIER | MEDIUM 6-PIN | 4L | 4 1/2" x 1 1/2" | HEATER | 5.0 | 2.0 | --- | --- | --- | --- | --- | --- | --- | --- | --- | --- | 1400 | 5.5 | 83-V |
| 84/824 | FULL-WAVE RECTIFIER | SMALL 8-PIN | 5D | 4 1/8" x 1 1/8" | HEATER | 6.3 | 0.5 | --- | --- | --- | --- | --- | --- | --- | --- | --- | --- | 1400 | 5.5 | 84/824 |
| 85 | DUPLEX-DIODE TRIODE | SMALL 8-PIN | 6G | 4 1/2" x 1 1/8" | HEATER | 6.3 | 0.3 | 250 | --- | 135 | -10.5 | --- | --- | 3.7 | 11000 | 750 | 8.3 | 25000 | 0.375 | 85 |
| 89 | TRIPLE-GRID POWER AMPLIFIER | SMALL 8-PIN | 6F | 4 1/2" x 1 1/8" | HEATER | 6.3 | 0.4 | 250 | 250 | 160 | -20.0 | --- | --- | 17.0 | 3300 | 1425 | 4.7 | 7000 | 0.30 | 89 |
| V-99 | DETECTOR & AMPLIFIER TRIODE | SMALL 8-PIN | 4E | 3 1/4" x 1 1/8" | D-C FILAMENT | 3.3 | 0.063 | 90 | --- | 250 | -31.0 | --- | --- | 32.0 | 2600 | 1800 | 4.7 | 5500 | 0.50 | V-99 |
| 112-A | VOLTAGE AMPLIFIER TRIODE | MEDIUM 6-PIN Bayonet | 4D | 4 1/2" x 1 1/2" | D-C FILAMENT | 5.0 | 0.25 | 180 | --- | 100 | -10.0 | 100 | 1.6 | 9.5 | 104000 | 1200 | 125 | 10700 | 0.33 | 112-A |
| 874 | VOLTAGE REGULATOR | MEDIUM 6-PIN Bayonet | 4S | 5 1/2" x 2 1/8" | --- | --- | --- | --- | --- | 90 | -4.5 | --- | --- | 2.5 | 15500 | 425 | 6.6 | --- | --- | 874 |
| 876 | CURRENT REGULATOR | MEDIUM SCREW | --- | 8" x 2 1/8" | FILAMENT | --- | --- | --- | --- | 90 | -4.5 | --- | --- | 5.0 | 5400 | 1575 | 8.5 | --- | --- | 876 |
| 886 | CURRENT REGULATOR | MOQU SCREW | --- | 8" x 2 1/8" | FILAMENT | --- | --- | --- | --- | 180 | -13.5 | --- | --- | 7.7 | 4700 | 1800 | 8.5 | --- | --- | 886 |

★ For Grid-leak Detection—plate volts 45, grid return to + filament or to cathode.
 ■ Either A, C, or D, C. may be used on filament or heater, except as specifically noted. For use of D, C. on A-C filament types, decrease stated grid volts by 1/3 (approx.) of filament voltage.
 ▲ Supply voltage applied through 20000-ohm voltage-dropping resistor.
 † Mercury-Vapor Type.
 ** Grid #1 is control grid. Grid #2 is screen. Grid #3 tied to cathode.
 †† Grid #1 is control grid. Grids #2 and #3 tied to plate.
 ‡ Grids #1 and #2 connected together. Grid #3 tied to plate.
 ‡‡ Grids #3 and #5 are screen. Grid #4 is signal-input control grid.
 ‡‡‡ Grids #2 and #4 are screen. Grid #1 is signal-input control grid.
 ‡‡‡‡ Triode Plate Supply Voltage and Max. Target Voltage: Min. Target Voltage = 90 volts.
 ‡‡‡‡ Both grids connected together, likewise, both plates.
 ‡‡‡‡ Power output is for two tubes at stated plate-to-plate load.
 ‡‡‡‡ For two tubes.
 ‡‡‡‡ This diagram is like the one having the same designation without the prefix G, except that Pin No. 1 has no connection.

‡‡ This diagram is like the one having the same designation without the prefix G, except that Pin No. 1 is connected to internal shield.
 ● Applied through plate resistor of 250000 ohms or 500 henry choke shunted by 0.25-megohm resistor.
 ▼ Applied through plate resistor of 100000 ohms.
 ◆ Applied through plate resistor of 250000 ohms. *Maximum.
 † Megohms.
 ‡ Requires different socket from small 7-pin.
 ‡ Grid #2 tied to plate. ‡ Grids #1 and #2 tied together. ‡‡ For grid of following tube.
 ‡ Plate voltages greater than 125 volts RMS require 100-ohm (minimum) series-plate resistor.
 ‡ Applied through plate resistor of 150000 ohms.
 ‡ For signal-input control grid (#1); control-grid #3 bias, -3 volts.
 ‡ Applied through 200000-ohm plate resistor.
 ‡ Note 1: Types with octal bases have *Miniature Metal Cap*; all others have *Small Metal Cap*.
 ‡ Note 2: Subscript 1 on class of amplifier service (as AB₁) indicates that grid current does not flow during any part of input cycle.
 ‡ Subscript 2 on class of amplifier service (as AB₂) indicates that grid current flows during some part of the input cycle.

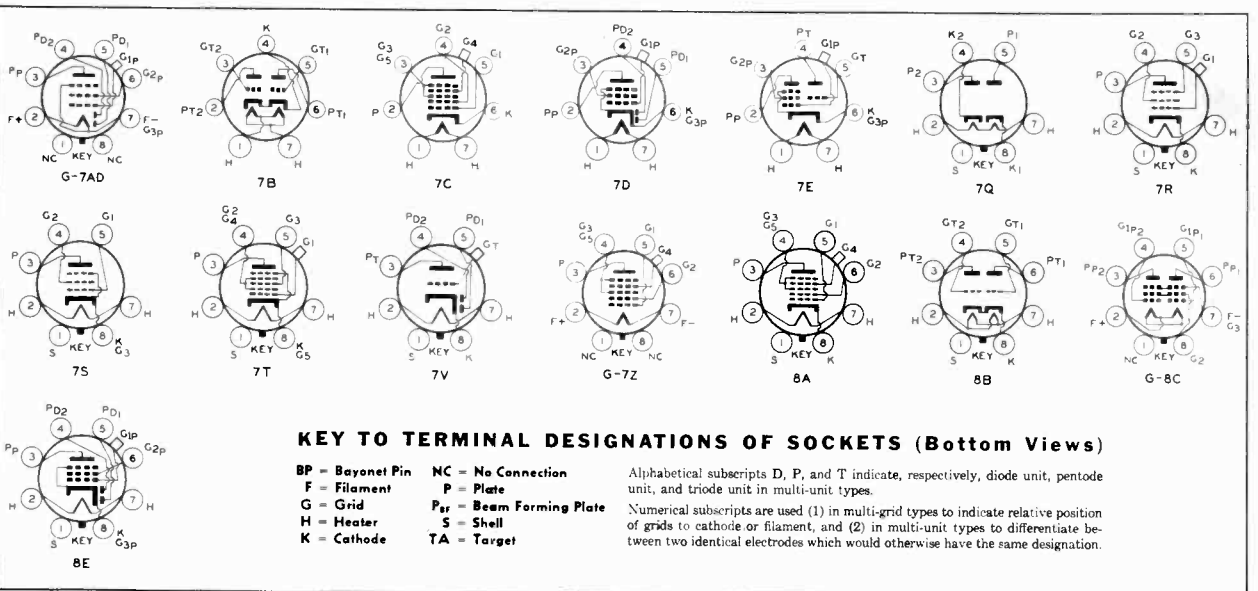
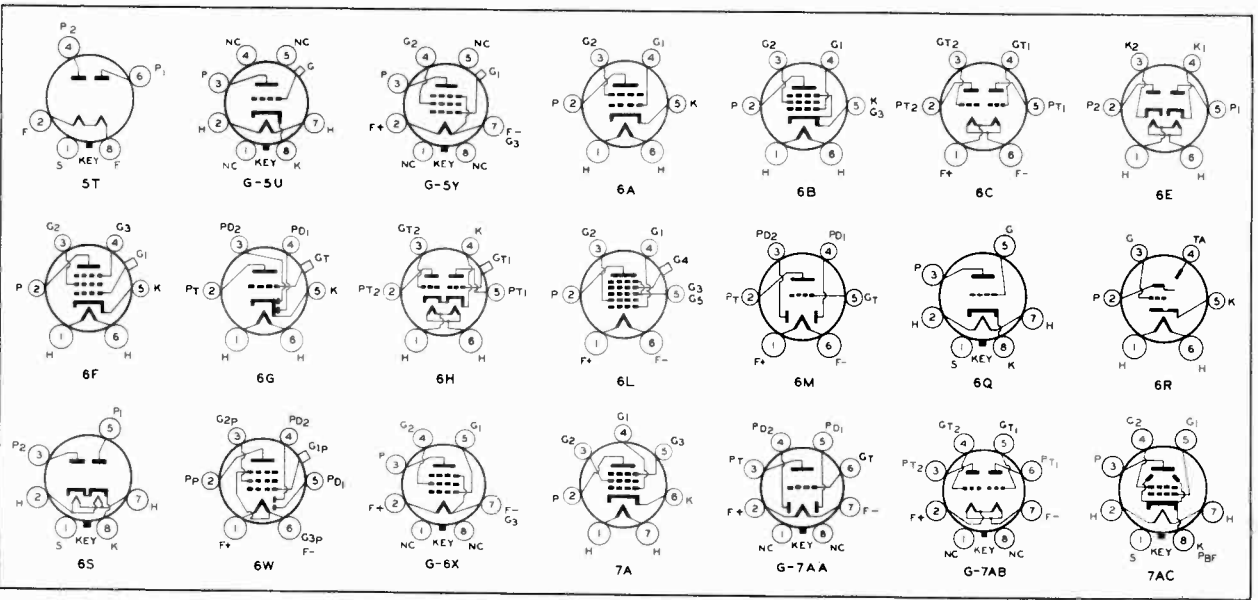
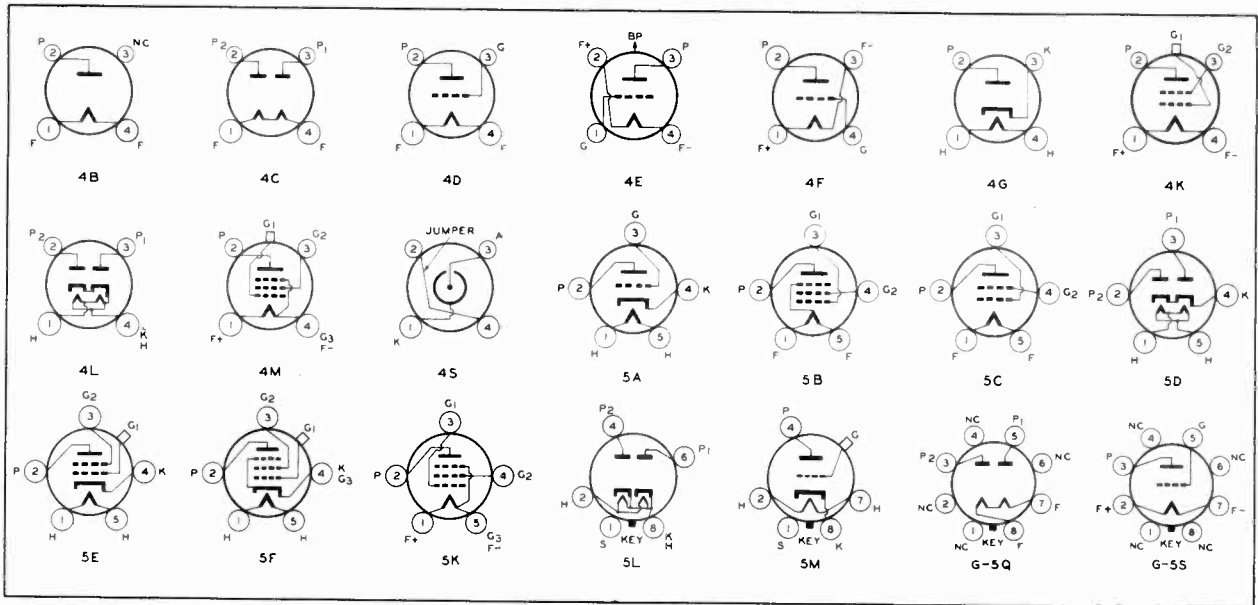

KEY TO TERMINAL DESIGNATIONS OF SOCKETS (Bottom Views)

- BP = Bayonet Pin
- F = Filament
- G = Grid
- H = Heater
- K = Cathode
- NC = No Connection
- P = Plate
- P_F = Beam Forming Plate
- S = Shell
- TA = Target

Alphabetical subscripts D, P, and T indicate, respectively, diode unit, pentode unit, and triode unit in multi-unit types.
 Numerical subscripts are used (1) in multi-grid types to indicate relative position of grids to cathode or filament, and (2) in multi-unit types to differentiate between two identical electrodes which would otherwise have the same designation.

PRICE LIST

REPLACEMENT PARTS FOR 1937-38 LINE

ALL PRICES AND DISCOUNTS ARE SUBJECT TO CHANGE OR WITHDRAWAL WITHOUT NOTICE

| STOCK # | PRICE | DESCRIPTION | STOCK # | PRICE | DESCRIPTION | STOCK # | PRICE | DESCRIPTION |
|---------|---------------|---------------------|---------|--------|---------------------|---------|---------------|---------------------|
| 150 | (\$64.50 net) | Oscillator | 4459 | .10 | Bracket | 5175 | | Superseded by 30754 |
| 151 | (39.95 ") | Oscillograph | 4460 | 1.35 | Switch | 5196 | .20 | Cap. |
| 2893 | \$0.06 | Spring | 4461 | .50 | Cable | 5206 | .85 | Resistor |
| 2917 | .03 | Washer | 4462 | .25 | " | 5210 | .05 | Screw |
| 3033 | | Superseded by 13730 | 4502 | 1.50 | Vol. Cont. | 5211 | .20 | Bolt |
| 3078 | .20 | Resistor | 4518 | .52 | Cap. | 5212 | 1.35 | Cap. |
| 3204 | .25 | Cable | 4543 | .25 | Damper | 5226 | .17 | Lamp |
| 3219 | .20 | Resistor | 4555 | | Superseded by 11762 | 5237 | .08 | Bushing |
| 3252 | .20 | " | 4560 | .06 | Screw | 5239 | .70 | Fuse Mtg. |
| 3261 | .10 | Bushing | 4563 | .04 | " | 5240 | .35 | Cover |
| 3322 | 1.40 | Switch | 4564 | .04 | " | 6122 | .02 | Clamp |
| 3376 | .80 | Fuse Mtg. | 4565 | .06 | Spring | 6503 | .80 | Pawl |
| 3387 | .02 | Screw | 4566 | .06 | Screw | 6679 | (\$1.10 net) | Wand |
| 3390 | .65 | Escutcheon | 4573 | .30 | Plug | 6805 | 4.20 | Switch |
| 3396 | .52 | Receptacle | 4577 | .45 | " | 6808 | .35 | Clutch |
| 3430 | | Superseded by 11762 | 4580 | .06 | Screw | 6809 | .65 | Finger |
| 3521 | .18 | Cover | 4604 | .40 | Fuse Mtg. | 7226 | 1.35 | Grease |
| 3666 | .04 | Spring | 4624 | .50 | Cap. | 7227 | .90 | Oil |
| 3670 | .45 | Finger | 4669 | .03 | Screw | 7228 | 1.20 | Lubricant |
| 3672 | .60 | Pin | 4671 | 1.10 | Switch | 7766 | .40 | Lead |
| 3676 | .04 | Spring | 4674 | | Superseded by 14805 | 7852 | 2.00 | Transf. |
| 3682 | .22 | Shield | 4752 | .26 | Cap. | 7853 | 2.35 | " |
| 3729 | 2.10 | Roller | 4753 | .02 | Link | 7900 | .60 | Switch |
| 3748 | .25 | Fuse | 4786 | .25 | Socket | 7931 | 8.15 | Motor |
| 3763 | .70 | Spring | 4787 | .25 | " | 7935 | .03 | Leather |
| 3764 | .15 | Nut | 4794 | .25 | " | 7936 | .10 | Nut |
| 3792 | .20 | Resistor | 4814 | .25 | " | 7937 | .30 | Ball |
| 3811 | .10 | Screw | 4836 | | Superseded by 4886 | 7938 | .28 | Gear |
| 3812 | 1.25 | Armature | 4838 | .25 | Cap. | 7939 | 1.40 | Spindle |
| 3829 | .25 | Knob | 4839 | .30 | " | 7940 | 3.15 | Governor |
| 3903 | .02 | Screw | 4840 | | Superseded by 12484 | 7941 | .75 | Plate |
| 3944 | .50 | Shield | 4841 | " | " 4839 | 7942 | .25 | Spring |
| 3950 | .26 | " | 4858 | .25 | Cap. | 7943 | 3.20 | Barrel |
| 3961 | .10 | Knob | 4868 | | Superseded by 4838 | 7944 | .35 | Shaft |
| 3994 | .40 | Cover | 4870 | .20 | Cap. | 7945 | .90 | Gear |
| 3998 | | Superseded by 12695 | 4886 | .20 | " | 7957 | 1.25 | Spring |
| 4055 | .30 | Post | 4937 | .25 | " | 8043 | .25 | Resistor |
| 4059 | .02 | Screw | 4982 | .05 | Spring | 8051 | .60 | Link |
| 4061 | .11 | Spring | 5005 | | Superseded by 30303 | 8052 | .06 | Spring |
| 4064 | .10 | Cable | 5023 | .40(5) | Fuse | 8058 | .20 | Clamp |
| 4067 | .05 | Spring | 5024 | .40 | Suppressor | 8059 | .20 | Board |
| 4083 | .02 | Washer | 5025 | .45 | Cap. | 8060 | .35 | Bracket |
| 4084 | .06 | " | 5027 | | Superseded by 14020 | 8063 | .20 | Resistor |
| 4119 | .02 | Screw | 5029 | " | " 12286 | 8064 | .20 | " |
| 4125 | .06 | Spring | 5030 | " | " 30546 | 8065 | | Superseded by 30409 |
| 4160 | (\$0.60 net) | Wrench | 5031 | " | " 12262 | 8067 | " | " 30147 |
| 4233 | .22 | Shield | 5033 | " | " 30683 | 8070 | " | " 14721 |
| 4241 | | Superseded by 12201 | 5035 | " | " 12486 | 8072 | " | " 30685 |
| 4284 | .25(10) | Spring | 5037 | " | " 12218 | 8073 | .25 | Resistor |
| 4285 | .25(10) | Washer | 5039 | .30 | Plug | 9545 | (\$63.95 net) | Oscillograph |
| 4286 | .25(10) | Ferrule | 5040 | .30 | " | 9558 | (27.50 ") | Freq. Mod. |
| 4288 | .25(10) | Cap | 5042 | .03 | Screw | 9572 | (29.95 ") | Calibrator |
| 4289 | .03 | Body | 5091 | .05 | Cushion | 9595 | (34.50 ") | Oscillator |
| 4290 | .02 | Insulator | 5107 | .20 | Cap. | 9632 | 2.00 | Transf. |
| 4291 | .06 | Clip | 5108 | | Superseded by 14983 | 9650 * | | Motor |
| 4293 | .60 | Cap. | 5112 | " | " 14720 | 9651 * | | " |
| 4317 | (\$4.00 net) | Indicator | 5114 | .22 | Resistor | 9692 * | | " |
| 4323 | .10 | Knob | 5118 | .25 | Plug | 9693 * | | " |
| 4325 | .15 | " | 5119 | .25 | " | 9694 | 30.00 | Speaker |
| 4327 | .20 | Insulator | 5129 | .15(5) | Ring | 9696 | 11.75 | " |
| 4340 | .17 | Lamp | 5131 | .15 | Resistor | 9699 | 10.10 | " |
| 4348 | .45 | " | 5132 | .15 | " | 9712 | 9.00 | " |
| 4358 | .15 | Clamp | 5140 | .10 | Fuse | 9713 | 20.00 | " |
| 4387 | .02 | Screw | 5144 | | Superseded by 14024 | 9720 | 10.75 | " |
| 4389 | .03 | " | 5145 | " | " 14560 | 9721 | 17.30 | Motor |
| 4391 | .70 | Box | 5147 | .22 | Resistor | 9722 | 17.40 | " |
| 4420 | .02 | Clamp | 5148 | .20 | Cap. | 9723 | 18.65 | " |
| 4427 | .18 | Bracket | 5158 | | Superseded by 12264 | 9724 | 17.85 | " |
| 4456 | .15 | Motor Acces. | 5159 | " | " 13716 | 9725 | 17.30 | " |
| 4458 | .80 | Post | 5170 | " | " 12484 | 9726 | 17.40 | " |

(*) PRICE UPON APPLICATION TO YOUR RCA VICTOR DISTRIBUTOR.

| STOCK # | PRICE | DESCRIPTION | STOCK # | PRICE | DESCRIPTION | STOCK # | PRICE | DESCRIPTION |
|-------------------|-------|---------------------|---------|-------|---------------------|--------------------|-------|---------------------|
| 9727 | 18.65 | Motor | 11364 | | Superseded by 12454 | 11823 | 1.50 | Cord |
| 9728 | 17.85 | " | 11365 | | " " 14023 | 11829 | .25 | Roller |
| 9729 | 17.30 | " | 11377 | .03 | Screw | 11847 | | Superseded by 13479 |
| 9730 | 17.40 | " | 11381 | .35 | Socket | 11859 | .25 | Cap. |
| 9731 | 18.65 | " | 11383 | .20 | Shield | 11869 | .32 | Screw |
| 9732 | 17.85 | " | 11387 | | Superseded by 11203 | 11873 | 10.50 | Motor |
| 9733 | 20.00 | " | 11391 | 1.50 | Trap | 11874 | 17.15 | " |
| 9734 | 19.75 | " | 11395 | .50 | Cap. | 11875 | 7.90 | Turntable |
| 9735 * | | " | 11397 | .15 | Resistor | 11876 | 7.90 | " |
| 9766 | 11.50 | Speaker | 11398 | .15 | " | 11880 | 9.00 | Transf. |
| 9768 | 14.50 | " | 11400 | .20 | " | 11881 | .90 | Base |
| 9771 | 10.00 | " | 11414 | | Superseded by 4839 | 11886 | .05 | Washer |
| 9776 | 6.40 | " | 11451 | " | " " 4752 | 11887 | 15.00 | Transf. |
| 9778 | 12.40 | " | 11452 | .15 | Resistor | 11890 (\$0.38 net) | | Tool |
| 9779 | 6.20 | " | 11453 | .15 | " | 11932 | .15 | Resistor |
| 9780 | 10.75 | " | 11454 | | Superseded by 12265 | 11935 | | Superseded by 14837 |
| 9797 (\$1.50 net) | | Cable Kit | 11456 | .07 | Screw | 11937 | .40 | Resistor |
| 9798 | 6.25 | Speaker | 11458 | 6.95 | Transf. | 11950 | 8.50 | P.U. & Arm |
| 9799 | 23.00 | Motor | 11465 | .48 | Cap. | 11951 | | Superseded by 3811 |
| 9802 | 7.35 | Speaker | 11466 | .95 | Resistor | 11955 | " | " 12453 |
| 9803 | 7.25 | " | 11469 | .30 | Coil | 11979 | .30 | Plug |
| 9813 | 2.50 | Transf. | 11488 | | Superseded by 14783 | 11982 | .01 | Fastner |
| 9814 | 3.00 | " | 11496 | 1.35 | Cap. | 11996 | | Superseded by 13615 |
| 9816 | 1.50 | Trans. Line | 11528 | .14 | Silencer | 11998 | .30 | Cap. |
| 10129 | .02 | Ball | 11529 | .85 | Bearing | 12004 | .45 | Resistor |
| 10174 | .30 | Spring | 11530 | .85 | Tip | 12006 | .15 | Core |
| 10184 | .22 | Plate | 11531 | .04 | Spring | 12007 | .02 | Spring |
| 10194 | .02 | Ball | 11534 | .04 | Screw | 12008 | .40 | Shield |
| 10705 | .02 | " | 11535 | .40 | Shaft | 12010 | .15 | Resistor |
| 10907 | .08 | Fuse | 11536 | .25 | Cushion | 12011 | | Superseded by 13477 |
| 10941 | .02 | Ball | 11537 | .60 | Collar | 12012 | 2.90 | Coil |
| 11151 | | Superseded by 12679 | 11538 | 3.00 | Bracket | 12013 | .15 | Resistor |
| 11172 | " | " 12285 | 11539 | 2.10 | Yoke | 12014 | .20 | " |
| 11175 | .20 | Resistor | 11543 | | Superseded by 13405 | 12021 | 6.30 | Breaker |
| 11195 | .20 | Socket | 11548 | 1.05 | Back | 12038 | .02 | Band |
| 11196 | .25 | " | 11549 | .06 | Screw | 12048 | 9.85 | Turntable |
| 11197 | .20 | " | 11553 | .60 | Escutcheon | 12049 | 9.90 | " |
| 11198 | .22 | " | 11554 | 1.25 | Lever | 12050 | 1.05 | Spring |
| 11199 | | Superseded by 14114 | 11555 | 2.45 | " | 12051 | 7.95 | Cap. |
| 11203 | 1.15 | Cap. | 11573 | .70 | Socket | 12082 | | Superseded by 11741 |
| 11210 | .05 | Screw | 11580 | .60 | Cover | 12083 | 18.85 | Motor |
| 11211 | 8.00 | Transf. | 11584 | 11.20 | Transf. | 12084 | 2.40 | Coil |
| 11212 | 11.65 | " | 11585 | 9.20 | " | 12085 | .30 | Core |
| 11213 | 15.30 | " | 11586 | .03 | Screw | 12087 | 1.00 | Vol. Cont. |
| 11222 | .25 | Socket | 11591 | .10 | Button | 12089 | 1.35 | Condenser |
| 11229 | 2.60 | Transf. | 11603 | .35 | Shield | 12095 | 1.85 | Transf. |
| 11233 | .35 | Coil | 11607 | .85 | Receptacle | 12096 | 2.80 | " |
| 11234 | 3.85 | " | 11617 | 2.85 | Coil | 12097 | 3.50 | " |
| 11240 | | Superseded by 11203 | 11618 | 3.50 | Coil | 12104 | .30 | Cap. |
| 11251 | 14.50 | Transf. | 11620 | .15 | Resistor | 12105 | .45 | Shaft |
| 11253 | 1.85 | " | 11621 | | Superseded by 12811 | 12106 | .04 | Spring |
| 11256 | .40 | Cap. | 11622 | .55 | Cap. | 12107 | .80 | Coupling |
| 11265 | .25 | Shield | 11623 | | Superseded by 13003 | 12108 | 14.00 | Crystal |
| 11272 | .10 | Clamp | 11624 | .30 | Resistor | 12110 | .14 | Shield |
| 11278 | .22 | Socket | 11626 | | Superseded by 12679 | 12118 | .03 | Cap |
| 11279 | .22 | " | 11646 | " | " " 12412 | 12125 | .04 | Screw |
| 11280 | .22 | " | 11647 | " | " " 13714 | 12128 | 1.45 | Jack |
| 11281 | .15 | Resistor | 11654 | .50 | Cap. | 12141 | 2.30 | Cap. |
| 11282 | .15 | " | 11668 | .20 | Resistor | 12179 | .55 | Coil |
| 11283 | | Superseded by 12267 | 11670 | .22 | " | 12194 | .20 | Resistor |
| 11284 | " | " 30983 | 11703 | 3.05 | Governor | 12195 | | Superseded by 13716 |
| 11287 | .65 | Cap. | 11704 | .25 | Damper | 12199 | .20 | Resistor |
| 11289 | .35 | " | 11708 | .50 | Cover | 12200 | | Superseded by 13730 |
| 11290 | | Superseded by 13894 | 11711 | .65 | Shade | 12201 | .20 | Resistor |
| 11297 | .15 | Resistor | 11726 | | Superseded by 12265 | 12218 | .20 | Shield |
| 11298 | .22 | " | 11730 | .55 | Cable | 12248 | .25 | Socket |
| 11300 | .15 | " | 11731 | 1.30 | Armature | 12249 | 1.00 | Tone Cont. |
| 11305 | | Superseded by 13998 | 11732 | 1.30 | Coil | 12252 | .02 | Screw |
| 11315 | .20 | Cap. | 11733 | 4.80 | " | 12254 | .45 | Stud |
| 11320 | 1.35 | Coil | 11734 | 4.90 | " | 12261 | .20 | Resistor |
| 11323 | | Superseded by 12199 | 11735 | 5.00 | " | 12262 | .20 | " |
| 11324 | " | " 12414 | 11740 | 2.80 | Base | 12263 | | Superseded by 14560 |
| 11332 | .22 | Resistor | 11741 | 20.40 | Motor | 12264 | .20 | Resistor |
| 11347 | .15 | Knob | 11748 | | Superseded by 14228 | 12265 | .20 | " |
| 11349 | .05 | Spring | 11762 | .50 | Box | 12270 | .35 | Cap. |
| 11350 | .05 | Cap | 11765 | .23 | Lamp | 12285 | .20 | Resistor |
| 11353 | | Superseded by 12262 | 11799 | .30 | Cap. | 12286 | .20 | " |
| 11355 | " | " 12261 | | | | 12288 | | Superseded by 14559 |

(*) PRICE UPON APPLICATION TO YOUR RCA VICTOR DISTRIBUTOR.

| STOCK # | PRICE | DESCRIPTION | STOCK # | PRICE | DESCRIPTION | STOCK # | PRICE | DESCRIPTION |
|---------|---------|---------------------|---------|--------------|---------------------|---------|-------|---------------------|
| 12311 | | Superseded by 14720 | 12636 | (\$1.00 net) | Wrench | 12853 | .50 | Resistor |
| 12312 | .20 | Resistor | 12638 | .30 | Knob | 12854 | .10 | Board |
| 12329 | 6.75 | P.U. & Arm | 12640 | .35 | Bracket | 12855 | .75 | Coup. Unit |
| 12330 | .20 | Resistor | 12641 | .20 | Board | 12857 | 11.15 | Transf. |
| 12333 | .20 | " | 12642 | 1.60 | Cone | 12860 | 1.50 | Tone Cont. |
| 12404 | .30 | Cap. | 12644 | | Superseded by 30607 | 12861 | 1.50 | Vol. Cont. |
| 12405 | .30 | " | 12645 | 8.60 | Transf. | 12866 | .50 | Foot |
| 12406 | | Superseded by 14712 | 12646 | 10.55 | " | 12868 | .50 | Link |
| 12408 | .35 | Shield | 12648 | 2.15 | Coil | 12870 | 1.00 | Dial |
| 12412 | .20 | Resistor | 12649 | 1.70 | " | 12874 | .20 | Resistor |
| 12414 | .20 | " | 12650 | .40 | Shield | 12875 | .22 | " |
| 12415 | .20 | " | 12651 | .40 | " | 12877 | 5.10 | Condenser |
| 12418 | .25(10) | Screw | 12652 | 2.60 | Transf. | 12878 | 3.60 | Switch |
| 12424 | 2.85 | Transf. | 12653 | 2.75 | " | 12879 | 3.45 | Coil |
| 12425 | .25 | Hanger | 12654 | 1.55 | Trap | 12880 | 3.60 | " |
| 12426 | .05 | Insulator | 12657 | .30 | Indicator | 12881 | 1.45 | " |
| 12427 | .03 | Link | 12659 | | Superseded by 13002 | 12882 | .20 | Core |
| 12429 | 2.00 | Trans. Line | 12660 | .55 | Cap. | 12883 | .25 | Shield |
| 12430 | 3.75 | " " | 12661 | .30 | " | 12884 | .60 | Cap. |
| 12445 | .26 | Lead | 12662 | .30 | Cap. | 12885 | .20 | Socket |
| 12447 | .04 | Screw | 12664 | .22 | Core | 12886 | 1.50 | Cable |
| 12448 | .45 | Stud | 12666 | .35 | Cover | 12887 | .40 | Plug |
| 12453 | .20 | Resistor | 12667 | 1.95 | Cone | 12888 | .70 | Coil |
| 12454 | .20 | " | 12670 | .25 | Cap. | 12889 | .70 | " |
| 12463 | 13.10 | Transf. | 12673 | .21 | Knob | 12890 | 1.05 | " |
| 12466 | 4.20 | Reactor | 12675 | .85 | Base | 12891 | .35 | Cap. |
| 12467 | | Superseded by 14531 | 12679 | .20 | Resistor | 12894 | | Superseded by 13003 |
| 12468 | 1.00 | Exp. Cont. | 12681 | .30 | Cell | 12895 | " | " 12723 |
| 12469 | 1.25 | Resistor | 12682 | .80 | Cap. | 12896 | .35 | Cap. |
| 12470 | 1.20 | Cap. | 12694 | .35 | " | 12897 | .65 | " |
| 12471 | .15 | Plate | 12695 | .20 | Resistor | 12898 | | Superseded by 13762 |
| 12472 | 1.15 | Cap. | 12698 | 1.55 | Crystal | 12899 | 7.80 | Drive |
| 12474 | 2.70 | Cone | 12699 | .20 | Knob | 12900 | .25 | Shaft |
| 12478 | .15 | Resistor | 12700 | .15 | " | 12901 | .75 | " |
| 12484 | .30 | Cap. | 12708 | 3.15 | Coil | 12903 | .02 | Spring |
| 12486 | .20 | Resistor | 12709 | 3.05 | " | 12904 | .35 | Bushing |
| 12487 | .25 | " | 12710 | .50 | Shield | 12905 | 1.25 | Coupling |
| 12488 | .35 | Cap. | 12712 | .30 | Indicator | 12906 | 1.50 | Gear |
| 12490 | 1.05 | Cable | 12714 | .50 | Cap. | 12907 | .02 | Spring |
| 12491 | 2.40 | " | 12715 | 1.00 | Resistor | 12908 | .30 | Indicator |
| 12492 | .85 | " | 12717 | .22 | Board | 12909 | 1.50 | Dial |
| 12493 | .30 | Plug | 12720 | .35 | Cap. | 12910 | .40 | Gear |
| 12494 | .40 | " | 12722 | .35 | " | 12911 | .20 | Screen |
| 12502 | .30 | Socket | 12723 | .35 | " | 12913 | 2.50 | Transf. |
| 12511 | | Superseded by 11350 | 12724 | .35 | " | 12914 | .25 | Board |
| 12536 | .45 | Cap. | 12725 | .35 | " | 12915 | 1.60 | Crystal |
| 12537 | .35 | " | 12727 | | Superseded by 12537 | 12916 | 2.10 | Shield |
| 12538 | 13.00 | Pickup | 12728 | .70 | Cap. | 12918 | 6.60 | Transf. |
| 12539 | .22 | Screw | 12729 | .55 | " | 12921 | 1.00 | Tone Cont. |
| 12541 | 1.05 | Coil | 12733 | .25 | Plug | 12925 | .40 | Shaft |
| 12542 | 11.75 | Arm | 12735 | .05 | Shield | 12926 | .75 | Shield |
| 12543 | .12 | Bracket | 12738 | .20 | Resistor | 12927 | .60 | Resistor |
| 12544 | .10 | Spring | 12741 | .30 | Cap. | 12930 | .20 | Board |
| 12545 | .10 | Rod | 12742 | .30 | Escutcheon | 12946 | .30 | Cap. |
| 12546 | .12 | Plug | 12759 | .20 | Resistor | 12948 | .35 | " |
| 12547 | .60 | Cable | 12769 | 1.80 | Switch | 12951 | .55 | " |
| 12549 | 4.55 | Switch | 12770 | 1.10 | Holder | 12952 | .35 | " |
| 12550 | .20 | Spring | 12771 | .30 | Socket | 12955 | .20 | Resistor |
| 12551 | .65 | Spring | 12772 | .35 | Bracket | 12979 | 1.50 | Tone Cont. |
| 12552 | 1.00 | Esp. Cont. | 12785 | 1.20 | Crystal | 12981 | 2.40 | Transf. |
| 12553 | 1.50 | Tone Cont. | 12797 | 2.40 | Coil | 12982 | 2.70 | " |
| 12557 | .45 | Bolt | 12798 | 2.25 | " | 12986 | .08 | Stud |
| 12559 | .58 | Cover | 12799 | .35 | Shield | 12988 | .75 | Switch |
| 12561 | .95 | Cap | 12800 | .35 | Core | 12990 | 1.55 | Transf. |
| 12562 | 1.45 | Cable | 12801 | 2.35 | Transf. | 12993 | .02 | Screw |
| 12563 | 1.35 | " | 12803 | 5.95 | " | 13001 | .35 | Cap. |
| 12564 | 1.10 | " | 12806 | .45 | Board | 13002 | .35 | " |
| 12565 | .40 | Plug | 12807 | .45 | Cap. | 13003 | .35 | " |
| 12566 | 23.30 | Coil | 12811 | .60 | " | 13005 | .15 | Resistor |
| 12567 | .22 | Plug | 12812 | .40 | " | 13024 | 1.45 | Cable |
| 12568 | 3.80 | Transf. | 12813 | .35 | " | 13030 | | Superseded by 14837 |
| 12569 | 1.15 | Diffuser | 12818 | 1.55 | Reactor | 13031 | .15 | Resistor |
| 12573 | | Superseded by 30787 | 12819 | .55 | Coil | 13033 | .25 | Cap. |
| 12581 | .25 | Shield | 12827 | .20 | Plug | 13035 | 2.80 | Transf. |
| 12595 | 3.35 | Knob | 12849 | .08 | Spring | 13036 | 3.55 | Cap. |
| 12607 | .20 | Shield | 12850 | .45 | Damper | 13037 | .75 | Resistor |
| 12629 | .35 | Cap. | 12851 | 1.40 | Switch | 13038 | 1.65 | Control |
| 12635 | .50 | " | 12852 | .60 | Cable | 13039 | 1.65 | Vol. Cont. |

| STOCK # | PRICE | DESCRIPTION | STOCK # | PRICE | DESCRIPTION | STOCK # | PRICE | DESCRIPTION |
|---------|-------|---------------------|---------|-------|---------------------|---------|---------|---------------------|
| 13040 | .90 | Cap. | 13545 | .35 | Cap. | 13730 | .20 | Resistor |
| 13041 | 1.10 | " | 13564 | 1.80 | Cable | 13732 | | Superseded by 13601 |
| 13042 | 1.70 | Control | 13566 | 8.65 | Transf. | 13733 | | " " 14983 |
| 13043 | 1.40 | Switch | 13573 | .30 | Screw | 13734 | .20 | Resistor |
| 13044 | | Superseded by 30271 | 13575 | .25 | Escutcheon | 13735 | .20 | " |
| 13045 | .20 | Resistor | 13583 | .50 | Regulator | 13736 | .20 | " |
| 13046 | 1.00 | Cap. | 13587 | 3.35 | Coil | 13737 | | Superseded by 12312 |
| 13048 | .55 | " | 13588 | 2.95 | " | 13762 | .50 | Cap. |
| 13049 | .22 | Resistor | 13589 | 1.00 | " | 13790 | 7.25 | Box |
| 13050 | | Superseded by 13601 | 13590 | 1.25 | " | 13791 | 3.90 | Box |
| 13052 | " | " 30433 | 13592 | 1.70 | Wave Trap | 13792 | 1.25 | Cable |
| 13053 | " | " 14079 | 13594 | .15 | Resistor | 13801 | 7.65 | Housing |
| 13054 | .50 | Cap. | 13597 | 4.55 | Condenser | 13802 | .90 | Cover |
| 13055 | | Superseded by 30433 | 13598 | .40 | Drive | 13803 | 1.65 | " |
| 13057 | .35 | Cap. | 13599 | .55 | Foot | 13804 | .45 | Socket |
| 13062 | .35 | Plug | 13600 | 2.20 | Coil | 13805 | .65 | Plate |
| 13063 | .20 | Board | 13601 | .20 | Resistor | 13806 | .60 | Ring |
| 13064 | 1.60 | Escutcheon | 13602 | | Superseded by 12694 | 13807 | 3.35 | Switch |
| 13066 | .20 | Disc | 13603 | " | " 30433 | 13808 | .40 | Escutcheon |
| 13072 | 7.80 | Turntable | 13604 | .40 | Cap. | 13809 | 1.00 | Cable |
| 13073 | 7.90 | " | 13605 | .35 | " | 13810 | 2.00 | " |
| 13074 | 9.00 | " | 13606 | .25 | " | 13811 | 3.25 | Condenser |
| 13075 | 7.80 | " | 13607 | .25 | " | 13812 | .75 | Switch |
| 13076 | 7.90 | " | 13608 | .30 | " | 13813 | 1.20 | Tone Cont. |
| 13077 | 9.00 | " | 13611 | .95 | " | 13814 | 1.95 | Dial |
| 13078 | 7.80 | " | 13612 | 5.28 | Filter | 13815 | .60 | Drive |
| 13079 | 7.90 | " | 13615 | .35 | Bracket | 13816 | 1.05 | Disc |
| 13080 | 9.00 | " | 13635 | 1.40 | Plate | 13817 | .60 | Indicator |
| 13081 | 5.55 | Coil | 13636 | .08 | Stud | 13818 | | Superseded by 12694 |
| 13082 | .12 | Knob | 13637 | .75 | Spacer | 13819 | .25 | Resistor |
| 13083 | .12 | " | 13638 | .08 | Spring | 13821 | | Superseded by 13677 |
| 13084 | 10.65 | Turntable | 13647 | 2.00 | Vol. Cont. | 13822 | 1.35 | Coil |
| 13085 | .22 | Hinge | 13648 | 2.70 | Switch | 13823 | | Superseded by 13678 |
| 13086 | .80 | Support | 13649 | 1.00 | Tone Cont. | 13824 | .65 | Escutcheon |
| 13087 | .35 | Cap | 13652 | 1.15 | Shutter | 13825 | .20 | Knob |
| 13088 | 1.65 | Turntable | 13656 | .15 | Button | 13834 | .50 | Resistor |
| 13089 | .35 | Brake | 13659 | .60 | Resistor | 13835 | 3.50 | Spring |
| 13090 | .35 | Regulator | 13660 | 3.75 | Coil | 13838 | .65 | Wave Trap |
| 13091 | .25 | Key | 13661 | 5.20 | Transf. | 13839 | 2.75 | Switch |
| 13092 | 1.00 | Vol. Cont. | 13662 | 3.75 | Condenser | 13840 | 1.45 | Resistor |
| 13093 | .25 | Escutcheon | 13663 | .40 | Drive | 13842 | .35 | Bracket |
| 13095 | | Superseded by 14114 | 13664 | 1.10 | Tone Cont. | 13844 | 3.00 | Turntable |
| 13097 | .22 | Resistor | 13665 | .85 | Switch | 13845 | .30 | Cap |
| 13098 | .25 | Board | 13666 | .80 | Dial | 13846 | .35 | Indicator |
| 13101 | 7.95 | Cap. | 13669 | .25 | Resistor | 13847 | .30 | Escutcheon |
| 13103 | .15 | Cap | 13673 | | Superseded by 13601 | 13849 | 3.75 | Arm |
| 13106 | 2.60 | Transf. | 13674 | .20 | Resistor | 13850 | .50 | Brake |
| 13107 | 2.75 | " | 13675 | .22 | " | 13851 | .06 | Spring |
| 13109 | .70 | Cap. | 13676 | 1.35 | Coil | 13852 | .20 | Cup |
| 13138 | .25 | " | 13677 | 1.75 | Cone | 13854 | 10.00 | Motor |
| 13140 | | Superseded by 13762 | 13678 | 2.00 | Transf. | 13855 | .95 | Gear |
| 13141 | .35 | Cap. | 13679 | 5.00 | Condenser | 13856 | 1.50 | Spindle |
| 13144 | 1.00 | Vol. Cont. | 13680 | .65 | Drive | 13857 | 3.65 | Governor |
| 13167 | .20 | Resistor | 13681 | 1.25 | Tone Cont. | 13858 | .50 | Gear |
| 13192 | .02 | Washer | 13682 | .85 | Dial | 13859 | .50 | " |
| 13200 | .35 | Cap. | 13683 | .35 | Mask | 13860 | .55 | Shaft |
| 13206 | .25 | Resistor | 13698 | .20 | Resistor | 13861 | 2.40 | Key |
| 13216 | .25 | Board | 13699 | .30 | Cap. | 13862 | .90 (3) | Weight |
| 13218 | .25 | Resistor | 13704 | 7.55 | Housing | 13865 | .06 | Screw |
| 13220 | .20 | " | 13705 | 1.20 | Cover | 13866 | .25(10) | Cap |
| 13250 | .20 | " | 13706 | 1.70 | " | 13867 | .03 | " |
| 13299 | 2.45 | Coil | 13707 | .03 | Fastener | 13868 | .85 | Dial |
| 13300 | .35 | Shield | 13708 | 1.15 | Cable | 13869 | | Superseded by 30607 |
| 13301 | .30 | Cap. | 13709 | 2.25 | Grille | 13870 | 1.15 | Cable |
| 13302 | .15 | Resistor | 13710 | .35 | Plug | 13871 | .45 | Socket |
| 13307 | .30 | Cap. | 13714 | .20 | Resistor | 13872 | .25 | Crystal |
| 13309 | 1.10 | Switch | 13715 | .20 | " | 13873 | 4.05 | Turntable |
| 13311 | .80 | Shield | 13716 | .20 | " | 13879 | .95 | Switch |
| 13314 | .30 | Indicator | 13718 | .50 | Dial | 13880 | .70 | Tone Cont. |
| 13392 | | Superseded by 30607 | 13719 | 5.75 | Box | 13881 | 1.50 | Control |
| 13393 | " | " 30607 | 13720 | 3.10 | " | 13882 | .70 | Resistor |
| 13394 | .30 | Cap. | 13721 | .20 | Plate | 13883 | .55 | " |
| 13405 | 1.85 | Armature | 13722 | 7.75 | Housing | 13884 | .25 | Shaft |
| 13454 | .20 | Resistor | 13723 | 1.25 | Cover | 13885 | .03 | Screw |
| 13467 | 2.65 | Wave Trap | 13724 | .15 | Button | 13886 | .90 | Switch |
| 13477 | .22 | Resistor | 13725 | 1.05 | Grille | 13887 | .10 | Resistor |
| 13479 | .20 | " | 13726 | .60 | Screen | 13888 | | Superseded by 14382 |
| 13542 | .40 | Plug | 13727 | .15 | Knob | 13889 | 1.35 | Jack |

| STOCK # | PRICE | DESCRIPTION | STOCK # | PRICE | DESCRIPTION | STOCK # | PRICE | DESCRIPTION |
|---------|--------|---------------------|---------|-------|---------------------|---------|-------|---------------------|
| 13890 | .55 | Cable | 14217 | | Superseded by 30374 | 14337 | 1.15 | Switch |
| 13891 | .75 | " | 14218 | " | " 30239 | 14338 | .06 | Bushing |
| 13892 | 5.20 | Condenser | 14219 | " | " 30375 | 14339 | 2.00 | Dial |
| 13893 | 2.80 | Switch | 14220 | 8.95 | Turntable | 14340 | .40 | Pulley |
| 13894 | .35 | Cap. | 14221 | | Superseded by 30376 | 14341 | .65 | Idler |
| 13895 | .70 | " | 14222 | " | " 30241 | 14342 | .04 | Spring |
| 13896 | .90 | Shaft | 14223 | 6.75 | Coil | 14343 | .03 | Retainer |
| 13897 | .03 | Spring | 14224 | 6.75 | " | 14344 | .20 | Indicator |
| 13898 | 8.95 | Drive | 14225 | 7.20 | " | 14345 | .40 | Drum |
| 13899 | 1.55 | Dial | 14226 | 7.00 | " | 14347 | .32 | Reflector |
| 13900 | .90 | Shaft | 14227 | .15 | Shield | 14348 | 5.15 | Condenser |
| 13901 | 1.35 | Coil | 14228 | .70 | Damper | 14349 | .40 | Gear |
| 13902 | | Superseded by 13677 | 14229 | .10 | Stop | 14350 | .03 | Screw |
| 13903 | " | " 13678 | 14230 | .02 | Washer | 14351 | .35 | Gear |
| 13905 | 1.85 | Escutcheon | 14231 | .02 | " | 14352 | .14 | Belt |
| 13906 | .40 | Screen | 14232 | .45 | Cap | 14353 | .70 | Drive |
| 13907 | .20 | Knob | 14233 | 2.20 | Base | 14354 | | Superseded by 12021 |
| 13908 | .25 | " | 14234 | 2.00 | Vol. Cont. | 14355 | 2.00 | Transf. |
| 13909 | 3.85 | " | 14235 | .10 | Screw | 14356 | .15 | Board |
| 13910 | .04 | Screw | 14256 | 3.50 | Condenser | 14357 | .06 | Washer |
| 13911 | 2.30 | Plate | 14257 | .95 | Coil | 14358 | .04 | Screw |
| 13912 | 2.30 | " | 14261 | 2.05 | Transf. | 14359 | .20 | Knob |
| 13913 | .65 | " | 14262 | .30 | Cap. | 14360 | 9.95 | Speaker |
| 13914 | .07 | Foot | 14263 | .25 | Indicator | 14361 | .75 | Reflector |
| 13925 | 1.20 | Shaft | 14264 | 1.20 | Dial | 14362 | 1.30 | " |
| 13926 | 1.20 | " | 14267 | .04 | Screw | 14363 | 4.90 | Condenser |
| 13964 | 3.70 | Transf. | 14268 | .25 | Crystal | 14364 | | Superseded by 14514 |
| 13965 | 3.25 | Turntable | 14269 | .20 | Knob | 14367 | 6.50 | Transf. |
| 13988 | .20 | Resistor | 14270 | .05 | Spring | 14368 | 7.20 | " |
| 13992 | .90 | Cable | 14271 | 14.30 | Transf. | 14369 | 9.95 | " |
| 13998 | .20 | Resistor | 14272 | .35 | Bracket | 14370 | 1.05 | Switch |
| 14020 | .20 | " | 14273 | 1.10 | Cap. | 14371 | 1.05 | " |
| 14021 | .35 | Cap. | 14274 | .25 | Socket | 14372 | 2.25 | Coil |
| 14023 | .20 | Resistor | 14275 | .25 | " | 14373 | 2.95 | " |
| 14024 | .20 | " | 14276 | .25 | " | 14374 | .35 | Shield |
| 14026 | 1.50 | Vol. Cont. | 14277 | .25 | " | 14375 | .40 | " |
| 14027 | 8.00 | Transf. | 14278 | .25 | " | 14376 | 2.45 | Transf. |
| 14028 | .03 | Nut | 14279 | .35 | " | 14377 | .95 | Cap. |
| 14078 | | Superseded by 30151 | 14280 | .25 | " | 14379 | .01 | Washer |
| 14079 | .35 | Cap. | 14281 | .20 | Resistor | 14380 | .30 | Arm |
| 14114 | .25 | Socket | 14282 | 1.50 | Vol. Cont. | 14381 | 1.50 | Dial |
| 14115 | 2.30 | Mechanism | 14283 | 3.80 | Transf. | 14382 | .20 | Indicator |
| 14134 | 1.50 | Tone Cont. | 14284 | .15 | Resistor | 14383 | .45 | Cap. |
| 14171 | .40 | Socket | 14285 | 1.25 | Coil | 14384 | .16 | Belt |
| 14181 | 3.20 | Turntable | 14287 | 1.05 | Cap. | 14387 | .30 | Escutcheon |
| 14183 | 3.30 | Cam | 14289 | .30 | Clip | 14388 | .15 | Belt |
| 14184 | 1.85 | Lever | 14290 | 14.20 | P.U. & Arm | 14389 | .80 | Dial |
| 14185 | 1.60 | " | 14291 | 1.45 | Armature | 14390 | .15 | Resistor |
| 14186 | 2.30 | Hub | 14292 | .25 | Damper | 14391 | .50 | Cap. |
| 14187 | 1.55 | Shaft | 14294 | 1.40 | Armature | 14392 | .35 | " |
| 14188 | .06 | Screw | 14296 | .20 | Resistor | 14393 | .30 | " |
| 14189 | .75 | Lever | 14298 | .07 | Screw | 14394 | 1.30 | Cable |
| 14190 | .08 | Spring | 14299 | .30 | Resistor | 14395 | 10.85 | Speaker |
| 14191 | .04 | " | 14301 | .26 | Fuse | 14396 | 1.50 | Escutcheon |
| 14192 | .08 | " | 14303 | 2.55 | Cone | 14397 | 5.10 | Condenser |
| 14193 | .60 | Lever | 14304 | 2.00 | Transf. | 14398 | .70 | Drive |
| 14194 | .65 | " | 14305 | 2.15 | Cone | 14399 | 1.50 | Dial |
| 14195 | .05 | Screw | 14306 | 2.00 | Transf. | 14400 | 1.00 | Vol. Cont. |
| 14196 | .90 | Pawl | 14307 | 1.50 | Vol. Cont. | 14401 | 1.00 | Switch |
| 14197 | .50 | Finger | 14308 | 2.90 | Transf. | 14402 | 1.15 | " |
| 14198 | .45 | Lever | 14309 | 4.25 | Vibrator | 14403 | 1.25 | Cap. |
| 14199 | 1.10 | Bushing | 14310 | 1.70 | Cap. | 14404 | .35 | Plug |
| 14200 | .08 | Screw | 14311 | 5.00 | Transf. | 14405 | .30 | Holder |
| 14201 | .80 | Lever | 14312 | .25 | Socket | 14406 | .20 | Resistor |
| 14203 | .70 | Post | 14313 | .25 | Mounting | 14407 | .60 | Cap. |
| 14204 | 3.75 | Turntable | 14314 | 1.35 | Cord | 14408 | 3.60 | Cable |
| 14205 | .50 | Support | 14315 | .20 | Shield | 14409 | .45 | Plug |
| 14206 | .90 | Switch | 14316 | .25 | Holder | 14410 | .30 | Resistor |
| 14207 | .55 | Roller | 14317 | .40 | Shield | 14411 | 9.00 | Condenser |
| 14208 | .40 | Bracket | 14318 | .25 | " | 14412 | .85 | Drive |
| 14209 | .08 | Bumper | 14319 | .20 | Holder | 14413 | 2.25 | Switch |
| 14210 | .10 | Rest | 14325 | 20.00 | Motor | 14414 | 3.10 | Coil |
| 14211 | .30 | Socket | 14326 | 22.25 | " | 14415 | .50 | Foot |
| 14212 | .30 | Escutcheon | 14327 | 24.20 | " | 14416 | 1.60 | Dial |
| 14213 | .06 | Washer | 14328 | | Superseded by 11703 | 14417 | | Superseded by 14498 |
| 14214 | .50(3) | Screw | 14329 | 13.85 | P.U. & Arm | 14418 | .35 | Resistor |
| 14215 | | Superseded by 11703 | 14335 | 1.50 | Vol. Cont. | 14419 | .05 | Mounting |
| 14216 | 20.00 | Motor | 14336 | 1.15 | Switch | 14420 | 4.90 | Transf. |

| <u>STOCK #</u> | <u>PRICE</u> | <u>DESCRIPTION</u> | <u>STOCK #</u> | <u>PRICE</u> | <u>DESCRIPTION</u> | <u>STOCK #</u> | <u>PRICE</u> | <u>DESCRIPTION</u> |
|----------------|--------------|--------------------|----------------|--------------|---------------------|----------------|--------------|--------------------------------|
| 14421 | .22 | Resistor | 14534 | 3.85 | Transf. | 14668 | | Superseded by 30607 |
| 14422 | 4.05 | Vibrator | 14535 | 12.90 | Speaker | 14669 | 1.65 | Cap. |
| 14427 | .02 | Screw | 14537 | 2.00 | Switch | 14670 | 1.40 | Coil |
| 14428 | .50 | Shaft | 14538 | 1.10 | " | 14671 | .20 | Resistor |
| 14429 | .25 | Collar | 14539 | 5.20 | Condenser | 14675 | 5.00 | Speaker |
| 14430 | 1.75 | Cable | 14540 | .85 | Drive | 14676 | 2.00 | Cone |
| 14431 | 5.50 | Coil | 14541 | 2.40 | Dial | 14677 | 1.75 | Transf. |
| 14432 | 5.45 | " | 14542 | .30 | Arm | 14678 | 5.65 | Speaker |
| 14433 | 4.45 | " | 14543 | .65 | Dial | 14679 | 2.00 | Cone |
| 14434 | 3.10 | " | 14544 | 2.35 | " | 14680 | 1.75 | Transf. |
| 14435 | 3.00 | " | 14546 | | Superseded by 12694 | 14681 | 5.25 | Speaker |
| 14436 | 8.10 | Switch | 14559 | .20 | Resistor | 14682 | | Superseded by 13677 |
| 14437 | 28.75 | Condenser | 14560 | .20 | " | 14683 | 1.75 | Transf. |
| 14438 | | Superseded by 3252 | 14596 | | Superseded by 14518 | 14684 | 7.65 | Speaker |
| 14439 | .20 | Resistor | 14597 | 2.00 | Vol. Cont. | 14685 | 3.10 | Cone |
| 14440 | .65 | Cap. | 14598 | 4.60 | Reflector | 14686 | 2.00 | Transf. |
| 14441 | .60 | " | 14599 | 1.05 | Switch | 14688 | .20 | Knob |
| 14442 | .55 | " | 14600 | 16.75 | Speaker | 14689 | 10.80 | Transf. |
| 14443 | .40 | " | 14601 | 4.05 | Transf. | 14690 | 14.35 | " |
| 14444 | 1.50 | Dial | 14602 | 2.15 | Cone | 14691 | 14.20 | " |
| 14445 | .20 | Screen | 14603 | 2.80 | Coil | 14692 | 1.00 | Resistor |
| 14446 | 1.55 | Disc | 14604 | .40 | " | 14693 | 1.35 | Switch |
| 14447 | 1.60 | Pulley | 14606 | | Superseded by 13867 | 14694 | .05 | Spring |
| 14448 | 2.05 | Shaft | 14609 | 4.15 | Transf. | 14695 | .50 | Rod |
| 14449 | 2.35 | Idler | 14611 | .20 | Index | 14696 | .35 | Slider |
| 14450 | .80 | Spring | 14612 | 1.50 | Cone | 14697 | .35 | Pulley |
| 14451 | .35 | Belt | 14613 | 5.75 | Speaker | 14698 | .55 | Drum |
| 14452 | .35 | " | 14614 | | Superseded by 13677 | 14699 | .40 | Cord |
| 14453 | .80 | Spring | 14615 | 1.90 | Transf. | 14701 | .40 | Arm |
| 14454 | .90 | " | 14616 | 1.90 | Coil | 14702 | .90 | Switch |
| 14455 | 2.30 | Cable | 14617 | 2.00 | Socket | 14703 | 1.50 | Tone Cont. |
| 14456 | .35 | Escutcheon | 14618 | .30 | Board | 14704 | 2.35 | Switch |
| 14457 | .35 | " | 14620 | 2.55 | Reactor | 14705 | 1.25 | " |
| 14458 | 1.80 | " | 14621 | 1.40 | Cap. | 14706 | 2.50 | Transf. |
| 14459 | 3.65 | Knob | 14622 | 1.40 | " | 14707 | 2.15 | " |
| 14460 | 5.15 | Escutcheon | 14623 | .25 | Board | 14708 | 2.15 | " |
| 14461 | 2.55 | " | 14624 | .80 | Cap. | 14709 | 2.15 | " |
| 14462 | 2.55 | " | 14625 | | Superseded by 12488 | 14710 | .30 | Cap. |
| 14463 | 2.60 | Shield | 14626 | .25 | Cap. | 14711 | .30 | " |
| 14464 | 82.80 | Drive | 14627 | 22.15 | Speaker | 14712 | .30 | " |
| 14465 | 25.60 | Motor | 14628 | 2.10 | Transf. | 14713 | 2.70 | Coil |
| 14466 | 28.25 | " | 14629 | .45 | Switch | 14714 | 1.60 | Cap. |
| 14467 | 1.10 | Plate | 14631 | 1.50 | Dial | 14715 | .15 | Indicator |
| 14468 | 1.10 | Gear | 14632 | .40 | Bracket | 14716 | 2.65 | Holder |
| 14469 | .20 | Shaft | 14633 | 4.35 | Condenser | 14717 | 1.30 | Dial |
| 14470 | 6.30 | Pulley | 14634 | .13 | Belt | 14718 | .45 | Shutter |
| 14471 | 1.05 | Shaft | 14635 | .20 | Indicator | 14719 | .45 | Link |
| 14472 | 1.55 | Pulley | 14636 | .15 | Pulley | 14720 | .20 | Resistor |
| 14473 | 2.55 | " | 14637 | .06 | Spring | 14721 | .20 | " |
| 14474 | 2.55 | " | 14638 | .30 | Shaft | 14722 | .70 | Cap. |
| 14475 | .60 | Gear | 14639 | .35 | Pulley | 14723 | .50 | " |
| 14476 | 2.10 | " | 14640 | .75 | Switch | 14724 | | Superseded by 12537 |
| 14477 | .10 | Stud | 14641 | 1.50 | Reactor | 14725 | .80 | Cable |
| 14478 | 3.35 | Dial | 14642 | 2.00 | Transf. | 14726 | .40 | Arm |
| 14479 | 1.10 | Escutcheon | 14643 | .85 | Cap. | 14727 | 13.00 | Condenser |
| 14498 | .45 | Cap. | 14644 | 1.45 | " | 14728 | .60 | Switch |
| 14499 | .20 | Resistor | 14645 | 1.50 | Vol. Cont. | 14729 | 4.25 | Motor |
| 14511 | 6.95 | Transf. | 14646 | 1.70 | Coil | 14730 | 6.20 | " |
| 14512 | 10.25 | " | 14647 | 1.45 | " | 14731 | 5.00 | Rotor |
| 14513 | 6.75 | Condenser | 14648 | .20 | Core | 14732 | .80 | Switch |
| 14514 | .45 | Drive | 14649 | .80 | Resistor | 14733 | .04 | Contact |
| 14515 | 2.20 | Switch | 14650 | .25 | Socket | 14734 | .50 | Gear |
| 14516 | 2.55 | Coil | 14651 | .90 | Drive | 14735 | .50 | " |
| 14517 | .25 | Board | 14653 | .10 | Resistor | 14736 | .65 | " |
| 14518 | 3.65 | Dial | 14654 | 1.50 | Escutcheon | 14737 | .30 | " |
| 14519 | .15 | Indicator | 14655 | | Superseded by 30607 | 14738 | .30 | " |
| 14520 | .15 | " | 14656 | " | " 30571 | 14739 | .65 | " |
| 14522 | 5.40 | Reflector | 14657 | " | " 30607 | 14740 | 1.75 | Drive |
| 14523 | .05 | Cable | 14658 | .30 | Socket | 14741 | .55 | Plate |
| 14524 | .05 | " | 14659 | .20 | Resistor | 14742 | .55 | Stud |
| 14525 | .20 | Resistor | 14660 | .20 | " | 14743 | 5.15 | Escutcheon |
| 14526 | .30 | " | 14661 | .20 | " | 14744 | .25 | Bracket |
| 14527 | 4.10 | Escutcheon | 14662 | 3.25 | Condenser | 14745 | .07 | Button |
| 14528 | .75 | Index | 14663 | .14 | Belt | 14746 | .03 | Shield |
| 14529 | .75 | " | 14664 | .50 | Pulley | 14747 | .25 | Card |
| 14531 | 1.55 | Cap. | 14665 | 1.50 | Dial | 14748 | .12 | Indicator |
| 14532 | .90 | Resistor | 14666 | | Superseded by 30607 | 14749 | .12 | " |
| 14533 | 10.95 | Speaker | 14667 | 7.50 | Transf. | 14750 | | Superseded by/30569 (30570) |

| <u>STOCK #</u> | <u>PRICE</u> | <u>DESCRIPTION</u> | <u>STOCK #</u> | <u>PRICE</u> | <u>DESCRIPTION</u> | <u>STOCK #</u> | <u>PRICE</u> | <u>DESCRIPTION</u> |
|----------------|---------------------|--------------------|----------------|---------------------|--------------------|----------------|---------------------|--------------------|
| 14751 | .10 | Key | 14852 | .65 | Cover | 14936 | 2.00 | Cone |
| 14752 | .20 | Resistor | 14853 | 7.10 | Cable | 14937 | 1.75 | Transf. |
| 14753 | 16.25 | Arm | 14854 | 1.80 | Reactor | 14939 | 2.00 | Cone |
| 14754 | 2.95 | Cam | 14855 | 5.45 | Transf. | 14940 | 1.75 | Transf. |
| 14755 | 1.65 | Lever | 14856 | .55 | Drum | 14941 | 2.00 | Cone |
| 14756 | .85 | Cover | 14857 | .35 | Cord | 14942 | 1.75 | Transf. |
| 14758 | .70 | Spacer | 14858 | 15.50 | Condenser | 14943 | Superseded by 13698 | |
| 14759 | 5.65 | Turntable | 14859 | .90 | Plate | 14944 | 11.85 | Transf. |
| 14760 | .45 | Cup | 14860 | Superseded by 14736 | | 14945 | 17.80 | " |
| 14761 | 2.10 | Rest | 14861 | .80 | Gear | 14946 | 2.70 | Reactor |
| 14762 | .45 | Damper | 14862 | 1.75 | Drive | 14947 | 9.40 | Switch |
| 14764 | 1.00 | Tone Cont. | 14863 | 1.10 | Switch | 14948 | 1.45 | Coil |
| 14765 | 2.05 | Transf. | 14864 | 7.60 | " | 14949 | 1.25 | " |
| 14767 | 1.80 | Cap. | 14865 | 1.45 | Coil | 14950 | .90 | " |
| 14773 | 1.00 | " | 14866 | 1.60 | " | 14951 | 1.70 | " |
| 14779 | .25 | Plug | 14867 | 1.55 | " | 14952 | .80 | " |
| 14781 | .35 | " | 14868 | 1.30 | " | 14953 | .70 | " |
| 14782 | .25 | " | 14869 | .85 | " | 14954 | 1.30 | " |
| 14783 | .25 | Socket | 14870 | .90 | " | 14955 | .80 | " |
| 14784 | 16.75 | Speaker | 14871 | 1.15 | " | 14956 | 1.15 | " |
| 14785 | 2.25 | Coil | 14872 | 1.15 | " | 14957 | .85 | " |
| 14786 | .30 | Plug | 14873 | 1.00 | " | 14958 | 2.55 | Transf. |
| 14787 | 1.50 | Control | 14874 | .85 | Switch | 14959 | 2.50 | " |
| 14788 | 1.00 | " | 14875 | 1.00 | Resistor | 14960 | .30 | Cap. |
| 14789 | .70 | Cable | 14876 | 1.05 | " | 14961 | .80 | Scale |
| 14790 | 1.70 | " | 14877 | .25 | Socket | 14962 | .80 | " |
| 14793 | .25 | Plug | 14878 | .45 | Bracket | 14963 | .20 | Resistor |
| 14795 | .25 | Resistor | 14879 | 10.85 | Transf. | 14992 | 5.65 | Transf. |
| 14796 | 5.50 | Transf. | 14880 | 14.85 | " | 14993 | .15 | Resistor |
| 14797 | 1.50 | Tone Cont. | 14881 | 15.00 | " | 14994 | 7.50 | Transf. |
| 14798 | 1.50 | Vol. " | 14882 | 1.60 | Shield | 14995 | 15.20 | Speaker |
| 14799 | .12 | Screw | 14883 | .75 | Arm | 14996 | 2.50 | Transf. |
| 14800 | 19.75 | Motor | 14884 | 1.30 | Bracket | 16293 | .22 | Resistor |
| 14801 | 4.35 | Turntable | 14885 | 1.30 | " | 16711 | 1.40 | Shield |
| 14802 | .60 | Cable | 14886 | .30 | Pulley | 16713 | .25 | Shaft |
| 14803 | 2.95 | Brake | 14887 | .01 | Retainer | 16803 | .80 | Knob |
| 14804 | .60 | Switch | 14888 | 13.60 | Dial | 16836 | .25 | Plug |
| 14805 | .20 | Plug | 14889 | .25 | Strap | 30010 | .80 | Scale |
| 14806 | Superseded by 30386 | | 14890 | 1.05 | Cushion | 30011 | .80 | " |
| 14807 | " | " 30386 | 14891 | .25 | Strip | 30012 | .80 | " |
| 14808 | " | " 30387 | 14892 | .60 | Slide | 30013 | .80 | " |
| 14810 | " | " 30389 | 14893 | .75 | Scale | 30014 | .80 | " |
| 14811 | " | " 30390 | 14894 | .75 | " | 30015 | Superseded by 12896 | |
| 14812 | 1.40 | Turntable | 14896 | .75 | " | 30016 | " | " 13002 |
| 14813 | 2.05 | Cap. | 14897 | .75 | " | 30017 | 1.95 | Cap. |
| 14814 | 1.30 | " | 14898 | .70 | Strip | 30053 | 1.35 | Comp. Pack |
| 14815 | 2.00 | Vol. Cont. | 14899 | .70 | " | 30057 | .55 | Cap. |
| 14816 | .15 | Screw | 14900 | .55 | Indicator | 30084 | Superseded by 14599 | |
| 14817 | .50 | Cable | 14901 | .25 | Shield | 30085 | 1.30 | Gear |
| 14818 | 14.95 | P.U. & Arm | 14902 | 1.10 | Cap. | 30087 | 3.80 | Arm |
| 14819 | .70 | Cable | 14904 | .70 | Switch | 30088 | .60 | Brake |
| 14820 | 9.60 | Mechanism | 14906 | 1.00 | Cap. | 30089 | .40 | Cap |
| 14821 | .90 | Support | 14907 | 1.00 | " | 30090 | .40 | Cover |
| 14822 | .05 | Screw | 14908 | 1.00 | " | 30091 | .20 | Cup |
| 14823 | .40 | Rod | 14909 | 1.00 | " | 30092 | .35 | Escutcheon |
| 14824 | .06 | Screw | 14910 | 1.00 | " | 30093 | .40 | Indicator |
| 14825 | .65 | Roller | 14911 | .40 | " | 30094 | 2.35 | Key |
| 14826 | 2.00 | Vol. Cont. | 14912 | 26.45 | Motor | 30095 | 3.00 | Sound Box |
| 14827 | .25 | Drive | 14913 | .15 | Spring | 30096 | Superseded by 13844 | |
| 14828 | 2.05 | Transf. | 14914 | .45 | Lever | 30100 | .08 | Spring |
| 14829 | 1.35 | Cap. | 14916 | .12 | Spring | 30101 | .50 | Cable |
| 14830 | .35 | Cable | 14918 | .70 | Cable | 30102 | 8.50 | Transf. |
| 14831 | Superseded by 12536 | | 14919 | .55 | " | 30103 | 1.55 | Comp. Pack |
| 14833 | 1.50 | Vol. Cont. | 14920 | 17.10 | Speaker | 30104 | Superseded by 30731 | |
| 14834 | 4.50 | Transf. | 14921 | 4.85 | Transf. | 30127 | .70 | Dial |
| 14835 | 2.00 | Vol. Cont. | 14922 | 3.25 | Coil | 30128 | .20 | Resistor |
| 14836 | 1.50 | Tone Cont. | 14923 | 4.95 | Escutcheon | 30129 | 1.50 | Vol. Cont. |
| 14837 | .15 | Resistor | 14924 | 11.10 | " | 30130 | 16.85 | Transf. |
| 14840 | 7.70 | Escutcheon | 14925 | 1.60 | Crystal | 30131 | 17.50 | Speaker |
| 14841 | .25 | Indicator | 14926 | .25 | Indicator | 30147 | .20 | Resistor |
| 14843 | 8.90 | Transf. | 14927 | .25 | " | 30151 | .22 | " |
| 14844 | .95 | Switch | 14928 | 11.15 | P.U. & Arm | 30156 | 16.15 | Transf. |
| 14845 | .85 | Resistor | 14929 | 14.80 | " | 30157 | .60 | Switch |
| 14846 | 17.85 | Transf. | 14930 | 1.20 | Coil | 30158 | .20 | Resistor |
| 14847 | 1.40 | Diffuser | 14931 | 15.75 | P.U. & Arm | 30160 | Superseded by 30057 | |
| 14848 | 7.50 | Selector | 14933 | 14.55 | " | 30226 | 2.50 | Switch |
| 14850 | .55 | Bar | 14934 | 2.00 | Cone | 30227 | 5.80 | Reflector |
| 14851 | 2.25 | Box | 14935 | 1.75 | Transf. | 30228 | 3.40 | Coil |

| <u>STOCK #</u> | <u>PRICE</u> | <u>DESCRIPTION</u> | <u>STOCK #</u> | <u>PRICE</u> | <u>DESCRIPTION</u> | <u>STOCK #</u> | <u>PRICE</u> | <u>DESCRIPTION</u> |
|----------------|---------------------|--------------------|----------------|---------------------|--------------------|----------------|---------------------|--------------------|
| 30229 | 4.10 | Coil | 30466 | .25(4) | Screw | 30655 | 1.00 | Switch |
| 30230 | 3.60 | Dial | 30467 | .05 | " | 30656 | 5.30 | Transf. |
| 30231 | Superseded by 30608 | | 30468 | .80 | Pulley | 30657 | 1.50 | Cap. |
| 30232 | .35 | Cap. | 30469 | .14 | Belt | 30658 | 1.50 | Vol. Cont. |
| 30233 | Superseded by 13057 | | 30470 | 5.50 | Speaker | 30659 | 1.80 | Coil |
| 30234 | 3.30 | Escutcheon | 30471 | 1.75 | Cone | 30660 | .20 | Holder |
| 30235 | .25 | Index | 30472 | 1.50 | Transf. | 30661 | Superseded by 11859 | |
| 30236 | 2.75 | Cone | 30474 | .25 | Plug | 30662 | 6.65 | Speaker |
| 30238 | 15.75 | Motor | 30475 | 22.75 | Motor | 30663 | 1.60 | Transf. |
| 30239 | 18.90 | " | 30476 | 14.80 | P.U. & Arm | 30664 | 2.90 | Cone |
| 30240 | 7.80 | Rotor | 30477 | .15(2) | Screw | 30665 | 5.95 | Transf. |
| 30241 | 9.80 | " | 30478 | .65 | Cable | 30666 | 3.60 | Vibrator |
| 30245 | .20 | Cap. | 30499 | .20 | Resistor | 30667 | .40 | Socket |
| 30248 | .85 | Screw | 30535 | .03 | Screw | 30668 | 1.10 | Cord |
| 30249 | .23 | " | 30545 | .20 | Resistor | 30670 | .25(25) | Screw |
| 30250 | .15 | " | 30546 | .20 | " | 30675 | .23 | Plate |
| 30271 | .20 | Resistor | 30552 | .20 | " | 30683 | .22 | Resistor |
| 30284 | .80 | " | 30557 | .55 | Plug | 30685 | .20 | Resistor |
| 30285 | .80 | Scale | 30567 | .25 | " | 30686 | Superseded by 14615 | |
| 30288 | 2.85 | Dial | 30568 | .25 | " | 30687 | " | 13677 |
| 30289 | 1.45 | " | 30569 | 3.00 | Escutcheon | 30693 | .25 | Plug |
| 30290 | .25 | Indicator | 30570 | 1.75 | " | 30695 | .15 | Card |
| 30291 | 1.15 | Switch | 30571 | 9.50 | Transf. | 30731 | .20 | Resistor |
| 30292 | 3.20 | Coil | 30572 | .75 | Drive | 30734 | .20 | " |
| 30293 | 1.55 | " | 30573 | 3.90 | Condenser | 30740 | 4.25 | Condenser |
| 30294 | 1.55 | " | 30574 | 1.50 | Switch | 30741 | 1.40 | Drive |
| 30295 | .40 | Cap. | 30575 | 1.00 | Vol. Cont. | 30742 | 1.50 | Switch |
| 30296 | .65 | Coil | 30576 | 1.05 | Switch | 30743 | 3.00 | Control |
| 30297 | 1.25 | Cap. | 30577 | 1.60 | Cap. | 30744 | 3.60 | Switch |
| 30298 | 1.40 | Cap. Pack | 30578 | 1.35 | Coil | 30745 | 2.05 | Coil |
| 30299 | .50 | Switch | 30579 | 1.40 | Coil | 30746 | 2.10 | " |
| 30300 | 1.30 | Resistor | 30580 | .55 | Condenser | 30747 | .60 | " |
| 30301 | Superseded by 30880 | | 30581 | .40 | Disc | 30748 | .60 | " |
| 30302 | " | 12488 | 30582 | Superseded by 14887 | | 30749 | .60 | " |
| 30303 | .40 | Cap. | 30583 | .15 | Indicator | 30750 | .45 | Cap. |
| 30304 | .40 | " | 30584 | .60 | Drum | 30751 | .55 | " |
| 30305 | 6.25 | Speaker | 30585 | .06 | Spring | 30752 | .25 | Bracket |
| 30306 | 4.65 | Cone | 30586 | .37 | Cord | 30753 | .40 | Disc |
| 30307 | 1.65 | Transf. | 30587 | .45 | Pulley | 30754 | .06 | Cable |
| 30308 | .25(4) | Screw | 30588 | .07 | Spring | 30755 | .35 | Arm |
| 30330 | .03 | Spring | 30589 | .65 | Dial | 30756 | .09 | Spring |
| 30340 | .20(10) | Retainer | 30590 | Superseded by 12415 | | 30757 | .30 | Pulley |
| 30361 | .60 | Card | 30591 | .20 | Resistor | 30758 | .25 | " |
| 30365 | .55 | Contact | 30592 | .50 | Cap. | 30759 | .70 | Dial |
| 30368 | 3.00 | Sound Box | 30593 | 1.25 | Escutcheon | 30760 | .45 | Shaft |
| 30369 | .90 | Wrench | 30594 | 1.30 | " | 30761 | .65 | Drum |
| 30373 | .24 | Knob | 30595 | .30 | Bracket | 30762 | .15 | Indicator |
| 30374 | 17.00 | Motor | 30596 | 1.50 | Vol. Cont. | 30763 | .40 | Cord |
| 30375 | 17.25 | " | 30597 | 1.45 | Cap. | 30764 | .45 | Cap. |
| 30376 | 7.80 | Rotor | 30598 | 1.65 | " | 30765 | .50 | " |
| 30385 | 15.85 | Motor | 30599 | 1.20 | Resistor | 30766 | .15 | Cap |
| 30386 | 17.50 | " | 30600 | 2.05 | Dial | 30767 | .55 | Cap. |
| 30387 | 21.95 | " | 30601 | 2.05 | " | 30768 | Superseded by 30608 | |
| 30388 | 7.30 | Rotor | 30602 | .40 | Pulley | 30769 | .40 | Cap. |
| 30389 | 8.40 | " | 30603 | .70 | Indicator | 30771 | .20 | Resistor |
| 30390 | 10.40 | " | 30605 | .16 | Belt | 30772 | .13 | Knob |
| 30391 | 2.20 | Turntable | 30606 | .20 | Knob | 30773 | .15 | " |
| 30392 | .25 | Spacer | 30607 | 7.25 | Transf. | 30774 | 4.30 | Escutcheon |
| 30393 | .35 | Cap | 30608 | .35 | Cap. | 30775 | 1.00 | " |
| 30396 | .30 | Cap. | 30609 | .30 | Socket | 30776 | 1.40 | " |
| 30397 | 1.65 | Dial | 30610 | 8.20 | Speaker | 30777 | .25 | Shield |
| 30409 | .20 | Resistor | 30611 | .25 | Plug | 30778 | .08 | Button |
| 30428 | Superseded by 13054 | | 30612 | 2.70 | Transf. | 30779 | .05 | Shield |
| 30433 | .35 | Cap. | 30613 | 2.20 | Coil | 30780 | .03 | Cushion |
| 30459 | .85 | Pulley | 30617 | Superseded by 30607 | | 30787 | .20 | Resistor |
| 30460 | .05 | Belt | 30620 | 1.15 | Switch | 30841 | .16 | Spring |
| 30462 | .05 | Spring | 30621 | 1.65 | Coil | 30846 | .30 | Core |
| 30463 | .02 | Screw | 30622 | .70 | Dial | 30880 | .20 | Resistor |
| 30464 | .70 | Pulley | 30623 | .60 | Cap. | 30963 | .20 | " |
| 30465 | .40 | " | 30647 | .28 | Resistor | | | |

CHART OF FREQUENCY OR IMPEDANCE VS. INDUCTANCE AND CAPACITY

The Chart shown below provides a quick method of determining several unknown factors when one or more are known. The Chart covers a very wide range, namely, from 10 micro-henries to 100 henries inductance, 10 cycles to 50,000 kilocycles, 1 ohm to 10 megohms and 1 micro-microfarad to 10 microfarads. If, for example, one wishes to know the capacitance to use with a 10 henry inductor to have it resonate at 50 cycles, it can be readily seen that it would be a 1 mfd. capacitor. This is determined by finding the intersection of the vertical line representing 10 henries and the oblique line representing 50 cycles. The intersection occurs at the horizontal line representing 1 mfd. The other oblique line at this intersection represents the impedance at this frequency. This is approximately 3000 ohms.

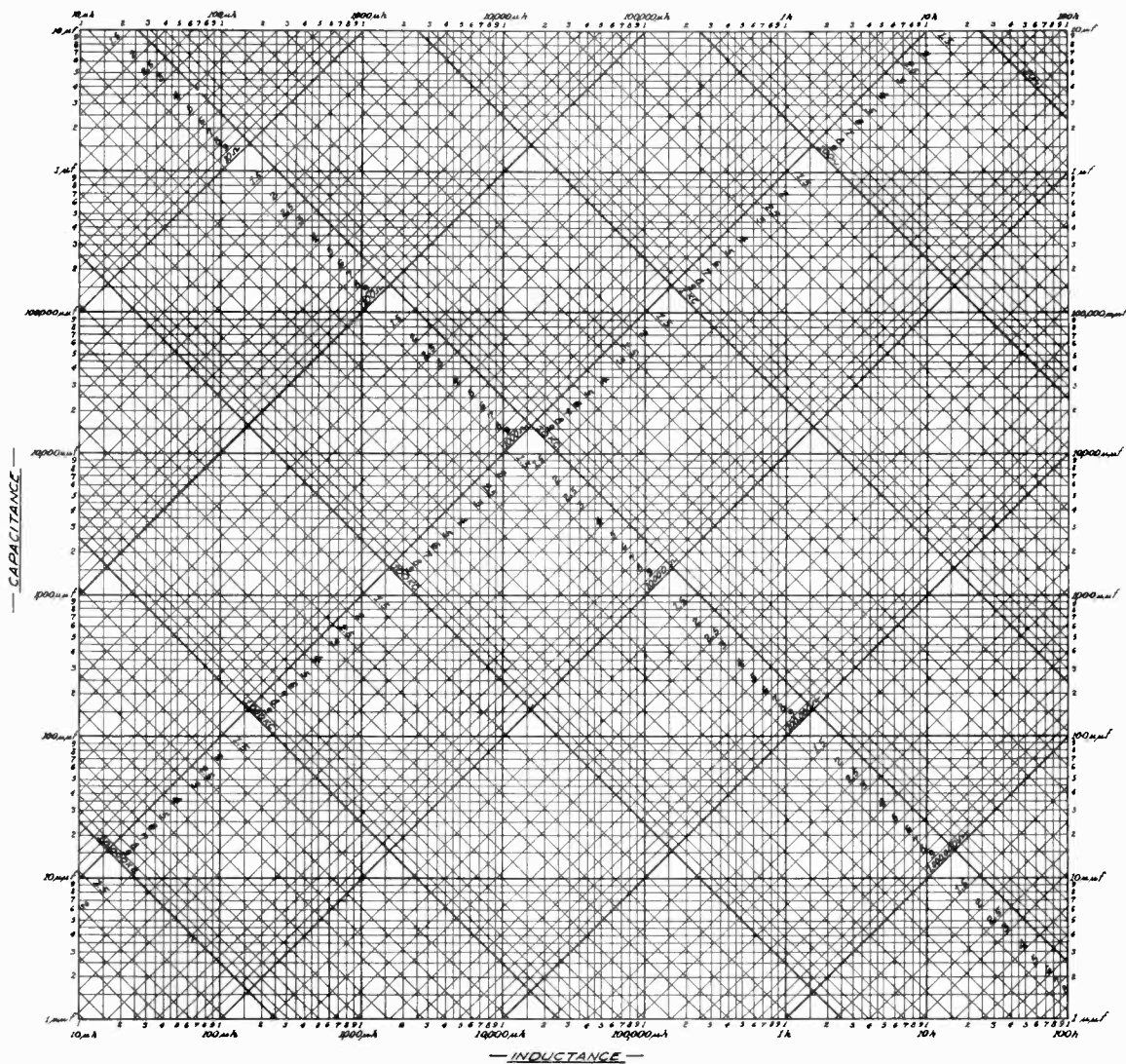

1941-1942



