



# RADIO SERVICE NEWS

VOLUME XIV, No. 1

RCA TUBE DEPARTMENT, HARRISON, NEW JERSEY

January-February, 1949

## NEW HORIZONS FOR SERVICE DEALERS IN THE TV FIELD

Television Sales and Service Offer Greater Than Ever Profit Opportunities

The year 1948 saw a drama unfold the equal of which has not been witnessed since the infant days of radio. In that short space of time, a new electronic team—sight and sound—grew from an unknown entertainment medium to a towering giant. Today, if you are in a television service area, you need only walk down the street, eyes roofward, to have proven for you the mass appeal of television.

But what does this mean to the service-dealer? Follow that thin ribbon down into the house. Between that antenna lead-in and the visible picture are an average of 25 tube sockets, each one of which must at one time or another be re-filled. Before each screen there lies a market for a magnifier. Across the street or next door, wherever the roof is void of the usual sign of television, lies a potential market for a receiver, an antenna, lead-in, installation work, a lightning arrester.

Analyze your potential standing in this TV business. As television broadcasting moves out to cover more and more areas, more and more service-dealers are in line for these big opportunities.

That's where RCA can help. Pioneer of television, RCA has planned ahead. Today, RCA's line of tubes meets all major requirements for the TV receiver renewal market. An outstanding line of genuine RCA components and accessories bear the consumer-proven RCA trademark. RCA test equipment is tops for servicing TV receivers. To back up its products RCA has outstanding advertising and sales promotion material that helps carry your message direct to the consumer.

RCA is ready to help you cash in on TV's rich dividends. Plan now for your part of the television era. Talk it over with your RCA distributor now.

Now appearing in RCA Ham Tips for Jan.-Feb. — Part II of J. L. Reinartz' TVI Elimination article. See your RCA Distributor.

## THE RCA CHANALYST\* ELECTRONIC ANALYZER

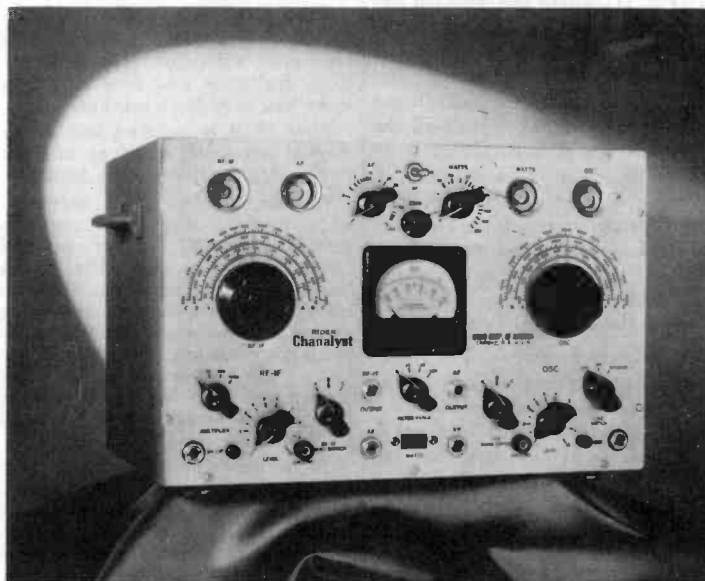

This is the famous Rider-designed RCA Chanalyst Electronic Analyzer 162-C, a real time-saving, profit-making service instrument for the up-to-date serviceman. See your RCA distributor today

## RCA CHANALYST\* CUTS SERVICING TIME, UPS PROFIT

Rider-Designed Chanalyst Electronic Analyzer is Profitable Investment

Back in 1936 John F. Rider developed an instrument especially designed for locating trouble in stubborn radio sets. For 12 years RCA instruments incorporating the design features of the original have been helping thousands of radio servicemen operate their businesses at a profit.

Time is the essence of prosperity in radio servicing. No radio technician can afford to waste his time tracking down intermittent faults by trial and error. For troubles that appear and vanish only to pop up later at another point, a non-eating, multi-armed robot is needed. Such a mechanism is the RCA-162-C Rider Chanalyst Electronic Analyzer. This instrument can be connected to a radio set so that it will give a positive indication of the approximate location of the intermittent trouble at the moment the trouble occurs. And during the time it is standing guard, the smart radio technician is servicing other sets that do not have obscure faults.

The Chanalyst Analyzer is also of great help in locating trouble that can not be found readily with Volt-Ohmmeters, Test Oscillators, and Tube Testers. Its tuned amplifiers will follow tunable hum and cross talk to the source. Its wattmeter will show up changes in ac power line input. Its tuned oscillator channel will tell you the frequency of the local oscillator as well as the amount of drift. Its electronic voltmeter will show voltage changes in high-impedance AVC circuits and grid-leak bias circuits. Its audio system will localize defective components in the audio amplifier. In fact, it's difficult to imagine any intermittent or obscure radio receiver defect that cannot be diagnosed by the RCA 162-C Rider Chanalyst Analyzer.

Why not see your RCA Distributor today and take a good look at the Chanalyst Analyzer? It can mean the difference between profit and loss to your business. Consider the benefits of this instrument in saving time for more profit.

\*\*Chanalyst\* is a registered trade mark of the Radio Corporation of America.

††VoltOhmyst† is a registered trademark of the Radio Corporation of America.

## "SHOCK OF THE MONTH CLUB" ANNOUNCES THE GRAND WINNER

The letter-writing competition for membership in RCA's "Shock of the Month Club" is over, and we've had a barrel of fun reading (even though the writer's experience may have been less amusing) all the entries and trying to pick a winner. It was tough to decide who should receive the transformers in the preliminary phases of the contest, but picking the final winner was really a problem.

Nevertheless, the judges picked a letter, which in their opinion tops them all. To him goes the RCA Battery VoltOhmyst†, WV-65A, and our sincere congratulations and best wishes. (He already received an RCA Isotap, too). The winner is Mr. Jack A. Johnson of Delton, Michigan, whose letter appears in this issue of RADIO SERVICE NEWS.

The three winning letters of the final lap, including Mr. Johnson's, are printed below. The writers of these have been sent RCA Isotap transformers. To them also go our best wishes. To all the many entrants whose letters could not be used, our sincere thanks for your interest in our little contest and your fine stories. We feel that basically everyone profited from hearing about or re-living a "shocking incident".

Editor  
RADIO SERVICE NEWS

While working on an ac/dc set recently I had an auto radio playing beside me testing it for fading. It was being run off an eliminator plugged in on the same line as the ac/dc set. I had my right arm against the ac/dc set and reached with my left hand to change the stations on the auto set. The resulting shock caused me to knock the ac/dc set off the bench, breaking several tubes and bending the condenser plates.

I was sitting on a high stool and when I drew back the stool fell against a fuel oil stove nearby jarring the stove pipe above, which came loose from the chimney. Two of the sections showered me with soot while the third section knocked

(Continued on Page 6, Col. 1)

# TELEVISION ANTENNAS AND TRANSMISSION LINES

By John R. Meagher  
Television Specialist, RCA Renewal Sales

## PART II—GHOSTS

We did not originally intend to devote much time to ghosts because the subject is generally well understood, at least in regard to the common or garden variety of ghosts. But on analyzing the subject, we were surprised to realize the great variety of ghosts that may, under unfavorable circumstances, unhappily haunt the kinescope. So we decided to make you better acquainted with them.

For instance, have you met all of the following members of the ghost family?—

- Leading ghosts
- Trailing ghosts
- Positive ghosts
- Negative ghosts
- Multiple ghosts
- Fluttering ghosts
- Transmission Line ghosts
- Tunable ghosts

If you do not recognize all of them, you may have wasted time trying to eliminate some varieties by orienting the antenna, which doesn't phase them a bit.

### Trailing ghosts

The usual type of ghost, or echo, or secondary image, is caused by reflection of the transmitted signal from a building or other structure or from a hill or cliff. The reflected signal, which is usually weaker than the direct signal, arrives at the receiving antenna later than the direct signal, and the ghost, therefore, appears on the right-hand or trailing side of the original picture.

The building or other object from which the signal is reflected may be situated in various locations with respect to the TV station and to the receiver, as shown in Fig. 1.

In Fig 1A where the direct and reflected signals arrive at the receiver from the same general direction, there is no practical remedy at present to eliminate the ghost.

Occasionally, in the hope that the plane of polarization of the reflected signal has been changed from horizontal, experimenters try tilting the antenna in various planes to get it at right angles to the plane of the reflected signal. Unfortunately, such trials have usually proved inconclusive or futile.

In Fig. 1B, where the reflected signal is arriving at the receiver from one side, it can be minimized by orient-

ing the antenna for least pickup in this direction.

In Fig. 1C, where the reflected signal is arriving at the receiver from the rear, a reflector on the antenna is helpful because it reduces rear pickup to some extent. As mentioned previously, it is not a cure-all for this condition. A reflector of large dimensions, such as a metal billboard, or a large screen of chicken wire, is generally helpful in reducing rear pickup. In a few cases, it is possible to position the antenna so it is "shielded" from the rear by a closely adjacent steel building.

In mid-city locations, it is sometimes advantageous to orient the antenna for maximum pickup of a strong reflected signal, and minimum pickup of the direct signal. This expedient may be necessary in locations where the direct signal is blocked by an intervening building, as in Fig. 1D.

In locations where several reflected signals from different buildings reach the receiver, there are several ghost images in the picture. These images are referred to as multiple ghosts, or multiple reflections. A typical condition in which multiple ghosts are produced is shown in Fig. 2.

A ghost may be either positive or negative using these terms in their photographic sense, where a negative is a reversed image; that is, the black portions are white and the white portions are black.

Whether a ghost is positive or negative depends on the relative phase of the direct and reflected signals. See Fig. 3. The relative phase depends on the position of the antenna. If the antenna is moved some distance toward or away from the transmitter, the relative phase changes, and the direct and reflected signals either aid or oppose, producing a positive or a negative ghost respectively.

### Fluttering ghosts

When an aircraft is in the vicinity of the receiver, it reflects signals from the TV transmitter to the receiver. The receiver also gets direct signal from the transmitter. The relative phase of the direct and reflected signals arriving at the receiver changes as the plane travels

(Continued on Page 6, Col. 1)

# Talking Things Over

With W. L. ROTHENBERGER  
Manager, Renewal Sales

How is your battery business?—And what is your battery IQ? Do you know that there is a selective distribution system of batteries now in operation that directs radio battery business to radio channels?

These are pointed questions, but they lead into the subject I want to talk over with you this month—RCA Batteries and how they can serve you in today's market.

First of all, let's take a look at the market potential, a survey of what 1949 holds for the battery business.

On the basis of RMA industry-wide figures, there are approximately 2,500,000 battery-operated farm radios in operation. With farming groups enjoying a higher level income, these sets are being used more and more for entertainment purposes, as contrasted to ten years ago when receivers were turned on only for vital weather information, market reports, and the like.

Battery-operated portables represent another sizeable market. 1948 was a peak year in the production of this type of set and a conservative estimate shows around 8,000,000 of them now in operation.

Now the average distributor is finding that his battery dollar volume equals or slightly exceeds twice his tube dollar volume. These figures indicate pretty much the profit potentials in the "radio battery for the radio trade", for serviceman and dealer. In some localities he may enjoy tremendous sales in portable types, while in others the demand is for farm packs. But, in either event, the battery picture represents a large volume of business.

The latest trend is a swing from non-electronic distribution (electrical, hardware, and automotive houses) to radio parts houses. By the same token, retail sales are transferring from the drugstore and hard-

ware counters to the radio sales and service outlets.

RCA's "controlled" battery distribution is furthering this trend with its merchandising of "radio batteries for the radio trade". This helps build business for you by bringing the customer back to your counter, again and again. I suggest you take a good look at your battery sales picture, and then dig in after your share of this market.

What's RCA's position in the battery field? One look at the list of types currently available in the RCA line will assure you that RCA is in the battery business with the strongest battery line ever offered. It is further backed up by helpful technical battery data, and colorful sales producing, radio battery promotion material.

Have a chat with your RCA Battery Distributor and get a close-up of the whole RCA battery picture. Get a copy of the RCA Battery Catalog (2F134) for a look at the line. A copy of the Battery Comparative Chart (2F232) will show you the proper RCA Battery for interchangeability. The correct RCA Battery for a specific make and model radio is shown in the RCA Quick Selection Guide (2F589). And a handy counter card shows RCA Battery List Prices (2F387). Finally, study the RCA Battery Sales Promotion Folder at your Distributor's and look at the outstanding material RCA makes available to help you sell RCA Batteries.

This is only a brief review of a big business; a business which will help build profits for you. Why not cut a slice for yourself now?

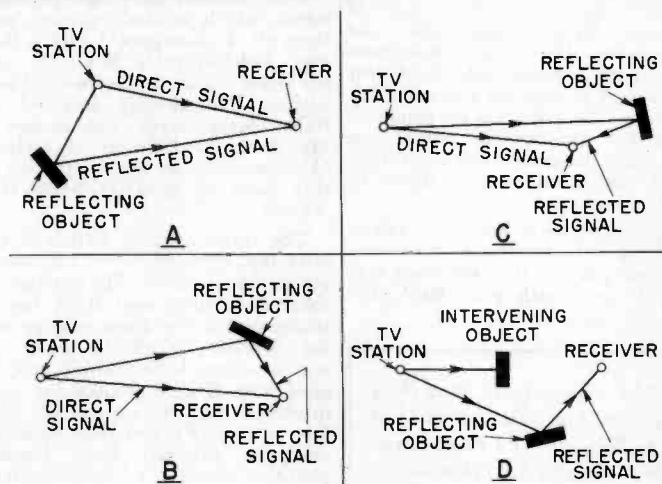

FIG. 1

# TELEVISION SERVICE

by John R. Meagher

Television Specialist, RCA Renewal Sales

## PART IV

In the first three articles of this series we explained the function and the application of television test patterns in analyzing the response of television receivers. These articles contain a large amount of practical information which to the best of our knowledge is not available elsewhere.

We have now paved the way for the second major section of this series: Starting in this article, and continuing for several issues, we will analyze the effects of actual troubles with the graphic aid of several hundred photographs that have been made by the author specifically for these articles. These photographs clearly show how the picture or test pattern is affected by various faults in different sections of a typical television receiver.

### Portion of Patterns for Clarity

Test pattern photographs are frequently printed in such a small size that most of the details are lost. It is not practical to use a magnifying glass to enlarge the printed reproduction because the dot structure involved in the half-tone printing process spoils the enlargement. If the photographs are printed in large enough size to make the details visible, only a few can be shown on each page. To overcome these limitations, the author is showing only a small portion of photographs in cases where it is necessary to observe small details. In this way it is possible to include numerous photographs on each page and yet maintain a sufficient size so that the reader can observe the desired effects.

The reader is probably aware that printed reproductions are not as sharp or as clear as the original photographs, and that some of the finer effects are lost in the printing process.

### Specially Designed Receiver

The receiver used in making these photographs was specially designed and constructed to facilitate the work, and will be described in a later issue.

The receiver employs essentially the same circuit as the standard RCA Model 630TS, 8TS30, etc. Readers who wish to brush up on the function and action of the circuits in this type receiver, as an aid in studying the photographs, should obtain the 630TS service notes. These are included in a booklet "RCA Television Service Data", Form TV-1003, available through RCA distributors at \$1.50.

### Video Troubles in This Issue

The photographs in this issue show how the TV picture is affected by certain troubles in the video amplifier. The circuit of the amplifier is shown in Fig. 1. The caption under each photograph states the nature of the trouble and describes the principal effects that are evident in the picture.

Inspection of the photographs will show that the troubles selected for this issue affect the picture "quality" and are generally accompanied by "smearing" that ranges from a slight to a severe condition.

It must be mentioned that some of the troubles pictured here can be duplicated in part by incorrect conditions of rf-if alignment. These troubles will be covered in a later article.

Other troubles in the video amplifier, such as open coupling capacitors, open plate, screen, or cathode circuits, dead tubes, etc., will result in complete absence of the picture, or a very faint picture.

A third class of trouble in the video amplifier is caused by incorrect bias, which may be due to off-value resistors, leakage in coupling capacitors, etc.

Any serious trouble in the video amplifier may produce symptoms of sync failure. However, even when the picture is completely out of sync and will not remain stationary, it is possible to judge the picture quality and to determine from this, and from the appearance of the sync pulses, whether the trouble is due to incorrect rf-if-video response, or to a defect in the sync circuits.

### Other Troubles in Following Issues

Study of the effects pictured in this and the succeeding articles will help to pave a smooth path to our goal, which is the development of a comprehensive and logical trouble-shooting procedure based on analysis of the picture.

In the following issues we will show photographs of the effects of troubles in the horizontal deflection, vertical deflection, rf-if, sync, and power-supply sections.

The Chinese say that one picture is worth 10,000 words. At that rate we will have the equivalent of at least 1,000,000 words in the next few issues.

It is suggested that the reader save all of these articles, because, like the exclusive information on test patterns, this photographic analysis of television trouble-shooting is not available elsewhere.

# 1948 RCA RADIO SERVICE NEWS

## Index of Technical Articles

### JANUARY-FEBRUARY

"TECHNICAL EDUCATION REQUIREMENTS OF THE MODERN RADIO INDUSTRY"

By Paul L. Gerhart, Chief Instructor, RCA Institutes, Inc., New York, N. Y.

"QUALITY CONTROL STRESSED IN RCA'S TUBE MANUFACTURE"

"NEW SIGNAL INJECTION TECHNIQUE SPEEDS SERVICING"

(Based on a staff written article appearing in "Radio Maintenance")

### MARCH-APRIL

"QUALITY CONTROL OF MINIATURE TUBES"

By W. L. Van Keuren, Manager, Quality Control Section

"HIGH-SPEED SERVICING"

By Arthur Liebscher, Test & Measuring Equipment

"MAINTAINING YOUR VOLT-OHMYST"

"PROFITABLE SUMMER SERVICING THROUGH EARLY PLANNING"

### MAY-JUNE

"QUALITY CONTROL STRESSED IN KINESCOPE MANUFACTURE"

By G. G. Thomas, Quality Control Section  
RCA Tube Dept., Lancaster, Pa.

"TELEVISION SERVICE"—PART I

By John R. Meagher, Television Specialist, RCA Renewal Sales

### JULY-AUGUST

"TELEVISION SERVICE"—PART II

By John R. Meagher, Television Specialist, RCA Renewal Sales

"DBM CHART EXPANDS USEFULNESS OF RCA-VOLT-OHMYST METERS"

### SEPTEMBER-OCTOBER

"NEW TV/FM/AM TEST EQUIPMENT"

By Arthur Liebscher, Merchandise Group, RCA Tube Department

"SOME NOTES ON TELEVISION RECEIVING ANTENNAS"

Reprinted from "Successful Servicing", a John Rider publication

"TELEVISION SERVICE"—PART III

By John R. Meagher, Television Specialist, RCA Renewal Sales

"HOW THE IMAGE ORTHICON WORKS"

"OVERLOAD PROTECTION FOR THE HORIZONTAL DEFLECTION CIRCUIT"

Television Tube Complement Data Sheet

### NOVEMBER-DECEMBER

"TELEVISION ANTENNAS AND TRANSMISSION LINES"

By John R. Meagher, Television Specialist, RCA Renewal Sales

"WIDE-BAND IF ALIGNMENT BY ALTERNATE LOADING"

By Robert G. Middleton,  
Commercial Engineering, RCA Tube Department

RECEIVER SENSITIVITY AND GAIN MEASUREMENTS AT HIGH

FREQUENCIES

RCA SPEAKER SPECIFICATIONS

## A MODERN SERVICE BENCH FOR TV-FM-AM

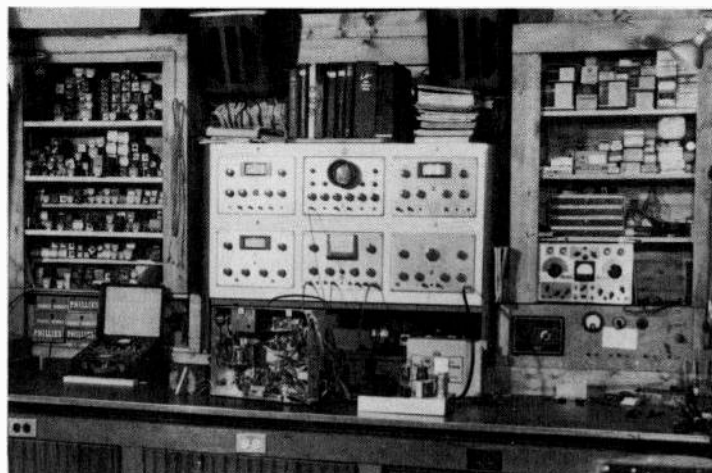

Proud possessor of a brand new RCA Test Rack and matched instruments is Ed White, Purdys, N. Y. serviceman. Not only is the set up good-looking, but it's tops for high efficiency servicing of TV-FM-AM equipment. Photo through the courtesy of Westchester Electronics, White Plains, N. Y., who sold the equipment to Mr. White.

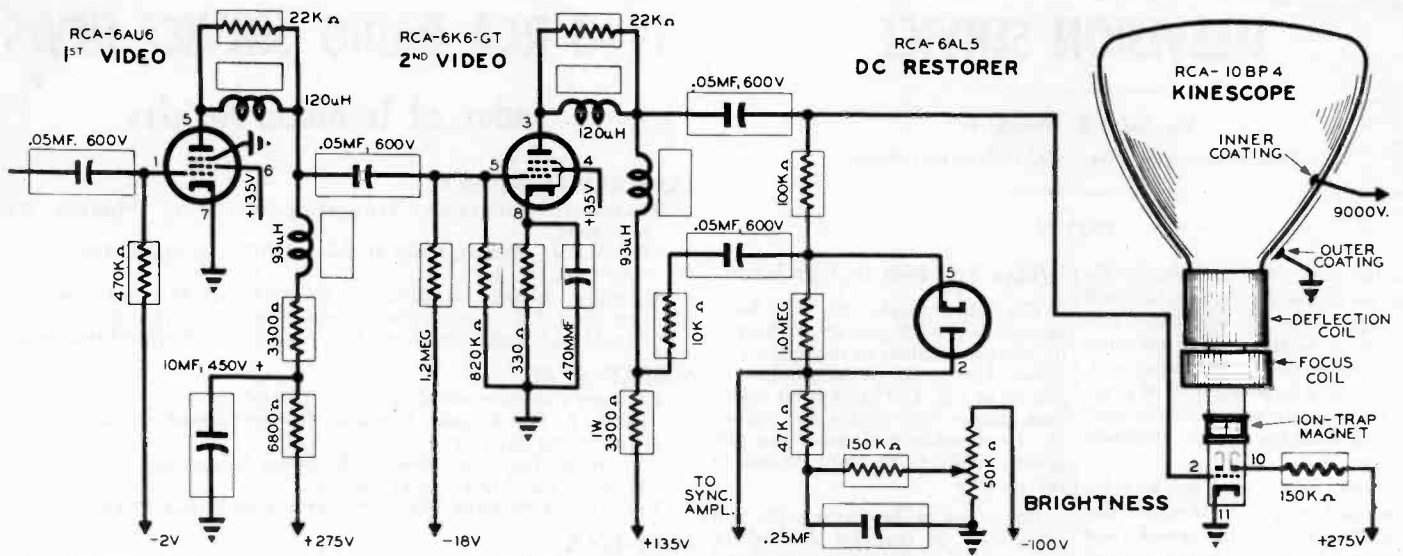

Fig. 1—Schematic of video amplifier as it appears in the special TV receiver used for these photographs. The illustrations in this article show how the picture quality is affected by various troubles in this circuit.



Fig. 2—This shows normal conditions. There is a slight trailing light-grey smear on the right-hand side of the lettering, and after the lines in horizontal wedge.



Fig. 3—Poor low-frequency response. 2nd-detector load resistor, not shown in schematic, dropped from 3900 to 100 ohms. Note trailing reversal, white after black, on right-hand side of lettering. Lettering and outer circle are not uniform.

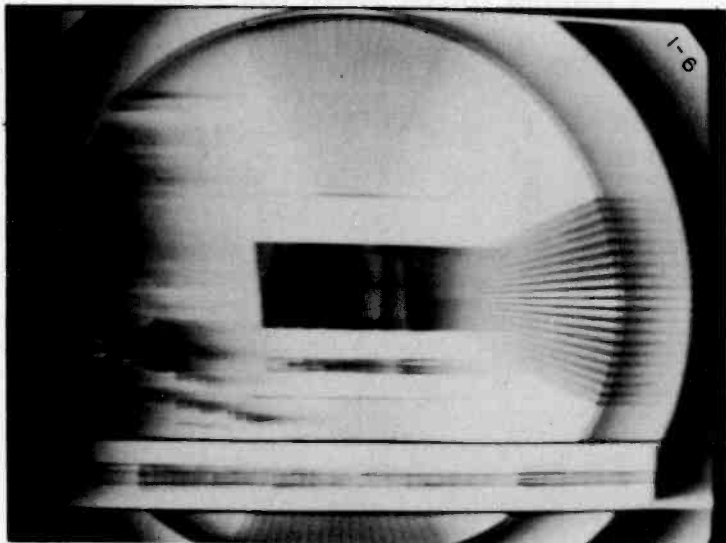

Fig. 4—Excessive low-frequency response and phase shift. 2nd-detector load resistor increased from 3900 to 100,000 ohms. Note smearing of lettering and horizontal wedge, and almost complete wiping out of vertical wedge.



Fig. 5—Low-frequency phase shift. 1st-video grid resistor dropped from 470,000 to 3000 ohms. The contrast was turned down, brightness turned up, and vertical hold control adjusted to show vertical blanking and sync. Note trailing reversal after vertical sync, and after vertical blanking.

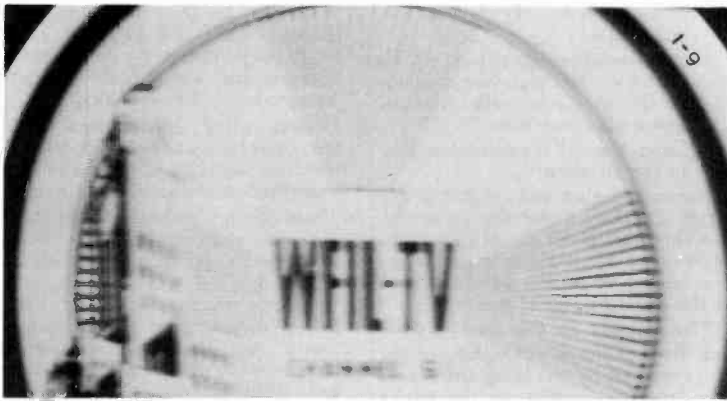

Fig. 6—Poor high-frequency response. 1st-video plate filter capacitor (10  $\mu$ f) open, effectively increasing plate load resistor from 3300 to 10,100 ohms (3300 plus 6800). General smearing of wedges except center lines in horizontal wedge.



Fig. 7—Excessive high-frequency response. 1st- or 2nd-video plate load of 3300 ohms dropped to 1000 ohms. Reduces low-frequency response, exaggerating highs. Note trailing reversal, white followed by a fine dark line, after lettering.



Fig. 8—Excessive low-frequency response. 1st- or 2nd-video plate load of 3300 ohms increased to 10,000 ohms. Increases low-frequency response, decreases highs. General smearing of both wedges except center lines in horizontal wedge. Same general effect as shown in Figs. 4 and 6.



Fig. 9—Trailing reversal, white after black, produced by 2nd-video cathode resistor increasing from 330 ohms to 1500 ohms. Resulting incorrect bias makes it difficult to obtain suitable contrast.



Fig. 10—Hum in video, produced by heater-cathode leakage (700 ohms) in 2nd video stage. Hum voltage darkens some portions and lightens other portions of picture. Hum also gets into horizontal-sync, distorting shape of picture.

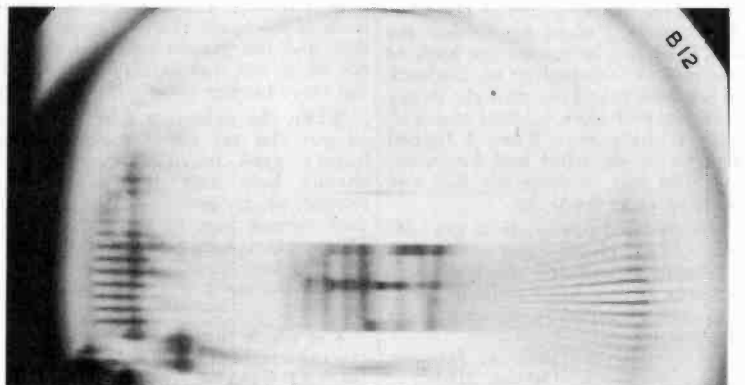

Fig. 11—Loss of highs, and low-frequency phase shift produced by open coupling capacitor (0.05  $\mu$ f) to the kinescope grid. Note that vertical wedge is practically wiped out. Note smear after lettering and after horizontal wedge.

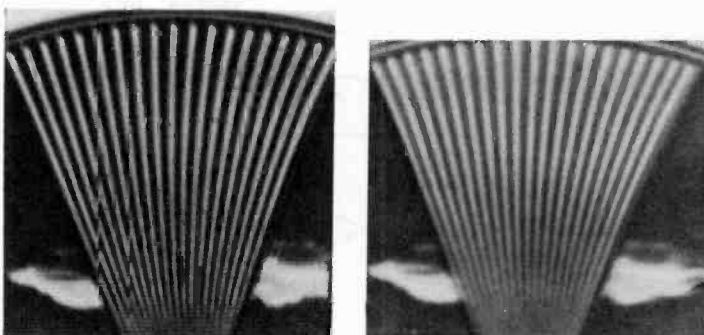

Fig. 12—Vertical wedge at left shows normal conditions in video amplifier. Wedge at right is with the 120-microhenry peaking coil in the 1st-video amplifier open. This condition reduces definition in the vertical wedge and makes the wedge and lettering fuzzy.



Fig. 13—Believe it or not, this is a roller-skating rink. The smearing is not caused by trouble in the receiver, but by unusually poor TV relay conditions. Moral. Don't tear the set apart until reception has been checked on other stations or on other receivers.



Fig. 14—Try guessing the cause of this condition. It is not due to trouble in the video amplifier. The correct answer will be given in the next issue, and it may be surprising to many technicians.

**"SHOCK OF THE MONTH"**

(Continued from Page 1)

off a radio setting on a shelf directly under the chimney.

Believe me the place was a mess. I was more surprised than hurt as I never suspected such a thing to happen.

John G. Cooney  
Cooney Radio Co.  
933 Hodiament Ave.  
St. Louis, Mo.

Editor  
RADIO SERVICE NEWS

I never before realized a little ac/dc could cause my wife to be afraid to come near me.

One day while working on an ac/dc in my usual crepe rubber soled shoes, unknown to me my wife came into my shop out of the rain. She quietly walked up behind me and bent to kiss me on the back of the neck. I felt the hair on the back of my neck stand out straight as my wife jumped back against the wall with a sharp cry. When I turned around to see what had happened my wife was rubbing her lips and backing away from me.

I have tried to explain to my wife about "hot" chassis, and wet feet on a cement floor, but I think she still believes it was some sadistic trick. She now approaches me with great caution.

Jack A. Johnson  
Delton, Mich.

Editor  
RADIO SERVICE NEWS

I had dropped into the service

**TELEVISION ANTENNAS**

(Continued from Page 2)

along. The two signals alternately aid and oppose each other, producing a flutter in picture brightness and also a flutter in the ghost image. In TV receivers with automatic gain control on the picture—if amplifier, the fluctuation in brightness is largely eliminated. Refer to Fig. 4.

The rate of flutter depends on the position, height, speed, and direction of the plane. The rate of flutter changes as the plane moves along.

Occasionally signals from a distant TV station that is beyond normal receiving range may be seen for short periods due to reflection from a plane as shown in Fig. 5. This

shop to chat with my friend, the serviceman; and we were listening to the salesman trying to sell a customer an ac/dc receiver.

"A nice feature of this set," he explained, "is that it will play anywhere." To illustrate his point, he cradled the little set in his hands and started to deposit it, still playing, on the top of an electric stove on the display floor.

A split second later he screamed and jerked violently backward, striking his head against the edge of a shelf; there was a flash of fire from beneath the receiver; and all of the lights in the store went out.

After both radio and stove had been disconnected, a new fuse installed, and the lights were back on, we found the salesman sitting on the floor rubbing a goose-egg on the back of his head; the customer had fled; and the chassis-holding bolt of the ac/dc set was firmly welded to the stove burner.

When the salesman had started to put the set on the stove, his fingers were between the "hot" chassis bolt and the grounded burner; so he got a violent shock that caused him to drop the set. The contact between the bolt and the burner struck an arc that caused the weld and also took out the fuse.

The whole thing was a most convincing argument in favor of RCA ISOTAP TRANSFORMERS.

John T. Frye  
1810 Spear Street  
Logansport, Indiana

occurrence demonstrates that the signals are passing over-head and could be intercepted if it were possible to place an antenna high enough in the air.

The usual type of ghost appears on the right-hand side of the picture. It is termed a "trailing" ghost because the reflected signal travels a longer path than the direct signal and arrives later than the direct signal.

There is a condition where one or more images may appear on the left-hand side of the picture. We have termed these "leading" ghosts for lack of a better description.

This type of ghost appears in locations where the following conditions exist, as shown in Fig. 6;

1. Location relatively close to the transmitter.
2. Considerable signal pick-up in the rf or 1st-detector circuits of the receiver, with the antenna disconnected.
3. Long run of transmission line to the antenna.

Because the antenna signal is delayed traveling down the transmission line, the direct signal picked up in the rf or 1st detector circuits appear ahead, or on the left-hand side of the antenna-signal picture.

The remedy in this case is to—

1. Reduce the direct pickup in the receiver, by shielding the rf and detector circuits, or the entire chassis.
2. Increase the signal from the antenna. (If there is some type of antenna distribution system, it may be defective, or attenuating the signal too much.)

In any case where direct signal pick-up by the receiver is evident in the picture, this signal will be altered by persons moving around the room, or near the TV receiver. (Remember that movement close to an unshielded transmission line will alter the antenna signal, particularly when the receiver does not terminate the line correctly.)

Under the conditions mentioned above but where the transmission line is shorter than a few hundred feet, the direct signal will not appear as a separate image but will blend with the antenna signal to produce a picture of poor quality which will change in quality when someone moves around the room or near the receiver.

In one actual case where leading ghosts were encountered, the following checks were made:

1. With the antenna connected to the receiver, and contrast and brightness correctly adjusted, there were about 12 distinct images on the kinescope.
2. Disconnecting the antenna from the receiver, without disturbing the contrast control, it was found that there were about 10 images.
3. From this it was assumed that the antenna was contributing very little to the signal, and that most of the pickup was from signals "coming in the window" and being picked up in the rf or detector circuits. The numerous images were due to reflected signals from different tall buildings in the vicinity.
4. Shielding of the rf and detector circuits did not help in this case.
5. It was then assumed that the rf tube had no gain, to account for the fact that connecting the antenna to the receiver produced very little difference in the picture on the kinescope. This proved to be the trouble: A resistor in the rf bias circuit had dropped to a very low value, which resulted in the rf tube being biased off at all times.
6. When this trouble was corrected and the antenna was connected to the receiver, the picture contrast control had to be turned back considerably because the antenna signal was then being amplified in the rf stage.
7. Leaving the contrast control in this new setting, the antenna was disconnected, and it was observed that no images were visible on the kinescope, indicating that at this low-gain setting of the contrast control, the direct signal pickup in the rf and detector circuits was

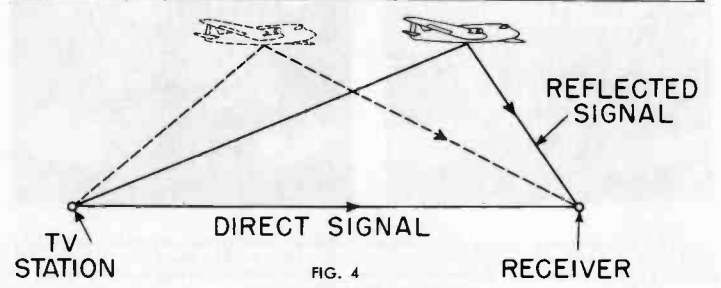
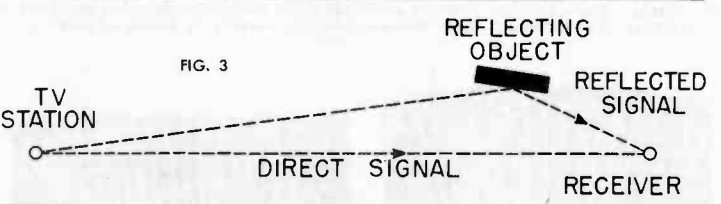
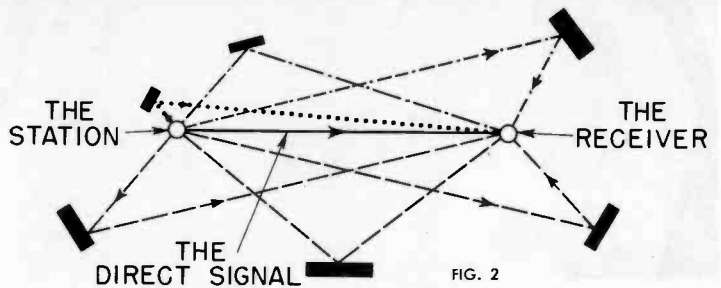

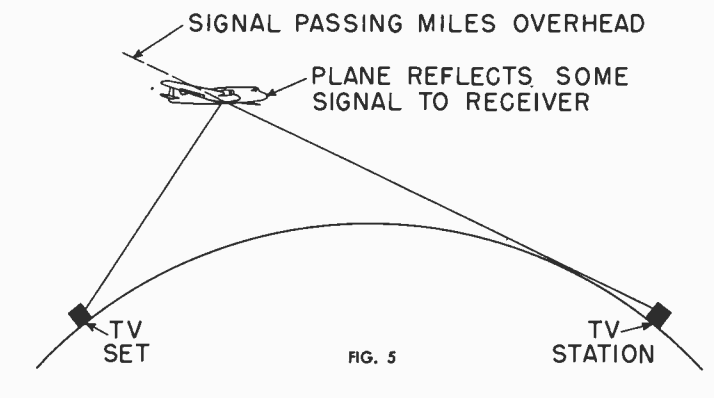

FIG. 5

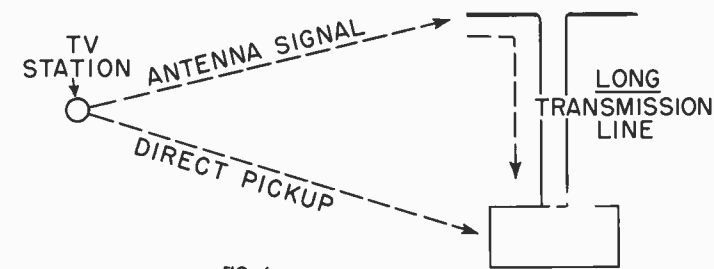

FIG. 6

not strong enough, compared to the antenna signal, to cause trouble.

8. The antenna was then reconnected, and after some time spent in finding the correct position and orientation, the final picture was excellent with only a few very faint reflections or trailing ghosts.

Another case in a similar location was traced to a defective component in the antenna distribution system.

These two actual cases are mentioned here because usually the presence of multiple ghosts is blamed on the particular location, and on the position and orientation of the antenna. It is worthwhile, at least in strong-signal areas, to check other factors, as proved in these two instances.

In working on reflection problems, it is sometimes helpful to know exactly which building or structure is acting as the reflecting object in producing a particular ghost.

To locate the reflecting object, it is necessary first to determine the "additional airpath distance" that the reflected signal must travel. (Any reflected signal travels a longer distance than the direct signal.)

The additional air-path distance is determined from knowledge of two facts:

1. The scanning spot in the kinescope requires approximately 53 millionths of a second, or 53 microsecond, to travel from the left- to the right-hand side of the picture. (Unblanked portion of picture.)
2. Radio signals travel approximately 1000 feet in one microsecond in air. In 53 microsecond a radio signal travels approximately 53,000 feet or 10 miles. Therefore, during the time it takes for the spot to travel from the left- to the right-hand side of the picture, a radio signal travels

about 10 miles. The horizontal width of the picture provides a distance scale, somewhat like the range scale on the radar "A" scope.

The procedure in determining the additional air-path distance of the reflected signal is as follows:

1. Adjust the picture width so it is the same size or slightly smaller than the mask, and adjust for the best possible horizontal linearity.
2. Measure the horizontal distance in inches between a point in the original picture, and the corresponding point in the ghost.
3. Measure the width of the picture in inches.

The additional air-path distance in feet is  $\frac{\text{distance between corresponding points}}{\text{width of picture}} \times 53,000$

(Fig. 7)

As an example, if the distance between corresponding points in the original and ghost pictures is one inch, and the width of the picture is 8 inches, the additional air-path distance is  $\frac{1}{8} \times 53,000$  or approximately 6,600 feet.

Note that this is the *additional* air-path distance that the reflected signal travels. It is NOT the distance from the reflecting object to the receiver or to the transmitter. For instance, if the distance from the transmitter to receiver is 50 miles, the direct signal travels 50 miles, and in the above example, the reflected signal travels 50 miles plus 6,600 feet.

In this particular example, if the reflecting object were directly in back of the receiver, it would be one-half of 6,600 feet or 3,300 feet in back of the receiver.

To find the buildings or other objects that could produce a ghost with a specific additional air-path distance, it is possible to draw an oval line on a map as shown in

Fig. 8. The additional air-path distance of a reflected signal is the same for all points along this line. Any large building or structure along this line can be the reflecting point.

This method is useful only when the distance between transmitter and receiver is relatively short.

**Transmission-line ghosts**

When the transmission line is not correctly terminated by the receiver, a portion of the signal is reflected at the receiver and travels back up the line to the antenna. If the antenna does not correctly terminate the line, a portion of this signal is reflected and travels down the line to the receiver, where it produces a trailing ghost.

With a normal length of transmission line, the reflected signal takes very little time in traveling up and down the line, so it is only slightly delayed and does not appear as a separate ghost. It merges with the original picture signal and affects the picture quality.

With a sufficiently long run of transmission line, the reflected signal appears as a separate trailing ghost.

Occasionally it is necessary to determine whether a particular ghost is due to incorrect termination of the transmission line, or to an external reflected signal. This determination will show whether it is

necessary to improve the line termination or to reorient the antenna.

First determine the additional air-path distance of the ghost, as described previously.

Then determine the equivalent air-path length of the particular transmission line, which is equal to:

$$\frac{\text{length of line in feet} \times 2}{k}$$

where k is the velocity constant of the particular line and is approximately 0.83 for some types of 300 ohm ribbon line.

As an example, let us assume that the additional air-path distance of a ghost is 4,000 feet and that the 300-ohm transmission line is 500 feet long. Then the equivalent air-path length for 500 feet of 300-ohm ribbon line, for a single reflection is

$$\frac{500 \times 2}{.83} = 1200 \text{ feet (approx.)}$$

Because the ghost signal in this example has an additional air-path distance of 4000 feet, it can not be caused by reflection in the transmission line which has an equivalent air-path length of 1200 feet.

**Tunable ghosts**

Echoes that vary in number and intensity with adjustment of the tuning control on the TV receiver are referred to as "tunable ghosts" or tunable echoes, and may be caused by incorrect alignment of the rf-picture if amplifiers, or by regeneration.

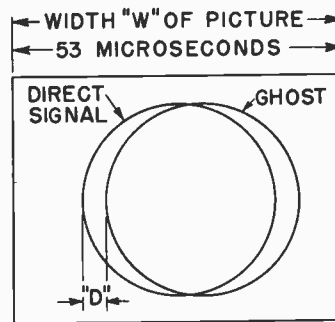

ADDITIONAL AIR-PATH DISTANCE TRAVELED BY GHOST SIGNAL, IN FEET =

$$\frac{D}{W} \times 53,000$$

(RADIO WAVES TRAVEL APPROX. 1000 FEET IN ONE MICROSECOND.)

FIG. 7

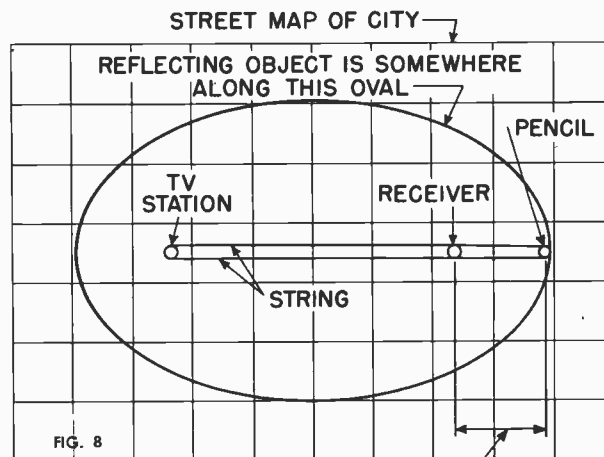

FIG. 8

HALF OF COMPUTED ADDITIONAL AIR-PATH DISTANCE OF REFLECTED SIGNAL.

**POSTMASTER:** If undeliverable for any reason, notify sender, stating reason, on Form 3547, postage for which is guaranteed.

From

TO:

## RADIO SERVICE NEWS

RCA Radio Service News is published by the RCA Tube Department in the interest of radio servicemen and dealers everywhere. It is distributed free of charge to members of the radio-service fraternity through the courtesy of RCA and its tube, battery, test equipment and parts distributors.

### Test Pointers

#### ON INTERMITTENTS

One of the greatest single problems encountered by the radio technician in his daily work is the intermittent radio set.

However, when suitable instruments are used to monitor intermittent receivers, the regular shop schedule can be maintained. Other service jobs can be completed while monitor instruments stand watch for any change in the functioning of an intermittent receiver.

Less effective methods are also used to shoot intermittent trouble. In an attempt to save man-hours, some technicians habitually replace a majority of the capacitors in an intermittent receiver at the outset. This remedy is frequently unsuccessful because many intermittents are caused by defective resistors, coils, switches, tubes, etc. Even after all of the suspected items are replaced, an appreciable percentage of receivers remain intermittent. In such cases, man-hour costs are pyramided on top of component costs: if these costs are passed on to the customer, good will suffers.

Artificial acceleration of the intermittent cycle is helpful in some cases. High line voltage will hasten the breakdown of certain marginal components. Low line voltage frequently causes a defective oscillator to cease operation. Some intermittents can be speeded up by increasing the operating temperature of the chassis by placing it in a carton with an incandescent lamp.

Although all of these methods work at times, signal-monitoring techniques have been found to be the best answer to the intermittent problem. Occasional checks of the monitor indicators show whether gradual operating changes are taking place. After the intermittent occurs, it can be localized to a particular section of the receiver by analysis of the monitor instruments.

Monitoring instruments have the advantage of providing a *continuous* check of the oscillator frequency and voltage, of the intermediate signal frequency and amplitude, of the audio input and output, of the receiver power consumption, and of the avc supply voltage.

Oscillator frequency shift is one of the most elusive causes of intermittent operation. Other obscure intermittents are caused by defective power-supply components, which show up on the monitor chiefly as a change in power consumption.

This brief discussion illustrates the important fact that many hours of time can be saved if the receiver is divided into five main sections, or channels, which can be monitored continuously. These are the hf oscillator, the rf or if channel, the audio system, the power supply, and the avc channel. After the intermittent has been localized to one of these sections, the instrument probes can be used to "close in" on the defective component.

Continuous monitoring places intermittent trouble-shooting on a firm technical basis.

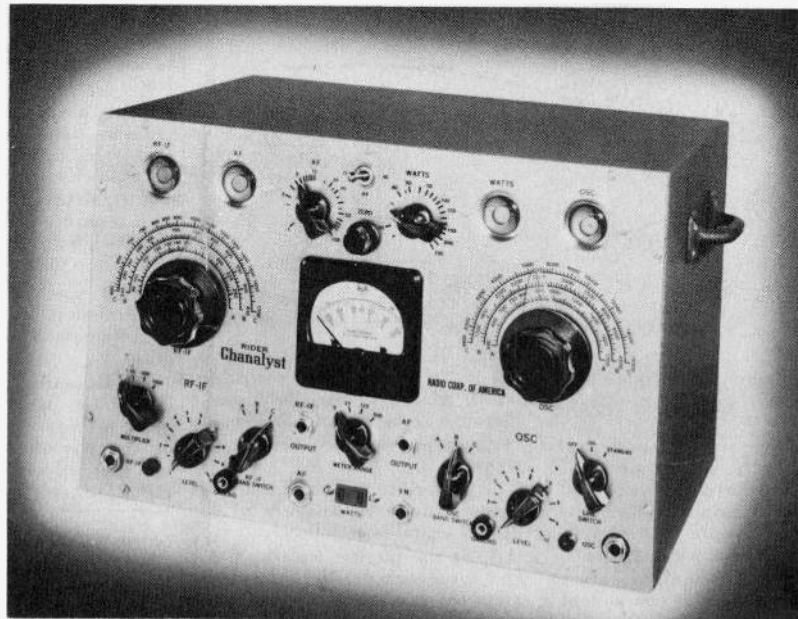

## The RCA-162-C Chanalyst Electronic Analyzer

# makes the difference between profit and loss

THE RCA-162-C Chanalyst Electronic Analyzer solves once and for all the problem of time-consuming intermittents. It works for you unattended—and spots the fault in any receiver whenever it shows—leaving you free for other work. That's why the RCA Chanalyst more than pays for itself in the time it saves.

The RCA-162-C will give you a *positive* check of any fault which takes place in the receiver under test. Its four electron-ray tubes plus an electronic voltmeter give an immediate indication of any change when it occurs. Once the trouble is localized it is a simple matter to determine the cause.

Find out today how the RCA-162-C Chanalyst Analyzer can make more

money for you. Ask your RCA Test and Measuring Equipment Distributor for the new bulletin on the 162-C, or write RCA, Commercial Engineering, Section 51AX, Harrison, New Jersey.

#### SPECIFICATIONS

**RF-IF Indicator Channel:**  
Frequency Range . . . . . 96 kc. to 1700 kc.  
Frequency Calibration . . . . .  $\pm 2\%$

**Oscillator Indicator Channel:**  
Frequency Range . . . . . 600 kc. to 15,000 kc.  
Frequency Calibration . . . . .  $\pm 2\%$

**AF Indicator Channel:**  
Frequency Response 150 to 50,000 cycles

**VT Voltmeter Indicator Channel:**  
Voltage Ranges 0-5, 25, 125, 500 DC Volts  
Scale . . . zero center with positive and negative deflection

**Input Impedance . . . . . 1 Megohms**

**Wattage Indicator Channel:**  
Input Range . . . . . 30 to 250 watts

Always keep in touch with your RCA Distributor