



RADIO AND TELEVISION

# Service News

A PUBLICATION OF THE RCA ELECTRON TUBE DIVISION

FALL  
1962



You can tell at a glance that RCA's fabulous new "Journey Thru Toyland" premium program is certain to win the acclaim of the Junior Set. Shown here are some of the exciting "Toyland" items that can be obtained with your purchases of RCA entertainment-receiving tubes through participating RCA distributors. See feature-story which begins on page 2 for photographic close-ups and descriptions of the numerous new premiums that can help you enjoy not only a lighter, brighter Christmas, but other important gift-giving occasions as well.

Vol. 27, No. 2

A young chemist explores the many scientific wonders revealed by the "Chemistry Experiment Lab" (JTT 12152), shown here in full view with its Chem-Dial (left). Using the Chem-Dial, the experimenter can obtain step-by-step instructions for performing various projects with the Lab's equipment and safety-tested chemicals. Also featured in this set are a molecular kit for constructing molecular models of elements; "adventures" in electroplating; and information on how to analyze chemicals through the magic of color. This item is one of the many educational toys available through the premium program.



## 'Journey Thru Toyland' Premium Pageant Highlights Wide Selection of Gift Items

Grab your hat and climb aboard Santa's sleigh for an exciting "Journey Thru Toyland." Here, indeed, is your preview of the most intriguing assortment of "holiday" premiums ever offered to service technicians anxious to delight the young in heart.

With your purchases of RCA entertainment-receiving tubes, your partici-

pating RCA distributor can present you with a selection of 17 outstanding gift items from three of the leading names in toy manufacturing. These names—"Gilbert®," "Ideal," "AMF"—are renowned for their reputations of superior product quality. Together, they provide an unsurpassed variety of useful toys designed to bring sheer joy to every youthful recipient.

"Journey Thru Toyland" is your cue to simultaneously enjoy the benefits of

top-quality premiums and top-quality receiving tubes. When you install RCA tubes in your customers' television, radio, and hi-fi sets, you can be sure that you'll save time and money through fewer costly callbacks.

Why not contact your participating RCA distributor *now* to learn all about this fabulous premium offer? He'll gladly explain how your RCA entertainment-receiving tube purchases accumulate valuable points which you

**RADIO AND TELEVISION**

**RCA**

*Service News*

A PUBLICATION OF THE RCA ELECTRON TUBE DIVISION

RCA RADIO & TELEVISION SERVICE NEWS is published in the interest of dealers and service technicians. It is written to assist them in providing better service, and to foster the growth of their business by supplying them with information on the latest troubleshooting and sales promotion techniques, sales and service aids, together with invaluable data on RCA tubes, transistors batteries, sound tape, and test equipment.

FALL 1962

RCA RADIO & TELEVISION SERVICE NEWS is a bi-monthly publication of the RCA Electron Tube Division, Harrison, New Jersey.

© 1962  
Radio Corporation of America

Harvey Slovik  
Editor

William Berce  
Associate Editor

There's real-live racing action in the photo of these two youngsters at the "controls" of their model stock cars. The "Auto-Rama Figure-8 Speedway Race" (JTT 19083)—another in the line of A. C. Gilbert Company products—can provide recreation for the entire family.

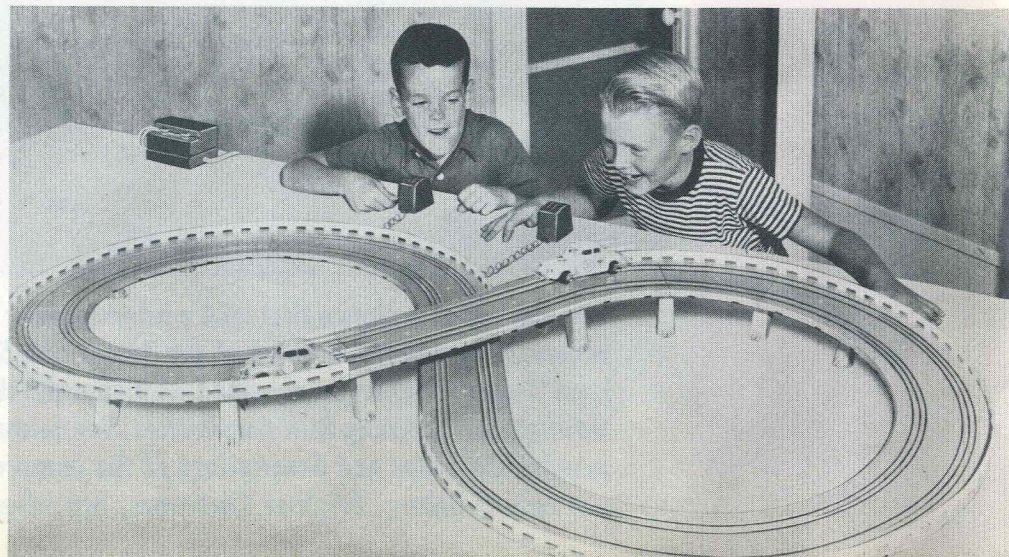

can use to obtain premiums of your choice. They include the following:

- **Auto-Rama Figure-8 Speedway Set (JTT 19083).** Here's an item the entire family will enjoy! There's lots of fun and excitement in watching the two separately-controlled "souped-up stock cars" twist and wind around the figure-8 racecourse. Youngsters will get a great kick out of taking turns at the "controls."

- **American Flyer Sky Streak "7" (JTT 40006).** A ready-to-fly airplane designed to start instantly and soar through the air time after time. The engine of this realistic model plane features removable muffler-silencers and an anti-reverse self starter. An automatic co-pilot helps prevent accidents.

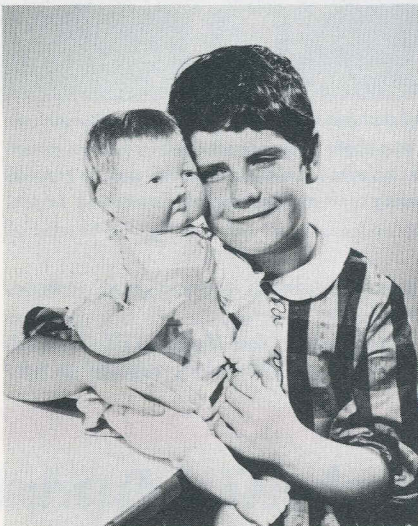

This little "doll with a doll" is quite ecstatic over Thumbelina—a cuddly, lifelike tot that wiggles and cries just like a real baby. One of 17 exciting premiums available in the "Journey Thru Toyland" program, "Crying Thumbelina Doll" (JTT 05157) is a creation of Ideal Toy Corporation.

- **Duesenberg Motorized Roadster Kit (JTT 36384).** Now youngsters can build an 18-inch scale model of this famous sports car that's virtually complete in every detail. Cam-A-Matic action, heavy-duty motor starts, stops, reverses, and steers this battery-operated roadster in any pre-programmed pattern.

- **Jumbo Gasoline Truck (JTT 41277).** This miniature truck features an unbreakable polyethylene body mounted on steel axles having polyethylene wheels. A removable front cap permits the tank to be filled with water. This water can then be drained out through a valve-controlled rubber hose.

- **Rocket Launcher Erector® Set (JTT 10202).** "Future engineers" will enjoy using the large assortment of parts and the electric motor to build

(Continued on next page)

## Four Advanced RCA Test Instruments Cover Wide Range of Servicing Needs

Ever alert to needs of the technician faced with the growing complexity of servicing today's radio, TV, and hi-fi equipment, RCA puts high priority on designing versatile, practical instruments that you can immediately translate into customer satisfaction and service-dollars. Four recent examples are RCA's WV-98C Senior VoltOhmyst®, improved WO-91A Five-Inch Oscilloscope, WG-307B(K) TV Bias Supply Kit, and WV-76A High-Sensitivity AC Vacuum-Tube Voltmeter.

By utilizing the new model WV-98C Senior VoltOhmyst, service technicians have the added flexibility with the inclusion of a high-sensitivity dc range of one-half volt full scale. This additional dc range is particularly valuable for accurate measurement of low voltages used in transistor circuits.

The WV-98C permits direct reading of peak-to-peak voltages of complex wave forms found in video, sync, and deflection circuits; rms values of sine waves; dc voltages; and resistance. It provides accuracy of  $\pm 3\%$  full-scale on both ac and dc measurements with less than 1% tracking error. Separate, color-coded peak-to-peak and rms-voltage scales in two distinctive colors simplify readings of the easily scanned 6½-inch meter face. A ground lead, permanently attached to the WV-98C, permits good ground contact to the circuit under test. The meter is electronically protected against burn-out.

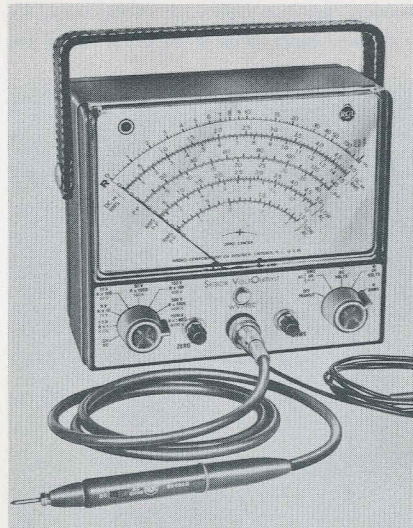

The new WV-98C Senior VoltOhmyst enables service technicians to have increased instrument flexibility with the inclusion of a high-sensitivity dc range of one-half volt full scale which is especially valuable for accurate measurement of low voltages used in transistor circuits.

Housed in a die-cast aluminum case equipped with a leather carrying handle, the WV-98C is available either in wired or kit form. As a complete, factory-wired and calibrated instrument, this latest addition to RCA's expanding line of precision test equipment is offered at an Optional User price of \$79.50—the same price as its predecessor model, the WV-98B.

In kit form—designated WV-98C(K)—this instrument is available at the attractive Optional User price of only \$57.95.

Both wired and kit versions include the pre-assembled and factory-tested WG-299D probe and cable, as well as a booklet of complete instructions.

RCA's improved WO-91A Five-Inch Oscilloscope features a new built-in, two-stage sync separator that simplifies the checking of TV horizontal and vertical sweep synchronization circuits. This new sync separator, which is incorporated in the preset TV "H" and "V" positions, provides exceptionally solid lock-in action on composite TV signals.

The WO-91A provides users with all the 'scope functions needed to troubleshoot TV receivers, and is equally useful for chrominance circuits, where it can be used to observe and measure color-burst signals. It is also useful for signal-tracing and aligning wide-band video amplifiers. The multi-scale, 5-

(Continued on page 8)

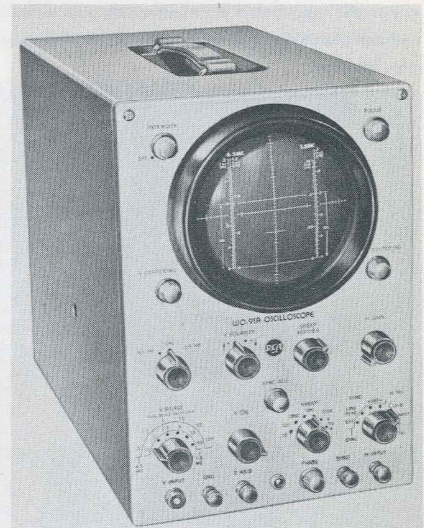

RCA's improved WO-91A Five-Inch Oscilloscope features a new built-in, two-stage sync separator that simplifies the checking of TV horizontal and vertical sweep synchronization circuits and provides exceptionally solid lock-in action on composite TV signals.

## 'Journey Thru Toyland'

(Continued from preceding page)

and rebuild hundreds of fascinating all-steel structures. First, of course, is the rocket launcher that automatically rises and fires a rocket while a radar antenna rotates.

• **Engineer's Erector® Set (JTT 10172).** Here's another highly fascinating and educational construction set with which mechanically-minded youngsters can build bridges, docks, cranes, a mobile robot scanner, and a rocket gantry. The set comes equipped with all-steel girders, wheels, plates, and other necessary parts.

• **Metal-Electric Zoom Microscope and Lab (JTT 13099).** A beautifully-made instrument that "zooms" in and out for wide focus range. This microscope provides enlargements of 72, 250, and 500 times. It can be rotated through 180 degrees to view both large and small objects, and is provided with electric plug-in lighting for better viewing. The microscope comes equipped with lab equipment and specimens.

• **Chemistry Experiment Lab (JTT 12152).** Here's a large steel-cabinet laboratory that's crammed with all the necessary equipment and safety-tested chemicals to perform hundreds of fas-

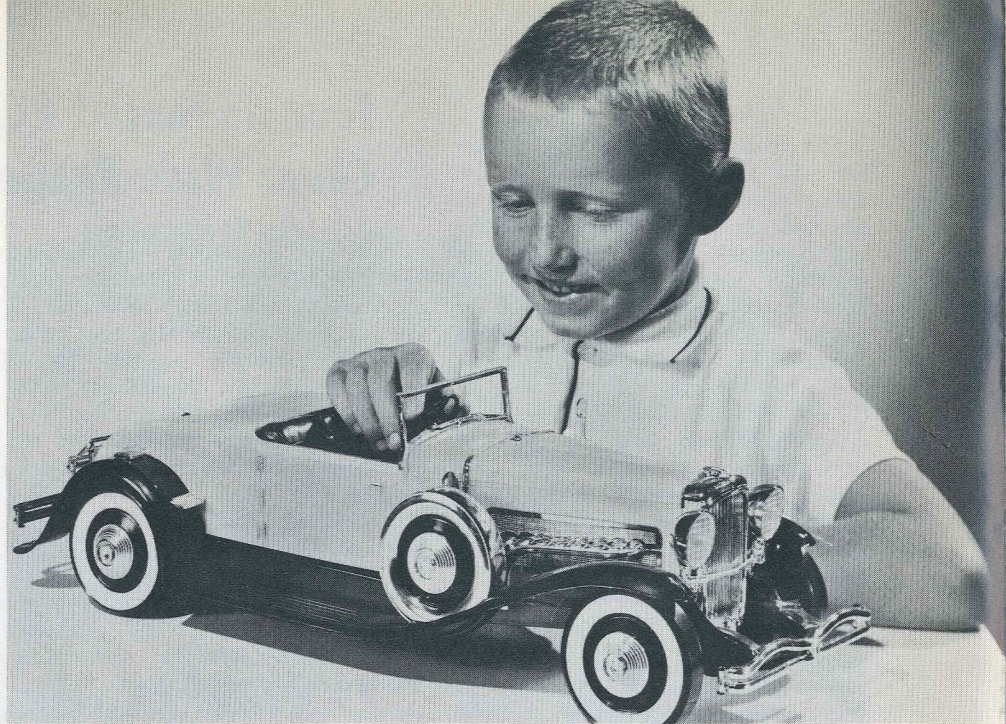

This young sports-car enthusiast is admiring the detail that has been designed into the "Duesenberg Motorized Roadster Kit" (JTT 36384)—shown here assembled as a complete 18-inch scale model. This easily-assembled kit by Ideal Toy Corporation includes Cam-A-Matic action and heavy-duty motor—battery-operated for starting, stopping reversing, and steering the auto according to pre-programmed patterns.

inating experiments and projects. Among the many features of this "lab" is the new Chem-Dial, a device that lets the young chemist *dial* his experi-

ment to obtain step-by-step instructions.

• **Smokey the Bear (JTT 78667).** This famed symbol of forest-fire pre-

**INTERESTED IN ELECTRONICS TEACHING AIDS?** Here, John R. Meagher, nationally known RCA authority on radio and television servicing, holds RCA's new WE-95A(K) Volt-Ohm-Milliammeter "Dynamic Demonstrator"—available in kit form at an Optional User price of only \$37.95. Especially designed for science and technical classes at the secondary school level, this dramatic training device is essentially a professional-type V-O-M which has been converted into an easy-to-assemble demonstrator for classroom instruction in the fundamentals of electronic measuring circuits. Once assembled, it becomes an actual test instrument that permits students to convert classroom theory and instruction into everyday applications. All necessary components, including a sensitive but ruggedly constructed microammeter and precision resistors, are furnished with the kit. Assembly instructions and a specially-prepared booklet giving a detailed explanation of the circuit theory are also included.

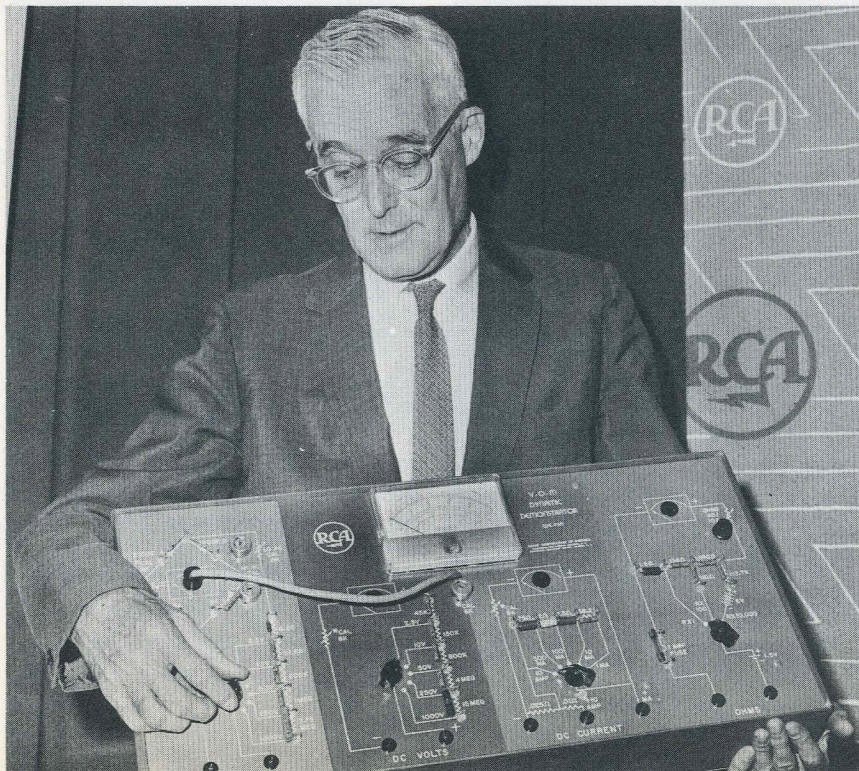

## Display-Card Assortments of

If you haven't discussed the SK-1 and SK-2 product kits with your RCA semiconductor distributor, it should prove advantageous for you to do so at your earliest opportunity.

These two convenient display-card assortments of fast-moving transistors and silicon rectifiers cover major replacement needs in equipment-servicing. Each transistor and rectifier is individually mounted and blister-packed on an attractive display card that can be placed on a wall or rack within arm's reach of your work bench.

The SK-1 "All-American 8" transistor package features eight types as an assortment of 12 transistors consisting of one each of types 2N405, 2N406, 2N411, and 2N412; two each of types 2N407, 2N408, 2N409, and 2N410. The quantities per type are based on typical transistor complements.

You can rely on these RCA transistors to meet direct-replacement requirements in over 80 makes and 450 models of portable and table radio receivers, as well as tape recorders and other portable instruments. The transistors in the "All-American 8" kit are



Her first gaze into a new and fascinating world of tiny life brings a smile of delight to the face of this youngster. She typifies the many thousands of children who will reap educational benefits from the A. C. Gilbert Company items to be found in the "Journey Thru Toyland" program. The "Metal-Electric Zoom Microscope and Lab Set" (JTT 13099) can enlarge slide specimens up to 500 times and be rotated through 180 degrees to accommodate viewing of large and small specimens.

vention needs no introduction. Cocoa-colored and 14 inches tall, "Smooky" comes with a membership application for the "Smooky Junior Forest Rangers"

(authorized by U.S. Forest Service through an Act of Congress).

- Zipper Frog (JTT 71050). A lov-

(Continued on next page)

The popular transistor types in RCA's "All-American 8" SK-1 product pack cover approximately 2,000 "sockets" in a wide range of electronic equipment which includes over 80 makes and 450 models of portable and table radio receivers.

Replace with  
**8 ALL AMERICAN 8 TRANSISTORS**  
 The same RCA transistors used in original equipment

portable radio receivers • tape recorders • table radio receivers • portable equipment  
**Free RCA transistor replacement guide**

## Fast-Moving RCA Transistors and Silicon Rectifiers

the very same original-equipment types that RCA supplies to U.S. radio manufacturers for factory use. This kit, therefore, will help you make your replacements without circuit changes and time-consuming guesswork.

Now available at an Optional List price of \$10.30, this handy transistor package can work for you as a "silent technician" in routine servicing operations.

And while you're talking over the SK-1 kit with your RCA semiconductor distributor, have him also show you the SK-2 display-card assortment of four RCA top-quality silicon rectifiers. Intended for replacement use in TV receivers, radios, hi-fi equipment, intercoms, CB radios, and test instruments, this assortment consists of three 1N3253's, four 1N3254's, four 1N3255's, and one 1N3256.

The design of these four silicon rectifiers permits quick, easy installation. Specially insulated, flangeless metal cases have glass-to-metal hermetic seals. Each rectifier is individually mounted on a small card which can be easily removed from the central dis-

play. The back of each card lists the four rectifiers and the 26 industry types they replace. Optional List price of the 12-silicon rectifier assortment is \$16.75.

Together, the SK-1 and SK-2 product packs can prove to be indispensable work aids in providing your customers with speedy, efficient service.

**RCA SILICON RECTIFIERS**  
 with insulated cases

REPLACEMENTS FOR EPOXY-RESIN TYPES, FLANGED METAL-CASE & CERAMIC TYPES  
 PRV RATINGS 200 TO 800 VOLTS

low cost • Mylar sleeves

light weight • hermetically sealed

small size • axial leads

flangeless metal case • diffused junction

non-combustible • self-supporting

SEE REPLACEMENT LIST ON REVERSE SIDE OF EACH RILSTER CARD

The SK-2 product pack features four top-quality silicon rectifiers that replace 26 industry types. Lightweight and non-combustible, these rectifiers have a PRV of 200-800 volts and provide outstanding performance at dc currents up to 750 ma.



Proudly wearing his new "Astronaut Helmet" (JTT 42028), this aspiring spaceman has just reported, "Everything Green and Go," through his microphone mouthpiece. The helmet is manufactured by Ideal Toy Corporation and is an authentic replica of the headgear worn by U.S. astronauts. It includes a movable bar for clamping the transparent-plastic face shield into place.

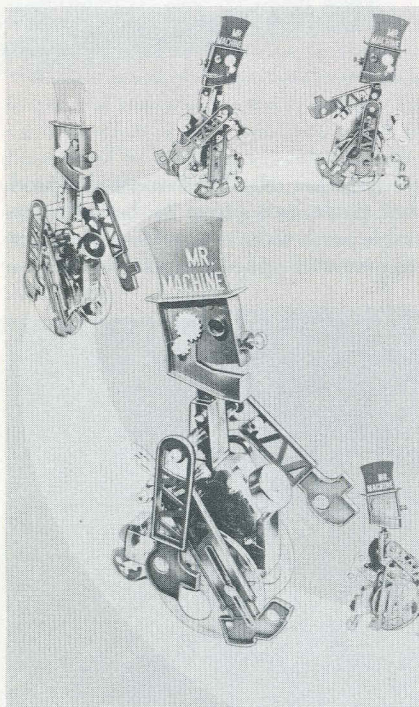

Here's "Mr. Machine" (JTT 48447), Ideal Toy Corporation's famous "robot with a personality." Wind him up, press a lever, and "Mr. Machine" walks along swinging his arms and ringing his bell. As he walks, his mouth opens and closes, and every 15 seconds, a siren sounds. What's more, he can be easily taken apart and put together again.

## 'Journey Thru Toyland'

(Continued from preceding page)

able, laughable, stuffed toy frog measuring 19 inches long. Its "mouth" is a satin-lined zippered compartment that can hold pajamas, handkerchiefs, and other personal articles.

• **Crying Thumbelina Doll** (JTT 05157). A cuddly, 20-inch-tall lifelike

doll that can be wound up to wiggle and cry. Pick her up and the crying stops—just like a real baby.

• **Counting School House** (JTT 30973). This play schoolhouse helps youngsters learn addition and subtraction. There are five numbered sections making up the structure, and as each one is added, the total registers visually in a side window beneath the school bell. As pieces are removed, the total is subtracted. A valuable educational

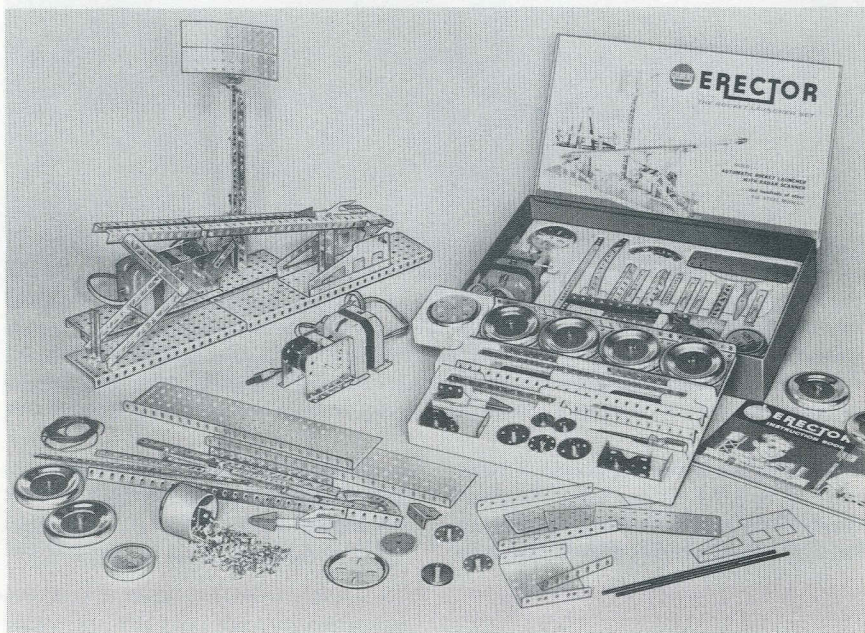

Here are two Gilbert Erector sets that will thrill the heart of any mechanically-minded youngster. The "Rocket Launcher Erector Set" (JTT 10202) shown above comes complete with an electric motor and features a rocket launcher that rises and fires a rocket while a radar antenna rotates. Pictured below is the "Engineer's Erector Set" (JTT 10172) which comes equipped with all-steel girders, wheels, plates, and other necessary parts for constructing everything from a bridge to a mobile robot scanner.

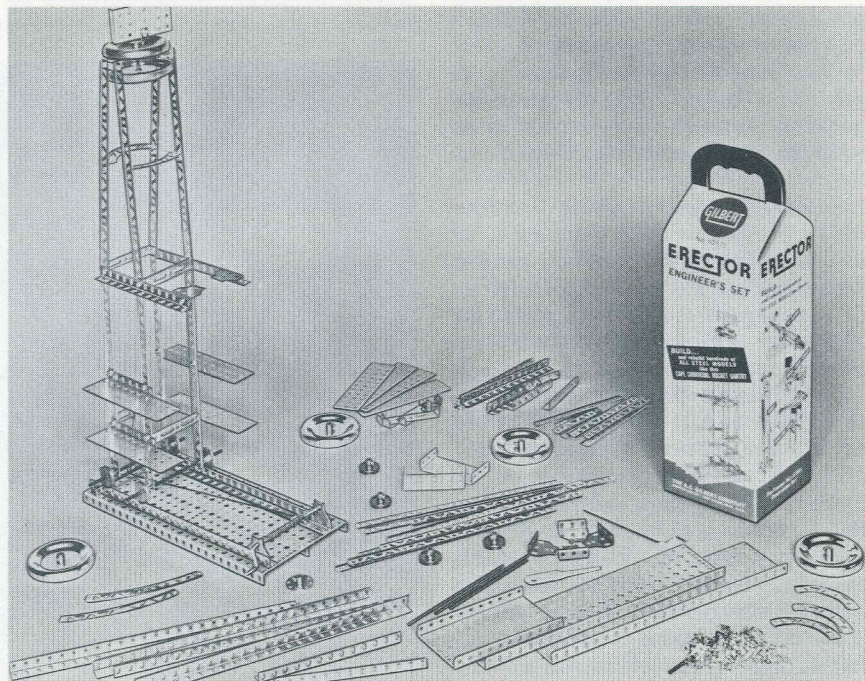

toy approved by editors of the Book OF KNOWLEDGE.

• **Mr. Machine (JTT 48447).** Introducing the famed take-apart "robot with a personality." You wind him up, press a lever, and Mr. Machine swings his arms and opens and closes his mouth while he walks. While he's doing this, a bell rings and a siren sounds every 15 seconds. And, what's more, he can be easily taken apart and put back together again.

• **Dinnerware Set Designed by Russel Wright (JTT 46375).** A complete service for three children. Set includes cups, saucers, plates, knives, forks, spoons, and also a creamer, sugar bowl, gravy boat, and stand.

• **Astronaut Helmet (JTT 42028).** Kids will go wild over this authentic replica of the official U.S. astronaut helmet. It has a lift-up, transparent-plastic face shield, microphone mouth-piece with voice-vibrator, and a movable bar for clamping shield into place. Bearing the proud title, "astronaut," this helmet adjusts to all sizes.

• **Roadmaster 26-Inch Boy's Bicycle (JTT 1675).** No toy collection can be complete without the "world of wheels." Here's a standout vehicle called the "Saturn." It features chrome fenders, a distinctive swept-back tank, and a handsomely streamlined chain guard. The boy's model is glistening jet black with flamboyant red-and-white trim. A proud addition to the belongings of any young "traveling man."

• **Roadmaster 26-Inch Girl's Bicycle (JTT 1685).** The same "Saturn" model bicycle has been attractively designed and colored to meet the tastes of the Junior Miss. Girl's model is turquoise and white.

Use the "Journey Thru Toyland" premium program to obtain the items you value for important gift-giving occasions. You'll find your participating RCA distributor willing to assist you in every way that he can.

Gilbert's "American Flyer Sky Streak 7" (JTT 40006) is a ready-to-fly airplane with an automatic co-pilot to help prevent accidents. Its engine features removable muffler-silencers and anti-reverse self starter.

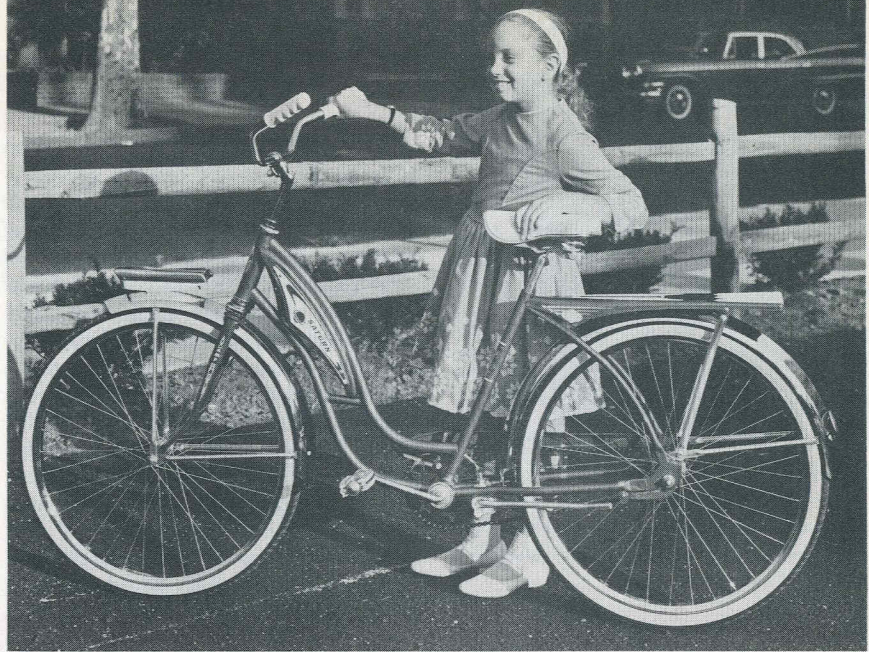

Here's a happy young damsel who's all set to go places with her "Saturn" 26-inch Roadmaster bicycle, a product of "AMF" (American Machine & Foundry Company). Both the boy's and girl's models of the "Saturn" are available through RCA's new premium program. The boy's model (JTT 1675) is glistening jet black with flamboyant red-and-white trim. The girl's model (JTT 1685) is gleaming turquoise and white.



Smokey the Bear (JTT 78667)



Zipper Frog (JTT 71050)

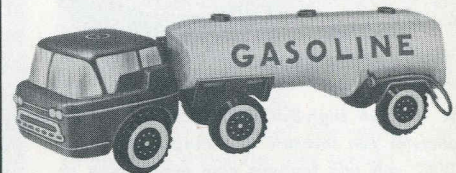

Jumbo Gasoline Truck (JTT 41277)

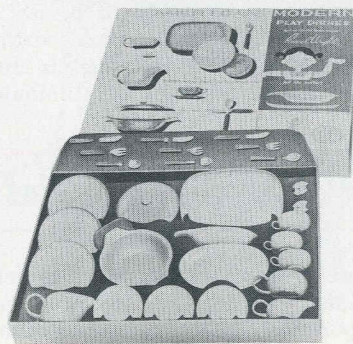

Dinnerware Set Designed By Russel Wright (JTT 46375)

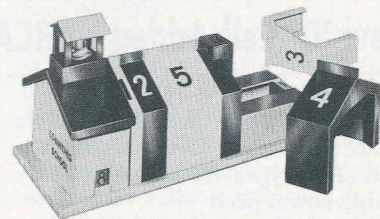

Counting School House (JTT 30973)

These five creations by Ideal Toy Corporation not only bring a lot of joy to the younger set but serve a wide variety of practical and educational purposes as well. With the "Counting School House," for example, a youngster is on his way to learning addition and subtraction. "Zipper Frog" can be used to store pajamas, handkerchiefs, or other personal articles. By adopting "Smokey the Bear," youngsters learn about forest fire prevention and receive a membership application for the "Smokey Junior Forest Rangers."

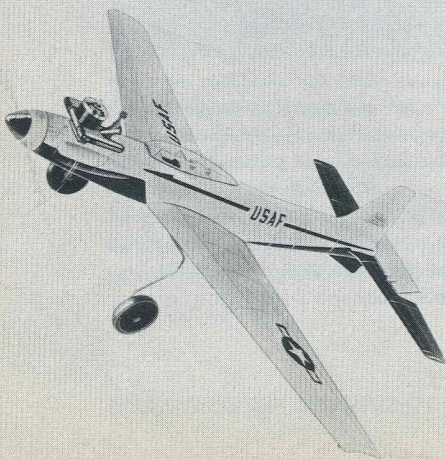

## Four Advanced RCA Test Instruments Now Available

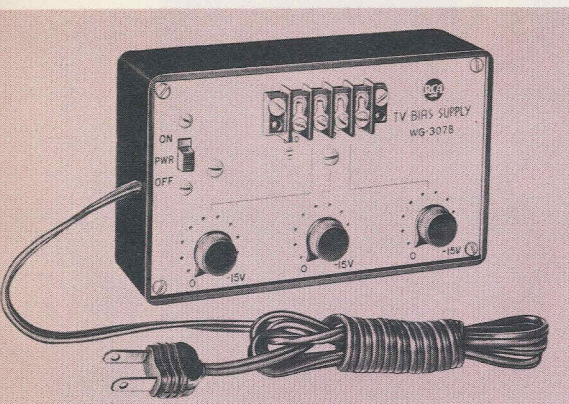

Money-saving kit version of WG-307B TV Bias Supply answers the need of service technicians who require a suitable instrument for the alignment and troubleshooting of both black-and-white and color-TV receivers.

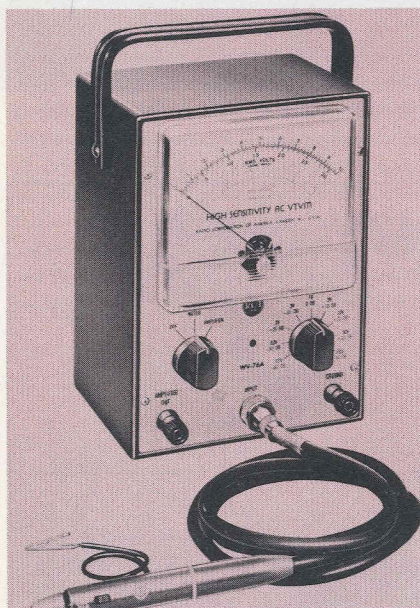

The WV-76A High-Sensitivity AC Vacuum-Tube Voltmeter can measure ac voltages as low as 0.0002 volt and features nine overlapping ac voltage ranges from 10 millivolts full scale to 100 volts full scale.

(Continued from page 3)

inch graph screen is scaled in volts, thus making direct measurement of peak-to-peak voltages as easy with the WO-91A as with a VTVM.

A front-panel switch provides a choice of wide-band or narrow-band (high-sensitivity) operation of the vertical amplifier. Other "plus" features include dual bandwidth (4.5 Mc with 0.053-volt rms/in. sensitivity; 1.5 Mc with 0.018-volt rms/in. sensitivity) and three-to-one voltage-calibrated, frequency-compensated step attenuator for the vertical ("V") amplifier.

Available at an Optional User price of \$249.50, this factory-wired and calibrated instrument includes a special direct/low capacitance shielded probe and cable.

The third of RCA's four recent advancements in electronic test instruments is the TV Bias Supply WG-307B(K)—now available as a money-saving kit at an Optional User price of only \$11.95, complete with detailed instructions, solder, hookup wire, and insulating sleeving.

This easily assembled instrument answers the need of service technicians who require a suitable TV bias supply for the alignment and troubleshooting of both black-and-white and color-TV receivers. It provides three separate output voltages—adjustable from 0 to -15 volts—for application in rf, if, and other circuits of television receivers.

The three output voltages are available from three separate terminals on top of the unit and are individually adjusted through separate potentiometers.

Utilizing a power transformer and operating from a 110-125-volt, 60 cps power source, the WG-307B has a power consumption of less than 5 watts. The brushed-aluminum panel is isolated from all circuits to eliminate

shock and short-circuit hazards.

Enclosed in a rugged, plastic case, the unit measures 6½ inches by 3¾ inches by 2 inches and weighs approximately 22 ounces.

In the new WV-76A High-Sensitivity AC VTVM—fourth of RCA's recent advancements in electronic test instruments—service technicians have a high-quality RCA test instrument for measuring ac voltages as low as 0.0002 volt.

Typical uses include frequency-response tests of preamplifiers, power amplifiers, and tone-control circuits; feedback-circuit design, signal tracing, audio-level and power-level measurements, gain measurements, amplifier

**Dealers Receive Additional Support With**

**Recent Ads, Television Comm**

One of your most direct routes to greater sales is the "image" you create among your customers and the public as a trustworthy and knowledgeable technician.

In recognition of the fact that a good image is your most-valued business asset, RCA and your RCA entertainment-receiving tube distributor have been engaged in a continuing

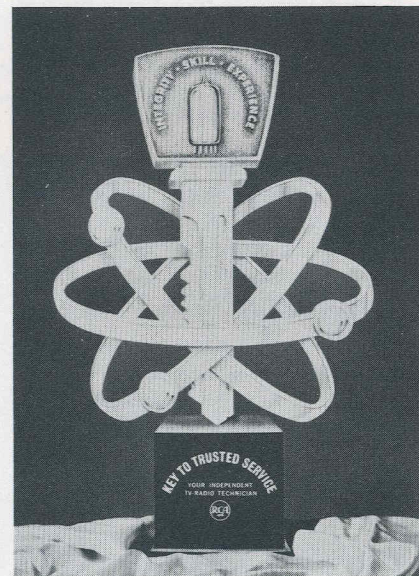

The "Trusted Service Key" (1A1226) represents the very heart and symbol of RCA's dynamic program to focus consumer attention on your technical competence and professional integrity as an Independent TV-Radio-HiFi Technician. Displayed in your store, this statuette will immediately call public attention to the fact that you provide the type of service on which your customers can rely.

## New 'D' Cell Added to RCA Line of Alkaline Batteries

Here's good news for battery dealers anxious to provide customers with a selection of types for virtually every portable-power need.

Your RCA battery distributor now makes available the VS1336 alkaline "D" cell—a 1.5-volt, multi-purpose type which is interchangeable with all standard "D" cells.

The new alkaline cell can handle currents up to one ampere. This makes it especially suitable for use in battery-

powered industrial applications, as well as radios, flashlights, photoflash service, portable shavers, toys, and other electronic equipment. Because it is an alkaline type, the RCA's recently announced VS1336 offers longer storage life and longer service life than the conventional zinc-carbon type.

This latest addition to RCA's line of alkaline batteries joins the VS1334 "AA" penlite cell; the VS1335 "C" cell; the VS1073 "N" cell; and the VS1149 transistor-radio battery.



balancing applications, and general audio voltage measurements.

Principal features of the WV-76A are:

- *Nine overlapping ac voltage ranges* from 10 millivolts full scale to 100 volts full scale. When the WG-300B input probe is set in the "Low-Cap" position, up to 500 volts or +56 db may be measured.

- *Nine decibel ranges* from -40 db to +40 db (zero reference level is 1.0 milliwatt in 600 ohms).

- *High input impedance* of 10 meg-ohms and 13  $\mu\text{f}$  with input probe set in "Low Cap" position, permits measurements in circuits sensitive to loading.

- *Frequency response* is flat from 10 cps to 500 Kc in "Low Cap" position,

and 10 cps to 1.5 Mc in "Direct" position.

- *Shielded probe and cable* eliminates pick-up from stray fields.

Additional stability and linearity in the WV-76A is provided by a feedback loop from the metering circuit. Heavy filtering in the power-supply section keeps hum to an extremely low level.

The WV-76A can also be used as a wide-range audio preamplifier (38 decibel maximum gain on 10-millivolt range) for magnetic phonograph cartridges, oscilloscopes, and other applications.

Available at an Optional User price of only \$79.95, this high-sensitivity AC VTVM comes equipped with a WG-300B direct/low-cap probe and shielded cable.

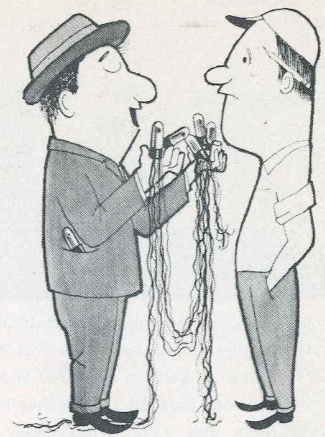

I COULDN'T SEE ANY REASON TO BRING THE WHOLE SET DOWN HERE!!!

With Long-Range 'Key to Trusted Service' Campaign

## Commercial Stress Skill and Integrity of Service Technician



"Trusted Service Window Display" (1A1228)

year-long program to focus consumer attention on your technical competence and professional integrity as an Independent TV-Radio-HiFi Technician.

Initiated early this year as the "Key to Trusted Service" campaign, this program has been constantly at work for you in promoting your specialized skills

and dependability among the people you serve.

To maintain your full support in this extensive program, special ads appeared in the September issue of ELECTRONICS WORLD, the October issue of ELECTRONIC TECHNICIAN, and the October 15th issue of RADIO AND

TELEVISION WEEKLY. And to remind the public of your high quality of service and product, the original "Key" television commercial is again featured on the popular NBC-TV network program, Walt Disney's "Wonderful World of Color." This commercial alerts viewers to look for the "Key to Trusted Service" symbol when seeking the services of a radio, TV, or hi-fi technician.

The "Trusted Service Key" statuette (1A1226) represents the very heart of this dynamic advertising and sales promotion program to increase your sales and prestige. Displayed in your store window or store, this symbol impresses potential customers in need of radio, television, and hi-fi repairs. Fourteen inches high, it highlights the slogan, "Integrity • Skill • Experience," and can remain as a permanent part of your store fixtures and a constant reminder of your dependability.

If you haven't had the opportunity to see the statuette and would like to display one or more in your business establishment, contact your RCA entertainment-receiving tube distributor. He will be glad to assist you in every way possible.

Then, too, you may also want to advertise your part in the program even further with the "Trusted Service Window Display" (1A1228). Imposing and colorful, this large, three-dimensional display dramatizes your greatest business asset—reliable service.

Remember, the "Key to Trusted Service" campaign is a program that has been designed to help you achieve *lasting results*. By using this opportunity to get your message of "Integrity • Skill • Experience" across to your local community, you will have realized another important goal in the climb to higher sales.

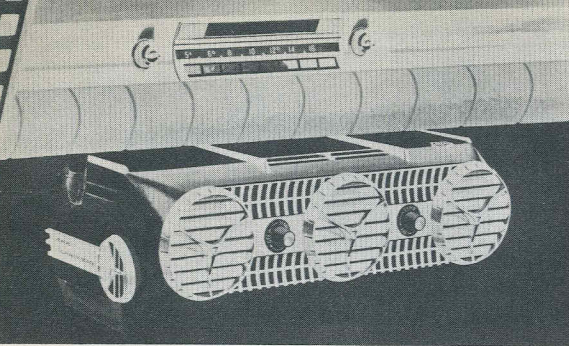

ARA "Chairman" Automobile Air Conditioner (92162) features variable-speed air control, 3400 (Blower) RPM, and air delivery of 285 CFM. Having case dimensions only 16-3/16 inches long, 5 3/4 inches high, and 12 1/4 inches deep, the "Chairman" takes up little room beneath the dash. The cooling panel itself, with its three chrome grilles and touches of gold, adds a grace note to the beauty of any car.



A triumph in performance, the RCA Victor "Tenor" Hi-Fi Stereo Console (3VE07) features a "Floating Action" record changer and "Living Stereo" ceramic pickup. The four-speaker system includes two 8-inch speakers for bass and mid-range and two 3 1/2-inch tweeters. Offered in Autumn Mahogany veneers and selected hardwoods, this console measures 29 1/4 inches high, 32 inches wide, and 16 3/4 inches deep.

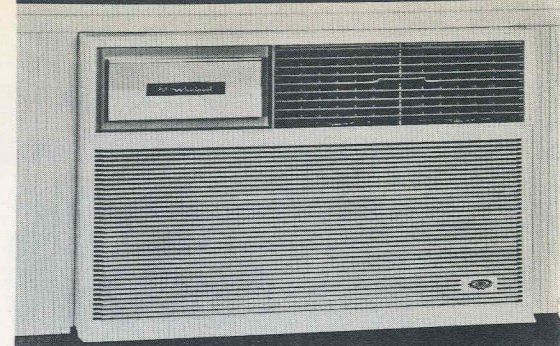

RCA Whirlpool "Custom" Home Air Conditioner (C-100D-20) provides an abundant dry-air cooling power at thrifty operating costs. Featured in this smartly styled air conditioner are a staggered-coil cooling, dehumidifying system; dual air direction control; two fan speeds; and "dry steel" moisture removal—specially designed to do a superior job of handling large amounts of moisture that are removed from air.

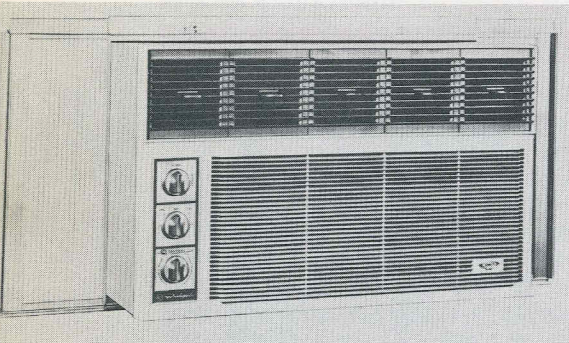

RCA Whirlpool "Metropolitan" Home Air Conditioner (MP-100D-20) has heavy plastic roll-out "Insta-Mount" sections which permit quick adjustment of air conditioner to window width and furnish a secure, permanent mount that's exceptionally weatherproof. Provided with two fan speeds, this handy home device features a room-air-circulation of 250 C.F.M. and can cool an area of 525 square feet.



RCA Victor "Elf" Pockette Transistor Radio (3RH10) operates on a single tiny battery and has six transistors plus two crystal diodes. Attractive IMPAC® case enclosing unit is colored in Champagne White. The "High T" circuit of this miniature entertainer is designed for long transistor and battery life. Tiny, tuneful, and terrific, the "Elf" measures only 4-1/32 inches high, 2 1/2 inches wide, and 1-3/32 inches deep.

# 'RCA Sales Safari'

## Features Outstanding Bonus Items With Purchases of Magnetic Sound Tape

There's no "beating around the bush" for big game when you join up with the RCA magnetic sound tape "Sales Safari." Here's a fabulous premium offer through which you can quickly set sights on a color-television set, a portable TV, a home air conditioner, a hi-fi stereo console, or any of several other highly prized "trophies."

All of these outstanding premiums are immediately available through your participating RCA magnetic sound tape distributor with your purchases of RCA's famed 5-inch and 7-inch *Red Seal* and *Vibrant Series* sound tapes. And to enable you to fully capitalize on the many benefits of this big-game hunt, you are offered the advantage of a long "open season" in which to accumulate purchase credits. This means, of course, that you should contact your participating RCA distributor as soon as possible for all the particulars.

Remember, the higher your sales goals and results—the greater your purchase requirements. And with your purchases of *Red Seal* and *Vibrant Series* tapes come the valuable certificates which are redeemable in various designated quantities for any of the following premiums of your choice:

- RCA Victor "Gaynor" 21-Inch Color-TV Consolette. Model Number 213-G-15-M (21-Inch Tube Overall Diagonal—260 square inches).
- RCA Whirlpool "Custom" Home Air Conditioner. Model Number C-100D-20.

- ARA "Chairman" Automobile Air Conditioner. Model Number 92162.
  - RCA Whirlpool "Metropolitan" Home Air Conditioner. Model Number MP-100D-20.
  - RCA Victor "Eldorado" 19-Inch Portable TV. Model Number 193-A-51-2 (19-Inch Tube Overall Diagonal—172 square inches).
  - RCA Victor "Tenor" Hi-Fi Stereo Console. Model Number 3VE07.
  - RCA Victor "Elf" Pockette Transistor Radio. Model Number 3RH10.
- Now available as "Sales Safari" premiums, these seven high-quality items are the very same products displayed in the windows of leading stores. Here's your big opportunity to give your home some of the "extras" you may have always wanted.

\* \* \*

Supporting your sales of RCA sound tape are the superb quality and reputation of the *Vibrant Series* and *Red Seal* brands.

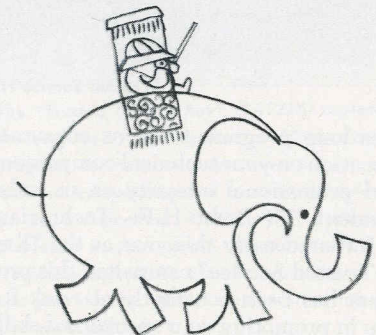

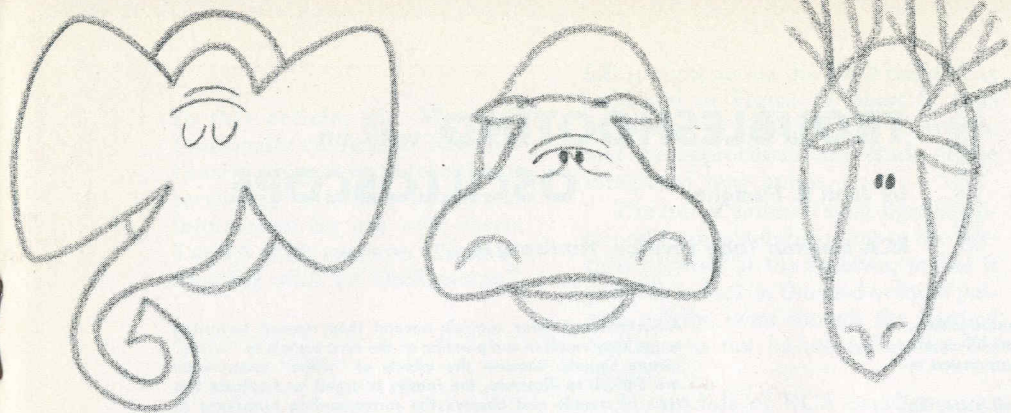

RCA Victor "Gaynor" 21-Inch Color-TV Console (213-G-15-M) is available in Autumn Mahogany, Natural Walnut, or Rift Oak grained finishes and has the performance-proved, built-in dependability that comes from RCA's long experience in designing and manufacturing compatible color instruments. You'll experience enormous pleasure in the "glare-protected" RCA high-fidelity color tube and marvel at the station-pulling power of the "New Vista" tuner. 21-inch tube overall diagonal—260 square inches.

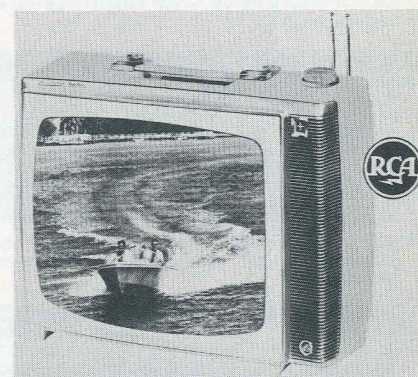

RCA Victor "Eldorado" 19-Inch Portable TV (193-A-51-2) features "V" antenna, power brackets, handy top tuning, and "Golden Throat" sound. Available in two-tone Charcoal-Storm Grey, this handsome portable measures 16 3/4 inches high, 21 inches wide, and 12 1/2 inches deep. 19-inch tube overall diagonal—172 square inches.

a registered duPont trademark for its polyester film.)

Carrying the famous RCA brand name—the name that enjoys the highest customer acceptance in electronics—Vibrant represents a sound tape that truly lives up to RCA's worldwide reputation as "The Most Trusted Name in Sound."

In offering RCA Red Seal sound tape to your customers, you are providing them with a product that adds professional dimension to their home tape recordings. *The very same tape used for RCA Victor master recordings, the Red Seal line represents years of research in magnetic materials and recording techniques.* RCA Red Seal tape—"The Tape of the Music Makers"—is used extensively in the duplicating and recording industry for mastering and for pre-recorded tapes.

In manufacturing RCA magnetic tape, every production run must meet rigid specifications for recording and playback frequency response, distortion, dropout, print-through, and noise.

Each run must also meet tight mechanical specifications for coating thickness, uniformity, anchorage, layer-to-layer adhesion, aging, cupping, and slitting accuracy. Special RCA techniques assure micro-precise control of particle size, dispersion, and consistency of slurry suspension.

Your customers owe it to themselves to try a reel and hear the difference.



Attention-getting counter displays offered to promote your sales of RCA sound tape.

The popular-priced RCA Vibrant Series sound tape now comes with its own attention-getting counter display to stimulate impulse sales. Having virtually *everything* your customers want, this "top-quality-for-less-money" line is offered in popular lengths ranging from 600 to 2400 feet, and in Acetate (plastic), "Mylar," and super-strong Tensitized "Mylar" bases. ("Mylar" is



Here are the RCA magnetic sound tape "Sales Safari" certificates which are redeemable for the premiums of your choice. These certificates are valid only in the U.S.A. and may not be redeemed after midnight of March 31, 1963. (Void where prohibited, taxed or restricted. Cash redemption value: 1/20¢.)

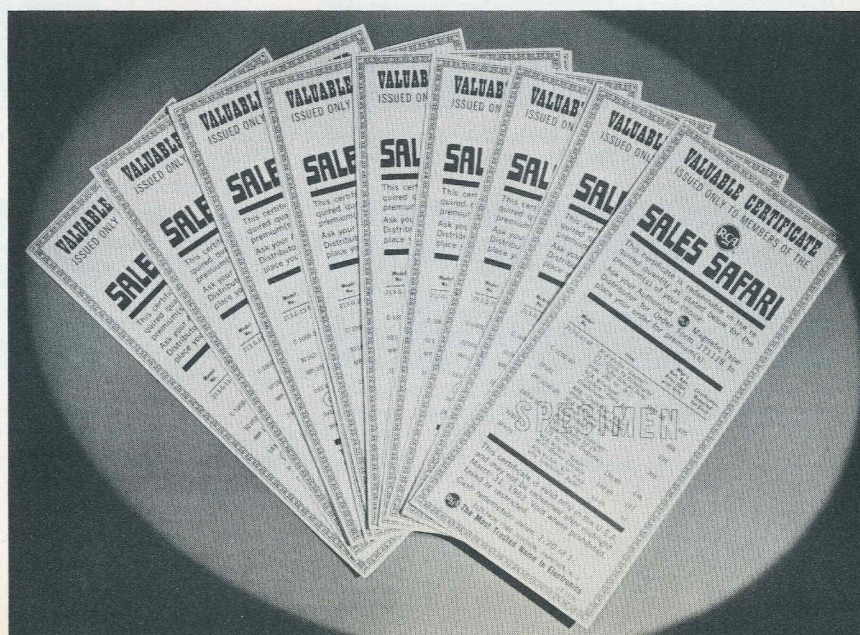

# CHART No.9 COMPRESSION IN VIDEO AMPLIFIER

# TROUBLESHOOTING with an OSCILLOSCOPE

by John R. Meagher

RCA Electron Tube Division, Harrison, N. J.

Sync Compression can occur in the rf-, if-, or video-amplifiers. Examples of sync compression in the rf and if amplifiers are given in charts No. 2 and 3. Examples of sync compression in the video amplifier are given below in 9E and 9J.

If sync compression occurs ahead of the sync take-off point, the sync action is likely to be unstable.

Compression of "white" picture signals can occur in the video amplifier, as shown below in 9B, C, G, and H. "White" compression does not occur in rf and if amplifiers.

In some direct-coupled video amplifiers, adjustment of the brightness and/or contrast controls changes the bias on the video output tube.

Adjustment of these controls beyond their normal operating range may result in compression of the sync signals or "white" picture signals. Because the effects of "white" compression are difficult to illustrate, the reader is urged to duplicate this type of trouble and observe the corresponding symptoms in the TV picture.

When checking composite TV signals at the output of a video amplifier, remember that if internally-generated vertical or horizontal blanking pulses are applied to the output tube, they will affect the normal waveforms and relative amplitudes of the TV sync and blanking signals in the output circuit.

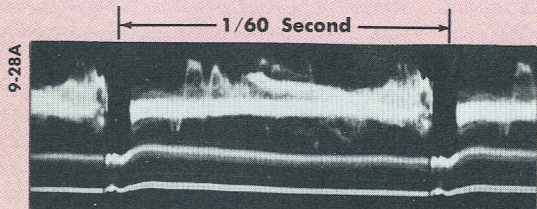

9A. Waveform of a normal TV signal. Note that the tips of the white-going signals, which extend upwards, are not clipped or flattened out.

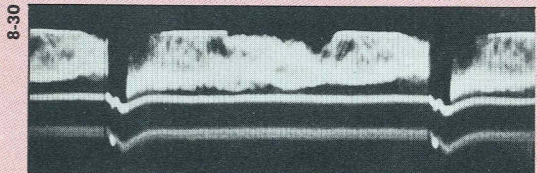

9B. The white-going signals in this example are flattened off, indicating "white" compression, due to incorrect bias on a video-amplifier tube.

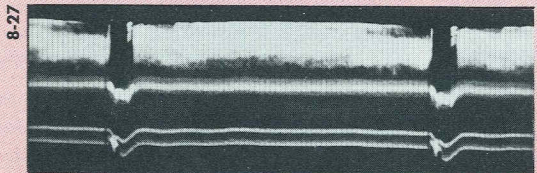

9C. Any appreciable amount of "white" compression reduces the amplitude of the picture signals with respect to the total signal, as shown here.

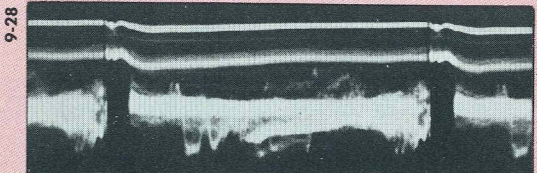

9D. Same as 9A, but opposite polarity. (The white-going signals extend downwards in this pattern, and in 9E, 9I, and 9J.)

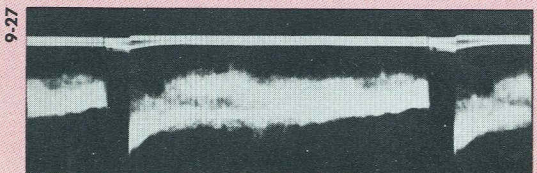

9E. Example of sync compression due to incorrect bias voltage on a video amplifier tube. Compare with normal waveform in 9D.

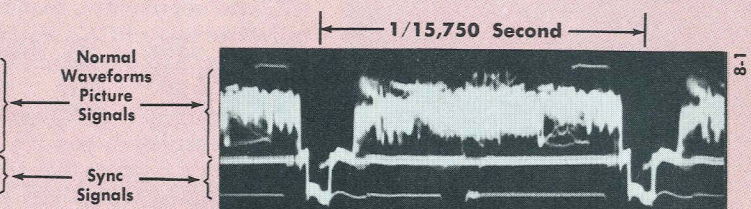

9F. Similar to 9A. Note that the white-going signals are not flattened or compressed.

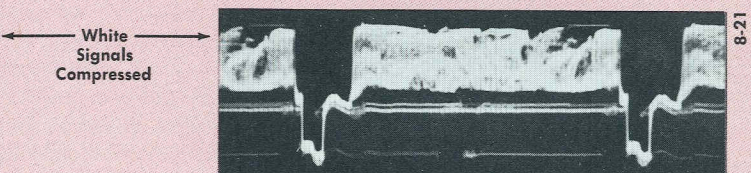

9G. Similar to 9B. The "white" compression in this case also was caused by incorrect bias voltage on a video amplifier tube.

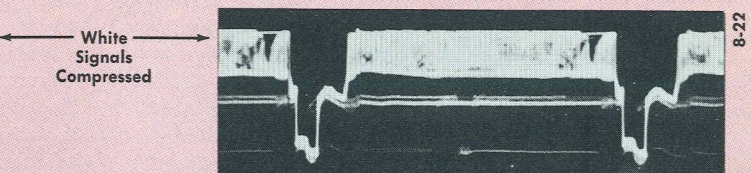

9H. Similar to 9C. Because of "white" compression, the relative amplitude of the picture signals is much less than it should be.

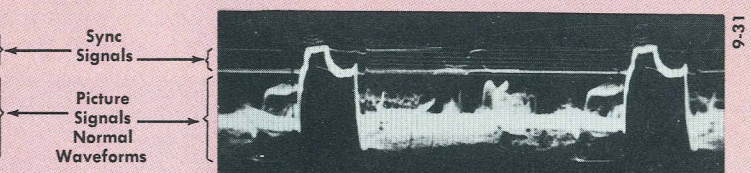

9I. Similar to 9D. The relative amplitude of the sync signals here and in 9D is normal, or approximately 25% of the total amplitude.

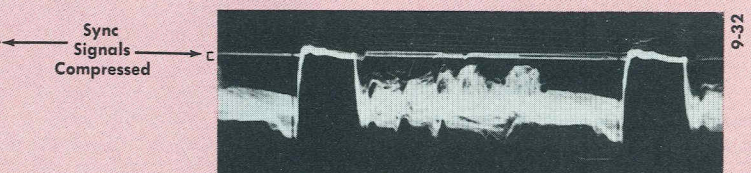

9J. Similar to 9E. In both cases the sync amplitude is reduced almost to zero. Additional compression would compress the black signals, as in 2E and 2K.

In this article, Mr. Meagher (nationally recognized RCA authority on practical television servicing) provides additional information for use with charts 7 and 8 of his series on "Troubleshooting with an Oscilloscope."

### Checking the Integrated Vertical-Sync Pulses

In all cases of incorrect vertical-sync action, it is advisable to make the usual preliminary checks, including tube substitution, and then check the waveform and amplitude of the integrated vertical-sync pulses at the grid of the vertical oscillator tube, as shown in chart 7.

The integrated vertical-sync pulses are the final output signals of the entire vertical-sync system. If these pulses are found to be normal, it may be assumed that the vertical-sync signals are being handled satisfactorily in the rf-, if-, and video-amplifier stages, in the sync-separator network, and in the integrating network. If the pulses are found to be abnormal, it may be assumed that there is trouble in at least one of these networks or in an associated circuit, such as the AGC circuit. In most cases, the trouble can be localized by using an oscilloscope to check waveforms and amplitudes at different points in these circuits, as shown in the waveform charts. Charts 4, 5, and 6, for example, show normal and abnormal waveforms in the sync-separator network of a typical TV receiver.

The service notes for most TV receivers show the normal grid-voltage waveform of the vertical oscillator, but *most service notes do not show the waveform and amplitude of integrated vertical-sync pulses.*

The normal grid-voltage waveform of the vertical oscillator in a typical receiver is shown in Figure A, chart 7. As pointed out in the caption for this illustration, the integrated vertical-sync pulses are "hidden" in the grid-voltage waveform, but the integrated pulses may easily be brought into view as follows:

(1) Use external signals, from the vertical-output tube circuit in the TV receiver, to sync the oscilloscope, as explained later.

(2) Adjust the vertical hold control in the TV receiver to make the TV picture roll slowly downward out of vertical sync. The integrated vertical-sync pulses will then move away from their locked-in position in the grid-voltage waveform and will move slowly from

left to right across the CRO pattern, as indicated in Figure C, chart 7, thus enabling you to check the waveform and the approximate amplitude of the integrated sync pulses.

The use of external sync signals, obtained from a suitable point in the vertical network of the receiver, makes it possible to lock-in the grid-voltage pattern solidly, even though the vertical oscillator is not locked in on the TV signals.

All models of RCA oscilloscopes have provision for using external-sync signals. To use external sync for this particular application, set the sync-selector switch to the "external-sync" position, and connect a lead from the external-sync binding post (on the front panel of the oscilloscope) to the cathode of the vertical-output tube. Most TV receivers have a resistor and a bypass capacitor in the cathode circuit of the vertical-output tube. In such receivers, the waveform and amplitude of the cathode voltage are usually suitable for use as external-sync voltage for all vertical-rate applications of the oscilloscope.

While checking the waveform and amplitude of the integrated vertical-sync pulses at the grid of the vertical oscillator, also check for the presence of unwanted picture-signal components and horizontal-frequency components which may produce effects similar to the examples shown in Figures E and H of chart 7.

### Checking the Differentiated Horizontal-Sync Pulses

The method of bringing the differentiated horizontal-sync pulses into view in the waveform at the input to the horizontal AFC circuit is similar to the method described above, but it is essential to apply correct values of fixed bias voltage to the rf and if amplifiers and to use a suitable source of horizontal-frequency voltage to sync the oscilloscope.

Because the actual procedure for the horizontal sync is slightly different, this procedure is given in detail as follows:

In all cases of incorrect horizontal-sync action, it is advisable to make the usual preliminary checks, including tube substitution, and then to check the waveform and amplitude of the differentiated horizontal-sync pulses at the input of the horizontal AFC circuit. (In receivers using the RCA "synchroguide" circuit, check the waveform at the grid of the horizontal-frequency control tube.)

The differentiated horizontal-sync pulses are the final output signals of

the horizontal-sync system. These pulses are fed into the horizontal AFC circuit. If the pulses are found to be normal, it may be assumed that the horizontal-sync signals are being handled satisfactorily in the rf-, if-, and video-amplifier stages, in the sync-separator network, and in the differentiating network. If the pulses are found to be abnormal, it may be assumed that there is trouble in at least one of these networks or in an associated circuit. In most cases, the trouble can be localized by using an oscilloscope to check waveforms and amplitudes at different points in these sections, as shown in prior waveform charts of this series. Charts 4, 5, and 6, for example, show normal and abnormal waveforms in the sync-separator section of a typical TV receiver.

Some service notes show the normal waveform and amplitude at the input of the horizontal AFC circuit; *but most service notes do not show the waveform and amplitude of the differentiated horizontal-sync pulses.*

The normal grid-voltage waveform in a "synchroguide" horizontal AFC circuit is shown in Figure A, chart 8. As mentioned in the caption for this pattern, the differentiated horizontal-sync pulses are "hidden" in the pattern, but they may be brought into view as follows:

(1) With the receiver tuned to a particular TV station, use a suitable VTVM, such as the RCA *VoltOhmyst*<sup>®</sup>, to measure the exact values of negative bias voltages on the rf and if AGC buses. Apply adjustable bias voltages, from a multiple-type bias box, to the rf and if bias buses. Adjust the potentiometers in the bias box to obtain the same values of rf- and if- bias voltage as in the procedure for vertical sync. (In cases where the AGC action is faulty, correct the trouble, or adjust the external rf and if bias voltages to obtain a satisfactory TV picture, with no evidence of sync compression in the composite TV signal at the input to the sync-separator circuit.)

(2) Use signals from the horizontal-output circuit in the TV receiver to sync the oscilloscope, as explained later.

(3) Slowly adjust the horizontal hold control on the TV receiver to bring the horizontal blanking bar (wide black vertical bar) into view at the left- or right-hand side of the TV screen. The differentiated horizontal-sync pulses will move away from their locked-in position in the oscilloscope pattern, as indicated in Figure D, chart 8. The horizontal oscillator probably will not remain in the "held-out-of-phase" con-

(Continued on next page)

# Troubleshooting

(Continued from preceding page)

dition for more than a few seconds; but during this brief period you can note the waveform and approximate amplitude of the differentiated horizontal-sync pulses.

The use of external signals, obtained from a suitable point in the horizontal output circuit, makes it possible to sync the CRO waveform pattern even though the horizontal oscillator is not locked in on the TV signal.

Set the sync-selector switch on the oscilloscope to the "external-sync" position. Connect a lead to the external-sync binding post on the front panel. Connect the other end of this lead to a suitable point in the horizontal-output-tube circuit. The voltage at the cathode of the horizontal-output tube may provide satisfactory external-sync action. It may be necessary, with some models of oscilloscopes, to use a potentiometer in order to reduce the amplitude of the external-sync voltage. The arm of the potentiometer should be connected to the external-sync binding post on the oscilloscope. (Application of excessive external-sync voltage may cause the pattern to become distorted. This subject will be covered more completely in a later article.)

The reason for applying fixed bias voltages to the rf and if amplifiers during this check may be explained briefly as follows:

Most TV receivers utilize some form of pulsed AGC circuit, the operation of which requires presence of the horizontal-sync pulses at the AGC tube during the horizontal-flyback periods. When the horizontal hold control is adjusted to bring the horizontal blanking bar into view on the TV screen, this requirement is no longer met because the horizontal-sync signals then occur either before or after the flyback pulses. Hence the AGC action becomes partially or wholly inoperative, and it becomes necessary to apply external bias voltages to the rf and if amplifiers.

After checking the waveform and amplitude of the differentiated horizontal-sync pulses, check for the presence of unwanted picture-signal components at the input circuit of the AFC section. Use a low vertical sweep rate, such as 20 cycles. Using this sweep rate, the normal waveform in a "synchroguide" circuit is shown in Figures G and H of chart 8. Examples showing the presence of picture-signal components are shown in Figures I and J of the same chart.

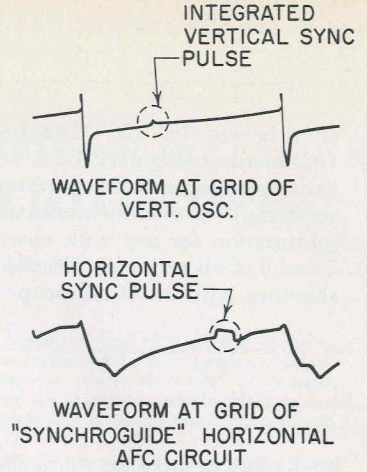
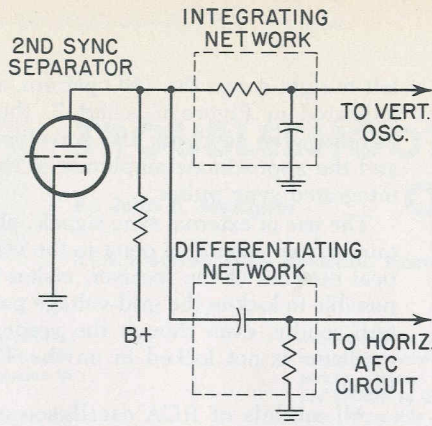

A QUICK OVER-ALL CHECK ON THE OPERATION OF THE SYNC SEPARATOR AND OTHER SECTIONS CAN BE MADE BY CHECKING THE WAVEFORM AND AMPLITUDE OF THE INTEGRATED VERTICAL SYNC PULSES AND THE DIFFERENTIATED HORIZONTAL SYNC PULSES, AS EXPLAINED IN THE ACCOMPANYING ARTICLE.

It would be helpful to all service technicians if TV service notes included waveforms and amplitudes of the integrated vertical-sync pulses and

the differentiated horizontal-sync pulses, such as the examples shown in Figure C of chart 7, and Figure D of chart 8.

Reproduced below is Chart No. 8 of John Meagher's "Troubleshooting with an Oscilloscope" series. It was featured in the April, 1962, issue of RADIO AND TELEVISION SERVICE NEWS. Other charts in the series appeared as follows: No. 1, September, 1959; Nos. 2 and 3, January, 1960; No. 4, February, 1960; No. 5, July, 1960; No. 6, November, 1960; and No. 7, December, 1961.

## CHART No. 8 H SYNC AT HORIZONTAL AFC

## TROUBLESHOOTING with an OSCILLOSCOPE

by John R. Meagher

RCA Electron Tube Division, Harrison, N. J.

Important: Except as noted, all CRO photographs in this chart were taken at the grid of the horizontal AFC tube, with the same vertical gain, with adjustable bias voltage on the rf and if amplifiers, and using "external" sync.

When using a CRO to localize horizontal sync trouble, one of the first steps is to make the following checks at the grid of the AFC tube:

- (1) Check waveform and amplitude as in 8A and 8B.
- (2) Check the shape and relative amplitude of the sync pulses, as in 8D.
- (3) Check for the unwanted presence of picture signals, using a vertical-rate sweep, as in 8I and 8J.

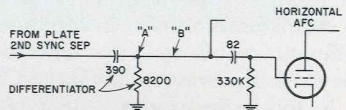

8F. Input portion of horizontal AFC circuit (RCA Synchroguide) used in obtaining the CRO photographs for this chart.

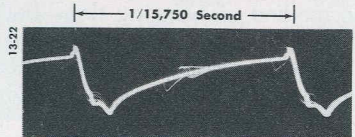

8A. Normal waveform, with receiver synced on a TV signal. The horizontal sync pulses are "hidden" in this pattern.

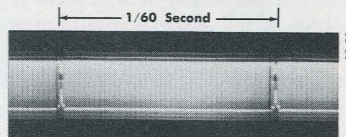

8G. Normal waveform, with receiver synced on a TV signal. The CRO sweep rate here, and in 8H, 8I, and 8J, is 20 cycles.



8B. Normal waveform, without a TV signal. A CRO sweep rate of 5,250 cycles was used for all photographs in this column.

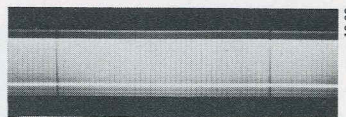

8H. Normal waveform, without a TV signal. (The two thin dark vertical lines in this and other photographs are made by two guide lines on the CRO screen.)

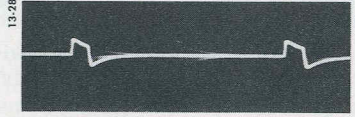

8C. Waveform of horizontal sync pulses at point "A" in 8F. Lead "B" was disconnected and "internal" sync was used for this photograph.

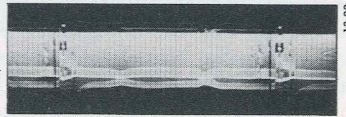

8I. If trouble, such as sync compression, allows picture signals to reach the AFC circuit, the pattern will be distorted, somewhat as shown here and in 8J, and the sync action is likely to be unstable.

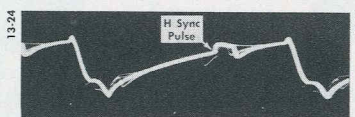

8D. The sync pulses may easily be brought into view, as shown here, by adjusting the hold control so that the horizontal blanking bar appears in the TV picture (as a wide black vertical bar).

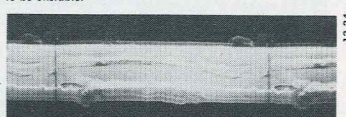

8J. Another example of the condition shown in 8I. The picture signals may produce a vague image in the CRO pattern, as shown below in 8K.



8E. The horizontal sync pulses move through the pattern, as indicated here, when the horizontal oscillator is out of sync.

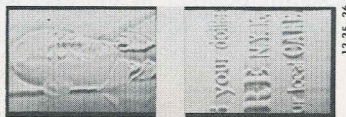

8K. Two examples of images formed in CRO pattern under conditions shown in 8I and 8J. (V gain was increased, H gain was decreased, and a 60-cycle sweep rate was used for these "image" photographs.)

# Four New Publications Now Being Offered by RCA Distributors

Keeping up with the latest product-reference material? The time you save by quickly pinpointing a replacement type, circuit, or application can more than offset the relatively small investment you require for technical literature.

That's why your RCA distributor attempts to keep you advised of all new technical literature on RCA products and day-to-day work assignments, and now offers four outstanding new RCA publications—two manuals and two booklets. They cover RCA transistors, transmitting tubes, receiving tubes, and television picture tubes, respectively.

Here's a review on these four up-to-the-minute reference aids that not only can lighten your daily workload, but also can provide valuable data for any sideline avocations as an amateur radio operator, experimenter, or student of electronics:

## First Comprehensive RCA Manual On Semiconductor Devices

- "RCA Transistor Manual" (SC-10)—the company's first all-inclusive, comprehensive manual on semiconductor devices. It contains detailed technical data for 373 RCA semiconductor devices, including transistors, silicon rectifiers, and tunnel diodes.

The highly informative text section of the 304-page manual covers basic transistor theory, installation, and applications. Separate chapters present similar information for silicon rectifiers and semiconductor diodes.

The Selection Charts classify RCA semiconductor devices by function and performance level. These charts are particularly useful for an initial selection of suitable transistors or rectifiers for a specific application.

For the technician, student, and hobbyist, as well as the design engineer, the Circuits Section of the manual presents more than 30 representative transistor circuits with complete parts lists. They include circuits for a stereo amplifier; an AM/FM radio; automobile, broadcast-band, and short-wave receivers; a Citizens-Band transceiver; a photo-relay; and many other interesting and novel applications.

The "RCA Transistor Manual" bears an Optional List price of \$1.50.

## Revised and Enlarged Edition Of Transmitting Tube Manual

- "RCA Transmitting Tubes" (TT-5)—a newly revised, 320-page transmitting tube manual. It should prove a valuable reference aid for service-dealers and technicians who are en-

gaged in amateur radio activities or are called upon to service various types of mobile-communications equipment.

Coverage of single-sideband information in this latest edition has been considerably increased and includes new single-sideband ratings, discussions of linear power amplifier design, and sample calculations of operating conditions for two-tone modulation.

The popular Circuits Section now contains 23 typical transmitting and industrial circuits, including a circuit for a class B linear rf amplifier for single-sideband service and a circuit for a 144-to-148 Mc mobile transmitter.

In easy-to-understand style, the manual's fully illustrated text material covers power-tube fundamentals, construction, applications, operation and adjustment, and installation, as well as rectifier considerations and interpretations of tube data.

Over 180 types of transmitting tubes and related rectifier tubes are included in the Technical Data Section, which gives maximum ratings, characteristics, typical operating values, and curves.

Optional List price of "RCA Transmitting Tubes" is \$1.00.

## Up-to-Date Versions of Two Popular Reference Booklets

- "RCA Receiving Tubes and Picture Tubes" (1275-K)—an enlarged, 64-page edition of an earlier popular favorite. It features a completely revised RCA receiving-tube classification chart, a new application guide for RCA receiving tubes, and up-to-date characteristics charts for RCA receiving tubes and black-and-white and color-TV picture tubes.

The tube classification chart is arranged to permit quick determination of tubes according to structure and

characteristic. In this chart, types having similar characteristics and the same filament or heater voltage are bracketed.

The tube application guide is arranged so as to furnish a convenient aid for quickly selecting a tube type for a specific application or class of service.

In the revised characteristics charts, you'll find not only characteristics, but operating conditions, base and envelope connection diagrams, tube dimensions, and descriptions for more than 1,050 entertainment-receiving tubes and black-and-white and color-TV picture tubes. The receiving-tube characteristics chart also provides technical data on discontinued RCA types.

Copies of "RCA Receiving Tubes and Picture Tubes" carry an Optional List price of 50¢ each.

- "RCA Interchangeability Directory of Foreign Vs. U.S.A. Receiving-Type Electron Tubes" (ICE-197B)—a new and enlarged edition of the Interchangeability Directory. It has been prepared to assist you in selecting the proper U.S. tube type as a replacement for a foreign tube type.

The eight-page chart covers approximately 800 foreign tube types used principally in entertainment equipment such as AM and FM radios, television receivers, and audio amplifiers. To facilitate your use of the chart, types in RCA's current line of tubes are shown in bold-face type.

This highly useful reference aid bears an Optional List price of only 10¢.

\* \* \*

For copies of RCA's latest reference literature, contact your local RCA distributor or write to Commercial Engineering, RCA Electron Tube Division, Harrison, N. J.

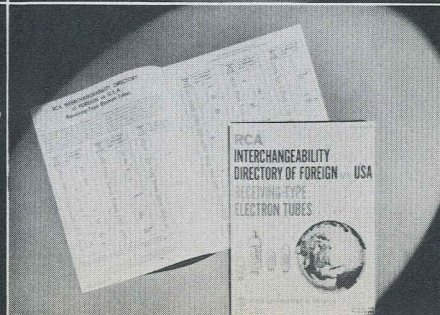
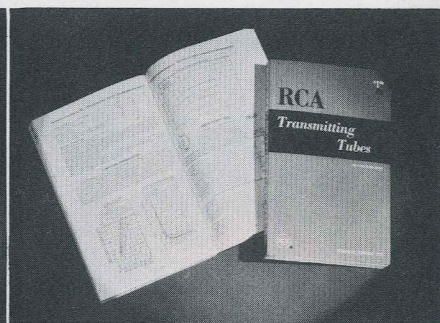
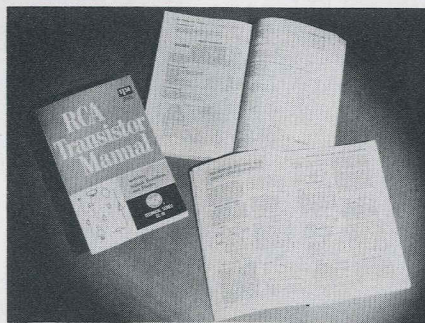

This many picture tubes from one box?

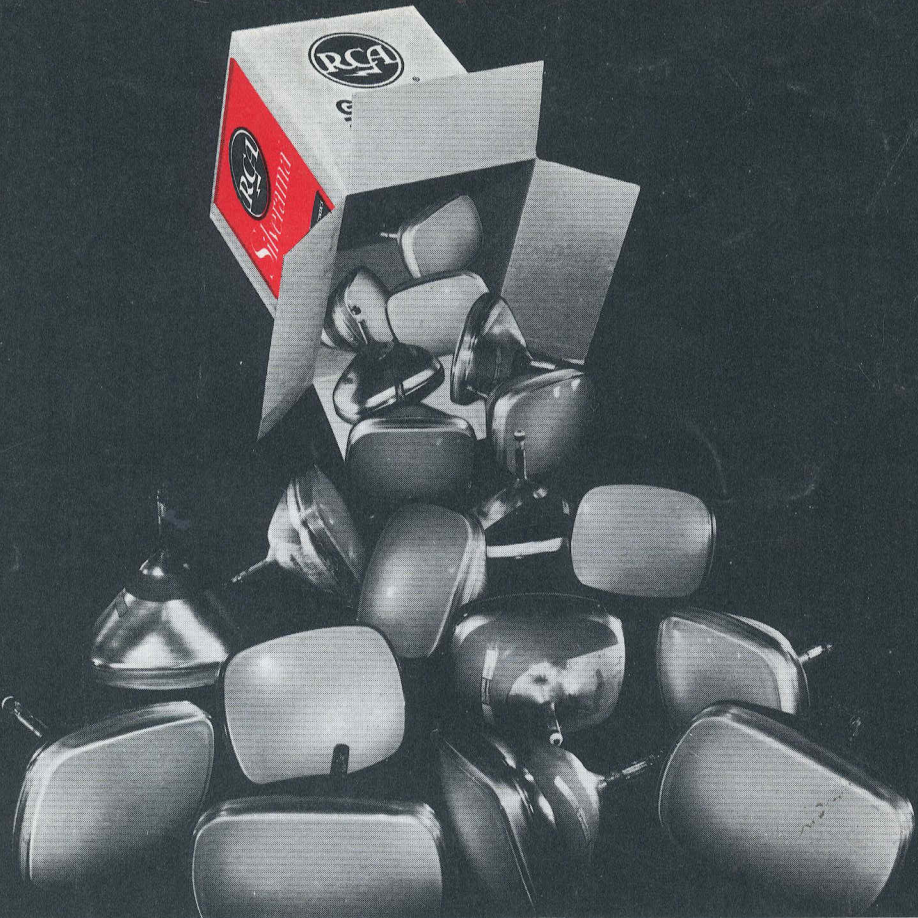

**YES!**

**Because RCA Universal Silverama® Picture Tubes Make Possible Multiple Replacements!**

*78 Universal Silveramas replace virtually every type on the market*

Every time you open an RCA Universal Silverama Picture Tube carton, you get the equivalent of *many replacements*—not just one!

RCA—pioneer of the Universal Picture Tube concept—has today achieved the greatest simplification of picture tube types.

First in the RCA Universal series—the 21CBP4A that replaces 19 industry types...or just about 25% of your replacement needs.

Next in the series, a family of four Universal Picture Tubes (the 21CBP4A, 21AMP4A, 21ZP4B, and 21YP4A) to replace 33 industry types—about half your replacement needs.

Every RCA Universal Silverama Picture Tube is made with an all-new electron gun, the finest parts and materials, and a glass envelope which, prior to reuse, has been thoroughly inspected, cleaned, and rescreened.

Now, 78 Universal Silveramas to replace 291 industry types—covering nearly any picture tube need. This makes for an inventory simple enough that your RCA Distributor can easily keep a full stock. For you this means no more lost time hunting high and low for special, unusual, or infrequently-used types.

The whole story is conveniently set out for you in a handy slide-guide. Simply look up the Universal Silverama type you want and the guide shows you all the standard types it replaces. In addition, look up the industry type you find in your customer's set, and the guide shows you its RCA Universal counterpart. Be sure to get a Silverama slide-guide from your Authorized RCA Silverama Distributor.

RCA ELECTRON TUBE DIVISION, HARRISON, N. J.



The Most Trusted Name in Television



The Most Trusted Name in Electronics  
RADIO CORPORATION OF AMERICA

Compliments of Your  
Local RCA Distributor

Headquarters for:

**RCA**  
Tubes  
Batteries  
Transistors  
Sound Tape  
Test Equipment  
Technical Publications

Information furnished by the Radio Corporation of America is believed to be accurate and reliable. However, no responsibility is assumed by RCA for its use; nor for any infringements of patents or other rights of third parties which may result from its use. No license is granted by implication or otherwise under any patent or patent rights of RCA.

RADIO CORPORATION OF AMERICA  
ELECTRON TUBE DIVISION  
415 S. Fifth Street  
Harrison, New Jersey  
*Return Requested*

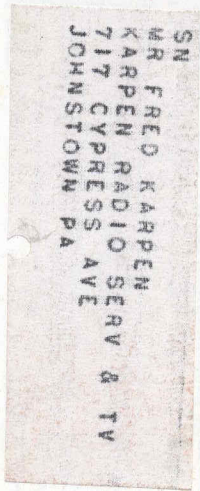

BULK RATE  
U. S. POSTAGE  
**PAID**  
New York, N. Y.  
Permit No. 3150