

RCA REVIEW

a technical journal

RADIO AND ELECTRONICS
RESEARCH • ENGINEERING

VOLUME XIV

JUNE 1953

NO. 2

RADIO CORPORATION OF AMERICA

DAVID SARNOFF, *Chairman of the Board*

FRANK M. FOLSOM, *President*

CHARLES B. JOLLIFFE, *Vice President and Technical Director*

JOHN Q. CANNON, *Secretary*

ERNEST B. GORIN, *Treasurer*

RCA LABORATORIES DIVISION

E. W. ENGSTROM, *Vice President in Charge*

RCA REVIEW

CHAS. C. FOSTER, JR., *Manager*

THOMAS R. ROGERS, *Business Manager*

Copyright, 1953, by RCA Laboratories Division, Radio Corporation of America

PRINTED IN U.S.A.

RCA REVIEW, published quarterly in March, June, September and December by RCA Laboratories Division, Radio Corporation of America, Princeton, New Jersey. Entered as second class matter July 3, 1950 at the Post Office at Princeton, New Jersey, under the act of March 3, 1879. Subscription price in the United States, Canada and Postal Union; one year \$2.00, two years \$3.50, three years \$4.50; in other countries; one year \$2.40, two years \$4.30, three years \$5.70. Single copies in the United States, \$.75; in other countries, \$.85.

RCA REVIEW

a technical journal

RADIO AND ELECTRONICS
RESEARCH • ENGINEERING

Published quarterly by

RCA LABORATORIES DIVISION
RADIO CORPORATION OF AMERICA

in cooperation with

RCA VICTOR DIVISION
RADIOMARINE CORPORATION OF AMERICA
RCA INTERNATIONAL DIVISION

RCA COMMUNICATIONS, INC.
NATIONAL BROADCASTING COMPANY, INC.
RCA INSTITUTES, INC.

VOLUME XIV

JUNE, 1953

NUMBER 2

CONTENTS

	PAGE
Optimum Utilization of the Radio Frequency Channel for Color Television	133
R. D. KELL AND A. C. SCHROEDER	
Principles and Development of Color Television Systems	144
G. H. BROWN AND D. G. C. LUCK	
Color Television Signal Receiver Demodulators	205
D. H. PRITCHARD AND R. N. RHODES	
Colorimetric Analysis of RCA Color Television System	227
D. W. EPSTEIN	
Television Coverage of the Presidential Inauguration	259
E. C. WILBUR AND H. L. GRELCK	
Equipments for Measuring Junction Transistor Admittance Parameters for a Wide Range of Frequencies	269
L. J. GIACOLETTO	
RCA TECHNICAL PAPERS	297
AUTHORS	299

RCA REVIEW is regularly abstracted and indexed by *Industrial Arts Index*, *Science Abstracts* (I.E.E.-Brit.), *Electronic Engineering Master Index*, *Chemical Abstracts*, *Proc. I.R.E.*, and *Wireless Engineer*.

RCA REVIEW

BOARD OF EDITORS

Chairman

D. H. EWING

RCA Laboratories Division

G. M. K. BAKER
RCA Laboratories Division

M. C. BATSEL
RCA Victor Division

G. L. BEERS
RCA Victor Division

H. H. BEVERAGE
RCA Laboratories Division

G. H. BROWN
RCA Laboratories Division

I. F. BYRNES
Radiomarine Corporation of America

D. D. COLE
RCA Victor Division

O. E. DUNLAP, JR.
Radio Corporation of America

E. W. ENGSTROM
RCA Laboratories Division

A. N. GOLDSMITH
Consulting Engineer, RCA

O. B. HANSON
National Broadcasting Company, Inc.

E. W. HEROLD
RCA Laboratories Division

R. S. HOLMES
RCA Laboratories Division

C. B. JOLLIFFE
Radio Corporation of America

M. E. KARNS
Radio Corporation of America

E. A. LAPORT
RCA International Division

C. W. LATIMER
RCA Communications, Inc.

G. F. MAEDEL
RCA Institutes, Inc.

H. B. MARTIN
Radiomarine Corporation of America

H. F. OLSON
RCA Laboratories Division

D. S. RAU
RCA Communications, Inc.

D. F. SCHMIT
RCA Victor Division

S. W. SEELEY
RCA Laboratories Division

G. R. SHAW
RCA Victor Division

R. E. SHELBY
National Broadcasting Company, Inc.

A. F. VAN DYCK
Radio Corporation of America

I. WOLFF
RCA Laboratories Division

V. K. ZWORYKIN
RCA Laboratories Division

Secretary

C. C. FOSTER, JR.

RCA Laboratories Division

REPUBLICATION AND TRANSLATION

Original papers published herein may be referenced or abstracted without further authorization provided proper notation concerning authors and source is included. All rights of republication, including translation into foreign languages, are reserved by RCA Review. Requests for republication and translation privileges should be addressed to *The Manager*.

OPTIMUM UTILIZATION OF THE RADIO FREQUENCY CHANNEL FOR COLOR TELEVISION*

BY

R. D. KELL AND A. C. SCHROEDER

Research Department, RCA Laboratories Division,
Princeton, N. J.

Summary—This paper is a semitechnical presentation of the underlying engineering and physiological considerations which serve as the basis for a color television system utilizing the National Television System Committee (NTSC) field test signal specifications. The paper is intended to serve as an introduction to compatible color television for those engineers who are not familiar with the subject.

IN ORDER TO have a proper understanding of some of the color television transmission standards now being field tested, it is well to review the basic thinking that has gone into their make-up. We can now transmit, in the radio-frequency channel allocated for monochrome television, a picture in color having practically the same detail as the present monochrome pictures. To do this we have had to make the most of our knowledge of communication engineering and a new field of study involving the subjective characteristics of normal vision.

The basic characteristics of the color television system now being field tested may be summed up as follows:

First: The signal is so arranged as to be compatible with present monochrome receivers.

Second: The signal has a minimum of redundancy.

Third: The signal make-up takes full advantage of the characteristics of vision. In order to achieve this:

- (a) Three-color presentation is provided and needed in large areas.
- (b) Two-color presentation along a preferred locus is provided and needed for intermediate area detail.
- (c) No color information is provided or needed in small detail.

There follows a review of the manner in which these basic characteristics have been integrated into a practical color television system.

To produce a television picture in color, three video signals, each representing a different primary color, must be fed to the reproducer.

* Decimal Classification: R583.1.

There are a number of combinations of primary colors which might be used; the primaries used in the system to be described are red, green, and blue. The first signal, then, represents the detail and color content of the red components of the original scene, the second signal represents the same information relating to green, and the third signal to blue. These three signals are derived from an analysis of the red, green, and blue components of the scene being televised. The communication problem is that of transferring this information from the scene to the receiver with the greatest possible efficiency.

There are two important considerations in achieving this goal: the first relates to the transmission of the information with a minimum of redundancy, while the second is the necessity of assuring that only information useful to the eye is fed to the communication channel for transmission. Each of the red, green, and blue components of the scene to be transmitted contains brightness information as well as color information. To satisfy the requirement of compatibility, the brightness of the scene must be transmitted as amplitude modulation of the carrier in the normal way. This brightness signal is made up by adding the red, green, and blue signals in such proportions as to produce a signal representing the visual luminance of the scene. When transmitting the brightness components of the three color separations in this way, it would be redundant and a waste of communication channel to also transmit the same brightness information combined with the color information. To remove the brightness components from the color separations, the brightness signal is subtracted from each of the red, green, and blue color signals. This produces three signals representing red minus brightness, green minus brightness, and blue minus brightness, which are denoted by $R - Y$, $G - Y$, and $B - Y$. If these three signals were transmitted to the receiver along with the brightness signal, signals corresponding to red, green, and blue could be recovered by simply adding the brightness signal to each of the three. However, the transmission of four pieces of information, when only three are required, would again represent the transmission of redundant information. The signal representing the green separation can be obtained at the receiver by subtracting the sum of the red and blue signals from the brightness signal, or by taking the sum of $R - Y$ and $B - Y$ to obtain $-(G - Y)$. Therefore it is necessary to transmit only signals representing $R - Y$ and $B - Y$ along with the brightness signal.

Bedford¹ has pointed out that the eye can not see color in small

¹ A. V. Bedford, "Mixed Highs in Color Television," *Proc. I.R.E.*, Vol. 38, p. 1003, September, 1950.

detail, and that this property of vision may be used to advantage in a color television system. Here, then, is another opportunity to reduce the amount of information transmitted. It has been determined experimentally that the color information may be limited in band width to approximately one and one-half megacycles without the loss of information being detected by the eye. There now remains the problem of transmitting these two pieces of color information with a minimum of visibility along with the brightness signal. An advantageous arrangement for transmitting color information is the use of two carriers of the same frequency displaced in phase by 90 degrees. To generate such a signal the subcarrier voltage is divided into two parts. The first part is amplitude modulated with a signal representing R — Y and

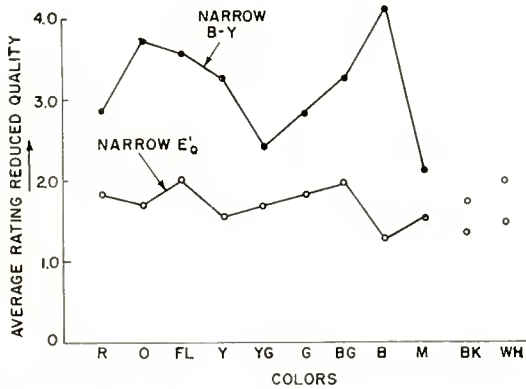

Fig. 1—Tabulation of average rating of deterioration of edges for indicated color versus all other colors for narrow band B-Y and NTSC field test signal specifications.

the second part is shifted in phase by 90 degrees and amplitude modulated with a signal representing B — Y. These components are then combined to form the transmitted signal. If, in the receiver, a voltage having a reference phase is available, the two signals may be detected without crosstalk, since they are detected in quadrature. By transmitting a small sample of the subcarrier at a fixed phase during horizontal blanking time, the necessary synchronous voltage can be made readily available in the receiver for synchronous detection.

Now that we have all of the color information on a single subcarrier, the problem is to choose a subcarrier frequency which will produce a minimum of spurious signal effects in the brightness channel. One obvious way to determine this frequency is to simply look at the kinescope and change the frequency of the subcarrier until it is least visible. This occurs when the positive half cycles of the carrier, which

appear as dots of light, interlace. This frequency is always an odd multiple of $\frac{1}{2}$ the frame frequency and can be an odd multiple of $\frac{1}{2}$ the line frequency, since line frequency is an odd multiple of frame frequency.

Another approach to the spurious signal problem is to interlace the subcarrier and its sidebands with the harmonics of frame and line frequencies. This also gives a subcarrier frequency which is an odd

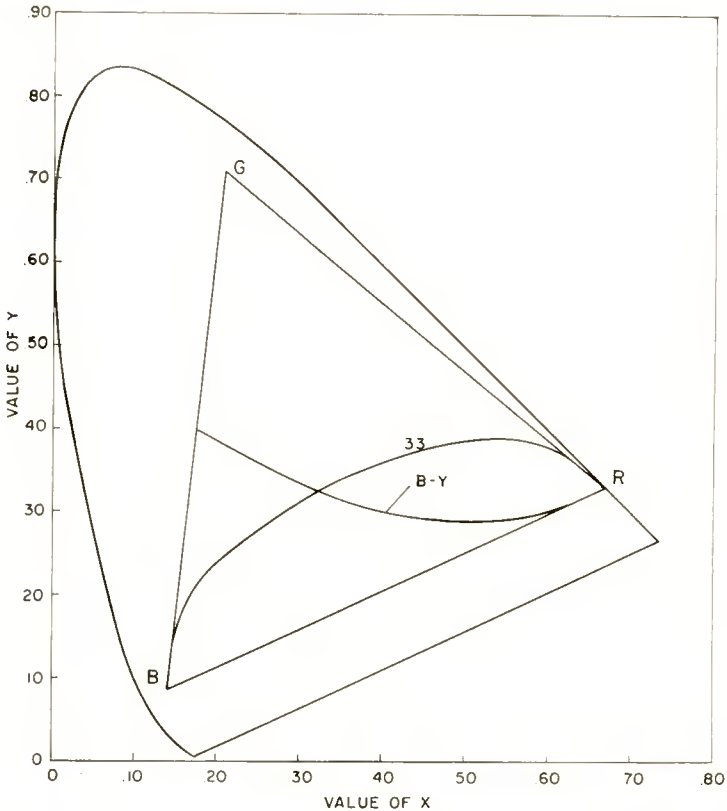

Fig. 2— $Q=0$ axis for narrow-band B—Y (curve labeled "B—Y"), and $Q=0$ axis for NTSC field-test signal specifications (curve labeled "33").

multiple of $\frac{1}{2}$ the frame frequency. When approached from this direction it is called frequency interlace. Thus, it is apparent that frequency interlace always gives dot interlace and dot interlace always gives frequency interlace, so that both names describe the same process, the purpose of which is to reduce interference between the brightness video signal and the color subcarrier.

With the color subcarrier frequency so chosen as to have a minimum visibility, there are reasons for wishing to choose a frequency as high as may be passed by the receiver circuits and other reasons for wanting a lower frequency. The fact that the receiving kinescope is nonlinear contributes to the visibility of the subcarrier. Also, insufficient persistences of vision and the kinescope screen material contribute to the visibility of the subcarrier. For these reasons it is desirable to

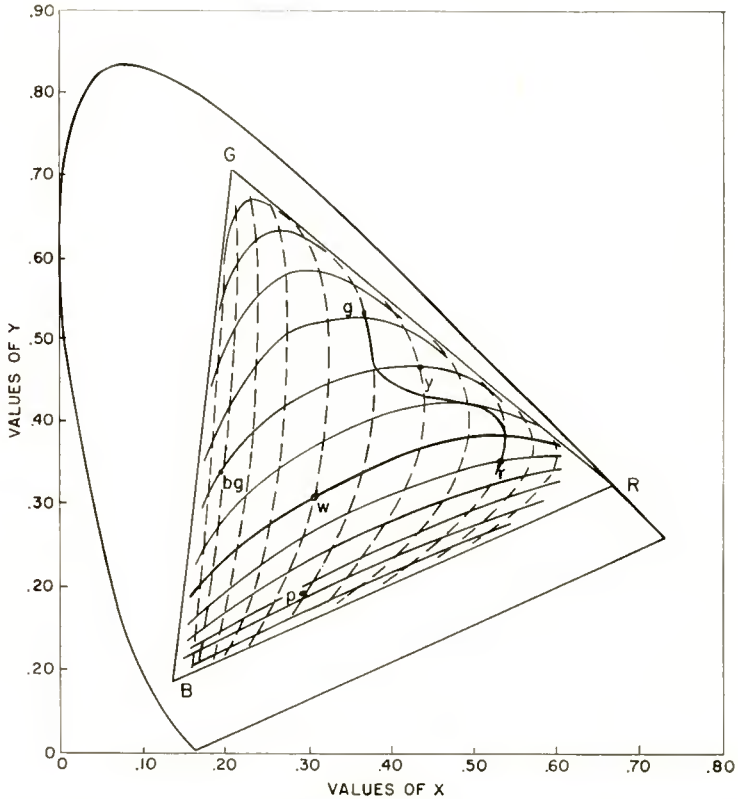

Fig. 3—Lines of constant I/Y' , and Q/Y' , for NTSC field test signal specifications showing transition between two colors.

make the residual dot structure as fine as possible by selecting a high subcarrier frequency. The reason for wishing to choose a lower frequency will be considered in more detail.

A choice of a nominal 3.58 megacycles as a subcarrier frequency represents a balance between the various factors involved. With this carrier frequency there is .6 megacycle between the subcarrier and the end of the pass band assuming the receiver passes frequencies up to

4.2 megacycles. This means that the two signals representing color information can be transmitted in quadrature without crosstalk up to a frequency of .6 megacycle. Beyond this frequency the missing sideband causes the carrier phase to shift, introducing spurious signals into each color channel from the other. These spurious signals appear as incorrect color on the edges of objects. To prevent this crosstalk between the two color signals, one of the signals is limited to .6 mega-

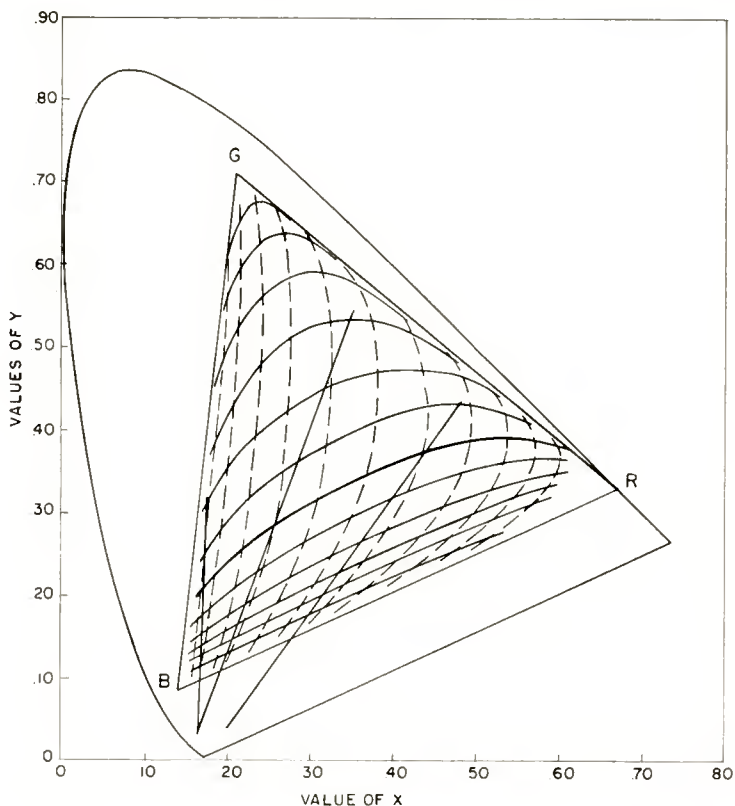

Fig. 4—Comparison of NTSC field test signal specifications with data of Wright and Willmar.

cycle. In this way the two color signals are transmitted in quadrature on the subcarrier only in the frequency range where double sideband transmission is possible. Beyond this point a single color signal is transmitted. The choice of 3.58 as a subcarrier frequency is the result of balancing the desire for reduced dot structure against the desire to transmit color signals in the range of detail where the eye can make use of the information.

Reference has been made to the signals $R - Y$ and $B - Y$ in quadrature on the same carrier. Obviously the carrier can have only a single instantaneous amplitude and phase—the resultant of the two color signal vectors in quadrature. In other words, the phase of the carrier actually represents color or hue information with the amplitude of the vector representing color saturation. Conversely, the single vector can be separated into other pairs of vectors at right angles to each other.

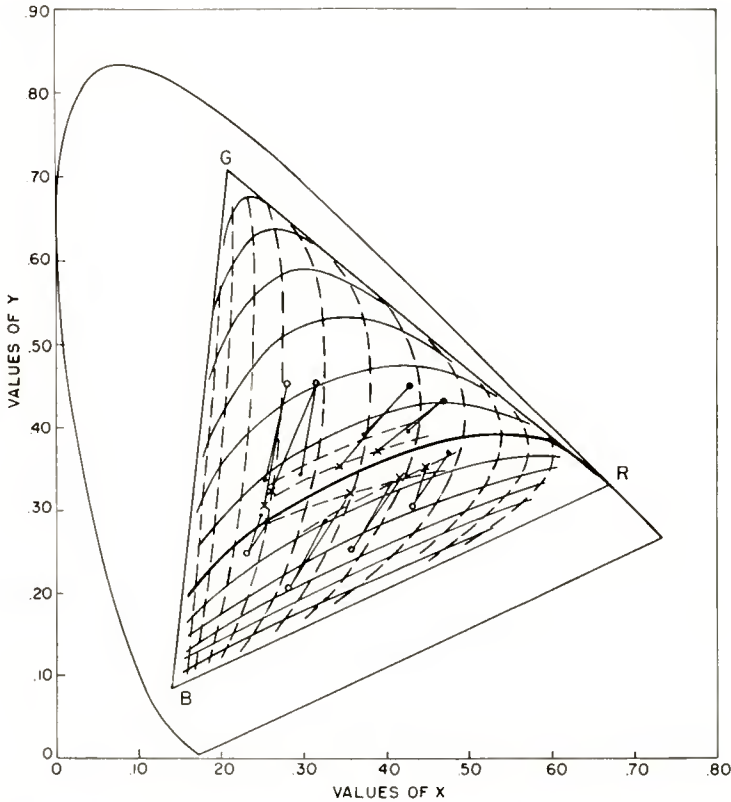

Fig. 5—Comparison of NTSC field test signal specifications with data of Middleton and Holmes.

By selecting pairs of vectors other than those representing $R - Y$ and $B - Y$, it is possible to select, on the color triangle, various loci along which all colors are reproduced for frequencies between .6 and 1.5 megacycles.

There is considerable information in the literature indicating that the eye becomes progressively color blind as the size of the viewed object is reduced. First there is three-color vision, then two-color

vision, and finally only brightness vision with no color sensation. To determine the preferred locus for the region of two-color vision, a series of tests was made using a complete color television system. The signal source was a studio camera. The viewers used were a tri-color tube and dichroic viewer using three kinescopes. The three-kinescope viewer had a highlight brightness of approximately 100 foot-lamberts which made possible critical viewing.

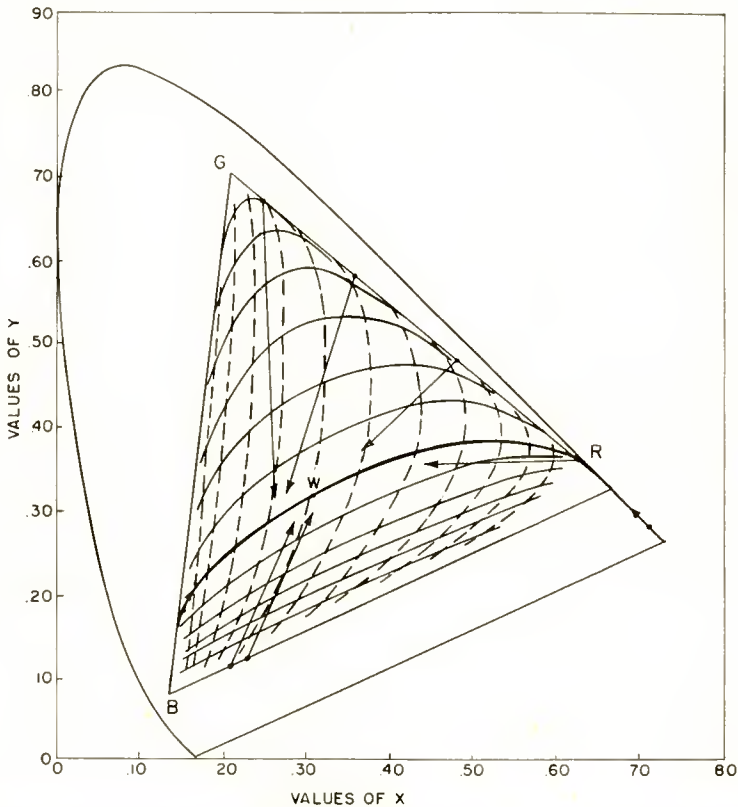

Fig. 6—Comparison of NTSC field test signal specifications with data of Hartridge.

A series of Munsell colors covering the color gamut were viewed, each in turn superimposed on each of the others. The evaluation of the quality of the transition from one color to the other was on the basis of 10, one being excellent and 10 representing an unsatisfactory reproduction. The circuitry was so arranged that the two quadrature vector signals, one of which was limited in band width to .6 megacycle, could be made up of varying proportions of the three primary color

signals. In this way the color locus for those frequencies between .6 and 1.5 megacycles could be selected. As a result of the tests, a preferred pair of vectors was found approximately 33 degrees from the B—Y and R—Y pair.

The summarized data comparing this preferred pair of vectors which have been termed I and Q with R—Y and B—Y is shown in Figure 1. Here the average rating of quality of color transition from

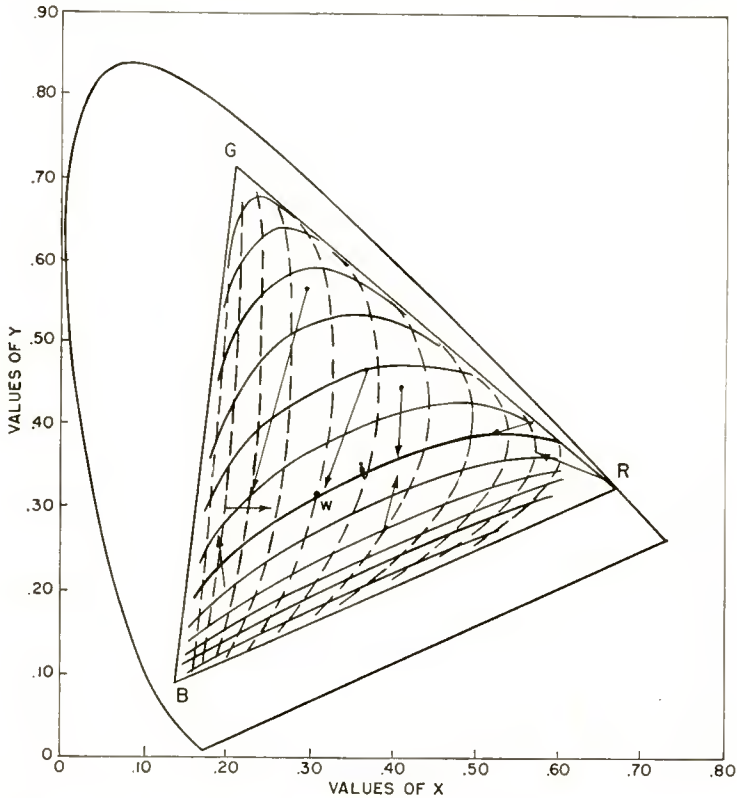

Fig. 7—Comparison of NTSC field test signal specifications with data of Kline.

each color to all other colors is shown. It is seen that improvement is obtained on all color transitions with the greatest improvement coming in the region of flesh tones and blues.

The color locus for the limited band width of B—Y and the vector composed of color information such as to produce the Q vector, displaced 33 degrees from B—Y, is shown in Figure 2. The curvature is caused by the addition of color components to produce the desired

vector after they have passed through the nonlinear circuits required for proper gamma reproduction.

With this selected choice of color vectors, a grid of transitions may be plotted on the color triangle (Figure 3). The solid lines represent the paths taken by a color transition in the direction having a frequency response limit of 1.5 megacycles. The dotted lines represent the path taken by color transitions in the direction having a frequency response of .6 megacycle. Stated in another way, a color transition from g to p in Figure 3 would have a steepness of rise corresponding to a band pass of .6 megacycle, while a transition from bg to y would have a steepness of rise corresponding to a band pass of 1.5 megacycles. The transition from g to r would contain components of steepness passed by both the .6- and 1.5-megacycle circuits.

There is material in the literature which shows how the eye tends to have color perception only along a line locus for small color detail. For example Willmer and Wright,² Figure 4, were able to color match all the colors of the spectrum with only a blue and red light source when the object was sufficiently small. This data may be presented on the color triangle, in the form of a series of diverging lines which pass through the test colors and the color mixture which gives a match. These lines would be parallel to the locus of low frequency transitions if the correlation between the television tests and those of Willmer and Wright was perfect.

The data of Middleton and Holmes³ is shown in Figure 5. Here may be seen the reduction of color sensitivity of the eye toward the color locus as experimentally chosen for our television system. Hart-ridge⁴ has made similar tests on color acuity in small detail. His data is shown in Figure 6. Again the same locus is indicated.

A different approach to the selection of the wide band color locus may be based on color-photography experience. Here the assumption is that in two-color photography a color locus has been chosen as a result of experience to produce the most satisfactory result. This means that the two chosen colors are such as to approximate most closely the results obtainable with a three-color process. In other words, the difference between the two-color and three-color processes is subjectively a minimum. In this television system, this minimum

² E. N. Willmer and W. D. Wright, "Color Sensitivity of the Fovea Centralis," *Nature*, Vol. 156, p. 119, July 28, 1945.

³ W. E. K. Middleton and M. C. Holmes, "The Apparent Colors of Surfaces of Small Subtense — A Preliminary Report," *Jour. Opt. Soc. Amer.*, Vol. 39, p. 582, July, 1949.

⁴ H. Hartridge, "The Visual Perception of Fine Detail," *Phil. Trans. Roy. Soc.*, Vol. 232, pp. 519-671, May 15, 1947.

difference is the information selected to be transmitted at the reduced band width.

The locus of colors as reproduced by a two-color process is shown in Figure 7. Here, again, from an entirely different approach, it is seen that the color reproduction is along the locus chosen for our television system.

From this brief review of some of the broad considerations involved in the proposed NTSC field test signal specifications, it can be seen that a compatible system has evolved which reduces to a minimum the transmission of redundant information and the transmission of information that, due to characteristics of vision, the eye cannot utilize. From the standpoint of ceiling performance it is believed that the broad concept of the proposed NTSC field test signal specifications has, in its make-up, the most efficient possible utilization of a six-megacycle channel for the transmission and reception of television in color.

PRINCIPLES AND DEVELOPMENT OF COLOR TELEVISION SYSTEMS*

By

GEORGE H. BROWN AND D. G. C. LUCK

Research Department, RCA Laboratories Division,
Princeton, N. J.

Editors' Note: This paper constitutes portions of a petition of the Radio Corporation of America and the National Broadcasting Company, dated June 25, 1953, requesting approval by the Federal Communications Commission of compatible color television standards. Because the material describes the fundamentals of compatible color television in a concise form, it is felt that its publication here will be welcomed by those of our readers interested in the subject.

Summary—A summary of research and development work in color television by the Radio Corporation of America is presented. The fundamentals of colorimetry and the physiology of vision, as they apply to color television, are first described. The evolution of compatible color television systems, together with the engineering problems encountered, is then traced. A mathematical treatment examines the signal make-up and displays the way in which the constant-luminance principle applies in the NTSC signal specifications.

INTRODUCTION

A SATISFACTORY television broadcasting system must provide pictures which are pleasing to viewers. This is not the same thing as providing a completely accurate reproduction of the original subject, but the operating parameters should include a set which will approach this ideal situation, particularly when color is used. Also, color television must grow in the framework of very wide popular use of existing black-and-white television service. It thus seems evident that a basic requirement for a color television signal specification should be the ability to produce acceptable black-and-white pictures on normal unmodified black-and-white receivers. This property of a color television signal is called "compatibility." Furthermore, in view of the general scarcity of space in the radio spectrum, excessive channel width to provide color service is not tolerable.

These general principles of pleasing human sight, providing compatible service, and avoiding waste of spectrum have guided the study of color-television systems in the Radio Corporation of America for many years. Certain facts regarding color vision, now to be set forth, and some basic characteristics of television systems, to be pointed out

* Decimal Classification: R583.1.

later, provide a framework in which the course of color-television system development in RCA can be chronicled.

VISION

Human vision is an extremely complicated process, occurring partly in the eye and partly in the brain, which connects the stimulus of physical light output from some object to the conscious sensation experienced by a person observing that object. This duality must always be borne in mind when vision is discussed. Vision is by no means fully understood, but many facts about it have been found by experiment, and some of these are the most significant guides for color television. We perceive color, as a conscious sensation, in terms of three major attributes. Primary among these, and the only one of them exhibited by both neutral or gray (achromatic) tints and truly colored colors, is "brightness." This is a matter of over-all intensity of light given out by objects seen—their physical "luminance." A second major attribute, and the one most characteristic of color, is the distinction among redness, yellowness, greenness, blueness, and so forth. This is called "hue," and among the pure colors of the physical spectrum it corresponds rather directly to wavelength. Finally, distinguishing strong colors from pale ones of the same hue, as red from pink, is the attribute of "saturation" or "chroma." Saturation may be thought of as related to physical "purity," or freedom from dilution with white.

Large-Area Color Vision

It is well known that large-area visual sensations of every brightness and hue are matchable or reproducible by mixing lights of only three suitable "primary" colors, usually chosen as red, green, and blue. Matching by mixing three light stimuli provides, in fact, the basis of some important methods of measuring color. Full *saturation* in every hue, however, is not reproducible in this way with real primary lights.

Once three actual primary lights have been chosen, no two of which can match the third, any color at all can be specified fully just by stating the amount of each primary needed to match that color. The luminance of a color is equal to the sum of the luminances of the primaries required to match it. "Chromaticity," or coloredness, is fully specified by the fractional contributions of any two primaries to the total (the sum of all three such fractions must be exactly one).¹

Standard primary colors have been chosen by international agree-

¹ D. W. Epstein, "Colorimetric Analysis of RCA Color Television System," *RCA Review*, Vol. XIV, pp. 227-258, June, 1953.

ment, and color measurements by different observers, using different actual primaries, can all be compared by expressing them in terms of the mixing fractions that would have been found if normal observers had measured with the standard primaries. All mixing fractions can be positive in matching all real colors only if the primaries chosen are "supersaturated" colors that are not themselves physically realizable. All three of the primary lights chosen as standards are of this unrealizable sort. Characteristics of the supersaturated green standard primary have been chosen to give it a very special property. The amount of this primary needed in a mixture to match any given color is by itself the luminance of that color.

One need not become an expert in colorimetry in order to understand clearly the broad features of color vision that are important guides for color television. However, some familiarity with the general form of chromaticity diagrams can be most helpful.¹ These diagrams result when colors are specified graphically in terms of mixtures of the International Committee on Illumination (CIE) standard primaries. They are plots, with axes at right angles, of mixing fractions of the CIE super-green or Y primary against those of the super-crimson or X primary. Any single color plots as one point on such a diagram; the location of this point specifies fully the chromaticity of that color, but tells nothing about its brightness.

Figure 1 shows how the colors of all spectral lines, the most saturated of real light sources, plot as an inverted-horseshoe curve, with its open end closed by the nonspectral purples. The numbers spotted along the horseshoe are wavelengths in millimicrons (billionths of a meter). Ideal incandescent radiators (black bodies) plot as an arched curve across the middle of the horseshoe, also shown in Figure 1, with some values of radiator temperature in degrees Kelvin shown by the numbers beside this curve. "White" is a general term for a light which evokes an achromatic (colorless) sensation. Points located in the central region of the chromaticity diagram, including the segment of the black body locus between 2500°K and 8000°K, are recognized as white depending upon particular adaptation conditions of the observer.

The hue of a color is related to its dominant wavelength. After selecting a standard white, the hue of any color can be expressed by the direction of the point representing that color from the "white" point on the chromaticity diagram. Similarly, the saturation sensation given by any color is related to its purity, which is represented by the distance along the radius from the white point to the point repre-

¹ D. W. Epstein, *loc. cit.*

senting that color, measured as a fraction of the total distance out to the spectrum locus, along that same radius. Chromaticity is fully given by just two numbers, whether x and y or angle and fractional radius, and to give any additional number conveys no further chromaticity information. Of course, a third number is needed to specify brightness, or rather physical luminance, but that is a separate matter. It should be noted that lines on the chromaticity diagram do not have the properties of vectors.

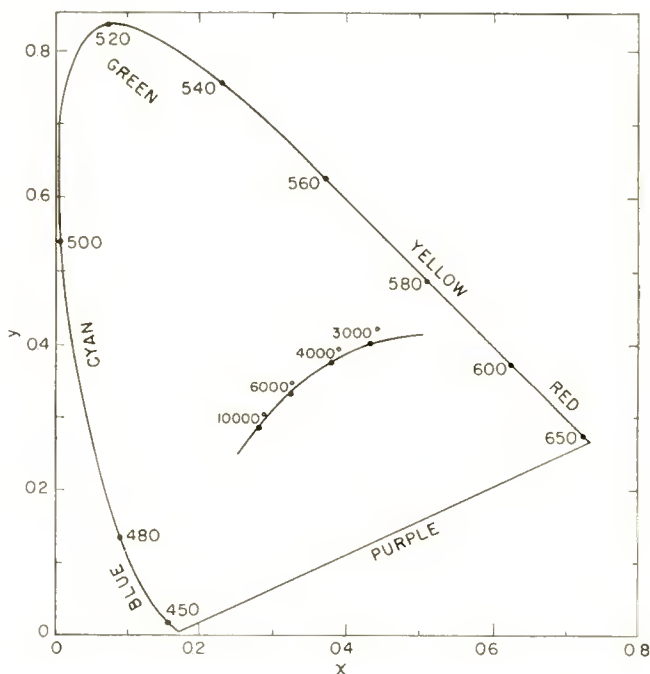

Fig. 1—Locus of the visible spectrum and the chromaticity locus of incandescent radiators.

Given any set of real primaries, such as the phosphor colors used in reproducing color pictures by television, they can be plotted on the diagram, as indicated by the points G, R, and B on Figure 2, which are for standard reproducer primaries as chosen by the National Television System Committee. The selected achromatic point at W represents CIE Illuminant C. Any color that is representable by a point within the triangle GRB is reproducible by a real mixture of these primaries. Experience with various types of color photography (“TECHNICOLOR” and “KODACHROME”) has shown limited satu-

ration capabilities to be quite acceptable in practice. Fortunately most natural objects display unsaturated colors.

Two further facts are to be noted. One is that three strongly colored real primaries, with intensities proportioned to give a good white when mixed, appear quite different in brightness when viewed separately. The green primary then appears as something like twice as bright as the red, and perhaps five to thirty times as bright as the blue primary. The other is that the apparent visual difference between adjacent patches of different colors becomes least when they appear equally bright.

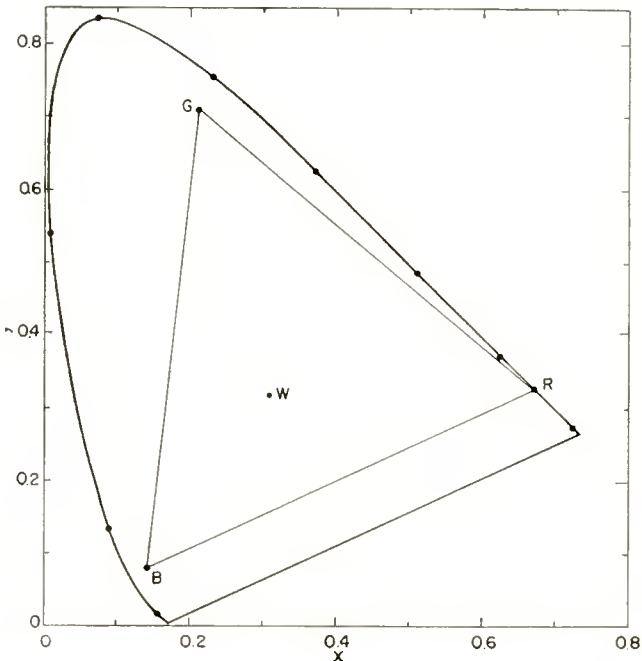

Fig. 2—Color triangle associated with the reproducer primaries chosen by NTSC.

Small-Area Color Vision

Much new data on vision, accumulated in recent years, is very important for color television, though still fragmentary and not yet widely known. The gist of this data is that normal color vision is a decidedly simpler matter for small objects than for large ones. It is well known that "vision is a three-color process," but very few people are aware that this cliché by no means tells the whole story.

Willmer and Wright,² in England, have found that any color, in a small enough patch well centered in the field of vision, can be matched by mixing only two, and not three, "primary" colored lights. The "chromaticity diagram" then becomes merely a straight line, and a single number specifies any small-object color as position along that line. Middleton and Holmes,³ in Canada, have found independently that small patches cut from large colored sheets are not as well matched visually by the original sheets as they are by sheets of somewhat differently colored material. Figure 3 shows some of their

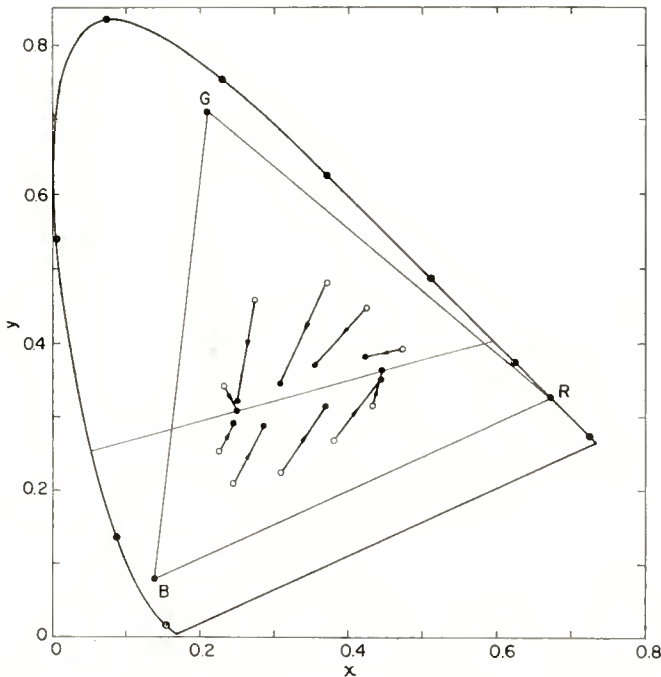

Fig. 3—Chromaticity data of Middleton and Holmes. Color matching of tiny patches.

results, the outer ring of points representing the chromaticities of the original sheets, and the inner ring those of the other sheets found by two observers to best match tiny patches (subtending about 2 minutes of arc at the eye of the observer) cut from the original sheets. The tendency of the chromaticity diagram to degenerate toward a single

² E. N. Willmer and W. D. Wright, "Colour Sensitivity of the Fovea Centralis," *Nature*, Vol. 156, pp. 119-121, July 28, 1945.

³ W. E. K. Middleton and M. C. Holmes, "The Apparent Colors of Surfaces of Small Subtense—A Preliminary Report," *Jour. Opt. Soc. Amer.*, Vol. 39, pp. 582-592, July, 1949.

line for these small patches is quite evident, as is the fact that the two primaries mixed to match the color of any tiny object should be chosen as a barely orange red and a greenish blue.

Still another English worker, Hartridge,⁴ has made a wide variety of investigations that differ in detail but generally corroborate the above findings. None of the three investigations cited was concerned particularly with television. Observations of sharpness of visibility of color and brightness contrast edges, made by RCA Laboratories Division,⁵ give further corroboration. It is evident from the totality of the work cited that individual observers actually see somewhat differently from one another; and there is, consequently, wide disagreement as to exact numerical details, but there is full agreement on the general character of the phenomena observed.

As colored test objects are decreased in size, four things are found to happen in succession. First, blues become indistinguishable from grays of equivalent brightness and, second, yellows become indistinguishable from grays. In the size range where this happens, browns are confused (in hue but not in brightness) with crimsons, and blues with greens, but reds remain clearly distinct from blue-greens. On the whole, colors with pronounced blue lose blueness, while colors lacking in blue gain blueness; all become less saturated. Third, with still further decrease in size, reds merge with grays of equivalent brightness and, finally, blue-greens also become indistinguishable from gray. A large nearby object of the same color helps a small object to retain its chromaticity, while a nearby large area of contrasting color helps to wash out the color of a small area. Decreasing brightness, like decreasing size, but in less drastic fashion, also washes out colors.

People with normal vision, then, see rather small objects in just the same way that certain color-blind people see all objects. For exceedingly small objects, normal visual sensations are devoid of all color connotation, and only perception of brightness remains. Statements made here do not put forth theoretical hypotheses, but do attempt to describe actual facts of observation. Much more research is needed to establish details firmly, but the general nature of the situation seems quite definite.

Television reproduction on a full three-color basis for all details of all objects, regardless of size, is thus seen to be a thoroughly wasteful process. It seems fairly safe to estimate that about twice the

⁴ H. Hartridge, "The Visual Perception of Fine Detail," *Phil. Trans. Roy. Soc. (London)*, Ser. B, Vol. 232, pp. 519-671, May 15, 1947.

⁵ A. V. Bedford, "Mixed Highs in Color Television," *Proc. I.R.E.*, Vol. 38, p. 1003, September, 1950.

information needed to produce the same picture in black and white should be entirely adequate. Color transmission should have the following properties:

1. Dominant wavelength, purity, and luminance data should all be transmitted for homogeneous color patches subtending relatively large areas at the eye.
2. Only purity (within reduced limits) and luminance information need be transmitted for quite small color details.
3. Only luminance information need be transmitted for the finest detail.

There is no single, positive "best" black-and-white equivalent of a colorful scene, as witness the variety of lights, films, and filters used by the black-and-white photographer. Of the single achromatic picture properties that might be so used, however, luminance seems as unobjectionable as any.

Visual Resolution

Ability to distinguish two nearby objects as separate, called "resolution," is another characteristic of vision that is very important for picture reproduction. It is a measure of "definition," the sensation of sharpness obtained in looking at a picture. Resolving power of the eye is strongly dependent on subject contrast. There is a well known and reasonably good rule of thumb that two small objects, placed side by side against a strongly contrasting background, can just be recognized as separate by a normal observer when viewed from a distance about 3400 times their separation (at which they subtend an angle of about one minute at the eye). Visual receptors in the human retina are tiny, physically separate elements called "cones." In the fovea centralis, the part of the retina used for sharpest seeing, the cones are probably spaced about 0.0001 inch between centers (this seems very difficult to measure), a pair subtending about $\frac{2}{3}$ minute of arc at the pupil. Loss of distinct red and blue-green color sensations, as described above, occurs only when isolated objects subtend at the eye an angle comparable to, or at most a few times greater than, that separating adjacent cones. Loss of blue and yellow occurs for objects considerably larger, possibly even as much as 30 cones across. Different observers disagree markedly on the exact numbers here.

When a picture $\frac{4}{3}$ times as wide as it is high is viewed from a distance 6 times its height, perhaps $\frac{1}{2}$ million separate cones in the retina are brought into use. This gives some idea of the maximum detail that the eye can use in a television picture. Another related

item is the fact that adjacent lines of a 525-line picture can be made to subtend just about the same angle at the pupil of the eye as do adjacent foveal cones within the eye, by viewing the picture from a distance 11 times its height. Line length scanned in one microsecond subtends 8 minutes of arc, or about 12 foveal cones, when viewed at 11 times picture height. These figures are not meant to recommend any particular viewing distance, but only to show relationship of picture resolution to eye resolution.

Persistence

Present-day television, like motion pictures, is possible only because of the fact that seeing is not an instantaneous process, but includes a retentive feature known as "persistence of vision." This feature enables a viewer to remain conscious of what he saw in one corner of a television picture, while the rest of the picture is being sketched, a speck at a time, until that first corner is gone over again. An area that is flashing in this way may give a sensation of flicker, however, if the time between flashes, the brightness of the light, or the size of the area becomes excessive. These quantities must be so chosen that there will be no objectionable flicker in the television picture. The practical importance of size of flashing area in determining the strength of flicker sensation, other things being equal, is very great. If the pattern of flashing is complex, flicker may show as an apparent crawling of detail within the picture. Flashing from one hue to another of equal brightness gives markedly less flicker sensation than does flashing from darkness to light of that same brightness. Breakdown of persistence of vision, giving rise to flicker sensations, can set a decidedly more stringent lower limit on acceptable picture-repetition frequency than does the need to reproduce motion smoothly.

TRANSMISSION SYSTEMS FOR TELEVISION SIGNALS

A complete color television system (neglecting sound), may be considered here to consist of four parts, as diagrammed in Figure 4.

1. A camera, that translates visual characteristics of a scene to electrical signals,
2. A reproducer, that builds up from these signals a reasonable facsimile of the original scene,
3. A transmission system that accepts the electrical signals from the camera, and
 - a. processes them,
 - b. transports them,
 - c. again processes them, and ultimately applies them to a distant reproducer, and

4. Scan synchronizing and driving devices for both camera and reproducer.

Only a necessary minimum will be said now about properties and structure of the camera and reproducer. The latter, for color, is a device which, when fed simultaneously with three electrical signals, proportional respectively to the amounts of three primary-colored lights required to match a portion of an original scene, emits properly mixed light in the proper location to give the observer the required visual sensation. Most simply, this reproducer may be thought of as a group of three synchronously scanned television picture tubes (“kinescopes”), each emitting light of one primary color, with their light outputs combined in register by a system of mirrors.

The camera may be thought of as performing the reproducer functions in reverse, and as resembling optically a one-shot photographic color-separation camera, with three synchronously scanned television

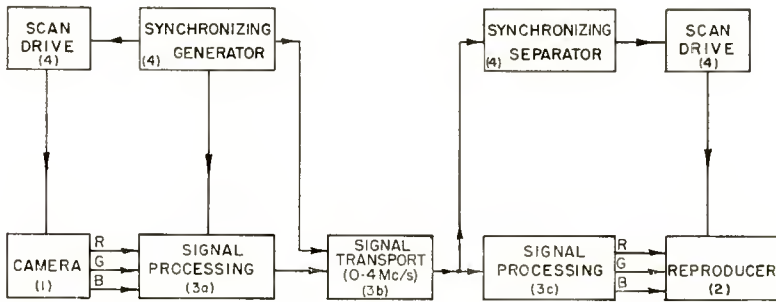

Fig. 4—A diagram of a complete color television system (neglecting sound).

pickup tubes in place of the three photo films. Both camera and reproducer are assumed for now to establish direct, linear proportionality between electrical and light signals.

It may be noted in passing that the camera spectral sensitivities needed to determine the subject-matching levels for the reproducer primaries are not the same as the spectral emission distributions of those reproducer primaries. Required camera characteristics may be built up electrically, even to the extent of providing regions of negative sensitivity, despite limitations of optical filters. This is a very distinct advantage possessed by television, as well as by slower electrical color-reproducing systems, over the laborious “masking” techniques of color photography.

Attention will be concentrated for the present on the signal-transmission system alone, disregarding the scan-synchronizing function. The transportation function of this system usually involves modulation,

transmission, reception, and detection of a radio signal, although direct transport over wires or cables is also used. Radio interference considerations do strongly affect the requirements to be met by the modulating signal, but this is the only way the radio link concerns the present discussion. Only the video signal entering the transmitter modulator and leaving the receiver detector (presumably without suffering distortion in between) will be considered at this point. This signal will be considered with regard both to its own properties and to the way it is developed from the camera output and is processed to provide reproducer input.

The signal-processing devices emerge as the heart of the transmission system, and as the means of distinguishing among systems. A sufficiency of specific examples will appear later. For the present, signal properties and possible processing devices will be described in general terms.

Channel Capacity

Rules of the Federal Communications Commission, in accord with recommendations of the National Television System Committee in 1940, operate to set up rather definite boundaries for the usable video channel. Thus arises a frame within which television must live. Extending upward from an assigned radio carrier frequency, which may be taken as zero for the scale of video modulating frequencies, the picture channel is bounded by the presence of a cooperating sound channel 4.475 to 4.525 megacycles above the picture-carrier frequency (with nominal center displaced 4.500 megacycles). Sound signal must be kept out of the picture channel and vice versa. Sound signal is kept out of picture signal by providing sharp rejection filters in reproducers. The upper frequency limit of the useful video channel is actually set by the capability of these filters, in turn determined largely by the cost considered acceptable for reproducers. No exact figure can be set for this upper picture-frequency limit, but 4.0 megacycles per second is a reasonable figure for this discussion.

It is shown in standard expositions of information theory that a transmission channel can, in principle, forget what it was doing last in just one-half cycle of the highest frequency passed. That is, instantaneous transmitted-signal amplitudes through such a channel can be completely independent, momentarily, at intervals of just one-half cycle at maximum frequency. The 4-megacycle video channel can, therefore, transmit a maximum of 8 million fully independent amplitude values per second.

Video-signal amplitudes differing by as much as the statistical amplitude of the prevailing noise on the channel can be definitely

recognized as separate. Information obtainable from each independent signal-amplitude element is, therefore, determined by the prevailing ratio of available signal power to noise power. The number of independent amplitude samples transmissible per second, set by channel width, and the number of distinguishable amplitude levels per sample, set by signal/noise ratio, together determine the maximum rate at which information can be passed over a given channel. In this way the nature of the physical world and the rules of the Commission cooperate to set outer limits to the transmission capabilities within which television must develop.

Effects of Scanning

Dissection and reproduction of the scene being televised, by a repetitive point-by-point and line-by-line scanning process, provide the transmitted picture with a highly characteristic artificial structure. The essence of compatibility among systems, which means in effect interchangeability of equipment, is that this scanning structure must not be altered in such ways as to violate its basic organization. Through the scanning process, reproducer and signal are placed in a lock-and-key relation. If the key will not enter the lock, one does not merely get reduced effectiveness of operation: he gets no operation whatever.

A little bookkeeping is in order here, to compare the television picture structure with the resolution of the eye, as discussed earlier. At 8 million picture elements per second in a 4-megacycle video channel, a line scan lasting $1/15,750$ second covers 508 elements. Signal blanking during the line-retrace time, however, leaves only 416 of these elements visible. Of the 525 lines per frame, 483 are left visible by field-retrace blanking. This represents 104 elements per unit length horizontally, against 161 per unit length vertically, in a picture 4 units wide and 3 units high. Because line structure may match poorly with subject structure, useful resolution may actually be nearly the same horizontally as vertically. Picture elements transmissible during the $1/30$ -second standard frame total 266,667.

Mertz and Gray⁶ long ago pointed out that the scanning structure also represents a typical spectrum of use of the frequencies within the video channel. They found that, for most subjects, almost all signal energy is concentrated at frequencies that are whole multiples of the line-scanning frequency. Halfway between these heavily used frequency bands, that is, at odd multiples of half the line frequency,

⁶ P. Mertz and F. Gray, "A Theory of Scanning and Its Relation to the Characteristics of the Transmitted Signal in Telegraphy and Television," *Bell Sys. Tech. Jour.*, Vol. 13, pp. 464-515, July, 1934.

substantially unused frequency bands are usually found.

More elements of independent amplitude can be transmitted per picture the smaller the number of pictures transmitted per second, since the possible number of elements per second is limited by the assigned video channel width. If the whole picture field is scanned in unbroken line sequence, however, the whole field flashes together at picture-repetition or frame frequency. Frame frequency must then be kept quite high to keep resulting flicker tolerable to the viewer, and this limits picture detail.

Scanning first only alternate lines throughout the whole picture field, then returning and scanning only the lines missed the first time, breaks up the flicker pattern so that adjacent lines flash at complete-frame frequency, but with opposite timing. The smaller-area flicker due to this "interlaced" scanning is much less visible than the solid-field flicker of the simple scan. Frame frequency of complete pictures can be reduced by two to one, while still keeping the frequency of the alternate-line fields that flash as a whole as high as before. Thus, twice as many elements per picture can be transmitted in this way, and such interlacing has been adopted as standard practice.

More complicated line-interlace patterns seem tempting, but they lead to orderly progression of small, bright areas, so that any residual flicker sensation manifests itself as an impression that lines are crawling up or down the picture. Thus, triple line interlace has been found to be self-defeating.

Interlaced scanning is such a very effective channel-saving device that it should be exploited to the fullest practical degree. (Application of horizontal interlace to black-and-white television signals to achieve greater definition than can normally be carried in a six-megacycle channel is possible, but does not seem to be justified in view of practical limitations.) If only alternate elements (or dots) of alternate lines are transmitted in a single field scan, four such fields are required to build up a complete frame. Adjacent areas, flashing at frame frequency, but in different time sequence, are then reduced to very tiny picture-dot size, and the visibility of the flicker is very much reduced. Holding the field frequency, at which large-area flicker occurs, as high as always, the frame frequency, at which complete pictures are built up, can be reduced to one fourth of that required for a simple once-over scanning scheme.

Use of dot interlace thus permits the number of elements transmissible per complete frame to be quadrupled. Residual flicker is then progressive, but is only a weak sensation, so that the very fine crawling pattern of residual dots is not annoying. (It can, in principle, be

entirely eliminated, but this requires more advanced and complex techniques than are customary today.)

Fourfold interlace takes place in fairly obvious fashion, as described above, if individual picture dots are reproduced as sharp, separate points of the scan. It is then clearly an additive process, as indicated for part of one line in Figure 5a, with one field scan filling in correctly one quarter of the total elements required for the complete picture, and with the remaining three quarters left blank throughout that field scan. The next three field scans simply fill in correctly the blank spaces, to complete one frame. A subtractive or cancelling type of interlace can be at least equally important for color television.

Suppose that an entirely normal black-and-white signal is transmitted, but that an additional, independent signal is mixed with it. This is to be done in such a way that, on any one field scan, the extra signal adds to the original one on every second picture element of each

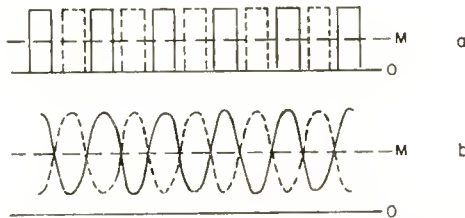

Fig. 5—(a) An example of additive interlace. (b) An example of cancellation interlace.

line, and subtracts from it on the other, alternate elements. On the second following field scan, the same line will be retraced, but this time the extra signal is to be arranged to subtract from the original one on those elements where it previously added, and vice versa. Time variation of the total signal, on two successive scans of the same line, is as shown in Figure 5b. Over a complete frame, comprising four field scans, the extra signal will then just average to zero on every picture element. This cancellation leaves the original black-and-white picture completely uncontaminated, at least to the extent that persistence of vision eliminates frame-frequency flicker. With suitable equipment, the extra signal can likewise be recovered separately, with minimum contamination by the original signal.

When studied in detail, the additive and subtractive types of interlace are recognizable as basically just two aspects of the same thing. Dot interlace of either sort can be produced merely by arranging to lock the picture-element signals firmly to the scanning pattern. This

is so done that picture-element signals occur at a frequency that is exactly an odd multiple of half the line frequency. The extra signal, alternately added and subtracted to give subtractive interlace, then develops a spectrum with energy concentrated just in the middle of those unused spectrum gaps found by Mertz and Gray in the ordinary signals. Such frequency separation further substantiates the concept that the two signals can be cleanly separated from one another. Because of its spectrum properties, the subtractive aspect of dot interlace has been referred to on occasion as "frequency interlace."

Multiplexing

Color television requires definitely that more information be transmitted per frame than is needed for black-and-white pictures of equal sharpness. This additional information must be treated as independent of the black-and-white information. It must be transmitted along with, but be kept separable from, the latter. Sending independent messages together over one transmission system, yet keeping them separable at will, is no new problem. In the older communications art, the process is known as multiplexing, and is widely used. Present use of multiplexing involves setting up a transmission channel wider in frequency band than is needed for one message, and then applying either or both of the techniques known as:

1. Frequency division.
2. Time division.

Frequency-division multiplexing is done, as might be expected, by using electrical filters to allocate distinct portions of the over-all frequency band to the separate messages being handled—letting one talk bass while another talks soprano. Shifting of messages from their original frequencies to the desired portions of the band, and back again, is usually done by modulation of appropriate subcarriers. These subcarriers must normally be synchronous at transmitter and receiver.

Time division, as also might be expected, involves the other alternative of allocating the entire channel briefly to each individual message, in a sequential manner. Synchronous switching at transmitting and receiving terminals is the mechanism used to accomplish this. Alternate transmission of the sum and the difference of two messages is one special form of time-division multiplexing. This is what is done in the cancelling type of picture-element interlace described earlier.

When modulation of a subcarrier is used, one sideband suffices for one message. If two sidebands are available, two independent messages

can be handled by one subcarrier. For example, one message can produce an upper sideband only and the other a lower sideband only, as a special sort of frequency-division multiplex. Or, since the above is difficult to do, one message may amplitude modulate and the other may phase modulate the subcarrier. Or, again, two subcarriers, synchronous in frequency but differing in phase (preferably by 90 degrees), may be amplitude modulated, respectively, by the two messages, with the results added for transmission. In any of these cases, the two resulting sidebands together may be treated as a single signal in any further multiplexing. Separate recovery of two messages so treated is effected by synchronous detection with local, phase-locked subcarriers, at the receiving terminal.

Still a third type of multiplexing is possible, but has not come into use. This may be called level-division multiplexing. If the desired signal is very powerful, or the noise level very low, more signal-level gradations may be positively distinguishable, between no signal and maximum signal, than are needed to handle a given message. With sufficient excess levels, a second message may, so to speak, be "written between the lines" of the first, without using any additional frequency band.

Band width economy may thus be purchased at the price of power, but the exchange rate becomes prohibitive if one seeks to accomplish very much in this way. Two on-off telegraph messages may be level multiplexed at a cost of 9 to 1 in power, but to multiplex three 20-level signals would increase required power by a factor of 177,240. Also, complexity of equipment and criticalness of its adjustment would increase beyond all reason in the latter case.

Crosstalk

Attempts to multiplex information beyond the capacity of the channel result in inability to separate cleanly, at the output of the transmission system, all the independent pieces of information that were fed into its input. This crosstalk or interference, taking place between messages while they are in the system, is the special bane of multiplex communication. Its effects correspond somewhat with those of outside noise or interference in simplex communication. Crosstalk can sometimes be made of such nature, however, that its effects are self-nullifying.

Cancelling interlace, described earlier, amounts to permitting strong instantaneous crosstalk between two picture-signal channels, and then arranging the display so that the retentivity of the observer's vision undoes the damage by averaging. The same thing can be carried a step further, with improved channel utilization, if limitations of visual

resolution of the observer can be put to use. If the second signal, which was chopped into dot-size pieces of alternating polarity for removal by interlace cancellation, consists of the sum of two signals during one set of alternate picture lines, and of their difference during the interleaving set, such a result can be accomplished. When the newly added third signal is recovered, and used to make a picture, that picture will show crosstalk, which will be of opposite polarity on adjacent lines. This crosstalk will be averaged out by observer vision when viewing is under conditions such that adjacent lines are not resolved, with regard to the type of information conveyed by the third signal. A single sideband of a single subcarrier can thus be made, on the average, to carry two distinct items of picture information, as a sort of space-division multiplex.

Effects of Nonlinearity

Linear, or proportional, properties have so far been assumed throughout the system. This provided the basis for the cancelling interlace of Figure 5 to work out exactly. Light output from kinescopes does not, in fact, vary linearly with the electrical input, and cancellation is consequently imperfect. While the kinescope is emitting light, this can be corrected by special design of the kinescope or the amplifier driving it, which might somewhat improve cancellation. Compensation of kinescope nonlinearity by intentional nonlinearity in remote parts of the system does not necessarily operate to clean up interlace.

Signals that call for less than no light from a kinescope can occur, and it is then not possible for the kinescope to respond. This basic nonlinearity must remain in the ordinary kinescope, and must interfere with complete cancellation, even if lesser nonlinearities are eliminated. It is called "kinescope rectification," and is the major source of imperfect interlace, with consequent visibility of dot patterns, in systems that are otherwise perfect in principle (if not yet in practice). Crosstalk cancellation by interline visual averaging, described above, aggravates this condition.

Kinescope rectification can be avoided completely, if signals can be stored electrically over the duration of a full picture frame. Negative signal elements that occur during one field can then be cancelled by overlying positive elements on a following field, before being used to control a light output. This is possible in principle, and even to some degree in practice, but picture-storage devices are still far too crude to be of real use against kinescope rectification. Nor is there present indication that the trouble is serious enough to justify future resort to this rather complicated remedy.

Consequences

Enough has now been said of the properties of human vision, and of television systems, so that the general form desirable for color-television signals should begin to be evident, as follows:

1. A full-band signal should be present, meeting normal black-and-white television standards, and should represent reasonably closely the luminance variations of the subject.
2. Amplitude of an additional subcarrier, at a frequency chosen to provide subtractive dot interlace, should represent (as a weighted fraction of the luminance signal) color-purity variations in the subject, such modulation occurring at least out to half the width of the video band (in single-side-band fashion where necessary) and being capable of both positive and negative values.
3. Phase of the modulated subcarrier should vary (without affecting amplitude) to represent hue variations in the subject (as polar angles about the "white" reference of the chromaticity diagram), but such phase modulation, requiring both sidebands, need only occur out to perhaps one eighth of the total channel. When phase modulation has a zero value, subcarrier phase should represent an axis from orange-red to blue-green.
4. A subcarrier-phase reference should be provided as part of the synchronizing signal.

As an alternative to the third item above, which requires as much as $\frac{1}{8}$ channel width available on each side of the subcarrier, a wholly single-side-band scheme is possible. This involves crosstalk between suppressed-subcarrier phase and amplitude, but by reversing the phase shift as between alternate picture lines, visual hue averaging to correct values takes place.

It is hoped that what has been said may help to place the episodes of the following chronicle of transmission-system development in proper perspective. Study of applicability to color television of known methods of multiplexing, as catalogued briefly above, will be seen from what follows to have been quite extensive. It represents, indeed, a long-term program now approaching completion. As would be expected, sophistication of approach has increased markedly as the program progressed.

SYSTEM PHASES OF
COLOR TELEVISION DEVELOPMENT IN RCA

Beginnings

Attention was given quite early by the Radio Corporation of

America to the possibilities of time-division multiplexing for color television. Figure 6 shows the basic form of all purely time-division color systems. Early trials, made in 1940 and 1941, naturally had the synchronous commutators running only rather slowly, namely at field frequency. That is, one full field was reproduced in one primary color, the next field in a second primary, and so on until both alternate-line fields of an interlaced picture had been picked up and reproduced in all three primary-colored components. Frame frequency became only $\frac{1}{6}$ of field frequency, and field-size flashing of green, the brightest primary, occurred at only $\frac{1}{3}$ of the field frequency. Because of the very low frequency involved, the very simple, if very crude, expedient of channel "switching" by direct mechanical interchange of optical color filters could be used.

Color pictures were readily transmissible in this field-sequential

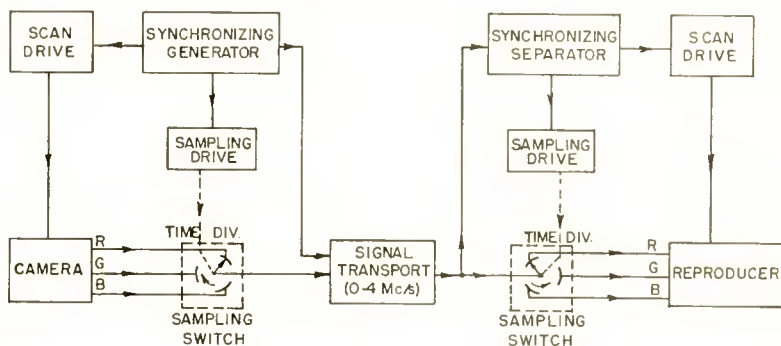

Fig. 6—The basic form of all purely time-division color television systems.

way, but its use immediately raised the horns of a basic dilemma. If standard black-and-white scanning rates were used, the 20-cycle green-field flashing caused wholly intolerable flicker, even at very modest brightness levels. Detail definition, to the full capability of the normal channel, then remained unimpaired in all colors. If, on the other hand, the field frequency was raised by a factor of about 3, flicker was reduced to its normal level, but the new color signal, so obtained, could produce no picture whatever on a normal black-and-white reproducer. The system had become completely incompatible.

Furthermore, the detail transmitted per picture was divided by about 3 at the higher scan rate, and for the same number of scanning lines, this resulted in an intolerable threefold reduction of horizontal definition. Nor did the system offer any flexibility, whereby red-green definition might be improved at the expense of the relatively imper-

ceptible yellow-blue definition. The dilemma of bad flicker versus complete incompatibility, seemingly inherent in field-sequential multiplexing of color, remains unresolved to this day.

Other early tests made at RCA included some which employed a three-kinescope reproducer, suitable for simultaneous, three-channel transmission, using triplicate equipment. In terms of Figure 4, such transmission would involve three separate 4-megacycle low-pass filters, as well as a scan-synchronizing link, connecting camera directly to reproducer. At the time, no simultaneous-signal camera was built, so no complete-system, simultaneous-channel tests were then made.

These early tests were made at a time when black-and-white television service was in its inaugural period. World War II not only put a stop to the initiation of regular television service, but also enforced a moratorium on development of color television.

Experiments on color television were resumed immediately after the war. Color cameras and reproducers using three full-band simultaneous channels were then built and tested successfully.⁷ Use of three full radio-frequency channels, however, was recognized to be intolerably wasteful of spectrum. When the experiments of Bedford⁵ made evident some of the limitations of vision, a more advanced simultaneous-transmission system, which permitted more economical frequency-division multiplexing, was tried. This was demonstrated by RCA, in 1946 and 1947, to the Federal Communications Commission and others. Figure 7 shows the system then proposed, using a technique called "mixed highs" for band saving. At frequencies above 2 megacycles, the only information transmitted was a single signal, combining green and red picture detail, sent on the "green" channel only. No blue information at all was sent in the 2- to 4-megacycle band, because the blue contribution to fine detail is hardly visible, and the blue contribution to luminance is very small.

The composite signal on the "green" channel was intended to be used alone as a monochrome signal, to render a fully compatible black-and-white service. Figure 8 shows the spectra of the signals in the respective channels; using one standard channel for the composite "green" or "achromatic" signal, the red and blue signals could readily be frequency multiplexed on one additional channel. The system had limitations: its requirement of two regular 6-megacycle channels was excessive, while the broad-area red blindness of the composite channel was found to lead too often to rather poor tone rendition in "black-and-white reception, and caused the black-and-white reproduction to

⁷ R. D. Kell, G. C. Sziklai, R. C. Ballard, A. C. Schroeder, K. R. Wendt, and G. L. Fredendall, "An Experimental Simultaneous Color-Television System," *Proc. I.R.E.*, Vol. 35, pp. 861-875, September, 1947.

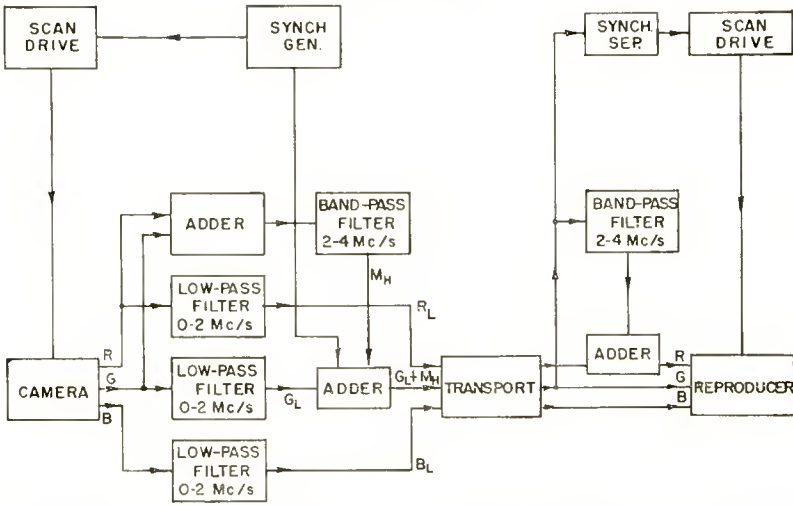

Fig. 7—A simultaneous-transmission system using “mixed highs” for band saving.

be rather disconcerting in the special case of broad all-red subject areas having fine detail.

Nevertheless, the system was a technically workable one, which could have been put into use in the ultra-high-frequency channels without disrupting black-and-white service, and its limitations other than extravagant channel use were easily remediable (provided two radio-frequency channels could be kept identical as to propagation vagaries).

“Mixed highs” is a term that might readily give rise to the idea that detail will be rendered in some confused fashion. This is not the case, and the concept will carry on through most of what follows, so some discussion of what actually happens is in order here, even though the particular system is not presently of practical importance.

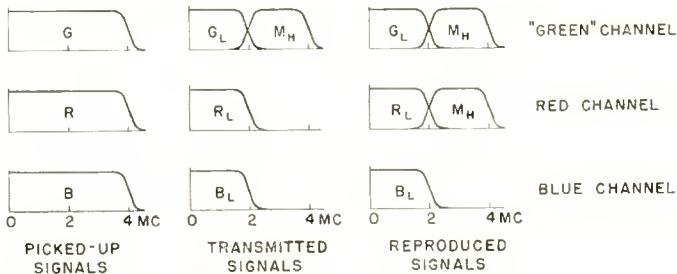

Fig. 8—Spectra of the signals in the simultaneous-transmission system.

First, it is necessary to note that any signal put out by a high-pass filter must be purely alternating, without any d-c component. Consider a purely white or gray subject. The color system of Figure 7 rendered the broad areas of such a subject correctly as to luminance and absence of hue. Fine-detail information gave a purely alternating signal applied to the green and the red reproducer tubes only, and so was reproduced as variations of yellow light. The broad-area average light output, on which the fine-detail variations were superimposed, was not tinted. Reduction of yellow-light component output alone in reproduction left dimmer-than-average details with a slightly bluish tint, while increase of yellow reproduced brighter-than-average details with a slight yellowish tint. These imperfections of physical light-pattern reproduction were exactly the ones found by research on vision to be least perceptible in fine detail, and did not result in any noticeable imperfection of visual sensation given by the reproduction.

Yellow areas were given physically as well as visually perfect reproduction, even as to fine detail. Pure blue areas were reproduced with no fine detail at all in the particular system shown in Figure 7. Green subject areas were reproduced correctly as to green light, even down to somewhat weakened fine detail. The pure alternating signal fed across to the red reproducer for a green subject, however, suffered kinescope rectification, so that, while dimmer-than-average details were reproduced only in green, brighter-than-average details got some red light added, so were reproduced at correct luminance level, but in green with a slight yellowish cast. Likewise, in broad red subject areas, dimmer-than-average details were reproduced in pure red, with somewhat reduced dimming, while brighter-than-average details got some added green, giving correct brightness increase, but a slight orange cast. Again, these are just the right physical defects to cause no noticeable impairment of color-detail sensation.

Development effort in the actual field of color television at RCA, during the following two years, was directed toward necessary improvement of terminal equipment and study of basic concepts of compatible high-performance systems capable of operating at reduced channel widths. The terminal equipment improvements included color cameras and slide scanners, with associated studio control equipment (including "masking amplifiers," or bipolar channel-mixing matrices),⁸ as well as three-kinescope color reproducers. Preliminary tests were

⁸ W. H. Cherry, "Colorimetry in Television," *RCA Review*, Vol. VIII, pp. 427-459, September, 1947.

also made of some proposals for color reproducers using only a single picture tube, and proposals for the application of level-division multiplexing to color-picture transmission were set forth.

Wholly independently, development of exceptionally fast time-division multiplex was actively in progress in groups within RCA concerned with communication systems in general. The need for economy of channels was universally becoming strikingly evident. This basic work in the communications field became the practical springboard of experience for moving forward with the developing concepts for color television.

The Period of the 1949-1950 FCC Hearings

During the early part of 1949, RCA proceeded to narrow its research to the most promising system for color television, with the objective of maintaining high-definition pictures and compatibility while keeping within a 6-megacycle channel. In mid-1949 the Federal Communications Commission called for an early showing of the then existing color television art, with particular regard to channel economy and to system compatibility with existing black-and-white service. The notices of this hearing naturally accelerated RCA's work on defining an all electronic, compatible color television system in order that RCA might be prepared to give as comprehensive a report as possible during the course of the FCC proceeding.

Radio Corporation of America began a careful review of the status of all color television developments known to it. This included a repetition of earlier tests of field sequential methods which soon gave the old answers—either intolerable flicker or complete inability to produce any picture on any of the black-and-white receivers in service. The acuteness of the television channel shortage was by that time fully evident and it had already become obvious that the wide channels needed for simple simultaneous transmission were not obtainable.

Radio Corporation of America wholeheartedly endorsed the conditions set up by the FCC in its notice of hearing that transmission should be within a 6-megacycle channel and that the color transmissions should provide service to the existing black-and-white receivers. These conditions RCA considered as necessary features in any practical color television system.

Status of fast time-division multiplex development was reviewed, in the light of earlier proposals for picture-element-sequential color transmission. It was decided that the fast-multiplex art was ripe for

successful application to television. Proposals for level-division multiplexing, or "quantizing," were also reviewed. The road to successful application here looked much longer. Nevertheless, experimental development of the most promising of the quantizing proposals was undertaken as insurance against possible difficulties in applying the simpler time-division approach.

Tests were also undertaken to provide first-hand familiarity with a line-sequential color television system, at that time actively proposed by another organization. Figure 6 again applies: it was only necessary to drive the synchronous commutators at 5250 revolutions per second to make and hold one contact for each line. This switching was fast enough to require electronic means for its accomplishment, but slow enough to pose no technical difficulty. As in the field-sequential case, no flexibility to apportion color information to meet the needs of vision seemed possible. Trials were made of several line-interlace schemes, using standard black-and-white scanning frequencies. Results were always the same: either the line structure was very coarse, or excessive flicker appeared, manifesting itself as very annoying line jitter or line crawl. Flicker effects were not as bad, however, for line-sequential as for field-sequential transmission at the same scan frequencies.

Figure 6 is also descriptive of element-sequential time division: for that, it was only necessary to drive the synchronous switches together at, for example, $2\frac{2}{3}$ million revolutions per second, electronically of course. This caused 8 million sharp, completely independent "samples" of the signals from the color camera to be applied per second to the 4-megacycle transmission channel, just loading that channel fully. By so driving the electronic time-division commutators that picture-dot interlace occurred (that is, at exactly an odd multiple of half the line-scan frequency), color-frame frequency could be reduced to $\frac{1}{2}$ the black-and-white value. Color-picture detail could thus be kept up to $\frac{2}{3}$ the value attained in normal black-and-white television, despite the 3-way division of channel time. Separate handling of each picture element gave flexibility for future improvement in matching color-detail transmission to the needs of human vision.

In mid-July of 1949, very creditable color pictures were produced by the above system. Confirmation of the decision that fast-multiplex methods were ripe for application to television thus came about very rapidly indeed. Normal, unmodified black-and-white receivers showed a normal black-and-white picture on the element-sequential color signal, and unmodified element-sequential color receivers showed a normal

black-and-white picture on the standard black-and-white signal. Successful operation of this fully-compatible color system in a six-megacycle channel, with both black-and-white and color reproduction, was a major event in the history of television. That the element-sequential system required circuit techniques regarded at the time as very advanced caused little dismay; accumulating experience and development have a way of making such things easy.

Problems requiring attention in the system as first tried were: excessive dot size, making residual flicker unduly perceptible as crawling dot structure in the picture, and reduction of resolution to $\frac{2}{3}$ that of normal black-and-white television. This was about the resolution usual in black-and-white transmission over the existing intercity

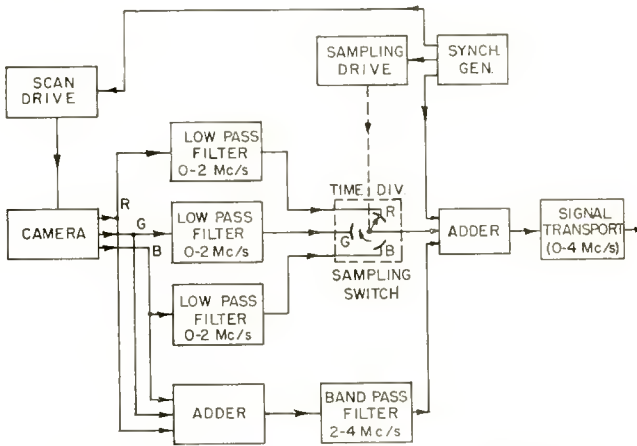

Fig. 9—Early element-sequential transmission system.

coaxial cables. The first trouble was alleviated by raising the sampling frequency, the frequency of complete revolutions of the commutators of Figure 6, from $2\frac{2}{3}$ to over $3\frac{1}{2}$ million per second. For the second defect, a mixed-highs signal was bypassed around the sampling commutators at the originating terminal, as shown in Figure 9. Increased sampling frequency meant that over $10\frac{1}{2}$ million samples per second were being impressed on a 4-megacycle channel, which was only capable of accepting 8 million of them without crosstalk. Resulting crosstalk, which was in the nature of color fringes at sharp, vertical color-contrast edges, was not found visually objectionable at that time, and the improved appearance resulting from the smaller dots was fairly marked. With sharp samples impressed on the reproducer, true additive dot interlace occurred in the reproduced pictures.

Synchronization of the time-division multiplexing "samplers" was initially done by way of extremely accurate timing of the trailing edge of the normal line-synchronizing pulse. This worked well in the laboratory, but did not prove rugged enough to continue working well in the face of the many sources of disturbance in field operation. An alternative method, utilizing a "burst" of several cycles of a signal at sampling frequency transmitted during the latter part of the line-retrace blanking signal, provided much firmer synchronization. Burst synchronization has, in fact, proved adequate in field use, even in the presence of strong interference.

Demonstrations were given in October, 1949, by RCA to the Federal Communications Commission and others, with the system of Figure 9, using pulse-edge synchronization and a sampling frequency of about 3.8 megacycles. Comparative tests, in November of 1949, were made with the same system, but at a sampling frequency of about 3.6 megacycles. Comparative tests in February of 1950 again used the same system, but this time with the more stable burst synchronization and at 3.583125 megacycles (455 dots per complete line). At this time, also, circuit stability had been improved by doing the electronic multiplex switching, or signal sampling, directly at the picture tubes of the three-tube reproducer.

Microwave relays going into service in 1949 and 1950 were able to transmit the RCA color signal from city to city without trouble, and new coaxial cables were expected also to have this capability. Existing intercity coaxial cables, however, were limited in bandwidth to less than 2.7 megacycles, and were unable to pass the 3½-megacycle sampling frequency. Special signal-processing terminal equipment, which cut picture detail to ½ (as compared to almost ¾ in coaxial handling of black-and-white), and employed reduced sampling frequency, proved able to pass a useful color signal over the existing cables, and to reconstitute it for normal radio use afterward. Such cable-terminal equipment was demonstrated in April 1950.

Reproducers using an assembly of three picture tubes and two mirrors were used in the RCA demonstrations of 1949 and early 1950. As soon as the practicability of a compatible transmission system was well assured, however, intensive effort on a large scale was applied to the problem of making practical a single picture-reproducing tube, capable of giving full-color pictures. Tubes using several different principles were made and tested. The story of these tubes is a very considerable one in itself,⁹ but is not a part of this story of system development.

⁹ "Direct-View Color Kinescopes," a series of eleven papers, *Proc. I.R.E.*, Vol. 39, pp. 1177-1263, October, 1951, and *RCA Review*, Vol. XII, pp. 445-644, September, 1951.

One type showed promise of becoming producible more rapidly than the others, so samples of two versions of this "shadow-mask" tube were built into receivers, and demonstrated by RCA to the Federal Communications Commission and others in March and April of 1950.

Extensive cochannel and adjacent-channel interference tests, using radio-frequency transmission, were made on standard black-and-white, field-sequential color, line-sequential color, and element-sequential color systems.¹⁰ No substantial difference was found among the various possible system combinations, from the standpoint of channel allocations.

Another activity intensified by RCA in the Summer of 1949 was the analytical study and comparison of proposed systems. This soon began to reveal many possibilities of further development and refinement inherent in the original element-sequential system. For one thing, it led to study of recent literature on vision, with recognition of the two-color nature of medium-detail vision, and of extensions of the mixed-highs principle thereby implied. It also led rapidly to recognition that the transmitting sampler of Figure 9, with its filters, was the exact equivalent of a set of three ordinary balanced modulators, each having a direct video-signal bypass, and each modulating a suitably phased sinusoidal subcarrier. Either scheme could produce just the same signal in the common transmission channel, the channel-bandwidth limitation leaving no sharp dots in either case. On the other hand, if the receiving sampler were replaced by video-bypassed modulators and filters, the positive dot interlace occurring on the reproducer-tube faces with sharp sampling was found to be replaced by a negative or error-cancelling interlace. Somewhat less dotted reproduction could thus be obtained.

Our study of the information content of the composite color signal quickly made it evident that two balanced modulators plus a single direct bypass channel would suffice for the entire signal-processing job, at either the originating or the reproducing terminal. Many ways of apportioning the required information among these three channels were evident. Several of these ways permitted avoiding crosstalk due to excessively frequent application of signal samples to the band-limited transmission channel. The very simple scheme of Figure 6 amounted to one symmetrical but rather inflexible choice of apportionment of information. The scheme of Figure 9 was the beginning of greater flexibility.

Results of these basic studies were not demonstrated experimen-

¹⁰ RCA Laboratories Division, "A Study of Cochannel and Adjacent-Channel Interference of Television Signals," *RCA Review*, Vol. XI, pp. 99-120 and 287-295, March and June, 1950.

tally during the period of the hearings. They did, however, lay a groundwork for much experimentation done since. Detailed studies were made of the way in which sharp sampling dissected and reconstituted the color picture, and in which excessively fast sampling led to crosstalk.¹¹ Results of these studies were presented to the Commission during the hearings.

May 1950 through December 1951.

Presence of a physical dot structure in the fluorescent screen of the single-tube, shadow-mask color reproducer could give rise to moiré patterns in the reproduced picture when sharp-dot samples were applied to such a reproducer. This indicated a probable advantage in signal filtering and negative interlace, theretofore regarded as merely an equivalent alternative to sharp-sample time sharing. Complete separation of video bypassing from sampling was also previously considered an equivalent alternative. This had been found practically advantageous in experiments carried out independently by Hazeltine Electronics Corporation.

The system of Figure 10 was, therefore, tried by RCA soon after the close of the hearings. It may be noted that, at the originating terminal, the change from Figure 9 to Figure 10 involved only the shifting of one band-pass filter from one signal path to another. Yet this single rearrangement resulted in handling the direct mixed-video monochrome signal quite separately from the added color signal, over the entire video band. This gave new freedom of control, while still producing exactly the same composite signal for transmission as did Figure 9. Somewhat greater changes at the reproducing end gave similar freedom there, while at the same time filtering out as much of the sampling structure from the reproduced color signals as possible. This reduced shadow-mask moiré effects.

The system of Figure 10, used during the Summer of 1950, was found to handle more conveniently than the earlier arrangements. Distinction between sharp sampling and subcarrier modulation, important under some circumstances in the basic element-sequential, time-division system of Figure 6, was already vestigial in the originating terminal of Figure 9. Because of the smoothing action of the filters shown, such distinction was entirely gone from both terminals in Figure 10. Choice between classical sharp-sampling commutators and sinusoidal modulators had thus become merely a matter of convenience.

¹¹ RCA Laboratories Division, "An Analysis of the Sampling Principle of the Dot-Sequential Color-Television System," *RCA Review*, Vol. XI, pp. 255-286 and 431-445, June and September, 1950.

Operation of modulated-subcarrier color systems is perhaps most readily understood in terms of the basic arrangement of Figure 11, in which signal paths are clearly separated. Here, the three camera signals, representing three primary-color components of the subject viewed, are mixed in appropriately chosen proportions to give three composite signals, each of which is filtered to an appropriately chosen

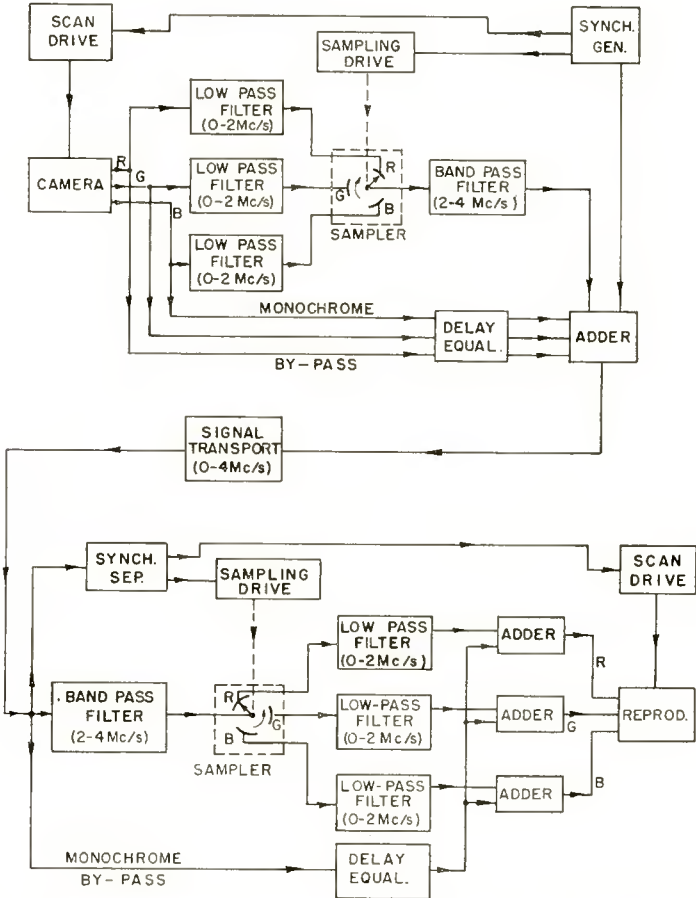

Fig. 10—A simultaneous-transmission system using complete monochrome bypass.

bandwidth. One composite signal, representing black-and-white picture information, is handled directly, as in an ordinary monochrome television system, while the other two, representing chromaticity information, are used to modulate, in balanced fashion, two suitably phased, sinusoidal subcarrier signals. After suitably filtering the two modulated-subcarrier color-mixture signals, these are added to the direct

signal to form for transmission (by radio or otherwise), a single composite signal, the complete color-television signal.

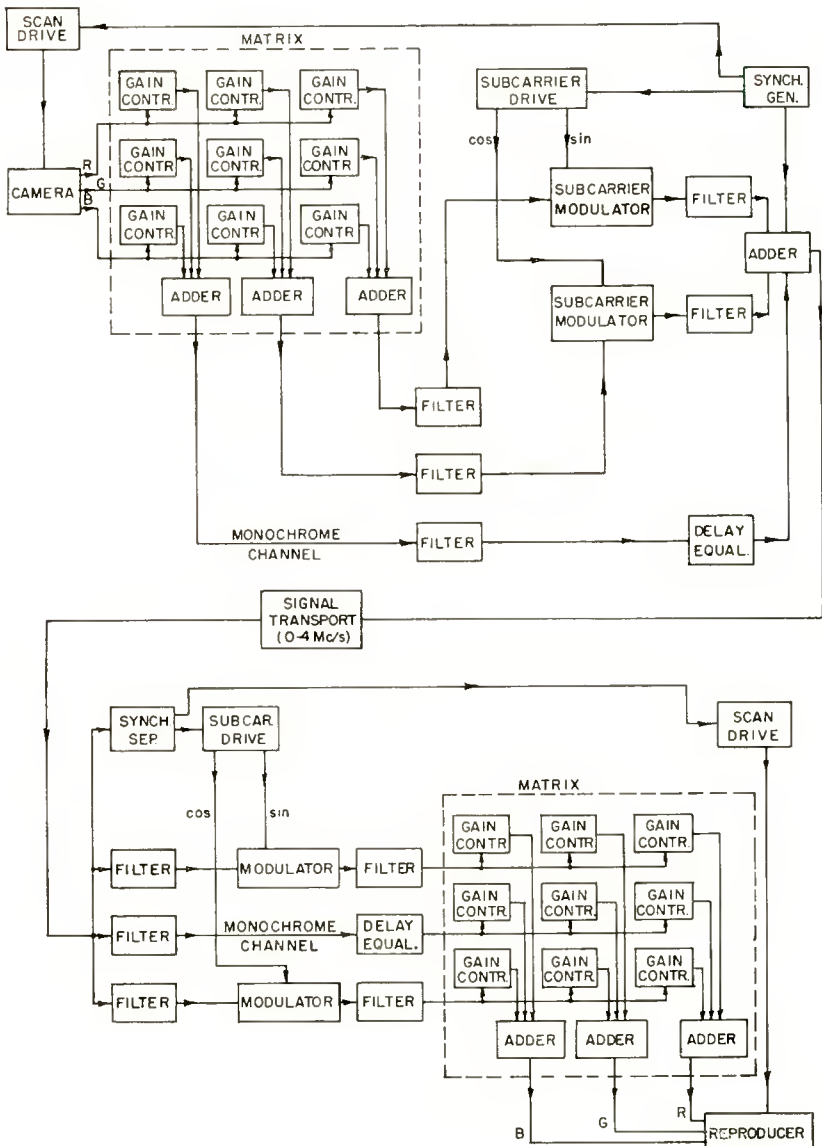

Fig. 11—A basic modulated-subcarrier color television system.

At the receiving terminal of Figure 11, the incoming composite signal, suitably filtered in each case, is used to modulate two suitably

phased sinusoidal subcarriers, as well as being passed on directly in a monochrome channel. The two chromaticity signals recovered by this second modulation process, after filtering, are added in appropriately chosen proportions to the direct-path composite signal. Thus, three primary-color control signals are recovered, for use as reproducer inputs.

Nine independent gain settings are involved in deriving three independent mixed-color signals from three primary-color camera outputs at the originating terminal. These gains may involve some negative values—that is, signal-polarity reversals. A similar nine-control gain matrix is involved at the receiving terminal. Camera-channel levels will be assumed hereafter to be so chosen that a white subject produces equal voltages at all three camera outputs. Similarly, reproducer-channel levels will be assumed so chosen that equal voltages applied to all three reproducer inputs result in white-light output from the reproducer. As mentioned in the earlier discussion of colorimetry, choice of a “reference white” is itself arbitrary, but once such a choice is made, the stated level relations become fully meaningful.

Each of the filters shown, in addition to its intended function of shaping the spectrum of the signal passing through it, also subjects that signal to a time delay. Filter delays must be so chosen or compensated that the signal from each camera output suffers the same delay in reaching the corresponding reproducer input, whatever path it follows through the system of Figure 11.

So far as the originating terminal is concerned, all system tests made by RCA since introduction of the mixed-high system of Figure 9, in the early Fall of 1949, have been direct equivalents of choosing various gain settings, filter pass-band limits, and subcarrier phase conditions in the single basic system of Figure 11. As regards the receiving terminal, the same is true of all system tests made by RCA since introduction of the output filters of Figure 10, in the late Spring of 1950.

Two modulators, as indicated in Figure 11, suffice to do all that can be done. Use of three modulators, with a single input channel feeding each one, is a particularly obvious equivalent of the three-position time-division commutator of Figure 6. Actually, however, such a three-modulator arrangement amounts simply to a way of taking advantage of the vector properties of polyphase modulators, to get control of two independent mixed signals by using three gain controls and three subcarrier-phase controls. This is alternative to the six gain controls feeding two modulators shown in Figure 11. Independent control of the two mixed-channel bandwidths, however, is not fully available when

using three modulators, so long as each of them has only a single-camera-channel input. Both two-modulator and three-modulator forms have been tested, and the former have proved more convenient in practice.

If three single-input modulators are run symmetrically as to carrier phase, as in Figures 9 and 10, certain rather special properties result, but freedom of control of the two mixed channels resulting is then very limited. To make the composite transmitted signal and the reproducer-input signals the same in the case of Figure 11 as for Figure 10, it would only be necessary to give the originating-terminal

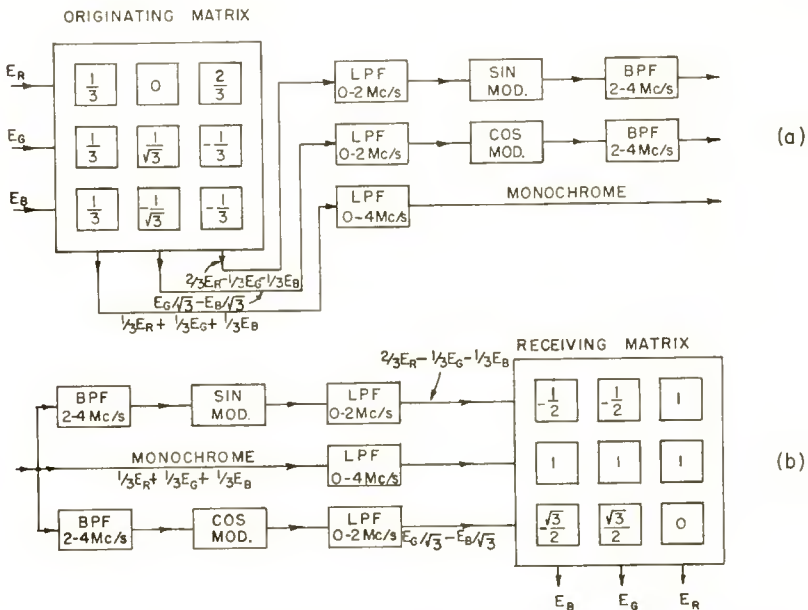

Fig. 12—Filter pass bands and matrix gain settings which make Figure 11 the equivalent of Figure 10.

gain matrix the settings shown in Figure 12(a), and the receiving-terminal matrix the settings of Figure 12(b), with filter pass bands also as shown.

Checking through the result of the settings shown in Figure 12, one finds that the signals applied to the red, green, and blue reproducer-input channels remain equal, respectively, to the signals on the red, green, and blue camera-output channels. This is true whatever those outputs may be, so long as the three channels remain free of crosstalk. Graphical representation of the modulated two- and three-phase subcarriers by rotating vectors, or phasors, which will be dis-

cussed later, can be helpful in visualizing the signal relationships between Figures 10 and 11.

Unity gain settings in Figure 12(b) between monochrome input to the receiving matrix and all three of its outputs should be noted. This feature has made possible the custom of applying the monochrome signal directly to all three grids of the color kinescope, with the remaining signal components applied separately to the three cathodes. Signal additions take place within the kinescope by the joint control action of grids and cathodes on the three electron beams. The external matrix actually used then comprises only the remaining six elements of Figure 12(b), the ones fed by the chromaticity signals. Matrix settings for other systems, to be shown later, retain this direct-monochrome feature.

Differences between areas of various colors are least apparent when such areas look equally bright, as mentioned earlier. Workers in the laboratories of Hazeltine Electronics Corporation pointed out early in 1951 that certain adjustments of systems having the capabilities of Figure 11 permit taking advantage of the above fact. What is required is that the output of each receiving-terminal modulator shall be fed to the three reproducer inputs in such proportions and polarities that it cannot alter the net luminance but only the hue and purity of the total reproducer light output.

Such constant-luminance operation results in minimum visual annoyance from interfering signals which reach the receiving modulators along with the modulated-subcarrier components of the desired signal. Flicker due to removal by cancelling interlace of the monochrome signal applied to these modulators is particularly sharply reducible in this way. Appendix C shows that constant-luminance operation necessarily results if the composition of the monochrome signal is so chosen as to represent subject luminance. System amplitude nonlinearities seriously limit the practical utility of the constant-luminance principle.

Certain spectrum properties of the system, evident from Figure 11, need to be borne in mind. Call the upper cutoff frequency of the transmission channel f_c , and the subcarrier frequency f_s . Modulation of the subcarrier by picture components of frequencies from zero to $f_c - f_s$ then results in double-sideband modulator output. This is the condition for the doubly cross-hatched regions of the spectrum diagrams of Figure 13. Modulation by picture frequencies exceeding $f_c - f_s$ produces only single-sideband useful output from the modulators, since the final transmission channel does not pass any upper sideband so produced. This condition exists for the singly cross-hatched regions of Figure 13.

In the double-sideband region, two independent signals can be handled without crosstalk. This requires first that, at the originating terminal, the two subcarrier signals, modulated directly by the two mixed-video signals which are to be kept separate, shall be, respectively, sine and cosine functions of time. Second, it is required that the two subcarriers, modulated at the receiving terminal by the combined output of the originating modulators, shall follow, respectively, time functions identical to the corresponding ones at the originating terminal. The two recovered signals will then be accurate and independent reproductions of the two original signals. In single-sideband operation, input to either originating-terminal modulator results in output from both receiving-terminal modulators, whatever the subcarrier phases used. This represents crosstalk. Signal components at frequencies

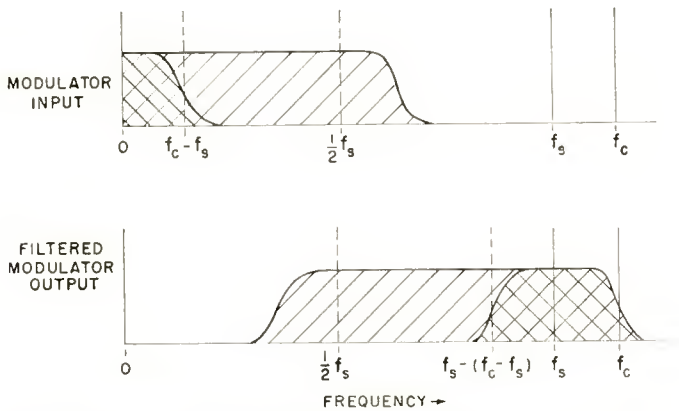

Fig. 13—Spectra of the signals in the system of Figure 12.

producing single-sideband modulation should be given twice as much gain as components which produce double-sideband modulation, to make up for attenuation due to loss of one sideband. This is a matter of properly shaping the amplitude characteristics of the filters at the outputs of the receiving-terminal modulators of Figure 11.

With f_c at about 4 megacycles and f_s about 3.6 megacycles, as they were in using the system of Figure 10, color-video components above about 0.4 megacycle produced single-sideband modulation, with resulting crosstalk. By the Summer of 1950, technical system performance was otherwise good enough to make this crosstalk annoyingly perceptible as discolored fringes following sharp, vertical color-contrast edges. Two methods of minimizing damage done by such crosstalk have been field-tested. The more complex method was tried first, and will be described first.

If the polarity of the subcarrier applied to one modulator at the originating terminal, and to the corresponding modulator at the receiving terminal, for example the cosine modulators of Figure 11, is reversed between successive picture fields, crosstalk effects will exactly reverse between adjacent, interlaced lines of the complete picture. Such breaking up of the crosstalk should enable the viewer's vision to respond only to its average, which is zero. Reversals may be made, alternatively, between successive lines of each picture field, with very similar visual averaging. Reversal of one subcarrier polarity in the two-modulator case corresponds to reversal of the order of subcarrier-phase progression in the three-modulator case.

These expedients for minimizing crosstalk damage, while still permitting crosstalk to occur, have been called "color-phase alternation," or CPA. Use of CPA should, in principle, permit full single-sideband operation. As the subcarrier frequency f_s is raised toward the main-channel cutoff frequency f_c , however, the width of the alternating-polarity vertical crosstalk bar following each sharp vertical edge must increase. CPA also has another effect. Errors in phasing of receiving-terminal subcarriers, relative to those at the transmitter, normally result in wrongly colored reproduction. CPA causes color errors of this sort to reverse periodically, so that the observer may disregard them on the average, and phase synchronization should thus be rendered less critical.

In addition to a readily acceptable coarsening of vertical color detail, without loss of brightness detail, the price of reducing crosstalk damage by CPA is a modified flicker pattern. Crosstalk bars flash as solid areas at one-half of field frequency if reversals are made between fields, or flash as line segment at one-quarter of field frequency if reversals are made between successive lines. Phasing errors result in similar flashing of entire solidly-colored areas.

Extensive tests have been made of several system modifications using color-phase alternation. Initial trials, early in 1951, involved merely some modification of the color-sampling drive in the system of Figure 10, to provide the needed reversals of color sequence. This resulted in an impressive improvement of color reproduction.

By early 1951, the National Television System Committee was actively engaged in a consideration of a signal choice for compatible color television. After extensive study of the work already done, certain panels of this committee set to work to produce system specifications for field testing. RCA has contributed heavily to the work of the NTSC, both in its initial studies and in the continuing work of its

panels. A set of signal specifications for field testing was completed by NTSC late in 1951 and released for publication on November 26, 1951. These signal specifications used color phase alternation, constant luminance, and a subcarrier frequency of 3.89 megacycles. Gain settings for Figure 11, to realize the specified signal, are shown in Figure 14. The monochrome signal resulting from these settings represents subject luminance, as shown in Appendix D, assuring constant-luminance operation.

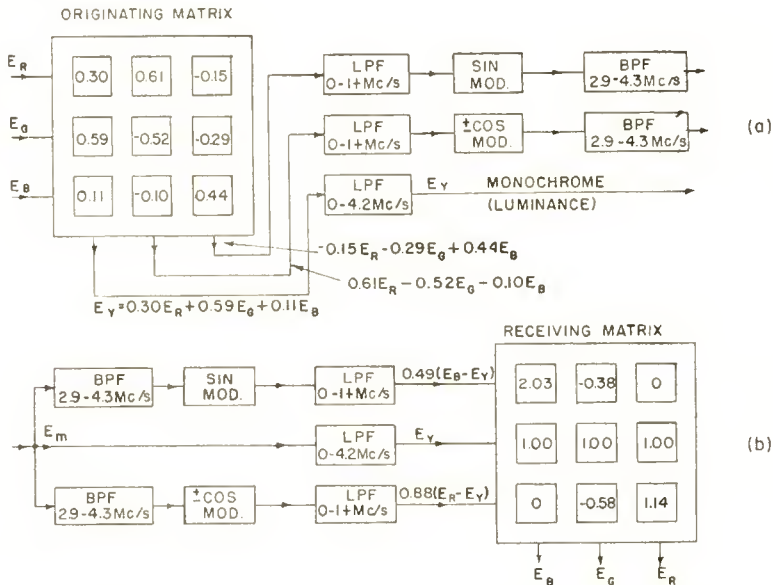

Fig. 14—Filter pass bands and matrix gain settings for the NTSC signal specifications of November 26, 1951.

1952

When the signal specifications of November 26, 1951 were adopted by the NTSC, RCA promptly began extensive field testing of the specified signal, and of the equipment necessary to radiate that signal and receive it in color. During 1952, RCA carried on four parallel lines of system investigation, two of them as parts of these field tests. First, extensive field testing with color receivers indicated that a lower subcarrier frequency was likely to produce better color pictures with greater stability. Therefore, studio equipment and receivers were provided so that three separate color signals could be generated and received. These three signals were alike except for the frequency of the color subcarrier. The subcarrier frequencies used in these tests

were 3.898125 megacycles, 3.740625 megacycles, and 3.583125 megacycles. Extensive observations confirmed our feeling that the lowest subcarrier frequency produced the best color pictures.

Secondly, a large amount of time was devoted to compatibility tests to assure ourselves that the many types of black-and-white receivers in use would perform satisfactorily on the new signal. These compatibility tests were performed in two ways—one by gathering a large number of representative receivers for observation by skilled observers and the other by broadcasting the signal and soliciting audience response. A small number of black-and-white receivers showed a slight disturbance in the received picture which was traced to the presence of the color-subcarrier burst in the synchronizing signals. The difficulty was overcome by a slight change in the character of the burst, involving removal of the low-frequency pedestal component that had been a part of the burst. The validity of this solution was verified by further field tests. It had also been observed that on a few black-and-white receiver types, a beat between the color subcarrier and the sound carrier appeared as a series of wavy lines. Again, corrective measures were applied. The solution in this case was brought about by lowering the subcarrier slightly, approximately thirty-five hundred cycles, thus reducing the beat to low visibility by applying the frequency-interlace principle. Extensive on-the-air broadcasts fully justified this "offsetting" of the color subcarrier.

When it became apparent that improved color reception could be obtained with a lower subcarrier, another series of compatibility tests by skilled observers and by audience response showed that no loss in compatibility was to be expected if a lower subcarrier were used. Hence, two distinct series of tests first shifted the color subcarrier from 3.898125 megacycles to 3.583125 megacycles to secure better color pictures (a relatively large change in frequency) and then shifted the subcarrier to 3.579545 megacycles (a relatively small change in frequency) to secure greater compatibility.

Third, work on methods and apparatus for transmission of color signals over limited-band coaxial cables continued through 1951 and 1952. A very straightforward method of accomplishing the necessary signal conversion was found and successfully developed.¹² This involves low-pass filtering of the composite color signal, to provide a 0 to 2 megacycle monochrome signal, and band-pass selection from the composite signal of the frequency region within plus or minus 0.3 megacycle of the color subcarrier. The narrow-band color signal so obtained,

¹² J. G. Reddeck and Howard Gronberg, "Network Transmission of Color Television Signals" (Accepted for publication in *Electronics*).

including the synchronizing burst, is heterodyned to center on a new subcarrier frequency, near 2.4 megacycles, which bears an exact fractional relationship to the original subcarrier frequency.

A composite color signal able to pass through 2.7-megacycle cable results from adding together the narrowed monochrome and heterodyned color components. Reversal of the heterodyning process, with appropriate filtering, reconstitutes at the far end of the cable a composite color signal entirely normal except for reduced detail. Such a system was first used in September, 1951; numerous successful demonstrations of cable transmission by improved versions of this method have been given since then.

Results of experience in the field with the NTSC signal during 1952 indicated that, in practice, effects due to single-sideband use of CPA rendered color reproduction less than fully satisfactory. Color-edge flicker was excessive, particularly at high reproducer luminance levels. Color-area flicker prevented CPA from markedly relaxing subcarrier-phase tolerances. At its best, the system produced very good pictures, and the technical shortcomings might have been accepted had no alternative been available.

The fourth line of investigation followed by RCA during 1952 stemmed from earlier analytical studies, centered on the problem of making the signal structure fit closely the characteristics of human vision. These studies had already indicated, in the Fall of 1949, the possibility of crosstalk-free, sharp-sampling color systems. By mid-1950 further study had shown how to adapt such schemes to modulated-subcarrier use, providing an attractive alternative to CPA.

This alternative approach employs:

1. Full-band transmission of the bypassed luminance-only signal.
2. Moderately wide-band, partly single-sideband transmission of a single color mixture signal distinguishing, for example, slightly orange red from blue-green.
3. Narrow-band, double-sideband transmission of an additional color-mixture signal distinguishing, for example, green from purple.

Suitable choice of gain settings and filter pass bands in the basic system of Figure 11 immediately gives just such operation. No crosstalk is generated, because no attempt is made to transmit more information than the system can handle. Application of this approach to studio and receiving equipment provides the benefits of color-phase alternation, while rendering actual alternation unnecessary. The constant-luminance property may be retained.

Considerable flexibility is inherent in the system obtained by adjusting the equipment of Figure 11 according to the above rules. So long as only frequencies below $\frac{1}{2} f_s$ are used to modulate the major or wider-band chromaticity channel, the modulator input and output filters indicated in Figure 11 can prevent any direct feed of modulator-input signals to modulator-output circuits. In principle, however, the bandwidth of the major chromaticity channel can have any value up to f_s , without ill effect, in particular without crosstalk, giving increased fineness of two-color detail that might perceptibly improve color-picture reproduction. Filters alone cannot separate desired modulator output from input, for input bands between $\frac{1}{2} f_s$ and f_s , as may be seen from the spectrum overlap in Figure 13. For such operation, modulators must be balanced against the video input signal, as well as (at the originating terminal) against the subcarrier input itself.

Another sort of flexibility has been made available to the receiving-terminal designer by the development of the circuit shown in Figure 10. By limiting the input signal to the modulators to frequencies above $\frac{1}{2} f_s$, with the bandpass filter, much of the energy in the monochrome signal, normally concentrated near the lower harmonics of the line-scan frequency, can be kept from entering these modulators. As a result, the spurious modulator output which has to be removed from the viewer's notice by cancelling interlace, is kept low. By limiting the monochrome-channel signal, with the aid of a low-pass filter, to frequencies appreciably below subcarrier frequency, most of the incoming chromaticity-channel signal energy, normally concentrated near the subcarrier, is prevented from being directly applied to the reproducer. In this way the subcarrier ripple that must be rendered imperceptible by subtractive interlace, as well as the moiré pattern due to beating of that ripple with reproducer-screen structure, are kept low.

Thus the receiver designer can choose for himself the extent to which he wishes to employ interlace cancellation, without requiring limitation of the detail transmitted to others. He can, if he wishes, remove almost all flashing of dot-sized areas at one fourth of field frequency, at the expense of reduction of reproduced detail. It is, in effect, possible to obtain truly simultaneous signals in the monochrome and chromaticity channels with negligible spurious components, thereby giving the designer considerable freedom in use of the signals.

The symmetrical-sampling type of signal obtained by setting the matrix controls of Figure 11 according to Figure 12 can readily be freed of crosstalk. It is only necessary to use filters passing 0 to 0.4 megacycle in association with originating and receiving cosine modulators, in place of the 0- to 2-megacycle filters indicated in Figure 12.

The reproduced-chromaticity locus controlled by the monochrome and wider-band color channels only, then becomes quite similar to the orange-cyan axis shown in Figure 3. The monochrome signal departs appreciably from representing subject luminance, and the system lacks the constant-luminance property. This arrangement should, nevertheless, provide decidedly good color reproduction.

A brief review of the steps leading from the original symmetrically sampled element-sequential system of Figure 6 to the much more refined system given by adjusting Figure 11 as above is of interest. Visually unproductive high-frequency color-detail signals were first removed by the mixed-high bypass of Figure 9, giving more efficient channel use. A separately controllable monochrome channel was then split off by the change to Figure 10, after which the change to Figure 11 replaced three interdependent color-modulation channels by two independent modulation channels. The last increase in freedom of control permits further discarding of unproductive color detail, by proper choice of filters, to clear up crosstalk and still further increase the effectiveness of channel use. Major cumulative improvement in performance has thus been possible with remarkably little change in the basic signal.

Numerous laboratory tests were made during 1952 on systems using graduated bandwidths to reduce crosstalk. These tests indicated that such systems are much less subject to technical difficulties than was the system using vestigial-sideband CPA. Matching time delays in the various filters of differing pass band proved fairly easy of accomplishment and maintenance. Reduction of green-purple contrast in small picture detail proved, as expected, to cause no readily noticeable deterioration of color reproduction. Reduction of color-screen moiré by filtering the subcarrier region out of the luminance signal applied to the color reproducer was found attractive, even at some cost in fine detail resolution. Improvement due to elimination of crosstalk was impressive, as it had been with CPA. Experiments with two different color-mixture signal compositions¹³ showed better results when the major-channel signal corresponded closely with the residual color axis found by Middleton and Holmes,³ in general agreement with Hartridge.

1953 to Date

A crosstalk-free system, using chrominance-channel bandwidths

¹³ R. D. Kell and A. C. Schroeder, "Optimum Utilization of the Radio-Frequency Channel for Color Television," *RCA Review*, Vol. XIV, pp. 133-143, June, 1953.

³ Middleton and Holmes, *loc. cit.*

graduated to the needs of vision, was first demonstrated by RCA to panels of NTSC in the Summer of 1952. These demonstrations led to activity by NTSC which resulted in a new set of signal specifications on which a new series of field tests was based. These "Revised Specifications for Field Test of NTSC Compatible Color Television," released for publication on February 2, 1953, are reproduced in full as Appendix A to this paper.

Matrix gain settings and channel bandwidths required to realize the specified signal with the system arrangement of Figure 11 are shown in Figure 15. Again, a check of the settings given will reveal

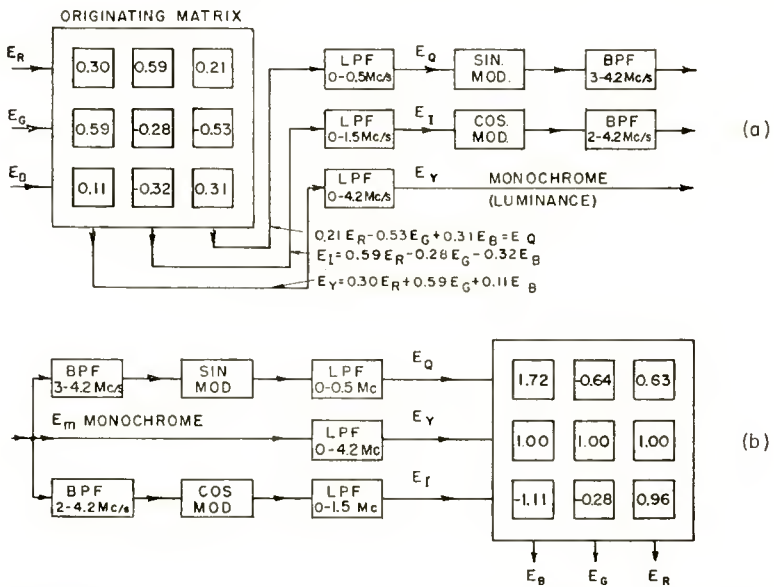

Fig. 15—Filter pass bands and matrix gain settings for the NTSC signal specifications of February 2, 1953.

that, for low video frequencies, the red, green, and blue-channel reproducer inputs remain equal, respectively, to the corresponding camera outputs, to give true three-color reproduction. More sudden color changes, for which only single-sideband transmission is available, can be found to be reproduced as chromaticity increments approximately along the desirable orange-cyan line indicated on Figure 3. The monochrome-channel signal is again proportioned to represent approximately subject luminance.

Linearity of the transmission system has so far been assumed throughout this narration. Actually, however, kinescope light-control

characteristics are quite nonlinear, and allowance for this is necessary. Both sets of NTSC signal specifications make such allowance by requiring compensatory nonlinear devices, or gamma-correcting amplifiers, to be interposed directly at the camera outputs of Figure 11. This arrangement gives a signal-to-noise advantage by compressing the dynamic range of the transmitted signal. Because filters and subcarrier sources are present between the gamma compensators and the kinescopes, however, complete compensation of kinescope nonlinearity is not possible in this way. Nor does such an arrangement give properly gamma-corrected black-and-white tone gradation. Freedom of the designer in applying widely different color cameras or color reproducers is somewhat restricted by this method of compensating for color-kinescope nonlinearity.

Kinescope control characteristics usually approximate a power law. Light output varies as something between the square and the cube of the applied video-signal voltage. Gamma correction therefore requires that the signal output from each gamma amplifier should vary as something between the square root and the cube root of the light input to the camera that feeds it. The over-all result, then, is that each color-kinescope light output varies linearly with the corresponding color-camera light input. Both NTSC signal specifications assume a 2.75-power kinescope-control law, and so require a gamma compensator which will combine with the camera to provide a 0.364-power response law. Gain settings given in Figures 14 and 15 apply with these gamma compensations in place.

Test Specification (11) of NTSC (see Appendix A) relates to the trichromatic coefficients of the assumed receiver phosphors. These coefficients enable one to compute the theoretical spectral sensitivities required of the three portions of the color camera.¹ In the embodiment of the camera which uses three separate picture tubes, the spectral sensitivity curves shown in Figure 16 apply to the red, green, and blue tubes together with their respective filters. In practice, the negative responses may be neglected and very good reproduction may still be maintained.

The total video voltage, E_m , corresponding to the scanning of a particular picture element, and applied to the modulator of the radio transmitter, is

$$E_m = E_Y + [E_Q \sin (\omega t + 33^\circ) + E_I \cos (\omega t + 33^\circ)], \quad (1)$$

where

$$E_Y = 0.30 E_R + 0.59 E_G + 0.11 E_B, \quad (2)$$

$$E_Q = 0.41 (E_R - E_Y) + 0.48 (E_R - E_Y) \tag{3}$$

$$= 0.21 E_R - 0.52 E_G + 0.31 E_B, \tag{3a}$$

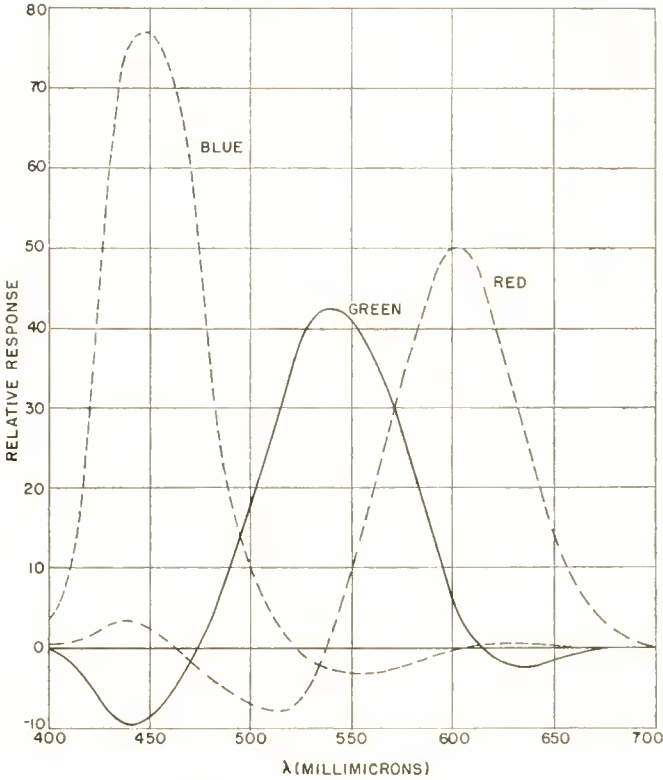

Fig. 16—Spectral sensitivity curves of the color camera, for the receiver reproducer phosphors having the following chromaticities:

	x	y
Red	0.67	0.33
Green	0.21	0.71
Blue	0.14	0.08

$$E_I = -0.27 (E_B - E_Y) + 0.74 (E_R - E_Y) \tag{4}$$

$$= 0.60 E_R - 0.28 E_G + 0.32 E_B. \tag{4a}$$

The voltages E_G , E_R and E_B are signals derived from the green, red and blue signal outputs of the camera, with operations such as gamma-correction performed on the signals before the combinations shown in Equations (1), (2), (3), and (4) are accomplished. These

individual voltages may assume values between zero and unity, depending on the hue and intensity of the light from the area under consideration. Equations (3a) and (4a) define directly the matrix settings of Figure (15a).

Equation (1) shows that the signal contains a main video component E_Y , which Equation (2) shows to be so constructed as to convey only luminance information, and which is capable of producing an excellent black-and-white picture on a conventional monochrome receiver. The chrominance information is carried on a color subcarrier.

The color signals E_Q and E_I are formed from the camera signals according to Equations (3) and (4), then go through individual low-

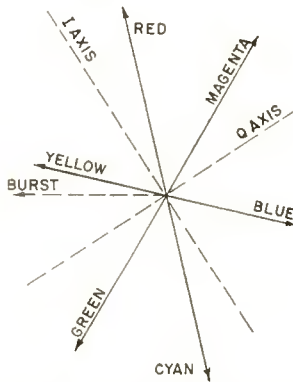

Fig. 17—Phase and amplitude of the total subcarrier for modulating frequencies less than 500 kilocycles.

pass filters whose characteristics are given in Specification (17) before these signals are applied to the encoder to form the signal of Equation (1).

For color signals with frequencies below 500 kilocycles, we may rewrite Equation (1), making use of Equations (2), (3) and (4), and find

$$E_m = E_Y + 0.493 (E_B - E_Y) \sin \omega t + 0.877 (E_R - E_Y) \cos \omega t. \quad (5)$$

Here the signal is expressed in terms of color-difference signals. Figure 17 shows the phase and amplitude of the total subcarrier for the three primary colors, as well as their complements, where the color signals are varying at a frequency less than 500 kilocycles.

When the frequencies of the original color-video signals are well above 500 kilocycles, the first subcarrier term in Equation (1) may be dropped, and the final-term signal due to any single-frequency video

component of amplitude E_i , phase ϕ and frequency f_i (angular frequency β) becomes

$$E_m = E_Y - \frac{1}{2} E_i \sin [(\omega - \beta)t + 33^\circ - \phi]. \quad (6)$$

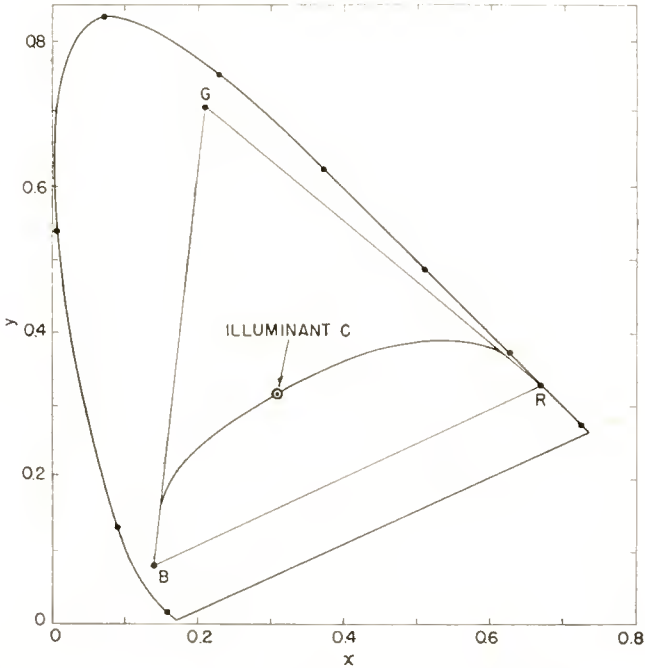

Fig. 18—Reproduction of color detail for the system of Figure 15.

- a. Frequencies below 500 kilocycles reproduce colors over the area of the triangle RGB .
- b. Frequencies between 500 kilocycles and 2000 kilocycles produce hues along the curved line.
- c. Color detail at frequencies greater than 2000 kilocycles reproduce in monochrome (Illuminant C).

The signal specification, making use of the I and Q filters of dissimilar bandwidths, makes possible the reproduction of color detail in three ways, illustrated by Figure 18:

1. Color detail which produces signals of frequency less than 500 kilocycles is reproduced accurately over the entire *area* enclosed by the triangle RGB .
2. Color detail which produces signals of frequency greater than 500 kilocycles and less than 2000 kilocycles is reproduced in

hues which lie along the curved *line* shown on Figure 18. Curvature of this color locus is the result of the amplitude nonlinearity of the gamma correctors and kinescopes.

3. Color detail which produces signals of frequency greater than 2000 kilocycles is reproduced in monochrome (the point on Figure 18 representing Illuminant C), thus making use of the principle of mixed highs.

Field tests by RCA have shown that a modulated-subcarrier color system, using picture-element interlace to reduce permissible picture-repetition frequency by half, and using two different color-mixture channel bandwidths to meet fully the needs of color vision, while avoiding transmission difficulties, gives color-reproduction quality adequate to warrant adoption of such a system.

CONCLUSION

We have discussed RCA work which has been directed toward achieving an adequate, compatible color system and a suitable set of signal specifications. It is important that any set of specifications adopted as standards be neither circumscribed by present-day equipment limitations, nor unnecessarily restrictive, so that the fruits of research and invention may result in more stable performance, better pictures and simpler equipment both at the transmitter and receiver. That is to say, the ceiling performance of the system must be sufficiently high to insure continued equipment improvement without a collision with restrictive standards.

It is of course difficult to disengage the signal specifications from equipment development entirely, since it is the equipment available at the moment which must be used to test the concepts which bring about the growth of the system. Thus the systems engineer must be guided by practicalities which his engineering judgment tells him will not be easily overcome, perhaps for economic or physical reasons, and at the same time he must be able to envisage possible solutions to present obstacles even though the details of the solutions are not apparent at the present time.

Study of the needs of color vision, and of the capabilities of systems using two multiplexed subcarrier channels to add color to a normal television signal, has shown a truly remarkable natural parallelism between them. It is believed that signal specifications which take advantage of this fortunate parallelism will provide a sound basis for adequate service with presently available equipment, and, at the same time, will allow for continued equipment development and improvement within the proposed standards.

APPENDIX A—REVISED SPECIFICATIONS FOR FIELD TEST OF
NTSC COMPATIBLE COLOR TELEVISION*

Test Specifications—Group I

(1) The image is scanned at uniform velocities from left to right and from top to bottom with 525 lines per frame and nominally 60 fields per second, interlaced 2-to-1.

(2) The aspect ratio of the image is 4 units horizontally and 3 units vertically.

(3) The blanking level is fixed at 75 per cent (± 2.5 per cent) of the peak amplitude of the carrier envelope. The maximum white (luminance) level is not more than 15 per cent nor less than 10 per cent of the peak carrier amplitude.

(4) The horizontal and vertical synchronizing pulses are those specified in Section 3.682 of Subpart E of Part 3 of the *FCC Rules Governing Radio Broadcast Services* (as amended April 11, 1952; effective June 2, 1952), modified to provide the color synchronizing signal described in Specification 21 (Group II of these specifications).

(5) An increase in initial light intensity corresponds to a decrease in the amplitude of the carrier envelope (negative modulation).

(6) The television channel occupies a total width of 6 mc. Vestigial-sideband amplitude-modulation transmission is used for the picture signal in accordance with the FCC Rules cited in Specification 4, above.

(7) The sound transmission is by frequency modulation, with maximum deviation ± 25 kilocycles, and with pre-emphasis in accordance with a 75-microsecond time constant. The frequency of the unmodulated sound carrier is 4.5 mc ± 1000 cycles above the frequency of the main picture carrier actually in use at the transmitter.

(8) The radiated signals are horizontally polarized.

(9) The power of the aural-signal transmitter is not less than 50 per cent nor more than 70 per cent of the peak power of the visual-signal transmitter.

* Approved for publication February 2, 1953, by the NTSC Editorial Committee.

The signal specifications reprinted in this appendix were subjected to field testing during the first half of 1953. As a result, minor modifications are to be made in Specification (13) regarding the value of the gamma exponent and in Specification (20) regarding the delay correction and the tolerance on the delay correction. In addition, tolerances on the phase and amplitude of the subcarrier signal for a given saturated primary have been established. However, at the time this paper was written, final action on these changes had not been taken. Since the substance of the signal specifications remains unchanged, the specifications of February 2, 1953, have been reproduced here.

Test Specifications—Group II

(10) The color picture signal has the following composition:

$$E_m = E_Y + \{E_Q \sin (\omega t + 33^\circ) + E_I \cos (\omega t + 33^\circ)\}$$

where

$$E_Q = 0.41 (E_B - E_Y) + 0.48 (E_R - E_Y)$$

$$E_I = -0.27 (E_B - E_Y) + 0.74 (E_R - E_Y)$$

$$E_Y = 0.30 E_R + 0.59 E_G + 0.11 E_B.$$

The phase of the color burst is $\sin (\omega t + 180^\circ)$.

Notes: For color-difference frequencies below 500 kc, the signal can be represented by

$$E_m = E_Y + \left\{ \frac{1}{1.14} \left[\frac{1}{1.78} (E_B - E_Y) \sin \omega t + (E_R - E_Y) \cos \omega t \right] \right\}.$$

In these expressions the symbols have the following significance:

E_m is the total video voltage, corresponding to the scanning of a particular picture element, applied to the modulator of the picture transmitter.

E_Y is the gamma-corrected voltage of the monochrome (black-and-white) portion of the color picture signal, corresponding to the given picture element.

E_R , E_G , and E_B are the gamma-corrected voltages corresponding to the red, green, and blue signals intended for the color picture tube, during the scanning of the given picture element.

E_Q and E_I are the two gamma-corrected orthogonal components of the chrominance signal corresponding respectively to the narrow-band and wide-band axes.

ω is 2π times the frequency of the chrominance subcarrier. The phase reference of this frequency is the color synchronizing signal (see Specification 21 below) which corresponds to amplitude modulation of a continuous sine wave of the form $\sin (\omega t + 180^\circ)$ where t is the time.

The portion of each expression between brackets represents the chrominance subcarrier signal which carries the chrominance information.

It is recommended that field-test receivers incorporate a reserve of 10 db gain in the chrominance channel over the gain required by the above expressions.

(11) The primary colors referred to by E_R , E_G , and E_B have the following chromaticities in the CIE system of specification:

	x	y
Red (R)	0.67	0.33
Green (G)	0.21	0.71
Blue (B)	0.14	0.08

(12) The color signal is so proportioned that when the chrominance subcarrier vanishes, the chromaticity reproduced corresponds to Illuminant C ($x = 0.310$, $y = 0.316$).

(13) Gamma correction is such that the desired pictorial result shall be obtained on a display device having a transfer gradient (gamma exponent) of 2.75. The equipment used shall be capable of an over-all transfer gradient of unity with a display device having a transfer gradient of 2.75. The voltages E_Y , E_R , E_G , E_B , E_Q , and E_I in the expression of Specification 10, above, refer to the gamma-corrected signals.

(14) The color subcarrier frequency is $3.579545 \text{ mc} \pm 0.0003\%$ with a maximum rate of change not to exceed 1/10 cycle per second per second.

(15) The horizontal scanning frequency is 2/455 times the color subcarrier frequency. This corresponds nominally to 15,750 cycles per second (the actual value is $15,734.264 \pm 0.047$ cycles per second).

(16) The bandwidth assigned to the monochrome signal E_Y is in accordance with the FCC standard for black-and-white transmissions, as noted in Specification 6 above.

(17) The bandwidth assigned prior to modulation to the color-difference signals E_Q and E_I is given by Table I.

Table I

Q-Channel Bandwidth

at 400 kc less than 2 db down
 at 500 kc less than 6 db down
 at 600 kc at least 6 db down

I-Channel Bandwidth

at 1.3 mc less than 2 db down
 at 3.6 mc at least 20 db down

(18) E_Y , E_R , E_G , E_B , E_Q and E_I are all matched to each other in time to within ± 0.05 microsecond. This is a tentative tolerance to be established definitely later.

(19) The over-all transmission bandwidth assigned to the modulated chrominance subcarrier shall extend to at least 1.5 mc below the chrominance subcarrier frequency and to at least 0.6 mc above the chrominance subcarrier frequency, at an attenuation of 2 db.

(20) A sine wave, introduced at those terminals of the transmitter which are normally fed the color picture signal, shall produce a radiated signal having an envelope time delay, relative to 0.1 mc, of zero microseconds up to a frequency of 2.5 mc; and then linearly decreasing to 4.3 mc so as to be equal to -0.26 microsecond at 3.579545 mc. The tolerance on all these delays shall be ± 0.05 microsecond relative to the delay at 0.1 mc.

(21) The color synchronizing signal is that specified in Figure 1.

(22) The field strength measured at any frequency beyond the limits of the assigned channel shall be at least 60 db below the peak carrier level.

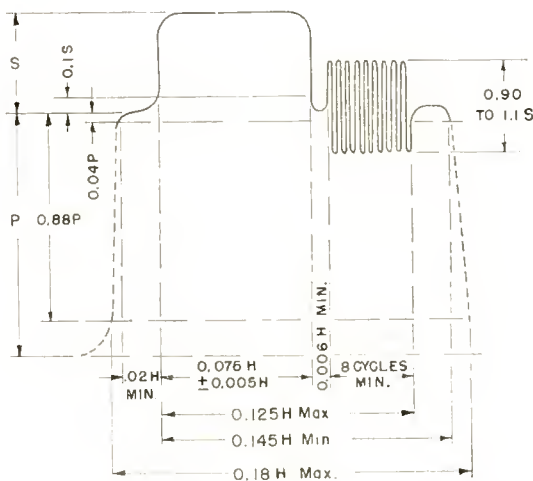

Fig. 1—Revised specifications for field test of NTSC compatible color television.

Notes:

- (1) The radiated signal envelope shall correspond to the modulating signal of the above figure, as modified by the transmission characteristics of specification number 6.
- (2) The burst frequency shall be the frequency specified for the chrominance subcarrier. The tolerance on the frequency shall be $\pm 0.0003\%$ with a maximum rate of change of frequency not to exceed 1/10 cycle per second per second.

- (3) The horizontal scanning frequency shall be 2/455 times the burst frequency.
- (4) Burst follows each horizontal pulse, but is omitted following the equalizing pulses and during the broad vertical pulses.
- (5) Vertical blanking 0.07 to 0.08v.
- (6) The dimensions specified for the burst determine the times of starting and stopping the burst, but not its phase.
- (7) Dimension "P" represents the peak-to-peak excursion of the luminance signal, but does not include the chrominance signal.

APPENDIX B—COMPARISON OF THE 1953 NTSC SIGNAL SPECIFIED IN
APPENDIX A WITH THE SPECIFICATION OF THE "DOT-
SEQUENTIAL" SIGNAL OF 1949-1950.

The signal specified in Appendix A consists of a monochrome signal together with a chrominance subcarrier to carry the color information. The earlier proposal of RCA¹¹ likewise consisted of a monochrome signal together with a chrominance subcarrier to carry the color information. There are differences in detail but the basic areas are common.

In 1950, RCA proposed that the subcarrier frequency should be 455 times half the line frequency, with a specific value of 3,583,125 cycles per second on the assumption of 15,750 lines per second. The present specification relates the subcarrier frequency to half the line frequency by the same factor, 455, but stipulates a line frequency of 15,734.264 lines per second (picture-sound intercarrier beat of just 4,500,000 cycles per second divided by 286) and a color subcarrier frequency of 3,579,545 cycles per second.

Using Equation (2), Equation (5) may be rewritten

$$(1953) \quad E_m = E_Y + 0.447 E_B \sin (\omega t - 12.5^\circ) \\ + 0.593 E_G \sin (\omega t - 119.5^\circ) + 0.632 E_R \sin (\omega t - 256.5^\circ). \quad (7)$$

The 1949-50 signal was often written in the form¹¹

$$(1949-50) \quad E_m = E_Y + (2/3) E_B \sin \omega t + (2/3) E_G \sin (\omega t - 120^\circ) \\ + (2/3) E_R \sin (\omega t - 240^\circ), \quad (8)$$

$$\text{where} \quad E_Y = (1/3) E_B + (1/3) E_G + (1/3) E_R. \quad (9)$$

¹¹ RCA Laboratories Division, *loc. cit.*

Comparison of Equations (7) and (8) shows striking similarity.

Figure 19 shows the phase and amplitude of the total subcarrier signal of Equation (8), for the three primary colors and their respective complementary colors. This figure may be compared directly to Figure 17.

It has become the fashion to express the 1953 signal specification Equation (5) in terms of "color difference" signals. The 1949-50 signal lends itself to the same treatment. Appropriate manipulation of Equations (5) and (8) yields:

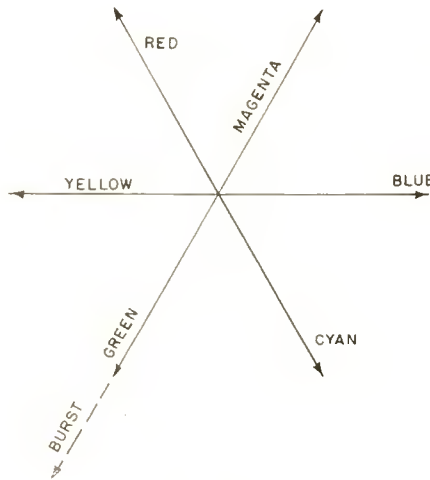

Fig. 19—Phase and amplitude of the total subcarrier for the RCA signal specification of 1949-1950. This figure may be compared directly to Figure 17.

$$(1953) \quad E_m = E_Y + 1.44 (E_G - E_Y) \sin (\omega t - 123^\circ) + [0.41 (E_B - E_Y) - 0.48 (E_R - E_Y)] \sin (\omega t - 33^\circ), \quad (10)$$

and

$$(1949-50) \quad E_m = E_Y + (E_G - E_Y) \sin (\omega t - 120^\circ) + [0.577 (E_B - E_Y) - 0.577 (E_R - E_Y)] \sin (\omega t - 30^\circ). \quad (11)$$

The similarity between Equations (10) and (11) is also striking.

The total video signal combined with the horizontal synchronizing signal and the color synchronizing burst is shown in Figure 20(a) for the (1953) signal and in Figure 20(b) for the (1949-50) signal.

Figure 20 uses as its zero reference for video voltage the value to be applied to the radio modulator to reduce picture-transmitter output to zero.

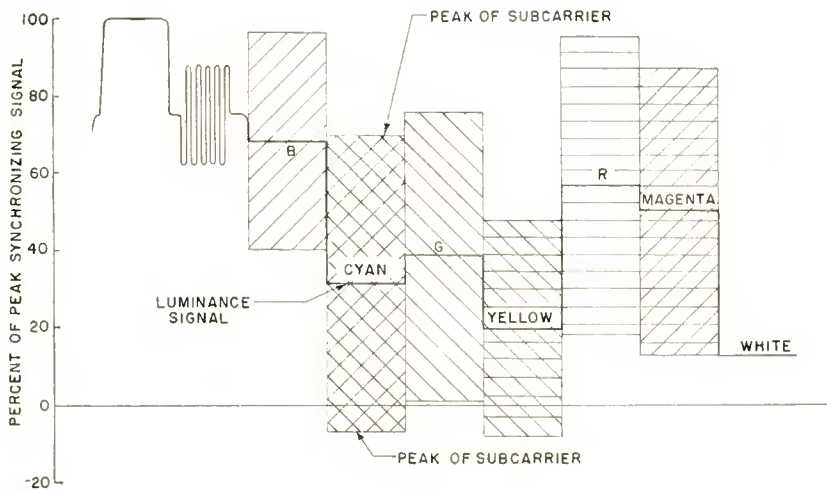

(a)

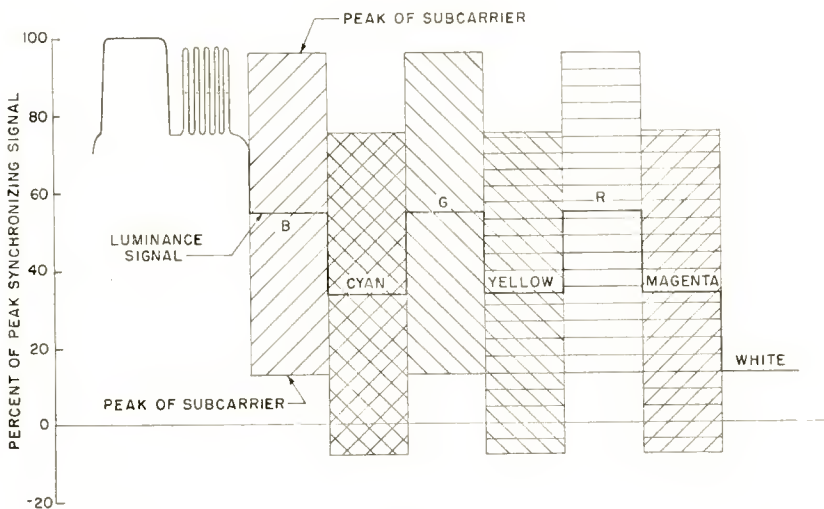

(b)

Fig. 20—The total video signal combined with the horizontal synchronizing signal and the color synchronizing burst.

(a) The 1953 signal specification.

(b) The 1949-1950 signal specification.

APPENDIX C—THE CONSTANT-LUMINANCE CONDITION IN TERMS OF THE CONSTRUCTION OF THE MONOCHROME SIGNAL

As shown by Equations (1) or (8), the color-subcarrier type of signal is made up of a monochrome signal and a chrominance subcarrier. The monochrome signal is formed by combining the voltages E_G , E_R , and E_B .

$$E_Y = aE_G + bE_R + cE_B. \tag{12}$$

The individual voltages may assume values between zero and unity, while the coefficients in Equation (12) are subject to the condition

$$a + b + c = 1. \tag{13}$$

Then the total video signal (for the low-frequency components) may be written as

$$E_m = E_Y + rE_B \sin \omega t + pE_R \sin (\omega t + \theta_R) + qE_G \sin (\omega t - \theta_G), \tag{14}$$

where the coefficients r , p , and q and the angles θ_R and θ_G may be chosen quite independently of the construction of E_Y , subject only to the restraining condition

$$r \sin \omega t + p \sin (\omega t + \theta_R) + q \sin (\omega t - \theta_G) = 0, \tag{15}$$

or simply

$$r + p \cos \theta_R + q \cos \theta_G = 0, \tag{16}$$

and

$$p \sin \theta_R - q \sin \theta_G = 0. \tag{17}$$

Once we have specified the coefficients in Equation (12) and selected the values to satisfy Equations (16) and (17), we may always express the chrominance subcarrier signal in terms of two color-difference components. Then (14) may be written

$$E_m = E_Y + K_1 (E_B - E_Y) \sin (\omega t + \beta) + K_2 (E_R - E_Y) \sin (\omega t + \gamma). \tag{18}$$

If Equation (18) is identical with Equation (14),

$$\begin{aligned}
 rE_B \sin \omega t + pE_R \sin (\omega t + \theta_R) + qE_G \sin (\omega t - \theta_G) \\
 = K_1 (E_B - E_Y) \sin (\omega t + \beta) + K_2 (E_R - E_Y) \sin (\omega t + \gamma). \quad (19)
 \end{aligned}$$

If we now apply Equations (12), (16), and (17) to (19), we find

$$K_1 \sin \beta = \frac{c}{a} p \sin \theta_R, \quad (20)$$

$$K_1 \cos \beta = \frac{(1-b)}{a} r + \frac{c}{a} p \cos \theta_R. \quad (21)$$

Rather obviously, then,

$$K_1 = \sqrt{(K_1 \sin \beta)^2 + (K_1 \cos \beta)^2}, \quad (22)$$

and

$$\tan \beta = \frac{c p \sin \theta_R}{(1-b) r + c p \cos \theta_R}. \quad (23)$$

Likewise

$$K_2 \sin \gamma = \frac{1-c}{a} p \sin \theta_R, \quad (24)$$

$$K_2 \cos \gamma = \frac{br}{a} + \frac{(1-c)}{a} p \cos \theta_R, \quad (25)$$

so

$$K_2 = \sqrt{(K_2 \sin \gamma)^2 + (K_2 \cos \gamma)^2}, \quad (26)$$

and

$$\tan \gamma = \frac{(1-c) p \sin \theta_R}{br + (1-c) p \cos \theta_R}. \quad (27)$$

Thus, we have shown that the chrominance subcarrier may be expressed in terms of two color-difference signals. The color-difference information may then be extracted at the receiver by means of two synchronous detectors. In the synchronous detector used to extract the term $(E_B - E_Y)$, the local oscillator signal should be in quadrature with the $\sin (\omega t + \gamma)$ term in Equation (18). Thus, the local oscillator signal is chosen to be $2 \sin (\omega t - 90^\circ + \gamma)$. The first synchronous detector then forms the product

$$2 \sin (\omega t - 90^\circ + \gamma) [K_1 (E_B - E_Y) \sin (\omega t + \beta)]$$

$$\begin{aligned}
 &+ K_2 (E_R - E_Y) \sin (\omega t + \gamma)] = \\
 &K_1 (E_B - E_Y) \sin (\gamma - \beta) - K_1 (E_B - E_Y) \cos (2\omega t - 90^\circ + \gamma + \beta) \\
 &\quad - K_2 (E_R - E_Y) \cos (2\omega t - 90^\circ + 2\gamma). \quad (28)
 \end{aligned}$$

The last two terms in Equation (28) are lost in the low-pass filter, since they have frequencies double that of the subcarrier, so the output of the first synchronous detector is simply

$$K_1 (E_B - E_Y) \sin (\gamma - \beta). \quad (29)$$

The local oscillator signal in the second synchronous detector is $2 \sin (\omega t + 90^\circ + \beta)$, and the output of this detector, after the filter, is

$$K_2 (E_R - E_Y) \sin (\gamma - \beta). \quad (30)$$

The amplification after the first synchronous detector is adjusted to be $\frac{1}{K_1 \sin (\gamma - \beta)}$ so that the signal shown by (29) arrives at the blue reproducer simply as $E_B - E_Y$, where it is added to the monochrome signal E_Y , giving a voltage E_B at the blue reproducer. Likewise, the gain of the second synchronous detector channel is adjusted to be $\frac{1}{K_2 \sin (\gamma - \beta)}$ to produce E_R at the red reproducer.

The green color-difference signal may be obtained by mixing (matrixing) the two color-difference signals already available. Thus

$$E_G - E_Y = m (E_R - E_Y) + n (E_B - E_Y). \quad (31)$$

Substituting (12) in (31)

$$\begin{aligned}
 (1-a) E_G - bE_R - cE_B \\
 &= (-ma-na) E_G \\
 &\quad + [m (1-b) - nb] E_R \\
 &\quad + [-mc + n (1-c)] E_B. \quad (32)
 \end{aligned}$$

Since the voltages E_G , E_R , and E_B vary independently one from another, the equality expressed in (32) applies to the coefficients of the respective voltages, giving three simultaneous equations:

$$-(1-a) = +m a + n a, \quad (33)$$

$$-b = m (1-b) - n b, \quad (34)$$

$$-c = -m c + n (1-c). \quad (35)$$

Since (33) is the sum of (34) and (35), only the latter two are needed for a solution. Then

$$m = -\frac{b}{a}, \quad (36)$$

$$n = -\frac{c}{a}. \quad (37)$$

It is interesting to apply the above analysis to the (1949-50) signal given by Equations (8) and (9). In this case,

$$a = b = c = \frac{1}{3}, \quad p = q = r = \frac{2}{3},$$

$$\theta_R = 120^\circ, \quad \theta_G = 120^\circ.$$

From Equations (20), (21), (22), and (23), we find

$$K_1 \sin \beta = \frac{1}{\sqrt{3}},$$

$$K_1 \cos \beta = 1,$$

$$K_1 = \frac{2}{\sqrt{3}} \text{ and } \beta = 30^\circ.$$

Likewise from Equations (24), (25), (26), and (27), we obtain

$$K_2 \sin \gamma = \frac{2}{\sqrt{3}},$$

$$K_2 \cos \gamma = 0,$$

$$K_2 = \frac{2}{\sqrt{3}}, \text{ and } \gamma = 90^\circ,$$

so, from Equation (18),

$$\begin{aligned}
 (1949-50) \quad E_m = E_Y + \frac{2}{\sqrt{3}} (E_B - E_Y) \sin(\omega t + 30^\circ) \\
 + \frac{2}{\sqrt{3}} (E_R - E_Y) \sin(\omega t + 90^\circ). \quad (38)
 \end{aligned}$$

The local oscillator signal in the $(E_B - E_Y)$ channel is $2 \sin(\omega t)$ and the gain in this channel is $\frac{1}{K_1 \sin(\gamma - \beta)} = 1.0$, while the local oscillator signal in the $(E_R - E_Y)$ channel is $2 \sin(\omega t + 120^\circ)$ with a channel gain of unity.

From (31), (36), and (37), we find

$$(E_G - E_Y) = -(E_R - E_Y) - (E_B - E_Y). \quad (39)$$

For the low-frequency components of the NTSC signal specification given by Equation (5),

$$K_1 = 0.493, \quad \beta = 0^\circ, \quad K_2 = 0.877, \quad \gamma = 90^\circ.$$

The local oscillator signal in the $(E_B - E_Y)$ channel is $2 \sin(\omega t)$ and the gain in this channel is $1/0.493 = 2.03$. In the $(E_R - E_Y)$ channel, the local oscillator signal is $2 \cos \omega t$, while the channel gain is $1/0.877$ or 1.14. From (31), we find

$$(E_G - E_Y) = -0.51 (E_R - E_Y) - 0.19 (E_B - E_Y).$$

Now let us return to the generalized expressions and examine the conditions existing when an interfering sine-wave voltage is present. For the sake of simplicity, we shall confine the discussion to a white area of the picture $(E_B = E_G = E_R)$ so the transmitted subcarrier disappears, and the only signal going through the synchronous detectors is the interfering signal, $S \sin(\omega_1 t + \tau)$. If the interfering signal has a frequency f_1 close to the subcarrier frequency, its effect will be manifested in two ways. First the signal will pass to the three color reproducers through the bypass monochrome channel and appear as a high-frequency bar or herring-bone pattern, just as on a normal black-and-white receiver. Secondly, it will beat with the local oscillator signal in each color-difference channel, producing a low-frequency pat-

tern in color. For instance, with a subcarrier frequency of 3.58 megacycles, an interfering signal with a frequency of 3.48 megacycles will produce a new signal with a frequency of 0.1 megacycle on each color reproducer.

The interfering signal will beat with $2 \sin (\omega t - 90^\circ + \gamma)$ in the (B-Y) channel to produce a signal on the blue reproducer (after the gain factor is applied) of

$$\frac{S}{K_1 \sin (\gamma - \beta)} \cos [(\omega - \omega_1)t - 90^\circ + \gamma - \tau]. \quad (40)$$

The signal on the red reproducer will be

$$\frac{S}{K_2 \sin (\gamma - \beta)} \cos [(\omega - \omega_1)t + 90^\circ + \beta - \tau]. \quad (41)$$

The signal on the green reproducer is found by applying (40) and (41) to (31):

$$\begin{aligned} & -\frac{c}{a} \cdot \frac{S}{K_1 \sin (\gamma - \beta)} \cos [(\omega - \omega_1)t - 90^\circ + \gamma - \tau] \\ & -\frac{b}{a} \cdot \frac{S}{K_2 \sin (\gamma - \beta)} \cos [(\omega - \omega_1)t + 90^\circ + \beta - \tau]. \end{aligned} \quad (42)$$

If the light-output versus voltage-input characteristics of the reproducer are linear, or if the interfering signal is small in amplitude compared to the desired signal, then Expressions (40), (41), and (42) are proportional to the intensity of light from the blue, red and green reproducers, respectively.

The resulting pattern on the face of the reproducer consists of a series of broad stripes across the picture. The relative subjective brightness of the three primary interference patterns, that is to say the relative brightnesses as they appear to an observer, are obtained by multiplying Expressions (40), (41), and (42) by the relative luminance of the phosphor corresponding to each signal. Thus the apparent brightness produced on the blue reproducer is

$$L_B = Y_B \cdot \frac{S}{K_1 \sin (\gamma - \beta)} \cos [(\omega - \omega_1)t - 90^\circ + \gamma - \tau], \quad (43)$$

$$L_R = Y_R \cdot \frac{S}{K_2 \sin(\gamma - \beta)} \cos [(\omega - \omega_1)t + 90^\circ + \beta - \tau], \quad (44)$$

$$L_G = -\frac{c}{a} Y_G \cdot \frac{S}{K_1 \sin(\gamma - \beta)} \cos [(\omega - \omega_1)t - 90^\circ + \gamma - \tau] \\ - \frac{b}{a} Y_G \cdot \frac{S}{K_2 \sin(\gamma - \beta)} \cos [(\omega - \omega_1)t + 90^\circ + \beta - \tau], \quad (45)$$

where Y_G , Y_R and Y_B are the relative luminance values derived in Appendix D.

The total luminance, or apparent brightness, is the sum of Equations (43), (44), and (45).

$$L_T = L_B + L_R + L_G \\ = \left(Y_B - \frac{c}{a} Y_G \right) \frac{S}{K_1 \sin(\gamma - \beta)} \cos [(\omega - \omega_1)t - 90^\circ + \gamma - \tau] \\ + \left(Y_R - \frac{b}{a} Y_G \right) \frac{S}{K_2 \sin(\gamma - \beta)} \cos [(\omega - \omega_1)t + 90^\circ + \beta - \tau]. \quad (46)$$

Then if we choose the coefficients of the monochrome signal so that $a = Y_G$, $b = Y_R$, and $c = Y_B$, we see that L_T is zero. Under this condition, the interference pattern changes color across the picture but maintains "constant luminance," thus reducing annoyance to the viewer. The constant-luminance feature applies also to reduce the visibility of high-frequency components of the monochrome signal which pass through the decoding channels of the receiver as well as high-frequency thermal noise.

It is interesting to note that the proper specification of the monochrome signal (the choice of a , b and c) completely establishes the constant-luminance effect.

APPENDIX D—NUMERICAL DETERMINATION OF THE RELATIVE LUMINANCE VALUES OF THE RECEIVER PRIMARIES

The trichromatic coefficients of the assumed receiver phosphors, as selected by NTSC, are given in Appendix A. This information, together with the knowledge that Illuminant C is to be used as standard white, enables one to compute the relative luminance values of the primaries. Because the tristimulus values of a *mixture* of lights are the sums of the corresponding tristimulus values of the components

of the mixture, one may apply the method of moments to the color triangle of Figure 2.

First we take the weighted moments of the sums of the tristimulus values about a horizontal axis passing through white, and obtain

$$(X_R + Y_R + Z_R)(y_R - y_W) + (X_G + Y_G + Z_G)(y_G - y_W) + (X_B + Y_B + Z_B)(y_B - y_W) = 0. \quad (47)$$

Since, by definition, $y = \frac{Y}{X+Y+Z}$, Equation (47) becomes

$$Y_R \frac{(y_R - y_W)}{y_R} + Y_G \frac{(y_G - y_W)}{y_G} + Y_B \frac{(y_B - y_W)}{y_B} = 0. \quad (48)$$

Similarly, when moments are taken about a vertical line through white, we obtain

$$Y_R \frac{(x_R - x_W)}{y_R} + Y_G \frac{(x_G - x_W)}{y_G} + Y_B \frac{(x_B - x_W)}{y_B} = 0. \quad (49)$$

Since our interest lies solely in the *relative* values of the luminances, we may add a third constraining condition for ease in solving the equations, that is,

$$Y_R + Y_G + Y_B = 1. \quad (50)$$

The simultaneous Equations (48), (49), and (50) may then be readily solved.

When one uses the values:

$$x_W = 0.310, \quad y_W = 0.316,$$

$$x_R = 0.67, \quad y_R = 0.33,$$

$$x_G = 0.21, \quad y_G = 0.71,$$

$$x_B = 0.14, \quad y_B = 0.08,$$

one finds $Y_G = 0.5866$, $Y_R = 0.2988$, $Y_B = 0.1146$.

These values, when rounded off to two places, yield the luminance values specified by NTSC:

$$Y_G = 0.59, \quad Y_R = 0.30, \quad Y_B = 0.11.$$

COLOR TELEVISION SIGNAL RECEIVER DEMODULATORS*

By

D. H. PRITCHARD AND R. N. RHODES

Research Department, RCA Laboratories Division,
Princeton, N. J.

Summary—This paper presents a discussion of the problems and techniques involved in the design and development of color television receiver demodulators. The basic concepts of a simultaneous subcarrier color system are described as relating to the receiver demodulator problem. The particular signal specifications for field testing as proposed by the National Television System Committee are included to the extent of their effects upon receiver demodulator design. The discussion is intended to provide at least a working knowledge of the demodulator techniques utilized to date in color television receivers, which form a background for future developments of improved techniques.

INTRODUCTION

IN THE FIELD of television techniques associated with color television receiver decoding apparatus, a great variety of approaches is possible. This paper describes the concepts and methods practiced to date in accordance with the color television signal specifications as proposed for field testing by the National Television System Committee (NTSC). In the interest of simplicity and clarity, certain references will be made to a "symmetrical" simultaneous color subcarrier system in describing basic concepts. These concepts can then be altered to conform to the present field test values.

It is difficult to confine a discussion of this type to receiver demodulator problems alone, due to the close interrelation between the demodulator and associated functions such as color synchronization, luminance and chrominance adder methods, etc. However, a general discussion of receiver demodulator problems, both from a basic concept and from a practical development standpoint, is presented herein. From this it is possible to derive at least a working knowledge of color signal receiver demodulator techniques.

BASIC PRINCIPLES OF SIMULTANEOUS SUBCARRIER SYSTEM

In order to understand the receiver demodulator techniques and

* Decimal Classification: R583.5.

problems, it is necessary to have a working knowledge of the basic principles of a simultaneous subcarrier color television system. The concept of compatibility in the development of a color system is of extreme importance. Thus, it is very desirable that the means by which the required color information is provided can be added to the present monochrome television signal without materially affecting black and white operation. The color television signal presently undergoing field test by the NTSC meets this requirement.

In order to provide a color reproduction, three independent pieces of information must be transmitted. For example, in the present NTSC color signal these three pieces of information are:

1. Brightness
2. Hue
3. Degree of Saturation

The present monochrome signal can provide the necessary brightness information (hereafter referred to as the "luminance" signal) and the fine detail possible within the four-megacycle video band limitation. This luminance signal is handled in the conventional manner and contains the standard vertical and horizontal synchronizing and blanking information. The color information is added to this luminance signal in the form of a color subcarrier located near the higher frequency end of the video passband. This color subcarrier is both phase and amplitude modulated in accordance with the hue and degree of saturation of the color to be transmitted. This subcarrier signal is hereafter referred to as the "chrominance" signal. The instantaneous phase of the color subcarrier determines the hue, while the envelope amplitude of the color subcarrier, with respect to that of the luminance signal, determines the degree of saturation.

The general method by which the color video information carried by the received color subcarrier and its modulation components can be recovered is known as synchronous detection. Consider as an example the simplified case in which the color video information takes the form of a slowly varying function of amplitude $A(t)$ as the result of the saturation of the original color. If the subcarrier frequency is ω_c , and its phase angle is ϕ as a result of the hue of the original color, the expression for the chrominance portion of the transmitted signal is

$$A(t) \cos (\omega_c t + \phi).$$

In the color receiver, this portion of the transmitted signal is multiplied by a local subcarrier of the form $\cos \omega_c t$. This is the

synchronous detection process. The information contained in the resultant product may be more easily recognized by expanding the product trigonometrically.

$$A(t) \cos(\omega_c t + \phi) \cos \omega_c t = \frac{1}{2} [A(t) \cos \phi + A(t) \cos(2\omega_c t + \phi)]. \quad (1)$$

The factor $\frac{1}{2}$ on the right side may be ignored since it is constant and may be eliminated by the addition of suitable gain. The term $A(t) \cos(2\omega_c t + \phi)$ involves frequencies in the order of twice the color subcarrier frequency and may therefore be eliminated by means of suitable low-pass filters. The remaining term $A(t) \cos \phi$ is then the product of terms proportional to the degree of saturation and the hue of the original color. As will be shown later, this signal, when added to certain other signals, gives complete re-creation of the original color.

The frequency of the color subcarrier is generally chosen to have a value high within the 4-megacycle video passband in order to reduce the visibility of any interference patterns experienced in the average black and white commercial receivers. In order to further reduce the visibility of such interference, the color subcarrier frequency is so chosen, and is synchronized with the horizontal scanning rate in such a manner, as to produce horizontal "dot-interlace." That is to say, the color subcarrier frequency is an odd multiple of one-half horizontal line rate, and for the present NTSC field test signal specification becomes 3.579545 megacycles. With a simultaneous subcarrier system such as described, the three basic sets of information required for satisfactory color reproduction can be transmitted within the limits set forth by present monochrome television standards and be compatible with it.

In the more or less basic description which follows, a "symmetrical" system will be assumed in the interest of clarity and simplicity. Later, the specific values involving a constant luminance signal as proposed by NTSC will be introduced. By a "symmetrical" system it is meant that in the generation of the signal at the color television transmitter, the modulating information representing the three primary colors, red, green, and blue, operate upon the color subcarrier at symmetrical phase angles of 0° , 120° , and 240° respectively. The amplitude relationships of the three color-difference signals have symmetrical relationships to each other and the amplitudes of the brightness, or luminance, components of each of the three primaries are equal to one another.

If one assumes a picture comprised of four vertical bars, the first being red, the second green, the third blue, and the fourth white

(Figure 1a), the following amplitude relationships result. The white bar is assumed to produce the peak modulation amplitude which has a value of unity as in monochrome operation. Therefore the luminance component of the red, green, and blue primaries each have an amplitude value of 33 per cent. A yellow bar, being an equal mixture of red and green, would have a luminance value of 66 per cent. A signal

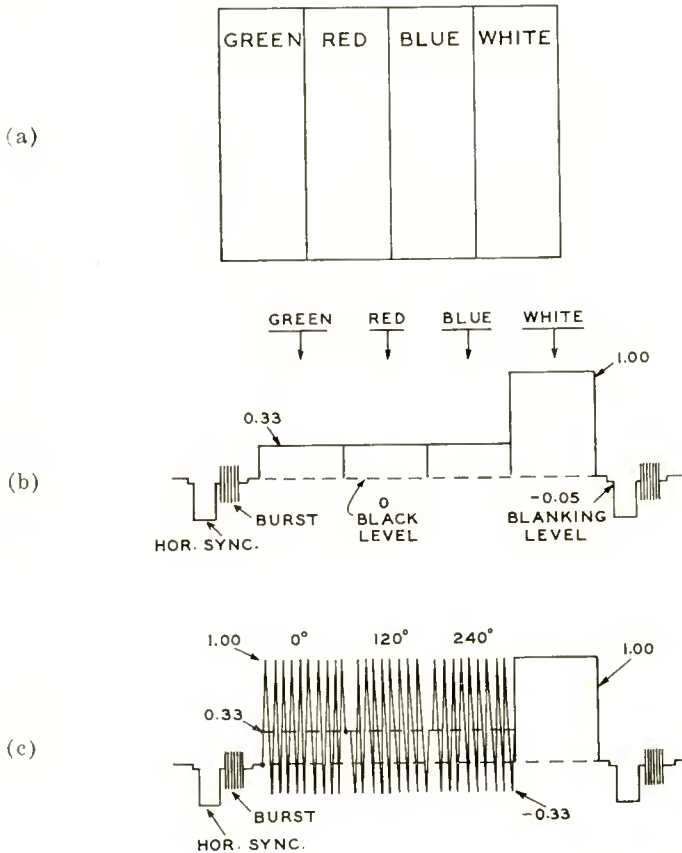

Fig. 1—Symmetrical signal values for receiver. (a) Original picture, (b) luminance signal values (symmetrical), (c) second detector output (symmetrical).

derived in this fashion, along with the appropriate synchronizing and blanking signals, comprise the complete luminance signal referred to as the "Y" signal and provides the brightness information required by the color system. Also, this luminance signal represents the appearance of a standard monochrome signal in which the pickup device has

equal response to the three color primaries. Figure 1b indicates the signal waveform described as seen by an oscilloscope observation of the second detector output of a television receiver. If this signal is applied simultaneously with the proper amplitude values to either a three-tube color reproducer, or to a tri-color kinescope, a black and white reproduction will result.

If to this luminance signal a color subcarrier containing the chrominance information is added, a signal waveform such as indicated in Figure 1c will be observed at the second detector output. It should be noted that the average value of the sine wave coincides with the luminance value of each primary color and corresponds to a value of 33 per cent above picture content black level (assuming that black level is set up by a nominal 5 per cent above the blanking level). Second, the peak amplitude of the sine wave corresponds to the peak amplitude of the white bar, or unity. Third, the sine wave swings in the blacker-than-black direction by 33 per cent. (Percentage values are taken to relate to the distance between picture signal black and picture signal white as representing 100 per cent, or unity.) The amplitude relationships as described above represent the values for a symmetrical system having equal brightness primaries and 100 per cent saturated colors. In this case the phase of the color subcarrier during each color bar would differ by 120 degrees.

In a color receiver, the video circuits following the second detector are split into the luminance channel and the chrominance channel as shown in the block diagram Figure 2a. The luminance channel carries all the brightness and detail information for the full bandwidth. Due to the possibility of errors being introduced into luminance values and into the degree of saturation, both resulting from kinescope rectification of the color subcarrier sine wave, this wave is often removed from the luminance signal by means of a trap or by adjusting the cutoff values of the video peaking circuits to permit the reduction of response at the color subcarrier frequency. Figure 3a is a typical amplitude response characteristic for the luminance channel. The chrominance information consisting of the color subcarrier and its sidebands must be separated from the composite signal. For a single-ended type of color signal demodulator, this is done by means of a band-pass filter, a typical characteristic of which is shown in Figure 3b. The output of this band-pass filter, for the color bar pattern assumed above, is shown in Figure 3c, and is fed to the inputs of the color signal demodulators as shown in Figure 2a. It should be noted that no chrominance information exists during the white portion of the picture. Each of the three demodulators is also fed by a locked ref-

erence carrier having a frequency identical to that of the color subcarrier and phase relationship of 0° , 120° , and 240° . The difference-frequency products are recovered in the modulator outputs according to the relationship of Equation (1) by means of low-pass filters having a typical characteristic shown in Figure 3d. The color bar signals appearing in a given demodulator output are of positive polarity with

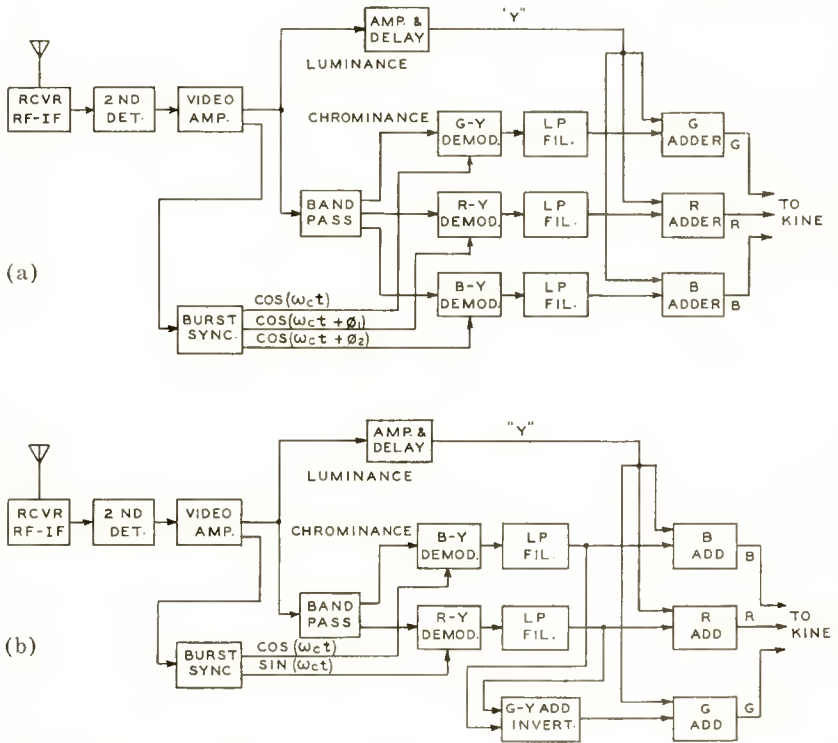

Fig. 2—Receiver block diagrams: (a) Three-demodulator type; (b) Two-demodulator type.

a relative amplitude equal to the peak value of the subcarrier sine wave during the period in which the subcarrier signal phase and the reference carrier phase are identical. In that same demodulator output during the remainder of the subcarrier signal the output-signal amplitude is one-half and of negative polarity, since the phase relationships of the other color components are 120° and 240° with respect to the reference carrier phase. The three signal waveforms for the color-bar pattern are shown in Figures 4a, 4b and 4c. These three signals are termed color difference signals and are designated as B - Y, R - Y and G - Y. They must then be individually added to the luminance

signal Y to produce the blue, red, and green color signals feeding the three reproducer unit inputs as shown in Figure 2a. The result of this addition is shown in Figures 4d, 4e and 4f. It should be noted that the positive values of the color difference signals are of such magnitude as to cause the peak color amplitude to equal the peak white amplitude. At the same time the negative components of the

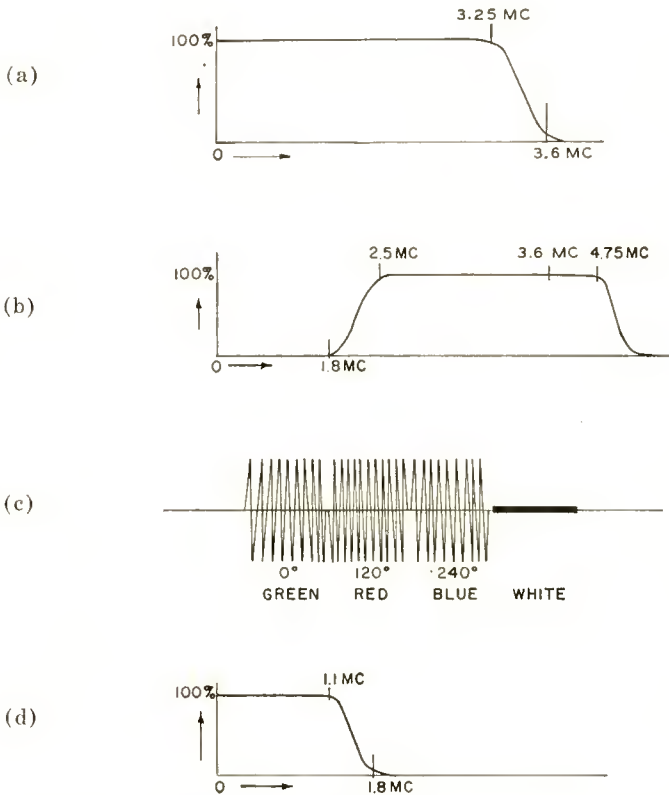

Fig. 3—Color television receiver pass band characteristic. (a) Luminance channel amplitude response, (b) band-pass filter characteristic, (c) band-pass filter output signal, (d) low-pass filter characteristic.

color difference signals exactly cancel the luminance components of the other two color signals, thereby producing the equivalent of a simultaneous color signal. For example, when the luminance signal Y (Figure 1a) is added to the B — Y color difference signal (Figure 4a), the blue video signal (Figure 4d) results. The red and green video signals (Figures 4e and 4f) can be obtained in a similar manner.

It is important in the case of the single-ended demodulator that

the band-pass and low-pass filter characteristics do not overlap, since this would result in direct feed-through of luminance signal components in the overlapped region, causing undesired spurious signals in the final output. For the balanced type of demodulator there is no need for the band-pass filter since the undesired luminance signals can be

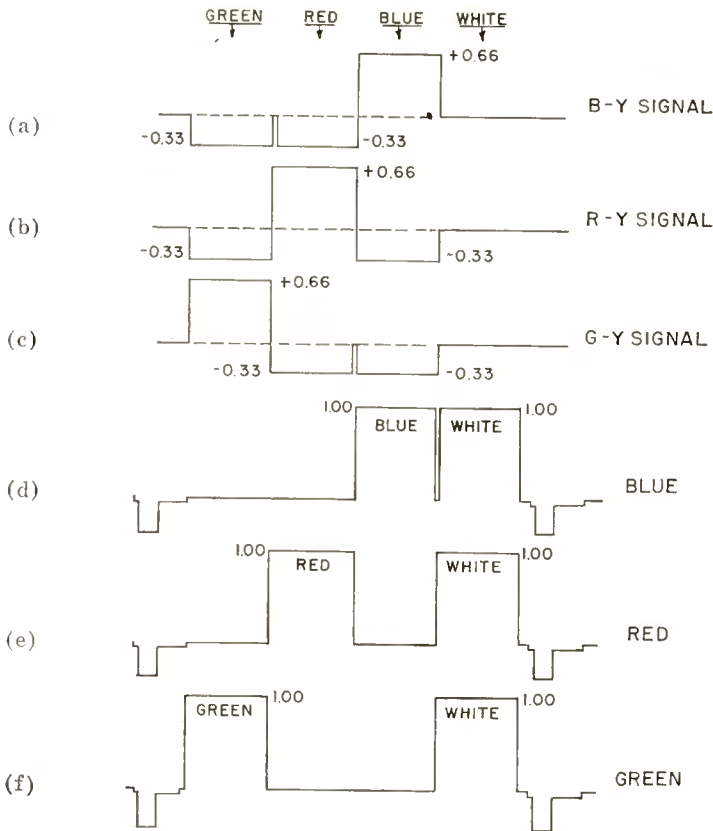

Fig. 4—Symmetrical signal values for receiver.

balanced out. However, the degree of balance must be great in order to minimize, or eliminate, the direct feed-through of these signal components.

In the system as described, the color difference signals must be added to the luminance signal in three separate channels. This addition can be accomplished in a number of ways. One obvious method is to impress the luminance signal upon the three grids (or cathodes) of the reproducer, and to impress the three color difference signals upon the three cathodes (or grids) of the reproducer, thereby utilizing the

kinescope itself as the "adder." Perhaps a more flexible method is to utilize, in three separate video channels, any of the well known procedures, such as a common plate impedance, common cathode impedance, etc. This allows a choice of signal level at which the addition can be accomplished, resulting in three simultaneous color signals, red, green, and blue, which can be amplified and fed to either the grids or cathodes of the color reproducer.

So far it has been assumed that three separate demodulators are required to produce the $B - Y$, $R - Y$, and $G - Y$ color difference signals. However, it can be shown by means of trigonometric identities that only two demodulators are actually necessary. Upon examination of any two of the color difference signal waveforms, it can be seen that they can be combined in such a manner as to produce the third color difference signal. If, for example, the $B - Y$ and $R - Y$ signals shown in Figures 4a and 4b are added, and their resulting sum inverted in polarity, the $G - Y$ color difference signal (Figure 4c) is produced. Deriving the $G - Y$ signal in this manner is usually desirable in most practical cases, since negative polarity $B - Y$ and $R - Y$ signals are available, and the $G - Y$ signal can be produced by a simple resistive adding matrix (see Figure 2b).

NTSC RECEIVER DEMODULATOR SIGNAL VALUES

In the preceding basic descriptive material, symmetrical values were utilized in the interest of simplicity and clarity. The same principles and procedures can now be applied to the NTSC constant luminance signal, taking into account the various amplitude values and reference carrier phase angle values. The NTSC luminance values were chosen instead of the symmetrical luminance values to take advantage of certain theoretical signal-to-noise and compatibility improvements.

For the color bar picture of Figure 1, it can be seen from Figure 5 that the NTSC luminance signal values for the three primaries are 59, 30, and 11 per cent for green, red, and blue, respectively, instead of the 33 per cent for each color assumed in the symmetrical case. For example, in the color difference signal at the output of the $B - Y$ demodulator as determined by NTSC color subcarrier amplitude values, the positive signal value would be 89 per cent, the negative value during the red bar would be 30 per cent, and the negative value during the green bar would be 59 per cent. Obviously, if this $B - Y$ signal is then added to the luminance signal (Figure 5b), the 59 and 30 per cent luminance values are exactly cancelled and the 89 per cent $B - Y$ component adds to the 11 per cent luminance signal value to produce a peak value of 100 per cent during the blue bar, thereby producing

a simultaneous blue color signal as in Figure 4d. The appropriate relationships hold for the red and green color signals as well.

QUADRATURE AND IN-PHASE CROSSTALK COMPONENTS

A discussion of receiver demodulator problems would not be complete without a description of the various crosstalk effects existing in

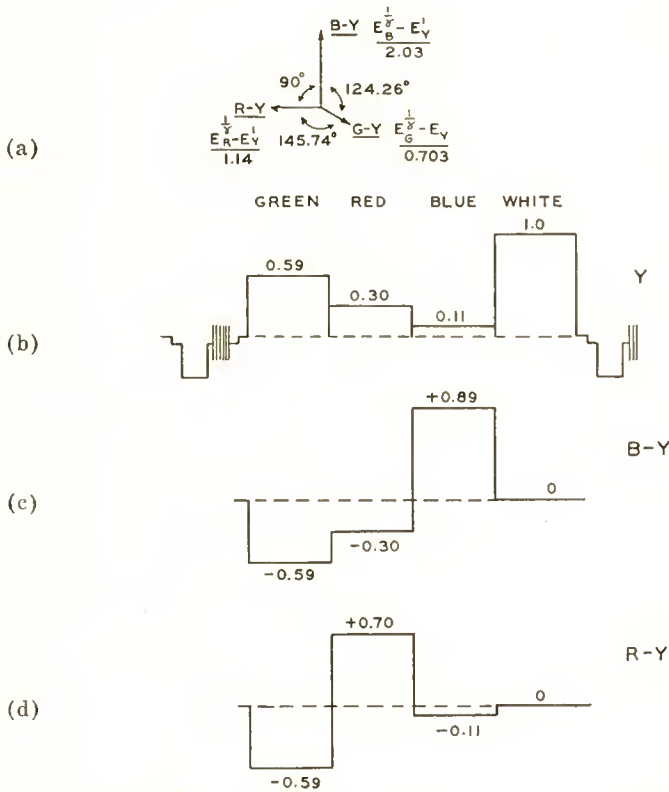

Fig. 5—NTSC values for receiver angles and amplitudes.

the present NTSC signal. These cause incorrect reproduction of edges. The four major sources of crosstalk components are as follows:

1. Transient response of luminance channel.
2. Transient response of chrominance channel.
3. Quadrature components in the chrominance channel.
4. Crosstalk of luminance channel into chrominance channel.

The transient, or in-phase, components of both the luminance and

chrominance channels are those commonly associated with the various filters and peaking circuits utilized in the receiver. The crosstalk of the luminance channel into the chrominance channel can be comprised of two components. The first results from direct feed-through of luminance signal components, either via stray capacity effects, or through the crossover of the band-pass and low-pass filters. The second component is the result of high-frequency luminance components being heterodyned in the color demodulators and appearing as interlaced spurious low-frequency components in the color-difference signals.

Quadrature component crosstalk is due to the partial loss of one set of modulation sidebands of the color subcarrier. A color transition in one color channel will cause a quadrature "spike" to appear in the other color channel. The elimination of this type of crosstalk is primarily a systems problem and means for eliminating its effect have been incorporated into the NTSC signal. However, an examination of this important aspect of the signal lies beyond the scope of the present paper.

COLOR DEMODULATORS

From the receiver demodulator viewpoint there are certain initial requirements in the choice of method and particular tube type employed to obtain the desired results. These basic requirements are simplicity, reliability, phase and amplitude linearity, relatively small physical dimensions, small power drain, ease of adjustment, high conversion transconductance, low reference carrier levels, and comparatively inexpensive components.

There are a number of practical methods of performing the synchronous detection process required in a color receiver; however, the most common methods fall into the following categories:

1. Single-ended multigrid multiplier circuitry.
2. Balanced modulator circuits.
3. Diode or pulse modulator circuits.

Since the variations in over-all receiver design are great, it would be difficult to develop a "universal" receiver demodulator which would best suit all the needs for all conditions and purposes. However, it is possible to describe the development of the single-ended multigrid multiplier circuit, which has proven to be extremely versatile and useful in its applications to a variety of color receivers designed and operated to date. The basic principles followed in the design of this circuit will apply to other types and become useful background knowledge for future developments of improved techniques.

SINGLE-ENDED MULTIPLIERS

In the choice of tube types, a multigrid tube lends itself more readily to this particular application. A pentagrid converter type might well be chosen in view of the comparatively high conversion gain characteristics. However, upon investigation of the available types, it was found that the power handling capabilities as well as the peak output signal values possible were much too small to fulfill the receiver demodulator requirements without the excessive use of additional amplifier stages. The use of such types are, however, desirable in laboratory test apparatus where total tube count is not a primary element and where comparatively low signal level operation is permissible. Certain balanced modulator circuits described later employ type 6SB7Y tubes in this manner. The next most likely group of tube types are standard pentodes such as 6AU6, 6BE6, etc. A number of these types provide the output levels desired, but all of them have comparatively low conversion gain versus amplifier gain, and require large values of reference carrier signal voltages applied to either the screen or suppressor grids.

A tube type fulfilling all of the requirements to a reasonable degree is the 6AS6, seven pin, miniature pentode, originally developed for use in gating circuits. This tube has the small physical size desired, the power handling capabilities are adequate, the output signal level values are high, the conversion gain is satisfactory, the ratio between conversion gain and amplifier gain is adequate, and comparatively low levels of reference carrier signal voltage can be applied to the suppressor grid, since this grid has control over the plate current comparable to that of the control grid. Therefore, the 6AS6 was chosen as the most satisfactory tube for use in a single-ended receiver demodulator circuit. A typical circuit diagram is shown in Figure 6, and the reasons for the various circuit parameters and operating conditions chosen will be indicated. Another tube type, designated as 7AK7 has very similar characteristics and has been utilized satisfactorily. This tube, although capable of higher output signal values, has the disadvantages of larger physical size, being loctal type, and requiring comparatively large direct currents—in the order of 30 milliamperes or more.

From Figure 6 it can be seen that the chrominance signal containing the color subcarrier and its sidebands is separated from the luminance signal by a band-pass filter, and is impressed upon the control grid (G1) of the 6AS6 demodulator tube. The reference frequency sine wave is impressed upon the suppressor grid (G3), and the difference-frequency modulation products are obtained in the plate circuit

by means of a low-pass filter. The band-pass filter indicated is a simple constant-K type having a characteristic impedance of 500 ohms. A comparatively low impedance is desirable to prevent self-biasing of G1 at high signal level values and to minimize interaction, or cross-feed between the G1 signal of one demodulator and the G1 signal of the second demodulator fed from the common band-pass filter. In addition, a low impedance at this point allows the use of input level controls such as indicated in the diagram. In the NTSC signal specifications

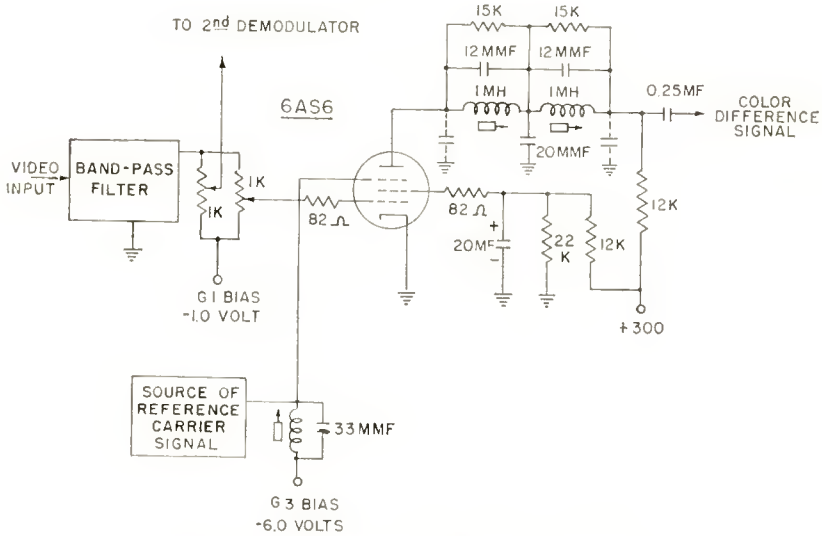

Fig. 6—6AS6 demodulator circuit diagram.

adopted in January 1953, if the B—Y demodulator output level is assumed to have a relative amplitude of 2.03, the relative R—Y demodulator output amplitude will be 1.14. The amplitude characteristic of the band-pass filter is as shown in Figure 3b. The response is 10 per cent or less at 1.8 megacycles (one-half the 3.6-megacycle subcarrier frequency) and rises to 90 per cent response at about 2.5 megacycles. The high-frequency end extends beyond the color subcarrier to about 4.75 megacycles with a gradual cutoff at about 5.5 megacycles. Thus, the r-f, i-f amplitude response becomes the determining factor in the high-frequency end of the chrominance channel bandwidth.

In the plate circuit of the demodulator, a high impedance is desirable in order to obtain the greatest possible voltage swing within the capabilities of the tube. Fortunately this is possible, since the low-pass filter required has a bandwidth of less than 2 megacycles in order to

obtain only the difference-frequency modulation products. A typical two-section M-derived low-pass filter having a characteristic impedance of 12,000 ohms is indicated in Figure 6, with an amplitude characteristic as shown in Figure 3d. The 90 per cent response point occurs at about 1.1 megacycles, the 50 per cent response point at 1.5 megacycles, with 1.8 megacycles having a response of 10 per cent or less. Obviously, the overlap between the band-pass and low-pass filters should be kept to a minimum in order to prevent feed-through of luminance information which would cause spurious signals in the final results. In the present NTSC signal specifications, the low-pass filter response (Figure 3d) may be altered according to the particular receiver techniques desired. These techniques are system problems, and do not alter the basic operation of the demodulators themselves.

The next problem encountered in the demodulator design is the proper choice of operating conditions such as the various direct-current potentials and grid-bias values. A plate-supply potential of between 250 and 300 volts is used, with approximately a 10-milliampere bleeder tapped at the 140-volt point supplying the screen grid (G2) potential. The screen grid is adequately bypassed for all frequencies in the conventional manner with a 20 microfarad electrolytic capacitor. Grounding of the cathode tends to stabilize the tube and provides maximum gain without the use of bypassed cathode resistors which might result in loss of low-frequency components. Data indicating the effect of introducing a cathode resistor will be shown later. Upon consultation of available data concerning the 6AS6, it was found that the greatest conversion gain resulted from a G1 bias of about -1.5 volts, and a G3 bias of between -4 and -6 volts. Using these figures as a basis, an investigation was made to determine the optimum operating bias values for the particular conditions involved. The question of the effect of various levels of the reference carrier impressed upon G3 was also considered in the investigation.

It is important that the direct-current impedance in the grid return path of G3 be low enough that no appreciable self-biasing action can result from the application of high signal level values of 3.6-megacycle reference-frequency sine wave. Since a single-frequency sine wave is involved, tuned circuits which have essentially zero direct-current impedance can be utilized to feed G3.

Figures 7, 8, 9 and 10 are families of curves taken for various G1 and G3 bias values and for several different values of reference carrier signal levels, indicating the linearity and amplitude values of the output signal versus input signal level applied to G1. All these curves represent maximum values for the input signal on G1 held either in

phase or 180 degrees out of phase with the reference-carrier sine wave. It can be seen that the average output level drops off rapidly at a reference-carrier level of 10 volts peak-to-peak or less. The output level values begin to flatten off at about a 20-volt reference-carrier level, with relatively small increased gain in output levels for carrier levels of 30 volts or more. Furthermore, as the carrier level increases, the problems of radiation and power handling capacity of the involved components become more difficult. Therefore, a nominal range of

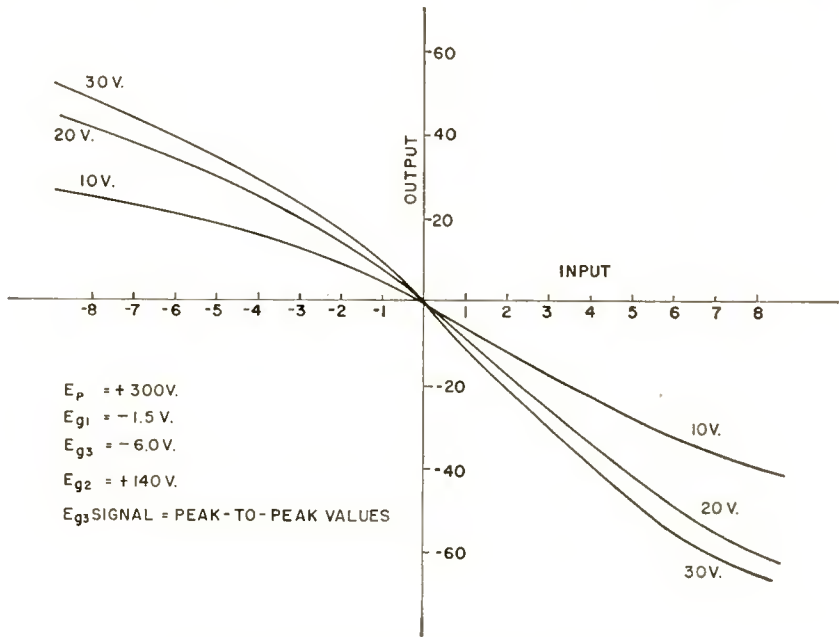

Fig. 7—6AS6 demodulator characteristics.

reference-carrier peak-to-peak values of between 15 and 30 volts was chosen for proper operation. These comparatively low levels minimize the shielding and radiation problems encountered in a practical receiver. Figure 7 represents the results obtained from the use of -1.5 volts $G1$ bias and -6 volts of $G3$ (circuit diagram in all cases as shown in Figure 6). Figure 8 indicates the results obtained with zero bias on $G1$ and -6 volts bias in $G3$. These two sets of curves indicate the extreme ranges of $G1$ bias values. In Figure 7, the positive output values are compressed, while in Figure 8 the negative output values are compressed. Figure 9 represents a reasonable operating compromise with $G1$ operation at -0.75 volt and with -6 volts $G3$ bias. Under these conditions it can be seen that with a reference carrier level of

20 volts (peak-to-peak), a satisfactory linear region is possible for input signal values of about 3 volts (peak-to-peak), resulting in a positive output voltage swing of about 25 volts and a negative output voltage swing of about 25 volts. Excellent linearity can be obtained up to 20 volts swing in *either* polarity. Figure 10 indicates the introduction of cathode degeneration which results in a G1 bias of -1.1 volts and a G3 bias set at -5.6 volts. It can be seen that although the linearity is slightly improved, the output is reduced about two to one

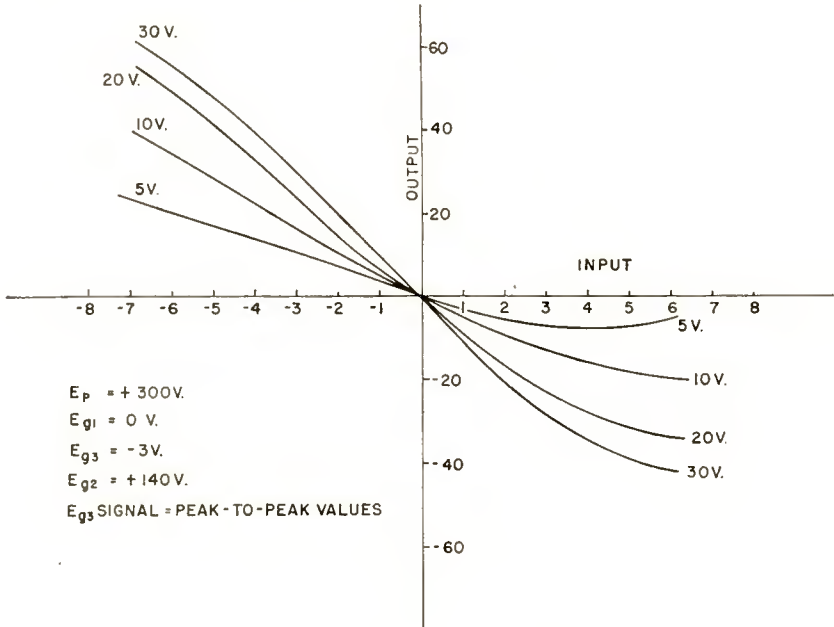

Fig. 8—6AS6 demodulator characteristics.

for an input of 3 volts and a reference carrier level of 20 volts. Another disadvantage of cathode degeneration results from the interaction between the G1 and G3 bias caused by any amplitude variations of the reference carrier signal. Therefore, the optimum operating conditions were chosen to be a G1 bias of -0.75 or -1.0 volt, a G3 bias of -6 volts, a reference carrier signal level of about 20 volts peak-to-peak, and with no degeneration in the cathode circuit.

An important characteristic of a synchronous detector is its phase linearity. Experience has indicated that the 6AS6 demodulator when operated as shown above provides a satisfactory degree of phase linearity. In actual practice, an apparent phase distortion can be introduced by stray pickup of reference carrier signal of improper

phase relationship. Care should be taken in the physical placement of circuit components, along with adequate shielding, to eliminate this effect in actual receiver construction.

The question of interchanging the action of the control grid and the suppressor grid by impressing the reference carrier signal upon G1 and the video signal upon G3 was investigated. Figure 11 indicates the results of this procedure. The video signal level required for a given output value is in the order of twice that previously required, with approximately the same range of reference carrier signal values

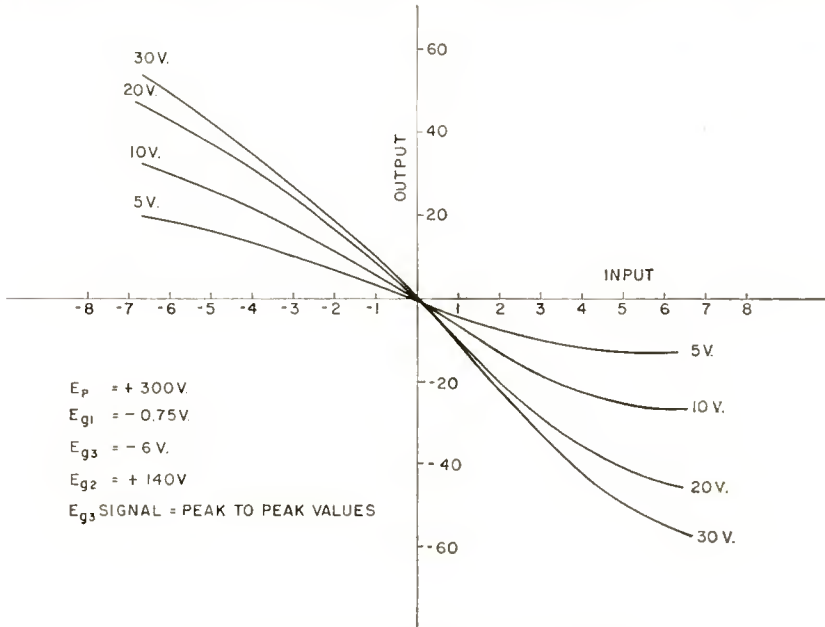

Fig. 9—6AS6 demodulator characteristics.

applied to G1. In this operating condition, the limiting properties of G3 are not available, consequently the demodulator under these conditions is sensitive to amplitude variations of the reference carrier signal. Another disadvantage of this arrangement is the feed-through of video signal components via the suppressor grid to plate capacity. When the reference carrier is applied to the suppressor grid, any stray feed-through is effectively removed by the low-pass filter rejection band, or an additional trap can be utilized, if necessary, since only a single frequency is involved.

In a practical receiver, the physical layout and placement of circuit components for the 6AS6 demodulators generally require no more care than that normally used in video techniques. Parasitic suppression

resistors are used in the screen grid and control grid leads, and if the screen grid by-pass electrolytic is located at any appreciable distance from the tube socket, it is sometimes desirable to place an additional by-pass condenser of about 0.01 microfarad directly at the tube socket to eliminate stray pick-up of reference carrier signal. The greatest care that must be exercised in receiver demodulator construction is the provision of adequate shielding between demodulator units. The reference carrier signal leads should be isolated from each other as

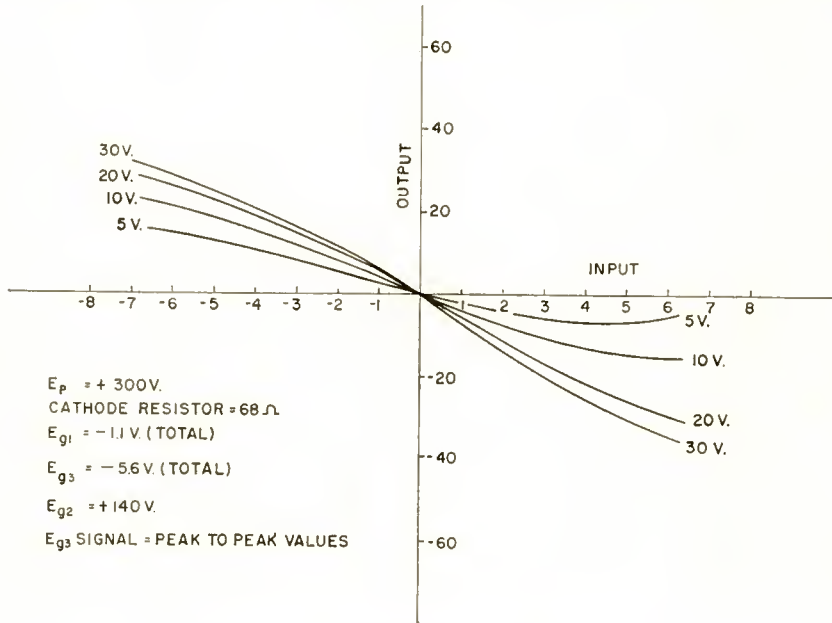

Fig. 10—6AS6 demodulator characteristics.

much as possible to prevent pick-up of incorrect phase components. These same reference carrier leads should be isolated from the video input signal leads to prevent stray pickup causing apparent phase distortion in the output signals.

CONTROLS

There are certain controls and adjustments necessary in conjunction with receiver demodulator operation. In the chrominance channel ahead of the band-pass filter, an over-all gain control is desirable in order to adjust the degree of color saturation (referred to as the "chroma" control). Although there is only one correct setting for this control for a given set of operating conditions, it is normally available

to the operator, either as a front panel adjustment or as a secondary control available on the rear of the chassis. It is important in the circuit design involving this control that its adjustment cause no phase shift of the color subcarrier signal components, since this would result in an over-all phase error causing incorrect color rendition. The output termination of a low-impedance band-pass filter provides a suitable point for introducing variable controls for the purpose of adjusting the demodulator output levels. Of course, the proper phasing of the

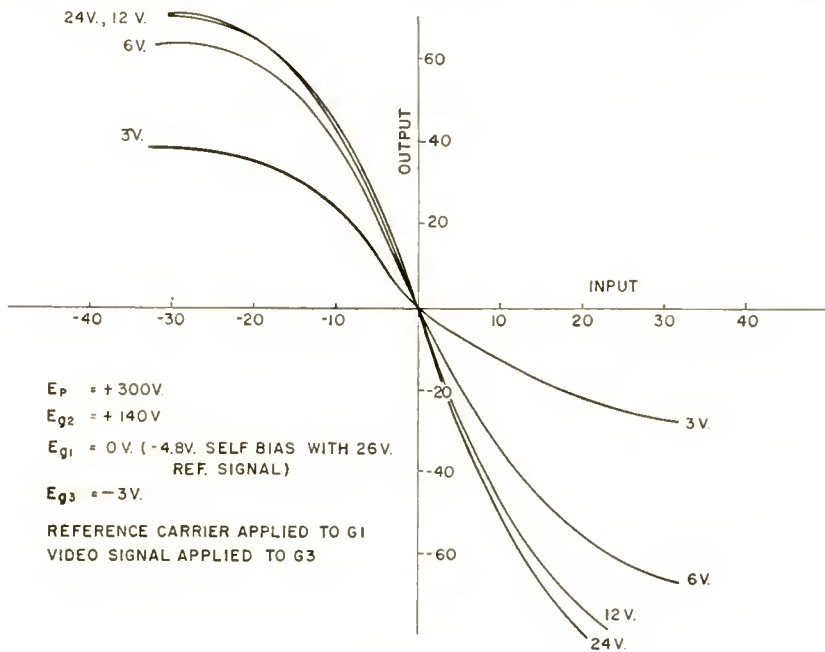

Fig. 11—GAS6 demodulator characteristics.

reference carrier signal feeding each demodulator must be made possible, preferably with vernier adjustments available for servicing purposes. The stability of these phasing adjustments is, of course, of primary importance, and to a great extent determine the quality of color reproduction possible for a given receiver design. Only two demodulators are necessary, the third color difference signal being obtained by a simple matrix in which the relative level adjustments can be made. In receivers designed for test purposes, it is desirable to make all these adjustments easily available in the form of potentiometers rather than fixed dividers.

If the addition of the color-difference signals to the luminance signal is accomplished in conventional "adder" circuits, capacity

coupling can be employed in the output of the color demodulators. Direct-current restoration is then accomplished in the three separate video amplifier channels feeding the three inputs of the color reproducer. If the kinescope itself is utilized as the "adder", it is desirable to direct-current couple the outputs of the color demodulators directly to the kinescope elements, since no sync pulses are available in those signals for simple direct-current restorer circuit operation. Pulsed or gated clamp circuits are not desirable due to the additional circuitry required and their lack of noise immunity.

The problem of "color killer" action should be mentioned at this point. When a color receiver is operating from a standard monochrome signal, the reference carrier signal is not synchronized, and causes the chrominance channel to produce variations from the ideal in the black-and-white reproduction. It is normally not sufficient to disable the reference carrier signal, since amplitude effects still pass through the demodulator channels and are added to the luminance signal. Therefore, the most desirable procedure is to remove the input signal to the demodulators, thereby eliminating any spurious signals in the chrominance channel. Manual operation of the over-all chroma control will accomplish this result, but automatic action might be more desirable. There are any number of simple detector circuits available which will operate in the absence of the "burst" synchronizing signal and bias a stage preceding the band-pass filter to cut off while operating from a monochrome signal. A certain degree of "killer" action can be realized in the 6AS6 demodulator circuit by causing the G3 bias to become sufficiently negative when the reference carrier signal is removed. With certain "crystal ringing" types of color hold circuits, this action becomes automatic, although in general a separate killer circuit is more desirable.

BALANCED COLOR DEMODULATORS

So far, only single-ended demodulator methods have been considered. However, semi-balanced or doubly balanced modulator techniques can be utilized as receiver color signal demodulators. The principal advantage resulting from the use of balanced demodulators is the elimination of the band-pass filter and the possibility of greater color resolution, since the output pass band can extend from zero up to the color subcarrier frequency. There are theoretical disadvantages as well as several practical problems to be considered when comparing the balanced technique with the single-ended procedures. In the discussion of various forms of crosstalk existing in the system, it was mentioned that luminance signal components impressed upon the demodulator

(passing through the band-pass filter) are multiplied in the demodulators, along with the color signal components, and produce undesired spurious signals in the output. In balanced modulator circuits, the entire frequency spectrum of the luminance channel is impressed upon the demodulator inputs, and the spurious beats produced in the demodulator outputs extend over the entire pass band with increased visibility of such undesired spurious signals.

From a practical standpoint, the shielding problems of a balanced modulator are increased, and the finite limits to which undesired signals can actually be balanced out, along with the stability of the best degree of balance possible, make the balanced modulator generally undesirable for most purposes. Difficulty is experienced in obtaining the two video signals which retain exactly a 180 degrees phase relationship over the entire 4-megacycle pass band. When this relationship is not maintained, unbalance results, usually in the higher-frequency portions of the video signal. In spite of the several practical difficulties mentioned above, balanced modulators can be utilized and have certain advantages for laboratory use where tube count and circuit complexity are not important. The technique has been successfully utilized in laboratory test receivers, and is particularly applicable to transmitter modulator methods. There are many other forms of balanced modulators such as four diodes, varistors, and "dummy" balance tube types, but none of them seems completely trouble free or particularly applicable to practical commercial receiver design.

DIODE COLOR DEMODULATORS

A type of color demodulator which appears attractive due to its comparative simplicity utilizes the nonlinear characteristic of a simple diode. Here the input video signal (output of band-pass filter) is impressed upon one element of the diode, while the reference-carrier signal is impressed upon the other element. The difference-frequency products can be obtained across the load resistor by means of a low-pass filter and then amplified to the desired signal level. A circuit utilizing a diode demodulator is shown in Figure 12. In addition to simplicity, an advantage of this circuit is the fact that large output signal levels can be realized, the amplitude being determined by the degree of amplification employed following the diode circuit. The particular 12AT7 circuit indicated in Figure 12 is capable of 50 to 60 volts output with from 3 to 5 volts video input level fed to the diode. The series trap in the grid circuit of the 12AT7 is tuned to the reference carrier frequency and prevents overload of the amplifier due to the high levels of reference carrier signals required. The phase lin-

arity of the diode demodulator is comparatively poor unless ratios in order of 10 to 1 are utilized between the reference carrier level and the video signal level. Due to the amplitude detection properties of the circuit, this method is particularly sensitive to amplitude variations of the reference carrier signal and requires complete color killer action in the video circuits preceding the demodulator.

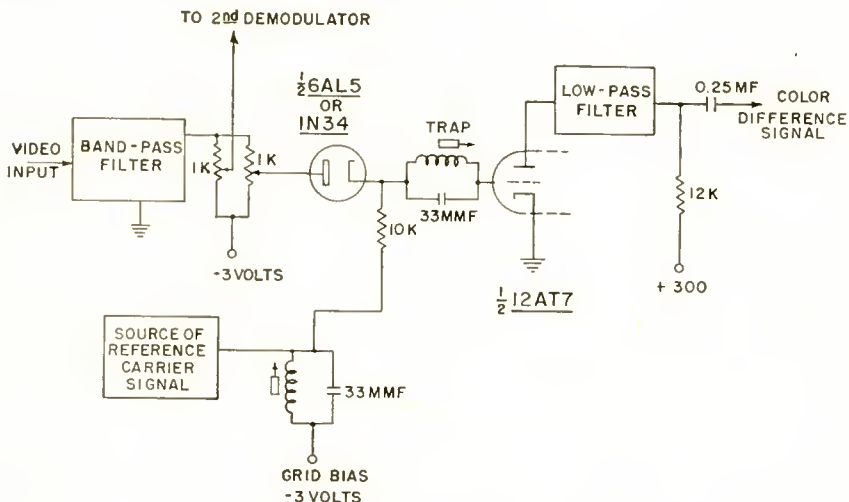

Fig. 12—Diode demodulator circuit diagram.

SUMMARY AND CONCLUSIONS

The material presented herein has attempted to provide a knowledge of the basic concepts involved in color signal receiver demodulators, along with a working knowledge of the problems and techniques involved in the design and development of practical demodulator circuits as utilized to date.

The single-ended technique appears to be satisfactory and has some advantages over the general balanced modulator procedures. So far, the 6AS6 tube has proven most useful in practical receiver demodulator circuits, although larger values of output signal level might be desirable in order to drive a kinescope directly from the demodulator output. The procedures and methods described herein should provide a basis for future development of improved and simplified demodulator circuits, resulting in improved color television receiver performance.

ACKNOWLEDGMENT

The authors wish to acknowledge the assistance of Joseph Preisig in the preparation of the data presented in the paper.

COLORIMETRIC ANALYSIS OF RCA COLOR TELEVISION SYSTEM*†

BY

D. W. EPSTEIN

Research Department, RCA Laboratories Division,
Princeton, N. J.

Summary—The objective of color television is the reproduction on the viewing screen of the receiver of not only the relative luminances (brightness) but also the chromaticities (hues and saturations) of the details in the original scene. Colorimetry, the science of color measurement and specification, is of great importance to the color television engineer, since it is with the aid of the principles of colorimetry that he is able to determine quantitatively the characteristics of reproduction and to accumulate engineering data for the constant improvement of the reproduction.

The purpose of this paper is to present an analysis of the colorimetric capabilities of the RCA color television system. Since some of the readers may not be well versed in colorimetry, the first section will be devoted to an introduction to the subject. This is followed by a section describing the ideal requirements for perfect reproduction and an analysis of the fidelity of reproduction when ideal requirements are not fulfilled.

COLORIMETRY

THE object of colorimetry is the unique quantitative specification of color. The difficulties in attaining this objective stem from the fact that color involves both physical and psychological factors. It is important to differentiate between the physical color stimulus and the psychological color sensation. Three attributes may be recognized in the color sensation. These are: (1) hue, which is described by terms red, violet, green, etc., (2) degree of saturation, which is implied by the use of such vague terms as pastel, pale, deep, etc., and (3) brightness. These psychological concepts serve to supply names to visual sensation, but since sensations are not measurable, they have very little quantitative significance. Purely physical concepts concentrate on the radiant power and its spectral distribution as the stimulus for the sensation of color. These might specify color by a spectroradiometric curve giving the watts per millimicron as a function of wavelength. It is found, however, that there is an infinite number

* Decimal Classification: 621.375.601 × R583.1.

† The material in this paper was originally presented as an exhibit in the 1949-1950 color television hearings conducted by the Federal Communications Commission. It is published here because it describes basic colorimetric methods and it furnishes a background for colorimetric methods used in other papers in this issue of *RCA Review*.

of spectroradiometric curves for all of which the same color sensation is produced. Thus the purely physical concepts do not yield a system of colorimetry. The system of colorimetry widely used at present is based upon the relationships which have been discovered between physical stimuli and the sensory or perceptual aspects of these stimuli.

Although the normal human visual mechanism is unsuitable for measuring, it can be considered as a satisfactory null instrument. It is this property of vision that is utilized in colorimetry. Thus any color stimulus may be specified by finding a known second stimulus which is equivalent to it. In modern colorimetry, the second stimulus is taken as a combination of three known stimuli. These three are called primary stimuli (usually taken as red, green, and blue lights), and the specification consists of giving the amounts of each primary stimulus required for matching. This is known as the *tristimulus* system of colorimetry or color specification.

Most colors can be matched by a proper additive mixture of three suitably chosen primary colors, in which case the amounts of the primaries are recorded as positive quantities and constitute the specifications of the unknown color. However, some colors cannot be matched with such an additive mixture, and it is then necessary to establish a match between a mixture of the unknown color with one of the primaries and a mixture of the other two primaries. In this case, the amount of the primary mixed with the unknown color is considered as a negative quantity. There may be some instances when it is necessary, in order to establish a match, to mix two of the primary colors with the unknown color and match this mixture with the remaining primary. In this case, the quantities of the two primaries mixed with the unknown would be considered as negative quantities. *All* colors can be matched with *any* three primaries if negative quantities are included. In practice, the three color primaries are usually chosen to minimize the occurrence of negative quantities. There is a prevalent impression that there is something unique about primary colors. Actual experiment shows, however, that an infinite number of sets of primaries can be used for color matching and the only requirements of primary stimuli are that no two primaries shall be the same and that no combination of two shall be capable of matching the third.

In the tristimulus system of colorimetry, the specification of a color stimulus made up of the sum of any number of component stimuli is obtained by merely adding together the specifications of the components. Thus, if (R_1, G_1, B_1) are the specified amounts of red, green, and blue equivalent to one color stimulus, (R_2, G_2, B_2) are the specified amounts of red, green, and blue equivalent to a second color stimulus,

and (R_3, G_3, B_3) those equivalent to a third color stimulus, then the specification of the stimulus obtained by superimposing these three stimuli is $(R_1 + R_2 + R_3), (G_1 + G_2 + G_3), (B_1 + B_2 + B_3)$. As a result of this, it is possible to *compute* all equivalent stimuli for an observer from his tristimulus specifications of the spectrum colors (a spectrum color is the color of light comprising only a very narrow range of wavelengths) because any stimulus may be considered as the sum of a number of spectrum stimuli. A set of curves which gives tristimulus specifications of the spectrum for any observer is called color-mixture curves.

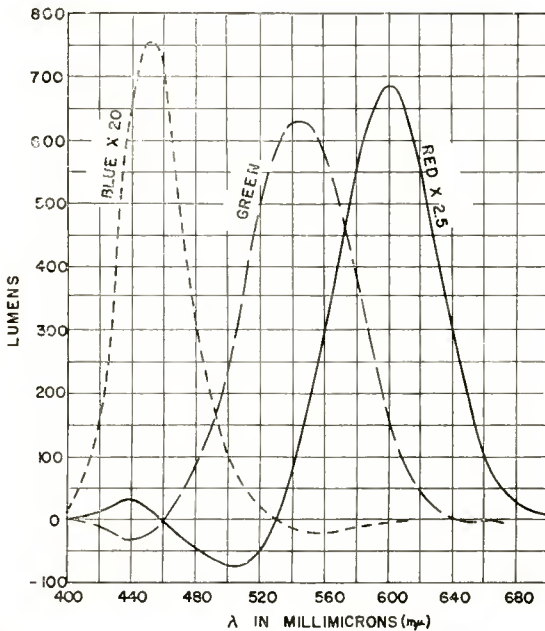

Fig. 1—Color mixture curves giving the number of lumens of three monochromatic primaries (Red—650 mμ, Green—530 mμ, Blue—460 mμ) required to match one watt of radiant power having the indicated wavelength. Based on data obtained by W. D. Wright.¹

Figure 1 shows a set of curves, obtained experimentally, which represents the averaged color-mixture data of a number of normal observers. The color-mixture curves of Figure 1 give the amounts of three monochromatic primaries needed to match all the spectrum colors. If other primaries had been used, a different set of curves would have been obtained. Since there is nothing unique about any set of pri-

¹ W. D. Wright, *Trans. Opt. Soc.*, Vol. 31, p. 201, 1929-1930.

maries, one set of curves obtained with one set of primaries must be transformable into any other set of color-mixture curves obtained with other primaries if the data is to have any general significance. This is the case, and all color-mixture curves for any observer can be computed from any one set of color-mixture curves for that observer.

The color-mixture curves corresponding to any possible set of real primaries require negative values of some wavelengths. For convenience of computation, the International Commission on Illumination (CIE) standardized in 1931 on the set of color-mixture data shown graphically in Figure 2 and tabulated in Table I. These curves can

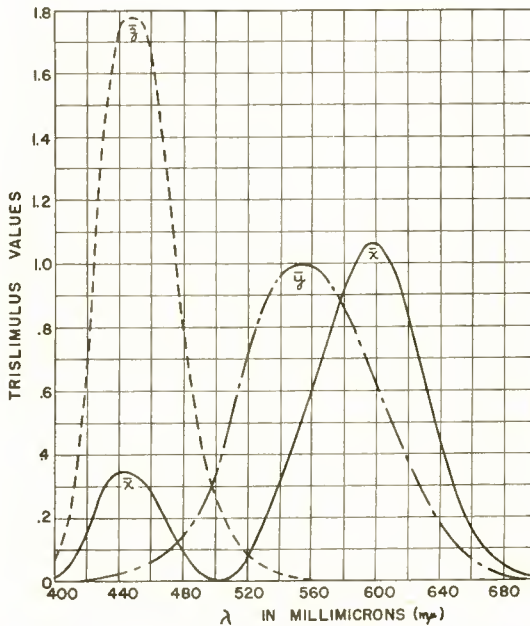

Fig. 2—Standard CIE color-mixture curves giving amounts of the three CIE primaries required to color match a unit amount of radiant power having the indicated wavelength.

be considered as based on fictitious primaries which cannot be actually obtained, but which serve to eliminate negative values. They were derived, by a suitable transformation, from experimental color-mixture curves such as shown in Figure 1.

The observer for whom the standard mixture curves apply is called the standard observer. The use of actual observers equivalent to the standard observer for the direct visual determination of standard colorimetric specification is impractical. As a result, an indirect method of colorimetry is generally used. This consists of the compu-

tation of standard colorimetric specification from the standard color-mixture data (Figure 2) and spectroradiometric data.

Specifications computed by indirect colorimetry permit the classification of ordinary colors in a manner corresponding quite closely to the appearance of the colors for over 90 per cent of the population.

The three tristimulus values of any sample of light are the relative amounts of the three CIE standard (fictitious) primaries which when added would match the sample. Two color stimuli are considered identical if they have identical tristimulus specification. The ordinates of the standard CIE color-mixture curves \bar{x} , \bar{y} , \bar{z} , at any wavelength give the tristimulus values of a spectrum color at that wavelength. For example, the tristimulus values of green light of wavelength 520 millimicrons are

$$\bar{x} = 0.0633, \bar{y} = 0.7100, \bar{z} = 0.0782.$$

In order to present these numbers graphically on a two-dimensional drawing, the quantities

$$x = \frac{\bar{x}}{\bar{x} + \bar{y} + \bar{z}},$$

$$y = \frac{\bar{y}}{\bar{x} + \bar{y} + \bar{z}},$$

$$z = \frac{\bar{z}}{\bar{x} + \bar{y} + \bar{z}},$$

are defined so that $x + y + z = 1$ and therefore any two of these quantities are sufficient to specify a chromaticity. Thus the chromaticity of the spectrum color just considered may be presented in a two-dimensional rectangular coordinate system by a point whose coordinates are,

$$x = \frac{0.0633}{.8515} = 0.0743,$$

$$y = \frac{0.7100}{.8515} = 0.8338.$$

If, using Figure 2, the same procedure is followed for all spectrum colors, and the values of x and y so obtained are plotted, the horseshoe-shaped curve shown in Figure 3 is obtained. The coordinates x and y

are known as the *trichromatic coefficients*, the diagram is known as the *chromaticity diagram*, and the curve is known as the *spectrum locus*. The measurement of color may be divided into two general problems: (1) the measurement of luminance (brightness), and (2) the measurement of chromaticity. Each point in the chromaticity diagram of Fig-

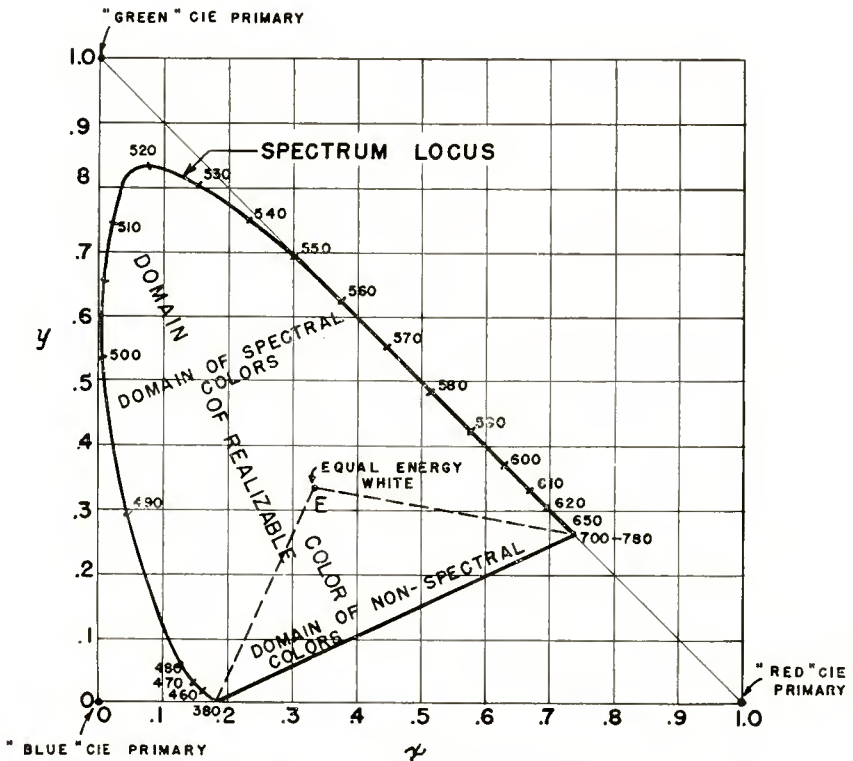

Fig. 3—CIE chromaticity diagram.

ure 3 specifies the chromaticity of a color independent of its luminance. The complete domain of all realizable colors is within the horseshoe-shaped curve of the spectrum locus and the straight line that joins the violet and red extremities of the spectrum locus. The CIE standard primaries or stimuli are represented by the point $x = 0, y = 1$ for the "green" primary, $x = 0, y = 0$ for the "blue" primary, and $x = 1, y = 0$ for the "red" primary. As may be seen from the chromaticity diagram of Figure 3, these primaries lie outside the domain of realizable colors.

The three tristimulus values of any sample of radiant energy are given by

$$X = \int_{\lambda = 380 \text{ m}\mu}^{\lambda = 780 \text{ m}\mu} \bar{x}(\lambda) f(\lambda) d\lambda,$$

$$Y = \int_{\lambda = 380 \text{ m}\mu}^{\lambda = 780 \text{ m}\mu} \bar{y}(\lambda) f(\lambda) d\lambda,$$

$$Z = \int_{\lambda = 380 \text{ m}\mu}^{\lambda = 780 \text{ m}\mu} \bar{z}(\lambda) f(\lambda) d\lambda,$$

where $f(\lambda)$ is the spectral distribution of the sample of light. The above integration is generally carried out by the ordinary methods of numerical integration such as

$$X = \sum_{\lambda = 400 \text{ m}\mu}^{\lambda = 700 \text{ m}\mu} \bar{x}(\lambda) f(\lambda) \Delta\lambda$$

$$= \bar{x}(\lambda_1) f(\lambda_1) \Delta\lambda + \bar{x}(\lambda_2) f(\lambda_2) \Delta\lambda + \dots + \bar{x}(\lambda_n) f(\lambda_n) \Delta\lambda,$$

where $\lambda_1 = 400 \text{ m}\mu,$
 $\lambda_n = 700 \text{ m}\mu,$
 $\Delta\lambda = 10 \text{ m}\mu.$

The trichromatic coefficients are then obtained as,

$$x = \frac{X}{X + Y + Z},$$

$$y = \frac{Y}{X + Y + Z},$$

$$z = \frac{Z}{X + Y + Z},$$

and the coefficients x and y are then plotted on the chromaticity diagram. Thus the point representing the chromaticity of white light from a source radiating an equal amount of energy throughout the spectrum has the coordinates $x = .3333, y = .3333$ and is represented by the point E in Figure 3.

Because the tristimulus values of a *mixture* of several varieties of light are the sums of the corresponding tristimulus values of the components of the mixture, the point representing the chromaticity of a mixture of two components is located on the straight line connecting the points representing the chromaticities of the separate components. Similarly, the chromaticity of a mixture of three components, whose points on the chromaticity diagram are not colinear, is located at a point within the triangular area obtained by connecting the three points. It may be seen from Figure 3 that, since the domain of all realizable color is within the area of the color triangle obtained by connecting the three points representing the CIE primaries, any realizable color will be "matched" with positive amounts of the three CIE primaries. As mentioned before, this is one of the reasons why these primaries were standardized.

If the trichromatic coefficients of a color are known, the coefficients of possible combining colors capable of producing a match can be deduced by drawing a straight line of arbitrary length, within the area of real colors, in an arbitrary direction through the given point. Any point on this line to one side of the given point represents a color capable of being combined with any color represented by a point on the other side to produce a match with the original color. This leads to another procedure of specifying chromaticity of a color, i.e., by giving its dominant wavelength and purity. The dominant wavelength of a sample is the wavelength of the monochromatic light which would have to be mixed with a suitable amount of achromatic or white light in order to match the chromaticity of the sample. The purity gives the proportion of the spectrally pure component in the mixture matching the chromaticity of the sample. Dominant wavelength and purity correspond approximately to the attributes of hue and saturation respectively of the color sensation. Thus the chromaticity of a mixture of white light represented by E and the spectrum color of 520 millimicrons ($m\mu$) wavelength (see Figure 3) must be represented somewhere on the straight line between E and 520 $m\mu$. The less the proportion of the spectrum component 520 $m\mu$ present in the mixture, the closer is the chromaticity of the mixture to point E. Impure colors such as those perceived as pastel or pale are represented by points near the chromaticity representing white light. Purer colors are represented by points more remote from E, approaching the spectrum locus. Colors represented by points on the spectrum locus are called spectrum colors even though, in some cases, the stimulus is not radiant energy confined to one small wavelength interval.

It should be noted that dominant wavelength and purity, as defined above, can only be used to specify the chromaticity of those colors indicated as the domain of spectral colors in Figure 3. In the domain of nonspectral colors (the purples) chromaticity is specified by complementary wavelength and purity. The complementary wavelength is determined by extending a straight line from the sample point through the achromatic or "white" point until it intersects the spectrum locus. The purity is determined by the distance of the sample point from the "white" point.

The specification of dominant wavelength and purity depends upon the point in the chromaticity diagram considered as white. Thus it is possible for a given point on the chromaticity diagram to be specified by a dominant wavelength of 583 $m\mu$ (orange) when referred to sunlight "white" or by a dominant wavelength of 484 $m\mu$ (blue) when referred to incandescent "white".

COLOR REPRODUCTION

The RCA color television system can be described from the colorimetric point of view as an additive three-color reproducing system. It is so called because the reproduced colors are the results of the addition of three colored lights emitted by the three phosphors of the picture reproducer.

It was shown in the preceding section on colorimetry that the gamut of colors that may be produced have chromaticities which lie within the color triangle whose apexes represent the receiver primaries. It can be seen from Figure 3 that it is impossible to choose three real primaries, i.e., primaries located on or within the horseshoe-shaped curve, such that the entire domain of realizable colors may be produced.

The choice of primaries in the RCA color television system is dictated essentially by the purely colorimetric considerations of phosphor spectral characteristic and efficiency, since flicker and phosphor decay characteristics play no more important roles than they do in black-and-white. This provides a wide latitude in the choice of phosphors for use as receiver primaries, and as a result a large color triangle can be obtained. The spectral distributions of a blue-emitting silicate phosphor, green-emitting silicate phosphor and red-emitting silicate phosphor are shown in Figure 4. The spectral distribution of the light output of red, green, and blue tubes as modified by dichroic filters and a red filter over the red tube is shown in Figure 5. These curves are the spectral distribution of the primaries of RCA direct-

view color receivers used in the 1949-1950 period. The chromaticities² of these primaries and the color triangle which they determine are shown in Figure 6. The gamut of colors that it is possible to produce with these primaries compares very favorably with that which can be produced by the best processes of color reproduction, and is much superior to that obtained with such commercial processes as color printing.

The fact that all colors within the triangle of the receiver primaries can be *produced*, does not mean that these colors can be reproduced faithfully. For good color reproduction, it is necessary that the tristimulus values or trichromatic coefficients of the subject and repro-

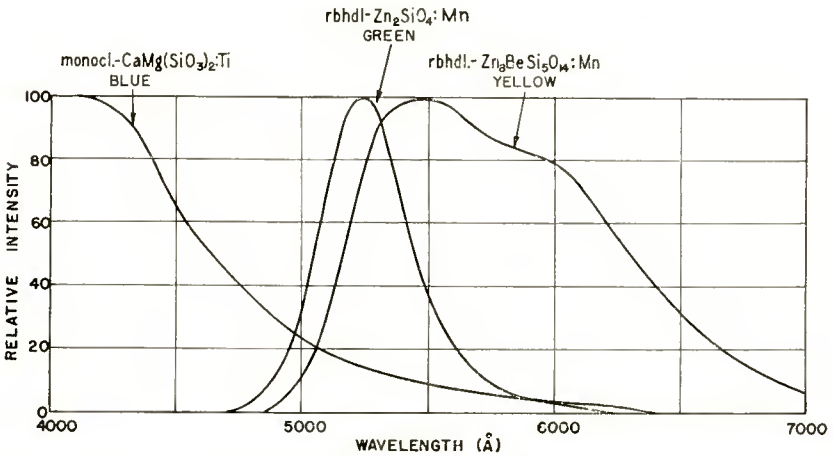

Fig. 4—Spectral characteristics of red, green, and blue silicate phosphors. At the present time (1953), ZnS:Ag is being used as the blue phosphor, and Zn₃(PO₄)₂:Mn as the red phosphor in tricolor kinescopes.

duction be the same. In order to reproduce faithfully all those chromaticities of the original scene which lie within the color triangle of the receiver primaries, it is necessary to control properly the relative

² The tristimulus values of the primaries were determined by forming the sums

$$X_r = \sum r(\lambda) \bar{x} \Delta\lambda \quad Y_g = \sum g(\lambda) \bar{y} \Delta\lambda \quad Z_b = \sum b(\lambda) \bar{z} \Delta\lambda, \text{ etc.}$$

$$\Delta\lambda = 10 \text{ m}\mu$$

where $r(\lambda)$, $g(\lambda)$ and $b(\lambda)$ are shown in Figure 5, \bar{x} , \bar{y} , \bar{z} are shown in Figure 2, and finally obtaining the trichromatic coefficients,

$$x_r = \frac{X_r}{X_r + Y_r + Z_r} \quad y_r = \frac{Y_r}{X_r + Y_r + Z_r}, \text{ etc.}$$

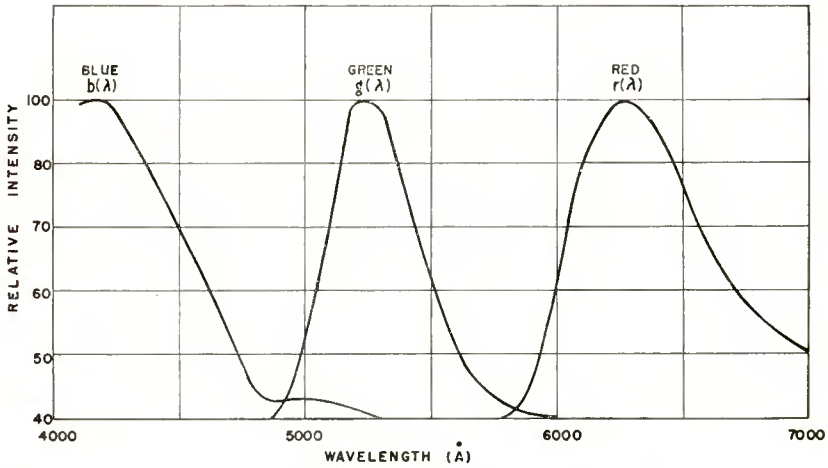

Fig. 5—Spectral characteristics of red, green, and blue kinescopes (receiver primaries) plus dichroics and red filter.

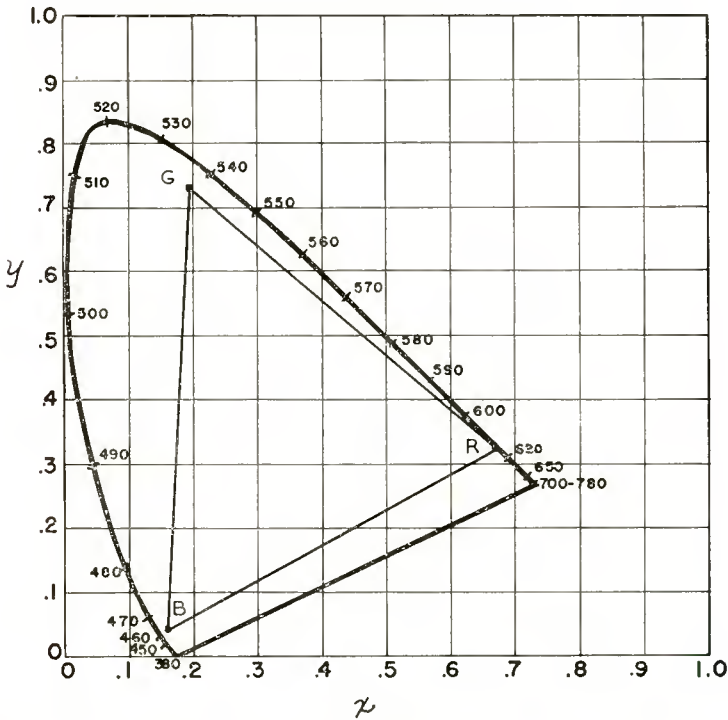

Fig. 6—CIE chromaticity diagram showing location of receiver primaries R, G, B, and color triangle of receiver. These primaries are only slightly different from those adopted by the NTSC February 2, 1953.

amounts of the primaries at every point of reproduction. This imposes special requirements on the three spectral sensitivity curves that are used in the camera for making the trichromatic analysis of the original scene. By imposing the condition that the tristimulus values of original and reproduced scene be identical, the theoretically correct spectral sensitivities of the camera may be deduced. The equations (derived in Appendix B) giving the ideal camera spectral sensitivities are:

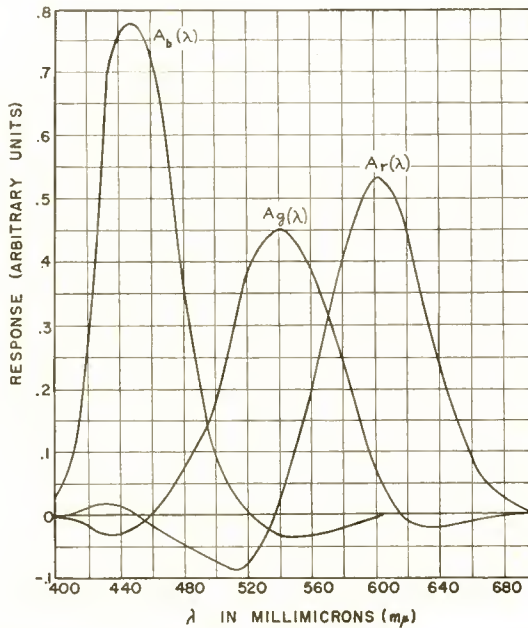

Fig. 7—Theoretical camera spectral sensitivities required with receiver of Figure 6.

$$A_r = (y_g z_b - y_b z_g) \bar{x} + (x_b z_g - x_g z_b) \bar{y} + (x_g y_b - x_b y_g) \bar{z},$$

$$A_g = (y_b z_r - y_r z_b) \bar{x} + (x_r z_b - x_b z_r) \bar{y} + (x_b y_r - x_r y_b) \bar{z},$$

$$A_b = (y_r z_g - y_g z_r) \bar{x} + (x_g z_r - x_r z_g) \bar{y} + (x_r y_g - x_g y_r) \bar{z},$$

where A_r , A_g , and A_b represent the spectral sensitivities of the red, green, and blue pickup tubes together with their respective filters, \bar{x} , \bar{y} , and \bar{z} represent the color mixture functions of the CIE standard observer (Figure 2 or Table I) and (x_r, y_r, z_r) , (x_g, y_g, z_g) and (x_b, y_b, z_b) represent the trichromatic coefficients of the red, green, and blue primaries of the receiver. Figure 7 shows graphically the theoretical camera sensitivities required with the receiver primaries shown

in Figure 6. Figure 8 shows another set of theoretical camera sensitivities computed for primaries which form a smaller triangle. It can be seen from Figures 7 and 8 that the theoretically required camera spectral sensitivity curves have regions where the sensitivity is negative. It can also be surmised from Figures 7 and 8 that:

- (1) The negative portions of the curves depend rather critically on the choice of receiver primaries.
- (2) The positive portions may vary only slightly for a wide choice of receiver primaries.

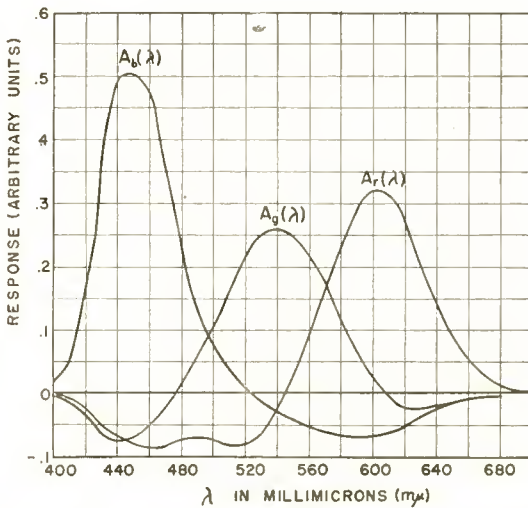

Fig. 8—Theoretical camera spectral sensitivities required with a receiver having primaries

$$\begin{aligned}
 x_r &= .575, y_r = .305, z_r = .120, \\
 x_g &= .260, y_g = .650, z_g = .090, \\
 x_b &= .235, y_b = .150, z_b = .615,
 \end{aligned}$$

The negative portions of these sensitivity curves correspond approximately in magnitude and spectral location to the areas and locations of the portions of the chromaticity diagram lying within the spectrum locus but outside of the color triangle of the receiver. As a result, the ratio of the areas of negative response to those of positive response is smaller the larger the color triangle of the receiver. This is another reason for choosing receiver primaries which form a large triangle.

Because of the regions of negative response, the attainment, in general, of the theoretically correct camera spectral sensitivities is very difficult,* and an investigation was undertaken to determine the effect on the fidelity of reproduction of various camera spectral sensitivities which are positive throughout the spectrum.

Any departure from the ideal camera spectral sensitivities results in some lack of fidelity. The degree of reduction in fidelity depends upon:

- (1) The receiver primaries.
- (2) The degree of departure of the actual camera spectral sensitivities from the ideal.
- (3) The "white" chosen to be reproduced exactly.
- (4) The chromaticity and spectral distribution of the color to be reproduced.

The computations were carried out on the basis that nonlinearity, cross talk, noise, etc. have negligible effect, and for the following set of conditions:

- (1) One set of receiver primaries, shown in Figure 6.
- (2) Four sets of camera spectral sensitivities shown on Figures 9, 10, 11 and 12.
- (3) Three "whites", selected for accurate reproduction—these correspond to the appearance of a white card illuminated by,
 - (a) Sunlight (approximated by an equal energy spectrum).
 - (b) Daylight fluorescent lamps.
 - (c) 2848° K tungsten lamps.
- (4) Nine chromaticities, three sources (the receiver primaries) and six reflecting subjects representing gold, light green, light blue, light yellow, light red, and light purple.

An outline of the calculation procedure follows.

Assuming a given illuminant (studio or outdoor), the six reflecting subjects become effective sources and their trichromatic coefficients are computed. A set of camera spectral sensitivities is then selected and the system adjusted so that the "white" for the illuminant chosen is accurately reproduced. The trichromatic coefficients of the nine subjects as reproduced by the system with this adjustment are then computed. The fidelity of reproduction may then be checked by comparing the original and reproduced trichromatic coefficients of the nine subjects. The calculations were then repeated for most of the

* See Appendix C.

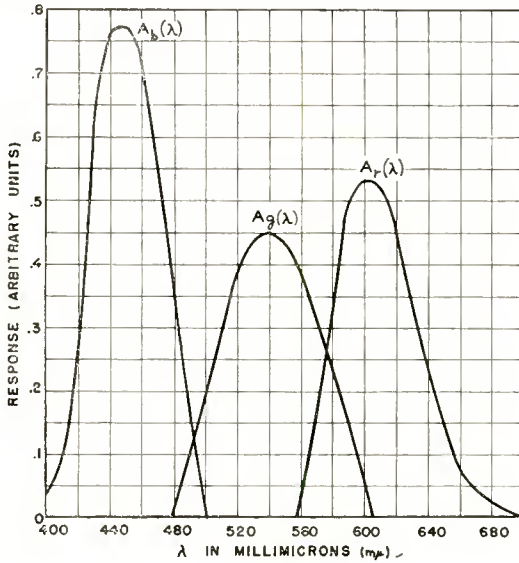

Fig. 9—Camera spectral sensitivities having only regions of positive response adjusted so that the areas under the curve are equal to those of Figure 7.

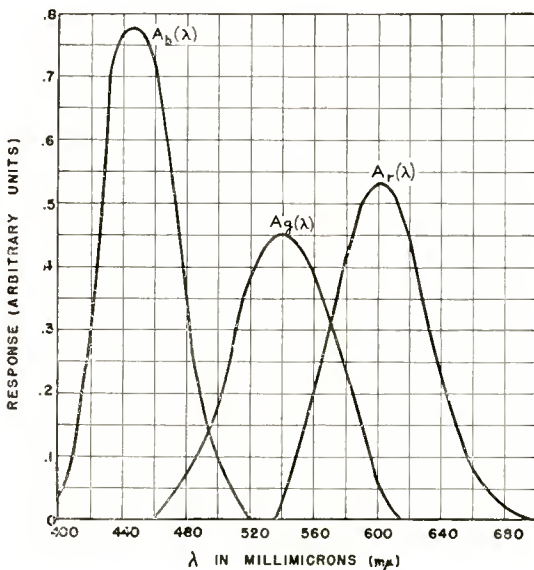

Fig. 10—Camera spectral sensitivities having only regions of positive response which are the same as those of Figure 7.

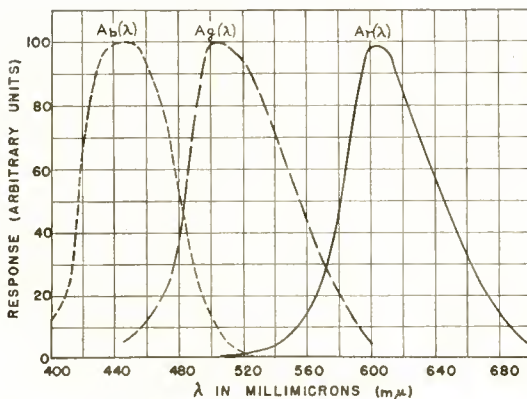

Fig. 11—Camera spectral sensitivities used during the October 1949 demonstrations at Washington, D. C.

possible combinations of camera sensitivities and studio illuminants. The equations used for computing the chromaticity of the reproduction are developed in Appendix A.

The CIE chromaticity diagram has the disadvantage that a fixed distance between two points on the diagram does not represent a fixed subjective difference between the two colors which these points represent. For example, a given range of orange colors extends over a much smaller area on the chromaticity diagram than does the same range of green colors. It is, therefore, not immediately obvious from the distance between the original and reproduced chromaticity as shown on the diagram, as to how well a given color is reproduced.

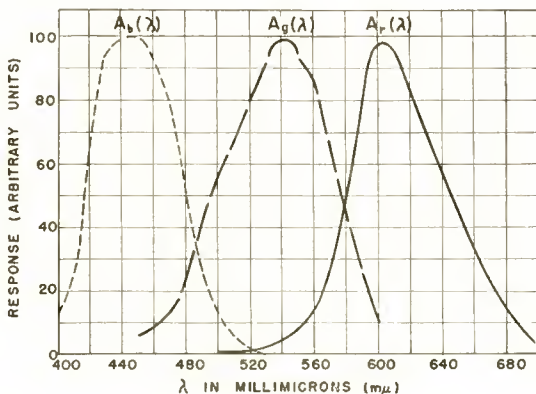

Fig. 12—Camera spectral sensitivities used during the November 1949 comparative demonstrations at Washington, D. C.

However, there have been published³ three contour diagrams with the aid of which the change in chromaticness* due to a known change in the CIE trichromatic coefficients can be calculated. This computation proceeds from the square of a distance,

$$ds^2 = g_{11}dx^2 + 2g_{12}dxdy + g_{22}dy^2.$$

Here, ds is the difference in chromaticness due to a change dx in the x trichromatic coefficient and to a change dy in the y trichromatic coefficient between the original and reproduced chromaticity. The quantities g_{11} , $2g_{12}$, and g_{22} are given on the contour diagrams of Figures 13, 14, and 15. The chromaticness difference ds is the number of times that the chromaticity difference is greater than the standard deviation of the observer in MacAdam's experiment. The number computed for ds represents approximately the number of times that the difference in chromaticness is greater than the minimum color difference that a normal observer can perceive.

The evaluation of the fidelity of color reproduction (when it is not perfect) is always open to criticism, since the visual sensitivity to color differences varies considerably for different individuals or for the same individual under different conditions of observation. However, it is reasonable to assume that color differences represented by a ds of perhaps 10 (computed on the basis of the charts of Figures 13, 14, 15) are negligible in the case of color television reproduction. Among the reasons for this are (1) the data on which the charts are based was obtained with the aid of a trained observer under relatively ideal conditions of observation, and this is not duplicated in viewing a color television receiver, (2) the original is not available for comparison.

RESULTS

The effects of camera spectral characteristics and studio lighting on fidelity of reproduction in the RCA color television system have been analyzed. The results of the analysis are shown in tabular form in Tables II to XIII, and graphically in Figures 17 and 18.

In the tables, the trichromatic coefficients of the original sample colors are given by x_o and y_o , those of the reproduced colors by x_R

³ D. L. MacAdam, "Specification of Small Chromaticity Differences," *Jour. Opt. Soc. Amer.*, Vol. 33, pp. 18-26, January, 1943.

* Chromaticness refers to the combined subjective hue and saturation attributes of color sensation, and thus represents the subjective reaction to a chromaticity.

and y_R . Figure 16 shows the location on the color triangle of all of the original sample colors. The locations of the original and reproduced chromaticities are shown graphically in Figures 17 and 18 for the cases of Tables X and III respectively. The fidelity of reproduction is evaluated in columns 8 and 9 of the tables both in terms of ds and

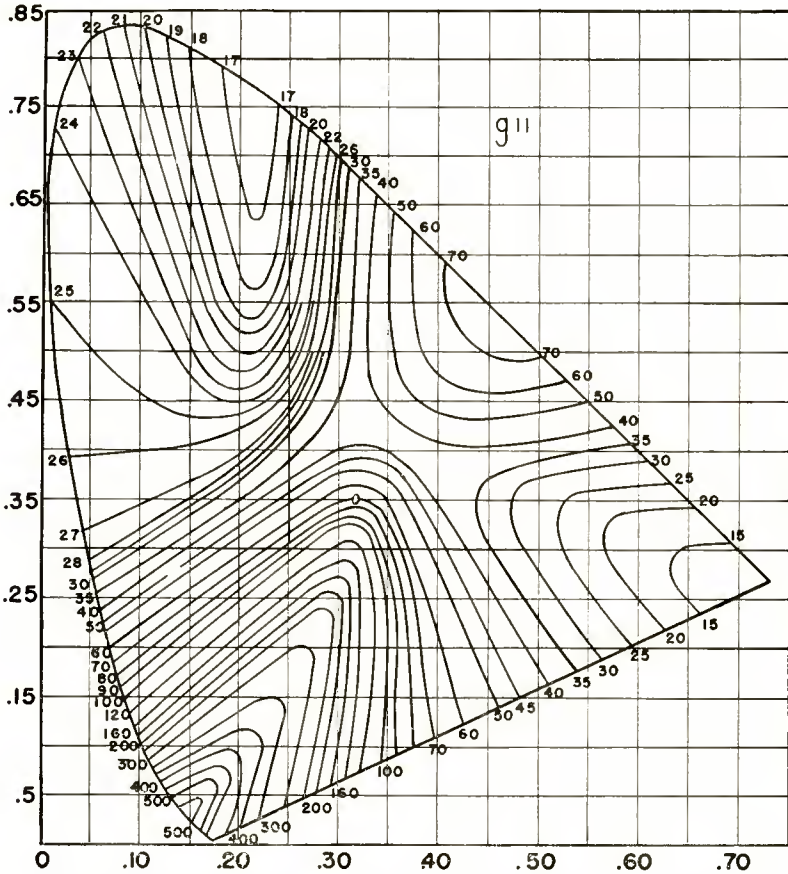

Fig. 13—Contour diagram of the values of the coefficient g_{11} (to be multiplied by 10^4) used in the determination of ds from the equation

$$ds^2 = g_{11}\Delta x^2 + 2g_{12}\Delta x\Delta y + g_{22}\Delta y^2,$$

reproduced from D. L. MacAdam.

in terms of the quantity

$$\sqrt{\Delta x^2 + \Delta y^2},$$

the latter being the distance, on the CIE chromaticity diagrams, be-

tween the original and reproduced colors. The evaluation in terms of ds is the preferable one, because a fixed distance on the chromaticity diagram does not represent a fixed subjective difference between the two colors which these points represent, but rather depends upon the location of these colors on the diagram. Thus, it may be seen from

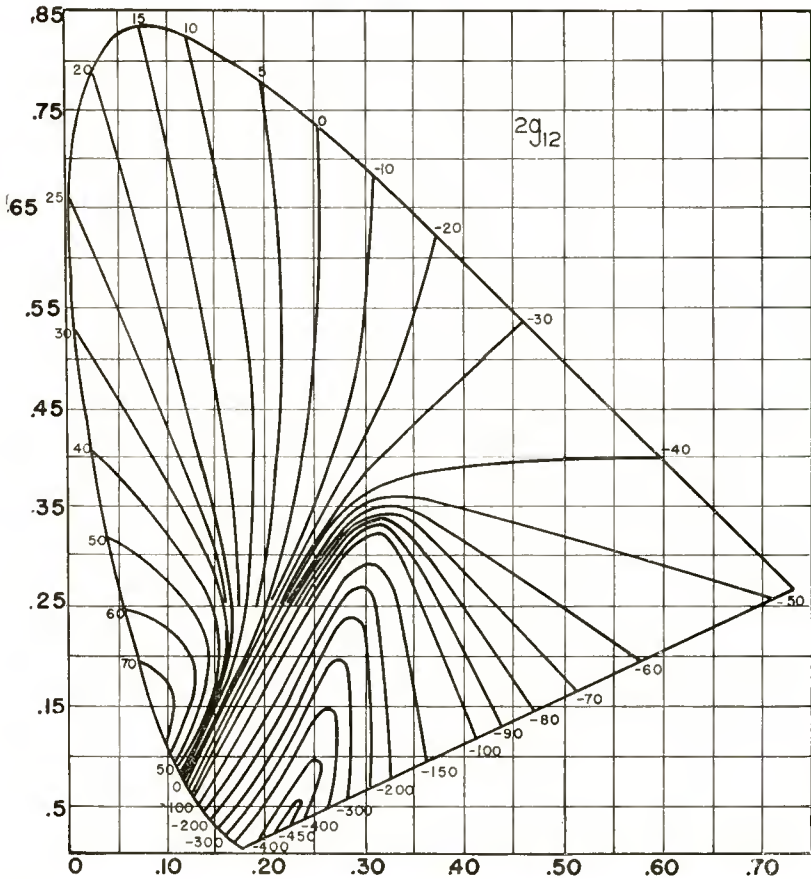

Fig. 14—Contour diagram of the values of the coefficient $2g_{12}$ (to be multiplied by 10^4) used in the determination of ds from the equation

$$ds^2 = g_{11}\Delta x^2 + 2g_{12}\Delta x\Delta y + g_{22}\Delta y^2.$$

the tables that a smaller distance,

$$\sqrt{\Delta x^2 + \Delta y^2},$$

in the blue (sample No. 3 in the tables) corresponds to a much greater

value of $\bar{d}s$ than a larger distance in the green (sample No. 2).

In all color-reproducing systems, as a result of not having the theoretically required camera sensitivities, the fidelity of reproduction depends upon the studio illuminant and, for any given illuminant, upon the chromaticity being reproduced. The computations confirm

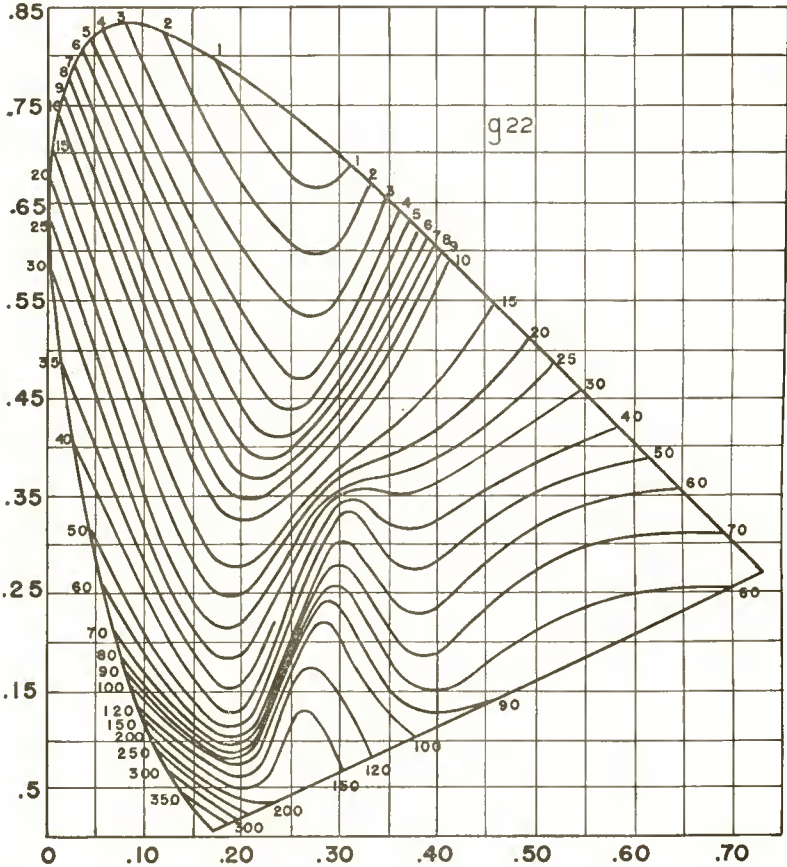

Fig. 15—Contour diagram of the values of the coefficient g_{22} (to be multiplied by 10^4) used in the determination of $\bar{d}s$ from the equation

$$\bar{d}s^2 = g_{11}\Delta x^2 + 2g_{12}\Delta x\Delta y + g_{22}\Delta y^2.$$

this as may be seen from the tables.

Camera spectral sensitivities which correspond to the positive sensitivity portion (Figure 10) of those theoretically required are often the objective in color reproducing systems. This has been practically attained with the characteristics of Figure 12.

It can be seen from the mean value of ds given in the tables that very good reproduction may be obtained by using the camera spectral sensitivities of Figure 9. Good color reproduction may be obtained with the camera spectral sensitivities shown in Figure 12.

The spectral sensitivities shown in Figures 11 and 12 were attained with readily available filters. Still further improvement in the fidelity of reproduction is in store because, as indicated in Appendix C, it is

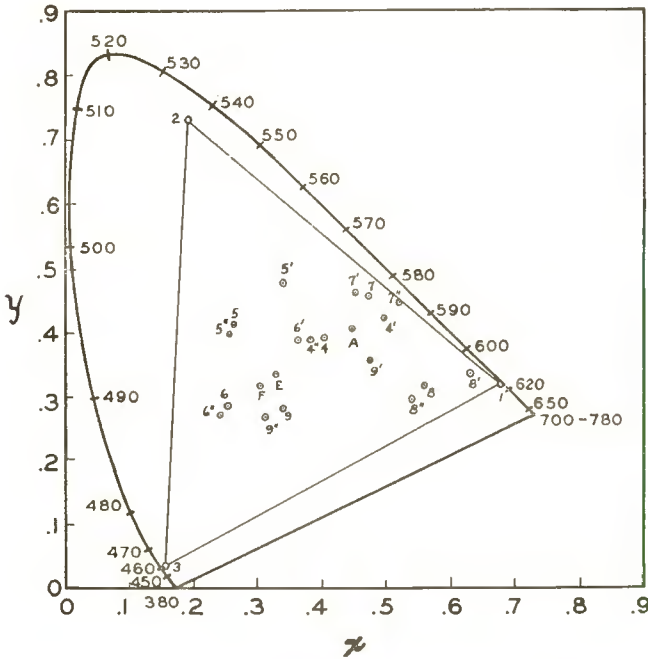

Fig. 16—Location of original test colors and working “whites” on CIE chromaticity diagram

possible with the RCA color television system to attain effectively the camera spectral characteristics shown in Figure 7.

CONCLUSIONS

To attain perfect color reproduction within the color triangle of the reproducer of any color television system, it is necessary that the camera spectral characteristics have regions of negative response. It is well known that such negative responses are extremely difficult to achieve in practice. Since the RCA color television system is essen-

tially a simultaneous system, it is relatively easy to attain camera spectral characteristics having regions of negative response. All known color reproducing systems and processes, therefore, employ spectral characteristics for the camera or taking device which are only approximations to those theoretically required for perfect reproduction.

Because the standards under which the RCA color television system operates are essentially identical with those used in the black-

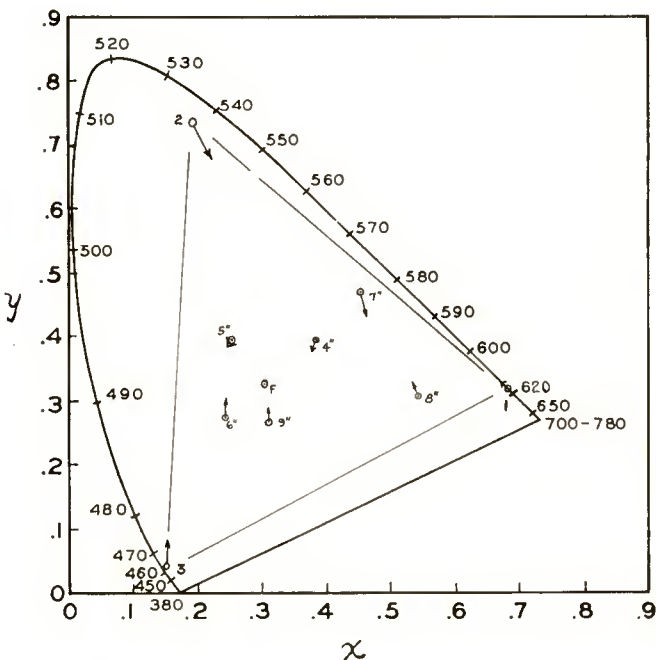

Fig. 17—Calculated chromaticity reproductions with receiver primaries of Figure 6, camera spectral sensitivities of Figure 12, and studio illuminant F (6500° K fluorescent):

- ⊙ = original chromaticities,
- = reproduced chromaticities.

Data from Table X.

and-white system, flicker and phosphor decay considerations play no more important roles than they do in monochrome, and the choice of receiver primaries is determined essentially by purely colorimetric considerations such as spectral response and efficiency of the phosphors used in the color reproducer. As a result, the gamut of colors that it is possible to produce with the RCA receiver primaries compares very favorably with that possible with the best processes of color reproduction and is much superior to most commercial processes.

Since the color triangle of the RCA color receivers encompasses a large gamut of colors, suitably chosen camera spectral characteristics which are positive throughout the spectrum are good approximations to those theoretically required, and the analysis shows that good color reproduction may be obtained with the camera spectral characteristics presently used.

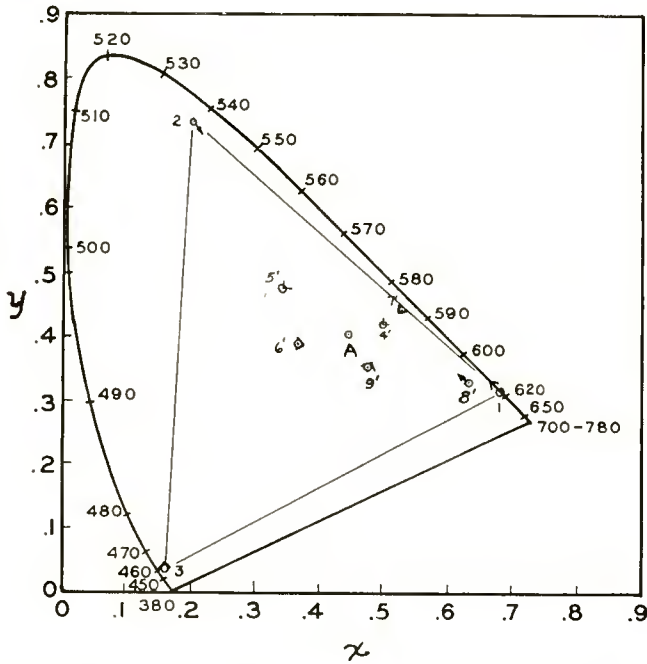

Fig. 18—Calculated chromaticity reproductions with receiver primaries of Figure 6, camera spectral sensitivities of Figure 10, and studio illuminant A (2848° K incandescent):

⊙ = original chromaticities,
 → = reproduced chromaticities.

Data from Table III.

REFERENCES

- (1) A. C. Hardy, *Handbook of Colorimetry*, Technology Press, Cambridge, Mass., 1936.
- (2) "Quantitative Data and Methods for Colorimetry," *Jour. Opt. Soc. Amer.*, Vol. 34, pp. 633-688, November, 1944.
- (3) A. C. Hardy and F. L. Wurzburg, Jr., "The Theory of Three-Color Reproduction," *Jour. Opt. Soc. Amer.*, Vol. 27, pp. 227-240, July, 1937.

(4) W. H. Cherry, "Colorimetry in Television," *RCA Review*, Vol. 8, pp. 427-459, September, 1947.

Table I—Monochromatic Tristimulus Values
(Plotted in Figure 2)

$\lambda (m\mu)$	\bar{x}	\bar{y}	\bar{z}	$\lambda (m\mu)$	\bar{x}	\bar{y}	\bar{z}
380	.0013	.0000	.0065	560	.5945	.9950	.0039
390	.0042	.0001	.0201	570	.7621	.9520	.0021
400	.0143	.0004	.0679	580	.9163	.8700	.0017
410	.0435	.0012	.2074	590	1.0263	.7570	.0011
420	.1344	.0040	.6456	600	1.0622	.6310	.0008
430	.2839	.0116	1.3856	610	1.0026	.5030	.0003
440	.3483	.0230	1.7471	620	.8544	.3810	.0002
450	.3362	.0380	1.7721	630	.6424	.2650	.0000
460	.2908	.0600	1.6692	640	.4479	.1750	.0000
470	.1954	.0910	1.2876	650	.2835	.1070	.0000
480	.0956	.1390	.8130	660	.1649	.0610	.0000
490	.0320	.2080	.4652	670	.0874	.0320	.0000
500	.0049	.3230	.2720	680	.0468	.0170	.0000
510	.0093	.5030	.1582	690	.0227	.0082	.0000
520	.0633	.7100	.0782	700	.0114	.0041	.0000
530	.1655	.8620	.0422	710	.0058	.0021	.0000
540	.2904	.9540	.0203	720	.0029	.0010	.0000
550	.4334	.9950	.0087				

Table II—Reproduction of Test Colors with Receiver Primaries Shown in Figure 6, Studio Illuminant (Working "White") E , $x_w = y_w = .3333$ and Camera Spectral Sensitivities Shown in Figure 9

Sample	x_o	y_o	x_R	y_R	Δx	Δy	$\sqrt{\Delta x^2 + \Delta y^2}$	ds
1	.6806	.3193	.6682	.3298	-.0124	.0105	.0162	12.6
2	.1969	.7311	.2132	.7118	.0163	-.0193	.0253	6.0
3	.1556	.0324	.1565	.0479	.0009	.0155	.0155	27.0
4	.4073	.3952	.4016	.3939	-.0057	-.0013	.0058	3.2
5	.2642	.4112	.2708	.4070	.0066	-.0042	.0078	4.3
6	.2584	.2877	.2668	.2880	.0084	-.0003	.0084	9.1
7	.4742	.4566	.4592	.4547	-.0150	-.0019	.0150	10.9
8	.5585	.3197	.5540	.3308	-.0045	.0111	.0119	10.3
9	.3404	.2824	.3458	.2853	.0054	-.0029	.0062	6.9

$\Delta x = x_R - x_o$ $\Delta y = y_R - y_o$ mean .0125 10.0

Table III—Reproduction of Test Colors with Receiver Primaries Shown in Figure 6, Studio Illuminant (Working "White") A, $x_w = .4476$, $y_w = .4075$ and Camera Spectral Sensitivities Shown in Figure 9

Sample	x_o	y_o	x_R	y_R	Δx	Δy	$\sqrt{\Delta x^2 + \Delta y^2}$	ds
1	.6806	.3193	.6686	.3295	-.0120	.0102	.0157	12.3
2	.1969	.7311	.2137	.7112	.0168	-.0199	.0260	6.1
3	.1556	.0324	.1566	.0485	.0009	.0161	.0161	28.5
4'	.4992	.4250	.4945	.4233	-.0047	-.0017	.0050	2.7
5'	.3441	.4784	.3451	.4766	.0012	-.0018	.0021	1.3
6'	.3673	.3907	.3751	.3919	.0078	.0012	.0079	4.4
7'	.5311	.4439	.5201	.4406	-.0110	-.0033	.0115	7.0
8'	.6323	.3336	.6212	.3459	-.0111	-.0123	.0166	7.7
9'	.4751	.3610	.4804	.3648	.0053	-.0038	.0065	4.9
$\Delta x = x_R - x_o$			$\Delta y = y_R - y_o$		mean		.0119	8.3

Table IV—Reproduction of Test Colors with Receiver Primaries Shown in Figure 6, Studio Illuminant (Working "White") F, $x_w = .3064$, $y_w = .3233$ and Camera Spectral Sensitivities Shown in Figure 9

Sample	x_o	y_o	x_R	y_R	Δx	Δy	$\sqrt{\Delta x^2 + \Delta y^2}$	ds
1	.6806	.3193	.6674	.3305	-.0132	.0112	.0173	13.5
2	.1969	.7311	.2122	.7125	.0153	-.0186	.0241	5.6
3	.1556	.0324	.1565	.0483	.0009	.0159	.0159	28.4
4''	.3849	.3911	.3715	.3934	-.0134	.0023	.0136	9.0
5''	.2569	.3992	.2570	.4006	.0001	.0014	.0014	0.4
6''	.2448	.2704	.2477	.2741	.0029	.0037	.0047	2.4
7''	.4542	.4653	.4302	.4685	-.0240	.0032	.0242	19.3
8''	.5422	.3024	.5212	.3286	-.0210	.0262	.0336	28.5
9''	.3136	.2666	.3135	.2713	-.0001	.0047	.0047	4.0
$\Delta x = x_R - x_o$			$\Delta y = y_R - y_o$		mean		.0155	12.3

Table V—Reproduction of Test Colors with Receiver Primaries Shown in Figure 6, Studio Illuminant (Working "White") E, $x_w = y_w = .3333$ and Camera Spectral Sensitivities Shown in Figure 10

Sample	x_o	y_o	x_R	y_R	Δx	Δy	$\sqrt{\Delta x^2 + \Delta y^2}$	ds
1	.6806	.3193	.6628	.3345	-.0178	.0152	.0234	18.2
2	.1969	.7311	.2403	.6676	.0434	-.0635	.0769	14.8
3	.1556	.0324	.1565	.0531	.0009	.0207	.0207	37.0
4	.4073	.3952	.4001	.3920	-.0072	-.0032	.0079	3.7
5	.2642	.4112	.2819	.3999	.0177	-.0113	.0210	12.2
6	.2584	.2877	.2694	.2904	.0110	.0027	.0113	10.8
7	.4742	.4566	.4598	.4516	-.0144	-.0050	.0152	10.0
8	.5585	.3197	.5408	.3330	-.0177	.0133	.0221	17.1
9	.3404	.2824	.3392	.2876	-.0012	.0052	.0053	4.6
$\Delta x = x_R - x_o$			$\Delta y = y_R - y_o$		mean		.0226	14.3

Table VI—Reproduction of Test Colors with Receiver Primaries Shown in Figure 6, Studio Illuminant (Working "White") A, $x_w = .4476$, $y_w = .4075$ and Camera Spectral Sensitivities Shown in Figure 10

Sample	x_o	y_o	x_R	y_R	Δx	Δy	$\sqrt{\Delta x^2 + \Delta y^2}$	ds
1	.6806	.3193	.6638	.3336	-.0168	.0143	.0221	17.1
2	.1969	.7311	.2429	.6674	.0460	-.0637	.0786	17.7
3	.1556	.0324	.1596	.0546	.0040	.0222	.0225	37.3
4'	.4992	.4250	.4932	.4229	-.0060	-.0031	.0068	3.4
5'	.3441	.4784	.3541	.4678	.0100	-.0106	.0146	9.1
6'	.3673	.3907	.3781	.3923	.0008	.0016	.0018	.6
7'	.5311	.4439	.5200	.4396	-.0111	-.0043	.0119	7.1
8'	.6323	.3336	.6146	.3496	-.0177	.0160	.0239	18.7
9'	.4751	.3610	.4741	.3682	-.0010	.0072	.0073	5.1
$\Delta x = x_R - x_o$				$\Delta y = y_R - y_o$		mean	.0209	12.9

Table VII—Reproduction of Test Colors with Receiver Primaries Shown in Figure 6, Studio Illuminant (Working "White") F, $x_w = .3064$, $y_w = .3233$ and Camera Spectral Sensitivities Shown in Figure 10

Sample	x_o	y_o	x_R	y_R	Δx	Δy	$\sqrt{\Delta x^2 + \Delta y^2}$	ds
1	.6806	.3193	.6629	.3344	-.0177	.0151	.0233	18.1
2	.1969	.7311	.2403	.6600	.0434	-.0711	.0833	16.7
3	.1556	.0324	.1568	.0517	.0012	.0193	.0193	32.8
4"	.3849	.3911	.3755	.3801	-.0094	-.0110	.0145	4.5
5"	.2569	.3992	.2708	.3796	.0139	-.0196	.0240	11.4
6"	.2448	.2704	.2520	.2649	.0072	-.0055	.0091	10.3
7"	.4542	.4653	.4398	.4550	-.0144	-.0103	.0177	9.8
8"	.5422	.3024	.5085	.3251	-.0337	.0227	.0406	31.4
9"	.3136	.2666	.3090	.2637	-.0046	-.0029	.0054	3.8
$\Delta x = x_R - x_o$				$\Delta y = y_R - y_o$		mean	.0264	15.4

Table VIII—Reproduction of Test Colors with Receiver Primaries Shown in Figure 6, Studio Illuminant (Working "White") E, $x_w = y_w = .3333$ and Camera Spectral Sensitivities Shown in Figure 11

Sample	x_o	y_o	x_R	y_R	Δx	Δy	$\sqrt{\Delta x^2 + \Delta y^2}$	ds
1	.6806	.3193	.6766	.3227	-.0040	.0034	.0055	4.1
2	.1969	.7311	.2257	.6738	.0288	-.0573	.0644	9.5
3	.1556	.0324	.1585	.0805	.0029	.0481	.0482	72.0
4	.4073	.3952	.4117	.3768	.0044	-.0184	.0189	11.5
5	.2642	.4112	.2665	.4195	.0023	.0083	.0086	2.3
6	.2584	.2877	.2646	.3128	.0062	.0251	.0258	10.9
7	.4742	.4566	.4933	.4166	.0191	-.0400	.0443	29.5
8	.5585	.3197	.5682	.3238	.0097	.0041	.0105	3.3
9	.3404	.2824	.3475	.2997	.0071	.0173	.0187	9.2
$\Delta x = x_R - x_o$				$\Delta y = y_R - y_o$		mean	.0272	16.9

Table IX—Reproduction of Test Colors with Receiver Primaries Shown in Figure 6, Studio Illuminant (Working "White") A, $x_w = .4476$, $y_w = .4075$ and Camera Spectral Sensitivities Shown in Figure 11

Sample	x_o	y_o	x_R	y_R	Δx	Δy	$\sqrt{\Delta x^2 + \Delta y^2}$	ds	
1	.6806	.3193	.6764	.3228	-.0042	.0035	.0055	4.2	
2	.1969	.7311	.2255	.6801	.0286	-.0510	.0585	10.3	
3	.1556	.0324	.1592	.0911	.0036	.0587	.0588	80.1	
4'	.4992	.4250	.5214	.4027	.0222	-.0223	.0315	23.4	
5'	.3441	.4784	.3317	.4908	-.0124	.0124	.0175	10.7	
6'	.3673	.3907	.3825	.4081	.0152	.0174	.0231	7.3	
7'	.5311	.4439	.5602	.4058	.0291	-.0381	.0479	34.0	
8'	.6323	.3336	.6377	.3364	.0054	.0028	.0061	2.0	
9'	.4751	.3610	.4976	.3679	.0225	.0069	.0235	9.9	
$\Delta x = x_R - x_o$							mean	.0302	20.2

Table X—Reproduction of Test Colors with Receiver Primaries Shown in Figure 6, Studio Illuminant (Working "White") F, $x_w = .3064$, $y_w = .3233$ and Camera Spectral Sensitivities Shown in Figure 11

Sample	x_o	y_o	x_R	y_R	Δx	Δy	$\sqrt{\Delta x^2 + \Delta y^2}$	ds	
1	.6806	.3193	.6764	.3229	-.0042	.0036	.0055	4.3	
2	.1969	.7311	.2247	.6743	.0278	-.0568	.0632	10.0	
3	.1556	.0324	.1585	.0799	.0029	.0475	.0476	73.1	
4"	.3849	.3911	.3798	.3748	-.0051	-.0163	.0171	6.2	
5"	.2569	.3992	.2486	.3877	-.0083	-.0115	.0142	5.4	
6"	.2448	.2704	.2462	.2991	.0014	.0287	.0287	13.9	
7"	.4542	.4653	.4637	.4281	.0095	-.0372	.0384	22.2	
8"	.5422	.3024	.5340	.3212	-.0082	.0188	.0205	18.0	
9"	.3136	.2666	.3132	.2864	-.0004	.0198	.0198	16.6	
$\Delta x = x_R - x_o$							mean	.0283	18.9

Table XI—Reproduction of Test Colors with Receiver Primaries Shown in Figure 6, Studio Illuminant (Working "White") E, $x_w = y_w = .3333$ and Camera Spectral Sensitivities Shown in Figure 12

Sample	x_o	y_o	x_R	y_R	Δx	Δy	$\sqrt{\Delta x^2 + \Delta y^2}$	ds	
1	.6806	.3193	.6721	.3266	-.0085	.0073	.0113	8.8	
2	.1969	.7311	.2271	.6709	.0302	-.0602	.0673	10.7	
3	.1556	.0324	.1581	.0617	.0025	.0293	.0294	47.8	
4	.4073	.3952	.4046	.3882	-.0027	-.0070	.0075	2.7	
5	.2642	.4112	.2693	.4070	.0051	-.0042	.0066	3.4	
6	.2584	.2877	.2672	.2962	.0088	.0085	.0122	6.8	
7	.4742	.4566	.4678	.4435	-.0064	-.0131	.0146	5.7	
8	.5585	.3197	.5648	.3273	.0063	.0076	.0099	5.3	
9	.3404	.2824	.3502	.2916	.0098	.0092	.0134	6.7	
$\Delta x = x_R - x_o$							mean	.0190	10.9

Table XII—Reproduction of Test Colors with Receiver Primaries Shown in Figure 6, Studio Illuminant (Working "White") A, $x_w = .4476$, $y_w = .4075$ and Camera Spectral Sensitivities Shown in Figure 12

Sample	x_o	y_o	x_R	y_R	Δx	Δy	$\sqrt{\Delta x^2 + \Delta y^2}$	ds
1	.6806	.3193	.6728	.3259	-.0078	.0066	.0102	12.4
2	.1969	.7311	.2304	.6713	.0335	-.0598	.0689	12.1
3	.1556	.0324	.1578	.0673	.0022	.0349	.0350	56.8
4'	.4992	.4250	.5133	.4109	.0141	-.0141	.0199	14.9
5'	.3441	.4784	.3388	.4782	-.0053	-.0002	.0053	3.5
6'	.3673	.3907	.3913	.3931	.0240	.0024	.0241	14.2
7'	.5311	.4439	.5404	.4235	.0093	-.0204	.0224	15.7
8'	.6323	.3336	.6349	.3390	.0026	.0054	.0060	3.6
9'	.4751	.3610	.5021	.3625	.0270	.0015	.0270	13.9
$\Delta x = x_R - x_o$			$\Delta y = y_R - y_o$		mean		.0243	16.3

Table XIII—Reproduction of Test Colors with Receiver Primaries Shown in Figure 6, Studio Illuminant (Working "White") F, $x_w = .3064$, $y_w = .3233$ and Camera Spectral Sensitivities Shown in Figure 12

Sample	x_o	y_o	x_R	y_R	Δx	Δy	$\sqrt{\Delta x^2 + \Delta y^2}$	ds
1	.6806	.3193	.6719	.3267	-.0087	.0074	.0114	8.9
2	.1969	.7311	.2266	.6705	-.0297	-.0606	.0675	16.1
3	.1556	.0324	.1575	.0636	.0019	.0312	.0313	49.3
4''	.3849	.3911	.3734	.3873	-.0115	-.0038	.0121	5.9
5''	.2569	.3992	.2505	.3752	-.0064	-.0240	.0248	7.1
6''	.2448	.2704	.2481	.2821	.0033	.0117	.0121	5.0
7''	.4542	.4653	.4381	.4571	-.0161	-.0082	.0181	10.9
8''	.5422	.3024	.5306	.3254	-.0116	.0230	.0276	22.6
9''	.3136	.2666	.3156	.2775	.0020	.0109	.0111	6.8
$\Delta x = x_R - x_o$			$\Delta y = y_R - y_o$		mean		.0240	14.7

APPENDIX A—COMPUTATION OF CHROMATICITY DIFFERENCE BETWEEN SUBJECT AND REPRODUCTION

Let $E(\lambda)$ be the spectral distribution of the light source illuminating a subject having a reflectivity $R(\lambda)$. The spectral distribution of the light reflected by the subject is then $S(\lambda) = E(\lambda) R(\lambda)$. Then if A_r , A_g , and A_b be the spectral sensitivities of the three portions of the color camera, the signal outputs of the red, green, and blue channels will be

$$\begin{aligned}
 V_r &= \int S(\lambda) A_r(\lambda) d\lambda, \\
 V_g &= \int S(\lambda) A_g(\lambda) d\lambda, \\
 V_b &= \int S(\lambda) A_b(\lambda) d\lambda.
 \end{aligned}
 \tag{1}$$

Let $X_r Y_r Z_r$, $X_g Y_g Z_g$, and $X_b Y_b Z_b$ be the tristimulus values of unit amounts of the primaries of the receiver, then the tristimulus values of the primaries when controlled by the signal from the camera will be

$$\begin{aligned} X'_r &= k_1 V_r X_r, & Y'_r &= k_1 V_r Y_r, & Z'_r &= k_1 V_r Z_r, \\ X'_g &= k_2 V_g X_g, & Y'_g &= k_2 V_g Y_g, & Z'_g &= k_2 V_g Z_g, \\ X'_b &= k_3 V_b X_b, & Y'_b &= k_3 V_b Y_b, & Z'_b &= k_3 V_b Z_b, \end{aligned} \tag{2}$$

where k_1 , k_2 , and k_3 are constants which include the gain of the red, green, and blue channels. It should be noted

$$x_r = \frac{X'_r}{X'_r + Y'_r + Z'_r} = \frac{X_r}{X_r + Y_r + Z_r}$$

and similarly for all other trichromatic coefficients of the receiver primaries. The tristimulus values of the reproduction (obtained by the addition of the lights from the three primaries) are then

$$\begin{aligned} X_R &= k_1 V_r X_r + k_2 V_g X_g + k_3 V_b X_b, \\ Y_R &= k_1 V_r Y_r + k_2 V_g Y_g + k_3 V_b Y_b, \\ Z_R &= k_1 V_r Z_r + k_2 V_g Z_g + k_3 V_b Z_b. \end{aligned} \tag{3}$$

Equation (3) may be written, except for a change in the constants k in terms of the trichromatic coefficients of the receiver primaries, as

$$\begin{aligned} X_R &= k_r V_r x_r + k_g V_g x_g + k_b V_b x_b, \\ Y_R &= k_r V_r y_r + k_g V_g y_g + k_b V_b y_b, \\ Z_R &= k_r V_r z_r + k_g V_g z_g + k_b V_b z_b. \end{aligned} \tag{4}$$

The proportionality constants k are determined by the condition that the receiver reproduce "white" exactly. The tristimulus values of "white" are those of the illuminant $E(\lambda)$ used in the studio for the light reflected by a nonselective reflector, say a white card, and are given by

$$\begin{aligned} X_w &= \int E(\lambda) \bar{x} d\lambda, \\ Y_w &= \int E(\lambda) \bar{y} d\lambda, \\ Z_w &= \int E(\lambda) \bar{z} d\lambda. \end{aligned} \tag{5}$$

The signal output of the red, green and blue channels for white is

$$\begin{aligned}
 W_r &= \int E(\lambda) A_r d\lambda, \\
 W_g &= \int E(\lambda) A_g d\lambda, \\
 W_b &= \int E(\lambda) A_b d\lambda.
 \end{aligned}
 \tag{6}$$

Since, for reproduction of white, it is merely necessary that the tristimulus values of white for the original are proportional to those of the reproduction, Equation (4) becomes

$$\begin{aligned}
 X_w &= k_r W_r x_r + k_g W_g x_g + k_b W_b x_b, \\
 Y_w &= k_r W_r y_r + k_g W_g y_g + k_b W_b y_b, \\
 Z_w &= k_r W_r z_r + k_g W_g z_g + k_b W_b z_b.
 \end{aligned}
 \tag{7}$$

The solution of Equation (7) gives the values of k_r , k_g , and k_b as

$$\begin{aligned}
 k_r &= [(y_g z_b - y_b z_g) x_w + (x_b z_g - x_g z_b) y_w + (x_g y_b - x_b y_g) z_w] W_g W_b, \\
 k_g &= [(y_b z_r - y_r z_b) x_w + (x_r z_b - x_b z_r) y_w + (x_b y_r - x_r y_b) z_w] W_b W_r, \\
 k_b &= [(y_r z_g - y_g z_r) x_w + (x_g z_r - x_r z_g) y_w + (x_r y_g - x_g y_r) z_w] W_r W_g.
 \end{aligned}
 \tag{8}$$

Having the values of k_r , k_g , and k_b , the tristimulus values (or actual quantities proportional to the tristimulus values) of the reproduction of the subject $S(\lambda)$ are then computed from Equation (4), and the trichromatic coefficients of the reproduced chromaticity are given by

$$\begin{aligned}
 x_R &= \frac{X_R}{X_R + Y_R + Z_R}, \\
 y_R &= \frac{Y_R}{X_R + Y_R + Z_R}.
 \end{aligned}
 \tag{9}$$

The fidelity of reproduction is then computed from the difference between the reproduced and original trichromatic coefficients. The original trichromatic coefficients are given by

$$\begin{aligned}
 x_o &= \frac{X_o}{X_o + Y_o + Z_o}, \\
 y_o &= \frac{Y_o}{X_o + Y_o + Z_o},
 \end{aligned}
 \tag{10}$$

$$\begin{aligned} \text{where } X_o &= \int S(\lambda) \bar{x} d\lambda, \\ Y_o &= \int S(\lambda) \bar{y} d\lambda, \\ Z_o &= \int S(\lambda) \bar{z} d\lambda. \end{aligned} \tag{11}$$

APPENDIX B—CAMERA SPECTRAL SENSITIVITIES REQUIRED FOR PERFECT REPRODUCTION

For perfect reproduction it is necessary that the tristimulus values of the reproduced and original be the same (or proportional to each other) i.e.,

$$X_o = X_R, \quad Y_o = Y_R, \quad Z_o = Z_R. \tag{12}$$

From Equations (12), (11), (4), and (1),

$$\begin{aligned} \int S(\lambda) \bar{x} d\lambda &= k_r x_r \int S(\lambda) A_r(\lambda) d\lambda \\ &\quad + k_g x_g \int S(\lambda) A_g(\lambda) d\lambda + k_b x_b \int S(\lambda) A_b(\lambda) d\lambda, \\ \int S(\lambda) \bar{y} d\lambda &= k_r y_r \int S(\lambda) A_r(\lambda) d\lambda \\ &\quad + k_g y_g \int S(\lambda) A_g(\lambda) d\lambda + k_b y_b \int S(\lambda) A_b(\lambda) d\lambda, \tag{13} \\ \int S(\lambda) \bar{z} d\lambda &= k_r z_r \int S(\lambda) A_r(\lambda) d\lambda \\ &\quad + k_g z_g \int S(\lambda) A_g(\lambda) d\lambda + k_b z_b \int S(\lambda) A_b(\lambda) d\lambda. \end{aligned}$$

Since all chromaticities have to be reproduced faithfully, Equation (13) must apply to all subjects regardless of the spectral distribution $S(\lambda)$. This is true only if, at every wavelength,

$$\begin{aligned} \bar{x} &= k_r x_r A_r + k_g x_g A_g + k_b x_b A_b, \\ \bar{y} &= k_r y_r A_r + k_g y_g A_g + k_b y_b A_b, \\ \bar{z} &= k_r z_r A_r + k_g z_g A_g + k_b z_b A_b. \end{aligned} \tag{14}$$

Solving Equation (14) for the red, green, and blue camera spectral sensitivities, there results

$$\begin{aligned} A_r &= k_g k_b (y_g z_b - y_b z_g) \bar{x} + k_g k_b (x_b z_g - x_g z_b) \bar{y} + k_g k_b (x_g y_b - x_b y_g) \bar{z}, \\ A_g &= k_b k_r (y_b z_r - y_r z_b) \bar{x} + k_b k_r (x_r z_b - x_b z_r) \bar{y} + k_b k_r (x_b y_r - x_r y_b) \bar{z}, \\ A_b &= k_r k_g (y_r z_g - y_g z_r) \bar{x} + k_r k_g (x_g z_r - x_r z_g) \bar{y} + k_r k_g (x_r y_g - x_g y_r) \bar{z}. \end{aligned} \tag{15}$$

The proportionality constants $k_g k_b$, $k_b k_r$, and $k_r k_g$ are unimportant,

since only relative values of the sensitivities are generally used. Equation (15) appears on page 238 without the proportionality constants.

APPENDIX C

In any color system, in order to reproduce faithfully all those chromaticities of the original scene which lie within the color triangle of the receiver primaries, it is necessary that the camera spectral sensitivity have regions of negative response similar to those shown in Figures 7 and 8. In color photography, the procedures called "masking" are carried out in order to attain some approximation to these regions of negative response.

It is also possible effectively to attain these regions of negative response with the RCA color television system.³ This can be accomplished by combining with linear networks, before sampling, the three simultaneous signals from the camera having only suitable positive spectral characteristics. The mixing of the camera signals requires

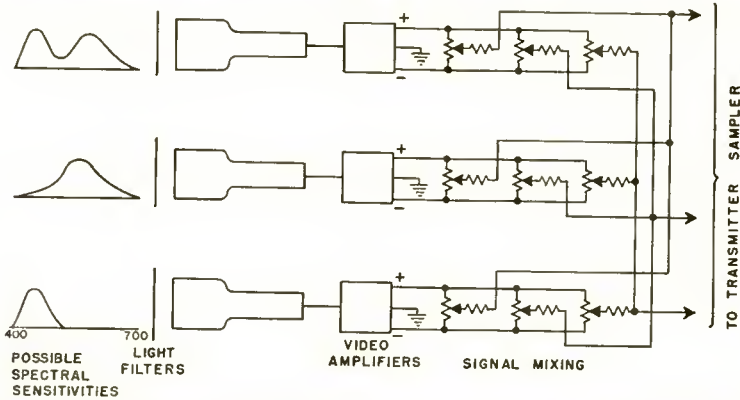

Fig. 19—Schematic arrangement for mixing camera signals in order effectively to obtain the theoretically required spectral sensitivities with regions of negative response.

some means of phase inversion. The three positive camera spectral sensitivities should be so chosen that when divided through by the spectral sensitivities of the photo-surface of the pick-up device, the resulting required filter characteristics are easily obtainable. Figure 19 shows schematically one arrangement of the signal mixing circuits which can be used to obtain exact color reproduction within the color triangle of the receiver. This has been tried in the laboratory, where it was found that with the then available apparatus, the signal-to-noise ratio was somewhat impaired by the subtraction process and that the adjustment procedure was rather complex. Therefore the use of the mixing (or "masking") amplifiers has been postponed till further development simplifies the complexity of the adjustments.

TELEVISION COVERAGE OF THE PRESIDENTIAL INAUGURATION*

By

E. C. WILBUR AND H. L. GRELCK

TV and AM Technical Operations, National Broadcasting Company,
New York, N. Y.

Summary—Extensive television and radio coverage of the inauguration of President Eisenhower in January was provided by the National Broadcasting Company. Because of the physical magnitude of the task and the fact that considerable mobile coverage was required, it is felt that a description of the operational procedures is of interest. A rather detailed description of a new small mobile unit is also included.

THE NBC television and radio coverage of the inauguration of President Eisenhower in January 1953 was one of the most ambitious projects of its type which has thus far been attempted. The inauguration-day coverage was continuous from 7 A.M. to 7 P.M., at which time equipment was moved out to Georgetown University Gymnasium where the Inaugural Ball was televised from 11:15 P.M. until after midnight.

The groundwork for the project began in November 1952. Since this was to be an integrated operation for both radio and television, there was joint planning for the two services. Information and suggestions were gathered from all available sources, and a survey made of the route to be followed by the parade. It was finally decided that four fixed locations along the route plus a mobile unit would give the desired television coverage. The locations were the Capitol, the Federal Trade Building, the Treasury Building, and Lafayette Park. In addition, the film studio at television station WNBW in Washington was used, and commercials for the sponsor (General Motors) originated at the Waldorf-Astoria Hotel in New York. For radio, there were, in addition, two mobile units and a fixed location at the Esso Building. The remote locations and the route of the parade are shown in Figure 1. After the locations had been selected, arrangements were made for equipment, power, telephone lines and similar details necessary for smooth operation.

A novel feature of the inaugural coverage was the first use of the new Cadillac Telemobile Unit which has been dubbed the "Traveling Eye." This is a self-contained unit with its own power supply, capable of transmitting complete audio and video signals of broadcast quality

* Decimal Classification: R550.

to a nearby relay receiver. Because of the uniqueness of the unit, and because its construction involved solution of many problems which may arise in future developments of this type, it is felt that a fairly detailed description of the construction would be of interest. The unit is described in the last section of this paper.

Switching Center

Over-all control of the entire television operation was exercised through the switching center which, together with a commentator's booth, was constructed on the stage of WNBW Studio "A" in the Wardman Park Hotel. The switching center for radio was located in Room 305D of the Wardman Park Hotel; cross feeds being provided.

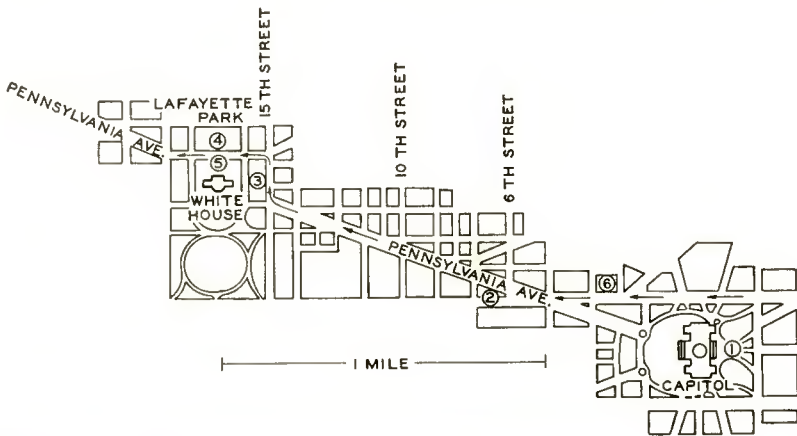

Fig. 1—Route at the inaugural parade up Pennsylvania Avenue from the Capitol to the White House. The remote pickup locations shown are: 1, The Capitol; 2, The Federal Trade Building; 3, The Treasury Building; 4, Lafayette Park; 5, Presidential reviewing stand; 6, The Esso Building.

Between each television fixed remote location and the switching center the following circuits were installed: a regular video line, an emergency video line, a regular audio line, an emergency audio line, a feedback line, a "program" phone line, an "engineering" phone line, and a business phone. Some of the feedback circuits were radio-frequency links. All of these circuits except the radio-frequency links and the microwave link between the Capitol dome and the Wardman Park Hotel were supplied by the telephone company. Diplexed video and audio signals from the mobile unit were beamed to the Capitol dome on microwave.

The system was designed to be as flexible as possible. All incoming video circuits had monitors which provided preview for the program

department as well as a constant check on operational condition of both circuits and equipment. Each video circuit fed into a variable 75-ohm pad, and then into a stabilizing amplifier. Both the switching system and the monitors were fed from this amplifier. The output of the switching system fed the outgoing circuits through additional stabilizing amplifiers, equalizers, and distribution amplifiers. A pulse cross monitor enabled the sync generators on field locations to be phased to WNBW in order to prevent picture rolling when switching the picture from one location to another. The system produced very stable pictures.

Parallel circuits were provided between remote locations and the output terminal feeding the NBC network and the WNBW transmitter.

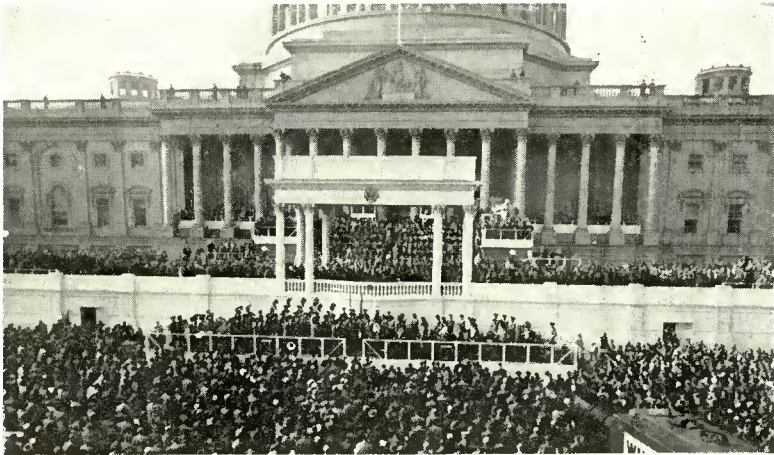

Fig. 2—View of the Capitol from the photographer's stand at the moment the Chief Justice was administering the oath of office.

This minimized the possibility of loss of program due to equipment or circuit failure.

Capitol Building

This was considered the most important of the remote locations, since the swearing-in ceremony and the acceptance speeches were made here. Accordingly, five camera chains were used—one on the second balcony, two on the photographers' platform, and two on the steps in front of the building. In addition to the camera chains, the Capitol setup included a 10-kilowatt gasoline engine-generator set for emergency power, and control rooms which were installed in the crypt. NBC radio provided a "pool" sound pickup for use by all networks and newsreels.

Treasury Building

Three camera chains were used here — two in the stands and one on the “Industrial Monkey” which is a boom-type lift mounted on a truck. The emergency New York telemobile unit, which includes a 10-kilowatt generator, was parked nearby and used as a control room.

Lafayette Park

Pennsylvania Avenue separates Lafayette Park from the White

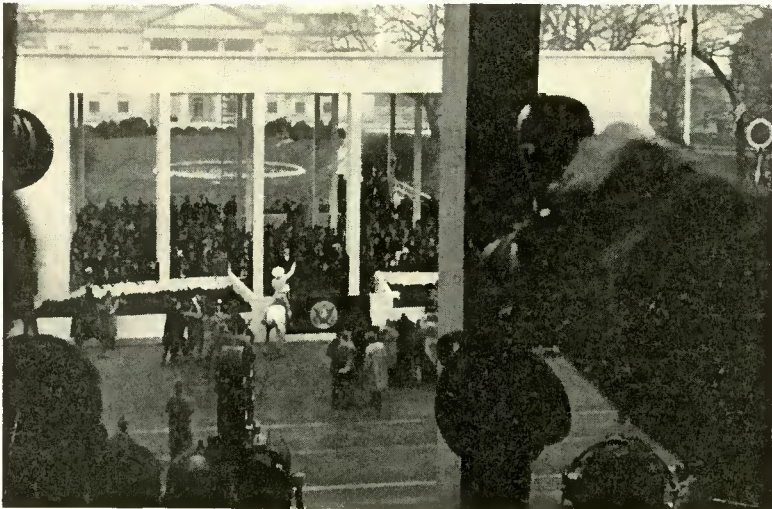

Fig. 3—The presidential reviewing stands on the White House grounds as seen from the Lafayette Park camera location.

House grounds. The presidential reviewing stands were erected on the White House side, and public stands on the Lafayette Park side. Three camera chains were set up here — two on the Park side and one on the White House side. It was originally planned to use the regular New York telemobile unit for the control room, but the soft ground in the Park would not support the weight of the truck. The control equipment therefore had to be transferred to a lighter truck and a separate 10-kilowatt generator was employed. The signal from the camera on the White House side was distributed to the other networks on a “pool” basis. It was the only camera operated in this manner.

Federal Trade Building

Three camera chains were set up on the balcony of the east end

of the Federal Trade Building. A roped-off section of the cafeteria was used as the control room.

Operation

The "program" phone lines were used by the producer for two-way



Fig. 4—The switching center in the Wardman Park Hotel. The producer's position is at the right.

communications with the various remote points. The feedback line fed the "on the air" audio to the monitors at each of the remote locations for the information of the commentators. In addition, an "off the air" video monitor was installed at each location, so that commentators could observe the picture being transmitted. A switching system was

installed which permitted the producer to utilize one or more feedback lines for giving instructions to various points. Since the feedback system used several radio-frequency links, and since other networks were using channels in the same portion of the spectrum, "beeper" signals were mixed into the feedback system for easy, positive identification of NBC.

That the program was carried out on radio and television without interruption of any kind is a tribute to the planners, the engineers, and the equipment. The magnitude of the operation can best be understood from the following list of some of the material requirements:

- 5000 feet of camera cable,
- 7000 feet of microphone cable,
- 2000 feet of coaxial cable,
- 2000 feet of power cable,
- 16 remote camera chains,
 - 4 remote control rooms (one for each location),
 - 3 10-kilowatt generator sets,
 - 8 radio relay transmitters,
 - 9 microwave transmitters.

A total of 57 engineers for television and 24 for radio participated in the program. The cooperation of personnel of the American Telephone and Telegraph Company, the Chesapeake and Potomac Telephone Company, and the Potomac Power Company was an important contribution to the success of the operation.

Cadillac Mobile Unit

In planning the inauguration coverage, the desirability of having a mobile television pickup unit, which could itself be a part of the parade, became evident. NBC has mobile units which carry the necessary technical equipment. Such a unit is pictured in Figure 5. It was felt, however, that, due to its size, the use of such a unit in the parade would not be in keeping with the dignity of the occasion. For this reason, the decision was made to convert a passenger car to a small mobile unit. A Cadillac limousine was chosen for the purpose.

The complete unit is shown in operation in Figures 6 and 7. As seen in Figure 6, two operators are stationed on the roof of the car. One operates an image orthicon camera, and the other "aims" the dish of the microwave transmitter used to beam the video and audio to the Capitol dome. The operators reach their stations by hydraulic lift seats which raise them into position.

In addition to the driver, there are a control engineer and an announcer in the car. Since the announcer's field of vision is some-

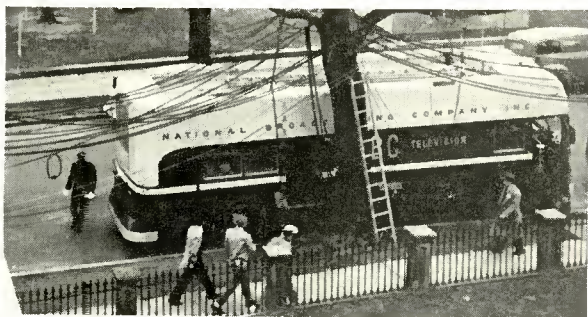

Fig. 5—The emergency New York Telemobile Unit in use as a control room for the Treasury Building cameras.

what restricted, he sometimes must depend on the monitor kinescope to observe the scene being picked up. When the vehicle is stationary, the driver doubles as a cameraman, using a developmental hand-held Vidicon camera as shown in Figure 7.

The electronic equipment carried in the unit includes:

- a field sync generator,
- an image orthicon camera chain,
- a Vidicon camera chain,
- a field relay transmitter,
- a diplexer,
- a field audio amplifier,



Fig. 6—The Cadillac Telemobile Unit moving down Pennsylvania Avenue toward the White House. The microwave relay dish is aimed at the Capitol.

a transmitter control unit,
 a two-way, 450-megacycle FM radio,
 a 26-megacycle FM receiver.

All the equipment operates on 110-volt 60-cycle current with the exception of the 450-megacycle radio which is powered by the 6-volt battery system of the car.

The 60-cycle power is supplied by a 3½-kilowatt gasoline-driven engine-generator set which, together with an 800 cubic foot per minute exhaust fan, is installed in the trunk as shown in Figure 8. The generator has 3 per cent voltage regulation and 3 cycles frequency regulation from no load to full load. With a constant 2.5-kilowatt load,



Fig. 7—Cadillac Telemobile Unit parked on Pennsylvania Avenue. The driver is operating the hand-held Vidicon camera.

a frequency deviation of ± 2 cycle about 60 cycles was measured. The drift is such that with the sync generator running on crystal, the picture stability is quite acceptable.

To accommodate all the equipment and personnel in a standard "75" Cadillac limousine, very extensive body modifications were made, and extensive acoustic damping installed. The interior was stripped down to the base metal and two hatches were cut into the roof. These were then fitted with water-tight sliding covers similar to sliding hatch covers used on a small boat. These hatches were surrounded by the stainless steel rings bearing specially designed carriages as shown in Figure 8. One of the carriages is used for the image orthicon camera

and the other for the microwave transmitter. The two positions are interchangeable.

To support the weight of the camera, carriage, and steel ring, the roof had to be completely rebraced with steel bows running athwartships and a structural member running the length of the car roof. Furthermore, the entire roof structure had to be supported by three steel stanchions running from floor to ceiling along the center line of the car. The stainless steel panning rings are supported on steel piping welded to the roof and to the supporting bows. The weight of all added bracing members and the panning rings is about 1500 pounds.

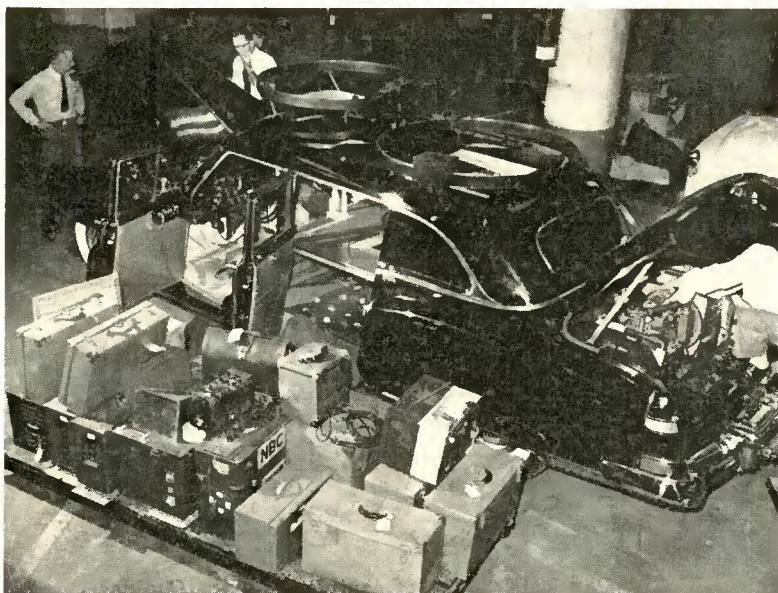

Fig. 8—The Cadillac "75" limousine in the process of conversion. The $3\frac{1}{2}$ -kilowatt engine-generator can be seen in the trunk. All the equipment on the dolly was fitted into the car.

The telescoping lift seats, which hold the cameraman and transmitterman, are supported on $\frac{1}{4}$ -inch steel plates on the car floor. The original hydraulic system in the car, used to move the driver's seat laterally, was converted to power the two lift seats.

The rear windows were replaced with very heavily tinted green glass to facilitate observation of the cathode-ray tubes by the engineer and the announcer. As further light control, the two side windows were equipped with black shades.

Since the car was expected to operate at low speeds for sustained periods, it was necessary to install a 5-bladed radiator fan, new drive

pulleys for higher fan speed, a shroud on the motor side of the radiator to allow for adequate engine cooling, and a slow commercial-type differential with a 4.27 to 1 ratio. Several exhaust fans had to be installed to provide cooling for the electronic equipment. A 90-ampere 6-volt alternator, rectifier, and regulator is driven from the fan to carry the load of the 450-megacycle 2-way radio equipment. To add further capacity to the 6-volt system, an auxiliary battery was installed. The left front grill air intake duct was replaced by an external air scoop on the left front fender to eliminate exhaust fumes being picked up from preceding units in the parade.

The car weighed 8000 pounds fully loaded, and required specially constructed rear springs, a reinforced front end suspension, and heavier commercial tires.

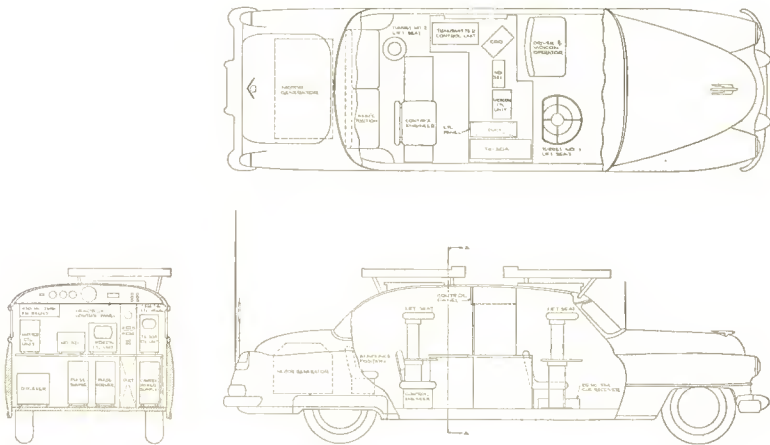

Fig. 9—Physical location of equipment in the Cadillac.

The completion of this conversion job in the short time allotted would have been impossible without the excellent coöperation of C. H. Schamel of Fisher Body Division, and C. A. Rasmussen of Cadillac Motor Car Division of General Motors Corporation together with that of the NBC Engineering Department.

EQUIPMENTS FOR MEASURING JUNCTION TRANSISTOR ADMITTANCE PARAMETERS FOR A WIDE RANGE OF FREQUENCIES*

BY

L. J. GIACOLETTO

Research Department, RCA Laboratories Division,
Princeton, N. J.

Summary—The small-signal operation of a transistor is accurately specified by means of four complex parameters having both a resistive and a reactive component. Therefore, eight quantities must be measured, and since these quantities in a fixed environment are potentially a function of operating voltage, current, and frequency, the measurement equipment must have considerable flexibility. This paper considers the design, construction, and operation of special equipments operating on the bridge principle for measuring admittance parameters of junction transistors. These bridge equipments operate in the frequency range of approximately 1 kilocycle to 1 megacycle, although by suitable modifications, the operating frequency range can be extended.

An important feature of the operation of the equipments is the use of a multi-frequency test signal such as a square wave, pulse, or swept frequency. With this mode of operation, multi-element equivalent circuit representations can be obtained which are valid over a wide range of frequencies so that a relatively complex measurement task is considerably simplified.

INTRODUCTION

MEASUREMENTS of junction transistors indicate that there are reactive effects that may become significant at audio frequencies. In this respect the transistor is similar to a vacuum tube operating at very-high frequencies. Measurement of the reactive effects is important: first, for a better understanding of the junction transistor; second, so that its performance as a function of frequency can be improved; and third, to make it possible for the circuit designer to take full advantage of the transistor capabilities. This paper describes the use of commercially available equipment for 1000-cycle measurement of conductance parameters associated with a junction transistor, and then describes the detailed construction of special apparatus for the measurement of both conductance and susceptance parameters as a function of frequency from approximately 1 kilocycle to 1 megacycle.

* Decimal Classification: R282.12 × R264.

SMALL-SIGNAL OPERATION

The measurement of junction transistor parameters which are used for the determination of the small-signal operation of the transistor will be considered. The small-signal, and therefore linear, operation of a transistor is accurately determined by means of four independent parameters. The four independent parameters are generally chosen as the coefficients in the equations associated with the input and output terminals. These terminal equations may be written in either loop or nodal form, and the independent parameters are impedances or admittances respectively.

The equipments described herein have been designed to measure the admittance parameters. This choice of admittance rather than impedance parameters was dictated by several factors,¹ the most important of which is the greater ease with which the admittance parameters can be measured. If desired, the impedance parameters can be determined by suitable transformations² of the admittance parameters. Since it is believed that most of the circuit applications for a junction transistor will use a common-emitter connection (emitter element common to both input and output circuits), the measurement of the admittance parameters associated with a common-emitter circuit will be considered. The appropriate parameters associated with common-base and common-collector circuits can be obtained by simple transformations.³

Accordingly, this paper will consider the measurement of the four admittance parameters indicated in Equations (1) and (2).³ These equations are Kirchhoff's nodal equations for the base and collector respectively when the a-c base-to-emitter voltage and a-c collector-to-emitter voltage are V_{be} and V_{ce} respectively and the a-c base current and a-c collector current are I_b and I_c respectively. These admittance parameters are further defined by means of Equations (3), (4), (5), and (6), which equations also serve as a basis for the admittance measurements.

$$I_b = y_{bbe} V_{be} + y_{bce} V_{ce}, \quad (1)$$

¹ These factors were considered in greater detail in a paper presented by the author at the National Electronics Conference on September 30, 1952: "Junction Transistor Characteristics at Low and Medium Frequencies," and published in Vol. 8, pp. 321-329, of the Proceedings of that conference.

² L. J. Giacoletto, "Terminology and Equations for Linear Active Four-Terminal Networks Including Transistors," *RCA Review*, Vol. 14, pp. 28-46, March, 1953.

³ Throughout this paper, lower-case letter subscripts are used for a-c quantities, and upper-case letter subscripts for d-c quantities.

$$I_c = y_{cbe} V_{be} + y_{cce} V_{ce}, \tag{2}$$

$$\begin{aligned} y_{bbe} &= g_{bbe} + jb_{bbe} \\ &= \text{input admittance with output short-circuited.} \end{aligned} \tag{3}$$

$$\begin{aligned} y_{bce} &= g_{bce} + jb_{bce} \\ &= \text{reverse transfer (feedback) admittance with input short-circuited.} \end{aligned} \tag{4}$$

$$\begin{aligned} y_{cbe} &= g_{cbe} + jb_{cbe} \\ &= \text{forward transfer admittance with output short-circuited.} \end{aligned} \tag{5}$$

$$\begin{aligned} y_{cce} &= g_{cce} + jb_{cce} \\ &= \text{output admittance with input short-circuited.} \end{aligned} \tag{6}$$

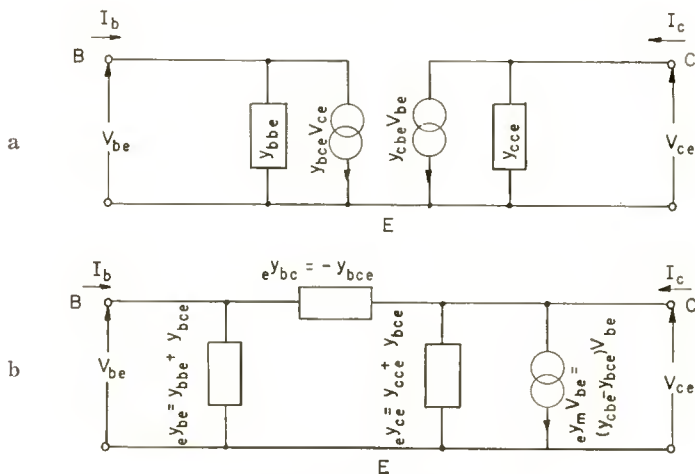

Fig. 1—Two- and one-generator common-emitter nodal-derived equivalent circuits.

The nodal Equations (1) and (2) can be depicted most directly by means of the two-generator equivalent circuit shown in Figure 1a. The more familiar one-generator π equivalent circuit is shown in Figure 1b. The admittance parameters can be used to define certain amplification factors as indicated in Equations (7) through (12).

α_{cb} = forward, collector-to-base, current amplification factor

$$= - \frac{I_c}{I_b} \Big|_{V_{ce}=0} = - \frac{y_{cbe}}{y_{bbe}}. \tag{7}$$

α_{bc} = reverse, base-to-collector, current amplification factor

$$= -\frac{I_b}{I_c} \bigg|_{V_{be}=0} = -\frac{y_{bce}}{y_{cce}}. \quad (8)$$

μ_{cb} = forward, collector-to-base, voltage amplification factor

$$= \frac{V_{cc}}{V_{bc}} \bigg|_{I_c=0} = \frac{y_{cbc}}{y_{cce}}. \quad (9)$$

μ_{bc} = reverse, base-to-collector, voltage amplification factor

$$= \frac{V_{bc}}{V_{cc}} \bigg|_{I_b=0} = -\frac{y_{bce}}{y_{bhc}}. \quad (10)$$

ϕ_{cb} = forward, collector-to-base, power amplification factor

$$= \frac{|y_{cbc}|^2}{4g_{bbc}g_{cce}}. \quad (11)$$

ϕ_{bc} = reverse, base-to-collector, power amplification factor

$$= \frac{|y_{bce}|^2}{4g_{bbc}g_{cce}}. \quad (12)$$

The small-signal circuit operation of a transistor can be completely determined after the admittance parameters have been measured.²

AUDIO-FREQUENCY PARAMETER MEASUREMENTS

If the measurement frequency is low enough, the admittance parameters are essentially conductance parameters. These conductance parameters may be very useful for operation throughout the audio frequencies. The conductance parameters can be measured by using a General Radio Company Type 561-D vacuum tube bridge.⁴ The use of this bridge will be well understood by those who have used it for measurement of vacuum tube parameters when it is noted that g_{cbe} , $1/g_{cce}$, and μ_{cb} for a transistor are the same as g_m , r_p , and μ for a vacuum tube and that g_{bce} , $1/g_{bbc}$, and μ_{bc} are these same quantities measured on the grid side of the vacuum tube. Although this vacuum-tube bridge can measure both sets of parameters for a vacuum tube, the parameters associated with the grid side are not significant in the absence of grid current. The bridge balances out reactive effects so

⁴ Since some of the parameters to be measured represent extremes in bridge range capability, it is desirable that the bridge employ double-shielded cables as is the case in all equipments with Serial Number 430 and over.

that conductance parameters are accurately measured at 1000 cycles. The instruction book⁵ on this bridge should be consulted for details in the operation and use of the instrument. Some supplementary comments will be made concerning the use of the bridge for junction transistor measurements.

A junction transistor is measured with the bridge in a manner similar to that employed in the measurement of a triode electron tube. The universal adaptor may be used for mounting the transistor or, if desired, a suitable socket may be made to be used with one of the standard tube base adaptors. A suitable collector-to-emitter bias supply is shown in Figure 2a. A suitable base-to-emitter bias supply is shown in Figure 2b. A large by-pass capacitor is important in this

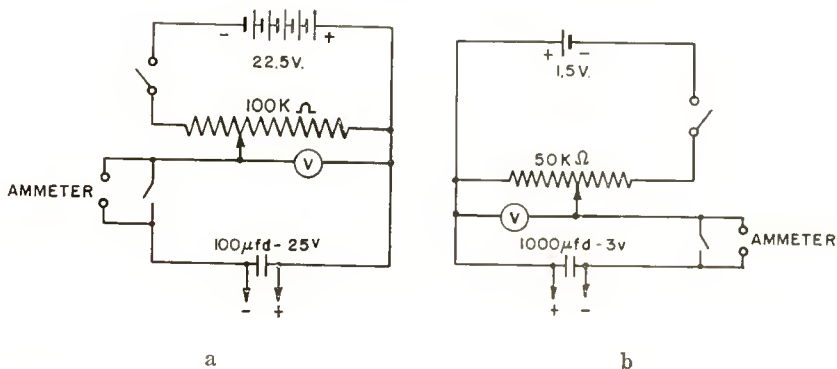

Fig. 2—Bridge bias supplies: a—collector-to-emitter (V_{CE}) supply; b—base-to-emitter (V_{BE}) supply.

supply since this capacitor provides the base-to-emitter short circuit. The auxiliary equipments required for the use of the bridge are a 1,000-cycle test signal of approximately 30 volts maximum output and a high-gain amplifier and null indicator.⁶

For measurements on the collector side of the transistor, the V_{CE} supply is connected to the "PLATE" terminals of the bridge (indicated

⁵ In addition to the bridge instruction book, information on the operation of this bridge can be found in W. N. Tuttle, "A Bridge for Vacuum-Tube Measurements," *General Radio Experimenter*, Vol. 6, May, 1932; W. N. Tuttle, "Dynamic Measurements of Electron-Tube Coefficients," *Proc. I.R.E.*, Vol. 21, pp. 844-857, June, 1933; A. G. Bousquet, "The Vacuum-Tube Bridge and its Accessories," *General Radio Experimenter*, Vol. 27, September, 1952; F. E. Terman and J. M. Pettit, *Electronic Measurements*, McGraw-Hill Book Co., 1952, pp. 297-306; and A. G. Bousquet, "Transistor Measurements with the Vacuum-Tube Bridge," *General Radio Experimenter*, Vol. 27, March, 1953.

⁶ E. W. Herold, "Bridge Null Indicator," *Electronics*, Vol. 18, pp. 128-129, October, 1945.

Table I — Typical Measurement Arrangements of 561 D Bridge

Parameter Being Measured	Bridge Panel Adjustments						Approx. Test Signal Level	Remarks				
	Coefficient Selector (Switch)	Sign of Coefficient (Switch)	Multiply by (Switch)	Divide by (Switch)	Multiplier (Switch)	Capacitance Balance (Control)						
$1/g_{ccc}$	Plate Resistance	Positive	1	1	Generally Out	Adjust for Balance	Adjust for Balance	Range of Values for Indicated Adjustment 10,000 to 100,000 ohms 0.01 to 0.1 mhos	Multiply Decade Resistor Value by +100 for ohms +10-4 for mhos	2V	Balance will be noisy	
g_{cbe}	Mutual Conductance	"	10 ⁴	1	"	"	"	to 0.01 mhos	+10-4 for mhos	2V	"	
μ_{cb}	Amplification Factor	"	10 ¹	1	"	"	"	-1,000 to -10,000	-10 For Negative μ_{cb}	2V	Negative Sign Used in Accordance With Definition of μ_{cb}	
Exchange Collector and Base Connections and Supplies												
$1/g_{bbe}$	Plate Resistance	Positive	1	10 ²	Generally Out	Adjust for Balance	Adjust for Balance	100 to 1,000 ohms	+1 for ohms	3V		
g_{bbe}	Mutual Conductance	Negative	1	1	"	"	"	-1 to -10 Micromhos	-10-2 for Negative Micromhos	30V		
μ_{bc}	Amplification Factor	"	1	10 ²	"	"	"	0.001 to 0.01	+10-5 for Positive μ_{bc}	30V	μ_{bc} is positive in accordance with definition and because g_{bbe} is negative	

terminal polarities are observed for n-p-n transistors and polarities are reversed for p-n-p transistors). The V_{BE} supply is connected to the "CONTROL GRID" terminals; the G terminal is positive for n-p-n transistors and negative for p-n-p transistors. The bridge cable connected to the transistor emitter is plugged into one of the "CATHODE AND GROUND" jacks; the cable connected to the transistor collector is plugged into one of the "PLATE" jacks; and the cable connected to the transistor base is plugged into one of the "CONTROL GRID" jacks. The V_{CE} voltage is set, and the V_{BE} voltage adjusted for the desired current. With this arrangement the following quantities can be measured: reciprocal of output self conductance, $1/g_{ccc}$; forward transfer conductance, g_{cbe} ; and their product, the negative of the forward voltage amplification factor, $-\mu_{cb}$.⁷ The detailed arrangement of the bridge for these measurements is indicated in the top of Table I. The bridge balance for the measurements on the collector side may be obscured to some extent by transistor noise. In order to minimize the effect of this noise, the input test signal should be adjusted to as large a value as is possible without producing distortion. If the test signal is too large, a null balance will still be possible, but the resulting measurement will not be correct. An oscilloscope null indicator, if not too selective, is very useful for setting the maximum value of the test signal. The maximum signal level will vary considerably among different transistors and for different parameter measurement. If the transistor is reasonably noise free (noise factor at 1 kilocycle less than 20 decibels) a bridge balance to three significant figures is possible, and the measured value of μ_{cb} should check the computed product of $-1/g_{ccc} \times g_{cbe}$ within a few per cent.

The bridge is next changed over for measurements on the base side of the transistor. The transistor base and collector cable connections are pulled out in the order named; the V_{CE} and V_{BE} supplies are interchanged with due attention to the correct polarity, i.e., "G" terminal of "CONTROL GRID" terminals and "P" terminal of "PLATE" terminals are positive for n-p-n transistor and negative for the p-n-p transistor; and finally, the collector cable is plugged into one of the "CONTROL GRID" jacks, and the base cable is plugged into one of the "PLATE" jacks. A slight readjustment of the V_{BE} voltage supply may be required in order to obtain the same current. Measurement of the following quantities can now be made: reciprocal of input self conductance, $1/g_{bbe}$; reverse transfer conductance, g_{bcc} ; and their product, the negative of the reverse voltage amplification factor, $-\mu_{bc}$.⁷

⁷ The negative sign is introduced in accordance with the definition of μ given in Equations (9) and (10) and because of the specified direction of the current generator shown in Figure 1.

The detailed arrangement of the bridge for these measurements is indicated in the bottom of Table I. The bridge null for the measurements on the base side is considerably less noisy than measurements on the collector side. The same precautions mentioned above concerning the test signal level must be observed.

The 561-D vacuum tube bridge was designed for measuring the nodal conductance parameters. However, since provisions are made for balancing out reactive effects, the nodal susceptance parameters also can be determined approximately. The simplest method of doing this is by direct substitution. The bridge is first balanced with the transistor, after which the transistor is removed and a passive network connected between the appropriate terminals of the bridge. The bridge balance is restored by adjustment of the passive network. After rebalance, the conductance of the passive network should check the bridge conductance, and the susceptance of the passive network is the desired susceptance parameter. The passive network required for y_{bbe} and y_{cce} will generally be a parallel arrangement of a conductor and a capacitor. A similar parallel combination connected between the base and collector terminals will suffice for y_{bce} . However, due to the current convention as shown in Figure 1, the susceptance of y_{bce} will be negative the susceptance of the passive network. Since y_{cbe} represents an active element, the "SIGN OF COEFFICIENT" switch must first be changed from positive to negative before the bridge can be rebalanced with a passive network. The passive network in this case is a series combination of a resistor and an inductor. y_{cbe} is then the reciprocal of the impedance of the passive network.

The bridge can also be used to measure the conductances of a junction transistor as a passive device, i.e., when the direct-current terminal voltages and currents are both zero. These conductances have been referred to⁸ as d-c conductance coefficients and are very valuable in specifying the complete volt-ampere characteristic of the junction transistor.

The preceding discussion has centered about the measurement of the common-emitter conductances. If desired, the bridge arrangement may be changed to measure the common-base or common-collector conductances, although these conductances can be easily computed² if the common-emitter conductances are known.

AUDIO THROUGH MEDIUM-FREQUENCY PARAMETER MEASUREMENTS

In order to determine the performance of a transistor as a function

⁸ W. Shockley, M. Sparks, and G. K. Teal, "P-N Junction Transistors," *Phys. Rev.*, Vol. 38, pp. 151-162, July, 1951.

of frequency, both conductance and susceptance components of the admittance parameters must be known. Both conductance and susceptance components for the four admittance parameters can be measured by means of four admittance bridges to be described. These admittance bridges will measure the four admittance parameters associated with the common-emitter circuit at any frequency desired from approximately 1 kilocycle to 1 megacycle. The corresponding admittance parameters associated with the common-base and common-collector circuits can be determined by simple calculation,² or, if preferred, admittance bridges for measuring these parameters directly may be devised. Likewise, bridge circuits for measuring the current and voltage amplification factors can be devised, although these factors can be computed from the admittance parameters as indicated in

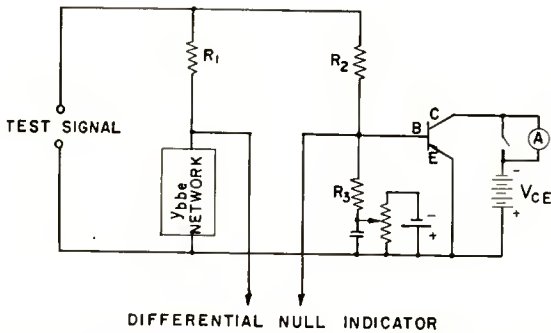

Fig. 3a—Block diagram of common-emitter input admittance y_{bbe} test set.

Equations (7) through (10). The admittance bridges to be described are for measuring p-n-p junction transistors. It is only necessary to reverse the various voltage polarities in order to measure n-p-n junction transistors.

The y_{bbe} admittance bridge is shown in block form in Figure 3a. Here it is seen that a test signal of suitable amplitude and frequency is connected to a bridge arrangement of $R_1 - y_{bbe}$ network and $R_2 -$ transistor. It is usually convenient to make $R_1 = R_2$ in which case the bridge will be balanced, i.e., no output from the differential null indicator (discussed in the next section), when the y_{bbe} network has the same admittance as is present between the transistor base and emitter. Since the collector is short-circuited to the emitter, the base-emitter admittance will be y_{bbe} provided R_3 is sufficiently large. The presence of R_3 can be compensated for by connecting an identical resistor across the y_{bbe} network. A detailed circuit of the y_{bbe} test set is shown in

Figure 3b. Top and bottom views of the component arrangement of this test set are shown in Figure 3c.

Consider first the d-c operation of the transistor. The collector-to-emitter voltage is supplied by means of a 10-position selector switch

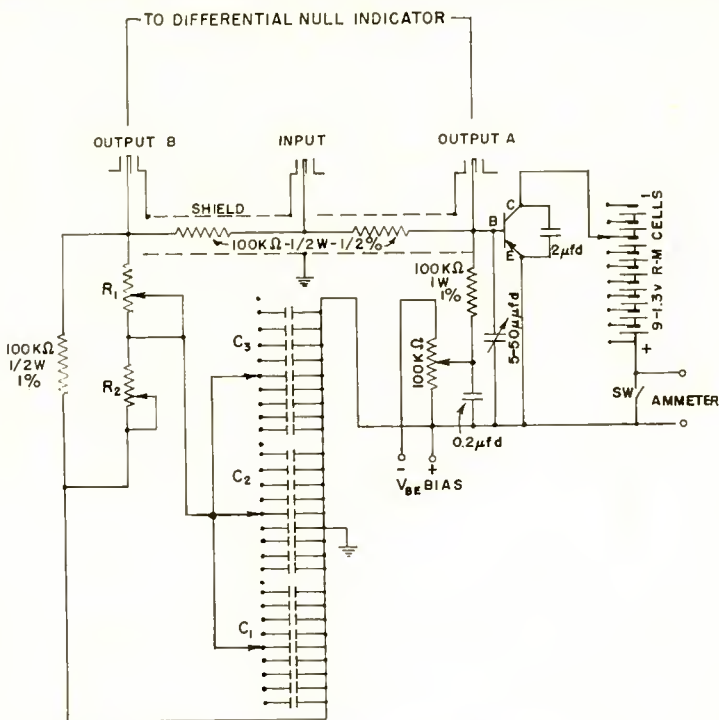

$$1/g_{bb'} = R_1 - \text{POTENTIOMETER } 500 \Omega \text{ CALIBRATED EVERY } 10 \Omega$$

$$1/g_{b'e} = R_2 - \text{POTENTIOMETER } 5K \Omega \text{ CALIBRATED EVERY } 100 \Omega$$

$$eC_{b'e} = \begin{cases} C_1 - 9 \text{ CAPACITORS: } .01, .02, .03, .04, .05, .06, .07, .08, .09 \mu\text{fd} - 1\% \\ C_2 - 9 \text{ CAPACITORS: } .001, .002, .003, .004, .005, .006, .007, .008, .009 \mu\text{fd} - 1\% \\ C_3 - 9 \text{ CAPACITORS: } 100, 200, 300, 400, 500, 600, 700, 800, 900 \mu\text{fd} - 1\% \end{cases}$$

$$y_{bbe} = \frac{e g_{b'e} + j\omega e C_{b'e}}{1 + \frac{e g_{b'e}}{g_{bb'}} + j\omega \frac{e C_{b'e}}{g_{bb'}}$$

Fig. 3b—Circuit diagram of y_{bbe} test set.

and nine R-M cells.⁹ This arrangement permits nominal 1.3-volt steps

⁹ These cells are P. R. Mallory and Co. No. IRX cells with short wire leads. The manufacturer's rating is 1.345 volts open-circuited and 300 milliampere-hours capacity. The small physical size of these cells permits a compact construction. The energy capacity is sufficient for occasional laboratory use. For continuous extended use, larger capacity cells are required.

in V_{CE} . For accurate data, the actual collector-to-emitter voltage should be measured. The base-to-emitter voltage is established with the aid of a potentiometer and an external V_{BE} bias battery. The battery voltage required for the bias will vary considerably depending upon the transistor base current. A 45-volt "B" battery is generally satis-

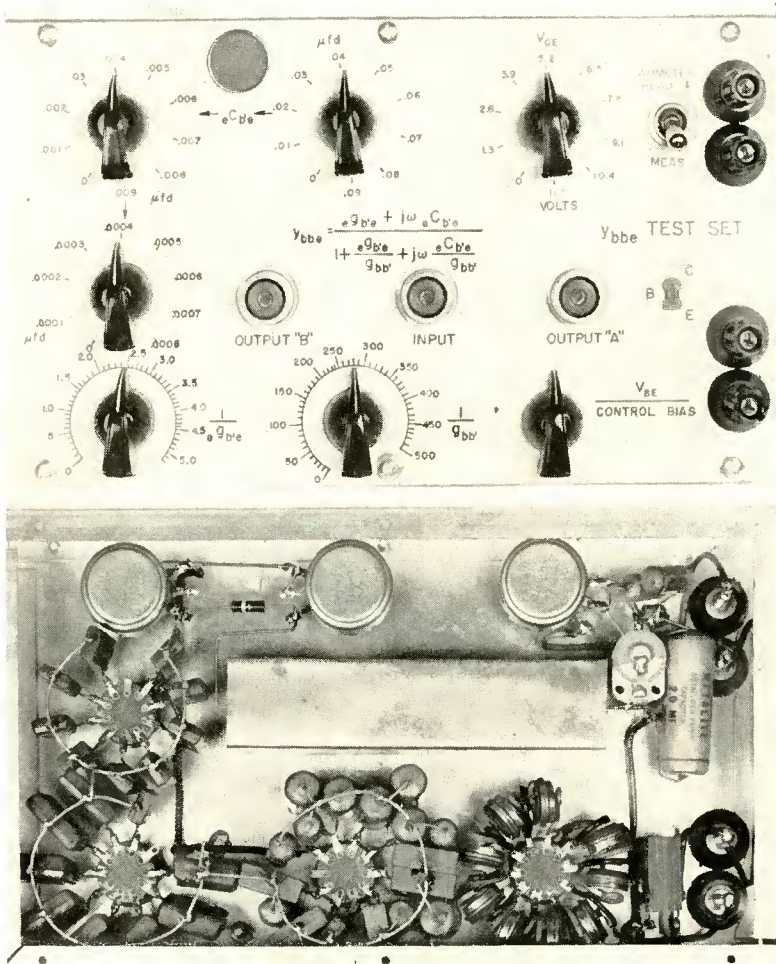

Fig. 3c—Top and bottom views of y_{bbe} test set.

factory. Adjustment of the " V_{BE} BIAS" control will provide a large range of values for the collector current.

The arrangement of the y_{bbe} network is shown in Figure 4. Normally, only two elements are required in the y_{bbe} network for point-by-

point measurements. Past experience with a considerable number of measurements has indicated that, to a fairly good approximation, y_{bbe} can be represented as a pure conductor, $g_{bb'}$, associated with base lead conductance in series with a parallel conductor ${}_c g_{b'e}$ and capacitor ${}_c C_{b'e}$. This network arrangement of y_{bbe} is very useful since it yields directly elements of some physical importance and elements that are to a good approximation, independent of frequency. However, since there are three elements to be balanced, the correct balance can be obtained only by multi-frequency testing. This method of testing will be considered in greater detail in a subsequent section. As shown in Figure 1b, y_{bbe} consists of a parallel combination of ${}_c y_{be}$ and ${}_e y_{bc}$. Normally, ${}_e y_{bc}$ is much smaller than ${}_c y_{bc}$ so that $y_{bbe} \approx {}_c y_{bc}$. Accordingly, the parallel conductor and capacitor of the y_{bbe} network (Figure 4)

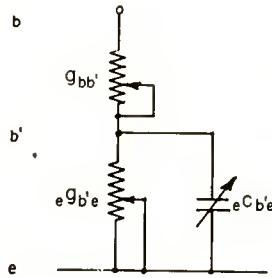

Fig. 4—Arrangement of y_{bbe} network.

are labeled ${}_c g_{b'e}$ and ${}_c C_{b'e}$, respectively. Here b' denotes an internal base point connected to the external base, b , through an ohmic resistor, $1/g_{bb'}$. The expression for y_{bbe} in terms of these elements is

$$y_{bbe} = \frac{{}_c g_{b'e} + j\omega {}_c C_{b'e}}{1 + \frac{{}_c g_{b'e}}{g_{bb'}} + j\omega \frac{{}_c C_{b'e}}{g_{bb'}}}. \quad (13)$$

In order to use the test set when small capacitances are being measured, it is necessary to balance the residual stray capacitances. This can be done as follows. Connect a resistor of about 4,000 ohms value between B and E in place of the transistor. Adjust $1/g_{bb'}$ and ${}_c C_{b'e}$ to zero. Adjust $1/{}_c g_{b'e}$ for a conductive balance at a moderately high frequency such as 0.5 megacycle. Simultaneously adjust the 5-50 micromicrofarad trimmer capacitor for a susceptive balance. This value of trimmer capacitance should be sufficient, although some additional padding may be required. In some cases, depending upon details

of wiring arrangement, the capacitor may be required on the other side of the bridge in order to obtain a susceptible balance.

The operation of the y_{hbe} test set should be checked in two ways. First, several known admittances, preferably having a form as indicated in Figure 4, should be connected between B and E in place of the transistor and measured as a function of frequency. The measured admittance should check the known admittance within a few per cent. Next, g_{hbc} should be measured for several transistors using the 561-D vacuum type bridge. These measurements should check, within a few per cent, similar measurements made at 1 kilocycle using the y_{hbc} test set.

The y_{cce} test set is similar to the y_{hbc} test set and is shown in block form in Figure 5a. Here, assuming $R_1 = R_2$, when the bridge is balanced the admittance of the y_{cce} network is equal to the y_{cce} admi-

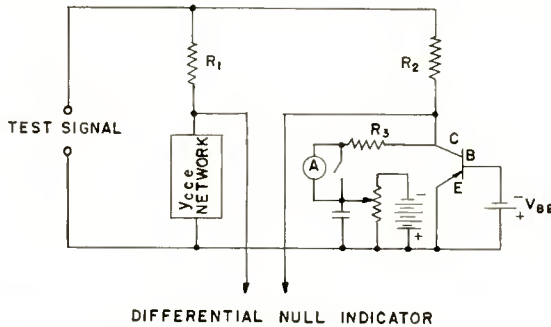

Fig. 5a—Block diagram of common-emitter output admittance y_{cce} test set.

tance of the transistor shunted by R_3 . It is not possible to make R_3 large enough so as to be negligible; accordingly, R_3 is made as large as possible and then compensated for by connecting a resistor of equal value across the y_{cce} network. The detailed circuit arrangement for the y_{cce} test set is shown in Figure 5b. Photographs of this test set are shown in Figure 5c. The detailed circuit, Figure 5b, indicates the following bridge component values: $R_1 = R_2 = 200,000$ ohms, and $R_3 = 56,000$ ohms. A variable (0 — 300 volts) regulated power supply can be used to provide collector bias. Control of the collector current is provided by emitter bias. The emitter is bypassed to the base by means of a 1000-microfarad 3-volt capacitor together with a 2-microfarad capacitor for improved high-frequency bypass.

The arrangement of the nine 1.3-volt R-M cells together with the selector switch and pushbutton switch is essentially an infinite resistance voltmeter for setting V_{CE} . If preferred, a vacuum-tube voltmeter may be used instead. The operation of the infinite resistance volt-

simultaneously a given V_{CE} and collector current. The sensitivity of the “ V_{CE} TEST” can be controlled by inserting a resistor in series with the R-M cells. A 10,000-ohm resistor is shown in the circuit.

The y_{cce} network consists of a conductor, g_{cce} , in parallel with a

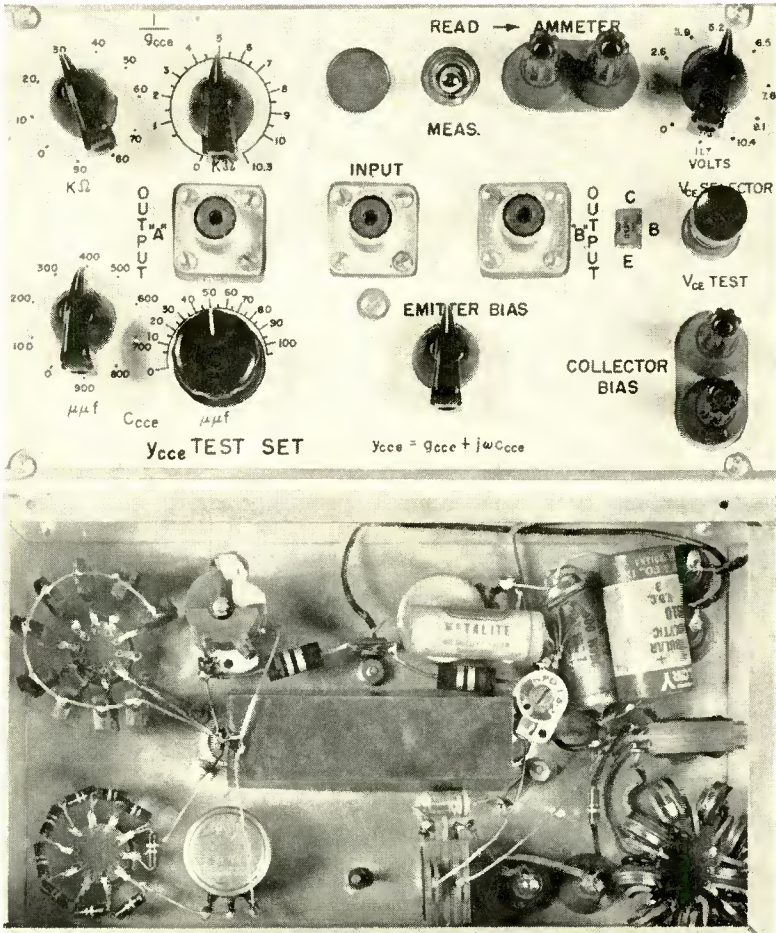

Fig. 5c—Top and bottom views of y_{cce} test set.

capacitor, C_{cce} . The y_{cce} admittance of the transistor is

$$y_{cce} = g_{cce} + j\omega C_{cce} \tag{14}$$

A 1.5–7 micromicrofarad trimmer capacitor is used to balance the stray capacitance as follows. A resistor of approximately 100,000 ohms

value is connected between C and B of Figure 5b in place of the transistor. Adjust C_{cvc} to zero. Adjust $1/g_{cvc}$ for a conductive balance at a moderately high frequency such as 0.5 megacycle. Simultaneously adjust the trimmer capacitor for a susceptive balance. Depending upon the wiring arrangement, this trimmer capacitor may have to be padded or possibly connected to the other side of the bridge in order to obtain a susceptive balance.

The operation of the y_{cvc} test set should be checked as follows. Several known admittances can be connected between C and either B or E in place of the transistor. Measurements of these admittances as a function of frequency should check the known value within a few per cent. Following this check, g_{cvc} should be measured for several transistors using the 561-D vacuum tube bridge. These measurements should check, within a few per cent, similar measurements made at 1 kilocycle using the y_{cvc} set. In order to obtain a check it is important that the operating point for the transistor be the same for both measurements.

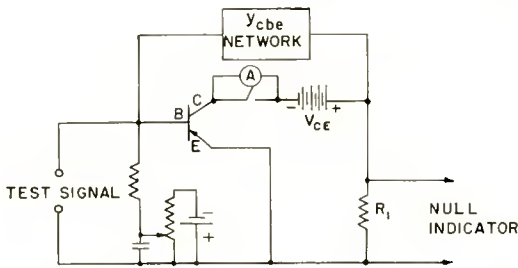

Fig. 6a—Block diagram of common-emitter forward transfer admittance y_{cbe} test set.

The y_{cbe} test set is somewhat different from the preceding two test sets since it measures transfer admittance rather than self admittance. The block diagram for the bridge arrangement of the y_{cbe} test set is shown in Figure 6a. The operation of this bridge circuit¹⁰ can be better understood by referring to Figures 1a and 7. A suitable test signal, V_{be} , is introduced between the base and emitter of the transistor. This voltage gives rise to a current generator, $y_{cbe}V_{be}$, in the collector. Let the original base-to-emitter voltage be connected to the collector through a y_{cbe} network. If the y_{cbe} network is adjusted so that there is no voltage across R_1 (bridge is balanced), there is no current flowing through either y_{cvc} or R_1 , and accordingly

¹⁰ F. B. Llewellyn, "Phase Angle of Vacuum Tube Transconductance at Very High Frequencies," *Proc. I.R.E.*, Vol. 22, pp. 947-956, August, 1934.

$$y_{cbe} V_{bc} = V_{bc} y_{cbe} \text{ (network)}. \tag{15}$$

Therefore, when the bridge is balanced, y_{cbe} is given by the value of the y_{cbe} network elements. Also, when the bridge is balanced, the collector is short-circuited to the emitter as is required for the measurement of y_{cbe} . A null balance can be obtained with the circuit of Figure 6a only because of the phase reversal that takes place in the transistor.

Measurements of junction transistors have indicated that the y_{cbe} network can be constructed most simply by means of a conductor, g_0 ,

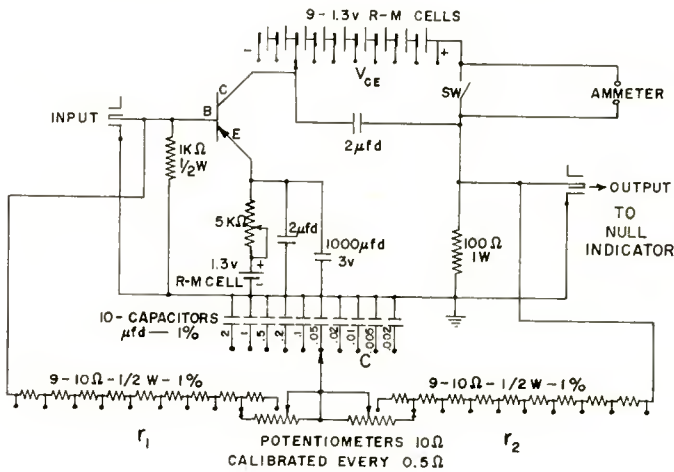

$$y_{cbe} = \frac{1}{(r_1 + r_2) + j r_1 r_2 \omega C}$$

Fig. 6b—Circuit diagram of y_{cbe} test set.

in series with an inductor, L . Consequently, y_{cbe} has the form

$$y_{cbe} = \frac{g_0}{1 + j\omega Lg_0}. \tag{16}$$

Bridge circuits have been built using a conductor-inductor combination for the y_{cbe} network, but have not been very successful for two reasons. First, it is rather difficult to make a continuously variable inductor, and second, the inductors invariably have appreciable resistance. In order to circumvent these difficulties, a y_{cbe} network which employs

resistors and capacitors was devised as shown in Figure 8. When the bridge is balanced, the voltage across R_1 is zero, and

$$I = \frac{V_{be}}{(r_1 + r_2) + j\omega r_1 r_2 C} = y_{cbe} V_{bc} \tag{17}$$

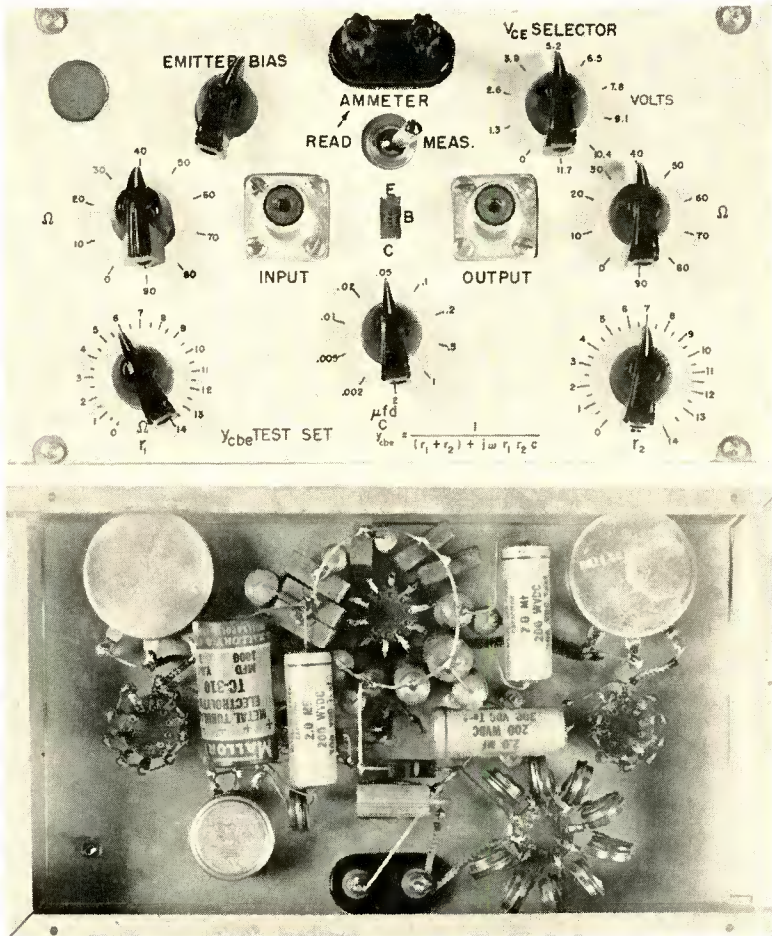

Fig. 6c—Top and bottom views of y_{cbe} test set.

Accordingly,

$$y_{cbe} = \frac{1}{(r_1 + r_2) + j\omega r_1 r_2 C} \tag{18}$$

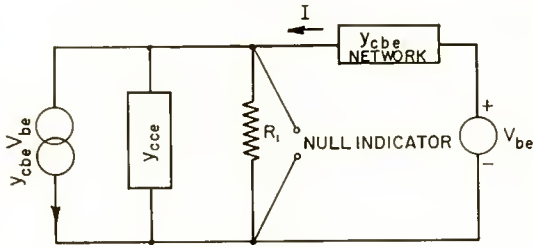

Fig. 7—Operation of y_{cbe} test set.

Although the y_{cbe} network now contains three elements, single-frequency measurements are possible since r_1 and r_2 are not independent elements. However, null adjustment is more difficult than with a two-element network. If desired, a two-element network can be obtained by “ganging” r_1 and r_2 so that $r_1 = r_2$ and making C continuously variable. A suitable method of adjusting the three elements for a null is as follows. First adjust C to its smallest capacitance value, 0.002 microfarad. Next adjust r_1 and r_2 , keeping r_1 approximately equal to r_2 so as to produce a minimum output. Increase C until a further minimum is obtained. Make small adjustments in r_1 and r_2 to obtain a final null. Adjustment of r_1 and r_2 will change the collector current slightly so that readjustment of the emitter bias may be required. A blocking capacitor was not used, since its reactance would introduce errors in measurements.

The detailed circuit of the y_{cbe} test set using the y_{cbe} network of Figure 8 is shown in Figure 6b. Photographs of this test set are shown in Figure 6c. Wire-wound potentiometers were tried for r_1 and r_2 , but these were found to be too noisy and erratic. To overcome these difficulties, a single-wire potentiometer was made by gluing a single loop of 0.0035” diameter Nichrome V wire inside a 200-ohm carbon potentiometer. Due to the presence of the 100-ohm resistor in the collector circuit, as well as the use of emitter bias, V_{CE} will be slightly

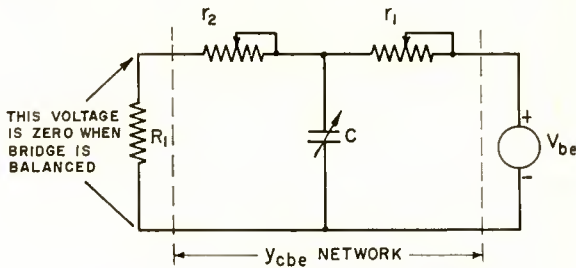

Fig. 8—Arrangement of y_{cbe} network.

different from the R-M cell voltage. For accurate data, V_{CE} should be measured with a voltmeter.

There is no simple way of checking the operation of the y_{cbe} test set using available admittances as standards. The reason for the difficulty is the 180-degree phase shift provided by the transistor. One method of providing a check is as follows. Disconnect the y_{cbe} network from the input. Connect a known admittance between B and C . Turn the V_{CE} selector switch to zero. Using an accurately balanced test signal (as for instance the test signal employed in conjunction with the y_{bcc} test set), connect one polarity of the test signal to the input and the other polarity to the disconnected lead from the y_{cbe} network. The measured admittance should check the known admittance within a few per cent. If the balance of the test signal is known to be

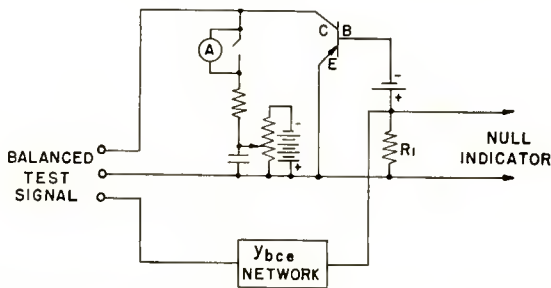

Fig. 9a—Block diagram of common-emitter reverse transfer admittance y_{bce} test set.

accurate, a trimmer capacitor may be introduced to balance stray capacitance. As a further check of the operation of the y_{cbe} test set, several transistors should be measured for g_{cbe} using the 561-D vacuum tube bridge. This data should check similar measurements with the test set within a few per cent.

The operation of the y_{bce} test set shown in block form in Figure 9a is similar to the operation of the y_{cbe} test set. The important difference is that there is no phase reversal associated with y_{bce} . Consequently, an accurately balanced test signal is necessary in order to produce a null across R_1 . The detailed circuit of the y_{bce} test set is shown in Figure 9b. Photographs of this test set are shown in Figure 9c. The value of R_1 shown in Figure 9b is 100,000 ohms. A large value is chosen for R_1 in order to increase the voltage available for null balance. When the bridge is balanced, the voltage across R_1 is zero, so that the base is short-circuited to the emitter as is required for the measurement of y_{bce} . The 100-ohm resistor in the collector circuit will cause V_{CE}

to be slightly less than the R-M cell voltage. For maximum accuracy V_{CE} should be measured with a voltmeter.

The arrangement for the $-y_{bce}$ network is a parallel conductor capacitor circuit. In order to provide for possible negative capacitance measurements in $-y_{bce}$, the bridge is balanced with 50-micromicrofarad capacitance in the $-y_{bce}$ network. This initial balance is carried out

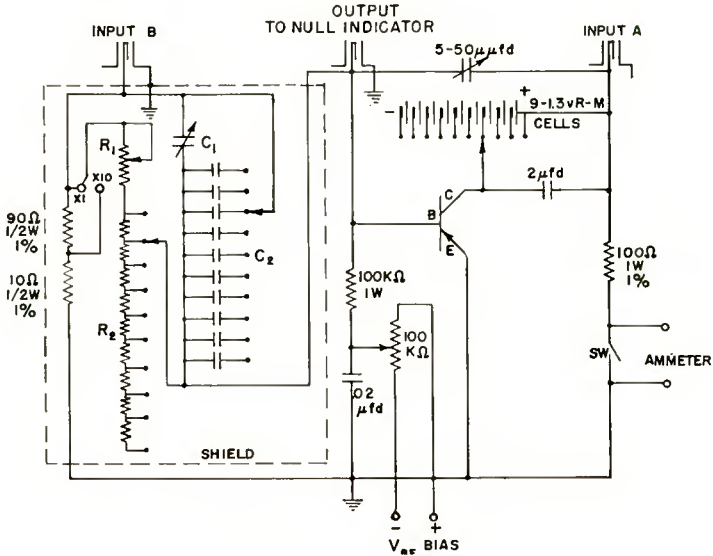

$$-1/g_{bce} = \begin{cases} R_1 - \text{POTENTIOMETER } 100\text{K}\Omega \text{ CALIBRATED EVERY } 5\text{K}\Omega \\ R_2 - 9-100\text{K}\Omega - 1/2\text{W} - 1\% \text{ RESISTORS} \end{cases}$$

$$-C_{bce} = \begin{cases} C_1 - \text{VARIABLE CAPACITOR } 0-10\mu\text{fd} \text{ CALIBRATED EVERY } 0.5\mu\text{fd} \\ C_2 - 10 \text{ CAPACITORS: } 10, 20, 30, 40, 50, 60, 70, 80, 90, 100\mu\text{fd} \\ \text{BUT DESIGNATED } 40-30-20 \text{ } \overline{10}, 0, 10, +20, +30, +40, +50, \mu\text{fd} \end{cases}$$

$$y_{bce} = g_{bce} + j\omega C_{bce}$$

Fig. 9b—Circuit diagram of y_{bce} test set.

as follows. A resistor of somewhat less than 1-megohm value is connected between B and C. $-C_{bce}$ is set at zero (50-micromicrofarad capacitance). Using an accurately balanced test signal of approximately 0.5 megacycle frequency, adjust $-1/g_{bce}$ and the 5-50 micromicrofarad trimmer capacitor for null output. Depending upon the stray capacitances, the trimmer capacitor may have to be padded to obtain a susceptive balance.

The "MULTIPLY BY" switch is used to multiply the $-1/g_{bce}$ values in the $-y_{bce}$ network by 10. This was done to accommodate a rather large range of values encountered in this parameter. Since $-C_{bce}$ does not vary over as large a range as $-1/g_{bce}$, the multiplier has been wired to be effective only for $-1/g_{bce}$.

The operation of the y_{bce} test set can be checked as follows. Several

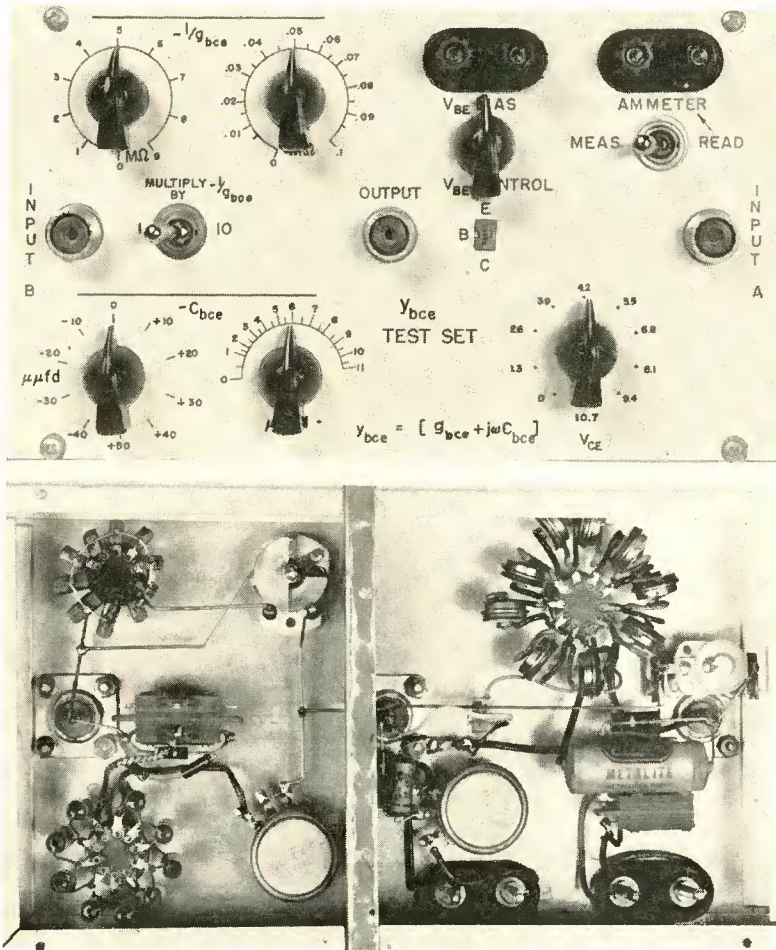

Fig. 9c—Top and bottom views of y_{bce} test set.

known admittances can be connected between B and C in place of the transistor. With the V_{CE} selector switch set at zero, these admittances can be measured. The measured value should check the known value within a few per cent. To obtain a further check, several transistors

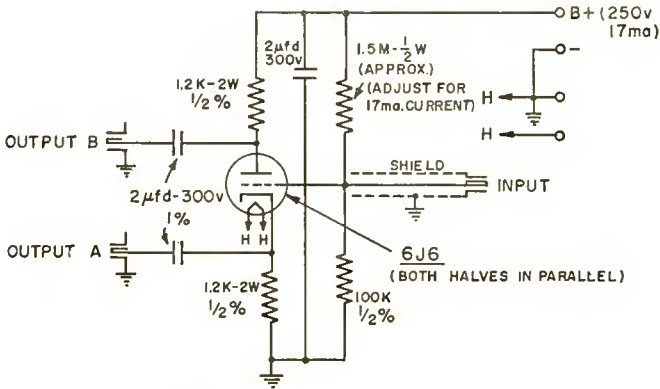

Fig. 10—Circuit for balanced test signal.

can be measured for y_{bcc} using the 561-D vacuum tube bridge. This data should check similar data using the y_{bce} test set within a few per cent.

An accurately balanced test signal is required for the operation of the y_{bce} test set. A circuit that has been employed to provide a balanced signal from an unbalanced source is shown in Figure 10. Although this is a simple circuit, its operation should be carefully checked to insure that the two outputs are accurately balanced at all frequencies for which it is to be employed. One method of doing this is to connect the two outputs and to measure, as a function of frequency, the resultant in-phase voltage to ground for an input signal of about one volt. This is shown in Figure 11. A smaller in-phase voltage should be possible at the higher frequencies, but this has not been investigated in detail.

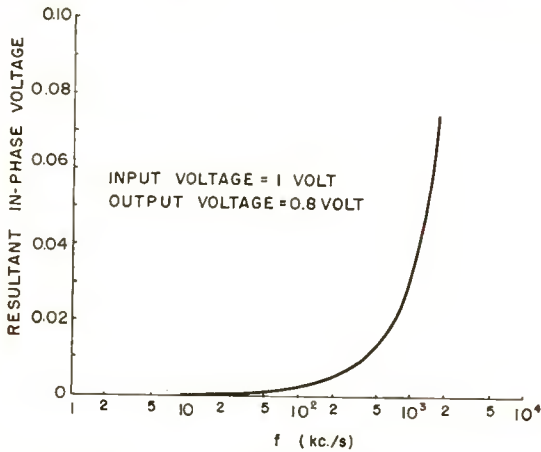

Fig. 11—Resultant in-phase voltage for balanced output circuit.

GENERAL COMMENTS CONCERNING ADMITTANCE MEASUREMENTS

A suitable test signal and null indicator are required for the operation of the four admittance test sets. A wide-band untuned null indicator simplifies measurement work considerably. A Tektronix, Inc. Type 512 cathode-ray oscilloscope has been found generally suitable as either a balanced or unbalanced null indicator.¹¹ When this equipment is used as a balanced null indicator in conjunction with the y_{bbe} test set and y_{ccc} test set, it is important that the vertical amplifiers be accurately balanced in accordance with the manufacturer's instructions. The oscilloscope is normally operated with maximum gain. For accurate measurements, additional gain is necessary. In order to simplify the presentation of the null information, the oscilloscope sweep should be synchronized to the input test signal, or alternately, the input test signal can be used as the horizontal sweep signal. The oscilloscope presentation in the latter case will be an ellipse for the unbalanced condition. As a further refinement, the null signal may be amplified and rectified to produce a d-c null indication. For a balanced null signal, the two signals should be combined differentially before amplification and detection. The balanced null detector in the y_{bbe} test set and the y_{ccc} test set can be changed to an unbalanced null detector if the input signal is changed from an unbalanced signal to a balanced signal. The choice between a balanced or unbalanced null detector versus an unbalanced or balanced test signal is determined by whether the unbalanced null detector is more accurate than the unbalanced test signal.

The Hewlett-Packard Company Model 650 Test Oscillator has been found satisfactory for single-frequency test work. Both the frequency range and signal level of this equipment are satisfactory. For the y_{bbc} test set a multi-frequency test signal such as a pulse, square-wave, or a swept-frequency generator is required in order to adjust the balance of the three independent elements of the y_{bbc} network. A multi-frequency test signal has been indispensable for the operation of the y_{bbe} test set. The cumulative effect of the phase shift of the individual component frequencies provides a sufficient net change to permit a bridge balance. In contrast, bridge balance at a single frequency is rather difficult when the phase angle is small. A square-wave generator¹² has generally been used as the multi-frequency test signal. For greater ease of adjustment, the fundamental frequency of the square-wave should be chosen so that $\omega_c C_{b'c} \approx g_{b'c}$.

¹¹ A similar cathode-ray oscilloscope with greater gain and bandwidth would be desirable because of its greater utility.

¹² The square-wave generator used is a laboratory constructed equipment following the circuit published by G. W. Gray, "Inexpensive Square Wave Generator," *Electronics*, pp. 101-103, February, 1952.

The operation of the y_{bb} test set using a square-wave test signal is shown in Figure 12. The top trace is the input test signal. The second trace is the test signal applied to the transistor. The third trace indicates the null (zero) signal when all three elements of the y_{bb} network are properly adjusted. The fourth trace indicates the null signal when g_{bb} is unbalanced. The fifth trace indicates the null signal when $g_{b'e}$ is unbalanced. The sixth trace indicates the null signal when $C_{b'e}$ is unbalanced. The cause of the unbalance is readily

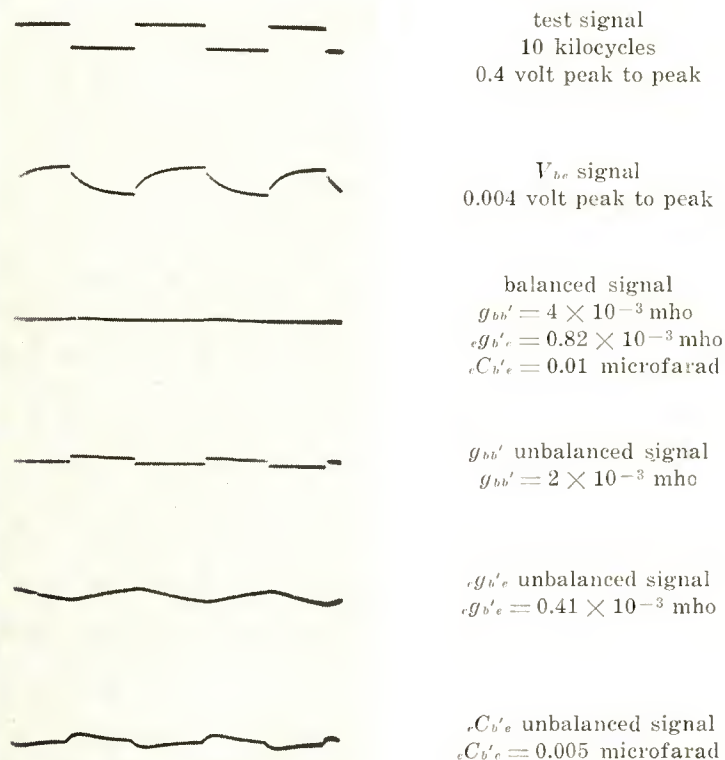

Fig. 12—Operation of y_{bb} test set using square-wave test signal.

ascertainable from the shape of the null signal so that a complete balance can be easily and rapidly obtained. Figures 13 and 14 show the operation of the y_{bb} test set using pulse and swept frequency test signals respectively. These figures are taken for test conditions identical with Figure 12 so that they may be compared directly with each other. It has been found that the network representation of Figure 8 for y_{bbe} is wide band, so that a multi-frequency test signal may be

advantageously employed in the y_{cbe} test set. The network representations employed for y_{cce} and y_{bcc} are not wide band, so that single-frequency test signals should be employed in the y_{cce} test set and the y_{bcc} test set.

For either single-frequency or multi-frequency test signals, the signal level must be carefully adjusted so as to be within the linear

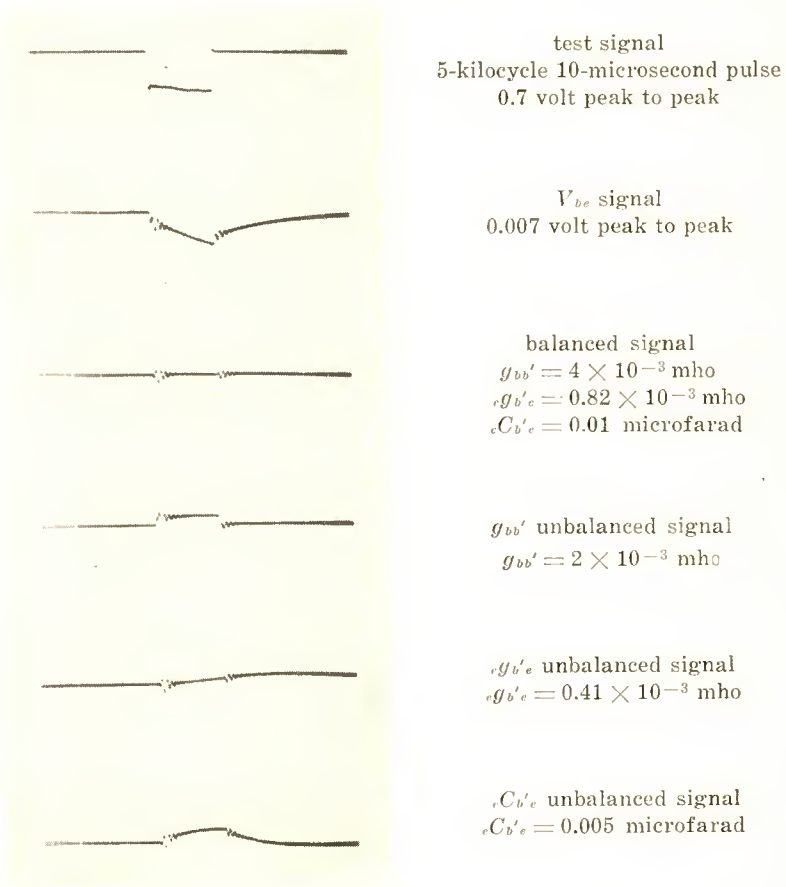

Fig. 13—Operation of y_{bbe} test set using pulse test signal.

region of operation. If this is not done, a complete null balance will not be possible and erroneous parameter values may be obtained. Non-linear operation is more easily ascertained when a single-frequency test signal is used, particularly if the ellipse type of oscilloscope presentation is used. The null for measurements of y_{cce} and y_{cbe} will

be obscured by noise as was the case in the use of the 561-D bridge. The y_{cr0} null may be particularly bad because of hum introduced by the V_{CE} power supply. In some cases, it may be desirable to replace the power supply with batteries. The collector current ammeter should be short-circuited while measurements are being made.

The network component values specified in the four test sets were

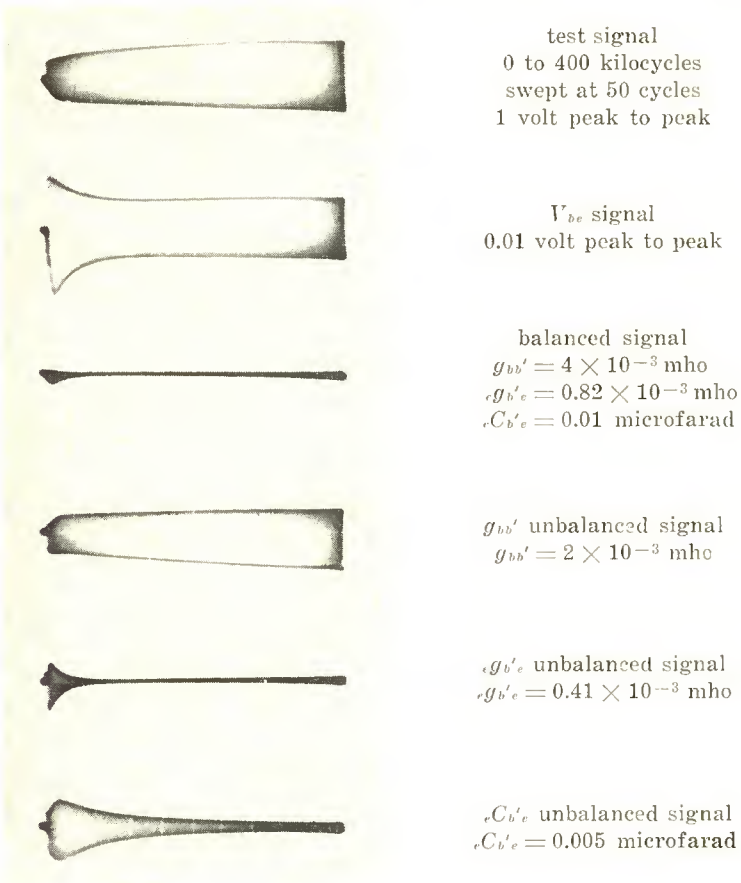

Fig. 14—Operation of y_{bbe} test set using swept frequency test signal.

chosen to cover a range of typical transistor parameters. For measurements beyond the range provided, or for special transistors, it will be necessary to change the network component values. Another method of providing a larger range of values is to switch in different values of R_1 and R_2 in the y_{bbe} test set and y_{cce} test set or to divide the test signal as was done in the y_{bce} test set. By careful design, a very large

range of values may be measured. All potentiometers and resistors used in the various test sets should be non-inductive. The various measuring potentiometers and variable capacitors used in the test sets were hand calibrated using commercial bridges for measurement.

The accuracy of a bridge is dependent to a considerable degree upon the extent and effectiveness of shielding. The shielding indicated in the four test sets should be considered as a minimum requirement. As a safety precaution, bottom covers should be used for all the test sets. Additional shielding may be desirable particularly if the upper frequency limit of test sets is to be extended. The test sets described herein are generally limited to an upper frequency value of 1 megacycle. This upper frequency limit is set in part by the bandwidth of the cathode-ray oscilloscope used as a null indicator. For some junction transistors this is a satisfactory upper frequency limit. However, for junction transistors with improved frequency performance, parameter measurements at still higher frequencies will be required. These measurements can be made by methods similar to those outlined in this bulletin, but considerably greater care must be exercised in the design and construction of the test sets. No attempt has been made to evaluate the accuracy of the various test sets. It is believed that for typical measurements the parameter data may be inaccurate by not more than approximately ± 5 per cent.

In this paper, only the measurement of junction transistors has been considered. The apparatus that has been described may be used for measuring point-contact transistors provided the point-contact transistor is short-circuit stable. If the point-contact transistor is not short-circuit stable, it may be possible to stabilize it by connecting a resistor in series with one of the elements and deducting this resistor from the measured parameters. However, point-contact transistor parameters may be outside the range of values provided in the four test sets described herein. The 561-D vacuum tube bridge will accommodate a wide range of parameter values so that conductance measurements at 1000 cycles should be possible.

The y_{hbc} test set and y_{ccc} test set may also be used for measurement of junction diodes in either the forward or reverse direction. Somewhat different values may be required for the network elements to accommodate junction diode parameters.

ACKNOWLEDGMENT

The mechanical and electrical details of construction of the test sets described herein were carried out by F. H. Corregan.

RCA TECHNICAL PAPERS†

First Quarter, 1953

Any request for copies of papers listed herein should be
addressed to the publication to which credited.*

"Channel Spacings at 152 to 174 Mc.," H. E. Strauss, <i>Communication Engineering</i> (March-April)	1953
"Clay-Slip Testing with the Vibrating-Plate Viscometer," G. W. Phelps, J. G. Woodward, and S. G. Maguire, <i>Jour. Amer. Ceramic Soc.</i> (February)	1953
"Construction of Inductors for TVI Filters," A. M. Seybold, <i>Ham Tips</i> (January-March)	1953
"Design Considerations for Series Heater Strings in Television Receivers," M. B. Knight, <i>RCA Industry Service Laboratory Bulletin LB-902</i> (January 12)	1953
"Drill Press Extrusion Cuts Costs of Thin-Wall Parts," W. N. Parker, <i>Iron Age</i> (March 5)	1953
"The Edison Medalist," E. W. Engstrom, <i>Elec. Eng.</i> (March)	1953
"The Electron Coupler—A Developmental Tube for Amplitude Modulation and Power Control at Ultra-High Frequencies," C. L. Cuccia, <i>RCA Review</i> (March)	1953
"Electronics for Defense and Industry," E. W. Engstrom, <i>Proceedings of the National Electronic Conference</i> (January)	1953
"The Evolution of Television," V. K. Zworykin, <i>Elec. Eng.</i> (March)	1953
"Factors in the Design of Point-Contact Transistors," B. N. Slade, <i>RCA Review</i> (March)	1953
"Field Strength of KC2XAK, 534.75 MC Recorded at Riverhead, N. Y.," G. S. Wickizer, <i>Proc. I.R.E.</i> (January)	1953
"Gunshot Generator for Television Studios," J. L. Hathaway and R. E. Lafferty, <i>Electronics</i> (February)	1953
"Impedance Matching with Transformer Sections," R. W. Klopfenstein, <i>RCA Review</i> (March)	1953
"Interaction of Manganese Activator Ions in Zinc-Orthosilicate Phosphors," S. Larach and J. Turkevich, <i>Phys. Rev.</i> (March)	1953
"Israel Intercity VHF Telecommunication Systems," L. C. Simpson, <i>RCA Review</i> (March)	1953
"Junction Transistor Characteristics at Low and Medium Frequencies," L. J. Giacoletto, <i>Proceedings of the National Electronic Conference</i> (January)	1953
"Light and Electron Microscopic Studies of Escherichia Coli-Coliophage Interactions. I. Preparative Method. Comparative Light and Electron Microscopic Cytology of the E. Coli B-T ₂ System," S. Mudd, J. Hillier, E. H. Beutner, and P. E. Hartman, <i>Biochimica et Biophysica Acta</i>	1953
"Light and Electron Microscopic Studies of Escherichia Coli-Coliophage Interactions. II. Electron Microscopic Cytology of the E. Coli B-T ₂ System," S. Mudd, J. Hillier, E. H. Beutner, and P. E. Hartman, <i>Biochimica et Biophysica Acta</i>	1953
"Luminescence and Trapping in Phosphors Containing Gallium," R. H. Bube and S. Larach, <i>Jour. Chem. Phys.</i> (January)	1953

† Report all corrections or additions to RCA Review, Radio Corporation of America, RCA Laboratories Division, Princeton, N. J.

* *RCA Industry Service Laboratory Bulletins* are not published and are issued only as a service to licensees of the Radio Corporation of America.

- "Mass Spectrometric Studies in Solids," R. H. Plumlee, *National Bureau of Standards Circular 522* 1953
- "Measurements of Some Operational Characteristics of an Amplitude-Modulated Injection-Locked UHF Magnetron Transmitter," L. L. Koros, *Proc. I.R.E.* (January) 1953
- "Microwave Equipment for Multichannel Communication Service," B. F. Wheeler, *Radio-Electronic Engineering* (March) 1953
- "More on UHF Coverage," J. P. Taylor, *Broadcast News* (January-February) 1953
- "New Developments in Traveling-Wave Tubes," W. J. Dodds, R. W. Peter, and S. F. Kaisel, *Electronics* (February) 1953
- "On a Limb," Albert Rose, *Electronics* (January) (Backtalk) 1953
- "On the Molecular Evaporation of Group IVB Elements," R. E. Honig, *Jour. Chem. Phys.* (March) (Letter to the Editor) 1953
- "One-Kilowatt Tetrode for UHF Transmitters," W. P. Bennett and H. F. Kazanowski, *Proc. I.R.E.* (January) 1953
- "Oscilloscope Tracer Plots Transistor Curves," J. Kurshan, R. D. Lohman, and G. B. Herzog, *Electronics* (February) 1953
- "Performance Evaluation of 'Special Red' Tubes," H. J. Prager, *Transactions of the I.R.E. Professional Group on Quality Control* (March) 1953
- "Practical Applications of Microphones for Television," H. M. Gurin, *Broadcast News* (January-February) 1953
- "Pressure Microphone for TV and Broadcast Service," L. J. Anderson, *Tele-Tech* (January) 1953
- "A Pulse Emission Test for Field Testing Hot-Cathode Gas Tubes," RCA Application Note AN-157, RCA Tube Department, Harrison, N. J. (January) 1953
- "RCA," E. C. Cahill, *Electronics* (January) (Backtalk) 1953
- "Signal Tracing in High-Voltage TV Circuits," A. Liebscher, *Rad. and Tele. News* (January) 1953
- "So, You Want to Be an Inventor," C. D. Tuska, *Jour. Frank. Inst.* (March) 1953
- "Some Applications of Permanently Magnetized Ferrite Magnetostrictive Resonators," W. Van B. Roberts, *RCA Review* (March) 1953
- "Terminology and Equations for Linear Active Four-Terminal Networks Including Transistors," L. J. Giacoletto, *RCA Review* (March) 1953
- "Time-Zone Delay of Television Programs by Kinescope Recording," R. E. Lovell, *Jour. S.M.P.T.E.* (March) 1953
- "TV Comes to Portland," V. Bary, *Radio-Electronics* (January) 1953
- "Type BHF-50A, 50-KW High Frequency Transmitter," C. J. Starner, *Broadcast News* (January-February) 1953
- "UHF Opens Up," R. F. Guy, *Radio-Electronics* (January) 1953
- "UHF Triode Design in Terms of Operating Parameters and Electrode Spacings," L. J. Giacoletto and H. Johnson, *Proc. I.R.E.* (January) 1953
- "The Uniaxial Microphone," H. F. Olson, J. Preston, and J. C. Bleazey, *RCA Review* (March) 1953
- "A Vibrating-Plate Viscometer," J. G. Woodward, *Jour. Acous. Soc. Amer.* (January) 1953
- "3-Element 14mc. Rotary Beam Antenna," C. A. West, *Rad. and Tele. News* (February) 1953

AUTHORS



GEORGE H. BROWN received the B.S. degree at the University of Wisconsin in 1930; the degree of M.S. in 1931; the Ph.D. degree in 1933; and his professional degree of E.E. in 1942. From 1930 until 1933 he was a Research Fellow in the Electrical Engineering Department at the University of Wisconsin, and from 1933 to 1942 he was in the Research Division of the RCA Manufacturing Company at Camden, N. J. Since 1942, he has been at RCA Laboratories Division, Princeton, N. J. Dr. Brown is a Member of Sigma Xi, the American Institute of Electrical Engineers, New York Academy of Sciences, and a

Fellow of the Institute of Radio Engineers and the American Institute of Electrical Engineers.

DAVID W. EPSTEIN received a B.S. degree in Engineering Physics from Lehigh University in 1930. In 1934 he received an M.S. and in 1937 a D.Sc. in Electrical Engineering from the University of Pennsylvania. He joined the Radio Corporation of America in 1930 and was associated with the Research Department of RCA Victor Company, Inc., from 1930-35, the Research Department of RCA Manufacturing Company from 1935-41, and RCA Laboratories Division from 1941 to date. Dr. Epstein is a Member of the American Physical Society, a Fellow of the Institute of Radio Engineers, and a Member of the Optical Society of America and Sigma Xi.



L. J. GIACOLETTO received the B.S. degree in Electrical Engineering from Rose Polytechnic Institute, Terre Haute, Indiana, in 1938, and the M.S. degree in Physics from the State University of Iowa in 1939. From 1939 to 1941, while a Teaching Fellow in the department of Electrical Engineering at the University of Michigan, he engaged in frequency-modulation research. He received the Ph.D. degree in Electrical Engineering from the University of Michigan in 1952. He was associated with the Collins Radio Company during the summers of 1937 and 1938, and with the Bell Telephone Laboratories

in 1940. From 1941 to 1945 he served with the Signal Corps and returned to inactive status as a major in the Signal Corps Reserve in May, 1946. Since June, 1946, he has been serving as a research engineer at RCA Laboratories Division, Princeton, N. J. Dr. Giacometto is a member of the American Association for the Advancement of Science, Gamma Alpha, Iota Alpha, Phi Kappa Phi, Tau Beta Pi, and Sigma Xi.

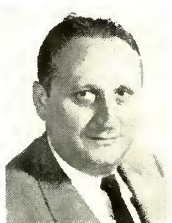

HARRY L. GRELECK graduated from RCA Institutes, Inc. in 1935. From 1932 to 1937 he was on the engineering staff of the International Broadcasting Corporation (WOV) and from 1937 to 1943 he was a studio engineer with the National Broadcasting Company. From 1943 to 1946 he served as Electronic Officer with the U. S. Navy at Philadelphia and Newfoundland. From 1946 to 1950 Mr. Greleck was a field engineer with the National Broadcasting Company. In 1946 he was an NBC representative on the U. S. Army Air Force-National Geographic Eclipse Expedition to Brazil. Since 1950 he has

been Radio Broadcast Field Technical Operations Manager with NBC. Mr. Greleck is a Member of the American Radio Relay League and of the Institute of Radio Engineers.

RAY D. KELL received the B.S. degree in E.E. from the University of Illinois in 1926. From 1927 to 1930 he was engaged in television research in the radio consulting laboratory of the General Electric Company. From 1930 to 1941 he was a member of the Research Division of RCA, and since 1941 he has been with RCA Laboratories Division. Mr. Kell received the "Modern Pioneer Award" from the National Association of Manufacturers in February 1940 for inventions in television and the "Stuart Ballantine Award" from the Franklin Institute in 1948. He is a member of Sigma Xi and a Fellow of the Institute of Radio Engineers.



DAVID G. C. LUCK received the B.S. degree from Massachusetts Institute of Technology in 1927 and the Ph.D. in 1932. In 1927-28 he was a Swope Fellow in Physics, and in 1928-29 he was a Malcolm Cotton Brown Fellow. He was an assistant in the Department of Physics at Massachusetts Institute of Technology in 1929-32. He joined the Research Division of RCA Victor Company in 1932 and was with the Victor Division of RCA Manufacturing Company from 1935 to 1941, working on pulse communication, direction finding, and radio guidance of aircraft. He was transferred to RCA Laboratories Division,

upon its formation, as a member of the technical staff of the Princeton laboratories where he has engaged in work on special electronic systems for military and other aircraft. Dr. Luck is a Member of the American Physical Society, the Institute of Navigation, and Sigma Xi, and a Fellow of the Institute of Radio Engineers.



Beta Pi.

DALTON H. PRITCHARD received the B.S. degree in Electrical Engineering from Mississippi State College in 1943. He served in the U. S. Army Signal Corps engaged in combat signal operations from 1943 to 1946. After release from active duty he joined the RCA Laboratories Division as research engineer engaged primarily in communications research involving single sideband, multi-channel, radio teletype diversity receiving apparatus. Since 1949 he has been engaged in research and development of color television systems and apparatus. He is a Member of the Institute of Radio Engineers and Tau

ROLAND N. RHODES received the degree of Bachelor of Electrical Engineering from the College of the City of New York in June, 1944. He then entered the U. S. Navy where he served until 1946. From 1947 to 1948 he was employed by Melpar Incorporated of Alexandria, Virginia. In 1948, he joined the RCA Laboratories Division, Princeton, New Jersey where he is employed in the Industry Service Laboratory group doing research in the field of color television. He is an Associate Member of the Institute of Radio Engineers.



ALFRED C. SCHROEDER received the B.S. degree in E.E. from the Massachusetts Institute of Technology in 1937, and his M.S. degree from M.I.T. in the same year. Mr. Schroeder joined the Radio Corporation of America in 1937, and is now engaged in television research at the RCA Laboratories Division in Princeton, New Jersey. He is a member of the American Association for the Advancement of Science, Sigma Xi and is a Senior Member of the Institute of Radio Engineers.

E. C. WILBUR has been active in amateur radio operation since 1911. From 1915 to 1929 he was employed in the public utility field engaged in the installation of electrical equipment and the development of high and low frequency radio-telephone carrier systems. In 1929 Mr. Wilbur joined the National Broadcasting Company working on the development and operation of radio relay equipment and mobile units and he has been active in many special broadcast field projects such as the Beebe Expeditions at Bermuda, and demonstrations of the Munson Lung and submarine rescue apparatus. During the war he did development work on U. S. Navy projects. Since 1951 he has continued with field work in television. Mr. Wilbur is a Member of the American Radio Relay League and a Voting Associate of the Institute of Radio Engineers.



100

101

102

103

104

105

106

107

108

109

110

111

112

113

114

115

116

117

118

119

120

121

122

123

124

125

126

127

128

129

130

131

132

133

134

135

136

137

138

139

140

141

142

143

144

145

146

147

148

149

150

151

152

153

154

155

156

157

158

159

160

161

162

163

164

165

166

167

168

169

170

171

172

173

174

175

176

177

178

179

180

181

182

183

184

185

186

187

188

189

190

191

192

193

194

195

196

197

198

199

200