

RCA



REVIEW

A QUARTERLY JOURNAL OF RADIO PROGRESS

VOLUME I

October 1936

NUMBER 2

E. B. REDINGTON

IN THIS ISSUE

RCA SOUND RECORDING SYSTEM

M. C. Batsel and E. W. Kellogg

BROADCAST STUDIO DESIGN

R. M. Morris and G. M. Nixon

TELEVISION RADIO RELAY

Bertram Trevor and O. E. Dow

RCA INSTITUTES TECHNICAL PRESS

A Department of RCA Institutes, Inc.

75 Varick Street

New York, N. Y.

RCA REVIEW

A Quarterly Journal of Radio Progress
Published in July, October, January and April of Each Year by

RCA INSTITUTES TECHNICAL PRESS
A Department of RCA Institutes, Inc.
75 Varick Street New York, N. Y.

VOLUME I

October, 1936

NUMBER 2

CONTENTS

| | PAGE |
|---|------|
| The RCA Sound Recording System..... | 3 |
| M. C. BATSEL AND E. W. KELLOGG | |
| Television Radio Relay..... | 35 |
| BERTRAM TREVOR AND O. E. DOW | |
| Harbor Radio Telephone Service..... | 47 |
| I. F. BYRNES | |
| An Electromagnetic Metal Detector..... | 53 |
| DAVID G. C. LUCK AND CHARLES J. YOUNG | |
| Broadcast Studio Design..... | 64 |
| R. M. MORRIS AND G. M. NIXON | |
| The Vacuum Cell Luminescence Microscope..... | 80 |
| JOHN GALLUP | |
| A New Piezo-Electric Quartz Crystal Holder with Thermal Compensator | 86 |
| W. F. DIEHL | |
| "M Derived" Band Pass Filters with Resistance Cancellation..... | 93 |
| VERNON D. LANDON | |
| NBC Radio in the Clipper Ships..... | 102 |
| HAROLD P. SEE | |
| Our Contributors | 107 |

SUBSCRIPTION: \$1.50 per Year. Foreign, \$1.85. Single Copies 50 cents.
Special Rate to Public and College Libraries.

Copyright, 1936, by RCA Institutes, Inc.

Entered as second-class matter July 17, 1936, at the Post Office at New York, New York,
under the Act of March 3, 1879.

Printed in U.S.A.

BOARD OF EDITORS

Chairman

CHARLES J. PANNILL
President, RCA Institutes, Inc.

RALPH R. BEAL
*Research Supervisor,
Radio Corporation of America*

H. H. BEVERAGE
*Chief Research Engineer,
R.C.A. Communications, Inc.*

IRVING F. BYRNES
*Chief Engineer,
Radiomarine Corporation of America*

LEWIS M. CLEMENT
*Vice President in Charge of
Research and Engineering,
RCA Manufacturing Company,
Victor Division*

DR. ALFRED N. GOLDSMITH
*Consulting Engineer,
Radio Corporation of America*

HARRY G. GROVER
*General Patent Attorney,
Radio Corporation of America*

O. B. HANSON
*Chief Engineer,
National Broadcasting Company*

WILLSON HURT
*Assistant General Solicitor,
Radio Corporation of America*

DR. CHARLES B. JOLLIFFE
*Engineer-in-Charge,
RCA Frequency Bureau*

FRANK E. MULLEN
*Manager, Department of Information,
Radio Corporation of America*

CHARLES H. TAYLOR
*Vice President in Charge of Engineering,
R.C.A. Communications, Inc.*

ARTHUR F. VAN DYCK
*Engineer-in-Charge,
Radio Corporation of America
License Laboratory*

J. C. WARNER
*Vice President,
RCA Manufacturing Company
Radiotron Division*

W. S. FITZPATRICK
Secretary, Board of Editors

Previously unpublished papers appearing in this book may be reprinted, abstracted or abridged, provided credit is given to RCA REVIEW and to the author, or authors, of the papers in question. Reference to the issue date or number is desirable.

Permission to quote other papers should be obtained from the publications to which credited.

THE RCA SOUND RECORDING SYSTEM

BY

M. C. BATSEL and E. W. KELLOGG

Research Engineering Division, RCA Manufacturing Co.

MOTION picture producing studios are the largest users of sound recording equipment. In the few years' time that sound pictures have been produced, there has been a continuous improvement in the product due to developments in operating technique and to improvements in the recording equipment.

In the beginning, the camera man with his camera was enclosed in a sound proof booth, making it impossible to resort to shots requiring the camera to be moved, and microphones were placed at various places in the sets requiring the actors to remain within range of the stationary microphones. The stationary camera and microphone were severe handicaps to the motion picture which depends to a great extent for its effectiveness upon the mobility of the camera.

At the present time, cameras are silenced by means of enclosing cases around the camera itself, known as "blimps." These are larger and more difficult to handle than were the silent cameras. Cameras are being developed that are sufficiently well silenced through improvements in the design to operate without enclosures. Ingenious mountings for the cameras have been designed that make it possible to follow the action effectively.

The microphone is mounted on a "boom" consisting of a long horizontal beam that is supported on a stand equipped with silent casters so it can be easily moved. The beam is made of telescoping tubing so the length can be adjusted as required, and the beam is pivoted so the height of the microphone above the floor can be adjusted. The beam is also capable of being rapidly swung about the pivot, and, in addition, provision is made for rotating the microphone mounting on the end of the beam so the microphone may be properly oriented. With the microphone "boom", it is possible for a man stationed on a platform at the controls where he has a good view of the set to swing the microphone over the actors as required for proper pickup of voices or sounds to correspond with the picture being photographed. The recording operation is under the direction of the "mixer," or operator of the volume controls for the microphones used. It is

preferable that the mixer be near the set where he is in view of the action and within hearing distance of the director.

Since the camera and microphone are moved during the recording operation, it is obviously necessary for the equipment to be noiseless in operation. The microphone itself must be capable of being moved through the air quite rapidly without resulting noise.

Sound equipment for use in motion picture studios is required to operate with certainty of results and without delays to production. Due to the expensive personnel and facilities required, delays or failures can not be tolerated. Practically all recording is by the photographic method on film and the recording is not heard until the following day.

Improvements in the RCA recording system have resulted both from developments in the studios where the equipment is used and in the research laboratories. The laboratories through studies of fundamentals have discovered methods of improving the system, while the operating engineers in the studios in cooperation with RCA engineers have developed features which have made for convenience in operation and increased flexibility and designs to meet the many special and new requirements which the rapidly developing sound picture art requires.

A recording system is made up of a number of items of equipment, some of which are used in other fields such as broadcasting and sound amplification.

The major items will be discussed in the following paragraphs to point out some of the requirements for motion picture application.

MICROPHONE

Alexander Graham Bell's first telephone, built in 1876, employed an electro-magnetic microphone. A few years later, the carbon microphone was invented and up to about 1916 had no competitors for either a commercial or high quality service. In 1916, Dr. E. C. Wentz developed the condenser microphone which was a great step forward from the standpoint of quality and constancy. The great fault of the carbon microphone is its hiss. It is also subject to large variations in output and is very easily overloaded. Condenser microphones are very insensitive compared with carbon microphones, but with amplifiers available, this has not been a paramount consideration, and until the advent of the RCA ribbon microphone, the condenser microphone has been employed for practically all high quality work, such as sound recording and broadcast transmitters.

Among the drawbacks of the condenser microphone is the fact that its directive properties vary considerably with frequency. Thus, up to

about 2000 cycles it responds almost equally to sounds from all directions. At higher frequencies it becomes more and more directive. This fault can be overcome by reduction in size, but this measure is at the price of serious loss in sensitivity. The shape of the condenser transmitter as usually built also results in a decided peak in the response at about 3000 cycles. The condenser microphone is expensive to construct, requiring extreme refinements, and has presented a serious problem in insulation in order that the circuit shall not be noisy. Its output impedance is so high and its actual power output so small that it is practically necessary to couple it by very short leads to the grid of an amplifier tube, preferably a screen grid tube. The output cannot practically be transmitted any distance prior to amplification. These faults in the condenser transmitter made it desirable to develop a new form of high quality transmitter and, in developing the present ribbon microphone, Dr. H. F. Olson reverted to the general principles of Bell's original transmitter except that instead of moving a piece of iron close to the poles of a polarized electro-magnet, a conductor is moved through a magnetic field and voltage is induced in the conductor.¹ This was not a new idea, but the type of conductor and method of construction resulted in a directive magnetic microphone having properties previously unobtained.

The moving conductor consists of an aluminum ribbon .0001 inch thick by .2 inch wide and 2 inches long between supports. It is provided with shallow transverse corrugations which increase its flexibility, the ribbon being under only sufficient tension to keep it in a proper position between the poles of the field magnet. The ribbon is so thin and light that the air in its vibratory movements can more easily move the ribbon than flow around it, so that it follows the movements of the air particles almost perfectly. In other words, the amplitude of its movement is practically equal to that which the air itself would execute were no microphone present. The air itself provides sufficient damping for such a light object and no tendency to resonate appears. In order that the vibrations of the ribbon may be as nearly as possible the same as would occur in air without the microphone, the field magnet structure is cut away so as to present the minimum obstruction to the movements of the air. From 70 to 2500 cycles the response is uniform. Above 2500 cycles the effect of the mass of ribbon becomes measurable and the output is down about 2db. at 10,000 cycles. This departure from the ideal flat response is smooth and readily compensated in the amplifier. Since the single conductor can generate only a very low voltage, a step-up transformer is provided. The transformer

is built into the microphone unit. The transformer is protected from external fields by a suitable shield, while the exposed circuit of the ribbon itself is balanced against such fields by splitting the conductor and providing a return conductor each side of the ribbon. The ribbon and magnet are enclosed in a wind-shield of silk cloth and perforated metal. Figure 1 shows a model 144-A microphone. The fact that the ribbon

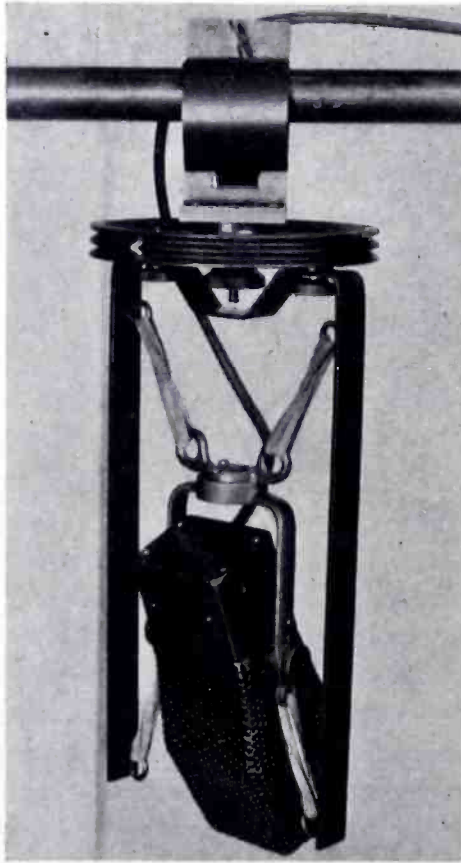

Fig. 1—Velocity microphone in mounting generally used in Motion Picture Studios.

microphone responds to the velocity of air movements rather than to air wave pressure, has led to its being termed a "Velocity Microphone."

The ribbon microphone presents no insulation trouble and the fact that it can operate directly into a transformer makes it possible to transmit the output distances up to several hundred feet through shielded cable, and therefore to place the microphone amplifier in the most convenient location, which is ordinarily at the mixer. The extremely smooth natural response (which, however, was only obtained after considerable development in which the ribbon itself and the form of the pole pieces were varied) and complete avoidance of resonance mean higher fidelity than had been obtainable with the con-

denser, but the most important practical advantage of the new microphone lies in its directive property. Only one side of the diaphragm of the condenser is exposed to free air, and pressure variations are experienced by the diaphragm, whatever the direction of the passing sound wave. It is only because the body of the microphone casts a sound-shadow that the condenser microphone shows any directive properties whatever. On the other hand, the ribbon microphone is entirely symmetrical and what the diaphragm does depends on the direction of travel of the sound wave. If the sound comes from directly in front, maximum response results. If the sound comes from directly behind the microphone, the phase of the diaphragm movements is reversed (with respect to the pressure variations in the wave). If the sound comes from the side, no ribbon movements result. The complete absence of response to sounds coming from 90 degrees to the normal (whether coming from directly above, below, or either side) and the reduction in response for intermediate directions means that the velocity microphone, when adjusted for equal sensitivity for sounds coming from directly in front, picks up less of the sound coming from random directions than is the case with a pressure operated microphone like the condenser. If sounds come equally from all directions, the average response of a ribbon is only one-third of that of a non-directional unit having the same sensitivity for sound coming from directly in front. The echoes which make the reverberation in a fairly live enclosure, approximate the condition of arrival from random directions, so that on the average the ribbon microphone picks up only one-third of the reverberation which a non-directional microphone would pick up. The decreased response to reverberation makes it possible to place a ribbon or velocity microphone about 70 per cent farther away from the source of sound than a non-directional microphone can be placed, without too much reverberation.

When a person with normal hearing is listening to sounds, his bin-aural sense enables him to discriminate against sound coming from random directions in favor of the sound which he wishes to hear. The benefit of this discrimination is lost in all single channel recording and reproduction. Far less reverberation can therefore be tolerated for microphone pickup than would be acceptable in direct listening. The reduction in reverberation is obtained by placing the microphone closer to the original source of sound. In general, it has been necessary to place pressure microphones so close to the source that there is a loss of balance unless the sources are confined to a very restricted space. It has, therefore, been necessary when recording orchestras to employ several microphones, while in recording sounds for motion pictures, the microphone must either be moved to follow the action or several micro-

phones must be employed. In motion picture work, it is of course necessary to keep the microphone out of the field of the camera. By acoustic treatment of the sound stages where most of the pictures are made, echoes from the more distant walls have been largely suppressed, and it is possible to obtain satisfactory sound pickup with pressure type microphones, but there are many situations in which reverberation or other unwanted sound constitute a problem and the ability to locate a velocity microphone considerably farther away is a decided advantage.

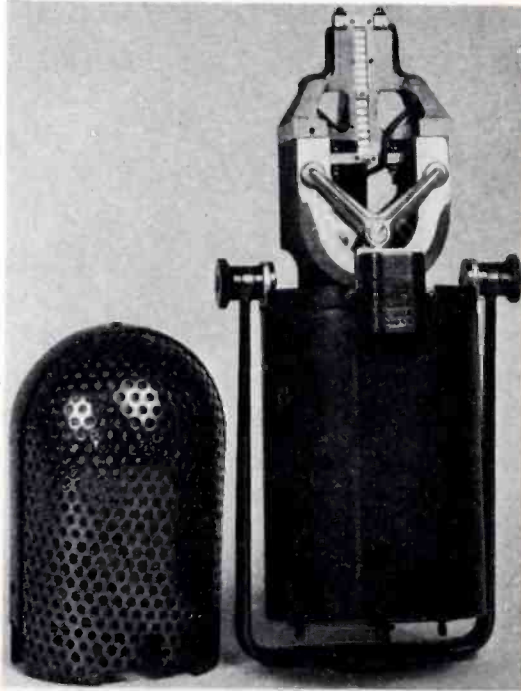

Fig. 2—Unidirectional microphone assembled.

Ability to work at greater distance simplifies the problem of avoiding the field of the camera, gives better perspective, makes it less necessary to follow the action closely by moving the microphone, and tends to give such reverberation as is recorded, a more natural quality.

The directive properties of the ribbon microphone have been found to be extremely helpful, but the form of the directivity curve can be still further improved. 100 per cent sensitivity for sounds coming from a direction opposite to the original sound is not desirable, while the forward directivity is, if anything, a little too sharp for convenience in recording some scenes in pictures. A wider angle of pick-up from the general forward direction is needed to better cover the action without making it necessary to turn the microphone. The improved directive characteristic is now available through a recent development (also the work of Dr. Olson) which has given us the uni-directional ribbon micro-

phone.² By suitable shielding of one side of the ribbon, it can be made into a pressure operated device. If a pressure unit and a velocity unit can be made to almost coincide in position, and adjusted to equal output for sounds coming from the forward direction and their output voltages added, there results a directive curve which shows zero response from the rear, 50 per cent response (in voltage) at 90 degrees and full response from in front. The total energy picked up from random sounds is again only one-third of what it would be with a non-directional device having the same forward sensitivity, while the forward directivity is broadened so that an angle of 90 degrees may be covered with little variation in sensitivity. The combination of two



Fig. 3—Unidirectional microphone, disassembled.

such units is provided by clamping the ribbon near its mid-point and providing a shield behind one portion. This shield must produce practically no acoustic reaction on the back of the diaphragm. In other words, it must imitate free air devoid of sound. This result has been obtained by means of a column of air about 20 inches long with loosely packed absorbent material sufficient to prevent resonance in the air column. The tube is in the form of a coil to minimize space requirements. Figures 2 and 3 show the form of the uni-directional microphone and something of its construction. The form of the pole pieces is similar to that of the bi-directional or simple ribbon microphone.

In the pressure microphone, called the "Inductor Microphone," an aluminum conductor is mounted on an extremely light paper diaphragm about $\frac{1}{2}$ inch wide by 3 inches long. This conductor is moved between magnet poles very much as in the case of the ribbon

microphone, except that the conductor of the inductor microphone can be in the form of a round wire instead of a ribbon, and the magnet poles can therefore be brought close together, thus giving a stronger field and increased sensitivity. The space behind the diaphragm is completely enclosed (which makes the inductor microphone a pressure operated device). By the employment of damping material, and by suitable design of the chamber, the air behind the diaphragm is made to so resist the motion of the diaphragm that it will have a velocity proportional to the instantaneous pressure of the sound pressure wave, thus giving the desired relation for uniform response. It is useful for outside work, since it is less affected by wind. Its response curve is not as smooth as that of the ribbon.



Fig. 4—Console type mixer.

MIXERS AND AMPLIFIERS³

For many purposes, it is desirable to employ several microphones—sometimes for picking up the sound from widely separated points; sometimes for introducing special sound effects, and sometimes for emphasizing certain sources of sound with a local microphone, as for example bringing out the voice of a singer accompanied by an orchestra.

The requirements for an ideal mixer are that any adjustment of the level of sound contributed by any one microphone shall not affect that of any of the others (or in other words, independent adjustments) and that no adjustments should alter the impedance match of either the incoming or outgoing circuits. This second feature is necessary since

the response characteristic of many pieces of equipment depend on the impedance with which they are connected. Figure 4 shows a console type mixer such as is ordinarily used in sound stages. No mixer can be made to comply with all these conditions and provide adjustable attenuation without throwing away considerable power. Since the level of the unamplified microphone output is already low, especially when faint sounds are being recorded, it is desirable from the standpoint of avoidance of disturbances by stray electric and magnetic fields and possible noise from the mixer contacts to provide some amplification between the microphone and the mixer.

It has been found possible by careful design and shielding to transmit the microphone output considerable distances through cable. This makes it possible to locate the microphone amplifier adjacent to the mixer, rather than at the microphone. The microphone output is stepped up to 250 ohms impedance. The other end of the cable is connected to a transformer having a high step-up ratio and the voltage is applied to the grid of an amplifier tube. The amplifiers used in this location are two stage using a screen grid tube and a triode. The compensation for the slight drop in the microphone response which has already been mentioned, is incorporated in the microphone-amplifier.

Compensation is provided in the mixer to introduce the desired amount of low frequency attenuation, and some high frequency attenuation, to give the best overall effects when speech is being recorded. Since voices are usually reproduced at abnormally high levels, they give the impression of an unnatural quality which it has been found possible to offset by certain modifications in the frequency characteristics of the system.

The output of the mixer is fed to the main amplifier, the output of which operates the recording galvanometer. This amplifier increases the power level from the mixer by approximately 80db at maximum volume control setting. This is sufficient for operation of the recorder galvanometer. Provision is made in the circuit arrangement for connections to the monitoring circuits and noise reduction equipment. A vibrating reed type of hummer is included in the amplifier case and can be connected in the circuit to provide a substitute for sound pickup as a convenient means of adjusting the galvanometer position and noise reduction system. The inclusion of the hummer as well as a meter for testing purposes eliminates several extra panels formerly used for mounting the equipment required for adjustment and tests.

The amplifier is very compact, but sufficiently rugged to withstand the jars and dust to which it is subjected when mounted in automobile trucks, which often make long trips over rough roads into dusty locations.

SOUND TRACK

There are fundamentally two types of photographic sound record. In one, the actual shape of the wave is shown as in an oscillogram. The area to one side of the line which marks the shape of the wave is preferably as black as it can well be made, while the other should be as clear as possible. In the other type of record, the transparency of

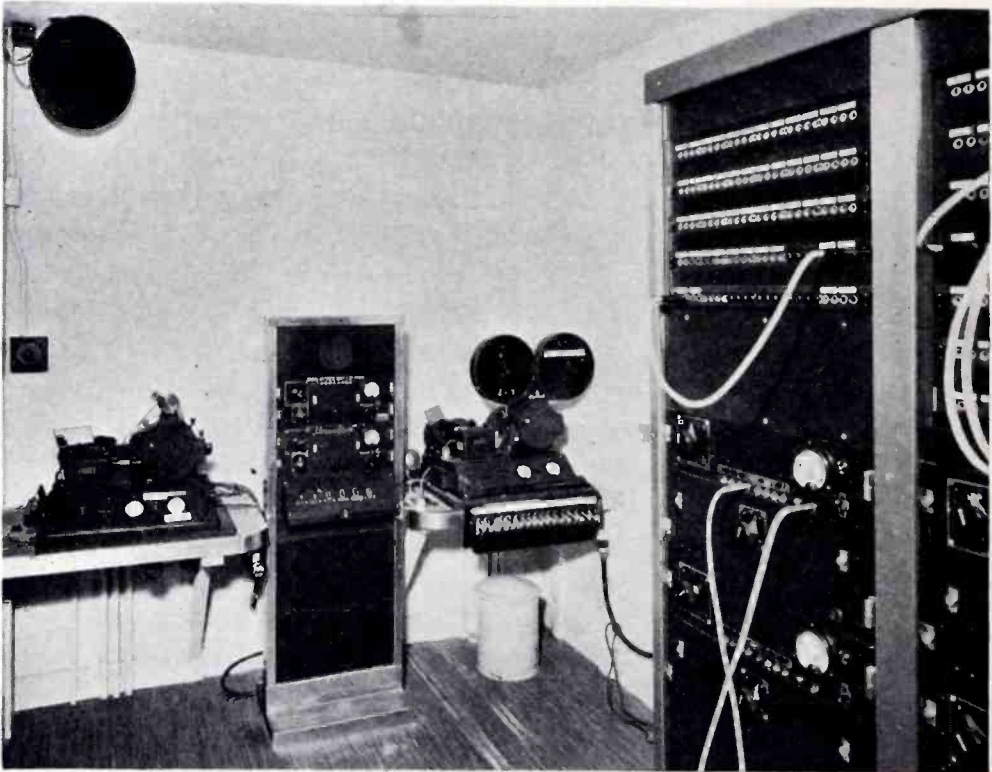

Fig. 5—Recording room used for musical scoring.

the film changes from point to point, but no change in shape is indicated. Sound tracks of both kinds are shown in Fig. 6. Many sound recordings have been made by mixtures of these two systems, but in modern high quality systems, the effort is to make the track distinctly of one type or the other, since the photographic requirements differ radically and what is best for one is not best for the other. The type of sound record first mentioned is usually described as "variable width", while the second is called a "variable density" record.

In reproduction, the record or sound track is passed through a sharply focused beam of light which has the form of an extremely narrow rectangle where it strikes the film. This rectangle or slit image is about .001" wide by .084" long. As the film passes through this light beam, the amount of light which gets through to the photocell varies in proportion to the width of the clear area if the record is of the

variable width type, or in proportion to the translucency if the record is of the variable density type.

Present RCA equipment can be readily adapted to make either type of record. The relative merits of the two systems⁴ have been the subject of prolonged controversy. The principal arguments are the following:

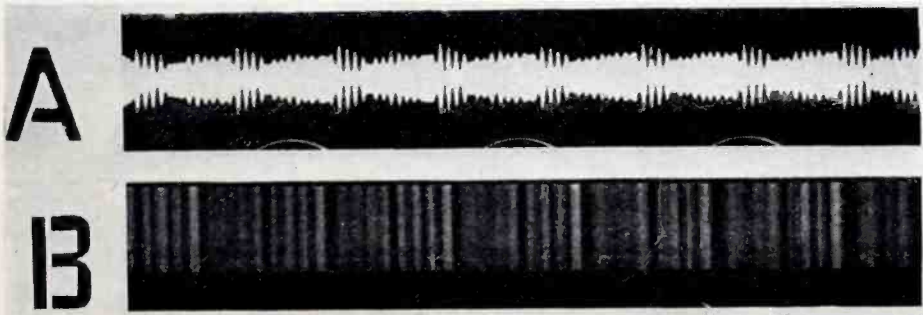

Fig. 6—Variable width and variable density sound tracks.

Advantages of the variable width system

- (1) Less distortion, especially of low frequency and high amplitude sounds.
- (2) Less critical to exposure and development. (The extremely close control of photographic and laboratory conditions, required for low distortion in the case of variable density records, has been a constant source of trouble.)
- (3) Higher photocell output. (A variable density record if so printed as to transmit more than about 25 per cent of the incident light on the average, gives rise to bad distortion, owing to the photographic characteristics of the film.)
- (4) Less ground noise of "hiss" type resulting from graininess of the negative and print films.
- (5) The form of the recorded wave is evident to the eye, and anything wrong can be more readily discovered or diagnosed.

Advantages of the variable density system

- (1) Lower ground noise of the type which results from dirt and scratches on the release print.
- (2) Quality of reproduction less affected by imperfections in the reproducing optical system.

The first RCA Photophone recording optical systems were so designed that a single trace of the sound wave was produced, the area on one side of the sound track being black and the other clear, as shown at A, Fig. 7. In 1932, the form of the track was changed to that shown at D or E, in which the clear area is in the middle of the track and the wave shape is traced symmetrically on both sides of the middle.⁵ This new form of variable width track presents certain advantages which will be explained in connection with ground noise reduction and also results in less distortion in case the angle of the reproducing light beam with respect to the film is not accurately adjusted.

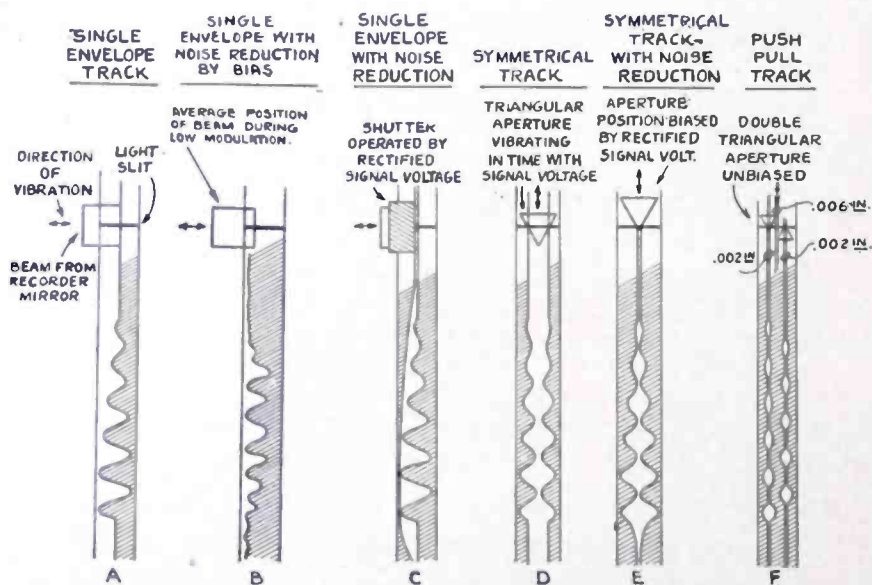

Fig. 7—Variable width sound tracks produced by different recorders.

Still another form of sound track of the variable width type is shown at F in Fig. 7. This is a push-pull system.⁶ Positive and negative half waves are recorded as separated transparent areas on the two sides of the track. The reproducing light beam is split and one part directed to one cathode and the other to the other cathode of a double photo-cell. The two photo-cell elements are connected to a push-pull transformer. The push-pull track affords important advantages on the score of ground noise and the avoidance of certain forms of distortion. Since it requires a special reproducing system its use has so far been confined to making master records rather than theatre release films, although the latest RCA reproducing soundheads are designed so that a simple conversion device can be applied, and change-overs quickly made.

RECORDING OPTICAL SYSTEM^{7 8}

The variable width sound track has been compared to an oscillogram of the sound wave. It is in fact a miniature oscillogram differing in

form from the ordinary oscillogram only in size and in the fact that the area on one side of the wave outline is black. It was natural in view of the similarity that the first galvanometers to be used should have been the same as oscillograph vibrators, modified only in detail and in the form of the magnet structure to suit the apparatus. Fig. 8 shows the arrangement of the optical elements and Fig. 9 shows the optical system assembly. The filament of a small high intensity incandescent lamp L is imaged by condenser lens C on the galvanometer mirror G. Close to the condenser lens is a diaphragm or mask M with an opening A of suit-

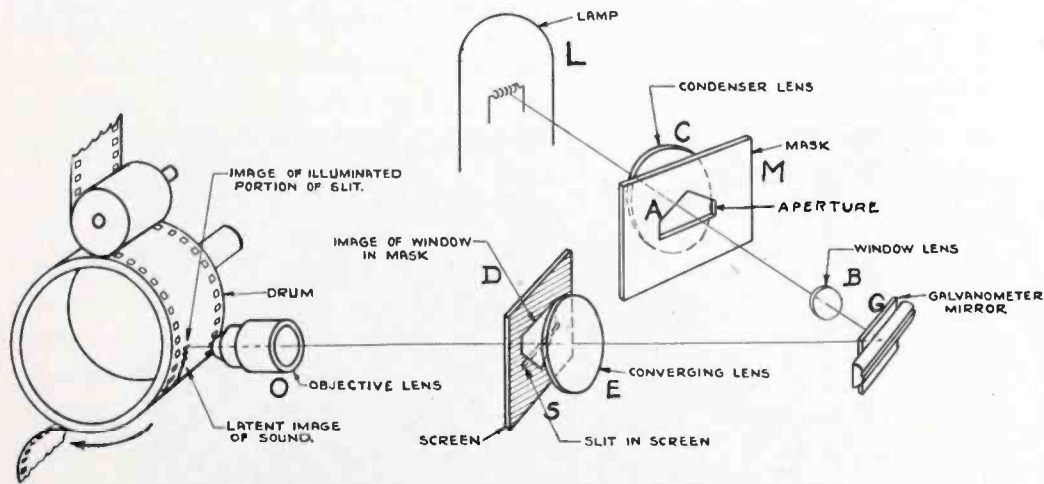

Fig. 8—Elements of the optical recording system.

able shape. Near the galvanometer mirror is a lens B which produces an image D of the opening A at the plane of the slit S. If the condenser lens is properly designed and adjusted, the spot of light D is uniform in intensity. Rotation of the galvanometer mirror causes the spot D to move, and illuminate more or less of slit S. Were a film placed directly behind this slit and voice currents passed through the galvanometer, a sound track would be recorded on an enlarged scale. Objective lens O produces a reduced size image of the illuminated portion of the slit. The lens E serves to direct all of the light which passes through the slit into the objective lens O. The perfection of this slit image on the film is an important factor in the recording of high frequency sounds. An even finer or narrower light beam is employed for recording than for reproduction. The present physical slit is $1\frac{3}{4}$ mils wide, and the objective lens forms an image $\frac{1}{7.5}$ of this size or $\frac{1}{4}$ mil wide on the film. Since all of the light which passes through the slit is concentrated in the small image on the film, the intensity within this image is very high, the brightness being such that it is possible to get adequate exposure during the extremely brief time that a given point on the surface of the film is within the light beam, or in $\frac{1}{72000}$ second.

Ever since the beginning of variable width recording there has

been pressure for increasing the amount of light which the optical system can concentrate into this slit image on the film. The proportions of the optical system may be varied within wide limits and, assuming proper design, the question of how much light can be concentrated on the film always comes back to the same factors—

How bright is the source (in candle power per square m.m. of projected area)?

How large is the mirror, and does the filament image occupy all of the mirror surface?

How large a solid angle can the slit be made to subtend from the mirror?

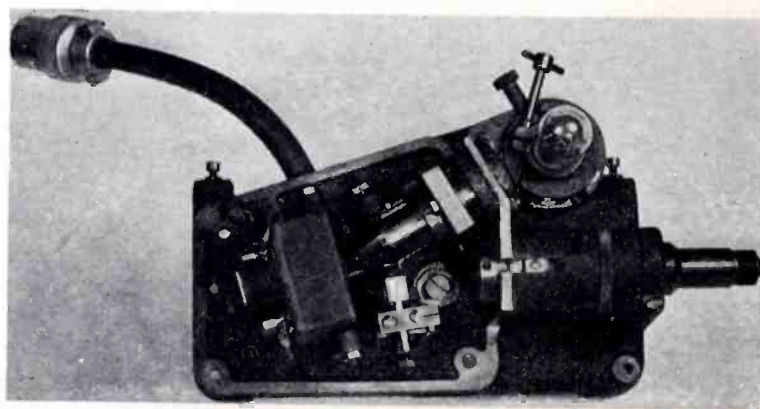

Fig. 9—Recorder with cover removed.

The size of the mirror and intensity of the image upon it determine the candle power of the beam of light which leaves the mirror. The angle subtended by the slit, multiplied by the candle power of the mirror, regarded as a source, gives the number of lumens passing through the slit. The mirror vibration swings the light spot *D* across the slit in such a way that various lengths of slit are illuminated. Obviously, the larger the angle which the slit subtends at the mirror, the farther the mirror must swing in order to move the light spot from a position which will completely cover the slit to entirely off. In the earlier forms of optical system the aperture *A* was rectangular and the galvanometer, which was of the oscillograph vibrator type, with its axis vertical, caused the light spot *D* to move horizontally or parallel with the slit. One of the important improvements which gave more light was to turn the mirror axis horizontal and swing the light spot across the slit instead of lengthwise, and provide for varying the length of the illuminated portion by imaging an aperture of triangular shape.⁹ If the aperture is made in the form of a triangle with its vertex at the middle, the present form of symmetrical track (Fig. 6-B or Fig.

7-D and E) is produced. The more acute the angle of intersection of the edge of the light spot and the slit, the smaller is the actual movement of the light spot required, and therefore, the closer can the slit be placed to the mirror, with resultant increase in the light passed. It is not desirable to make this angle extremely acute because when this is done the end of the illuminated portion becomes less sharp on the film. The angle can be made sufficiently acute to afford a gain of 3 or 4 to 1 in light intensity at the film.

VARIABLE DENSITY RECORDING WITH THE RCA OPTICAL SYSTEM

If instead of a triangular opening at A, a rectangular aperture is employed, so that the entire slit is illuminated at all times, and if a dark glass of suitably graded density were placed in this aperture, the slit illumination would change in intensity only, as the image of this glass "wedge" moves up and down in response to the mirror vibration. The result would be a variable density track on the film. A simpler expedient than the glass wedge serves the same purpose. A horizontal mask edge is located at such a position that it is out of focus at D, appearing as a soft edged shadow or "penumbra". Conditions can be so chosen that the light intensity within this penumbra decreases linearly from full brightness to zero, which exactly meets the requirements for variable density recording. The RCA variable density system avoids a certain form of distortion which has been well recognized as inherent in the usual "light valve" form of variable density recording system, and which results from the fact that the light valve controls the exposure by varying the width of the slit image on the film.¹⁰

MAGNETIC GALVANOMETER

A second important improvement consisted in the development of the present form of galvanometer which has superseded the oscillograph vibrator type. In the present type, which was developed by Mr. G. L. Dimmick,¹¹ and which is illustrated in Fig. 10, an armature of silicon steel vibrates between pole pieces of laminated silicon steel. A permanent magnet provides the polarization. The moving end of the armature is sharpened to provide a knif edge which engages a groove in a duralumin block in the form of a short half-round bar, on the flat side of which the mirror is mounted. A ribbon .001" by .006" of phosphor-bronze, under tension, is so arranged as to act as a pivot as well as to hold the duralumin block against the knife edge. The effective center of rotation of this block or mirror carriage is only .020" from the knife edge, and the result is that a small displacement of the latter causes a large rotation of the block with its mirror. Damping is provided by

small blocks of rubber clamped against the armature just behind the pole-tips, by a U shaped metal piece which serves as a load. The damper does not affect the amplitude of vibration at low frequency, but the mass of the metal piece and elasticity of the rubber blocks combine to form an anti-resonant system which provides strong damping at the frequency at which the armature would otherwise have a large resonance peak.

The great advantage of the magnetic galvanometer is its ability to

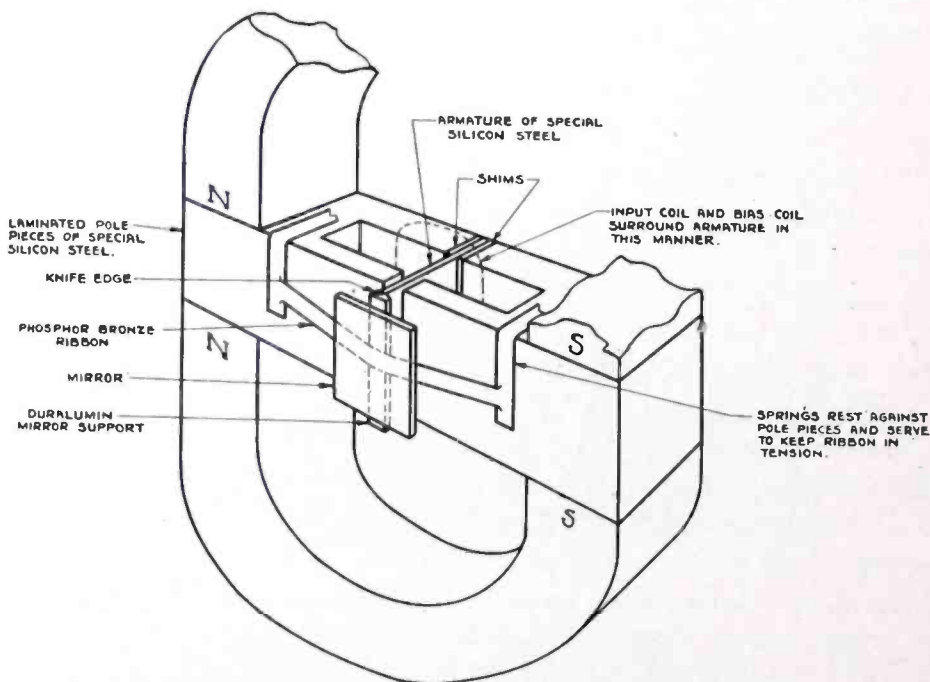

Fig. 10—General construction of magnetic galvanometer.

swing a large mirror. The mirror used is $.1" \times .125" \times .005"$ thick, which provides ten times the area of the mirrors employed in the oscillograph galvanometers. This results not only in an increase in the amount of light leaving the mirror, about in proportion to the increase in area, but the relative amount of stray light from the edges of the mirror (which was formerly a serious problem) is greatly reduced, enabling the new galvanometer to give cleaner and sharper images, as well as far more light. The mirror can swing through about the same angle as the oscillograph vibrator, and requires about the same power to operate.

By a series of refinements in design and materials, the galvanometer has been steadily improved, giving flatter response, more uniform behavior and less hysteresis and wave-shape errors. The natural frequency of the armature when driving the mirror is about 9000 cycles. There is a slight peak at this point and at higher frequencies the am-

plitude falls rapidly. This characteristic is found in nearly all apparatus in which the mass plays a part in limiting the high frequency response. It is not regarded as a drawback since in practically all sound reproduction it has been found desirable to attempt to reproduce or transmit all frequencies up to a certain definite upper limit and cut off the response sharply at this point. Although of delicate construction, the moving elements are so light that the galvanometer is decidedly rugged. It can stand heavy overload without injury, being protected at about 200 per cent. amplitude by saturation of the armature and pole pieces, which limits the forces which can be produced magnetically.

GROUND NOISE REDUCTION

When a film is run through a reproducing system the light is modulated not only by the photographic image on the film, but by accidental variations in transparency. Some of these variations are due to inherent graininess of the film.^{4, 12, 13, 14} If for example, two equal microscopic areas which have the same exposure are examined they will be found to differ slightly in the number and size of developed silver grains, and therefore in the amount of light which they will transmit. Over larger areas these differences tend to average out, so that the difference between the total transmission through two fairly large areas is an extremely small fraction of that total. In other words, the variations in average density over large areas that have had the same exposure are practically nothing; but in scanning a sound record an extremely small area is in the light beam at one time, and the variations due to the accidental distribution of grains become appreciable in comparison with the total light transmitted.

A second cause of noise is dirt and abrasions on the film. Utmost care in handling the film is required for best results. All good laboratories carry out their film processing in rooms which are ventilated entirely with filtered and washed air. All machines through which film must be run must be designed so that as far as possible nothing comes in contact with the film within the picture area or the sound track.

A dirt speck on the blackened part of the sound track has little effect, for little light gets through for it to modulate. A similar speck in the clear area may produce a loud click. It is therefore desirable to have as little clear film as possible. In order to accomplish this result, Mr. L. T. Robinson, of the General Electric Company, proposed biasing the recording galvanometer by means of rectified current in such a way that the clear area of the film was just sufficient to accommodate

the recorded waves.¹⁵ The difference which this makes in the recorded sound track may be seen by comparing tracks A and B of Fig. 7. Mr. C. R. Hanna, of the Westinghouse Company, worked on the same idea and provided rectifying and biasing arrangements which were used in the earlier photophone recordings.¹⁶

The sound track shown in Fig. 7-B is open to objection because when the modulation is small the waves are all recorded near one edge. It is unfortunately true of many reproducing optical systems that the quality and intensity of the slit image becomes poorer towards the ends. There are also many machines in which the film is not sufficiently well guided, and weaves slightly from side to side. Under such conditions, there is a possibility that small waves recorded at the extreme edge of the sound track will not be well reproduced or may be even cut off. To obviate this difficulty, Mr. Hugh McDowell, Jr., of RKO, reduced the width of clear film, not by biasing the galvanometer, but by providing a separately actuated shutter which moved back and forth in front of the slit in such a way as to permit the illumination of only so much as is required for the modulation.^{17, 18} The resulting track is shown at C, Fig. 7. Fig. 7 also shows the light spot and shutter relations for producing the various tracks. The adoption of the symmetrical track shown at D, Fig. 7 and produced by moving a triangular shape light spot across the slit instead of a rectangular light spot parallel with the slit, made it possible to revert to the simpler arrangement of biasing the galvanometer in accordance with the modulation. For full modulation, the light spot moves up and down about a mean position such that half the slit is, on the average, illuminated. When the modulation goes down, the light spot moves upwards as shown in Fig. 7-E so that the slit crosses the triangle near the tip, and only a short section of slit near the middle is illuminated.

The slowly varying current for biasing the galvanometer is supplied from a special amplifier and rectifier known as the "ground noise reduction amplifier".^{3, 19} The input to this unit is taken from a tertiary winding on the interstage transformer preceding the output stage of the main amplifier. The audio frequency input voltage is applied through a volume control, to the input grid of a two-stage "buffer" amplifier, the output of which operates the rectifier. The output of the rectifier is arranged to increase the negative bias on an output tube, the plate current of which biases the galvanometer. Thus at zero modulation the plate current is maximum, the exact value being adjusted to bias the galvanometer until a very small fraction of the track width is illuminated. As the modulation increases the plate current falls and the galvanometer returns toward the mid position at which maximum modulation can be accommodated. The galvanometer is set for mid position

with zero plate current, and the volume control of the ground noise reduction amplifier is adjusted so that the output tube will be biased to cut-off or zero plate current when the modulation is about 75 per cent. of maximum. This insures definiteness of the galvanometer position for high modulation, which is very important. If anything should go wrong with the ground noise reduction amplifier, the most likely result would be that the plate current would fall, or perhaps become zero. This would do no harm except cause some increase in ground noise.

Distortion will occur if the tip of the triangular light spot actually crosses the slit. With the galvanometer biased so that the tip is near the slit it is obvious that vibration in one direction is in danger of producing distortion, while there is abundant room for movement in the opposite direction. This relationship justifies the use of a half-wave rectifier, and correct polarity relations must be preserved between the ground noise reduction amplifier and the recording galvanometer.

Since the changes in galvanometer bias must be such as to accommodate peak amplitudes rather than r.m.s. values, the rectifier should as nearly as possible be designed to give a rectified voltage proportional to the peaks of the irregular audio frequency waves. This can be closely approached in the case of a practically unloaded rectifier, or one loaded only with the grid of an amplifier tube. A resistance-capacity filter between the rectifier and the grid of the output tube eliminates audio frequency voltages from the latter, and also limits the rate at which the bias can increase; and a discharge resistance allows the tube bias to slowly come back toward the zero modulation setting when the modulation decreases. It is obvious that in case of a sudden increase in modulation the unmasking must take place quickly. At the same time, this unmasking involves a change in the amount of light passing through the sound track. If this change takes place above certain rate, a thumping sound is heard in reproduction. Therefore, the rectifier is designed so that the maximum rate of opening is limited. The closing of the track after the sound has decreased in intensity is made quite gradual since it is not desirable to have the track width continually changing in an attempt to follow every little change in amplitude. The actual opening and closing times are about .014 and .25 seconds respectively when the modulation is suddenly changed from zero to full value and back.

The narrowing of the clear track gives about 10db. decrease in ground noise when the modulation is low. This means 10db. increase in the useful volume range, since the faintest sound that can be satisfactorily recorded must be louder than the ground noise by a certain definite margin, while the loudest sound recorded must not over-shoot the track. In order that ground noise due to the graininess of the film

may be kept at minimum, it is important that the black areas be as dense as possible and the clear areas free from fog, and that the line which divides the two shall be as clean and sharp as possible. If this line of division is soft it means that there is a certain amount of gray film, and gray film produces more noise of this type than either clear or black film. Various improvements in the lenses employed in the recording optical system, the availability of a galvanometer which can swing a large mirror, and the use of the recently developed front surface aluminum coated mirrors have all contributed to sharper images and cleaner outlines of the sound track. The sharp outline makes it possible to set the minimum track width still closer, to keep down the ground noise due to abrasions and specks on the film.

RECORDING MACHINES

Whether or not they have recognized the cause, there are few people who have listened to music reproduced from records of any kind, who have not suffered (a form of torture greater or less in proportion to one's musical appreciation) from the "twangy", out of tune, and Hawaiian guitar effects which result from speed fluctuations in recording and reproducing machines. These fluctuations and the disturbances in sound quality which they produce, have been dubbed "wows". Disturbances which occur at a rapid rate are termed "flutter", "ripple" or "gurgle". Sometimes the rapid fluctuations result in an outright treetoad trill, and sometimes simply in muffled and "wheezy" tones.

Engineers concerned with the earlier developments which eventuated in the exploitation of sound pictures by RCA Photophone,* seem to have recognized that a film cannot be moved at constant speed by means of a sprocket.²⁰ A disturbance in speed in the nature of a tooth ripple inevitably results.

For many purposes, the departure from constant speed which this tooth ripple introduces is not serious, but in sound reproduction it results in a serious impairment in quality, depending of course, on the degree of misfit between the sprocket and the film. Some misfit is inevitable since films originally perforated with a certain pitch are subject to shrinkage which varies all the way from $\frac{1}{4}$ per cent. to $1\frac{1}{2}$ per cent. This tooth ripple can be avoided if the film is carried on a smooth drum against which it is held by friction, (usually provided by a soft

* The pioneer work of Mr. C. A. Hoxie, of Schenectady, deserves special mention in this connection. Contributions of C. L. Heisler and E. D. Cook, of Schenectady, of C. R. Hanna, of the Westinghouse Company, and others, should also be recognized.

tired, spring mounted pressure roller) the recording or reproducing light beam being arranged to strike the film where it is supported by the drum, and the drum being driven at as nearly constant speed as possible. In the various laboratory machines constructed in the earlier development of the Photophone system smooth drums were consistently employed and these were almost without exception connected to fly-wheels to minimize fluctuations. Film may be propelled through other parts of the machine, such as the picture projector, or withdrawn from the supply reel or controlled where it enters the take-up magazine by means of sprockets, but at the recording or reproducing point its speed is under control of the drum. Practically all other manufacturers of recording and reproducing machines have until quite recently ignored the impossibility of obtaining satisfactorily constant speed for sound work, if a film is driven at this point by a sprocket. Even the recording machines have recorded directly on sprockets, great refinement being introduced in the attempt to rotate the sprocket at constant speed, but the benefit being thrown away by the inherent pulsations which the sprocket teeth impart.

Unfortunately for the performance of the earlier machines of the drum and fly-wheel type, this expedient by itself does not give constant speed. The sprockets, which are necessary in all machines which must run synchronously, propel the film at a rate which may be measured in terms of perforations per second. This happens to be 96 per second, which corresponds to 1.5 feet per second when the film is first perforated, but would be 1 per cent. less when the film has shrunk by that amount. Therefore, the speed of the drum, which depends entirely on the linear speed of the film, cannot be determined in advance. The drum must be permitted to find its own speed, and the loops of film between it and the sprockets must in some way control the drum speed. The simplest arrangement is to drive the drum by means of the film. With such a drum drive, speed irregularities occur because:

- (1) The tension on the film is often so great that slipping on the drum occurs, even though the film is held against the drum by a pressure roller.
- (2) If the film is at all tight, it is incapable of acting as an elastic link and taking-up the slight pulsations imparted to it by the sprocket which does the pulling, and the inertia of the drum and fly-wheel are not sufficient to iron out the irregularities without the cooperation of flexibility, any more than a heavy body can give a smooth riding automobile without springs or rubber tires.

- (3) The flexibility in the driving system and loop of film, combined with the inertia of the fly-wheel attached to the drum, produce an oscillatory system, which is found to have very little damping, and the slightest irregularity in speed at the sprocket (provided this irregularity has a periodicity near that of the oscillation system) causes large fluctuations in drum speed. This is analogous to the well known "hunting" in synchronous motors in which the magnetic field is an elastic means of im-

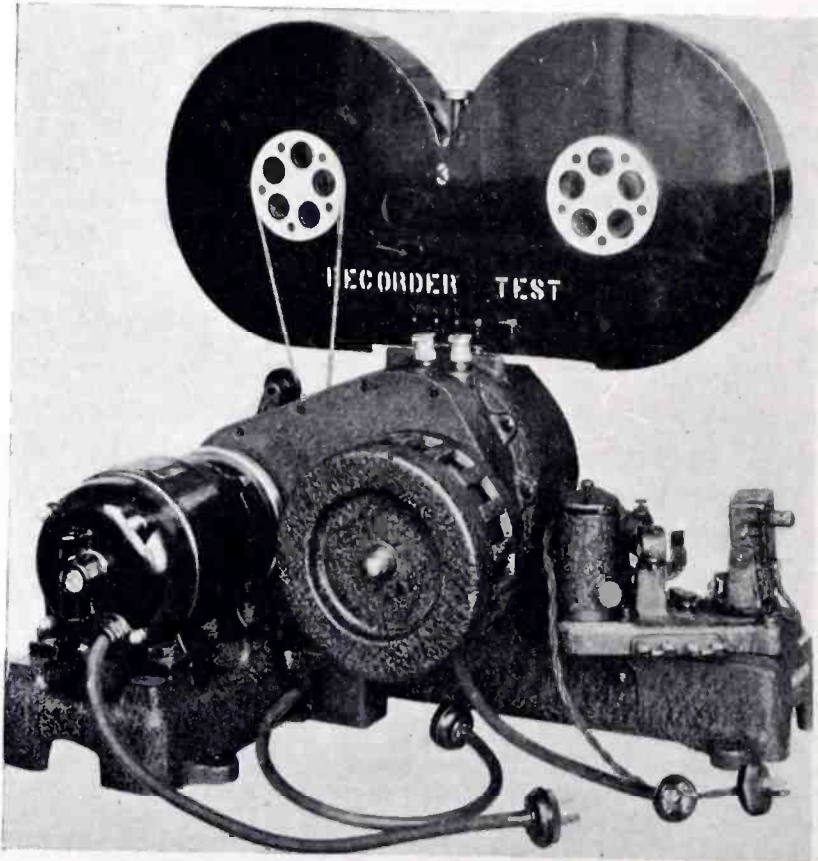

Fig. 11—Recorder which employs electro-magnetic damping.

parting torque to the armature, and this elasticity forms an oscillatory system in conjunction with the armature inertia. In synchronous motors the tendency to hunt is controlled by grids in which currents are induced and energy dissipated whenever an oscillation takes place. Or again using the automobile analogy, shock absorbers are needed as well as springs and a reasonably heavy body.

A recorder²⁰ which employed the principle of electro-magnetic damping was brought out in 1930. In this recorder, a copper flange is mounted on the fly-wheel, and this reacts with a multi-pole magnet,

currents being induced in the flange in proportion to the velocity of the relative movements between flange and magnet. Fig. 11 is a photograph of the recorder from the motor side, showing the fly-wheel and magnet.

Any steady or continuous speed difference between the magnet and the flange exerts a continuous torque, while oscillatory motions produce an alternating component of torque which resists or damps the oscillations. The damping effect is practically independent of the steady torque effect. A stationary magnet would tend to damp out oscillations, but would have the undesired effect of resisting the continuous rotation and thereby imposing a heavy load on the film which acts as a driving belt. In the magnetic drive, as embodied in the PR-4 and all subsequent models of Photophone studio recorders, the magnet is connected to the driving motor and driven at about 10 per cent. higher speed than the drum.²¹ By this expedient the continuous component of torque due to the difference in mean speed, is caused to help rotation instead of producing a drag. Enough torque is supplied to the drum shaft by the magnet to overcome the bearing friction and relieve the film of the work of rotating the drum. As the magnet current is increased, the loop of film which pulls the drum is gradually relieved of its steady tension until this becomes zero, and with still higher magnet current, the slack film is thrown into this loop and the loop above the drum begins to exert a retarding tension. Conditions for guiding the film are better when the film approaching the drum is under a slight tension. The recorders are therefore operated with enough magnet current to more than overcome friction losses. Before a recording is made a piece of "daylight film" is run through the recorder and the magnet current adjusted to a value which throws the slack film into the lower loop (film leaving the drum) and the upper loop is under very slight tension, such that it forms an easy bow (See Fig. 12) which possesses a high degree of flexibility, but can still exert enough tension to exert the final control of the drum speed. Such a loose loop of film can transmit little or no disturbance from the sprocket. During starting, the lower film loop is under tension for accelerating the drum, but the magnet assists in the acceleration. When the drum is up to speed the film loops are relieved of tension, and with the oil films in the bearings established, the drum almost floats along, held at constant speed by its fly-wheel with no appreciable forces to disturb the speed constancy. The oscillation produced by starting dies out in a few seconds. The path of the film and location of all guiding rollers has been carefully worked out to facilitate the formation of easy film loops, to lay the film onto the drum accurately directed and guided, to prevent edgewise movements or weaving, and to insure its lying snugly against the drum at the recording point. Fig. 12 is a front view of the PR-4 recorder, showing the drum

and film path. The film loops shown are fairly representative of conditions during running. Fig. 13 shows the most recent type of magnetic drive recorder.

FILM RESOLUTION PROBLEM

Early photographic sound recordings were extremely deficient in high frequency response. Some of this fault was due to imperfect optical arrangements which failed to confine the light beam in recording or reproduction to the desired narrow rectangle. At the standard

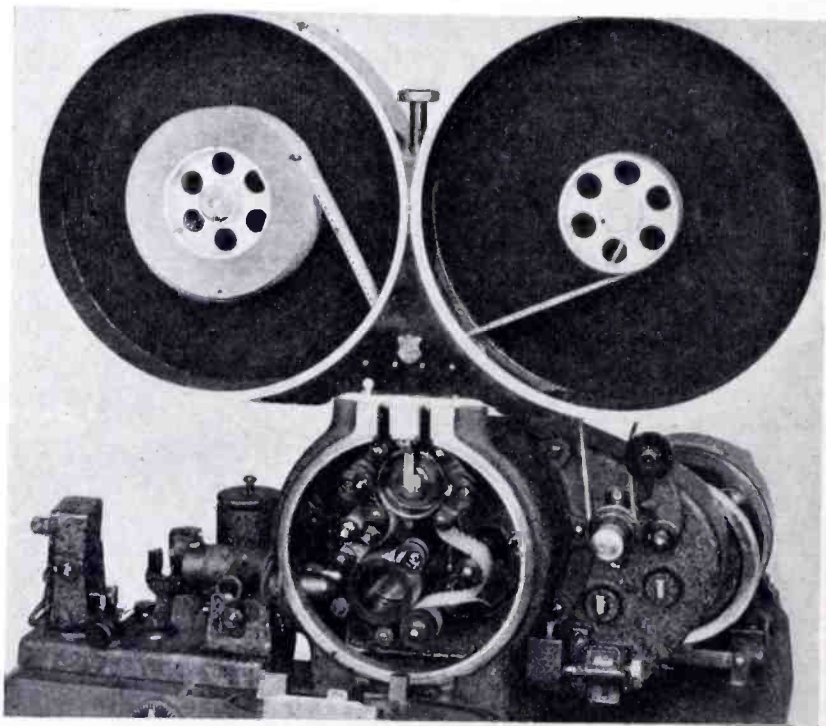

Fig. 12—Recorder showing normal film loops.

speed of 90 feet per minute, a 9000-cycle wave is only .002" long. Obviously, to record such a wave or to reproduce it, the light beam must be extremely fine. Its width should be a small fraction of a wavelength. Only a properly designed and corrected lens will suffice to produce the required sharp images of this size. Extreme care is necessary in manufacturing the actual slit which is imaged on the film, and stray light of all kinds must be carefully avoided.

Analyses have been made of the effect of employing a light beam whose width is a considerable fraction of a wavelength.^{22, 23} The harmful effect in loss of high frequency response is much more serious in recording than in reproduction, and results not only in loss of high frequencies, but in a form of distortion analogous to rectification,

whereas in reproduction the only harm is in the loss of high frequencies. In the earlier equipment it was not feasible to reduce the width of the recording slit image below .001" because there was not enough light available to expose the film. In the case of a reproducing machine too much sacrifice of photocell illumination results in trouble from microphonics, hum and other disturbances. Reproducing machines still employ a one mil slit image, which gives about 65 per cent. response at 9000 cycles. In recording, advantage has been taken of every improvement which increases the light intensity or film sensitivity, to reduce the size of the slit image. It has been found that there is some gain in resolution as this width is reduced even beyond the present $\frac{1}{4}$ mil width. The gain, however, from further reduction is extremely small especially in view of the limitations of the resolving power of the film itself.

A film emulsion consists of minute crystals of silver bromide dispersed in a layer of gelatine. Both are transparent, but the index of refraction of the silver bromide crystals differs from that of the gelatine, with the result that light is refracted whenever it passes from one medium to the other. This results in diffusing or scattering the light just as drops of water in a fog or crystals of ice in a snow bank diffuse light. The light which strikes a minute area of the surface of a film therefore diffuses in all directions with the result that the image spreads beyond the nominally exposed areas.^{12, 24, 25} Astronomers take advantage of this spreading of the image and estimate the amount of light from a star by the size of the spot on the film rather than by its blackness. In sound recordings, the diffusion of light in the film emulsion has qualitatively the same effect as that of a recording with a wider slit image. The most important improvements in recording with respect to high frequency response have been the result of developments which have made it possible to reduce this spread of the image. At first it was necessary to employ the most sensitive films available, namely, picture negative film. This is relatively coarse grain and has less resolution than the positive type. Before commercial exploitation of the Photophone System was undertaken, progress in the improvement of the optical system had made it possible to expose picture positive to the desired blackness or density with a $\frac{3}{4}$ mil slit image. It happened that this film was the best of all available commercial emulsions. It has high resolving power, fine grain and is inherently a high contrast film which helps to give good resolution and sharp edges in a variable width recording system. This was extremely fortunate for the reason that picture positive is the type of film used in largest quantities and is therefore the cheapest of the various films manufactured. The high resolving power of standard picture positive is

also fortunate in that this is the film on which the sound track must finally be printed.

Film manufacturers have devoted a great deal of effort to the production of still better sound recording films. The most important practical result of these developments has been a film which is substantially faster than the picture positive, while having equal resolution. Advantage has been taken of this improvement to narrow the recording light slits. Certain extremely fine grain emulsions have been

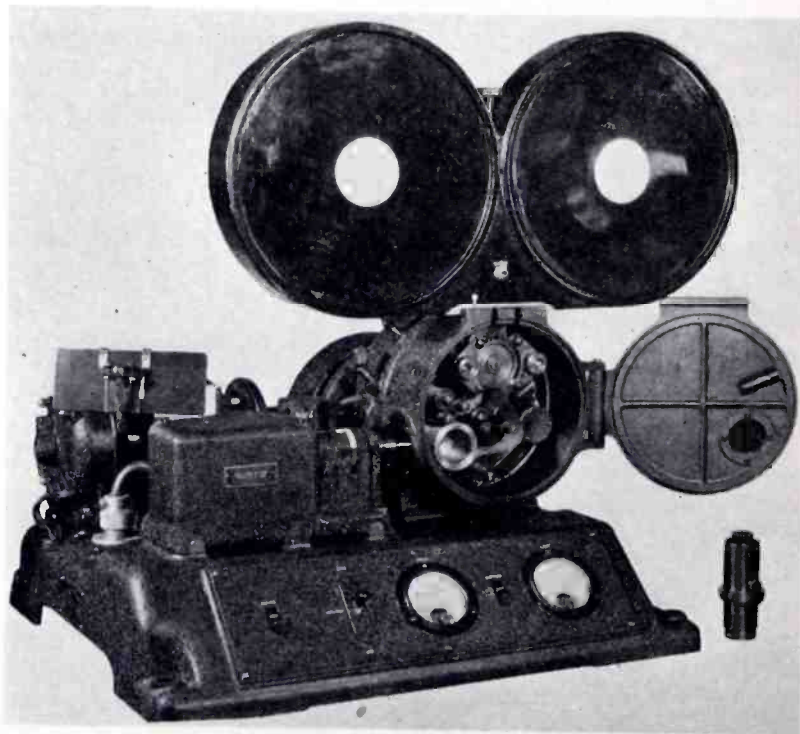

Fig. 13—Magnetic drive recorder.

developed which show considerably higher resolution than the picture positive, but these fine grain films require some ten times more exposure to give a satisfactory density, and they have not come into use. Some advantage has been shown in experimental films, from the use of anti-halation backings which reduce the light reflected from the back surface of the film. This expedient, however, has been rendered practically unnecessary by the most recent important development, namely, ultra violet recording.

Extensive studies have also been made of the effects of various developers and to determine the optimum exposures and degrees of development.²⁶

ULTRA VIOLET RECORDING²⁷

The most striking improvement in film resolution which has been made is probably the recent advent of ultra violet recording. The benefits gained are probably more than would have been anticipated. Some reasons for the improvement are understood, but how much each factor contributes is a question. It is well known that lenses exhibit greater resolving power with light of short wavelength than with longer wavelengths, assuming the lens in each case to have been corrected for the wavelength used. A higher degree of lens correction is possible if the light is restricted to a narrow range of wavelength than if a wide band is employed. In ultra violet recording, the visible rays are almost completely excluded by the No. 584 Corning filter employed. On the other hand, the limitations of the tungsten lamp and the transmitting properties of the special glass used in the lenses, determine the limit on the short wave side, so that the entire exposure is produced by light within the range of 350 to 400 millimicrons. It has been found that the tungsten lamps used in RCA recording systems radiate enough ultra violet light to record on some of the sound recording films which are now available. Only by certain changes in the optical system, however, has it been possible to obtain enough ultra violet light from a tungsten lamp to give the high negative densities which have been found to give best results. These densities are greater than have been found best for white light recording, very high contrast being possible with the ultra violet system.

The second factor which makes for higher resolution with ultra violet light is the fact that the emulsion itself absorbs ultra violet light very strongly. Therefore, the light which strikes the surface of the film although it is scattered by the silver halide grains as in the case of white light recording, does not spread as far. This confines the image to the surface. A high density or high degree of film blackening can be obtained only by heavy exposures, but this means that all of the grains immediately in the vicinity of the exposed surface are rendered developable, whereas with enough white light exposure to produce the same density only a part of the grains in this region would be used and the remainder of the density would be contributed by developed grains farther within the emulsion and to either side. Fig. 14 shows the difference between a 9000-cycle wave as recorded and printed with ultra violet light and with white light. The clean, sharp edges of the ultra violet recording make for reduced ground noise, higher response at high frequency, and reduced distortion of the kind mentioned as rectification, or change in average transmission when a high frequency wave is recorded. The use of ultra violet light results

in about the same improvement in the printing operation as in the recording, provided the printer maintains the films in close contact.

THE NON-SLIP PRINTER²⁸

Picture printers have for years operated on the plan of running both negative and raw stock around a large sprocket with the negative inside. Light is thrown on the films from a lamp on the other side of the sprocket, the sprocket being cut away to permit the light to pass. Since the two films are wrapped around the sprocket with the raw stock on the outside the travel of the raw stock is slightly greater than that of the negative. By choosing the proper sprocket diameter, this can be made to compensate for the fact that the negative will on the average have shrunk, and therefore be somewhat shorter for the same number of sprocket holes than the fresh film on which the print is being made.

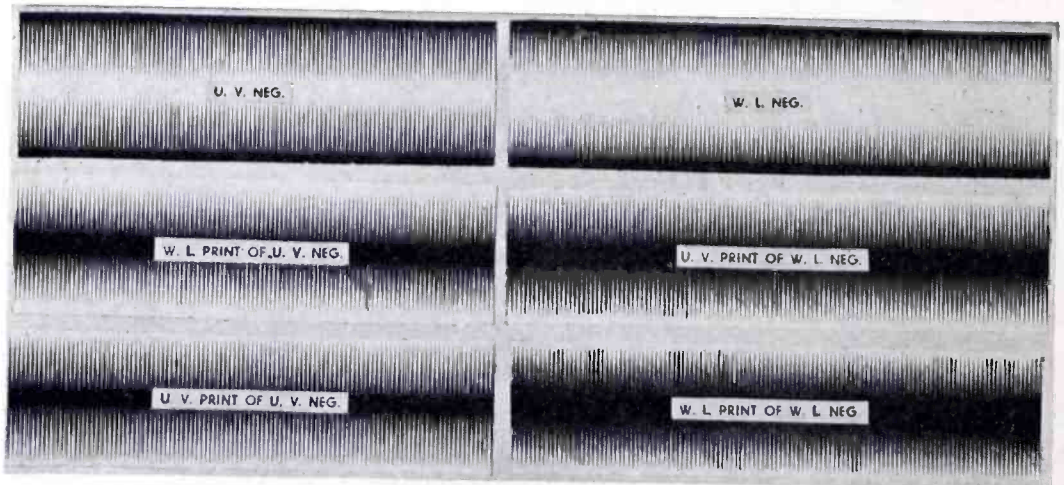

Fig. 14—Direct enlargements of 9000 cycles.

This crude approximation to correction for shrinkage of negative in excess of that of the raw stock, has sufficed for picture printing, and up till recently for sound printing, but each improvement which reduces the imperfections resulting from one cause, makes the faults of some other operation more apparent. It has been known for a long time that there was some loss due to inevitable slipping in the sprocket type printer, but only recent refinements have compelled wide spread attention to this fault.

A number of years before the industry recognized the need of better sound printers, Mr. A. V. Bedford realizing that here was a fault which would sooner or later have to be corrected, began experimenting with a printer which operates on a different principle.²⁹ Mr. R. V. Wood, independently, but at a later date, worked on the same principle.³⁰ Mr.

Bedford had previously suggested the same idea for application to projectors. He had found that if the film is driven by a drum rotating at constant speed and is held against the drum by a pressure roller (the pressure roller being free to find its own speed) the actual linear speed of the film could be varied within a limited range by merely changing the direction from which the film approaches the point at which it is pinched between the drum and pressure roller. This direction was made to vary automatically in proportion to the length of the loop of film between a sprocket and the drum. Provided the surface speed of the drum was *approximately* equal to the mean linear speed at which the sprocket propelled the film, the loop would gradually change in length until the angle of approach was correct to make the film speed at the two points exactly equal, after which the device continued to run under constant conditions. The same principle is applicable to a printer. In

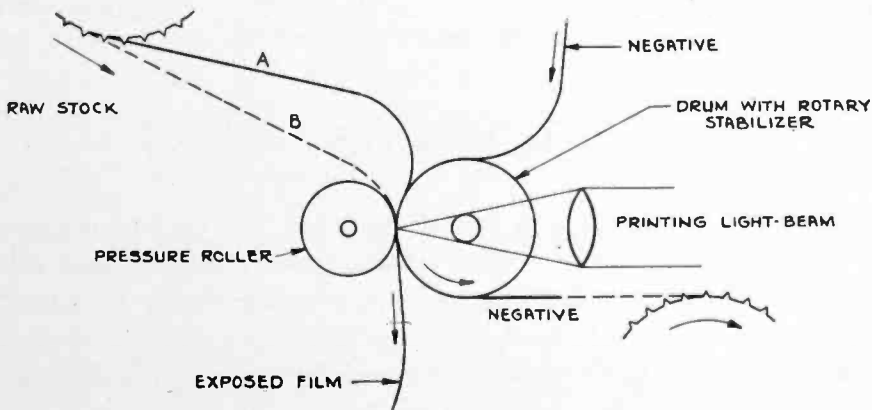

Fig. 15—Principle of the non-slip printer.

this case, the negative film is wrapped around the drum and the outer surface of the negative film is the speed to which the raw stock must adjust itself. The drum is driven by the negative film, and since the negative film may vary in shrinkage, the actual drum speed may differ from one negative to another, and the raw stock in each case finds a certain loop length and angle of approach which enable it to pass through this point of contact at exactly the right speed and without any slipping. Fig. 15 indicates the arrangement of the essential features.

The principle of operation may be thought of in terms of stretching or compressing the raw stock. It is not necessary to stretch or compress the entire film in order that it may be maintained in non-slipping contact with the negative and still pass exactly the same number of sprocket holes per minute. It is only necessary that the surface in con-

tact be stretched or compressed, and this, it will be readily recognized, is accomplished by bending. The actual curvature of the raw stock at the point where it is gripped between the rollers is altered by a change in the direction from which it approaches.

The improved resolution obtained from the use of the non-slip printer is not due solely to the absence of slipping, but also to the better contact. In a sprocket printer the films must be allowed to slip slightly, and therefore cannot be held very tightly. In the non-slip printer they are held in firm contact. To realize the benefit of this principle, the printing must be done at the point where the films are held together. The printing light is therefore supplied in the form of a beam about .005" in width, and the optical system is adjusted to make the light strike the film at exactly the right position. Small speed variations at the drum would not produce "wows" in the case of a non-slip printer since the negative and print must move together, but slight variations in print density might result. The well known "Rotary Stabilizer" (which is essentially an oil damped fly-wheel) is employed to insure speed constancy at the drum.

RE-RECORDING

A large proportion of the sound recorded for motion pictures is re-recorded before printing on the release print. This is done for the purpose of adjusting loudness levels, introducing extra sound effects and other matters pertaining to editing the sound. For a number of years it was the general practice to run the original sound record through an ordinary sound picture projector, the output from which was supplied to a recorder. The speed constancy of sound projectors has not been what it might be, and serious impairment of quality has been the result. RCA Photophone furnishes a re-recording machine in which the reproduction, as well as the recording, takes place on a drum with magnetic drive, thus performing both operations at the most constant speed obtainable. The reproducing optical system has special adjustments by which some faults in original negatives can be corrected if necessary and, of course, a light beam of the best obtainable quality and uniformity is employed. The re-recording console is provided with a mixer so that sounds from several records or from a recording plus an orchestra, or the voice of an announcer, can be mixed at whatever relative levels are desired. A very flexible system of compensation is also provided so that sounds being re-recorded may have either very high or low frequency components boosted or lowered by various amounts to give whatever is found to be the best overall result.

BIBLIOGRAPHY

- ¹ Olson, H. F.: "The Ribbon Microphone", *J. Soc. Mot. Pict. Eng.*, (June, 1931).
- ² Olson, H. F.: "A Unidirectional Ribbon Microphone", *J. Acous. Soc. Amer.* (Jan., 1932). Weinberger, J., Olson, H. F., and Massa, F.: "A Unidirectional Ribbon Microphone," *J. Acous. Soc. Amer.*, (Oct., 1933). Olson, H. F.: "A Unidirectional Microphone," *J. Soc. Mot. Pict. Eng.*, (Sept., 1936).
- ³ Read, S., Jr.: "RCA Victor High Fidelity Film Recording Equipment", *J. Soc. Mot. Pict. Eng.*, (May, 1933).
- ⁴ Kellogg, E. W.: "A Comparison of Variable Density and Variable Width Systems", *J. Soc. Mot. Picture Eng.*, (Sept., 1935).
- ⁵ Dimmick, G. L. and Belar, H.: "Extension of the Frequency Range of Film Recording and Reproduction", *J. Soc. Mct. Pict. Eng.*, (Nov., 1932).
- ⁶ Dimmick, G. L. and Belar, H.: "An Improved System for Noiseless Recording", *J. Soc. Mot. Pict. Eng.*, (July, 1934).
- ⁷ Hardy, A. C.: "The Optics of Sound Recording Systems", *Trans. Soc. Mot. Eng.*, (Sept., 1928).
- ⁸ Sachtleben, L. T.: "Characteristics of Photophone Light—Modulation System", *J. Soc. Mot. Pict. Eng.*, (Aug., 1935).
- ⁹ Kellogg, E. W.: U. S. Patent No. 1,740,406.
- ¹⁰ Shea, T. E., Herriot, W. and Goehner, W. R.: "The Principles of the Light Valve", *J. Soc. Mot. Pict. Eng.*, (June, 1932). Miller, B. F.: "Harmonic Distortion in Variable-Density Records", *J. Soc. Mot. Pict. Eng.*, (Sept., 1932).
- ¹¹ Dimmick, G. L.: "Galvanometers for Variable Area Recording", *J. Soc. Mot. Pict. Eng.*, (Oct., 1930).
- ¹² Mees, C. E. K.: "Some Photographic Aspects of Sound Recording", *J. Soc. Mot. Pict. Eng.*, (April, 1935).
- ¹³ Hardy, A. C. and Jones, L. A.: "Graininess in Motion Picture Negatives and Positives", *Trans. Soc. Mot. Pict. Eng.*, (May, 1922).
- ¹⁴ Sanvik, O.: "A Study of Ground Noise in the Reproduction of Sound by Photographic Methods", *Trans. Soc. Mot. Pict. Eng.*, (Sept., 1928). Sanvik, O. and Hall, V. C., and Grimwook, K.: "Further Investigation of Ground-Noise in Photographic Sound Records", *J. Soc. Mot. Pict. Eng.*, (Feb., 1934).
- ¹⁵ Robinson, L. T.: U. S. Patent No. 1,854,159.
- ¹⁶ Hanna, C. R.: U. S. Patent No. 1,888,724.
- ¹⁷ McDowell, H., Jr.: U. S. Patent No. 1,855,197.
- ¹⁸ Kellogg, E. W.: "A Shutter for Use in Reduction of Ground Noise", *J. Soc. Mot. Pict. Eng.*, (Aug., 1931).
- ¹⁹ Kreuzer, B.: "Noise Reduction with Variable Area Recording", *J. Soc. Mot. Pict. Eng.*, (June, 1931).
- ²⁰ Kellogg, E. W.: "A New Recorder for Variable Area Recording", *J. Soc. Mot. Pict. Eng.*, (Nov., 1930).
- ²¹ Kellogg, E. W.: U. S. Patents Nos. 1,892,554; 1,899,571; and RE 19270.
- ²² Cook, E. D.: "The Aperture Effect", *J. Soc. Mot. Pict. Eng.*, (June, 1930).
- ²³ Stryker, N. R.: "Scanning Losses in Reproduction", *J. Soc. Mot. Pict. Eng.*, (Nov., 1930).

²⁴ Jones, L. A. and Sanvik, O.: "Characteristics of Sound Recording Film", *J. Soc. Mot. Pict. Eng.*, (Feb., 1930).

²⁵ Series of Papers by O. Sanvik, *J.O.S.A.* XIV, No. 169, 1927, *J.O.S.A.* XVI, No. 244, 1928, *J.O.S.A.* XVII, No. 107, 1928. Reprinted, Eastman Kodak Scientific Publications XI, No. 289, XII, Nos. 334, 344, 352, 1927 and 1928.

²⁶ Dimmick, G. L.: "High Frequency Response from Variable Width Records as Affected by Exposure and Development", *J. Soc. Mot. Pict. Eng.* (Nov., 1931).

²⁷ Dimmick, G. L.: "Improved Resolution in Sound Recording and Printing by the Use of Ultraviolet Light", *J. Soc. Mot. Pict. Eng.*, (Aug., 1936).

²⁸ Batsel, C. N.: "A Non-Slip Sound Printer", *J. Soc. Mot. Pict. Eng.*, (Aug., 1934).

²⁹ Bedford, A. V.: U. S. Patent No. 1,754,187.

³⁰ Wood, R. V.: "A Shrinkage Compensating Sound Printer", *J. Soc. Mot. Pict. Eng.*, (June, 1932).

TELEVISION RADIO RELAY

BY

BERTRAM TREVOR

R.C.A. Communications, Inc., Riverhead, L. I.

O. E. DOW

R.C.A. Communications, Inc., Rocky Point, L. I.

Summary—A general description of the 177 Mc television radio link between the RCA Building and the Empire State Building in New York City is given. The transmitter and receiver are described in detail along with results of tests on the circuit.

WITH the installation of the new television transmitter in the Empire State Building, it became necessary to provide a connecting link to carry the video frequencies from the studios at Radio City to the transmitter. Both a coaxial cable and radio circuit are used for this link. This paper is devoted entirely to the radio circuit and its terminals.

The radio circuit is operating on a carrier frequency of 177 Mc which was chosen to be clear from harmonics of the picture and sound transmitters operating in close proximity to the relay receiver. A high frequency was chosen to be free from interference on existing radio services, to allow directive antennas to be used in which space was a limiting factor, and to take advantage of the lower man-made noise level encountered from sources such as elevator contactors, motors, etc. Vacuum tubes now available make operation above 200 Mc difficult. The air line distance from the transmitting antenna at Radio City to the receiving antenna at the Empire State Building is approximately 4600 feet. Ultra high frequencies are particularly adaptable to distances of this sort, and to the wide modulation band required.

PROPAGATION TESTS

The video frequencies up to 1500 kc. to be transmitted require the radio circuit to carry a band of 3000 kc. with double side band transmission. Calculation showed that the combination of the direct and reflected rays at the receiving antenna could cause serious variations in transmission efficiency throughout the extremely wide band,

depending upon the location of the points of reflection, and the intensity of the reflected ray or rays. To obtain more accurate information regarding this variation in transmission efficiency, propagation tests were carried out over the band of 176 to 182 Mc. This work is described in a paper by P. S. Carter and G. S. Wickizer.¹ The results of these tests showed that a reasonably flat response could be obtained by using transmitting and receiving antennas having moderate horizontal directivity. Fig. 1, from the above paper, shows the response curve obtained with a directive transmitting antenna located at the 14th floor level of the RCA Building and a directive receiving

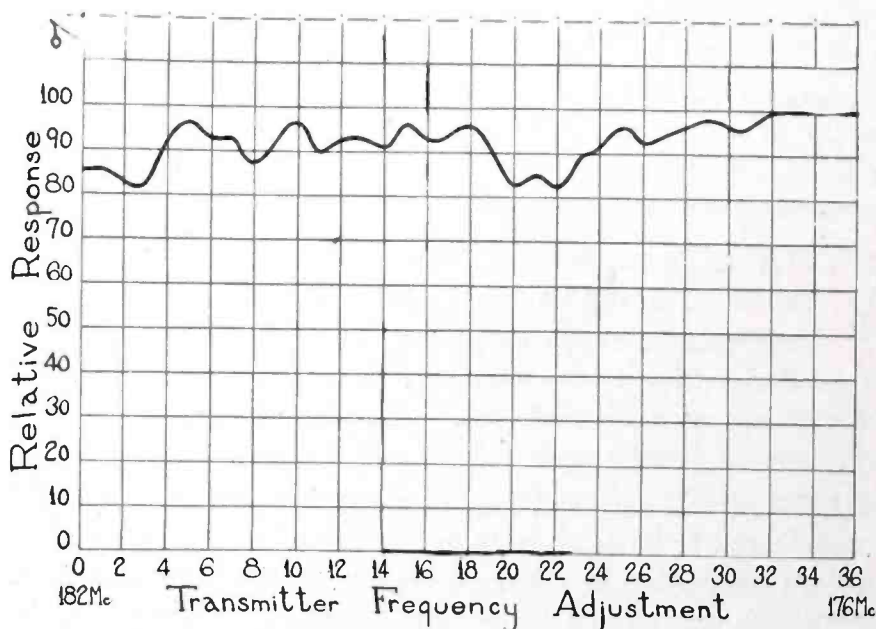

Fig. 1—Variation of received signal—horizontal one wavelength transmitting antenna at 14th floor level; receiving antenna, two horizontal half wave dipoles end to end spaced $1\frac{1}{2}$ wavelengths between centers.

antenna at the 85th floor of the Empire State Building. The antennas now in use at each end of the circuit are electrically equivalent to each other and consist of a one wavelength horizontal radiator, fed at the middle, located in front of a metal reflector. Fig. 2 is a photograph of the transmitting antenna now in use. These antennas are sufficiently broad to pass, without appreciable attenuation, the 3000 kc. band.

TRANSMITTER

The complete transmitter is mounted in a standard relay rack as shown in Fig. 3. The top unit contains the power amplifier, master oscillator, modulator and modulator amplifiers. This unit is mounted on rubber to protect the tubes and circuits from vibration. A peak voltmeter has been provided to measure the input level to the

modulator amplifier and the output of the monitor rectifier. It is located just below the rubber mounted unit. Below the peak voltmeter panel is the d-c filament supply unit for the master oscillator. The bottom two units are plate supply rectifiers for the radio frequency stages and the video frequency stages. A schematic diagram for the transmitter is shown in Fig. 4.

The master oscillator, right hand compartment of Fig. 5, consists of two RCA-834 type tubes operating in push-pull at a frequency of 177 Mc. The frequency of the oscillator is determined by a low power factor, concentric resonator to which the grids are inductively coupled. The grid loops which are coupled to the frequency control circuit are



Fig. 2—Transmitting antenna at 14th floor level of RCA Building.

in opposite polarity so that the phase of the grid voltages differ by 180° .² The ratio of the diameters of the concentric conductors of the frequency controlling circuit is 3.5.³ A theoretical Q of 11,370 is obtained with an inside conductor diameter of 2.25 inches.^{2, 4} The inner member, which is .2 of a wavelength long, has one end silver soldered to an end plate of the outer sheath, and the other end connected to a four-inch diameter syphon bellows one inch long. The free end of this bellows is screwed to an invar rod which is connected to the same end plate which supports the inner conductor. Since the temperature coefficient of expansion of invar is nearly zero the electrical length of the inner conductor is approximately constant with changes in temperature. Thus the resonant frequency of the low power factor circuit is made substantially independent of temperature.

The master oscillator has adjustable impedances in its plate and filament circuits. The grid circuit reactance was adjusted to about

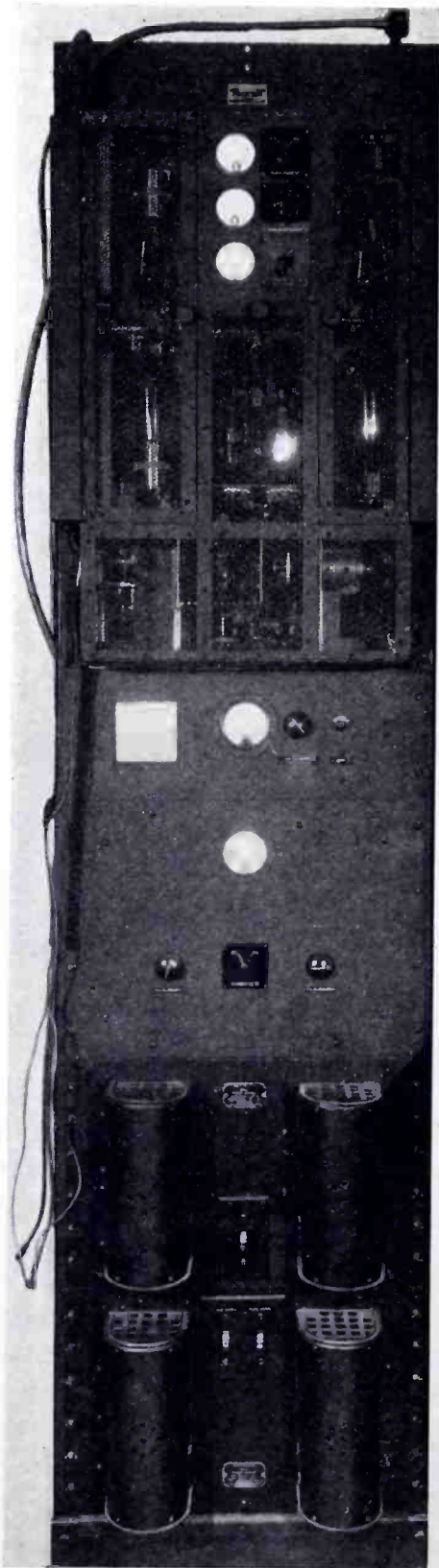

Fig. 3—177 Mc television radio relay transmitter.

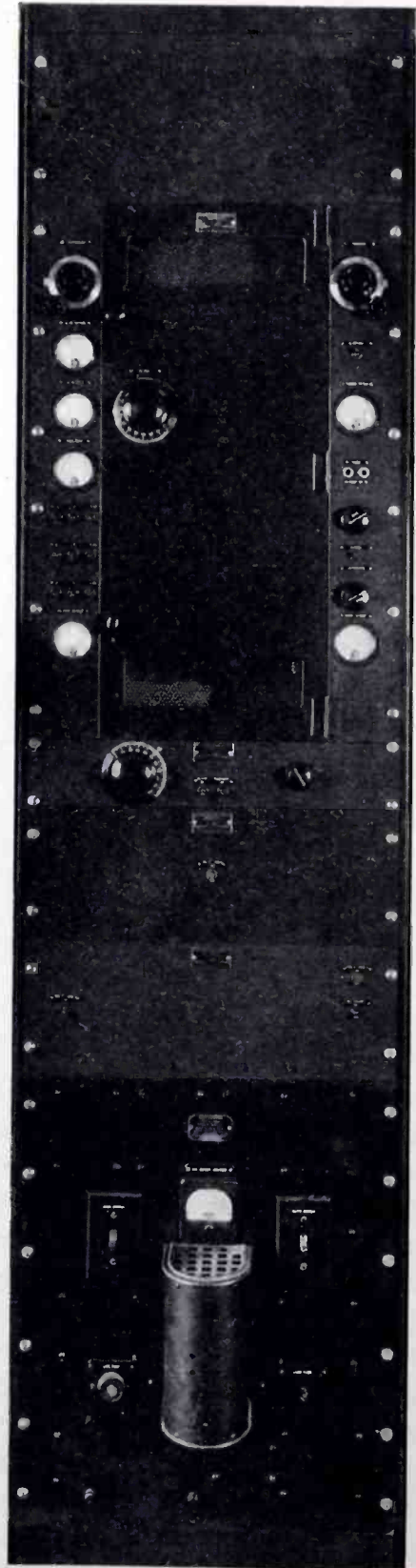

Fig. 7—177 Mc television radio relay receiver.

the required value by a short wire connected from grid to grid. This wire is in parallel with the grid loops which couple to the low power factor circuit. The plate inductance is a concentric conductor line connected from plate to plate. At the neutral point on this line the inside conductor is exposed so the power amplifier grid coil may be inductively coupled to it. The photograph of Fig. 5 shows the master oscillator on the right hand side, the modulator in the center, and the power amplifier on the left. With such an arrangement the connection from the modulator to the power amplifier grid circuit is short and the modulator output capacitance is reduced. However, this makes the link from the master oscillator to the power amplifier rather long.

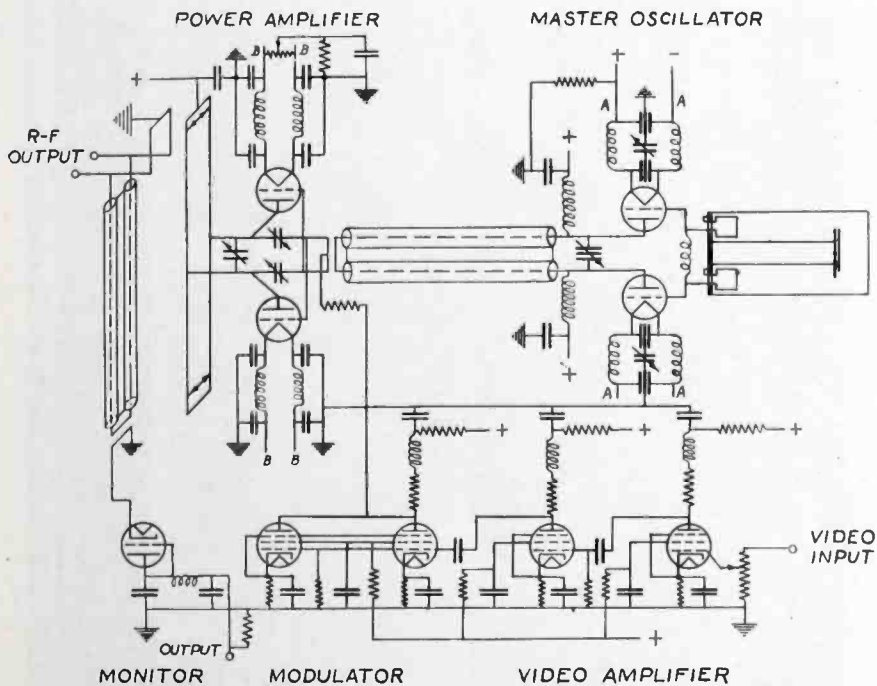

Fig. 4—Schematic diagram of television relay transmitter.

This link is the master oscillator plate inductance and its maximum reactance is fixed by the tube inter-electrode capacities. The correct inductance was obtained by the proper choice of the conductor diameters. A small balanced condenser connected from plate to plate is used for fine adjustment of the master oscillator circuit. Plate voltage is supplied to each tube through an r-f choke.

The r-f output stage is a conventional, push-pull, cross neutralized amplifier.⁵ The tubes (two RCA-834's) are located as shown in Fig. 5 to make the length of the connections from the grid and plate tube prongs to the neutralizing condensers a minimum. This is necessary to prevent parasitic oscillations. The neutralizing condensers are the horizontal concentric cylinders at the center of the power amplifier compartment. The outside cylinders are connected to the plates and

are made up of two telescoping tubes for adjusting the neutralizing capacitance. The inside cylinders are connected to the grids. This arrangement reduces the stray capacity between the input and output circuits of the power amplifier.

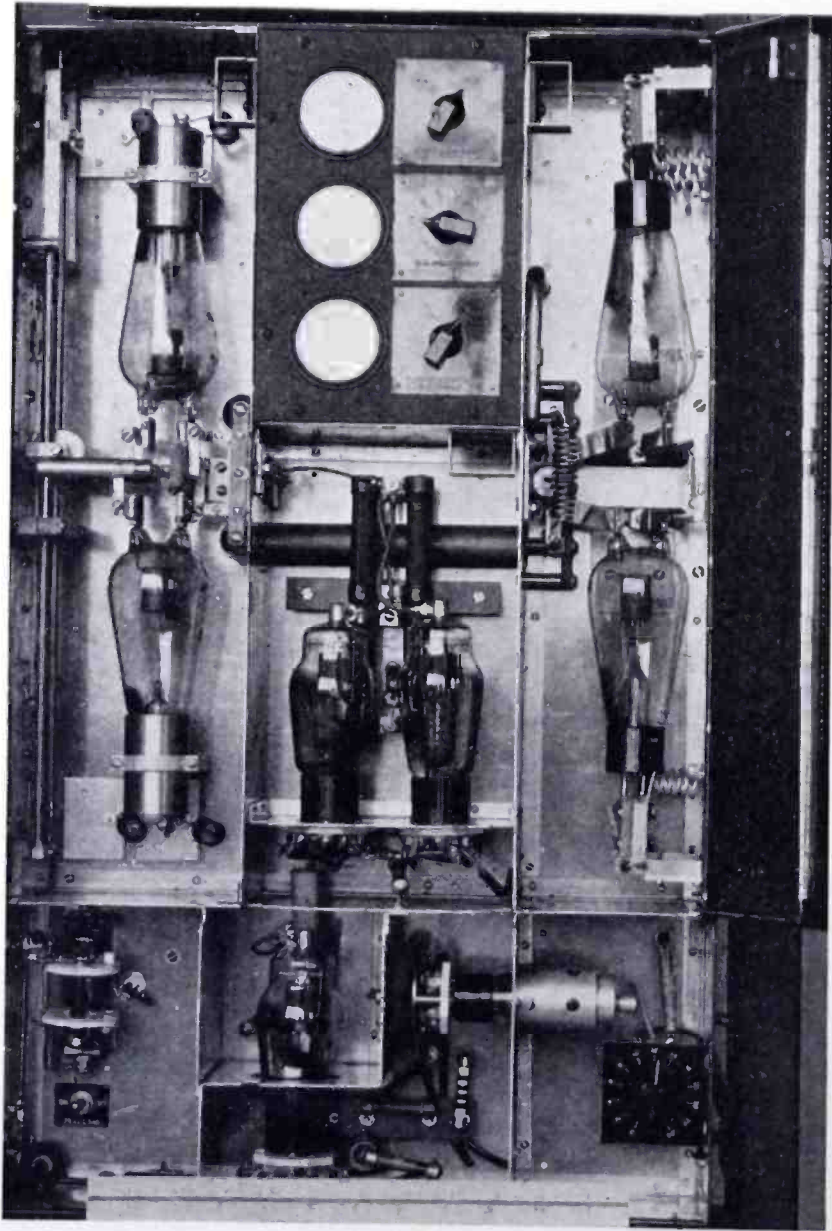

Fig. 5—Radio and video-frequency units of transmitter; left, power amplifier; right, master oscillator; center, modulator; lower left, monitor; lower right, modulator amplifiers.

The power amplifier grid circuit is an untuned inductance composed of a short brass strip connected from grid to grid, and closely coupled to the voltage nodal point of the master oscillator plate inductance.

The center point of the grid inductance is directly connected to the modulator plates. By eliminating the blocking condenser between the modulator and the power amplifier the stray capacitance of the modulator output circuit to ground is reduced. Since the power amplifier grids are connected directly to the modulator plates they are maintained at a plus potential of 250 volts. To give proper operating bias the filaments are maintained at a plus potential of 400 volts by a filament return resistor.

To maintain the symmetry of the power amplifier output circuit the plate inductance is made of two balanced lines in parallel. Slides on these two wire lines are provided for approximate tuning of the power amplifier plate circuit, and a small two-plate variable condenser for the fine adjustment. One branch of the plate circuit is inductively

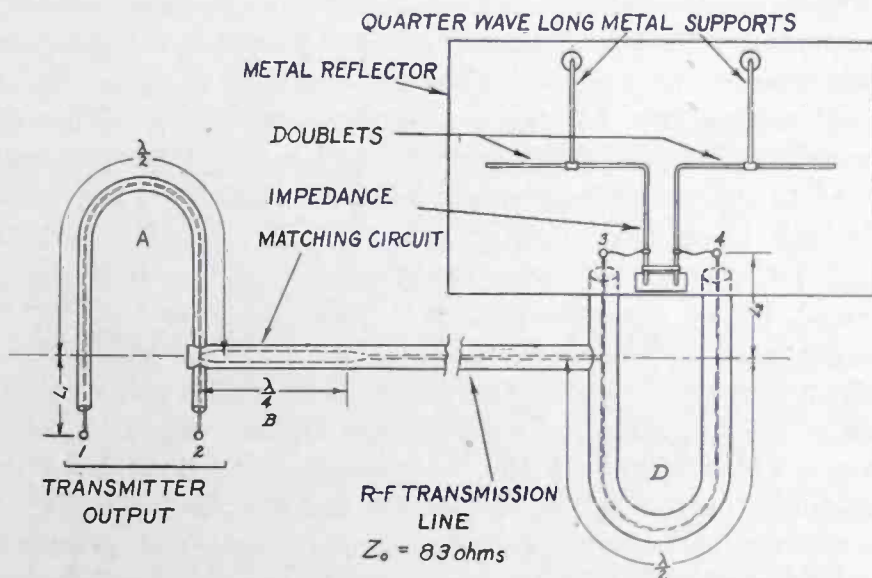

Fig. 6—Balanced to unbalanced transfer circuits, transmission line, and transmitting antenna.

coupled to a balanced 150-ohm load. The power amplifier will deliver to this load a 15-watt carrier.

The monitor step-down transformer is a concentric conductor line one half wavelength long connected across the output terminals of the power amplifier. At the center or voltage nodal point on this line a loop is inductively coupled to the inside conductor. This loop is connected to a rectifier which is used to monitor the transmitter r-f output.

The modulator uses two RCA-802's in parallel. The frequency response curve for each video frequency stage was made flat by using the system described by Messrs. Kell, Bedford and Trainer.⁶ If the total output capacitive reactance is X_C at the highest frequency (1.5

megacycles) it is desired to transmit, then the plate load impedance at this frequency is made $1.13 X + j .5 X_0$ ohms. The phase shift produced by the resultant plate impedance is proportional to frequency over the transmission band and, hence, does not produce phase distortion. The attenuation and phase shift produced at the low frequencies by the interstage coupling and cathode by-pass condensers are compensated for by choosing a suitable value of plate supply by-pass capacitance. The plate supply of each stage has a series resistance or damped reactor to isolate it from the power supply.

The modulator amplifier consists of two stages, an RCA-802 and RCA-6C6. An input level of .45 volts r.m.s. is required to modulate the transmitter 85 per cent.

The possibility of transferring the balanced output at the transmitter to an unbalanced load suitable for feeding a single coaxial line was considered. The circuit shown in Fig. 6 proved to be satisfactory. A coaxial line A with a characteristic impedance of 75 ohms was made $2L_1 + \lambda/2$ meters long. L_1 may be any convenient length. When there is a traveling wave on A the proper impedance of 150 ohms will be presented to the transmitter output terminals 1 and 2. The voltages on terminals 1 and 2 differ in phase by 180 degrees. The path from terminal 1 to the quarter wavelength section of line B is one half wavelength longer than the path from terminal 2 to this junction. Hence, the wave that leaves terminal 1 arrives at B in phase with the wave from terminal 2. The section of line B which has a characteristic impedance of 55.8 ohms steps the 83-ohm transmission line down to 37.5 ohms, which will match the two sections of the loop A.⁷ The r-f transmission line is made of a one-inch inside diameter copper pipe and a quarter-inch outside diameter copper tube. The quarter-inch tube is held concentric with the one-inch pipe with low-loss insulators. These insulators are spaced about every quarter wave to reduce the reflections produced by them. The length of the line is 100 feet and the efficiency about 90 per cent. At the antenna the unbalanced feed is transformed to a balanced feed of 332 ohms. The wave that leaves the transmission line and travels over the longer branch of D arrives at terminal 4, 180 degrees out of phase with the wave which travels over the shorter branch of D to Terminal 3. The concentric conductor D has a characteristic impedance of 166 ohms. The two branches in parallel will match the transmission line if the Terminals 3 and 4 are connected to a load of 332 ohms.

The impedance matching circuit shown is adjusted to step the antenna input load down to this value at 177 Mc. This is necessary to give maximum efficiency and flat frequency response over the band used.

RECEIVER

The receiving antenna on the north wall of the 85th floor of the Empire State Building is approximately 100 feet from the receiver location. The antenna feed line is composed of two 76-ohm, 13-gauge, coaxial cables, located in a conduit running from the receiver rack to the back of the antenna reflector. The use of two cables gives in effect a balanced, shielded, 152-ohm transmission line. Special tests were carried out to properly match the antenna to the feed line at 177 Mc to get the greatest overall efficiency and flattest response with frequency. The transmission line loss was estimated to be not more than 1.9 db. With all adjustments made the cables were sealed off, evacuated, and filled with dry nitrogen under pressure. This process insures the removal of moisture from the cables, and gauges permanently installed show whether the pressure is maintained. The sealed cables are thus impervious to weather conditions.

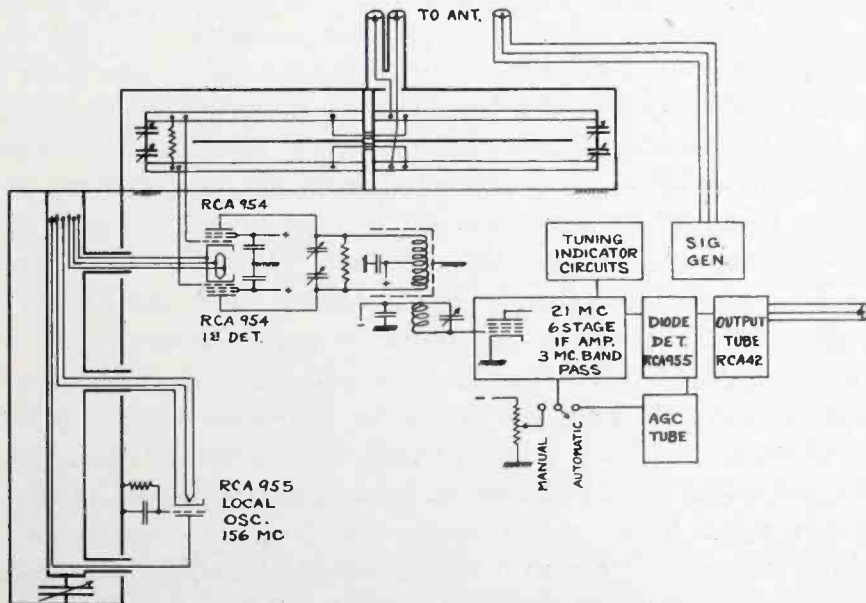

Fig. 8—Receiver schematic diagram.

Fig. 7 on Page 38 is a photograph of the front of the receiving rack as installed in the Empire State Building.

Fig. 8 shows a schematic diagram of the receiver circuits. A balanced concentric line type band-pass transformer, receives 177 Mc energy from the balanced coaxial feed line. The transformer in turn feeds a balanced heterodyne detector consisting of two RCA 954 acorn tubes whose cathodes are excited by a concentric line type of local oscillator operating at 156 Mc. The intermediate frequency of 21 Mc appears push-pull in the output of the balanced detector stage and is coupled to a single ended 6-stage, band-pass amplifier using coupled

circuit transformers. The overall flat band width is 3 Mc. The i-f amplifier is fed to a linear diode rectifier (RCA 955), which in turn feeds the RCA 42 output tube. Video frequencies are carried from the receiver over a coaxial cable to the transmitter line amplifier.

Automatic gain control of the i-f amplifier is accomplished by means of a d-c amplifier driven from a voltage divider across the diode load resistance. This circuit is arranged to feed variable negative control voltages to two tubes in the i-f amplifier. A switch is provided to allow the gain to be controlled manually.

A set of switches on the front panel allows the plate currents of the i-f amplifier tubes to be checked on one meter without interrupting the operation of the receiver. The other plate currents with the exception of the automatic gain control tube are shown continuously on individual meters.

Due to the extreme width of the i-f amplifier it is necessary to provide an indicator to show when the signal carrier is tuned to mid-band. This indicator allows the operator to easily find the correct setting of the local oscillator. A 0-1.5 ma. meter on the front panel shows the plate current of a biased triode detector, which is excited by a high C resonant circuit having fairly high Q. This resonant circuit is driven by an r-f pentode fed from the i-f amplifier. A push button is arranged to connect a small fixed capacity across part of the resonating inductor, and the resonant frequencies with the push button out and in are set to be equally spaced about the i-f mid-band. With such an arrangement the tuning indicator meter (0-1.5 ma) in the plate circuit of the biased detector will show no change with the push button out or in when the carrier is accurately tuned to mid-band.

A separate regulated power supply having an effective internal resistance of less than one ohm is used to supply power to the RCA 42 output tube. Thus, objectionable low frequency resonance often occurring in ordinary power filters is eliminated which permits a flat frequency response to be obtained down to 10 cycles or less with the output tube working into a load resistance of only 100 ohms.

In a receiver of this sort having a tuned band-pass input transformer at signal frequency, the problem of properly tuning these two circuits presents itself. The correct tuning to give a flat band pass is not necessarily that obtained by setting each dial for maximum response in the usual way. This problem is overcome by supplying in the receiver rack a shielded oscillator to supply energy over a single coaxial cable to a point on the antenna reflector. The cable termination near the antenna includes a damping resistance, a small radiating rod, and a shunt inductance all combining to produce a correct terminating impedance over the band of frequencies used. With this arrange-

ment the operator can vary the oscillator frequency over the receiver pass band and observe the shape of the (antenna—feed line—receiver) characteristic on the output of the receiver. With a few trials the correct tuning of the input transformer can be obtained. These adjustments may be made when the 177 Mc television transmitter is off the air. These circuits once set require little attention thereafter.

RESULTS OF TESTS

As might be expected a signal of considerable intensity is received at the Empire State Building. Calculation shows that the transmitter power and antenna directivity used should result in a direct ray field strength of approximately 30 millivolts per meter at the receiving antenna. A strong signal is necessary to override local disturbing noises from elevator machinery, etc., which become more bothersome the wider the receiver band width. It might be mentioned that lightning flashes in the immediate vicinity give only moderate clicks in the receiver output.

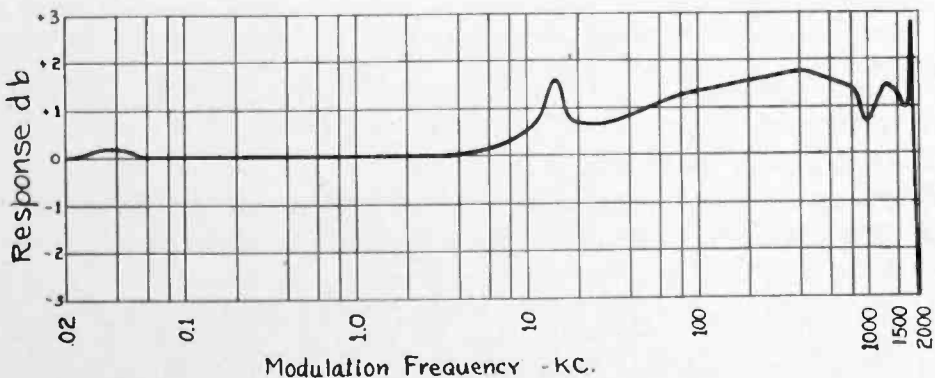

Fig. 9—Overall frequency characteristic of the radio relay.

Signal strength observations made so far show variations in intensity of only a few per cent, showing that variations in rays reflected from the ground are unimportant.

Overall frequency characteristic measurements have been made from the transmitter input to the receiver output over a range of from 20 cycles to 2000 kc. Fig. 9 shows the result of these tests. The irregularities in the curve from 100 to 1700 kc. are mostly caused by the propagation path as mentioned earlier. The peak at 1800 kc. is produced by an equalizing circuit in the receiver output. It will be observed that the maximum deviation over the desired band of 20 cycles to 1500 kc., is 1.8 db which occurs at 400 kc.

Signal to noise level measurements were made at the receiver using a measuring amplifier having an effective band width of 20 kc.

These measurements showed a signal to noise level of 44 db with 85 per cent. modulation at the transmitter. The noise level was almost entirely 60 and 120-cycle power supply hum.

Although the receiver is located near the high power television broadcast transmitters no trouble is experienced from interference. Pictures have been transmitted over this circuit without altering their quality.

ACKNOWLEDGMENT

The authors wish to acknowledge the cooperation and assistance given by the engineers of the National Broadcasting Company, and engineers of RCA Communications, Inc.

BIBLIOGRAPHY

- (1) P. S. Carter and G. S. Wickizer, "Ultra High Frequency Transmission Between the RCA Building and the Empire State Building in New York City," presented at the joint meeting of the International Radio Union and the Institute of Radio Engineers, at Washington, D. C., May 1, 1936; Proc. I.R.E., Vol. 24, pp. 1082-1094, August 1936; and published in TELEVISION, RCA Institutes Technical Press, July 1936.
- (2) Clarence W. Hansell and Philip S. Carter, "Frequency Control by Low Power Factor Line Circuits," Proc. I.R.E., Vol. 24, pp. 597-619, April 1936.
- (3) U. S. Patent No. 1,937,559.
- (4) F. E. Terman, "Resonant Line in Radio Circuits," Electrical Engineering, Vol. 53, pp. 1046-1061, July 1934.
- (5) U. S. Patents No. 1,334,118 and 1,560,332.
- (6) R. D. Kell, A. V. Bedford and M. A. Trainer, "An Experimental Television System," Proc. I.R.E., Vol. 23, pp. 1246-1265, November 1934.
- (7) Sterba and Feldman, "Transmission Lines for Short Wave Radio Systems," Proc. I.R.E., Vol. 20, pp. 1163-1202, July 1932.

HARBOR RADIO TELEPHONE SERVICE

By

I. F. BYRNES

Chief Engineer, Radiomarine Corporation of America

IN THE maritime mobile field, radio communication services have been available for a considerable number of years to medium and large classes of commercial vessels, yachts, and other types of deep water craft. However, in the case of harbor communication for hundreds of smaller vessels, such as tugboats, there has not been any extensive use of radio. Certain frequencies in the band between 2000 and 3000 kc have been available for some time for two-way harbor communication. For small vessels the expense of the installation and of message tolls has, so far, greatly restricted commercial application.

During the early part of the present year experiments were undertaken by Radiomarine Corporation of America to determine if an economical one-way system of handling messages to tugboats by radio telephone could be developed. New York Harbor and surrounding waters were selected as a logical area in which to carry out tests. It was decided to use wavelengths at the upper end of the so-called ultra short wave part of the spectrum, namely wavelengths around 10 meters. An experimental frequency of 27.1 megacycles (10.07 meters) was available. It was recognized that frequencies in this portion of the spectrum while having occasional very long distance ranges, are primarily useful for short distance work and that the same frequency assignments could be used in different harbors with relatively little interference with one another, compared to the conventional medium frequencies.

The transmitting station is located at 75 Varick Street, near the New York side of the Holland Tunnel. This building, which is 17 stories high, is fortunately located so as to be somewhat higher than any other building within a radius of several blocks. From the roof of this building it is possible to view Upper New York Bay, several miles along the Hudson and a small portion of the East River. The vertical antenna used is about 250 feet above the street level. This antenna consists of a 30-foot section of galvanized iron pipe arranged to permit the upper portion to function as a half wave vertical radiator. Below the half wave section a quarter wave impedance matching unit is provided consisting of a short vertical copper rod spaced

from the antenna proper. The lower end of the mast is grounded for lightning protection. The quarter wave section is used to match the antenna to a non-resonant two-wire transmission line which runs for a distance of approximately 150 feet to the radio transmitter.

A 100-watt transmitter of the type shown in Figure 1 is used. This is of the same design as transmitters employed for broadcast

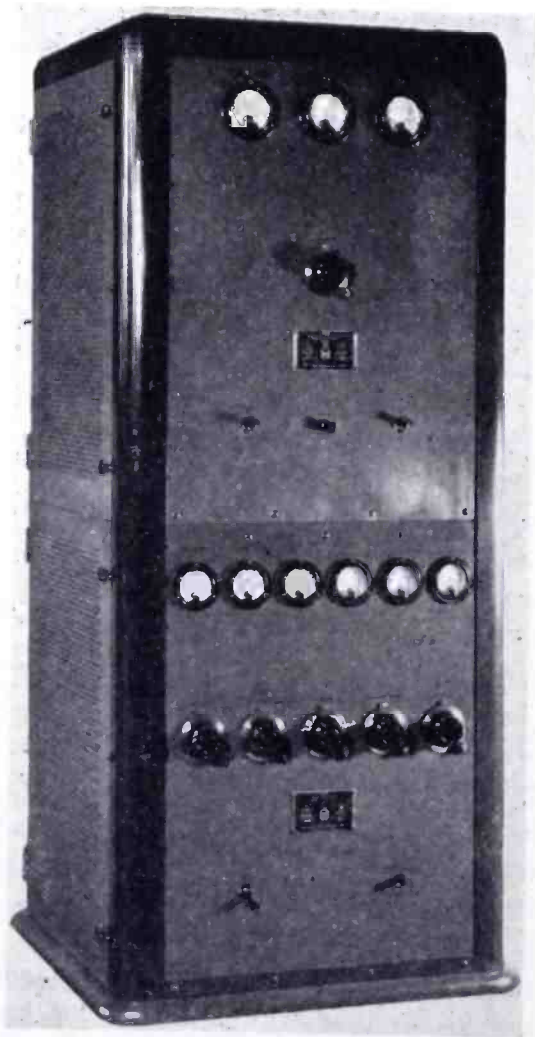

Fig. 1—100-watt telephone transmitter.

purposes in the 30 to 40-megacycle band and, with minor modifications was arranged for operation on 27.1 megacycles. The radio frequency circuit comprises a Type 10 crystal oscillator using a low temperature co-efficient crystal of 3387.5 kc. The crystal stage is followed by three doubler stages, the first two doublers using Type 10 tubes and the third doubler a Type 800 tube. After the crystal frequency has been multiplied eight times, it passes to a Type 800

tube, which in turn drives four Type 800 tubes in the final amplifier. The final amplifier is plate modulated as a class C device by means of transformer coupling from a pair of 203-A class B audio amplifiers. The 203-A's are in turn driven by two stages of class A amplifiers. The carrier may be completely modulated with an input level of minus 15 db. Suitable rectifiers are used in the transmitter for plate and bias supply so that the complete transmitter operates from a 110-volt, 60-cycle single phase source.



Fig. 2—Tugboat receiver installation.

In order to provide 24-hour service for the tests, remote control of the transmitter is arranged from the Radiomarine New York City Station (WNY) at 60 Hudson Street, where operators are on duty at all times for harbor radio telegraph traffic as well as for the telephone circuit.

The procedure in transmitting messages to the tugs is as follows. The dispatcher at the office of the tugboat company calls the operator at 60 Hudson Street, who takes down the message. The operator then starts up the transmitter and sends out a preliminary tone signal for about 10 seconds, which warns the tugboat captain that a message is about to be transmitted. The tone is then switched off and the message telephoned to the tug. As a check on the accuracy of the message and the speed with which it is handled, a monitoring re-

ceiver is used by the tugboat dispatcher so that he has constant supervision over his outgoing instructions. The time required to deliver the average message from the dispatcher's office to the tugboat is about two minutes.

The receiver installation as used on the tugboats is shown in Figure 2 and a view of one of the tugs is shown in Figure 3. A rubber mount for the receiver and dynamotor unit is fitted to a small shelf at the rear of the pilot house, with the loud speaker overhead so that sound is directed forward toward the wheelsman. Power supply for the receiver is obtained from a 6-volt 160-ampere hour storage battery, which is automatically charged from the tugboat 110-volt lighting circuit. Since the receivers are in continuous use for periods 12 to 15 hours per day, it is evident that suitable provision must be



Fig. 3—Tugboat Alice M. Moran.

made to keep the battery in good condition. The charging panel is, therefore, arranged to charge the battery at a rate of 30 per cent. greater than the discharge. This enables the tugboat dynamo to be shut down for periods of several hours for repairs or maintenance, without disabling the radio receiver.

A total of nine tubes are used in the receiver, which is of the superheterodyne type, being designed for fixed tuning and a carrier operated noise suppressor. A schematic diagram of the receiver cir-

uits is shown in Figure 4. By referring to the schematic diagram, it will be seen that the 6-B-7 tube performs the functions of I. F. amplifier, second detector, noise suppressor control and a.v.c. The D.C. procured from one diode is used to give automatic gain control of the r-f and i-f stages. Delayed a.v.c. action results from the presence of an initial negative bias on the a.v.c. diode plate. A 6-C-6 tube is used as the noise suppressor control. D.C. resulting from signal detection on the second diode is applied to the 6-C-6 noise suppressor control circuit. With no incoming carrier the grid of the first audio amplifier is biased negatively to cutoff. Nine tuned circuits are used in the receiver, of which seven are at the intermediate frequency of 2100 kc and two for the incoming signal frequency. A minimum number of controls are required on the receiver so that unskilled personnel may secure satisfactory performance. An on-off switch and an adjustment for volume are the only controls which must be handled by the tugboat captain.

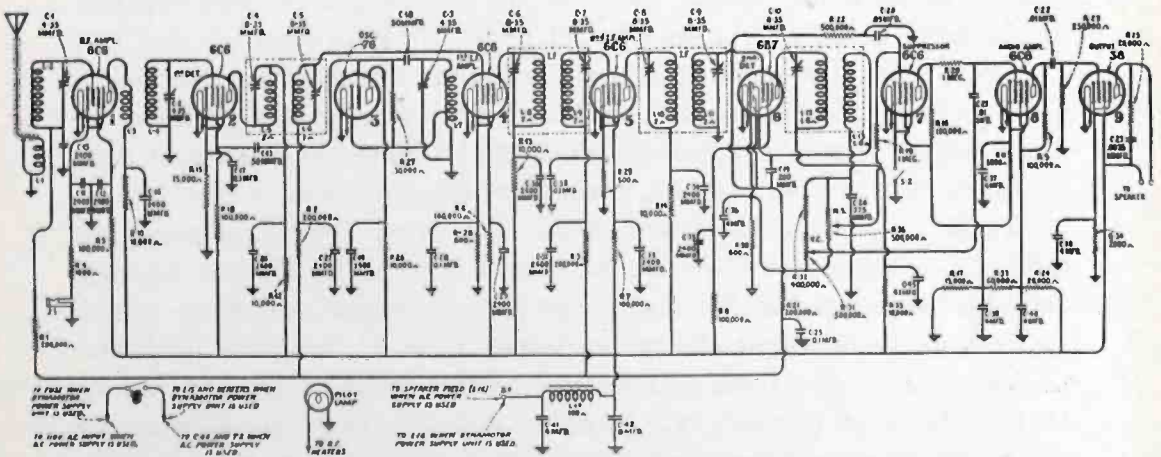

Fig. 4—Schematic circuit of receiver, used in the "Harbor Radio Telephone Service."

The automatic noise suppressor is of considerable utility in a service of this character. Without such a device there would be a continuous background of noise from the loud speaker and a tendency on the part of the personnel to regulate the volume so that calls might be lost. However, through the use of the noise suppressor circuit, the audio amplifier in the receiver is cut off except when the carrier wave from the transmitter is turned on for transmission of a message.

Plate power for the receiver is obtained from a 200-volt dynamotor which in turn takes its supply from the 6-volt storage battery. The battery drain is approximately 7 amperes.

The performance characteristics of the receiver are of interest. The relatively high intermediate frequency of 2100 kc that is used

permits some variation of the local oscillator in the receiver without causing detuning. The band width at ten times resonant input is 380 kc and at one hundred times resonant input approximately 500 kc. Sensitivity of the receiver is such that an input of 5 microvolts, 30 per cent. modulated will produce 50 milliwatts audio output with a negligible amount of receiver noise. The audio fidelity permits substantially uniform output from 200 to 3500 cycles. Experience has shown that when once tuned the receivers will deliver satisfactory performance over a period of several months under the various changes in temperature and humidity that are encountered in harbor service.

The tugboat installations have shown nearly 100 per cent. reception. The effect of the East River bridges was negligible, consisting usually of interference from electric trains running overhead, which is limited to the period when the tug is passing directly underneath the bridges. Strong signals are obtained even when a tug pulls alongside a large ocean going vessel, where it might be expected that the hull of the large vessel would tend to act as a shield between the tug and the transmitting station. Strong signals are received as far North as City Island, in the waters around Staten Island and in the area around lower Manhattan, where many tall buildings in downtown New York are between the tug and the transmitting station.

Three tugboat installations have been used for experiments to date. These tugs are the *Alice M. Moran*, the *E. F. Moran, Jr.*, and the tug *Ideal*. During the first three months a total of 230 test messages were transmitted. These messages were in the form of actual instructions to the tugs so that a practical analysis could be made of the utility of the service. In many cases it was learned that the radio circuit was of considerable value in changing the instructions to a tug or in diverting its course after it had left the pier. Without radio it is necessary for the tugboat captain upon the completion of one job to pull up to a pier and phone his office for additional instructions. Further advantage of the radio equipment is in connection with the use of tugs in docking large ocean going vessels. By means of radio the tugboat dispatcher may keep his tugs accurately informed when a vessel passes Sandy Hook or leaves Quarantine so that the tugboats may be at the pier in time to assist in docking.

AN ELECTROMAGNETIC METAL DETECTOR

By

DAVID G. C. LUCK and CHARLES J. YOUNG

(RCA Manufacturing Co., Inc., Camden, New Jersey)

THE development of the detector described in this article originated with a request for a method of inspecting prisoners and prison visitors for concealed weapons, especially guns. The resulting study of the general problem of detecting metallic bodies within a specified region culminated in the design of a commercial Gun Detector. This apparatus is now installed in a number of prisons and is proving very useful. An analysis of the means for solving the problem will be given first, followed by a description of the actual unit.

The properties which are common to most metals, and on which a detecting device might be based, are high density, electrical conductivity and, in many metal objects, high magnetic permeability. The most obvious method of discovering such objects would depend on their high density and would be an X-ray tube and fluorescent screen. Such a system is expensive and delicate and its continued use for detecting objects carried by persons might involve some danger to those inspected. Devices indicating metallic objects by disturbance of an electric field (capacitance change) are subject to spurious effects from any large mass of dielectric material accompanying the metal. A steady magnetic field is disturbed by a piece of ferromagnetic material, but the magnetometer necessary to detect such a disturbance is a delicate instrument. Obviously, therefore, no one of these three detection systems is particularly satisfactory.

A conducting object placed in an alternating magnetic field decreases the energy stored in the field and results in energy dissipation; that is, the inductance of a coil producing an alternating magnetic field is reduced and its resistance is increased by the presence of a conducting object. A ferromagnetic object, on the other hand, increases the energy in the field and so increases the inductance as well as the resistance of the field-producing coil. The effect of a non-magnetic object, which is a result of eddy currents induced in the object, increases rapidly with increasing frequency, so that a high frequency field should be used for the detection of such bodies. The inductive effect caused by the permeability of a ferromagnetic object

is opposed by the effect of its conductivity and does not depend on frequency, so that a low frequency field is desirable for the detection of magnetic bodies.

Change of inductance of a coil producing a magnetic field in a region to be searched for metallic bodies may be shown by the resulting change in frequency of a self-excited oscillator driving the coil, or by the unbalance of a bridge circuit. An oscillator is a complicated dynamical system and is inherently unstable, though care in design may do much to counteract this disadvantage; the bridge, on the other hand, is a passive network of high inherent stability. As either method of detection may be so refined as to have very high sensitivity, the bridge, being the more stable, is the more desirable. The bridge

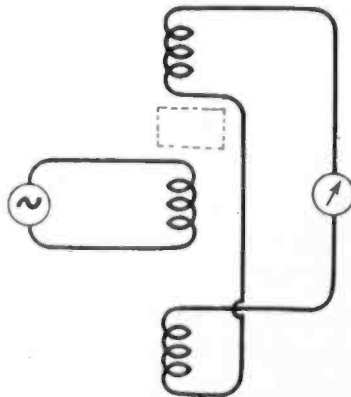

Fig. 1—Fundamental circuit of induction balance.

has the further advantage of being sensitive to resistance changes as well as inductance changes. The change in self-inductance of a coil when metal is brought near it is a measure of the change in total field energy; if a region about the size of a man is to be searched for small objects, the fractional change in total field energy to be detected is extremely small.

A second coil immersed in the magnetic search field will be coupled to the exciting coil to a degree depending not only on the total field energy but also, very markedly, on the distribution of the magnetic flux; thus, a metallic object, altering slightly the direction of the magnetic flux lines, can produce a much greater fractional change in the mutual inductance between two coils than in the self-inductance of either of them. Because mutual inductance can be negative, the usual four-element bridge network can, in this case, be reduced to a two-element form known as an "induction balance". Use of an induction balance for metal detection is quite old¹, but the devices used do not seem to have been highly developed. Application of modern

¹ C. Gutton, *Comptes Rendus*, 161, 71 (1915).

methods and equipment to the induction balance principle seems to the authors to provide the best general solution of the metal detection problem.

The fundamental induction balance circuit is shown in its simplest form in Figure 1. Here, an alternator feeds a single primary or driver coil which fills the region to be explored with a magnetic field of moderately uniform intensity. On the opposite side of the protected region, indicated by the dotted rectangle, from the primary coil is placed a secondary or pickup coil. This coil is connected in series with a similar pickup coil of opposite polarity, occupying a symmetrical position in the primary field, and with an indicating instrument. Placing driver and pickup coils on opposite sides of the protected region is rather an innovation in metal detection and increases the sensitivity markedly over that obtained with older devices having the entire coil system off at one side of the region of interest. If all three coils were coincident, obviously no differential change in the two mutual inductances could be produced by introduction of metal into the field; similarly, little differential change could occur with very widely separated coils. The maximum effect may be expected for separations comparable to the dimensions of the coils, which fact helps to determine the coil dimensions required for different applications.

It is not surprising to find that the effect of a magnetic object is determined largely by its extension in the direction of the magnetic field, and that of a non-magnetic object primarily by its area transverse to the field. Therefore, to insure detection of an object in any position, it is necessary to pass it through the protected region in such a way as to cause encounter with field components in every direction. This is illustrated by Figure 2, which shows the magnetic field pattern in a plane section through the common axis of the three coils; the round black spots represent the intersection of the coil windings with the plane of section, and the small black rectangles are sections of metallic objects placed in the field. A magnetic object in position 2 gives a relatively large unbalance, while the same object in position 3 has very little effect; thus, an object carried in position 3 along the axis of the coil system might pass through the apparatus undetected. On the other hand, an object in position 1 has little effect, but if carried without turning in the direction of the arrow, a considerable unbalance will occur when position 2 is reached; likewise, the object shown at 3 will produce unbalance when such a position as 4 is reached. It is thus possible to insure detection of an object pointing in any direction in the plane of the figure by carrying it through the coil system in the direction of the arrow. The housing indicated by the

light lines in Figure 2 serves a threefold purpose: it prevents mechanical disturbance of the coils themselves, it keeps foreign objects out of the region between the primary coil and the compensating secondary coil, and it forces material undergoing inspection to be carried through the apparatus in the proper direction.

The large coils needed to give reasonably uniform sensitivity over a region the size of a man are quite expensive, so it may appear strange that some small scale mutual impedance is not substituted for the third coil, which besides its cost is very wasteful of space. The

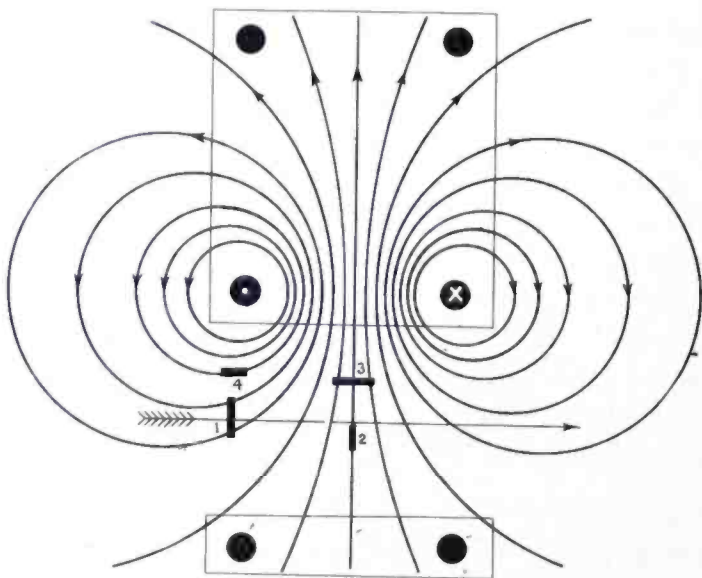

Fig. 2—Field distribution in coil system.

main reason is that in most places considerable stray magnetic fields are present to interfere with operation of the device and that the use of two similar coils connected in opposition cancels out the effect of the spatially uniform portion of such stray fields and so greatly reduces the interference level. A further reason is that the high electrical and mechanical symmetry of the system shown results in a considerable stability of balance with respect to such disturbing events as electrical surges, temperature changes and so forth.

The requirement that the unbalance signal output from the pickup coils resulting from the presence of some definite small metal object in the protected region shall always exceed the interference output can only be met by the provision of a sufficiently strong primary field. In particular, at small field strengths the permeability of many ferromagnetic materials increases linearly with the field strength, so that the signal output resulting from a magnetic body in the field increases approximately as the square of the primary field, as shown by some recent experiments made by Mr. R. D. Serrell. Now, for a given

size of protected region, the square of the field strength is proportional to the reactive power stored by the primary coil, so that for any given protected region and interference level, the useful sensitivity can only be increased by increasing the volt-ampere-reactive rating of the driver coil. The requirement of large reactive power immediately suggests the desirability of using the 60-cycle supply as a power source and resonating the driver coil to prevent a large reactive load on the supply line.

It will be of interest now to proceed from this analysis of the problem to a picture of the form in which the apparatus is actually built. Figure 3 shows one form of mounting for the three coils or loops. Three heavy plywood panels support the loop frames and protect them from accidental physical contacts as the suspect moves through the passage between the central power loop and the near pickup loop. Such protection is essential as a very slight distortion of the coils will cause an unbalance and a consequent false alarm. The opening on the other side of the driver coil is normally closed, the panel being removed here to show the rear pickup coil. In order to obtain a normal sized doorway the coils are $6\frac{1}{2}$ feet high, 3 feet wide and are mounted on 3 foot centers.

The structure of the coils is shown in Figure 4, which represents a distinct improvement over the earlier model of the preceding figure. The form in which the winding is placed is a rounded rectangle made of aluminum channel. It is simple to manufacture, and because of the curved sides the wire is easily wound and stays tight in the form. The same form is used with different windings for the power coil and for the pickup coils.

The winding specification for the power coil is determined, as would be expected, by a proper compromise between manufacturing and operating costs. As has been pointed out, the reactive power storage required in the driver coil depends on the interference from stray fields. It was found that 1200 ampere turns were sufficient to permit the reliable detection of small revolvers under normal interference conditions. For a coil size of $6\frac{1}{2}$ feet by 3 feet, 1200 a.t. corresponds to a reactive power of about 2 kilovars. It is apparent that this value of ampere turns can be obtained either with a coil of small winding section and consequent low manufacturing costs and high operating costs, or with a coil of large section having high first cost and low operating cost. The lower limit of the coil winding section depends on the permissible heat dissipation and the upper limit is determined largely by the physical size and the manufacturing cost. Temperature runs with a power coil mounted in a typical

enclosed structure indicated that 650 watts was about the maximum practicable input. Good ventilation cannot always be insured and the surrounding structure may be of wood. It is interesting to note that the temperature rise is materially reduced by providing a rough black lacquer surface.

The number of turns for the power coil depends on the way it is supplied from the 110-volt line. If simply connected across the line

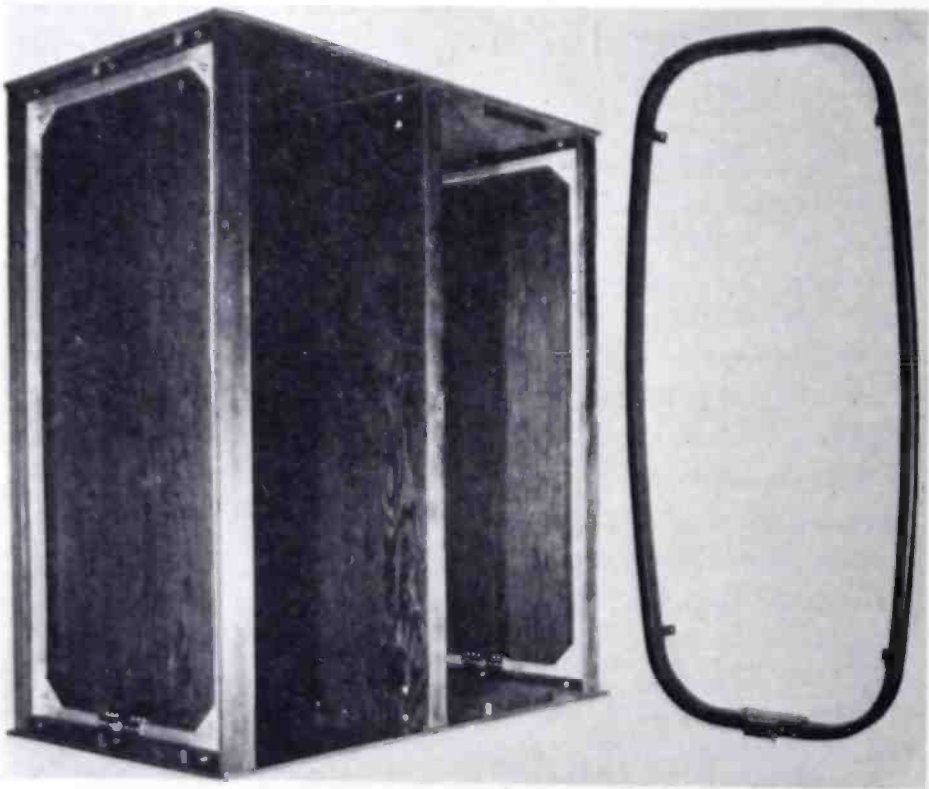

Figs. 3, 4—Gun Detector housing with pick-up loops, and view of oval loop design.

it will be found that an excessive reactive current is required through relatively few turns. Parallel tuning to correct the power factor would require several hundred microfarads of low voltage capacitors, an uneconomical form of energy storage. Consequently, at this supply voltage, series tuning of the power coil circuit is the only satisfactory solution.

If the maximum permissible watts dissipation is taken as 650 and the maximum line voltage as 120, the resonant current in the series tuned circuit is fixed at $5\frac{1}{2}$ amperes. Thus at least 240 turns are needed on the coil to provide 1200-ampere turns at normal supply voltage. The actual number of turns was increased to 275, at which point the condenser voltage reached the maximum allowable for the chosen type. The current in the coil was limited to the desired value

by correct choice of wire size. Consideration was also given to controlling the current by a certain amount of detuning of the circuit. This was found undesirable because variations of capacity within the commercial tolerances caused marked phase change of the current and made balancing difficult.

The requirements of the pickup coils are less exacting. The amount of power is extremely small, and the voltages across the coil and between the coil and frame are less than a hundred volts. The only requirements are that the impedance of the two coils match the input impedance of the amplifier unit, and that the losses be kept as low as is economically feasible. Experience shows that tuning to 60 cycles greatly reduces interference from stray fields at other frequencies.

The amplifier and indicator unit for use with the loop structure already described is shown in Figure 5. Four tubes and a three-inch cathode ray tube are employed. The parts are chosen for reliability and long life as such an equipment may be operated many hours a day. In the schematic diagram of Figure 6 the active parts of the circuit are generally shown in heavier lines than the associated power supply network.

In the upper left corner of the diagram are indicated the pickup loops and power loop. In practice there is always some residual unbalance in this system, even when undisturbed. As some part of the unbalance will usually be due to stray fixed metal in the field, a resistive unbalance may be expected; this component can be nullified by adjusting the losses in one or both secondary coils by rheostats connected in parallel with the coils. The obvious means of compensating inductive unbalance is a mechanical adjustment of coil position; it is, however, possible to use an adjustable capacitor shunted across one coil to accomplish the desired result. The use of adjustable shunt capacitors and resistors permits balancing to be done in the amplifier at a position remote from the actual coil installation. The need of large variable capacitors can be eliminated by the use of a fixed capacitor in series with an adjustable resistance. In the actual amplifier the rheostats are replaced with potentiometers. It will be seen in the diagram that the common connection of the pickup coils is grounded and that they are balanced to ground in the control network, on the left leg for resistance, and on the right for reactance. By dividing each potentiometer a coarse and fine control is provided, which is essential if all installation variations are to be compensated without loss of the refinement of adjustment required for operation at high sensitivity.

Naturally, amplification is required in order to operate an alarm from the minute unbalance voltages which are available. Both to sup-

press off-frequency interference and to minimize the number of amplifier stages required, the secondary coil system, the matching transformer coupling it to the amplifier, and the amplifier itself are all tuned to the operating frequency. A voltage gain of about 85,000 is thus obtained, from the signal induced in the secondary coils to the output of a single stage amplifier. For purposes of coarse adjustment and of operating at reduced sensitivity a potentiometer gain

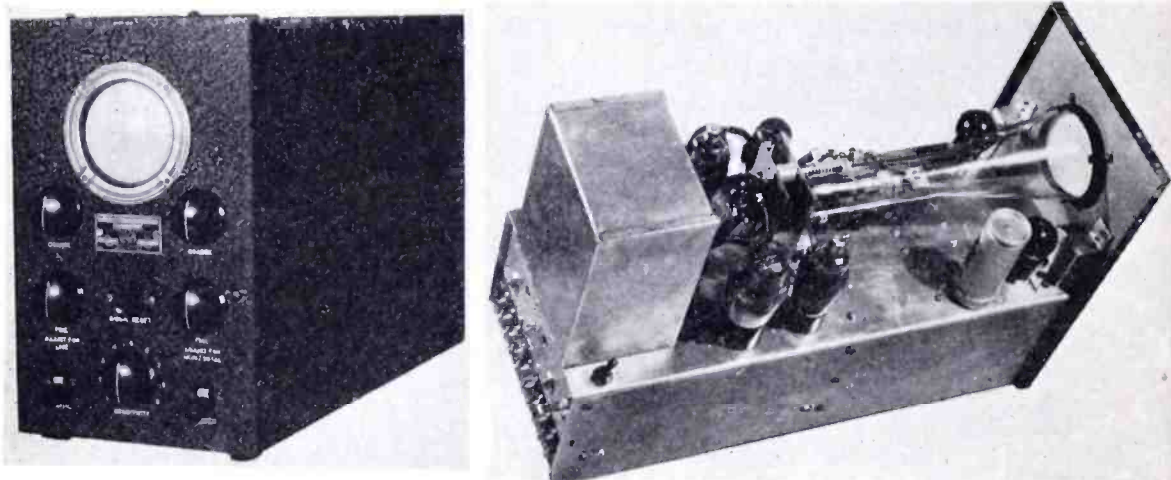

Fig. 5—Panel and chassis views of the new design Gun Detector Amplifier.

control is placed on the amplifier tube grid. The amplifier output operates a small thyratron used as a power relay. Thyratron operation from the steady plate voltage source results in a locking-in alarm requiring acknowledgment from the operator by manipulation of the signal reset button, which breaks the plate supply and permits deionization of the tube. In series with the plate circuit is a relay which indicates that the balance has been upset, by lighting two red lamps placed next to the cathode ray tube. These turn the tube screen a bright red, and at the same time the magnetic field from the relay deflects the cathode beam off the screen. This type of signal is much more effective than a separate alarm lamp as the screen is the center of the operator's attention during adjustment and operation.

To permit maintenance of balance and to indicate the presence of small metal objects for which no alarm is desired, some type of continuous indication of degree of unbalance is necessary. Furthermore, operation of the device by technically unskilled personnel requires a type of indicator which will permit the balancing operation to be almost intuitive: that is, simultaneous indication of the direction and amount of the adjustment needed by each of the two balance controls must be given. Indication of the sense of unbalance and sep-

aration of the resistive and reactive components requires reference to driving voltage phase. In the past simultaneous indication would have required two instruments, but now a satisfactory solution of the indicator problem is found in the cathode ray oscillograph with grid control. If the driving voltage is applied to the horizontal deflecting plates of the oscillograph tube and the unbalance voltage to the vertical deflecting plates, the figure generally appearing on the screen is an ellipse. The tilt of the ellipse axis from the horizontal indicates the magnitude of the unbalance voltage component in phase with the driving voltage, while the vertical spread of the ellipse about its center indicates that component in phase quadrature with the driving voltage. The direction of tilt indicates the direction of the cophased unbalance. Furthermore, by supplying the oscillograph control grid with voltage in phase quadrature with the horizontal deflection, one side of the elliptical pattern becomes brighter than the other, and so gives the ellipse a distinctly three dimensional appearance. The direction of the quadrature unbalance is then shown by the tipping of the ellipse backward or forward in its apparent perspective.

With all tuning elements suitably adjusted, motion of the resistive balance control will collapse the ellipse to a straight line, while motion of the reactive balance control will tilt this line to a horizontal position, corresponding to a condition of complete balance. The fully phase-sensitive cathode ray balance indicator here described is exceptionally convenient for use with any type of impedance bridge or alternating potential comparator, having as sole disadvantage a lack of inherent discrimination against obscuring of the balance point by harmonic unbalance voltages.

In the circuit of the amplifier as shown in the schematic diagram the vertical deflection plates are excited through a coupling condenser from the amplifier unbalance voltage appearing on the grid of the relay tube. The voltage for the horizontal deflecting plates is obtained from a resistance divider supplied from the power transformer through a blocking condenser. Thus this excitation is in phase with the field of the driver coil. From the same source the control grid, in parallel with a resistor, is fed through a small capacitor, giving a grid voltage in quadrature with the field.

The remainder of the diagram is conventional except for two details of interest. The first is the use of a voltage limiting glow tube permanently connected across the secondary of the input transformer. The need of this was discovered when a small iron truck passed the loop structure, generated an unbalance of 50 volts, and broke down the transformer secondary and tuning condenser. The second feature is the grid bias network on the amplifier tube. This eliminated the

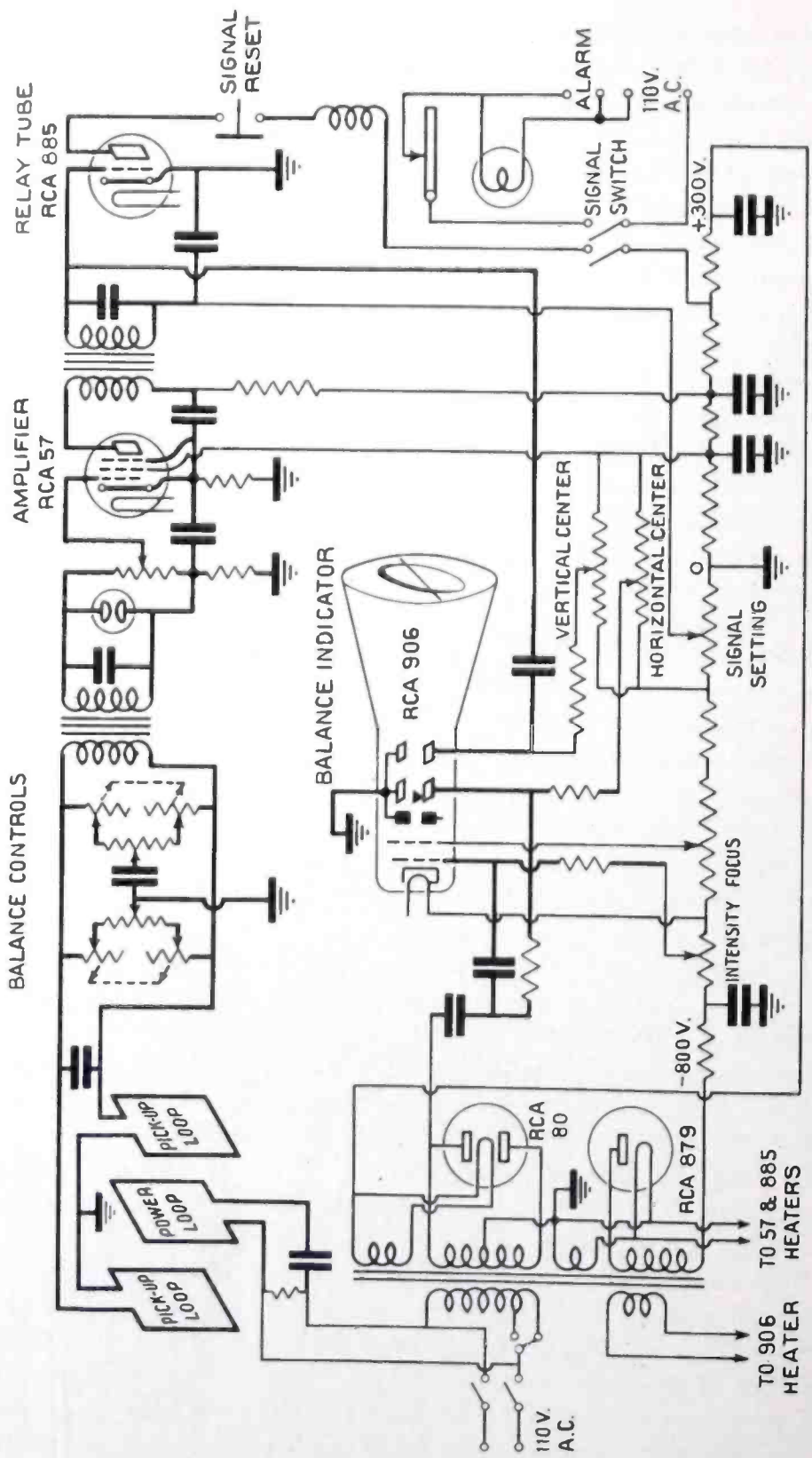

Fig. 6—Schematic circuit diagram of the electromagnetic metal detector.

need of the usual cathode resistor by-pass condenser, which becomes very large for 60-cycle amplification. Four potentiometer controls are shown which adjust voltages on the cathode ray tube to center the pattern on the screen, and to set focus and intensity of the spot. The signal setting control is adjusted so that the relay tube will trigger when the pattern on the screen spreads to a height of about $\frac{1}{2}$ inch. This permits readjustment for drifts in the balance with temperature, line voltage and so on, without setting off the alarm. All of these potentiometer adjustments are at the rear of the chassis.

Because of the high degree of electrical symmetry in the device, changes of line voltage have relatively little effect. Slow changes of 15 per cent. are hardly noticeable, while even sudden changes of 30 per cent. affect the balance only moderately. The most serious effect of frequency changes is to produce interlocking of the balance controls because of phase shift in the various resonant circuits.

It is interesting to note the very great sensitivity which can be obtained from this detector when low interference levels permit the use of full gain. For example, an oscillograph pattern $\frac{1}{8}$ inch wide, corresponding to a deflecting voltage of about 2.6 volts r.m.s. or an induced secondary voltage of 30 microvolts is easily observable. Such an induced voltage results at a frequency of 60 cycles per second with the 300-turn coils used, from a difference in flux linking the two pickup coils of 0.027 maxwell r.m.s.; the primary coil of 275 turns carrying 5 amperes produces a flux of about 560,000 maxwells r.m.s. An unbalance of one part in twenty millions is thus easily observable. At such sensitivities masses as small as shoe nails in the protected region begin to be indicated while such objects as a small gun or a set of brass knuckles give a tremendous effect. This, however, is an exceptional condition.

In the normal installation the device is adjusted to give the alarm on the smallest types of guns. Unfortunately, this same sensitivity will also detect such bodies as tobacco tins, spectacle cases, trusses and, in particular, steel arch supports which many people unknowingly wear in their shoes. This fact limits the major usefulness of the device to conditions under which the cause of each alarm can be investigated and some embarrassment to innocent persons is not a disadvantage. That is, such a device as this is useful for prevention of arms smuggling into penal institutions or of metal pilfering from industrial plants, as well as for detection of foreign metal in packaged goods such as foodstuffs or textiles; but it is of little use for purposes like protection of commercial banks or stores from armed robbery.

BROADCAST STUDIO DESIGN

R. M. MORRIS AND G. M. NIXON

National Broadcasting Company

This paper was presented before the May, 1936 Convention of the Acoustical Society of America in Chicago, and has been re-written for the RCA Review.

DURING the past ten years there have been many technical improvements in radio broadcasting. Frequency range and harmonic distortion of amplifiers have been improved. The power and service areas of radio transmitters have been greatly increased. Microphones and loudspeakers having many improvements have been developed. In keeping with this progress, the design of the point of program origin, the broadcast studio, has of necessity been materially advanced. It is now possible to state rather definitely what acoustical conditions are required for a studio to be satisfactory under a wide variety of circumstances. It is further possible, by proper specification and use of acoustical and structural materials, to obtain these conditions in practice with acceptable precision.

Most of the criteria recommended herein have been established as the result of acceptance in network service under the most critical of circumstances. Wherever possible, however, it has been attempted to rationalize observations based on musical taste with contemporary theory. The relation between frequency and optimum reverberation time which has been found desirable for broadcast studios was originally obtained by correlation of reverberation time characteristics of studios regarded as having good acoustics. The results were found to approximate the curve advanced by McNair† as a result of theoretical analysis.

A person faced with the problem of designing and specifying the construction of broadcast studios may be in any of several positions. He may have to add a single studio to an existing plant. He may, because of obsolescence, be required to devise new and improved treatment for studios to be otherwise unchanged. He may in rare instances have the problem of designing a complete studio plant in either an existing building or one to be erected for the purpose.

† The Journal of the Acoustical Society, January, 1930, Vol. I, No. 2, Page 242.

It may be well, therefore, to consider briefly factors limited to the general design of multiple studio layouts and to elaborate on fundamental design features applicable to any studio.

The choice of location for a studio group is usually not wholly the prerogative of the engineer. It is, however, necessary that certain fundamental requirements be met if satisfactory service is to be rendered. A building must have widely spaced columns to accommodate moderate-sized studios. The space between floors must be adequate to accommodate overhead air-conditioning ductwork and still provide necessary



Fig. 1—Speakers studio.

studio ceiling height. An investigation should be conducted as to the type of business of other occupants of the building, from the standpoint of noise. A building, for example, housing large printing presses or machinery, may at first appear desirable, but be found uneconomical because of the necessity of additional sound isolation. Studios are usually best situated within the "entertainment center" of a city and near the business area, thus affording accessibility for artists, clients, and general public.

The number of studios provided must accommodate rehearsals to the extent of six times the broadcast period. A recent investigation of studio usage in the NBC revealed a ratio of rehearsal to program time for sustaining programs of 4.3 to 1 and for commercial programs

of 10 to 1. The average for overall operation was 6.3 to 1. For a continuous program transmission therefore, eight studios are desirable. This number is reduced, of course, if some program material is obtained by network or transcription.

Broadcast programs vary over wide limits both as to type of program and number of artists involved. In some cases, no one is permitted in the studio other than those concerned in the broadcast, in others, a large audience is invited. The answer to the problem is the provision of studios, suitably graduated in size and corresponding



Fig. 2—General purpose studio.

acoustical condition, to accommodate anticipated loading to the best advantage. Studios usually fall into one of three general classifications. The smallest of the three, the speakers' or living room studio, Figure 1, ranges in size from 2000 to 4000 cubic feet (floor area 230 to 420 square feet). The most common type, the general purpose studio, varies in volume from approximately 4000 to 40,000 cubic feet (floor area 420 to 1800 square feet), Figure 2. The auditorium studio, built specifically to accommodate an audience, is the largest of the three types and has no well-defined limits. The largest of this type at present has a volume of 320,000 cubic feet (floor area 10,000 square feet), Figure 3.

Figure 4 shows a relation between studio volume and optimum

number of artists determined originally from actual data on studio usage and justified since by results in studios built in accordance with it.

There is also shown a curve indicating maximum number of persons which the studio will accommodate if an audience is to be permitted. This is determined by available seating space, floor loading, and air-conditioning. Curves showing recommended dimensions as a function of volume are also given.

The admission of large audiences to studio programs with the consequent introduction of considerable absorption, is not as undesirable

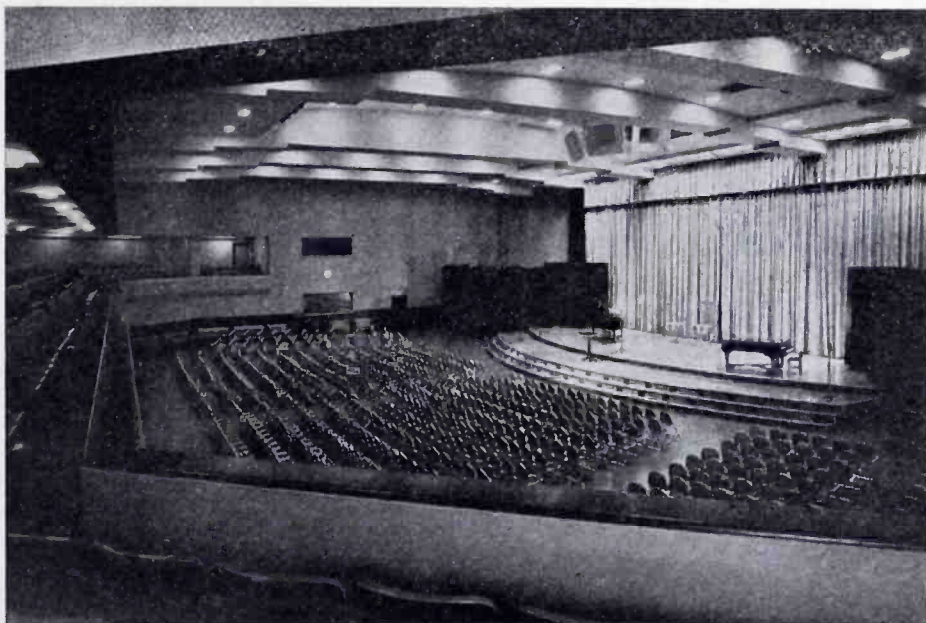

Fig. 3—Auditorium studio.

from the acoustical standpoint as might at first appear. For example, a studio of 20,000 cubic feet (reverberation time empty, at 1000 cycles, of 0.7 seconds) will, with a 20-piece orchestra set up in accordance with normal practice, have a reverberation time of 0.66 seconds at 1000 cycles. If it is desired to permit an audience of 200 to witness the performance, the program is of necessity shifted to a larger studio of say 70,000 cubic feet and a time empty of 0.9 seconds. However, the reverberation time of the larger studio, when occupied by the 220 people is reduced to 0.64 seconds. The effective reverberation time for the performing group is therefore essentially the same in both cases.

Broadcast operating technique requires the provision of space for control booths so located that the studio engineer has an unobstructed view of the studio. The control booth floor should therefore be 9" to

18" higher than the studio floor level. The control booth should be provided with a window of sufficient width and height to permit vision while the engineer is seated or standing. Additional space is required for the main control room in which technical supervision of program transmission is exercised; also space for necessary technical equipment arranged for convenient maintenance.

In the larger studio groups, as the third and fourth floors of the NBC Studio Section, Radio City, N. Y., separate spaces are of necessity provided for these functions. There are three functional

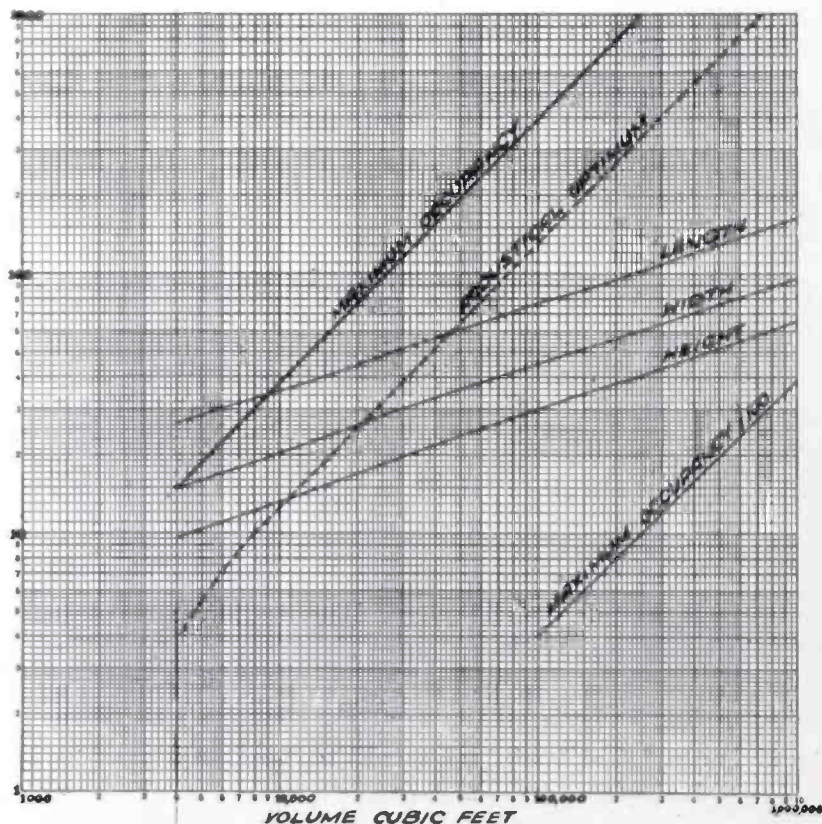

Fig. 4—Relation of studio capacity, dimensions and volume.

spaces associated with each of these two-story studios. The control booth is located on the same floor and immediately adjacent to the studio, enabling the engineer to change readily the microphone location, arrangement of artists, or perform any of his regularly assigned duties involving the studio. The public observation and clients' booth suitably furnished, equipped with monitoring loud speaker, and provided with double windows are located on the next higher building floor.

Separate corridors, elevators, and stairways are provided for the operating staff and for the general public or artists, so arranged that

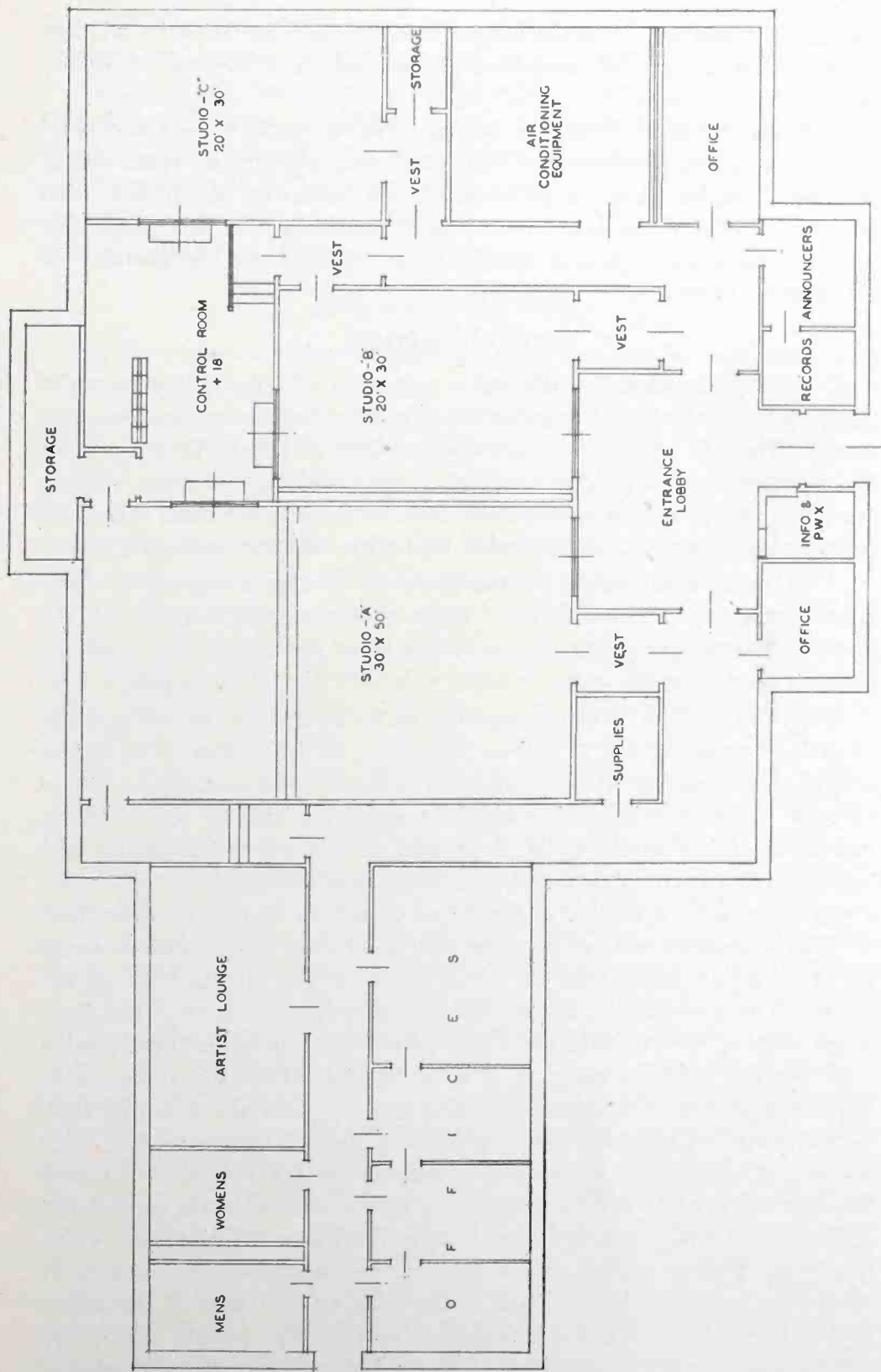

Fig. 5—Floor plan typical three-studio group.

the studios and appurtenant spaces are readily accessible to all concerned without mutual interference because of crowding or cross-traffic.

The smaller station may be forced to affect compromises and combine these three requirements into one room. It will be observed in Figure 5, which shows a satisfactory arrangement of studios with common control room, that one of the compromises in this particular plan is inadequate vision of Studio C as viewed from the position of the control operator.

SOUND ISOLATION

It is obvious that simultaneous operation of all studios must be possible without mutual interference or disturbance from extraneous noises. The use of corridors between studios will materially assist in the attainment of the high degree of sound isolation necessary. Where studios must be adjacent, separate structural walls for each should be erected, thereby providing a double wall with an intervening air space.

Partitions constructed of materials of cinder composition have been found more desirable than those of terra-cotta because of the increased attenuation for an equivalent mass per square foot and the absence of any pronounced resonance within the audible range.

Isolation of this form is generally satisfactory for the attenuation of airborne sounds, but is rather ineffective in the reduction of noises due to structural vibration or impact. Efficient and economical reduction of these "mechanical noises" is accomplished by the resilient mounting of the studio walls, floor, and ceiling. Sound isolating systems utilizing springs, felt, and other materials for achieving this effect are commercially available and will not therefore be further described.

Efficient sound control must be exercised over all potential sources of noise which may affect or disturb the proper functioning of the studio. The air conditioning or ventilating system because of the ductwork opening directly into the studio constitute a possible transmission path for fan noise or noise from other spaces where the studio ductwork is common to other spaces. The use of sound absorbers of sufficient length, of efficient sound absorbing material such as felt, rock wool, etc., properly placed greatly attenuate the transmission of sound. The ductwork while within the confines of the studio should be wrapped with felt, rock wool blanket, etc., to effectively dampen vibration which might be transmitted along its length. Canvas collars are necessary where the ductwork is connected to the floating structure of the studio and to the inlet and discharge sides of the fan. The supply and return outlets used should be designed to avoid the creation of turbulence in the air stream and the consequent generation of noise. The use of

low velocities below 1200 f.p.m. in the ductwork and below 400 f.p.m. through the outlets will aid materially in avoiding turbulent noises.

Rotating and reciprocating machinery located near the studio must be isolated by means of rubber, springs, or similar material to prevent the transfer of vibration to the building structure.

Electrical wiring to outlet boxes mounted on the studio structure should be "run" through Greenfield or similar flexible armor to maintain the efficiency of the isolating system.

REVERBERATION PERIOD

Of those factors which determine whether a studio is satisfactory, none is more important, perhaps, than the reverberation time. Several factors combine to determine the most desirable or optimum reverberation time. Besides volume and frequency, which of course are the most important, there is the type and tempo of music to be rendered and the variety of microphones employed. The directional properties of various microphones affect the ratio of direct to reflected sound and so influence the placement and manner of use.

There are three general types of microphone in use in present-day broadcasting which may be classified as regards directivity. The carbon and condenser microphones are almost nondirectional below 1000 cycles, but becomes more directional with increasing frequency and the effective solid angle of response is about 60 degrees.

The velocity operated ribbon microphone is bi-directional, with a "Figure 8" response in the horizontal and vertical planes, and its directivity is essentially the same at all frequencies. The microphone is effective over a solid response angle of 90° on each side; the response decreasing to zero at an angle of 90° normal to the ribbon.

The nondirectional microphone, the crystal or spherical dynamic, as the name implies, responds equally well to sound from all directions.

The apparent reverberation of the studio is determined largely by the ratio of direct to random sound energy which the microphone receives. The wider the effective response angle, other factors being equal, the lower will be the ratio of direct to random sound. Another consideration is the effect of microphones which are effective on two sides or completely nondirectional; to avoid undesirable reflections on the rear side. These effects may be compensated to some extent by proper microphone technique, but it is apparent that they are of interest in the acoustical consideration. A more comprehensive discussion of microphones and microphone technique is beyond the scope of this paper. It is evident that a studio in which nondirectional microphones are used should be less reverberant, requiring a greater area of treatment, than one in which microphones with appreciable direc-

tive characteristics are employed. The type of microphones employed should therefore be included in the consideration of the acoustical design of studios.

As previously mentioned, the relation of reverberation time to frequency and volume used by the NBC for the calculation of acoustic treatment in studios was obtained principally from experience. This relationship is shown in Figure 6. The reverberation time for a given volume is obtained from curve A and multiplied by the frequency factor obtained from curve B for each frequency calculated. It will be noted that the frequency range extends from 60 to 8000 cycles. Calculations are normally made for studio treatment from 60 to 6000. While this is a somewhat greater range than is customarily encountered in acous-

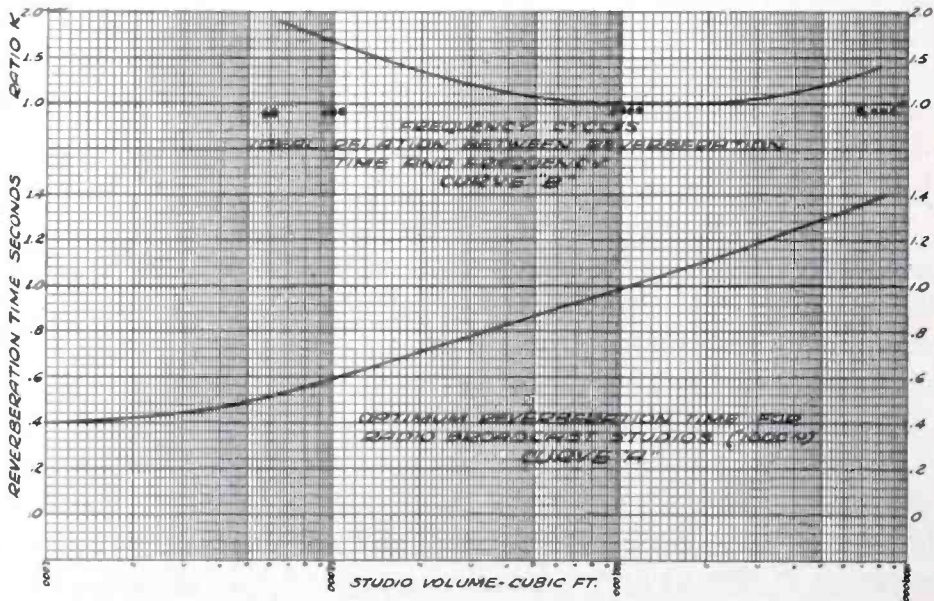

Fig. 6—Relationship of reverberation time to frequency and volume.

tical work, it is still considerably less than that of electrical measurements in associated apparatus and it is hoped that this range may be extended.

ACOUSTICAL MATERIAL

The optimum reverberation time characteristic dictates the necessary absorption which must be provided in any given studio. It may be of interest primarily to acoustical manufacturers and perhaps to others to consider determining factors for the minimum absorption coefficients of a material which may be applied to a broadcast studio. The studio floor, for practical reasons, is best covered with linoleum or similar material having practically no absorption. An abuse-resisting wainscot of non-absorbent material extending three and one-half feet up from the floor is also necessary. Doors and large observation

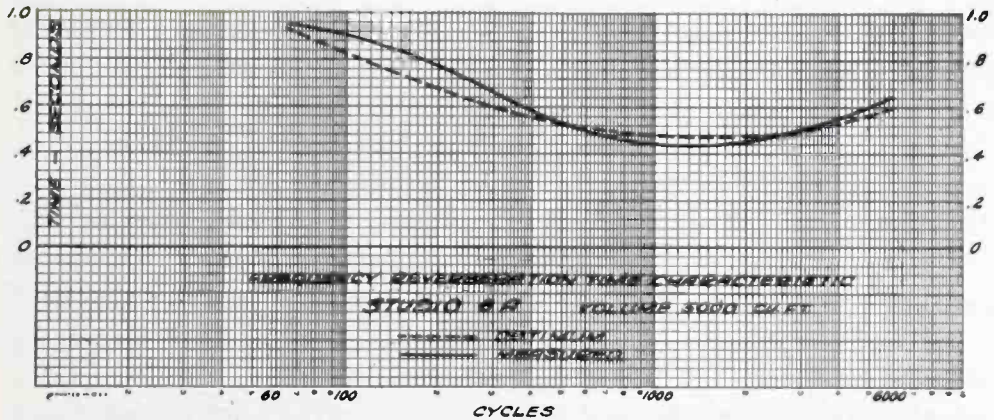

Fig. 7—Frequency reverberation time characteristic of Studio 8A.

windows must occupy an appreciable portion of the wall surface. The available area for acoustical treatment, therefore, particularly in small studios, is rather limited. Frequently, as little as half the total surface area of the room is available for treatment. An acoustical material applied over the entire available surface in such a case, must, to produce optimum reverberation time, possess at least 55% absorption at 1000 cycles. This situation unfortunately limits the number of satisfactory acoustic treatments available at present very seriously; especially so from the decorator's viewpoint. It should be understood that this figure of 55% is somewhat more serious than would seem to be the case from an inspection of data published by the manufacturers. The published coefficients of acoustical materials have not been found satisfactory in the calculation of studio treatment. In general, the published coefficients are high and require revision by a factor of approximately 0.75. Measurements made of samples of acoustic treatment in the laboratory of the National Broadcasting Company have been consistently lower than published data, and have been found to agree well with coefficients obtained of material applied in a studio. In practice it has been possible to use data obtained from NBC measure-

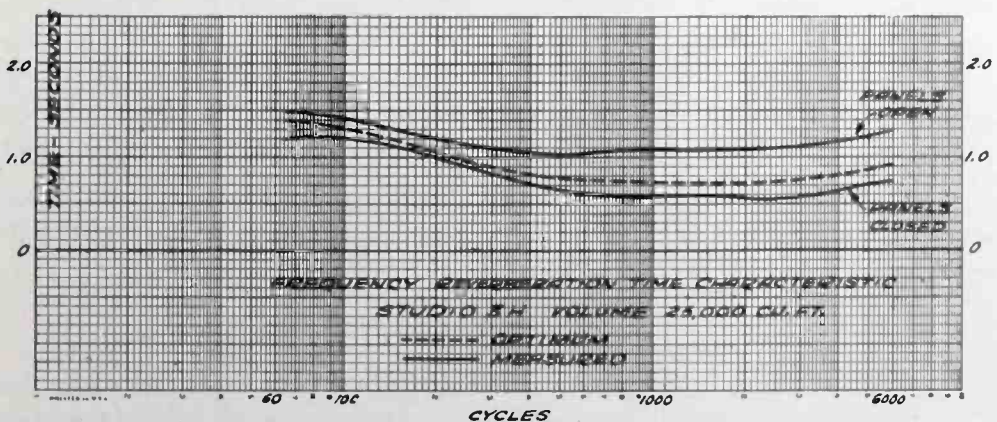

Fig. 8—Frequency reverberation time characteristic of Studio 3H.

ments in the specification of acoustic treatment and have resulting reverberation times agree with desired values within ten per cent. See Figures 7, 8, and 9.

The painting of acoustical materials which rely on porosity for absorption invariably greatly reduces the absorption at medium and high frequencies unless the surface texture is extremely coarse. The published coefficients frequently show only a very slight decrease at the higher frequencies and in some instances an increase in absorption at medium frequencies after the application of paint. Our experience has, however, been at variance with such information. Only those materials having a perforated non-absorbing surface have been found to be unaffected by painting.

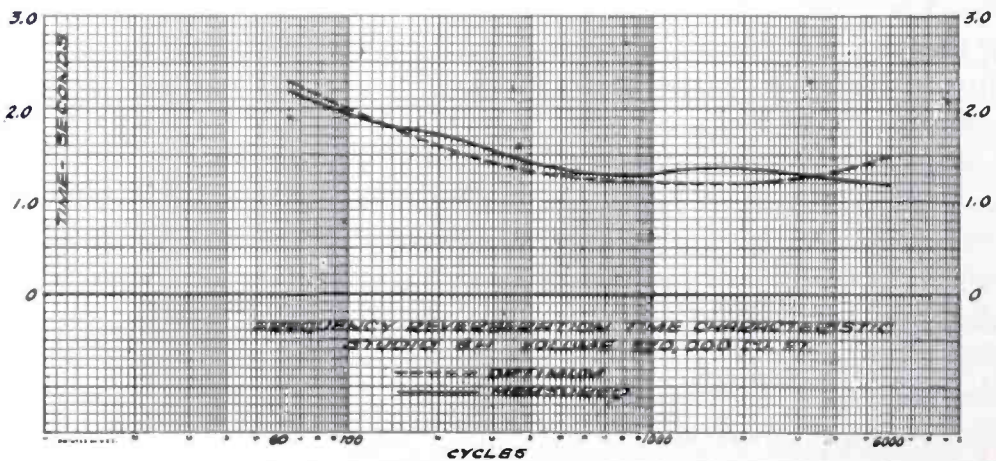

Fig. 9—Frequency reverberation time characteristic of Studio 8H.

Acoustical materials such as Acoustone, Rockoustile, and Acousti-Celotex, etc., are most efficient at the medium and higher frequencies, and are chosen usually for the variation in decoration which they make possible. Due to their deficiency in the low frequencies, a material having more than optimum absorption in the bass range, such as 4-inch rock wool blanket, is necessary in conjunction with tile treatments.

Acoustical plasters offer additional possibilities from the standpoint of the decorator. Unfortunately, however, they have proved, in practice, disappointing almost without exception. The majority of plasters do not have sufficient absorption to be used in studios except in small areas and frequently the coefficient of the material as applied under job conditions is considerably below that measured in the laboratory or supplied by the manufacturer.

“BREATHING”

An effect which has caused much difficulty in connection with the use of acoustic treatments and which should be taken into consideration

FIGURE 10 — TYPICAL WORK SHEET

| | | | |
|--------------------------|--------------|--------------------------|----------------------|
| Volume—19,000 cubic feet | | 05V = 950 | |
| Length—45' | Width—30' | Height—14' | |
| Perimeter—150' | | Wainscot Height—3' 6" | |
| Floor | 1350 sq. ft. | Wainscot | 525 sq. ft. |
| Ceiling | 1350 " " | Floor | 1350 " " |
| Side Wall | 630 " " | Windows, etc. | 100 " " |
| Side Wall | 630 " " | | 1975 sq. ft. |
| End Wall | 420 " " | Available for treatment— | |
| End Wall | 420 " " | | 2825 sq. ft. (total) |
| Total Area | 4800 sq. ft. | Available for treatment— | |
| | | Walls—1675 sq. ft. | |

| | | | | | | | | |
|-----------------------------|------|-----|------|------|------|------|------|------|
| Frequency | 64 | 128 | 256 | 512 | 1024 | 2048 | 4096 | 6000 |
| Required Absorption | 650 | 790 | 980 | 1120 | 1180 | 1180 | 1100 | 960 |
| 1350 sq. ft. Concrete | 80 | 70 | 55 | 40 | 40 | 40 | 40 | 40 |
| 930 sq. ft. 4" R.W. | 370 | 470 | 560 | 680 | 680 | 600 | 560 | 510 |
| 750 sq. ft. Rockoustile | 80 | 100 | 145 | 370 | 520 | 430 | 420 | 400 |
| 1770 sq. ft. Furred plaster | 160 | 130 | 90 | 70 | 50 | 50 | 50 | 50 |
| | 690 | 770 | 950 | 1160 | 1290 | 1120 | 1030 | 1000 |
| | 720 | 860 | 1040 | 1320 | 1400 | 1280 | 1150 | 1090 |
| Calculated Time | 1.32 | 1.1 | .92 | .73 | .68 | .73 | .81 | .88 |
| Optimum Time | 1.35 | 1.1 | .88 | .74 | .70 | .70 | .78 | .88 |

Notes: Ceiling border furred plaster 3' wide around periphery of studio.

Sabine Formula

$$t = \frac{0.05V}{a}$$

t = Reverberation time*—seconds

V = Volume—cubic feet

a = Total absorption units

Eyring Formula

$$t = \frac{0.5V}{-S \log_e (1-a)}$$

t = Reverberation time*—seconds

V = Volume—cubic feet

S = Total surface area—square feet

a** = Average absorption coefficient

* Reverberation time may be defined as the length of time for sound energy in an enclosed space which has reached steady state conditions to decay 60 db.

** Total absorption units divided the total surface area in square feet.

in acoustical design is that of "breathing". Breathing appears to be caused by a difference in air pressure across the partition on which the material is mounted. Pressure differences as low as 0.01 inch water can apparently cause an appreciable collection of dust and dirt in a couple of months. Factors which have been investigated and which seem to contribute their share to the breathing problem are, variations in pressure due to operation of an air-conditioning system, variations due to opening and closing doors, stack effect, changes in barometric pressure and others.



Fig. 11—NBC Studio 3A, Radio City, N. Y.

"Breathing" can in some cases be remedied by sealing walls of rough plaster prior to application of acoustic treatment to reduce air flow. Using rock wool blanket, the only solution found to date consists of omitting any covering over the perforated membrane which will collect dust, and employing paint for the desired decorative effect.

STUDIO TREATMENT

Figure 10 shows a sample work sheet indicating the method used in determining treatment of a studio. After the volume, surface areas and essential dimensions have been tabulated, the necessary total absorption at all frequencies to obtain optimum reverberation time is determined. Preliminary calculations at 128 and 1024 cycles with the materials considered for use will facilitate adjustment of the relative

areas of treatment to obtain the required total absorption. The need for calculation at all frequencies is thereby obviated, hence the adjustments necessary for final calculation are relatively small. Where "floating construction" of walls and ceiling is used, proper allowance must be made for the effective increase in absorption at the lower frequencies. The average absorption coefficients (total absorption units divided by total area in square feet) are sufficiently high to make the use of the more accurate Eyring formula preferable to that developed by W. C. Sabine. These formulas are shown at the bottom of Figure 10.

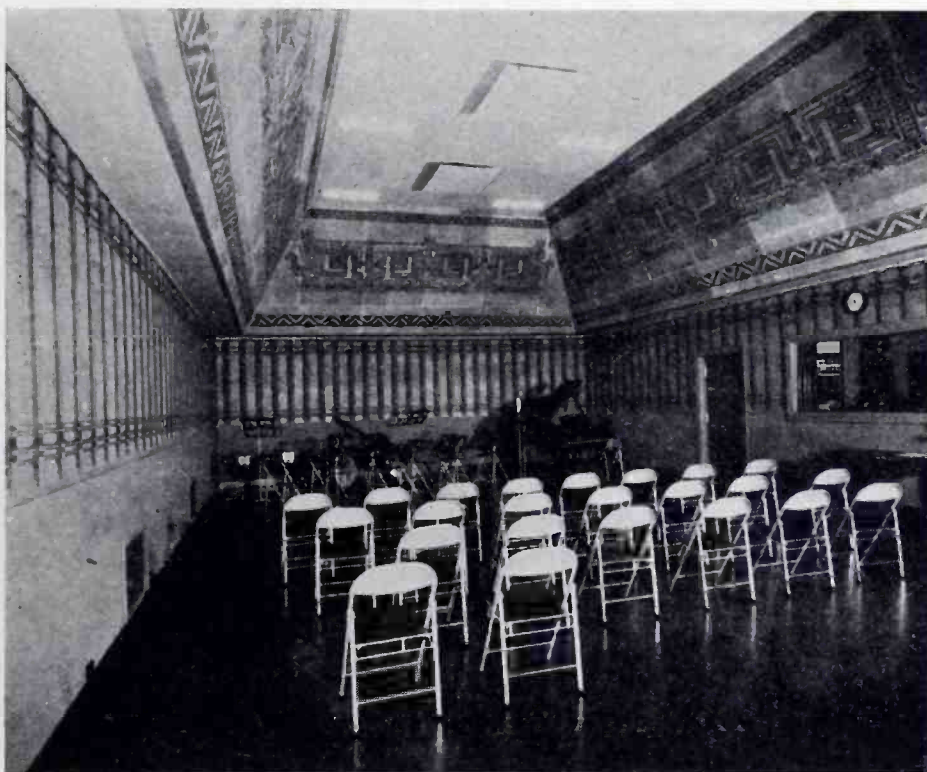

Fig. 12—NBC Studio A, Pittsburgh, Pa.

The optimum reverberation time characteristic may be obtained in a studio by a sufficient area of one treatment having the desired frequency absorption curve. The use, however, of the proper relative areas of two or more treatments of complementary characteristics to secure the proper total absorption is usually preferable because of the latitude afforded in the decorative or aesthetic treatment of the studio.

Figure 11 shows Studio 3A, NBC, Radio City, N. Y., in which two treatments have been employed. The wall treatment chosen primarily for its decorative value is arranged in vertical strips alternated with hard plaster. The ceiling is treated with rock wool blanket covered with painted perforated transite except for a hard plaster border around the periphery of the room.

Studio A of NBC, Pittsburgh, Pennsylvania, shown in Figure 12 is of interest because of the ornate decoration and the unusual "splayed" ceiling. The wall treatment is continuous above the wainscot; the decoration is applied by sponge-painting through a stencil. The flat portion of the ceiling is entirely treated with rock wool blanket covered with a perforated transite. The "splayed" portion is treated in alternate panels with rock wool blanket. The entire area, however, is covered with the painted perforated transite. The ceiling borders, or "soffits," are of hard plaster.

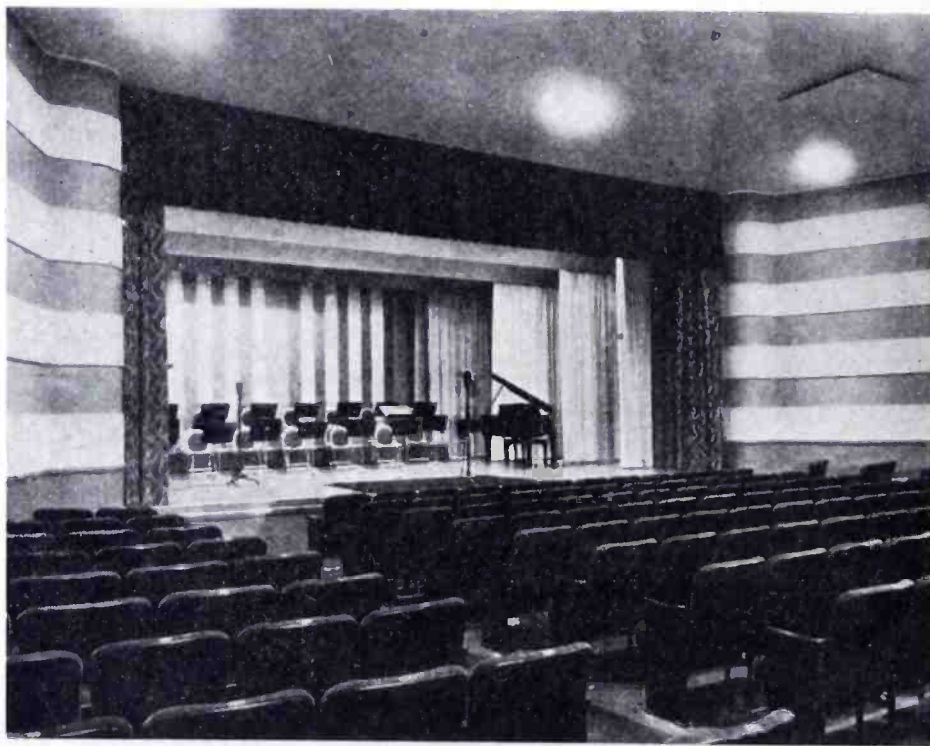

Fig. 13—NBC Studio B, Hollywood, Calif.

Figure 13 shows Studio B, NBC, Hollywood, California, which is representative of the auditorium type studio in which a stage and permanent upholstered seats have been provided. The ceiling above the stage is treated with rock wool blanket covered with painted perforated hardboard. The auditorium ceiling is of hard plaster because of the heavily upholstered seats and carpeted walking areas. The wall treatment is arranged in horizontal bands with intervening bands of hard plaster.

It will be observed in all cases parallel and opposite reflectant surfaces have been avoided to prevent persistent reflections or flutter. Where, of necessity, large reflectant areas are in opposition the surfaces are "V'ed" or ornamentally treated to effectively disperse imping-

ing sound. The stage area where microphones would normally be located is treated as a general purpose studio, with linoleum floor and acoustically treated ceiling.

Studio design is therefore no longer a matter of guesswork or "trial and error" methods. Certain acoustical criteria previously used such as the optimum time, were the result of the critical judgment of comparatively few people. The present standards are the result of years of operating experience and the collective judgment and opinion of thousands of listeners. The accuracy now possible does not approach that of allied engineering fields, but progress has been made toward that end.

THE VACUUM CELL LUMINESCENCE MICROSCOPE AND ITS USE IN THE STUDY OF LUMINESCENT MATERIALS*

BY

JOHN GALLUP

RCA Radiotron Division, RCA Manufacturing Co., Inc., Harrison, New Jersey

Summary—A new type of luminescence microscope is described. Its use in the examination and comparison of materials luminescing under electron bombardment in vacuum is explained. Fields of self-luminous particles are obtained of sufficient brightness to permit of satisfactory visual observation at magnifications up to 500X. Good photomicrographs can be made at 100X with ordinary film. In the study of manganese-activated calcium silicates, this microscope has facilitated the determination of many of the relationships which exist between color of luminescence, intensity of luminescence and crystal form. The low temperature form of calcium metasilicate luminesces more brightly than any other calcium silicate studied. A thorough wet mixing of raw materials is necessary to obtain a product of uniform luminescence.

INTRODUCTION

DURING recent work on the microscopic identification of luminescent calcium silicates (manganese activated) intended for use in the luminescent screens of cathode-ray tubes, it became apparent that much time could be saved and much more information obtained if the materials could be examined at high magnifications illuminated by their own emitted light. Such observation should reveal external crystal forms and tie up crystal structure with colors and relative intensities of luminescence.

In order to obtain such a self-illuminated field it would be necessary to provide some means of exciting the particles of the material to luminescence on the microscope stage. Since x-rays, ultraviolet light, and cathode rays furnish the principal means of exciting materials to luminescence, one of these would need to be employed. However, since equipment for x-ray bombardment or for ultraviolet illumination is quite expensive and somewhat complicated, a self-illuminated field at any considerable magnification could best be attained cheaply and easily with an ordinary microscope by viewing the materials in vacuum under bombardment from a high-frequency discharge. This method

* An abbreviated form of this paper was published in the Journal of the Optical Society of America, May, 1936. Republished by permission.

would have the further advantage of showing the material under approximately the same form of excitation as that under which it is used in cathode-ray tubes. This is important since a material may exhibit different colors and intensities of luminescence under different forms of excitation. With these considerations in mind, the author devised the cell described here.

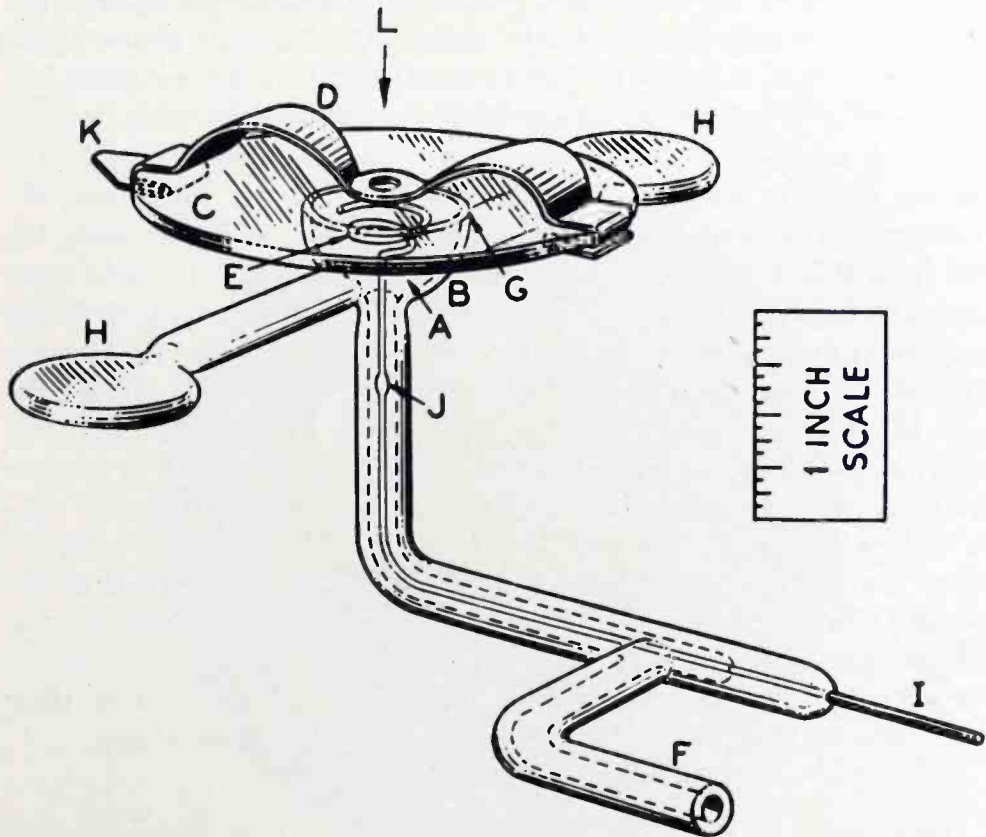

FIG. 1. Vacuum cell. *A*, vacuum space; *B*, glass cup; *C*, cover glass; *D*, upper electrode of spring steel; *E*, lower electrode of coiled nickel wire; *F*, capillary tubing to vacuum pump; *G*, ground-glass joint sealed by grease; *H*, glass arms flattened at ends for clamping to microscope stage; *I*, tungsten wire to coil; *J*, weld; *K*, contact to ground; *L*, direction of viewing.

THE VACUUM CELL

Essentially, the luminescence cell consists of a small cup-shaped bowl with a removable cover glass and two electrodes between which the sample is placed. Provision is made to evacuate the cell with a pump to a pressure of the order of 1 mm of mercury. Bombardment of the sample by cathode rays is produced by the high frequency discharge of a spark coil.

The cell can be made with the exhaust tube arranged to pass down through the microscope stage, or with this tube sealed at the side of the cell so that the assembly can be supported by a clamp rather than

by the microscope stage as it is in the first case. In either event, the cell can easily be made in a short time by an experienced glass blower.

Fig. 1 shows the details of a satisfactory construction. The vacuum space *A* is about $\frac{5}{8}$ of an inch in diameter and $\frac{1}{4}$ of an inch in depth. The lower electrode *E* is a coiled nickel wire on which rests the metal cup containing the sample. This wire is welded at *J* to a tungsten wire *I* sealed in the glass tubing below the microscope stage. The tungsten wire goes directly to the spark coil. The cell should be so constructed that no part of the lower electrode or its connection to the spark coil approaches closer than an inch to the metal of the grounded microscope stage. The glass tube *F* which leads to the vacuum pump is made from capillary tubing in order to increase the resistance to ground through the vacuum pump, and thus keep the loss from this source at a minimum. The cover glass *C* is made extra large and heavy so that it does not overheat from the spark discharge and soften the grease in the vacuum seal. Such softening would cause the spark discharge to puncture the seal and to ground, around the edge of the cover glass, to the upper electrode *D*. A good abrasive for grinding the cover glass to fit the cell wall is obtained by placing 600-mesh silicon carbide in heavy stopcock grease. The upper electrode *D* is formed so that only the central ring is in contact with the top of the cover glass. This removal of the remaining portions of the spring from the proximity of the vacuum space avoids spreading the field set up between the cup and ring electrodes. The glass supporting arms *H* are glass rods sealed to the cell and flattened at their outer ends to facilitate clamping them to the microscope stage.

OPERATION

When a sample is being prepared for viewing, a small amount of the material is spread in a shallow metal cup and placed in the cell on the lower metal electrode. The cover glass is placed on the previously greased edge of the cell and the vacuum pump started. The ground contact is then clipped to the upper electrode and the spark coil turned on as soon as the pump works with a somewhat sharp or metallic sound. The luminescent material will glow strongly. The pump must be turned off at this stage, or the vacuum will become too high for bombardment of the luminescent material to occur at the voltage obtained from the spark coil. If this happens, the admission of a small amount of air through a stopcock in the vacuum line will start the luminescence again. If the ground-glass joint has been properly greased, the luminescence will continue unchanged at a high level of efficiency for four or five minutes without attention. The microscope is focused in the usual manner. The luminous particles

stand out sharply against the dark background of the metal cup. This enables crystal forms to be seen clearly. The comparative colors and intensities of different luminescent materials may readily be determined by placing samples of each in the same field. Colors of particles below 0.5μ across can be seen.

Magnifications up to $250\times$ are obtained with a 16-mm objective ($10\times$) used with oculars up to $25\times$ magnification. High magnifications require a thinner cover glass than the one shown in the drawing (2.5 mm). A 9-mm objective (working distance 2 mm) is used with a cover glass 1 mm thick to produce satisfactory fields for visual

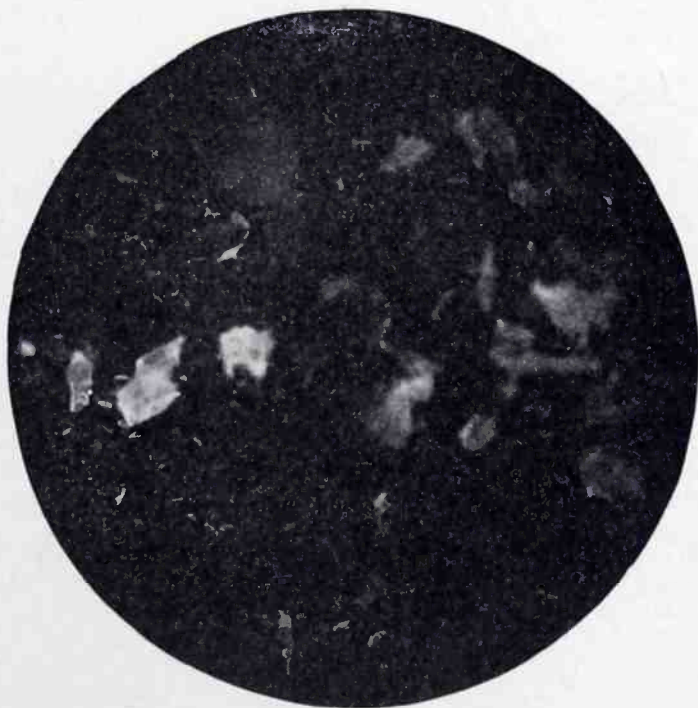

FIG. 2. Luminescent flat needles and bundles of needles of calcium metasilicate. Magnification $100\times$.

observation at magnifications up to $500\times$. Good photomicrographs can be made at magnifications up to $100\times$ with a 2-minute exposure on Eastman D-C ortho plates (see Fig. 2). This exposure time can be considerably shortened by using panchromatic film, which is more sensitive than ordinary film to the reds, greens, and yellows prevalent in the fluorescence of many materials.

THE LUMINESCENCE OF CALCIUM SILICATES

A considerable number of samples of calcium metasilicates¹ have

¹ Made by H. W. Kaufmann, RCA Manufacturing Co., Inc., Harrison, N. J.

been examined, but so far, only a few activated orthosilicates² have been studied. The crystal forms were identified by petrographic examination, based on the optical characteristics given by Winchell³ for calcium silicates.

Many of the first batches of the metasilicates were found to contain much dead material mixed with long needles which luminesced a bright yellow. After the raw materials were wet-milled together for several hours, all of the fired product luminesced. However, the brightest luminescence in every case was given by the long crystals (Fig. 2). Petrographic determinations disclosed that these were the characteristic lath-shaped crystals of the β or low-temperature form of calcium metasilicate.

All the orthosilicates examined contained large amounts of finely crystalline material, but no batch was composed exclusively of any one crystal form, nor was any free from inert material. Two characteristic colors of luminescence were obtained, a green and a red. A correlation of the results of the luminescence microscope with those from petrographic determinations indicates that the low-temperature form luminesces green while the high temperature forms luminesce red. The red and green are of about equal intensity. Both are far weaker than the yellow of the metasilicate.

Some success was attained in separating the various crystals according to color of luminescence by flotation in heavy liquids. However, a preliminary grinding to the dimensions of individual crystals, 1 to 10 microns, was found necessary before they could be separated by floating.

SUMMARY

1. This new type of luminescence microscope can be constructed cheaply to give readily reproducible results with any microscope which may be available.
2. Visual magnifications of luminescing particles can be obtained up to 500 diameters. This is sufficient to show any characteristic crystal form in particles as small as 3 or 4 microns in largest dimensions. However, luminescent colors from particles which are not resolved by the objective, that is under 0.5 microns, are shown very clearly.

² Made by H. W. Leverenz, RCA Manufacturing Co., Inc., Camden, New Jersey.

³ A. N. Winchell, *Microscopic Characters of Artificial Minerals* (John Wiley & Sons, New York, 1931).

3. Photomicrographs for permanent records of crystal form, size, and intensity of luminescence can be made at magnifications up to 100 \times , using exposure times of 2 minutes or less, with ordinary film. Higher magnifications require longer exposures or more sensitive film.
4. The results from this method of examination show the need for wet grinding of the raw materials together before firing in order to obtain uniformity of luminescence.
5. The " β " or low-temperature form of calcium metasilicate has a yellow luminescence which is more intense than that given by any other manganese-activated calcium silicate studied.
6. Preliminary investigation of the calcium orthosilicates indicates that two characteristic colors are to be found. One is a green which seems to belong to the low-temperature form; the other, a red of about the same brilliance as the green, seems to be associated with the high-temperature forms. Neither color is as bright as the metasilicate yellow.
7. If flotation-separation methods are to be used in quantitative separations of calcium silicate mixtures into fractions of uniform luminescence, the material must first be ground to the size of the component crystals. For the specimens separated, these were from 1 to 10 microns.

Acknowledgment and thanks are due Dr. L. B. Headrick of this laboratory for much valuable help in the development of the vacuum cell to its present form.

A NEW PIEZO-ELECTRIC QUARTZ CRYSTAL HOLDER WITH THERMAL COMPENSATOR

By

W. F. DIEHL

Crystal Appl. Section RCA Mfg. Co., Inc., RCA Victor Div.

IN ORDER that a broadcast transmitter may remain on the frequency to which it has been assigned by the Federal Communications Commission it is essential that some form of accurate control of the fundamental carrier frequency of the transmitter be

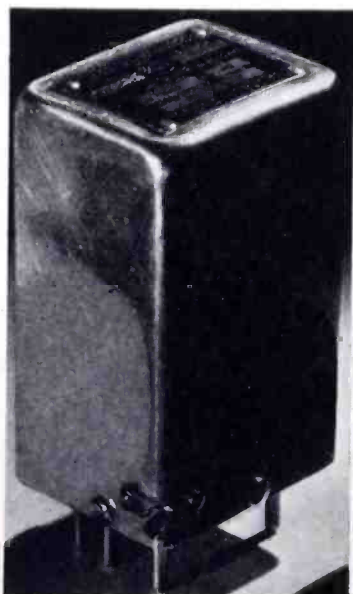

Fig. 1—Crystal Holder.

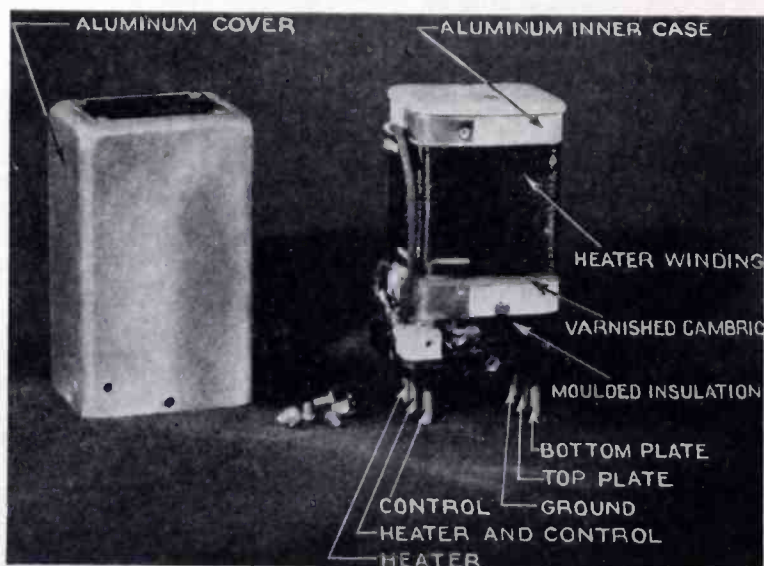

Fig. 2—Crystal Holder with cover removed showing assembly.

provided. A very accurate and simple control means which is now used in practically all broadcasting transmitters is the piezo-electric quartz crystal oscillator. It is based on two essential facts: Namely, that when a quartz crystal is subjected to pressure, voltages are produced on certain of its surfaces and also that such a crystal has certain definite frequencies at which it will vibrate and cause such voltages to be generated to a maximum degree. A quartz crystal can, therefore, be ground to the proper size to vibrate at the broadcast transmitter's assigned frequency and will then maintain the trans-

mitter on the frequency. The only factor which will affect the frequency produced by the crystal is temperature. Previously, very elaborate temperature control boxes were necessary to keep the crystal temperature constant. However, a simple and compact crystal holder designed to maintain the crystal temperature within the desired limits has recently been designed.

Piezo-electric quartz plates when properly orientated with respect to the crystallographic axes (this orientation is first about the optic or "Z" axis, where the "A" angle θ_1 is the angle between an "X" axis and a new axis, and where the "B" angle θ_2 is an orientation about θ_1 plus 90°) of the natural crystal may be finished so as to have substantially zero temperature coefficient in the temperature range 0 deg. C to plus 70 deg. C.

Since it is possible to produce in quantity such plates with a temperature coefficient within $1\frac{1}{2}$ parts per million per degree centigrade, the need for an elaborate heat box with mercury thermostat, relay, and other accessories, is eliminated and a small compact unit

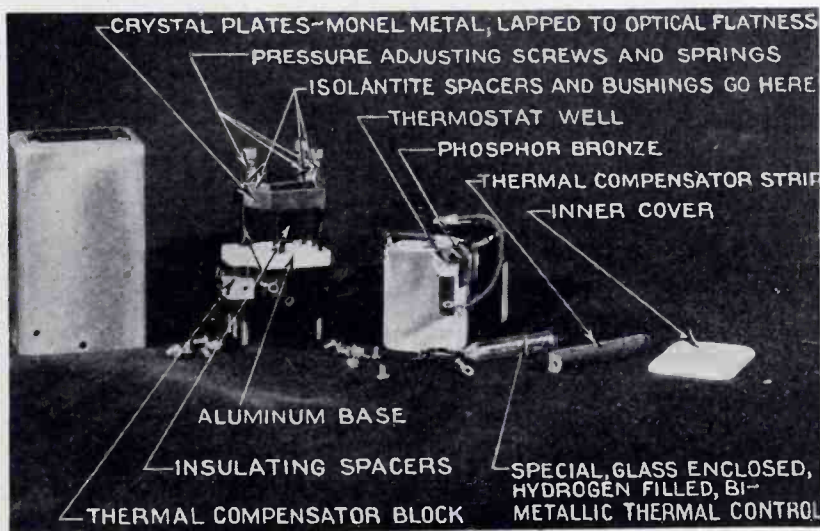
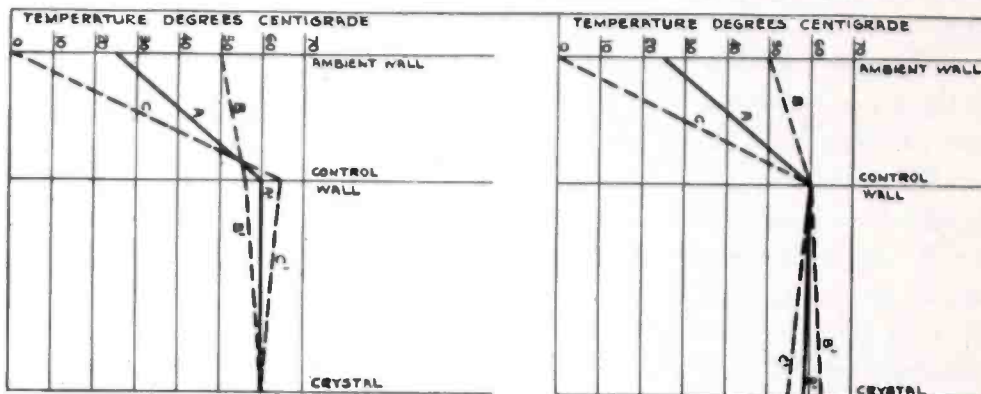

Fig. 3—Further details of the Crystal Holder.

with superior performance has been developed. This unit is a precision air gap type quartz crystal holder incorporating a special thermostatic control and temperature compensator. The unit was developed for use expressly with a low temperature coefficient V-cut crystal. This crystal holder, shown in Fig. 1, is 2" wide, 4" high, 2-7/16" deep, occupies $19\frac{1}{2}$ cubic inches and weighs only $12\frac{1}{2}$ ounces. All connections are made through 6 prongs protruding from the base, and two of these units may be plugged into a quartz oscillator, thus providing a spare unit in case of failure of the one in use.

Fig. 2 illustrates the holder with the outer aluminum cover removed and shows the assembly of the inner completely shielded case



Curve 2—Single heater control with ambient thermal compensation.

Curve 1—Single heater control without ambient thermal compensation.

Fig. 4—Characteristics of thermal compensation adopted for broadcast crystal oven.

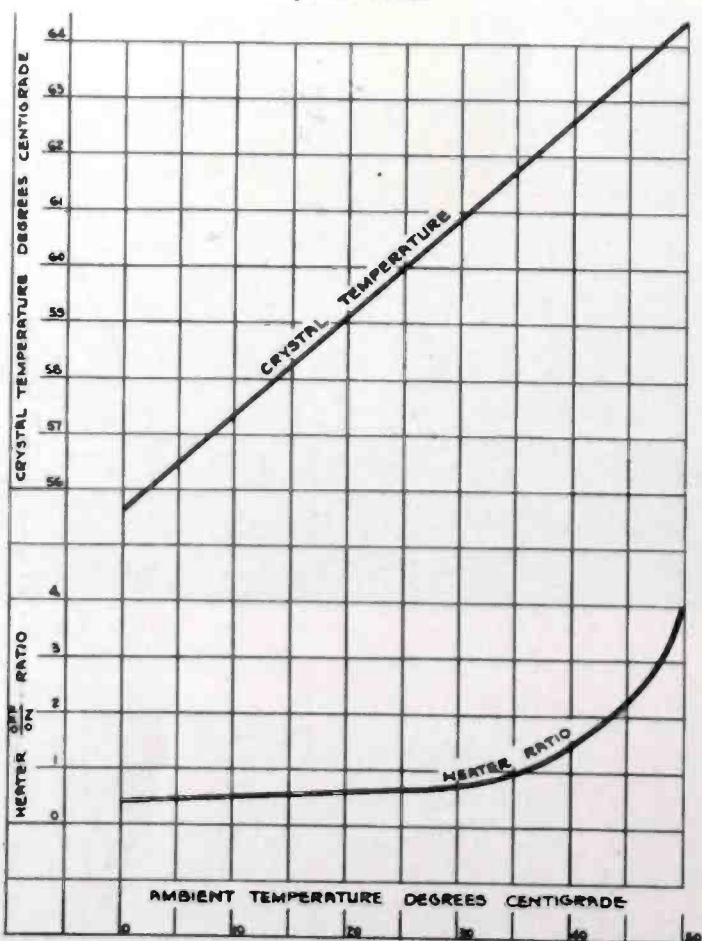

Fig. 5—Temperature stability of Broadcast oven without thermal ambient compensation.

on which is wound the heater, which consumes 14 watts, the entire assembly being mounted on a moulded base.

Fig. 3 illustrates the remaining details of the holder and shows the thermostat well in the inner cover, in which is mounted a special glass enclosed hydrogen filled bimetallic control. The compensator strip is placed adjacent to the control and connects to the compensator block. The quartz plate is mounted between the monel metal electrodes and is spaced from the upper electrode with isolantite spacers providing an approximate airgap of 2 thousandths of an inch.

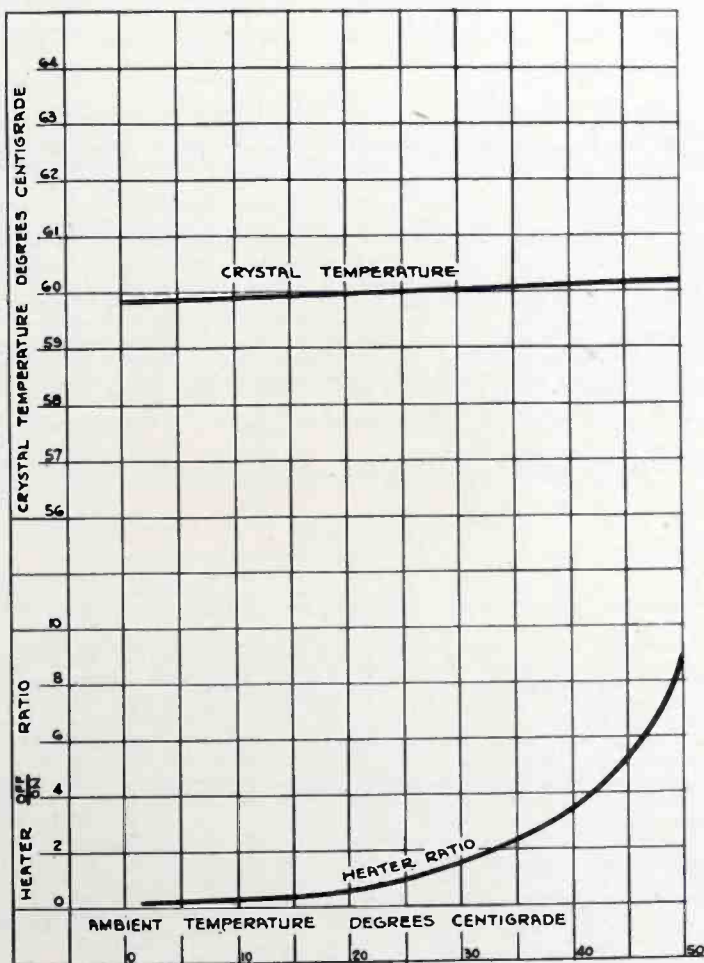

Fig. 6—Temperature stability of broadcast oven with thermal ambient compensation.

The curves, Figs. 4, 5 and 6 show the advantage of using the thermal compensator. By selecting the proper material and length of the compensator, the point of zero temperature gradient can be "focused" on the crystal plate as shown in curve 2 of Fig. 4.

The bimetallic thermal control used in this holder is manufactured by the Edison Company and was developed by their engineering department in cooperation with RCA engineers. Many samples and nu-

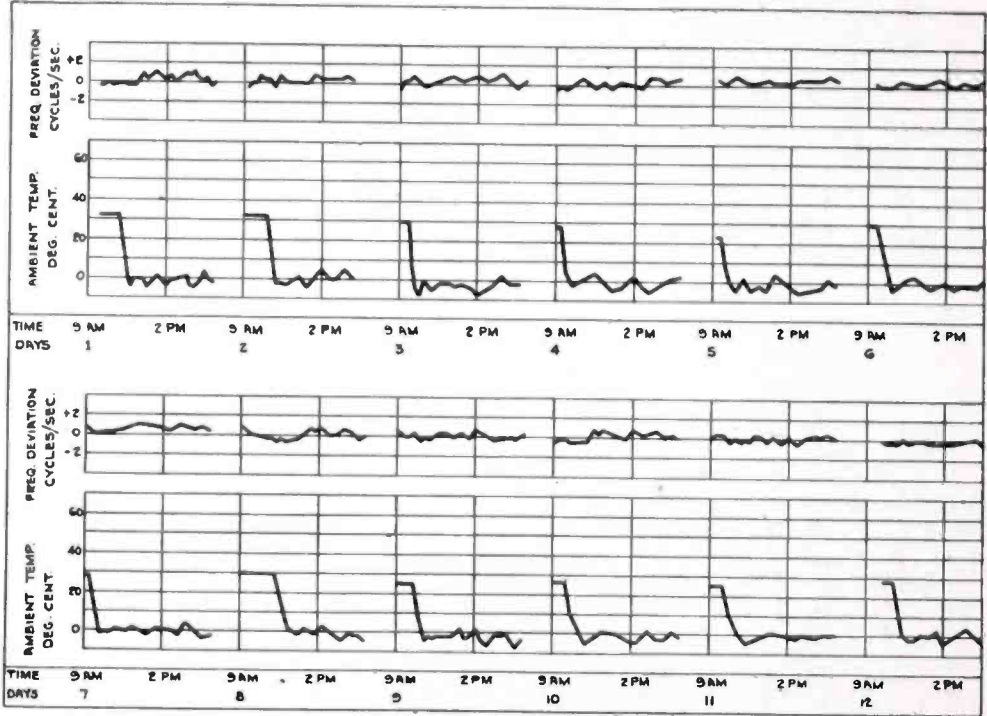

Fig. 7—Performance of Quartz Crystal Holder the first 12 days.

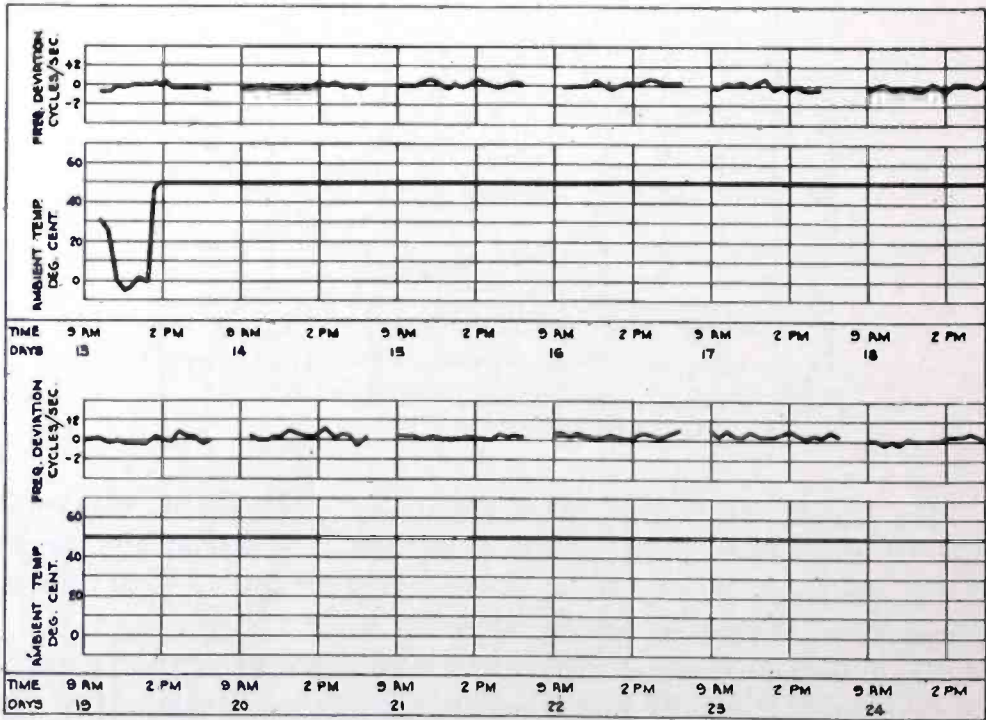

Fig. 8—Performance of Crystal Holder during the second twelve days.

merous tests extending over approximately a year were necessary in order to arrive at the quality being obtained at the present time. An example of the performance of these controls as now received is indicated in the following table:

| Control No. | Temp. On | Temp. Off | Sensitivity* |
|-------------|----------|-----------|--------------|
| 264 | 61.2 | 61.6 | 9.6 |
| 207 | 60.3 | 60.8 | 9.0 |
| 277 | 59.6 | 60.1 | 8.4 |
| 280 | 59.0 | 59.5 | 7.8 |
| 284 | 60.0 | 60.6 | 8.4 |



Fig. 9—Performance of Crystal Holder the last 8 days.

In order to maintain this performance special test equipment for checking the “on” and “off” temperature and the cycle of the thermostat has been developed.

A facsimile recorder has been modified to automatically print a record of the “on-off” cycle of these controls. The recorder will accommodate 8 controls which may be tested simultaneously and this equipment is now located in the laboratory where each control is tested. Space does not permit a description of the recorder at this time.

* Sensitivity: The time in seconds required for a control to open when the temperature is suddenly changed from 35 deg. C to 70 deg. C.

The performance of one of these units is shown in the curves of Figs. 7, 8 and 9. This type unit was tested over a period of 32 days at temperatures ranging between 0 and 60 deg. C. The crystal was a V-cut crystal having a temperature coefficient of -2.26 parts per million per degree centigrade, the frequency being 679,864 cycles. The oscillator circuit was a standard quartz oscillator which was maintained at approximately room temperature during the test. These tests indicate that over the ambient temperature range, with experience in practice, and using the V-cut crystal which averages within $1\frac{1}{2}$ parts per million per deg. C, that a stability of $\pm .00015\%$ can be expected. In terms of frequency stability, this unit will contribute less than 1 cycle variation at 550 kc and less than 3 cycles at 1500 kc.

"M DERIVED" BAND PASS FILTERS WITH RESISTANCE CANCELLATION

BY

VERNON D. LANDON

(RCA Manufacturing Company, Inc., RCA Victor Division, Camden, N. J.)

Summary—In the design of "M derived" band pass filters, the most serious difficulty is in designing rejector circuits having coils with sufficiently low losses. Circuits are given whereby the effective losses in the rejector circuits are reduced to zero, giving infinite attenuation at the desired points. The circuits are compared to the crystal band pass filter. The effect of unequal terminal resistors is briefly discussed.

INTRODUCTION

AS THE communications art progresses, the need for highly selective filter networks becomes more and more pressing. The desired performance curve has a flat central portion called the pass band and slopes downward as rapidly as possible on either side of the pass band, as shown in Fig. 1. The theory of filters is rather well developed and formulas exist for designing filters of almost any desired selectivity. The difficulty is in obtaining physical reactances having the constants dictated by the formulas. Inability to produce high inductance coils having sufficiently small distributed capacity is a frequent limitation, but this difficulty can usually be avoided by changing to a circuit having different constants and the same performance.

A more formidable difficulty is the dissipation of the coils. There are always practical minimums for the power factor of coils below which it is impractical to attempt to go. Yet the dissipation theoretically allowable may be much less than this practical minimum.

One solution for the problem is the crystal filter of Fig. 2, which was disclosed by Mason in U. S. Patent No. 1967250. This is a fairly practical solution of the problem, and will be discussed in more detail later.

CANCELLATION OF REJECTOR LOSSES

However, a simpler solution of the problem exists. The method of procedure was pointed out by Bode in U. S. Patent No. 2002216. Bode was chiefly concerned with a sharp cutoff low pass filter, and he

stopped just short of showing a practical band pass circuit with high attenuation on each side of the pass band.

The new principle introduced by Bode is that of cancellation of the effect of losses in rejector circuits. A circuit which he uses to

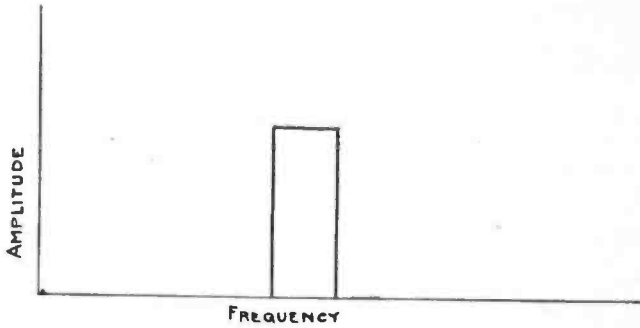

Fig. 1
IDEALIZED RESPONSE CURVE

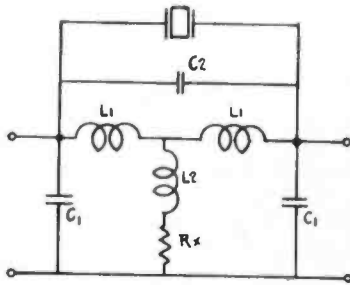

FIG. 2
MASON'S BANDPASS CRYSTAL FILTER

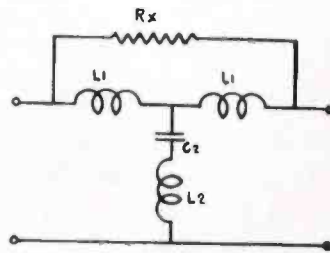

FIG. 3
CIRCUIT ILLUSTRATING RESISTANCE CANCELLATION

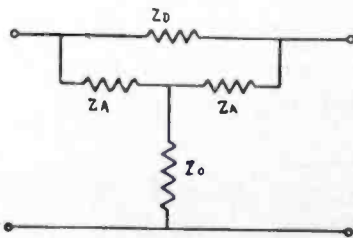

FIG. 4
GENERALIZED BRIDGED T NETWORK

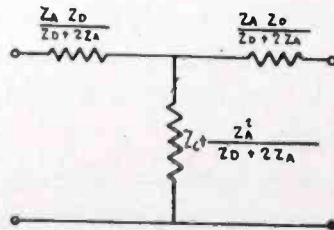

FIG. 5
T STRUCTURE EQUIVALENT TO FIG. 4

illustrate the principle is that of Fig. 3. In this circuit the reactive elements L_2 , C_2 , L_1 , L_1 form a T structure which may constitute a portion of an "M derived" filter of either low pass or band pass characteristics. L_2 and C_2 comprise a series resonant circuit shunted across the signal circuit. The effect is to produce a high attenuation at the frequency of resonance $L_2 C_2$. In the absence of R_x the degree of attenuation is limited by the resistance of $L_2 C_2$. In general, this resistance is higher than is desired, and the attenuation is not very

great. The function of the resistance R_X bridging $L_1 L_1$ is to increase the attenuation by balancing. The effect is much the same as though the resistance of L_2 were reduced. The degree of attenuation is limited only by the accuracy of adjustment.

This can be better understood by referring to Figs. 4 and 5. Fig. 4 is a generalized bridged T network, and Fig. 5 is the equivalent T structure. These figures are taken from K. S. Johnson's "Transmission Circuits for Telephonic Communication", Page 282. In Fig. 5, the impedance of the stem of the T structure is

$$Z_C + \frac{Z_A^2}{Z_D + 2Z_A}$$

Setting this equal to zero gives the conditions for maximum attenuation,

$$Z_C + \frac{Z_A^2}{Z_D + 2Z_A} = 0$$

$$Z_D = -\frac{Z_A^2 + 2Z_A Z_C}{Z_C}$$

If Z_A is a great deal larger than Z_C , then Z_D equals approximately

$$\frac{-Z_A^2}{Z_C} = \frac{-j^2 w^2 L_1^2}{R_2} = \frac{w^2 L_1^2}{R_2} \text{ (in Fig. 3)}$$

It is well to note that infinite attenuation cannot be obtained if Z_D and Z_C are both pure resistances. It can always be obtained, however, if the phase angle of Z_C may be adjusted as well as its magnitude. This simply means that the point of greatest attenuation is at a slightly lower frequency than the true resonant frequency of Z_C . A more rigorous analysis would be too lengthy to include here.

It can be seen that in Fig. 3, R_X is by far the largest impedance of the network. It has but little effect on the performance of the circuit, except at frequencies near the resonance point of the rejector circuit. Thus the standard design formulas for "M Derived" band pass filters may be used and the ill effects of undue losses in the rejector circuits may be counterbalanced as explained above.

A SIMPLE BAND PASS FILTER

A band pass filter may be obtained from Fig. 3 by adding a condenser and a terminal resistor at each end of the network, as shown in Fig. 6a. The filter has an attenuation peak on only one side of the pass band, as shown in Fig. 6f, but it may be followed by another section having an attenuation peak on the other side.

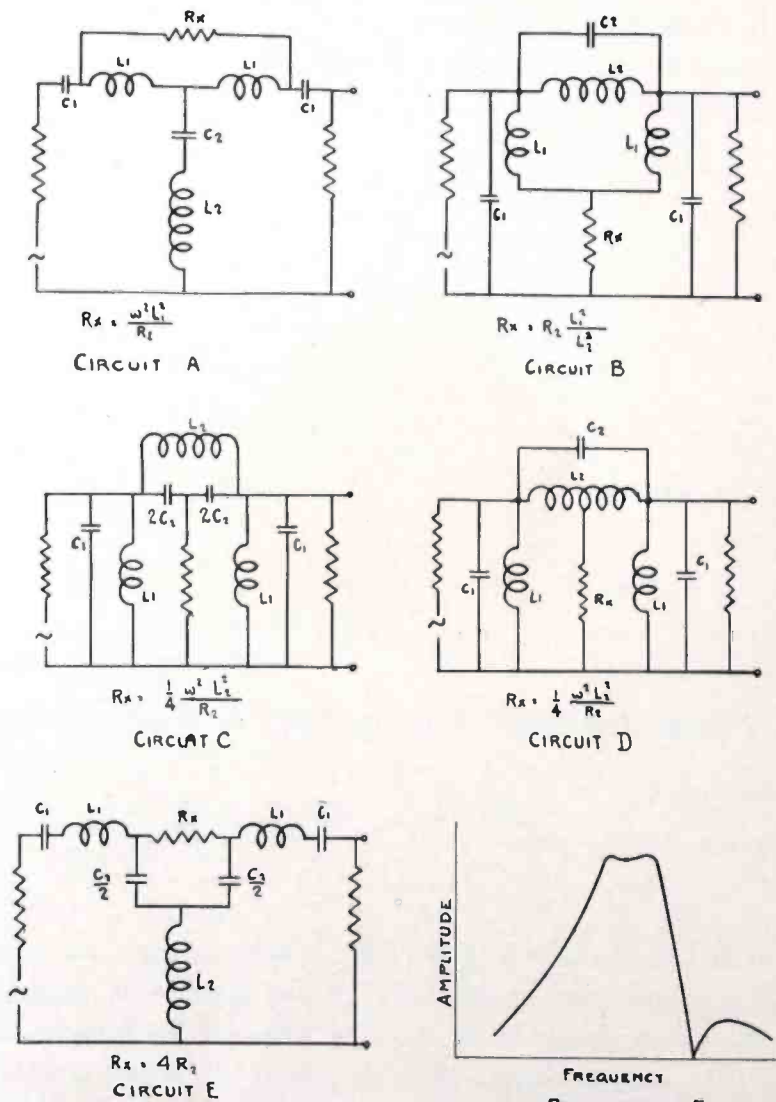

BAND PASS FILTERS WITH A SINGLE ATTENUATION PEAK
FIG. 6.

Other circuits, having the same performance as 6a, are shown at b, c, d, and e of the same figure. In each circuit R_x is the resistor employed to cancel the effect of losses in $L_2 C_2$. The required value of R_x is given in each case. R_2 is the total series resistance of $L_2 C_2$ in each case. All these circuits require another section if a second attenuation peak is desired.

FILTER WITH TWO ATTENUATION PEAKS

A simpler method of obtaining a curve with high attenuation on each side of the pass band is to use one of the circuits of Fig. 7. Taking circuit "a" of the figure as typical, the two meshes $L_1 C_1$ are each tuned to the mean frequency of the pass band. The mesh $L_2 C_2$ is tuned to the attenuation peak on one side of the pass band and $L_3 C_3$ is tuned to the other. Considering $L_2 C_2$ and $L_3 C_3$ in parallel, to comprise Z_C of Fig. 4, it can be seen that there are two frequencies at which Z_C may assume the proper value for infinite attenuation.

The performance curve is given at Fig. 7e. Each of the circuits of the figure may be adjusted to give the same curve. Every "M derived" filter that can be designed, can be improved by the method just explained.

ADDITIONAL FILTER SECTIONS

It should be noted that this performance curve has a high attenuation immediately on either side of the pass band, but that the attenuation is reduced at frequencies farther removed from the pass band. To obtain a nearer approach to the ideal curve of Fig. 1 it is necessary to include more sections of filter. These may take the form of constant K sections (having no rejector circuits) or of "M derived" sections with the rejectors tuned farther from the pass band. Both may be used for still better performance.

FILTERS AS INTER-STAGE COUPLING DEVICES

Conventionally, these additional sections would be connected so as to form one continuous filter. However, amplification is often required as well as frequency selection, and in this case it is convenient to use one of the circuits of Fig. 7 as an interstage coupling device. A second stage of the amplifier might employ the same circuit, but with the rejectors tuned farther from the pass band. (Appropriate changes in the L/C ratio of the various meshes is also indicated in the design formulas. See Shea's "Transmission Circuits and Wave Filters", Page 315.) A third stage might consist of a pair of tuned coupled circuits.

Certain changes are required before the circuits of Fig. 7 are suitable for interstage coupling units. Most apparent is the need for segregating d-c supply voltages. Thus Fig. 7b becomes Fig. 8b in which C_B , R_g and C_g have been added for this purpose.

However, circuits 7a, c and d, cannot be designed at a sufficiently high impedance level to be suitable. In circuit d, the limitation is in

the coil marked L_4 . The formulas call for an absurdly large coil here, if a high terminal impedance is required. In circuits a and c, the limitation is in L_1 which becomes absurdly large. Another requirement, in filters which are to be used as interstage coupling units, is that the filter terminates in a shunt condenser at each end because

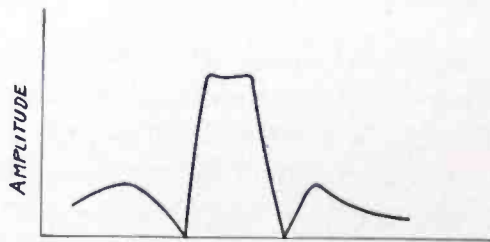
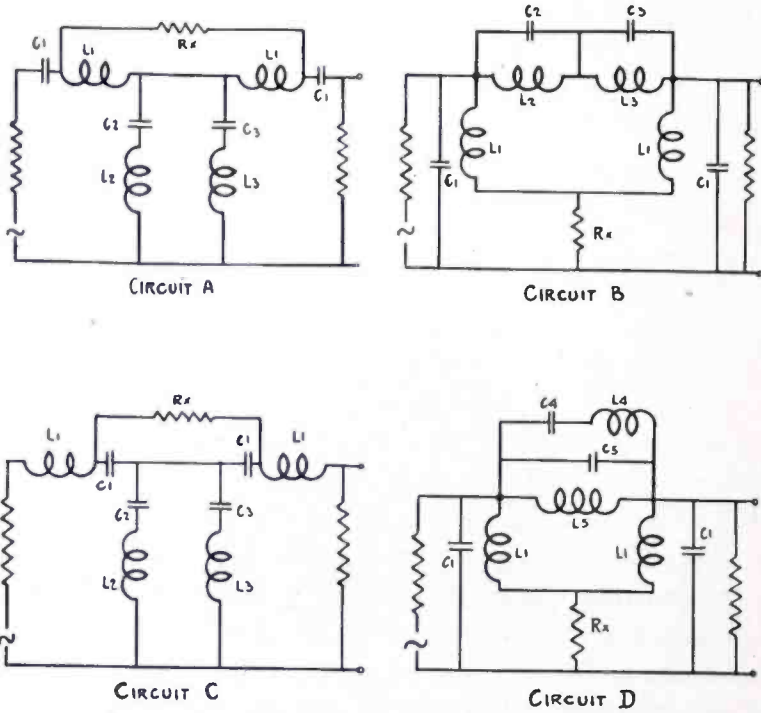

PERFORMANCE E.
BAND PASS FILTER CIRCUITS HAVING TWO POINTS OF HIGH ATTENUATION
FIG. 7.

the input and output capacities of the associated tubes are unavoidably present.

For circuit 7a, a slight change is sufficient to correct both difficulties. The change, (resulting in Fig. 8a) consists in moving the terminal resistors and the points of application and utilization of the signal from in series with the terminal condensers C_1 to in parallel with them. This change from series to parallel resonant cir-

circuits for the input and output accomplishes the desired increase in impedance level. The circuit now terminates in shunt condensers as required also. While this arrangement is not as conventional as 8b, it operates just as well. It will in general be found necessary to detune the circuits $L_1 C_1$ slightly from the mean pass band frequency, to obtain a flat transmission in the pass band.

If a similar change is made in Fig. 7c, an even less conventional arrangement is obtained, as shown in Fig. 8c. This circuit has the advantage of not requiring parallel feed for the plate voltage and can be used with tubes having large plate current.

With this arrangement, the input and output capacities of the tubes act like misplaced portions of C_1 , hence the input and output resonant circuits must be mistuned from the mean pass band frequency by a greater amount than required in circuit 8a. In fact, if C_1 is not considerably larger than the input and output capacities of the associated tubes, the performance curve cannot be made flat in the pass band.

UNEQUAL TERMINAL RESISTORS

At this point a few remarks in regard to terminal resistors is in order. In conventional filter theory it is nearly always assumed that equal resistors are to be placed at the two ends of the filter. Where the filter terminates on the grid of a vacuum tube there is usually some advantage in deviating from this practice. A simple example will illustrate the point.

If identical tuned circuits are inductively coupled and used as an interstage coupling device, a slightly double peaked curve may be obtained by proper adjustment, but the low frequency peak is always higher than the high frequency peak. No adjustment of tuning or coupling can ever make the high frequency peak as high as the low frequency peak. However, if the damping of the two coupled circuits is different, it is only necessary to tune the low loss circuit to a higher frequency, in order to make the high frequency peak as high or higher than the low frequency peak. In fact, the two peaks may be given any desired ratio of amplitudes by this method. Also, with a given value of capacity, the greatest product of gain times band width is obtained when the damping is concentrated in one of the tuned circuits.

A similar situation exists with more complicated circuits, whether of the "M derived" type or of the "Constant K" type. The correction of assymetry in the performance curve, by detuning one or more circuits, is easier if the damping is concentrated at one end of the

filter. Also, the shoulders of the pass band have less tendency to droop. The proper value for this single terminal resistor is a complicated function of the distributed damping of the network and is best found by experiment. If the internal dissipation alone has the proper value, no terminal resistance is used.

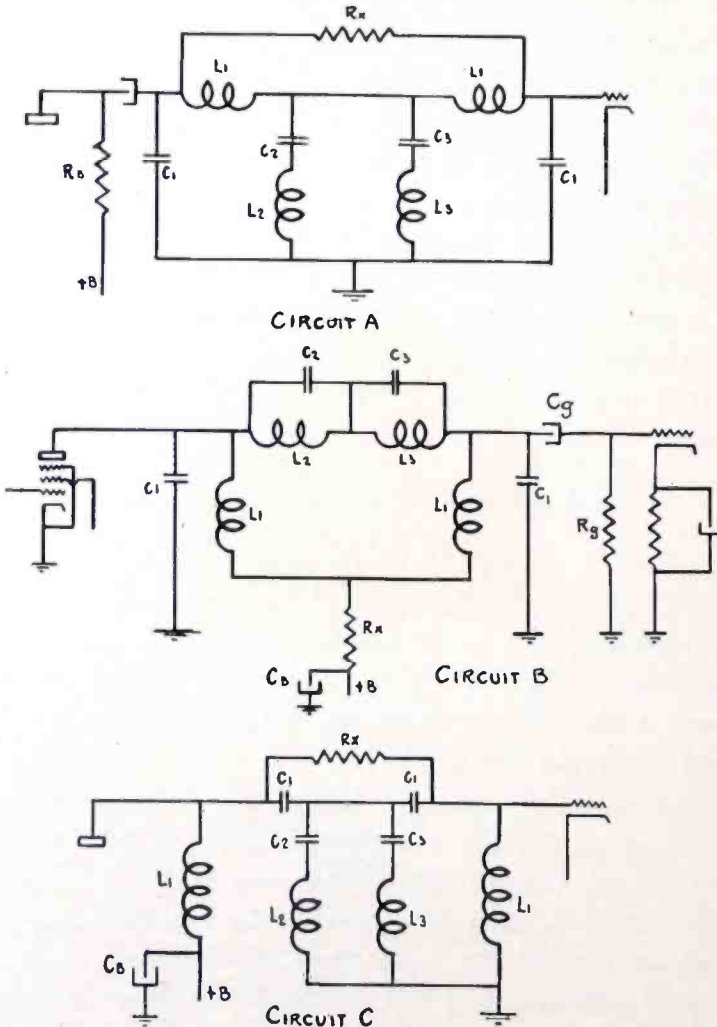

CIRCUITS SUITABLE FOR INTERSTAGE COUPLING UNITS

FIG. 8

ACCEPTOR CIRCUIT LOSSES

The fundamental limitation on filter design introduced by losses in rejector circuits has been removed. However, limitations still exist, due to losses in the circuits which resonate in the pass band. If these losses are too high, the shoulders of the pass band droop. For the circuits of Fig. 7, this following general statement may be made:

The pass band cannot be made flat topped or double peaked unless the losses of the terminal resonant circuits are sufficiently low to show a marked double peak in the same band if they were properly coupled together to do so.

EQUIVALENT CIRCUIT OF CRYSTAL FILTER

The crystal filter of Mason, shown in Fig. 2, is subject to about the same limitations. This is necessarily true because the following transformation shows that the crystal circuit of Fig. 2 is equivalent to Fig. 7d. A crystal can be shown to be equivalent to a series resonant circuit shunted by a condenser. Making this substitution and performing a T to π transformation on the T structure $L_1 L_1 L_2$ of Fig. 2, gives the circuit of Fig. 7d.

Mason employs the low loss crystal to keep the losses down in L_4 , C_4 , C_5 , and uses the resistor R_X for the purpose of reducing the resistance of the phantom inductance L_5 to zero. When dissipative reactances are used at L_4 , C_4 , C_5 , it is only necessary to increase R_X slightly to cancel the losses of these elements also.

This increase in the value of R_X causes the effective power factor of the terminal resonant circuits L_1 , C_1 to be somewhat higher. Thus the crystal filter may be designed for a slightly narrower band than the circuits of Fig. 7.

CONCLUSION

In "M derived" filters of practically any type, the losses of the rejector circuits may be effectively cancelled by adding resistance in the proper place in the circuit. Losses in acceptor circuits remain a fundamental design limitation. In crystal filters in which the crystal is confined to the rejector meshes of the network, the limitation is about the same. However, such a crystal filter may be designed for a slightly narrower pass band than the equivalent network using dissipative reactors and resistance cancellation. Nevertheless the latter type of filter is expected to have a wider field of usefulness because of its lower cost and greater flexibility of design.

NBC RADIO IN THE CLIPPER SHIPS

HAROLD P. SEE

National Broadcasting Company

THE issuance of a Federal certificate granting Pan American Airways permission to carry passengers 8000 miles across the broad expanse of the Pacific Ocean, may see that service inaugurated almost on the anniversary of the maiden crossing of the Philippine Clipper. This flight, started on December 9, 1935, carried an RCA transmitter from San Francisco to Manila and return. Its function was to bring the listeners on NBC networks periodic descriptions of the progress of the flight.

The initial installation of the special aircraft type transmitter was aboard the China Clipper. Located with its associated equipment in the spacious baggage compartment aft of the passenger quarters, it was used to broadcast programs from the clipper ship as it flew from Baltimore to San Francisco via Miami, Acapulco, Mexico, and San Diego.

It was on the last leg of this "ferrying flight" that the equipment added one more notable achievement to NBC's wide coverage of headline events. The stratosphere balloon ascension, planned for months, had become a reality on Armistice Day, November 11, 1935. The China Clipper was about sixty miles at sea off a point approximately midway between San Diego and San Francisco. The balloon had gone to its "ceiling" of over 70,000 feet and was descending. Contact was established with RCA Communications at Bolinas and Point Reyes and our signal transmitted on 4797.5 kc was received and re-routed to the balloon. Station KEG supplied our cue or talk-back circuit. A most interesting and unusual conversation was thereby made possible between Captain Stevens, sealed in the gondola of the Explorer II, and Captain Musick aboard the China Clipper.

The transmitter had been especially designed for aircraft use, giving a maximum of power output for weight and size, the two most important limiting factors in aircraft equipment. Fully shock mounted, its light metal case enclosed a radio frequency unit giving a 100-watt unmodulated carrier and high quality speech equipment sufficient to modulate the transmitter 100 per cent from a microphone input. The total weight of the transmitter was eighty pounds.

The power supply was built into a metal box almost identical to that housing the transmitter. It consisted of two plate supply machines together with their respective filters and operating relays. The smaller of the two developed 300 volts for the plates of the speech equipment, exclusive of the 203-A modulators, and also fed the Type 47 oscillator. The modulator and RF tubes were supplied by the 1000-volt machine. Two 12-v, 150-ampere capacity batteries supplied the filaments, the relays, and the motors of the plate machines.

The crystal controlled Type 47 oscillator fed a single 802 buffer. This in turn drove a pair of 802's, which tubes supplied the grid excita-

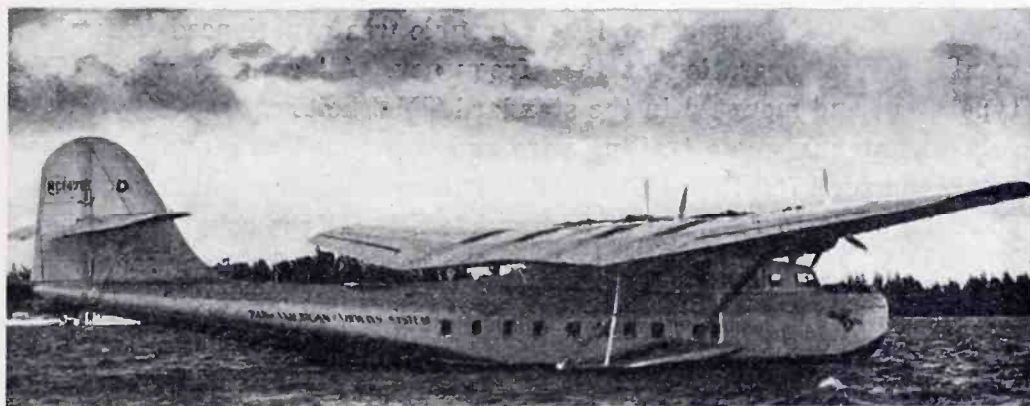

China Clipper at Miami.

tion for a pair of 800's in parallel. The output stage was modulated by a pair of 203-A's operating in class "B". All tank circuits were pre-tuned plug-in units in semi-enclosed cans, with the exception of the output plate tank. The output was matched to the antenna through a specially designed network.

The speech equipment consisted of two stages of resistance coupled Type 56's and a pair of 45's in parallel which drove the modulators. In addition there was a Type 56 audio oscillator for test work and ICW.

When the equipment was first installed, we made tests in flight with two types of microphones. These were the carbon and the inductor microphone. The velocity was out of the question due to the fact that it was necessary most of the time to hold the microphone in the hand and the condenser microphone necessitated additional battery supply and accordingly more weight. The RCA type 50-A microphone was found to be the most suitable for aircraft work. It is easily held in the hand and can be held close to the mouth somewhat in the manner of a close-talking microphone without there being any frequency discrimination or distortion. In addition, although there was not much noise from the four great motors of the clipper ships, the method that

could be employed in speaking into the microphone and the manner in which it could be held almost completely eliminated motor noise.

That portion of the spectrum allotted to re-broadcast being unquestionably unsuited to the contemplated plans of re-broadcasting from points enroute to Manila, the transmitter was licensed to operate on special experimental bands. One of the re-broadcast frequencies was used, however, for signals originating from the plane when it was within 200 miles of the receiving location. This was 2760 KC. The other frequencies were 4797.5 KC, 6424 KC, 8655 KC, and 12,862.5 KC. The transmitter operated at fundamental control with the exception of the 12 MC frequency. There were also provisions made to double down to the 8 MC frequency if any trouble was experienced in fundamental crystal operation at that frequency. All crystals were RCA type V cut and mounted in the standard TMV holder.

Our antenna was a trailing wire and was tuned as a quarter wave to ground for 2760 KC. With a 90-foot length of wire, all frequencies could be made to resonate at odd quarters by slight coupling tuning. All would have been serene, had we the sole use of this antenna. It was necessary, however, to share it with the ship's operator and sandwich in our work between the ten-minute operating periods of the ship. Inasmuch as our frequencies were not alike, this meant constant reeling and unreeling of the antenna.

On a ship of this size, additional antennas could easily be erected, but the drag of an antenna stretched between the tail surfaces and a wing tip is an important factor. Had we constructed such an antenna, computations show that in the long hop from San Francisco to Honolulu, it would be equivalent to 15 minutes extra fuel consumption. With load requirements which existed, this would have materially reduced the safety factor.

Our receiving antenna consisted of the after section of the ship's fixed antenna which runs from the tail surfaces to the leading edge of the wing. This antenna was split and insulated, and a lead was brought in through the navigators' observation hatch.

The inability to obtain clear channels for portable re-broadcast on frequencies higher than 2760 resulted in considerable interference being experienced on the special experimental frequencies. Successful tests had been completed prior to many particular broadcast periods, but by the time that broadcast period arrived, we would on many occasions find that we were sharing the band with someone else. This was particularly true on 4 and 6 MC as we neared the Orient. In some cases it was not so much the fact that other stations similarly licensed were creating the interference, but that adherence to published frequency assignment seems to be taken rather lightly by some Asiatic stations.

The schedule maintained by the radio operators of the clipper ships calls for communication to their land points at least once every ten minutes. With the exception of the hop from the West Coast to Honolulu, the ship is never more than 600 miles away from a land station. Only CW transmission is used on Pan American lines.

Our schedule called for a contact once an hour. The flight took 5 days and the average flying day was 12 hours. Although we only had 100 watts, we managed to conduct successfully 62 per cent of our scheduled programs. Experience on this flight, while not conclusive, indicated that at least 200 watts would have been necessary to assure reliable communication.

There were many interesting observations made concerning the function of altitude of the aircraft as it is related to the successful use of particular frequencies over certain distances. Notable among such experiences was one that occurred while flying between the islands of Midway and Wake. We were being received on this leg of the Pacific flight by RCA Communications, Honolulu. The distance from the plane to the Hawaiian Islands was approximately 1900 miles. Tests were made on both 4 and 6 MC and the former was found to be putting in a good signal to Honolulu. At this time the altitude of the Philippine Clipper was between 10 and 11 thousand feet. Weather reports from Pan American bases at Wake Island indicated that more favorable winds could be found at a lower altitude. Accordingly, Captain Tilton sent the great 25-ton flying boat down to within 2000 feet of the water. When the time for our next scheduled period arrived, Honolulu unceasingly called us, but attempts on all our frequencies to make contact were fruitless. We had travelled approximately 360 miles since our last contact. Listening at RCA Communications, Manila, over 4000 miles away, the operators picked us up on 8 MC, but by the time the information was received, our broadcast time period had passed.

After having originated some fifteen programs as we winged our way westward over the world's greatest ocean, we came to our final program before landing at Manila. We were about 900 miles east of Manila when Burke Miller, our program representative, contacted the leading officials of the Philippine government. This program was put on the local radio station and created quite a sensation among native residents as well as the foreign population. The newspapers devoted considerable space to the story of the arrival of the Clipper and the greetings extended by NBC aboard this history-making craft.

In locating their way stations for refueling the ships as they fly from the United States to the Orient, Pan American Airways has utilized four islands in the Pacific. The Hawaiian Islands and Guam are sizeable islands and the former is famed the world over for its beauty.

The latter is chiefly known as a Naval fueling station. The remaining two, however, are comparatively unknown, and appear as mere dots on the map. They are Midway and Wake.

Midway Island has been occupied as a cable repeater station since 1907 and since that time the employees of the cable company have been able to make a comfortable home and surroundings for themselves. The airways company occupy a portion of the island and have erected machine shops, radio stations, and homes for the men. Perhaps the most interesting island is Wake. Before the landing of the Pan American forces, this was practically a virgin island. Some German sailors had occupied it in the middle of the 19th century, when their ship was dashed against the shoals during a storm. They were rescued not long thereafter by Japanese fishermen, however, and except for an occasional Japanese fishing boat crew's visit, it has been uninhabited.

From a height of 5000 feet, the Wake group which consists of the three islands of Wake, Wilkes, and Peale, appears as but a tiny dot surrounded by white foam. As the ship comes down lower and lower to make its landing in a reef-protected lagoon, the white foam resolves itself into giant breakers rolling ashore and striking the reef. Safely down and tied to the landing float, one is on an island which has an area of one square mile. The lagoon abounds with tropical fish. An occasional shark and now and then an octopus is washed over the reef by the surf and swims about in crystal clear water with a depth not exceeding twelve feet. A struggling and hardy type of vegetation manages to gain sustenance in the rocky and sandy soil. A whir is heard overhead and a group of frigate birds and Arctic terns soar above the giant man-made bird riding on the smooth blue-green waters of the lagoon. These wild creatures alight at your feet and seem to be totally unafraid of man.

It does not seem possible that one left New York 7300 miles away just four days ago, and yet we are on an island in the Pacific enjoying a Wednesday afternoon siesta as we listen to a New York dance orchestra playing for dancers after midnight on a Tuesday. Fantastic as this may seem it is possible today as a result of modern aviation and radio.

On the return trip, the most interesting program was the singing of Christmas carols by seven members of the crew. Denied a Christmas at home by their participation in the flight, the entire crew joined their voices in song as the ship left Christmas in Honolulu behind and sped through the night for California, 2100 miles away.

OUR CONTRIBUTORS

MAX C. BATSEL, upon receiving his degree of B.M.E. in 1915 from the University of Kentucky, joined the Western Electric Company. In 1916 he went with the Bureau of Standards. In 1918 he was commissioned a lieutenant in the Signal Corps. In 1920 Mr. Batsel became engineer in charge of radio receiver development and design for the Westinghouse Company and in 1929 joined RCA Photophone, Inc., as Chief Engineer. When the Photophone Company was taken over by RCA Victor in 1932, Mr. Batsel became section engineer, Photophone Development and Design.



M. C. BATSEL

IRVING F. BYRNES entered the General Electric Test Department in 1918 and later engaged in radio development in their Engineering Laboratory. From 1920 on he was occupied in the development of radio equipment for commercial and military vessels, submarines and aircraft. He participated in the design and tests of the early ship-to-shore duplex radio telephone equipment used on the *SS. America* in 1922. Mr. Byrnes joined the Engineering Department of RCA Manufacturing in 1930, later in that year transferring to the Radiomarine Corporation of America of which he has since been in charge of engineering activities.



IRVING F. BYRNES

WILLIAM F. DIEHL is an alumnus of Columbia University. He is a Fellow, Radio Club of America and a Fellow, Institute of Radio Engineers. He is the on Standards Committee of I.R.E., and was Chairman of the I.R.E. Ninth Annual Convention. He also is a member of the Committee on Acoustic Measurements and Terminology, A.S.A., and is on the sub-committee for instrument methods of E.E.I., N.E.M.A., and the R.M.A. In 1918 he was appointed instructor and inspector for the U.S.N.R.F., following which he joined with A. H. Grebe as Chief Engineer. The end of the year 1928 saw him as Assistant Engineer in Charge of Radio for the Victor Talking Machine Company, and the following year as Division Engineer, in Charge of the Laboratory Methods and Equipment Section. He is now in charge of the Piezo Electric Applications Sections of RCA Mfg. Co.



W. F. DIEHL

ORVILLE E. DOW received his degree of B.S. in electrical engineering from the University of Colorado in 1928, and in the same year joined the Transmitter Research and Development Laboratory of R.C.A. Communications, Inc., in which activity he is still engaged.



ORVILLE E. DOW

JOHN L. GALLUP received the degree of B.S. in Ceramic Engineering from Alfred University in 1931, and the degree of M.S. from Rutgers University in 1933. For the past four years he has been research ceramist and microscopist for the Radiotron Division of the RCA Manufacturing Company. His prior engineering activities included several years as assistant in the General Electric research laboratory and a year as research and teaching assistant at Rutgers University. Mr. Gallup is an abstractor for the publication *Ceramic Abstracts* and is a member of the American Ceramic Society; Keramos, and Sigma Xi.



JOHN GALLUP



E. W. KELLOGG



V. D. LANDON



DAVID G. C. LUCK



GEORGE M. NIXON



HAROLD P. SEE



BERTRAM TREVOR



CHARLES J. YOUNG

EDWARD W. KELLOGG's interest in sound and related subjects started while an instructor in electrical engineering at the University of Missouri. Through several years of teaching in universities, he specialized in sound and telephony. He joined the Research Laboratories of the General Electric Company, where he worked on submarine detection apparatus. After the war he worked on long wave reception and later on loudspeakers. He assisted in the early development of sound recording on film. Probably his most important work at that time was on the mechanical system for moving the film past the sound recording or reproducing point, the outcome of which was the magnetic drive. Upon transferring to the RCA Victor Company, Mr. Kellogg was in charge of the Recording Section. In 1932 he changed to the Research Laboratories, where he engaged on problems relating to disc recording and speed measurements. He is now in charge of the Advance Development Section in the Photophone Division of RCA Manufacturing Company.

VERNON D. LANDON, following his graduation from Detroit, Jr. College, became a Westinghouse engineer and for six years was in charge of their radio frequency laboratories. In 1929 he went with the Radio Frequency Laboratory in Boonton, N. J., as Assistant Chief Engineer, and in 1931 became Assistant Chief Engineer for Grigsby-Grunow. Since 1933 he has been with the Engineering Department of RCA Manufacturing Company.

DAVID G. C. LUCK attended the Massachusetts Institute of Technology, from where he received his Bachelor of Science degree in 1927 and his Doctor of Philosophy degree in 1932. He held a Swope Fellowship in Physics, a Malcolm Cotton Brown Fellowship, and was Assistant, Department of Physics, M.I.T. Dr. Luck joined the Research Division of RCA Victor in 1932. He is a member of the American Physical Society.

ROBERT M. MORRIS—See July, 1936, issue.

GEORGE M. NIXON attended Pratt Institute and New York University. Since 1928 he has been engaged in general development work in the Development Group of the National Broadcasting Company. Mr. Nixon is a member of the Acoustical Society of America and the American Institute of Electrical Engineers.

HAROLD P. SEE spent three years as a newspaper reporter, then engaged in radio receiver construction work and later became a commercial radio operator. He joined the National Broadcasting Company in 1930 as field engineer and in 1936 was transferred to his present position in the NBC Development Group.

BERTRAM TREVOR received his E.E. degree from Cornell University in 1928, and in the same year joined the Research and Development Division of R.C.A. Communications, Inc., where he has since remained.

CHARLES J. YOUNG graduated as a Bachelor of Arts from Harvard University in 1921. After spending a year at the Harvard Engineering School, he joined the General Electric Company. Since 1930 he has been engaged in research work for RCA Manufacturing Company.

