

Plain Talk

and Technical Tips

RCA Corporation
Consumer Electronics

Technical Training
600 N. Sherman Drive
Indianapolis, Indiana 46201

New RCA Color TV Alignment Probes

Two new probes which make color TV alignment easier and quicker have been announced by RCA Electronics Components.

RCA WG-450A ChroMarker Probe

Function and design

This new probe, shown in Figure 1, develops 3.08-MHz and 4.08-MHz notch-type markers on direct video sweep response curves. The probe consists of two high-Q absorption traps, one tuned to 3.08 MHz and the other tuned to 4.08 MHz, which, when the probe is connected to the output of a source of video sweep signal, absorb a small amount of the sweep signal at these frequencies. This, in turn, produces small notches, or dips, at the 3.08-MHz and 4.08-MHz positions on the displayed response curve.

Identification of the two markers is provided by a small contact on the cable end of the probe which, when touched, eliminates the 4.08-MHz marker.

Application

A typical application of the WG-450A ChroMarker probe is illustrated in Figure 2. This is the test setup and response curves for direct video sweep alignment of the two-stage chroma bandpass section in an RCA hybrid color TV receiver. The video sweep signal from the RCA WR-514A TV Sweep Chanalyst is applied through the WG-450A probe to the grid of the 1st chroma amplifier. The scope input is connected through a WG-434A chroma/video detector probe to the grid of the 2nd chroma amplifier. The transformer in the plate circuit of the 1st chroma amplifier is tuned to produce the response curve labeled (1) *1ST CHROMA*. The scope input then is moved to the secondary of the transformer in the plate circuit of the 2nd chroma, and this transformer is tuned to produce the response curve labeled (2) *2ND CHROMA*.

Completion of the preceding two alignment steps is followed by adjustment of the chroma take-off coil. The test setup in Figure 2, including the WG-

450A, is *not* used for this final step in the alignment of the chroma bandpass amplifiers. Instead, an *IF* sweep signal is applied to the collector of the 1st mixer in the tuner. This *IF* sweep signal is processed by the video *IF* amplifiers and then is converted to a video sweep signal by the video detector. After amplification by the 1st video amplifier and chroma preamplifier, the video sweep signal then is applied through the chroma take-off coil to the chroma bandpass section. In this manner, the sweep input to the chroma take-off coil reflects the overall response of the link, video *IF* and 1st video amplifier circuits, which, if these circuits are properly aligned, amplify the low (3.08) portion of the 1-MHz passband of the chroma amplifiers more than the high portion (4.08). To equalize the amplitude of the upper and lower portions of the chroma passband before application to the chroma bandpass amplifier section, the chroma take-off coil is

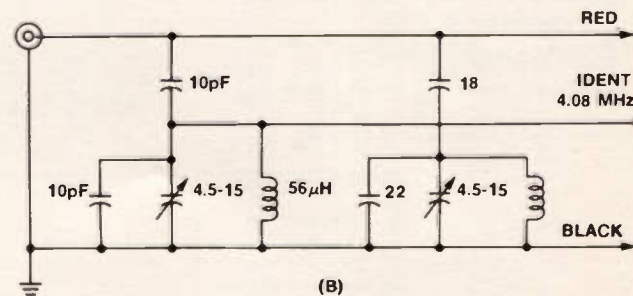
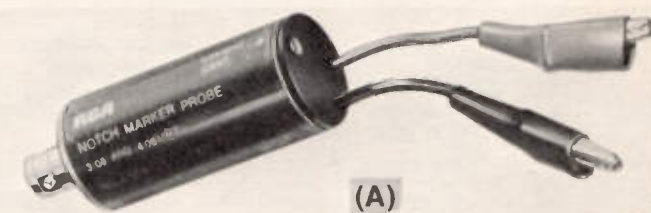

Figure 1—The RCA WG-450A ChroMarker probe. A) Photo of probe. B) Schematic diagram.

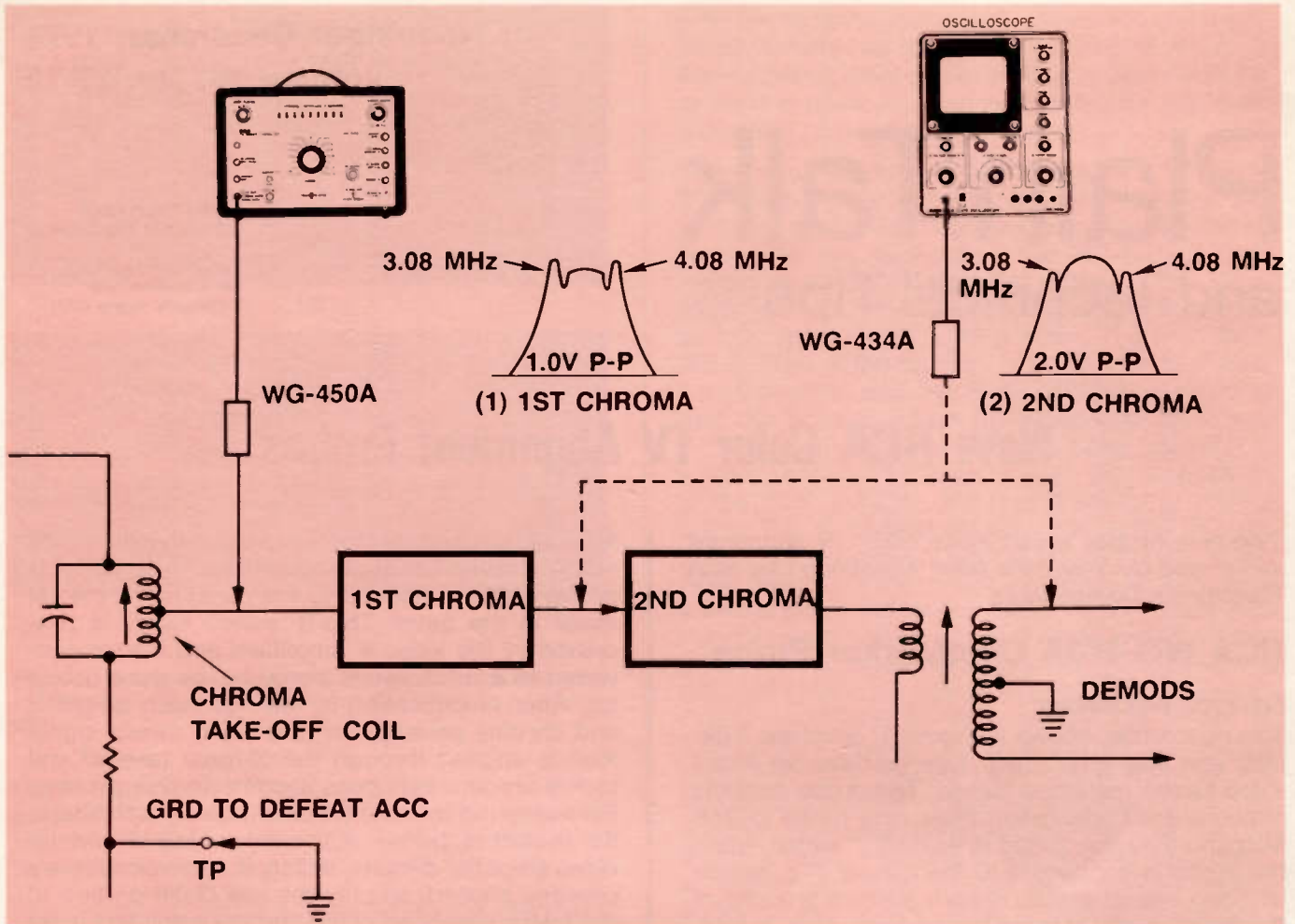

Figure 2—Functional diagram illustrating how the WG-450A ChroMarker probe is used to align the chroma bandpass amplifiers in RCA hybrid color TV receivers.

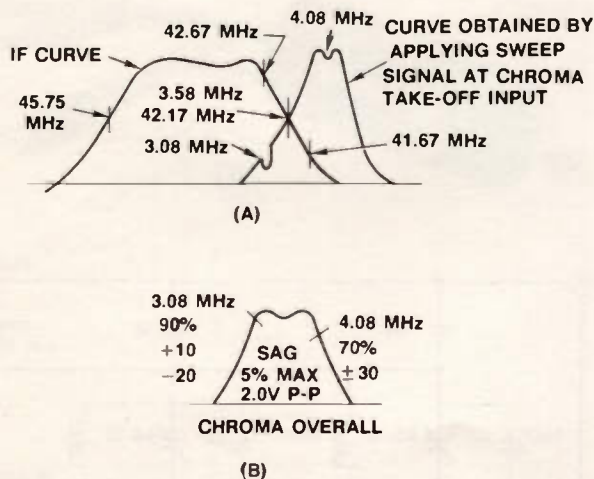

Figure 3—Response curves which illustrate the function and effect of the chroma take-off coil. A) Superimposed response curves of the video IF section and chroma take-off coil. B) Curve of desired overall chroma response.

adjusted to accentuate the higher portion of the chroma passband and reduce the amplitude of the lower portion. The correct relative responses of the link/IF section and the take-off coil, shown in Figure 3A, produce an input to the chroma bandpass section, which, with the chroma bandpass amplifiers aligned as described in the first two steps, establishes an overall chroma bandpass response which is relatively flat from 3.08 MHz to 4.08 MHz. The desired overall chroma response is shown in Fig. 3B.

RCA WG-449A 4.5-MHz Resonant Demodulator Probe

Function and design

This new probe, shown in Figure 4, recovers the modulation on a 4.5-MHz sound carrier and blocks or reduces all other frequencies. The frequency-selective characteristics of this probe make adjustment of the 4.5-MHz sound trap in color television receivers easier by eliminating most of the harmonics and harmonic products which cause signal-obscuring "hash" in or on the pattern dis-

played by the scope. The probe, when used with a VTVM or VOM, also makes possible accurate 4.5-MHz trap adjustment with the receiver tuned to an off-the-air signal.

The probe consists of a 4.5-MHz series-resonant input circuit, a voltage doubler and an RC output filter, as illustrated by the schematic diagram in Figure 4B.

Applications

The 4.5-MHz sound carrier is recovered in the video detector by the "mixing" of the 45.75 IF picture carrier and the 41.25 IF sound carrier. If the 4.5-MHz sound carrier is allowed to feed into the chroma section of the receiver, it will beat with the 3.58-MHz chroma reference subcarrier, producing a 920-KHz "difference" signal, which will cause a "herring-bone" pattern on the receiver. To prevent the 4.5-MHz detected sound carrier from reaching the chroma take-off coil, a 4.5-MHz trap is built into the color receiver between the video detector and the 1st video amplifier. The method of adjusting the 4.5-MHz trap by using the RCA WG-449 probe, a WR-514A TV sweep chanalyst and a WO-505A scope is illustrated in Figure 5. This method makes adjustment of the 4.5-MHz trap a continuation of IF alignment. Because correct alignment of the chroma take-off coil and, therefore, overall chroma response, is dependent on correct adjustment of the 4.5-MHz trap, the trap always should be ad-

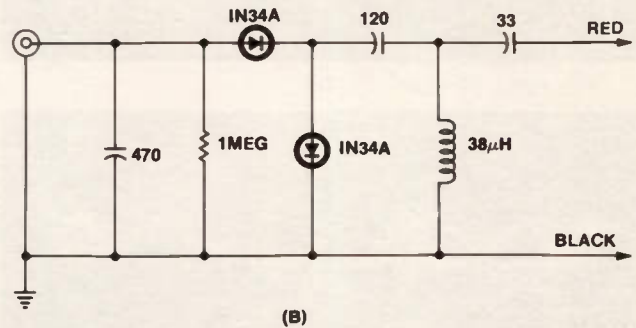
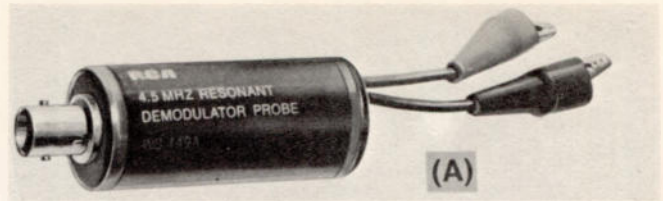

Figure 4—The RCA WG-449A 4.5-MHz Resonant Demodulator Probe. A) Photo of probe. B) Schematic diagram.

justed before chroma bandpass alignment is attempted.

With the test equipment connected and adjusted as illustrated in Figure 5, the 4.5-MHz trap is tuned to produce minimum amplitude of the detected

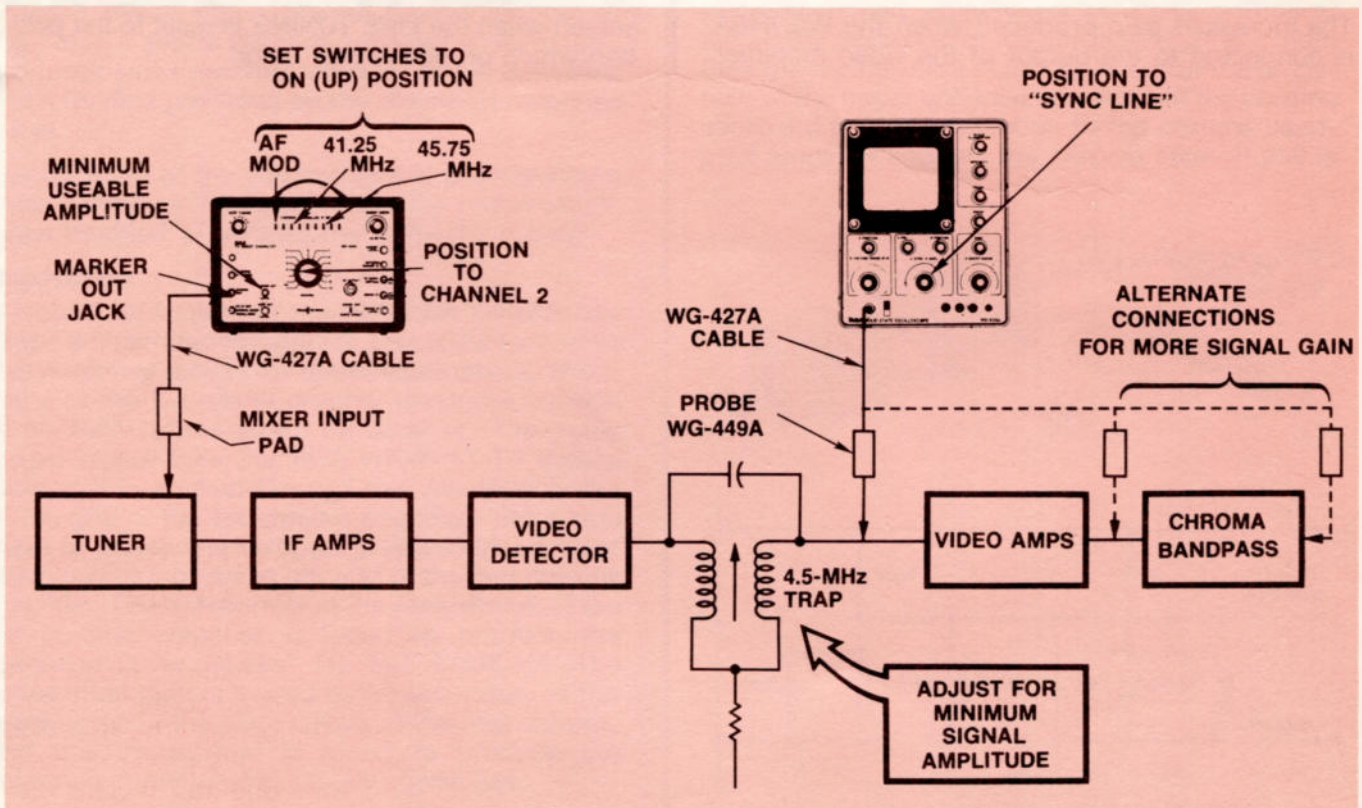
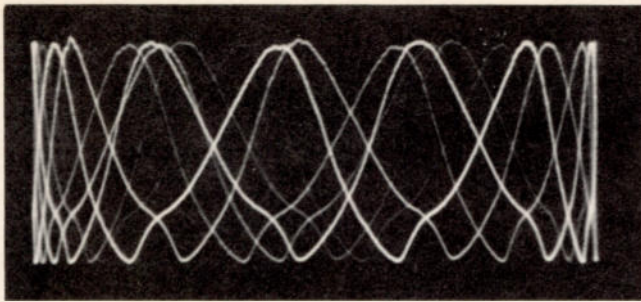
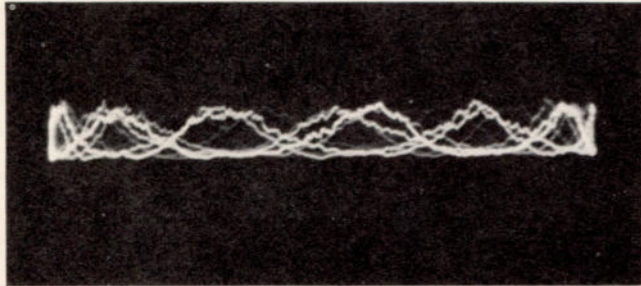

Figure 5—Functional diagram illustrating how the RCA WG-449A probe is used for adjustment of the 4.5-MHz trap in a color TV receiver.



(A)



(B)

Figure 6—Scope displays produced by the test setup illustrated in Figure 5. A) 4.5-MHz trap mistuned. B) 4.5-MHz trap correctly adjusted.

signal displayed by the scope. The scope display produced when the trap is mistuned is shown in Figure 6A. Correct trap adjustment produces a scope display like that in Figure 6B.

The increased gain produced when the WG-449A is connected to the output of the video amplifier

or to any point within the chroma bandpass amplifier(s) permits use of a VTVM or sensitive VOM as the indicating device in place of a scope. If a VTVM or VOM is used, the trap is adjusted for minimum deflection of the meter pointer.

The use of the WG-449A probe with a VTVM or VOM also makes possible accurate in-home adjustment of the 4.5-MHz trap using an off-the-air signal. For this application, the WG-449A is connected to a convenient point following the video amplifier or in the chroma bandpass section, such as the top of the COLOR control. The CHANNEL SELECTOR of the receiver is positioned to a local active channel and the FINE TUNING is adjusted past the position which produces best color and into the position where a herring-bone (sound bar) pattern is produced on the screen. (At this position of the FINE TUNING, the sound carrier is shifted out of the 41.25-MHz sound traps in the IF, producing an excessively strong sound carrier at the video detector. This, in turn, produces an excessive 4.5-MHz detected sound carrier which feeds into the chroma circuitry, where it beats with the 3.58-MHz chroma reference subcarrier, producing the 920-KHz difference signal which causes the herring-bone pattern on the screen.) The VTVM or VOM is set on a range which produces a mid-scale indication. The 4.5-MHz trap then is adjusted for minimum deflection of the meter pointer. If the trap is correctly adjusted and the alignment of the RF, IF and chroma sections of the receiver is correct, no herring-bone pattern will be produced on the screen when the FINE TUNING is reset to the position which produces best color. □