

# PLAIN TALK

AND

# Technical Tips

RCA RCA VICTOR

VOL. 7

NO. 7

JULY, 1964

a monthly publication for the service industry about products of: RCA VICTOR HOME INSTRUMENTS OPERATIONS  
RADIO CORPORATION OF AMERICA

## THE CTC 16

The CTC 16 color receiver represents still another advance in color performance for RCA.

Similar in basic layout to the previous CTC 15, this new chassis has improved color rendition, maintained reliability, and higher performance.

As with Black and White television, the Color receivers for 1965 will be factory equipped for all channel UHF reception.

Several refinements have been incorporated in the CTC 16 chassis including a new placement of front

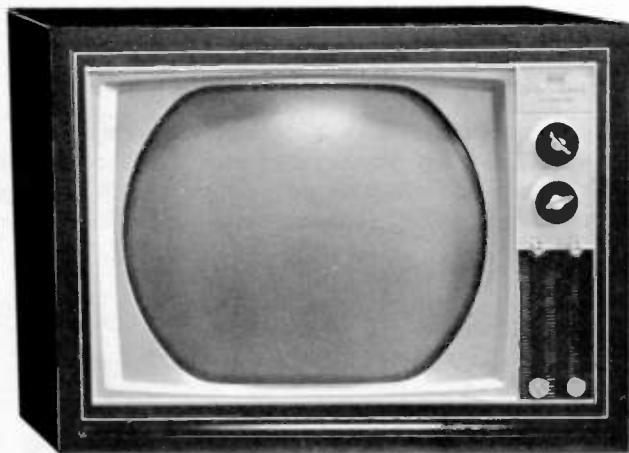

Figure 1—FF-567E Receiver

panel operating knobs; this permits new variations in overall cabinet styling.

There are many continuing features which are carried over to the CTC 16 which have proven successful and desirable in previous chassis.

A redesigned high voltage compartment is employed in the CTC 16; this permits relocation of the shunt regulator to a more accessible area, giving better ventilation for this tube. The shunt regulator itself is a 6BK4A capable of higher dissipation than the previous 6BK4. A new molded cap is used which has higher insulating properties from both a heat and high voltage standpoint.

## Chassis Ventilation

Heat reduction is one of the primary considerations in achieving reliable, trouble-free performance in television receiver design. The CTC 15 of last year introduced many innovations which contributed to heat reduction; this year the CTC 16 carries on these features such as the use of novar tubes, special mounting socket for the horizontal output tubes, the use of sealed circuit boards, etc. In addition the new sound board and the relocation of the shunt regulator contribute even more to improved heat dissipation. The shunt regulator plate cap is newly designed, providing for additional air flow due to its ribbed construction.

## New Video Tube

A new tube type, the 6LF8 is employed as 1st and 2nd video. This tube is similar to the 6AW8 but with selected characteristics to provide optimum performance as a positive grid amplifier.

## Convergence

The setup procedure for the CTC 16 retains the same basic features as used previously.

An improvement is made in the labeling of the controls on the convergence board. Each control is identified and indicates the function of the control based upon its effect on the crosshatch test pattern. The service switch and picture tube bias switch, as well as the screen and video drive controls, continue

(Continued on Page 2)

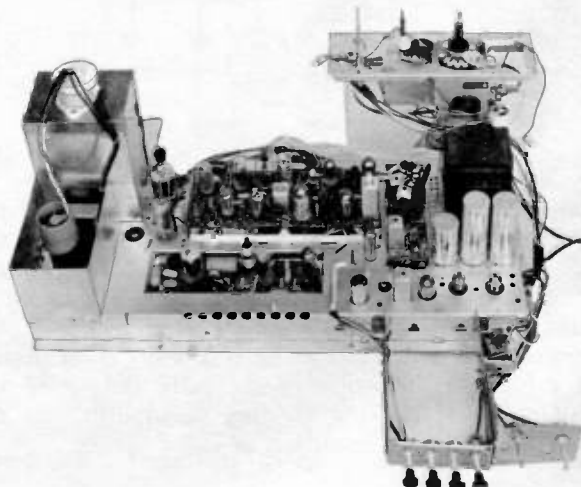

Figure 2—CTC 16 Chassis

# THE CTC 16

(Continued from Page 1)

in the CTC 16. The adjustment procedure for all convergence and temperature adjustments remain the same as the previous color chassis. Better control of the lateral motion of the blue beam is accomplished with a new blue lateral magnet. All rectifiers used in the convergence circuit are included in a single rectifier unit.

## Focus Circuit

A new focus adjustment transformer permitting greater variation and faster action is used in the CTC 16 chassis. A tube type focus rectifier is used; the overall focus circuit gives minimum loading of the high voltage transformer.

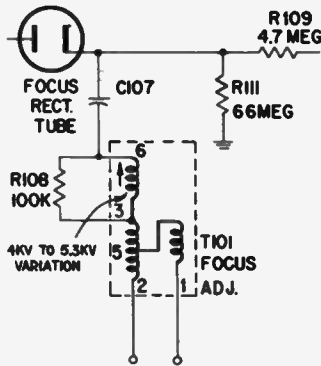

Figure 3 — Improved Focus Circuitry

## Color Circuits

Basically the chroma section of the CTC 16 retains the familiar circuitry as used in the CTC 15; however, a change in the operation of the "X" and "Z" demodu-

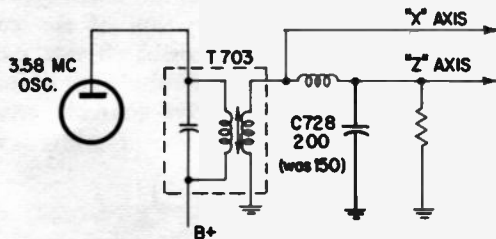

Figure 4 — Improved Color Rendition

lators has been introduced. A change in value of the capacitor, C728, results in greater displacement of the "X" and "Z" axes; this gives better color rendition. The need for the change is based upon the range of colors delivered by the sulphide type picture tube; therefore the demodulators in this way "compensate" for the slight difference in the color output of the sulphide tube. From a viewing standpoint, the net effect will be truer rendition of color values.

## Automatic Degaussing

A new feature is included in all wood cabinet Color receivers which automatically degausses the receiver. Automatic Degaussing or "ADG" is accomplished during initial warm-up each time the set is turned on. At the time the power switch is turned on, the chassis and power supply circuit cause a substantial current flow, part of which flows through the degaussing coils. RT201, being temperature dependent, has about 120 ohms resistance at this time. RV201 presents a low resistance since it is voltage dependent, and an AC voltage is present at this time.

As RT201 heats, its resistance drops to about 2 ohms shunting the Automatic Degaussing coils. Also since AC is now lowered across RV201, its resistance rises. The accumulative effect is that after warm-up of the receiver, very little current flows through the ADG coils and degaussing ceases. This action takes place prior to the appearance of a picture on the screen and thereby causes no distraction to the viewer.

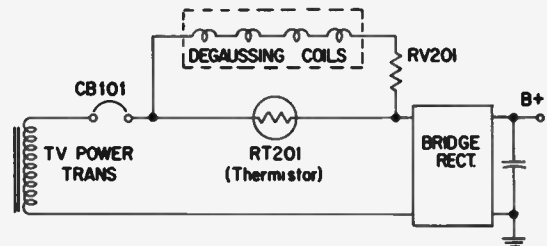

Figure 5 — Automatic Degaussing

## Video Peaking

A new selection of peaking levels are included in the CTC 16 video peaking circuitry. On the highest position of the three-position peaking switch a sharp picture is produced without "ringing" effects. The

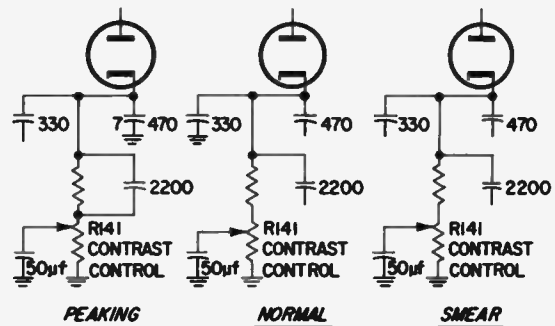

Figure 6 — Improved Peaking Switch Action

middle position gives uniform video response, and in the lowest position a "soft" picture can be produced. Since the transmitted picture can vary somewhat in different geographical areas regarding picture detail, the switch can be thrown to the position giving the

# THE CTC 16

(Continued from Page 2)

desired video response based upon signal conditions and customer viewing preference. All color receivers are shipped from the factory with the video peaking switch in the middle position.

## Low Voltage Supply

Refinements in the low voltage (B+) supply also have taken place in the CTC 16. A bridge-type rectifier is used giving full wave rectification and less ripple. Silicon rectifiers are used in this circuit; the

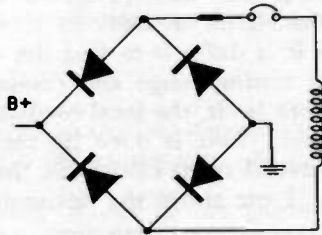

Figure 7 — Bridge Type Low Voltage Rectifier

rectifying diodes are mounted on a new sound board. The components, RT201 and RV201, for the "ADG" circuit are also mounted on the sound board. A 128 volt line tap is provided from the power transformer which can be used in the event that high line voltage operation is required.

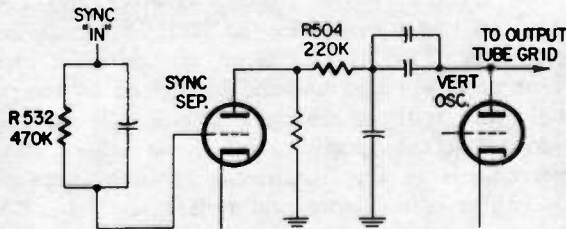

Figure 8 — Improved Vertical Sync

## Vertical Circuit

The CTC 16 vertical circuit provides for stabilized picture size with the use of the "Voltage Dependent Resistor" in the grid circuit of the vertical output tube. Improved vertical synchronization is included in this new chassis; R532 and R504 in the sync circuits have been changed in value to optimize the lock-in characteristics of the CTC 16.

## Other Circuit Refinements

The new CTC 16 color chassis includes several engineering improvements in other areas of the receiver.

The CTC 16 employs an improved horizontal efficiency circuit. Extended life of the horizontal output tube and improved horizontal linearity result from this new design. The adjustment procedure for the

horizontal efficiency coil remains the same as that used in the previous CTC 15 chassis.

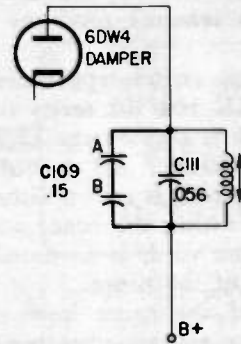

Figure 9 — Improved Horizontal Efficiency Circuit

Another refinement is in the AGC filtering components which feed the 1st picture IF amplifier. This involves a choice of a 100 k resistor in the grid circuit of this stage; good AGC action results with a minimum tendency of AGC "lock-out."

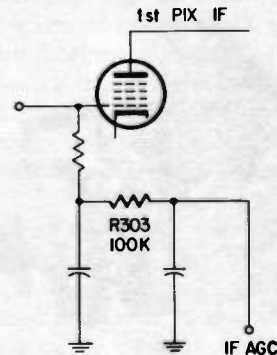

Figure 10 — Improved AGC Filtering

In the event of a failure of the shunt regulator tube, the high voltage developed would have a tendency to soar to a level which would be undesirable. An interconnection is made between the blanker tube grid and the horizontal output grid. A high negative voltage will appear at the blanker grid connection if such failure occurs; this negative voltage is in turn applied as bias to the horizontal output tube which prevents an excessive rise in high voltage.

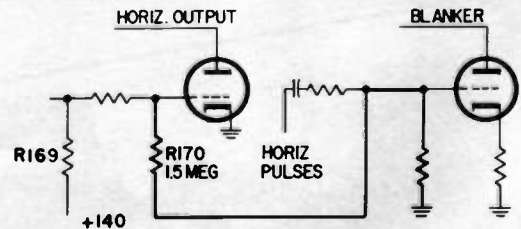

Figure 11 — Added Hi-Voltage Limiting

The high standards set by RCA engineering in Color television is reflected in the overall performance of the new CTC 16 color chassis.

As always, special attention is given to the serviceability aspects by providing the service technician with highly legible roadmapping, simplified adjustments, and full accessibility to components and test points.

## THE KRK 118 TUNER

The KRK 118 tuner is used on all 1965 Color instruments. The KCS 136X and the KCS 149 Black and White (non remote) receivers also employ the KRK 118 tuner.

This four-circuit switch-type tuner is an improvement on the KRK 104/108 series tuners. Channel 1 position is wired as a two-stage IF amplifier for the output of the UHF tuner. All switching functions, except dial light control, is accomplished by wafer type switches located within the tuner assembly. The dial light switch, when used, is mounted on the control shaft at the rear of the tuner.

All versions of the tuner have concentric preset fine tuning, using a similar mechanism as employed in current production tuners. When used on remote control Color instruments, the tuner is programmed to bypass any channel by turning the fine tuning control 7 turns in a clockwise direction. By fine tuning for best sound and picture on the bypassed channel the tuner will re-program that channel.

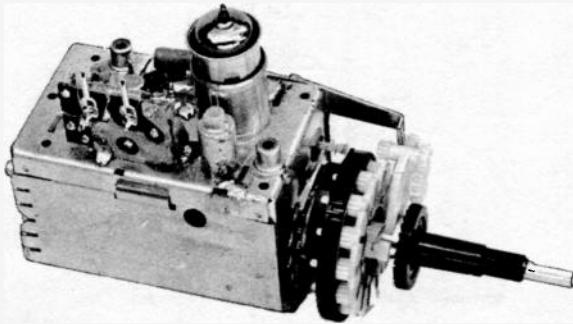

Figure 12 — KRK-118

The KRK 118 tuner is specifically intended for use in all-channel receivers. The signal-to-noise figure of this tuner has been improved over previous models by the better selectivity of the RF circuits, more efficient coupling from RF plate to mixer grid, and improved oscillator injection.

Alignment procedure for the KRK 118 is basically the same as for current production four-circuit tuners such as the KRK 108.

The tuner uses an improved combined mixer-oscillator tube, the 6KZ8. The RF tube is the nuvistor 6CW4 for Black and White receivers and the 6DS4 in Color instruments. Oscillator injection limits are from -2 volts to -4 volts. The new limits stem from the new tube characteristics as well as oscillator injection circuit changes.

Oscillator adjustments are made at channel 13 and channel 6. Access to these adjustments can be achieved by simply removing the channel selector knob and fine tuning knob. The fine tuning has enough range to enable the oscillator to track at all other channel settings. Since it is difficult to find the electrical center of the fine tuning range and comparatively easy to locate the high limit, the local oscillator is adjusted at the high limit. This is done by turning the fine tuning knob several turns clockwise, then setting the local oscillator 2 mc above the optimum frequency.

## 6LF8 VIDEO AMPLIFIER

The CTC 16 uses a new tube type in the 1st and 2nd video amplifier. This tube, designated as the 6LF8, has the same electrical characteristics and basing connections as the 6AW8A; however, the tube is especially selected and must undergo a test for positive grid operation. Optimum and uniform video performance is realized by the use of the new 6LF8.

## COLOR REMOTE CONTROL

The CTP10 remote control receiver and CRK6 Hand Unit will be used for the CTC 16 remote series instruments. This is the same system used in the current receivers and will be continued in the 1965 model year without change. There will be minor variations in the location and mounting of the receiver chassis in the instrument cabinets, depending upon cabinet dimensions and styling.

## RCA SALES CORPORATION

600 NORTH SHERMAN DRIVE  
INDIANAPOLIS 1, INDIANA

A RADIO CORPORATION OF AMERICA SUBSIDIARY

Tmks. © Reg. U. S. Pat. Off.