

J. D. Callaghan, 215-800

RCA ENGINEER

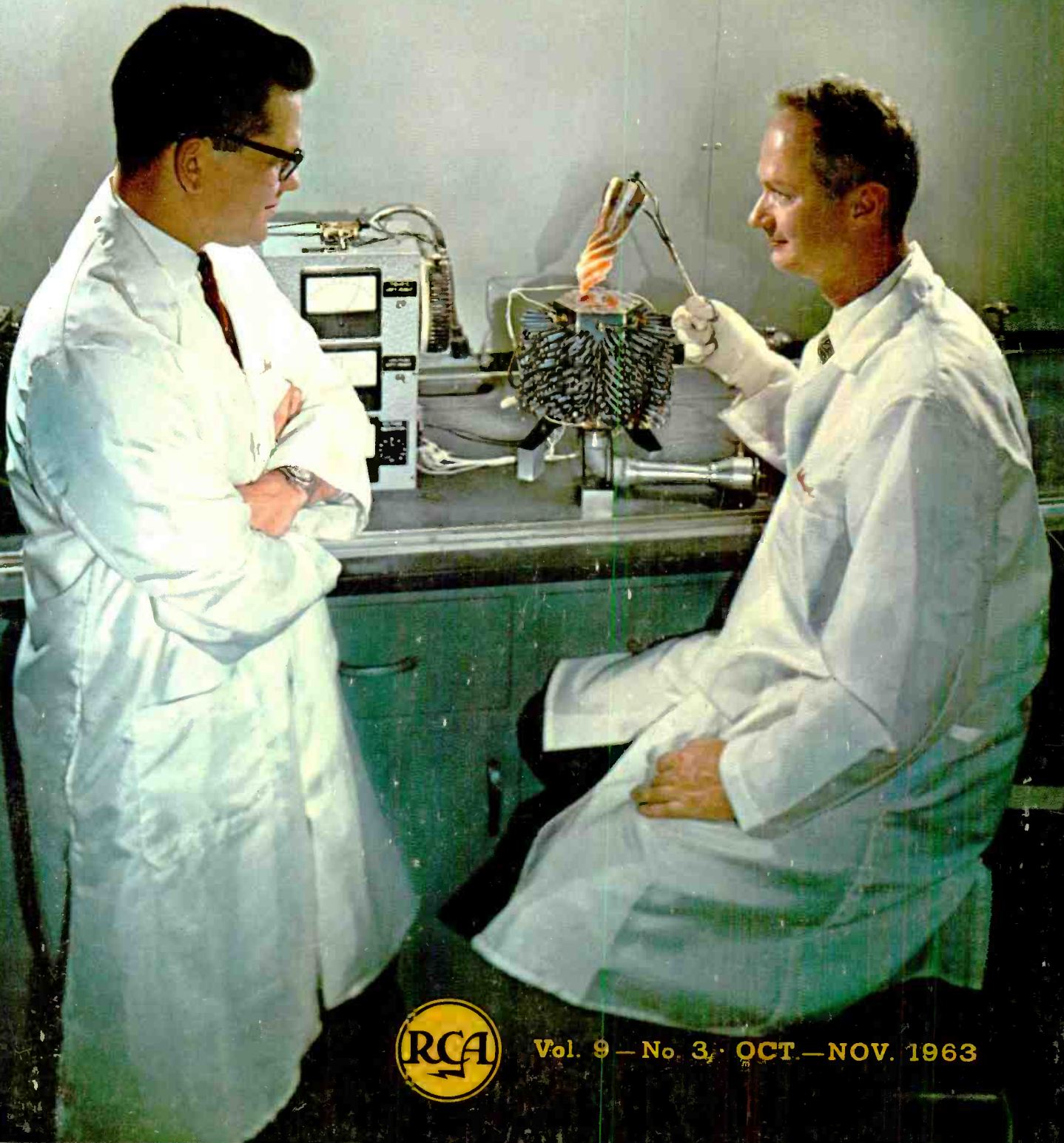

Vol. 9 - No. 3 - OCT. - NOV. 1963

RCA ENGINEER Staff

W. O. Hadlock Editor
E. R. Jennings Assistant Editor
Mrs. C. S. Marchionni Editorial Secretary
J. L. Parvin Art Director
J. O. Gaynor Photography

Engineering Editors

C. A. Meyer, Mgr., Commercial Engineering
Technical Services,
Electronic Components and Devices
T. T. Patterson, Mgr., Technical Publications,
Electronic Data Processing Engineering
C. W. Sall, Technical Publications
Administrator, RCA Laboratories
L. A. Thomas, Mgr., Publications Services
Astro-Electronics Division
F. D. Whitmore, Technical Publications
Administrator, Defense Electronic Products

Editorial Advisory Board

E. I. Anderson, Mgr., Operations,
RCA Victor Home Instruments Division
A. D. Beard, Chief Engineer
Electronic Data Processing
J. J. Brant, Director, Personnel
C. C. Foster, Mgr., RCA REVIEW
M. G. Gander, Mgr., Consumer Product
Administration, RCA Service Co.
Dr. A. M. Glover, Division Vice President
Technical Programs,
Electronic Components and Devices
C. A. Gunther, Division Vice President,
Technical Programs, DEP and EDP
E. C. Hughes, Administrator, Technical
Committee Liaison,
Electronic Components and Devices
E. O. Johnson, Mgr., Engineering,
Technical Programs,
Electronic Components and Devices
W. C. Morrison, Chief Engineer, Broadcast and
Communications Products Division
D. S. Rau, Vice President Engineering,
RCA Communications, Inc.
H. E. Roys, Chief Engineer,
RCA Victor Record Division
D. F. Schmit, Staff Vice President,
Product Engineering
C. M. Sinnett, Director, Product Engineering
Professional Development
V. E. Trouant, Chief Technical Administrator,
Broadcast and
Communications Products Division
Dr. H. J. Watters, Chief Defense Engineer,
Defense Electronic Products
J. L. Wilson, Director, Engineering
National Broadcasting Co., Inc.

OUR COVER

... an experimental 50-watt silicon-germanium thermoelectric generator developed by RCA. It converts heat from a propane burner directly into electrical energy with no moving mechanical parts. Shown are design engineers Dr. Andrew Dingwall (left) and Robert Buttle of the Thermoelectric Products Engineering activity of the Special Electronic Components Division, Electronic Components and Devices, Harrison, N. J.

Direct Energy Conversion

This issue tells a story of high technical accomplishment by a number of RCA scientists and engineers in the rapidly moving and exciting field of *direct energy conversion*. The story would not be complete, however, without recognizing the contributions of thousands of other RCA scientists and engineers who helped generate the profits needed to support this promising new corporate opportunity. Without their work, parts (if not all) of this issue could not have been written. This story, then, emphasizes the great team strength of RCA in securing the future of us all.

RCA is in the enviable position of having the skills and experience which made it possible to recognize the opportunity and meet the challenge which direct energy conversion presents. Much has already been done, as you will see in the pages that follow—but still *more* remains to be accomplished. The final measure of success will be to guide this new and challenging opportunity into a profitable growth business. To accomplish this we must exploit the momentum of our technical progress. But of equal importance is the continuing vital need to stimulate profitable growth in our established operations so that we can support the growth of our new businesses. *This* is the story of RCA's success. In this sense, all RCA engineers can share in the pride of accomplishment and the responsibility for the future of RCA's direct energy conversion effort.

W. W. Watters

W. W. Watters
Group Executive Vice President
Radio Corporation of America





VOL. 9, NO. 3
OCT.-NOV. 1963

CONTENTS

	The Engineer and the Corporation: Modern Management for R&D Programs?; A Case Study—TRADEX	R. A. Newell	2
	Decision	E. A. Laport	8
	Direct Energy Conversion—A Management Viewpoint	L. R. Day	9
	RCA's Role in Direct Energy Conversion	D. W. Chace	10
	Thermoelectrics for Power—A Look at Product Engineering Potentials. .	R. L. Klem	14
	Fossil-Fuel Thermoelectric Generators. . .	W. F. Lawrence and Dr. A. G. F. Dingwall	16
	Thermoelectrics for Space.....	L. J. Caprarola and W. J. Helwig	21
	Design and Analog of a Thermoelectric Refrigerator for the MICROPAC Core Memory	G. Rezek	24
PAPERS	Thermoelectric Refrigeration, Heating, Temperature Control, and Distillation	P. E. Wright	28
	Magnesium Reserve Batteries	Dr. G. S. Lozier	33
	Solar Cells 1963—A Status Report	P. Rappaport	36
	Magnetohydrodynamic Power Generation—Status and Prospects	Dr. K. H. Fishbeck	40
	Superconducting Magnets	N. S. Freedman	44
	The Thermionic Energy Converter	F. G. Block and Dr. K. G. Hernqvist	48
	Some Recent Developments in High-Sensitivity, Cooled-Filter, Infrared Detectors	Dr. H. Pullan	53
	Computer Technology Prognosis—1970 and Beyond	Dr. Y. Chu	56
	Uses of Radioisotopes in the Semiconductor Field at RCA	W. Kern	62
	Radar Geodetic Measurements with a Passive Satellite	A. Reich	67
	Interferometer Horn Antenna	A. J. Bogush, Jr.	70
NOTES	Development of a New Package for Tunnel Diodes	W. H. Liederbach	73
	Five-Layer Diode Guards Electronic Equipment at Cable Termination	H. R. Montague	73
	Domain Structure in Liquid Crystals	Dr. R. Williams	74
	VSWR of Broadband Waveguide Series-T Junction	R. M. Kurzrok	74
DEPARTMENTS	Pen and Podium		75
	Professional Activities—Dates & Deadlines		75
	Patents Granted		76
	Engineering News and Highlights		77

A TECHNICAL JOURNAL PUBLISHED BY **RADIO CORPORATION OF AMERICA**, PRODUCT ENGINEERING 2-8, CAMDEN, N. J.

- To disseminate to RCA engineers technical information of professional value.
- To publish in an appropriate manner important technical developments at RCA, and the role of the engineer.
- To serve as a medium of interchange of technical information between various groups at RCA.
- To create a community of engineering interest within the company by stressing the interrelated nature of all technical contributions.
- To help publicize engineering achievements in a manner that will promote the interests and reputation of RCA in the engineering field.
- To provide a convenient means by which the RCA engineer may review his professional work before associates and engineering management.
- To announce outstanding and unusual achievements of RCA engineers in a manner most likely to enhance their prestige and professional status.

THROUGHOUT the electronics industry, the problem of how best to manage complex R&D work is of great concern. In fact, the question is often more basic: Can we really manage advanced R&D programs at all—in the sense of closely controlling their costs and meeting strict schedules? And, can we do this without squelching the professional creativity and job interest of the engineers and scientists upon whom technical success absolutely depends?

There is also today a fact of business life that cannot be ignored: Government procurement in defense-electronics R&D is depending more and more on a matrix of technical capability, low price, and shortest schedule. Competition



Background: What is TRADEX?

TRADEX (Target Resolution and Discrimination Experiments) forms a large part of Project DEFENDER, an R&D effort being directed by ARGMA (the Army Rocket and Guided Missile Agency) for the Advanced Research Projects Agency (ARPA). It involves a large very advanced radar with many major technical innovations—innovations that often matched and pushed back the state of the art. For example, it is the first radar with the following features:

- 1) A combination of pulse compression, pulse doppler, and velocity tracking.
- 2) Fine-line target separation within a single pulse.
- 3) Two radars in one, with the highest average power L-band radar in existence.
- 4) Capability for determining target frequency sensitivity through correlation of returns from simultaneous monopulse tracking at UHF and illumination at L-band and with all polarizations.
- 5) The IF recording enabling subsequent processing of data on all targets in the beam with phase, amplitude, and time relationships preserved.

TRADEX has been in operation since November 30, 1962, with full system capability. Since the first mission nearly four months prior to full checkout, the TRADEX equipment has done its job successfully. All target information initially contemplated has been obtained on each mission. Through June 1963, it successfully performed in its 17th out of 17 assigned ICBM missions. In so doing it has collected more data than any other sensor, and in addition data which heretofore has not been available to the missile defense research community.

The Engineer and the Corporation

MODERN MANAGEMENT FOR R & D PROGRAMS?

A CASE STUDY—TRADEX

R. A. NEWELL, Mgr.

TRADEX-PRESS Program*

(*Presently Deputy Director and Chief Engineer,

AADS-70 Study Program)

Missile and Surface Radar Division

DEP, Moorestown, N. J.

is currently severe. Throughout the defense electronics industry, many companies have built up expert—often large—technical staffs over the past years. Now profit success depends upon applying the talent potential of such staffs in the most productive manner—where *productive* implies maximizing technical achievement relative to fixed dollars and time. That objective, and the need to bring R&D staffs into close identity with that objective, is a primary mission of program management. It has thus become essential that we approach R&D program management in a creative, dynamic manner. To do this, we must be willing to try advanced management concepts, to develop new techniques when needed, and to critically reexamine established managerial methods—discarding readily that which can be improved, while retaining only that which continues effective.

Recently, the DEP Missile and Surface Radar Division in Moorestown, N. J. completed a major program—TRADEX—that will be used herein as a case study to understand how advanced management techniques can be used to enhance R&D work. As TRADEX demonstrated, advanced-management techniques for planning, delegating, and measuring *can* be applied to complex R&D programs with great success. It is also a good example of how major problems can thereby be overcome in R&D—which for TRADEX included drastic curtailment of funds, tight schedules, severely increased requirements for technical advances, and a shift in the planned location for initial assembly and tests nearly halfway around the world. The advanced-management techniques were applied to achieve technical breakthroughs, “on-time” delivery within budget, and

favorable customer reactions. These techniques may also help form a process of mental evolution for achieving a competitive advantage through matching professional job satisfaction to company objectives.

The methods involved computer techniques such as SCOPE¹ (an improved network-analysis technique developed on TRADEX for the evaluation, reporting, and simulation of operations); MERT² (for allocation of manpower resources); and PERT³ (used on TRADEX only for early planning of critical-path schedules, not for measuring performance). A number of organizational techniques were used successfully to cut red tape in communicating with functional groups, to ensure that SCOPE reported *realistic* performance data, and to more closely involve the technical managers and their groups with the overall program and company objectives.

PROBLEMS—PLANNING, DELEGATING, MEASURING

Typical of defense R&D, TRADEX involved technical challenges of great magnitude. As originally budgeted (tens of millions) and scheduled, these were serious enough. But early in the program, funding was slashed sharply *without* significant relaxation in technical requirements or in the already tight schedule. With the dollar squeeze accentuated, it was evident that past management practices were simply not good enough. Even though the history of this Moorestown Project Management group showed noteworthy successes in meeting difficult technical, cost, and schedule requirements (e.g., the AN/FPS-16 instrumentation radar, and DAMP) we could not envision success with TRADEX by relying solely on previously proven manage-

ment techniques—no matter how we might better their efficiency.

At that early stage, it appeared to be a straightforward choice: quickly devise new or improved techniques to solve the technical management problems, or *fail*.

Then, as the TRADEX Program unfolded, funds were slashed again. As if the earlier problems hadn't been enough, we now had to look for additional means to reduce cost. Answers were found by examining critically the functions of planning, delegating, and measuring—a study that we called "Operation Bootstrap."

Planning

When TRADEX started, previous programs were reviewed for clues to improved planning, since nothing is quite as expensive as late or inadequate plans. Throughout the industry, the price of fuzzy objectives and inadequate plans had been high, including poor technical performance, financial losses and over-runs, loss of customers, loss of ability to compete effectively, and resultant loss of valuable technical and managerial staff.

Even though a company's personnel has to face a mass of day-to-day technical and management problems, these must not be allowed to delay or prevent adequate concentration on the advanced planning that will so vitally affect tomorrow's chances of success.

False starts had been costly. Some programs with very short delivery cycles had entered the design phase prematurely, at best using no more than the system engineering from the proposal. Good intentions for updating this basic technical planning sometimes succumbed to problems of immediacy, once the button had been pushed. The consequences occurred late in the program as necessary but expensive changes (or worse problems). A costly regenerative process existed when people were *always* busy with immediate crises. The resultant inadequate or late systems planning frequently prevented achieving an optimum balance between technical refinements and limitations, or between technical requirements and program resources.

TRADEX could not afford the uncertainties—and consequences in dollars and time—of an unordered approach to the basic system planning.

Delegating

Delegation couples the organization to the objectives. The exact meaning of *delegation*, as used herein, should be understood: With 100% effective delegation, each person on the program would: 1) know exactly what his contributions to the overall effort *should* be; 2) know how his efforts should be integrated into and synchronized with the efforts of others for maximum effectiveness; 3) thus be able to measure his own performance against expectations; and 4) know how his performance was to be measured by others. Toward this end the delegatee should participate in, and contribute to, planning. It may seem incredible that a process could facilitate the effective measurement required for program success and *at the same time* provide personal job satisfaction through a high degree of freedom and the opportunity for professional self-fulfillment. The principles of effective management confirm that it can. (On TRADEX we made a small start toward this goal. *The potential is great.*)

We were convinced that the basic form of the Moors-town organization made sense. The competitive situation in the defense industry has forced organization into groups of specialists—so-called *skill centers*—in order to provide the concentration of technical capabilities upon which project

success in R&D work depends. When this necessary complex array of technically specialized groups must handle many programs simultaneously, the problem of integrating their efforts for efficient performance on a given program becomes increasingly severe. On some past programs this had placed excessive burdens on top management.

Delegating has been found to be relatively ineffective when afflicted with lack of planning, communication problems, organization complexities, resistance to change, preoccupation with complicated technical details, opposition to the use of accurate progress-measuring tools, conflicts between programs competing for limited but choice resources, and cases of poor interpersonal horizontal relationships (lack of respect and trust). In such cases, the delegator (usually the program management group) either abdicated or "breathed down the neck" of the delegatee—in either case jeopardizing performance. Defensive or self-preservation reporting was frequent. Significant items needing attention were difficult to highlight. There was considerable random activity and frequent crises. In too many cases, progress measurement was ineffective in the resultant noise. Under these circumstances, control was entirely unsatisfactory.

Measuring

The remaining problem area involved measuring. A fixed base for measuring performance against objectives, such that high expectations for achievement would be realistic, is most critical to success and had given trouble in the past.

As used herein, "measurement" implies all of the management function except planning and delegating. Measurement is more fundamental to effective management than control. Control is relatively easy with adequate measurement, but without measurement, control is impossible. Measurement and control imply *management action*. Meas-

R. A. NEWELL received his BME from Rensselaer Polytechnic Institute in 1949. His graduate work at Drexel Institute of Technology in electrical engineering was interrupted in 1956 when he received a Sloan Fellowship award for the 12-month executive development program at M.I.T., where he received the SM degree in Industrial Management. In 1949, Mr. Newell joined the engineering staff of Eastman Kodak Company. He joined RCA in 1952 as a component project engineer. In 1954, Mr. Newell was promoted to Leader, Design and Development, of the Precision Mechanism Group. In 1957, Mr. Newell was promoted to Project Manager of the AN/FPS-16 Instrumentation Radar program, with responsibility for the overall project engineering direction for the R & D, production, construction, and field operations. In 1958, he was promoted to Project Manager of Range Radar Tracking Systems. In this capacity, in addition to the Instrumentation Radar Program and Advanced Radar Projects, he was responsible for the project management of the Downrange Anti-Ballistic Measurement Program (DAMP) including the design, implementation and operation of the (DAMP) ship, DAMP Moors-town Research Center, and implementation of the Croyden Data Reduction Center. In 1960 he was promoted to Program Manager of the TRADEX-PRESS Program. In 1962, he was promoted to Manager, Missile Support Programs, which included responsibility for TRADEX, PRESS, TERRIER Weapon System Study, and NIKE-ZEUS Support. Mr. Newell is presently Deputy Director and Chief Engineer for the AADS-70 Program, a feasibility study being conducted by RCA for the Army's System for air defense in the 1970 era. He is a member of Sigma Xi, Tau Beta Pi, Pi Tau Sigma, American Management Association, and Army Ordnance Association, and is a Senior Member, IEEE.



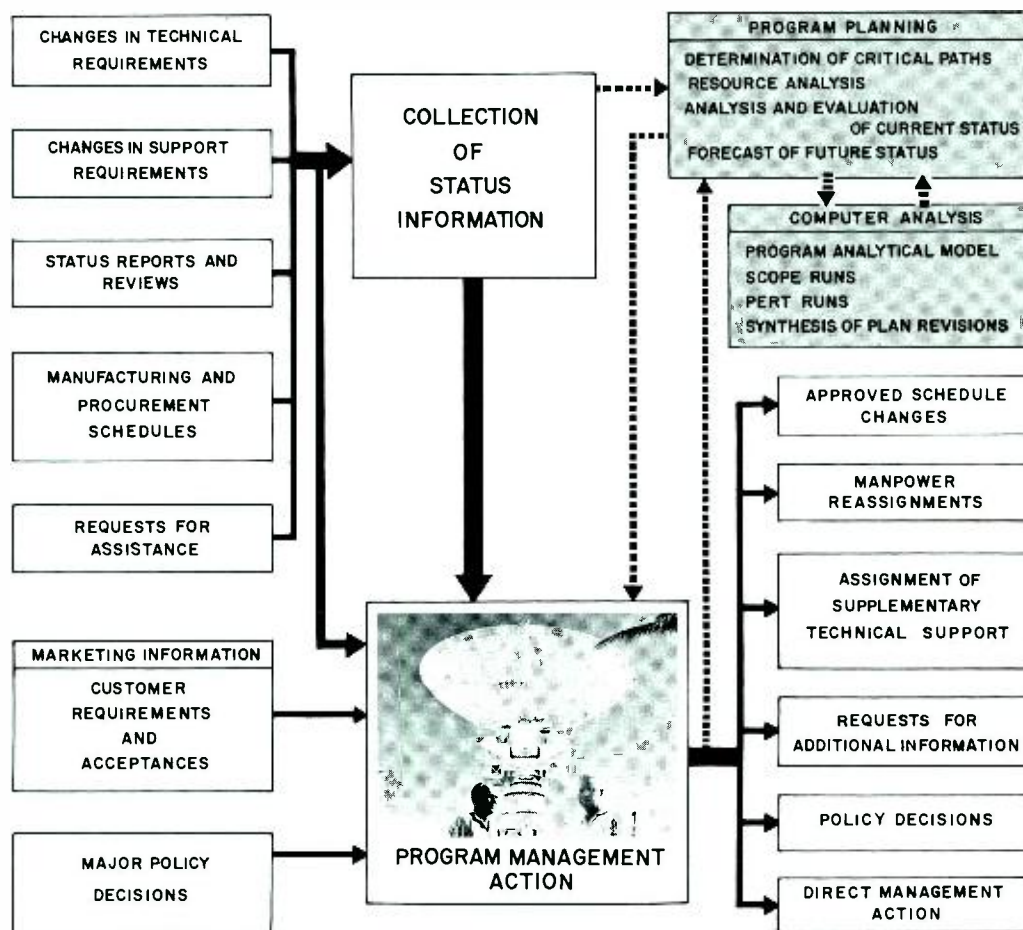

Fig. 1—Conventional flow of information for management action (unshaded) and the role played by the TRADEX Management Information Group (shade blocks and dashed lines).

uring is facilitated by effective planning and delegating. The remaining problem involves seeing that the tools are used effectively.

ATTACKING THE PROBLEMS WITH ADVANCED-MANAGEMENT TECHNIQUES

We saw no way out, as TRADEX proceeded, but to go into management techniques with a "vengeance"—rapid, radical improvements in previous capabilities of the industry for *planning, delegating, and measuring* of progress. These words had to be implemented with new, vigorous meaning. We set out to do so.

The planning, delegating, and measuring functions are mutually dependant and comprise a dynamic, never-ending process. It seemed logical to seek a more ordered approach through corrective action which would affect all three.

System Review, Specifications, and Technical Coordination

As a first step, a carefully selected, small but capable, group of system and planning engineers initiated the job before any work started elsewhere. They *thoroughly* reviewed the customer's requirements, to be sure that we understood them. System and subsystem specifications and scopes of work were prepared *with the participation of functional engineering groups* who would later be involved with hardware development.

Specifications provided for what was unknown *as well as what was known*. The unknown areas probably received more attention than the known through the use of a "red-line" technique. At this phase (early design), constant

attention to keeping the system plans and subsystem specifications current was essential. With the possibility of as many as twenty different technically specialized groups contributing to the program, the coordinating problem was severe in both technical and management functions. Consequently, a *Technical Coordination Group* or "purifying control" was established. That group was kept independent of organizational ties in order to enhance their objectivity. In essence, they reported only to themselves and to the program manager. Technical requirements and plans were checked at frequent intervals as changes evolved. No changes to subsystem specifications could be made until their effect on system integrity was validated by this group.

Management Information

As a second step we tackled the too-busy-to-plan and value-system problems by creating an independent, objective, *Management Information Group* within the Project Management Organization. Their aim was to assure that with the help of the line group involved, adequate tools for planning and measuring were prepared, maintained, and used. These tools were to provide schedule and cost data needed to identify present and projected trouble spots—early enough to permit corrective action. Initial TRADEX planning had sought improvement, through the use of more "go, no-go" milestones as measuring points on the bar or Gantt-type charts. However, the sheer magnitude and apparent insurmountability of the task soon forced the Management Information Group to seek the next major step forward—improved tools. Early in 1960, this led to

the selection of PERT techniques, especially the network-analysis approach to planning. Fig. 1 illustrates the conventional flow of information for management action contrasted with the utility of the TRADEX Management Information Group.

SCOPE—Systematic Coordination of Operations and Program Evaluation

Later, Operation Bootstrap sought an approach to the second funding curtailment. The new and more stringent requirements of TRADEX demanded two refinements in techniques: 1) we had to have an improved method for planning the budgeting of time and other resources; 2) also, we needed a better fixed reference to measure performance against, so that our subsequent evaluations could be more realistic. What we sought was not some new technique, but a refinement to the then-new PERT methods.³

The PERT-based network-analysis methodology of SCOPE is based on the concept that resources are in limited supply and cannot be applied in "saturation" quantities to ensure a satisfactory outcome, a situation made more complicated by the uncertainties associated with completion of each succeeding task supporting the end objective. (In a large program, thousands of discrete, but inter-related "tasks" may be involved.) The PERT approach expresses the logical relationship—i.e., a network—of those tasks leading to the end objective, and allows estimation of the time required to complete an activity relative to a known quantity of money and/or skilled effort.

As TRADEX began, industry and government experiences with PERT were convincing more and more people of its utility in *planning* how to integrate the activities of many groups on a single program. Because it was computer programmed, it allowed program management to quickly revise the complex network of plans and schedules as necessary changes arose. It was pointing up the technical and management responsibility of each group and each man; however, we felt that it left something to be desired relative to delegating and measuring. Specific areas of concern were:

- 1) Conventional PERT methodology, using three estimated completion times (*optimistic, most-likely, and pessimistic*) for intermediate milestones introduced an implication that schedules were "loose" and did not *have to be met*.
- 2) Scheduled dates changed frequently as resources were reallocated to reduce time on the critical path in PERT replanning. Consequently, an adequate long-term fixed base for measuring performance did not exist.
- 3) Activity or task completion dates had a compliance probability of 50% as planned with PERT. Good performance records from measurements against such dates were unlikely (since it was probable that 50% would be missed). "Tight-ship" planning as a basis for measuring performance was needed. Yet, this had to be achieved without ruining incentives through the imposition of impossible goals.

In view of the foregoing, the new and more stringent requirements of TRADEX demanded refinement in network-analysis techniques. As a result, SCOPE was developed by the TRADEX Management Information group. (This article can provide only the following brief insight into the mechanics of SCOPE; however, for the interested reader, we have available a detailed report.¹)

SCOPE, when fully developed, enabled network-analysis planning utilizing a variable-probability approach to inves-

tigate the adequacy of *all program resources*, including time and slack time. (The original PERT analyses provided summary answers only in term of the time resources.)

A most-significant concept of SCOPE is the variable-probability approach to network planning. While the standard 50-percent PERT probabilities may yield a satisfactory plan in many instances, we can often expect (or *require*) better than a 50-50 planned chance for meeting end objectives. Likewise, functional groups often *must* have better than a 50-50 chance for meeting intermediate engineering goals. For these reasons, we conceived the SCOPE *feasible plan* approach in which probabilities over 50% (to 90%+) were used where needed.

We established such feasibility probabilities by relating the degree of difficulty anticipated in funding, proportion of research effort to development or production, and general schedule outlook. Methods were developed for objective selection of the probability and feasibility factors, for example making use of nomographs to consider the various influences.

There are two distinct approaches to updating the SCOPE analysis. In one, the so-called *dynamic* approach, all changes to the network (time re-estimates, logic revisions, resource re-allocations) are reflected to develop an indication of current program outlook. This approach is also typical of routine PERT updating procedure.

In implementing the SCOPE system, however, the second kind of updating process differs critically. Once a *feasible plan* is developed and approved, it becomes a SCOPE *fixed plan* to be used as the standard for measurement of performance and as a framework for selection of SCOPE (major) milestones. Each of the selected SCOPE milestones has a SCOPE-derived feasible date, which defines a schedule for management to monitor progress. Recognizing that the detailed day-to-day work plan may change, prudent management will also support the normal PERT (or dynamic SCOPE) analyses, which performing groups utilize to achieve the selected SCOPE milestone as well as end date schedules. Unless the total objective of the planned task is re-defined, it should not prove necessary to revise the standard fixed plan.

As we shall discuss further later on, SCOPE produced many advantages: Interim milestones and resource budgets became more reasonable of attainment. The yield was performance measurement of the utilization of time and all other resources (including purchased materials, drafting and engineering) against SCOPE *must-do* goals which lost no incentive through unrealistic demands. In fact, SCOPE *in many ways became a new way of effectively implementing a whole philosophy of modern management*—not just another technique.

Communicating Directly—The "Design Executive"

As pointed out earlier, the necessary organizational grouping by technical specialties had placed excessive burdens of integrating their activities into an effective whole on top management in some earlier programs. As a solution, program-management organizations were developed to attack this problem by acting as planning, delegating, and measuring arms for top management. The TRADEX Program Management Office performed as a "prime contractor" within RCA by delegating tasks to the functional groups within the Division Engineering Department, to other RCA Divisions, and to other companies.

In looking for effective delegation practices, the most pressing need was for short, direct lines of communications. Another was means for impressing upon an appro-

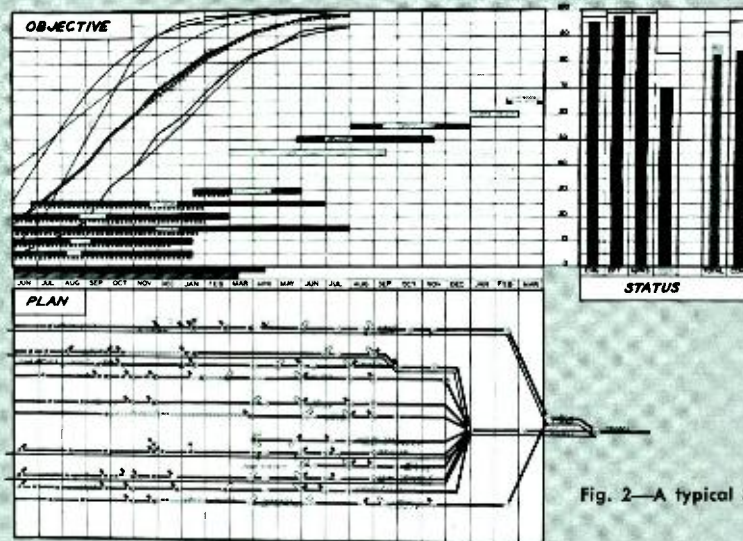

Fig. 2—A typical SCOPE presentation.

appropriate unit manager the importance and effect of his subsystem responsibility on the total program. These were solved by designating appropriate functional unit managers in the Division Engineering Department as TRADEX Design Executives.

This concept identified TRADEX team members within the Engineering Department; it tied them horizontally and directly to their counterparts in Program Management. There was no need to “go through channels.” *Lines of communication were known and were short.* It was now very clear who would be held responsible for obtaining planned results for each subsystem. This direct relationship enabled most problems to be solved by the individuals close to the point of action, thus minimizing delays and cost. Each Design Executive functioned as the head of a “company” with full responsibility for a subsystem “sub-contracted” to him by Program Management. Design Executives participated in TRADEX staff meetings and status-review meetings in which problems were aired. (This Design Executive approach had bonus effects, as we shall discuss later.)

EXPERIENCES IN APPLYING THE METHODS

From the start, great emphasis had been placed on measuring results to assure the accomplishment of plans. We were out to make the truism, “managers do what upper management inspects” pay off—and pay off it did.

The immediate result was improved performance on the job. Improved ways of going about the managing of jobs were later, secondary benefits and included adoption of network-analysis techniques for planning (PERT³) and the development of SCOPE¹ and MERT.² (MERT is a tool to optimize manpower that was especially useful in the planning and implementation of the TRADEX field installation and checkout. It is most useful when cost and performance are heavily manpower-oriented.)

Justifying the Management Information Group

The philosophy leading to the creation of the Management Information Group was put into practice, but not without difficulty. Acceptance developed only as the ability to plan and measure proved its value.

The Management Information Group was no passive staff function. It was comprised of several top engineers who worked actively with all levels on the TRADEX Program. They had no other responsibilities and no alle-

giances, with full immunity from outside and inside pressures. A continuous crusade was carried on aimed at increasing the effectiveness of the tools in use. At the outset, considerable missionary work was necessary to overcome resistance to change. People had to be convinced that the cost of the planning activity would be returned from savings in the operation and that the independent group was there to aid them, not replace them. *People had to be convinced that it was possible to plan complex R&D work.*

This group had not just the Program Manager’s backing, it had his active and personal participation as well—to a degree such that everyone throughout the organization knew the importance which he placed upon it. In addition, frequent inspections were made at one- to two-week intervals to see that the tools were being used properly and that we were not just “going through the motions” with “lip-service” planning and measuring.

Experiences verified expectations and substantiated the following quote from *Management in Action*, by L. A. Appley, President A.M.A.: “Separate the responsibility for providing adequate plans, policies, and basic policy decisions from the regular responsibility for operating the business within the framework of those policies and the organization will stand strong and effective; combine them and it may fall of its own confusion.”

Improvement of Network-Analysis Tools

Network-analysis planning was improved greatly, as SCOPE grew into much more than a technique. Initially, PERT was used both to plan and to provide reference data for comparison with results; however, it did not work well because the references for interim goals changed as plans varied. Then, SCOPE was developed to provide both an improved fixed reference for measuring, and predictions of resource need vs. availability. After this, PERT was used for planning only and SCOPE was used for measuring.

Further advantages were achieved as the SCOPE Management System separated the process of managing into two distinct elements: 1) Systematic Coordination of Operations (SCO), a combination of *planning* and *delegating*, and 2) Program Evaluation (PE), *measuring*.

Part of the success came from the fact that the network analysis was arrived at with the participation of those who would execute the plan. In other words, the planning process was such as to “integrate” conflicts between subsystems, and to optimize the overall system as early in the

cycle as possible. This approach led to earlier maturity of plans.

SCOPE improved the utility of plans by highlighting areas having the greatest potential for immediate cost reduction and improved efficiency. A forecasting system and an unbiased measuring system were provided to both the Design Executives and to Program Management. It enabled detailed optimized budgeting of each resource and provided accurate forecasts of expected utilization of each resource, followed by detailed measurements. SCOPE was also used to compare quantity of planned work with total available planned resources for improved guidance of managers. The PE (program evaluation) portion of SCOPE gave back to PERT its birthright of being a tool for planning and optimizing the time resource. Then, PERT could be used continually for replanning—without bias or report-card effects. SCOPE enabled anticipatory management action, a continuing refocusing of attention to the greatest action payment points, and simulation to predict the effect of decisions before their institution. Measurements for decisions had increased utility.

A healthy competitive atmosphere developed when the Design Executive began to try to out-perform each other in terms of the SCOPE "score." (Though this is a powerful tool, it is not without controversy.) A great deal of loyalty evolved—to the program areas and to the overall program. Delegation was aided by the SCOPE graphical analysis, which combines a form of network plan and line of balance technique. A typical presentation is shown in Fig. 2. This powerful communications aid was truly a picture worth a million words. Thus, early in the program cycle, each participant could realize the importance of his contribution to the whole. This stimulated thinking in terms of and concentration on optimizing the whole program rather than some small part of it. It provided a kind of catalytic effect, encouraging the integration and synchronization of the efforts of the various contributors.

THE END RESULT—SUCCESS FOR TRADEX

The success of the TRADEX Program has been gratifying. But this success was not a result of just PERT or SCOPE management, or any other one method. It happened because a dedicated technical and management staff succeeded in the face of a seemingly impossible situation. The part played by program and functional management was made more effective because several new or improved advanced management tools were applied in an integrated manner—even in the face of the often-unpopular action of introducing a really effective measurement system.

The customer's satisfaction is evident in a recent letter of commendation recognizing the technical and management advances made. Earlier, the customer recognized the performance of the TRADEX Management Information Group. As a result, RCA obtained a contract for assisting with setting up a PERT System for the Army. The contract included requirements for running the Army's first PERT application, which was on the PRESS Program.

TRADEX had a number of crises; however, rapid reactions were on an orderly, best-course-of-action basis, made possible by the planning, simulation, and communication techniques of PERT and SCOPE.

THE OUTCOME—SOME PROGRESS TOWARD BETTER R & D MANAGEMENT

The greatest rewards are available for those who effectively combine the present dichotomy of modern manage-

ment philosophy and organizational dogma. New management techniques can help point the way. SCOPE is an early mechanized attempt to bridge the gap through combining (SCO & PE). Increased attention to planning, delegating, and measuring on the TRADEX Program enabled compliance with difficult contract requirements under rapidly changing circumstances. In some way, an improved "signal-to-noise ratio," or "order-to-confusion ratio," may have helped.

Secondary benefits accrued in the form of information for improving future programs. We scratched the surface of the potential in the new management data systems. *Means must be found to assure that these vastly improved tools are accepted and used effectively by all people at all levels.*

Further progress toward a tight ship is consistent with a person's desire for job satisfaction through accomplishment. Similarly, the organizational goals, *if communicated*, are consistent with a person's desire for job satisfaction. Potential for large gain rests in optimization of these factors.

A tremendous potential for improving our competitive position rests in learning how to better match job satisfaction for individuals to company objectives. An individual desires professional achievement. This can come, in important part, from knowing that he is contributing to a productive group. The individual's desire for more control over the day-to-day conduct of his work can be met through management by objective. Plans enabling effective progress measurement set objectives for each man, with which he can measure and govern his own performance—and thus the importance of *his contribution* to the whole. Job enrichment can lead to personal job satisfaction.

As management methodology becomes more complex, it is important to avoid overdependence on a lot of handbook rules. Regardless of what technique is involved, belief in the underlying basic principles and the act of applying them *naturally* is essential—for any other approach is likely to be interpreted as manipulative. Put another way, by reducing the problem to basic principles we can separate cause and effect. When we can do this, we can bring order out of confusion. As the mathematician said, "if you can't differentiate you can't integrate."

Thus, modern management *is needed* for R&D problems. And by *modern*, we mean management that may well shift its methods and tools to fit contemporary situations as they arise—much as was done for TRADEX—and we mean management that can successfully draw together the inherently related objectives of the company and the individual.

ACKNOWLEDGEMENT

The author wishes to express appreciation for the original contributions to the development of SCOPE and to this article made by F. G. Adams, H. R. Headley, and J. A. Vaughan.

BIBLIOGRAPHY

1. *SCOPE: Systematic Coordination of Operations and Program Evaluation—An Introduction to the SCOPE Computer Technique*; Report available from: Missile Support Programs Planning, DEP-M&SR, RCA, Moorestown, N. J.; August 1963.
2. *MERT: Manpower Evaluation Review Technique*; Report available from: Missile Support Programs Planning, DEP-M&SR, RCA, Moorestown, N. J.; Feb. 1963.
3. T. A. Nupp, "PERT—Program Evaluation and Review Technique", RCA ENGINEER, Vol. 7, No. 4, Dec. 1961—Jan. 1962.

DECISION



EDMUND A. LAPORT attended Northeastern University, Massachusetts University Extension, and McGill University. In 1924 he joined the Westinghouse Electric and Manufacturing Company of Springfield, Mass., as a radio engineer. From 1933 to 1934 he was with the Paul Godley Company, Montclair, N. J., and from 1934 to 1936 with Wired Radio, Inc., of Ampere, N. J. In 1936 he became associated with the RCA

Victor Division, Camden, N. J.; in 1938, Chief Engineer of engineering products in the RCA Victor Company Limited, Montreal; and in 1944, Chief Engineer of the RCA International Division, New York. Since November 1954 he has been Director, Communications Engineering, for the Radio Corporation of America. Mr. Laport is a Fellow of the Institute of Electrical and Electronic Engineers.

E. A. LAPORT, Director

*Communications Engineering
Research and Engineering
Princeton, N. J.*

DECISION is the key to action. Action is necessary for progress and success.

Decision must be timely—not too soon and not too late. As Al Smith once said “You mustn’t be so far ahead of the parade that people can’t tell that you are leading it.” (As a corollary, people won’t know you are in the parade at all if you trail too far behind.)

The superior man is known by his power of decision. Right decision springs from *wisdom* and *courage*.

Leadership of men and affairs requires prompt decision. A man of decision also must decide when he has enough information and enough opinions. He must know that inaction and delay are deadly. Sometimes an arbitrary decision is better than none.

Morale is strongest when men know where they are going. Morale falters when work appears to be unappreciated or pointless. Aimless drifting is the most demoralizing of influences.

Successful team action involves an endless succession of decisions at all levels. Executive decision to attain stated objectives provides a clear map for the guidance of all these consequential decisions, day by day, down the line of organization. People who know where they want to go always know how to

make the myriad minor decisions that lead in that direction.

Constancy of purpose on a program of work that spans months and years requires occasional reiteration of the original primary objectives to reassure all participants that they still hold. Otherwise enthusiasm and sense of purpose dies down.

Long-term efforts tend to become diluted as later projects temporarily are glamorized. Continuous zeal on older projects is sustained only by frequent executive recognition and encouragement. People have to feel that what they are doing is important—otherwise the pace lags and efforts drain off into nothingness. Valuable experience is then lost by people taking every opportunity to transfer to newer glamor projects. This is one of the problems of a diversified company, and is one of the reasons for segregating major undertakings into self-contained units where the influence of other projects is less felt. There is also less tendency to pull people from the older projects to man the latest undertaking.

The decision to start a major enterprise has to be constantly backed by recurring decisions to continue it, unless the original decision turns out to be less worthy than supposed, or because

of a later decision to subordinate it to more important newer opportunities that require re-direction or concentration of forces and resources. Executive wisdom must decide when to retreat on one front so as to advance on another. To make such a decision clear is better than to let an effort languish; but even if severely scaled down, the incentive to achievement can be retained by suitable statements of revised objectives.

A decision to start a new enterprise is motivated by the conviction that there are profit opportunities in new products and services. The scale of the undertaking depends upon a decision about the desired place in a field—whether dominance, prominence, or merely participation. Prominence or simple participation in a large, active, enduring field may be more fruitful than dominance in smaller fields.

Decisions concerning the nature of new products and services for a professional or business user requires as much knowledge of that business as the user possesses. Users seldom are foresighted enough to conceive more than trivial innovations in their methods and facilities. Product planning has to combine expert knowledge of a business with a manufacturer’s knowledge of technical potentialities. Ability to plan an effective product line is a synthesis of all that a user knows with all that a producer knows technically and economically. Products are sold on their economic value to a user, under financial terms that he can manage. Very large single customers may provide smaller marketing incentives than a great number of small firms. Expensive equipment can be sold outright to large firms, while it may have to be rented to small firms.

The decision to create a meritorious new product line goes far toward assuring its success. Most people decide what they can do with what is available. Few users are able to imagine the impact of a particular idea, so “market surveys” are of limited value for finding relative acceptance of a new product idea. Effective product conception includes that element of wisdom that assures recognition by a customer that he just cannot exist without it—or that he can expand his markets and profits because of it. This assumes that the concept is well realized.

In a widely-diversified, fast-changing industry such as electronics, there are forces acting constantly to lure a firm into many by-ways at the expense of compromising the older reliable lines of effort. The choice of route through the maze of possibilities especially calls for wisdom and *decision*.

DIRECT ENERGY CONVERSION ... A Management Viewpoint

L. R. DAY, General Manager

Special Electronic Components Division
Electronic Components and Devices, Harrison, N. J.



LLOYD R. DAY received the BA from Colgate University with a major in Economics. After service with the U.S. Marine Corps during World War II, he joined RCA as a specialized trainee in 1946. Following a six-month indoctrination program which touched upon all phases of corporate activities, he was assigned to the advertising and sales promotion staff of the Tube Department. In 1950, he was appointed to the position of staff assistant to the Vice President and General Manager of the Tube Department. Five years later, he became

Manager of Planning for the Electron Tube Division, and in 1960 was appointed Manager of New Business Development for the Division. In that capacity, he guided RCA's early projects in direct energy conversion. In January 1963, he was appointed Manager of the newly established Direct Energy Conversion Department of the Electron Tube Division, and in July became General Manager of the new Special Electronic Components Division in the Electronic Components and Devices organization. He also remains Acting Manager of the Direct Energy Conversion Department which is now part of his new Division.

IT MAY COME as a surprise to many RCA engineers to find that much of RCA's activity in direct energy conversion grew out of the former Electron Tube Division. Most of us are well aware of the Tube Division's years of dedication to a single business goal—that of becoming and maintaining a position as the "World's Best Tube Makers." That dedication has spawned some handsome results in earned recognition as the industry leader, in establishment of a solid reputation as a good place to work, and most important, in the realization of a steady growth and profitability.

However, no organization can remain fixed in its habits. Realizing this, Tube Division management recognized several years ago that, because of the increasingly rapid rate of change in the electronics field, *WBTM* alone would not be sufficient to insure continued profitable growth. This led to the establishment of a New Business Development activity¹ at the Electron Tube Division. The NBD activity was charged with seeking out, screening, evaluating, and pursuing *new* business possibilities. Three primary ground rules were established for this new activity at the outset:

- 1) New Business Development would confine its attention to ideas *not* directly related to existing tube product lines. Responsibility for maintaining and modernizing tube product lines would rest with the established line organizations.
- 2) The advantages of strong liaison with RCA Laboratories were recognized from the outset. Therefore, particular attention would be given to those ideas most likely to earn continued support from the Laboratories.
- 3) New Business Development would concentrate on ideas which could best utilize the kind of skills and

talents already developed over the years in ETD.

In the first few years of its existence, NBD investigated many ideas, more than 90% of which were discarded after careful evaluation. However, of those selected for follow-up, several fell directly within the developing field of direct energy conversion. In fact, it was these direct-energy-conversion projects that grew fastest. At the end of 1962, a total of 300 people, mostly technical personnel, were engaged in direct-energy-conversion projects in various ETD locations.

As a result of this rapid growth, it was decided to centralize the management responsibility for energy-conversion projects in a newly-formed Direct Energy Conversion Department which was established as a full-fledged operating unit of the Electron Tube Division in January 1963. This not only permitted a closer integration of project effort, but also made clear RCA's determination to pursue this new field as a corporate business opportunity. Subsequently, on July 1, 1963, this Department became one of the principal activities of the Special Electronic Components Division, the "investment, building-for-the-future" division of the RCA Electronic Components and Devices organization. Today, RCA stands among the industry leaders in direct energy conversion, a field in which it was virtually unknown a short time ago. Despite our success to-date, much remains to be done and many substantial problems need to be solved. As usual, the road to success is not easy.

Direct-energy-conversion technology is still in a developmental state, and the likelihood of early mass markets for direct-energy-conversion devices is slim. It is very likely that highly specialized military and space applications will continue to represent the major uses for DEC techniques in the next five to ten years—

perhaps even longer. This means continued dependence on government research and development support, where the competition is already severe. It also means that great care must be taken in selecting those areas where limited RCA funds can best be invested to support programs aimed at technical improvements and cost reductions.

Costs, incidentally, are a major challenge. Direct-energy-conversion devices today are exceedingly expensive when compared to conventional techniques for generating power. This higher cost will have a severe dampening effect on their widespread usage for a long time to come. However, there seem to be no fundamental reasons why costs shouldn't ultimately yield to continued, imaginative, cost-reduction efforts and the effects of gradual increases in volume.

All of this adds up to an exciting and challenging future. For those who can survive in the struggle of the next five to ten years, there are strong possibilities that large scale uses for direct energy conversion will develop. RCA's ability to profit from this opportunity will depend directly upon our ability to balance technical, market, and financial considerations.

One of RCA's great assets in tackling a new venture such as direct energy conversion is the variety and blending of skills which it can bring to bear from all of its various activities. There is great scope to RCA's support of this new opportunity. *It is precisely this kind of support that enhances the likelihood that some day profits from direct energy conversion will be used to support future new business ventures.* It is to the fulfillment of this kind of responsibility that RCA's Direct Energy Conversion Department is setting its sights.

BIBLIOGRAPHY

1. RCA ENGINEER, April-May 1952, p. 55.

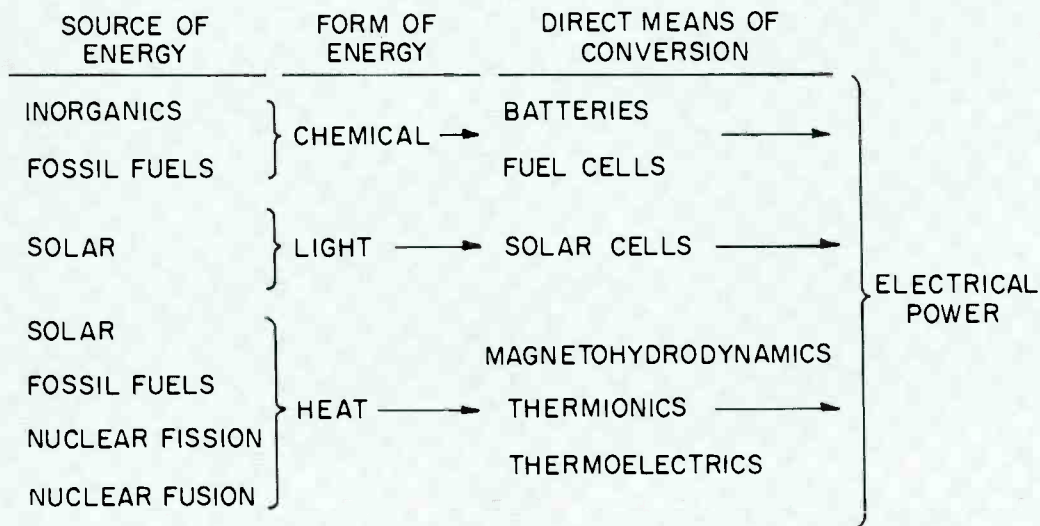

Fig. 1—Direct energy conversion technologies.

RCA'S ROLE IN DIRECT ENERGY CONVERSION

D. W. CHACE, Mgr.

Administration

*Special Electronic Components Division, Electronic Components and Devices
Harrison, N. J.*

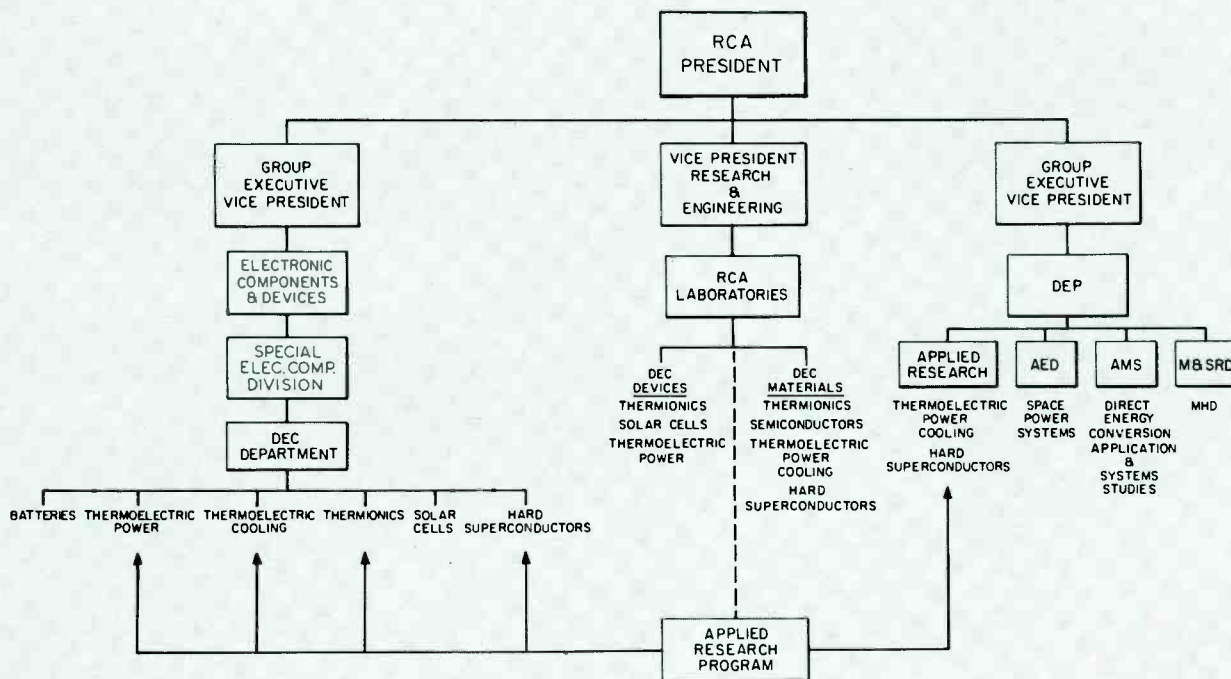

Fig. 2—RCA direct energy conversion activities.



DEAN W. CHACE received a BS in Basic Engineering from Princeton University in 1951. He joined RCA in the Washington Office of the Patent Department upon graduation and pursued studies in the George Washington University School of Engineering and School of Law. In 1952, he transferred to the Patent Department in Camden. He received an LLB degree from Temple University in 1955. He is admitted to practice before the United States Patent Office, the U.S. Court of Customs and Patent Appeals, the U.S. District Court for the District of Columbia, and the U.S. Court of Appeals for the District of Columbia Circuit. He transferred to the Patent Department in Princeton in 1957 and in 1959 was appointed to the position of Administrator, Research with responsibility for general RCA Laboratories administrative matters and the administration of the Applied Research Program under the Director of Research, RCA Laboratories. He was appointed to the position of Senior Technical Administrator, RCA Laboratories, on January 1, 1962, a position he held until July 1, 1963, when he was appointed Manager, Administration, of the Special Electronic Components Division, Electronic Components and Devices.

In its promise for the future, the direct conversion of energy from light and heat seems destined to become a great area of business for the electronics industry within the next few decades." These remarks, made by Dr. Elmer W. Engstrom at the 1962 WESCON annual banquet, acquire substantial and immediate significance when it is realized that today direct energy conversion represents about a \$10 million largely research and development effort in RCA. The fact that this issue can be devoted largely to the status of direct energy conversion technology is evidence of RCA's technical progress in the field. It is the purpose of this paper to recount briefly the highlights of RCA's direct energy conversion effort to provide background for the technical papers that follow in this issue.

STATUS OF DIRECT ENERGY CONVERSION TECHNOLOGY

When Thomas Edison opened the Pearl Street Station in New York City eighty years ago he provided electricity for less than five dozen customers with noisy rotating machinery capable of generating 30 kw of electrical power. Today, the United States electric utility industry produces around a trillion kw-hr of electricity annually, ranks *first* (and has so ranked for many years) in capital outlays for plant and equipment, and is tops in plant facilities—about \$50 billion. It is doing all this (although much more efficiently) with essentially the same noisy rotating equipment used by Edison.

Devices for *directly converting* heat, light, or chemical energy into electricity are not, at the present state of the art, commercially competitive with conventional electrical generators. Yet, research and development activity in direct energy conversion is being undertaken with a real sense of urgency. The reason, of course, is the needs of the United States' space program for reliable long-life and light-weight power supplies. As we expand our capability to launch bigger and more sophisticated payloads, it is obvious that more efficient and more reliable energy conversion devices, capable of providing larger amounts of power, will be needed.

In addition to the requirements of the space program, there is a need for silent power generators in a variety of military applications. Beyond these are the commercial applications. Portable packaged electrical power at a reasonable price has virtually an endless number of applications, not the least of which is the production of power for the vast underdeveloped areas of the world where central power is unavailable.

The present substantial research and development effort on energy-conversion devices, largely government-sponsored and space-oriented, is hopefully laying a technological base from which commercial portable direct energy conversion devices can be developed. There is also hope that direct energy conversion devices will share in the continuing growth of the electric utility industry. The technical and economic problems that must be overcome to achieve practical commercial uses of energy conversion devices are imposing. The rewards may be so great that virtually all segments of the electronic industry, and major segments of the chemical industry, are engaged in research and development on energy conversion devices with substantial government support. The direct-energy-conversion field is thus charac-

terized by competition for prominence among the devices themselves. For the technical man, therefore, the direct-energy-conversion field represents a tremendous challenge. While the magnitude of future business in this field is uncertain, the prospects are enhanced daily by the imagination, ingenuity, and resourcefulness that the competing companies, including RCA, are bringing to bear on the problems.

RCA'S INTEREST IN DIRECT ENERGY CONVERSION

RCA's growth has been largely in electronic products and services for sending, collecting, storing, and reproducing information. At the root of this growth is RCA's broad base in virtually all the principal areas of electronics. One of the newest and most promising of these is direct energy conversion (DEC). In its concern with the generation of power efficiently and reliably, DEC is a departure from RCA's principal concern with the electronic handling of information. The departure is an altogether logical one, however, for at least the following reasons:

- 1) Electronics, which is RCA's business, is basic to all of the known means of directly converting chemical, light, or heat energy into electricity.
- 2) The skills and facilities needed to develop and produce DEC devices are closely related to existing RCA skills and its extensive technological background, particularly in electron tubes and solid-state devices.
- 3) DEC can create new applications for electricity and thus new markets for electronics. In some cases, DEC devices must be used to satisfy the power-supply requirements of existing RCA products, notably in the case of electronic equipment for space vehicles.
- 4) DEC gives RCA an additional opportunity to share in the United States' space program, where the prospects of beneficial technological fallout are particularly great.

Thus, RCA's strength as an integrated company in electronics has provided it with both the wherewithal and the incentive to look to DEC as an opportunity for future major growth.

DEC DEVICES

The appeal of DEC devices lies in their capability to convert chemical, heat, or light energy into electricity *directly* without moving parts. These three forms of energy are derived from inorganic chemicals, fossil fuels, the sun, or from

nuclear fission or fusion processes, as shown in Fig. 1, with the conversion process being achieved by one of the six DEC devices indicated.

Batteries, and to a lesser extent solar cells, have found widespread use, particularly in spacecraft. They remain, however, subjects of extensive research and development programs. The other devices—fuel cells, thermionic converters, thermoelectric converters, and magnetohydrodynamic generators—are still in some early stage of research and development, although the feasibility of each device has been demonstrated by the construction of experimental generators capable of providing power, even if feebly and for short periods of time. It is much too early to predict the eventual role of each DEC device. It is likely, however, that all the DEC devices will find specialized military and space applications. The role each will play in commercial applications, on the other hand, will largely depend on future unpredictable technical progress, with cost being a vital consideration. Thermoelectric generators appear to have an edge insofar as reliability is concerned, while thermionic converters promise high-power-density operation. For some applications, thermionics and thermoelectrics are directly competitive; for still others they appear to complement each other. Fuel cells seem capable of efficiencies (around 60%) not obtainable with either thermionics or thermoelectrics, but have the disadvantage of requiring moving gases or liquids, as opposed to the completely static operation of thermoelectrics and thermionics. Magnetohydrodynamic generators are usually considered only in terms of large power generation.

In a broad sense, RCA has an interest in all these devices and in their ability to provide power for electronic equipment. From the beginning, however, RCA's interests have been concentrated chiefly on those DEC technologies most closely related to technical areas in which RCA has a particular proficiency and in devices capable of providing power in convenient packages, rather than those that might be competitive with central power generators. Thus, RCA Laboratories' research program on DEC materials and devices has been largely concerned with thermoelectricity, thermionics, and solar cells. RCA's battery research and development program was also started at RCA Laboratories and later transferred to the Semiconductor and Materials Division (now part of Electronic Components and Devices). RCA Laboratories has not had formal research programs on either fuel cells or magnetohydrodynamics (MHD), but it has made technical contributions to

each in electrochemical and plasma research. Work on MHD has been done in the Missile & Surface Radar Division of Defense Electronic Products, leaving the fuel cell as the only DEC device not the subject of a major RCA technical program.

RCA also has technical programs on thermoelectric cooling and hard superconductors, each of which is closely related to direct energy conversion; thermoelectric cooling because of its close technical association with thermoelectric power; and hard superconductors because of their apparent capability of high-magnetic-field generation, which is of vital interest to the generation of power by MHD techniques and by nuclear fusion processes.

RCA DEC ACTIVITIES

The geographical division of RCA's DEC activities in eight different Corporate locations belies the size of RCA's research and development effort in DEC, which is small measured in terms of the total Corporate technical effort. In some respects this geographical separation, caused by the interest of a number of RCA divisions, is a measure of the importance of DEC to RCA's business. The size of the DEC effort relative to the total RCA technical effort is not a measure of its stature nor of RCA's competitive position, both of which are extremely favorable. RCA, in fact, has secured a significant share of the total Government research and development expenditures in DEC, directly reflecting the quality of RCA's DEC programs and the degree of RCA's technical achievement.

Fig. 2 depicts the various RCA DEC activities. But Fig. 2 does not show the communication channels and cooperative endeavors that have minimized the disadvantages that accrue from geographical separation. The fact that product-division activity in all the DEC technologies (save MHD) was spawned by research at RCA Laboratories has established an effective communication link between the Laboratories and the product divisions. In some cases, notably thermoelectric power and hard superconductors, the technical programs have been team efforts with a single-mindedness of purpose. Technical communications and liaison have also been strengthened by means of the RCA Laboratories applied-research program. RCA Laboratories is sponsoring and supervising applied-research programs in both the Direct Energy Conversion Department and in Defense Electronic Products on DEC devices and materials, as illustrated in Fig. 2.

The formation of a Direct Energy Conversion Department at the beginning

of 1963 has also served to strengthen RCA's inter-division communications. The new department grew out of what was the Electron Tube Division New Business Development activity which, in the short period of two years, succeeded in establishing major development programs on thermoelectric power and superconducting magnets in the Electron Tube Division. These programs, together with solar cells, thermionic power, thermoelectric cooling, and batteries, have now been consolidated under the management of the Direct Energy Conversion Department, which has been charged with the task of coordinating the effort and seeking means which will convert the DEC opportunity into a profitable growth business. From the beginning, the New Business Development activity has evidenced a determination to use, as appropriate, *all* RCA's resources in its quest for new business. This determination has been a vital ingredient in the activity's success. In its determination to make the most of the DEC opportunity, the Direct Energy Conversion Department has adopted the same philosophy of looking beyond its own boundaries for help. The result has been the establishment of ties with RCA Laboratories, and with the appropriate departments of Defense Electronic Products, notably Advanced Military Systems and Applied Research. The Direct Energy Conversion Department, in fact, has invested funds in DEC projects of both those Defense Electronic Products activities. On balance, the disadvantages of multidivision activity in far-flung geographical locations have been overcome, and RCA's activities in DEC have a unity which is in the best corporate interests.

THERMOELECTRIC COOLING

As early as 1954, Nils Lindenblad of the RCA Laboratories staff designed and built a small thermoelectric refrigerator which, while highly successful, also demonstrated the need for thermoelectric cooling materials with higher figures of merit. Thus, an active cooling materials research program was started at RCA Laboratories. The improved materials that came out of this research permitted the demonstration in 1956 of a small electronically air-conditioned room, which was cooled by two 4 x 6 feet thermoelectric panels. By 1959, a 50% improvement in the cooling capability of materials was achieved. At this time, the major emphasis of the research shifted to thermoelectric materials for power generation as the military need for direct energy conversion power packages came to the forefront, and substantial contract funds were available for thermoelectric power research.

More recently, the Applied Research group of Defense Electronic Products has done contract work on thermoelectric air conditioners for submarines, and programs on cooling materials and modules have been undertaken in Electronic Components and Devices. Also, there has been renewed research emphasis on thermoelectric cooling materials research at RCA Laboratories. Of all the DEC and related technologies, none has more potential business promise than thermoelectric cooling. Substantial advances in material performance are needed, however, to fulfill this promise and this is the chief aim of the RCA research programs.

THERMOELECTRIC POWER

The research emphasis on thermoelectric power at RCA Laboratories, starting in 1959, included a search for materials that would operate at temperatures in excess of 500°C. The intent of this research was to develop new materials that could be combined with known thermoelectric materials to provide high-efficiency operation over a wide temperature range. A silicon-germanium thermoelectric alloy was developed as a result of this research. The development of this alloy in 1961 has provided RCA with the unique capability of providing electrical power with thermoelectrics at temperatures in excess of 500°C and with devices capable of reliable, long-life operation. As a result, RCA was awarded the thermoelectric converter sub-contract for the AEC's SNAP 10A system, which will convert the heat from a nuclear reactor into 500 watts of electricity for space applications. The demands of this contract alone have required the rapid staffing and facilitation of a thermoelectric engineering activity in Harrison, which now employs over 150 people in research and development and the manufacture of thermoelectric power materials and devices. In addition to this activity and the research group at RCA Laboratories, in Defense Electronic Products the Applied Research group has built prototype thermoelectric generators and the Astro-Electronics Division is designing a radioisotope thermoelectric generator for space applications.

THERMIONICS

Research on thermionic energy converters started at RCA Laboratories in 1956. By 1959, a small development group was formed at Lancaster to bring the extensive skills and background developed in high-power tube work to bear on thermionic energy converters. This group picked up the research rapidly and has built up a store of technology

and skills that have permitted it to grow over tenfold in less than five years. The thermionic converter technology has been extended to include all the known heat sources. Notable among these are systems in which nuclear material is used to supply the heat. RCA has successfully tested thermionic converters in pile in reactors and in indirect nuclear systems where the heat for the converter tube is supplied by a reactor coolant, such as the liquid metal lithium. The low specific weight (pounds per watt) of the thermionic converter is one of its chief advantages, especially for space applications. Life and reliability fall short of many requirements, however, and much of the research and development is aimed at improving these characteristics of thermionic tubes.

SOLAR CELLS

RCA Laboratories has had research programs on photovoltaic materials and devices for a number of years. This research has been instrumental in the establishment of applied research and development and, more recently, manufacturing activities in the product divisions on solar cells (n-on-p silicon solar cells are manufactured at the RCA Mountaintop, Pennsylvania, plant). The superior radiation resistance properties of this type cell were discovered originally at RCA Laboratories. Applied research and development on gallium arsenide solar cells is done at Somerville. Both the n-on-p silicon and gallium arsenide solar cells are of present interest almost exclusively for space applications. In this regard, the Astro-Electronics Division is one of the largest assemblers of solar-cell supplies for space vehicles in the industry. For both space and commercial applications, large-area (and thus inexpensive) solar cells are of chief interest and it is to this end that RCA Laboratories research is largely directed.

BATTERIES

Research at RCA Laboratories on batteries started in 1953 in anticipation of the rapid dominance of solid-state devices in electronic equipment. The RCA Laboratories activity on batteries was transferred to Somerville in 1957 where it has continued, largely with Government contract support. At the present time, major emphasis is on the development of a novel reserve battery, useful primarily for military applications. There is also a development program on high-reliability automatically activated primary batteries. These specialty batteries are representative of a rapidly growing

segment of a market which presently exceeds one-half billion dollars annually.

MHD

The MHD generator is one of the most promising devices for generating large amounts of power although in point-of-time it is probably in the earliest stage of research and development of any of the known DEC devices. Hence, less can be meaningfully said about its prospects of achieving a practical status. RCA's work on MHD generators, which has been done in Moorestown, has been directed toward MHD systems in which AC power can be extracted directly. The capability to generate AC power is one of the potential advantages of MHD generators, although most research and development programs are directed toward obtaining DC power.

SUPERCONDUCTING MAGNETS

Both MHD generators and nuclear-fusion machines, among the new power-generating devices, require powerful magnetic fields in order to operate. The workers in both fields desire higher fields than they are able to obtain practically with conventional techniques. Thus they have turned to superconducting magnets. Of the known superconducting materials, the compound niobium-tin is one of the most promising for high-magnetic-field generation (over 100,000 gauss), but it is difficult to synthesize in a useful form. The Superconducting Materials and Devices Laboratory of the Special Electronic Components Division is working on an RCA Laboratories developed method for synthesizing niobium-tin in useful form and on devices using this compound. In Defense Electronic Products, Applied Research is also working on hard superconductors, chiefly in a measurements program and in applications work. The potential of all this activity on hard superconductors, chiefly niobium-tin, is exceedingly great. Not surprisingly, the problems which must be overcome to fulfill this potential are also very great.

CONCLUSION

RCA is doing research and development work on virtually all the known DEC technologies and on such directly related technologies as thermoelectric cooling and superconducting magnets. The extent of this activity is a measure of the importance of DEC to the electronic industry and to RCA. It is also an expression of faith in the future born out of more than ten years of substantial technical progress, not the least of which has been provided by RCA.

THERMOELECTRICS FOR POWER

... A Look at Product Engineering Potentials

R. L. KLEM, Mgr.

*Thermoelectric Products Engineering
Special Electronic Components Division
Electronic Components and Devices
Harrison, N. J.*

THERMOELECTRIC power systems may contribute significantly to man's ever increasing use of reliable electric power. The requirements for reliable electric power for long-duration space missions, the special needs of the military services, and certain industrial uses are providing challenging technical objectives for this relatively new technology.

A thermoelectric principle, discovered in 1821 by Seebeck, is based on the phenomenon that a current flows in a closed circuit formed by the junction of two dissimilar metals if one junction is maintained at a higher temperature than the other. Until recently, the practical application of thermoelectrics was generally limited to temperature-measuring and temperature-sensing devices because of the low conversion efficiencies of the available metallic thermocouples which were used. The development of the semiconductor technology over the recent past has provided a new insight into the principles of thermoelectric energy conversion and has been the spawning ground for potential new materials for thermoelectric energy conversion. In modern power-generating thermocouples, carefully controlled p-type and n-type semiconductors replace the dissimilar metals originally

employed by Seebeck and result in significantly improved thermocouple performance. The advent of these new materials has permitted the fabrication of thermoelectric devices of improved efficiencies and gives promise of many interesting and valuable developments for the future.

THERMOELECTRIC SYSTEMS

Thermal energy for thermoelectric converters can be obtained from nuclear reactors, the energy output of radioisotopes, the combustion of fossil fuels, or directly from the sun by means of solar concentrators. For space applications, the use of thermoelectrics with nuclear reactors and radioisotopes appears most promising. In general, nuclear-reactor thermoelectric systems are more suited to large power requirements, and radioisotope thermoelectric power systems are more applicable to lower power requirements. Both systems can be constructed ruggedly, have

long life, employ no moving parts, and can be fabricated to operate satisfactorily in either space or atmospheric environments. Although such characteristics make these systems especially suitable for space applications, the systems are equally suitable for many terrestrial applications in which conventional power techniques are not practical or suitable.

Thermoelectric power systems using thermal energy from the combustion of fossil fuels such as gasoline, kerosene, diesel fuel, and propane are currently being considered with great interest for military and special industrial and commercial applications. Power systems of this type, which can be developed to provide from a few watts to kilowatts, have the potential advantages of relatively silent operation, elimination of moving parts, and the ability to produce power reliably for long periods without maintenance or attended operation. Present thermoelectric generators fired by fossil fuels have comparatively low overall efficiencies (under 5%). The extent of future applications depends on successful development of materials, techniques, and systems that will provide greater efficiency in the conversion of thermal energy. Before thermoelectric



ROBERT L. KLEM received the BSE from Columbia University in 1950. He was employed by the Bell Telephone Laboratories in 1942-43 and again in 1946-47, following service with the U.S. Air Force. He joined RCA in 1950 as a design and development engineer in electron-tube development. In 1953, he was appointed Staff Assistant to the Manager, Harrison Engineering, and in 1954 became Manager, Engineering Administration, Engineering, Receiving Tube Operations Department. In 1959, he was assigned additional responsibility for special receiving-tube development projects in Engineering. In 1962, he was made Manager, New Products Engineering; in this position he was responsible for engineering in the RCA Electron Tube Division's programs for Thermoelectrics for Power. This assignment included the work on the SNAP-10A program, in which he has served as Project Engineer since January, 1962. In 1963, he assumed his current duties as Manager, Thermoelectric Products Engineering.

generators can come into widespread use, the initial costs of devices and systems as well as operating costs must be substantially reduced. In certain space and military applications, however, the cost consideration is tempered because of the importance of such other factors as power-to-weight ratios, silent operation, and reliability.

INITIAL RCA CONTRIBUTIONS

RCA has played a vital role in material development for thermoelectric energy conversion by aiding the transition of thermoelectrics from a measuring technique to a power-generation technique. For example, RCA Laboratories has developed (on a Bureau of Ships contract) a new thermoelectric material which has contributed significantly to the progress and practical application of thermoelectric energy conversion. This material, developed by a team of scientists led by Dr. Fred Rosi, is a silicon-germanium alloy doped with a suitable third element to obtain specific n- and p-type material. The alloy has good thermoelectric characteristics, superior mechanical properties, and excellent resistance to unusual environmental conditions.

RCA's New Business Development (NBD) activity at Harrison investigated the market opportunities of the new material developed at RCA Laboratories. A favorable evaluation led to the establishment of a thermoelectric product-development activity at Harrison staffed with a highly qualified group of receiving-tube engineers. This activity, which was assigned the task of translating laboratory results on thermoelectric materials into practical devices, contributed greatly to the technology by developing a contacting technique for the production of thermoelectric thermocouples that resulted in rugged contacts having low electrical resistance.

As a result of RCA's unique thermoelectric material development, the Atomic Energy Commission discussed with RCA the possibility of applying this technology to AEC's SNAP (Systems for Nuclear Auxiliary Power) programs. An initial AEC-sponsored program at Harrison during the latter part of 1961 proved the feasibility of the new silicon-germanium material and associated RCA technology for a specific AEC application—the SNAP-10A program.

THERMOELECTRIC SYSTEMS

In January 1962, as a result of the early feasibility studies, Atomics International awarded a two-million-dollar sub-contract to RCA at Harrison to develop the thermoelectric portion of the SNAP-10A nuclear-reactor thermoelectric

power system. Atomics International, a division of North American Aviation, is the prime contractor to AEC for the SNAP-10A power system. This thermoelectric power system uses silicon-germanium thermoelectric modules to convert heat from a compact nuclear reactor into electrical power.¹ Heat from the reactor is transferred to the modules by means of a loop system containing liquid sodium potassium.

The SNAP-10A system, which is currently in a research and development phase, is scheduled for flight testing in 1964. When completely developed, the system will include the first nuclear reactor in space and will provide 500 watts of electrical power for long periods of time. Such a power system is designed to provide the necessary reliable electric power required for deep space probes or for long-life satellites. Although the SNAP-10A compact reactor thermoelectric system is designed to provide 500 watts, extensions of this thermoelectric system could provide still greater amounts of power for future space systems.²

In addition to the work on nuclear reactor-thermoelectric systems, RCA is actively exploring the use of thermoelectrics with other heat sources including fossil-fuel burners and radioisotopes. In the area of fossil-fuel-fired systems, RCA has constructed a number of developmental generators, and results to date are encouraging. Recently, the DEC's Thermoelectric Products activity at Harrison was awarded a contract by the Signal Corps to develop a "Thermoelectric fossil-fuel burners."³

FUTURE OF THERMOELECTRICS

Although work has been carried on in thermoelectrics at RCA for about a decade, efforts have been greatly accelerated by the development of the new silicon-germanium material. RCA's thermoelectric program and engineering effort represents a multimillion dollar annual expenditure. Most of this effort is carried on at the Direct Energy Conversion Department thermoelectric activity at Harrison. The Direct Energy Conversion Department, which is an outgrowth of the New Business Development activity, was established early in 1963 and is now part of the newly established Special Electronic Components Division of RCA Electronic Components and Devices.

The basic technical skills, the facilities, and the general technology required for thermoelectric device development are very similar to the skills and experience acquired over many years in the development of electron tubes. This accumulated knowledge has

permitted RCA to realize significant reductions in development time and program schedules for various phases of the thermoelectric projects.

The future of thermoelectric energy conversion in many applications appears extremely promising. Nuclear-reactor thermoelectric systems like SNAP-10A and radioisotope thermoelectric systems may prove vital to future space programs. These techniques can be applied to certain terrestrial applications in which long-term unattended operation is essential and cost is a secondary factor. Extensive use of thermoelectric power for space requires no further major scientific breakthrough, but does require product-engineering effort to refine designs and fabricating techniques and establish reliable associated hardware.

For special military applications, thermoelectric fossil-fuel burner technology is rapidly approaching the technical level required for many applications. Current development programs are daily advancing the state of the art and RCA is adding significantly to this knowledge.

More extensive application of thermoelectric power will be determined by two factors familiar to product-development engineers, *efficiency* and *cost*. Any evaluation of a thermoelectric power-generation system must consider conversion efficiency, initial cost, operating cost, maintenance cost, and attended as opposed to unattended operation. Extensive effort on the development of thermoelectrics for broad applications is under way. Many foreign countries which lack extensive electrification are also vitally interested in this new power-generating technique.

The RCA effort, being carried on at the David Sarnoff Research Center, the Direct Energy Conversion Department at Harrison, and Defense Electronic Products, is significantly contributing to the progress of this technology. The successful application of this effort to the critical needs of our country's space and military programs is one of the prime objectives of RCA's effort. The exploration, evaluation, and development of the potential commercial and industrial applications of thermoelectrics is another major objective with many exciting long-range possibilities.

BIBLIOGRAPHY

1. G. Montgomery Anderson, "Nuclear Reactor Systems," *Astronautics and Aerospace Engineering*, May 1963, Vol. 1 No. 4, pp. 27-36.
2. L. J. Caprarola and W. J. Helwig, "Thermoelectrics for Space," *this issue*.
3. W. F. Lawrence and Dr. A. G. F. Dingwall, "Fossil-Fuel Thermoelectric Generators," *this issue*.

FOSSIL-FUEL THERMOELECTRIC GENERATORS

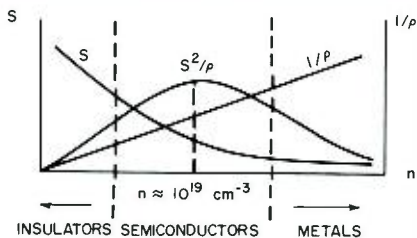

Fig. 1—Theoretical dependence of Seebeck coefficient S , electrical resistivity ρ , and S^2/ρ on carrier concentration n .

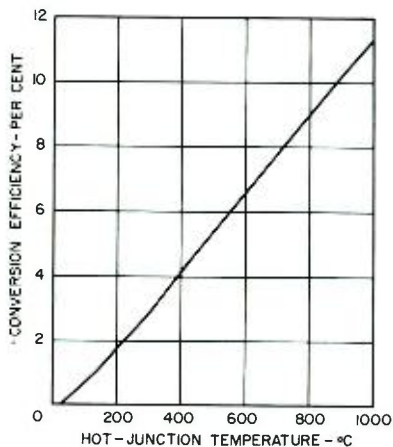

Fig. 2—Energy-conversion efficiency of typical Si-Ge thermoelectric alloys as a function of hot-junction temperature (cold-junction temperature = 25°C).

For applications in which conventional electrical power supplies are not practical, a potential market exists for high-efficiency, reliable thermoelectric generators utilizing available low-cost fossil fuels (i.e. hydrocarbons such as propane, kerosene, etc.). The physics involved, the thermoelectric materials, the fuels, and the generator design are presented herein. Also presented are recent RCA developments in Si-Ge alloys that have made RCA a strong competitor in this field, along with descriptions of some designs of several RCA Si-Ge thermoelectric devices.

**W. F. LAWRENCE
and DR. A. G. F. DINGWALL**
*Thermoelectric Products Engineering
Special Electronic Components Div.
Electric Components and Devices
Harrison, N. J.*

strong theoretical and technological foundations for semiconductor materials in turn provided a clearer insight into the basic physics of thermoelectric conversion.

The recent development of silicon-germanium (Si-Ge) thermoelectric alloys as an outgrowth of basic research at the RCA Laboratories in Princeton and the establishment of manufacturing facilities at the Direct Energy Conversion Department in Harrison have made RCA a strong competitor in the thermo-

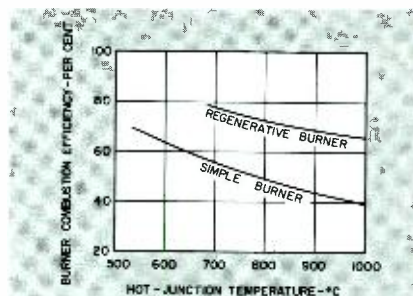

Fig. 3—Computer burner combustion efficiency vs. hot-junction temperature assuming 10% excess air and combustion products exhausted at hot-junction temperature.

ALTHOUGH THE basic principles of thermoelectricity discovered by Seebeck, Peltier, and others in the 1800's are old and well recognized, it was not until the early 1950's that concentrated scientific and engineering effort was applied toward the development of superior thermoelectric materials and the fabrication of reliable practical devices for power generation. Most of the heavy program support began as recently as 1956 and 1957, when various branches of the military saw needs developing in such diverse areas as portable generators for communications and monitoring networks, direct-current silent propulsion systems using thermoelectric conversion of heat from a submarine's nuclear reactor, and light-weight reliable power sources for space applications.

Initial emphasis was directed toward the development of materials having improved conversion efficiencies. The work on thermoelectric materials was also accelerated by, and received much benefit from, the concurrent emphasis in the fifties on solid-state devices with all the associated research. The development of



Fig. 4—Si-Ge thermoelement with tungsten contacts of type used for space applications.



Fig. 5—Si-Ge Airvac thermocouple developed for use in high-temperature-air and combustion-product environments.

electric-generator field. Because of their good strength properties, stable life performance in adverse high-temperature air and vacuum environments, and good efficiency performance, Si-Ge energy-producing devices have many potential uses in both space and terrestrial environments.

PHYSICS OF THERMOELECTRICITY

Advances in solid-state theory have provided a qualitative explanation of the thermoelectric effect. Essentially, the physical mechanism responsible for the thermoelectric effect (in n-type material) is that the electrons at the "hot" end of a conductor have greater energy than the electrons at the "cold" end; electron diffusion, and hence charge movement, tends to result because of this energy difference. As a result, a potential gradient becomes established (negative at the cold end of n-type material) which can be used to supply electrical energy to an external load. In p-type material, "holes" also tend to diffuse and produce a voltage of opposite sign. The magnitude of such thermoelectric voltages (in

volts per degree centigrade) across the specimen is commonly designated the Seebeck coefficient S .

Analysis of the factors which influence the efficiency performance of a thermoelectric material shows that the necessary combination of material properties can be expressed in terms of a figure of merit Z , as follows:

$$Z = \frac{S^2}{\rho} \left(\frac{1}{\kappa} \right) \quad (1)$$

Where: Z is the figure of merit ($^{\circ}\text{C}^{-1}$), S is the Seebeck coefficient (volt/ $^{\circ}\text{C}$), ρ is the electrical resistivity (ohm-cm), and κ is the thermal conductivity (watt/cm - $^{\circ}\text{C}$).

These factors are sufficient to specify the electrical output from and the thermal input to a thermoelectric device, and thus permit computation of the maximum conversion efficiency η_{max} , as follows:

$$\eta_{\text{max}} = \frac{T_h - T_c \sqrt{1 + \frac{1}{2}Z(T_h + T_c)} - 1}{T_c \sqrt{1 + \frac{1}{2}Z(T_h + T_c)} + (T_c/T_h)} \quad (2)$$

For the condition $ZT_h \ll 1$:

$$\eta_{\text{max}} \cong \frac{1}{4}Z\Delta T \quad (2a)$$

Where: T_h is the hot-junction temperature ($^{\circ}\text{K}$), T_c is the cold-junction temperature ($^{\circ}\text{K}$), and $\Delta T = T_h - T_c$.

Eqs. 2 and 2a indicate that the efficiency performance of a thermoelectric generator depends on both the figure of merit of the thermoelectric material and the temperature difference ΔT which can be maintained across the thermoelements. The factor $Z\Delta T$ provides a convenient measure of the potential performance of a material in a thermoelectric device.

Theoretical analysis of the performance of possible classes of thermoelectric materials indicates that the Seebeck coefficient depends on several factors. These factors include temperature, effective mass of the charge carriers, the types of lattice scattering experienced by the charge carriers, and, in particular, the concentration of charge carriers per cubic centimeter. Fig. 1 shows schematically the theoretical dependence on carrier concentration n of the Seebeck coefficient, electrical resistivity, and the term S^2/ρ , which appears in the figure of merit. In general, large numbers of carriers result in a low Seebeck coefficient. It is basically for this reason that metals ($n \sim 10^{22}$) have a low Seebeck coefficient so that in spite of low resistivity the net figure of merit is low. At the other end of the carrier concentration range, insulators,

which frequently exhibit high Seebeck coefficients, have high electrical resistivity so that the figure of merit again is low. Theory predicts that optimum thermoelectric materials are to be found at intermediate carrier concentrations ($n \sim 10^{19}$) corresponding to heavily doped semiconductor materials. The efficient thermoelectric materials in use today all belong to this class of semiconductor alloys.

Thermal conductivity κ , the final term in Eq. 1, gives the figure of merit of thermoelectric materials. During operation, heat must be supplied to maintain a temperature gradient across the thermoelements. Although thermal energy accepted by the charge carriers contributes to the basic energy-conversion process, heat conducted through the lattice of thermoelectric material is wasted and does not contribute to energy conversion. It is essential that the thermoelectric materials used have a low lattice thermal conductivity to minimize such heat losses. One of the most effective known methods for achieving this result is to employ semiconductor alloys containing atoms of different mass ratio.

MATERIALS

Based on a general understanding of the mechanisms involved, a great variety of thermoelectric materials have been developed and evaluated. As yet no clear theoretical foundation has been established for predicting the maximum limit of Z which can be ultimately obtained. Although it has been reported in the literature that values of nearly 2 have been obtained for $Z\Delta T$, more generally these values are in the range of 0.5 to 1.0. When it is further realized that materials of practical interest for device construction must also have good structural and chemical properties (corrosion resistance, ease of contacting, stability at elevated temperature, high strength, fabricability, and proper coefficients of thermal expansion), it is clear why only a few of the hundreds of materials tested are of real significance to the designer.

TABLE I—Comparison of $Z\Delta T$ of Thermoelectric Materials for Fossil-Fuel Generators with a Cold-Junction Temperature of 150°C . (Calculated from Data given in Reference 10).

Material	Max. Temp $^{\circ}\text{C}$	ΔT @ $T_c = 150^{\circ}\text{C}$ $^{\circ}\text{C}$	Average Fig. of Merit Over Temp. Range $Z(^{\circ}\text{C}^{-1})$	$Z\Delta T$
BiTe	250	100	0.0018	0.18
PbTe	600	450	0.001	0.45
ZnSb	400	250	0.001	0.25
GeBiTe	600	450	0.001	0.45
SiGe	1,000	850	0.0006	0.51
PbSnTe	550	400	0.001	0.40
AgSbTe	600	450	0.0015	0.68
CeS	1,200	1,050	0.0002	0.21

cance to the designer. Table 1 summarizes the properties of some of the more likely possibilities; lead telluride (or variations) has been the material most widely used in power generation despite certain stringent design compromises which must be made to overcome some of its practical difficulties such as volatilization, difficulty of contacting, and relatively low strength.

Dr. Abeles and co-workers at the RCA Laboratories developed special methods for measuring thermal conductivity at very high temperatures. They discovered that Si-Ge alloys at high temperatures have a much lower thermal conductivity than had been expected. By use of suitable n and p dopants, they developed a new high-temperature alloy having a favorable $Z\Delta T$ and superior mechanical properties.

The potential for the fabrication of high-efficiency thermoelectric power generators using relatively straightforward construction techniques was sufficiently great to encourage a number of programs at RCA. Foremost among these programs has been the development of Si-Ge thermoelectric modules for use in the SNAP-10A 500-watt nuclear-reactor space-power system and the development of specialized couples for other space applications using isotope or solar-collector heat sources.

FOSSIL-FUEL GENERATORS

For general terrestrial use, potential military and commercial requirements seem to be best served by thermoelectric generators using a fossil-fuel (sometimes called hydrocarbon) heat source. The general availability and low cost of gaseous fuels (propane, natural gas), liquid fuels (gasoline, kerosene, diesel oil), and solid fuels (special burners have been developed for wood chips, grain hulls, and even dried animal dung) permit stationary and portable thermoelectric generators to be designed for use on, under, and over the face of the globe wherever air is available to support combustion.

The use of fossil-fueled thermoelectric generators is most often considered for remote areas where electric power lines do not exist and the more conventional portable sources of electric energy such as batteries and motor-generator sets prove unsuitable. Battery power systems are beset by problems of weight, shelf life and operating life, and poor resistance to adverse ambient environments. Although large motor-generator sets (2 to 10 kw) are capable of significantly better efficiency performance than present-day thermoelec-



WALTER F. LAWRENCE received the BS in 1947 and the MS in Ceramics in 1949, both from Alfred University. He joined RCA in 1949 as a ceramics engineer in the Chemical and Physical Laboratory of the Receiving-Tube Engineering activity at Harrison, and in 1953 was appointed Engineering Leader in the Ceramics Unit. In 1959 he was given the additional responsibility of Acting Engineering Leader in the Chemical Analysis Unit of the Chemical and Physical Laboratory. His work has covered the development of ceramics, dimensional control for accurate parts and other applications, solution metalizing, materials research, and most recently, major contributions to the design and development of thermoelectric generators. Mr. Lawrence is a member of the American Ceramic Society and the National Institute of Ceramic Engineers.



DR. ANDREW G. F. DINGWALL received the BS from Princeton University in 1949 and the MS from Columbia University in 1950, both in Mechanical Engineering. He was a Fulbright Exchange Scholar at the University of Sheffield, England, in 1951 and 1952, and received the PhD degree in Glass and Ceramic Technology there in 1953. He also received the MS degree in Mathematics from the Polytechnic Institute of Brooklyn in 1956, and is currently working for a doctorate in mathematics at the same institution. He has been a member of the Electron Physics section of the Chemical and Physical Laboratory at Harrison since 1953. He has made engineering contributions in connection with the high-temperature operation of electron tubes and electronic devices, and recently has been engaged in the design and development of thermoelectric devices. Dr. Dingwall is a member of the American Ceramic Society, the American Physical Society, and the American Mathematical Society.

tric generators, the efficiency of motor-generator sets decreases rapidly as the power ratings decrease. As a result, in the power-source range below 500 watts, the efficiency of present thermoelectric generators becomes quite competitive. Also, thermoelectric generators, which have no moving parts, are capable of long periods of unattended operations. All internal-combustion engines require regular lubrication and maintenance by skilled personnel and cannot be depended upon for long periods of unattended operation.

For applications in which conventional power supplies are not practical, a potential market exists for high-efficiency, reliable thermoelectric generators. The following examples indicate the scope of such applications. Commercial possibilities for which thermoelectric generators can supply energy as a primary source (or as battery trickle chargers) include cathodic protection for gas and oil pipe lines, remote repeater stations for communications networks, highway caution or direction signals, billboards and display advertising, beacons and navigation aids, control of remote valves and switches, remote monitoring and data taking, detection and alarm systems. Military applications include many of the foregoing, as well as weather stations and telemetry, silent power supplies for clandestine and guerilla-type operations, buoys, portable units for individual and network communications, surveillance, silent propulsion systems, self-contained forced-

air engine heaters, all-environment clothing, and standby power having no shelf-life problems.

PORTABLE GENERATOR DESIGN

Fig. 2 shows the efficiency capability of present Si-Ge thermoelectric alloys as a function of hot-junction temperature when the cold junction is maintained at 25°C. The conversion efficiency (the ratio of electrical power output to heat accepted by Si-Ge) is approximately a linear function of the temperature difference maintained across the thermoelements and, as a rough rule of thumb, amounts to 1.15%/°C of temperature differential. Because of the relative ease with which individual Si-Ge thermo-

couples may be electrically contacted and assembled as structural members of a subassembly, the efficiency performance of presently manufactured Si-Ge modules closely approaches the levels in Fig. 2. This high efficiency recovery is a distinct advantage compared to other competitive thermoelectric materials, in which significant efficiency losses may result from the use of pressure contacts, encapsulation, and compression loading required to ensure reasonable life.

An interesting characteristic of virtually all thermoelectric generators is that the active thermoelectric materials tend to account for less than 10% of the weight and volume of the finished generator. Important device characteristics such as over-all dimensions, watts per pound, and watts per cubic foot are largely dictated by the need to supply adequate heat-flux inputs to the hot junction and maintain desired levels of heat rejection at the cold junction. The most compact device designs are possible in installations in which water cooling can be employed. With water cooling, heat-rejection rates of 20 w/cm² are readily achieved without substantial increase in cold-junction temperature over that of the cooling water. When water cooling is available, Si-Ge thermocouples operated near 1,000°C can produce useful power at the rate of 2 w/cm² (equivalent to approximately 2,000 w/ft²) of active thermoelement area. Such power-density levels are high and permit the design of power sources (10 to 30 w/lb) that are substantially more compact than conventional motor-generator sets.

In the more usual case, however, water is not available for cooling, and it is necessary to resort to convection cooling in air for terrestrial applications. Heat rejection at the rate of 2 w/cm² of finned base-plate area (at 150°C)

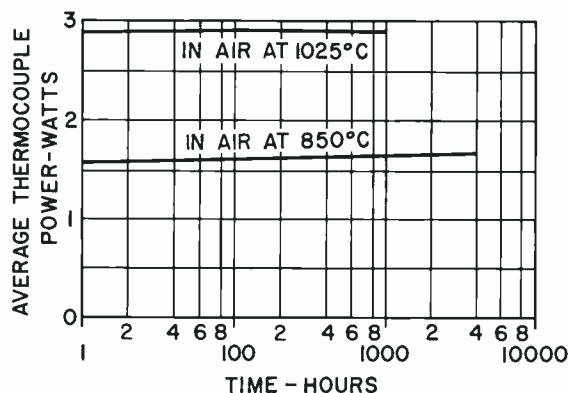

Fig. 6—Life-test performance of Si-Ge thermoelectric modules with Airvac couples.

approximates the maximum rate that can be achieved with free convection at satisfactory radiator weight ratios. In portable thermoelectric generators which dissipate heat by free convection, therefore, heat-dissipation restrictions tend to be such that the optimized generator size and weight (5 to 10 w/lb) is dictated to a large extent by heat-sink requirements. In applications where maximum portability is essential, the use of an electric air blower (which operates from the output of the thermoelectric generator) may be considered. With forced convection cooling, it is probable that net generator power ratings of 10 to 15 w/lb can be achieved.

Other important types of design "trade-off" are also required in thermoelectric generators using a hydrocarbon fuel as an energy source. Simple burner systems can recover only a portion of the heat energy inherently available in a hydrocarbon fuel because of three effects. First, combustion of the fuel results in the formation of combustion products with substantial quantities of water vapor which have a significant heat of condensation that cannot be easily recovered; for gasoline fuels, this energy-loss term amounts to 7%. Second, to ensure complete combustion of the fuel it is necessary to supply somewhat more than the minimum theoretical amount of air required. Third, and most important, the gaseous products of combustion (which are exhausted from a generator at a temperature equal to or greater than the hot-junction temperature) carry away important amounts of sensible heat. Fig. 3 shows computed efficiencies for a simple burner system as a function of hot-junction temperature (it is assumed that there is 10% excess air and that the gaseous products of combustion are exhausted at hot-junction temperature). In large thermoelectric installations, significant improvements in burner efficiency may be achieved through regeneration, that is, by preheating the incoming burner air with the exhaust gasses from the burner.

In spite of several sources of efficiency loss inherent in thermoelectric generators which use fossil fuels, the electrical ratings of present Si-Ge materials and devices is such that they are competitive in the power-spectrum gap between batteries and existing generators of large output. The over-all efficiency of portable gasoline generator sets having outputs below 500 watts, at the present time, is approximately 5% at a rating of 3 to 5 w/lb; these sets require major maintenance after approximately 1,000 hours of operation. As shown in Figs. 2 and 3, the achievable performance of

potential Si-Ge thermoelectric generators is in the range of 2.5 to 4% for simple burner systems and 4 to 6% for regenerative-burner and water-cooled systems. Such power ratings should be achieved at better than 5 w/lb under conditions of long-term unattended operation.

PRESENT STATUS

RCA has developed a variety of Si-Ge thermoelectric couples for different end uses and is continually exploring new techniques which will permit even greater design flexibility. Fig. 4 shows a contacted element of the type adapted by RCA for use in SNAP 10A and similar systems which will be operated in the air-free environment of deep space. Elements of this construction have demonstrated extreme stability and reliability, and have been completely evaluated against the rigorous specifications associated with vehicle launch and life-time requirements of space-power systems. Although highly satisfactory for the intended application in space vacuum, this

construction uses metallurgically bonded tungsten contacts which oxidize in high-temperature air. Therefore, it has limited usefulness in fossil-fuel generators unless relatively low hot-junction temperatures are used or special encapsulations, coatings, or hermetic enclosures are employed to prevent oxidation and subsequent degradation of the tungsten contacts and tungsten-to-silicon germanium bonds.

For applications in which thermal energy can be supplied directly to the thermocouple by radiation and/or convection, a second basic type of Si-Ge thermocouple construction has been developed to eliminate the need for protective coatings or hermetic enclosures. The AIRVAC thermocouple shown in Fig. 5 is constructed entirely of oxidation-resistant semiconductor material (except for metal contacts at the cold junction) and is suitable for operation in both high-temperature-air and vacuum environments. In addition to the benefits of oxidation resistance, advantages are gained in ease of manufacture

Fig. 7—RCA 50-watt fossil-fueled thermoelectric test generator.
(Also see front cover, this issue.)

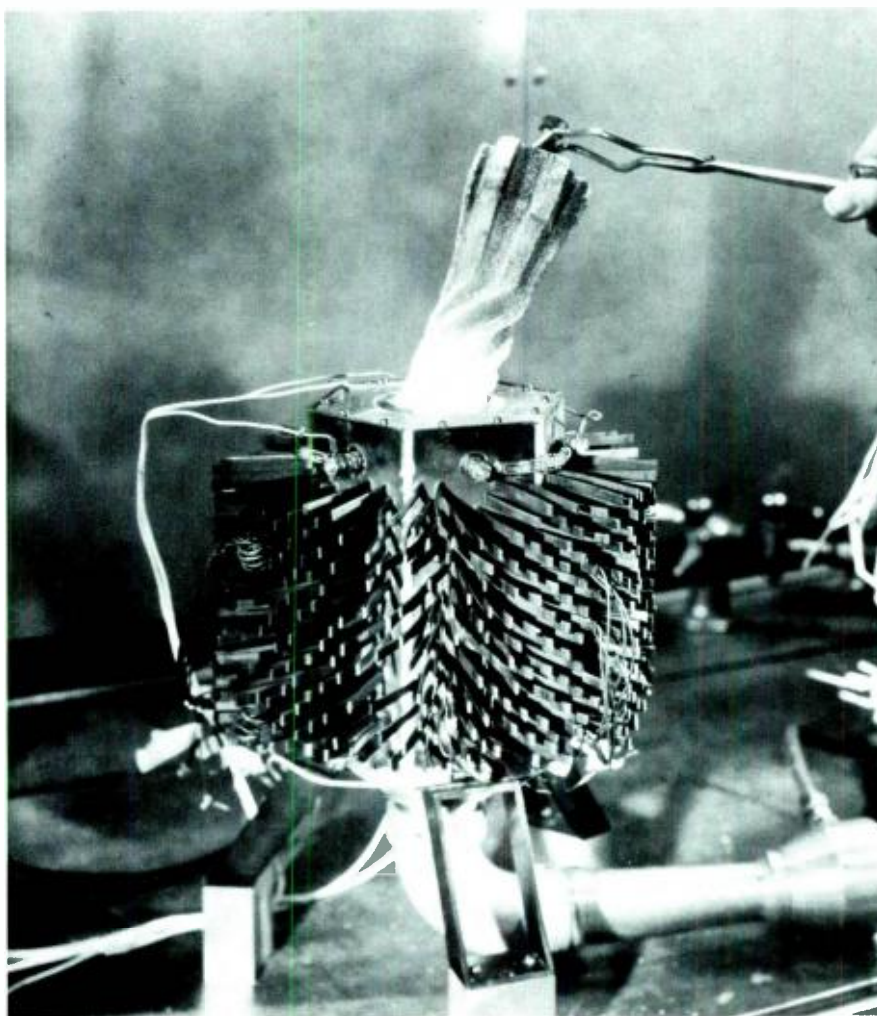

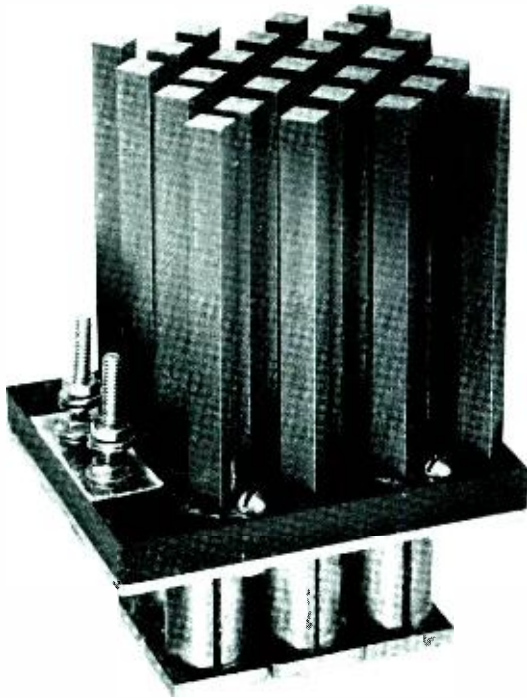

Fig. 8—Self-contained 0.75-volt 3.2-watt thermoelectric module.

and essential freedom from possible stresses or sources of chemical reaction at the hot-junction joints. AIRVAC thermocouples can be operated in air at extremely high temperatures and, in fact, normally are directly exposed to the flames and hot combustion products in a fossil-fuel burner system. The efficiency performance of typical AIRVAC thermocouples is generally 90 to 95% of the basic Si-Ge performance (see Fig. 2). This performance level, combined with the high temperatures that can be attained, results in effective or practical thermoelectric conversion efficiencies which are, to our knowledge, higher than have been attained with competing materials. Thermocouples of this construction have been operated in air for many thousands of hours at temperatures in excess of 900°C, and measurements made at temperatures of 1,025°C hot junction and 60°C cold junction show values for thermoelectric conversion efficiency in excess of 10%. Fig. 6 shows typical life performance of such units.

Fig. 7 shows one of several fossil-fueled generators built at RCA to demonstrate the use of Si-Ge thermoelectric couples in a complete device. This lightweight, highly compact unit, even though built primarily as a test vehicle to explore basic principles, equals or slightly exceeds the performance of competitive units that have already gone through optimization and product design stages (see Table II).

Another interesting development, shown in Fig. 8, is a 0.75-volt, 3.2-watt module developed under Contract No. DA 36-039-AMC-00110(E) for the U.S.

Army Signal Supply Agency, Fort Monmouth, New Jersey. These self-contained modules (in the sense that the couples, insulation, and cooling fins are integral to the structure) are designed so that generators of almost any voltage-wattage relationship can be obtained by suitable series-parallelism of a sufficient number of units.

POSSIBLE FUTURE DEVELOPMENTS

As shown in Fig. 2, the basic conversion efficiency of Si-Ge materials is somewhat in excess of 10%. Although a number of uses exist at this efficiency level, the number of potential applications would undoubtedly grow rapidly with increases in over-all device efficiency. One means by which such increases in device efficiency can be obtained, even with presently available materials, would be through coupling Si-Ge with other thermoelectric or thermionic devices. Silicon-germanium alloys exhibit maximum efficiency levels in the temperature range between 300 and 900 °C. When Si-Ge thermoelements are cascaded with other thermoelectric materials which are operated in the temperature range below 300 °C and with thermionic devices operating in the temperature range above 900 °C, it is possible to visualize devices having efficiencies in excess of 20%. Undoubtedly, substantial engineering effort would be required to reduce such composite structures to practical devices, but none of the engineering problems appears to be insuperable. When such efficiency levels are achieved, direct energy conversion devices will have even greater potential for widespread, everyday use.

BIBLIOGRAPHY

This list includes both source references for this paper and titles for suggested further reading.

1. B. Abeles, D. S. Beers, G. D. Cody, and J. P. Dismukes, "Thermal Conductivity of Ge-Si Alloys at High Temperatures", *Phys. Rev*, 125, 44 (1962)
2. D. K. C. MacDonald, *Thermoelectricity: An Introduction to the Principles*, John Wiley & Sons, Inc., New York, London; 1962.
3. H. J. Goldsmid, *Applications of Thermoelectricity*, John Wiley & Sons, Inc., New York; 1960.
4. I. B. Cadoff and E. Miller, *Thermoelectric Materials and Devices*, Reinhold Publishing Corp., New York; 1960.
5. A. F. Ioffe, *Semiconductor Thermoelements and Thermoelectric Cooling*, Infosearch, London; 1957.
6. W. Ehrenberg, *Electric Conduction in Semiconductors and Metals*, Clarendon Press, Oxford; 1958.
7. P. Egli, "Progress in Thermoelectricity", *Trans. IRE on Military Electronics*, Vol. MIL-6, pp 27-34; January, 1962.
8. T. M. Corry and G. Spira, "Thermoelectric Generator Design, Performance, and Application", *ibid*, pp 34-40.
9. *Selected Papers on New Techniques for Energy Conversion*, Edited by S. N. Levine; pp 9-16, 45-286, Dover Publications, Inc., New York; 1961
10. W. G. Evans, L. J. Schmerzler, G. E. Smith, and R. Wolfe, "Special Thermoelectric Issue", *Semiconductor Products*, Vol. 6 No. 4, pp 23-44; April 1963.
11. R. W. Fritts, "The Development of Thermoelectric Power Generators", *Proceedings IEEE*, Vol. 51 No. 5, pp 713-721; May 1963.
12. R. W. Ure, Jr., "Theory of Materials for Thermoelectric and Thermomagnetic Devices, *ibid*, pp 699-713.

TABLE II—Comparison of RCA 50-watt Thermoelectric Test Generator and Similar Competitive Unit.

	RCA 50-Watt Test Unit	Competi- tive 50-Watt Generator
<i>Electrical:</i>		
Power Output, watts	50	50
DC Load Voltage, volts	7.2	6
DC Open-Circuit Voltage, volts	14.4	12
Load Current, amps	7.0	8.3
Internal Resistance, ohms	1.0	0.8
Over-all Device Efficiency, %	2.35	2.25
<i>Fuel Requirements:</i>		
Fuel	Propane	Propane
Approx. Operating Pressure, psig	10	15
BTU/hour	7,200	7,550
Lb/hour	0.33	0.34
Gal./year	680	705
<i>Dimensions, with similar case & accessories:</i>		
Height, inch	12	16.5
Length, inch	16	21.5
Width, inch	10	13.25
Weight, lb.	22	60
Watts/lb.	2.3	0.85

THERMOELECTRICS FOR SPACE

This paper presents the basic concepts of thermoelectric space-vehicle power supplies, and describes the thermoelectric converter developed by RCA for the SNAP 10A system (which uses a nuclear reactor and is scheduled for orbiting in 1964). Major SNAP 10A objectives are one-year lifetime, 500-watt output, and a completely static system after orbital start-up.

L. J. CAPRAROLA and W. J. HELWIG

*Thermoelectric Products Engineering
Special Electronic Components Division*

Electronic Components and Devices, Harrison, N. J.



LEROY J. CAPRAROLA received the BSME from Johns Hopkins University in 1949 and the MSEE from Stevens Institute of Technology in 1953. In 1949, he joined RCA Receiving Tube Engineering in Harrison. In 1953, he became an Engineering Leader, product development, responsible for the development of tube-making techniques. In 1957, he was appointed Manager of the Methods and Process Laboratory. Mr. Caprarola has been awarded several patents. More recently, he has made significant contributions in thermoelectric bonding techniques, and techniques for fabrication of thermoelectric generators. In July 1962, he became Manager, Thermoelectric Device Development. He is a member of Tau Beta Pi, Pi Tau Sigma and the IEEE.

WILLIAM J. HELWIG received his BSEE from Newark College of Engineering in 1948, after having served with the U.S. Navy during the war. He has done graduate work in Electrical Engineering at Stevens Institute of Technology and the University of Pittsburgh. He was with the Westinghouse Electric Corporation until his recall to the Navy in 1951. He joined RCA in 1953, and since early 1962 has been Engineering Leader of the Applications and Test Group of the Thermoelectric Device Development Section. He has been closely associated with the RCA development effort on the SNAP-10A power conversion system. He is also responsible for measurement work on the fundamental thermoelectric properties of silicon-germanium thermoelectric alloy. Mr. Helwig holds 5 patents and is a member of Tau Beta Pi, and a senior member of the IEEE. He is Past Chairman of the New York Chapter of IEEE-PTGED.

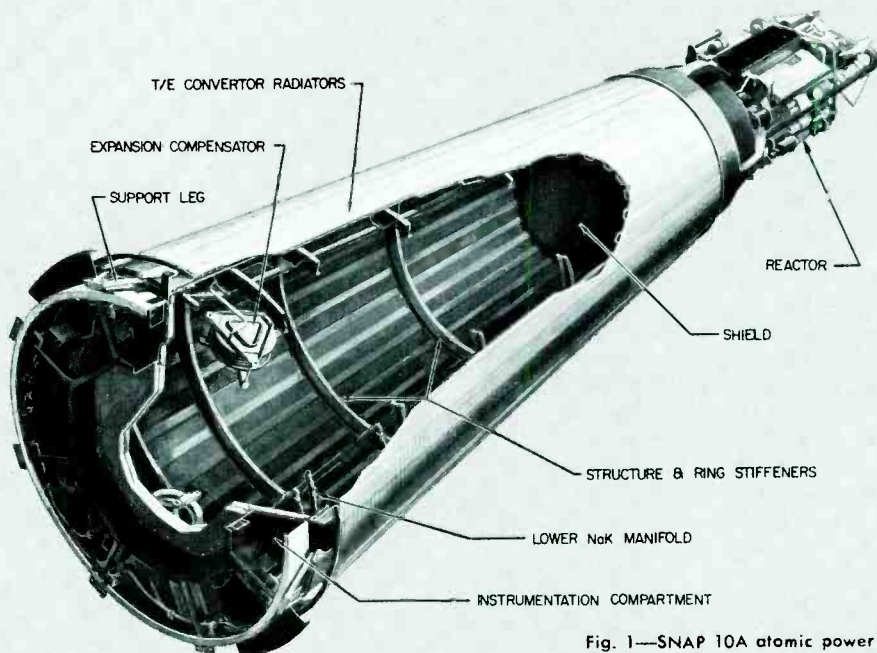

Fig. 1—SNAP 10A atomic power unit.

BATTERIES and fuel cells are examples of methods to convert chemical energy to electrical energy. Useful fuel cells have not yet been developed, but batteries have played an important part in space operations. The first satellite launched by the United States, EXPLORER I, used storage batteries, and the most ambitious space project to date, the MERCURY satellites, also depended on batteries for all of the life-support and operational equipment. The batteries carried in Col. Glenn's capsule were capable of supplying 13,500 watt hours of electrical energy, about enough to light a No. 47 pilot lamp for a little over a year. However, chemical-energy power sources as we know them can provide only finite amounts of energy.

Solar-cell systems are the only practical method to date of converting solar energy into electrical power in space. Solar cells have the advantage of a free, inexhaustible source of energy and

a high energy-weight ratio. RCA had major responsibility for seven successful TIROS satellites and a RELAY satellite, all of which have been primarily powered by solar cells. There are some disadvantages in solar-cell power-supply systems. For example, a storage system, usually in the form of a secondary battery, is required to provide power while the vehicle is in the earth's shadow. Vehicles powered by solar cells and requiring less than 100 watts of power have generally been spin-stabilized. In such vehicles, the weight and cost of the solar-cell system is increased by a factor of approximately four because of partial sun exposure. Above 100 watts, most vehicles are designed to be stabilized and have sun-oriented panels of solar cells with their attendant complexities.

THERMOELECTRIC SYSTEMS

Thermoelectric energy conversion can utilize either solar or nuclear energy.

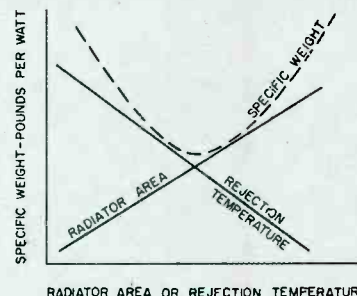

Fig. 2—Optimization of specific weight of the thermoelectric generator as a function of radiator area or weight.

A thermoelectric system employing solar heat is being investigated, but would generally require large energy-collecting areas plus a means of concentrating the energy to achieve the required temperatures. Therefore, such a system would have many of the same limitations as the solar-cell systems.

The most promising application of thermoelectric energy conversion for use in space appears to be with nuclear heat sources. A thermoelectric conversion device is basically a heat engine which takes energy in the form of heat, converts a small amount of this energy into the form of electricity, and then rejects the waste heat energy. The necessary heat may be made available in space from radioisotopes or from the fission energy produced in a nuclear

TABLE I — SNAP Reactor Characteristics

Heat Power	35 kw-therm.
Over-all Length ...	16 inches
Diameter (incl. Be reflector)	14 inches
Core Volume	0.3 cubic feet
Power Density	99 kw-therm/ft ³
Weight	270 pounds
Max. Fuel Temp. ...	1,050 °F
Heat Flux	10,200 btu/hr/ft ²
Coolant	
Temperature at output ..	1,010°F
Temperature at input ...	902°F

cessfully orbited in satellites. These two generators, capable of producing 2.7 watts of electrical power, supplemented the solar cell system aboard the vehicles. These generators represent both the first use of isotope energy sources and the first use of thermoelectric energy conversion devices in space. The SNAP 10A system, which employs an RCA-developed thermoelectric converter, is expected to be the first system to be launched into space using a nuclear reactor; it is presently programmed for flight testing in 1964.

DESIGN CONSIDERATIONS

In space, weight is one of the most important considerations. A thermoelectric energy conversion system differs from other systems available for use in space in that the weight of the generator is not a direct function of the power supplied. The same amount of active thermoelectric material is capable of supplying more power if the supply temperature is increased or if the rejection temperature (i.e., the temperature of the heat energy not converted to electrical power) is decreased. The source temperature of both isotope and reactor thermal sources are variable within small ranges, but can be considered practically constant. As a result, the power available from a thermoelectric conversion system becomes a function of the rejection temperature.

In outer space, the only means of rejecting heat is by radiation. Because the amount of power which can be radiated per unit area is a function of the rejection temperature, the radiator surface area must be increased to reduce this temperature. However, radiator area is almost directly proportional to radiator weight, and as such is one of the limiting factors in design. With a fixed source temperature, therefore, the electrical power per pound of generator increases as the rejection temperature is decreased, but at the same time the specific power decreases as radiator weight and area increase. Obviously an optimum value of radiator area exists which provides the maximum power output in terms of watts per pound (see Fig. 2).

SNAP 10A UNIT

SNAP 10A (Figs. 1, 3) is an example of an optimized design of a thermoelectric energy conversion system powered by a compact nuclear reactor. Atomics International, a division of North American Aviation, has been responsible for the design of the over-all SNAP 10A system. The Thermoelectric Product Engineering activity at Harrison has had the responsibility for the development of the thermoelectric modules. The heart of the system is the compact reactor developed by AI, which is extremely small and is capable of supplying approximately 35 kilowatts of thermal energy at a fuel temperature of 1,050°F. The first SNAP experimental reactor went critical in 1959 and was operated for about one year with long endurance runs at 1,200°F. A practical thermoelectric conversion system was not demonstrated until 1962, however, when RCA began development of modules using the silicon-germanium thermoelectric alloys developed by the RCA Laboratories at Princeton.

The thermal energy developed in the SNAP 10A reactor is transferred to the thermoelectric converter by means of a liquid-metal coolant which circulates through the entire system. Although the liquid metal is the heat source for the thermoelectric system, it is referred to as a coolant because it removes heat from the reactor. The metal used is an alloy of 78-percent sodium and 22-percent potassium.

The reactor itself is extremely compact and is controlled by four reflector drums. These drums are rotated into position to start up the reactor. Once it is operative, the control drums stay in position and the reactor operates in a self-regulating manner. As a safety feature, the reflector and control drums are held in place by a fusible tension band which is designed to be broken remotely or separated when overheated during a launch abort or re-entry from orbit. The reflector and drums then fall away from the reactor and cause it to become inoperative. The NaK coolant is circulated through the core of the reactor and extracts heat from the fuel rods which is later released in the thermoelectric converter (see Table I).

The coolant is circulated throughout the entire system by means of an electro-magnetic pump. This pump, of the Faraday type, is in itself a thermoelectric device. The coolant, which has been heated in the reactor, passes through the square metal throat of the pump, which has thermoelectric elements on the opposing outer surfaces. The connections to the pump throat form the hot junctions for these ele-

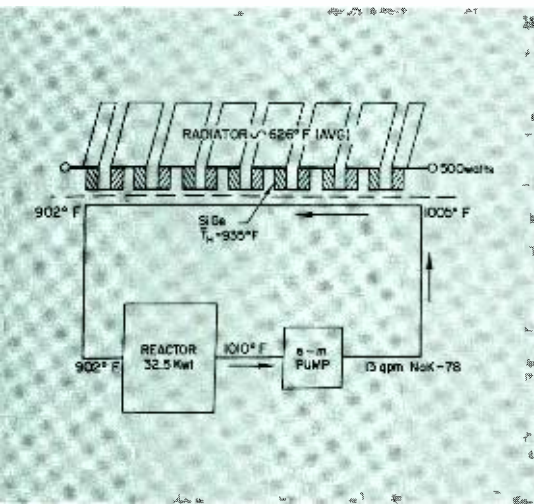

Fig. 3—SNAP 10A system schematic.

reactor. Eight radioisotopes presently being considered as fuels for isotopic power generators are capable of producing specific powers ranging from 0.2 thermal watt per gram to more than 100 watts per gram. Mission lifetime is limited by the half-life of the isotopes, which ranges from a few months to many years. The longer-life isotopes generally have the lower specific powers.

Almost all energy conversion systems employing either radioisotopes or nuclear-reactor heat sources are being developed by the United States Atomic Energy Commission and are included in the SNAP (Systems for Nuclear Auxiliary Power) programs. There are presently about ten SNAP systems under active development, of which seven are intended for use in space. Of these seven, four utilize thermoelectric devices as the energy conversion system. SNAP 3, 9, and 11 are radioisotope generators, and SNAP 10A is powered by a compact nuclear reactor. Two SNAP 3 generators, built by the Martin Co., have been suc-

ments. The cold junctions are thermally connected to a radiator surface, and are all electrically connected together. The resulting electrical short circuit, formed partly of liquid metal, causes a very strong current to flow across the throat of the pump through the coolant. At the same time, a permanent magnet applies a strong transverse magnetic field at right angles to the current flow. The crossed electric and magnetic fields create a force on the liquid metal which causes it to circulate through the system. This type of pump has no moving parts to wear out or to cause friction losses. It derives its energy from the thermal energy in the liquid which it is pumping. The SNAP 10A pump extracts approximately 700 watts of thermal power from the NaK coolant to pump it at approximately 13 gpm.

The coolant coming out of the pump is conveyed to a ring manifold about

**TABLE II — SNAP 10A
System Characteristics**

Power Output	0.5	kw-elec.
Reactor Power	33.5	kw-therm.
Efficiency (converter)	1.96	%
Output Voltage (Regulated)	28.5	volts
Avg. Hot Junction Temp.	~911	°F
Avg. Radiator Temperature	~604	°F
Radiator Area	62.5	square feet
Unshielded Weight	725	pounds
Over-all Length	136	inches
Diameter at Base	52	inches

one-tenth of a volt under open-circuit conditions), a great number of couples are connected in series to provide a useful output voltage. Seven hundred and twenty couples are connected in series in each of two parallel circuits to provide a load voltage of approximately 30 volts. (See Table II.)

parallel circuit paths to increase the reliability of the converter system. The use of subparallel circuitry provided by the auxiliary connections affords minimal loss of power in the event of a possible open circuit in any of the converter elements.

The outer surface of each radiator is covered with a special high-emissivity coating in order that the maximum heat per unit area may be radiated at the operating temperature. A second special coating applied over this high-emissivity coating minimizes absorption of thermal energy from the sun which would tend to raise the rejection temperature. The difference in spectral characteristics of these two coatings achieves both these objectives.

The SNAP 10A atomic power unit is scheduled to be launched from an ATLAS AGENA-D suitably modified for the orbital tests (see Fig. 5). The U. S.

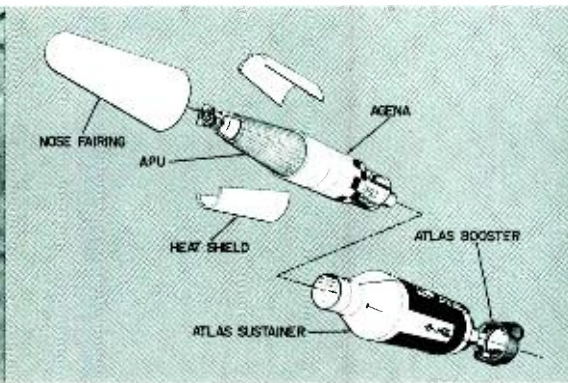
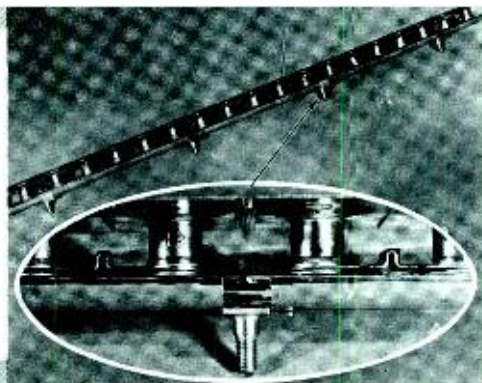
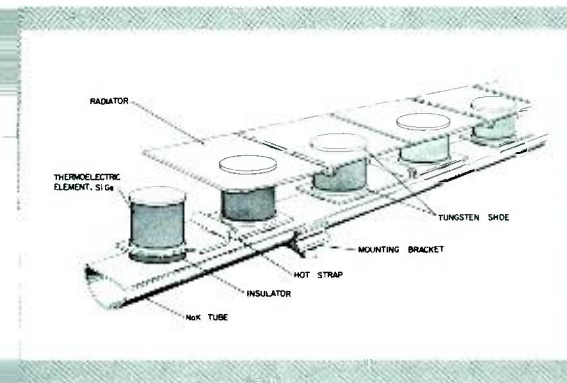

Fig. 4—Sketch and photograph of portion of thermoelectric converter module.

Fig. 5—ATLAS-AGENA SNAP 10A system.

the top of a frusto-conical supporting structure. From this manifold, forty stainless-steel tubes positioned around the outer surface of the cone carry the liquid metal to a lower ring manifold. The NaK is then returned to the reactor for reheating and recirculation.

Each of the forty stainless-steel coolant tubes is a part of a leg of the thermoelectric converter. Thirty-six thermocouples, each consisting of an n-type element and a p-type element, are mounted on each of these legs. The hot junction of each couple is formed at the stainless-steel tube, which is the source of the thermal energy for the thermocouples. The other ends of the elements are connected to individual aluminum radiators which reject the waste heat and form the cold junctions. The entire surface of the converter is covered with these radiators, giving a heat-rejection area of 62.5 square feet.

Because the voltage developed by each thermocouple is very small (about

Because of the necessity of connecting the couples in electrical series, the individual elements must be electrically isolated from the coolant tubes to prevent short-circuiting. At the same time, thermal impedance between the tubes and elements must be kept very low so that thermal energy may be transferred to the couples with minimum loss. The development of this "insulator stack" was a major accomplishment in establishing the feasibility of the Harrison concept of the SNAP 10A thermoelectric converter. Conductors are provided at the hot junctions of the couples, and the radiators of the individual elements are paired to provide electrical connections at the cold junctions. A sketch of a portion of module showing these features is shown in Fig. 4a and a photograph in Fig. 4b. The terminal radiators are the connections for the total voltage developed by each leg. Auxiliary connections between radiators at other points in the circuit provide for

Air Force will be responsible for all flight operations. As a safety measure, the reactor will not be started until the vehicle is in orbit, and will be automatically disassembled during re-entry.

Some of the major objectives of the SNAP 10A system are: a life-time capability of one year, an electrical output of 500 watts, and a completely static system after orbital start-up. It is expected that the SNAP 10A system can be used as the basis for higher-power systems with little additional innovation required. This system and its potential successors will provide power sources for space which have high power capability, are completely static, and are essentially independent of their environment.

ACKNOWLEDGMENT

The authors thank Atomics International for supplying the illustrations shown in Figs. 1, 3, 4, and 5.

DESIGN AND ANALOG OF A THERMOELECTRIC REFRIGERATOR FOR THE MICROPAC COMPUTER CORE MEMORY

G. REZEK

Communications Systems Division, DEP, Camden, N. J.

This application of a thermoelectric refrigerator was made in a random-access coincident-current-driven ferrite-core memory for MICROPAC, a miniaturized computer using micro-modules in the electronic circuitry section and designed by RCA for the U.S. Army.⁵ The core material of this memory required an environment of 20° to 55°C for optimum operation. A broad ambient range from -30°C to 52°C was specified for the computer, necessitating refrigeration to stay within the upper limit. Planned and designed three years ago, this particular application does not take into account the recent advent of temperature-stabilized ferrite core materials. But the refrigerator has noteworthy features, and the design fulfilled the specified requirements. The thermal analysis presented will serve as an informative basis for enhanced understanding of basic refrigeration applications. (More details are given in Ref. 1).

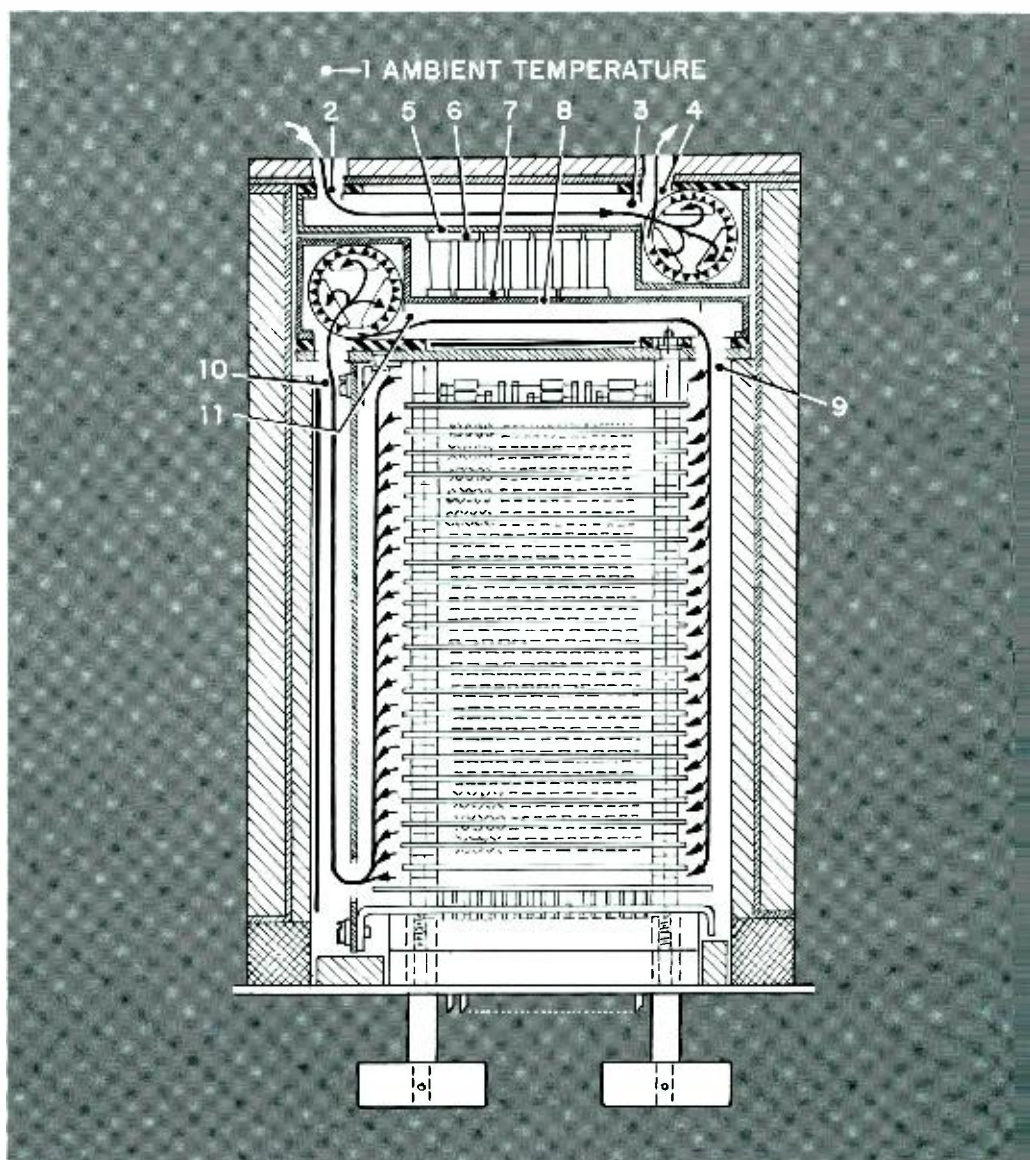

FIG. 1 shows the refrigerator, at 6.9 x 5.4 x 1.5 inches a minimum space design, located on top of the memory stack. In the primary of recirculating flow, air is drawn at location 10 into two small blowers of the cold chambers. Air enters the fin cold plates at 11, there transferring its heat. Leaving the cold chamber at 9, the air is distributed in a plenum chamber to each memory array, that is into 23 air passages. It leaves the memory stack at the lower left corner to return to 10. The blowers in the cold chamber have a dual purpose: 1) they enhance the heat transfer in the heat exchanger, 2) they help equalize the stack temperature field and are therefore operating whenever the memory is energized. Note the location of these blowers at the memory passage exits (they generate the major amount of the heat power, 7.3 watts compared to only 2.7 watts maximum in the memory

windings). Thus the memory obtains the coolest air in the cycle. In terms of heat power their location is irrelevant, and the refrigerator must pump the sum of heat power, i.e. 10 watts, regardless of air-flow direction.

In the secondary air flow path ambient air enters at 12 and absorbs heat from the fin plates of the hot chamber. It enters the suction side of the blowers at 3 and is expelled at 4, to ambient. By locating these blowers at the exit side, their heat load is eliminated from the refrigerator.

Thus by the action of the refrigerator, heat will be pumped from bottom to top, that is from memory through cold chamber, to thermoelectric modules, to hot chamber to ambient.

Fig. 2 shows the refrigerator viewed from the cold chamber. On the right side of Fig. 3, the detachable hot chamber is shown. The cold chamber shown

on the left supports the 32 individual thermocouples (recognizable in the picture by the pattern of lines and spaces). Looking again at the hot chamber at the right, a black anodized Martin Hard-coat finish serves as thermal conductor and electrical insulator, preventing shorts with the current carrying couples. The rigid construction insures flatness of the surfaces, and the application of silicone grease enhances heat transfer at minimum temperature elevation, between thermoelectric module surfaces and adjoining hot- and cold-side heat exchanger surfaces.

Fig. 4 shows the hot chamber alone, with the cover plate removed exposing gang-milled fins, integral with the fin base. (For quantity production this method would give way to methods of forming and braising of fin structures to the base). The large fin surface area

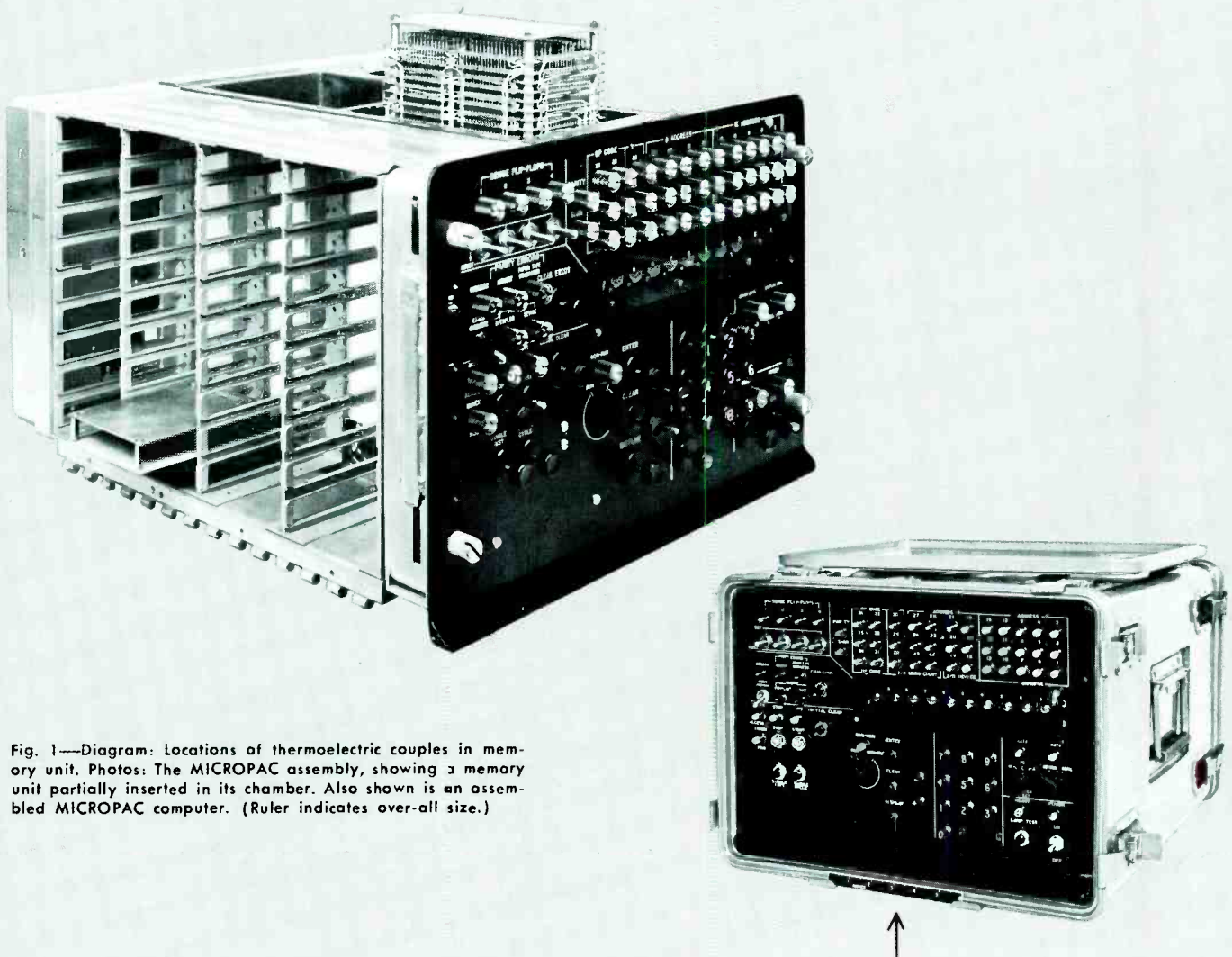

Fig. 1—Diagram: Locations of thermoelectric couples in memory unit. Photos: The MICROPAC assembly, showing a memory unit partially inserted in its chamber. Also shown is an assembled MICROPAC computer. (Ruler indicates over-all size.)

provides heat transfer at minimum temperature elevations between air and surfaces. Note the four nylon blocks, used as locknuts in Fig. 3, to anchor the assembly (thermoelectric module sandwiched between hot and cold chamber) without providing a thermal short from hot to cold side.

THERMAL DESIGN

The knowledge of heat transfer over a required temperature difference forms the basis for the choice of the thermoelectric modules. Appraisal of the thermal requirements goes hand-in-hand with a preliminary design. The thermal load to be pumped consists of:

- 1) heat generated in the memory winding.
- 2) heat from cold chamber blower motors.
- 3) influx of heat through insulated structure (regarded as negligible).

The heat load for the hot chamber heat exchanger comprises items 1, 2, and 3 plus the ohmic losses caused by the DC current in the thermoelectric elements.

The required pumping temperature depends on the efficiency of all elements involved in the heat transfer, in the hot chamber, in the cold chamber and to and from the thermoelectric module. Temperature elevations are caused 1) when heat is conducted through adjoining surfaces, 2) in the film boundary layers between air and fin metal surfaces, and to a major extent, 3) when heat is absorbed by the limited air mass, causing temperature differences between exit and entrance. The thermal resistances causing these temperature differences 1, 2, and 3 can be made part of an analog thermal or electrical network of the refrigerator as shown later in Fig. 7.

With the thermal requirements known, the choice and number of thermoelectric elements can be made by calculation, or made with the aid of curves available from the manufacturer.² One such family of curves expresses heat power pumped per element vs. temperature difference reached, with the thermoelectric DC current as parameter. Another family of curves expresses the coefficient of performance vs. DC current with the temperature reached, as parameter. In Ref. 4, a computation is described which uses these graphical values to arrive at a relationship correlating:

$$\Theta = -\Theta_{\text{pump}} + aQ + bI^2R \quad (1)$$

Where: Θ = air temperature difference between locations 9 and 2 in Fig. 1; Θ_{pump} = temperature difference between the hot and cold sides of the thermoelectric elements; a and b are constants

expressing combinations of thermal resistances; Q = heat power in the cold chamber; and I^2R = heat power generated in the thermoelectric module (ohmic losses).

This relation is plotted in Curve A in Fig. 5. Curve B shows the actual measured temperature performance at 10-watt load. It is seen that at an optimum thermoelectric current of about 10 amperes, an optimum temperature of refrigeration is reached. Curve C, for zero thermal load, has also its optimum at about 10 amperes. The shape of performance curve (A or C) is characteristic for the thermoelectric elements as well as for the system. At zero current in the refrigerator, with the hot chamber blowers de-energized, the refrigerator performs only as an inefficient heat exchanger. In this mode, point D in Fig. 5, the memory will reach 17.5°C above ambient (temperature point on curve B for zero thermoelectric current). If no current flows but blowers in both chambers are energized, this heat exchanger becomes more efficient and a temperature of only 8°C above ambient will be reached (curve B, at zero amperes). As the thermoelectric current increases, the temperature begins to drop proportionately due to the Peltier cooling. Soon however, the I^2R losses outweigh this gain and beyond a maximum of about 10 to 12 amperes, the application of larger currents has a detrimental effect. We note from these results that at optimum point of operation the refrigerator reduces the ambient temperature from 52°C to 52-7° = 45°C, but without the refrigerator the temperature in the memory would have reached 52°C+17.5 = 69.5°C, at which point the memory would not have been electrically operative. Other results derived are, that for the shown system at optimum thermoelectric current either lowest temperatures are reached or maximum thermal load is transferred. The larger the thermal load the less refrigeration, in terms of temperature, can be achieved (Equation 1). Due to the temperature drops described above the system can only reach smaller refrigeration temperature differences than the elements alone would reach were they exposed in vacuum. It can also be shown by analysis that the optimum thermoelectric current for a simple system is smaller than for the thermoelectric module alone.

ANALOG OF THERMOELECTRIC MODULE

The net heat power transferred from the cold to hot side by a thermoelectric module is:

$$Q = I T_c S - \frac{I^2 R^*}{2} - K(T_h - T_c) \quad (2)$$

(*The heat power caused by the ohmic losses I^2R distributed over the volume of the elements can be thought as being lumped into two parts, one half at the hot surfaces, and one half at the cold surfaces; only the latter half has to be pumped through the elements to the hot side.)

In equation 2, Q = useful cooling (load), R = electrical resistance of elements in series or module, K = thermal conductance of module, S = difference of Seebeck coefficients of dissimilar material, I = DC current flowing through

Fig. 2—Thermoelectric refrigerator viewed from cold chamber.

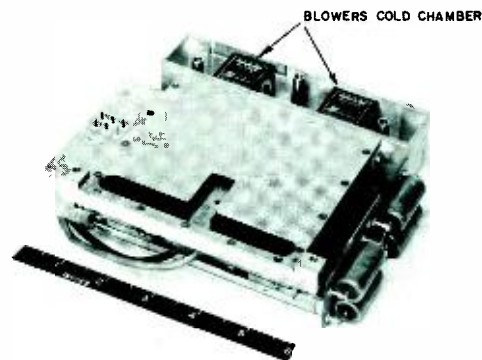

Fig. 3—Thermoelectric refrigerator showing hot chamber (right) and thermoelectric module.

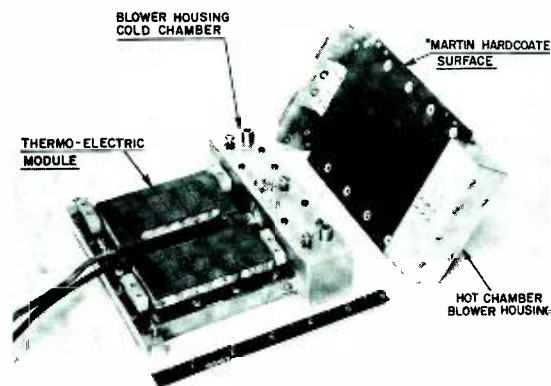
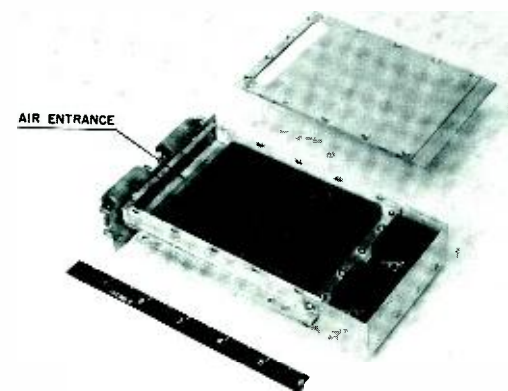

Fig. 4—Hot chamber showing heat exchanger fins.



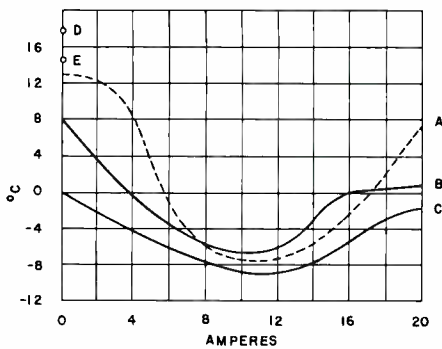

Fig. 5—Air temperature difference between memory stack entrance and ambient air as a function of current in the thermoelectric module. Curve A) Thermal load of refrigerator 10 watt temperatures calculated from equation 9a. Curve B) Thermal load 10 watt, temperatures measured between locations 2 and 9 (refer to Fig. 1). Curve C) Thermal load 0 watt, temperatures measured between locations 2 and 9. Point D) Thermoelectric current off hot chamber blowers off, 2 blowers in cold chamber operating, temperature between locations 1 and 9. Point E) Thermoelectric current off, only 1 blower in cold chamber operating, temperature between location 1 and 9.

junctions, T_c = temperature of cold junction, °K, T_h = temperature of hot junction, °K, and $\Theta_{pump} = T_h - T_c$ in °C.

Equation 2 shows that the useful cooling obtained at the cold junction is equal to the Peltier cooling diminished by one half of the I^2R losses and further diminished by the back flow of heat from the hot to the cold junction due to thermal conduction.

If Equation 2 is solved for $(T_h - T_c)$ we obtain:

$$\Theta_{pump} = \frac{I S T_c}{K} - \frac{(Q - \frac{I^2 R}{2})}{K} \quad (3)$$

The first term of the right side pre-

Fig. 6—Equivalent thermal and electrical model for thermoelectric module.

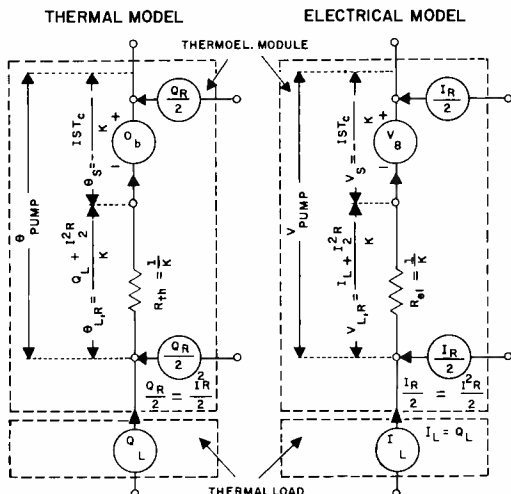

sents the cooling temperature difference (temperature difference generation), the second term the temperature difference (loss) due to transfer of the thermal load Q_L plus half of the ohmic load across the thermal resistance $1/K$.

The thermal model expressing this equation is shown in Fig. 6a. Note that the other portion of the ohmic losses, although not pumped through the elements, appears in the diagram. That portion nevertheless presents a load to the hot chamber heat exchanger. To arrive at the analogous electrical model, electrical resistances can be equated to thermal resistances, electric current to temperature drops and voltage generation to temperature generation (Fig. 6, electrical model.)

EQUIVALENT ELECTRICAL MODEL FOR THERMOELECTRIC REFRIGERATOR

This is shown in Fig. 7 with the various quantities denoted. The quantities R_i to R_e are the thermal resistances involved in the heat transfer in the cold and hot chamber. The current I_m and I_b represent the heat generation as caused by the energized memory windings and blower motors. This heat together with the (lower) half of the ohmic losses, is pumped by the voltage (temperature) generator V_s through the hot chamber and from there to the heat sink.

The magnitude of V_s must be obtained by trial of computation, since it contains the variable T_c , which amounts to an iterative calculation (neither T_c nor T_h are known).

In the system presented the memory was well insulated and heat was generated inside. Therefore the thermal leakage resistance R_{L1} was high and the thermal leakage current I_{L1} small. In

Fig. 7—Equivalent electrical model for thermoelectric refrigerator.

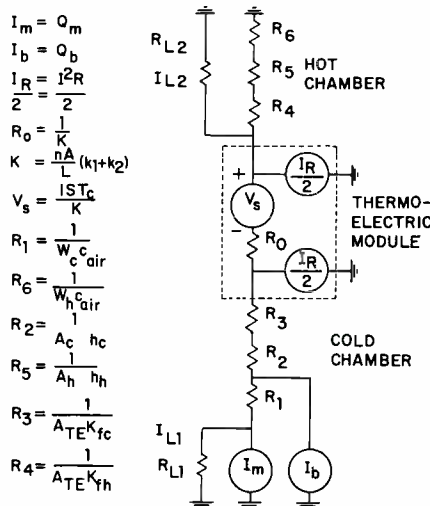

$$\begin{aligned} I_m &= Q_m \\ I_b &= Q_b \\ \frac{I_R}{2} &= \frac{I^2 R}{2} \\ R_0 &= \frac{1}{K} \\ K &= \frac{dA}{L} (k_1 + k_2) \\ V_s &= \frac{I S T_c}{K} \\ R_1 &= \frac{1}{W_c c_{air}} \\ R_6 &= \frac{1}{W_h c_{air}} \\ R_2 &= \frac{1}{A_c h_c} \\ R_5 &= \frac{1}{A_h h_h} \\ R_3 &= \frac{1}{A T E K f_c} \\ R_4 &= \frac{1}{A T E K f_h} \end{aligned}$$



GERARD REZEK graduated in 1940 as Mechanical Engineer and in 1948 as Electrical Engineer from the Swiss Federal Institute of Technology in Zurich. He has had over 14 years of experience in electro-mechanical design and development, ranging from high-pressure pumps to electronic instruments. Since his employment with RCA in 1951, Mr. Rezek has worked on computer devices such as random access, high-speed memories and input-output devices. Since 1958 he has been working with the DEP Surface Communications Division (now called the Communications Systems Division) in Micromodule Engineering, especially concerned with thermal problems and packaging designs for micromodule computers. Mr. Rezek holds five U.S. patents. He is a senior member of the IEEE.

some other systems, heat generation might be small ($I_m = 0, I_b = 0$), and in that case heat enters solely through R_{L1} from the heat sink into the system. The heat power I_{L1} is then almost proportional (except for the non-linearity of T_c) to the temperature generation V_s . Leakage resistance R_{L1} can be determined by an experiment using heat generation (which is simple to arrange) by knowing the heat power generated inside the cold chamber and by measuring the resulting temperature difference between cold chamber and ambient. As for R_{L1} , it aids refrigeration and may be neglected for conservative computation.

CONCLUSION

The objects of the mechanical and thermal design of this refrigerator have been more than met in establishing the specified environment under the given ambient temperatures and also in providing minimum temperature variations within the memory stack.

ACKNOWLEDGEMENT

The author acknowledges advice obtained in discussions with Dr. Paul K. Taylor and Mr. Marvin Crouthamel, both from RCA, and Prof. George Auth, Professor at Villanova University.

REFERENCES

1. G. Rezek, "Thermal Design and Analog Representation of a Thermoelectric Refrigerator," Paper at IEEE International Convention, March 1963, N. Y. and *Convention Record*.
2. Materials Electronics Products Corporation, Trenton, New Jersey. Vendor's Brochure on Melcor Thermoelectric Modules.
3. M. B. Grier, "Lumped Parameter Behavior of a Single Stage Thermoelectric Refrigerator," *Proc. IRE*, September 1939.
4. A. F. Joffe, "Semiconductor Thermoelements and Thermoelectric Cooling," *Information Limited*, London, England.
5. A. S. Rettig, "MICROPAC—A Micromodule Digital Computer for Military Field Use," *RCA ENGINEER*, Vol 8, No. 4, Dec. 1962—Jan. 1963.

THERMOELECTRIC REFRIGERATION, HEATING, TEMPERATURE CONTROL, AND DISTILLATION

Thermoelectrics is unique among the various methods of direct energy conversion because of its dual nature. A thermoelectric circuit can serve as either a generator of electrical energy or as a refrigeration machine. This paper emphasizes thermoelectric applications other than power generation; e.g., refrigeration, heating, temperature control, dew-point sensing, and distillation.

P. E. WRIGHT, Ldr.

Applied Research, DEP, Camden, N. J.

A CIRCUIT which includes an n-p semiconductor junction and a DC electrical current source will perform as a refrigeration machine, as schematically shown in Fig. 1. As current flows in the manner indicated, a temperature difference is created across the thermoelectric device. Thermal energy is absorbed at the cold junction and rejected at the hot junction. By attaching the cold junction to the region where refrigeration is desired and attaching the hot junction to a heat sink, the thermoelectric device performs as a refrigerator. The maximum temperature difference obtainable is:

$$(T_H - T_C)_{max} = \frac{1}{2} ZT_c$$

Where: Z is the figure of merit and subscripts c and h indicate *cold* and *hot*, respectively. This parameter is a measure of the effectiveness of materials for use in thermoelectric refrigerators. Refrigerator performance is measured by its coef-

ficient of performance (COP). This is the ratio of the thermal energy absorbed at the cold junction to the amount of electrical power required to drive the device. In other words, it is a ratio of the watts of heat pumped to the watts of electrical power used. The coefficient of performance is related to the figure of merit and the temperatures of operation:

$$COP_{max} = \frac{T_c \sqrt{1 + \frac{1}{2} Z(T_H + T_c)} - \frac{T_H}{T_c}}{T_H - T_c \sqrt{1 + \frac{1}{2} Z(T_H + T_c)} + 1}$$

The semiconductor material generally used for thermoelectric refrigeration is bismuth telluride (Bi_2Te_3). The figure of merit of Bi_2Te_3 is approximately $3 \times 10^{-3} \text{ } ^\circ K^{-1}$ for $275^\circ K < T < 325^\circ K$.

AIR CONDITIONING

Certain military applications call for

vans (trucks) of electronic equipment to be air-conditioned. When weight, volume, and silent operation are critical parameters, thermoelectric air conditioning is superior to conventional types. An analysis of a specific situation for the Army supports this declaration. The thermoelectric air conditioners under consideration would have the following parameters: 1) initial cost (in production), \$1,500 per ton; 2) weight, 75 pounds per ton; 3) volume, 0.75 cubic feet per ton. This equipment can be built to operate with high reliability and flexibility. A complete family of thermoelectric air conditioners can be built using one basic component (Fig. 2).

It is clear that thermoelectric air conditioning can be extended to any number of space cooling requirements. Limitations at this time on its use in commercial and industrial applications are the initial cost and relatively low coefficient of performance ($COP_{TE} = 1$ to 2 vs $COP_{FREON} = 2$ to 4.)

In 1958, DEP Applied Research received one of the first important device contracts in the area of thermoelectric refrigeration. Under this contract we demonstrated the basic feasibility of adapting thermoelectric refrigeration to air conditioning systems for submarines. Figs. 3 and 4 are photographs of the finished unit. In 1961, DEP Applied Research was awarded a contract to build a 9-ton thermoelectric air conditioner for a submarine. Out of this contract is coming a device which represents a major step forward in the thermoelectric art. It demonstrates sev-

Fig. 2—A thermoelectric air conditioner.

Fig. 1—A thermoelectric refrigeration model.

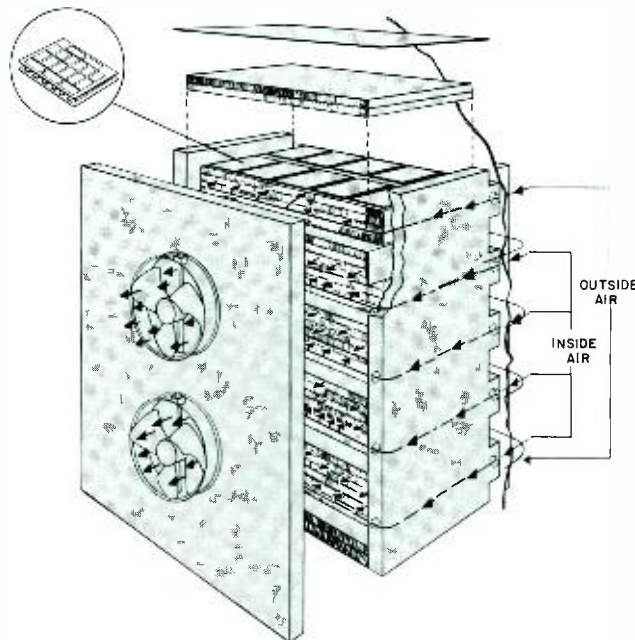
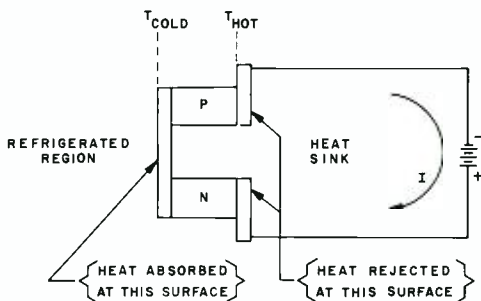

Fig. 5—Nine-ton thermoelectric air-conditioner: 1) cooling core, 2) thermoelectric modules, 3) water jacket.

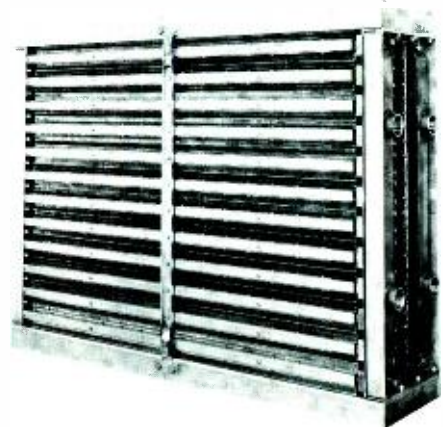
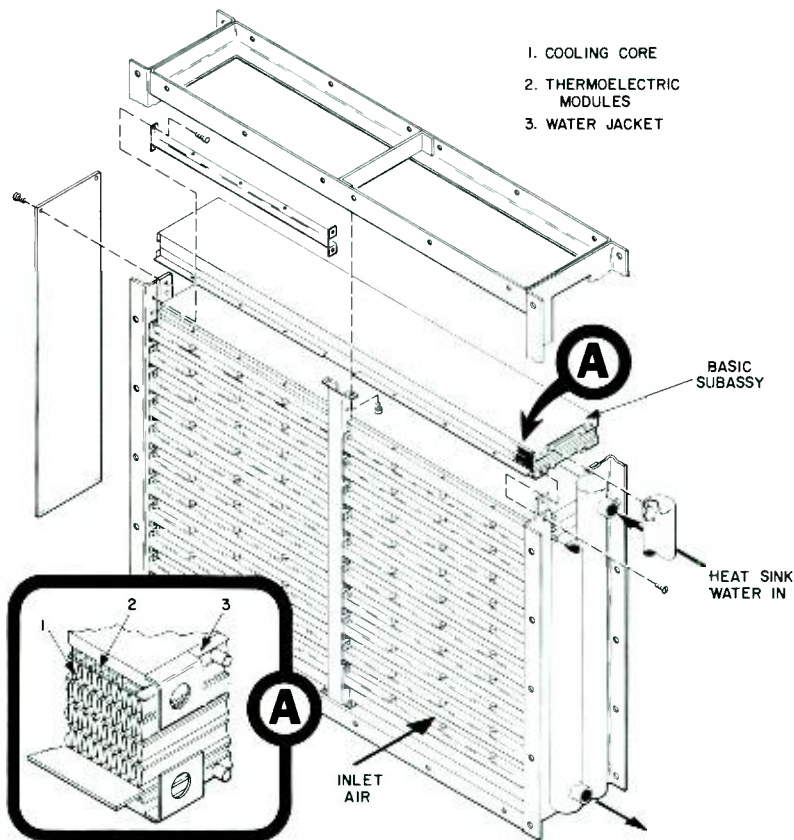

Fig. 6—A 9-ton thermoelectric air-conditioner.



Fig. 3 — One-ton thermoelectric air conditioner.

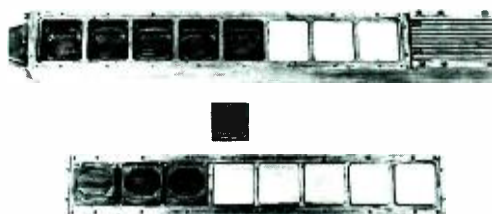

Fig. 4—Thermoelectric air-conditioner sub-unit.

eral major advantages: 1) a coefficient of performance greater than two, 2) silent operation, 3) substantial weight and volume reduction, 4) reliability, 5) ease of maintenance and installation, 6) ability to be used as a heater, 7) reasonable initial cost. Figs. 5 and 6 show this equipment. The major competitors of thermoelectric air conditioning for military applications are lithium bromide absorption systems and freon compression systems. Table I compares these systems relative to several important parameters.

MISCELLANEOUS REFRIGERATION

The cold storage of cooling of food, water, or medical supplies is only one of many possible thermoelectric refrigeration applications. These applications become feasible in special instances, where the initial cost and the somewhat lower performance is off-balanced by lower weight and volume, silent operation, and reliability.

The application of thermoelectrics to the individual refrigeration (spot cooling) of electronic components or sub-systems is extremely important. In the heat-load range of 0 to 100 watts, thermoelectric refrigeration is without competition for cooling to temperatures as low as -75°C . The cooling of transistors, image tubes, and parametric amplifiers are but three of the many examples of this application. DEP Applied Research has recently completed two important contracts for image tube thermoelectric coolers. Fig. 7 is a schematic of one cooling system. Fig. 8 is a photograph of the finished cooler. The performance of this type of cooler is summarized in Fig. 9 and Table II. It has reached the preproduction stage in its development. Because thermoelectric refrigerators have no competition for this application, it is believed that the first large volume use of thermoelectric refrigeration will be for military spot cooling jobs.

The RCA Laboratories are conduct-

ing research on materials for low temperature thermoelectric applications. DEP Applied Research has a complementary program for device-development of low temperature thermoelectric refrigerators. It is anticipated that from this joint effort will come refrigerators capable of performance well below -75°C , hopefully pushing eventually toward liquid-nitrogen temperatures. If, and when, this can be accomplished, thermoelectric refrigeration for cryogenic application will become a new area of application.

MISCELLANEOUS APPLICATIONS

There are several important thermoelectric applications which do not fall directly in the category of power generation or refrigeration, which will now be discussed.

Heating

By reversing the direction of current flow in the thermoelectric module, it is possible to make a refrigerator perform as a heater. This interesting flexibility provides complete atmospheric control, rather than just air conditioning for room air processing. It also makes much more efficient heater systems possible. Heating jobs normally done by resistance heaters can be carried on by thermoelectric heaters at a *COP* of 2, 3, 4, or even greater.

Temperature Control

Because of the ability of thermoelectric systems to either heat or cool by the simple reversal of current flow, temperature control devices can be built to hold temperature stabilities at a fraction of a degree variation. Fig. 10 is a photograph of a device by which thermoelectrics is used for this purpose.

Temperature Sensing

The age-old technique of temperature measurement by the use of thermo-

couples can not go unmentioned. The sensing of temperature by the use of the Seebeck voltage generated between the junction of dissimilar metals is still one of the most reliable methods of measuring temperatures.

Dew-Point Sensor

By varying the current flow in a thermoelectric module until the temperature for condensation on the cold junction has been achieved, a simple, accurate, and inexpensive dew-point sensor is provided. The U.S. Weather Bureau has shown interest in this device, and RCA Electronic Components and Devices holds a contract to supply thermoelectric modules for this application.

Distillation

Thermoelectric distillation devices operate with high efficiency, low weight, and small volume. The thermoelectric module provides an excellent building block for distillation of all kinds. Fig. 11 symbolically shows how thermoelectric distillation is achieved. Liquid to be distilled is boiled on the hot side of the module. The vapors are channeled to the cold junction, where they condense. The latent heat of condensation is pumped through the module to the hot side. This heat is then reused for boiling. This makes the system extremely efficient. If good heat-transfer practice is executed, the temperature drop across the module will be small and the coefficient of performance appropriately high.

The possibility exists for distillation of sea water or other brackish water. At present, the cost per unit of water distilled is uneconomically high for large plants. For special use in remote areas, however, thermoelectrics is a leading candidate. Figs. 12, 13, and 14 show the relationship between power consumption and capacity, weight and capacity,

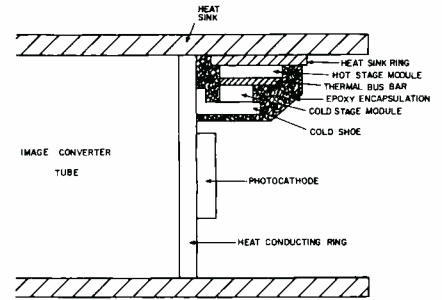

Fig. 7—Thermoelectric photocathode cooler schematic.



Fig. 8—Thermoelectric photocathode (TPC) cooler: This TPC is completely self-contained refrigeration machine. The thermoelectric material, the air heat exchanger, and the circulator fans are all contained in a package weighing only two pounds. The high performance, the proven reliability, and the practical power requirements (28 volts-dc, 2.5 amps) make the TPC a practical unit for Army field use.

and volume and capacity, respectively.

The more immediate application of thermoelectric distillation is in satellite systems for purifying urine and wash water for astronaut consumption. RCA has built a urine still for this purpose (Fig. 15). Table III is a comparison of thermoelectric distillation with competitive systems. Specimens distilled by thermoelectric units are purer than Camden drinking water.

Satellite Temperature Control

Thermoelectric panels can be used effectively as variable-thermal-conductivity shields, or "thermal switches." In the simplest case, the thermal conductivity can be changed almost two to one by switching the thermoelectric module between the open and closed circuit con-

TABLE I—Comparison of Air Conditioning Systems

	THERMOELECTRIC	Lithium Bromide	Freon Compression
Weight/Ton	65 lbs	235 (Mach.) 63 (Coils)	179 (Mach.) 63 (Coils)
Volume/Ton	0.75 ft ³	3.68 (Mach.) 0.58 (Coils)	4.25 (Mach.) 0.58 (Coils)
Power/Ton	1.76 kw	18 lb steam/hr (5.37 kw)	0.88 kw
\$/Ton	\$1500	\$1180 (Mach.) \$ 75 (Coils)	\$380 (Mach.) \$ 75 (Coils)
Redundancy	15%	System is backed up 100% with Freon Comp.	100%
\$/Ton (incl. Redundancy)	\$1725	\$1635	\$835
Reliability	Good	Good	Good
Maintenance	Simple	Major	Major
Installation	Negligible Cost	Very Expensive	Expensive
Silence	Good	Good	Poor
Heat	Yes	No	No

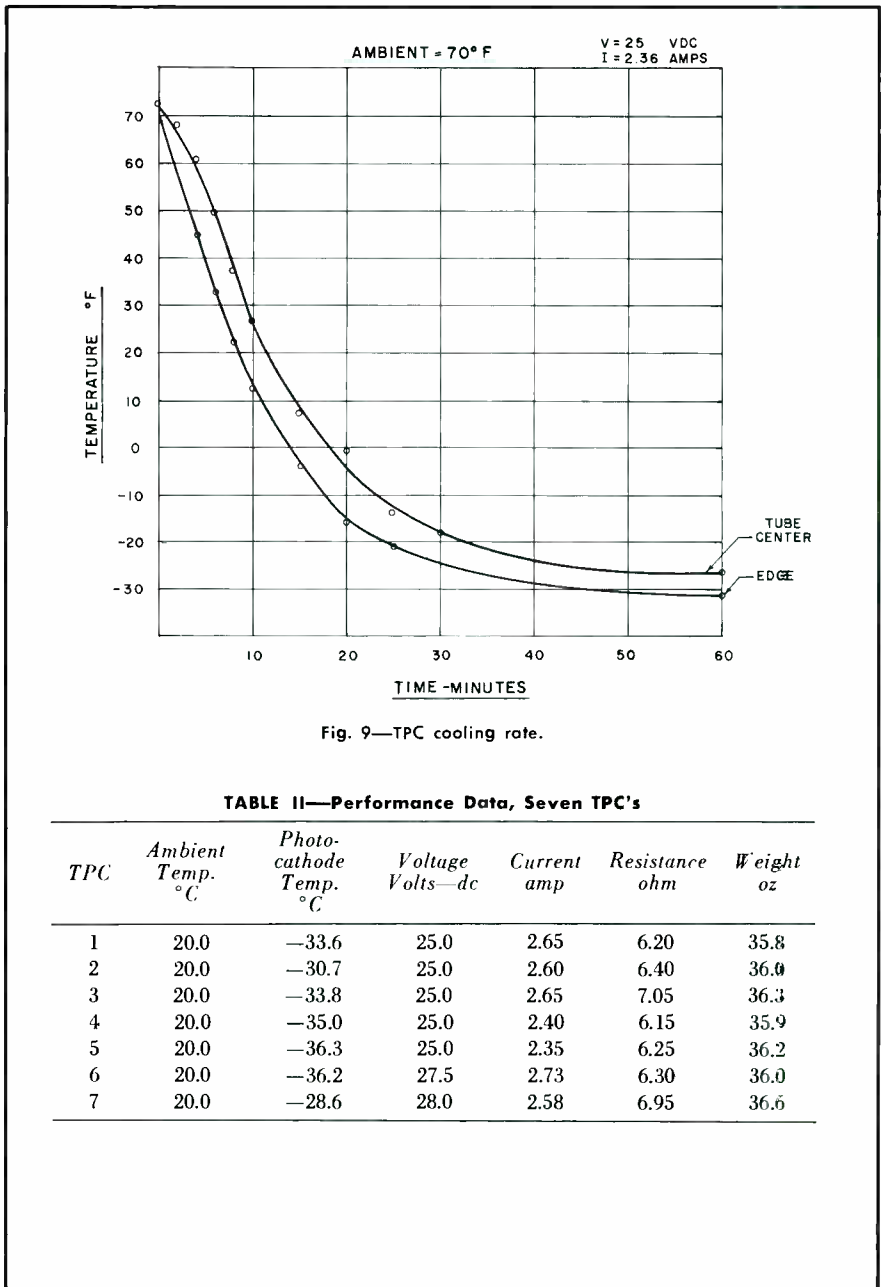

Fig. 10—Thermoelectric temperature control for infrared sensor.

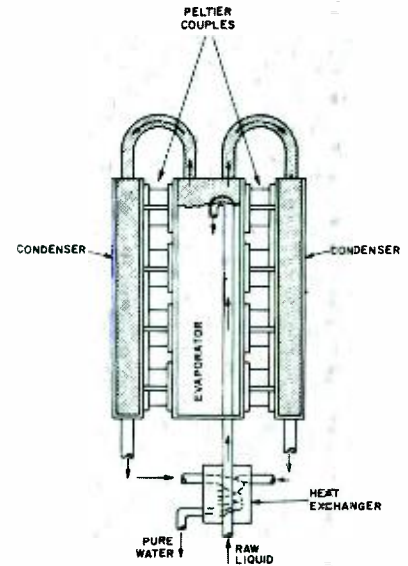

Fig. 11—A thermoelectric distillation device.



P. E. WRIGHT received his BSME from the California State Polytechnic College and his MSME from the University of Pennsylvania. From 1958 to 1960, Mr. Wright participated in the RCA Graduate Study Program. Mr. Wright joined RCA in 1958 as a member of DEP Applied Research, moving through various assignments and responsibilities to the present position of Engineering Leader. His work has included thermoelectrics, both refrigeration and power generation, thermionics, fuel cells, and battery systems. Mr. Wright was responsible for the development of the first thermoelectric air conditioner with a coefficient of performance of greater than two. He was responsible for the first fossil-fuel, silicon-germanium thermoelectric generator. Under Mr. Wright's direction, a magnesium-mercuric oxide battery was developed which exhibited an energy density of 60 watt-hours per pound. Mr. Wright has directed several system studies in the area of direct energy conversion. Mr. Wright is the author of several technical papers on the subjects of energy conversion and heat transfer.

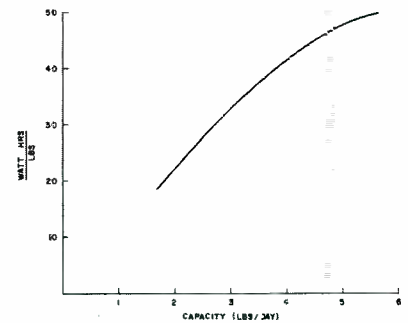

Fig. 12—Energy density versus capacity.

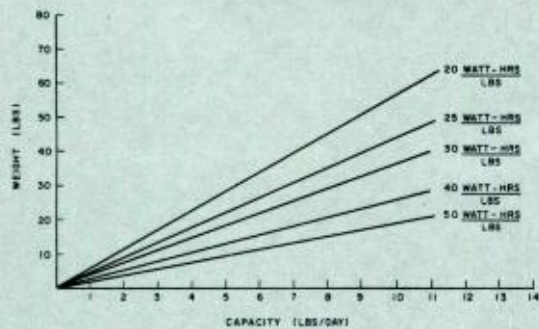

Fig. 13—Weight versus capacity.

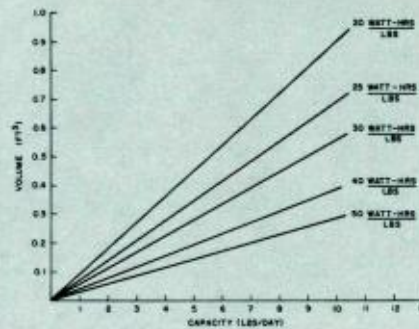

Fig. 14—Volume versus capacity.

TABLE III—Comparison of Distillation Systems

Basic Technique	Maximum Condenser Temp. °F	Minimum Power Required w/man	Minimum Area of Radiation Panel ft ² /man	Estimated Weight		Estimated Volume Required ft ³ /man	Reliability	Comment
				Fixed gm/man	Variable gm per man/day			
Freeze Distillation	-15	none	10.8	4,000	none	5.4	very high	Materials handled in solid state. Requires additional filtering and sterilization.
	20	none	7.93	4,000	none	7.9	very high	
Vacuum Distillation	32	none	7.36	2,700	75	3.7	very high	Small, simple system. Requires additional filtering and sterilization.
	70	none	4.85	1,800	75	2.0	very high	
Atmospheric Distillation	212	185	2.0	540	75	1.0	high	Small, but large power requirement. Requires additional filtering. Can be operated 24 hours a day.
Solid State Atmospheric Distillation	212	23	none	600	75	0.062	highest	Very small, moderate power requirements, but heavy centrifuge and bladders utilized. Can be operated 24 hours a day.
Compression Distillation	212	6.2	none	20,000	75	2.0	high	Small, low power requirements, but heavy centrifuge and bladders utilized. Can be operated 24 hours a day.

dition. The only power consumption is the operation of a simple switch. A wider range of thermal conductivity can be achieved by current flow in the circuit. Ref. 5 discusses this application in detail.

CONCLUSION

Thermoelectric is a challenging new field of engineering and scientific endeavor, not only because of its theoretical interest and challenge to the engineer, but also because of the vast field of application and the chance for contribution by the reduction of theory to practice in truly useful devices.

BIBLIOGRAPHY

1. A. D. F. Dingwall and W. F. Lawrence, "Fossil Fuel Thermoelectric Generators", *RCA ENGINEER*, this issue.
2. W. J. Helwig and G. Rose, "Thermoelectrics for Space Application", *RCA ENGINEER*, this issue.
3. J. R. Andersen, "Influence of Longitudinal Heat Conduction on the Performance of a Thermoelectric Cooler", *unpublished paper*.
4. M. S. Crouthamel and B. Shelpuk, "Cascaded Filter Coolers," to be published in the Sept. 1963 issue of *RCA Review*.
5. C. M. Usiskin, "Thermoelectric Temperature Control in Satellites" *ASD TDR63-260 A & T Proceedings of First Space Vehicle Temperature and Atmospheric Control Symposium*.

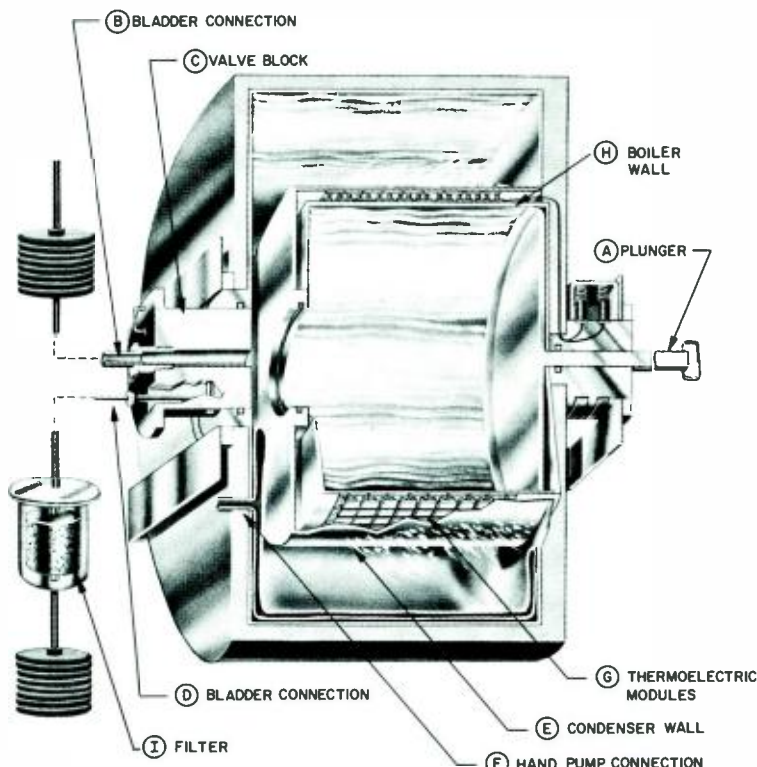

Fig. 15—Artist's conception of a thermoelectric distillation device to produce drinking water from astronaut's urine and wash water.

MAGNESIUM RESERVE BATTERIES

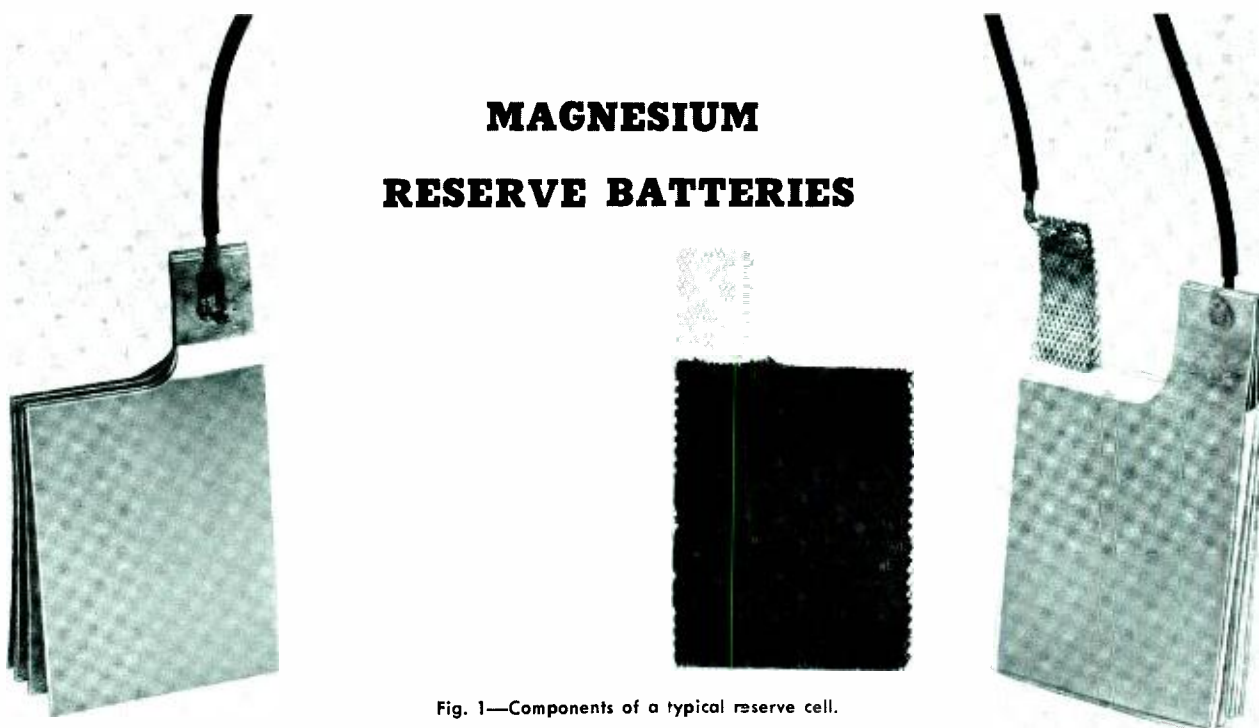

Fig. 1—Components of a typical reserve cell.

During the past two years, the emphasis of the RCA battery program has been on the development of a high-performance reserve battery based on the magnesium, magnesium-perchlorate, mercuric-oxide system. This system, because of its high capacity per unit weight and volume over a wide temperature range, should find application in arctic environments, anti-submarine-warfare sonobuoys, missiles, rescue equipment, and field communication equipment. This paper describes the basic properties of the system and its application to sonobuoys and to arctic environment.

Dr. G. S. LOZIER

*Special Electronic Components Division
Electronic Components and Devices, Somerville, N. J.*

THE BASIC components of the electrochemical system are a magnesium anode, a magnesium perchlorate electrolyte, and a mercuric oxide cathode. Magnesium reserve cells are composed of multiple, thin, flat plates of magnesium; the cathode material is assembled in alternate fashion with a thin separator material between. This arrangement provides greater electrode-surface area than that in corresponding round-type dry cells, and thus increases efficiency at high discharge rates, pulsed loads, and at low temperature. The components of the system are shown in Fig. 1.

Typical voltage-time discharge curves for cells at room temperature are shown in Figs. 2 and 3. Typical capacity figures for the system are given in Table I. Preliminary data have shown that the system can provide more than 40 w-hr/lb and 4 w-hr/in³ at a 1-minute discharge rate. In a dry-cell configuration, the system

has provided more than 90 w-hr/lb and 7.5 w-hr/in³ at discharge rates in excess of 100 hours. To obtain these latter high capacities in a reserve cell, it will be necessary to develop new methods of cathode preparation.

An inherent property of the magnesium-mercuric oxide system is the heat generated during discharge. The heat is generated by the irreversibility of the magnesium anode and the wasteful corrosion reaction at the anode during current flow. The heat involved Q is:

$$Q = V A T 860 + \Delta H$$

Where: V is the difference between the theoretical potential of magnesium and the operating potential in volts, A is the current drain in amperes, and T is the time in hours. The value of V is approximately 1.1 volts.

The heat evolved at a magnesium anode is shown in Fig. 4 as a function of current drain and anode efficiency. This heat is used to maintain the battery

temperature in a range where high efficiency is obtained in low-temperature applications.

ASW APPLICATIONS

The excellent high-rate performance of this system permits the design of batteries for advanced sonobuoys requiring high-current pulses and totally enclosed batteries. In comparison with the magnesium-silver chloride system, the magnesium-mercuric oxide system offers the advantages of better performance on pulsed loads, less sensitivity to temperature, and a self-contained package.

The design of a magnesium-mercuric oxide battery for sonobuoy applications is shown in Fig. 5. The construction material may be either sealed hard-coated aluminum or molded plastic. The general design factors of the battery and their effect on activation and operation are as follows:

- 1) The battery is activated by an electric pulse of short duration to squib (discharge) the diaphragm valve, which is ruptured by the gas pressure generated by the squib.

TABLE I—Typical capacity figures for Mg/Mg(ClO₄)₂/HgO system

Discharge Rate	w-hr/lb	w-hr/in ³
5 min	45	4.0
30 min	55	4.5
1 hr	60	4.5
10 hrs	60	4.0
20 hrs	55	3.5

Fig. 2—Voltage-time characteristic of magnesium-5N magnesium perchlorate-mercuric oxide cell. Discharge = 20 amperes constant current. Element volume = 1 cubic inch. Average voltage = 1.68 volts. Average watt-hours per cubic inch = 4.6. Watt-hours per pound = 50.

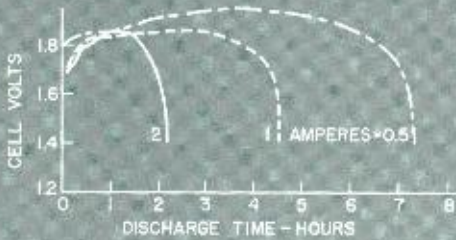
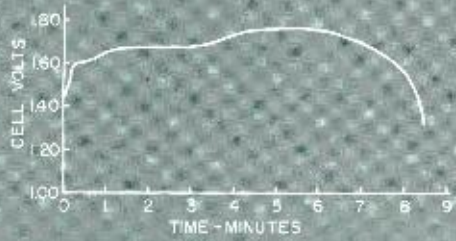

Fig. 3—Capacity data for Mg/Mg(ClO₄)₂/HgO reserve cells. Various discharge drains at 70° F.

- 2) The electrolyte is uniformly distributed to the cells by a manifold design which provides equal pressure and pressure-relief valves at exhaust vents. The activation time is less than one second after (1).
- 3) The use of a resin-dipped hard-coated aluminum case produces a cell holder that provides uniform temperature throughout the battery. In addition, this case design provides easy access for controlled thermal contact to provide an optimum battery temperature. In some applications, it is conceivable to use a molded-plastic cell container.

The performance of the battery with a pulsed load is shown in Fig. 6. The initial voltage-time characteristic on the pulse can be improved by use of a slow-blow fuse across the battery to increase the battery temperature, or by the addition of silver I oxide to the cathode.

LOW-TEMPERATURE APPLICATIONS

Military applications, such as man-pack communications and portable radar, will

TABLE II—Performance of various batteries at 40° C

Battery	w-hr/lb	w-hr/in ³
RCA Mg-HgO	50	1.5*
Lead-acid	3.1	0.22
Nickel-cadmium	8	0.6
Silver-zinc	—	—
Silver-cadmium	10	0.6

* Function of jacket design

Fig. 4—Calories evolved from magnesium corrosion reaction as a function of electrode efficiency at low discharge rates.

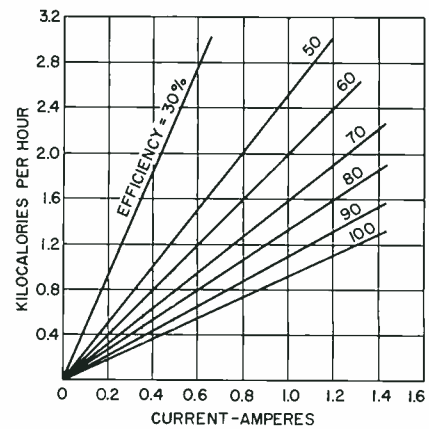

Fig. 5a—Cutaway view of Mg-HgO battery designed for sonobuoy applications.

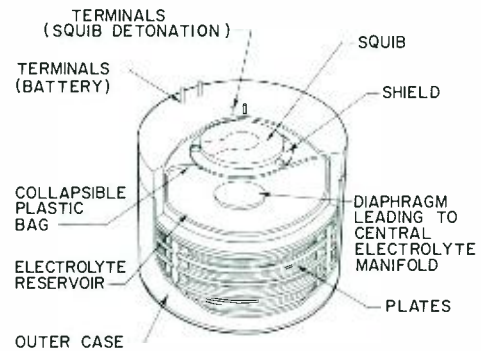
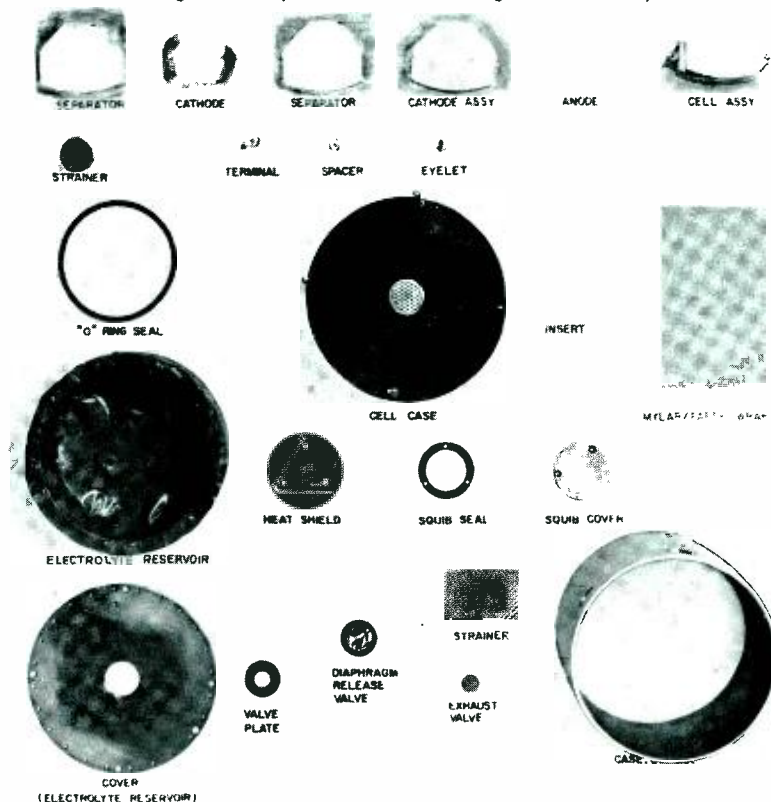

Fig. 5b—Components of a medium-high reserve battery.



require a small, light-weight power source. These applications are projected to require between 300 and 800 w-hr at -40°C (or $^{\circ}\text{F}$). At present, the use of batteries at low temperatures is limited by their poor performance at -40°C . The performance of various batteries at this low temperature is shown in Table II. Although magnesium water-activated batteries can provide up to 20 w-hr/lb at -40°C , these batteries cannot be readily activated in the field below 32°F .

For the capacities required, the weight of the battery is a major problem for low-temperature applications for a man-pack application. For these applications, the most important properties of the magnesium-mercuric oxide reserve cell are its high capacity per unit weight and volume over a wide range of operating temperatures, the heat generated on discharge, and its flat voltage characteristic. A typical discharge curve at -40°C is shown in Fig. 7. On continuous drains, capacities in excess of 40 w-hr/lb have been obtained at discharge rates between 24 and 48 hours. The capacity per cubic inch varies between 1 and 2.5 w-hr, depending on packaging. Batteries have been designed for weather-balloon applications which have provided more than 50 w-hr/lb at -58°F at a 1-hour discharge rate. The construction of a typical battery for low temperature is shown in Fig. 8.

Several activating procedures are being considered. In all procedures, no external source of heat or power is required for activation. The most desirable procedure is one in which the electrolyte container is not carried with the battery after activation. This procedure insures minimum weight and volume during use in the equipment. Activation is accomplished by manual release of a locking mechanism or by forcing the electrolyte under pressure into a manifold from which it flows into the cell compartments. Activation can be accomplished with the electrolyte at -40°C .

Preliminary data indicate that activated batteries have a 90% capacity retention after two to three days at 125°F and one week at -40°C . Inactivated batteries show no loss in capacity after storage at 70°F and 40 to 60% relative humidity for 2 years.

CONCLUSION

The magnesium-mercuric oxide system has been shown to have desirable properties for low-temperature, high-performance active sonobuoys and missiles. The next step is the conversion of the engineering models to designs practical for production and cost reduction.



DR. GERALD S. LOZIER received the B.S. in chemistry in 1952, the M.S. in chemistry in 1953, and the Ph.D. in 1956 from Western Reserve University, Cleveland, Ohio. From September 1950 until September 1952, he held a Teaching Fellowship at Western Reserve. For the next two years, he was engaged in research on the effects of ultrasonics on electrode processes at Western Reserve. In January 1955, he joined the RCA Laboratories, where he was engaged in research into new electrochemical systems. In 1957, he received the RCA Achievement Award for outstanding research in electrochemical systems. In July 1959, he was transferred to the RCA Semiconductor and Materials Division in Somerville, N. J. As head of the group responsible for the development of both military and commercial systems, he has continued research on battery systems and fuel cells. Dr. Lozier is the author of 12 papers, a book, and has been granted two patents. He is a member of the ACS and the Electrochemical Society.

Fig. 6—Discharge characteristics of Mg-HgO battery of the design in Fig. 5a. Battery specifications are: weight 3.3 lbs, volume 55 cubic inches, dimensions 4.2" diameter by 4" high. Water temperature = 0°C . 0.56 amp load for 1 minute, then pulse applied. Battery left in water for $\frac{1}{2}$ hour before activation. Battery had two shorted cells for means of bringing temperature up.

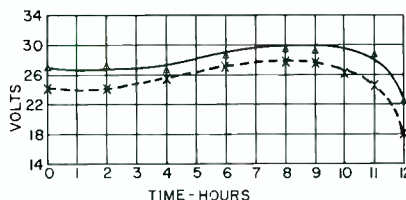
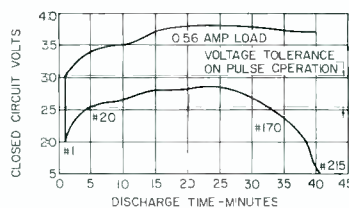
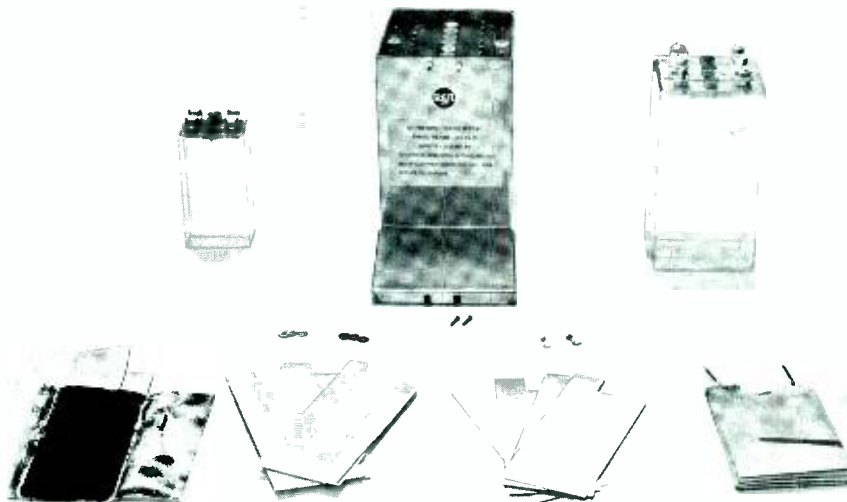

Fig. 7—Discharge curves at -40°C of Mg-HgO man-pack battery, weight 14.5 pounds. Solid line = 0.46-amp pulse, 9-minute duty cycle. Dashed line: 14.0-amp pulse, 9-minute duty cycle.

Fig. 8—Low-temperature battery construction.



SOLAR CELLS 1963—A STATUS REPORT

P. RAPPAPORT
RCA Laboratories
Princeton, N. J.

The solar cell will probably continue to be the mainstay for space electrical power for the next 5 to 10 years. Well over 100 satellites have thus far utilized solar-cell power—ranging from the 5-watt VANGUARD (now 5 years old and still transmitting) to the 150-watt MARINER that delivered electric power near Venus at 125°C. While emphasis has been on space application, the long range future for solar cells seems to be in potential terrestrial application—a truly low-cost solar cell could have a profound effect on the economy of the emerging nations of the world. Presented here is the present state of cell development, with emphasis on the more-important problems of single-crystal devices, film-type devices, and radiation-damage effects.

Paul Rappaport (author) and a solar-cell laboratory experiment

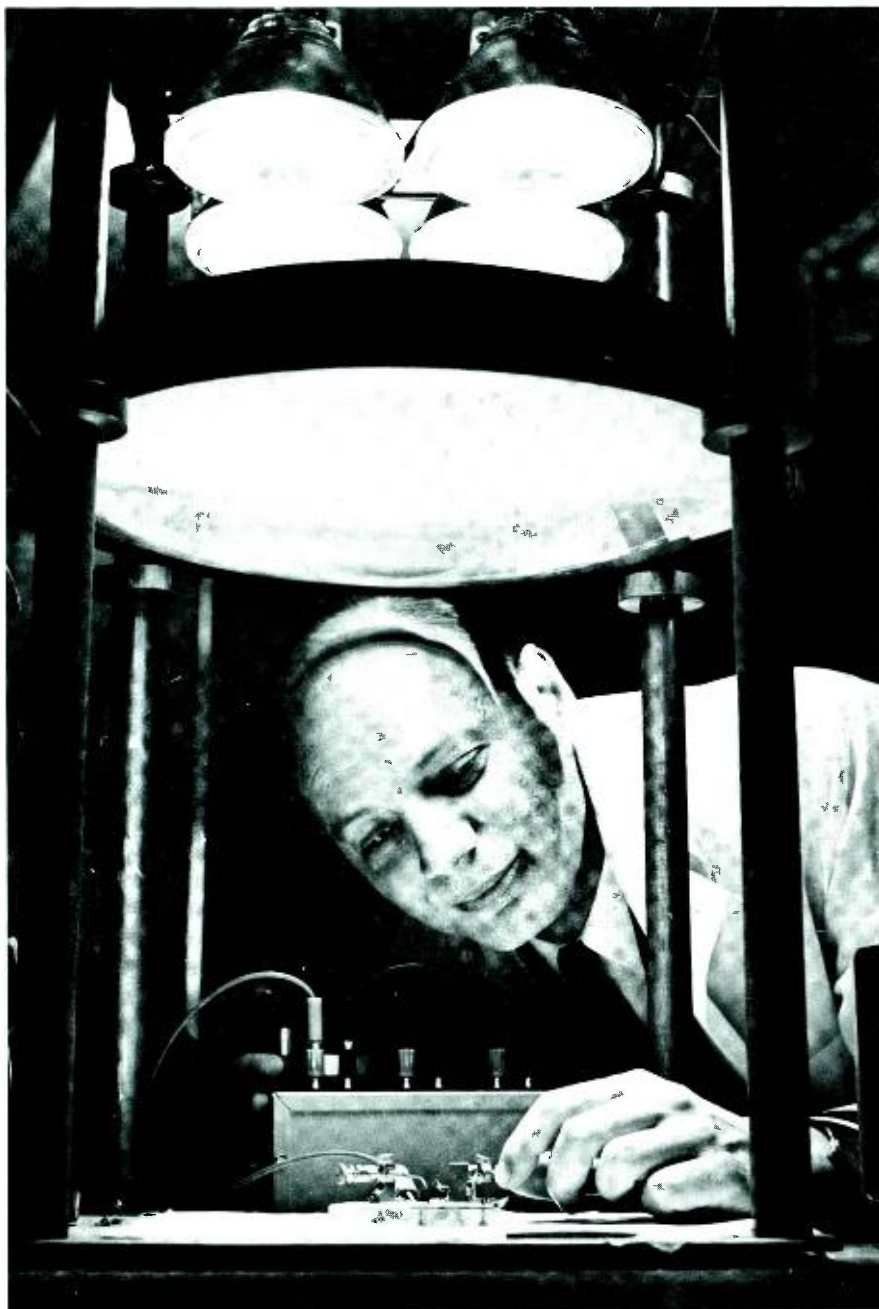

PAUL RAPPAPORT received the BS and MS degree in Physics from the Carnegie Institute of Technology in 1948 and 1949, respectively, whereupon he joined the Technical Staff of RCA Laboratories. During the next two years, his work led to his invention of the Atomic Battery in 1953, which was the predecessor of the solar cell. In the following 12 years, he specialized in research on solar and radiation energy converters on radiation damage to semiconductors and on the physics of III-V compounds. In 1960 he was appointed Head of the Energy Conversion Research Group. He has had 30 papers published, two book articles and has filed 15 patent applications. He is the recipient of two "RCA Achievement Awards" for outstanding work in research. Mr. Rappaport is a member of Pi Mu Epsilon, Sigma Xi, and the American Physical Society, and is listed in American Men of Science and Who's Who in Atoms. He is on the Editorial Board of the new "Journal of Advanced Energy Conversion" and is serving on several government research advisory committees on Electrical Energy and Space Power Systems, including a present membership on a NASA Committee and a term just completed for the National Academy of Sciences. He has also been appointed to the AIAA, IEEE, and ASME technical society energy conversion committees for the current year. Mr. Rappaport was selected by NATO to present a discussion of space power systems at its recent meeting in Athens, Greece, July 8, 1963.

WHILE MANY DEVICES show promise of competing with the solar cell for space power, they have not been developed to the stage of 1) converting solar energy to electricity with 10% system efficiency, 2) operating without special power conditioning equipment to produce higher voltages, 3) being relatively insensitive to orientation effects, 4) being relatively lightweight and rugged, and 5) requiring no special solar collector or heat radiator.

Solar cells, on the other hand, have limitations such as, 1) relative sensitivity to radiation damage, important to many space applications, 2) relative high cost, important to terrestrial applications, 3) need for storage during dark periods (usually required in any low-power system) and 4) limitation to power levels up to about 1,000 watts, although power in the low-kilowatt range may be as feasible for solar cells as for other systems now being contemplated.

While past emphasis has been concerned with space applications, the long-range future for solar cells seems to be in the possibilities for terrestrial applications. A truly low-cost solar cell could have a profound effect on the economy of many of the emerging nations of the world.

SINGLE CRYSTAL DEVICES

Today, almost all of the several million solar cells sold per year are made of single-crystal silicon. Substantial R&D effort has been applied to other crystalline materials such as gallium arsenide and cadmium sulfide. Indium phosphide, cadmium telluride, and gallium phosphide have also been investigated for solar cell use but with considerably

less effort. Conversion efficiencies for the materials considered to be important are shown in Table I.

Two important material properties relating to the efficiency of the photovoltaic effect are the optical absorption α and the diffusion length L . For high efficiency, the diffusion length of the semiconductor must be as great as the spread in depth over which the photons are absorbed. For Si and GaAs this length L must be 100 microns and 2 microns, respectively (a factor of 10^5 difference in lifetimes, τ). Even if $L > \alpha$ and neglecting other losses such as reflection, the solar conversion efficiency of the photovoltaic effect is limited by the relative number of solar photons absorbed and the potential at which the electrons are delivered compared with the energy of the photons. For silicon this efficiency is therefore limited to less than 22%. (See Table I for theoretical efficiencies of other materials.)

Silicon and gallium arsenide are the most promising single-crystal solar-cell materials investigated to date. Silicon cells are manufactured and sold by at least five companies, whereas GaAs cells are made and sold *exclusively* by RCA—a venture in which several other companies have failed. While the present results with GaAs as seen in Table I represent many years of great effort applied to a most stubborn material, improvement in efficiency and reduction in cost is still necessary before the position of silicon for solar cells is challenged. However, for high-temperature operation (Venus or Mercury satellites) and for high radiation areas GaAs cells will be preferred over Si cells. Because of the higher cost of gallium (it has been estimated that each solar cell requires \$1.00 worth of gallium alone) and the difficulty in making GaAs crystal, it is evident that such solar cells will probably always be more expensive than Si cells.

Other materials such as GaP and InP could result in interesting solar cells, although the effort to develop these materials may be prohibitive when compared with the gain. InP cells should be less expensive and probably more efficient than GaAs cells. GaP could yield a solar cell capable of operating at temperatures of 500°C. On the other hand, CdS, a material with bandgap energy similar to GaP does not yield a cell with high-temperature properties. This seems to be due to the formation of a metal semiconductor-type contact rather than a p-n junction in the typical CdS cell. While the type of barrier in CdS is a subject of considerable controversy, actual measurements do show a temperature characteristic more typical

Table I — Efficiencies of Some Solar Cell Measurements

Material	Bandgap Energy ev	Theoretical Efficiency %	Maximum Sunlight Efficiency %
Si	1.11	20	14
InP	1.25	23	3
GaAs	1.40	24	11
CdTe	1.45	21	6
GaP	2.23	17	1
CdS	2.4	16	7

of silicon (1.11 ev) than any other material. The difficulty of making single crystal CdS or CdTe and the lack of advantage of such a solar cell (efficiency \sim 6 to 7%) make it unlikely that such cells will find commercial application.

LARGE-AREA FILM-TYPE CELLS

Two of the most urgent requirements of future solar cells are lower cost and lighter weight. Present cost of solar cells is in the \$200 to \$400/watt range, which makes their extensive use for nongovernment terrestrial applications rather unreasonable. The major reason for this high cost is, of course, the need for single-crystal material in the cells. It has long been known that non-single-crystal films can be used for solar cells as, for example, in the selenium and copper oxide photoelectric exposure meter. More recently,³ the cadmium sulfide film-type solar cell has been developed. The exposure meter devices have less than 1% efficiency while the CdS cells have yielded over 5% efficiency.

Film devices are basically light in weight thus making them more interesting for space application. This light weight stems from the fact that only very thin layers (microns) of most semiconductors are required for con-

verting solar photons into electricity. Most of the 10 to 20 mils of silicon or gallium arsenide used in single crystal devices serves as structural support. The thickness of semiconductor film required for solar cells is given by their optical absorption. Fig. 1 shows the optical absorption versus radiation wavelength for various semiconductors. These data are very important for film-type solar cells, as the area under each curve determines how effective the material will be as a solar converter. Table II shows the approximate minimum film thickness required for effective solar conversion. This is estimated on the basis of about 80 to 90% utilization of the possible material absorption of solar photons.

To collect solar-generated carriers in film devices some diffusion length is required. One would not expect to find diffusion lengths as great in films as in single crystals; however, as seen in Table II, values as small as one or two microns are required, and several materials look promising. A silicon film, however, does not appear very promising since diffusion lengths of about 100 microns are required in films where the grain size may be no more than 10 microns. The diffusion of carriers across grain boundaries is not expected to be very efficient.

The materials CdS and CdTe are receiving considerable attention as film photovoltaic devices. CdS and CdTe films are being studied by several different companies, the state of development being about the same for both. Small area (1-cm²) films made by evaporating the semiconductor and then forming a barrier layer with copper yield efficiencies up to 5%. However, in large area films (100-cm²) the efficiency drops to about 1% to 2% because of series-resistance effects. A difficulty with the CdS and to a lesser extent with CdTe is a deterioration caused by moisture in the air. For space purposes this may not be serious, but for terrestrial applications a hermetic seal may be required which undoubtedly would add to the complexity of the device.

Films have been made on relatively flexible organic or metallic substrates. The metal cell requires construction of a front wall cell since light cannot penetrate the conducting metal substrate. This problem has been solved by several companies. Power-to-weight ratios of about 10 watts/pound are claimed for such flexible CdS cells. This improvement by a factor of 3 over silicon cells is important for space applications, even though these CdS cells are 1% to 2% efficient. It has been pointed out⁴ that such devices in very large area

Fig. 1—Absorption constant vs λ .

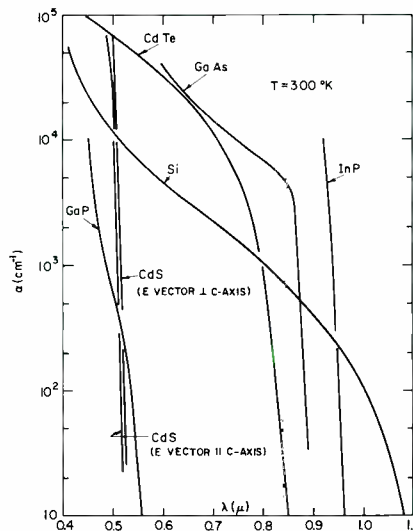

Table II — Minimum Film Thickness Required for Various Materials

Material	Bandgap Energy (ev)	Thickness (microns)	% Utilization (estimated)
Si	(1.11)	100	85
InP	(1.25)	1	95
GaAs	(1.40)	2	90
CdTe	(1.45)	10	90
CdS	(2.4)	1	anomalous behavior
GaP	(2.23)	10-100	90

films (1.000 m²) could supply power in the kilowatt range and compete strongly on a cost, weight, and time-available basis with a system such as SNAP 8. The large areas in such a solar-cell system would require some ingenious unfurling technique so that an area about a third the size of a football field need not be launched while open. Presumably, the flexible cell would allow for a neat launch package.

It is expected that improvement in film-type solar cells can be obtained from the III-V group of semiconductors because of their steep optical absorption characteristics and better transport properties in both n- and p-type material. Work on GaAs and GaP has been initiated at RCA in an endeavor to prove this. Films are made by vapor-transport techniques. Control of conductivity has been obtained; however, good, large-area junctions have been difficult to fabricate. In small areas, GaAs p-n films have yielded conversion efficiencies of about 1%; but many approaches have yet to be explored in the attempt to find the 10% efficient film photovoltaic device that does seem possible.

RADIATION DAMAGE EFFECTS

Because of the importance of the solar cell as a space-power source and the existence of high-energy electrons and protons (due to the artificial and natural radiation belts) in outer space, it is natural that researchers working with solar cells should be concerned with radiation damage effects. The problem is compounded because semiconductor devices are known to be more sensitive to radiation than other devices such as resistors, capacitors, or vacuum tubes, and the semiconducting solar cells must lie about the periphery of any satellite to be fully exposed to the sun, and inadvertently to radiation also.

A great stroke of fortune befell solar-cell advocates when it was discovered in 1960 that a reverse-type silicon solar cell, the n-on-p cell, was considerably more resistant to radiation than the then almost standard p-on-n silicon cell. This fact became known shortly before three satellites using p-on-n cells were made virtually inoperative on July 9, 1962, after a high-altitude atomic explo-

sion created an artificial high-energy-electron radiation belt. The discovery of the increased resistance to radiation was made at RCA Laboratories using n-on-p cells made by members of the United States Army Electronics Research and Development Laboratories at Belmar, New Jersey.

The silicon n-on-p solar cell is in every way identical to its p-on-n counterpart except that the upper face provides a negative voltage. The electrical characteristics of such cells are substantially identical to the p-on-n cells. However, radiation resistance increases with increasing resistivity of the starting p-type silicon, and this causes a small reduction in output voltage and, hence efficiency, of a solar cell. Therefore a compromise must be reached between efficiency and radiation resistance. The practice today is to use starting material of about 2 to 5 ohm-cm (p-type) which is at least five times higher than the previously used n-type resistivity. Such cells can be made without any reduction in efficiency.

The superior qualities of p-type silicon over n-type in the present instance are probably due to the relative positions of the radiation-induced recombination levels with respect to the Fermi levels in the two materials. Measurements on p-type material have shown more uniform behavior than on the n-type material, a fact also observed on solar cells made of these materials. The source of variation in damage rates on n-type material (by a factor of about 10) has still not been found although impurities that can combine with radiation-induced defects are suspected.

Fig. 2 shows typical curves of reduction of power output of silicon n-on-p

and p-on-n cells under the effect of electrons (1 Mev) and protons (18 Mev). Note that for a given power level there is a factor of about 20 in electron flux (or time in radiation environment) and a factor of about 3 in proton flux favoring the n-on-p cell. This means that in a 1-Mev electron environment an n-on-p cell will yield a given power output after withstanding 20 times the flux that a p-on-n cell can withstand.

There are two very important further facts to note in the curves of Fig. 2:

- 1) For a given type cell of a given junction depth the damage will be along the same straight line on the semilog plot independent of the starting efficiency. Therefore, if operation is to be in a damaging environment, a premium should not be placed on initial high efficiency, since an 11% and a 10% efficient cell will be at the same efficiency point after a dose of say 10¹⁵ electrons/cm². For this fact to apply, the cell's initial efficiencies must have been limited by diffusion length.
- 2) Because of the nature of the damage it is possible to effectively increase life by adding to the area of the array. For example, an 18% increase in array area would increase "life" by a factor of ten; i.e., the same power output would be achieved after intercepting ten times the flux.

Because of these facts and the proper use of cover glasses (such as glass, quartz, or sapphire) solar-cell power supplies can be designed to give 1 to 5 year life with operation in the radiation belts. Outside the radiation belts, life of solar cells would be much longer

Fig. 2—Power output vs cumulative exposure to 1-Mev electrons and 18-Mev protons.

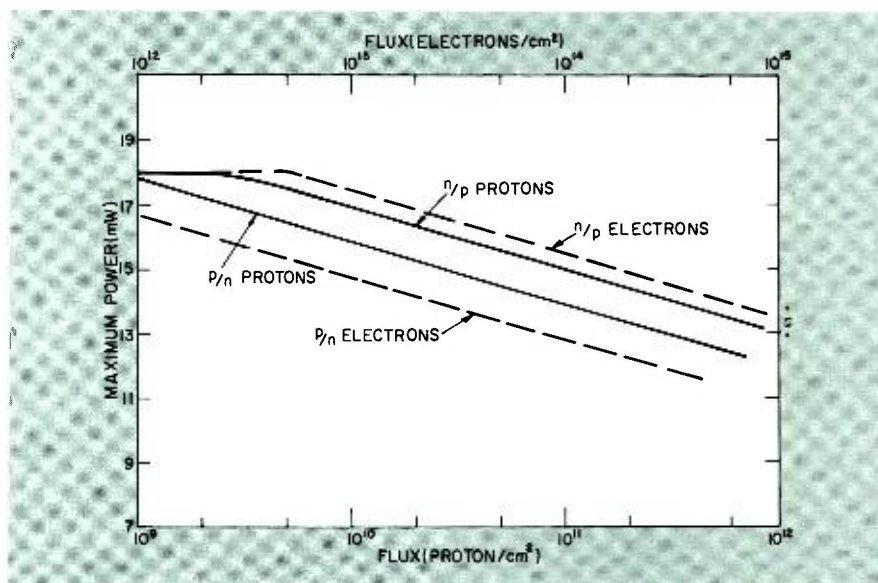

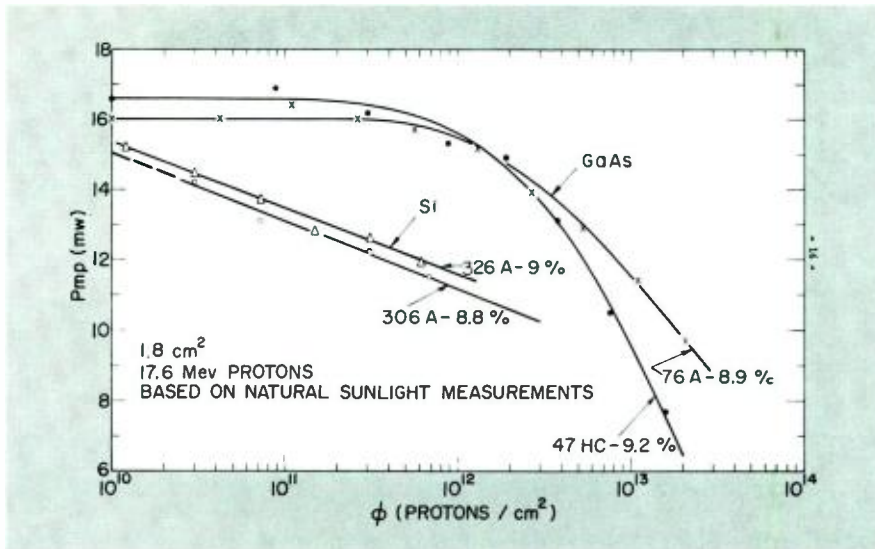

Fig. 3—Damage with 17-Mev protons in a GaAs cell compared with silicon for similar initial efficiencies.

depending on the intensity and number of solar flares encountered. The TELSTAR I satellite launched in July 1962 was the first satellite to utilize n-on-p silicon solar cells. Even though it operated in the heart of the natural proton belt and in a very intense region of the artificial electron belt, its life (70% of initial power) was predicted to be one year.

Gallium arsenide solar cells show evidence of being even more tolerant of radiation, especially protons and high-energy electrons, than silicon n-on-p solar cells. This is reasonable when one considers the fact that a GaAs cell, unlike silicon, depends almost totally on its front or diffuse layer for photovoltaic response. This dependence is caused by the strong optical absorption seen in Fig. 1. Silicon depends on its base layer, the p-type material in a n-on-p cell, for most of its response. The diffused layer in a GaAs cell is highly doped, the diffusion length probably limited by an already high concentration of impurities and defects. Therefore, it takes a rather large additional number of defects to produce damage in such a cell. (A similar argument can be used if one assumes that the diffusion length is initially limited by the direct recombination process). Fig. 3 shows the damage with 17-Mev protons in a GaAs cell compared with silicon for similar initial efficiencies. The "square" damage characteristic is a direct consequence of the above argument. Note that when the damage starts, it continues with great speed as the diffusion length in the 1- to 2-micron collection region is diminished. This is also verified analytically since the decay of a surface-response solar cell (GaAs) depends exponentially on the lifetime

and a base-response solar cell (Si) on the square root of the lifetime.

The GaAs solar cell is more sensitive to very low energy particles than silicon because of its front layer response. This has been borne out in both laboratory studies and satellite experiments. However, very thin shielding can eliminate this problem. Such shielding is usually required on both GaAs and Si solar cells to maintain thermal radiation characteristics consistent with lower operating temperatures. Recent experiments⁵ on the ANNA IB, APL satellite showed that a GaAs cell with 6-mil glass maintained output at about the same level as an n-on-p silicon cell with 30 mils of sapphire. The sapphire represents ten times the shielding effectiveness as the 6-mil glass, and the glass alone is subject to discoloration due to ultraviolet and soft-particle radiation exposure. On RELAY an uncovered GaAs cell degraded to about 10% of initial short-circuit current after a few orbits. Uncovered silicon cells degraded to 20% of initial short-circuit current a short while later. Laboratory experiments with low-energy (0.2- to 0.4-Mev) protons do reproduce these effects and

incidentally show the relative reduction in power to be even closer in the two type cells. Fairly large variations in damage rates of solar cells in the low-energy proton region are possible depending on where the proton loses its energy—in the front diffused layer, the junction, or the base region of the solar cell.

Table III gives an up-to-date accounting of the damage rate of various particles on various type solar cells of efficiency in the 8 to 10% range. In Table III, ϕ_c is defined as the flux required to reduce the initial cell power by 25%. Note the effects of the very high energy electrons (5.6-Mev) on the n-on-p silicon solar cell. The damage rate of the p-type material seems to be much faster than can be accounted for by calculation, thus indicating the possibility of a new center being formed.

CONCLUSION

Much further work is required in all aspects of the work reported here before the kind of understanding is obtained that will enable us to predict all solar cell parameters to the satisfaction of the design engineer. Such work is going on in many laboratories throughout the country.

ACKNOWLEDGEMENT

The author wishes to thank J. J. Wysocki and J. A. Baicker for material contributed to this paper.

BIBLIOGRAPHY

Refs. 1-5 are cited in the text. The remainder are other RCA ENGINEER papers relating to this field.

1. P. Rappaport and J. J. Wysocki, *Acta Elect.* 5, 365 (1961).
2. J. J. Loferski, *Proc. IEEE* 51, 667 (1963).
3. A. E. Middleton, D. A. Gorski, and F. A. Shirland, *Energy Conversion for Space Power* (Academic Press Inc., New York, 1961) p. 275.
4. G. Gordon, *private communication*, 1963.
5. R. Fischell, *private communication*, 1963.
6. P. Rappaport and H. I. Moss, "Low Cost Photovoltaic Conversion of Solar Energy," *RCA ENGINEER*, 7-4, Dec. '61-Jan. '62.
7. A. R. Gobat *et al.*, "Improved Solar Cells from Gallium Arsenide," *RCA ENGINEER* 7-4, Dec. '61-Jan. '62.

Table III — Average Critical Fluxes of GaAs and Si Solar Cells (Sunlight Measurements)

Bombarding Particle & Energy	ϕ_c (particles/cm ²)		
	GaAs	Si n/p	Si p/n
0.8 Mev electrons	1.1×10^{15}	1.3×10^{15}	4×10^{13}
5.6 Mev electrons	2.7×10^{11}	3.0×10^{12}	2×10^{12} *
0.1 Mev protons	$\sim 10^{12}$	$\sim 10^{13}$	$\sim 10^{13}$
0.4 Mev protons	$< 10^{11}$	$\sim 10^{11}$	$\sim 10^{11}$
1.8 Mev protons	2.4×10^{12}	1.3×10^{11}	4×10^{10}
17.6 Mev protons	5.7×10^{12}	4×10^{11}	7×10^{10}
95.5 Mev protons	$> 2 \times 10^{12}$	7×10^{11}	2×10^{11}

* Private communication from D. Brown, NASA

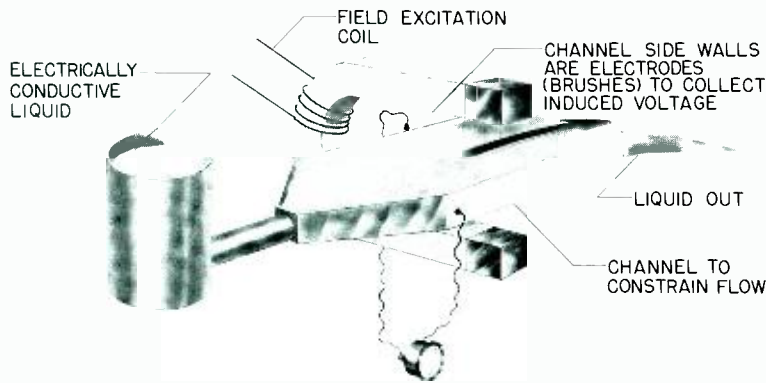

Fig. 1—Liquid MHD channel.

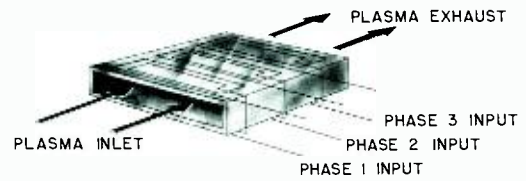

Fig. 2—Schematic presentation of AC MHD channel.

MAGNETOHYDRODYNAMIC POWER GENERATION

...Status and Prospects

Conversion of heat into electrical power by magnetohydrodynamics has been the subject of serious scientific study for the past six years. As time and technical understanding have progressed, both the nature and objectives of such study have changed. It is worthwhile at this time to bring into fresh perspective the status and prospects for MHD electric power generation, with the emphasis herein on a systems application viewpoint. It is concluded that study of MHD power generation is a long-range technical effort with important civilian and military potential. It is not possible, now, to predict with assurance that this potential will ultimately be realized. Many technical problems remain, while economic factors and the merits of competing systems must continually be reassessed. However, the market potential and the possibility of solving the problems justify work in this field by any organization aspiring to become a supplier in the new generation of power-conversion equipment.

Dr. K. H. FISCHBECK

Advanced Military Systems, DEP, Princeton, N. J.

MMAGNETOHYDRODYNAMICS (MHD) is the science concerned with the interaction between electrically conductive fluids and magnetic fields. (A current summary of the plasma physics relating to MHD is in the literature.¹) The idea of applying this science to the generation of electricity is apparently due to Faraday, who first demonstrated the phenomenon in 1831. Today, there are practical flow meters and liquid metal pumps based on MHD technology, but in spite of sporadic efforts extending over more than 50 years and intensive effort during the past 6 years, practical MHD electric power generators have not yet been perfected.

BASIC CONCEPTS

According to Faraday's principle of motional induction, an electrical conductor moving through a magnetic field has an electric voltage induced across it. Almost all of the electric power pro-

duced today is generated by such electromagnetic induction, that is, by the motion of an electrical conductor relative to a magnetic field and using the induced voltage to drive a current.

Fig. 1 illustrates, in stylized fashion, the basic concept of MHD power generation. An electrically conducting working fluid is constrained to move through a transverse magnetic field. The induced electromotive force in the liquid armature causes current to flow across the channel. This current is collected and directed through an external load by the sidewall electrodes which act as brushes or slip rings. Part of the load could be the field excitation coil and the device would then be self-exciting.

The working fluid need not be a liquid, and in fact, most MHD research is concerned with an electrically conductive gas or plasma flowing in a suitable channel. Some MHD generators may produce AC instead of DC electric

power.² The generator³ investigated by RCA at DEP's Moorestown Plant is stylized in Fig. 2. A set of AC field coils is located adjacent to, but external to a plasma channel. When excited they generate a traveling magnetic field that penetrates the channel. This field induces currents in the plasma that react back on the coils coupling power out. Stated most simply, this generator is the MHD analog of an ordinary asynchronous induction generator, or an over-driven induction motor.

There are a number of variants of both DC and AC MHD generators.⁴ The proponents of each profess some particular potential advantage for their device, but by far the greatest effort has been addressed to the study of the simple DC channel with plasma as the working fluid.

Like thermoelectrics and thermionics, MHD generators may be used to convert heat into electrical power. With

MHD, however, this is done in two steps. The random motions of a heated gas must first be organized into directed motion of flow by means of a nozzle. The flow can then be exploited as a moving conductor to generate the electrical power. The properties of the working fluid in the MHD channel are determined by the source of heat. For commercial power generation, fossil fuels such as oil or pulverized coal would be combusted under pressure with pre-heated or oxygenated air. The combustion product gases themselves, perhaps with additions,⁵ would be the MHD fluid. For military applications, special chemicals such as rocket fuels might be used providing gaseous reaction products as the working fluid. For space and naval applications, the heat source would be a nuclear reactor. While the commercial and military generators would operate in open cycle expending their exhaust combustion products to the atmosphere, the reactor driven generators would operate in closed cycle, either Brayton or Rankine depending upon whether the reactor was gas or liquid cooled. The working fluid in these might be noble gases, metal vapors, or liquid metal.

FUNDAMENTAL PROPERTIES AND SCALING LAWS

The stimulus for development of MHD generators can be quickly identified.⁶ Truly fantastic power levels and power densities are promised at operating temperatures which imply high Carnot efficiency. The only limit is the temperature capability of the heat source.

The MHD channel density of electric power generation is expressed in watts per cubic meter as:

$$P_e \simeq \frac{\sigma v^2 B^2}{4}$$

Where: σ is the electrical conductivity in mhos/m, v is the fluid velocity in m/sec. and B is the magnetic field in Webers/m². High, yet achievable, values for these parameters indicate power densities of 10⁹ watts/m³ of channel volume.

In these generators the containing structure is stationary. It is possible to use refractory materials as thermal insulators resulting in a structure capable of operating in the presence of very high temperatures. High overall thermal efficiencies may thus be achieved particularly if the waste heat from the generator is used by conventional technologies to provide additional electrical power.

There does, however, exist a lower power limit for an efficient MHD generator. This may be demonstrated by the following argument. For a fixed

power density and channel form, the total power generated varies as the volume or a linear dimension cubed. Since the magnetic field is fixed, the power required by the magnet will vary linearly with that dimension⁷ while wall losses vary as its square. Thus there exists a minimum dimension for each geometry below which the generated power will not exceed the power losses. This threshold size expressed in generated power is between 10 and 1,000 kw. depending on the particular assumptions made for the generator.

For AC generators, the power density is roughly the same as above if the rms B field is used. However, the AC machine has reactive power in its windings as well. The ratio of real to reactive power at maximum coupling is:

$$\frac{\mu \sigma v \lambda}{4\pi}$$

Where: μ is the permeability of the fluid, and λ is the wavelength of the traveling wave. To avoid excessive reactive power, the product of $\sigma v \lambda$ in MKS units must exceed 10⁷.

Efficient dimensions of the AC channel may be related to the wavelength through the following arguments: to minimize entrance and exit losses, the channel length l should be a number of wavelengths long:

$$l \gtrsim 5 \lambda$$

To make efficient use of the field coils, the channel height h should be less than a wavelength while to avoid side losses in the fluid electric current, the channel width w should exceed a wavelength:

$$h < \lambda < w$$

In addition, the channel height should not exceed the fluid skin depth:

$$h < (\mu \sigma f)^{-1/2}$$

The voltage generated by a DC machine is:

$$V \simeq \frac{vB}{2} w$$

For velocities attainable with liquids (< 100 m/sec) this voltage is quite small, but for plasma velocities it may easily exceed a kilovolt.

A final limitation on the above parameters is imposed by the Hall Effect. In plasma fluids, the free electrons will tend to gyrate about magnetic field lines. Instead of moving in the direction of the motionally induced EMF, they will tend to drift in an $E \times B$ direction along the MHD channel rather than across it. This is generally deleterious to generator performance. Scattering collisions interrupt the electron gyrations and permit the desired cross channel flow. For good operation the generator design should provide:

$$\omega \tau < 1$$

Where: ω is the electron cyclotron frequency and τ the electron mean time between scattering collisions. Thus for a given fluid state there exists a maximum B if Hall Effects are to be avoided.

COMMERCIAL APPLICATIONS

In flames and other hot gases, some of the molecules become ionized releasing electrons so that these gases become electrical conductors. If the combustion takes place under pressure, the resulting hot combustion products can be nozzleed to very high velocity in a manner of a rocket engine. The high velocity gases may be directed through an MHD channel. The conductivity of the combustion products of fossil fuel in air is negligible below about 2,000°C and increases to a few mhos per meter at about 3,000°C. Electrical conductivity of the gas may be increased by about an order of magnitude by seeding it with easily ionizable atoms such as potassium. However, simple combustion of fossil fuels in air cannot yield 3,000°C temperatures in the MHD channel, particularly after the gases had been cooled by expansion through a nozzle. Three methods have been examined as possible ways to obtain appropriately high electrical conductivity for this application.

One method is the use of heat exchangers. Combustion gases cooled below about 2,000°C are no longer useful for MHD but are excessively hot for steam generation purposes, hence, some of the heat from the MHD channel exhaust could be used through a heat exchanger to preheat the air used in combustion.^{8,9} This results in higher-temperature combustion products, and the entire process may thus be bootstrapped into a temperature regime of good electrical conductivity. The technical and economic problems of a 2,000°C heat exchanger have not yet been solved.

A different approach is to incorporate with the power station an oxygen plant such that the combustion of the fuels takes place in an oxygenated atmosphere.¹⁰ This procedure is certainly technically feasible, but the economics of the process are not encouraging.

The third possibility would involve a so-called *frozen flow* expansion nozzle.¹¹ If the expansion of the gases through the nozzle into the MHD channel takes place sufficiently rapidly, it may be possible to retain at least momentarily, the ionization level appropriate to the temperatures which exist in the combustion chamber.¹¹ This process would involve very high velocity channel flows, and its feasibility is not established. With our present understanding, the conductivity of fossil fuel combustion

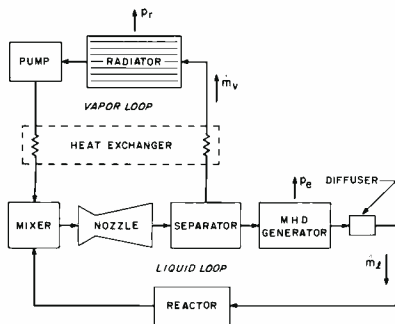

Fig. 3—Two-fluid MHD power conversion cycle.

products is not likely to exceed a few hundred mhos per meter in any plant approaching economic feasibility in the foreseeable future. Referring the above expression for reactive power in the AC generator, it is apparent that with such low values of conductivity and even with gas velocities as high as 3,000 m/sec, a designer is faced with a choice between an extremely poor power factor, or an extremely large, and hence extremely high power generator. For this reason, with fossil-fuel heat sources the AC generator is at least a generation beyond the DC machine.

Two outstanding problems for the DC generator, namely, electrodes and inverters, appear to be at this writing not so much questions of technical feasibility, but a question of economic reasonability. Even as MHD research and development has been identifying and solving problems, competing techniques to generate commercial electric power have been making progress also. Nuclear steam plants have become economically competitive with fossil fuel plants in the areas like New England and California, but more competitive still for MHD generators are gas turbines driven by combustion products and used individually or as topping stages on steam plants. Such turbines evidence increasing reliability and high performance.⁹

In summary, MHD generators for commercial applications are still of ultimate interest for the same reasons that stimulate their study at this time. But economics and perfection of competing processes are forcing still further materials development before a real MHD advantage can be realized. Technical problems will continue to receive attention, but commercially competitive MHD power is not anticipated within at least several decades.

SPECIAL-PURPOSE MILITARY APPLICATIONS

Open-cycle, short-life, DC, MHD devices have been built and operated in a

number of industrial and government laboratories. To date, DC power at megawatt levels has been generated, but only for a fraction of a minute. Tens of kilowatts have been generated for fractions of an hour. There are no apparent insurmountable technical obstacles to prevent the development of MHD generators capable of delivering tens to hundreds of megawatts for modest time periods. The available power density in a typical rocket exhaust exceeds 10^6 watts/m². A terrestrially emplaced rocket engine exhausting through an MHD channel could provide the very high power short burst requirements envisioned for certain central war electronic needs.¹² Such an installation would have poor fuel and thermal efficiency, but it would possess long dormant standby capability and have a very rapid start-up characteristic. The capital investment per kilowatt capacity would not be excessive and even though the generator might have only a 15-minute life it should be borne in mind that a quarter hour can be a very long time in a modern central war situation. Such an application might well provide the first use of MHD generators since neither technical nor economic problems are limiting. The question here is, rather, whether and when a generator with these characteristics will be needed.

SPACE AND NAVAL APPLICATIONS

The high temperature at which MHD generators reject heat affords small radiators and hence the possibility of very powerful, yet low weight power systems. In space, MHD generators would be driven by fluids heated by nuclear reactors.¹³

Liquid Metal Generator Systems

Alkali metals in the liquid state are good electrical conductors and one possible choice of working fluid to meet the electrical requirements is to use a liquid metal in the generator duct. An alkali-metal vapor at the temperature levels proposed for these systems (around 2,000°F) is a reasonably good electrical conductor. Thus, another possibility is the use of alkali-metal-vapor MHD generators.

With liquid-metal MHD generators, an important problem is the conversion of thermal energy of the reactor to kinetic energy of the working liquid—a component for this purpose is required in the power system. Several proposals have recently been made in this regard and they center on either the use of a single fluid in both liquid and vapor phases,¹⁴ or two separate working fluids.¹⁵ In both cases, heat is imparted

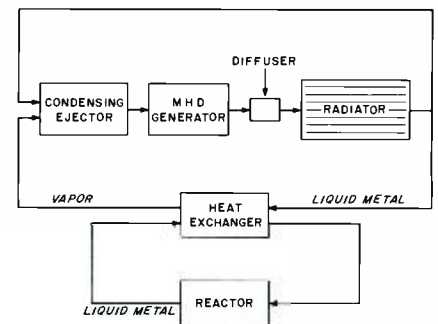

Fig. 4—Single-fluid, two-phase MHD power conversion cycle.

to a vapor which is allowed to expand and drive liquid metal droplets. In the single-fluid case, *condensing*, and the two-fluid case, *separation*, precedes the MHD generator duct so that liquid operation is ensured in that component. The two-fluid system originally proposed by Elliott is shown in Fig. 3, while the single-fluid arrangement proposed by Jackson and Brown is given in Fig. 4. Preliminary cycle studies indicate an efficiency of about 10%. A successful power system of this type depends on: 1) development of high-efficiency mechanical drivers; and 2) generators with a higher electrical efficiency than that achieved on MHD pumps currently available. Given that these developments can be made, a liquid-metal MHD system appears at this time to have reasonable prospects for application to space power generation.

In the case of liquid-metal AC power generation does not suffer from excessive reactive power. Accordingly, an important aspect of the study of liquid-metal MHD system is the development of an RCA type AC electrodeless generator as an alternative to the low-voltage, high-current DC device which would otherwise be involved.

Metal Vapor Generator Systems

At the temperature levels involved with liquid-metal-cooled reactors, thermal ionization is not possible and some scheme for nonequilibrium ionization is required. This depends on an electron recombination rate which is at least comparable with, and preferably longer than, the transit time of the working fluid through the MHD generator duct. Fortunately, both noble gases and alkali-metal vapors have this property, and schemes for the elevation of their electron temperature leading to an acceptable conductivity is the key problem for vapor MHD generator systems.

Various methods are available for this elevation of electron temperature. These include DC or RF discharges, fis-

sion-product ionization, and electron-beam excitation; but, current efforts center on the use of the electric field induced by motion of the working fluid through a DC magnetic field. The regime in which operation would occur is one where Hall Effect cannot be neglected. An important aspect of this work is the proper inclusion of Hall considerations.

The simple theory of nonequilibrium conductivity in the absence of bulk motion has been derived,¹⁶ and some experimental results are now available.¹⁷ Pure alkali-metal vapors, helium (seeded with lithium), and hydrogen, helium, argon, neon, mercury, and nitrogen (seeded with cesium) are included among the fluid system currently receiving attention.¹⁸

Experiments to study conductivity in dynamic channel flows are currently being planned^{19,20} but no results are as yet available. However, considerable progress has been made with the theoretical study of the electrical behavior of these flows and of the characteristics of DC generators operated with them.⁸ No attention has yet been given to AC generators working on nonequilibrium ionization.

It appears that alkali-metal-vapor generators will require rather higher operating temperatures than in the case of liquid-metal machines. Since the SNAP 50 temperature range is already close to the limit of the capability of currently available materials for these power systems, development of materials for the higher temperature vapor systems is an important aspect which should not be overlooked in favor of the electrical and fluid problems discussed above.

High Temperature Gas Systems

In a period since MHD research was extended to include closed-cycle systems with potential space power applications, the use of gas-dynamic MHD generators in conjunction with gas-cooled reactors in a Brayton cycle has received limited attention.¹³ An important preliminary requirement in this case is the development of gas-cooled nuclear reactors in the power range required. The higher operating temperatures on these systems should have a beneficial effect on the electrical properties of the working fluid, but might further aggravate the problems of material containment. Conductivity experiments, flow studies, and generator evaluation need to be carried out in here just as with metal vapors, but extended into the fluid temperature range 2,000 to 2,500°K. No work at the present is being undertaken along these lines and no reports of any plans to do so have come to hand.

CONCLUSION

The study of MHD power generation is in the category of a long range technical effort with important potential applications to both civilian and military electrical power systems. It is not possible, at this time, to predict with any assurance that this potential will ultimately be realized. Many technical problems remain to be solved while economic factors, together with the merits and demerits of competing systems, must continually be reassessed. However, the potentials of the market and of the possibility of solving the problems justify work in this field by any organization aspiring to become a supplier in the new generation of power-conversion equipment.

BIBLIOGRAPHY

- McCune, J. J., "Magneto-hydrodynamic Energy Conversion," AMS paper #63-87-77 also, *Physics Today*, Vol. 16, p. 44, (1963).
- Bernstein, I. B., et al., "An Electrodeless MHD Generator," *Engineering Aspects of Magneto-hydrodynamics*, Mannal, C., and Mather, N. (Editors), Columbia University Press, 1962.
- Electrodeless MHD Generator Research, Part I: Theoretical Analysis* (March 1962), *Part II: Laboratory Facility and Experimental Results* (January 1963), RCA, Defense Electronics Products Technical Documentary Report No. ASD-TDR-62-411.
- Donaldson, C. duP., "The Magneto-hydrodynamic Vortex Power Generator," *2nd Annual Symposium on Engineering Aspects of MHD (1961)*, Mannal and Mather (Editors), Columbia University Press 1962.
- Rosa, R. J., *Engineering Magneto-hydrodynamics*, Ph.D. Thesis, Cornell University 1956.
- Sporn, P., Kantrowitz, A., *Power*, November 1959.
- Stekly, Z. J., deWinter, T. A. and El Bindari, A., *Field Coils for MHD Generators*, AVCO Everett Research Report 119 (1961).
- Sutton, G. W., *The Theory of Magneto-hydrodynamic Power Generators*, General Electric Space Sciences Laboratory Report No. R62SD990, Dec. 1962.
- Brown, J. J., "Some Aspects of MHD Power Plant Economics," presented at the 3rd Symposium on Engineering Aspects of Magneto-hydrodynamics, Rochester, March 1962.
- Brogan, et al., "Progress in MHD Power Generation," 2nd Symposium on Engineering Aspects of MHD *op cit*.
- Eschenroeder, A. Q., and Daiber, J. W., "Ionization Non-equilibrium in Expanding Gas Flows," ARS Paper 1458-60 (1960).
- Magneto-hydrodynamic Power Generation Feasibility Study*, Pratt & Whitney Aircraft Division of United Aircraft Corporation, Report No. 1940, February, 1961; Rome Air Development Center Contract AF30(602)—2268, ASTIA Document No. AD257619. (Unclassified).
- Freedman, S. I., "Performance of, and Entropy Production in, MHD Space Power Cycles," presented at the 4th Symposium on the Engineering Aspects

of Magneto-hydrodynamics, Berkeley, California, April 1963.

- Elliott, D. G., "Two-Fluid Magneto-hydrodynamic Cycle for Nuclear-Electric Power Conversion," *ARS Journal*, Vol. 32, p. 924, (1962).
- Jackson, W. D. and Brown, G. A., *A MHD Liquid Metal Space Power System Utilizing the Condensing-Ejector*, M.I.T. Patent Disclosure, October 15, 1963.
- Kerrebrock, J. L., "Conduction in Gases with Elevated Electron Temperature," *Engineering Aspects of Magneto-hydrodynamics*, Mannal, C. and Mather, N., (Editors), Columbia University Press, 1962.
- Croitoru, J. and de Montardy, A., (Electricité de France), "Electrode Phenomena, Tensor Conductivity and Electron Heating in Seeded Argon," *Proceedings of the 4th Symposium on the Engineering Aspects of Magneto-hydrodynamics*, Berkeley, California, April 1963.
- Sutton, G. W., et al., *Investigation of Non-Thermal Ionization for MHD Energy Conversion*, General Electric Space Sciences Laboratory Quarterly Progress Reports, June, September and December 1962.
- Way, S., et al., *Long Life Closed Loop MHD Research and Development Unit*, Westinghouse Research Laboratories, Interim Scientific Reports No. 1 (June), 2 (September) and 3 (December) 1962.
- Talaat, M. E., *Research Program on Closed-Cycle Magnetoplasmadynamic Power Generation with Non-Equilibrium Ionization*, Martin Marietta Corporation, Semi Annual Technical Summary Report MND-2939, Dec. 1962.

DR. KENNETH H. FISCHBECK received his BSEE from the Massachusetts Institute of Technology in 1945. He has subsequently been awarded an MS in Physics by Wayne University, an MS in Systems Engineering by the University of Pennsylvania, and his PhD from the University of Pennsylvania. From 1945 to 1947 Dr. Fischbeck served as an Ensign in the U. S. Navy where he worked at the U. S. Naval Underwater Sound Laboratories. From 1947 to 1954 he was employed by Bendix Aviation Corporation Research Laboratories, where he worked on the design of meteorological computers, guidance concepts and systems analysis for the SPARROW II missile, and nuclear reactor control and kinetics simulation. In 1954 he joined RCA's Missile and Surface Radar Division, where he contributed to the interpretation procedures for BMEWS radar data, the cruise guidance concept for the Land-Based TALOS Missile and the optimal use of data from multiple radars tracking a single target. Since joining the AMS staff in 1960 he has been concerned with applications of plasma physics and magneto-hydrodynamic phenomena. His contributions have been to the theory of AC-MHD motors and generators and to electric space engines. Dr. Fischbeck is a member of the APS, AAAS, AIAA, and IEEE.

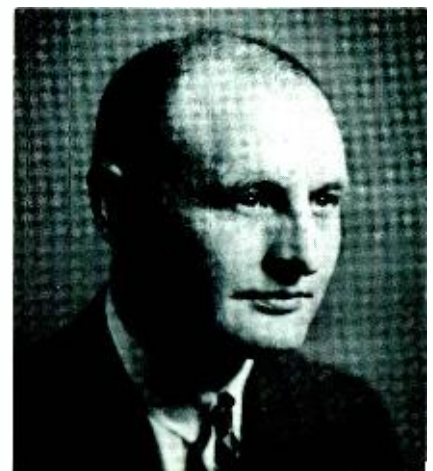



The author, N. S. Freedman (left) and H. F. Scott, both of Electronic Components and Devices, with a diagram depicting operation of a superconducting magnet.

SUPERCONDUCTING MAGNETS

Superconductivity allows the design of very-high-field magnets that can be started by low-voltage storage batteries and then operated with little or no further current input because of the zero loss in the windings. The RCA process for producing niobium-tin ribbon produces a unique, practical superconductor. RCA modular designs using this ribbon have an excellent chance of providing breakthroughs in the technology of large superconducting magnets.

SUPERCONDUCTIVITY, the phenomenon of near-zero electrical resistance which occurs in certain materials (superconductors) when cooled to temperatures close to absolute zero, is providing the basis for dramatic new device development as well as radical improvements in many existing devices.

This remarkable property of zero resistance is particularly useful in the operation of electromagnets, especially large-volume high-magnetic-field magnets. For example, a present-day non-superconducting copper-conductor water-cooled 2-inch-ID solenoid developing 100 kilogauss (kg) requires 1.46 Mw of power and sufficient cooling to dissipate the large copper-conductor power losses (NASA magnet located at Lewis Research Center, Cleveland, Ohio). In con-

N. S. FREEDMAN, Mgr.

*Special Project Development
Special Electronic Components Div.
Electronic Components and Devices
Princeton, New Jersey*

trast, a comparable superconductive direct current magnet would require high electrical current only for energizing (it could be started from low-voltage storage batteries) and then, because of zero power loss in the windings, could continue to operate indefinitely with little or no further input of electrical power. Typically, liquid-helium cooling would be required to cool down and maintain an operating temperature of 4.2°K; however, containment in modern efficient cryogenic containers (Dewars) would keep cooling requirements in the

watt or kilowatt range depending upon magnet size.

The projected costs of building and operating superconducting magnets appear highly favorable compared with the costs of conventional water-cooled copper magnets, even in the small-bore high-magnetic-field range; the economic advantages increase greatly as the requirements of volume and magnetic field strength are increased. More important, as field strength and magnet size increase, current densities required in the conductors to attain the high magnetic fields increase beyond the current-carrying capabilities of copper conductors even with extreme techniques of water cooling.

The operating requirements of the relatively-small-bore (1-inch-inner-diam-

NORMAN S. FREEDMAN received the BS in Chemical Engineering from New York University in 1943, and has since done graduate work at Columbia University. He joined RCA in 1943, and has since specialized in electrochemical work and the process development of materials and electron devices. Mr. Freedman received an RCA Laboratory Award in 1950 for outstanding work in the research and development of "The Method Employed in the Fabrication of Phosphor Screens in Tri-Color Kinescope Tubes." In 1953, he became Manager, Methods and Process Laboratory, in Receiving Tube Product Engineering. In 1954, he was on special assignment to the Color Kinescope Operations in Lancaster, Pa., where he was responsible for developing precision aperture masks for color tubes. In 1955, he became Manager, Process and Test

Engineering, and in 1958 Manager, Chemical and Physical Laboratory, in the Harrison plant. From 1961 to 1962 his responsibilities included the direction and management of work on thermoelectric and superconducting materials and devices. In July 1962, he was made Manager of the Superconductor Materials and Devices Laboratory of the Electron Tube Division at Princeton, N.J. In 1963, he received the David Sarnoff Team Achievement Award in Engineering for heading up a team which developed practical structures and production methods for thermoelectric power generators. In July 1963, he was promoted to his present position as Manager, Special Project Development, in the newly formed Special Electronic Components Division. Mr. Freedman is a Member of the ACS and APS, and a Senior Member of the IEEE.

eter) 126-kg Bitter-type copper magnet located at the National Magnet Laboratory at MIT (1.88 Mw and 320 gpm of cooling water) illustrate the difficulties of operating even a small research-size nonsuperconducting high-field magnet. One proposed interim solution, a cryogenic magnet with a pure-aluminum conductor cooled with liquid neon, takes advantage of the very low electrical resistance of a pure metal at low temperatures (the boiling point of neon is 27.2°K). Fairly high current densities (1.5×10^9 amp/cm²) become possible with this technique and a successful large-bore high-field magnet should be attainable. A 200 kg neon-cooled cryogenic magnet, having 12-inch-diameter bore, now under construction at NASA, Lewis Research Center, Cleveland, Ohio,

will require approximately 470 kw of cooling at the temperature of liquid neon.¹ However, initial magnet and power-supply costs will be high and operation of the magnet will require costly power dissipation at cryogenic temperatures.

It has become apparent that large-size high-field magnets require materials having low electrical resistance and conductors of high-current-carrying capacity. Thus, the superconductor magnet which has conductors of high current density (greater than 1×10^9 amp/cm²) and negligible power consumption regardless of magnet volume and field strength, is a most desirable solution to the problem of constructing practical and economically feasible large-volume high-field magnets.

MAGNET APPLICATIONS

The applications for very-high-field magnets are many and varied. Although an urgent need for such devices exists, only a few conventional high-field magnets ranging from 90 to 152 kg are available in this country. (For example, the NRL Magnet, 152 kg, 1½-inch-diameter bore, requires 6 Mw and 660 gpm of cooling-water.) Because the few present small-bore high-field magnets are necessarily brute-force solutions, the successful construction of larger-bore (greater than 12-inch-diameter) high-field magnets required in applications such as bubble chambers and bending magnets for high-energy physics experiments will depend on the use of superconductivity. Although magnetohydrodynamic (MHD) and thermonuclear-fusion energy conversion are only in the research stage, large-size high-field magnets will ultimately be required for successful commercial applications of these energy-conversion techniques. Small-size, efficient, low-loss rotating electric generators and motors with superconducting coils and high-current superconductors could provide high power for commercial applications. Compact uniform high-field superconducting magnets are being considered to extend present magnifications of electron microscopes. Masers, which operate at cryogenic temperatures, will greatly benefit from the smaller size and extremely low power requirements of superconductive magnets.

SUPERCONDUCTIVE MATERIALS

Of the more than two dozen elements and hundreds of alloys and intermetallic compounds which exhibit superconductivity, only a few are suitable for use as conductors in high magnetic fields. Although cooled below their critical temperatures, most superconductors revert to their normal conductive state as the ambient magnetic field increases. The discovery of superconductive alloys which are capable of carrying high currents in high magnetic fields is relatively recent. Two alloys of particular interest are being extensively investigated. Niobium zirconium (Nb-Zr), a cold-drawn, hard-worked alloy, drops rapidly in current density in magnetic fields above 60 kilogausses. For fields above 50 kg, niobium stannide (Nb₃Sn), which is capable of supporting very high current densities (greater than 1×10^9 amp/cm²) in magnetic fields in excess of 90 kg, is undoubtedly the more suitable high-field superconductor.

Nb₃Sn WIRE

Substantial effort is being given to the preparation of Nb₃Sn wire and ribbon



Fig. 1—Photomicrograph showing cross section of superconductive material.

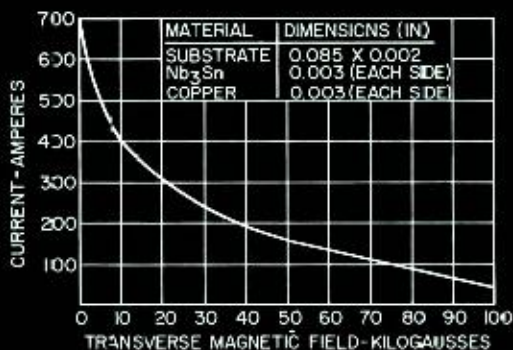

Fig. 2—Typical performance curve of Nb₃Sn coated ribbon.

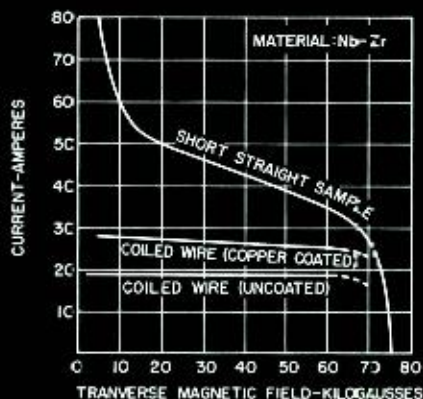

Fig. 3—Performance of a coiled superconductive wire compared with performance of a short straight sample.

because of its superior superconducting current densities at very high magnetic fields. Nb_3Sn , a brittle, intermetallic, peritectic compound, is difficult to make. An important material development was Nb_3Sn cored wire described by Kunzler, Buehler, Hsui, and Wernecke.² In this process, a niobium tube is filled with near-stoichiometric amounts of niobium and tin powders, sealed, swaged, and hard-drawn to a diameter of approximately 0.015 inch. The resulting, as yet non-superconducting, wire is wound to a final magnet configuration on a coil form and then heat-treated at approximately 1,000°C for 10 to 15 hours to form the compound Nb_3Sn , which has superconducting properties. Because the compound is brittle after the heat treatment, the coiled wire cannot be bent or distorted without reducing its superconducting properties. Large-size magnets made by this technique require miles of conductor and present almost insurmountable construction problems. At this writing, the highest reported field developed by a magnet of this type is 72 kg; the magnet has a bore size of only $\frac{1}{4}$ inch.

In another technique,³ tin is coated on niobium wire and then heated in vacuum to form Nb_3Sn at the surface. A variation of this technique in which the coil is heat-treated after winding is reported to have been used in making a 101-kg superconducting magnet having a useful bore of $\frac{1}{4}$ inch.

RCA PROCESS FOR Nb_3Sn

Dr. J. J. Hanak of the RCA Laboratories, (supported by the U. S. Air Force, ASD, WPAFB, Ohio under Contract No. AF 33 (657) - 7733) developed a chemical technique for depositing pure single-phase crystalline Nb_3Sn continuously on

a moving platinum substrate.⁴ Briefly, the method involves an irreversible gas-phase reaction in which the chlorides of niobium and tin are individually formed, mixed, and then continuously hydrogen-reduced at approximately 1200°C to form stoichiometric Nb_3Sn . This RCA-developed Nb_3Sn material is superconductive as deposited and, when tested at the University of California Lawrence Radiation Laboratories, proved to support the highest current densities ever reported at very high magnetic fields (5×10^5 amp/cm² at 93.5 kg).

In order to take full advantage of the RCA Laboratories breakthrough, the Electron Tube Division (now part of Electronic Components and Devices) established an applied research laboratory, at the David Sarnoff Research Center at Princeton on July 1, 1962. Since then, the process has gone through several stages of development. At present, 0.090-by-0.002-inch ribbon is Nb_3Sn -coated in continuous strips up to 1,000 meters long. The costly low-strength platinum substrate has been replaced by a high-strength low-cost stainless-steel alloy, and a special electroplating process has been developed for continuously copper-plating the Nb_3Sn surface. In addition to improving coil performance, the copper surface provides a durable composite ribbon sufficiently ductile to be wound over a $\frac{1}{2}$ -inch-diameter form with no loss in superconductive performance. A cross-sectional photomicrograph of the wire is shown in Fig. 1. Typical superconducting performance at 4.2°K is shown in Fig. 2. (Data taken with NASA Lewis Research Center magnet under Contract NAS3-2520.)

SUPERCONDUCTIVE MAGNETS

Various laboratories have reported successful small-bore high-field magnets. (Westinghouse reported $\frac{1}{2}$ -inch bore, 60 kg, Nb_3Zr ; BTL $\frac{1}{4}$ -inch bore, 72 kg, Nb_3Sn ; GE $\frac{1}{4}$ -inch bore, 101 kg, Nb_3Sn .) The higher-field (70- to 101-kg) Nb_3Sn magnets that have been reported as successful were wound with wire made by either of the processes described by Kunzler, et. al. or Saur and Wurm. The wire was wound on a coil form and then subjected to a long-time high-temperature heat treatment in vacuum.

On the other hand, Nb-Zr, when properly hard-drawn, is already at its maximum superconducting state. The wire is first either copper-coated and/or insulator-coated and then wound into the desired magnet configuration. However, because of their maximum potential upper limit of 50 to 60 kg, Nb-Zr magnets are not truly high-field magnets. (Small-bore, medium-field supercon-

ducting magnets made with NbZr are available commercially; approximate sizes range from 2-inch bore, 15 kg to 1-inch bore, 50 kg.)

In the design of magnets made by any of the previously mentioned techniques or by the RCA design to be discussed, the simple assumption is made that the developed field in a superconducting magnet follows approximately the same relationship to size, current density, turns, and spacing as do nonsuperconducting (normal) magnets. The evidence developed to date on superconducting magnet design, at least for small magnets, bears out this assumption; at a given current flow for a particular design, magnet performance is predictable.

Unfortunately, the current-carrying capacity of superconductors is not equally predictable. The most troubling discrepancy is the difference in maximum current densities in a given magnetic field between short-length test samples and long-length coils exposed to comparable magnetic fields. This difference in maximum-current-density performance, generally termed "degradation," between short samples and long samples of Nb-Zr coiled configuration is shown in Fig. 3.

Current density of Nb_3Sn short samples as compared with coil performance has not been extensively reported in the literature, and at this time the relationship is not clear. Tests now under way at the Superconductor Materials and Devices Laboratory have demonstrated that Nb_3Sn -coated material which has been vapor-deposited by the RCA process can have almost identical short-sample and coil performance characteristics that do not show the "degradation" effect.

RCA MODULAR DESIGN

The ribbon geometry of the superconductive Nb_3Sn -coated ribbon (0.090 inch wide by 0.002 inch thick) is particularly suited to the winding of solenoid magnets. A modular magnet design has been developed in which one end of the copper plated Nb_3Sn -coated ribbon is soft-soldered to the outer surface of an inner OFHC copper ring and the ribbon is wound spirally to form a coil similar to a watch mainspring. Mylar film, (0.0005 inch thick) is simultaneously wound and interleaved to provide electrical insulation and protection against arcing. The final winding turn is soft-soldered to the inside surface of the outer copper ring. The rings, which are normal conductors, provide the means for making electrical contact to the superconductive ribbon. A magnet module is shown in Fig. 4. The laboratory winding apparatus is shown in Fig. 5.

Fig. 4—Modular magnet assembly. Spiral-wound Nb_3Sn — coated ribbon is interleaved with Mylar film. Top and bottom end-pieces are also shown.

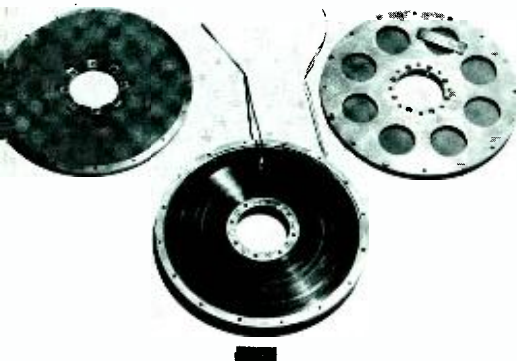

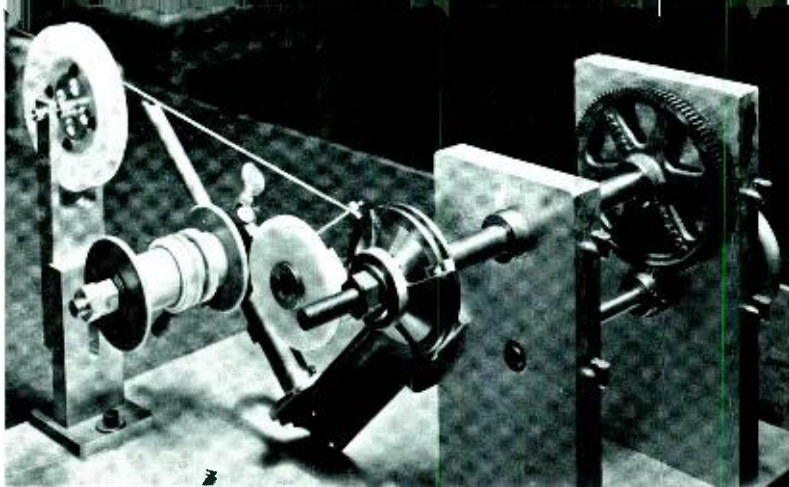

Fig. 5—Laboratory apparatus for winding superconductive ribbon.

The modular construction, particularly during this early stage of development, has several advantages over the more conventional technique of layer-upon-layer winding used in most solenoid construction. With the modular construction, shorter lengths of superconductive ribbon are needed, each module may be thoroughly tested before assembly into the finished magnet, and modules may be performance-graded and located in the magnet assembly accordingly for magnetic-field uniformity. In addition, magnet modules may be wound with various turn densities and properly located for increased magnetic-field uniformity, or even special nonuniform field effects. In the assembled solenoid shown in Fig. 6, the magnet modules are electrically connected in series by alternate insulation of the inner or outer rings with 0.015-inch bakelite separators and alternate fastening of adjacent inner or outer rings with conducting metal screws for good electrical contact. The final magnet stack is a rugged and compact structure which can withstand fairly rough handling including repeated thermal cycles of 290°K (i.e., during cool-down from room-temperature to 4.2°K and warm-up back to room temperature).

The presently used series-connected solenoid stack of 10 modules develops a magnetic field of 14.5 kg at a current flow of 58 amperes at 4.2°K. The working core diameter is $1\frac{3}{8}$ inches, the inside turn diameter is $1\frac{7}{8}$ inches and the outermost turn diameter is $2\frac{7}{8}$ inches. The over-all solenoid diameter is $3\frac{3}{8}$ inches and the length is $1\frac{1}{2}$ inches. Each module having approximately 130 turns contains 82 feet of superconducting ribbon. This magnet, which has been in almost daily use for over $3\frac{1}{2}$ months, shows no evidence of any change in superconducting or magnetic performance. Performance is so reproducible that the desired magnetic fields are merely adjusted by current setting and only rarely is the curve of current as a function of field rechecked with a fluxmeter. The magnet may be turned on and brought

up to full field (14.5 kg) in less than 10 seconds. When the magnet is suddenly switched off or made to go normal, the stored energy (160 joules) is safely dissipated in the copper coatings and copper rings.

A magnet now under construction has a higher field, a larger outside diameter (5 inches), and the same $1\frac{3}{8}$ inch working bore as the present model; however, it has double the length and, consequently, twice the working volume. This solenoid is designed as a stack of 20 modules, each containing 420 turns and requiring 426 feet of superconducting ribbon. With a designed current-flow of 55 amperes, this developmental magnet having a total of only 8,520 feet of superconductive ribbon will develop a magnetic field of 50 kg. At the time of this writing, no comparable superconducting solenoid is known to have been reported.

In any solenoid, superconducting or normal, as magnetic fields are increased, radial forces outward increase quadratically with the field; at 100 kg radial pressure exceeds 5,800 psi on the windings of the new solenoid. Plastic encapsulation of the windings is being planned to prevent the superconducting ribbon from tearing apart in high fields and to eliminate conductor current instability resulting from movement of the windings. A vacuum-impregnated molded encapsulation of one of the 5-inch-diameter modules is shown in Fig. 7.

In addition to the work effort on the design and construction of the 50-kilogauss solenoid just described, the Superconductor Materials and Devices Laboratory at Princeton is carrying on a study of the feasibility of designing and constructing a 150-kg solenoid. At this field strength, the proposed magnet size, a minimum bore of 12 inches, is beyond today's state-of-the-art.

The study, which has been underway since March 1963 (and is supported by NASA, Lewis Research Center) is intended to help meet the requirements of superconducting very-high-field magnets for research in space propulsion. The

nonsuperconducting 70-kg 4-inch-bore NASA magnet located at Lewis Research Center in Cleveland, Ohio is being used for extensive high-field testing of RCA superconductive materials and coils.

CONCLUSION

Progress to date and the data now being developed in this study confirm that the RCA process for depositing Nb_3Sn continuously on ribbon does produce a unique and practical superconductor and that the RCA modular design for constructing a superconducting solenoid using this ribbon has an excellent chance of providing the needed breakthrough in the technology of large-size superconducting very-high-field magnets.

BIBLIOGRAPHY

1. *High Magnetic Fields*, MIT Press, 1961, p. 177
2. Kunzler, Buehler, Hsui, and Wernecke, *Phys. Rev. Letters*, 1961, Vol. 6, p. 89.
3. Saur and Wurm "Preparation and Superconductive Properties of Nb_3Sn coated Niobium Samples." *High Magnetic Fields*, MIT Press, 1962, p. 509
4. News item in RCA ENGINEER, February—March 1963

Fig. 6—Magnet modules and bakelite separators assembled into solenoid.



Fig. 7—Magnet module after plastic encapsulation to immobilize winding and increase strength.



THE THERMIONIC ENERGY CONVERTER

In simplest terms, the thermionic energy converter is an electron device which converts heat directly to electricity. Specifically, it is a thermionic diode-type tube filled with cesium vapor, the construction of which requires the most advanced techniques in the art of tube manufacture. Its great potential and the scope of its future applications make the thermionic energy converter a subject of great interest to the entire electron-tube industry.

F. G. BLOCK, Mgr.

*Thermionic Converter Engineering, Special Electronic Components Division
Electronic Components and Devices, Lancaster, Pa.*

and

Dr. K. G. HERNQVIST

RCA Laboratories, Princeton, N. J.

LIKE ALL electron tubes, the thermionic converter contains a cathode and an anode. The materials for the cathode and anode are selected so that there is a relatively high contact-potential difference in the "work functions" of the cathode and anode. (The work function ϕ of a metal is the amount of energy required to remove an electron from the surface of the metal.) The space between these electrodes is filled

with a gas such as cesium and the cathode is then heated. The heat at the cathode raises the energy of some of the electrons to a level which allows them to leave the cathode surface. These electrons then travel through the space between the electrodes and enter the anode. When they enter the anode, the electrons lose some energy. Because this energy loss appears as heat, the anode must be cooled to remove it. (The anode must be

kept at a temperature low enough so that it does not emit electrons.) The electrons collected by the anode now have a potential energy with respect to the cathode. By connection of the anode to the cathode through an external circuit, the electrons are allowed to work, as illustrated in Fig. 1.

CESIUM—LIFE-BLOOD OF THE THERMIONIC CONVERTER

One of the biggest problems in the development of a practical thermionic converter is to overcome the space charge, the cloud of electrons which forms in front of the cathode and prevents the flow of high current. This space charge can be overcome and unhindered current flow assured by the generation of a gaseous plasma, such as that used in thyratrons and other gas tubes, between the cathode and the anode. It is well known that plasma generation involves an expenditure of electrical energy which reduces the potential output of the converter. An efficient ion-generating mechanism is thus required.

Of the gaseous materials suitable for such use in thermionic converters, cesium is ionized most easily. Cesium can be ionized either by contact ionization, when it hits a hot surface like the cathode, or by electron impact within the plasma. Contact ionization is most efficient at higher cathode temperatures. Impact ionization is most useful in converters working at lower cathode temperatures. In either case, cesium is the key to effective thermionic conversion because it performs the essential job of space-charge neutralization.

In addition, cesium covers the electrode surfaces and thereby gives them the desired work functions. The work function of any surface immersed in cesium vapor depends on the cesium

Fig. 1—Potential diagram.

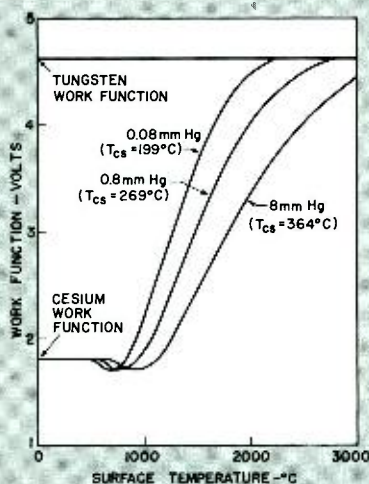
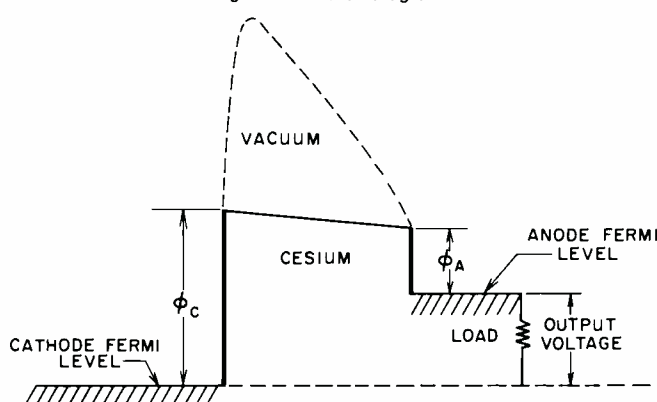

Fig. 2—Work function of tungsten in cesium vapor as a function of temperature with cesium vapor pressure in mm of Hg as parameter.

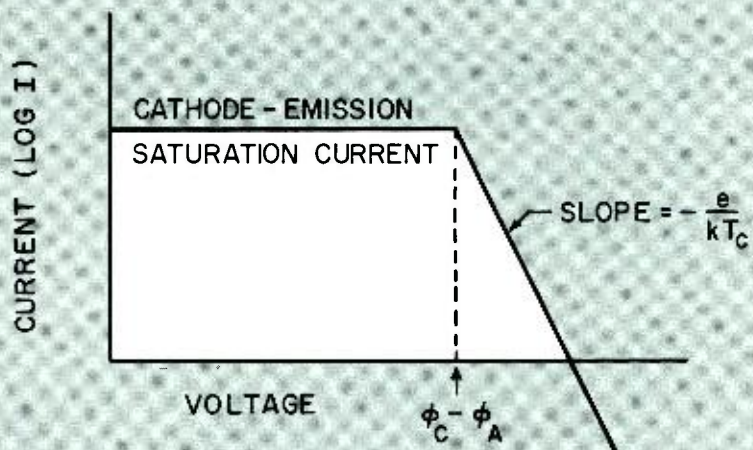
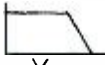
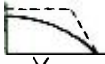



Fig. 3—Idealized volt-ampere characteristic for thermionic energy converter.

TABLE I—Characteristics of Three Modes of Operation of Cesium Diode-Type Thermionic Converters

Mode	Cathode Temp. (°C)	Cesium Pressure (mm of Hg)	Ionization	Cathode	Cathode to Anode Spacing (mm)	V-I Characteristic
A. High Temp. Low Cs Pressure	2,000-3,000	0.001-0.01 (T = 100-160° C)	Contact	Uncoated	Up to 1	Log I 
B. Intermediate Temp. High Cs Pressure	1,500-2,000	0.1-1 (T = 200-280° C)	Contact	Cs-Coated	0.05-0.1	Log I 
C. Arc Discharge	1,200-1,500	1-10 (T = 280-350° C)	Impact	Cs-Coated	0.1-0.5	Log I 

pressure (i.e., the arrival of neutral cesium) as well as on the temperature of the surface. Fig. 2 shows how the work function of tungsten in cesium vapor varies with temperature from that of pure cesium to that of pure tungsten.

As an example, if a thermionic converter were operated at a cesium pressure of about 1 mm-Hg, an anode temperature of 600° C would yield a work function of 1.8 volts and a cathode temperature of 1,200° C would yield a cathode work function of 2.3 volts. This decrease in the work function of the pure metal is a result of surface metal film. This film is established by an equilibrium rate of arrival and rate of evaporation of cesium. Thus it is not a static film, but is continuously replenished from the vapor phase. When a cathode covered with such a cesium film is overheated and then returned to its normal operating temperature, the cesium redeposits from the vapor phase and the cathode is as good as new. The advantage of this characteristic for a converter is significant because it provides ruggedness and reliability to a degree not normally found in electron tubes. It also gives the electrodes essentially infinite life, because the evapora-

tion rate of the film-bearing metal can be very small.

THREE ESTABLISHED MODES OF OPERATION

Fig. 3 shows a voltage-current (*V-I*) characteristic of the converter when it is assumed that there is no penalty in the ionization of the cesium. This idealized curve is a good approximation in some cases; for others it is not. As shown, the device is a constant-current generator up to an output voltage equal to the contact difference of potential (the difference between the cathode and the anode work functions).

Three different modes of operation have been established for the cesium diode converter. The characteristics of these modes are summarized in Table I. As indicated, Mode A is limited to high heat-source temperatures (2,000° C or higher). In this mode, the cathode work function is high and efficient contact ionization is obtained at low cesium pressure. Very little energy is used for the generation of ions, and the *V-I* characteristic is very similar to that of the idealized converter (Fig. 3).

For Mode B, the cesium pressure is raised to provide a partial cesium coat-

ing on the cathode and a somewhat lower cathode work function. The high cesium pressure impedes the flow of electrons across the diode and results in a deviation from the idealized *V-I* characteristic. The effect of the high cesium pressure can be minimized by the use of a smaller cathode-to-anode spacing. Thus the performance in Mode B is limited by the practical difficulties of making diodes having small cathode-to-anode spacings.

In the temperature range from 1,200 to 1,500° C, the cathode work function must be so low to obtain practical cathode-emission-current densities that contact ionization is an insufficient ionizing mechanism. For this temperature range, the arc mode of operation (Mode C) is most suitable. In Mode C, an arc discharge is ignited and part of the available contact difference of potential is used inside the diode to provide the energy for plasma generation, which is due mainly to electron impact processes in the plasma itself. Although a comparatively high penalty is paid for the ion generation, the discharge mechanism is efficient enough to yield substantial electrical output of the converter. The voltage necessary for plasma generation is current-dependent, and yields the *V-I* characteristic shown in Table I.

THE THERMIONIC CONVERTER AS A HEAT ENGINE

No discussion of the thermionic energy converter is complete without consideration of the heat source and its properties. An electron tube is normally thought of as a rather fragile device which requires great care and exactness in applied voltages and power inputs. This concept does not apply to the thermionic converter. An electron tube used in this type of application is subject to a great deal of downright "abuse," and ruggedness must be a primary design goal.

Actually, from the point of view of system design, the thermionic converter is a link or module in a heat-transfer system, as illustrated in Fig. 4. Heat gen-

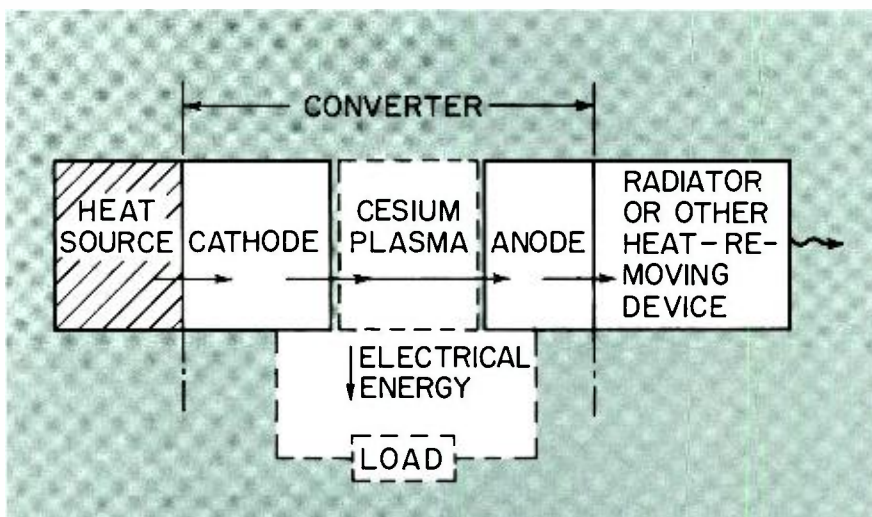

Fig. 4—Schematic diagram showing the thermionic energy converter as a link in a heat transfer system; heat flow from left to right.

Fig. 5—Thermionic converter designed for operation within nuclear reactor.



Fig. 6—Thermionic converter designed for operation in an external loop.

erated in the heat source flows first into the cathode, as indicated by the arrows. This heat-source-to-cathode flow can be either by radiation (as with solar heat source) or by direct conduction from a nuclear heat source or a flame. Within the converter, the heat flows from the cathode to the anode by radiation and by electron evaporation from the cathode. A large temperature drop occurs during the flow, and the heat appears at the anode at a much lower temperature. Finally, the heat appears at the radiator and is removed by radiation or convection. As previously described, electrical energy is developed by the loss of energy between the cathode and the anode.

There are a number of important features in this heat-transfer system. Because the efficiency of the converter generally increases with cathode temperature, it is important to operate the cathode at a temperature as close to that of the heat source as possible. Thus,

care must be taken to avoid temperature drops during the heat transfer from the heat source to the cathode. Another important feature is the heat rejection at the radiator. The anode must operate at a temperature low enough to avoid electron back emission. In practice, this temperature may be as high as 500 to 800° C. This high heat-rejection temperature is a very important feature of the thermionic converter. It means, for instance, that if heat is to be rejected by radiation, which is the case for space applications, a relatively small and lightweight radiator may be used. It also means that for ground applications this reject heat is at a sufficiently high temperature to be used by other heat-conversion methods.

APPLICATIONS

The heat sources available for thermionic converters can be classified into three areas: solar, nuclear, and fossil fuel. Each of these has different charac-

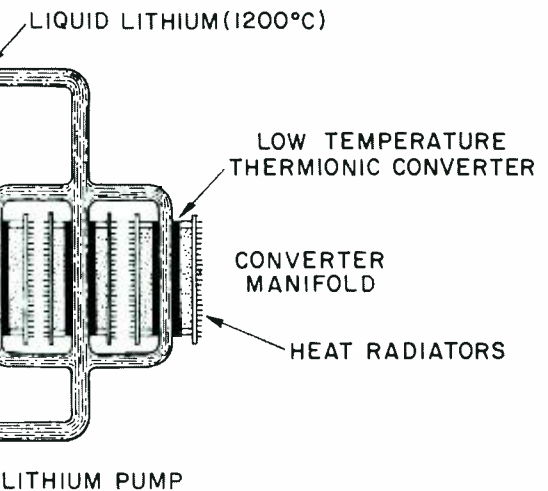

REACTOR THERMIONIC SYSTEM

Fig. 7—Reactor thermionic system using liquid lithium cycled through thermionic conversion loop.

teristics, can be used in various ways, and presents a number of unique problems, as illustrated in Table II.

One of the ideal heat sources is the nuclear reactor. Present-day power plants use coal or nuclear fuel to produce heat to boil water; the generated steam is then used to drive turbines which in turn activate generators to produce electricity. A large amount of auxiliary equipment in the form of boilers, pumps, heaters, preheaters, condensers, and turbines is required. In time, all this equipment may be replaced with a thermionic nuclear reactor which can utilize the heat the reactor is capable of generating at a very high energy level, and convert it directly into electricity without moving parts, noise, or auxiliary equipment and with a minimum of maintenance. The thermionic converters may be placed inside or outside the reactor. If they are inside, the fuel may either be used as the cathode itself or the cathode may be indirectly

heated by the fuel. If they are outside, the converters may be arranged at the periphery of the reactor or they may be heated from liquid metal in an external loop (the liquid metal is heated by the reactor). The specific method chosen will depend upon the final application. It will also depend on the power level required, and whether it is to be used in space or for terrestrial applications.

An example of a converter designed for operation inside the reactor is shown in Fig. 5. This converter (developed under BuShips sponsorship) is designed to produce 150 watts of electricity, and has run successfully for 310 hours in a reactor. Many of these converters connected together could be used to build a nuclear reactor which could produce power of a megawatt or more.

Fig. 6 shows an example of a converter to be heated from liquid metal in an external loop. This converter is designed to deliver 80 watts of power, and has operated successfully on a liquid-lithium loop in a simulated space environment. A systems concept of this type is shown in Fig. 7. Other applications include the generation of power from solar heat. A converter designed (under sponsorship of the Jet Propulsion Laboratories) for this purpose is shown in Fig. 8. Another potentially very important application is the conversion of fossil-fuel energy to electricity. A converter built for this purpose is shown in Fig. 9.

PROBLEM AREAS

As discussed, cesium is the life-blood of the thermionic converter because it provides both easy ionization and electrode surface conditioning. However, there are some disadvantages. For example, there is a problem with the effects of the high chemical activity of cesium on the tube envelope. Because of this activity, one of the main problems with

the thermionic converter at present concerns the integrity of the tube envelope. Although modern metal-ceramic technology makes it possible to construct vacuum envelopes of high rigidity and structural stability, the envelope in converter applications is subject to a rather severe environment both on the inside (because of the cesium) and on the outside (because of the heat source). Inasmuch as cesium is very active chemically, a very careful selection of materials for tube construction must be made. Table III summarizes results of cesium compatibility tests with different materials.

As shown, the precious metals are to be avoided; the refractory are preferred. Ceramic insulators are preferred to glass. Envelope puncture is not the only defect that can allow the cesium to attack the tube parts; the attack can also be caused by release of gases from the

Table III—Effect of Cesium on Materials Used in Tube Construction.

<i>Insignificant Attack</i>	<i>Intermediate</i>	<i>Severe Attack</i>
Refractory Metals Nickel Stainless Steel Aluminum Oxide	Copper Zirconium	Precious Metals Aluminum Carbon Glass-to-Kovar Seals

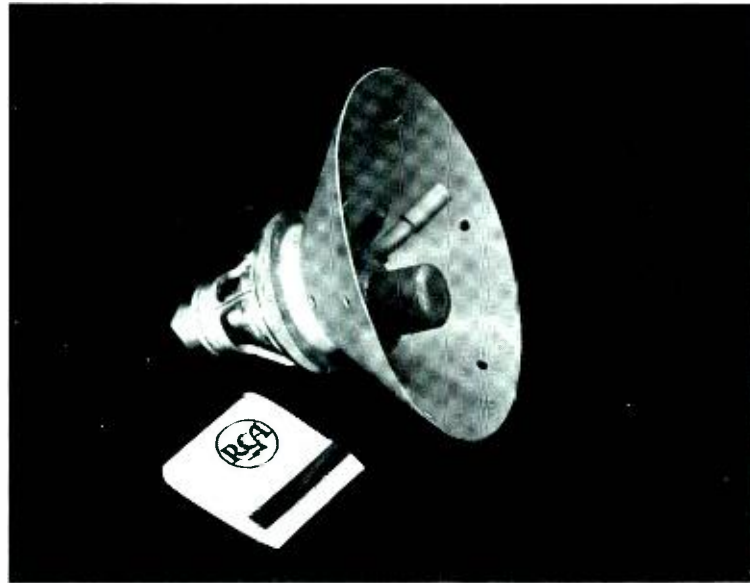

Fig. 8—Thermionic converter using solar heat source.

Fig. 9—Flame-heated thermionic converter.

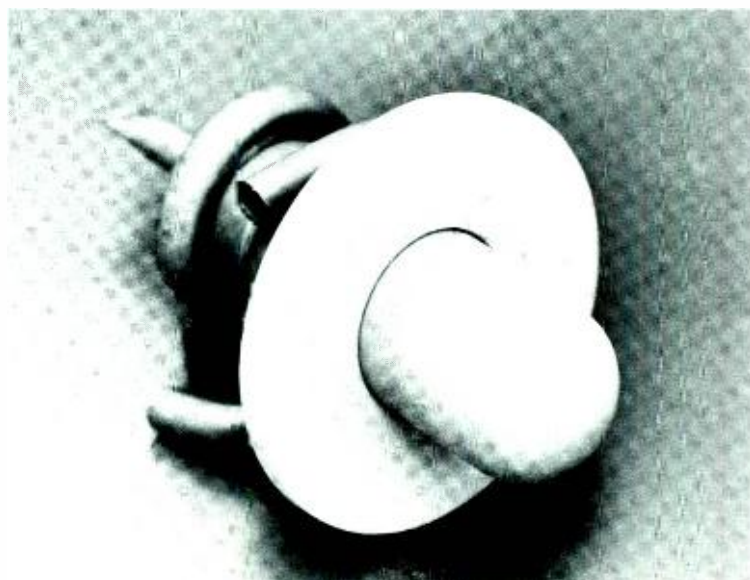

Table II—Application and Problem Areas

Heat Source	Space	Terrestrial	High Temp.	Low Temp.	Typical Problems
Solar	X		X		Cathode-lead design Radiator design Interelectrode spacing
Nuclear Isotope	X	X		X	Heat-Input variation Heat transfer
Reactor: In-pile	X	X	X	X	Radiation damage Neutron Cross-section Heat transfer
Liquid-Metal Loop	X			X	Insulation Efficiency Weight
Fossil fuel		X		X	Atmos. corrosion Gas permeation Temp. uniformity



F. G. BLOCK received the B.S. in Electrical Engineering magna cum laude from the College of the City of New York in 1949, and the M.S. degree in Industrial Management from Stevens Institute of Technology in 1954. He came to RCA as a Specialized Trainee in 1949. Subsequently he joined the Electron Tube Division in Lancaster, Pa., where he worked on such diversified tubes as magnetrons, power tubes, color kinescopes, traveling-wave tubes, and thermionic energy converters. He became an Engineering Leader in 1953, and Manager of the Power Tube Methods and Process Laboratory in 1959, when he was responsible for developing advanced techniques and materials for tube construction. At present he is Manager of Thermionic Converter Engineering, and has directed the thermionic-converter program since its inception. Mr. Block is a member of the IEEE, Tau Beta Pi, and Eta Kappa Nu. In 1962, he was honored with the David Sarnoff Team Award for the development of the Cermolox power-tube family.



DR. KARL G. HERNQVIST received the Ph.D. in Electrical Engineering from the Royal Institute of Technology, Stockholm, Sweden, in 1959. He worked on radar and microwave instrumentation in the Royal Swedish Air Force in 1945 and 1946. From 1946 to 1952 he was concerned with electron-tube research at the Research Institute of National Defense, Stockholm. He was an American-Scandinavian Trainee at RCA Laboratories in 1949. In 1952 he joined RCA Laboratories, where he has worked on microwave tubes, electron guns, and gas-discharge devices. In 1956 he independently conceived and reduced to practice the thermionic energy converter. He is presently a leader of a group concerned with physical electronics phenomena. In this area he is doing research on thermionic converters and gas lasers. Dr. HERNQVIST has gained an international reputation for his work. He has been the recipient of two RCA Achievement Awards for outstanding work in research. He has authored several dozen technical papers and holds 15 patents. He is a Senior Member of IEEE and a member of the American Physical Society and Sigma Xi.

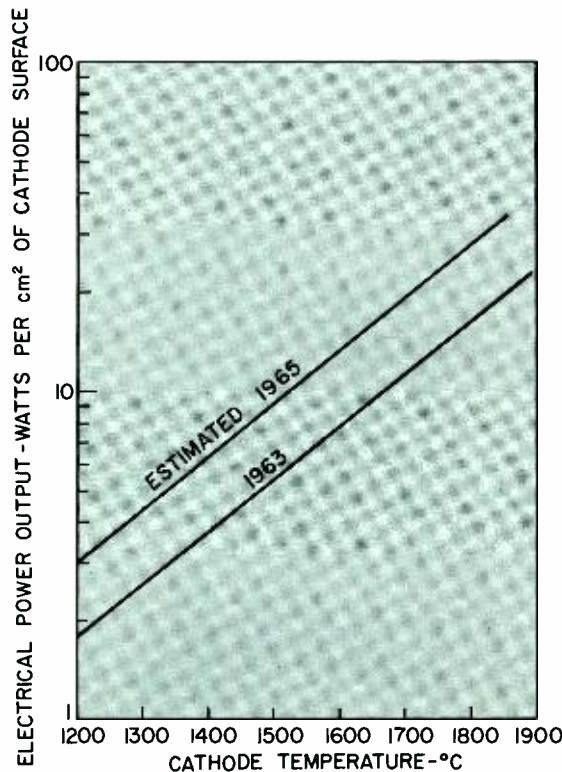

Fig. 10—Diagram showing state-of-the-art performance of thermionic converters.

walls, which ruins the cesium vapor purity. Such foreign gases may change the electrical properties of the electrode surfaces as well as the plasma.

Another problem concerns the effects on envelope integrity from outside attack, primarily on the hot heat-source side. When this side can be operated under vacuum, as in solar applications, it poses no problem. However, when a flame (gasoline or natural gas) is used, gas permeation of the hot wall and envelope corrosion pose severe problems. Considerable progress at RCA in both of these areas is making a flame-heated converter a practical reality.

PRESENT PERFORMANCE

Converters are usually evaluated on the basis of electrical power output per square centimeter of cathode area. This relationship is an appropriate basis of comparison because efficiency involves stray heat losses which depend on the size and shape of the device. The main heat losses per square centimeter are a function of temperature and can be calculated to obtain actual efficiencies from knowledge of power output. Fig. 10 shows the present and estimated future capability of thermionic converters. As shown, the power output and efficiency rise quite rapidly with temperature. This increase is to be expected because larger contact difference of potential is available at higher temperatures for the same current. In general, efficiencies in the range of 8 to 15% are now obtainable in the 1,200-to-1,500° C temperature range in practical converters and 15 to 20% in the 1,500-to-2,000° C temperature range. Tube life of several thousands of hours has already been demonstrated with a number of converters.

CONCLUSIONS

After about five years of intensive research and advanced development work, the thermionic converter stands at the threshold of practical applications, mainly in the space-power field. Components are being made and systems assembled to match the converter to heat sources of both the nuclear type and the solar type.

Converters can be made which operate efficiently at heat-source temperatures obtained from gasoline or natural-gas burners, and progress is being made in solving the problems of tube-envelope integrity in the flame environment.

The thermionic converter is inherently a very simple device which potentially could be mass-produced at a low price. Thus, it appears that the thermionic converter is a new conversion device which has a good chance of entering the competitive consumer market.

Several types of cooled infrared detectors have been developed during the last five years for special applications. Recent models incorporate cooled filters which, through reduction of background radiation, enhance detectivity over restricted wavelength intervals. Promising work by the RCA Victor Research Laboratories, Montreal, Canada, resulted in a prototype instrument, the "Spectrotor," which gives detectivities of over 10^{11} cm/watt in the 5-to-7-micron region, making use of a series of liquid-helium-cooled filters mounted on a rotating disk. This work suggests the feasibility of one extremely sensitive cooled-filter spectrometer for the whole wavelength region between 2 and 30 microns.



Dr. H. PULLAN
*Research Laboratories
 RCA Victor Company, Ltd.
 Montreal, Canada*

DR. HARRY PULLAN graduated in Physics in 1950 from the University of Oxford, having been a Litton Forbes Scholar at Wadham College. He received his D.Phil. degree in 1953 after three years of research in low-temperature physics at the Clarendon Laboratory, where he devised a new means of measuring thermal expansion by electronic means. At the end of 1953 he emigrated to Canada to take up a Postdoctorate Fellowship at the National Research Council in Ottawa. His main work there was the development of a high-vacuum Czochralski furnace, and the growth and evaluation of silicon crystals. Dr. Pullan joined the RCA Victor Research Laboratories when they opened in 1956, and designed and built much of the basic equipment in the Semiconductor Laboratory. Since 1957 he has specialized on the application of semiconductors to infrared detection, and is at present Head of the Infrared Research Group. In recent years he has delivered many lectures on scientific matters including appearances on Canadian national radio and television networks. He is a member of the Canadian Association of Physicists.

Fig. 1—Cross-section of WEIRD.

Fig. 2—Completed WEIRD unit.

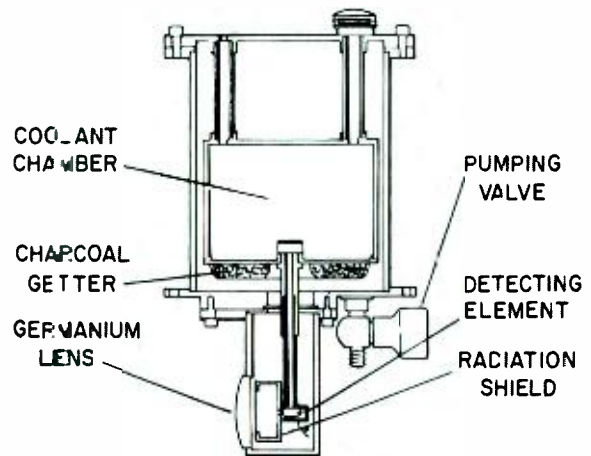

SOME RECENT DEVELOPMENTS IN HIGH-SENSITIVITY COOLED-FILTER INFRARED DETECTORS

Fig. 3—Schematic of the cooled-filter detector.

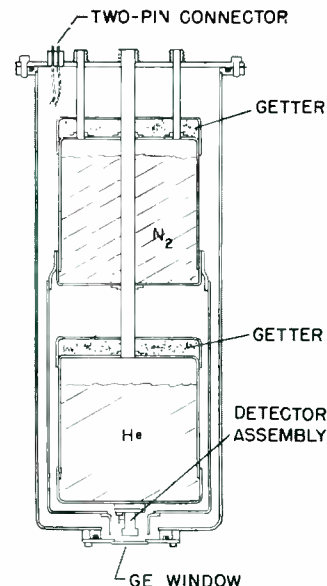

THE CLASSICAL APPROACH to infrared detection uses the heating power of the radiation to create a small temperature change in a thermopile or bolometer. Modern detectors, in contrast, sense the arrival of the quanta in the signal radiation in a direct electronic manner and therefore have a very much higher speed of response; in addition, they are usually much more sensitive. Although a given quantum detector works well only over a certain range of wavelengths, it is possible today to select an infrared quantum detector for use at any required wavelength between the visible and microwave regions.

UTILIZING THE PHOTOCONDUCTIVE EFFECT IN DOPED GERMANIUM

One of the principal lines of work performed by the Infrared Research Group of the RCA Victor Research Laboratories, Montreal, has been the application of the photoconductive effect in doped germanium to specific problems of infrared detection. Each impurity atom in doped germanium at ordinary temperatures contributes a current carrier, resulting in perhaps 10^{10} carriers per cubic centimeter. On cooling to a sufficiently low temperature, all but one in about a billion of these carriers are "frozen out", that is, return to their parent impurity atoms, resulting in very-high-resistivity material. The arrival of a stream of infrared quanta of suitable energy releases some of these bound carriers and thereby causes a small change in resistance, which can be detected by applying a steady bias current and observing the change of voltage. The beam of signal radiation is normally interrupted by a mechanical chopper wheel so that the output signal can be handled by a highly selective low-noise amplifying system.

Gold in germanium produces an acceptor level with an ionization energy of 0.15 electron-volts, which is the energy of a quantum of 9 microns wavelength. Thus radiation of wavelengths up to this value can be detected by gold-doped germanium—provided it is sufficiently cold. It turns out that a temperature of 65°K is adequately low, which is rather fortunate as this figure can readily be obtained by pumping over liquid nitrogen. In a properly assembled and treated detector the limiting sensitivity is then set by the noise in the radiation from the background viewed by the detector, which is sensed by the same mechanism as is the signal radiation; at higher temperatures, noise generated internally by thermal excitation predominates. Detectors of this type have been developed for use by CARDE (Canadian Armament Research

and Development Establishment) in balloon-borne experiments on atmospheric emission effects. They are housed in relatively large all-metal dewar vessels capable of holding enough coolant to give several hours of operation without refill. These demountable dewars require initial evacuation with only a simple mechanical pump, as the necessary high vacuum needed for dewar action is produced automatically on cooling by a molecular sieve material carried in a basket attached to the coolant chamber. Figs. 1 and 2 show WEIRD, an alternate version designed for use in the tip-tank of a jet aircraft. (The name is derived facetiously from the large germanium lens, which suggests a *Wide-Eyed Infra-Red Detector*.)

HIGH-SENSITIVITY DETECTORS AT 5 TO 7 MICRONS

As a result of the successful application of these detectors in high-altitude experiments, a requirement arose for detectors having unusually high sensitivity at a number of predetermined wavelengths in the 5-to-7-micron region of the spectrum. Since our existing detectors were already limited by radiation noise, the approach taken was the reduction of background radiation through the use of cooled narrowband infrared filters. In this way, the detectivity at the wavelength of the filter's peak would be improved at the expense of sensitivity outside the filter's pass-band. This argument assumes that the noise due to internal thermal agitation still remains negligible compared to the reduced radiation noise. For gold-doped germanium, this means that the operating temperature must be a little below 50°K, which is outside the range of pumped liquid air, leaving liquid helium as the only coolant which is both available and safe.

A new and versatile type of cryostat was developed to investigate the performance of detectors under these special conditions. With this system, a detector can be maintained at any desired temperature between 8°K and room temperature. Either of two cold filters can be swung into the path of signal radiation coming from an infrared monochromator, which is admitted through a hermetically-sealed window in the side of the cryostat. In this way, the effect of a given filter on a detector can be examined as a function of temperature; in the absence of the detector the properties of the filter itself can be studied, as the transmitted beam then emerges from the cryostat through a second window. The principal result to emerge from these studies was that although the predicted gain in detectivity

could be achieved under laboratory conditions, a minimum permissible temperature existed in addition to the expected maximum temperature. As a gold-doped germanium detector is cooled through 25°K, the output signal (but not the noise level) falls off drastically to a degree which annuls the detectivity gain available from the cooled-filter technique. This effect was unexpected and is not properly understood.

The development of a reliable and portable device which would produce an operating temperature between 50°K and 25°K simply by adding liquid helium is a formidable problem. A more practical alternative was to change the detector material to one which was already known to operate satisfactorily at liquid-helium temperatures. One such material is copper-doped germanium which, having an ionization energy of 0.04 electron-volts, makes an excellent detector for wavelengths around 24 microns. It is not normally regarded as suitable for the 6-micron region, effectively because of its broad spectral response, which makes it particularly susceptible to radiation noise from the background; however, this limitation does not apply if the detector is used in conjunction with a cooled narrowband filter. Several detectors have been developed along these lines and are now being used by CARDE. The schematic layout of the dewar housings is shown in Fig. 3; the upper container is filled with liquid nitrogen, which cools the radiation shield shrouding the liquid-helium container to which the detector element and cooled filter are attached.

A NEW INSTRUMENT — THE SPECTRATOR

Although these units meet their specifications they are of course subject to a fundamental limitation. Each detector responds only over a wavelength region of about half a micron so that the acquisition of data over a few microns of the spectrum requires several sets of separate experiments, each involving a tricky and expensive balloon flight. To overcome this limitation and yet retain the useful detectivity gain afforded by the cooled filter technique, an instrument has recently been developed, called the *Spectrator*, in which the single fixed cooled filter is replaced by a number of filters mounted on a disk which can be rotated in steps as required. The detector element, the filter disk, and its stepping motor (Fig. 4) are mounted in a gas-tight chamber which is an extension to the bottom end of the liquid-helium container, as indicated in Fig. 5. In use, this chamber contains helium gas at a low pressure which ensures

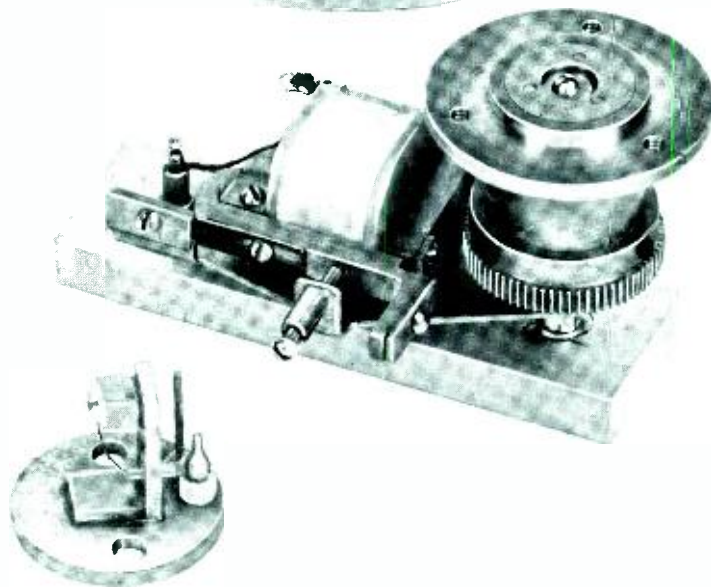
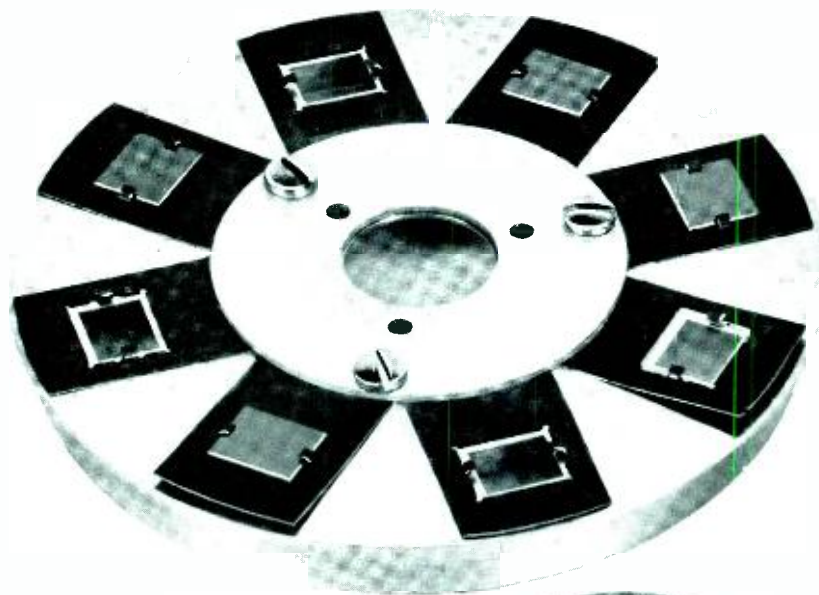

Fig. 4—Internal components of the Spectrotor, showing a mounted germanium detector, the filter wheel, and its stepping motor which here is mounted on a test jig.

that both the detector and the filter system are adequately cooled. Three potential design problems caused little difficulty in practice: these were concerned with the demountable seal for the chamber's lid, the cold infrared window which separates gas from vacuum (both of which must remain utterly leak-free despite repeated cooling), and the stepping-motor, which involves moving parts at liquid-helium temperatures.

The prototype Spectrotor performs extremely well. The detectivity available is somewhat better than that given by the fixed-filter device because of the difficulty of supplying adequate cooling in the latter case (the filter being in a high-vacuum environment). The wave-

length region of sensitivity is shifted simply by applying a series of voltage pulses to the stepping-motor, using a telephone dial. Detectivity values of 10^{11} cm/watt and more are available in the 5-to-7-micron region, corresponding to minimum detectable power levels of less than 4×10^{-12} watts. It is believed that such high detectivity has not hitherto been realized in this wavelength region. In this connection the filters used had a typical bandwidth of 0.6 microns, which is not particularly small; if narrower bandwidths were to be used, there is every reason to expect that correspondingly greater sensitivity would result. The detectivity would also improve if filters peaking at longer wavelengths were used. A logical extension

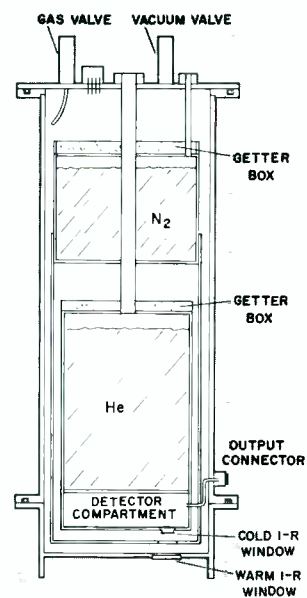
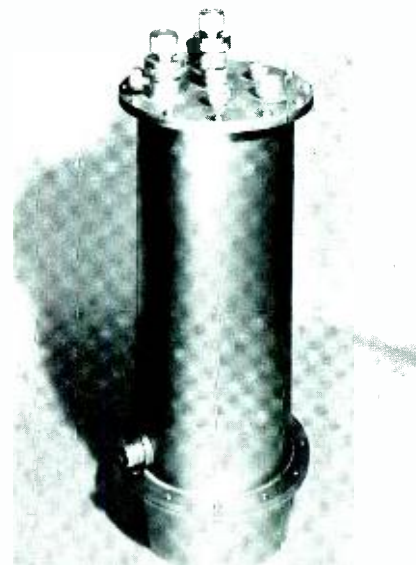

Fig. 5—Schematic of the Spectrotor.

Fig. 6—Complete Spectrotor.



of the principle, presently being considered, is the incorporation of a large number of narrowband filters having peak-transmission wavelengths which are adjacent and consecutive. The instrument would then become a portable and compact spectrometer containing its own extremely sensitive detector, capable of covering any desired wavelength region between 2 and 30 microns. Such a device should find wide use in both laboratory and field applications.

BIBLIOGRAPHY

1. Detectivity gain in Gold-doped Germanium Detectors by Spectral Filtering; *Proc. IRIS* Vol. 6, No. 3, p. 35.
2. Enhanced Detectivity in Doped Germanium Detectors by Spectral Filtering; *Proc. NATO Conference on Far Infrared Techniques*, Vol. I, p. 105 (Paris, May 1962).

DR. YAOHAN CHU received a BS in 1942 from Chiao-Tung University, an MS in 1945 and an ScD in 1953 from the Massachusetts Institute of Technology. Prior to joining RCA, Dr. Chu was Manager, Information Electronics, Research Division of Melpar, Inc. His research included microelectronic computers and logic of next-generation digital computers. He was earlier associated with Westinghouse Electric Corporation and the Ford Motor Company. At the RCA Data Systems Center, Dr. Chu is responsible for computer implementation

aspects of advanced data system design and establishes the functions and requirements which are to be implemented by future or new classes of data processors. Dr. Chu has also taught courses since 1953 and is currently Lecturer, Department, EE University of Maryland. Dr. Chu is the author of "Digital Computer Design Fundamentals", McGraw-Hill Book Company, October 1962, and has written numerous technical papers. Dr. Chu is a senior member of the IEEE and a member of the ACM and of Sigma Xi.



COMPUTER TECHNOLOGY PROGNOSIS ... 1970 AND BEYOND

Digital computers of today have a logic structure similar to that conceived by von Neumann (and others) about 18 years ago. Some users are satisfied with the computer's flexibility while others are not because complex logic must be programmed in detail from simple arithmetic and simple logic. Three great assets of today's computers are: stored-program logic, high speed, and a hierarchy of large memories. However, today's computers require a large effort in programming for effective use, and ordinarily do not learn from experience. What kinds of computers are we going to have in 1970 and beyond whose characteristics may offset these limitations? This paper explores answers to this question, based on an early-1963 view of the field.

Dr. Y. CHU

Data Systems Center, Bethesda, Maryland

THE PROGNOSIS on technical developments such as computer technology seven years or more from now is risky because of unforeseen inventions and breakthroughs. Nevertheless, from current research status and future needs, one may speculate the following:

- 1) Cost will go down while reliability will go up. Its effect on the future spread of computer usage will be far reaching.
- 2) Computers will become smaller in size and weight and consume less power as a result of using microelectric and cryogenic circuits. The gigacycle computer may emerge.
- 3) Computers will be built for efficiency of computer users as well as efficiency of computer usage.
- 4) Computers will be built with an aim toward a great reduction in programming effort, hopefully a tenfold reduction. This task will be a challenging undertaking.
- 5) Computers will be built so that more people can use them and use them directly, hopefully a tenfold increase. This goal should be achieved not merely by building more of them, but also by using better machine organization such as time-sharing computers.
- 6) Computers will be built with a greater processing capability.

One prominent trend is to use a multicomputer organization whereby the computer is built from modules such as memory modules and processor modules. Million-word random-access memories, billion-character mass memories, and associative memories with a significant capacity will be available. Read-only memories may receive a wider usage. Real time capability will become commonplace.

- 7) A central, or master, control will become *the brain* of the "brain." The central control assigns routines to various modules, allocates memories, initiates data transfers among a hierarchy of memory modules, carries out interruptions, and provides a gradual degradation when one or more modules malfunction.
- 8) There will be a great increase in the development and application of computers for information storage and retrieval, language processing, pattern recognition, image processing, management control systems, and command and control systems.
- 9) More and better character readers will come, and speech recognizers will emerge. The dream of reading unrestricted character

fonts and handwritings and recognizing conversational speech may become true.

- 10) Remotely connected data systems with one or more centralized computers will be numerous. Data communication may be a larger activity than data processing.
- 11) Copying the human being may become more successful than at present. Computers or intelligent machines may be used to perform tasks of judgment or proof for theorems which may surpass those of man, and robot-like machines might have both muscle and brain power.

These and other speculations are evolved or extrapolated from current research status and future needs. Some rationales are presented below.

MILLION-WORD

RANDOM-ACCESS MEMORY

The need for a larger random-access memory has been ever increasing. When von Neumann first conceived the stored-program computer, it was estimated that 1,000 words of memory capacity would be sufficient; but in anticipating unforeseen needs a 4,000-word memory was chosen. Today, a fairly complex system already requires a few hundred thousand instructions. It is quite conceivable by 1970 a random-access memory with a capacity of a million words will be needed.

A possible future of location-addressed (conventional) memories for magnetic elements, tunnel diodes, and superconductive elements has recently been analyzed by J. A. Rajchman.¹ The conclusions (with slight modification) are:

- 1) Present ferrite-core technology has achieved capacities of a few million bits (and over 10 million bits will be soon available) and cycle time as short as 0.8 μ sec.
- 2) Extension of magnetic technology to faster memories is likely to be limited. The limit, which depends on the number of words, is about 100 nsec for about 64,000 words. Ferrite and thin-film technologies may be pushed into this limit. Both present engineering difficulties, which are perhaps more severe with thin film.

- 3) Extension of magnetic memories to larger capacities depends on economic factors. Substantial extension requires batch-fabrication techniques for both magnetic elements and semiconductor circuitry. Greater advance must be made in semiconductor batch-fabrication to make this a real possibility.
- 4) Tunnel-diode memories may extend computer speed beyond the limit of magnetic memories by a factor of 10 and provide capacity of several thousand words.
- 5) Superconductive thin-film technology (and particularly the continuous sheet superconductive memory) offers the possibility of a very large capacity memory because of its ideal storage and switching characteristics combined with batch-fabrication technique and high packing density.
- 6) Fig. 1 indicates the possible limits of speed and storage capacity of magnetic, tunnel-diode, and superconductive memories and summarizes the above statements.

It is seen in Fig. 1 that a million-word (say, 64 bits per word) random-access memory will most likely be a superconductive memory. Since superconductive technique is also suitable for logic circuits, one would predict that a cryogenic computer is the best hope at present, when need for a million-word random-access memory does arise. The feasibility and practicability of a cryogenic computer will be discussed later.

TEN-BILLION-CHARACTER MASS MEMORY

Mass memory here refers to a memory with a capacity of 50 million characters (say, 8 bits per character) or more. Magnetic tape memory is a sequential-access mass memory, while magnetic disc or drum or cards is generally regarded as a random-access mass memory.

Mass memory has become an essential unit in a computer installation. Since the advent of random-access mass memory, which has an access time of a fraction of a second, real time (or quasi real time) data systems have emerged. Random-access memory is often used as a data file from which information is retrieved or in which information is updated. A typical random-access mass memory today has a capacity of 50 million characters. Applications where several random-access mass memories are employed already exist.

It is likely that before 1970 the capacity of 10 billion characters for a single random-access mass memory will be available. The access time of such a memory will be improved. The hope

for such mass memories at present lies in the use of high-density storage media. Some promising media are now described.

HIGH-DENSITY STORAGE MEDIA

Photographic Medium

The photographic medium of silver halides is well known; it is nonerasable. Although a density of 25,000 lines/inch (1,000 lines/mm) is feasible, a more reasonable limit would be 10,000 lines/inch because of film imperfection. With additional limitations on light source, lens systems, and light detectors, a density of about 3,000,000 bits/square inch has been achieved. Because of the nonerasable nature of this medium, it is limited to read-only memories.

Magnetic Medium

Because of its erasability, the magnetic medium has been the most favored for use in digital memories. For magnetic tape, a longitudinal bit density of 1,500 bits/inch and an area density of 24,000 bits/square inch have already been achieved with a transfer rate of about 200,000 bits/sec per channel. The practical limit on storage density has been estimated at 20 channels with a longitudinal density of 2,000 bits/inch and an area density of 40,000 bits/square inch, and the practical limit on writing and reading is at 300,000 and 400,000 bits/inch per channel, respectively. The capacity of a magnetic tape memory also depends on the tape transport.

The heads in a magnetic disc or drum memory do not contact the storage medium; this results in a higher surface speed but lower longitudinal density than those in magnetic tape memory. Since the advent of the air-floated head, the head-to-surface spacing approaches 2.5×10^{-6} inches; this brings about a large increase in bit density. At present, the storage density is comparable to a magnetic tape density of 30,000 bits/inch. It is estimated that in the future longitudinal density of 2,500 bits/inch and 100 tracks/inch, or a density of 250,000 bits/square inch may be achieved. The ultimate limit of the magnetic medium may be 1 million bits/inch.

Thermoplastic Medium

The thermoplastic medium is erasable. In the form of tape, it consists of a high-melting-point base film coated with a transparent conductor which has a thin film of a low-melting-point thermoplastic on its surface. The stored information is a charge pattern on the surface of the thermoplastic film created by means of an electron beam. The film is then heated to the melting point of the thermoplastic. Electrostatic forces between the charges on the film and the ground plane depresses the surface where the charges occur until these forces are in equilibrium with the surface tension restoring forces. The film is then cooled, and the deformations are fixed into the surface. To erase the film, the charge pattern must be discharged by heating the film well above its melting point so that its conductivity will increase. The tape, electron gun, and the tape transport are all in an evacuated space at a pressure of about 10^{-7} mm-Hg. The reading is done optically. Both black-and-white and color are possible. It is claimed that the storage density can be 100 times better than that of magnetic tape.

Photochromic Medium

Photochromic media are light-sensitive dyes. The storage may be a glass or plastic surface coated with a uniform thin film of transparent minute capsules containing a suitable photochromic dye in solution. To write, the surface is scanned by a discrete light beam of proper wave length to produce the stable colored state. To erase, the surface is scanned by a second discrete light beam of appropriate wave length to return the dye to its stable colorless form. To read, the surface is scanned by a third light beam which causes only negligible writing or erasing. The reading may be accomplished by reflection or by transmission reading.

Both photochromic and thermoplastic media have the advantages of the high storage density of the photographic medium and the erasability of the magnetic medium.

Two Operational Factors—Access and Cost

If we assume that each character consists of 8 bits, then 10 billion characters mean 80 billion bits. Table I shows the minimum amount of high storage areas for several densities. The difficulties of such high-density mass memories are: uniformity and homogeneity of the storage surface and the means of access. Random-access of ten billion characters is too costly, therefore the use of some sort of sequential access appears unavoidable. No new and better technique for access has so far been found.

Fig. 1—Memory speed and storage limits.

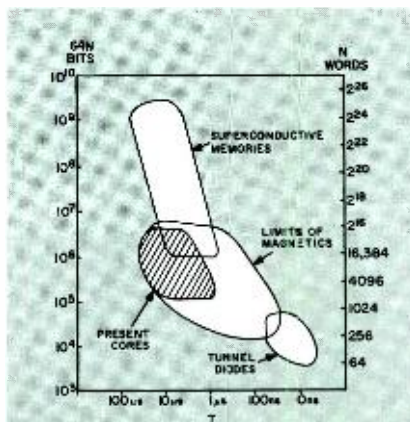

TABLE I—High-Density Storage Areas for 10 Billion Characters

<i>Density bits/square inch</i>	<i>Storage area square inches</i>	<i>Possible medium</i>
0.25×10^8	320,000	magnetic
10^8	80,000	photographic, at present
10^7	8,000	thermoplastic or photochromic
10^8	800	photographic, in future

One major consideration of a mass memory is its economic feasibility. The cost per bit of today's mass memories ranges from 0.1¢ to 0.01¢. The cost for 10-billion-character mass memory should be less than 0.001¢/character. To accomplish such a low cost requires an ingenious way of gaining access to hundreds of thousands of square inches of high-density storage surface.

TEN-FOLD REDUCTION IN PROGRAMMING EFFORT

Contemporary computers have rather limited built-in capability aside from very high speed. They recognize only numbers or at best characters. They are capable of performing only simple arithmetic tasks and making simple logic decisions. The necessity to instruct step by step in minute detail has resulted in the profession of programming.

One could argue that the advent of compilers and other aids has greatly reduced the need for programmers. But the compilers and other aids still have to be written. Due to the existence of many problem oriented languages (more are coming) such as FORTRAN, COBOL, ALGOL, etc., many compilers must be written and there have been attempts to write programs for translation of one language to another. Apparently, the solution to the problem of programming cannot and should not be coped with by programming alone; a more sophisticated machine has to be built. Computer designers with such a viewpoint are increasing in number.

More and faster computers will be built and installed for use in this decade. Programmers are needed to write the programs and programming systems. It appears that the need for more programmers will outstrip the reduction on programming effort by programming methods. On top of this, more applications of digital computers are forthcoming. One may speculate that the growth of the computer industry may be limited by the availability of programmers. For these reasons, a ten-fold reduction in programming effort should be established as a goal for the coming ten years.

It is uncertain whether a ten-fold reduction of programming effort can be achieved in the 1970 era, unless a positive effort is instituted to find a solution. Two possible directions are: more

built-in logic and the use of associative memory. The cost of logic has been gradually decreasing and will continue to decrease. The advent of integrated circuit technology will have a pronounced effect. More built-in logic can then be afforded. If additional logic can be effectively incorporated, programming effort can be reduced.

Associative memory is one where the retrieval of a word or words is done by using content of a stored word; this makes it possible to eliminate addressing by numbers. Associative memory is built in with parallel search logic and can handle symbols as conveniently as numbers. The use of associative memory can thus simplify the handling of symbols, from which the human language is formed. The direct use of human language, even a subset of the language, can reduce the programming effort.

TEN-FOLD INCREASE IN USAGE

Great strides in computer usage have been made during the last decade. Although a wider usage of computers is evolving, a dilemma exists in that many individual users or small companies cannot afford to obtain direct access to a computer installation. A common solution is to rent computer time. However, the problem of program debugging and turn-around time often frustrates the users, because the computer has to be operated efficiently. In some cases, a direct interaction between the user and the computer is highly desirable if not absolutely required. In the future, more low-cost computers will be built and in addition the idea of the time-shared computer offers another possible solution.

A time-shared computer is one which interacts with many simultaneous users through a number of remote consoles. The idea of time sharing is not new, as arithmetic and control operations in many computers of today are time-shared with their peripheral equipment to improve hardware efficiency. The major difference lies in the fact that a time-shared computer achieves time efficiency for the user (as well as hardware efficiency) and the ability of sharing the computer among many users on a real time basis. This idea of the time-shared computer was first introduced at M.I.T. to cope with the programming-

debugging dilemma (machine efficiency vs users' efficiency).

When such a time-shared computer becomes available, the program debugging waiting can be largely eliminated. If such a computer is made available to a school, the computer can be turned into a giant teaching machine. If made available to a research and development organization, each scientist can directly interact with the computer so that the computer may be used as an extension of his memory and logic capability. Management decisions could be tested by the manager himself directly on the computer. This would in turn justify a larger computer and then more users. Predictions have been made that computer time could become a public utility.

MICROELECTRONIC TECHNIQUE

By microelectronics, we mean techniques by which circuits become minute in size. Several alternative names are integrated circuits, microcircuits, molecular circuits, thin-film circuits, etc. Microelectronics is a major and promising step in the evolution of miniaturization.

Microelectronic Capabilities

Two widely used techniques of today's microelectronics are: thin-film technique and single-crystal technique. In the thin-film technique, layers of thin films of metals, oxides, and other materials are vacuum deposited to make electronic components. This technique has been the most favorable way to make passive elements such as conductors, resistors, and capacitors. Recent success at RCA Laboratories in demonstrating thin-film transistors has shown the feasibility of making both active and passive elements by the thin-film technique. The single-crystal technique employs a silicon wafer on which processes such as alloying, diffusion, and etching are performed. This technique is adaptable to making elements such as bipolar transistors, unipolar transistors and diodes, to a lesser extent resistors, and to a still lesser extent conductors and capacitors. In either single-crystal or thin-film technique, it is difficult to make inductors. In both techniques, the outstanding problem is the circuit uniformity and reproducibility which affects the yield of the fabricating process. At present, microelectronic circuits involving only a relatively few components can be made with a practical yield.

It should be added that both cryogenic circuits and electroluminescent-photoconductor circuits make use of thin-film technique; thus, they are microelectronic circuits and inherit the uniformity and reproducibility problem. Electroluminescent-photoconductor circuits are slow at present; cryogenic circuits will be discussed subsequently.

The packing density of microelectronic circuits has been forecast to range from 10^5 to 10^9 parts (or components) per cubic foot. The wide range of the packing density is due to many factors such as the use of a particular technique, the method of interconnection, and the possible need of cooling. Circuits with such a density are already too small to be handled and therefore will be small enough for most applications for years to come including the applications in space.

The immediate use of microelectronic circuits now is to increase circuit reliability by possible reduction of ordinary interconnection or by redundancy. Each microelectronic circuit can be made to perform one function; a derived merit is that a more complex electronic system may in turn become feasible or practical. Other advantages are reduction in size, weight, and possibly power. An ultimate goal would be reduction in cost.

Microelectronic Computer

Because of the use of a large number of relatively few circuits, digital computers will be one of the earliest applications of microelectronics. Besides the problem of yield in fabricating microelectronic circuits, there are a number of problems that are related to such an application. We will discuss three of these problems.

The first problem is concerned with interconnections of the large number of microelectronic circuits required in a digital computer. Experimental models of microelectronic computers have been built with limited speed and word length. In these computers, a logic circuit (say, a nor circuit) is replaced by a solid state circuit. Since the number of interconnections can hardly be much reduced replacement of a malfunctioning solid state circuit is difficult. A new approach is to recognize the fact that in a microelectronic circuit each conductor is a component just as a diode or a resistor is. Philosophy in logic design should be changed so that minimization of circuits is not as important as before.

The second problem is the random-access memory. While the size of logic circuits can be greatly reduced, the reduction in size of random-access memory has been less successful. Since the random-access memory amounts to a very significant portion of computer hardware, the merit that can be achieved by microelectronics thus becomes limited. One possibility is to use a microelectronic transistor memory to replace a magnetic core memory. However, unless the most of microelectronic circuits can be immensely reduced in the future, a microelectronic transistor memory with a large capacity is not practical. Some tradeoffs would be: to build in

more logic capability, to organize a machine so that small-capacity microelectronic memories can be effectively used, and to use microelectronic read-only memories.

The third problem is concerned with speed. A microelectronic circuit, as it stands now, cannot have a speed as high as a circuit built by assembling individual components because, in the latter case, the best components can be chosen for use. If the speed of microelectronic circuits can be made high enough, the need for extremely fast circuits will be limited to a relatively few applications.

Despite these problems, the microelectronic computer is definitely forthcoming. After reliability is proved, it will first be used in applications where the increase of reliability and the reduction of size and weight and power is important. However, wide-spread use of microelectronic circuits requires a cost advantage. By the 1970 era, microelectronic circuits will be as wide-spread in use as transistor circuits today.

CRYOGENIC TECHNIQUE

Superconductivity (loss of electrical resistance by some metals and alloys at near absolute-zero temperatures) was first observed about 50 years ago. The late D. A. Buck in 1954, described a superconductive switching element, called the cryotron. Early cryotrons were wire-wound; today, a thin film technique (batch fabrication by a vacuum deposition process) is being used. The exploitation of cryotrons as logic circuits and memory elements has been pursued by many laboratories. One of the most attractive features of the superconductive technique is that it can be used equally well for logic elements and memory elements.

The phenomenon that resistivity of superconductors is truly zero below the so-called transition temperature was demonstrated in an experiment by Prof. S. C. Collins of M.I.T. A persistent current of several hundred amperes was induced in a lead ring immersed in liquid helium on March 16, 1954, and the current continued to flow until the experiment was voluntarily terminated on September 11, 1956. This phenomenon of persistent current (or trapped flux) has been utilized in several ways (persistor, persistatron) to make cryogenic memory elements.

More recently, other cryogenic devices have been found: tunneltron, cryosar, and cryosistor. If a very thin insulating layer (about 30 angstroms thick) is interposed between two different metal superconducting films (aluminum-aluminum oxide-lead), the resulting sandwich exhibits a negative resistance region; this device is called a tunnel-

tron. When neither metal is superconducting, the sandwich can be used as a resistor or capacitor. When one metal is normal and the other superconducting, the sandwich can duplicate the functions of a diode, and can behave as a triode if external control elements are added.

The cryosar, a two-terminal cryogenic switching device, consists of a thin wafer of doped germanium with ohmic contacts on opposite faces. There are two types; in one type, where the impurities such as indium are not compensated, there are two distinct regions: one of high and the other of low resistance. In the other type where the indium impurities are compensated for by antimony impurities, a negative resistance characteristic is exhibited which makes it possible to set the device into one of two stable states. Cryosistor, a three-terminal device, consists also of a thin wafer of germanium with two ohmic contacts and an indium-alloyed p-n junction. It exhibits a negative resistance region between the high- and low-resistance regions at cryogenic temperatures. Both cryosar and cryosistor are cryogenic, but not superconductive.

Superconductive Memory

Two promising superconductive memories are the one using an apertured sheet and that using a continuous superconductive sheet. The continuous sheet memory is briefly described since it appears to be simpler, more compact, reproducible, and requires a smaller driving current. In this memory, two families of orthogonal and parallel lead strips (*X* and *Y* strips) which are properly insulated are evaporated on top of a continuous film of tin. When an *X* and *Y* strip carry a current, the resulting magnetic field pattern at their intersection is at 45° with respect to the strips. The intensity is maximum at the intersection and diminishes gradually with distance. This is a boundary within which the field exceeds the critical value and outside of which it does not. The persistence current flows in a figure-eight pattern, and the two regions have been found to be stable. Cryotrons can be used for the selection tree. For a reasonably large storage capacity, a memory cycle time of less than $1 \mu\text{sec}$ is not likely if superconducting technique alone is used.

The RCA Laboratories, Princeton, is building a superconductive random-access memory using continuous superconductive sheets for a significantly large capacity.

Cryogenic Computer

Progress in cryogenics during recent years has made the cryogenic computer attractive. First, the cryotron is a close-

to-ideal switching device, and its logic and circuit design becomes quite simple. Thin-film cryotron logic circuits are integrated circuits and consume little power. Second, superconductive techniques for memory applications are also close to ideal: persistent current in storage form consumes no power, there are sharp switching thresholds, shields against unwanted signals are almost perfect, switching time of the memory cell itself is of several nanoseconds, and memory cell density can be of 10,000 cells per square inch. Third, the same thin film fabricating technique can be used to make both switching and storage elements equally well. This particular advantage makes the cryogenic technique the prime candidate at present for high-speed associative memory with a reasonably large capacity.

On the other hand, the superconductive technique at present depends heavily on the success of thin film fabrication techniques. The solution of the uniformity and reproducibility problem requires elaborate control of the evaporation process and further understanding of the behavior of thin film superconductors. It also depends on the availability of cryostats at a reasonable price, at a cooling capacity of about 3 watts, and at a temperature of about 3° K. In addition, there are problems of servicing superconductive circuits in the cryostat and matching of circuits inside and outside of the cryostat.

Should the above difficulties be overcome and the advantages realized, the first cryogenic computer could arrive before 1970. It may be that 1970 will be the era of cryogenic computers.

GIGACYCLE COMPUTER

A gigacycle (billion cycles per second) computer is one where the clock pulse period is of the order of 1 nsec. In 1 nsec, light travels about 1 foot. For a gigacycle computer, it is generally agreed that a logic level may have a propagation time of about 1/5 nsec, and memory cycle time of about 10 nsec.

Why An Ultra-High-Speed Computer?

The progress of computer technology has shown that when a computer operates faster, the cost per computation becomes lower. This situation has some sort of limit beyond which it does not hold. At present, the cost for a gigacycle computer is prohibitive, and the additional programming effort is tremendous if the computer is to be efficiently operated. On the other hand, an alternate choice is to use more than one computer or to use a multi-computer system. However, there are few applications where the need of such speed is required.

Research for an ultra-high-speed computer was sponsored by the U. S. Navy for a special application. This research effort, in which RCA was a participant, was a five-year effort, beginning in 1957. Several undertakings in the project were ultra-high-speed transistor logic, microwave logic, cryogenic logic and memory, tunnel-diode logic and memory, and magnetic thin-film memory. The last three have shown significant promise. The recent invention of the laser may bring about another possibility. In any case, the fabrication of a gigacycle computer today is far from reach.

Tunnel Diode Computer

Tunnel diodes with a switching time as short as 0.05 nsec have been built, but the difficulties encountered in using them for computer circuits are many: the tunnel diode is a two-terminal device and has a wide parameter tolerance; wiring delays become significant; a great increase in signal waveform distortion and crosstalk takes place; a very low impedance power supply is essential; the effect of common ground paths; the problem of line terminations; the distributive effect of interconnections, etc.

The tunnel diode exhibits negative resistance; thus, it can be used as a binary storage device. For use in logic, the diode acts as a threshold with resistors or backward diodes in performing majority logic. For use in memory, the diodes are fast enough and integrated technology can be applied. Unlike magnetic memory, DC holding power is needed. Each tunnel diode memory cell is more complex than a magnetic memory cell. However, the tunnel diode offers at present the best and possibly the only solution to a 10-nsec random-access memory. RCA has built a 71-tunnel-diode logic network and a 64-bit memory plane with a 100-nsec cycle.

At present, the most promising candidate for a gigacycle computer is a tunnel diode computer. Should integrated technology be applied to the tunnel diode computer, the highly probable success of microelectronics would possibly make the tunnel-diode computer emerge as the first gigacycle computer.

COMMUNICATION WITH THE COMPUTER

Many devices are already available for one to communicate with the computer; keyboards, paper tape equipment, punch card equipment, magnetic tape units, displays, printers, and the like. Some devices are also available for remote communication with the computer. However, computers cannot understand the talking and writing of men, and remote communication with the computer is in its early stages.

Eyes and Ears for the Computer

Character (printed or handwritten) reading and speech recognition is the classification of a set of patterns or sounds into different categories; the former is spatial, while the latter is in time. Two approaches are: template matching and property-list matching. Template matching is well adapted to known fonts; property-list matching may ease the problem of variability. A crucial aspect of the recognition problem is the selection of suitable features of the words to be read or heard, and the subsequent formulation of recognition logic. Some researchers look into the generating mechanisms of speech and handwriting for discovering constraints and thus confining the range of choices. For example, in speech recognition, studies of vocal tract acoustics and speech synthesis have established the vocal resonances as central features.

Recognition can be improved by using context. For example, grammar and language can reveal how words and phonemes are contrived to make phrases, clauses, and sentences. Recognition may also be supplemented by using learning or adapting technique where correct recognition is reinforced.

Efforts to mechanize character reading and speech recognition have been greatly accelerated in recent years. Automatic reading of printed characters (or handprinting from careful writers) can now be achieved if the task is suitably delimited. Isolated spoken words taken from a small number of talkers and a limited vocabulary can be automatically recognized with a reasonable rejection rate. Reading unrestricted fonts and handwritings and recognizing conversational speech is beyond reach at present.

In the years to come, more practical recognizing devices will emerge, and studies of human perception and sensory mechanisms hold promise.

Teleprocessing

Teleprocessing means remote (data) processing in the same sense that telegraphy, telephony, telemetry, or teletype means remote communications. Remote processing requires digital communication. Digital communication as it now exists may be divided into the following three categories:

- 1) off-line communication between remotely located peripheral devices.
- 2) on-line communication between many remotely located peripheral devices and a central computer,
- 3) on-line communication between computers.

Examples of the first category now in existence are: teletypewriter network, punch card to punch card, and magnetic tape to magnetic tape. Examples of the second category are a number of real

time remote data gathering systems, remote data distribution systems, and remote control systems. There are but a few examples of the third category except some experimental setups.

The major problem in digital communication is the lack of redundancy in the data to be transmitted. Therefore, some means has to be provided to overcome the transmission difficulties. Much analytical work has been done on error control or error correction, but application of this work has often been found uneconomical.

The majority of today's digital communication is now carried on teletypewriter networks. Recent improvements are new modulation techniques, higher transmission rates, and more effective error control schemes. There does not appear to be much technical difficulty in building teleprocessing computer systems (for current computers), but the work toward a truly automatic central teleprocessing system has been slow. A number of applications for such central teleprocessing systems (either in completion or in development) are: reservation systems, centralized banking, central inventory control, air traffic control, and above all, military systems including command and control systems. Teleprocessing data systems offer great promise in the era of 1970; most of the problems would be practical rather than technical.

COPYING THE HUMAN

How does the human brain work? This problem has long baffled scientists. While progress has been made, much of it has related to either the electrochemical operation of individual nerve cells or to finding which areas of the brain are concerned with various functions. Within the areas, the method of operation is still very obscure.

With the advent of computers, this problem is now being attacked from other approaches. One approach is to make the computer undertake more intelligent tasks; this is so-called *artificial intelligence*. Another approach is to imitate neurons and to build simulated neuron networks to perform some tasks being done by the human brain; this approach belongs to the so-called *bionics* field.

Artificial Intelligence

The field of artificial intelligence is young. Some milestones can be mentioned. Samuel wrote a program that can make a computer play checkers. This game is complicated enough to be interesting and has definite goals and rules of play; but the strategy is such that no one can be sure of winning every game. This checker-playing program is able to learn in two different ways: rote memorization and experience generalization.

The learning by generalization uses a set of routines which evaluate various features of board position and determine what moves should be made. Learning occurs when the program is asked to adjust the choice of these routines. There is a "scoring polynomial" (used to pickup moves) whose terms can be upgraded or downgraded by learning.

A program to play chess (which is more complex than checkers) has been written by Bernstein and others. The program was written with looking ahead of no more than four half-moves, but it can play an interesting game. Newell, Shaw, and Simon have also designed a chess program; so far, it has not beaten anyone. Nevertheless, such programs have shown that, in a certain sense, a computer can do more than it is told.

Newell, Shaw, and Simon have also developed a program to prove theorems in elementary symbolic logic by using so-called heuristic programming. Heuristic programming is a cut-and-try approach in which an attempt is made to provide the problem-solver with hints (generated by the program) along the way so that only the most promising avenues are explored. This approach, of working backwards from the desired result and asking whether the problem-solver is obtaining success or not, is the heart of many of the problem-solving computer programs now being studied. Hao Wang has achieved a more impressive result on theorem proving. Recently, he has made an IBM 704 prove all theorems (over 350) of the first ten chapters of *Principia Mathematica* (written by Whitehead and Russell) in 9 minutes. Wang emphasizes the use of mathematical logic and suggests developing "inferential analysis" as a sister discipline of numerical analysis. H. Gelernter has developed a theorem-proving program to find proofs in plane geometry. He also employed heuristic reasoning.

With these successes, can one answer the question, "*Can a machine think?*" No answer is offered here. It all depends on what one means by thinking.

Bionics

Bionics is defined by Steele as the science of systems which function, after the manner of, or in a manner characteristic of or resembling living systems. Other names are self-organizing system, adaptive system, etc. Although they are not exactly the same, they are, to various extents, attempts to copy human learning or that of other living organisms.

Two directions have been pursued. One direction attempts to learn more about how the human brain and sense organs work. The other direction tries to imitate, simulate, or duplicate them. In the end, we hope to make artificial

brain, artificial nose, artificial eye, artificial ear, and artificial touch sensors.

An example of the first direction is a study of the frog's eye. When the eye is stimulated, electrical impulses emanate from it to the visual area of the brain where the image is formed. It has been shown that five kinds of impulses are sent to the brain over five different kinds of nerve fibers. Some carry color, others shape, others size, etc. All must be coordinated in the final image before the frog really sees anything. Sense of smell is also being studied. Electrodes are being used to record, from single cells in the frog's nose, the animal's response to different chemical stimuli. Skin originated sensation is being investigated by studying the fifth pair of cranial nerves of the cat whose face is stimulated. The central nervous system is also being studied to determine how various sensory systems are interconnected.

In the second direction, most work is in simulated neurons (such as artron, neuristor) and simulated neuron networks by using electronics (such as the perceptron). Each simulated neuron requires many active and passive elements, and it will be costly to simulate thousands of neurons to form a neuron network. Therefore, the property of a random interconnection of many artificial neurons is studied either by mathematical analysis or by simulation on a digital computer. Although the exact model of a neuron is not known, simple networks of electronic neurons possess a very limited capability of learning or adaptation. An electronic model of the frog retina has been built at DEP Applied Research which simulates many visual properties of the frog. It is hoped that these two directions will gradually merge.

Although no satisfactory model in copying the human has been conceived, a very limited success has been achieved. It is a long term research subject with a possible payoff in the uncertain future. Besides, a significant number of people are interested and involved and the stake is high. It is quite possible that at one end the use of artificial intelligence might become a useful research tool to aid in discovering and proving new mathematical theorems, and artificial neuron networks and artificial organs might be usable in a number of applications. At the other end, computers might be used to perform tasks of judgment which may surpass those of man, and robot-like machines might have both muscle and brain power. But one thing is certain: *a thinking man cannot yet be replaced.*

BIBLIOGRAPHY

1. J. A. Rajchman, "Computer Memories—Possible Future Developments" *RCA Review*, June 1962.



Fig. 1—Radiation hot cell for remote-controlled manipulation of high-level radiation sources. The window is 3 feet thick and is made of a radiation-resistant glass.

USES OF RADIOISOTOPES IN THE SEMICONDUCTOR FIELD AT RCA

A literature survey of radioisotope applications in the semiconductor field is presented and essential properties of radioactive isotopes are briefly reviewed. New techniques and typical results are discussed for determining the distribution of components in columns and ingots, for solving problems of device etching and rinsing and the study of semiconductor surface contamination. The principle of neutron activation analysis is illustrated by discussion of a problem concerning the transfer of impurities from quartz crucibles to gallium arsenide crystals during synthesis. Reference is made to impurity-gettering studies of glasses and the extension of radioisotope applications to other areas of importance in device technology.

W. KERN

Electronic Components and Devices, Somerville, N. J.

IN THE SEMICONDUCTOR INDUSTRY, radioactive isotopes are used almost exclusively in applied research and technology. An exception in device manufacturing is the use of krypton-85 for leak-detection testing of encapsulated transistors. A unique application was reported for preparing uniform-resistivity n-type silicon by nuclear transmutation of silicon into phosphorus by thermal neutron capture in a nuclear reactor¹. The availability of suitable semiconductor materials and powerful radioisotope radiation sources has led to the development of radioisotope-fueled thermoelectric generators for use as power sources in remote locations.²

In applied research and analysis, the most common application of radioisotopes is in solid-diffusion measurements. Typical examples for germanium³, silicon⁴, and compound semiconductors⁵ are listed in the references. Radiotracer techniques are indispensable in self-

diffusion studies⁵ where no other practical method of analysis exists. Neutron-activation analyses of trace impurities in semiconductors have been described for germanium⁷, silicon⁸, and semiconductor materials in general⁹. Radioactivation by deuteron bombardment can be used for determining submicrogram quantities of boron in silicon¹⁰. A pictorial report of activation analysis and tracer studies in electronics research was published in 1953¹¹. Radioisotopes are powerful tools in the investigation of semiconductor-surface phenomena, but surprisingly few papers have been published^{12,13}. Other applications in the semiconductor field concern electrochemical studies¹⁴, correlation of electrical measurements¹⁵, vapor-transport phenomena¹⁶, and examination of electronic components and materials¹⁷.

PROPERTIES OF RADIOACTIVE ISOTOPES

Two essential features make radioisotopes so invaluable in tracer applications and radiochemical analyses: 1)

the characteristic radiation they emit as a result of their nuclear disintegration, and 2) the chemical properties which are not measurably different from those of the stable element under identical conditions. A radioactive isotope of an element can therefore be utilized validly as a tracer for that element. Furthermore, because the radioactivity associated with an isotope is independent of nonradioactive atoms present, a radiotracer has a unique specificity. This property makes it possible to follow directly the changes of reactions involving atoms or molecules of the same species, such as self-diffusion or ionic exchange between a metal and its ions in solution.

The emitted radiations differ in type, energy, and rate of emission. As a rule, radioactive isotopes which are heavier than their stable isotopes disintegrate by emitting beta radiation to the element of next higher nuclear charge. Radioisotopes which are lighter than their stable isotopes can decay by alpha-particle emission or orbital electron capture accompanied by the emission of specific x-rays. Most frequently, however, this type of isotope disintegrates by positron (positive electron) emission to the element of next lower nuclear charge. If the emitted positron has sufficient energy, it interacts with an electron and the mass energy of each is converted to a quantum of electromagnetic radiation known as annihilation radiation. The product or "daughter nucleus" from any of these transformation processes may have an excess of energy which causes instability. The nucleus dissipates the excess energy in the form of electromagnetic radiation known as gamma radiation, or by internal conversion involving the ejection of an orbital electron accom-

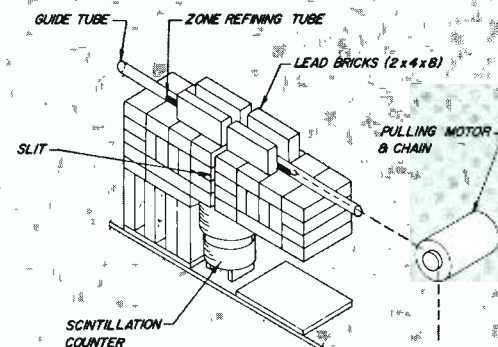

Fig. 2—Apparatus for radioactivity measurements of columns or ingots.

panied by x-radiation. Because the disintegration of a radioactive nucleus is a random event, it may be treated by statistical methods; the probability is called the decay constant. The rate of disintegration, or activity, is usually measured in curies. One curie is defined as the quantity of any radioactive substance which undergoes 3.70×10^{10} disintegrations per second; this corresponds approximately to the disintegration rate of one gram of radium. Mathematically, radioactive decay follows exponential laws.

The emitted radiation causes complex interactions with matter and can be detected by a variety of techniques. Geiger-Mueller counters, proportional-gas-flow counters, and ionization chambers are examples of gas-ionization devices. Various types of scintillation phosphors, such as sodium iodide crystals for gamma counting and anthracene crystals for alpha and beta particle detection, are examples of scintillation devices. Photographic emulsions on film are used in film badges for personnel radiation monitoring or as a localizing detector in autoradiograms.

Many factors must be considered in the choice of both a radioisotope as tracer in a particular situation and the most suitable method of radiation detection. Some of these considerations are discussed below.

THE DISTRIBUTION OF TRACE QUANTITIES IN COLUMNS AND INGOTS

It is often necessary to ascertain the distribution behavior of impurities in columns and ingots as a function of a particular treatment. Typical examples are investigations in zone-refining, chromatographic column separation, ion-exchange purification, and semiconductor crystal growing or doping. In many investigations a non-destructive method of analysis in a sealed system would have advantages with respect to simplicity, cost, and safety. This type of method is particularly desirable in the

case of zone-refining studies, where segregation coefficients of trace impurities are measured in highly reactive gallium trichloride, an important intermediate in the synthesis of gallium arsenide. The method developed is based on the addition of parts-per-billion to parts-per-million quantities of radioactively labeled impurities to the gallium trichloride. The mixture is then sealed in a quartz tube, and the gamma radiation emitted from the tracer is measured as a function of ingot distance before and after zone-refining by various techniques. Massive lead shielding is required to reduce the background radiation from the ingot to a minimum. The lead bricks are positioned on top of the detector to form a narrow slit across which the column is pulled, as shown in Fig. 2. A thallium-activated sodium iodide scintillation crystal is used as the radiation detector. The pulses from the multiplier phototube are passed to the amplifier of a scaler assembly and to a four-linear-range countrate meter. For radioscanning the columns are pulled across the slit slowly by means of a variable-speed motor, and the counting rates from the radiation meter are automatically plotted on a calibrated and synchronized strip-chart recorder to provide ingot profiles of radioactivity as a function of column distance. A static counting technique is employed for more accurate measurements, i.e., the column is retained in a particular position so that one section at a time can be radiocounted. This method permits study of the segregation behavior of impurity elements for various zone-refining techniques by a simple remixing of the gallium trichloride before re-use under different conditions. It was found, in combination with spectrographic analyses, that iron, zinc, copper, nickel, aluminum, magnesium, manganese, and sodium in gallium trichloride can be effectively accumulated in the tail end of the column.¹²

In addition, the apparatus (Fig. 2) and scanning techniques can be utilized for dynamic radiographic examinations of voids in columns and ingots. A radiation source consisting of millicurie quantities of a low-energy gamma emitter is positioned above the column, which moves across the slit of the radiation-detector shield. The increase in the radiation transmission is registered on the chart recorder and immediately indicates the location of voids.

This method is also valuable in the preparation of ultrapure etch reagents by column chromatography and ion exchange. The distribution of radioactively labeled trace impurities in those columns can be measured at various stages of processing. A typical column profile was obtained by percolating hydrofluoric acid containing radioactively labeled gold through a column of high-purity silicon particles showed that more than 99.8% of the gold was removed from the acid in a single pass, and 95% of it was retained in the first sixth of the column. Similar results were obtained with other metals in hydrofluoric acid, buffered hydrofluoric acid oxide-etch, and hydrogen peroxide. Copper was removed at a high efficiency, similar to gold. This new purification method makes it possible to prepare high-purity reagents easily and efficiently for etching of silicon, gallium arsenide, and other semiconductors by use of the respective semiconductor as impurity adsorbent. Besides being highly effective, therefore, the method has the additional advantage of not introducing other harmful impurities during processing. Radiotracer tests showed that hydrochloric and nitric acids are effectively purified by distillation in an apparatus with a condenser of high-purity synthetic quartz.

TRANSISTOR ETCHING AND RINSING

The etching and subsequent rinsing of transistors are two of the important

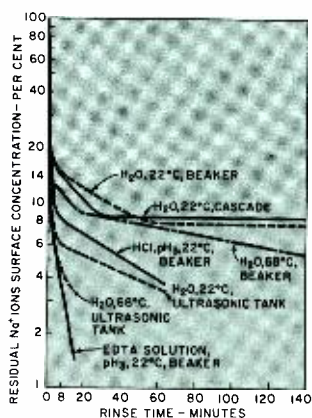

Fig. 3—Rinse-system efficiencies for 2N217 germanium transistors electrolytically etched in Na^{22}OH .

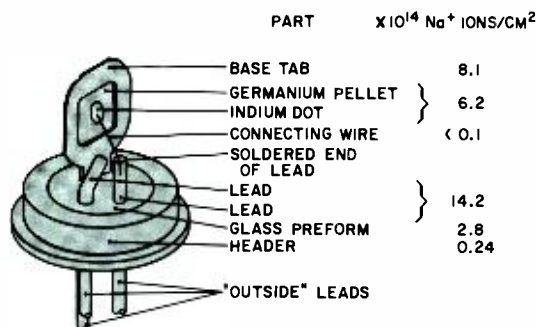

Fig. 4—Distribution of radioactive sodium residues on a 2N217 germanium transistor.

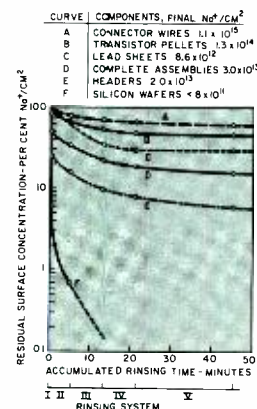

Fig. 5—Efficiency of "old" rinsing of Si transistor components etched in hot Na^{24}OH . Tracer studies drastically reduced residues. I—dip in HCl; II—deionized H_2O , ultrasonic; III, IV, V—deionized and distilled H_2O at 100°C ., barnstead cascade.

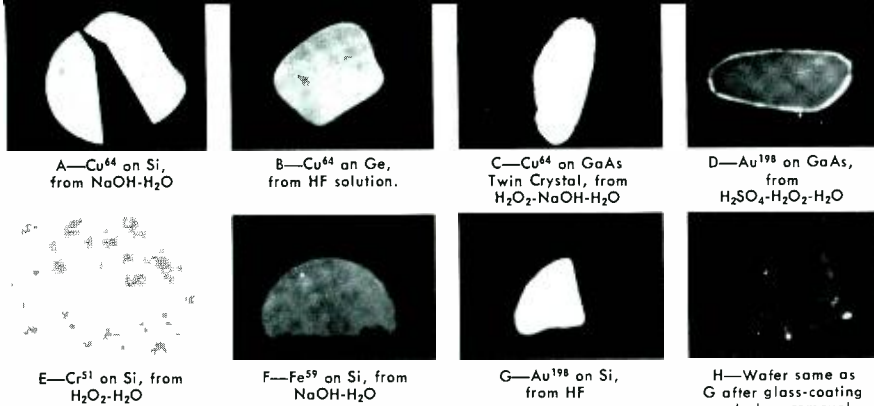

Fig. 6—The use of autoradiography for studying the distribution of surface contaminants.

factors that determine the quality of the finished device. Radioisotopes can be used for studying practical aspects of surface treatments of this type.

The mounted assembly of the RCA 2N217 n-p-n germanium transistor is electrolytically etched by anodic oxidation in strong alkali hydroxide solution, primarily to remove particulate impurities from the germanium surface. Although the bulk of the electrolyte is easily eliminated by water rinsing, small quantities of alkali that remain at the transistor surfaces can cause surface leakage, low-frequency noise, and other electrically detrimental effects. The residual impurity concentrations were determined as a function of various types of rinsing treatments by use of radioactive Na^{22} . This nuclide is obtained by deuteron bombardment of magnesium in a particle accelerator; it emits positrons and gamma radiation and has a convenient half-life of 2.6 years. Factory conditions were simulated with a miniature electrolysis cell designed for etching one transistor at a time. After an etching process in the Na^{22}OH bath, a series of 5-second rinses with deionized water was used to remove the adhering electrolyte solution. The transistor was then analysed by gamma scintillation counting to determine the residual sodium-ion concentration. The activities after various subsequent rinsing treatments are expressed as percentages of this initial value, and are plotted semilogarithmically as a function of rinse time, as shown in Fig. 3 for various rinse treatments with complete transistors. Many conclusions can be drawn from the results. For instance, the usual 8-minute factory cascade rinsing was found to leave a 14% residue, two thirds of which was retained as strongly chemisorbed layers which were desorbed with cold water only very slowly. Ultrasonic rinsing at 22°C was 30 times as effective as cascade rinsing for removing these residues, and rinsing with EDTA chelating solution was 280 times as effective. The distribution of sodium on a typical cascade-rinsed transistor is shown in Fig. 4.

A similar investigation was conducted

with the components of the RCA 2N1482 p-n-p silicon power transistor; the mounted assembly of this device received a final etch in boiling sodium hydroxide solution. The isotope of sodium with a half-life of 15 hours, Na^{24} , was prepared by neutron activation for use in this study. Because the radioactivity levels were several thousand times higher than those used in the previous experiment, extremely low surface concentrations equivalent to small fractions of one monoatomic layer could still be measured. Etching and rinsing with these curie-quantities of sodium-24 were performed entirely by remote-control manipulation, using the

radiation hot-cell facilities at the Industrial Reactor Laboratories Inc. (Fig. 1). Typical desorption curves showing final surface concentrations for components of this transistor are shown in Fig. 5.

Contamination of the 2N1482 silicon transistor by metal impurities normally occurring in reagent-grade sodium hydroxide was assessed by isotopic tagging with Cr^{51} , Fe^{59} , Cu^{64} , and Au^{198} and measurement of the resulting surface concentration of these impurities; ways could then be found to prevent or minimize such contamination. The efforts in these areas of radioisotope application have been quite successful and have contributed to improvements in product quality, reliability, and yield. For example, a process developed during these studies for removing metallic contaminants on semiconductor surfaces was applied to the processing of the RCA 2N2102 silicon power transistor, and resulted in a product-yield improvement (based on extensive life testing) of over 200 percent.

SEMICONDUCTOR-SURFACE CONTAMINATION

In spite of the rapid advances in solid-state science and technology, the semi-

TABLE I—Contamination of Semiconductor Surfaces by Selected Metal Ions During Chemical Surface Treatments

Semiconductors	Reagent	Radiotracer	Conditions*	Impurity Atoms**	
Silicon Wafers, p-type, 2 to 9 ohm-cm resistivity	HF 49%	4.5ppm Fe^{59}	30 min. 23°C	$1.3 \times 10^{11}\text{Fe/cm}^2$	
	HF 49%	6.2ppm Au^{198}	30 min. 23°C	$2.2 \times 10^{15}\text{Au/cm}^2$	
	HF 49%	2.3ppm Cr^{51}	30 min. 23°C	$2.2 \times 10^{12}\text{Cr/cm}^2$	
	HCl 19%	3.7ppm Fe^{59}	30 min. 23°C	$2.8 \times 10^{11}\text{Fe/cm}^2$	
	HCl 37%	3.1ppm Au^{198}	15 min. 23°C	$2.4 \times 10^{12}\text{Au/cm}^2$	
	HNO_3 70%	3.1ppm Au^{198}	15 min. 23°C	$1.9 \times 10^{12}\text{Au/cm}^2$	
	NaOH 5%	3.7ppm Fe^{59}	60 sec. 100°C	$6.4 \times 10^{15}\text{Fe/cm}^2$	
		10ppm Au^{198}	60 sec. 100°C	$3.3 \times 10^{15}\text{Au/cm}^2$	
		H_2O_2 3%	2.3ppm Cr^{51}	15 min. 95°C	$1.6 \times 10^{15}\text{Cr/cm}^2$
		93 vol. HNO_3 70% + 5 vol. HF 49%	6.2ppm Au^{198} 2.3ppm Cr^{51}	15 min. 23°C 100 sec. 23°C	$7.4 \times 10^{13}\text{Au/cm}^2$ $4.5 \times 10^{12}\text{Cr/cm}^2$
Germanium Wafers, p-type, 1 to 5 ohm-cm resistivity	Iodine Etch***	6.2ppm Au^{198} 2.3ppm Cr^{51}	60 sec. 23°C 60 sec. 23°C	$2.0 \times 10^{14}\text{Au/cm}^2$ $3.9 \times 10^{12}\text{Cr/cm}^2$	
	HF 49%	2.3ppm Cr^{51}	30 min. 23°C	$1.6 \times 10^{14}\text{Cr/cm}^2$	
	HCl 18%	3.7ppm Fe^{59}	30 min. 23°C	$5.6 \times 10^{10}\text{Fe/cm}^2$	
	NaOH 5%	1.0ppm Fe^{59}	60 sec. 100°C	$8.6 \times 10^{13}\text{Fe/cm}^2$	
	93 vol. HNO_3 70% + 5 vol. HF 49%	6.2ppm Au^{198}	15 min. 23°C	$1.7 \times 10^{14}\text{Au/cm}^2$	
	95 vol. HNO_3 70% + 5 vol. HF 49%	2.3ppm Cr^{51}	100 sec. 23°C	$2.4 \times 10^{13}\text{Cr/cm}^2$	
	Iodine Etch***	6.2ppm Au^{198} 2.3ppm Cr^{51}	60 sec. 23°C 60 sec. 23°C	$2.8 \times 10^{13}\text{Au/cm}^2$ $4.5 \times 10^{12}\text{Cr/cm}^2$	
	Gallium Arsenide Wafers, p- and n-types	1 vol. H_2O_2 30% + 5 vol. NaOH 5%	5.0ppm Cu^{64}	30 sec. 70°C	$1.8 \times 10^{15}\text{Cu/cm}^2$
		1 vol. HF 49% + 5.5 vol. H_2O_2 30%	5.0ppm Cu^{64}	5 min. 23°C	$2.8 \times 10^{13}\text{Cu/cm}^2$
		KOH 16%	5.0ppm Cu^{64}	5 pulses of 2 amps for 3 sec. 23°C	$1.1 \times 10^{15}\text{Cu/cm}^2$
	5 vol. H_2SO_4 98% + 1 vol. H_2O_2 30%	11.0ppm Au^{198} 1.1ppm Au^{198} 0.11ppm Au^{198}	5 min. 23°C 5 min. 23°C 5 min. 23°C	$3.3 \times 10^{14}\text{Au/cm}^2$ $1.2 \times 10^{12}\text{Au/cm}^2$ $2.1 \times 10^{11}\text{Au/cm}^2$	

*0.5 to 5 ml solution per cm^2 sample area.

**Number of atoms per cm^2 geometric surface area after $\frac{1}{2}$ min. of water rinsing.

***Mixture of 100 ml HF 49%, 100 ml HNO_3 70%, 140 ml CH_3COOH , 0.5 gm iodine crystals, 0.8 ml Triton -X100 Nonionic Wetting Agent.

conductor industry is still plagued with problems related directly or indirectly to surface contamination by trace impurities. In fact, the advent of greatly increased device reliability demands has made these problems even more acute. Contamination can occur during any of the numerous processing steps to which the semiconductor is subjected in the course of its evolution to a device, and it can be caused by several types of impurities. Minute amounts of metallic impurities can cause changes in surface states and can deleteriously affect the electrical properties of a semiconductor device. For instance, one ten-thousandth of one monolayer of an impurity can be sufficient to invert the surface of 1-ohm-centimeter silicon.¹⁹ If copper (atomic weight 64, density 8.9) is considered as a typical example of an impurity, its calculated density is 8.3×10^{22} atoms per cubic centimeter, or 1.9×10^{15} atoms per square centimeter. Thus, one-ten-thousandth of one monoatomic layer of copper contains 1.9×10^{11} atoms per square centimeter, which is 2.0×10^{-11} gram, or twenty millionths of one microgram. Obviously, conventional methods of analysis cannot be used for quantitative investigations at these extremely low concentration levels. Radiochemical methods, on the other hand, are sensitive, specific, and simple. They have been used to great advantage in the study of semiconductor-surface contamination during chemical surface treatments, one of the major sources of contamination. The primary objective of these investigations was to study adsorption and desorption phenomena and to apply the results to the development of methods for removing contaminants from solutions and surfaces.

Materials and devices were processed by standard methods, but the various reagents were labeled by the addition of radioactive isotopes. After treatment, the adhering reagent was rinsed off under standardized conditions, and the radioactivity on the samples was measured with a suitable nuclear counting instrument. From the counting rate and the previously determined specific activity (radioactivity per unit weight of substance traced) of the reagent, the average surface impurity concentration was computed. The distribution of a radioactive impurity on the sample surfaces was determined by microprobe counting and by autoradiographic techniques. The samples were placed on a photographic emulsion sensitive to the emitted radiation. Development of the photographic film produced images of the distribution of the radioactive material, as shown in Fig. 6. After these

initial examinations, the samples were subjected to various kinds of rinsing treatments to determine the rates of desorption of the active impurity with water, acids, organic solvents, and complexing and chelating agents at various temperatures. Mechanical rinsing parameters included simple stirring, cascade treatments, counter-current-flow systems, and ultrasonic agitation. In all cases the radioactivity on the sample served as an accurate measure of the residual impurity surface concentration.

In these studies both the main constituents of standard etch solutions and the trace impurities contained in them were labeled isotopically. For the tracing of ions or molecules of main constituents, Na^{22} or Na^{24} was used in the case of sodium hydroxide, F^{18} for hydrofluoric acid-containing etches, Cl^{36} for hydrochloric acid, I^{131} for etch solutions with iodine, and C^{14} tagged acetic acid etches containing this acid. The F^{18} , a positron emitter with a half-life of only 112 minutes, was prepared²⁰ at Brookhaven National Laboratories by neutron bombardment of Li^6CO_3 ; the high-energy tritium nuclei resulting from the $\text{Li}^6(n, \alpha) \text{H}^3$ reaction caused a nuclear transformation of the oxygen to fluorine: $\text{O}^{16}(t, n)\text{F}^{18}$. Radioactive hydrofluoric acid was prepared and purified by ion-exchange chromatography and used in the etch mixtures. A radioactive isotope of chlorine with a half-life of only 36 minutes, Cl^{36} , was made by thermal neutron bombardment of sodium chloride, followed by ion exchange to hydrochloric acid; all work was conducted directly at RCA reactor facilities at the Industrial Reactor Laboratories because of the short half-life of this nuclide; gamma spectrometry was used exclusively for radiation analysis. The I^{131} , with a half-life of 8 days, posed no special problems.

Adsorption analyses of trace impurities were simple in comparison to those of main constituents because much higher specific activities could be used and greater sensitivity resulted. A selection of these data is in Table I.

CONTAMINATION OF SEMICONDUCTOR CRYSTALS BY CRUCIBLE IMPURITIES

Reaction vessels in which semiconductor crystals are grown at high temperature are frequently a source of contamination, especially in the case of gallium arsenide, which is usually synthesized in fused quartz boats. The radioisotope investigation made of this problem can serve as an example of the neutron activation analysis method.

Synthesis of gallium arsenide in radioactivated quartz boats and subse-

quent analysis of the emitted nuclear radiation from the crystal samples was chosen as the analytical basis because of the inherent sensitivity of this method for trace quantities. The experiments were designed primarily to obtain information on the extent and mechanism of silicon contamination; other impurities originating from the quartz and encountered in the course of this work were identified as a secondary objective.

Bombardment of pure quartz with nuclear-reactor neutrons leads to several nuclear transformations, of which the $\text{Si}^{30}(n, \gamma)\text{Si}^{31}$ reaction was crucial in this work. The reaction product, Si^{31} , decays with a half-life of 2.62 hours to stable P^{31} by emitting one 1.471-Mev negatron per disintegration. However, interference from neutron-activated impurities in the fused quartz manufactured from natural sources was anticipated and confirmed by the radionuclides resulting from the neutron bombardment.

Boats of natural and synthetic fused quartz activated at the RCA facilities at the Industrial Reactor Laboratories were used for the synthesis of gallium arsenide. The crystals were then sliced for standardized radioactivity measurements over a period of time. The determination of the silicon concentrations was made from beta radiation gas-flow counting data. The specific activities were plotted semilogarithmically as a function of the time when the counting was performed. Graphical resolution of the radioactivity decay curves into the components made it possible to obtain the 2.62-hour Si^{31} activity. The quantity of silicon was calculated on the basis of the specific net beta Si^{31} activities in the gallium arsenide samples and the corresponding quartz standards of known silicon contents.

Gamma-ray emitters were identified

Fig. 7—Resolution of gamma spectrum from GaAs crystal grown in neutron-activated quartz boat.

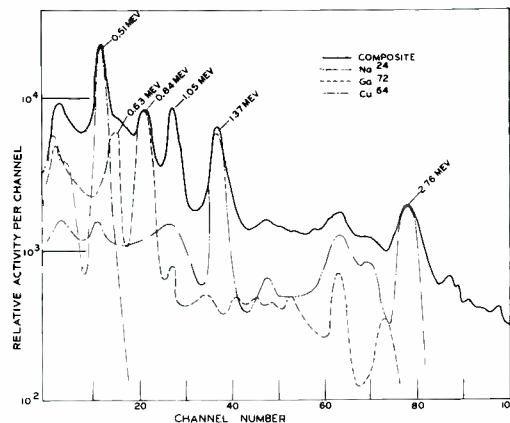

by gamma scintillation spectrometry with a 200-channel differential pulse-height analyzer. Absolute disintegration rates were calculated by integration of the areas under the characteristic photo-peaks resulting from the successive graphical resolution of the spectra into the components. Typical spectra from a gallium arsenide sample are shown in Fig. 7. The concentrations of the detected elements were estimated from the total number of disintegrations by absolute neutron-activation calculations.

One remarkable result was that each of the five gallium arsenide crystals was found completely enveloped in an impurity-enriched surface layer less than 0.025 millimeters thick with very high silicon concentrations. This result demonstrated the importance of careful removal of the entire crystal surface by sandblasting and chemical etching to prevent contamination during the subsequent processing. The silicon concentration in the bulk of the crystal material ranged from 1×10^{17} to 3.0×10^{18} silicon atoms/cm³.

As expected, high-purity synthetic quartz produced much lower nonsili-

con contamination levels than natural quartz. Most of the other detected impurity elements occurred below a concentration level of 10^{15} atoms/cm³. A more detailed discussion of this work has been presented elsewhere²¹.

FUTURE APPLICATIONS

Present work includes the investigation of impurity-gettering actions of certain glass films when applied to semiconductor surfaces contaminated with radioactive metals. The effectiveness of such films, demonstrated in the autoradiograms included in Fig. 6, confirms observed improvements in electrical device parameters. The diffusion of doping atoms through oxide layers deposited on gallium arsenide is also being measured with radiotracers.

Radioactive isotopes could be usefully applied to many other problems in the semiconductor field and related technologies. For instance, the penetrative and reflective properties of alpha, beta, and gamma radiation can be utilized for radiographic structure testing of devices, for routine thickness gaging of materials, or for thin-film measurements on certain substrates. The properties of radiotracers are ideal for study of vapor-transport and vapor-pressure phenomena of solids, impurity segregation in grain boundaries, surface diffusion, and contamination mechanisms. Tracers could also be used advantageously in many special problems relating to the electroplating of devices and to quality-control analyses. Routine application of radioactivation methods for analysis of trace amounts as well as macro-quantities in solids should be exploited fully. As the great potentials of radioactive isotopes are becoming more generally known, their application will undoubtedly expand further in this and other fields.

ACKNOWLEDGEMENTS

The work described was done in part under the sponsorship of the Manufacturing Technology Laboratory, Aeronautical Systems Division, Air Force Systems Command, United States Air Force.

BIBLIOGRAPHY

1. M. Tannenbaum and A. D. Mills, "Preparation of Uniform Resistivity n-Type Silicon by Nuclear Transmutation," *J. Electrochem. Soc.* 108, 173 (1961).
2. Research Notes: "Radioisotope-Fueled Thermoelectric Generators," *Electro-Technology*, 70, 12 (July 1962).
3. R. C. Miller and F. M. Smits, "Diffusion of Antimony Out of Germanium and Some Properties of the Antimony-Germanium System," *Phys. Rev.* 107, 65 (1957).
4. J. J. Rohan, N. E. Pickering, and J. Kennedy, "Diffusion of Radioactive

- Antimony in Silicon," *J. Electrochem. Soc.* 106, 705 (1959).
5. B. Goldstein, "Diffusion in Compound Semiconductors," *Phys. Rev.* 121, 1305 (1961).
6. F. A. Trumbore, "Solid Solubilities of Impurity Elements in Germanium and Silicon," *The Bell Systems Techn. J.*, 39, 205 (1960).
7. G. H. Morrison and J. F. Cosgrove, "Activation Analysis of Trace Impurities in Germanium Using Scintillation Spectrometry," *Anal. Chem.*, 28, 320 (1956).
8. B. A. Thompson, B. M. Strause, and M. B. Leboeuf, "Gamma Spectrometric and Radiochemical Analysis for Impurities in Ultrapure Silicon," *Anal. Chem.* 30, 1023 (1958).
9. J. P. Cali and J. R. Weiner, "Practical Neutron Activation Analysis for the Electronic Scientist," *J. Electrochem. Soc.* 107, 1015 (1960).
10. J. Roesmer, "Determination of Sub-microgram Quantities of Boron in High Purity Elemental Silicon," in *Ultra-purification of Semiconductor Materials*, M. S. Brooks and J. K. Kennedy, MacMillan, 1962.
11. G. H. Morrison, "Radiochemistry in Electronics Research," *Nucleonics* 11, 28, (1958).
12. S. P. Wolsky, P. M. Rodriguez, and W. Waring, "Adsorption of Sodium Ions by Germanium Surfaces," *J. Electrochem. Soc.* 103, 606 (1956).
13. G. B. Larrabee, "The Contamination of Semiconductor Surfaces: I. Metal Ions from Acid Solution on the Intermetallics, GaAs and InSb," *J. Electrochem. Soc.* 108, 1130 (1961).
14. W. B. Harvey, W. J. LaFleur, and H. G. Gatos, "Electrochemical and Adsorption Measurements of Single Crystals: The Germanium-Iodide Solution System," *J. Electrochem. Soc.* 109, 155 (1962).
15. G. L. Pearson, J. D. Struthers, and H. C. Theuerer, "Correlation of Geiger Counter and Hall-Effect Measurements in Alloys Containing Germanium and Radioactive Antimony 124," *Phys. Rev.* 77, 809 (1950).
16. W. E. Baker and D. M. J. Compton, "Radiotracer Studies of the Incorporation of Iodine into Vapor-Grown Ge," *IBM J. Res. and Dev.* 4, 269 (1960).
17. H. A. Stern, "Gas-Phase Proportional Counting: A Radiotracer Technique for Examination of Electronic Components and Materials," *Sympos. on Mat. and Electron Device Processing*, ASTM, 82, 300, (1961).
18. W. Kern, "Zone Refining of Gallium Trichloride: Radiochemical Method for Determining the Distribution of Components in a Column and Its Application in Analyzing the Zone Refining Effectiveness in Purifying Gallium Trichloride," *J. Electrochem. Soc.* 110, 60 (1963).
19. M. M. Atalla, E. Tannenbaum, and E. J. Scheibner, "Stabilization of Silicon Surfaces by Thermally Grown Oxides," *Bell Syst. Tech. J.* 38, 749 (1959).
20. L. G. Stang, Jr., et al., "Development of Methods for the Production of Certain Short-Lived Radioisotopes," *Radioisotopes in Scientific Research, Vol. 1*; pp. 56-57, Pergamon Press, N.Y. (1958).
21. W. Kern, "Neutron-Activation Study of Gallium Arsenide Contamination by Quartz," *J. Electrochem. Soc.* 109, 700 (1962).

WERNER KERN received a State Diploma of Switzerland in chemical technology in 1946 and a BS in Chemistry from Rutgers University in 1955, where he also did graduate work in analytical chemistry and radiochemistry. He was employed with Hoffman-LaRoche, Inc. in Basle, Switzerland from 1942-1948, and with the same Company in Nutley, New Jersey from 1948-1957 as research chemist. He joined Nuclear Corporation of America in Denville, New Jersey, in 1958 as a chief chemist and radiological safety officer. Mr. Kern joined the RCA Semiconductor and Materials Division in Somerville, N. J. in 1959 as an Advanced Development Engineer in charge of the radioisotope laboratory. His work included the radiochemical investigations reported in this paper. He has also completed an extensive radiochemical study of semiconductor surface contamination which has resulted in improved processing methods now being applied to Minuteman. He has been working since early 1962 on the passivation and protection of silicon and gallium arsenide device surfaces by oxide glasses. Mr. Kern is a member of the ACS and the Research Society of America, and is author of nine papers.



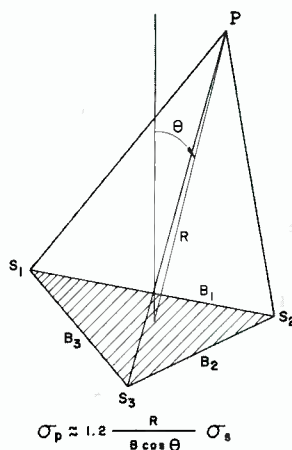

Fig. 1—Trilateration scheme.

RADAR GEODETIC MEASUREMENTS WITH A PASSIVE SATELLITE

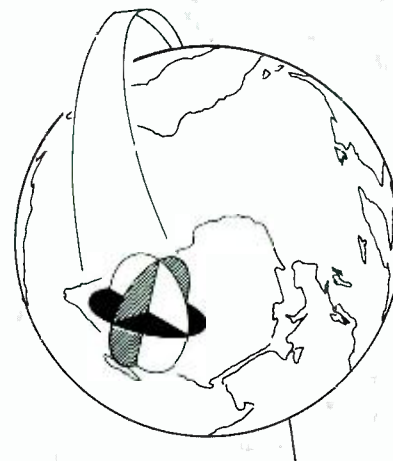

Fig. 2—Passive, corner-reflector satellite.

Radar is the instrument that is proposed to make geodetic measurements with the aid of a high altitude passive corner reflector satellite. The measurement used is slant range with nominal accuracy of better than 10 feet. The accuracy with which a radar site can locate itself, observing this satellite, has been determined to be of the same order of magnitude as the slant range measurement.

A. REICH

*Missile and Surface Radar Division
DEP, Moorestown, N.J.*

MODERN TRACKING requirements generally involve more than one radar site for gathering data of a particular mission. An intercontinental ballistic missile track, a MERCURY capsule track, or the tracking of any one of a multitude of satellites relies upon the deployment of radar installations distributed around the globe. For purposes of prediction, orbit determination or post-flight reduction, it may be necessary to utilize the data from the several sites. If this is the case, the mixing of data from several sites will contain errors greater than that due only to measurement inaccuracies. With the individual radar sites not too well defined, the additional data added from one site to another carries along with it the errors in site location.

Presently, angle errors represent the largest source of position error which increases with range. It is reasonable then to decrease the reliance upon angle information for measurements of position of far removed vehicles. One procedure of accomplishing this is to use range data only in a trilateration scheme. In this setup, we determine the position of a vehicle using the most accurate positional data available. The error in position for a trilateration determination of position will be due to the errors in range measurement, errors in site location and the geometry involved.¹

ALFRED REICH graduated from the College of the City of New York with a BEE degree in 1954, and received the MSEE degree from the University of Pennsylvania in 1958. In 1954 he joined the RCA Communication and Navigation Section located in Camden, New Jersey. In 1955 he joined the Missile and Surface Radar Division of RCA located in Moorestown, New Jersey. Mr. Reich's responsibilities were the development and design of pulse circuitry, analog computers, and servomechanisms. With the systems engineering group he has been involved in studies concerning satellite tracking, prediction and general systems analysis. He is presently on the AADS-70 project with the guidance techniques and error analysis group. Mr. Reich is a member of the IEEE. He is the author of two papers.^{5,6}



In Fig. 1, σ_p is the error in position, R is the range from the center of network, B is the baseline distances between sites (baselines are assumed to be about equal), O is defined in Fig. 1, and σ_s is the error in the site location. For lunar distances, the major error in a trilateration scheme (with reasonable geometry) is due to site uncertainties. The position accuracy obtainable will be 1,000 feet at 256,000 miles range if the site locations are known to within 10 feet; or, if doppler data is used in the same manner, one can achieve a 10-fps velocity error. This example is offered to demonstrate that site location does limit position determining accuracies.

The primary objective of radar geodesy is to perform radar site location to the same order of accuracy as radar range measurements. One can presently use 10 feet-rms as the range measurement accuracy, and if a site is located to this accuracy, it represents an improvement in site location by at least an order of magnitude. In order to achieve this aim, a passive satellite is launched into a stable orbit and tracked in range by the radars included in the network. Once the radar geodetic network is established, one can locate a new tracking station with as few as two satellite passages to within a few feet of its true position. An obvious extension of this is the

TABLE I—Single-Satellite-Pass Site Determination

Case	High Elevation Pass	Low Elevation Pass	Noise Range σ Ft.	Maximum Error in Site Coordinate Feet	Errors in Bias Estimate
1	x		10	770	Typical
2	x		20	425	Value
3		x	10	908	400
4		x	20	701	Feet
Single Pass 3 Parameter					
5	Estimation Instead of 4 10 & 20		133	Mostly under 50 Feet	Bias Present But not Solved For

σ is Standard Deviation. 10-foot noise bias included in simulation data

TABLE II—Two-Satellite-Pass Site Determination

Range Noise σ , Feet	Maximum Error in Site Coordinate Feet	Error in Bias Estimate, Feet
10	11	3.4
20	25	8.3

Bias is held at 10 feet.

application to instrumentation ships. All of the range instrumentation tracking ships in use or proposed, have the radar capable of "skin" tracking the passive satellite. These ships, using a buoy for reference between satellite passages, can realize this positioning accuracy.

In addition, the geodetic satellite, by virtue of its orbit stability, can be used as a calibration, exercise and control source for all radar and optics capable of performing "skin" track.

PROCEDURE

A network is tied together beginning with three mainland sites which are located using standard geodetic techniques. Calibration of the radars at the three sites can be accomplished using corner reflectors mounted on high wooden poles. With the radars, surveyed in and calibrated, we form our reference system to locate other sites.

At this point, we can use an *intervisibility* approach to locate nearby radar sites. By *intervisibility*, we mean the target being considered is positioned such that it can be simultaneously tracked by the radars involved. Thus, to use an *intervisibility* approach to locate a fourth site, we simultaneously track an object by three reference radars as well as the fourth. The three reference radars will establish the position of the object, independent of target dynamics, and the fourth radar using range measurements only, will locate itself by using a differential correction scheme to find a least square fit to the range data. With this site located, one can then use any three of the four to locate a fifth, and continue this process until *intervisibility* can no longer be applied. Although any "skin" tracked target (rocket, aircraft, ballistic missiles, etc.) is suitable, a high-altitude satellite will offer increased coverage.

When an *intervisibility* situation does not exist, one can then attempt to use a limited prediction procedure. In this case, the data from the already-located

radars are required to calculate future positions of the target for a short prediction interval. The short interval will minimize prediction errors and enable one to establish the location of a site that is just outside the region of *intervisibility*. The target must then have the properties that its future position can be accurately extrapolated outside the observation interval. Ballistic missiles and satellites will provide this stability.

For remote sites, outside *intervisibility* regions and require long prediction intervals, one must rely on a high-altitude satellite in a stable orbit. Using the data from located radars, one establishes the orbital parameters of the satellite to enable long term accurate prediction. The remote site to be located then uses a differential correction scheme based on minimizing the sum of the squares of the differences between observed and computed range values to perform site location.

SIMULATION RESULTS

Site location was performed in which range-only measurements were used. It was assumed that the orbit of the satellite was precisely known. Perfect data was generated to which we added uncertainties to simulate measured data. Gaussian noise with a non-zero mean was added to the generated data to represent systematic observation errors or system biases.

The satellite trajectory data comprises data from two satellite passages, described as the high-elevation pass and the low-elevation pass. The respective maximum elevation angles were 58° and 23°. The high elevation pass contained 47 data points uniformly separated by 25 seconds. For the low elevation pass, we used 41 points with the same separation. In both cases, the semi-major axis was 1.979 earth radius units with an eccentricity of 0.40.

The computation was based on a differential correction program solving for

the earth radius vector to locate the site in terms of polar coordinates: ρ , the length of the radius vector; ϕ , the latitude; and λ , the longitude.

On a single-pass basis, there appeared to be no significant difference whether a high-elevation pass or a low-elevation pass was observed. With a standard deviation of 10 feet in the range noise, the error in a coordinate direction was as high as 900 feet and the solution for the system bias appeared to be an insensitive determination. That is, the estimate of the bias fluctuated considerably from run to run.

However, when data from two passes was used to establish the site coordinates and bias, dramatic results were obtained. The estimates of the coordinates were within 25 feet with noise inserted into the data having a standard deviation of 20 feet. The estimates of the bias were now a quantity of a great deal more sensitivity. With three or more passes, one would expect even greater improvement in the estimates of both site coordinates and instrument biases.

An interesting result was obtained when bias was not solved for in the single-pass case. For a 10- to 20-foot-RMS noise and a 10-foot bias, it was found that the maximum error in a site coordinate was 113 feet—almost an order of magnitude better than when trying to solve for the biases. In this case the bias estimate was held fixed to zero. Thus, for a single pass, one would be advised to solve for the site coordinates alone when the system bias is approximately 10 feet. Tables I and II summarize the results of the simulation.

In order to substantiate the simulation results, the next step was to use actual radar data. The ECHO 1 satellite was tracked over three consecutive passes and the data was processed to re-establish the location of the radar tracking site. That is, assuming the radar site location is known, the data was processed to obtain a set of orbital elements for

TABLE III—ECHO 1 Results

Set No.	Passes	$\Delta\rho$ ft.	$\Delta\phi$ ft.	$\Delta\lambda$ ft.	Comments
1	2 & 3	2	-7	0	Four parameter estimation
2	1 & 2	0	11	14	ρ, λ, ϕ and
3	1 & 3	-4	-4	7	Bias
4	2 & 3	-6	-7	4	Three Parameter estimation
5	2	42	-94	-97	ρ, ϕ, λ

each satellite pass. Using the derived elements and the radar data, the problem was reversed to see whether one can establish the site's location. The results are displayed in Table III. These numbers represent errors in site location essentially due to measurement errors and not due to uncertainties in satellite position.

SATELLITE SELECTION

A passive satellite is employed to avoid the need for a complex instrument with no loss of operational modes and accuracies. One type of reflector that well suits this application is the corner reflector (Fig. 2). If the surfaces are made smooth enough, the corner reflector satellite can be used by optical masers as well as radar equipment.

This choice was based on a study to determine the type, complexity, and lifetime of satellites that would be compatible with existing radars for geodetic measurements.

Both passive and active satellites were considered. The following factors motivated the selection: reliability, availability and sensitivity of available radars, satellite orbit altitude, and optical visibility.

It was found that a passive satellite consisting of a rigid corner reflector cluster in an 800-mile orbit can be tracked on "skin" by available radars of the AN/FPS-16 or SCR-584 class and by optics of the Baker-Nunn or Wild

BC-4 class. The area-to-mass ratio should not exceed 10 cm²/gram and of course it should be as small as possible to minimize the perturbing effects of the earth's atmosphere and solar pressure. Table IV summarizes the size of satellite and corresponding instruments capable of tracking it.

COVERAGE

If one combines nine radars of the Atlantic Missile Range, Pacific Missile Range, and National Aeronautical and Space Administration, one can obtain observation of the satellite 60% of the time.³ This holds for an 800-mile orbit with an inclination of 30°. If two radars are added to the network, one in India and one in Japan, then the continuous coverage would be extended to 90% of the time.

TIMING

In order to combine data from several sites not only is it required to precisely know the site locations, but also time synchronization is required. If it is assumed that the maximum velocity of the tracked object is 25,000 fps, then for a foot inaccuracy due to timing errors, the time synchronization should be within 40 μ sec. Reder⁴ has outlined four methods of time distribution in his paper and presents results carried out over a distance of 5,000 miles. The systems considered by Reder all hold promise of time synchronization to better than 10

μ sec. The method recommended by Reder, for the next few years, is the use of crystal clocks at the sites backed up by atomic oscillators for periodic rate checks and to use the atomic oscillators for transporting from site to site. Negligible error is then introduced due to timing errors.

CONCLUSIONS

The demonstration we have is that with the use of existing radar equipment, a corner-reflector stable satellite, it is possible to locate a set of radar sites to accuracies comparable to radar range measurements. *Stable* in this case refers to the ability of determining precisely the location of the satellite at any instant of time. To obtain this stability, one must first minimize the area-to-mass ratio compatible with present-day boosters. This, however, is *not* sufficient. Errors in the estimate of the satellite's position will result because of our lack of knowledge concerning the earth's gravitational field. It may be necessary to then define the coefficients in the spherical harmonics expansion of the earth's gravitational potential field to a higher degree of accuracy than presently defined. *Here is where the system offers unique opportunities.* This system, besides having virtually unlimited life and all-weather application, also has the extremely important feature of high-density data availability. Whereas data collection presently depends upon satellites of opportunity with limitation on the quantity of data, this system offers orbit-to-orbit data collection of high density with almost complete independence from weather. This is an important feature for the determination of earth potential terms needed for geodetic applications.

BIBLIOGRAPHY

1. D. K. Barton, "The Future of Pulse Radar for Missile and Space Range Instrumentation," *IRE Transactions on Military Electronics*, Vol. MIL-5, No. 4, October 1961.
2. R. Lieber and S. Shucker, "Angle-Damped Doppler Tracking System," *RCA ENGINEER*, June-July 1961.
3. *Proceedings IAS Symposium on Tracking and Command of Aerospace Vehicles*, February 19-21, 1962.
4. F. H. Reder, "Atomic Frequency and Time Standards," *NEREM Record*, 1961 page 145.
5. A. Reich, "Attitude Determination—A New Dimension for Radar," *Proceedings of the 1962 Winter Convention on Military Electronics*.
6. A. Reich and S. Shucker, "Radar Applications to Geodesy," Ninth Annual East Coast Conference on Aerospace and Navigational Electronics (1962).

TABLE IV—Applicable Tracking Equipment

Satellite Diameter (Meters)	Applicable Tracking Equipment	
2	Ballistic and Baker-Nunn Cameras f:115 mm	FPS-16 (3 Megawatt, Paramps, 16 Foot Dish)
4		FPQ-6
6		Unmodified FPS-16
		SCR-584 (Paramps, 12-ft. Dish)

Fig. 1—Interferometer horn antenna showing image sources.

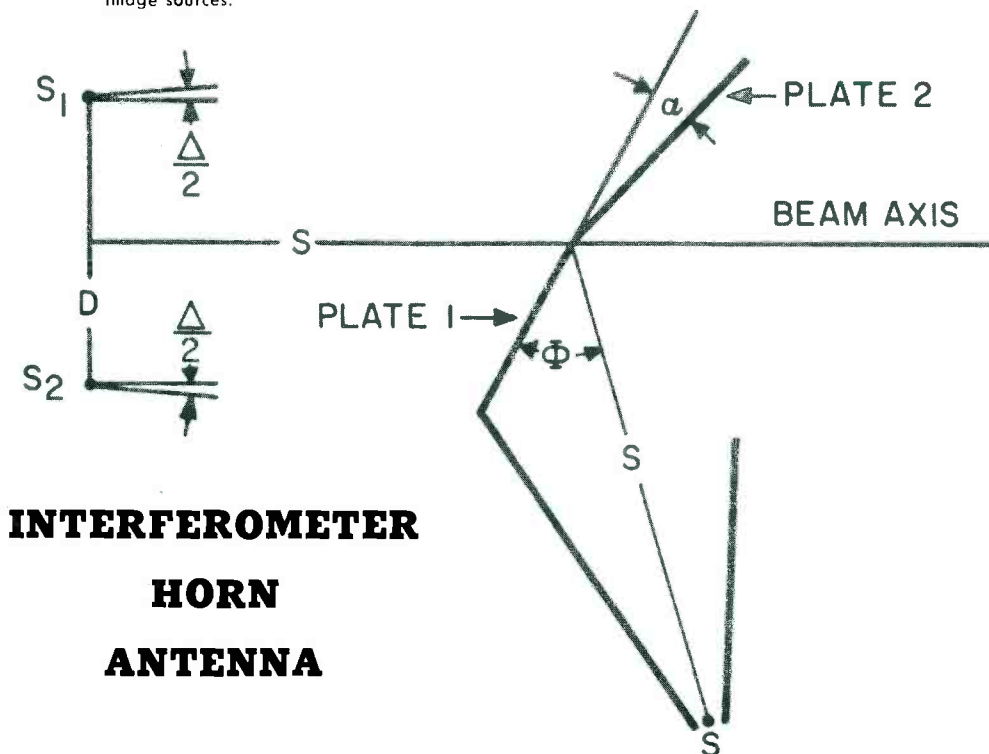

INTERFEROMETER HORN ANTENNA

This microwave interferometer horn antenna is based upon the optical Fresnel mirror interferometer. Design considerations included the effects of reflecting plate size and plate intersecting angle. An experimental program showed the effects of critical plate size. One major advantage of the design is that an effective two-source antenna is produced simply from a single source—an advantage in millimeter-wave regions.

A. J. BOGUSH, JR., Ldr.
Missile and Surface Radar Division
DEP, Moorestown, N. J.

ONE DEFINITION of an interferometer is a device which utilizes the interaction of two or more coherent wave fronts. This interaction involves interference phenomena which implies vector addition of the field quantities. For radar applications, it is best to define an interferometer as "an array of two or more radiating elements, coherently driven, and spaced many wavelengths apart." This definition is equivalent to the first one, except that attention is given to specific sources of radiation.

The major advantage of the interferometer is that it provides the best angular resolution for a given aperture size. For example, a typical antenna design for optimum beam width-side-lobe relationships, with side lobes con-

sidered 20 db, will yield a lobe width of about $3 \lambda/D$. A two-source interferometer with an element spacing equal to D would yield a lobe width of λ/D . The overall result is an increase of angular resolution by a factor of three.

Scientists concerned with radio astronomy initially utilized the advantage of this improved angular resolution. Most recently, work has been done with the application of interferometer techniques for radar systems. An example of an interferometric approach is given¹ wherein a radar system is described with side-lobe suppression objectives. Some of the unique problems in working with interferometers involve beam shaping, null position, and null depth considerations. These problems are es-

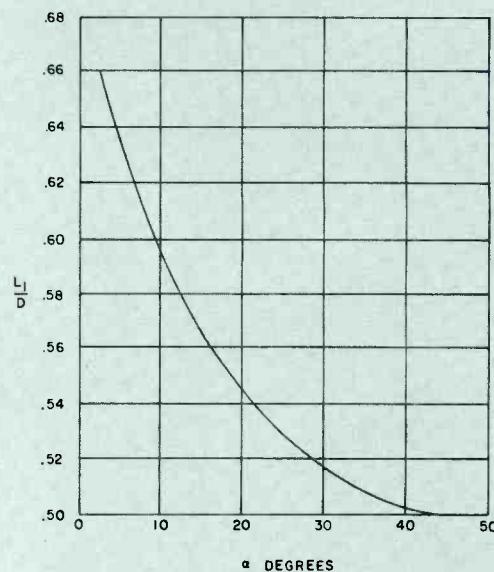

Fig. 2—Critical-plate-size curve, primary source angle is 45°.

essentially the same as those confronted when designing monopulse antennas, the error patterns of which can be represented by an equivalent two-source interferometer with shaped element beams.

APPLICATION OF FRESNEL OPTICAL EXPERIMENTS

An application of the Fresnel optical experiments to an interferometer horn antenna consisting of two reflecting plates and a source of radiation is shown in Fig. 1. The use of reflecting plates to achieve interference is based upon the Fresnel experiments.² The physical appearance of the horn radiator is similar to the one described by Schelkunoff³ with the reflecting plates replacing a parabolic reflector.

One of the characteristics of this device is the consideration of range dependence. The intent is to control a given number of lobes in a fixed region in space as a function of range. Range dependence, critical plate size, and non-range-dependence cases will be discussed. The analysis described is based strictly on geometric optics. Work has been done considering diffraction effects evolving from the fields contained inside the horn. It is not the intention here to describe this approach rigorously, except to note the effects of diffraction in interpreting some of the measured results.

DESIGN PROCEDURE

In Fig. 1, α is the plate intersecting angle, ϕ is the primary source reflecting angle, and s is the distance from the primary source to the intersection of the reflecting plates. From the geometry of the system, the separation D between sources is:

$$D = 2s \sin \alpha \quad (1)$$

Considering the primary source as isotropic, the interference pattern, restricted in angular location, is then the same as two isotropic sources separated a distance D apart. The separation between nulls (or peaks) in the inter-pattern is given approximately by:

$$\delta \approx \frac{\lambda}{d} \quad (2)$$

Since range-dependent interference regions are involved, it is necessary to consider fields at all ranges. This can be done, considering isotropic sources, by use of:

$$E(\theta) = \frac{\exp(j\beta r_1)}{r_1} + \frac{\exp(j\beta r_2)}{r_2} \quad (3)$$

Where: r_1 and r_2 are the distances from the image sources to the observation point. It can be shown that $D = 100 \lambda$ and range D the null depths are greater than 50 db with null separations given to a good degree of approximation by Eq. 2.

Figs. 2, 3, and 4 are design curves for use for critical and non-range-dependent interferometer horn antennas. A critical plate curve is found in Fig. 2. This

represents the condition when $\Delta/2 = 0$, and L_1 and L_2 are the lengths of plate 1 and 2, respectively. Thus, for non-range-dependent interference regions ($\Delta/2 > 0$) $L_{1/D}$ must be greater than the critical values of $L_{1/D}$ given by the curve. The ratio $L_{2/D}$ is a constant equal to $\sqrt{2}/2$ with the primary source angle assumed constant at 45° .

Fig. 3 contains a family of curves which relate the total interference region Δ to the plate intersecting angle for various $L_{1/D}$ ratios. Fig. 4 is a similar set of design curves with $L_{2/D}$ as the ordinate. Both sets of curves yield L_1 and L_2 for a given D and α .

Experiments were conducted at 10 Gc and 35 Gc. The plate sizes at the lower frequencies were approximately 4 feet long, with a small (nearly an open waveguide) horn as a primary source. The objective, initially, was to produce narrow interference lobes, which at 10 Gc required large reflecting screens. The small horn was chosen to insure illumination of the entire surface of the reflecting plates. Several horns were designed and constructed for use at 35 Gc. Fig. 5 is a photograph of one designed for three lobes contained in a 16° region.

MEASURED RESULTS

The Fig. 6 continuous curve is a typical example of a measured interferometer pattern: null depths are all greater than 20 db with null separations reason-

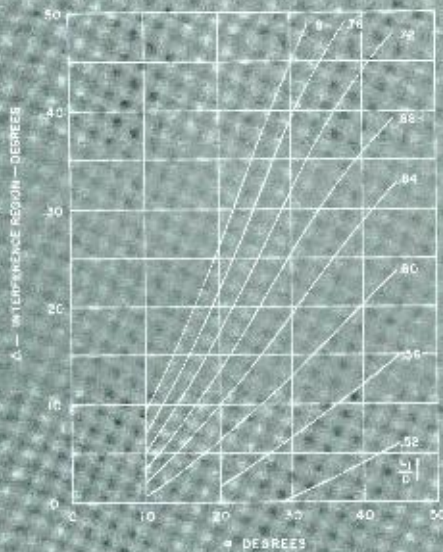

Fig. 3—Total angular interference region for non-range-dependent fresnel mirror interferometer, primary source angle is 45° .

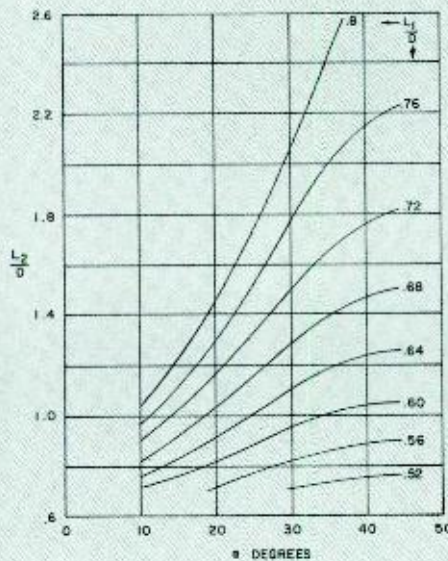

Fig. 4—Plate size curve for a non-range-dependent fresnel mirror interferometer, primary source angle is 45° .

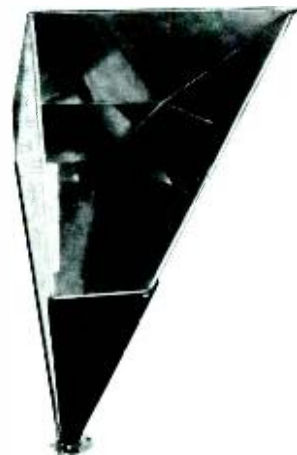

Fig. 5—A horn designed for three lobes contained in a 16° region.



ALFRED J. BOGUSH, JR. graduated with a BSEE from the University of Missouri, School of Mines and Metallurgy in 1955, and received an MS from Drexel Institute of Technology in 1961. He is presently studying towards a doctorate at the University of Pennsylvania. Since joining RCA as a specialized trainee in 1955, he has worked, as a member of the Microwave and Antenna Group, on antenna problems associated with Talos Guidance Radar, ANFPS-16, MADRE, and BMEWS. He has presented several papers involving detailed Fresnel region properties of tracking radar antennas. As a Leader in the Advanced Technique Development Group, he has been directly involved with problems concerning millimeter wave techniques, lightweight antennas, electronically tuned cavity resonators, and nanosecond pulse techniques. Presently, he is engaged in studies involving transfer of stored energy into wire loads. He is a member of IEEE (PTGAP, PTGTT and PTGUE).

TABLE I — MEASURED RESULTS

Measurement #	s, inches	α , deg.	d, inches	Comp. δ , deg.	Meas. δ , deg.
1.	37	40	47.5	1.47	1.31
2.	30	40	38.5	1.78	1.65
3.	20	40	25.6	2.71	1.51
4.	37	30	37.0	1.87	1.82
5.	108	10	37.0	1.87	1.95
6.	15	15	6.2	11.00	11.00

ably constant. The Fig. 6 dashed curve illustrates the effects of critical plate size; the plate sizes were determined for the critical case using the design curves. On the dashed curve, a deep null occurs in the vicinity of the beam axis, with nulls filling in at points further away from the axis. The same effect results when screen sizes are kept constant and is increased appropriately. During measurements, plate sizes were reduced using RF-absorbent material.

Additional measured results are given in Table I. The parameters s, and D are well varied; computed null separations are found using Eq. 2 for the various source separations D. The plate

intersecting angle α , is changed from 10° to 40° with good interference patterns achieved in all cases. Lines 4 and 5 in Table I demonstrate the relationship between D, s, and α . The last item in Table I is the smallest physical interferometer tested at 10 Gc. The plate sizes for this antenna were 8" x 8" x 16". Good comparison between computed and measured null separations can be noted.

The interferometer horn antenna in Fig. 5 was designed with the following characteristics:

$$L_1 = 3.75''$$

$$L_2 = 5''$$

$$s = 9.5''$$

$$d = 3.3''$$

$$\Delta = 16^\circ$$

$$\delta = 5^\circ$$

Typical measured results are shown in Fig. 7. The null depths are excellent with a reasonably good comparison between computed and measured null separations. Discrepancies in null positions can be attributed mainly to small angle approximations used in the derivation of Eq. 2. Diffraction effects can also be noted. The measured pattern shown can be represented by a two-source interferometer with each source 2.25 inches long and with a cosine aperture distribution.

CONCLUSIONS

The major advantage of the interferometer horn is the ability to produce an effective two-source antenna very simply from a single source. As frequencies increase into the millimeter-wave region, component and transmission line loss becomes a serious problem. The elimination of the two separate sources is indeed an advantage. In addition, for a given required null separation, the physical size of the horn becomes smaller as frequency increases. This again emphasizes the increased practicability of the interferometer horn antenna in the millimeter wave region.

ACKNOWLEDGEMENT

The author acknowledges the efforts of B. Zaslov, H. Spiegall, and J. Delany for mechanical engineering contributions and A. Slater for assistance in the taking of the measurements.

BIBLIOGRAPHY

1. W. F. Gabriel, *Pattern Measurements on an Experimental Compound Interferometer Antenna*, Stanford Research Institute, SRI 3619, Oct. 1961.
2. L. Page, *Introduction to Theoretical Physics*, D. Van Nostrand, New York, N. Y., p. 638.
3. S. A. Schelkunoff, *Antennas*, John Wiley and Sons, 1952, p. 569.

Fig. 6—Measured results showing comparison between non-range-dependent and critical case. Primary source angle is 45° and plate intersecting angle is 30° ($f = 10$ Gc).

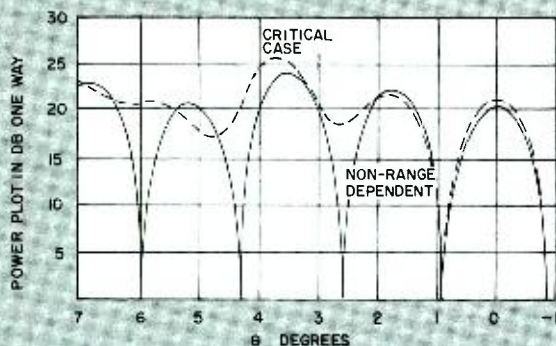
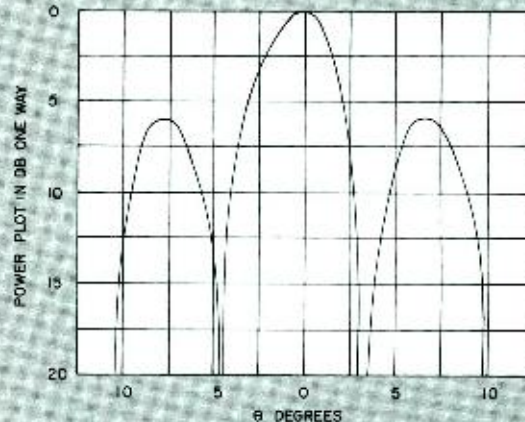

Fig. 7—Measured interferometer horn antenna pattern ($f = 35$ Gc).



Engineering and Research NOTES

BRIEF TECHNICAL PAPERS OF CURRENT INTEREST



Development of a New Package for Tunnel Diodes

W. H. LIEDERBACH, *Electronic Components and Devices, Somerville, N. J.*

During a recent research project at Somerville, a novel method was developed for the fabrication of metalized ceramic insulators and for the assembly of packages used with tunnel diodes. New methods became necessary when preparation of acceptable units in the required small sizes proved impractical with available methods, and the metalizing of the minute insulators was found to be all but impossible.

The classical sequence of operations for preparing the insulators, which include mixing, forming, firing, metalizing, final firing, electroplating, jig loading, and brazing, has been consolidated into a much simpler method that enables large-volume production with a high yield of acceptable units. In the new method, the conventional multistep operation for metalizing the minute insulators has been replaced by a three-layer lamination technique. This technique has also eliminated one firing step.

The successful achievement of five objectives of the research project led to the new ceramic-metalizing and diode-packaging techniques. These objectives were to: 1) provide a hermetic tunnel-diode package; 2) improve mechanical stability (reduce the sensitivity of the device to changes in pressure); 3) reduce the size of the diode package; 4) provide for universal lead attachment; 5) reduce the manufacturing cost (to less than \$0.25 per unit in quantity runs).

Metalized Ceramic Insulators: The new method for preparing the metalized ceramic insulators consists of three basic steps: 1) preparing a three-ply laminated array in which two metalizing layers are sandwiched about the ceramic, 2) punching out insulator cylinders in the appropriate sizes, and 3) firing and plating the insulators to stabilize their characteristics and to prepare them for assembly into the diode package.

The layers of metalizing and ceramic materials that are used to form the laminated array are obtained in the following manner: The mixtures of both materials, as given in Tables I and II, are individually milled to an average particle size of 2 microns. A 2-pound batch in a 2-quart-capacity ball mill requires 12 hours of milling. Upon completion of the milling operation, the mixtures are diluted with methyl ethyl ketone to obtain viscosities between 600 and 1,000, as measured on a Brookfield RVF viscosimeter, No. 3 spindle, at 20 rpm. The laminate layers are then obtained by doctor-blading these mixtures on clean, smooth, impervious substrates, such as plate glass (Fig. 1). The layers are then air-dried and stripped away from the substrate, preparatory to being laminated into a three-ply array (Fig. 2). The lamination of the two metalizing layers to the ceramic is accomplished in air at 100 to 120°C, by subjecting the three-ply array to a pressure of 500 psi for 60 to 90 seconds.

Figs. 3 and 4 indicate the steps required to produce the final insulator elements from the laminated array. The small insulators in the size required, are punched from the laminated ceramic and metalizing and are then fired and plated as the final steps in preparing them for inclusion in the diode package. The firing, which is done in a wet forming-gas atmosphere at 1,550°C, volatilizes the binders, matures the ceramic material, and bonds the metalizing layers more securely to the ceramic substrate. The plating prepares the insulator surfaces for brazing to metal parts in the diode package.

The metal and ceramic parts are brazed together in the conventional manner using carbon brazing jigs. Before the brazing operation is performed, thin brazing rings of the BT alloy (72% silver and 28% copper in a eutectic ratio) are electroplated onto the metalized ceramic. A barrel-plating process is used to avoid handling of the very fragile, 0.002-inch-thick rings of brazing alloy. This

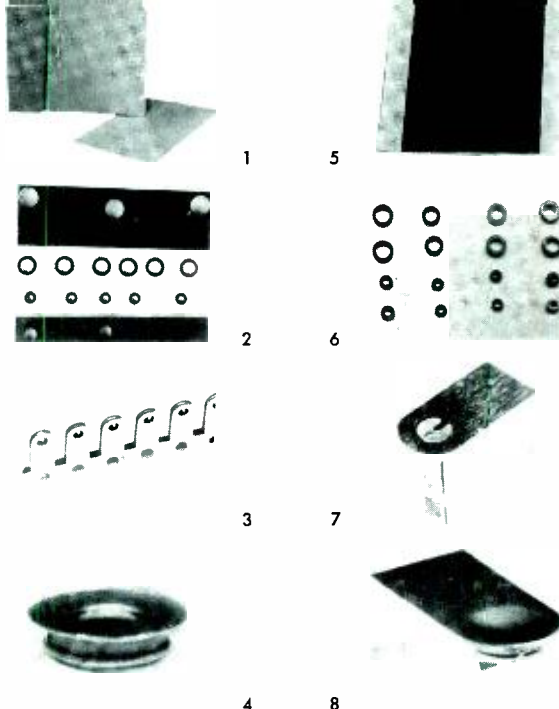

Fig. 1—Doctor-bladed ceramic sheets.

Fig. 2—Laminated ceramic and metalizing layers.

Fig. 3—Punched metalized insulators (green).

Fig. 4—Insulator processing.

Fig. 5—Original tunnel-diode package.

Fig. 6—A miniature 0.080-inch hermetic tunnel-diode package with a bent-tab junction contact. This assembly was the result of the first attempt to design a new tunnel-diode package.

Fig. 7—A 0.125-inch-diameter button package developed for use in evaluating various techniques proposed for the final tunnel-diode package.

Fig. 8—Final tunnel-diode package.

TABLE I

Composition of Ceramic Material	
90 parts powdered (325 mesh) alumina	
4 parts of ball clay	
13 parts binder (vinylite VVNS)	
85 parts solvent (methyl ethyl ketone)	
2 parts plasticizer (Santicizer 160)	
6 parts talc (magnesium silicate)	

TABLE II

Composition of Metalizing Material	
80 parts powdered (2 to 5 microns) molybdenum	
20 parts powdered (4 to 6 micron) manganese	
13 parts binder (vinylite VVNS)	
85 parts solvent (methyl ethyl ketone)	
2 parts plasticizer (Santicizer 160)	

procedure permits thousands of parts to be plated in one operation, and the number of parts for jig loading is minimized.

Tunnel-Diode Package: Figs. 5 through 8 show the progressive design stages in the development of the new tunnel-diode package. The original package (Fig. 5) fulfilled all of the electrical requirements, but it was not hermetic, was sensitive to changes in pressure, and was excessively large. The first attempt to design a new package resulted in a hermetic assembly that was significantly smaller than the original one (Fig. 6); this new assembly, however, was also sensitive to changes in pressure, could not be easily adapted to jig-assembly techniques, and the weld closures required to seal the assembly were difficult to make.

Fig. 7 shows a button package, of the same size as the original package, which was developed for use in analyses of means for making the final package impervious to pressure variations and of techniques for improving weld closures and contacts. This effort led to the final design of the new tunnel-diode package shown in Fig. 8. This new package includes the following features: 1) universal caps and terminals of tab, lead, or stud design; 2) a welding projection of the button package to insure that satisfactory weld seals can be obtained; 3) a screen type of juncture contact instead of a bent metal finger; and 4) provisions that permit the use of semiautomatic jigs in the assembly of its components, which reduces the cost.

The new diode packages passed the following tests: 1) hermeticity, 2) solderability (exposure for five seconds up to 240°C), 3) environmental (moisture and salt atmosphere per MIL STD 19500B), 4) drop (from 24 to 48 inches), 5) shock and vibration, 6) mounting and etching, and 7) mechanical strength (pressure sensitivity).

Acknowledgments: The writer wishes to acknowledge the effort of W. Gyurk and L. Bacher for package assembly; M. Blumenfeld and L. Trager for package electroplating; A. Curcio for punch designs; and D. Pearson for metal parts preparation.



Five-Layer Diode Guards Electronic Equipment at Cable Termination

H. R. MONTAGUE, *Communications Systems Division, DEP, Camden, N. J.*

A solid-state, five-layer diode device was developed at Surface Communications Division (now called Communications Systems Division) to protect cable terminating equipment from high-power surges due to lightning, electromagnetic radiation, and power-line faults. The p-n-p-n-p device can be applied to buried-cable networks of missile systems, as well as aerial cables. The diode can be best described as two controlled rectifiers placed back-to-back. Over-voltage and breakdown produce carrier multiplication and an eventual negative resistance region which permits high conduction.

The five-layer diode undergoes a negative-resistance region, so that after breakdown, the voltage drop across the device is comparable to that of an ordinary silicon rectifier. Thus, high surge currents can be conducted to ground. Inherent reliability of a solid-state protector is much greater than more commonly used devices.

Physical arrangement of the five-layer diode precludes failure due to over-voltage. The device will break down and conduct in either direction, so the limiting factor is the induced heating at the junction. The junction is designed so that it will not fail until failure of the copper conductors occurs. Two five-layer diodes are connected in series across a typical cable pair, with ground between the diodes. These semiconductors are selected in pairs for close tolerance and break-over voltage. For longitudinal surges, it is probable that both lines will be grounded simultaneously. When the diodes conduct, the voltage drop across each is limited to 1 or 2 volts, thus lowering the stress on electrical terminal equipment. Voltage breakdown level is independent of the number of operations, and within its rating, the solid-state device will have the same mean time to failure independent of the duty cycle.

Design parameters for the protector were current surge of 5,000 amps for 100 μ sec (dependent on specific cable system), conduction and recovery time less than 10 μ sec, and leakage resistance greater than 100 kilohms up to 0.9 of breakdown voltage. The holding current was specified to be greater than 5 amps and breakdown voltage of 300 volts. A five-layer device was required, since over-voltage conditions may be of either polarity referred to ground.

Tests run on many samples showed no deterioration in performance after many surges at various combinations of current and pulse times.

Carbon blocks have been most commonly used as surge arrestors. While initial cost of the five-layer diode is high compared to carbon blocks, the diode requires *no maintenance nor frequent testing and replacement*, as does the carbon type.

[Editor's Note: This Note first appeared in *Electronics* magazine, where it generated such widespread interest and response from readers, including USAF missile personnel and electronics firms in Canada and Europe, that it is being republished here because of potential direct interest to various RCA engineering activities.]



Domain Structure in Liquid Crystals

DR. R. WILLIAMS, *RCA Laboratories, Princeton, N. J.*

Certain organic compounds melt to form liquids in which the molecules are oriented in a special way which gives the liquid remarkable electrical and optical properties. Such liquids are called *liquid crystals* because they have the flow properties characteristic of ordinary liquids, but their optical and electrical properties are strongly anisotropic, similar to those of crystalline solids.

It has been found that such liquids have a domain structure which can be made visible by application of an electric field. (Fig. 1). The liquid crystal is contained between two glass plates having transparent conductive coatings. In Fig. 1, the boundary of the conductive coatings is the vertical line, about $\frac{1}{3}$ of the way in from the right edge of the picture, which separates the two areas

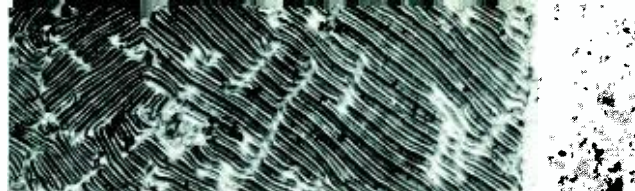

Fig. 1—Photomicrograph of domain structure in liquid phase of the organic compounds, para-azoxyanisole. Viewed by transmitted light. Magnification 90X.

of the picture. To the left of this there is an electric field of 1,000 volts/cm perpendicular to the plane of the page and to the right there is no field. Before application of the field and after it is removed the entire area looks like that to the right of the line. The regular striated pattern indicates a remarkable kind of structure within the liquid. This structure is probably present without the field, but is made visible when the field is applied because of the unusual electro-optical properties of the liquid.

The pattern is visible to the unaided eye by either transmitted or reflected light. It permits modulation of reflectivity at television frame frequencies and may be of use as a display element. In addition it gives new information on the structure of liquids.



VSWR of Broadband Waveguide Series-T Junction

R. M. KURZROK, *Systems Laboratories, Communications Systems Division, DEP, New York, N. Y.*

The technique of using $\lambda_g/2$ transformers in a waveguide series-T junction to obtain low vswr's over broad bandwidths has already been presented in the literature.¹ The vswr's less than 1.15 for transmission through the aligned arms, and less than 1.30 for transmission around the bend, were reported for bandwidths of 17.4%. In work performed at RCA, the analysis of Griememann and Kasai was extended² to include the discontinuity reactance of the T junction.³ This discontinuity reactance is primarily responsible for the poorer vswr performance realized for transmission around the bend.

Recent experimental efforts at RCA have been directed toward improving vswr performance for transmission around the bend. A broadband series-T junction was designed using RG-49/U waveguide, with a design-center guide wavelength of 3.400 inches (Fig. 1). Efforts were primarily directed toward achieving low vswr's over the range 4.4 to 5.0 Gc. For various reasons connected with the intended application, the transformer impedance selected was 0.794 the full-height waveguide impedance. Determination of transformer lengths was based on considerations of the appropriate reference planes of the T junction, as well as the capacitive discontinuities at the steps. Neglecting the series discontinuity reactance, vswr's ≤ 1.24 were obtained over the 4.4 to 5.0-Gc range for transmission around the bend. By using a 4-40 capacitive compensating screw *within* the $\lambda_g/2$ transformer, significant improvement in vswr performance was obtained (Fig. 2). A vswr ≤ 1.15 for transmission around the bend was obtained over the frequency range 4.2 to 5.2 Gc. The proper location of this screw was determined from conventional impedance measurements and standard Smith Chart impedance-matching techniques.

The broadband waveguide series-T junction is a useful component in duplexer applications. It should be noted, however, that the performance curve shown in Fig. 2 will not necessarily be duplicated when the physical short circuit on Port 2 (Fig. 1) is replaced by the out-of-band reactance of a bandpass or band-reject filter.

1. Griememann and Kasai, "Broadband Waveguide Series-T for Switching", *Voe, MTT-4, IRE Transactions on Microwave Theory and Techniques*, pp 252-255, October 1956.
2. R. Pettai, *Private Communication*.
3. N. Marcuvitz, *Waveguide Handbook*, Rad. Lab. Ser., McGraw-Hill Book Co., Inc., Vol. 10, p 338, 1951.

Fig. 1—Compensated E-plane T cross-section, RG-49/u waveguide, side view.

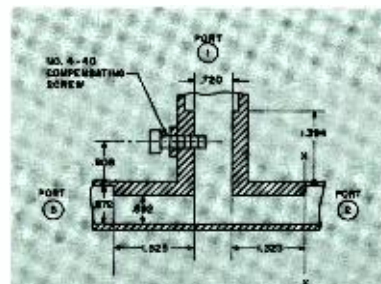
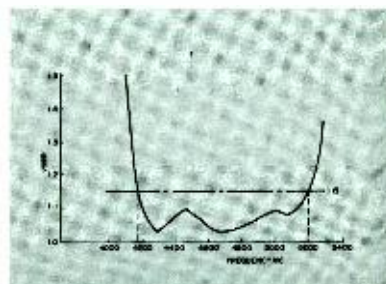

Fig. 2—Measured results, input VSWR at Port 1 vs. frequency. Port 2 short-circuited at X-X with Port 3 terminated in matched load.





AS REPORTED BY YOUR
TECHNICAL PUBLICATIONS ADMINISTRATOR

RCA LABORATORIES

Spectral Studies of $\text{Fe}(\text{CN})_6^{3-}$ Generated Photochemically and Electrolytically—I. Bernal and E. F. Hockings: XIX International Congress of Pure and Applied Chemistry, London, July 10-17, 1963

Photochemical Generation of Paramagnetic Species Utilizing an Induction Plasma Torch—I. Bernal and L. Ekstrom: XIX International Congress of Pure and Applied Chemistry, London, July 10-17, 1963

Mass Spectrographic Microanalysis of Solids with a Focused Laser Beam—R. E. Honig and J. R. Woolston: 19th International Congress of Pure and Applied Chemistry, London, July 10-17, 1963, *Handbook of Abstracts*.

A Passive Endoradiosensory System for Determination of Cyclic Ovarian Function—F. L. Hatke: IFME 5th International Conf. on Medical Electronics, Liege, Belgium, July 22, 1963

Lattice Imperfections in Magnesia-Rich Spinel—A. Miller: International Union of Pure and Applied Chemistry, London, July 10-17, 1963

Triggered Low-Voltage Sources for Positive Ions—R. E. Honig, S. S. Glass, and J. R. Woolston: VI Conference on Ionization Phenomena in Gases, Paris, France, August 8-13, 1963

The Application of Epitaxial Growth to the Fabrication of Laser Diodes—H. Nelson: Technical Conference on Semiconductor Materials, Boston, Mass., August 26-28, 1963

Elastic Constants of Single Crystal Indium Arsenide—D. Gerlich: American Physical Society Meeting, Edmonton, August 1963

Space Power Devices and Systems—P. Rappaport and S. H. Winkler: NATO Conference, Athens, Greece, July 8, 1963, *Proceedings of the Conference*

Anomalous Band Gap in Superconducting Nb_3Sn —Y. Goldstein: International Conference on the Science of Superconductivity, Hamilton, N.Y., August 26-28, 1963

Flux Stabilization in Superconducting Cylinders—J. J. Hanak: International Conference on the Science of Superconductivity, Cornell Univ., Ithaca, N.Y., August 26-28, 1963

Thermal Conductivity of Nb_3Sn —G. D. Cody and R. Cohen: International Conference on Science of Superconductivity, Colgate Univ., Hamilton, N.Y., August 24, 1963

Telemetering Internal Biological Potentials with Passive Type Capsules—F. L. Hatke, L. E. Flory and V. K. Zworykin: 5th International Conference on Medical Electronics, Liege, Belgium, July 22, 1963; *Proceedings or Digest of Conference*

The Properties of Some Nitrosyl Co-ordination Compounds—E. F. Hockings and I. Bernal: International Union of Chemistry, London, England, July 12, 1963

Magnetic Load-Sharing Switches for High-Speed Applications—R. B. Lochinger: *RCA Review*, June 1963

A Rigorous Analysis of Harmonic Generation Using Parametric Diodes—K. K. N. Chang and P. E. Chase: *RCA Review*, June 1963

The Performance of Sum and Difference Mode Parametric Amplifiers in Television Receivers—D. D'Agostini: *RCA Review*, June 1963

An Analysis of the Characteristics of Insulated-Gate Thin-Film Transistors—H. Borkan and P. K. Weimer: *RCA Review*, June 1963

Gravimetric Determination of Germanium in Silicon-Germanium Alloys—K. L. Cheng and B. L. Goydich: *Analytical Chemistry*, August 1963

AC Field Excitation of Rare Earths in Zinc Sulfide—G. J. Goldsmith, S. Larach, R. E. Shrader and P. N. Yocom: *Solid State Communications*, Vol. 1, pp. 25-27, 1963

Decoration of Imperfections on Cleaved Germanium—W. Mehl and M. C. Coutts: *Journal of Applied Physics*, July 1963

Surface Decoration and Domains in Very Thin Magnetic Films—M. D. Coutts and H. L. Pinch: *Journal of Applied Physics*, July 1963

Space-Charge-Wave Decay Along a Signal-Current-Excited Multi-Velocity Beam—S. Bloom and B. Vural: *Journal of Applied Physics*, July 1963

Tunnel-Injection Electroluminescence—A. G. Fischer and H. I. Moss: *Journal of Applied Physics*, July 1963

Continuous Operating $\text{CaF}_2:\text{Tm}^{3+}$ Optical Maser—R. C. Duncan and Z. K. Kiss: *Applied Physics Letters*, July 15, 1963

Effect of Doping on the Emission Peak and the Absorption Edge of GaAs—R. Braunstein, J. I. Pankove, and H. Nelson: *Applied Physics Letters*, July 15, 1963

The Doherty Temperature of III-V Compounds—E. F. Steigmeier: *Applied Physics Letters*, July 1, 1963

Efficiency Calculations of Thermoelectric Generators with Temperature Varying Parameters—R. W. Cohen and B. Ables: *Journal of Applied Physics*, June 1963

Operation of a Memory Element Based on the Maser Principle—H. J. Gerritsen: *Proceedings of the IEEE*, June 1963

On the Parametric Resonance Spectrum of the $\text{Cr}(\text{CN})_6^{3-}$ Ion—I. Bernal and S. E. Harrison: *Journal of Chemical Physics*, May 15, 1963

Electroluminescent Lines in ZnS Powder Particles II. Models and Comparison with Experience—A. G. Fischer: *Journal of the Electrochemical Society*, July 1963

Comparison of the Crystal Fields and Optical Spectra of Cr_2O_3 and Ruby—D. S. McClure: *Journal of Chemical Physics*, May 1, 1963

Determination of Oxygen in Gallium Arsenide by Neutron Activation Analysis—R. F. Bailey and D. A. Ross: *Analytical Chemistry*, June 1963

Optical Studies of the Cesium Arc—F. M. Johnson: *Advanced Energy Conversion*, 1963

Variable-Characteristic p-n Junction Devices Based on Reversible Ion Drift—J. O. Kessler, B. E. Tompkins and J. Blanc: *Solid-State Electronics*, 1963

Meetings

Nov. 10-15, 1963: 9TH ANN. CONF. ON MAGNETISM AND MAGNETIC MATLS., PTG-MTT-IEEE-AIP; Chalfonte-Haddon Hall, Atlantic City, N.J. *Prog. Info.:* C. J. Kriessman, Physics, Matls. and Processes Sec., Box 500, Blue Bell, Pa.

Nov. 11-13, 1963: RADIO FALL MTC., IEEE-EIA; Hotel Manager, Rochester, N.Y. *Prog. Info.:* V. M. Graham, EIA Eng. Dept., 11 W. 42nd St., N.Y.

Nov. 12-15, 1963: 9TH ANN. CONF. ON MAGNETISM AND MAGNETIC MATLS., PTG-MTT-IEEE-AIP; Chalfonte-Haddon Hall, Atlantic City, N.J. *Prog. Info.:* W. L. Shevel, Jr., IBM Mag. Res. Dept., Yorktown Heights, N.Y.

Nov. 12-14, 1963: FALL JOINT COMPUTER CONF., AFIPS (IEEE-ACM); Las Vegas Convention Center, Las Vegas, Nev. *Prog. Info.:* Paul Davies, Abacus, Inc., 1718-21 St., Santa Monica, Calif.

Nov. 18-20, 1963: 16TH ANN. CONF. ON ENG. IN MEDICINE AND BIOLOGY, IEEE-ISA; Lord Baltimore Hotel, Baltimore 3, Md. *Prog. Info.:* Dr. R. L. Schoenfeld, c/o 16th Ann. Conf., Jenkins Hall—John Hopkins Univ., Baltimore 18, Md.

Dec. 4-6, 1963: ULTRASONICS ENG. SYMP., PTG-UE; Marriott Hotel, Wash., D.C. *Prog. Info.:* Dr. T. R. Meeker, Bell Tel. Labs., 555 Union Blvd., Allentown, Pa.

Dec. 5-6, 1963: 14TH NATL. CONF. ON VEHICULAR COMMUNICATIONS, PTGVC; Dallas, Texas. *Prog. Info.:* A. C. Simmons, Comm. Industries, Inc., 511 N. Akard, Dallas, Texas.

Dec. 6, 1963: 4TH ANNUAL SEMINAR ON RELIABILITY IN SPACE VEHICLES, PTG-R, ED and CP; Los Angeles, Calif. *Prog. Info.:* J. Doshay, Space Genl. Corp., 9200 E. Flair Dr., El Monte, Calif.

January 7-9, 1964: 10TH NATL. SYMP. ON RELIABILITY AND QUALITY CONTROL, IEEE, ASQC; Statler Hilton Hotel, Wash., D.C. *Prog. Info.:* Dr. L. S. Gephart, Lockheed Missiles and Space Co., Department 64-01, Building 104, Sunnyvale, Calif.

Feb. 5-7, 1964: 5TH WINTER CONY. ON MILITARY ELECTRONICS (MILECON), PTG-MIL; Los Angeles Sec.; Ambassador Hotel, Los Angeles, Calif. *Prog. Info.:* IEEE, L.A. Office, 3600 Wilshire Blvd., Los Angeles, Calif.

Feb. 19-21, 1964: INTL. SOLID-STATE CIRCUITS CONF., IEEE-Univ. of Pa.; Sheraton Hotel and Univ. of Pa., Philadelphia, Pa.

Prog. Info.: Howard Parks, Martin Co., R and AT Dept., Mail 683, Baltimore 3, Md.

Calls for Papers

Feb. 24-25, 1964: WRITING-IMPROVEMENT PROGRAMS FOR ENGINEERS SEMINAR, IEEE, PTGEWS; N. Y. *DEADLINE:* Summary, 11/15/63. to: C. A. Meyer, RCA, Harrison, N.J.

Feb. 26-28, 1964: NINTH SCINTILLATION AND SEMICONDUCTOR COUNTER SYMP., IEEE; Hotel Shoreham, Washington, D.C. *DEADLINE:* Abstracts, 12/1/63. to: W. A. Higginbotham, Chairman, Prog. Committee, Brookhaven Natl. Laboratory, Upton, L. I., N. Y.

Apr. 1-2, 1964: 5TH SYMP. ON ENG. ASPECTS OF MAGNETOHYDRODYNAMICS, IEEE-AIAA, MIT; MIT Cambridge, Mass. *For Deadline Info.:* Dr. C. S. Janes, Avco Everett Res. Labs., Everett 49, Mass.

Apr. 6-9, 1964: INTL. CONF. ON NONLINEAR MAGNETICS (INTERMAC), IEEE; Shoreham Hotel, Washington, D.C. *For Deadline Info.:* W. L. Shevel, Jr., IBM Mag. Res. Dept., MRD 807, Box 218, Yorktown Heights, N. Y.

Apr. 8-10, 1964: ISA MEASUREMENT AND CONTROL INSTRUMENTATION DIVISION SYMP., with District III Exhibit; Hotel Floridian, Tampa, Fla. *DEADLINE:* Abstracts, approx. 12/1/63. to: J. Barker, Taylor Instrument Companies, P.O. Box 13735, Station K, Atlanta 24, Georgia.

Apr. 19-25, 1964: INTL. CONF. AND EXHIBIT ON AEROSPACE ELECTRO-TECHNOLOGY, IEEE, et al.; Westward-Ho Hotel, Phoenix, Ariz. *DEADLINE:* Abstracts, 8/19/63, Manuscripts, 11/1/63. to: E. E. McEllan, Motorola Inc., 8201 E. McDowell Rd., Scottsdale, Ariz.

Apr. 21-23, 1964: SPRING JOINT COMPUTER CONF., AFIPS (IEEE-ACM); Sheraton-Park Hotel, Wash., D.C. *DEADLINE:* Manuscript, approx. 11/10/63. to: Jack Roseman, 2313 Coleridge Dr., Silver Spring, Md.

Apr. 22-24, 1964: SOUTHWESTERN IEEE CONF. AND ELEC. SHOW (SWIEECCO); Region 5; Dallas Memorial Auditorium, Dallas, Tex. *DEADLINE:* Abstracts (approx.) 10/1/63. to: Richard A. Arnett, Tex. Instruments, Inc., P.O. Box 35084, Dallas, Texas.

May 4-6, 1964: 10TH NATL. ISA AEROSPACE INSTRUMENTATION SYMP., ISA; Biltmore Hotel, New York City. *DEADLINE:* Abstracts, approx. 1/1/64. to: J. K. Stotz, Jr., Grumman Aircraft Eng. Corp., Bethpage, Long Island, New York.

May 11-13, 1964: NAECON (NATL. AEROSPACE ELECTRONICS CONF.), PTG-ANE Dayton Sec., AIAA; Biltmore Hotel, Dayton, Ohio. *DEADLINE:* Abstracts, approx. 12/15/63. to: IEEE Dayton Office, 1414 E. 3rd St., Dayton, Ohio.

May 19-21, 1964: INTL. SYMP. ON MICRO-WAVE THEORY AND TECHNIQUES, PTG-MTT; Intl. Inn, Intl. Airport, Idlewild, N. Y. *DEADLINE:* Abstracts, approx. 1/8/64. to: Dr. L. Swern, Sperry Gyroscope Co., 3 T 105, Great Neck, N. Y.

May 25-28, 1964: 13TH NATL. TELEMETERING CONF., ISA, AIAA, IEEE; Biltmore Hotel, Los Angeles, Calif. *DEADLINE:* Abstracts, approx. 1/1/64. to: A. P. Gruer, 7530 Sandia Corp., Box 5800, Albuquerque, New Mexico.

June 1964: 2ND NATL. ISA BIOMEDICAL SCIENCES INSTRUMENTATION SYMP.; New Orleans, Louisiana. *DEADLINE:* Abstracts, approx. 2/1/64. to: Dr. R. Jonnard, The Prudential Insurance Co. of America, Newark, N. J.

June 19-21, 1964: 5TH ANN. JOINT AUTOMATIC CONTROL CONF., ISA, AICHE, ASME, IEEE; Stanford Univ., Stanford, Calif. *DEADLINE:* Abstracts, approx. 2/1/64. to: D. A. Rodgers, Consolidated Systems Corp., 1500 Shamrock Ave., Monrovia, Calif.

Aug. 25-28, 1964: WESCON SHOW AND IEEE SUMMER GENL. MTC., Region 6, WEMA, All PTG's; Los Angeles, Calif.

DEADLINE: Abstracts, approx. 4/15/64. to: WESCON, 3600 Wilshire Blvd., Los Angeles, Calif.

Sept. 7-11, 1964: INTL. CONF. ON MICRO-WAVES, CIRCUIT THEORY AND INF. THEORY, IECE of Japan, et al.; Tokyo, Japan. *For Deadline Info.:* Dr. K. Morita, Oki Elec. Indus. Co., Ltd. 1, 4 Chome, Nishi-Shibaura, Minato-Ku, Tokyo.

Sept. 14-16, 1964: 8TH NATL. CONVENTION ON MILITARY ELECTRONICS, (MILECON), PTG-MIL; Washington Hilton Hotel, Washington, D.C. *For Deadline Info.:* IEEE Headquarters, Box A, Lenox Hill Station, New York, N. Y.

Sept. 22-24, 1964: PTG ON ANTENNAS AND PROPAGATION SYMP., PTG-AP; Long Island, N. Y. *DEADLINE:* Abstracts, 3/1/64. to: H. Jasik, Jasik Labs., 100 Shames Dr., Westbury, N. Y.

Oct. 4-9, 1964: NATL. SYMPOSIUM ON SPACE ELECTRONICS, PTG-SEI; Phila., Pa. *For Deadline Info.:* Chas. H. Doersam, Jr., Instruments for Industry, Hicksville, L. I., New York.

Oct. 5-7, 1964: 10TH NATL. COMMUNICATIONS SYMP., PTG-CS; Utica, N. Y. *DEADLINE:* Abstract, approx. 6/17/64, manuscripts, approx. 9/1/64. to: IEEE Headquarters, Box A, Lenox Hill Station, N. Y., N. Y.

Oct. 19-21, 1964: NATL. ELECTRONICS CONF., IEEE, et al.; McCormick Place, Chicago, Ill. *DEADLINE:* Abstracts, approx. 5/15/64, manuscripts, approx. 8/1/64. to: Natl. Elec. Conf., 228 N. La Salle St., Chicago, Ill.

Oct. 21-23, 1964: EAST COAST CONF. ON AEROSPACE AND NAVIG. ELECTRONICS (ECANE), PTG-ANE Baltimore Section; Baltimore, Md. *DEADLINE:* Abstracts, approx. 6/17/64, manuscripts, approx. 8/19/64. to: IEEE Headquarters, Box A, Lenox Hill Station, N. Y., N. Y.

Oct. 27-29, 1964: FALL JOINT COMPUTER CONF., AFIPS (IEEE-ACM); Civic Center, Brooks Hall and St. Francis Hotel, San Francisco, Calif. *For Deadline Info.:* Mrs. P. Huggins, P.O. Box 53, Malibu, Calif.

Oct. 29-30, 1964: ELECTRONIC DEVICES MTC., PTG-ED; Sheraton-Park, Washington, D.C. *DEADLINE:* Abstracts, approx. 8/1/64. to: IEEE Headquarters, Box A, Lenox Hill Station, N. Y., N. Y.

Nov. 4-6, 1964: NEREM (NORTHEAST RES. AND ENG. MTC.), Region 1; Boston, Mass. *DEADLINE:* Abstracts, approx. 6/7/64. to: IEEE Boston Office, 313 Washington St., Newton 58, Mass.

Be sure DEADLINES are met—consult your Technical Publications Administrator for lead time needed to obtain required RCA approvals.

Computer Memories: Remarks on Possible Future Developments - J. A. Rajchman: *Switching Theory in Space Technology*, Stanford University Press, 1963

Design and Operating Characteristics of High-Bit-Density Permalloy Sheet Transfluxor Memory Stack—G. R. Briggs and J. W. Tuska: *Proceedings of the Intermag Conference*, April 1963

Paramagnetic Resonance of Divalent Holmium in Calcium Fluoride—H. R. Lewis and E. S. Sabisky: *The Physical Review*, May 15, 1963

Cadmium Selenide Thin-Film Transistors - F. V. Shallcross: *Proceedings of the IEEE*, May 1963

Analysis of the Arc Mode Operation of the Cesium Vapor Thermionic Energy Converter—K. G. Hernqvist: *Proceedings of the IEEE*, May 1963

Valence Band Structure of Germanium-Silicon Alloys - R. Braunstein: *The Physical Review*, May 1, 1963

Lattice Vibration Spectra of Germanium-Silicon Alloys - R. Braunstein: *The Physical Review*, May 1, 1963

RCA VICTOR COMPANY, LTD., MONTREAL

Semiconductor Beta and Gamma Detectors—Dr. R. W. Jackson: IEEE Summer Meeting, Toronto, June 18, 1963

Impurity Activated Germanium Detectors—Dr. H. Pullan: I.R.I.S. Detector Speciality Sub-Group, Syracuse, N. Y., June 17, 1963

RECORD DIVISION

High Speed Copper Electroforming of Disk Record Matrices—A. M. Max and M. L. Whitehurst: Annual Mtg. American Electroplaters Society, Atlantic City, N. J., June 24-27, 1963; *Proceedings of the American Electroplaters Society*.

Problems in Using Films for Packaging—H. W. Hittie: *Management Bulletin #27* of the American Management Association, Packaging Division.

ELECTRONIC DATA PROCESSING

Real Time Electronic Computer Analysis by an RCA 501 of Electroencephalographic Data—D. S. Himmelman: 5th International Conference on Medical Electronics, Liege, Belgium, July 22-26, 1963

The Use of the Ternary Numerical System in Digital Computer—A. Turecki: *Thesis*—Moore School of Electrical Engineering, July 18, 1963

Separable Multi-Contact Connectors for High Speed Computer Circuits—M. Erker, H. Kaupp and D. Schnorr: 4th International Electronic Circuit Packaging Symposium, August 14-16, 1963

ELECTRONIC COMPONENTS AND DEVICES

Note on the Anomalous Behaviour of a Travelling-Wave Tube When Operated in Vacuum—M. Nowogrodzki: Electron Device Research Conference, University of Utah, June 26-28, 1963

Theory and Performance of Depressed Trochoidal Collectors for Improving Travelling-Wave-Tube Efficiency—T. S. Chen and H. J. Wolkstein: *IEEE Transactions on Electron Devices*

X-Ray Spectrometric Determination of Composition and Distribution of Sublimates in Receiving-Type Electron Tubes—E. P. Bertin & R. J. Longobucco: Conference on Applications of X-Ray Analysis, Denver, Colo., August 7-9, 1963

Ham-Band Charts Covering FCC Allocations from 1.8 to 450 Mc—L. W. Aurick: *RCA Ham Tips*, Summer 1963

The Development of a Thermionic Energy Converter for Nuclear Applications—F. G. Block, C. Y. Eastman and W. E. Harbaugh: American Nuclear Society Annual Meeting, Salt Lake City, Utah, June 17-19, 1963

Travelling-Wave Tubes for Satellite Applications—C. L. Cuccia: Microwave Society of Long Beach, California, June 15, 1963

1.5 dB Noise Figure at 3 KMc with New RCA Parametric Amplifier—P. Koskos, D. Manayek, W. Rumsey and L. L. Cuccia: *Electronics*, June 28, 1963

An Improved Implosion-Protection System - C. T. Lattimer: IEEE Spring Conference on Broadcast and TV Receivers, June 17, 1963

Sub-Microsecond Ferrite-Core Memories - D. F. Joseph and H. P. Lemaire: 10th International Scientific Conference on Electronics, Rome, Italy, June 20-21, 1963

Modulation and Demodulation of Light—F. Sterzer: Laser Materials and Applications, New York University, June 17-21, 1963

Microwave Phototubes Using Transmission Electron Multipliers—D. J. Blattner, J. E. Ruddy, G. A. Morton, H. C. Johnson and F. Sterzer: Electron Device Research Conference, Salt Lake City, Utah, June 26-28, 1963

Microwave Phototubes with Transmission Photocathodes—D. J. Blattner, H. C. Johnson, J. E. Ruddy and F. Sterzer: *Convention Record*, June 1963

A New Alkali Antimonide Photoemitter with High Sensitivity to Visible Light—A. H. Sommer: *Applied Physics Letters*, August 15, 1963

Determination of Epitaxial-Layer Impurity Profiles Using Microwave Diode Measurements—H. Kressel and M. A. Klein: *Solid-State Electronics*, May-June 1963

Reciprocal Energy Converters: Solar Cell and Junction Light Source—B. V. Keshavan, M. F. Lamorte and L. J. West: Solid-State Device Research Conference, MSU, East Lansing, Mich., June 12, 1963

Stimulated Emission from Gallium Arsenide Junctions at Low Current Density—B. V. Keshavan, M. F. Lamorte and L. J. West: Solid-State Device Research Conference, MSU, East Lansing, Mich., June 12, 1963

A Solid-to-Solid Diffusion Technique—W. Greig, J. Olmstead and J. Scott: Solid-State Device Research Conference (MSU), East Lansing, Mich., June 12, 1963

Influence on Forward Junction Characteristics of Reabsorption of Radiation Resulting from Junction Electroluminescence—M. F. Lamorte: Solid-State Device Research Conference (MSU), East Lansing, Mich., June 12, 1963

Growth Rates of Epitaxial Gallium Arsenide—N. Goldsmith: *Journal of Electro-Chemical Society*, June 1963

A Non-Destructive Measurement of Carrier Concentration in Heavily Doped Semiconducting Materials and Its Application to Thin Surface Layers - I. Kudman: *Journal of Applied Physics*

High-Cutoff-Frequency Diffused-Junction GaAs Varactor Diodes—M. F. Lamorte, A. Widmer and L. Gibbons: *RCA Review*, June 1963

High-Voltage Epitaxial GaAs Microwave Diodes—H. Kressel and N. Goldsmith: *RCA Review*, June 1963

Status and Future of Semiconductor Devices—A. M. Glover: *Electronic Industries*, June 1963

Factors in the Design of Transistor Deflection Circuits—C. F. Wheatley: IEEE Broadcast and TV Receiver Conference, Chicago, Illinois, June 17-18, 1963; *IEEE Transactions on Broadcast and Television Receivers*, July 1963

A 19-Inch, 114-Degree, Line-Operated All-Transistor TV Receiver—R. A. Santilli, H. Thanos and C. F. Wheatley: IEEE Broadcast and TV Receiver Conference, Chicago, Illinois, June 17-18, 1963; *IEEE Transactions on Broadcast and Television Receivers*, July 1963

The RCA Integrated Device Program—E. O. Johnson: *Solid/State/Design*, July 1963

The Diffusion of Zn into GaAs to Achieve Low Surface Concentrations - H. Becke, D. Flatley and D. Stolnitz: AIME Metallurgical Society, Boston, Mass., August 26, 1963

Influence of Impurity Dopant in GaAs on Junction Electroluminescence - B. V. Keshavan, M. F. Lamorte and L. J. West: Electronic Materials Committee, IMD, and Boston Section, AIME, August 26-28, 1963

Breakdown Voltage of Graded GaAs p-n Junctions—H. Kressel and A. Blicher: *Journal of Applied Physics*, August 1963

HOME INSTRUMENTS DIVISION

Sound Signal-to-Noise Ratio in Intercarrier Sound Television Receivers - J. Avins: Chicago Spring Conference of the PTGBTR, June 18, 1963

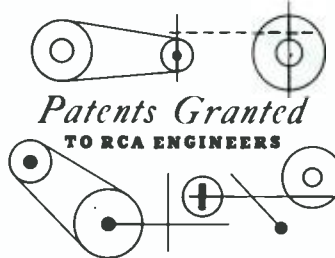

AS REPORTED BY RCA DOMESTIC
PATENTS, PRINCETON

DEFENSE ELECTRONIC PRODUCTS

3,093,771—A.C. Modulator Protective Device, June 11, 1963; R. J. Carl and C. B. Parkinson (assigned to U.S. Government)

3,104,343—Characteristic Ascertaining Circuit, September 17, 1963; E. P. McGrogan, Jr.

ELECTRONIC COMPONENTS AND DEVICES

3,098,553—Tube Cage Orienting and Positioning Apparatus, July 23, 1963; H. Hermanny

3,098,908—Reed Switch, July 23, 1963; A. W. Heath

3,099,081—Braze Jig, July 30, 1963; G. A. Lalak

3,099,764—Photomultiplier Tube, July 30, 1963; A. F. McDonie and R. M. Matheson

3,099,804—High Frequency Negative Resistance, July 30, 1963; D. E. Nelson

3,100,005—Wire Guide for Grid Making Machine, August 6, 1963; O. H. Schade

3,100,158—Methods for Obtaining Films of Magnetic Spinel Crystals on Substrates, August 6, 1963; H. P. Lemaire and W. J. Croft

3,100,329—Solid Capacitors, August 13, 1963; E. J. Sherman

3,101,100—Electron Tube Grid and Method of Making, August 20, 1963; H. J. Albrecht

3,101,428—Electron Discharge Tube and Its Method of Fabrication, August 20, 1963; W. F. Griffin

3,103,283—Apparatus for Feeding Parts, September 10, 1963; W. A. Preuss

DEFENSE ELECTRONIC PRODUCTS

Direct Television Broadcasting Using Earth Satellite Repeaters—D. S. Bond: Astronautics and Aerospace Engineering, Sept. 1963

Calculating Distortion for Complex Waveforms—R. Nuto: *Electronic Equipment Engineering*, August 1963

Accuracy is Improved in Vidicon Bandwidth Tests—J. Pirkle: *Electronics*, September 14, 1962

Worst Case Tolerance and Delay Considerations in Logic Design—R. J. Merkert and Y. C. Lee: *Electronic Design*, March 1, 1963

High-Speed Digital Communication Networks—C. Hammer: *Electronic Industries*, January 1963

The Grounding of Structures - R. F. Ficcki: International Conference and Exhibit on Aerospace Support, August 4, 1963, Washington; *IEEE Trans. on Aerospace*, Aug. 1963

Computer Simulation of Large-scale Data Communication Systems—H. R. Seltzer and E. W. Veitch: International Conference and Exhibit on Aerospace Support, Washington, August 4, 1963; *IEEE Trans. on Aerospace*, Aug. 1963

Solar Simulation and the Continuous Burning Carbon ARC Lamp - R. Carpenter: *MSEE Thesis*, University of Penna., July 1963

Sampled Data Control of a System with a Large Bandwidth/Rotational Velocity Ratio - L. P. Dague: *Thesis*, University of Penna., August 1963

3,103,738—Method of Assembling a Heater Mount, September 17, 1963; J. A. Chase

3,103,741—Materials for and Method of Bonding, September 17, 1963; A. J. Stoekert

3,104,841—Wire Winding Machine, September 24, 1963; C. T. Johnson and I. E. Smith

RCA LABORATORIES

3,099,005—Stabilized Tracking System, July 23, 1963; E. A. Goldberg

3,099,790—Voltage Regulators, July 30, 1963; T. G. Marshall, Jr.

3,100,838—Binary Full Adder Utilizing Integrated Unipolar Transistors, August 13, 1963; M. E. Szekely

3,102,167—Phase-Shifted Double-Sideband Two-Channels A.M. Communications System, August 27, 1963; L. E. Barton

3,102,201—Semiconductor Device for Generating Modulated Infrared Radiation, August 27, 1963; R. Braunstein and E. E. Loebner

3,103,554—Interstate Network Using Cancellation Trap as Effectively Untuned Coupling Between Resonant Circuits, September 10, 1963; J. Avins and B. Fisher

3,104,226—Short Luminescence Delay Time Phosphors, September 17, 1963; C. W. Struck

3,104,729—Stereophonic Sound Reproducing Loudspeaker System, September 24, 1963; H. F. Olson

3,105,113—Stereophonic Loudspeaker System, September 24, 1963; H. F. Olson

3,105,109—Receiver Having Automatic Gain Control Voltage Determined by Burst During Color Reception, September 24, 1963; A. Macovski

RCA VICTOR COMPANY, LTD., MONTREAL

3,099,808—Channel Tuning System for Signal Receivers in Which Tuning Components Assigned to Unselected Channels from Part of Adjacent Channel Traps, July 30, 1963; P. Hobley

HOME INSTRUMENTS DIVISION

3,102,171—Monophonic-Stereophonic Phonograph Cartridge, August 27, 1963; D. E. Laux

3,103,637—Wide Band Electric Tuning Utilizing Diodes, September 10, 1963; W. Y. Pan

ELECTRONIC DATA PROCESSING

3,102,209—Transistor-Negative Resistance Diode Shifting and Counting Circuit, August 27, 1963; A. I. Pressman

3,105,159—Pulse Circuits, September 24, 1963; H. Ditkofsky

Digital Transmission in Media of Variable Time Delay—E. M. Bradburn and F. Assadourian: 7th MIL-E-CON, Washington, D. C., Sept. 10, 1963; *Proceedings*

Nomograms for the Statistical Summation of Noise in Multitap Communications Systems—B. Sheffield: *IEEE PTCGS Transactions*, September 1963

On a Problem in Single Sideband Communications—Dr. J. Dutka: *RCA Review*, September 1963

BROADCAST AND COMMUNICATIONS PRODUCTS DIVISION

Instrumental Factors in the Use of Electron Microscopes—Dr. J. H. Reiser: Electron Microscope Soc. of America, Denver Hilton Hotel, Aug. 28-31, 1963; *Program of EMSA and Journal of Applied Physics*

High Voltage Disturbance, Its Measurement and Effect Upon Image Quality—R. Libbey: Electron Microscope Soc. of America, Denver Hilton Hotel, Aug. 28-31, 1963; *Program of EMSA and Journal of Applied Physics*

FEDERAL GOVERNMENT SYSTEMS SUPPORT

Indexing a Random Access File - W. Rudenhi: RCA Computer Users Association, Buffalo, N. Y., June 3-5, 1963

On the Solution of an Information Retrieval Problem - B. Sams: Spring Joint Computer Conference, Detroit, Mich., April 22-23, 1963

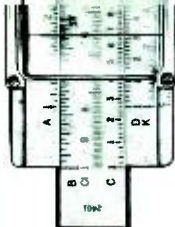

DR. KOZANOWSKI OF B&CP RECEIVES SMPTE AWARD

Dr. Henry N. Kozanowski, Manager of television advanced development, Broadcasts and Communications Products Division, Camden, N. J., will receive the 1963 David Sarnoff Gold Medal Award of the Society of Motion Picture and Television Engineers. The citation with the award notes Dr. Kozanowski's "sustained drive to improve the quality and practical operation of television studio and film camera equipment." Formal presentation of the medal was during the Society's semiannual Technical Conference Oct. 13-18 at Hotel Somerset in Boston.

Dr. Kozanowski took bachelor's and master's degrees in physics at the University of Buffalo in 1927 and 1928. He earned a doctorate in physics in 1930 at the University of Michigan. For the next five years, Dr. Kozanowski was employed in the Westinghouse Research Laboratories. Upon joining RCA in Camden in 1935, he participated in the development of camera equipment and military television. Dr. Kozanowski played a major role in design projects for airborne TV cameras for experimental work in surveillance and missile guidance in World War II.

Among other accomplishments in TV engineering, he is credited with many of the developments that transformed color television cameras from laboratory instruments into practical tools for broadcasters. He received the RCA Victor Award of Merit in 1956.

Dr. Kozanowski is a Fellow of SMPTE and of the IEEE. He is an Associate of The Franklin Institute and a member of the American Physical Society, Phi Beta Kappa, and Sigma Xi.

PROFESSIONAL ENGINEER'S SOCIETY PLANS RESEARCH TO INCREASE ENGINEERING OPPORTUNITIES IN SOUTH JERSEY

The Engineering Society of Southern New Jersey has announced that it is studying and planning a research program to help ad-

SMPTE HONORS QUIROGA OF NBC

Alex Quiroga, color and technical coordinator in Hollywood for National Broadcasting Company, will receive this year's Herbert T. Kalmus Gold Medal Award of the Society of Motion Picture and Television Engineers. The Award—established in 1955 in honor of the developer of the technicolor process—recognizes outstanding technical achievement in color motion pictures for theater or television use.

A graduate of Realgymnasium Meerstern in Switzerland and of Filmakademie Berlin-Ufastadt, Mr. Quiroga is a pioneer in the field of color television. In 1954 he was awarded the Johns Hopkins Television Fellowship. Since 1957, Mr. Quiroga has established a close relationship between film manufacturers, studios, processing laboratories and the NBC television network.

Among his many inventions are the quirogascope, an optical attachment for television cameras to permit the tilting of scenes; a gyrostabilized camera mount, a three-dimensional television system, a videotape editor, and instrumentation in color film reproduction.

Mr. Quiroga is a member of SMPTE, the Optical Society of America, the American Institute of Physics, and the International Color Council.

OBERLANDER RECEIVES 1963 SES FELLOW AWARD

Fred M. Oberlander of Corporate Standardizing, was named as recipient of the 1963 Fellow Award of the Standards Engineers Society. This award was announced at the SES Annual Meeting, in Washington, D. C., September 25, 1963.

GOKHALE SPENDS YEAR IN INDIA FOR U.N.

Madhu Gokhale has returned to DEP Central Engineering, Camden, after spending a year in India for the United Nations Technical Assistance Organization (UNTAO). Mr. Gokhale has worked for RCA since 1930. His UNTAO assignment was to assess the status of standardization in Indian industries and encourage the industries to recognize standardization potential for improving the quality of the national product.

By his lectures, seminars, and personal contacts, Mr. Gokhale worked to convince management groups at various levels of the value of in-plant standardization. Through U.N. sponsored courses, he trained 88 engineers from industries throughout India to form a nucleus of standards engineers. He also trained a counterpart in the Indian Standards Institution to continue to work initiated by him. A former President of the Standards Engineers Society, Mr. Gokhale also was instrumental in starting three chapters of the Society, in Bombay, Calcutta, and Madras.

vance the development of South Jersey by further application of Science and Engineering.

Henry W. Phillips, President of the Society, stated, at the first meeting of the Society for the 1963-64 period at Kenney's Restaurant in Camden, Wednesday evening, September 25th, that the Society recognizes the great need for more diversification of industry to increase the diversity of opportunities for scientists and engineers in the area. He stated that the problem is emphasized by the number of scientists and engineers who are leaving the area for professional assignments in other states. He announced the appointment of a Special Committee, "South Jersey Research Study and Planning Committee," to investigate the problem and develop a plan for action. He stated that a non-profit research activity for public service may result from the study. The activity would cooperate with educational facilities in the area and would draw on professors, engineering society members, retired scientists and engineers, and consultants for talent to perform initial studies and research activities in cooperation with industrial firms, government organizations, and other interested groups. Mr. Phillips is Chairman of the Committee.

W. C. MORRISON APPOINTED CHIEF ENGINEER FOR BCP

Appointment of Wendell C. Morrison as Chief Engineer, Broadcast and Communications Products Division was recently announced by C. H. Colledge, Division Vice President and General Manager. V. E. Trouant, former Chief Engineer, has been named to the post of Chief Technical Administrator for the Division. In his new assignment, Mr. Morrison will direct overall engineering activities for the Division and its product line, which includes radio and television broadcast equipment, microwave communications systems, scientific instruments, two-way mobile radio, Radiomarine equipment



W. C. Morrison

and audio visual products. Mr. Morrison, who has been Assistant to the Chief Defense Engineer of Defense Electronic Products for the past two years, joined RCA at Camden, N. J., in 1940, after receiving his BSEE and MSEE from the University of Iowa.

Two years later, he became a research engineer at the RCA Laboratories, Princeton, N. J. During this period he became a senior member of the technical staff. In 1957, he returned to RCA's Camden facilities as a staff engineer. He became Manager, Engineering Plans and Services, of the former Communications and Controls Division in 1959. Mr. Morrison is a Senior Member of the IEEE. He has long been active with the RCA ENGINEER Advisory Board.

USAF OFFICERS STUDY AT RCA

Electronic Data Processing and Defense Electronic Products are sponsoring a nine-month course on "Automated Data Communications" being given in RCA facilities for six Air Force communications officers. The course is part of the Civilian Institutions Programs of the Air Force Institute of Technology, a component of the Air University.

RCA had previously sponsored two similar courses—"Astronautics and Space Vehicles—Project Management" at the DEP plant in Burlington, Mass. The current course, however, is the first in the Civilian Institutions Programs to be given on data communication equipment and systems techniques.

. . . PROMOTIONS . . . to Engineering Leader & Manager

As reported by your Personnel Activity during the past two months. Location and new supervisor appear in parenthesis.

Home Instruments Division

- E. M. Hinsdale, Jr.:** from Mgr., New Electronic Systems Dev. to *Mgr., TV Prod. Eng.* (L. R. Kirkwood, Eng. Dept.)
R. N. Rhodes: from Mgr. Adv. TV Prod. Dev. to *Mgr., New Electronic Systems* (E. M. Hinsdale, Jr., TV Prod. Dev.)

Aerospace Systems Division—DEP

- F. F. Dupre:** from Sr. Eng. Scientist to *Mgr., Eng. Planning* (H. J. Woll)
S. Franklin: from Prin. Mbr. D&D Eng. Staff to *Ldr., Dev. & Des. Eng. Staff* (R. W. Landee)
F. Marsden: from Sr. Proj. Mbr., Tech. Staff to *Ldr., Tech. Staff* (P. Gibson, AN/TSQ-47 Program)
J. C. Meagher: from Prin. Mbr. D&D Eng. Staff to *Ldr., Dev. & Des. Eng. Staff* (J. J. Murphy)
K. Nanavaty: from Adm., Prgms. Adm. & Control to *Mgr. Prgms. Adm. and Control* (H. Talberth)
A. Rosenberg: from Sr. Pub. Engr. to *Ldr., Publications Engr.* (S. Hersh)
B. H. Scheff: from Sr. Proj. Mbr., Tech. Staff to *Ldr., Tech. Staff* (H. Platt, Data Processing Eng.)

Astro-Electronics Division—DEP

- J. J. Corr:** from Sr. Engr. to *Ldr., Eng. Systems Projects* (B. P. Miller, Ranger Project)
L. A. Freedman: from Engr. to *Ldr., Engineers* (J. E. Dilley, Spec. Camera Systems)
K. Greene: from Engr. to *Ldr., Engineers* (V. R. Monshaw, Program Reliability)
J. Kiesling: from Engr. to *Ldr., Engineers* (R. B. Marsten, Space Communications Systems)
B. P. Miller: from Ldr., Eng. Systems Project to *Mgr., Ranger Proj.* (R. E. Hogan, System Program Management)
E. Miller: from Eng. Ldr. to *Mgr., Apollo TV Project* (C. S. Constantino, Equip. Projects)
J. E. Mortimer: from Engr. to *Ldr., Engineers* (S. H. Fairweather, Propulsion Systems)
S. J. Rand: from Engr. to *Ldr., Engineers* (M. H. Mesner, TV Camera Systems Projects)
R. A. Smith: from Engr. to *Ldr., Engineers* (V. R. Monshaw, Program Reliability)
J. R. Staniszwski: from Sr. Engr. to *Ldr., Eng. Systems Projects* (B. P. Miller, Ranger Project)
N. Weintraub: from Ldr., Engineers to *Mgr., Tape Recorder Eng.* (R. B. Marsten, Space Comm. Systems)

Applied Research—DEP

- M. B. Herscher:** from Engr. to *Ldr., D&D* (E. E. Moore, Signal Processing)
R. F. Kenville: from Engr. to *Ldr., D&D* (W. R. Isom, Electro-Mechanics)
F. E. Shashoua: from Ldr. to *Mgr., Electro-Optics & Thermoelectrics* (D. J. Parker, App. Res.)
D. J. Woywood: from Engr. to *Ldr., D&D* (F. E. Shashoua, Electro-Optics & Thermoelectrics)

Communications Systems Division—DEP

- R. C. Bitting:** returning from MIT Sloan Program to *Mgr., Data Communications Programs*

M&SR ALIGNS ORGANIZATION WITH NEW DOD AND NASA CONCEPTS

The DEP Missile and Surface Radar Division, Moorestown, N. J., has realigned to conform with the new DOD and NASA organizational and procurement concepts. **J. H. Sidebottom**, Division Vice President, said the action of the Department of Defense in paralleling Army, Navy, and Air Force weapon requirements into single programs called *military missions* and the DOD's new concept of big-systems management were important considerations in the changes. Under the new alignment, three project-management organizations will handle the Division's business:

Range Systems Programs will be headed by **E. W. Petrillo** with responsibility for high-accuracy instrumentation radars, the AN/FPS-16 and AN/FPQ-6, and other instrumentation radar projects.

Strategic and Defensive Systems Programs will handle such programs as the TRADEX radar project and RCA's remaining effort on BMEWS. It will be managed by **Avrel Mason**.

The third project-management organization is *Tactical Systems Programs*, managed by **W. H. Congdon**. Army tactical radars and missile systems, Navy shipboard missile systems, and similar programs will be the responsibility of this group.

In addition, an *Advanced Systems Group*, under the direction of **N. N. Alperin**, has been established in Engineering to develop concepts for new business not directly related to present programs.

- J. J. Connelly:** from Engr. to *Ldr., D&D* (N. E. Edwards, Ground Comm. Equip.)

Missile & Surface Radar Division—DEP

- A. Gold:** from Eng. Ldr. to *Mgr., Re-entry Analysis* (E. Gerjuoy, Plasma & Space)

RCA International Division—Clark

- F. Harris:** from Ldr. Comm. Eng. to *Mgr., TV & Broadcast Eng.*
K. W. Mitchell: from Sr. Comm. Engr. to *Ldr., Comm. Eng.* (C. A. Passavant, CENTO Telecomm. Projs.)

RCA Service Co.

- G. W. Crouch:** from Engr. Elec. BMEWS to *Ldr., Engineers BMEWS* (A. H. Shepherd, Fac. Eng. Oper. & Maintenance)
A. B. Freeman: from Engr.—BMEWS to *Ldr., Engineers BMEWS* (J. Vilmerding, Site I Eng.)
R. N. Giles: from Field Engr. to *Ldr., Field Svc. Eng.* (W. G. Kolter, Missile Test)
J. O. Kessinger: from Ldr., Engineers to *Mgr. Engineers* (T. E. Duce, Eng. Support Missile Test Proj.)
W. E. Martin: from Engr. to *Mgr., Optics, Eng.* (H. Reese, Jr., Nuclear & Scientific Svcs.)
E. B. Ray: from Assoc. Engr. to *Mgr., Tech. Support NASA/DAF* (R. A. Orth)

Electronic Data Processing

- J. P. Brennan, Jr.:** from Engr. to *Ldr., D&D Eng.* (R. A. Alexander, Common Components & Stds. Eng.)
R. Gollub: to *Mgr., Computer Systems Eng.* (R. E. Montijo, Mgr., Systems Eng.)
R. F. Small: from Mgr., Drafting Design to *Mgr., Technical Svcs.* (H. Kleinberg, Eng.) West Palm Beach

STAFF ANNOUNCEMENTS

Broadcast and Communications Products Division: **C. H. Colledge**, Division Vice President and General Manager, announces the organization of the Broadcast and Communications Products Division as follows: **N. R. Amberg**, Mgr., Industrial and Automation Products Department; **T. J. Barlow**, Mgr., Production Department; **W. R. Fitzpatrick**, Mgr., Personnel; **J. F. Groark**, Controller, Finance; **E. J. Hart**, Mgr., Microwave Department; **A. F. Inglis**, Division Vice President, Communications Products Operations; **A. M. Miller**, Mgr., Broadcast Merchandising and West Coast Operations; **W. C. Morrison**, Chief Engineer, Engineering Department; **J. P. Taylor**, Mgr., Marketing Services; **E. C. Tracy**, Mgr., Broadcast, Technical and Scientific Sales Department; **M. A. Trainer**, Mgr., International Liaison and Customer Relations; and **V. E. Trouant**, Chief Technical Administrator.

V. E. Trouant, Chief Technical Administrator, B&CPD, announces his staff as follows: **W. R. Johnson**, Mgr., Engineering Services; **D. R. Pratt**, Mgr., Technical Publications; **G. G. Zappasodi**, Mgr., Packing Design; and **A. E. Garrod**, Mgr., Drafting.

W. C. Morrison, Chief Engineer, B&CPD, announces the organization of the Engineering Department as follows: **F. C. Blanche**, Coordinator, Mechanical Design; **N. C. Colby**, Mgr., Meadow Lands Engineering; **H. N. Kozanowski**, Mgr., TV Product Advanced Development; **A. H. Lind**, Mgr., Studio and Scientific Instruments Engineering; **H. S. Wilson**, Mgr., Microwave Engineering; and **J. E. Young**, Mgr., Broadcast Transmitting Equipment Engineering.

DEP Communications Systems Division: **S. W. Cochran**, Division Vice President and General Manager, announces the organization of the DEP Communications Systems Division as follows: **M. R. Amsler**, Mgr., Marketing Department; **R. C. Bitting**, Mgr., Data Communications Programs; **O. B. Cunningham**, Chief Engineer, Engineering Department; **J. A. Doughty**, Mgr., Proposals and Presentations; **R. W. Greenwood**, Mgr., Operations Control; **C. K. Law**, Mgr., Airborne Communications Programs; **C. M. Ledig**, Mgr., Quick Reaction Facilities; **J. M. Osborne**, Mgr., MINUTEMAN Program; **C. A. Steuernagel**, Mgr., Communications Systems Manufacturing; **T. J. Tsevdos**, Mgr., Ground Communications Programs; and **J. D. Woodward**, Mgr., Product Assurance Quality Control.

Electronic Components and Devices: **E. E. Spitzer**, Mgr., Power Tube Operations Department, announces his staff as follows: **W. P. Bennett**, Mgr., Advanced Development Engineering—Power Tubes and Space Components; **J. J. Fencel**, Mgr., Regular Power Tube Manufacturing; **C. Hanlon**, Mgr., Super Power Tube Manufacturing; **J. W. Hollingsworth**, Mgr., Quality Control—Power Tube Operations; **R. T. Rihn**, Mgr., Operations Planning and Controls—Power Tube; **M. B. Shrader**, Mgr., Product Engineering—Power Tubes and Space Components; and **P. T. Smith**, Mgr., Power Tube Applied Research Laboratory—Princeton.

DEP Applied Research, Camden: **F. E. Shashoua** has been named as Manager, Electro-optics and Thermoelectrics, by **D. J. Parker**, Mgr., DEP Applied Research, Camden, N. J. In this newly created position, Mr. Shashoua is responsible for the advanced thermoelectric techniques and electro-optics systems.

PROFESSIONAL ACTIVITIES

RCA Victor Research Laboratories, Montreal: **Dr. F. G. R. Warren**, Laboratory Director, Systems Research, was appointed for a further term, Chairman, Montreal Joint Chapter of the IEEE Professional Technical Group on Microwave Theory and Techniques, Antennas and Propagation. **Dr. R. W. Jackson**, Laboratory Director, Solid State Physics, was Chairman of Symposium on Industrial Research, Canadian Association of Physicist's Annual Meeting, Quebec. **Dr. H. Pullan**, Head, Infrared Group, participated in half-hour television program "The Infrared" on the Canadian Broadcasting Corporation series "The Nature of Things." **Dr. G. G. Cloutier**, Microwave and Plasma Physics Group, gave a series of invited lectures on Magnetofluid and Plasma Dynamics at the University of California Summer Course.—*J. Russell*

DEP-ASD, Van Nuys, Calif.: **W. H. Miller**, Principal Member, Engineering Staff, DSD, has been installed as President of the San Fernando Valley Chapter, California Society of Professional Engineers, National Society of Professional Engineers. **Robert Goss**, Manager, Plant Engineering, DSD, has been installed as 2nd Vice-President.

DEP-MSR Moorestown, N. J.: **Karl Seiler** of SEER was on special assignment in California for two months at the request of the USAF to participate in its Project FORECAST studies.—*I. N. Brown*

Corey Roerdomp, Lou DiPaolo, and W. F. Meyer (all Eng. Writers) recently completed a training course in Eng. Writing given at the Moorestown plant. The course consisted of nine two-hour sessions and several half-hour individual consultations. It was conducted by Assistant Prof. Robert Welsh of the Drexel English Department. The course content focussed on basic writing skills, covered report structure, and included workshop writing sessions in class as well as homework assignments. Approximately twenty engineers and writers attended the course.—*W. F. Meyer*

BCD, Camden, N. J.: **M. K. Wilder** was elected Secretary of the PTGCS Philadelphia Section of the IEEE for 1963-64 term.—*D. Hymas*

Data Systems Center, Bethesda, Md.: **Sidney Kaplan** was the RCA representative at the Conference on Libraries and Automation, held at Airlie Foundation, Warrenton, Virginia. **Milton Goldin** was appointed National Chairman of the Membership Committee of the Society for Information Display.—*J. Carter*

Jack Minker is serving on the Program Committee for the 1964 Association for Computing Machinery Spring Joint Computer Conference to be held in Washington, D. C.

DEP-ASD, Burlington, Mass.: An engineering seminar on Integrated Electronics was held in Burlington. The speakers were

E. O. Johnson and **R. D. Lohman** from ECD Somerville. Mr. Lohman discussed those factors which have led to smaller and more reliable circuit packaging techniques. The major portion of Mr. Lohman's talk was concerned with the metal oxide semiconductor (MOS) and its application to integrated circuits.

E. Kornstein was the after-dinner speaker at the Post Chairman's night meeting of the St. Louis Section of the IEEE. The talk was "Lasers—Present and Future."

E. Kornstein was recently elected to the Board of Governors of the Boston Section of the Society of Motion Picture and Television Engineers.

Alfred R. Pelletier, Senior Member, Technical Staff, was Chairman of the Acoustic Session at the Institute of Environmental Sciences, 1963 Annual Technical Meeting, at Los Angeles, Calif. Mr. Pelletier also delivered a lecture entitled "An Introduction to Basic Acoustic Fundamentals as Applied to Acoustic Testing in the Laboratory."—*R. E. Glendon*

B. H. Scheff participated in an IEEE Workshop on Programming Languages for Automatic Checkout Equipment held at Columbus, Ohio.—*D. Dobson*

RCA Communications, N. Y.: **David S. Rau** has been elected Chairman of the IEEE Professional Technical Group on Communication Systems for 1963-64.—*W. C. Jackson*

ECD, Harrison, N. J.: **Thomas F. Berry**, a Senior Engineer in the Chemical and Physical Laboratory of Electronic Components and Devices, Harrison, was recently elected Vice-Chairman of the Metropolitan New York Section of the American Ceramic Society.

Toastmasters is an international organization devoted to the improvement of its members' skills in public speaking. The Torca Chapter, located at Electronic Components and Devices, Harrison location, is starting its second year of operation. New officers were recently installed and are as follows: **Dr. I. F. Stacy** (President), **E. Ratyniak, J. A. Kohanski, D. H. King, W. Griffin, M. J. Fath, and R. Anderson.**—*I. F. Stacy*

RCA Labs, Princeton, N. J.: Certificates have been presented to 21 members of the Laboratories who successfully completed the RCA Institutes transistor Course conducted at the Laboratories. In awarding the certificates, **H. W. Leverenz**, Associate Director of RCA Laboratories, commended the group for their interest in keeping pace with the changing technology in the electronics field. He also complimented **Paul Schnitzler** of the technical staff, who served as instructor for the Course, for the important part that he played in the success of the program. The Course was offered through the Personnel training activity with **Robert Craig** serving as coordinator.—*C. W. Sall*

RCA Service Co., Patrick AFB, Fla.: **John Stephenson** was in Washington, D. C., September 16-18 accompanying Air Force and PAA personnel to discuss data reduction techniques, ships positioning, least squares analysis and MISTRAM.

Joe Kirklin of Systems Programming was invited to participate on a panel discussing IBM Operating System (IBSYS) experience at AMR, at the Association for Computing Machinery Regional Meeting in Atlanta, Georgia, September 20-21. **Dr. Garrett**, Manager, Mathematical Services, also attended.

Warren Dryden (who is the Chairman of the Electromagnetic Propagation Working Group of the Inter-Range Instrumentation Group) was in San Francisco the week of September 13, attending the semiannual meeting of the steering committee of the IRIG.—*W. L. Strayer*

DEP-CSD, Tucson, Ariz.: **Dr. Martin L. Touger**, Mgr. Engineering, was reappointed as a member of the NRC Committee on Hearing and Bio-Acoustics by the President of the National Academy of Sciences—National Research Council.—*J. F. Gibbings*

DEP-CSD, Cambridge, Ohio: At its annual meeting in March, the IEEE Professional Technical Group on Product Engineering and Production re-elected **P. J. Riley** to a second 3-year term on its National Administrative Committee. He was also reappointed National Meeting Chairman for the group and again will be responsible for the group's technical presentation at the International Convention in 1964.

DEP-CSD, Camden, N. J.: **C. W. Fields**, Communications Systems Division, Camden, has been elected Vice Chairman, IEEE Professional Technical Group on Engineering Writing and Speech, Philadelphia Chapter.

R. F. Trump was elected as associate member of Society of Sigma Xi, national honorary society of research scientists, on the basis of his graduate work at University of Pennsylvania. Thesis title: "Matching Network for High-Power Transmitting Networks."—*C. W. Fields*

DEP-CSD, N. Y.: **S. J. Mehlman** and **B. Sheffield** attended a one-week seminar in Space Communications given by the Polytechnic Institute of Brooklyn at their Graduate Center in Farmingdale, L. I.

New York Systems Lab will be represented by a new slate of Eta Kappa Nu (Electrical Engineering Honor Society) New York Alumni Chapter: President 1963-64, **B. Sheffield**, Vice President, **D. Douglas**, Bridge Correspondent, **E. Markard**, and Chairman Programs, **Leonard Pugliese**.

W. H. Buchsbaum has been appointed lecturer in the Graduate School of the Brooklyn Polytechnic Institute. During the 1963 fall semester, he will teach Courses EE 855, Monochrome and Color Television Theory.—*M. Rosenthal*

**AEROSPACE INFORMATION CENTER
SERVICES AVAILABLE FOR RCA USE**

RCA is one of 27 charter members of the *Aerospace Research Applications Center* (ARAC) at Indiana University. ARAC was established through a grant from NASA to fulfill one of the objectives of the Space Act of 1958—the dissemination to industry of information gained in research paid for by NASA. Because it handles only unclassified information, ARAC requires no “need to

know” in the two types of service—*Reference* and *Flash Sheet*—it furnishes.

The *Reference Service* is basically a NASA library of technical documents with an information storage and retrieval system—both manual and machine. Data accumulated by NASA and the American Institute of Aeronautics and Astronautics—trade publications, reference books, and various types of technical reports—are furnished to ARAC by NASA’s Office of Scientific and Technical Information to be indexed and abstracted. When personnel from member companies submit search requests, ARAC supplies them with abstracts in the pertinent fields. Up to 25 descriptors can be accepted by the ARAC machine system. From these abstracts, the requestor can then specify exactly which reports he wants copies of.

The *Flash Sheet Service* is intended to speed information on significant innovations, manufacturing techniques, etc. After screening the flash sheets for quality of content and potential patent problems, NASA forwards the flash sheets to ARAC which sends abstracts of them to the member companies. If a member company sees a potential use for the innovation, additional detail can be furnished by ARAC. License arrangements for use are not handled by ARAC and would require negotiation between RCA and the holders of the patent rights.

Within RCA, the ARAC program is being coordinated by **R. W. Horn**, Corporate Planning, Camden 2-7. Twelve ARAC “interest centers” have been set up with the following individuals in charge: **Clyde Hoyt**, Home Instruments, Indianapolis, Ind.; **W. M. James**, ECD, Harrison, N. J.; **H. V. Knauf**, ECD, Somerville, N. J.; **M. W. Tilden**, RCA Service Co., Cherry Hill, N. J.; **C. C. Foster**, and **C. Price Smith**, RCA Laboratories, Princeton, N. J.; and the following persons in Camden: **R. E. Montijo**, EDP, 10-2; **E. H. Panczner**, Production Engineering, 2-3; **V. E. Trouant**, BCP, 15-7; **Dr. H. J. Watters**, Chief Defense Engineer, 2-5; and **Miss J. M. Steever**, DEP Librarian, 10-2.

The DEP library in Camden has been selected as the RCA clearing house for forwarding search requests to ARAC. It is co-operating with the other RCA libraries to make the ARAC services available throughout the Corporation. To use the ARAC services, RCA employees should contact their nearest Company library or ARAC “interest center.”



**J. DI MAURO NAMED ED REP FOR ECD
MICROELECTRONICS, SOMERVILLE**

Joseph DiMauro has replaced **J. L. Swentzel** as Editorial Representative for the Microelectronics Department, RCA Electronic Components and Devices, Somerville, N. J.

Mr. DiMauro received a BME in 1950, from the Polytechnic Institute of Brooklyn. He began his professional career in 1950 with the Thomas A. Edison Company, West Orange, New Jersey. In May, 1953, he joined the Electron Tube Division of RCA, Harrison, New Jersey, as an equipment development engineer. Mr. DiMauro was also assigned administrative duties in connection with the initiation, preparation, processing, and follow-up of all equipment development requests for electrical and mechanical equipment. Mr. DiMauro joined the Semiconductor and Materials Division of RCA, Somerville, New Jersey, in February 1961, in the Microelectronics Department, now a part of the Special Electronic Components Division of EC&D. He has been assigned as project engineer responsible for all technical services including: scheduling, budgeting, and delivery of technical, manpower, and contract financial status reports under the U. S. Signal Corps Micromodule Contract; preparation of cost estimates for all microelectronics publishing and writing projects such as proposals, brochures, engineering data bulletins and other technical promotion material; and Quality Control Engineering on Micromodule manufacturing processes. Mr. DiMauro is a registered New Jersey Professional Engineer. He has been awarded a U. S. Patent.

DR. NICOLL TO STUDY ABROAD

Dr. Frederick H. Nicoll, a Senior Member of the technical staff of RCA Laboratories, left for England on August 9 for a year of study and research at the University of Cambridge. He is the eighth RCA scientist to be offered the opportunity of studying abroad under an RCA Laboratories program established in 1954. At Cambridge he will be engaged in a program of study in the field of solid-state physics at the Cavendish Laboratory.

**DR. ENGSTROM HONORED BY
AEROSPACE ELECTRICAL SOCIETY**

Dr. Elmer W. Engstrom, President, RCA, was honored on Oct. 9, 1963, by the Aerospace Electrical Society for his outstanding contributions to development of electronic data collection and dissemination equipment for simplifying and speeding management techniques in the aerospace industry. It is being made with specific reference to the development by Lockheed Aircraft Corporation and RCA of an electronic data acquisition system to report production information direct from missile and space vehicle assembly lines to top management hundreds of miles away in fractions of a second.

**SEISMIC NOISE AMPLIFIER
CONFERENCE HELD AT RCA LABS**

A two-day conference was held at RCA Laboratories on September 5 and 6 to discuss the measurement and description of inherent noise in amplifiers used in seismic detection systems. Organized under the auspices of **Lt. Colonel W. J. Best**, Chief of the Geophysics Division of the Air Force Office of Scientific Research, the conference included representatives from groups participating in Project Vela Uniform and from companies engaged in the manufacture of amplifiers for seismic detection. Project VELA UNIFORM is a research project aimed at improving the capabilities for detecting underground explosions.

RCA Laboratories staff members taking part in the conferences included **Harold Blatter**, **John T. Fischer**, and **Dr. Donald S. McCoy**.

**KREMLIN-WASHINGTON "HOT LINE"
RADIO CIRCUIT TO BE BUILT BY
RCA COMMUNICATIONS, INC.**

A contract to provide the radio “hot line” circuit between Washington, D. C., and the Kremlin has been awarded to RCA Communications, Inc. The radio teletypewriter link operating at the standard speed of 66 words a minute will provide the most direct available contact between the two heads of state. To assure maximum reliability, RCA Communications will use its powerful Tangier relay station to provide automatic electronic regeneration and boosting of the signals in both directions. The circuit will parallel a cable circuit connecting Washington and Moscow via London, Copenhagen, Stockholm, and Helsinki.

RCA has operated record communications circuits with the Soviet Union since 1930. It was the first American company to establish direct telegraph communications with the U.S.S.R.

Clip out and Mail to Editor, RCA ENGINEER, #2-8, Camden

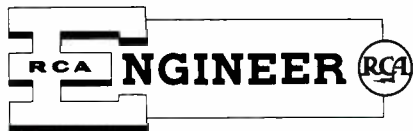

HAVE WE YOUR CORRECT ADDRESS?

If not indicate the change below.

PLEASE INDICATE THE CODE LETTER(S) THAT
APPEAR NEXT TO YOUR NAME ON THE ENVELOPE.

Name _____ Code _____

Street or Bldg _____

City and State or Plant _____

Editorial Representatives

The Editorial Representative in your group is the one you should contact in scheduling technical papers and announcements of your professional activities.

DEFENSE ELECTRONIC PRODUCTS

F. D. WHITMORE *Chairman, Editorial Board, Camden, N. J.*

Editorial Representatives

Aerospace Systems Division

D. B. DOBSON *Systems Support Eng., Burlington, Mass.*
R. B. GLENDON *Technical Administration, Burlington, Mass.*
S. HERSH *Data Systems Eng., Van Nuys, Calif.*

Astro-Electronics Division

I. SEIDEMAN *Engineering, Princeton, N. J.*

Missile & Surface Radar Division

I. N. BROWN *Systems Engineering, Moorestown, N. J.*
T. G. GREENE *Engineering Dept., Moorestown, N. J.*

Communications Systems Division

C. W. FIELDS *Engineering, Camden, N. J.*
J. F. GIBBINGS *Systems Labs., Tucson, Ariz.*
G. LIEBERMAN *Systems Engineering, Camden, N. J.*
W. C. PRAEGER *Engineering, Cambridge, Ohio*
M. P. ROSENTHAL *Systems Labs., New York, N. Y.*

Defense Engineering

J. J. LAMB *Central Engineering, Camden, N. J.*
G. E. MORRIS *Advanced Military Systems, Princeton, N. J.*
M. G. PIETZ *Applied Research, Camden, N. J.*

FEDERAL GOVERNMENT SYSTEMS SUPPORT

H. J. CARTER *Data Systems Center, Bethesda, Md.*

BROADCAST AND COMMUNICATIONS PRODUCTS DIVISION

D. R. PRATT *Chairman, Editorial Board, Camden, N. J.*

Editorial Representatives

N. C. COLBY *Mobile Communications Engineering, Meadow Lands, Pa.*
H. E. GHIRING *Brdcst. Transmitter & Antenna Eng., Gibbsboro, N. J.*
C. E. HITTLE *Closed Circuit TV & Film Recording Dept., Burbank, Calif.*
D. G. HYMAS *Microwave Engineering, Camden, N. J.*
R. N. HURST *Studio, Recording, & Scientific Equip. Engineering, Camden, N. J.*
D. H. McCONNELL *Industrial & Automation Products Engineering, Plymouth, Mich.*

ELECTRONIC DATA PROCESSING

T. T. PATTERSON *Technical Publications Administrator, EDP, Camden, N. J.*
R. R. HEMP *Palm Beach Engineering, West Palm Beach, Fla.*
B. SINGER *Data Communications Engineering, Camden, N. J.*
H. H. SPENCER *Computer Advanced Development, Pennsauken, N. J.*

ELECTRONIC COMPONENTS AND DEVICES

J. F. HIRLINGER *Chairman, Editorial Board, Harrison, N. J.*

Editorial Representatives

Commercial Receiving Tube & Semiconductor Division

H. J. CARTER *Semiconductor Operations, Somerville, N. J.*
P. L. FARINA *Receiving Tube Operations, Harrison, N. J.*
J. KOFF *Receiving Tube Operations, Woodbridge, N. J.*
G. R. KORNFELD *Memory Products Dept., Needham and Natick, Mass.*
R. J. MASON *Receiving Tube Operations, Cincinnati, Ohio*
J. D. YOUNG *Semiconductor Operations, Findlay, Ohio*

Television Picture Tube Division

J. D. ASHWORTH *Television Picture Tube Operations, Lancaster, Pa.*
J. H. LIPSCOMBE *Television Picture Tube Operations, Marion, Ind.*

Industrial Tube & Semiconductor Division

H. J. CARTER *Semiconductor Operations, Somerville, N. J.*
R. L. KAUFFMAN *Conversion Tube Operations, Lancaster, Pa.*
M. N. SLATER *Semiconductor and Conversion Tube Operations, Mountaintop, Pa.*
G. G. THOMAS *Power Tube Operations and Operations Svcs., Lancaster, Pa.*
H. J. WOLKSTEIN *Microwave Tube Operations, Harrison, N. J. and Los Angeles, Calif.*

Special Electronic Components Division

P. L. FARINA *Direct Energy Conversion Dept., Harrison, N. J.*
J. DiMAURO *Microelectronics Dept., Somerville, N. J.*

RCA VICTOR HOME INSTRUMENTS

K. A. CHITTICK *Chairman, Editorial Board, Indianapolis*

Editorial Representatives

J. J. ARMSTRONG *Resident Eng., Bloomington, Ind.*
D. J. CARLSON *Advanced Devel., Princeton, N. J.*
R. C. GRAHAM *Radio "Victrola" Product Eng., Indianapolis, Ind.*
P. G. McCABE *TV Product Eng., Indianapolis, Ind.*
J. OSMAN *Electromech. Product Eng., Indianapolis, Ind.*
L. R. WOLTER *TV Product Eng., Indianapolis, Ind.*

RCA SERVICE COMPANY

A. L. CHRISTEN *EDP Svc. Dept., Cherry Hill, N. J.*
W. W. COOK *Consumer Products Svc. Dept., Cherry Hill, N. J.*
E. STANKO *Tech. Products Svc. Dept., Cherry Hill, N. J.*
M. W. TILDEN *Govt. Svc. Dept., Cherry Hill, N. J.*

RCA COMMUNICATIONS, INC.

W. C. JACKSON *RCA Communications, Inc., New York, N. Y.*

RCA VICTOR RECORD DIVISION

M. L. WHITEHURST *Record Eng., Indianapolis, Ind.*

NATIONAL BROADCASTING COMPANY, INC.

W. A. HOWARD *Staff Eng., New York, N. Y.*

RCA INTERNATIONAL DIVISION

L. S. BEENY *Clark, N. J.*

RCA VICTOR COMPANY, LTD.

H. J. RUSSELL *Research & Eng., Montreal, Canada*

RCA LABORATORIES

C. W. SALL *Research, Princeton, N. J.*

ENGINEER

A TECHNICAL JOURNAL PUBLISHED
BY PRODUCT ENGINEERING.
"BY AND FOR THE RCA ENGINEER"

RADIO CORPORATION OF AMERICA