

OBJECTIVES

To disseminate to RCA engineers technical information of professional value.

To publish in an appropriate manner important technical developments at RCA, and the role of the engineer.

To serve as a medium of interchange of technical information between various engineering groups at RCA.

To create a community of engineering interest within the company by stressing the interrelated nature of all technical contributions.

To help publicize engineering achievements in a manner that will promote the interests and reputation of RCA in the engineering field.

To provide a convenient means by which the RCA engineer may review his professional work before associates and engineering management.

To announce outstanding and unusual achievements of RCA engineers in a manner most likely to enhance their prestige and professional status.



OUR COVER

... RCA computers and some of the engineers behind them in the EDP Division . . .

TOP: New packaging for computer plug-ins, with J. E. Palmer, Leader, Design and Development Engineers.

CENTER: A prototype console for a large-scale computing system, with J. L. Owings, (r.), Manager, Auto-Data Engineering, G. H. Williams (c.), and A. S. Rettig, (l.), Leader, Design and Development Engineers.

BOTTOM: K. Kaufmann, (c.), Leader, Design and Development Engineers, illustrates mechanical design of the ComLogNet Communication Data Processor to R. A. Alexander, (r.), Manager, Equipment Design Engineering, and J. Pogson (l.).

RCA's Electronic Data Processing Engineering Has Come of Age!

The electronic data processing field today encompasses the three C's of industrial electronics — *Computers, Communications, and Controls*. From the start, engineers of the Electronic Data Processing Division have had an active part in this development. Over forty RCA 501 Systems are now in operation; the first RCA 301 System will be in use early in 1961, with the RCA 601 Systems soon to follow. Also in 1961, the first of five centers for the U. S. Air Force's ComLogNet System will be delivered. The MUX/ARQ, EDGE, and DaSPAN Systems have already been completed — first phases in a product line of data communications equipment which will include data collection, data transmission, and data switching.

The new field of industrial computers has been successfully broached with the installation of the first RCA 110. In addition to the research and development work on a 1000-mc computer now being successfully prosecuted, many special applications of standard equipment for the military and industry are being developed. Major strides have been made in the field of character recognition and high-speed printing. Important effort is aimed at the great potential, as yet unrealized, in information storage and retrieval.

However impressive these achievements are, they are but the beginning. Mr. John L. Burns, President of RCA, has stated that in ten years he expects RCA's yearly revenues in the data processing field to equal the present combined dollar value for all RCA products. Obviously, this will require a tremendous expansion in facilities and manpower. It also provides a great challenge to all engineers, for even at this early stage in the rapidly expanding field, competition is very keen. We can expect this competition to become more real, thus placing a premium on low cost and high performance.

To engineers, this will mean the conception of many new practical systems, components, and techniques, while achieving greater efficiency in applying engineering effort and reaching seemingly impossible goals of low cost and high performance. Even more important to engineers will be the added challenge of developing and producing better electronic tools for use by the U. S. Government and industry in the ever-present need of making the United States stronger.

It is my hope that the articles herein will give you a better picture of our accomplishments and future expectations in the Electronic Data Processing Division.

J. Wesley Leas*

Manager
Data Communications and Custom
Projects Department
Electronic Data Processing Division
Industrial Electronic Products
Radio Corporation of America

* Formerly Chief Engineer, EDP Division, IEP.



CONTENTS

The Engineer and the Corporation: A New Look at Scheduling	W. A. Portouw and E. J. Shuppas	2
RCA and Commercial Computer Systems	H. M. Elliott	5
The RCA 301: Flexibility at Low Cost—An Engineering Challenge. . .	H. Kleinberg	8
Development of a 1000-Mc Computer	R. K. Lockhart	11
The RCA 110: A Pioneer Industrial Control Computer.	R. W. Sonnenfeldt	14
Installing and Maintaining RCA Computer Systems. .H. Mogensen and J. J. Lawler		17
Dynamics of Information in Manufacturing—Factors Behind a Computer Application	W. K. Halstead	20
Computer Research—Its Impact Today and Tomorrow.....	J. N. Marshall	22
Semiconductor-Junction Nuclear-Particle Detectors.	Dr. R. W. Jackson	25
New Approaches to the Study of Cathode Nickel.....	W. G. Rudy	28
Mechanized Production of Color Picture Tubes	E. H. Loomis	30
Fracture Analysis for Glass Breakage Problems.....	J. F. McKenna	34
DATS—Dynamic Accuracy Test System—for Air-Borne Fire-Control Systems	E. R. Campbell, Jr., and O. T. Carver	37
A Packaged Micromodule Laboratory for Industry.....	D. T. Levy	40
Pen and Podium		44
Patents Granted		45
Engineering News and Highlights		46

VOL. 6, NO. 4 • DEC. 1960-JAN. 1961

Copyright 1960
Radio Corporation of America
All Rights Reserved

PRINTED
IN
U.S.A.

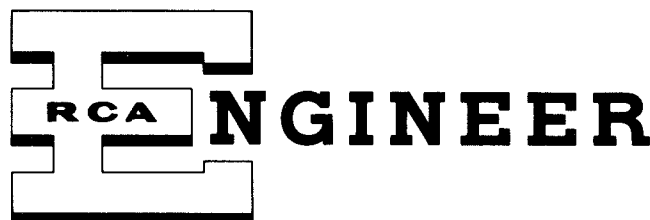

The logo features the letters 'RCA' in a bold, sans-serif font, enclosed within a stylized, blocky letter 'E'. To the right of this graphic, the word 'ENGINEER' is written in a large, bold, sans-serif font.

Editorial Advisory Board

E. I. Anderson, Chief Engineer,
RCA Victor Home Instruments

J. J. Brant, Director, Personnel

C. C. Foster, Mgr., RCA REVIEW

M. G. Gander, Mgr., TV and Radio Engineering
RCA Service Co.

C. A. Gunther, Chief Defense Engineer,
Defense Electronic Products

J. Haber, Director, Community Relations

E. O. Johnson, Chief Engineer,
Semiconductor and Materials Division

W. C. Morrison, Mgr., Engineering Plans &
Services, Industrial Electronic Products

J. C. Rankin, Mgr., General Employment

H. E. Roys, Chief Engineer,
RCA Victor Record Division

D. F. Schmit, Vice President, Product Engineering

Dr. G. R. Shaw, Chief Engineer,
Electron Tube Division

C. M. Sinnett, Director, Product Engineering
Professional Development

RCA ENGINEER Staff

W. O. Hadlock, Editor

E. R. Jennings, Assistant Editor

J. L. Parvin, Art and Production

J. O. Gaynor, Photography

Engineering Editors

K. A. Chittick, Mgr.,
Engineering Administration,
RCA Victor Home Instruments

S. F. Dierk, Technical Publications Administrator,
Industrial Electronic Products

C. A. Meyer, Mgr., Commercial Engineering
Technical Services, Electron Tube Division

L. A. Thomas, Mgr., Technical Services,
Astro-Electronics Division,
Defense Electronic Products

F. D. Whitmore, Technical Publications
Administrator, Defense Electronic Products

IS THE PROJECT on schedule? Engineering groups must often answer this question—quickly, factually, and with a minimum of effort. To provide the answer, a technique is required to tell at all times where the project *is* and where it *should be*.

Improved scheduling and control techniques are of primary importance to engineering today, because of the ever-increasing complexity of electronic systems and the very-competitive nature of the industry. There is no justification for missing schedule dates if problems causing delays can be foreseen with a good method of scheduling and control. Most ideal is a method of control that graphically indicates the *significant* factors of over-all project status and highlights

The Engineer and the Corporation

A NEW LOOK AT SCHEDULING

by W. A. PORTOUW and E. J. SHUPPAS

Surface Communications Division, DEP, Camden, N. J.

problem areas. Such a technique, *Line of Balance*, is currently being utilized effectively in the DEP Surface Communications Division for monitoring research and development, and production programs. It is a technique perfected by the Office of Naval Material, U. S. Navy, for the *Polaris* program that meets the objectives of an ideal method of status reporting.

BASIC CONCEPTS

Line of Balance is a newspaper-headline type of reporting to management that quickly points out in graphic form deficiencies or delinquencies in progress or cost that are not in accord with the plan. It utilizes the principal of "exception" to show only the most important facts to its audience. It is a technique for assembling, selecting, interpreting, and presenting in graphic form the essential factors involved in a program from the design or raw-material stage to the end product, against a background of time requirements.

It indicates how well the various phases of a project are synchronized, by setting forth time relationships between various elements of a project. Since it is a positive means for determining areas needing corrective action, successively updated studies provide checks on the effectiveness of remedial measures.

APPLICATION TO AN ENGINEERING PROJECT

The SurfCom Programming activity has taken the basic concept of Line of Balance and refined and tailored the technique to suit specific needs. The experience gained in adapting the technique to a wide variety of projects, both engineering and production, has developed distinct major steps for a study.

Plan

The first and most important step is to establish a *plan* (Fig. 1). This requires a thorough knowledge

of all phases of the project from the contract award date through the engineering cycle to completion. This Line of Balance plan differs from the conventional schedule or control system in that it is a management tool, not a detailed control system. Most conventional control systems consider all factors, regardless of their importance or bearing on the program. Line of Balance considers only the principal factors or tasks of a program plus those which may be determined to be limiting, even though not principal.

Typical areas to be considered are design, drafting, procurement (if it is a limiting factor), model shop, and technical data. Any number of others might be appropriate, but these are commonly the essential ones. The elements of work to be programmed can be plotted by days, weeks, or months. The best approach is to set up the plan by starting with the required contract delivery or end date and work backwards to the study or design starting dates. In establishing time elements for individual tasks, milestones should be used to provide task goals and furnish better monitoring points. Each task of the plan should be identified by a number working from left to right. Identification symbols can be established as in Fig. 1 for general categories of effort.

Whether or not an individual study turns out to be useful and reliable depends very strongly on the quality of the design of the program plan.

Objective

The *objective* is the next step to consider for the study. It is a curve or curves delineating schedules for accomplishment of the tasks taken from the program plan of a single end-item project plotted against time. Each curve (Fig. 1) has a different start and stop date, and is self dependent, since each task or phase is treated as a separate entity.

The tasks for the various phases of the project are lifted from the plan and plotted on a similar condensed time base and percentage ordinate scale on the *objective* chart. This is accomplished by connecting the start date at 0 percent and the end date at 100 percent with a straight line for each task. If it is known that the task schedules are not linear, and the curvature is known, then the appropriate weighted curves can be used. Each objective task line is keyed by number to its counterpart in the *plan* and *progress* sections.

With the plan established and its corresponding task elements plotted on the objective chart, the study is updated periodically on the *progress* chart.

Progress

The program *progress* section of the chart pertains to the status of actual performance and is comprised of a bar chart which shows the percentage of completion of each task at the date of study (where the job is) and the Line of Balance itself (where the job should be). On the progress chart, the same percentage-of-completion scale is used for the ordinate as was used for the objective chart. The abscissa corresponds, by duplication numbers, to the numbered tasks or control points depicted in the plan. The progress status bars and the Line of Balance are subsequently plotted on this section at each date of study.

Line of Balance

Development of the plan, the objective, and the program progress completes the accumulation of physical

information. There remains the task of utilizing the intelligence already gathered. This is accomplished by plotting a *Line of Balance* as the basis for comparing progress and objectives:

- 1.) A vertical line is plotted on the objective chart at the date of study. The point where this line intersects a task line indicates (in percent of completion) where that task should be on the date of study.
- 2.) The point of intersection for each task is, in turn, projected horizontally to the corresponding status bar on the progress chart. This is the balance quantity for that bar.
- 3.) Each balance quantity is then joined to form one stair-case type line across the face of the progress chart—result, the *Line of Balance*.
- 4.) The study can be easily updated daily, weekly, or monthly as required by moving the vertical date of study line to the right on the objective chart and repeating steps 1, 2, and 3.

Cost Status

Having this ready method of monitoring the schedule progress, a means of comparing progress with planned expenditures makes it a more-effective tool. This comparison is graphically presented by plotting the planned cumulative monthly spending rate for the life of the project. Then, as monthly expenditure reports are issued, the actual costs are plotted adjacent to the corresponding planned monthly spending rate bar.

Interpretation and Use

The sample chart of Fig. 1 shows tasks 1, 2, 3, 6, and 7 on schedule, with task 4 ahead of schedule and task

W. A. PORTOUW graduated from Oregon State College with a BS in IE. His experience includes manufacturing engineering, production scheduling and facilities procurement with special emphasis on machine-tool utilization and special tooling and production projects. As a Project Administrator with Surface Communications Division, he has participated in such programs as BMEWS, AN/TLR Receiver Countermeasures, Time Division Multiplexers, Ionoscatter Transmitter, Countermeasure Service Program, and various acoustical products.

ELVED J. SHUPPAS graduated from Franklin and Marshall College, Lancaster, Penna. with a BS in Economics and specialized in Industrial Management. He joined RCA in 1959 as a Project Administrator in the Surface Communications Division of DEP and is associated with Closed Loop TV, AN/WIC-2 and various other programs. He introduced the use of the *Line of Balance* technique to Surface Communications and has improved its adaptation for engineering and production controls. Previously, he held supervisory positions with G. L. Martin Co. and Bell Aircraft Corporation in manufacturing operations, budgets and control, and industrial planning.

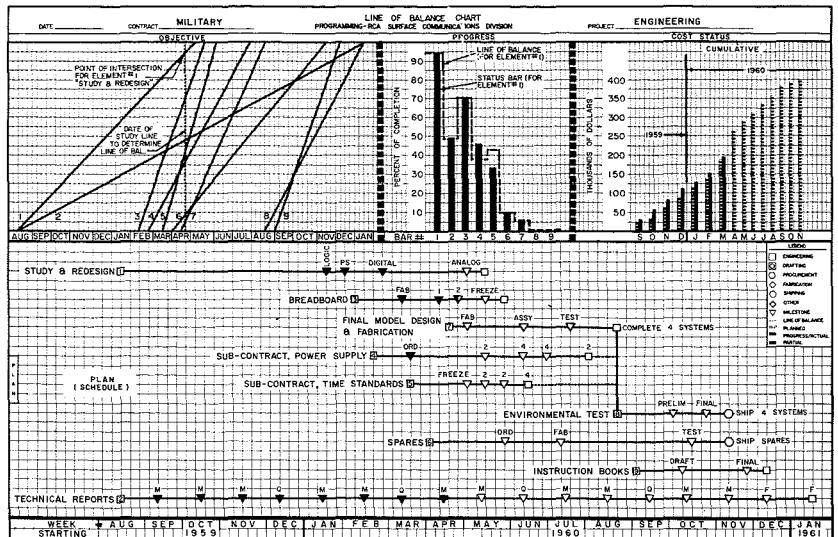

Fig. 1—Sample *Line of Balance* chart for an engineering project.

5 behind schedule. Tasks 8 and 9 are not scheduled to start as yet, so they are not plotted, on the progress chart. The behind-schedule condition of task 5 is immediately highlighted as a problem area on the Sub-contracted Time Standards task and indicates the possible need for corrective action or at least an investigation. If continuing studies highlight a particular task as developing into a serious problem, this task can be charted separately and broken down in full detail. It can then be monitored to pinpoint the factors limiting the over-all project.

The ahead-of-schedule status of task 4 is usually a healthy condition in terms of meeting final delivery requirements. However, in some cases, it could indicate excessive inventory buildup—an unhealthy condition.

The comparison of actual expenditures against the planned spending rate shows that a cost overrun had developed at the start and was then corrected.

Hypothetical cases can be built around this phase of the chart. For example, a behind-schedule condition coupled with underexpenditure cost status could indicate that the program needs additional manpower or perhaps overtime to bring it on schedule. Conversely, an ahead-of-schedule condition coupled with an over-expenditure cost status could indicate that a cut-back in effort is needed to bring schedule and cost in line.

Although the plan (schedule) is used on the chart as a means to an end, it is nevertheless of additional value to identify a problem task as well as show the over-all schedule of the project for future planning.

APPLICATION TO A PRODUCTION PROJECT

The *Line of Balance* technique was originally developed to monitor production projects where there was a phased objective or delivery schedule that required repetitive steps at a specified rate.

In conducting a study for a production project, the chart itself is prepared much like an engineering project except that the objective becomes the first step.

Objective

In a production study, the first phase is to set down the *objective*, in this case the contract delivery schedule (Fig. 2). This is done by plotting cumulatively the number of end items required per unit of time. Actual



E. J. SHUPPAS

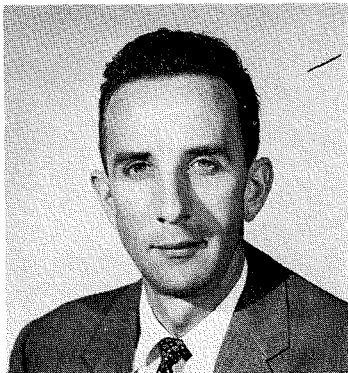

W. A. PORTOUW

deliveries are also plotted on the objective chart to show status of deliveries. The ordinate scale of the objective chart is set up in number-of-units instead of percent-of-completion.

Plan

The second phase is the preparation of the *plan*, a series of limiting and/or principal steps which must be accomplished to achieve completion of the end item. This is a pattern or assembly tree for *one* unit only (the cumulative schedule is presented in objective).

The easiest way to prepare the plan is to start at the point of delivery and work backwards to the point of engineering release, setting down each of the principal or limiting steps in the process in terms of working time prior to delivery (lead time) in which each must be accomplished. The time scale can be shown in days, weeks, months or years depending on the over-all cycle involved.

Progress

The *progress* section of the production chart presents the same information as an engineering chart. However, the main difference lies in the method of striking the Line of Balance (a most-important step).

The Line of Balance is a series of steps, each of which is a balance quantity for an individual bar or element on the progress chart. Each of these levels is arrived at in identical fashion:

- 1.) A study date is established on the abscissa of the Objective Chart.
- 2.) The lead time (working time prior to delivery) for each element is picked off from the plan (See Fig. 2, eight weeks lead time for element No. 1).
- 3.) This lead time is counted off in weeks to the right of the study date on the objective chart base.
- 4.) This point, eight weeks to the right of study date, is then projected vertically to the cumulative delivery schedule line.
- 5.) This point of intersection is in turn projected horizontally to the corresponding numbered status-bar area of the progress section, establishing the point where the element will be in balance on the date of study.

Fig. 2—Sample Line of Balance chart for monitoring production.

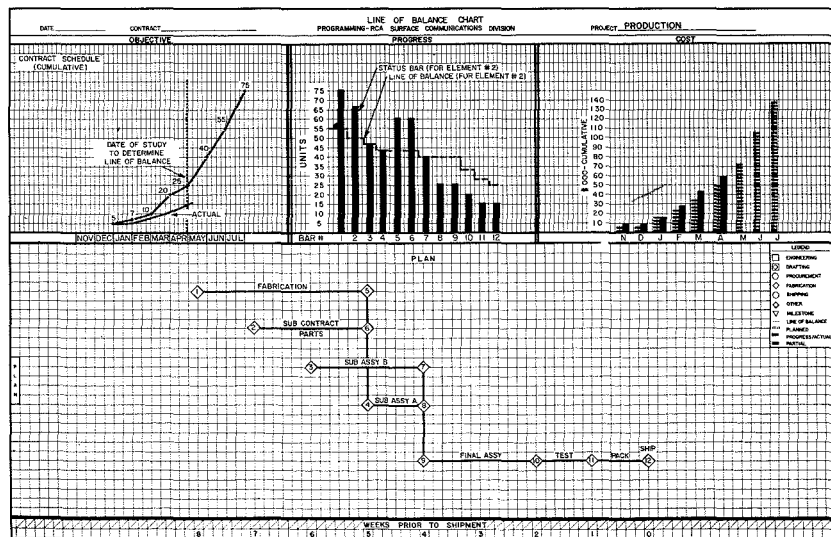

- 6.) After plotting the level of balance for each element, they are linked together, forming the Line of Balance.

The height of the status bar for each element is adjusted according to job status information received from the activities concerned with the production project. The production cost-status section is plotted and monitored in the same manner as for engineering.

Interpretation and Use

The interpretation of the information conveyed by the sample chart (Fig. 2) is relatively simple. The procedure is to observe jointly the status of the bars on the progress chart as compared to the balance line and coordinate this information with the plan.

The sample chart of Fig. 2 shows items 1 through 7 ahead of and on schedule. Items 8 through 12 are behind schedule, highlighting the fact that item 8 is causing the others to be delinquent, since final assembly, Item 9, cannot be started until all subassemblies are available.

The cost section of the study shows that expenditures are exceeding the planned spending rate with deliveries delinquent as of May 1. The overexpenditure is probably because all raw materials have been received, and fabricated and subcontract parts are ahead of schedule—all these perhaps having been paid for. Such a condition might or might not require an investigation, but in any case will not go unnoticed.

On occasions, it will turn out that even though a single general chart will point out areas of deficiency, further expansion and highlighting of the lagging segments will assist management in focusing on the exact problems. This is accomplished by preparing an additional Line of Balance study of the item or segment causing trouble, arranged so that delivery requirements will coincide with the master study. Line of Balance reporting by subcontractors is also very helpful, because their plan and deliveries are established from the master chart, and periodic reporting illustrates their progress, delinquencies, or shortcomings.

SUMMARY

A thorough understanding of the Line of Balance provides information which can be used to forecast and predict such items as manpower, space, tools, equipment, necessary overtime, and cost to complete job in progress. The reporting method for Line of Balance studies is uncomplicated once the program is established. Instead of pages of detail, or names of parts or items, reference is only made to numbers—whether it be the item numbers of the plan, quantities of the items or progress and deliveries of the objective. It is time-saving and to the point.

Surface Communications management has evaluated the Line of Balance method and adapted its use to major engineering and production programs. Engineering managers gain a better picture of their programs, and working with them, the Programming activity prepares and updates the charts periodically (weekly or monthly) for submission to higher management with a brief summary of the project status.

The technique is simple, but its effectiveness in surveying a program is of real value, by providing a coordinated picture of all the pertinent facts needed for the evaluation of achievement, and by highlighting those phases to which management must give attention for the successful conclusion of a program.

RCA AND COMMERCIAL COMPUTER SYSTEMS

by **H. M. ELLIOTT, Mgr.**

Engineering

Commercial Systems Dept.

Electronic Data Processing Division

IEP, Camden, New Jersey

ENGINEERING EFFORT on computers at RCA in Camden can be traced back to 1949, some eleven years ago. This was initiated as the result of a study indicating that if RCA were to maintain its leadership in the field of electronics, it would be necessary to enter the field of electronic data processing. Effort in Camden was initiated under the Advanced Development Engineering Section in what was then the Engineering Products Department, the progenitor of IEP and DEP.

OTAC ELECTRONIC DATA-PROCESSING SYSTEM

A contract was negotiated in 1951 with the Army Ordnance Corps for equip-

ping one of their large supply depots (Letterkenny, Pa.) with an RCA electronic data-processing system. In 1952, the Army enlarged the contract to cover the inventory-control activities at one of their largest stock control points, the Ordnance Tank-Automotive Command (OTAC) in Detroit, Michigan. Delivery of the complete system was set for 1955.

In 1953, a separate engineering department, under the management of J. Wesley Leas, was organized to carry out the development and design of an RCA computer system. By mid-1954, elements of the OTAC system were under construction, and in December 1955 this system was delivered. It was—

and still is—the largest commercial data processing system sold to any user installation (see inset, Fig. 1). It covers about 20,000 square feet and consists of 357 separate equipment units, with over 25,000 tubes and 60,000 diodes. The equipments range from the high-speed computer, occupying 46 racks, to 180 magnetic tape stations, each in a “file drawer.”

Operation of so large a complex is of necessity under the control of a *system central*, which consists of three major parts: 1) the *switching unit*, which makes the actual relay connections between the tape stations and the machines using information on tape or writing on it; 2) the *operation control*



Fig. 1—At the New York Life Insurance Co., an RCA 501 system (left) supplements an earlier RCA computer (right). Inset: The first RCA commercial computer installation (OTAC, U. S. Army) delivered in 1955 and still the largest of its kind in the world.

unit, again a relay device, which actuates the switching unit in detail and also transmits certain set-up instructions to the processing equipment; and 3) the *operator-attended consoles*, used in a team set-up to dispatch the work to the machines and to monitor over-all system performance.

THE AMC SYSTEM

A second RCA data-processing system and an on-line sales recorder were built for the Associated Merchandising Corporation. The sales recorder consisted of point-of-sale recorders connected to a special-purpose digital computer known as the *recorder central* (Fig. 2). This recorder central kept a file of stock numbers and prices in its magnetic-drum memory. After proper entry of information by the sales clerk and insertion of a print-punch merchandise ticket, it would look up the price of the item, do the necessary calculations, and print out a sales ticket at the point of sale. This pilot system was delivered in 1957 and operated successfully at the Higbee Co. department store in Cleveland for a period of fifteen months, with a system efficiency of better than 97 percent.

In 1956, a team of RCA programming, engineering, and marketing personnel was organized to devise a smaller system that would be more economical and efficient in lower-volume data applications. In effect, this meant a computer-oriented system rather than one centered about a system central. A number of improvements were made in the computer itself, such as doubling the high-speed-

memory capacity to 8192 characters, adding more-powerful tape instructions to improve sorting operations, and incorporating simultaneous operations. The magnetic-tape-station speed was increased from 10,000 to 16,667 characters/second. A number of these improved systems were built and are still in operation (main photo, Fig. 1).

In parallel with the engineering effort on this smaller system, a development program for a new computer system was also underway. This program, jointly manned by personnel from the Advanced Development Department and EDP Engineering, resulted in the RCA 501 system design. The engineering prototype of the RCA 501 was in operation by mid-1958, and in October 1958, the first production release was made.

Fig. 3—Evolution of EDP circuit boards.



Fig. 2—AMC System, left: point-of-sale recorder prepares sales slip from tag and keyboard entries (1957); right: recorder-central stores sales information and prepares magnetic tape for data processing.

SUCCESS OF THE RCA 501

The RCA 501 system is the core of RCA's bid for leadership in commercial computer systems. The various equipments in the system employ transistor logic of advanced design, making possible the use of low-cost transistors manufactured by the RCA Semiconductor and Materials Division. Each equipment in the system has been designed and styled for easy and economical installation.

The RCA 501 computer, together with its high-speed memory, is a very flexible machine. It can perform more than one operation at a time, and the decision to perform two things sequentially or do them simultaneously is made by the machine itself. It can handle up to 63 magnetic tape units; it can operate a high-speed printer

a) Tube type, OTAC and AMC

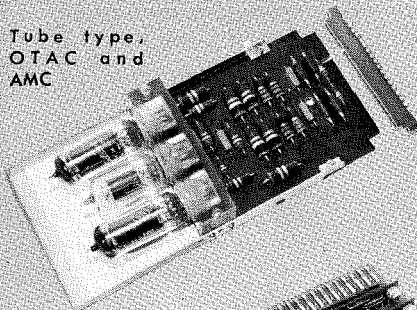

b) First transistor plug-in

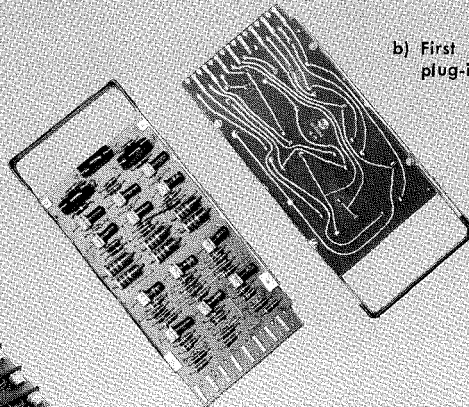

c) RCA 501 transistor plug-in

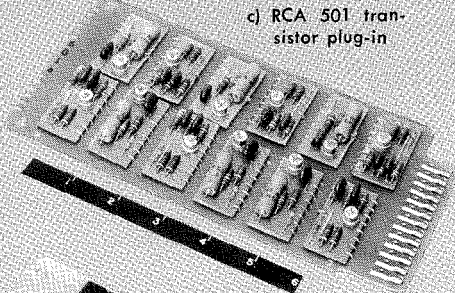

d) RCA 301 transistor plug-in

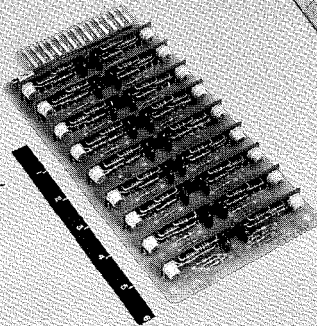

e) RCA 601 transistor plug-in

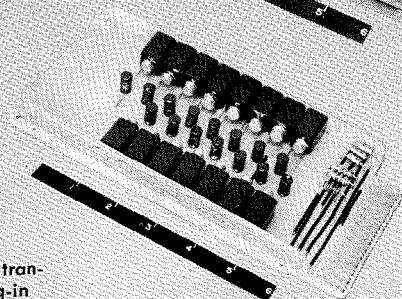

which spills out hard copy at the rate of up to 600 lines a minute; and its internal memory can be expanded to sixteen times its original size merely by plugging in banks of magnetic-core planes (i.e., $16 \times 16,384$ characters).

The machine has the facility to read punched paper tape at 1000 characters/second, and to read and write on magnetic tape at 33,000 characters/second. Further, the RCA 501 product line includes equipments for reading and punching cards, both on-line to the computer and off-line, and high-speed tape punches, operating on-line at either 100 or 300 characters/second, both in five-level and seven-level codes.

At this writing, more than forty RCA 501 systems have been installed, and in some cases, they are operating more than 20 hours a day on a regularly scheduled basis. RCA has received orders for more than 75 of these systems since the first RCA 501 system was introduced. Customers include such diverse industries as banks, utilities, steel companies, and government agencies, as well as the RCA Service Co., the RCA Electron Tube Division, and RCA Defense Electronic Products.

PROGRAMMING SUPPORT

The success of any data-processing system is a function not of the equipment design, but also of the programming support the manufacturer provides. Within the EDP Division, there is a large, well-organized, capable group of analysts and programmers, known as EDP Methods, who assist the sales force and the customer in analyzing the application and formulating the necessary procedures and programs.

a) Early memory stack, 1024 characters

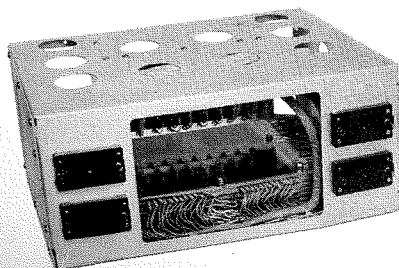
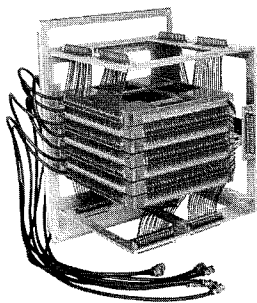

c) RCA 301 memory stack, 20,000 characters

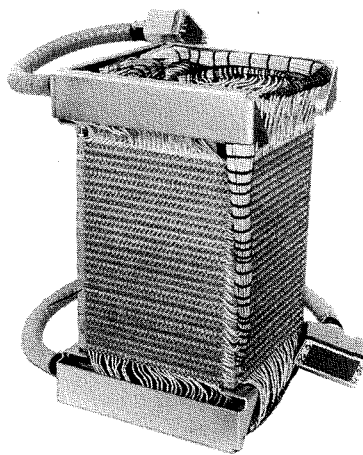

b) RCA 501 memory stack, 16,384 characters

In addition, the Advanced Programming Group has designed an automatic-programming system which has greatly speeded up the generation of customer programs. Briefly, automatic programming may be defined as the use of a language suitable to human beings for problem preparation, together with a computer program capable of translating this language to one acceptable to the computer.

NEW COMPUTER PRODUCTS

Following up on the success of the RCA 501, in the Spring of 1960 two new all-transistor electronic data processing systems for commercial use were announced.

The first, the RCA 301, is a low-cost, flexible system designed to operate efficiently in diversified applications. System elements have been molded and integrated to achieve a true system philosophy for modest-volume data-processing applications—a market big enough to warrant additional production facilities like those recently started at Palm Beach Gardens, Florida. The first RCA 301 system is to be installed in a customer's site early in 1961.

While the RCA 301 system flanks the RCA 501 on the smaller side, the second new system—the RCA 601—flanks it on the larger side in power and speed. An internal memory speed of 1.5 microseconds makes it the fastest data-processing system announced to date. A variation of the RCA 601 is the Communication Data Processor of the ComLogNet System, a system that will consist of five large automatic switching centers with connecting terminals



H. M. ELLIOTT received the B.A. from the City College of New York in 1946, and the B.S.E.E. and the M.S. in Physics in 1950 from the University of New Hampshire. He was then employed by the Air Force Cambridge Research Center and the Lincoln Laboratory, MIT, in research and development of special devices for digital data-transmission systems. In 1953, he joined RCA in the High-Speed Memory group of the Computer Engineering Department. During 1956, he was promoted to Mgr., Computer Devices Engineering, with responsibility for design of commercial computers. In this capacity, he has been very instrumental in establishing a product line of RCA computer systems, from the RCA 501 to the RCA 301 and RCA 601. He was recently appointed Manager of Engineering in the EDP Commercial Systems Department. Mr. Elliott is a member of Tau Beta Pi, Phi Kappa Phi, Pi Mu Epsilon, Sigma Pi Sigma, and the IRE.

at 450 air bases, air stations, and civilian contractors.

Recognizing the potential of the industrial computer market, RCA during the past year also introduced the RCA 110, and variations thereof, to fill an apparent void. Today a new engineering and manufacturing facility is in full operation at Natick, Mass., with the first RCA 110 recently having been installed in a steel-manufacturing plant.

With the introduction of the RCA 110, 301, and 601, RCA now has a family of electronic data processing systems in this highly competitive field.

However, the data-processing industry is a very dynamic one, and development of new systems must be maintained at a high level. To this end, the EDP Division has the Ultra Program underway. Its objective is to generate a whole new family of electronic-data-processing systems with internal speeds an order of magnitude faster and versatility far greater than present systems. In addition, a high-speed computer program, sponsored by the Department of Defense, is developing computer components to be used in machines 1000 times faster than those available today.

The combination of the success of the RCA 501 system, the introduction of the RCA 110, 301, and 601 systems, and DaSPAN and EDGE (communication and data-gathering systems), together with a comprehensive program of advanced system design and development puts RCA well on the way to becoming a leader in electronic data processing.

Fig. 4—Evolution of computer memories; relative size about as shown.

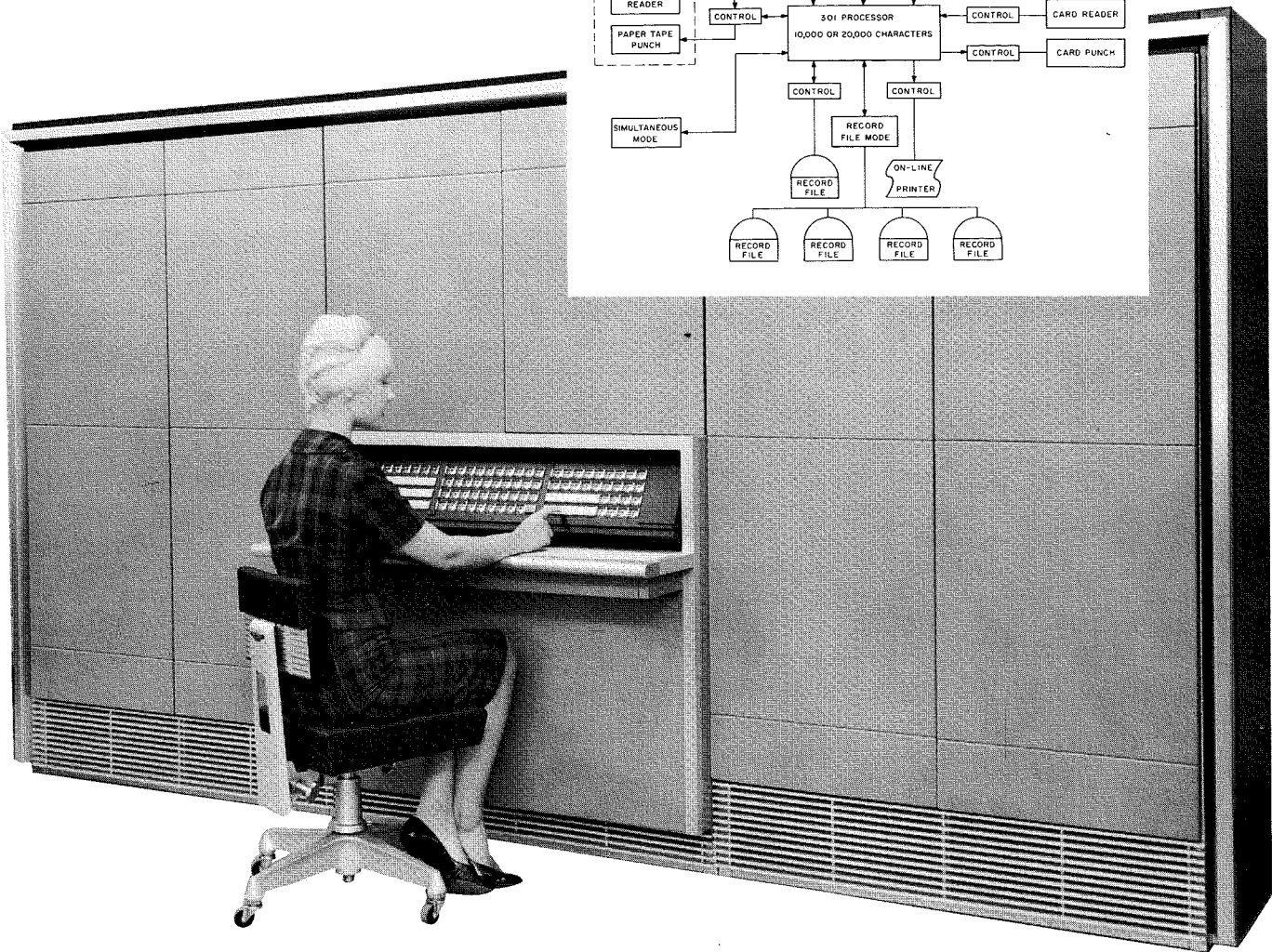

THE RCA 301 . . . Flexibility at Low Cost – An Engineering Challenge

by **H. KLEINBERG, Mgr.**
*Product Line Engineering,
 Electronic Data Processing Division
 IEP, Camden, New Jersey*

MANY PARALLELS CAN be drawn between two apparently very different industries—automobiles and computers—over the course of the past few years. In both of them, a trend toward bigger, more powerful, more expensive machines was the rule, until very recently a reverse toward compact models has set in. While the analogy must not be overworked, one other point of similarity can be noted: Just as a large and a small car perform basically the

same function with different load capacities, so the large and small business computers are faced with problems of equal complexity, but with different data volumes.

SMALL-COMPUTER DESIGN PROBLEMS

In the case of computers, small machines with the required capability have not been practical in the past, largely because of the lack of depth in supporting technology. Core memories, for

Fig. 1—The RCA 301 basic computer (center cabinet) with modular power-supply and control cabinets at left and right. Inset: The RCA 301 data-processing system.

example, presented a fixed cost to the designer of the small computer that invariably led him to the use of drum memories, with a consequent loss of speed by a factor of 1,000. Magnetic-tape units, highly reliable diodes, transistors, and almost every other system component presented a similar problem. It was only when these costs were lowered, through the volume production of large and medium systems, that the

successful design of powerful, low-cost computing systems became possible.

Another problem encountered in the successful design of a small computer lies in the production phase. In order to have a system that markets at a reasonable price, volume production of the same units is necessary. Customizing and tailor-making of systems cannot be economically supported. On the other hand, each customer for a data-processing system has a situation that differs in certain aspects from every other user of the same system. Some users rely on paper tape for their input, others rely on punched cards; some users have a large amount of internal computation, others have a large volume of output printing. Thus, in order to reach a wide market, the system must be flexible. This, of course, works in direct contradiction to the production requirements of a large volume of identical units. It is in this field that the RCA 301 system offers a most novel solution. Modularity, enabling customizing of systems to the specified need of the user, has been made compatible with the volume production required. The RCA 301 system is illustrated in the diagram of Fig. 1.

MODULARITY

This modularity has been achieved through the concept of separate control panels for each piece of input-output equipment. From Fig. 2, it can be seen that the basic computer includes the memory and control hardware necessary for the execution of instructions, but that it includes no input-output equipment. It is, in effect, a central brain with no means of communication with the outside world. This communication is provided by means of peripheral equipment (printer, card punch, etc.) through a set of control panels and associated cables. Each of these panels ties to the central processor and is specifically designed to work with a peripheral unit. Thus, a control panel is associated with the printer, a different control panel with the card reader, a third control panel with the paper-tape reader, and so on. These panels can be attached to the basic computer by means of plug connectors. They can be produced in any volume required and stocked separately. When a customer is to receive shipment of an RCA 301 system, he receives a basic computer, peripheral equipment as required, and a control panel for each of the pieces of input-output equipment that he receives.

INPUT-OUTPUT EQUIPMENT

The choice of input-output equipment for a small system presents a whole set

of problems by itself. Again, a balance between cost and performance, between customer requirements and production volume must be found. The past emphasis on speed can no longer be the major determinant in specifying equipment. Two new input-output units have been specifically designed for the RCA 301 system—the *record file* and the *hi-data tape group* (see diagram, Fig. 1).

The record file is a storage device holding information on a set of magnetic recording disks. Each disk as used in the system can store 36,000 characters of information made up of 9,000 characters on each of two bands on both sides of the disk. Access time to information in the record file averages $4\frac{1}{4}$ seconds. This device is not truly a random-access unit as normally defined. It may not be applicable to a larger, much more powerful system such as the RCA 601 or the RCA 501, but it has specific uses and capabilities within the framework of the RCA 301 system such as program storage and file storage under certain conditions.

The hi-data tape group is a set of six magnetic-tape transports, each of which can handle information at the rate of 7500 characters per second. A set of common electronics is housed

H. KLEINBERG received the Bachelor of Applied Science, Engineering Physics, in 1951 from the University of Toronto, whereupon he joined the Ferranti Electrical Ltd. in Toronto as a research engineer in the digital data-handling equipment field. Mr. Kleinberg joined RCA in 1953, where he worked on electronic controls for input-output tape, and film units and circuit standards. He spent three years on logic design, manufacture and test, of the first RCA computer system. He has since been active in the design and development of RCA's transistorized data-processing systems, such as the RCA 501 and RCA 301. In 1959, he was promoted to Mgr., Computer Devices Engineering, and in 1960 was named Mgr., Product Line Engineering. Mr. Kleinberg is a Member of the IRE.



with the six tape drives, permitting access to any one of them at a time. Here again, economy has been the byword. Tape start time, including switching of the desired tape drive, is 30 milliseconds—again, a figure that would hardly be impressive within the framework of a large-scale system, but providing a unit which has a place and a function in the RCA 301 system.

Other input-output equipment is, of course, available. Card reading and card punching are provided, with the reading speed of 600 cards/minute and the punching speed of 100 cards/minute. Paper tape may be utilized, with reading and punching speeds of 100 characters/second. A line printer, providing hard copy at 600 lines/minute, 120 characters/line may also be included. The RCA 301 may work with other tape stations of the RCA product line at the rates of 22,000 or 33,000 characters/second. Special input-output equipment is available as required, and here again, the merits of a control-panel system show themselves. In one of the early systems the customer (in this case a large bank) required the ability to handle through the RCA 301 a magnetic-ink check-reading and -sorting device. There was no requirement to modify or redesign the basic computer for this function, since all tie-in to this system is handled by a specially-designed control panel.

BASIC COMPUTER

The basic computer (Fig. 2) is arbitrarily divided into the *high-speed memory* and *program control* units, although both are housed in a single rack (Fig. 3).

The memory comes in sizes of 10,000 or 20,000 characters. This choice is made at the time of purchase, and corresponds roughly to selecting a 4-passenger or 6-passenger car. The memory is organized so that two characters (14 bits) may be read in or out in a 7-microsecond cycle, which includes the regeneration time.

The program control unit consists of the necessary register for addressing the memory, holding information to be read out of or stored in the memory, and the registers necessary for execution of the instructions. The instructions are two-address, made up of ten RCA 301 characters. The *A* and *B* addresses normally specify the memory locations that are to be used in the instructions; they require four characters each. One character, the *N* character, contains information that usually pertains to the number of characters that are to be handled in this instruction. This is one of the ways in which

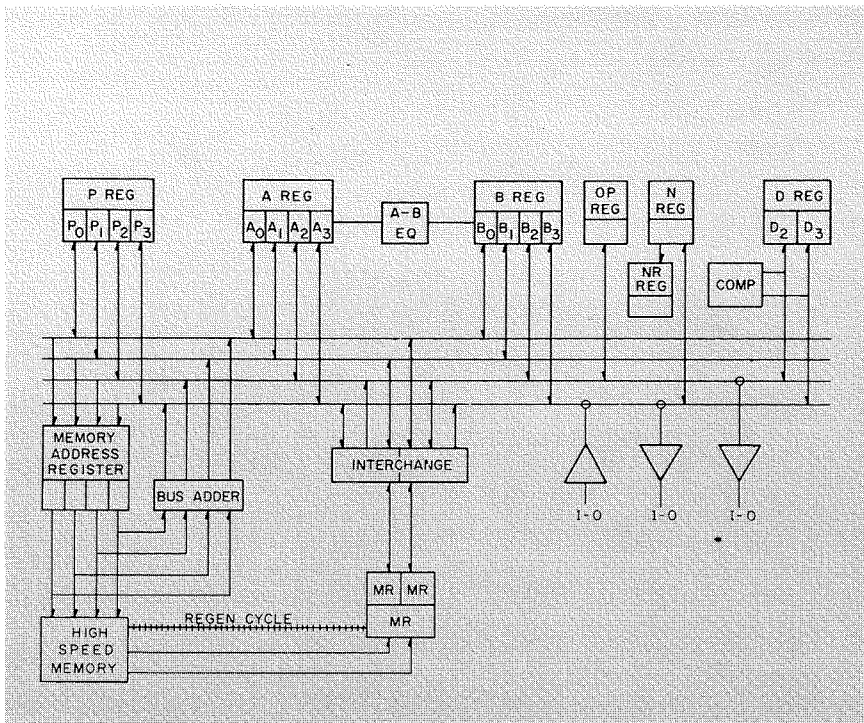
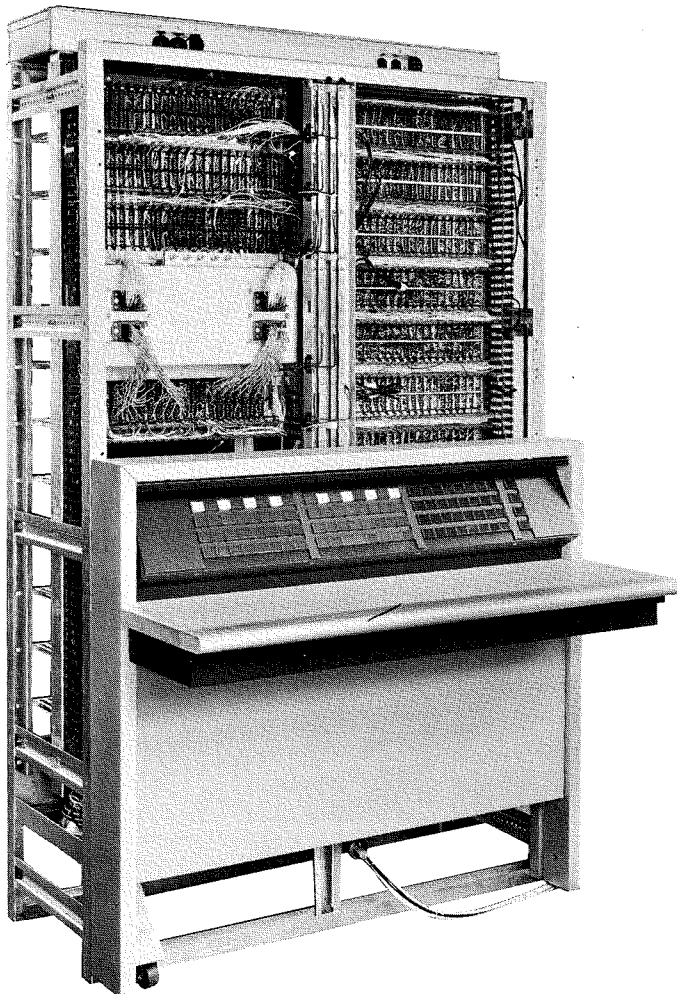

Fig. 2—RCA 301 basic computer.

Fig. 3—RCA 301 basic computer rack and console.



variable word length is handled within the computer. The tenth character of the instruction specifies the operation to be executed by the computer. Instructions are stored sequentially in the high-speed memory, each requiring ten consecutive memory locations.

Much of the packaging for the computer has been carried over from hardware used in the RCA 501 System. To achieve substantial cost reduction, a separate console was eliminated and the control console is now attached to the central computer rack (Figs. 1 and 3). This console swings aside for maintenance and testing of the computer rack itself.

CIRCUITRY

The choice of circuitry for a low-cost system such as the RCA 301 is one of the most basic and difficult portions of the design. Reliability is, of course, the prime consideration. To this has been added increased speed (compare 7-microsecond memory cycle with a 15-microsecond memory cycle in the RCA 501), the requirement for low cost, and the requirement for compactness of the total system. It may be seen that the design problem facing the circuit engineers was indeed formidable.

It should be pointed out that minimum system cost does not always follow from minimum cost of components used in the circuitry. Considerable negotiation and discussion between logic designers and circuit designers is necessary to optimize the final choice of circuits. For example, it may be found that a circuit costing 25 percent more will provide 75 percent more ability to drive loads in the form of other logic circuits. Application of such a new circuit would be worthwhile if enough "chains" of logic are used. Here, too, the problem of volume production versus custom design reappears. The logic designer would like many special-purpose logic plug-ins, while the circuit designer wants a small number of general types that may be produced in volume. A balance must be found that optimizes the over-all system cost.

SUMMARY

As RCA's entry into the low-cost computer field, the RCA 301 System presented a difficult challenge to the design engineer. At every step, the divergent needs of production, user, logic designer, circuit designer, and systems engineer had to be weighed, and the proper compromises made. The result is a powerful, competitively priced system that shows promise of having wide acceptance by customers.

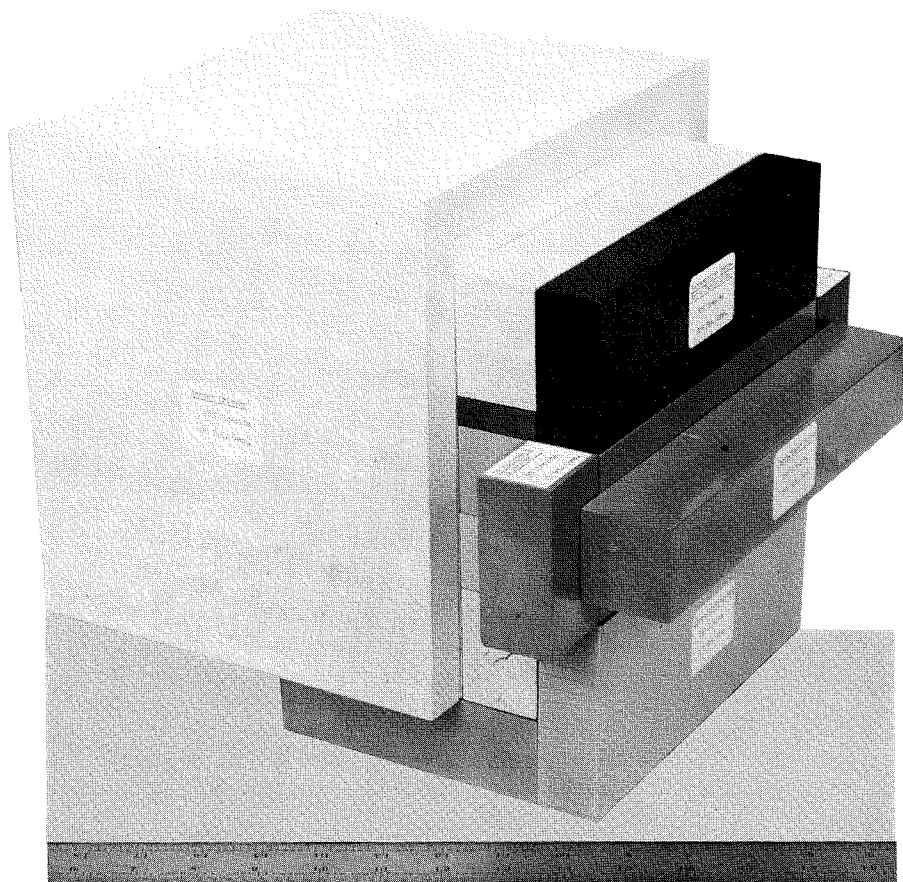

DEVELOPMENT OF A 1000-MC COMPUTER

by R. K. LOCKHART, Mgr.

*Lightning Development Engineering
Electronic Data Processing Division
IEP, Camden, New Jersey*

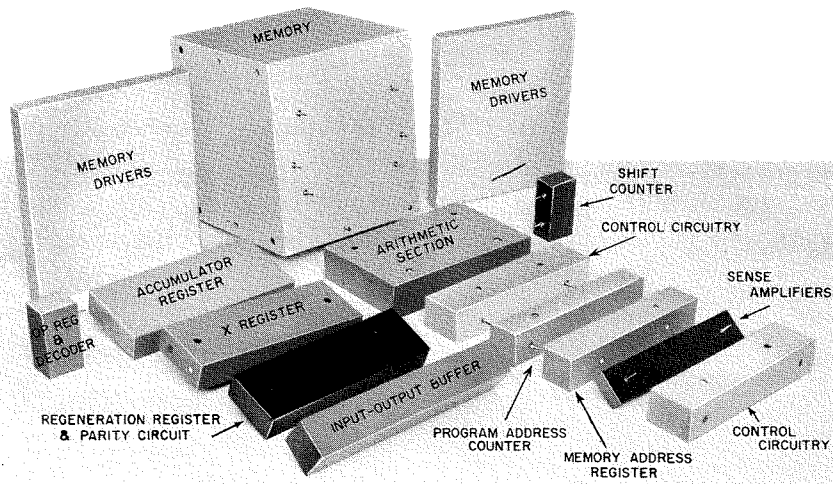

THIS HIGH-SPEED computer development project was born as a result of a proposal request by the U. S. Government in early 1957 asking that thought be given toward a computer approximately an order of magnitude faster than anything then in the research stage. The definition was later construed to signify a 1000-mc machine. A contract was signed by mid-1950 initiating eighteen months of intensive thinking, brainstorming, blue-skying, or whatever was required to produce a feasible approach to such an ultra-fast computer. At the end of 1958, feasibility was proposed by three companies. RCA's summation described the following three possible approaches:

- 1) an all-out push of the art of transistor development and application;
- 2) the utilization of cryogenics;
- 3) the use of microwave techniques in carrier form

The U. S. Government thereupon assigned a major category to each of the three companies, with IBM to follow cryogenics, the Univac Division of Remington Rand Corporation to explore thin magnetic films, and RCA to develop suitable microwave techniques.

An important aspect of this assignment specifically forbade the art of transistors on the basis that this project would not be accelerated by such a contract—only subsidized—and that the art of transistors would be brought up as fast as commercial companies could move anyway. However, the contract did allow that the major effort could be supplemented by additional exploratory work wherever appropriate.

THE MICROWAVE APPROACH

The primary attraction of the microwave approach was the fact that although the percent bandwidth of a baseband-driven 1000-mc scheme is very great, in terms of a carrier system it could be made relatively small provided the carrier frequency was sufficiently large. Although other microwave techniques and devices were studied, the best approach appeared to be the microwave version of the Parametron, the phase-locked oscillator (PLO), around which greatest effort was centered.

The operating principle of the PLO is as follows: If a parametric amplifier of fairly high Q is pumped at twice its

Full-scale model of the proposed Memory Test Unit, a small internally programmed computer having very short signal-path lengths; it will be used to prove the feasibility of high-speed tunnel-diode circuits for computer applications. Note the total size in the assembled view at top left; a breakdown of its subsystems is at bottom left.

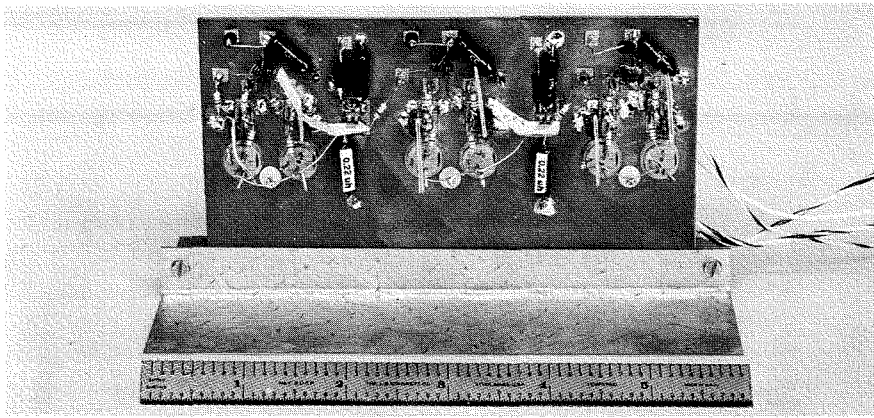

Fig. 1—Typical breadboard setup, showing three bits of a tunnel-diode shift register.

own resonant frequency, it will oscillate at its natural period, but in either 0° or 180° (π) phase which is determined by any small incoming signal or noise at the time the device starts to oscillate. It follows, then, that a small incoming or controlling signal will specify completely the phase of the oscillation build-up, and thus, 0° phase may be defined as a binary zero and π as a binary one. Since the phase must be controlled by that of the incoming signal, (as opposed to the presence or absence of such) it follows that the phase of build-up can be dictated by the resultant phase of several incoming signals. Thus is described a device whose output signal is a function of the predominance of a number (always odd) of inputs. The type of logic described is majority.

Almost immediately, the timing and spacing problems were evident, and it became necessary to specify the computer more completely to understand just how serious they were. Of course, the definition of a computer as a 1000-mc machine tells very little, but this was done deliberately to give maximum research freedom. First thoughts were toward considering this as a definition of a logic level. (The term *logic level* as used herein is the function of a basic gate switch.) By normal logic-level-rate to memory-speed ratios, this concept would mean a 50-nanosecond memory cycle, which appeared to be slower than the intent of the Government. Today, the following has been agreed to by all: A logic level will require about 1/5 nanosecond, with a memory cycle of about 10 nanoseconds.

It became apparent that there was little hope for a memory in the form of a microwave configuration, although several possible dynamic storage schemes were explored. One small plane of a "di-cap" memory (using variable-capacity diodes) was built to cycle at

about 25 nanoseconds. However, dynamic storage appeared useful for only a very small memory, causing a search for new approaches.

The RCA Laboratories was actively investigating the tunnel diode and its usefulness as both a storage and logic element. Under the provisions of the contract, this medium of static storage was selected, since basic studies had shown that magnetic cores could probably not achieve the speeds of interest.

TUNNEL DIODE APPLICATIONS

At this time, it also appeared that basic investigations of circuits utilizing the tunnel diode as a basic logic element should be pursued. Work was begun in Princeton on clocked power supplies, and in Camden on d-c driven circuits. Success came very quickly in both areas. The tunnel diode's basic limitation of directionality (it is a one-port device) could be overcome in either approach. [Ed. Note: For detailed articles on tunnel-diodes, see Vol. 6, No. 2; especially R. H. Bergmann and M. M. Kaufman, "Tunnel Diodes in Digital Computers," p. 14.]

To prove the concepts of tunnel-diode possibilities, subsystems were built; i.e., a logic system showing the operation of the required gates. The system was composed of two synchronous counters

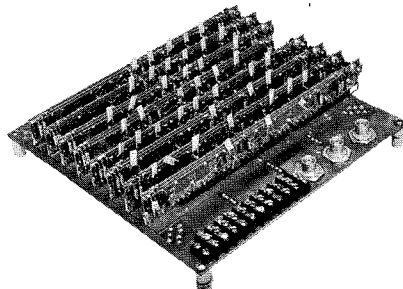

Fig. 2—Experimental packaging of a computer subsystem with 71 tunnel diodes.

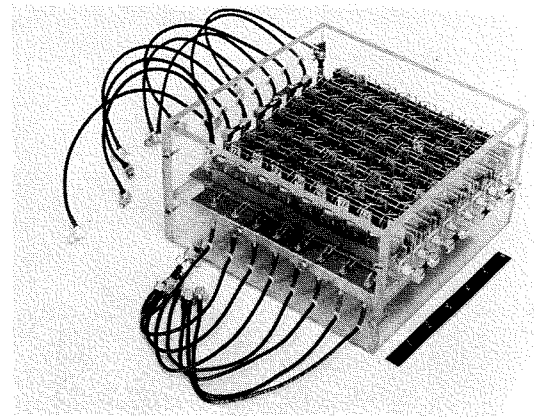

Fig. 3—An experimental 8 x 8 bit tunnel-diode memory plane.

(three bits each), whose overflow pulses were compared in a gate by one inhibiting the other (Fig. 1). The absence of either pulse would produce an output designated as an error. This error, in turn, would inhibit the input to one of the counters, thus describing the device as self-checking and self-correcting.

The logic design was completed for the PLO and the tunnel-diode circuits, both of which were to operate at logic level speeds of about 3 or 4 nanoseconds. The pump frequency for the PLO system was chosen to be 4 kmc, the signal carrier frequency being 2 kmc. The tunnel diodes used had about 20-ma peak current, with about $180 \mu\text{mf}$ junction capacity. Dynamic loop logic was used with the tunnel diodes, while majority logic with dynamic rings was central to the PLO system. Many techniques were developed in both subsystems which are apropos to the final 1000-mc machine. Working operation of the tunnel-diode approach was demonstrated to the U. S. Navy Bureau of Ships' representatives in the form of a 71-tunnel-diode subsystem (Fig. 2). A small group of working PLO's was delivered to them which performed majority logic at 4-kmc pump and approximately 4-nanosecond stage delay.

During this period, work had also proceeded toward a companion memory composed of tunnel diodes in the individual cells (Fig. 3). A plane consisting of 64 bits (with drive-line loadings equal to 1024 bits) was fabricated and cycled with special (but available) transistor circuitry in 100 nanoseconds. This plane, built full size to simulate a 32×32 bit plane, showed solution to the problems of drive-access and memory-reading techniques, and showed the capabilities of information storage and retrieval with fully tolerable signal-to-disturb ratios even with the lack of precise tolerancing of the available storage tunnel diodes.

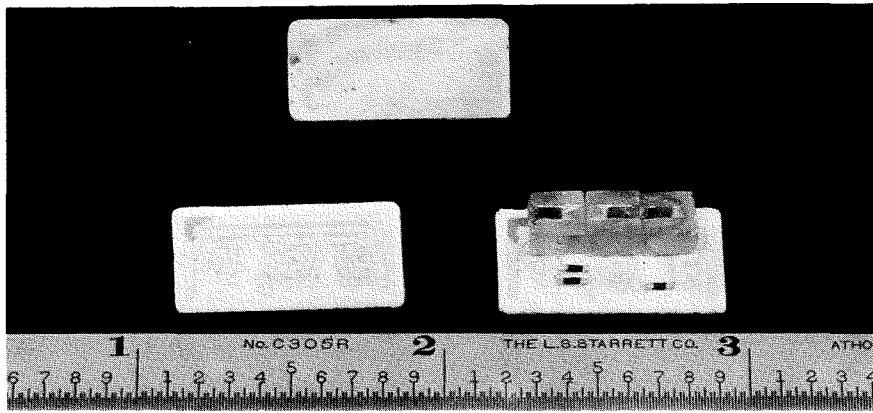

Fig. 4—Packaging wafer circuits; each wafer holds three gates.

PROBLEMS ASSOCIATED WITH A 1000-MC COMPUTER

Perhaps this is the best point to introduce some of the problems associated with a machine of 1000-mc speed category. First, in defining the speeds of interest, the timing definitions are all stated in terms of nanoseconds. The speed goal is to be about 3 to 4 logic levels per nanosecond, 10 nanoseconds per memory read-regenerate cycle, and have a shift rate of about 6 to 8 bits per memory cycle. [Although the prefix *nano* is now standard for 10^{-9} , a physical example will give an idea just how extremely fast a nanosecond is: a *nano-century* is about $3\frac{1}{8}$ seconds.]

With these speeds in mind, relative problems arise such as packing densities, wiring propagation delays, and crosstalk. If a velocity factor of about 0.5 is assumed, an interconnecting transmission line of $1\frac{1}{2}$ inches in length will represent a delay of one logic level which must, of course, be compensated by other means if machine speed is to be maintained. (Light travels about a foot in a nanosecond).

There is only one real way of combating this problem: reduce the physical size. This is, however, a hollow solution inasmuch as a proportional wiring schedule would show that a 10-mc machine built with the best available techniques would have lines of nearly 9 feet in length corresponding to the aforementioned $1\frac{1}{2}$ -inch leads. Present study shows a technique of assembling wafers of about $\frac{3}{4}$ inch by $\frac{3}{8}$ inch, composed of alumina substrate supporting a ground plane on one side and printed wiring on the other (Fig. 4). This wafer, containing three gates, will be inserted into a box-like support of copper-clad material carrying connection lines imbedded in slots or channels to allow freedom of crossover, while maintaining transmission-line characteristics for all leads. This technique will give packing densities of about 30 logic

gates per cubic inch. With this high packing density, the full machine should occupy less than 3 cubic feet for all registers, arithmetic units, memory, etc.

SUMMARY

The tunnel-diode art has progressed very remarkably, mainly as a result of the excellent background of solid-state physics and fabrication techniques developed from transistor experience. Tunnel diodes have been built with switching times in the order of 0.05 nanosecond. But, herein lies one difficulty: a device of such gain-bandwidth has never before been available; therefore, new circuit-handling techniques had to be developed. Lead inductances of even a few picohenries (10^{-12} henry) are no longer negligible, and even breadboard setups must be assembled with a care that was heretofore afforded only finished products. Nonetheless, work progresses at about $\frac{1}{2}$ nanosecond/logic level, and such circuits as

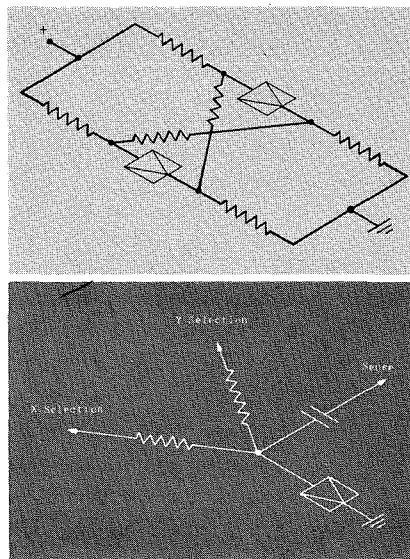

Fig. 5—Tunnel diode circuit configurations for computer applications. Top, tunnel diode flip-flop; bottom, one version of a memory cell.

flip-flops, complete with “worst-case” tolerance analyses, have been developed (Fig. 5).

The first major goal of hardware construction is to be that of a memory test unit. This machine, a small, internally programmed computer, will generate various instructions and automatically carry these out in “leap-frog” sequence through every memory location to prove feasibility and reliability of the very-high-speed circuits. System and logic design is currently being carried out in parallel with circuit design, so that each can be of assistance to the other.

Simultaneous with the memory test unit, system design is being done on a full-scale machine. This high-speed data processor is being designed to take best advantage of the circuit speeds available.

The basic philosophy of this study is that since this project will represent a major step in the state of hardware art, the system organization will remain conventional for the time being. Under this ruling, several designs have been compared, and trial programming is being currently undertaken to test the design.

This is a research program; nevertheless, as the third phase of the total program is begun, parallel work is being done on all fronts of systems, memory, logic, and fabrication. The demeanor is *optimistic*.



R. K. LOCKHART was graduated from Purdue University in 1947 with the degree of B.E.E. That same year he started with RCA in the Television Division Advanced Development group. For ten years he worked on the design of television receivers, primarily color television receivers. His work in this area resulted in 20 patents being issued with his name and in his being named as an RCA *Award of Merit* recipient in 1953. In 1957 Mr. Lockhart was promoted to Manager, Color TV Circuit Technique Advanced Development. He joined the Electronic Data Processing Division in 1959. In his present capacity as Manager, Lightning Development Engineering, he directs a group investigating circuits and techniques to develop a 1,000 megacycle computer. This project requires Mr. Lockhart to coordinate efforts at the RCA Laboratories, Princeton, and the RCA Semiconductor and Materials Division, Somerville, with those of his development engineers in the investigation and implementation of new techniques.

THE RCA 110 INDUSTRIAL COMPUTER is best viewed in the perspective of its intended application to industrial control. Today, the industrial-control computer market is in its infancy. This is partly due to inadequate knowledge relative to computer applications to industrial processes. You can only control by computer what you understand sufficiently to formulate as a mathematical model with predictable characteristics. It has come as a shocking surprise to many computer experts that today only few industrial processes can be reduced

tem analysis, writing of specifications, budget approvals, competitive bidding, contract award, design, production, installation, and operational testing, it is understandable that this period is normally three years.

The user of industrial computing equipment buys it on a "pay-out" basis, which means he expects savings through use of a computer to pay back the investment he has to make in the purchase. Typical are the demands of the petro-chemical industry for pay-out in one year or less; at the other end of the

the industrial computer market. The RCA 110 is the first general-purpose, high-performance computer designed specifically for industrial applications.

One of the RCA 110's most important features is its packaging, which eliminates much site preparation. The computer can be installed on any flat floor that will support its cabinets and in any environment of temperature and humidity where humans can work. Its cabinets contain heat exchangers that recirculate and cool the atmosphere within the cabinets, while entry of out-

THE RCA 110 ... A Pioneer Industrial Control Computer

by **R. W. SONNENFELDT, Mgr.,**
Engineering
Industrial Computer Systems Dept.
Electronic Data Processing Division
IEP, Natick, Mass.

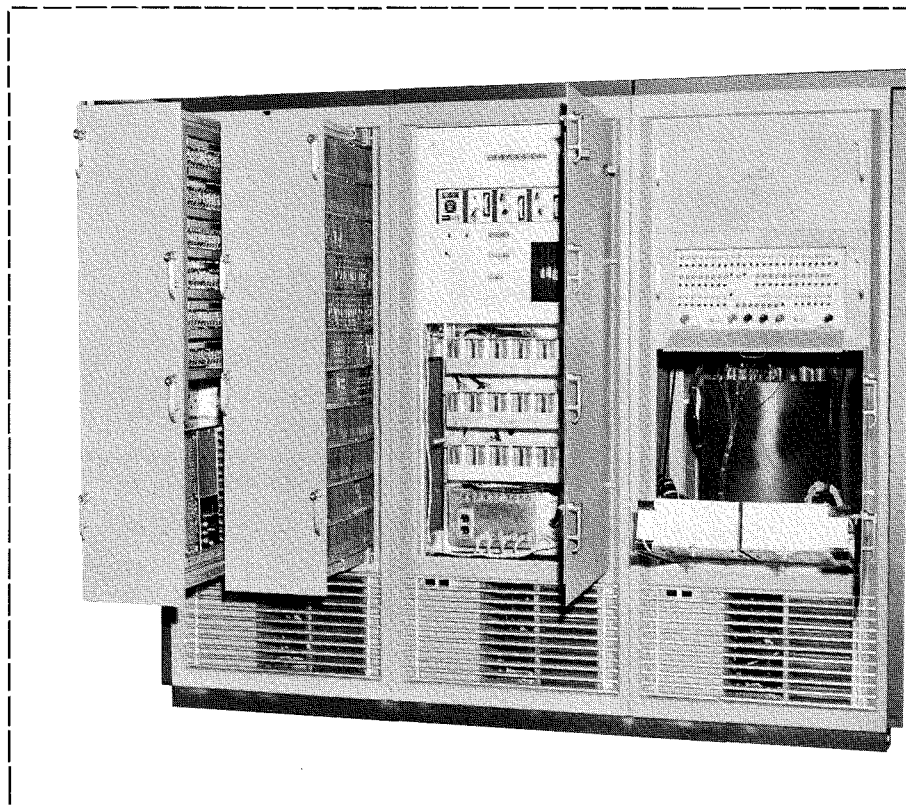

to a precisely stated problem meaningful to methods of machine solution.

On the other hand, the anticipated rewards of complete, consistent automatic industrial control are so great that many suppliers now are competing in this infant market, in order to stake out their claim in an area that is often thought to represent the new frontier for nonmilitary computer applications.

MARKET DETERMINANTS

One reason for this eager competition, at such an early stage and in such a difficult market, is the long period of time that must elapse between first conception and final acceptance of an industrial-control system. If this period includes the months required for sys-

scale, utilities may accept pay-out periods of as long as five or six years. Because of the *long period of time required to install* a complete system and the *short pay-out* period demanded, this market is generally regarded as one that will rather suddenly "turn the corner" when actual installations start to pay out. At that point, orders will go to that manufacturer who has proven his capabilities. Hence, many suppliers are investing in a position of preparedness for this future stage of the industrial computer market.

RCA 110 FEATURES

In this general context, the decision was made last year to offer the RCA 110 to

side air is prevented by seals and partial pressurization. This feature is vital to long-term reliability, since it excludes harmful atmospheric agents such as hydrogen sulphide or coal dust normally found in industrial sites. Fig. 1 shows the RCA 110 computer main frame.

Another feature is the unique cabinet construction, which permits all servicing to be done by a single person from the front of the cabinets, with all inter-rack wiring being carried in special channels on top of the heavy-duty racks. The computer racks are unitized into equipment groups before shipment, making unnecessary false floors or extensive ducting on the site.

Not only in its packaging, but also in its performance characteristics, has the RCA 110 been provided with unique features tailored especially for industrial applications. One such feature is automatic program assignment; this feature permits initial loading of up to eight independent programs that are called for on a priority basis. This arrangement permits utilization of the RCA 110 for such multiple concurrent tasks as control, optimizing computation, incentive calculation, data analysis and recording, and automatic sequen-

MEMORY OPTIONS

Another way in which the design of the RCA 110 matches its intended applications is in the organization of its memory. It has a high-speed, random-access, core-working memory with a cycle time of 10 microseconds, and five memory size options from 256 to 4096, 23-bit words. This core memory is the basis of the computer's relatively high addition speed of 56 microseconds (including memory access), the avoidance of minimum latency-programming with attend-

register is used for transfer of information between drum and high-speed memory.

The drum is also provided with nine buffer tracks for storage of input and output information. Fig. 2 shows a block diagram of the computer main frame, including a conventional arithmetic unit, program control section, and various registers. A distinctive feature of the RCA 110 computer is its method of handling inputs and outputs to and from the core memory with only two generalized micro-programmed input-output instructions. This feature permits use of this computer with such diverse devices as tape stations, typewriters, paper-tape readers and punches, analog-to-digital converters, multiplexers, and process instrumentation.

A TYPICAL APPLICATION

To understand more fully how the RCA 110 might be used in a complete industrial control system, consider the application shown in Fig. 3—to automatic tin-plate production control.

A customer's order containing such information as the amount of material to be made, its width, the plating thickness, and the maximum number of permissible defects is received at the RCA 110 in the form of a punched card which is inserted in the card reader. From this information, the computer determines the plating current, the line speed, and it programs the shear so as to cut this order at the proper point in the productive process.

During processing of the order, the computer monitors several dozen variables, such as plating thickness, plating current, line speed, and number of feet processed, to determine that the customer's order is in fact being produced as required. The computer also monitors several different detection stations indicating the presence of common defects such as pin holes and oil streaks.

WHY DIGITAL COMPUTERS FOR CONTROL?

At this point, it might properly be asked why is a digital computer needed to do this kind of control job? There are several aspects to the answer.

An important point is that the steel to be plated in this application moves at rates up to 3,000 feet per minute, and because it is sold on a per foot basis, all controls must be effectively applied on a per-foot basis. That is, every foot of finished material must be tested for conformance to customer specifications; and, moreover, from the readings of many instruments, the com-

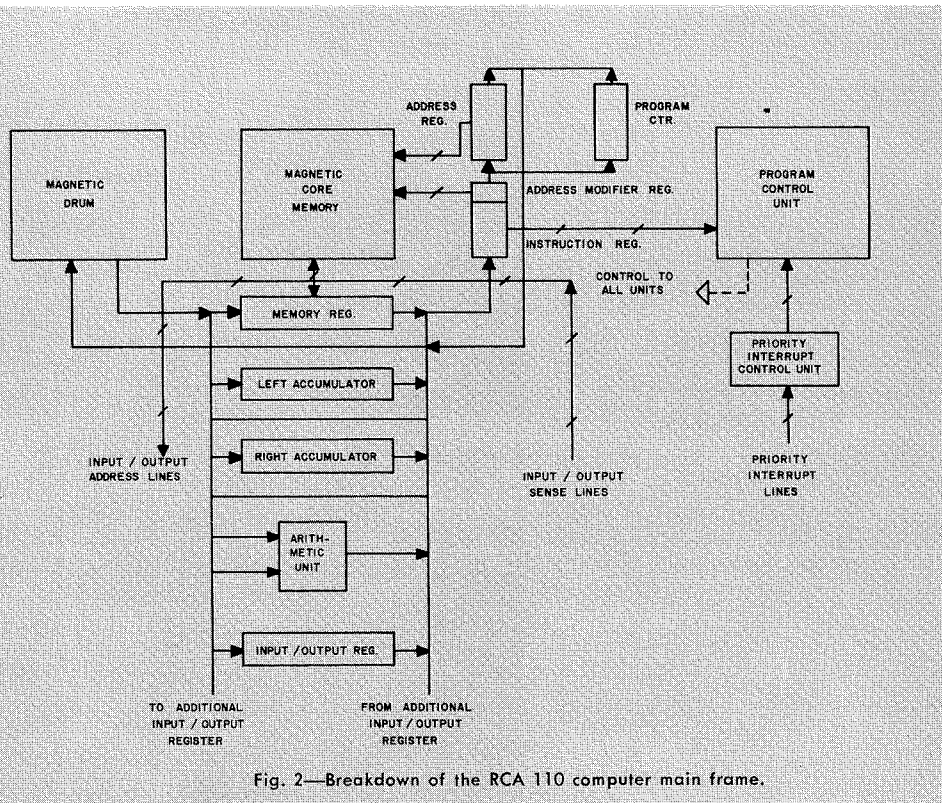

Fig. 2—Breakdown of the RCA 110 computer main frame.

ing of production machinery. Without the ability to pre-load independent programs and to call for them automatically, the programming of industrial computers becomes a difficult task because of the many combinations of action that may be required. Yet, all emergencies must be allowed for in all their consequences in the program. A computer can only do what it is programmed to do. Where a program can be divided into separate sections that are called for on a priority basis, planning for emergency action is much simplified because priority call up of an emergency program has no effect on the remaining portions of the overall program. Program portions may also be written independently.

ant difficulties in fast real-time control, and the computer's priority-program-assignment capabilities.

On the other hand, core storage is relatively expensive, often ten times as expensive as magnetic-drum storage. In order to provide economic rapid access bulk storage, the RCA 110 computer is designed with an optional magnetic-drum bulk memory available in eight size options of from 4096 to 51,200 words of 23 bits each. The drum has a maximum access time of 17 milliseconds and is provided with its own timing track, read and write amplifiers, and a switching matrix. The drum pulse rate is 250 kc, while the high-speed memory clock rate is 900 kc. A buffer

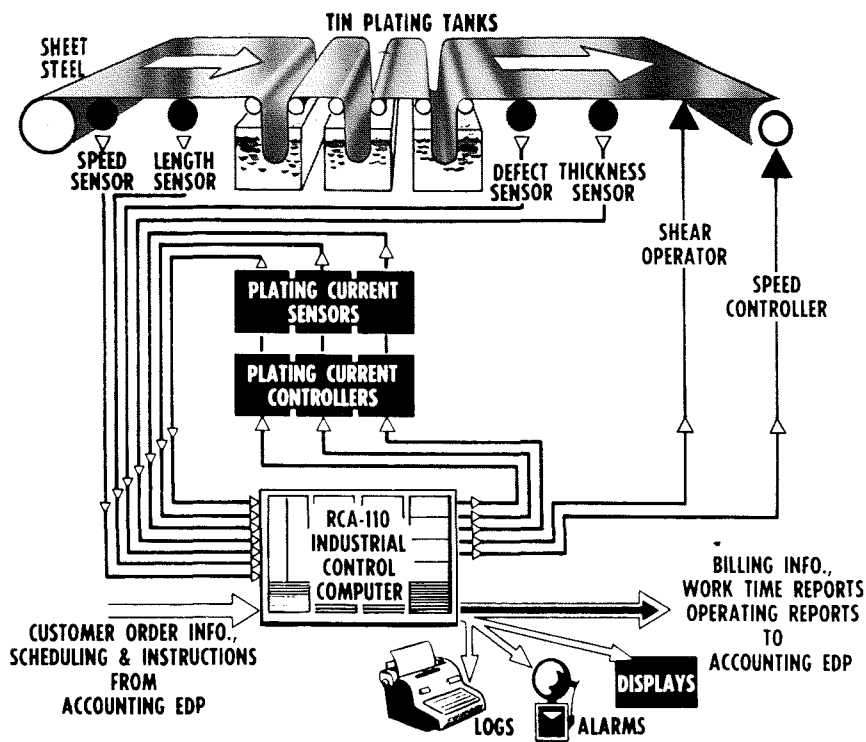

Fig. 3—A typical application of the RCA 110 to industrial control—in this case, automatic production control of a tin-plating process.

puter must determine what corrections, if any, are needed. This amounts to keeping track of several dozen fast-changing variables and making a complete set of logical decisions and calculations every 30 milliseconds. Many of these logical decisions are complex and require a digital computer's ability to decide the optimum course of action, particularly under fault conditions.

Typical decisions to be made by the computer involve switching of plating-current generators generating thousands of amperes, calculation of line-speed assignments, and possible decision to shut down the line when attempted corrections do not eliminate occurrence of quality defects. Normally, the computer optimizes economic usage of the line. For each customer's order, the computer prints out a delivery ticket. It also handles such tasks as recording incentive-pay data for the operating crew and printing of statistical reports that are issued every hour, every shift, every week, every month, etc.

To understand why people see a future in industrial control computers, suffice to say that in this application—where a *single* automatic tinning line produces *over a million feet* of tin plating per day—savings in either tin or scrap material through better decision-making pays for the computer installation in less than a year.

To do all of these things, the computer must communicate with the process, since its information is derived from instrumentation or sensors and its output commands are sent to controllers or actuators. These external devices are relatively slow compared to the internal speed of the computer; therefore, a multiplexer is provided, enabling the computer to look at them in sequence. The input signals are usually voltages or currents or pressures that must be converted to digital language that the computer can understand. This is done in the analog-to-digital converter in the input. The reverse process is needed on the output, where the computer's digital language must be converted to analog signals that are applied to the actuators. This is done in a digital-to-analog converter which is followed by power amplifiers to furnish the required degree of control.

SUMMARY

It is clear that the industrial control computer must fit into an environment that cannot be selected by the computer designer, but which is in the domain of the process designer. The industrial computer must, therefore, be designed to fit into a great variety of industrial production systems. In that respect, it differs markedly from the

RICHARD W. SONNENFELDT, an honor graduate of John Hopkins University in 1949, joined RCA that year and participated in the development of the RCA system of color television. His experience includes contributions to RCA's Data Link and AGACS Systems, as well as development of multiplex pulse systems; noise, interference and cross-modulation-elimination techniques; several test instruments; and circuit development. He had also designed industrial control systems, prior to joining RCA in 1949. Upon transferring to the EDP Division, Mr. Sonnenfeldt assumed engineering responsibilities for the development of control and automation systems and special-purpose computers. Establishment of the Industrial Computer Systems Department at Natick, Mass. early in 1960 was followed by his appointment as Manager of Engineering there. In this capacity he has led in the development of the RCA 110 and other industrial computer systems. In 1956, Mr. Sonnenfeldt received the *RCA Award of Merit* for his engineering contributions and for organizing and teaching a course in "Pulse Systems and Techniques," now in its fourth year. He is the author of many technical publications, and the holder of more than 25 U. S. Patents.



business data processor, which can be designed as a unit of a planned system with all peripheral gear specified. Those who are now attempting to use business data processors for industrial production-control applications are finding great difficulty in matching such machines to the tasks.

The industrial control computer with its specific product requirements is as distinct from a business data processor as is a sports convertible from a jeep. The RCA 110 industrial computer is a pioneering effort to meet the infinitely diverse demands of industrial control. With this machine, RCA can look confidently to "turning the corner" in industrial-computer applications.

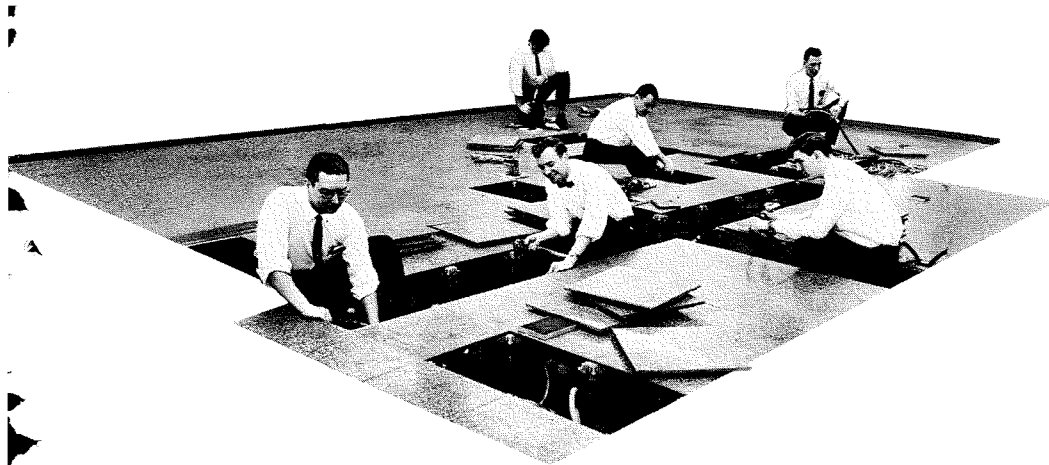

Fig. 1—Preparing an office area for an RCA-501 data-processing system. Cables are being routed under the false flooring, which was installed specifically for the computer system, before the equipment is placed in position.

INSTALLING AND MAINTAINING RCA COMPUTER SYSTEMS

by **H. MOGENSEN, and J. J. LAWLER, Mgr.**

Engineering

Electronic Data Processing Service Dept.

RCA Service Company

Cherry Hill, N. J.

THE INSTALLATION and maintenance of RCA commercial electronic data processing systems with their many complex individual units is one of the challenging assignments of the RCA Service Company.

The RCA Service Company entered this field in 1955 when they installed the world's largest and first commercial RCA data-processing system at Detroit, Michigan for the U.S. Army's Ordnance Tank-Automotive Command (OTAC). Since that time, the Electronic Data Processing Service Department has maintained all of RCA's commercial data-processing systems and currently installs these on a routine basis.

Responsibility begins at the customer's site prior to delivery of equipment and continues on throughout the many years of actual operation. For the many RCA customers who lease the equipment, maintenance is automatically done by the RCA Service Company; however, customers in all cases where systems were purchased outright have chosen the Service Company to do their maintenance.

For maximum performance at minimum cost, considerable planning is required. Some of the important areas are training of site personnel, standardization of tools and test equipment, and intersite liaison.

TRAINING OF SITE PERSONNEL

The foundation of effective maintenance is in the man who must keep the equipment in proper working order. To ensure that service personnel will be equipped to handle this responsibility, the RCA Service Company operates an extensive educational program, which

advances inexperienced men to the high skill level necessary. The trainees are carefully selected from top-ranking graduates of two-year electronic technical schools. During the training program, which continues for several months, they receive instruction on the equipment to which they will eventually be assigned. Through many specialized training techniques, an individual having no prior knowledge of computing equipment can be thoroughly trained in a few months on a system that took thousands of man hours to design.

Training for the Model 503 Computer, the heart of the RCA 501 system, requires a 12-week course conducted eight hours each day. The technician is thoroughly schooled in all phases of operating and programming, since problems involving these factors may appear to an equipment operator to be maintenance difficulties. The 503 computer training course is followed by several weeks of practical work on the laboratory computer, part of a complete system laboratory operating on a 24-hour schedule at Cherry Hill and used only for training of such personnel.

As each new installation is planned, men are scheduled to complete their training before equipment delivery. They are transferred to the site prior to equipment arrival, where they are joined by experienced men to form the installation and maintenance crew.

Although some of the larger computing systems have specialists who concentrate their efforts on maintenance of a particular group of units, the trend is toward training system specialists, since smaller sites with their small crews require men qualified to work on all equipment.

INSTALLATION

When the customer has decided upon the equipment complement and floor layout, installation planning is begun to ensure that equipment turnover dates will be met. Because of the building-block concept of the RCA 501, each installation has a complement of equipment tailored to suit customer needs; consequently, installations are normally planned on an individual basis.

A detailed cable-connection diagram is prepared, for each installation, from the master item listing of equipment to be delivered and the engineering drawings. The variables for each installation are clearly marked on the cable diagram—for example, cable markers, cable lengths, connection points, and notes on shared cables. The cable-connection diagram is used not only by the installation team for the purpose of connecting equipments, but also by the permanent maintenance crew for systems trouble-shooting.

All engineering drawings necessary for mechanical assembly are collected for use by the installation team. A pre-installation inspection is then made of the area where the equipment is to be housed. This includes a check of proper installation of the raised flooring, proper positioning of floor cut-outs for cable routing, and a check that all a-c power lines have been brought into proper positions. A typical scene is shown in Fig. 1.

When the pre-installation checks are completed, the equipment is shipped. Normally, the cables are shipped before any other equipment, in order that they may be laid down and routed without interference. Items of maintenance equipment are delivered and the maintenance area is arranged. The equipment then arrives, is placed into position, unpackaged, and mechanical assembly of the trim and doors is performed. Finally, the cables and power lines are connected, as in Fig. 2. At this time,

Fig. 2—Installing the data-processing equipment. These tape stations are being connected to the computer via the cables routed under the floor.

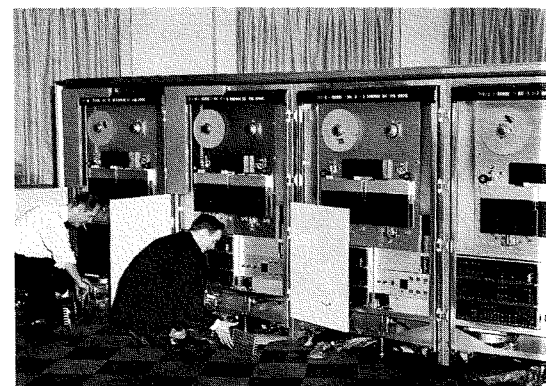

power is applied, and voltages are carefully checked and adjusted. In approximately two days the system is assembled and ready for electronic tests.

The system is placed in operation section by section. Installation debugging starts with individual equipment and proceeds to eventual system operation. Marginal voltage testing of the logic and vibration testing is now performed. Vibration testing uncovers the loose connections or other malfunctions that may have developed during shipment. After these tests, the customer's programs are usually run for several days, and customer operator training is performed, to ensure that efficient operation can begin immediately after the turnover date. The rigorous final tests conducted by the factory and the efficiency of the installation team often allows system turnover ahead of schedule.

MAINTENANCE

After successful acceptance tests, the system is turned over to the customer. Now, the maintenance period begins. During the first few months of operation, the computer's data-processing workload is usually inordinately heavy, as conversion of the customer's old files, etc., to the new system is taking place. To realize maximum value from an electronic data processing system, the service team must maintain the equipment at a high degree of reliability—especially during this initial period.

Maintenance requirements are determined by the equipment complement, the experience of maintenance personnel, and the operating schedules of the customer. The equipment complement will vary from site to site. For example, one installation may contain one computer and six tape stations, while another might contain two computers, thirty tape stations, and six off-line input-output devices. In the first case, the crew will be smaller and consequently must perform maintenance on both computer and tape stations. In the latter case, the maintenance crew will be larger, and a larger degree of specialization per equipment is practical.

Experience of personnel will affect maintenance to some degree, and technicians with little experience are usually assigned to work on only one or two pieces of equipment. As the men gain experience, their assignments become more diversified and eventually they can work on all units in the system.

Operating schedules vary between sites from one eight-hour shift, five days a week, to a 20-hour operation,

seven days a week. One interesting variation is an installation operating a full eight hours, then 15 minutes every four hours for the next sixteen hours. This means that the uninterrupted period available for maintenance is eight or more hours daily in one case, and only 3 hours and 45 minutes, four times daily, in another. Obviously, the maintenance men must be able to cope with these wide variations in available time.

A TYPICAL SERVICING OPERATION

For a typical system scheduled to operate one eight-hour shift daily, members of the maintenance crew report an hour before the start of customer operation to apply power to the equipment. The equipment is then run through a series of operational checks to ensure that it is properly functioning.

The system is then turned over to the customer. If a malfunction should occur during customer operation, the trouble usually can be quickly corrected by replacing a plug-in with a spare. The length of down time and a description of the failure is noted on a job card. At the conclusion of the operating shift, scheduled maintenance is performed on the equipment, reports are written, and the equipment is turned off.

To facilitate maintenance and the training of newly assigned personnel, preventive-maintenance check lists have been developed for the various major equipment units. For example, the Model 503 computer has a daily and monthly check list. During a typical daily check-out, console indicators are tested, repaired plug-ins are returned to those locations where they had originally malfunctioned, and a series of test and maintenance programs are run which exhaustively check out all computer logic. Finally, to simulate the worst condition that customer operation would encounter, a sort routine is run to check out both the computer and all tape stations connected to it.

During a typical monthly checkout, fans are checked and filters cleaned, and a marginal check is performed on the computer, a section at a time. The marginal check lowers the bias voltage on the transistor circuits to cause failure of those plug-ins which could otherwise fail at a later time. Consequently, the marginal check has the effect of causing malfunctions to occur during maintenance periods, rather than during customer operating periods.

When malfunctions do occur and provided sufficient display is available at the console, the service man can often localize the malfunctions to within

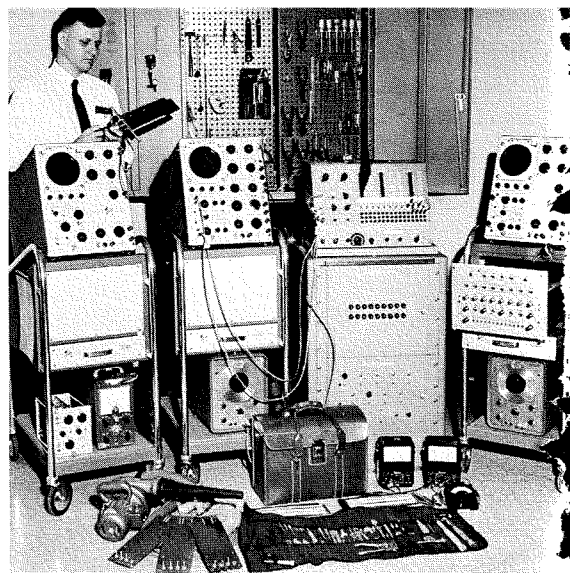

Fig. 3—H. Mogensen and a complement of the equipment used to install a computer system.

several plug-ins by the display on the console. At that time, console controls are depressed to activate the logic under suspicion, and the waveforms are then observed with an oscilloscope to pinpoint the failing plug-in. Quite often, the technician may spend 90 percent of trouble-shooting time at the console, with only 10 percent of the time observing waveforms.

Therefore, the primary trouble-shooting tool for the system is the console. When many displays are available at the console, a comprehensive picture of machine operation is readily obtained, and trouble-shooting time is significantly reduced over that of a console with minimum display. To reconcile the needs of maintenance and the desire to provide a simple, easy-to-use console for the customer operation, two consoles are sometimes made available. One is tailored for customer use with simple, easy-to-operate controls and displays. A second console is provided for maintenance use, which contains a large number of displays and controls to permit rapid localization of malfunctions.

STANDARDIZATION

As systems are installed, experienced maintenance men are transferred to the new locations from existing field sites. Working habits and methods are inevitably carried by the experienced man to the new location. To ensure that the transition will be made with maximum efficiency, standard maintenance facilities are made available at all field sites.

Standardization of test equipment and other maintenance facilities is considered of prime importance for improving efficiency, and reducing costs. This is effected by procurement of items in large quantities, reducing and simplifying inventory, avoiding delays in procurement, and permitting interchangeability of test equipment.

The standard maintenance equipment complement was selected after an extensive investigation of maintenance requirements, which was based on reliability, safety, frequency of usage, cost, flexibility, ease of procurement, and existing RCA standards. In many cases, field requirements were satisfied by commercially available items. However, some items were not available and had to be designed, such as the Module Analyzer used for plug-in repair, the Tape Station Tester used for off-line repair of tape stations, and various tools, jigs, and fixtures. Fig. 3 shows some maintenance test equipment required by an average RCA 501 installation.

Since the type and number of data-processing equipments vary from one field location to another, maintenance-equipment requirements will also vary between sites. These requirements are outlined by formulas on standards listings that relate the number and type of computer equipment with the number and type of maintenance equipment, in a readily understandable form.

INTERSITE LIAISON

With sites scattered throughout the United States, the problem of communicating technical information becomes extensive. Channels of communications have been established so that accuracy of information as well as speed of transmission may be assured.

HARRY MOGENSEN received the BSEE from M.I.T. in June 1955, having worked as a part-time student engineer at Lincoln Laboratory. He then joined RCA's training program and, a few months later, entered military service, spending two years in the Army Signal Corps. In December 1957, he joined the EDPS Dept. of the RCA Service Co., receiving classroom and field training on early RCA computer equipment. Later, he organized and taught RCA 501 courses. In 1959, he joined EDPS Engineering and was responsible for maintenance-facility standardization at 501 installations. He is now with the 601 Systems and Logic Design group as a Service Co. engineering representative.

General information for distribution to all site personnel is sent by direct mail in the form of technical bulletins. These bulletins contain information such as problems common to many sites with suggested solutions, new trouble-shooting techniques, and in many cases, ideas submitted to the home office by site personnel which are considered desirable at all sites.

Technicians at the various sites often develop improvements of existing procedures or, in some cases, encounter difficulties which cannot be solved locally.

Questions not requiring immediate action are written in detail on a special form and sent directly to the Electronic Data Processing Service Dept.'s Engineering section for action. Answers are returned to the originator, usually on the same form, as soon as the technical accuracy is checked.

Should problems arise when the site men require emergency assistance, the information is relayed by telephone. The home-office activity maintains a complete file of blueprints on all equipment and copies of all the technical information ever published on it. In addition, engineers are available to discuss problems directly, and should additional help or information be required, action can be taken within minutes of the notice.

When equipment failures require demand-maintenance or when preven-

JOHN J. LAWLER received the BS in EE degree from the University of Massachusetts in 1950 at which time he joined the RCA Service Company as a Field Engineer. He was engaged in part time graduate work at Syracuse University in 1952 and returned to the University of Massachusetts in 1953 receiving the MS in EE in 1954. He then returned to the RCA Service Company's Computing System Service Section where he worked as an engineer and as Manager of Engineering and Training. Mr. Lawler is now Manager of Engineering in the Electronic Data Processing Service Department. He is a member of IRE and a Registered Professional Engineer.

tive maintenance or other work is performed, the technician enters this data on a job card. Information entered includes the length of time required, equipment type and serial number, complete description of the failure, and a list of all parts used. The cards are then returned to the home office on a weekly basis where they are used for several purposes: tabulations are made relating to equipment performance and reliability, parts used are tabulated for automatic reorder to proper site stock levels, and finally, data is available for other studies which may indicate the need for greater maintenance or action by the engineering department.

LIAISON WITH DESIGN ENGINEERING

Information concerning quality, reliability, and efficiency of maintenance features are the natural outgrowth of a carefully monitored maintenance activity. Many suggestions concerned with methods of improving equipment are also generated. All such data is routed to the cognizant design group for use in planning new equipment along with improvement of existing product lines.

As equipment is delivered to the field, unusual troubles may develop which are not apparent in the laboratory. These problems are reported to engineering for action. When the solution is found, an Engineering Change is originated, from which a Field Change Bulletin is prepared and sent to each site for incorporation into the equipment by site personnel.

In order to obtain advance information for the field as well as provide serviceability assistance, members of the Electronic Data Processing Service Dept. are often assigned to engineering design groups on new equipment. Thus, field experience is made available for use in early design, and often, features may be incorporated which result in more-serviceable equipment.

SUMMARY

Profitable operation of today's commercial computing systems requires a high degree of system reliability. This overall system performance is a result of the combination of equipment reliability and maintenance efficiency. The maintenance efficiency results from successfully merging the maintenance team with the equipment—in a sense, they become an integral part of the system. Such combination of careful engineering and planned maintenance assures high maintenance efficiency—a major factor in the success of RCA's data-processing systems.

Fig. 4—The authors, H. Mogensen (at left) and J. Lawler.



DYNAMICS OF INFORMATION IN MANUFACTURING FACTORS BEHIND A COMPUTER APPLICATION

MUCH OF THE traditional thought about business organization is based on the conventional organization chart. Such "static" charts show the lines of authority that link together the people and departments within a major organization; however, they do not reveal the working relations between various functional parts that must deal with each other in order to fulfill the aim of the organization—which, in the manufacturing industries, is to make and sell a line of products at a profit. Consciousness of the traditional organization chart actually tends to inhibit, at times, the free flow of information from one activity to another.

DYNAMICS OF BUSINESS OPERATION

For better understanding of how a business functions, a different type of chart, a *Dynamic Organization Chart* or *Flow Chart*, is more useful. A manufacturing business, particularly, is concerned with the flow and interaction of resources such as materials, money, machines, and men.

If the flow of material is used as an example, a straight-line chain can be developed from the vendor through receiving department, stockrooms, various manufacturing activities, to a finished-goods warehouse, and finally, to the customer. Such a chain is shown in the top row of Fig. 1 (cross-hatched blocks). However, material would not actually flow, would not be made into product, and would not be sold unless there were information flowing along with the material at every step along the way (second row of Fig. 1). This information generally is of the nature of receiving reports, material requisitions, shipping papers, and the like.

The physical material flow is also vitally affected by another flow of a different kind of information which moves in the opposite direction (bottom row of Fig. 1). This flow usually starts with the customer in the form of an order or an indication of future business; flows through *marketing*, where future manufacturing requirements are established; to *production control*, where these requirements are translated into production schedules; to *material control*, where the schedules are translated into the supporting material requirements; and then to *purchasing*, where the material requirements are translated into purchase orders on the

by **W. K. HALSTEAD, Mgr.**

Electronic Business System Planning
RCA Electron Tube Division
Harrison, N. J.

The RCA Electron Tube Division is now substantially reworking its operating systems to take advantage of an RCA-501 computer, to be installed at Harrison in the Spring 1961. Early in the period of preparation, some basic ideas were formulated about information flow in a business; these are summarized here.

vendor. This chain may be called the planning chain of information flow.

At every step along the planning chain, there is also a strong flow of information to and from the corresponding point in the production chain. Thus, an information network is developed which makes it possible to trace major information-flow patterns.

INFORMATION-FLOW PATTERNS

For the material-flow aspects of production, at least three such information-

WALTER K. HALSTEAD received the B.S.E.E. from Massachusetts Institute of Technology in 1939 and the M.S. degree from Ohio State University in 1941. From 1939 to 1941 he taught as an Assistant and Instructor in the Electrical Engineering Department at Ohio State University, and from 1941 to 1944 in similar positions at MIT. From 1944 to 1947 he was employed by the Polaroid Corp., Cambridge, Mass., and from 1947 to 1950 as Chief Engineer of the W. S. MacDonald Co., Inc., Cambridge. In 1950 he joined RCA in Camden in the Advanced Development Section and became associated with the BIZMAC project. He was Supervisor in charge of the development of the BIZMAC Laboratory System and in 1953 transferred to the Computing Systems Engineering Section as Manager of Computer Systems and Advanced Product Development. In 1957 he came to the Electron Tube Division to take part in the systems and automation work then being started. He is now Manager of Electronic Business System planning.



flow patterns can be identified. Customer, marketing (sales), and warehousing may be called the *product-distribution area*; in this area, information generally flows in a clockwise direction, as shown in Fig. 1. Marketing (market planning), production and material control, stockroom, and manufacturing are the *production area*; again, the information generally tends to flow in a clockwise direction, as shown. Finally, purchasing, the vendor, receiving, and the stockroom form the *procurement area*; information again flows clockwise, as shown.

In each case, the completed material flow causes an additional information flow back to the planning chain; this additional flow permits comparison of performance against plan, and serves to modify future planning. (Engineers would call this flow a feedback or closed-loop system.)

The three information-flow patterns are structurally similar; they differ principally in the element of elapsed time. In product distribution, an order is received, filled from inventory, and invoiced in a matter of a day or so (getting the customer to pay may take a little longer). In production, plans are usually made for a week or a month at a time; the work is then carried out for that period, and results are compared to the previously made plan. In procurement, time cycles may stretch over many months, depending upon lead times for obtaining the required materials.

So far, only the information system surrounding physical, quantitative material flow has been discussed. Similar patterns can be drawn for the specifications and quality aspects of material for the flow and use of labor, and for the flow and use of money. These flow patterns can be thought of as additional layers, comprising a three-dimensional information-flow pattern with complicated interactions between the layers, as shown in Fig. 2.

CHARACTERISTICS OF INFORMATION

Although each of the above areas (and any others that could be mentioned) deals with matters of different substance, it can be shown that the information problems are similar from a somewhat abstract and formal viewpoint.

First, every major data-processing job depends on some basic files of

information which describe the ingredients of the business. In the production area, these files might be a complete set of bills of material for each end product, an inventory record for production materials, a list of machines and their capabilities, and a running record of production output. A continuing flow of new data interacts with these reference files, as shown in Fig. 3, either to bring them up to date, or to use them as a reference to develop new information. In each such case, the volume or amount of information that has to flow and be processed in a given period of elapsed time is important. For example, the "move tickets" for tomorrow's production must be issued today.

High-volume jobs, such as keeping an inventory record up to date or compiling a production record from many detail ingredients, are normal food for data-processing machines.

Second, almost every data-processing operation contains decisions which are based on clear and firm operating rules set down in advance. These decisions might be called "attribute decisions" because, in every instance, the outcome is entirely based on the attributes (i.e., characteristics) of the information at hand. An example of this type of decision is the decision to reorder a certain material when the inventory level falls below a specified point. The steps involved in this decision are shown in Fig. 4.

Computers are especially suited for this kind of attribute decision, in which the rules of the game can be spelled out beforehand.

Summarizing and analyzing large volumes of routine information, and reporting only the significant trends and/or exceptions, is another job which computers can perform to help management at the operating level. In the future, instead of long lists and tabulations, the manager may well get a few machine-produced graphs and a brief report which says, in effect, "Everything is working within the control limits you have set, except certain few items, and here's what's wrong with them!"

Management, of course, also faces more-complicated decisions, and sometimes may be forced by time pressure to make an operating decision in the absence of adequate information. For example, in a highly seasonal business, decisions must be made at or near the beginning of the season about the production level and the "product mix", and often must be based on only meager sales information. Because of

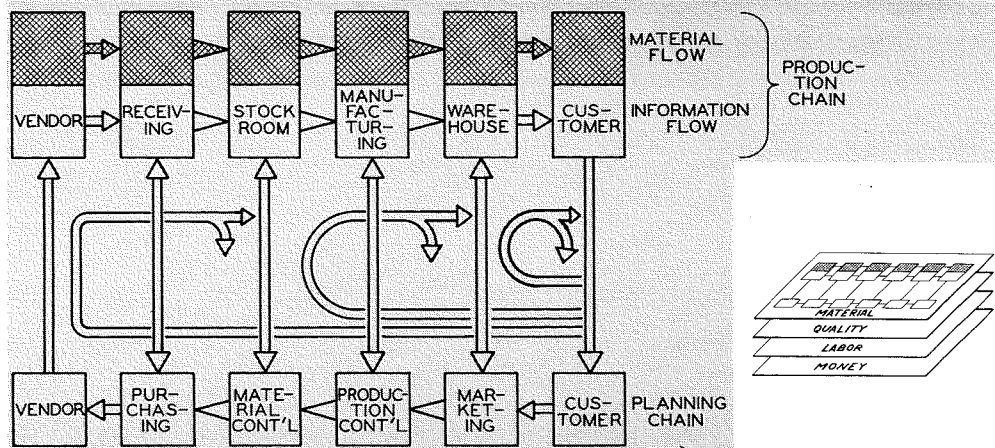
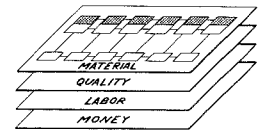

Fig. 1—Dynamic organization chart (or flow chart) showing material and information flow.

Fig. 2—(inset) Several layers of information-flow patterns that interact.



its speed of operation, computing equipment can often cut valuable time out of the normal delay encountered in collecting information. Techniques are also available to project from relatively little information what is going to happen in the future, provided the general pattern of behavior of the particular business system is known. Developments in this field come under the heading of Management Science or Operations Research.

Finally, management must make directive choices, i.e., choices which set or change the aims of the business as a whole, based on the knowledge of business trends, available capital and operating resources, and the like. In this field, computers can help management by rapidly figuring out the likelihood and relative magnitude of success of many different combinations of possible conditions. The term "simulation" is applied to such attempts to look into the future.

CONCLUSION

What has been said so far about information-flow patterns and the characteristics of information can be combined as follows:

Fig. 3—Interaction of continuing flow of information with reference files.

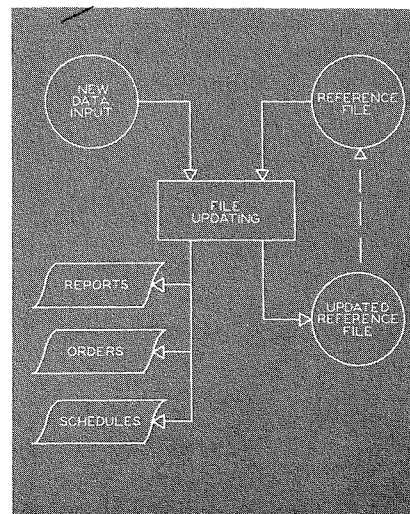

At the operating level, emphasis must be placed on timely operating information to keep operations going, in preference to "historical" accounting reports which have been, and still are, all too prevalent in many businesses. *It is necessary to develop and process the basic operating information so that it can actually be used for day-to-day, even minute-to-minute, operating control.* The word "control" is used here in the sense of steering, rather than reviewing long after the fact and trying to do better the next time.

Finally, reports needed and wanted at various higher levels of management (which are more and more removed from the operating level and, therefore, from the operating problems) can in turn be abstracted from the same basic operating information that made the business go and permitted its dynamic control.

ACKNOWLEDGEMENT

The author is indebted to W. E. Bahls of the Electron Tube Division for guidance and stimulation in much of the work that underlies the material in this paper.

Fig. 4—Steps involved in "attribute decision" of reordering material when inventory is low.

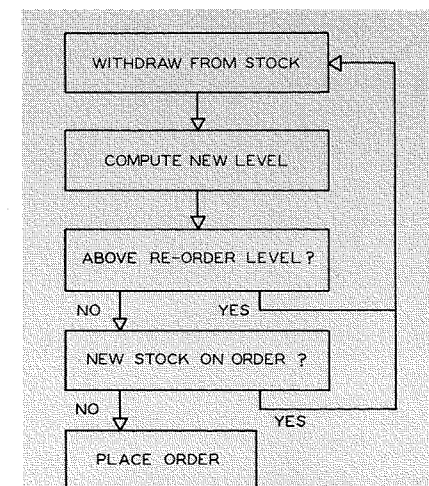

COMPUTER RESEARCH . . . Its Impact Today and Tomorrow

THE TECHNICAL PROBLEMS behind a computer differ from those in typical communication systems in a number of respects. For example, linearity in circuit properties is undesirable in computers, but a key objective of most communications. The outstanding difference, however, is the greater importance of the organization of the parts of a computer. A logical design has a life separate from the design of the components, and the work involved in inventing, developing, designing, and checking this logic, or organization, is as time-consuming as the equivalent work on the parts from which it is built. To bring a TV network program to a home requires over 50,000 electron tubes; yet the TV information flow charts would seem simple compared to those of a computer, just as in the TV network, circuit problems would seem highly varied and complex to a computer engineer.

NATURE OF COMPUTER RESEARCH

Research on computer organization has been going on for over 100 years, for most of its life entirely independent of communications systems research. Some overlap exists in telephone switching, and because of the rapid expansion of digital communications for military and industrial purposes, a communications engineer should know something of Boolean algebra, and a computer engineer of information theory. In the area of devices, however, the overlap is large, and present computer device technology is largely an application of techniques developed for the communications field. Present research can be classified into:

- 1) *Devices*: transistors, cores, and tapes and heads
- 2) *Assembly*: circuits, memories, and tape stations—and their associated wiring and cabling
- 3) *Logic*: for the computer itself, and for the data-processing system
- 4) *Standard Applications*: assemblers, compilers, and service libraries
- 5) *Specific Applications*: business methods, and numerical analysis

In the *techniques*' area, the phases of research, development, and design are better separated, and the picture of an idea starting with a dreamy physicist and finishing with a hard-headed engineer has some resemblance to reality. This is characteristic of a mature technology. In the *logic* and *standard applications* areas, invention and design are not so well separated and organized, as was indeed true of electronics in its early years. They are becoming separated, but the dreamers will be mathe-

by **J. N. MARSHALL, Mgr.**

*Advanced Systems—
Development Engineering
Electronic Data Processing Division
IEP, Camden, New Jersey*

maticians, logicians and perhaps neurologists.

DEVELOPMENT OF COMPUTER RESEARCH

In 1930, an engineer who was told that the 1950's would see the development of a billion-dollar business in computers could be forgiven for not seeing its dependence on communication techniques. He could have looked at the desk calculators, Babbage's computing engine, and the first major punched-card system being installed in the Bureau of Census and foreseen the future computer as a mass of gears, ratchets, and levers.

Yet, the first major computer, the Harvard MK1 built in 1938, employed the stepping switches, relays, and punched-tape equipment developed for telegraph and telephone. The first computer to operate in microseconds instead of milliseconds was the ENIAC (1946, University of Pennsylvania). It employed vacuum tube techniques developed in connection with TV and radar. The ENIAC derived a great deal from RCA research on a digital fire-control computer. J. A. Rajchman and others concluded that the accuracy require-

J. N. MARSHALL graduated from Cambridge University, U.K., with an Honors Degree in Mathematics and Physics in 1939. He then worked on rapid-scanning radar and identification at the R.A.F. Research Establishment. In 1943, he was assigned to the U.S. Naval Research Laboratory as project engineer on r-f test equipment and check-out systems for a radar identification system. With RCA since 1946, he has been project engineer on part of the Teleran Air Navigation System, a Target Designation System for the Navy, and later, Mgr., Information Handling Systems. As Mgr., Advanced Development, for Commercial Electronic Products, he supervised development of a computer, a complex telemetering system, and industrial instrumentation of various types. Since joining the EDP Division two years ago, Mr. Marshall has headed up development engineering groups on industrial computer applications and ultra-high-speed computers. In the recent reorganization of the EDP Division, he was appointed Mgr., Advanced Systems Development Engineering. He is an IRE Member and has several U.S. Patents.



ments could be met, but that the 3,000 tubes required was impractical for field equipment. War-time pressures prevented them from following up the possibilities of these techniques for performing scientific calculations.

In the late 1940's and early 1950's, many inventions used in today's computers were made. In the late 1940's, Dr. Aiken's group at Harvard made a vacuum-operated start-stop mechanism for use with a type of magnetic tape originally used for audio recording. In 1948, Bell Laboratories announced the transistor, and its lower power consumption made it of immediate interest to computer engineers in spite of its original limitation to audio frequencies. The development of the combinationally addressed ferrite memory took advantage of ferrite materials originally developed for communications purposes.

In the early 1950's, research solutions were required to some specific problems associated with computer use. Vacuum tubes developed high-resistance barriers between the oxide coating and cathode base metal. Research on cathodes, in which Dr. Nergaard's group at the RCA Laboratories was among the leaders, showed that the effect occurred when no current was drawn for extended periods (a new problem created by computers) and could be corrected by the use of pure nickel for the cathode base. Similar problems were the need for square hysteresis loops and low drive currents on ferrite cores, transistors which would recover rapidly after being driven into saturation, and magnetic tape without flaws. These problems are characteristic in that they concern adaptation of devices to computer use, rather than new devices invented for computers.

In 1960, computer business is as big as the communications business, and today's research is concentrating on the ideal computer device, without concern as to other applications. What are these ideal properties? Logic devices must be nonlinear so that input signal groupings produce one of two outputs. They must drive several similar circuits and therefore have gain—though only a small number of circuits are required to produce definite power outputs where output equipment is to be driven. Memory elements must be available in massive quantities (at least 10^5 , and now 10^6 or 10^7 bits), and this information be selected and read out with moderate power and complexity. Even larger quantities of information (10^7 to 10^{10} bits) must be available in seconds, and results printed out at rates of 10^3 to 10^5

bits/second. The prime aims of the researchers are more speed and more capacity, for less money.

SPEED

Computer speeds jumped with the introduction of electronic techniques, and it took ten years to consolidate this position. Circuit switching in a little less than one microsecond and memory cycles of 10 to 25 microseconds were normal over a long period, but memory capacity, reliability, and size, for example, have changed rapidly.

Now it is clear that a factor of 100 to 1,000 increase in speed can be obtained for a negligible increase in cost per element. There is an apparently insatiable demand for higher performance, and increased element speed is the cheapest way to supply it. These elements are rapidly becoming available, and will enable us to write *nano-seconds* (10^{-9} second) where we used to write microseconds. Transistors switching in 5 nanoseconds and tunnel diodes switching in 0.5 nanosecond are being made now. For memory elements, both thin films and minute ferrite elements can be switched in 1 to 3 nanoseconds.

This new plateau of speed will require time to consolidate, and the hardest problems appear to lie in the passive wiring rather than the active element. Propagation delays of 2 nanoseconds/foot make great demands on physical and logical organization to minimize information paths. Cross-coupling, already a problem in today's faster computers, must be solved by complete shielding and short ground-current paths. Size must be reduced to a few cubic feet. These problems will be particularly severe in the memory.

The prospect of nanosecond computers was foreseen several years ago by some farsighted members of the Department of the Defense; and under a research and development contract, RCA is actively developing nanosecond techniques for the U. S. Navy's Bureau of Ships. (See "Development of a 1000-Mc Computer," by R. K. Lockhart, elsewhere in this issue.)

I would predict that by 1966-68, medium and large computers will have memory cycles of about 50 nanoseconds and circuit delays of 1 to 2 nanoseconds. At somewhat greater cost, speeds of five times this will be available. The primary limitation is that propagation delays force the computer dimensions to go down inversely with speed, and volume therefore inversely as the cube of speed. Thermal noise may be an ultimate limit, since power is proportional to volume for a given cooling technique, and bandwidth increases with speed.

CAPACITY

Capacity here refers to the number of elements in a computer per fixed amount of dollars. Very roughly, a memory element now rents for 1 to 3 cents/month, and a logic element for around 50 cents to \$1.00/month. Anything over 10^5 logic elements and a few times 10^6 memory elements becomes a very large and expensive computer. About 10 percent of this cost goes into the active elements, and hopefully, the same amount will be retained by the manufacturer as profit. The remaining 80 percent is split about equally between 1) the costs of assembly, wire, passive elements, power supplies, and racks; and 2) designing and programming the computer, and finding the customers. The researchers working on the physical parts of the machine are, therefore, emphasizing very compact elements easy to put together.

The whole art of *thin films* is being developed at great expense, primarily by computer manufacturers, for this reason. Cryotrons are superconductors which work because the magnetic field from one conductor makes the other nonsuperconducting. Magnetic thin films may be deposited next to a wire which switches them. Cryotrons have gain, while magnetic thin films at this time do not and are limited to memory use. The cost of cooling cryotrons does not appear to be much more serious than air conditioning present large computers. Both the magnetic thin films and cryotrons have the desirable property that groups of elements (both passive and active) can be printed in one process at astonishing densities of 1000 or more per square inch. They also have the property of taking power only when a change of state occurs, which is desirable in logic where duty cycles run 1 percent or less, and even more so in memories (Fig. 1) when duty cycles are 100 times lower.

Several similar efforts are being made with semiconductors. Dr. Wallmark at the RCA Laboratories is building small circuit groupings out of unipolar transistors, with germanium resistor couplings all made out of a single strip junction (Fig. 2). There are possibilities for the fabrication of tunnel diodes and transistors by evaporation. The tunnel diode has an attractive advantage in its sharp knee—it takes 0.1 volt to switch a tunnel diode and 1.0 volt to switch a transistor. However, it looks today as if tunnel-diode and transistor circuitry would have about equal cost, since more tunnel diodes will probably be used, which counterbalances its simplicity in construction and circuitry.

Building the large, complex commer-

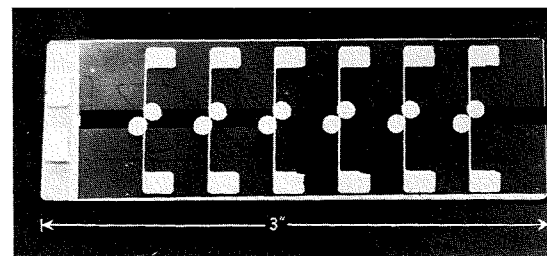

Fig. 1—Experimental cryoelectric elements in a 1 x 6 memory array.

cial computer will pose many problems. However, again risking a prediction, I expect to see the first computer made from *integrated circuits* in 1964, and the art consolidated to produce logic elements renting at 2 to 5 cents/month and memory elements at under 1/10 cent before the end of the 1960's.

PERIPHERAL EQUIPMENT

Turning to peripheral equipment, three major areas of research impress me as having revolutionary possibilities: *files*, *communications*, and *character reading*.

Files

If a large file of magnetic tape or disks is used as an intermediate memory, its performance depends on how much is stored, how long it takes to read the information, and how long it takes to find it. Solutions are weakest on the third problem. Improvements depend on greater density of data and superior methods to reach it.

For the better part of ten years, tapes have been run at around 100 inches/second and stopped or started in a few milliseconds. During the same time, the recording density has increased from 100 bits/inch to several thousand. It is to be expected that further improvements will be made in magnetic-tape recording, and there is considerable research activity in new recording techniques which offer the possibility of a radical improvement.

The big problem in manipulating recorded data is the random access file. Typical equipments are the IBM Ramac, and the RCA record file used with the RCA 301 system. These are solid designs based on known concepts. All the radical ideas, such as picking sheets from a book, etc., have so far not found acceptance. One reason is that very few applications can pay a large premium price for random access to the entire file because most present data processing is by batches which can be presorted.

Fig. 2—Full adder employing direct-coupled, unipolar transistor logic (24 elements).

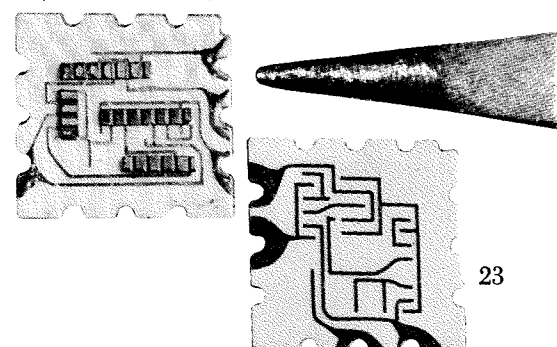

Communications

There is a tremendous development effort in data communications to bring in data as it develops and supply answers to interrogations of the central data-processing equipment. At the moment, the problems are organization and development, and research needs are not too significant. However, this trend will bring pressure to bear on the random-access-file problem, so that remote inputs on line to the computer and immediate access to files can together make possible the immediate processing of data in a single step.

Character Reading

A short study of a typewritten page shows the difficulty of this problem. Characters have variable density and pieces missing, they overlap, and dirt and paper defects provide background noise. Presently, the problem is simplified through the use of magnetic inks or large, specially designed type fonts where the document can be generated under control of the user. The problems lie as much in developing a set of rules for distinguishing characters as in finding the method of scanning them. These rules must not be too sensitive to position and orientation in the field of view.

The next level of difficulty is typewritten material and written characters where the positions are controlled by reference marks. Solutions at this level are in development. The hardest problem is handwriting. Good handwriting often requires the context as an aid to reading, and bad writing may be illegible even with reference to context. The development of the rules for solving this problem is at least a very-long-range problem and quite possibly insoluble.

"Peripheral" Predictions

Trying to make predictions in these areas of peripheral equipment is risky; but, it seems likely that in five years radically new recording techniques will provide access at internal machine speeds to about 10^6 bits of information, and within seconds to any page of a book or tape of such recorded sheets containing 10^9 bits or more. In conjunction with such files, input information from turn-around documents, and typewritten and carefully handwritten material will be fed to the system on line as it develops, and immediately processed against file data.

COMPUTER ORGANIZATION

All digital computers built to date have certain basic similarities in organization. They have a memory, an arithmetic unit, input and output, and a control system which, by the proper sequencing of transfers over a data bus and by setting the correct gates controlling infor-

mation flow, cause the execution of the instructions written by the programmer. This general organization dates from Babbage's computing engine (1830's).

The human brain does not have this organization and can do things we would like to have computers do. This is a constant stimulus to wonder and discussion, but so far there are no indications of an early breakout from this basic organization.

Computer organization is not as easy to measure and evaluate as computer circuits, but certain developments stand out and indicate future trends—*decisions, clean flexibility and word lengths, and automatic design.*

Decisions

The difficulty of programming computers lies largely in the extreme detail with which its work must be specified. The ability to select program steps on the basis of data resulting from previous steps gives the programmer a great increase in flexibility. A basic tool is the conditional transfer. In England, this is credited to a Lady Lovelace who, as a pupil of Babbage's, programmed his machine. She must have been the first to suffer the blow of doing programming assistance to design on a machine which was never built.

The interchangeability of program and data, first implemented in the early 1950's, gave the programmer freedom to develop his own methods for modifying programs on decisions and was a major revolution. Some recent machines for commercial data processing contain an innovation in using symbol control to indicate the word limits so that the programmer can handle variable length data with a minimum of housekeeping, letting the machine decide when the word is "used up."

A number of people, such as Newell and his associates at Rand Corporation, have published descriptions of techniques for proving theorems by using intelligent trial and error. Even with the computer's great speed in making trials, random trial and error is impossible except in trivial problems, because alternates multiply so fast with complexity. This work is a realistic step in "learning machines." The computer research group at the RCA Laboratories is exploring this general field.

There is considerable speculation about multiple computers which are programmed to assign work for optimum performance. There is also a lot of "far-out" talk about self-organizing machines which will form their own logic on an intelligent trial-and-error basis, but this seems to be discussion of a need rather than invention.

What does seem clear is that enabl-

ing a machine to make more decisions and the programmer fewer permits the use of increased complexity of organization and program. If we are ever to be able to make computers of 10 or 100 times the present complexity and get value from them, improvements of this kind are necessary. The fact that woolly and romantic talk is common in this area should not blind us to a probability that major revolutions are likely here, though I would suspect not for at least ten years.

Clean Flexibility and Word Length

An innovation used in the Institute of Advanced Studies' machine was to handle a complete word in parallel binary code, whereas the Harvard MK1 and ENIAC handled decimal digits in serial.

Parallel operation gives tremendous increase in speed over serial operation. Word length is an important indication of machine's power. With increasing word length comes increasing instruction length and complexity. This makes the machine more "intelligent" and more powerful, but it brings trouble in its wake because the machine's code must be simple to interpret and uniform in its meaning—or errors in programs increase rapidly. Compilers do not completely eliminate this problem. Though the program is now written in a problem-oriented language and the computer will interpret this language into its own program, it is very difficult to eliminate the need for precautions and exceptions due to details in the compiler and the instruction code.

If we are to build computers with longer word lengths and more-powerful instruction codes, then the problem of "cleanness" of instruction code becomes an area for major effort.

Automatic Design

At present, automatic design uses the computer to do some of the drudgery of detailed layout and wiring instructions. Research on logical minimization—both of Boolean forms and others such as majority decision elements—has done little to help computer designers, though it provides perspective and, occasionally, an unexpected solution. It should pay off rapidly as automatic design encompasses more of the logic design.

SUMMARY

It appears likely that the next five years will see major breakthroughs in the components of computers, but that research on organizational problems is less sure of its direction and less well funded, and does not appear likely to offer the designer a radical and profitable direction in such a short time.

SEMICONDUCTOR-JUNCTION NUCLEAR-PARTICLE DETECTORS

by **DR. R. W. JACKSON, Director**
*Semiconductor Laboratory
Research Laboratories
RCA Victor Company, Ltd.
Montreal, Canada*



The Montreal Research Laboratories have achieved a new solid-state **Alpha-Particle Detector** that is attracting world-wide attention for heavy-particle detection. Corollary work is aimed at a solid-state detector for lighter particles like beta and gamma radiation, principle constituents of fallout. Pocket-size, economical simplicity makes such detectors promising for space applications, as well as in military, scientific, and industrial areas.

KNOWLEDGE OF THE properties of atomic nuclei has advanced as means of detecting and measuring the elementary particles has improved. The elementary particles now include neutrons, positive and negative electrons (or beta particles), photons (or electromagnetic quanta of visible light, X-rays, gamma rays, etc.), and protons, deuterons, tritons, and alpha particles (the last four being the completely ionized atoms or nuclei of hydrogen, deuterium, tritium, and helium, respectively). The list continues up the scale to nuclei of heavier and heavier atoms, not to mention the whole family of mesons, and all the particles of anti-matter both hypothetical and observed. The main detecting devices for all these particles fall into three or four types: the scintillator, the ionization chamber, the ion-multiplying chamber, the cloud chamber.

The cloud chamber has its solid-state form in the nuclear photographic emulsion; the scintillator is already a solid crystal, except for the photomultiplier tube used with it. The Research Laboratories of the RCA Victor Company, Ltd., Montreal, recently developed a new solid-state version of the ionization chamber which is exciting great world-wide interest, particularly for the detection of the more heavily ionizing particles like protons, deuterons, and alpha particles.

The more lightly ionizing, longer-range particles such as beta and gamma radiations are more common in industry and medicine and are the principal radiations associated with fallout. They are most commonly detected with the ion-multiplying type of counter, such as the "proportional" counter and the familiar Geiger-Muller counter. A solid state equivalent is being eagerly sought.

BACKGROUND

Over the last three or four years, the realization has been growing that semi-

conductor junctions can make excellent detectors of individual nuclear particles. Although McKay¹ in 1949 demonstrated the detection of alpha particles by a p-n junction, his experimental devices were not in such a form as to make obvious the potential advantages.

The real development of devices for nuclear-particle detection and the appreciation of their features by nuclear physicists followed upon improvements in semiconductor technology—primarily the preparation and general availability of extremely high purity germanium and silicon, and secondarily the development of the diffusion process for preparing very thin surface layers.

Most of the earlier work, as for instance the work of McKenzie & Bromley at the Chalk River² Laboratories of Atomic Energy of Canada, Ltd., was done with "surface-barrier" junctions on germanium, formed by evaporating a thin layer of gold onto the surface of n-type material. However, the germanium had to be cooled, usually in liquid nitrogen, to reduce the junction reverse current to a tolerable value, for it is the noise from saturation and leakage currents that ultimately limits the sensitivity of the junction as a nuclear-particle detector. More recently, the emphasis has shifted to silicon as the basic material, since its higher energy gap makes possible devices which work well at room temperature, and to impurity diffusion for forming junctions.

A leading role in bringing the silicon-junction alpha detector to a usable form has been played by the Research Laboratories of RCA Victor Company,

Fig. 1—A p-n junction formed just below the surface, with an alpha particle penetrating through the n-layer and being stopped within the depletion layer.

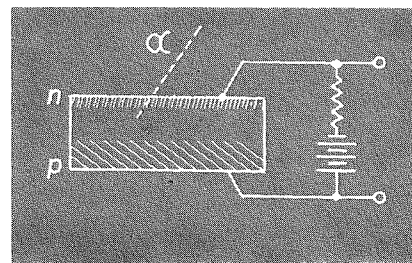

DR. RAY W. JACKSON graduated in 1944 from the University of Toronto with a B.A.Sc. in Engineering Physics, specializing in X-rays and spectroscopy. After two years in the Royal Canadian Navy as a radar officer, he entered the Graduate School at McGill University, receiving a Ph.D. degree in Nuclear Physics in 1950. From 1951 to 1952 he held a post-doctoral fellowship at Yale University from the American Council of Learned Societies, for study in the philosophy of science. He remained there until 1954, working for the Yale Edwards St. Laboratories on under-sea detection. He then joined the Research Laboratories of the Sprague Electric Company, doing research on semiconductor materials. In 1950, he joined the Research Laboratories of the RCA Victor Company, Ltd., Montreal, as head of the Electronics section. In early 1959, Dr. Jackson became head of the Semiconductor section. His specialized experience includes accelerator physics and electronics (particularly the synchrocyclotron), r-f induction heating, preparation and properties of rectifying junctions, measurement of minority-carrier lifetime, and semiconductor device applications. He is a member of the IRE, Sigma Xi, the Canadian Association of Physicists, and the American Association for the Advancement of Science.

Ltd., Montreal. (This work was supported in part by the Canadian Defense Research Board through the Electronic Components Research & Development Committee, and was carried out in close association with Dr. J. M. McKenzie of Atomic Energy of Canada Laboratories, Chalk River.) The first encapsulated units for general use were available in sample quantities from the Montreal Laboratories in February, 1960.

DETECTOR PRINCIPLES

In Fig. 1, a p-n junction has been formed just below the surface of a slab of p-type silicon by diffusing n-type impurity (phosphorus) to a very shallow depth. Experience shows that a good rectifying junction can be obtained with the n-layer as thin as one or two tenths of a micron. Just below this layer, which is very highly doped with phosphorus atoms, is the depletion layer—a layer depleted of free charge carriers.

For the understanding of the devices, it is important to recall how this depletion layer comes about. Any concentration of particles free to move in a medium, e.g. molecules in a gas, will diffuse by random motions until the average density of distribution everywhere is uniform. At the p-n junction,

the high concentration of free electrons in the n-region and the high concentration of free holes in the p-region tend to inter-diffuse. As they do so, each charge carrier leaves behind it an uncompensated charge (the donor or acceptor impurity atom fixed in the lattice) and a dipole field builds up until equilibrium is reached between the diffusion field and the electric field. (The exact treatment is quantum mechanical and expresses the equilibrium condition in terms of the Fermi level). There is then a transition region virtually depleted of charge carriers and having an electric field across it.

When an external voltage V is applied in the reverse biasing direction in addition to the "diffusion voltage" V_D , the depleted region widens to a width defined by:

$$W = \left[\frac{k(V_D + V)}{8\pi e N_a} \right]^{1/2}$$

Where k is the dielectric constant and N_a the concentration of uncompensated acceptor centers in the p-region.

Only the p-region is here taken into account, on the assumption that the n-layer will always be much more highly doped with impurity centers than the p-layer; thus, the penetration of the depletion layer into the n-layer will be relatively small, since equal amounts of charge must be uncovered in the two regions. Typical figures show that for an acceptor density of $1.5 \times 10^{13}/\text{cm}^3$, or resistivity of 1000 ohm-cm, and an applied bias of 50 volts, the depletion layer width will be 65 microns. Detectors have been made from material of resistivity as high as 30,000 ohm-cm; and, with voltage biases as high as 400 volts, depletion layer width up to 800 microns, or 0.8 mm, have been achieved.³

ALPHA-PARTICLE DETECTION

It happens that practically all alpha particles from decaying radioactive

nuclei have energies in the range from 2 to 10 Mev. Radioactive atoms which give alpha particles outside this energy range have lifetimes too long or too short to be practically observed. The corresponding distances which alpha particles of these energies will travel in silicon before being brought to a stop are 5 and 65 microns. Thus, even a 2-Mev alpha particle will lose very little of its energy in passing through the n-layer and will expend practically all its energy in the depletion layer, creating a trail of ionization, or hole electron pairs. Since this is the region of high field, the electrons and holes are quickly swept out—the electrons to the n-region and the holes to the p-region—to appear as a sudden increment of charge on the junction capacitance. This pulse of charge, which may have risen in a time of 10^{-8} or 10^{-9} seconds, decays with the time constant given by the junction capacitance (plus amplifier capacitance) and the resistance of the external circuit. The amplitude of the pulse is closely proportional to the energy of the alpha particle.

Thus, the operation of a semiconductor-junction nuclear-particle device is very similar to the operation of the gaseous ionization chamber, with the depletion layer forming the sensitive volume and the n-layer serving as a very thin window. The solid-state ionization chamber, however, has a number of advantages:

In the first place, the energy loss required to create a hole electron pair is almost an order of magnitude lower in the solid than in the gaseous state. McKay measured the average energy loss by an alpha particle in creating a hole-electron pair as 3.5 ev in silicon, and 2.8 ev in germanium. This is to be compared with 32.5 ev in air, for example. Thus, nearly ten times the charge is released in the semiconductor as in the gas, allowing a greater sensitivity

and, more important, a greater resolving power for distinguishing between particles of nearly equal energy. With junction detectors up to one sq. cm. in area, it has been possible to measure the energy of alpha particles to an accuracy better than 1 percent with the junction detector simply followed by a low noise amplifier and a pulse-height analyser.⁴ Thus, many accurate energy spectra can be rapidly obtained which previously could be obtained only slowly with a relatively large magnetic spectrometer. Fig. 2 shows an alpha spectrum from Bismuth²¹², taken at Chalk River with a 100-channel pulse-height analyser.

Further comparison with the gaseous ionization chamber shows that the semiconductor counter has the advantage in all respects of window thickness, ruggedness, small size, speed, and low voltage. The p-n junction will detect particles even with no voltage applied, while the gaseous ionization chamber requires a bias of 200 volts or more.

DETECTION OF OTHER PARTICLES

Other nuclear particles besides the alpha particle can be usefully detected with the p-n junction—heavy particles in particular—because of the effectively very thin window. In fact, it appears that the effective thickness of window approaches zero because of the diffusion of carriers through the n-layer to the depletion layer. Even a heavy ion or a fission fragment which barely penetrates the surface can be detected and a good measure of its energy obtained. The junction detectors have been eagerly seized upon by the physicists studying nuclear reactions with heavy ion accelerators.

The devices can be converted to detectors of neutrons by coating the front layer with a suitable material, such as Li⁶ or B¹⁰, which reacts to emit alpha particles under bombardment by fast neutrons, or with U²³⁵, which breaks up by fission on capture of a slow neutron. There is wide interest in this application though, at time of writing, the efficiencies of neutron detectors made this way are not yet known.⁵

For lightly ionizing particles, which therefore have a longer range, the obtainable depth of depletion layer becomes the deciding factor. Protons, which have a range four to five times the range of alpha particles, can be detected with linear measurement of energy up to an energy of the order of 10 Mev with the deepest depletion layers in silicon. The limit for electrons is of the order of 300 kev. Of course,

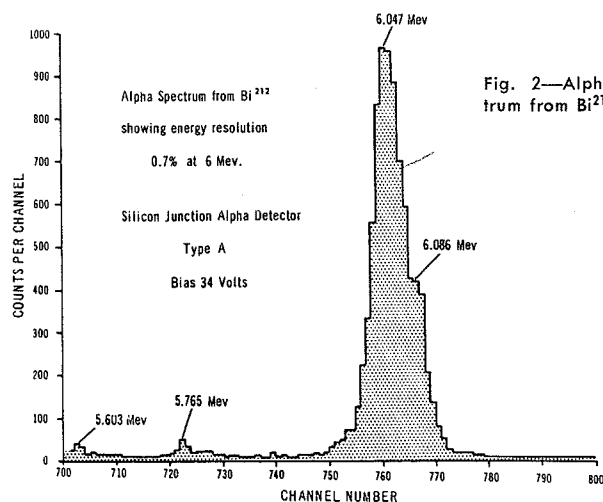

Fig. 2—Alpha spectrum from Bi²¹².

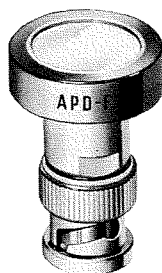

Fig. 3—Three types of RCA Victor Company Ltd. alpha detectors.

particles with greater energy can be detected, but not with an appreciably greater charge release in the detector—though it has been observed that a certain proportion of electrons are scattered sufficiently to lose all their energy in the depletion layer up to energies higher by a factor four.⁶

Even gammas can be detected, at low efficiency, chiefly by resonance capture with emission of an electron, the electron creating the detectable ionization.³ However, for efficient detection of betas and gammas to compare with the scintillator crystal and photo-multiplier tube, it appears that larger sensitive volumes are needed than can be obtained with depletion layers in silicon. Experiments are proceeding on other techniques and materials in the hope that an entirely solid state beta-gamma detector can be developed. Such a device would have an extremely wide application.

The limits of the p-n junction for detecting low-energy particles and lightly ionizing particles are, of course, set by the signal-to-noise ratio. The signal (voltage) amplitude is set by the charge collected, divided by the junction capacitance, and thus goes down as the area of the junction is made larger. The noise arises from the saturation and leakage currents, and from the amplifier. With the small area junctions, say 5 to 20 sq. mm., for which the best energy resolutions have been obtained, junction current noise tends to be important. For larger areas, as the signal amplitude decreases (and junction noise with it), the amplifier

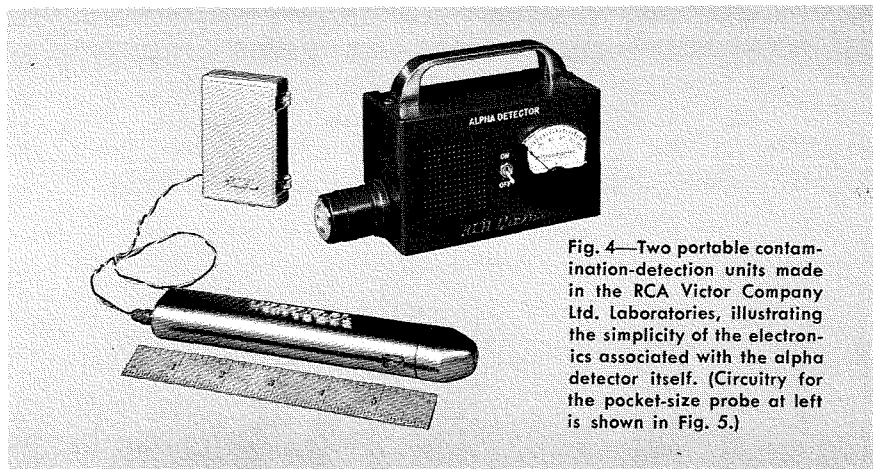
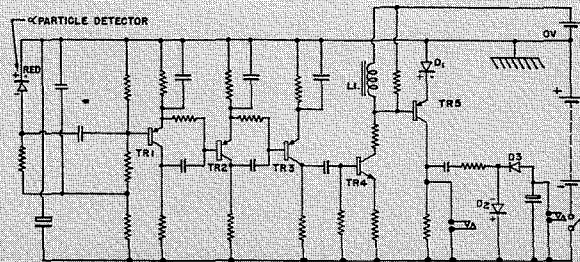

Fig. 4—Two portable contamination-detection units made in the RCA Victor Company Ltd. Laboratories, illustrating the simplicity of the electronics associated with the alpha detector itself. (Circuitry for the pocket-size probe at left is shown in Fig. 5.)

Fig. 5—Alpha detector circuitry. This entire circuitry is contained within the metal probe seen at left of Fig. 4.



noise becomes the limiting factor. When 1000-ohm-cm silicon is used as the basic material, the maximum useful areas for alpha detection are of the order of 3 to 10 sq. cm., the total junction area depending, of course, on the minimum energy to be detected. In an encapsulated form, the actual detecting area must be less than this to allow for the contact and seal to the front surface. Fig. 3 shows three sizes of alpha detector made by RCA Victor Company Ltd., the largest being 2 sq. cm. in window area.

APPLICATIONS

Because of its small size, ruggedness, and low voltage requirements, the silicon-junction particle detector is ideal for portable use and for sending aloft in satellites to measure the heavy particle radiation outside the earth's atmosphere. Fig. 4 is a photograph of two portable contamination detector units made in the RCA Victor Company Ltd. Laboratories to demonstrate how simple the associated electronics can be. Fig. 5 shows the circuit used for the small pocket-sized probe. Four transistor amplifying stages are sufficient to trigger a thyristor, which then generates a pulse of sufficient power to drive the small loudspeaker shown, or to drive a count-rate indicating meter. The entire circuit with batteries is contained in the metal probe. Essentially the same circuit is used in the larger unit, which has the loudspeaker and meter incorporated in a self-contained instrument.

BIBLIOGRAPHY

For the interested reader, the following references give more-detailed information—in particular the proceedings of the Seventh Scintillation Counter Symposium and the Gatlinburg conference on Solid State Radiation Detectors, both of which are to be published in the *Transactions of the IRE Professional Group on Nuclear Science*. For general reading, see 7, 8, and 9:

1. K. G. McKay, *Phys. Rev.* 76, 1537, 1949; 829, 1951; and *Phys. Rev.* 84, 829; 1951.
2. J. M. McKenzie, D. A. Bromley, *Phys. Rev. Letters*, 2, 303; 1959.
See also:
J. Mayer, B. Gossick, *Rev. Sci. Instr.*, 27, 407; 1956.
J. W. T. Dabbs, F. J. Walter, L. D. Roberts, *Physics Progress Report*, Oak Ridge National Laboratory, ORNL 2501, p. 73; 1958.
A. V. Airapetyants, S. M. Ryvkin, *Soviet Phys. Tech. Phys.*, 2, 79; 1957.
3. P. F. Donovan, G. L. Miller, B. M. Foreman, *Bulletin Am. Phys. Soc.*, 5, 355; 1960.
4. J. L. Blankenship, C. J. Borkowski, paper no. A-3. IRE-PGNS Gatlinburg Conference October 1960.
5. See, however, T. A. Love, paper no. C-1. IRE-PGNS Gatlinburg Conference October 1960.
6. J. M. McKenzie, G. T. Ewan, paper no. B-2. IRE-PGNS Gatlinburg Conference October 1960.
7. *Proceedings of the Seventh Scintillation Counter Symposium*, Washington, Feb. 1960; published in IRE Transactions NS-7, June-Sept. 1960; see particularly J. W. Mayer, p. 178.
8. R. W. Jackson, *Physics in Canada*, 15, 21 (Winter, 1959).
9. S. S. Friedland, J. W. Mayer, J. S. Wiggins, *Nucleonics*, 18, 54; February, 1960.

NEW APPROACHES TO THE STUDY OF CATHODE NICKEL

by W. G. RUDY

Chemical and Physical Laboratory
Electron Tube Division
Lancaster, Pennsylvania

UNTIL RECENTLY, work on thermionic emission has concentrated on the emission mechanism within the cathode coatings, with relatively little listed, even in Noelcke's bibliography,¹ on the effects of the cathode base material. Since the introduction of the semiconductor model of the oxide cathode, rapid advances have been made in understanding the principles of thermionic emission. However, many of the details remain to be explained. One such detail, the influence of the base material in creating activation centers in the coating, is only beginning to receive serious attention.

In the very early work on oxide cathodes, the base metal played a secondary role. Its primary functions were to support the oxide coating, transfer heat to the coating, and supply electrons to maintain the potential equilibrium of the coating. As demands were made for higher current and longer life, it was realized that the base material could greatly influence the cathode emission. Minute traces of certain elements incorporated in the base material during refining and processing were recognized as the origins of this influence. These elements chemically reduced the oxide coating and created activation centers. This reduction process occurs during initial activation and may continue throughout the life of the cathode.

The most common base material used commercially is nickel alloyed with small quantities of elements such as magnesium, manganese, and silicon. Nickel is commonly classified as either active, normal, or passive, depending upon the quantities of these (Table I).

TABLE I—TYPICAL NICKEL ALLOYS

Element	Active, %	Normal, %	Passive, %
C	0.04*	0.05-0.10	0.05*
Mg	present	0.03-0.10	0.005*
Si	0.15-0.25	0.01-0.05	0.01*
Mn	0.20*	0.20*	0.02*
Ti	0.05*	0.005*	0.005*
Cu	0.20*	0.15	0.10*
Fe	0.20*	0.10	0.06*
S	0.008*	0.008*	0.005*
Co	1.0	1.0	—

*Maximum.

COMPOSITION CONTROL

A very pure, refined nickel is not very malleable and cannot be used for the cathode base, which requires considerable hot and cold working. However, a magnesium deoxidation process produces a nickel which can be worked, with optimum malleability obtained by adding traces of elements such as titanium and manganese. Control of these residual elements is essential to good cathode base material.

One new approach to composition control is vacuum melting.² Electrolytic nickel and reducing elements are melted and alloyed under vacuum—with the advantage of control of the atmosphere surrounding the molten alloy. For example, hydrogen instead of carbon can be used as the deoxidizer. With carbon, it is uncertain how much will be used up and how much will remain as free carbon. Any sizeable trace (over 0.1 percent) results in undesirable gas evolution from the cathode.

Preparing cathode alloys by vacuum melting has other distinct advantages:

- 1) Adsorbed and dissolved gases are reduced.
- 2) The formation of chemical compounds such as oxides and sulfides from reducing agents is prevented.
- 3) Tighter limits on the quantities of reducing elements.
- 4) A better choice of crucible material to minimize contamination.
- 5) The presence of inclusions is reduced.

Efforts at other laboratories^{3,4} also are being made to control the base nickel composition. In one method, the basic nickel is prepared first by the Mond process, in which Ni(CO)₄ produced by treatment of nickel oxide in producer gas is heated to decompose the carbonyl. A very pure nickel in the form of powder is produced. In a typical carbonyl nickel, only oxygen and carbon are in excess of the desired limits. By subsequent firings in wet and dry hydrogen, dry helium, and vacuum, these impurities are controlled. As in vacuum melting, reducing

WILLIAM G. RUDY received the B.S. at Dickinson College in 1943, receiving Phi Beta Kappa honors. After three years of military service in the United States Army Signal Corps, he continued his education at the American University at Biarritz, France. In 1948 he received the M. Sc. in Physics from Carnegie Institute of Technology. He joined the Chemical and Physical Laboratory of the RCA Electron Tube Division in Lancaster in 1948 and has been chiefly concerned with improvement in pickup-tube performance. He is presently a senior engineer working in the field of thermionic emitters, and has recently co-authored a paper on the molded nickel cathode.



elements are added after oxygen removal to prevent their loss as oxides. The goal of this work is nickels having only single and double additives.

The exacting efforts to control the nickel melt are wasted if subsequent processing is not just as carefully controlled. When nickel is worked to cathode form, contamination may be introduced. Hot and cold rolling sometimes cause surface iron contamination, removable by acid pickling. Very dry atmospheres must be ensured, to prevent oxidation of reducing elements. When lubricants are used (e.g., in deep drawing of some varieties of cathode sleeves), a degreasing step must be included. Finally, proper handling of the cathodes in tube manufacture contributes immeasurably to long cathode life.

COMPOSITION ANALYSIS

A second important facet in obtaining better oxide cathodes is chemical analysis of the base nickel. A determination must be made of not only what is present in the nickel but also what and how much is available for reacting with the alkaline earth oxides. Without this knowledge, the tube engineer cannot correlate cathode behavior with the amount of impurities.

The emission spectograph is usually employed to determine what is present in the base alloy. A rapid qualitative analysis can thus be made, and the quantity of the elements can also be measured from the intensity of the spectral lines. However, frequent disagreements over quantitative data suggest the need for a more accurate analytical method.

The "availability" question has been studied.⁵ Not only do the reducing agents diffuse into the oxide coating but also they evaporate along with some of the nickel substrate to other parts of the tube during processing and operation. In this investigation,⁵ a quartz balance, housed in a vacuum-tight enclosure, was used to weigh the sublimate to 0.5×10^{-6} grams accuracy. Pure nickel (impurities less than 0.005 percent) with single additive reducing elements were used to determine diffusion constants (Table II). Although the method

TABLE II—DIFFUSION CONSTANT FOR 0.1% MAGNESIUM NICKEL ALLOY

Temperature, °C	Diffusion Constant, cm ² /sec
848	2.2×10^{-11}
943	5.0×10^{-11}
982	7.1×10^{-11}

appears to be highly useful for analysis of single additive alloys, considerable work would be entailed in an analysis of a multi-constituent nickel alloy.

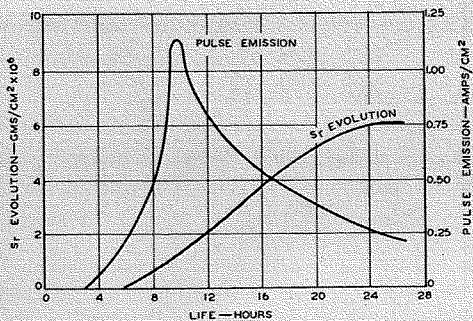

Fig. 1—Typical strontium evolution throughout cathode activation and life.

Less-exacting experiments are being conducted by the author. Base nickel, in its final physical form, is heated to 1100°C for various intervals to produce sublimation on the enclosing glass envelope. An analysis of the relative quantities of elements comprising the sublimate is then made with an emission spectrophotometer.

If it is assumed that the evaporation rate of the nickel is constant, the data shows a degree of correlation with diffusion rates of the various constituents in nickel. The data suggests that the rate at which magnesium, for example, reaches the cathode coating interface is proportional to t^{-n} , where n is probably $\frac{1}{2}$. Other reducing agents, though not presently studied as thoroughly as magnesium, appear to have comparable arrival rates. It is hoped that this type of analysis will be of practical value in evaluating cathode-nickel melts and in guiding the tube engineer in evaluating activation and aging-schedule changes.

EFFECT OF ALLOY COMPOSITION

Analysis and control of the composition of the base nickel is of no value unless the effect upon cathode emission can be evaluated. Initial activation and life have been studied with radioactive tracers.⁶ The influence of the base composition upon the cathode's ability to resist oxygen poisoning has been investigated by the Electron Tube Division, Lancaster. Basically, both approaches seek to show that emission can be controlled by diffusion of reducing agents from the base nickel.

The first technique⁶ provides for direct measurement of oxide-coating reduction. Because cathode activation is believed to result from the effects of an excess of alkaline earth metals present in the coating, reducing agents diffusing into the coating produce the active centers. If the rate of reduction were constant, a state of dynamic equilibrium would be obtained with as much alkaline earth metal being evaporated as is formed. In the actual cathode, the dynamic equilibrium state is never achieved because the diffusion rate is not

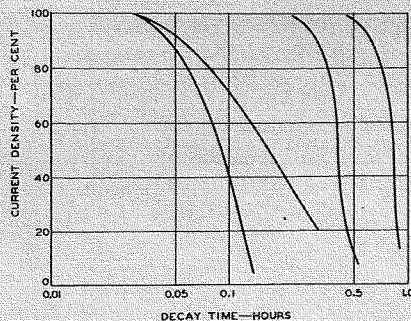

Fig. 2—Typical emission decay curves for various nickels. Cathode temperature = 1100° K (brightness); pressure = 2.5×10^{-6} mm-Hg.

constant. However, monitoring the evaporation of any one alkaline earth metal provides a measure of the diffusion rate. Radioactive strontium was used for these experiments.

Barium and calcium carbonates were co-precipitated with radioactive strontium carbonate to give the customary triple carbonate used in oxide-coated cathodes. This carbonate was applied to several different types of bases. In one case, the base consisted of pure nickel backed by a carbon disk. In other cases, the base materials were dilute nickel alloys of tungsten, aluminum, and manganese. The anode used to receive the evaporation products is moved away from the cathode to permit frequent monitoring. Thus, determinations of the evolved strontium are made throughout cathode activation and life (Fig. 1). Earlier experimental work by this same group provided diffusion rates in nickel with which to correlate the evolved strontium. For cathodes operating without current drain (i.e., the use of pulse emission only), the thermionic emission was observed to correlate with the strontium evolution rate and, hence, with the diffusion rate of the reducing agents.

The author has developed a method for evaluating the effects of nickel-alloy composition in terms of thermionic emission decay. In a study of oxygen poisoning of cathode emission, it was noted that the results were influenced markedly by base-nickel composition. This method makes use of the fact that adequate emission is obtained only by virtue of activating centers within the cathode coating; these centers are produced most easily by the reaction between reducing agents and the alkaline earth oxides.

To determine the relative number of activating centers produced by a particular base nickel, the centers are destroyed with oxygen. The cathode is surrounded with oxygen at pressures of about 10^{-6} mm of mercury, and the emission decay curve is determined (Fig. 2).

Table III presents the results of choosing an arbitrary 50-percent current-decay time and comparing the data with

TABLE III — COMPARISON OF THE DECAY TIME AND BASE NICKEL COMPOSITION.

Ni Alloy*	50% Emission Decay Time, Min.	Chemical Composition, %				
		Mg	Mn	Si	C	W
P	5	0.007	0.005	0.015	—	0.0
N	12	0.012	0.004	0.026	0.04	4.0
N	17	0.013	0.021	0.021	0.01	0.0
N	22	0.015	0.004	0.045	0.05	4.0
N	40	0.075	0.13	0.026	0.03	0.0
N	51	0.090	0.15	0.035	—	0.0
A	19	0.020	0.08	0.18	—	0.0

* P, passive; N, normal; A, active.

the chemical analysis obtained on the emission spectrophotometer. The cathode activity appears to be primarily a function of the magnesium concentration. For the normal and passive nickel alloys, the result is not unexpected; however, the poor result for active nickel having high silicon content is puzzling. The advantage, corroborated by these experiments, of the active alloy is the ease with which emission is obtained even under poor vacuum conditions. However, under good vacuum conditions, the normal nickel alloys with high magnesium content appear to produce a higher concentration of active centers than the so-called active nickels.

SUMMARY

Much attention is being given to cathode base nickel. A number of laboratories are supporting efforts to better understand the contribution base nickel makes in achieving long cathode life. As more experimental data becomes available, it is likely that a coherent theory will be developed.

BIBLIOGRAPHY

- Noelcke, C. L., *Deterioration Mechanism in Electron Tubes*; Arinc Research Monograph #6, Publication #101-4-127, Arinc Research Corporation, Washington, D. C.
- Horsting, C. W., "Application of Vacuum Metallurgy to Electronic Materials"; *RCA ENGINEER*, Vol. 4, No. 3, Oct.-Nov., 1958; pp. 36-38.
- Olsen, K. M., "Superpurity Nickel Melted Under Controlled Atmosphere"; *Metal Progress*, Vol. 72, September 1957, pp. 105-107.
- Frost, H. B., & Gee, R. C., *A Study of Tungsten, Magnesium, and Aluminum as Nickel Additives for Oxide Cathode Use*. Paper presented at Thermionics Symposium, Electrochemical Society, May 1959.
- Rouse, G. F., *Oxide Coated Cathode Sublimation Studies*; Scientific Reports 1, 2, and 3, Contract AF CRC 55-24, 55-30, and 58-3, National Bureau of Standards, Washington, D. C.
- Peterson, R. W., Anderson, D. E., and Sheppard, W. G., "Influence of the Cathode Base on the Chemical Activation of Oxide Cathodes"; *Journal of Applied Physics*, Vol. 28, No. 1, 1957, pp. 22-23.

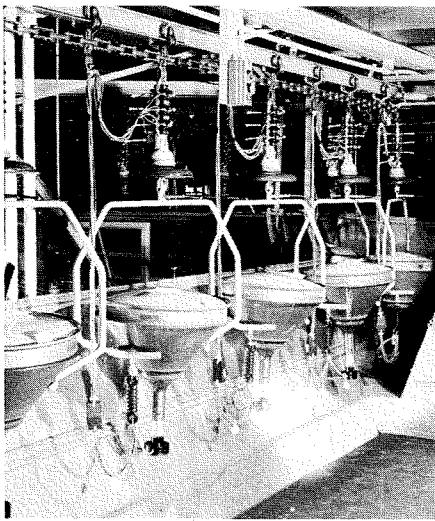

In the short span of ten years since RCA first demonstrated an all-electronic, wholly compatible color television system, production requirements for color picture tubes have greatly increased. To permit mass production of high-quality tubes, it has been necessary to mechanize their fabrication and handling. Major pieces of manufacturing equipment were designed and built for that purpose and then integrated into the production system. This engineering accomplishment has made possible the quantity production of high-quality color picture tubes at a competitive price.

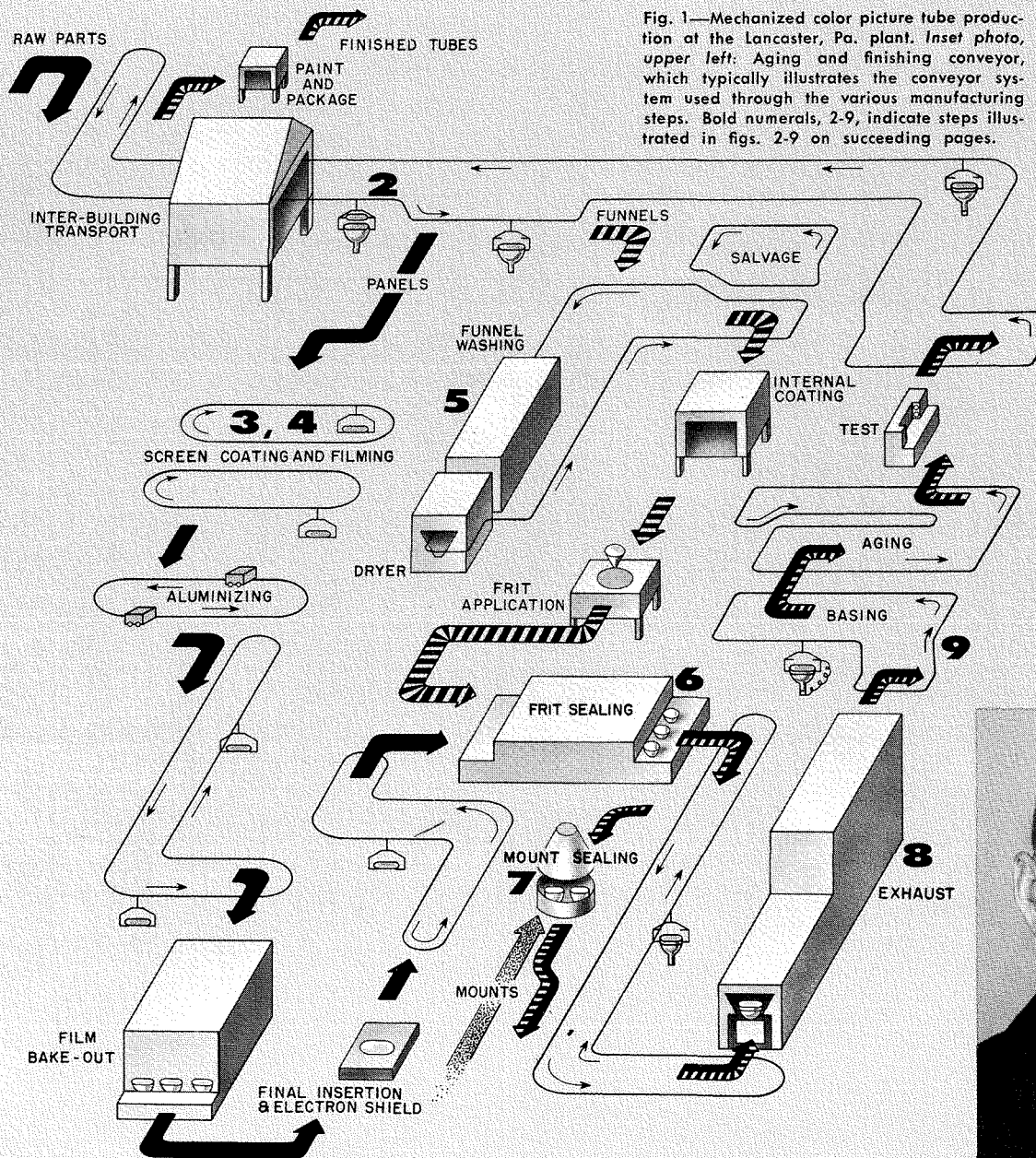

Fig. 1—Mechanized color picture tube production at the Lancaster, Pa. plant. Inset photo, upper left: Aging and finishing conveyor, which typically illustrates the conveyor system used through the various manufacturing steps. Bold numerals, 2-9, indicate steps illustrated in figs. 2-9 on succeeding pages.



MECHANIZED PRODUCTION OF COLOR PICTURE TUBES

THE COLOR PICTURE tube—heart of the color television receiver—is produced at the Lancaster plant of the Electron Tube Division. In the early stages of development, when production was limited and space was at a premium, temporary modifications were made to existing production equipment for black-and-white picture tubes, and some experimental manually-operated equipment was designed. Within the past few years, however, factory operations have been redesigned for mechanization.

The major components of the color picture tube include the shadow-mask assembly, the top panel, the funnel, the mount assembly, the stem, and the base. Basic manufacturing operations involve the processing of these components, their assembly, and the testing of the finished tube (Fig. 1).

SHADOW-MASK ASSEMBLY

Two major pieces of semiautomatic equipment are used in the processing of the shadow-mask assembly: (1) a spring-to-frame welding machine, and (2) a mask-to-frame welding machine.

The semiautomatic, spring-to-frame welding machine welds locating and retaining springs to the frame. This power-driven, indexing mechanism has a turntable, support fixtures which hold the parts to be welded, and an automatically positioned self-equalizing welding gun. Two of these machines require only one operator. As compared with the old method of assembling the parts in a jig and welding them manually, the machine provides increased output and improved and uniform quality due to the elimination of possible operator error.

The mask and the frame are then loaded manually on the semiautomatic aperture-mask-to-frame welder and are

by **E. H. LOOMIS, Administrator**
Equipment Development and Engineering
Electron Tube Division
Lancaster, Pa.

automatically assembled and welded. This machine, shown in Fig. 2, is a power-driven unit incorporating a unique indexing mechanism, necessary welding equipment, parts-locating and alignment fixtures, and a platen suspension system for minimizing operator fatigue. The welds are made two at a time around the periphery of the mask in a series weld for a total of 72 welds through 36 indexing positions. One operator can handle two machines. As compared with the earlier method, in which the frame and mask were manually assembled in a locating jig, indexed by hand, and welded by foot control, the machine increases the output, and improves uniformity of quality.

SCREEN APPLICATION

The automatic in-line screen-coating machine, shown in Fig. 3, performs all the phosphor-screen application operations except screen photographic exposure. The basic concept of this machine was developed by the Lancaster Advanced Equipment Development activity prior to the development of the 21-inch color picture tube. When it became apparent that individual hand-screening units and transporting trucks would require excessive space and a great number of operating personnel, an experimental model was made to prove out the automatic sequential operation. Factory production machines were then designed and built which index the top panel through all the processing stations and final inspection. From the time the top panel and mask assembly are inserted into the operating head, the

panel is handled only when it is removed for screen photographic exposure and then reinserted into the head.

The 60-head machine operates over a rectangular, closed, conveyerized loop, carrying the top panels and masks from one work station to another. All three of the color phosphors are applied on a dual-machine setup. Previously, all of the individual operations were performed on hand units, and the masks and panels were transported by trucks between operations. Besides the obvious savings of space and truck costs, the machine setup produces screens of uniformly high quality and requires only a minimum of operator judgment and technical control of product.

The phosphor photo-resist slurry solutions required for the automatic in-line screen-coating machine are provided by specialized phosphor-slurry mixing equipment. This equipment (Fig. 4) mixes, filters, electronically weighs, and stores all solutions. It consists of four basic units having individual storage tanks, and valving and piping to interconnect the system. All operations are automatically sequenced and interlocked. An electronic scale equipped with a recording chart balances and records the composition of the mix, which is prepared in tank lots. The mixing equipment for all three phosphor colors is controlled by one operator.

In the earlier mixing procedure, a phosphor paste was made, milled on a roll-mill, and then mixed to make a slurry. All handling was manual, and solutions were made in small lots. The automatic equipment provides for better control of solution formula and consistently uniform lots, reduces the required floor space, and eliminates capital costs of transporting trucks.

After application of the phosphors on

EMERY H. LOOMIS attended Pennsylvania State University and Franklin and Marshall College in Education and Business Administration, and holds a Certificate in Industrial Management. He joined RCA in 1943 in the Material Control Activity at Lancaster. During World War II, he served overseas with the U. S. Navy, returning to RCA in 1946. He then held various positions in the Central Planning Department until joining the Equipment Development and Engineering Department in 1950, as a Group Leader. In the same year, he advanced to Mgr., Technical Services, Equipment Development. In 1953, he was appointed Coordinator of Engineering Design and Development, and was promoted to Mgr. of Administration in 1954. He assumed his present position of Administrator, Lancaster and Marion Plants Equipment Development and Engineering, in 1958. In his association with Engineering, he was responsible for authoring a department *Designers Handbook*. Also, he installed the presently used system of project engineering, *Equipment Model Catalog*, and drafting practices system.

Fig. 2—Semiautomatic mask-to-frame welding machine. Sketch shows detail of weld. (Spring was welded to frame in a previous step on a similar semiautomatic welder.)

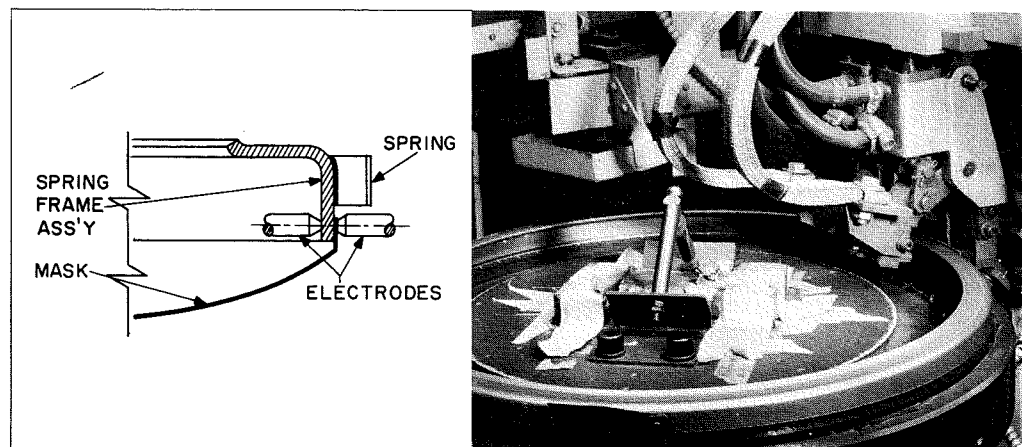

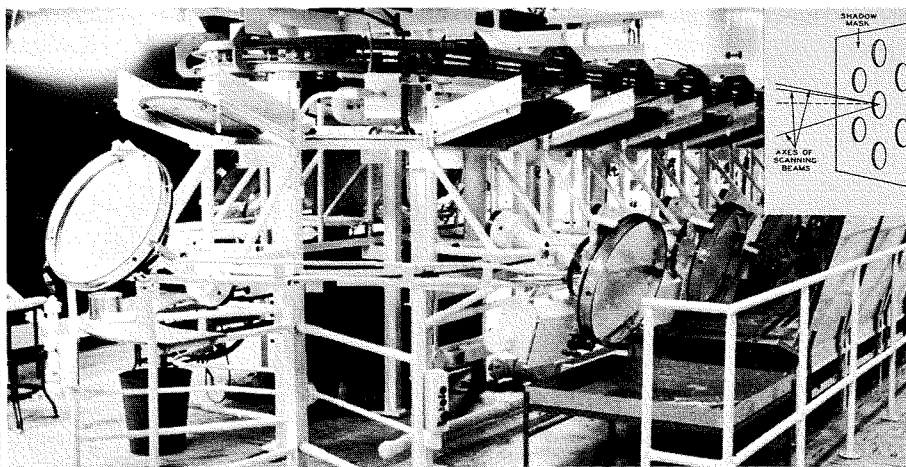
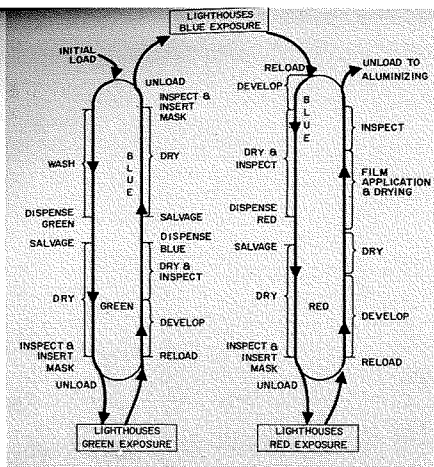

Fig. 3—Automatic machinery for screen-coating the panels. Schematic details the process on this two-machine unit. The "lighthouses" are groups of photo-exposure units, where the photo-resist material for each color is fixed to form the necessary dot structure, whose function is illustrated in the inset sketch. Photo shows an end of one machine.

the top panel to form the dot pattern, this phosphor "screen" is aluminized on a commercial in-line evaporating machine. This machine also performs additional processes, including bake-out, inspection, and panel-to-mask matching. The mask-panel assembly is then conveyed overhead to the area in which it is assembled to the funnel.

FUNNEL PREPARATION

The in-line funnel-washing machine (Fig. 5) is basically a closed-loop conveyor which carries the funnels through a closed tunnel in which a series of washing and drying stations are located in a straight line. It also conveys the funnel through additional work stations for application of internal coatings. The automatic setup makes possible a uniformly adhering internal coating. Previously, funnels were processed on conventional hand units—washed in sinks, coated on individual units, and dried on stationary racks. They were manually handled and transported by trucks.

SEALING

The envelope assembly is completed by sealing the funnel to the mask-panel assembly. The two pieces are first mated,

Fig. 4—Phosphor-slurry mixing equipment, where the photo-resist material for screen-coating (Fig. 3) is mixed, filtered, weighed, and stored automatically.

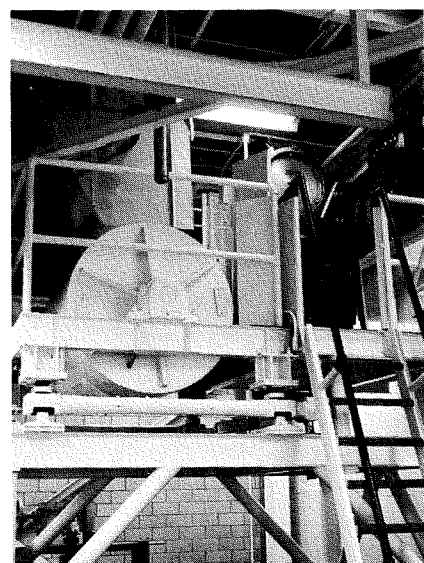

and the assembly is then conveyed through a high-heat "frit-sealing" oven. This oven (Fig. 6) is a commercial unit built to RCA specifications for the 21-inch envelope and utilizes an endless woven-steel belt passing continuously through controlled heating and cooling zones. Provisions are included for varying the speed. The gas-fired oven is capable of making the glass-to-glass envelope seals employing a devitrifying solder-glass sealing compound (frit).

A unique sealing fixture is employed for orienting and holding the envelope assembly during travel through the oven. This fixture rides on the oven belt and is designed to utilize grav-

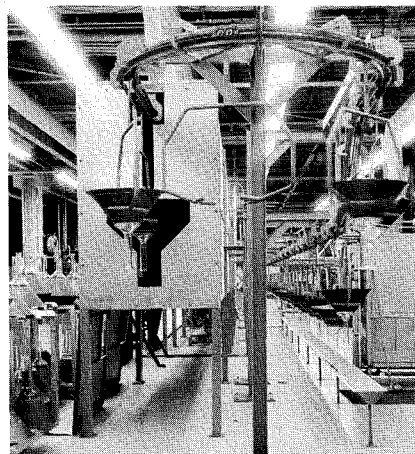
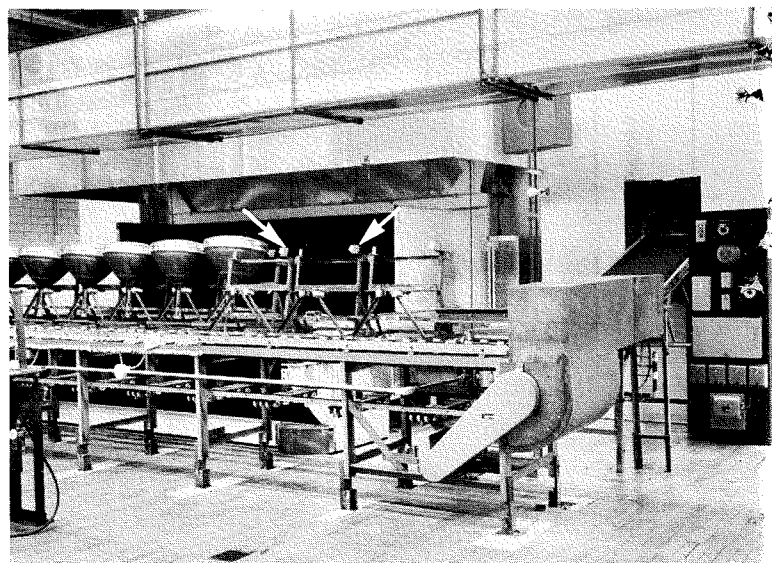

Fig. 5—Machine for "funnel" washing, done prior to assembly of funnel and panel.

Fig. 6—Frit-sealing oven (unloading end), where panels and funnels have been sealed together to form the envelope. Note sealing fixtures (arrows) in position. Photo at right is oven control panel.



ity instead of clamping features to obtain the "micro-match" tolerances required. Automatic conveyors return the fixture after reloading. Orientation and support have been achieved to a degree never before possible with either hand or mechanized equipment.

MOUNT ASSEMBLY

"Sealing-in" of the mount, or electron-gun assembly, is performed in the same manner as for conventional black-and-white picture tubes. The eight-head rotary sealing machines are the same type used for black-and-white tubes, but have been modified to provide the critical alignment necessary in color tubes.

EVACUATION

The color-picture-tube envelope is evacuated and sealed off on the automatic straight-line exhaust machine (Fig. 7). This machine automatically exhausts and bakes out the tube, bombards the cathode, degasses the getter, and pinches off the tubulation. Only one operator is required to load the machine. The heavy structural steel frame of the machine serves as a common base for support of the various equipment components, the 128-foot-long heated oven, the two-level enclosed cooling conveyor, and the front and rear tracks over which the 71 exhaust cars are indexed.

TUBE FINISHING

The basing conveyor (Fig. 9) is a closed-loop conveyor suspended from the building roof trusses. It features specially designed tube carrier heads which

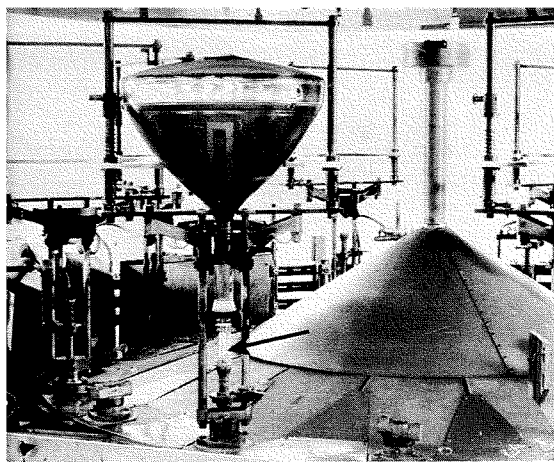

Fig. 7—Machine for sealing the electron-gun assembly, or "mount" (arrow), to the envelope, prior to exhaust.

are indexed around the conveyor through processing stations at which the leads are threaded through the base, trimmed, and soldered; the base is baked and checked for gas; and the getter of the tube is flashed. Tubes are processed both manually and automatically as they proceed from the loading position to the point of transfer to the aging and finishing conveyor. Previously, each of these processes was performed on a separate manually-operated unit and manual handling was required between.

The aging and finishing conveyor forms a closed loop (Fig. 1, inset) suspended from the roof trusses. It has specially designed carrier heads which carry the tube in a face-up position through the spot-knock, preheat, hot-shot, aging, cathode-warmup-test, short-circuit-test, and continuity-test stations. After the tube is loaded manually on the carrier head and the test socket is attached, the tube is completely and automatically processed and conveyed to the final test station.

Conveyorized equipment such as the basing and aging conveyors has solved the problem of tube handling and have eliminated the use of valuable floor space for shuttling and parking of trucks. Additional space savings are effected because this type of equipment operates overhead except for the loading positions, which are at floor level. Conse-

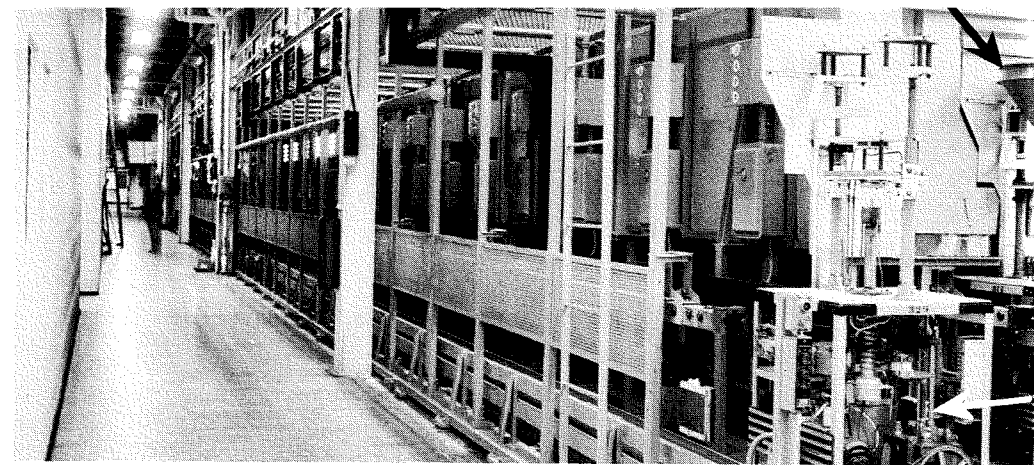

Fig. 8—Automatic straight-line exhaust machine. The tubes are carried through on "exhaust cars." One of these (71 are used) appears at lower-right arrow at end of its cycle; the tubes were removed at the opposite end. Upper-right arrow shows tube on exhaust car about to enter machine.

quently, there is in essence a "stacking" of processing equipment.

Tubes are manually unloaded from the aging conveyor and inserted into the finished-tube test set, a 35-kilovolt console-type, for dynamic screen quality tests and related tests such as leakage, breakdown, light output, screen uniformity, color purity, monochromatic resolution (with black-and-white video signals), and beam convergence. Except for the type and period of testing, the operation is similar to that used for black-and-white picture tubes. When tube production schedules warrant, automatic testing units can be installed to perform all of the required tests by positioning and indexing the tube through the testing stations in pallets operating on parallel conveyors.

TUBE AND PARTS HANDLING

Extensive use has been made of overhead transporting conveyors, supported from the roof, which operate over various processing areas and equipment, and which link all operations into a complete unitized factory. More than a mile of connecting conveyors are used both to transport material and, at the same time, to provide storage.

A unique transporting conveyor is employed between the tube factory and the incoming-inspection warehouse and the parts factory buildings. The special carrier head on this continuously operating conveyor is designed so that the various tube components are firmly held in position while being transported to the proper factory areas. On the return trip, the heads carry finished tubes to the warehouse for packaging.

SUMMARY

All of this manufacturing and processing equipment, as well as the many lesser items used in the production of color picture tubes, are particularly noteworthy in view of the physical characteristics of present-day tubes. The tubes have an over-all length in excess of 25 inches and a 21-inch over-all diameter. The top panel alone weighs approximately 22 pounds, and completely finished tube 36 pounds. The factory facilitation for this tube is a tribute to the cooperation of the men and women, technical and nontechnical, who worked together toward the common goal of making possible the mass production of high-quality, low-cost color picture tubes.

Fig. 9—Basing conveyor, where the plastic base (arrow) is attached to the exhausted tube. The wires are threaded through the hollow base pins by an operator at the right, and then soldered by another operator at the left.

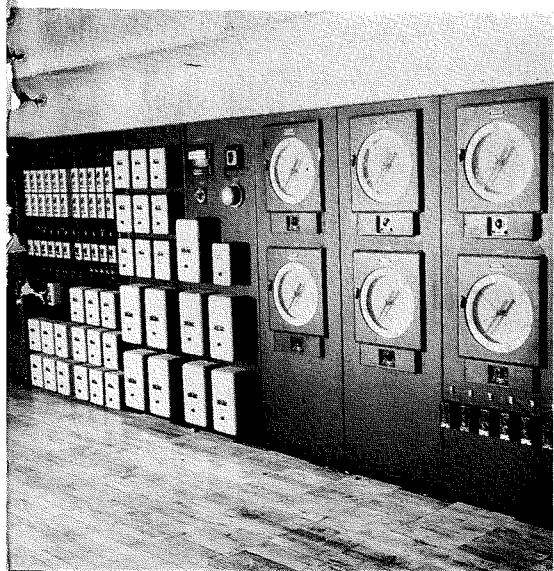

FRACTURE ANALYSIS FOR GLASS BREAKAGE PROBLEMS

by **J. F. McKENNA**
Electron Tube Division
Harrison, New Jersey

FRACTURE ANALYSIS is a method for determining the causes of glass breakage by studies of the modes of fracture propagation and the markings on fracture surfaces. It provides important information such as origin of fracture, direction of fracture travel, type of shock causing failure, and stress distribution at time of failure.¹

It is also an effective tool for evaluation of changes in machine and tube design, because it permits the analyst to determine when a change in design decreases or increases a particular type of failure, or if it introduces new types of failure. Without fracture analysis, he must rely on insensitive over-all percent-defect figures for this evaluation and, consequently, can easily overlook the introduction of new types of failure.

FUNDAMENTALS

A fracture propagates in a direction which is approximately at right angles to the plane of maximum tension.² If the forces causing failure are strong, the fracture will "fork out," as shown in Fig. 1, at angles dependent upon the stress distribution in the glass at the time of failure.³

Two kinds of marks are visible on fracture surfaces, "rib marks" and "hackle marks." As shown in Fig. 2, rib marks appear as curved lines which run perpendicular to the direction of fracture travel and hackle marks as lines which run parallel to the direction of fracture travel. Viewed endwise, rib marks show up as peaks and hackle marks as steps in the fracture surface (see Fig. 3).

EQUIPMENT AND PREPARATION

The only devices needed for fracture analysis are a 10-power microscope, a lamp equipped with a 25-watt frosted show-case bulb, and a lump of modeling clay to hold the specimen. As shown in Fig. 4, the specimen is positioned so that the microscope receives light reflected directly from the fracture surface. With this arrangement, the fracture surface markings show up clearly.

Because even a small amount of perspiration from the hands will hide the surface markings, it is extremely important that the fracture surface be clean. A dirty fracture surface can be cleaned simply by breathing on it and then wiping it clean with a piece of soft tissue.

Glass breakage from various causes often occurs in the mass production of electron tubes. To keep this breakage low, it is necessary to rapidly determine the causes of the trouble, so that immediate corrective action can be taken. A method meeting these requirements is **Fracture Analysis**.

PROCEDURE

The fracture origin is found by examination of the rib marks on the fracture surface. If forking has occurred only the fracture surface leading to the fork point need be taken into account. As shown in Fig. 2, rib marks appear to radiate from a single point, presenting their convex faces in the direction of fracture travel. To locate an origin, therefore, it is only necessary to note the direction of fracture travel, and trace back in the opposite direction.

The fracture origin is then inspected for defects which can cause failure, such as foreign particles, bubbles, rough surfaces, or re-entrant angles. If any such defects are found, steps can be taken to see that they are eliminated or minimized. If none are found, the cause of failure can generally be determined from the prominence and spacing of the rib marks, especially near the fracture origin, and from the location of hackle marks.

As shown in Fig. 5, spontaneous failures of the type caused by high permanent strain (a) display near the origin very faint, widely-spaced rib marks on a mirror-like fracture surface; thermal-

Fig. 1—Fracture path in glass-miniature-tube stem, showing "forking."

Fig. 2—Surface of stem fracture showing origin, rib marks, and hackle marks.

Fig. 3—Edgewise views of fracture surface shown in Fig. 2. Top: rib marks as viewed from bottom of stem; bottom: hackle marks areas A, B and C, viewed from right-hand edge of stem.⁴

Fig. 4—Equipment for fracture analysis.

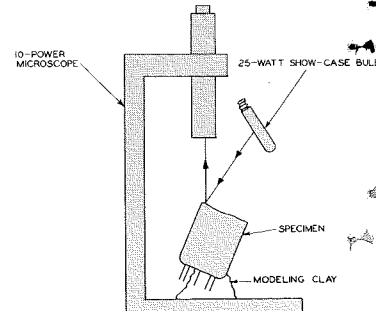
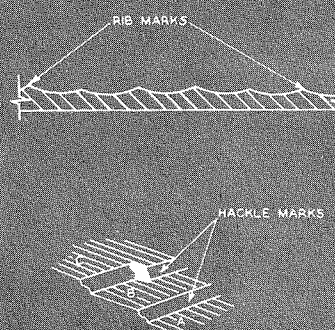
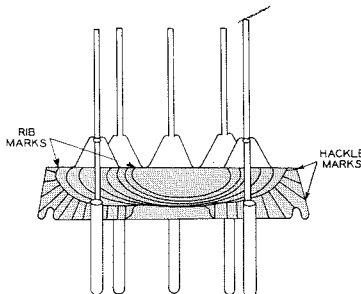
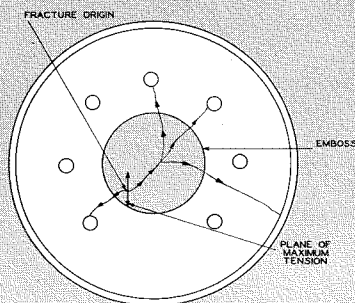

shock failures (b) display closely-spaced rib marks which are more pronounced than those of the spontaneous type; and mechanical-shock-type failures (c) display rib marks even more pronounced than those seen on thermal-shock-type failures. Impact-type failures in thin-wall glass of the type used in electron-tube bulbs, can also be identified by the "cone of percussion" shown in Fig. 5c and by the "star crack" shown in Fig. 6.

Hackle marks occur in zones of high compression which have suddenly been changed by fracture to zones of tension. According to Murgatroyd,⁴ these marks are always associated with sudden fractures due to relatively large forces. In mechanical-shock failures, hackle marks usually are visible in close proximity to the origin, superimposed on the rib marks as shown in Fig. 5c. In thermal-shock-type cracks these marks are present if the forces causing failure are strong, but usually not in close proximity to the origin. Hackle marks are seldom seen on a spontaneous failure, except when the fracture passes through a high compression zone.

STRESS DISTRIBUTION

Examination of the fracture pattern also permits qualitative determination of the stress distribution normal to the fracture surface at the time of failure.⁵ Knowledge of the stress distribution pinpoints the areas of high tension and thus indicates the action to be taken, particularly with respect to strain setting. It is important to emphasize that only stresses perpendicular to the fracture surface can be determined. As shown in Fig. 7, tension normal to the fracture surface is indicated where the rib marks are widely spaced, whereas compression

is indicated where the marks are crowded together.

FRACTURES IN MINIATURE-TUBE MANUFACTURE

Figs. 10, 11, and 14 show typical stem fractures occurring during stem-to-bulb sealing. In this operation, the stem and the bulb are warmed up rapidly with gas-air burners and then sealed together with gas-oxygen burners. The rapid warm-up produces high temporary stresses which will cause cracks to start at any defects that may be present.

For example, the crack shown in Fig. 11 originated at the line of bubbles indicated by the arrow in the relatively weak embossed area of the stem. These bubbles further weakened the embossing sufficiently to cause failure. In Fig. 10, it is evident from the rib-mark pattern that the stem crack originated at the metal particle in the embossing as indicated by the arrow. The fracture shown in Fig. 14 originated on the outer surface of the stem at the "kink" in the fracture line indicated by the arrow. This fracture is presumably a thermal-shock-type because no defect is visible at the origin.

Fig. 16 shows the fracture pattern of a stem failure which occurred during thermal-shock tests. (In these tests, the tube is immersed alternately in hot and cold water.) The rib marks show that the fracture originated at the base of the fillet and then radiated through the stem. They also indicate that the inner surface of the stem went into tension during the thermal-shock tests. To prevent recurrence of this type of failure, the Sealex machine is adjusted to provide a layer of higher compression on the inside surface of the stem.

Fig. 15 shows the fracture pattern of



JOHN F. McKENNA was graduated from Alfred University, Alfred, New York in 1954 with a B.S. in Glass Technology. After graduation, he joined the Servo Corporation of America as a glass engineer. In 1955 he joined R.C.A. as a glass technologist in the Chemical and Physical Laboratory in Harrison, New Jersey. In 1960 he transferred to the Manufacturing Engineering Activity in Woodbridge, New Jersey. He holds memberships in The American Ceramic Society and Keramos.

a typical seal crack which occurred during thermal-shock tests. The rib marks indicate that the fracture originated at the base of the fillet and then radiated through the seal area. The weak point at which this crack started was a sharp angle formed between the base of the fillet and the bulb wall during sealing.

Fig. 8 shows a bulb crack of the type which frequently occurs during sealing. The crack originated in the cut-off area of the bulb and traveled through the bulb in the direction indicated. Fig. 17 shows one type of fracture pattern

Fig. 5—Surface markings of bulb fractures due to various causes: a) strain fracture; b) thermal-shock fracture; c) impact-shock fracture.

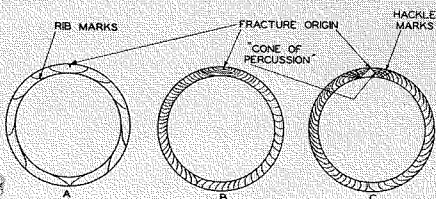

Fig. 6—Star-crack bulb fracture produced by impact-type shock.

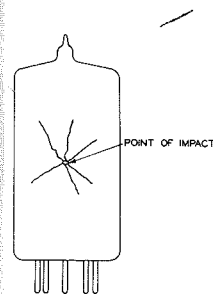

Fig. 7—Typical stem-fracture surface, illustrating relationship between markings and stress distribution. Wide spacing between rib marks at top indicates tension; hackle marks and crowded rib marks at sides and bottom indicate compression.

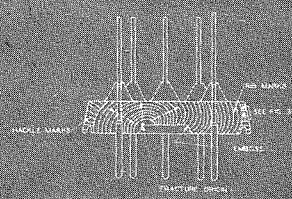

Fig. 8—Bulb fracture of type which occurs during sealing operation. Arrows show direction of fracture travel.

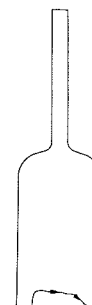

Fig. 9—Surface pattern produced by complete break-off of bulb tip.

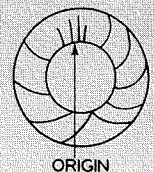



Fig. 10—Surface pattern of stem fracture which originated at metal particle indicated by arrow (10x).

Fig. 11—Surface pattern of fracture caused by bubbles (arrow) in embossed area of miniature-tube stem (8x).

Fig. 12—Satisfactory miniature-tube tip (6x). Note symmetry and freedom from reentrant angles.

Fig. 13—Defective miniature-tube tip (6x). Crack (arrow) originated at reentrant angle between rounded suck-in and inner wall.

Fig. 14—Forked thermal-shock fracture in miniature-tube stem (3x). The fracture origin is at the kink indicated by arrow.

Fig. 15—Composite photograph showing surface pattern of seal fracture caused by thermal shock (7x).

Fig. 16—Surface pattern of stem fracture caused by thermal shock (7x).

Fig. 17—Surface pattern of typical bulb fracture caused by combination of high permanent strain and thermal shock (21x).

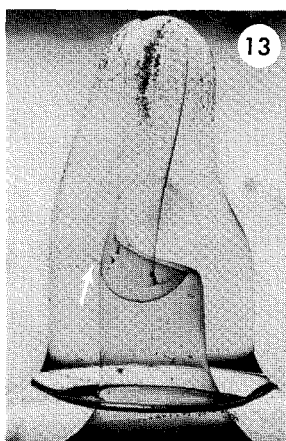
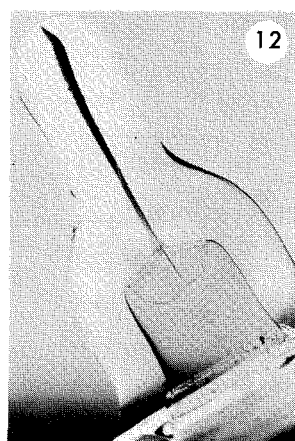
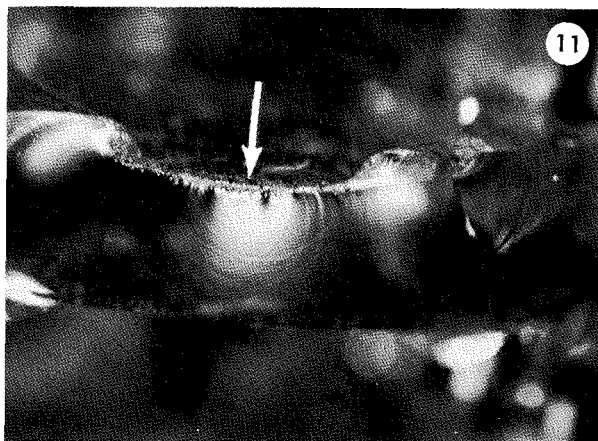
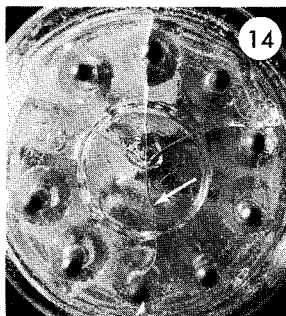
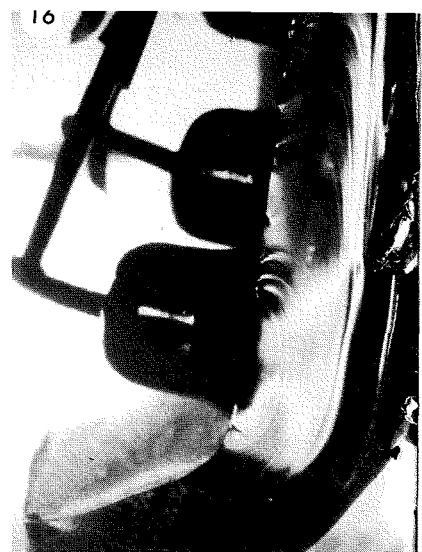
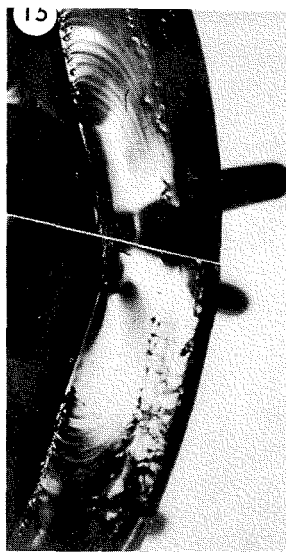

which results. The origin of the fracture (indicated by the arrow) is on the inside surface of the bulb wall about $\frac{3}{32}$ inch from the cut-off. This crack (Fig. 17) was caused by a combination of high permanent strain in the cut-off area of the bulb and thermal shock.

TIP FRACTURES

Fig. 12 shows a satisfactory miniature-tube tip. Note that the tip has good symmetry and no re-entrant angles. Fig. 13 shows a cracked tip. Both photographs were taken with the tip immersed in oil to eliminate surface reflections. The crack (indicated by the arrow) started

during thermal-shock testing as the result of high stresses developed at the re-entrant angle between the sucked-in ball of glass and the inside surface of the tip wall. Fig. 9 shows the fracture pattern which results when the tip cracks completely off. The origin, indicated by the arrow, is the point where the "suck-in" touched the inside surface of the tip wall. Once started, the crack radiated out through the tip.

ACKNOWLEDGEMENTS

The author is indebted to A. G. F. Dingwall, J. L. Gallup, A. A. Kulakowich, and W. F. Lawrence for their helpful

suggestions, and to F. Coccozza and V. Di Giacomo for supplying the factory samples.

BIBLIOGRAPHY

1. Oughton, C. D., "Analysis of Glass Fractures," *Glass Ind.*, 26, 72-4, 90 (1945).
2. Shand, E. B., "The Fracture Process," *J. Amer. Cer. Soc.* 37(2), 52-60 (1954).
3. Preston, F. W., "The Angle of Forking as an Indicator of the Stress System," *J. Amer. Cer. Soc.*, 18, 175-6 (1935).
4. Murgatroyd, J. B., "The Significance of Surface Marks on Fractured Glass," *J. Soc. Glass Tech.*, 26(115), 22T, 156-71T, (1942).
5. Stanworth, J. E., *Physical Properties of Glass*, Oxford Press, p. 65, 224pp (1950).

DATS . . . Dynamic Accuracy Test System . . . FOR AIR-BORNE FIRE-CONTROL SYSTEMS

by E. R. CAMPBELL, JR. and O. T. CARVER
Systems Support Engineering, Airborne Systems Division
DEP, Camden, N. J.

MODERN WEAPONS SYSTEMS have placed stringent demands upon maintenance techniques to ensure proper system performance in operational use. This is particularly true for air-borne fire-control systems, which must always be ready for a possible "scramble." To achieve this, it is imperative that the military commander have accurate, current information on the readiness of his aircraft fire-control systems, as well as the means to quickly locate equipment malfunctions.

The DEP Airborne Systems Division has developed and is currently producing for the U.S. Air Force the *Dynamic Accuracy Test System* (DATS), which allows just such rapid determination of system performance and fault location. Its effectiveness has been proven by field evaluation at Eglin and Tyndall Air Force Bases.

SYSTEM CONCEPT

DATS is based on a concept of *dynamic straight-through testing*. Under this concept, when an aircraft's fire-control system is to be checked, a target signal simulating a realistic tactical situation is used to exercise the system. DATS then determines performance by comparing actual system outputs with its programmed information, which is based on predetermined performance parameters. The results are displayed *quantitatively*, thus indicating the level of system performance. Such quantitative read-out has advantages over a simple go, no-go indication: e.g., it provides actual miss-distance in yards, thus

allowing more-realistic evaluations of combat readiness.

DATS consists of a number of major subsystems mounted in a mobile console (Fig. 1) which can be towed to the flight-line. It is connected to the aircraft through a cable receptacle located in the nose-wheel well. The total time required for connection, test set-up, warm-up time, completion of the DATS preflight test, and disconnection is about fifteen minutes.

A TYPICAL FIRE-CONTROL SYSTEM

A basic understanding of how a typical fire-control system works will provide an insight into the sophistication of simulation achieved by DATS, which will be described later.

An aircraft's fire-control system (Fig. 2) detects an air-borne target at a distance well beyond the range of its armament. The fire-control system then computes the optimum course to a position where the aircraft's rockets or missiles can be fired with a high probability of a hit and gives steering information to the pilot in the form of a radar display. The pilot becomes a loop-closing device, maneuvering the aircraft to minimize the error between the computed and true course. The fire-control system consists essentially of an integrated air-borne radar, a ballistic computer, an air-data computer, and the actual armament—either missiles or rockets.

A typical mission begins with the aircraft flying a course provided by a ground-control station to put it within

air-borne-radar range of the target. Prior to target detection, the air-borne radar is in an automatic-search phase, scanning the air space ahead of the aircraft where the target is expected to appear. When the target is within detection range, it will appear on the pilot's indicator, where target range and bearing are shown.

The pilot, after switching to manual control of the radar antenna, locks on the target by positioning the antenna in elevation and azimuth directly on the target, and by positioning a range gate to the target range. When the target return is coincident with the range gate, the fire-control system is transferred to an automatic-tracking mode.

After lock-on, the radar provides inputs to the ballistic computer: target azimuth and elevation angles, the angular rates of change, and target range. The air-data computer accepts inputs of pressure, temperature, and angle of attack, calculating air speed and density for additional inputs to the ballistic computer.

The ballistic computer converts target range into range rate and, with the target angle, angle rate, and data from the air-data computer, solves the fire control problem. The solution is presented to the pilot via a radar display in the form of a steering dot. If the aircraft is flying the computed course, the steering dot is centered on the indicator.

If the computer determines that the azimuth component of the course being flown deviates from the correct course, the steering dot is displaced horizontally from the center of the indicator by an amount proportional to the azimuth error. Elevation errors are similarly displayed. The position of the steering dot, then, indicates to the pilot the direction and magnitude of steering error and how to maneuver to eliminate the error. As steering errors are corrected, new inputs are received by the computer, which continuously resolves them as new steering instructions to the pilot.

In addition to steering commands, the computer determines the proper moment to fire, considering air density, angle of attack, and other constants peculiar to the armament.

In this example, the aircraft flies a lead-collision course—continuously headed toward a predicted point of interception of the target and the aircraft's missiles or rockets. This course differs from a true collision course in that it is displaced by a fixed angle; that is, the aircraft is leading the true collision course, and the target will

Fig. 1—The DATS mobile console.



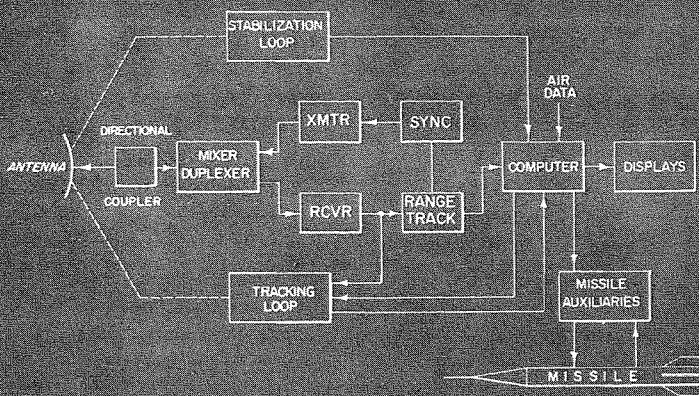

Fig. 2—Typical air-borne fire-control system.

pass directly in front of the interceptor. The lead-collision course makes use of the higher speed of the armament relative to the interceptor. Immediately after the armament is fired, the pilot receives pull-out instructions on the command indicator.

By continuously solving equations for miss in azimuth and in elevation and by presenting steering instructions to the pilot which are intended to reduce this error to zero, the fire-control system is able to fire the armament at the correct armament-flight-time-to-impact.

DATS simulates a series of attack courses which satisfy the steering and timing equations, by constructing the space geometry of the desired attack and assigning values to the ballistic terms which are identical to those used in the computer under conditions of actual operation.

DATS OPERATION

DATS evaluates performance of automatic weapon-control systems by subjecting it to a fire-control problem and measuring the system's reaction to the problem. Synthesized targets are injected into the directional coupler of the system undergoing test. The simulated target varies in range, azimuth, and elevation as would an actual radar return from a target during an attack. The system under test locks onto the DATS target and attempts to solve the fire-control problem. At the completion of the run, as evidenced by a fire signal from the weapon-control system, DATS provides a quantitative measurement of the distance an actual weapon would have missed the target in azimuth and elevation. In addition, DATS measures power output and lock-on sensitivity.

The basic DATS contains four major functional components: the programmer, the target synthesizer, the miss computer, and the power supply. The programmer generates the fire control problem used to test the weapon sys-

tem. The target synthesizer generates the synthetic target used to exercise the system under test. The miss computer determines the elevation and azimuth miss distance had the weapon been fired, and displays the quantitative measurement on direct-reading meters. The self-contained power supply generates the necessary d-c voltages.

Programmer

The programmer (Fig. 3) can repeat the dynamic problem indefinitely without variation or drift. Outputs of the programmer control the target synthesizer and consist of elevation-error, azimuth-error, and range-reference signals. Inputs to the programmer are taken from the weapon system's antenna elevation and azimuth resolvers. The test is initiated by operation of the attack start switch. The programmer drive motor begins driving accurately machined elevation, azimuth, and range cams. These cams, in turn, operate transducers to generate electrical signals.

Initiation of the attack starts the DATS-generated target moving on the radar screen of the weapon system. The operator locks onto this target just as the pilot would in actual operation. At the time of lock-on, the angular difference between the DATS elevation and azimuth channel and the weapon system azimuth and elevation channels is small (ΔE , elevation, and $\Delta \theta$, azimuth). The output from the programmer elevation and azimuth resolvers is the electrical analog of the error angle (see Fig. 3). These programmer-derived error signals are sent to the target-synthesizer demodulator-modulator channel and are used to modulate the DATS synthetic target signal.

A range reference, generated by a precision potentiometer driven from the range cam assembly, is fed to a range-delay module in the target synthesizer. This signal is used as the range reference for generating the DATS target.

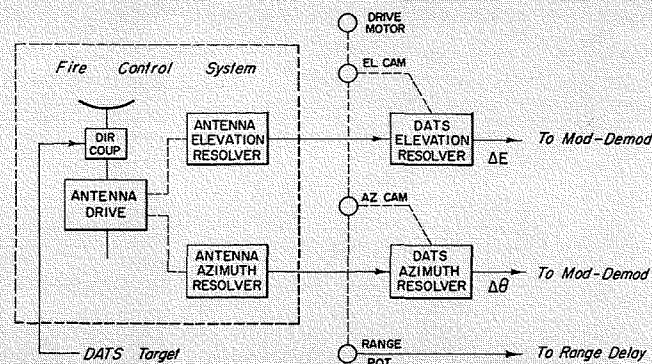

Fig. 3—The DATS programmer.

Target Synthesizer

The target synthesizer (Fig. 4) accepts a sample of the transmitted RF signal from the fire-control system and antenna-position error information from the programmer. The synthesizer generates a target modulated with control information to position the antenna of the system under test and which is delayed in time equivalent to radar range. The target synthesizer also can monitor fire-control-system magnetron power output, DATS RF-power output, and weapon-system receiver sensitivity.

The afc portion receives a sample of the RF pulse transmitted by the fire-control system at some frequency f_t . The afc unit maintains the DATS klystron frequency 30 mc above the transmitted f_t .

A sample of the RF pulse is also detected by the receiver crystal, and this video pulse is used to trigger a range-delay generator. When range delay becomes coincident with the reference range signal generated by the programmer, a gated oscillator is triggered to produce a 30-mc pulse. This gated output is mixed with the klystron output ($f_t + 30$) in the magic-T mixer. The resultant output of the mixer is a delayed pulse whose delay represents target range at the weapon-system radar frequency f_t , and at $f_t + 60$ mc. This output is fed to the DATS RF-modulator.

Elevation and azimuth error information from the programmer is received in the demodulator-modulator section of the target synthesizer. This data, received as modulation on a 400-cycle carrier from the resolvers, is demodulated to produce a varying d-c voltage. The varying d-c is used to modulate the incoming spin-reference signal from the weapon-system antenna resolver. The modulated spin-reference signal is fed to the RF modulator, where it modulates pulsed RF, delayed to represent target range, from the magic-T mixer. The output of the modulator is the

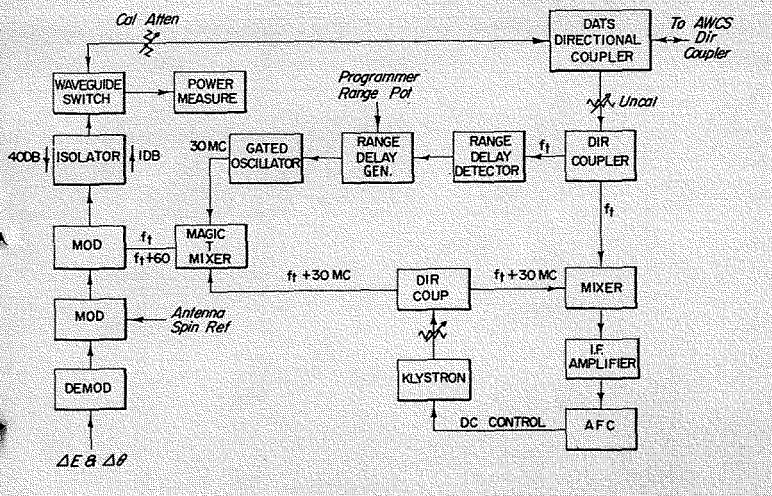

Fig. 4—The DATS target synthesizer.

DATS target, modulated to provide antenna angular error.

Miss Computer

The miss computer determines the distance in azimuth and elevation that the weapon would have missed the target, if it had been fired. Miss is computed in yards and displayed quantitatively for the operator. Whether the system fired early or late is also displayed.

Computation of elevation and azimuth miss distances are very similar. In determining elevation miss, three inputs are used in the miss computer: the elevation-steering-error signal ΔE , the weapon-system firing signal, and the DATS reference firing signal. Both firing signals go to a firing-signal indicator module which energizes an early- or late-firing indicator. The firing signals operate a time-delay circuit which clamps the elevation and azimuth error meters at the end of the delay. This is the firing-time-error channel.

Firing signals also go to the steering-error channel. The output of a time-of-firing comparator is a nominal 12-volt pulse. The pulse width is a function of the time difference (Δt) between the weapon-system firing signal and the DATS reference signal. This pulse is integrated to produce a voltage level representative of Δt . The integrated voltage is fed to the elevation summing amplifier.

The elevation steering error signal, ΔE , is also fed to the elevation summing amplifier through a cathode follower. The steering error ΔE is summed with the Δt voltage to produce an output miss distance. The weapon-system miss distance, in yards, is displayed on a meter to indicate above or below target.

The azimuth error channel functions in a similar manner, except that it receives the azimuth steering error signal $\Delta \theta$ from the weapon system, and computes miss for targets programmed in the right or left quadrant.

Self-checking of the miss computer

is accomplished by introducing a fixed error into the azimuth and elevation error channels along with a fixed firing-delay error into the time of firing comparator. These signals are processed by the computer, and the indicated results compared by the operator to predetermined values and tolerances.

Power Supply

The power supply uses an external source of 115 volts a-c at 400 cps, and +28 volts d-c to provide regulated plate and bias voltages and relay switching voltages. The three regulated d-c voltages are +300, +150, and -250 volts. The d-c supplies operate after a 2-minute time delay. An interlock removes all plate power in the event of failure in the negative supply.

SUMMARY

DATS is an example of test-system design using analog techniques to ac-

E. R. CAMPBELL, Jr. was graduated from the University of Virginia with a B.S.E.E. in 1947. Upon graduation he joined the Philco Corporation where he worked on the design and development of airborne radar systems, ASW equipment and microwave relay equipment. Upon joining RCA in 1955, Mr. Campbell was assigned to work on the MG-10 Fire Control System program. Following this, he was assigned to the ground support equipment development program for the ASTRA I project. More recently, he has participated in the Dynamic Accuracy Test System (DATS) development program for support of the MG-10 Fire Control System. Mr. Campbell is presently in the Advanced Systems Projects group of Systems Support Engineering and is primarily concerned with determining support equipment requirements for advanced weapons systems and other radar systems.

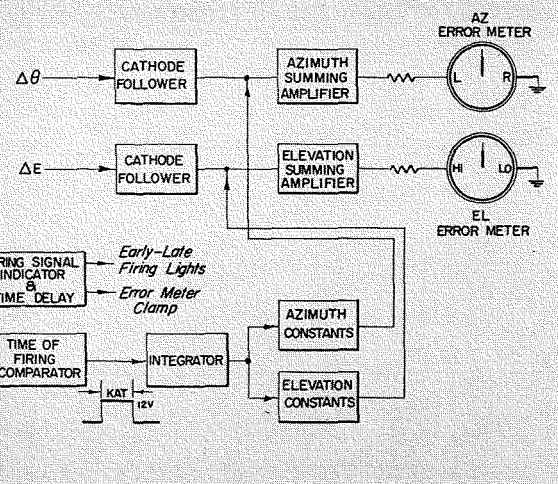

Fig. 5—The DATS miss computer.

complish an over-all weapon-control-system test, providing as a direct readout a quantitative measure of operational capability. The DATS technique, a dynamic closed-loop test, energizes each component of the system-under-test as it would function in actual operation.

DATS has been field-evaluated, and the accuracy of the miss distance readout has been verified. It has shown excellent reliability in determining system performance, and is now in production for the U.S. Air Force, for use with the MG-10 Fire Control System.

The basic DATS concept is presently being extended for application to other weapon systems. Studies have been made to apply DATS to missile and aircraft monopulse fire-control systems, as well as heavy ground radar systems. These efforts have been well received, and the prospects for additional DATS applications look good.

O. T. CARVER received his B.S.E.E. degree from West Virginia University in 1949 and has done graduate work at George Washington University. He joined RCA in 1949 as a Field Engineer, working on installation of Air Force communications equipment problems of UHF air-to-air and air-ground communications. As a transmission engineer, he made studies of transmission problems in relocation of military communications centers in Japan. In 1956, he was assigned to Army missile test-equipment standardization studies which led to the DEE system for testing automatically subassemblies from five Army missile systems. Since 1959, Mr. Carver has been a Leader in the Advanced Systems Support group of ASD's System Support Engineering, responsible for studies of modular training devices, support of advanced ICBMS, and advanced automatic-testing techniques.



The **Micromodule Laboratory** (Fig. 1) is a cleverly conceived package of microelements, processing equipment, and instructional material for equipment designers interested in applying the micromodule concept. It is a practical engineering tool that allows an individual engineer to design, assemble, and evaluate experimental micromodules in minimum time for specific product applications.

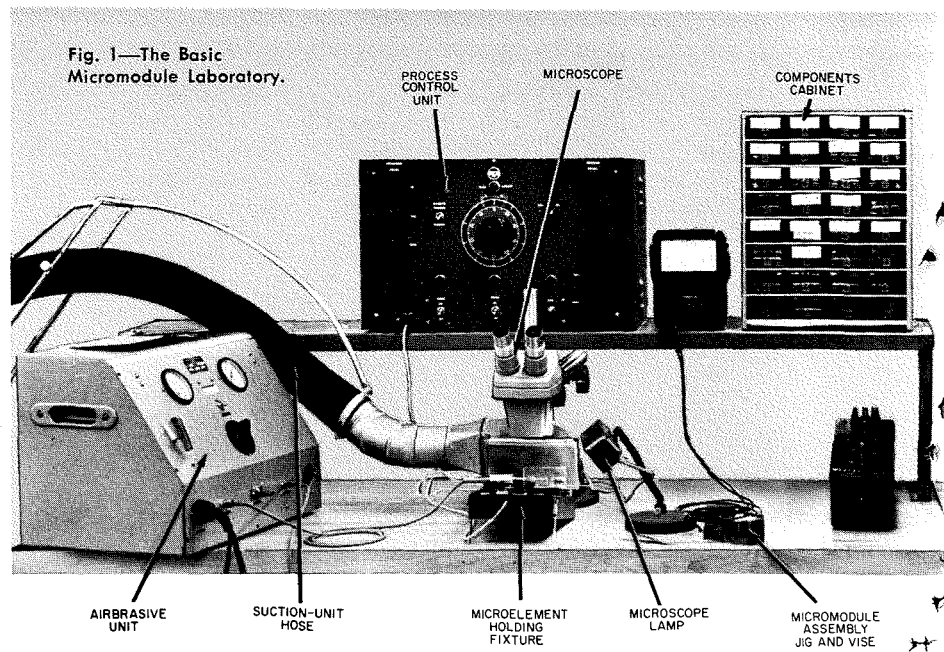

A PACKAGED MICROMODULE LABORATORY FOR INDUSTRY

THE MICROMODULE CONCEPT has been an important factor in the development of miniaturized transistorized circuitry. In a micromodule (Fig. 2), individual components are stacked in a predetermined order designed to minimize stray capacitance and regeneration and to protect heat-sensitive active elements. A production assembly fixture spaces the microelements and holds them rigidly while an operator hand-solders the twelve leads into notches on the edges of the wafers. The structure is then completely encapsulated for rigidity and environmental protection.

Because each type of element is a separate entity, no design compromises have to be made to make one element serve the functions of another. Thus, the micromodule concept offers the dual advantages of reduction in mass and increased reliability by judicious use of materials and techniques.

PURPOSE OF THE MICROMODULE LABORATORY

The Basic Micromodule Laboratory (Fig. 1) is built around equipment especially designed to enable the user to modify microelements to meet specific design needs. It was conceived for electronic equipment manufacturers interested in the conversion of existing systems to the micromodule form. The Laboratory permits equipment design engineers to design, assemble, and evaluate experimental micromodules privately and in a minimum of time.

In addition to microelement components and processing equipment, the laboratory provides two instruction

by **D. T. LEVY**

Micromodule Dept.

*Semiconductor and Materials Division
Somerville, N. J.*

books and a technical assistance program, thus making available necessary application information from personnel experienced in micromodule production. One of the instruction books, *Micromodule Design Manual*, describes the principles of micromodule construction and the methods by which complete electronic circuits may be divided into individual micromodule units. The second book describes the tools, fixtures, and microelements provided with the Basic Micromodule Laboratory.

LABORATORY DESIGN GOALS

One of the design goals for the Basic Micromodule Laboratory was to reduce to a minimum the number of operations required in the preparation of microelements. Another was to keep the modification of each microelement to a minimum to avoid reducing component reliability. A further design goal was completeness; all necessary small tools, chemicals, jigs, and fixtures are included. Components were specially designed for this equipment so that a small stock of microelements would provide a wide range of component values and termination possibilities through the use of adjustable resistors and capacitors, and simplified post-terminating techniques.

Most microelements furnished in the Laboratory have areas of fired-on metal

which are specially provided to allow the designer to choose the desired electrical termination arrangement and to adjust resistors and capacitors to their proper values. After the termination arrangement has been selected, the undesired electrical paths are removed. (A typical multiple termination arrangement is shown later in Fig. 7.)

Each resistor microelement has a vacuum-deposited metal film which can be scribed to divide the film into two separate resistances and to adjust the individual films to the desired higher values. Capacitor microelements have fired-on silver electrodes. The capacitors are adjusted to the desired lower values by removing parts of the electrodes. The air abrader is used to perform all of these operations.

MICROMODULE LABORATORY EQUIPMENT

The basic technique in the operation of the laboratory is an adaptation of precision sandblasting, or *air-abrading*. The air-abrading process is used to modify basic microelements to specific resistance or capacitance values and to establish termination leads by forming precise patterns on metal coatings that have been fired on ceramic substrates.

Air-Abrader

The abrader, a modified commercial unit, provides a pressurized stream of inert gas which carries extremely fine abrasive particles. The pressure of the gas stream and the quantity of powder sprayed are regulated by a foot switch.

The abrading process is performed

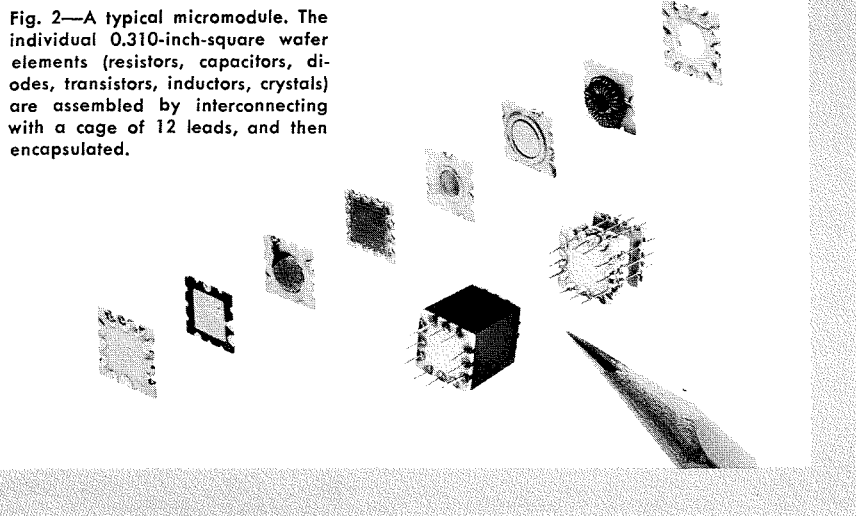
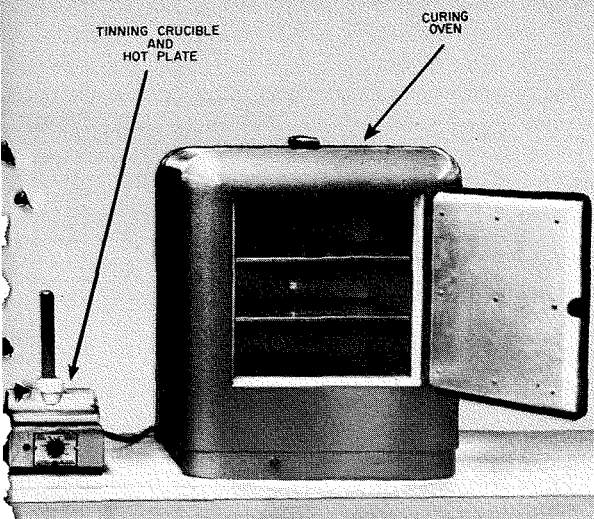

Fig. 2—A typical micromodule. The individual 0.310-inch-square wafer elements (resistors, capacitors, diodes, transistors, inductors, crystals) are assembled by interconnecting with a cage of 12 leads, and then encapsulated.

on a fixture which firmly holds the microelement, makes electrical contact to the metallized pattern at each notch of the wafer, and accurately positions the abrading nozzle over the wafer. The wafer can be manipulated laterally under the stationary abrading nozzle by a mechanical cross-feed similar to the type used on a microscope stage, as shown in Fig. 3.

During the adjustment of resistors and capacitors, the operator must watch the cutting action of the abrasive stream while manipulating the wafer under the cutting nozzle. Therefore, a *process control unit*, which is preset to the required value of resistance or capacitance, was designed to shut off the abrading unit automatically when the resistor or capacitor reaches the desired value. The control unit has built-in resistance and capacitance decades against which the element being adjusted is compared. During the abrading operation, the electrical value of the component is monitored by the control unit.

Stereoscopic Microscope

The Laboratory also includes a constant-focus stereoscopic microscope designed to provide continuously adjustable magnification from 10 to 20 power. The microscope is mounted on a special arm and pedestal which permit it to be used for observation of wafers in the holding fixture without interference with fixture adjustments, and to be used equally well in the other operations of the laboratory.

Solder-Coating Equipment

After the microelements have been adjusted and terminated as desired, the notches on the wafer are solder-coated. For this purpose, the Laboratory includes a controlled-temperature hot plate, solder crucible, and thermometer for use in solder-coating the wafer notches, as shown in Fig. 4. It is very important that all the solder needed for proper assembly of the micromodule

be on the wafer and leads prior to assembly. This procedure minimizes the danger of dropping globules of excess solder on the micromodule and prevents overheating of the microelements.

The use of the air-abrading technique permits a minimum number of microelements to serve a wide number of circuit functions because the design engineer can adapt the basic microelements to specific values and termination patterns. On each microelement, positive contact must be established to all connecting leads, and each lead must be isolated from the others. Because lead configuration varies greatly with the design of each micromodule, present design procedures include all the possible paths on each wafer and provide a safe method for removing the unwanted conductive paths.

COMPONENT MICROELEMENTS

The laboratory process flow chart, shown in Fig. 5, indicates the operations required for the assembly of mi-

DONALD T. LEVY, received his B.E.E. in Electronics from Syracuse University in 1951. He has completed some graduate study toward an M.S.E.E. at the Polytechnic Institute of Brooklyn. From 1951 until 1953, he served with the U.S. Army Signal Corps. He then worked as a project engineer at the New York Naval Shipyard until 1956. Between 1956 and 1958, he worked on electronic research and tube design for Sylvania Electronic Products and the Philco Corporation, specializing in metal-to-ceramic sealing techniques and low-power heater designs for electron-tube structures. In June, 1958, he joined RCA in the Micromodule Engineering Group at Somerville. He has been instrumental in developing the Basic Micromodule Laboratory. Mr. Levy heads the Reliability Assurance Group of the Micromodule Dept. and is also concerned with mechanization planning, system development, and product assurance.



cromodules. Almost all of the microelements require the same type of modification.

End Wafers

Detailing the functions of an end wafer may clarify the design requirements of the other components. The end wafer (Fig. 6) primarily provides a solid mechanical joint at the ends of each lead. Because the micromodule is usually plugged into a printed-circuit board, the joints at the end of the module must be designed to take severe punishment. The end wafer has metal and solder on all twelve notches to assure maximum strength. However, the small size of the micromodule multiplies the problem of designing a printed-circuit board because there may be as many as twelve leads plugging into the board in an area 0.400 inch square. The printed-circuit problem is simplified by use of the end wafer as a jumper from lead to lead so that the input, output, and power connections to the module do not present complicated printed-wiring problems.

In the patterned end wafer designed for the Laboratory, each notch is metallized, and a path on each side connects all the notches. In the design of the end wafer for a particular module, it may be desirable to employ a jumper from notch No. 2 to notch No. 8. The air-abrasive tool and the holding fixture can be used to cut through and modify the connecting pattern and isolate the desired notches. Because the patterns on each side of the wafer are identical, crossover jumpers can also be used.

The wafer shown in Fig. 6 has a hole drilled through the center for use in tuning the micromodule; an adjustable capacitor is located just below this hole.

Resistors

Various-resistance microelements are available with multiple-resistor patterns having specific ohms-per-square values.

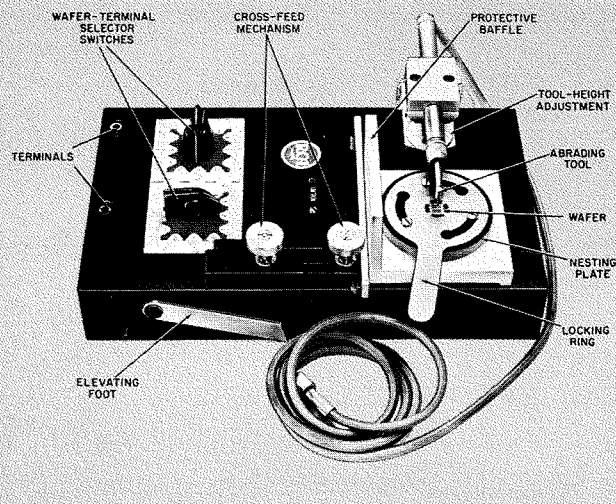

Fig. 3—Microelement holding fixture used in the air-abrading process.

For example, an area 0.010 by 0.010 inch of a particular resistive material has a specific resistance value of 100 ohms. If three 100-ohm squares were laid end to end, the series resistance would be 300 ohms. Each of the resistive areas of the resistance microelement supplied with the Laboratory has a length-to-width ratio of 2.66; the total resistance of each pad is 2.66 times its ohms-per-square value.

Three basic resistor films have been developed having ohms-per-square values of 100, 500, and 1000. Each is a vacuum-deposited nickel-chromium film applied to a high-purity alumina substrate. All resistor elements are coated for protection.

The resistor microelements supplied with the Laboratory are of the multiple type and are provided with two rectangular conductive areas on each side. These areas are covered with a continuous coating of resistance material and are connected to all twelve notches, as shown in Fig. 7. Each side may be divided into two separate resistors by removing resistance material between the two conductive areas with the abrading tool. Undesired terminations may also be removed. The initial value may be increased by removal of portions of the resistance material with the abrading tool to change the initial length-to-width ratio. This operation, called adjustment, is performed with the aid of the process control unit.

By proper selection and adjustment of a single resistance path, any resistance value between 38 and 19,000 ohms can be obtained with an accuracy within ± 2 percent. Resistance values up to 76,000 ohms can be obtained by series connection of two or more of the four resistance paths on a single wafer. The individual resistance paths have power-dissipation ratings of $\frac{1}{8}$ watt. The four paths on a single microelement can be connected in series or parallel, or in a

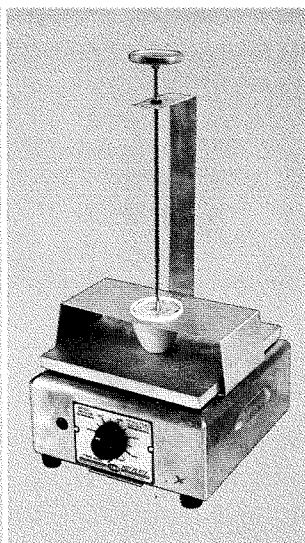

Fig. 4—Controlled-temperature hot plate, solder crucible, and thermometer.

series-parallel combination, to allow a power dissipation of $\frac{1}{2}$ -watt per microelement. Thus, by the combination of multiple termination paths and several values of resistive material, resistors can be created which have a wide range of resistance values.

Capacitors

The capacitance of the microelement single-layer capacitor is determined by the K value of the dielectric body and the area of the two electrodes printed on each side of the wafer. Several different dielectric bodies are provided with the Laboratory. Each single-layer capacitor is imprinted with a termination pattern, as shown in Fig. 8, which is connected to a 0.200-inch-square electrode. On the top of the wafer the electrode is connected to seven notches, on the bottom to the remaining five notches. Unnecessary conductive paths are removed by means of the air-abrader. For example, notch No. 2 can be connected to the top electrode, notch No. 8 connected to the bottom electrode, and notch No. 4 left in as a mechanical support notch. For a single-layer capacitor, the capacitance is gen-

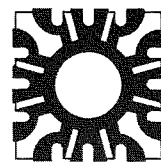

Fig. 6—End wafer (Side A or B).

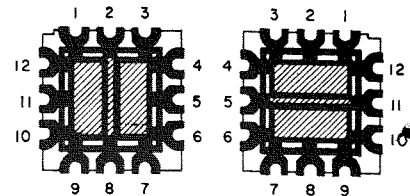

Fig. 7—Multiple resistor (Side A, left; B, right).

erally equivalent to nine-tenths of the K value of the material of which it is composed. This capacitance can be reduced to two-tenths of its initial value by air-abrading one or both of the electrodes to a smaller area.

The general-purpose capacitors have maximum nominal values ranging from 270 to 9000 picofarads, and are made in three temperature-characteristic classes for dc working voltages of 50 and 100 volts. Precision ceramic single-layer capacitors are available in the 27-to-80-picofarad ranges of NPO, NPO330, and N750 materials.

A multilayer capacitor consists of a number of alternate thin layers of ceramic and silver fired together to form a single structure, as shown in Fig. 9. There may be as many as ten layers in a single capacitor. As with the single-layer capacitor, seven of the notches are connected to one stack of electrodes and the remaining five notches are connected to the other stack. The air-abrading technique is again used to remove the unwanted terminations and reduce the over-all value of the multilayer capacitor by removing a portion of the outer electrode area.

Multilayer capacitors range in value from 56 picofarads to 0.3 microfarad in both general-purpose and precision types. Each laboratory is shipped with a full assortment of single- and multilayer-capacitor types.

Fig. 5—Micromodule laboratory process flow chart showing the types of components available for use with the Laboratory and the techniques required for completion of each type.

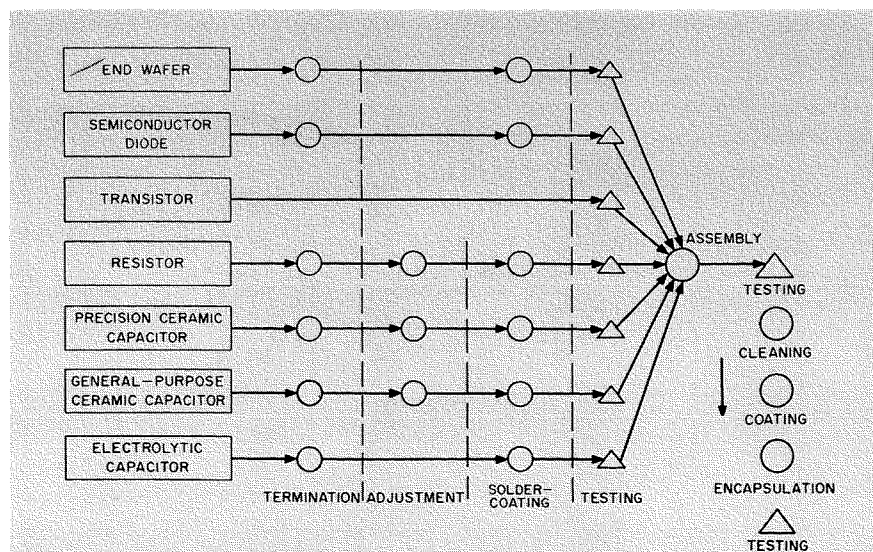

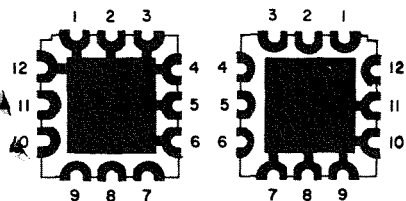

Fig. 8—Single-layer capacitor (Side A, left; B, right).

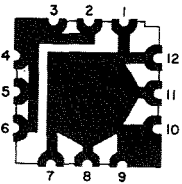

Fig. 9—Multi-layer capacitor (Side B).

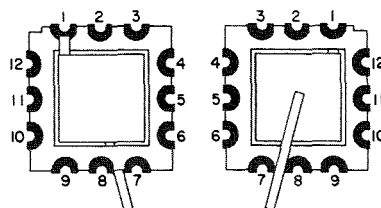

Fig. 10—Electrolytic capacitor showing tantalum-ribbon connection to anode (Side A, left; B, right.)

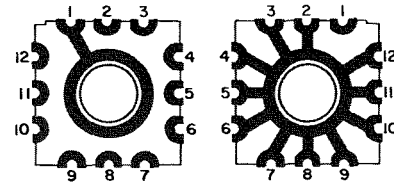

Fig. 11—Diode (Side A, left; B, right).

The electrolytic capacitor consists of a sintered tantalum-powder slug having a thin dielectric film over the sponge-like tantalum structure, as shown in Fig. 10. When the pores of this structure are filled with a conductive material, a capacitor is created. In the basic Laboratory, the finished unit is provided in a number of capacitance values. Each of these units has a small tantalum ribbon connected internally to the anode of the capacitor. Wafers which have been drilled to accept these rectangular capacitors are also provided with the laboratory. The capacitor is epoxy-mounted in the wafer, and a tantalum cathode lead is soldered in place on a presoldered portion of the pill. This tantalum cathode lead can be attached to any of the other eleven notches on the wafer.

The electrolytic capacitor requires no air-abrading. The anode lead is firmly affixed to one of the twelve notches at the factory. This arrangement prevents possible damaging of the capacitor structure.

Diodes

RCA microelement diodes are fast-recovery silicon diffusion types designed for use in micromodules for computer applications. They have multiple conducting paths which connect the cathodes to several different terminals of the microelements, as shown in Fig. 11. Before the diode is installed in a micromodule, the connecting paths not required by the circuit are removed by the abrading process.

One family of diodes provided with the kit has a maximum reverse recovery time of 0.3 microsecond, a maximum continuous reverse d-c working-voltage rating of 175 volts, and a maximum continuous forward-current rating of 40 milliamperes. These diodes have the standard 0.310-inch-square micromodule form and are approximately 0.035 inch thick.

Another group of diodes provided with the kit has a maximum average rectified forward-current rating of 75 milliamperes and a continuous reverse d-c working-voltage rating of 60 volts. The diode element in these types is mounted in a hole in the center of the

wafer and is sealed between top and bottom cover plates. These diodes are also made to the standard 0.310-inch-square micromodule form and are 0.050 inch thick.

The diode wafer can be rotated or flipped into eight different positions at the time of assembly. Therefore, a diode wafer, which can have eleven different pairs of anode and cathode connections by judicious cutting of the pattern, can be rotated or flipped at assembly to yield 88 different terminations.

Transistors

The transistors in the basic laboratory, like all standard microelement transistors, are terminated on notches 3, 6, and 12. This termination imposes a starting point from which any micromodule design may begin. No additional process is required before transistors can be used in modules. More than twenty additional germanium and silicon transistor types are now being adapted for use in micromodules and will soon be made available.

MICROMODULE ASSEMBLY

When the microelements have been prepared as described above, they are ready for assembly into micromodules. The technique used in the Basic Micromodule Laboratory for assembling micromodules has greatly simplified the process. A set of silicon rubber blocks, shown in Fig. 12, forms a jig into which the end wafers and microelement wafers can be easily loaded. Spacing is accomplished by means of small removable shims. The three leads which connect one side of the micromodule are soldered into place by use of a small soldering iron and a heat-sink tool. When these three leads are secured, a third side of the jig is clamped into position, the jig is rotated, and one of the first jig sides is removed.

Fig. 12—Assembly jig for microelements showing silicon-rubber blocks (A, B) soldering iron, and heat-sink tool.

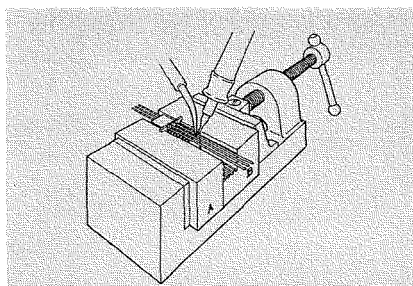

The leads for a second side of the module are then soldered in place. When two sides have been soldered, the module is self-supporting and assembly can be finished in the small vise provided with the laboratory. Finally, the second end wafer is soldered in place, and a silicon rubber block is placed on the open end of the module to act as a dam during encapsulation. During assembly, which is carried out under the microscope, the designer can take full advantage of the rotating and flipping possibilities of the wafers.

In the design of the Basic Micromodule Laboratory, special attention has been given to eliminating chemical processes unfamiliar to most equipment-development personnel. For the encapsulation process, a special package has been developed which contains an accurately measured sample of epoxy and, in a separately sealed inner bag, an accurately measured amount of catalyst. Pressure on the outer package breaks the inner bag, and the two materials can be thoroughly mixed inside the package. The assembled module, together with two silicon rubber dams, is then placed in an encapsulating mold, and the mixed encapsulant is fed into the top of the mold until the filling well is full. The entire mold is placed in the oven, and the unit is cured for five hours. The mold is then opened and the finished module broken out. The design of the mold assures a neat, clean module. Full instructions for the process are included in the instruction booklet in the Laboratory kit.

When the experimental micromodules have been encapsulated, the design engineer may test and evaluate their performance. Redesign, if necessary, should not cause undue delay because the whole procedure of processing, assembling, and encapsulating a micromodule takes only about two days. One engineer and one technician using ten feet of lab bench are required to implement the laboratory.

The Basic Micromodule Laboratory is not designed for production; it is intended for building and testing of experimental micromodules. As such, it is a completely functional and challenging tool.

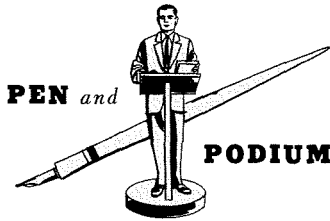

BASED ON REPORTS RECEIVED OVER A PERIOD OF ABOUT TWO MONTHS

DEFENSE ELECTRONIC PRODUCTS

A Proposed Variable Data Rate Communication
J. E. Palmer: 6th Nat'l Communications Conf., Utica, N. Y., Oct. 3, 1960.

Mechanical Design Reviews for Reliability
D. P. Simonton: IRE-RGRQC, Boston, Mass., April 21, 1960; presented by C. A. Spurling.

Training—An Engineering Management Tool
R. H. Lesser: 16th Nat'l Electronics Conf., Chicago, Illinois; Oct. 10-12, 1960.

The Post-Launch Performance of the Tires I Satellite
S. Sternberg: IAF Stockholm Mtg., August 17, 1960.

Maintenance Function Analysis for Space Vehicles
H. B. Matty, W. G. Sommer and T. Taylor, Jr.: *Space Aeronautics*, Oct., 1960.

Standardization of Support Equipment
D. B. Dobson and L. L. Wolff: *Missile Design and Development*, Oct., 1960.

Digital Evaluation Equipment—A Multipurpose Test System
O. T. Carver: Aero-Space Transportation Conf., San Diego, California, August 9-12, 1960.

Value Engineering—Chain Reaction
L. R. Sheppard: Electronics Industries Assn., Disneyland, Calif., Oct. 6, 1960.

A Modern Acoustic Missile Launch Locator, The AN/TNS-5
R. M. Carrell: Audio Engineering Society Mtg., October 10-13, 1960.

An Approach to the Evaluation of Vocoder Speech
W. F. Meeker: Acoustical Society of America, October 21, 1960.

Comparison of Digital, Multilevel, Modulation Systems
S. Kasowski: Trans. of 5th Annual Symposium on Electrical Warfare, University of Michigan, September, 1960.

Monitoring, Reporting, Data Processing and Control of a World Wide Communications Network
S. Kaplan and L. Stambler: 4th Nat'l Symposium on Global Communications, August, 1960.

Switching for the Aircom System
G. F. Abbott and W. B. Groth: 4th Nat'l Symposium on Global Communications, August, 1960.

Digital Transmission in the Unicorn System
E. M. Bradburd and S. M. Signer: 4th Nat'l Symposium on Global Communications, August, 1960.

Computer Simulation Techniques in Global Communication Network Engineering
R. L. Dujack: 4th Nat'l Symposium on Global Communications, August, 1960.

Dynamic Accuracy Test Set
O. T. Carver: Design Course for Automatic Test Equipment, New York Univ., August 29, 1960.

An Automatic Multi-Purpose Checkout System Using Analogue-Digital Techniques
K. K. Zeiger: Masters Thesis, Univ. of Penn., June, 1960.

Maintenance Function Analysis for Space Vehicles
T. Taylor, W. Sommer and H. Matty: October issue of *Space/Aeronautics*.

Standardization of Support Equipment
D. Dobson and L. Wolff: *Missile Design and Development*, November, 1960.

Automatic Test Equipment
D. Dobson and L. Wolff: *Electronics*, July 15, 1960.

Infrared Vidicon Performance Data
J. J. Dishler, L. Arlan and C. T. Shelton: Infrared Information Symposium, Boston, Mass., Oct. 11, 1960.

The Effect of Signal Fluctuation on the Performance of a 'Double Threshold' Detector for Pulsed Radar Signals
S. H. Buder: Masters Thesis, Univ. of Penn., June, 1960.

A Note of Caution of the Square-Law Approximation to an Optimum Detector
J. J. Bussgang and W. L. Midgett: Sept., 1960, *IRE Transactions*.

Comparison of Pertinent Transmitter Configurations for High Performance Microwave Phased Array Radars
E. Gronroos and J. Sandison: 6th Symposium on Hydrogen Thyristors and Modulators, Fort Monmouth, N. J., May 19, 1960.

A Combined Infrared-Radar System
R. Malech, Jr.: Microwave Radar Symposium, June 8, 1960, Moorestown, N. J.

Microwave Radio Astronomy Equipment and Measurements
H. W. Rudolph, Jr.: Microwave Radar Symposium: June 8, 1960, Moorestown, N. J.

Analysis and Synthesis of Dynamic Performance of Industrial Organizations; The Analysis of Feedback Control Techniques to Organizational Systems
R. B. Wilcox: Joint Automatic Control Conf., M. I. T., Cambridge, Mass., Sept., 1960.

An Error Minimization Technique for Sampled Data Systems
C. W. Steeg, Jr. and A. F. Engelbrecht: *IRE Proceedings*, Oct., 1960.

Transient Ablation and Heat Conduction Phenomena at a Vaporizing Surface
R. C. Fleddermann: American Inst. of Chemical Engineers and International Congress of Chemical Engineering; Mexico City, Mex., June 21, 1960.

A Statistical Analysis of a Monopulse Angle Estimator
J. McGinn, F. Sandy, and S. Sharensen, *Proceedings*, 6th Annual Radar Symposium, Univ. of Michigan.

Theoretical Radar Cross-Section of Re-entering Vehicles at Head-On Incidence for C-Band or Higher Frequencies (Secret)
H. Safran: *Proceedings*, Symposium on the Plasma Sheath, AF Cambridge Research Center, Dec. 7, 1959.

Rendezvous with a Space Station as a Terminal Guidance Problem
C. W. Steeg, Jr. and A. W. Engelbrecht: Annual NEREM Mtg., Boston, Mass., Nov. 18, 1959.

The Relationship Between Selected Physical Measures and Human Performance in a Pattern Recognition Task
W. R. Bush, V. M. Donahue, and R. B. Kelly: *IRE Transactions*, March, 1960.

Optimum Estimation of Impulse Response in the Presence of Noise
M. J. Levin: *IRE Transactions*, March, 1960.

Bit-Sequential and Block-Sequential Decoding
J. J. Bussgang: International Conf. on Information Processing, Paris, France, June, 1959.

Terminal Guidance and Rocket Fuel Requirements for Satellite Interception
M. J. Nason: ARS, Controllable Satellites Conf., Boston, Mass., April, 1959.

A Discrimination Radar
G. Weiner and D. Winfield: 5th AF BMD-STL Aerospace Mtg. on Ballistic Missiles and Space Technology: Los Angeles, Calif., August, 1960. (Secret)

RCA Participation in the 1958 IRMP
H. J. Wetzstein and R. A. Coudry: IRIS, Baltimore, Md., Feb. 17, 1959. (Secret)

INDUSTRIAL ELECTRONIC PRODUCTS

New X-Ray Equipment from RCA
V. E. Buhke: Society for Applied Spectroscopy, Chicago, Illinois, June 20, 1960.

A Generalization of a Theorem of Quine for Simplifying Truth Functions
J. T. Chu: Association for Computing Machinery National Meeting, Milwaukee, Wisconsin, August, 1960.

Topological Nature and Logical Properties of a Computer-Simulated Alpha-Numeric Recognition Circuitry
D. S. Himmelman and J. T. Chu: Association for Computing Machinery National Meeting, Milwaukee, Wisconsin, August, 1960.

"Autodesign," Automated Wiring Design System
M. E. McLean: ACM National Meeting, Milwaukee, Wisconsin, August, 1960.

Use of COBOL for Systems Analysis
Mary K. Hawes: ACM National Meeting, Milwaukee, Wisconsin, August, 1960.

Voltage Reference Sources for Electron Microscope Power Supplies
R. L. Libbey: 1960 Annual EMSA Meeting, Marquette University, Milwaukee, Wisconsin, August, 1960.

Design Parameters for the Telefocus Grid Cap
J. W. Coleman: 1960 Annual EMSA Meeting, Marquette University, Milwaukee, Wisconsin, August, 1960.

Instrumentation
J. H. Reiser: 1960 Annual EMSA Meeting, Marquette University, Milwaukee, Wisconsin, August, 1960.

A Practical Method for Estimating Specimen Thickness in the Electron Microscope
J. H. Reiser: 1960 Annual EMSA Meeting, Marquette University, Milwaukee, Wisconsin, August, 1960.

Computer for Industrial Controls
R. W. Sonnenfeldt: Annual Meeting of the Iron and Steel Association, September, 1960.

Drafting Standards—Their Influence on Manufacturing Costs
K. M. Stoll: American Society of Tool and Manufacturing Engineers, Binghamton, New York, September 7, 1960.

Tunnel Diode Application to High Speed Instrumentation
H. Ur: International Conference on Instrumentation for High Energy Physics, University of California, Berkeley, Calif., September 12, 1960.

A New Video Signal Processing Amplifier
R. N. Hurst and A. C. Luther: IRE Professional Group on Broadcasting, Washington, D. C., September 23, 1960.

TV Station Automation
Floyd R. McNicol: IRE PGB, Washington, D. C., September 23, 1960 and Philadelphia Chapter of IRE PGBTR, Philadelphia, Penna., October 13, 1960.

Directional Antennas for VHF Television
H. E. Gihring: IRE PGB, Washington, D. C., September 23, 1960.

AutoData-Automatic Message Switching System
J. L. Owings: Sixth National Communications Symposium, Utica, New York, October, 1960.

Some Methods for Simplifying Switching Circuits Using Don't Care Conditions
J. T. Chu: Fall General AIEE Meeting, Chicago, Illinois, October 10-14, 1960.

ELECTRON TUBE DIVISION

Voltage Comparisons Using a Universal Ratio Set
K. H. ReCorr: *Electronic Design*, Aug. 17, 1960.

Introduction to X-Ray Microradiography, Diffraction, and Spectroscopy
E. P. Bertin: 2nd Annual X-Ray Diffraction and Spectroscopy School, Camden, N. J., Sept. 6, 1960.

An RF Modulation Monitor: Modified RCA-WO-33A 3-Inch Oscilloscope
R. A. Rainboth and J. F. Sterner: *RCA Ham Tips*, Sept., 1960.

Design Considerations for Grid-Controlled Electron Guns for Traveling-Wave Tubes
H. J. Wolkstein: *RCA Review*, Sept., 1960.

The Magnetic Field and Flux Distribution in a Periodic Focusing Stack for Traveling-Wave Tubes
M. J. Schindler: *RCA Review*, Sept., 1960.

A Rapid Method for Estimation of Grid-Cathode Contact Potential
A. G. F. Dingwall: Tube Techniques Conference, New York City, Sept. 12-13, 1960.

Deformation of Wire on Pulleys
J. Paull: *Machine Design*, Sept. 15, 1960.

Modern Traveling-Wave Tubes and Related Solid-State Microwave Amplifiers
C. L. Cuccia: IRE Subsection Meeting, St. Louis, Mo., Sept. 22, 1960.

An Electronic Metronome
H. A. Wittlinger: *Electronics World*, Oct., 1960.

A Simple Stable VFO
G. D. Hanchett: *QST*, Oct., 1960.

Use of Nuvistors in Amateur Radio Applications
M. Adams: Amateur Radio Club Meeting, Boonton, N. J., Oct. 23, 1960.

An Ultra-Low-Noise Wide-Band Traveling-Wave Tube
G. Hodowanec and H. J. Wolkstein: IRE Electron Devices Meeting, Washington, D. C., Oct. 27-28, 1960.

The Influence of Thermal and Resonance Considerations on the Design of Brazed Cylindrical Grids
D. M. Burton and J. L. Gutowski: IRE Electron Devices Meeting, Washington, D. C., Oct. 27-28, 1960.

The Helix Parametric Amplifier, a Wide-Band Miniature Solid-State Microwave Amplifier
C. L. Cuccia: IRE Electron Devices Meeting, Washington, D. C., Oct. 27-28, 1960.

The Application of the Nuvistor Triode in UHF Tuners
C. Gonzalez: IRE/EIA Radio Fall Meeting, Syracuse, N. Y., Nov. 1, 1960.

New Combination Tube Types for Low-Cost Compact Automobile Receivers
N. C. Johnson: IRE/EIA Radio Fall Meeting, Syracuse, N. Y., Nov. 1, 1960.

How Vacuum-Tube Problems are Solved by the Use of Radio-Isotopes
H. A. Stern: Tube Techniques Conference, New York City, Sept. 12-14, 1960.

Degassing and Permeation of Gases in Tube Materials
R. H. Collins and J. C. Turnbull: Tube Techniques Conference, New York City, Sept. 12-14, 1960.

Thermal Outgassing of Tube Materials
R. H. Collins and J. C. Turnbull: Tube Techniques Conference, New York City, Sept. 12-14, 1960.

The Effects of Oxygen on Emission of Oxide Cathodes
W. G. Rudy: Tube Techniques Conference, New York City, Sept. 12-14, 1960.

New Design Methods for Obtaining 40g Vibrational Capability in Kilowatt-Class Tubes
J. J. Free: Tube Techniques Conference, New York City, Sept. 12-14, 1960.

A Large Bakeable Ultra-High-Vacuum Valve
W. B. Parker and J. T. Mark: American Vacuum Society Meeting, Atlanta, Ga., Oct. 12-13, 1960.

A Simple Technique for the Accurate Determination of Electron Trajectories
R. P. Stone: IRE Electron Devices Meeting, Washington, D. C., Oct. 27-28, 1960.

New Helix-Support Method for Traveling-Wave Tubes
D. J. Blattner and F. E. Vaccaro: *IRE Transactions on Electron Devices*, July, 1960.

Tunnel-Diode Microwave Oscillators with Milliwatt Power Outputs
F. Sterzer and D. E. Nelson: IRE WESCON Meeting, Los Angeles, Calif., Aug. 23-26, 1960, and published in *IRE WESCON Convention Record*, Aug., 1960.

Slow-Wave Structure for Electrostatically Focused High-Power Traveling-Wave Tubes
E. F. Belohoubek: *RCA Review*, Sept., 1960.

SEMICONDUCTOR AND MATERIALS DIVISION

Magnesium-Sulfur Dry Cells
C. K. Morehouse and R. Glicksman: *Journal of the Electrochemical Society*, July, 1960.

A Packaged Micromodule Laboratory for Industry
D. T. Levy: IRE WESCON Meeting, Los Angeles, Calif., Aug. 23-26, 1960, and published in *IRE WESCON Convention Record*, Aug., 1960.

Hall Measurements on Tunnel-Diode Materials
T. E. Seidel: AIME Metallurgical Society Meeting, Boston, Mass., Aug. 29-30, 1960.

Growth of Gallium Arsenide Crystals from Dilute Solutions
L. J. Vieland and S. Skalski: AIME Metallurgical Society Meeting, Boston, Mass., Aug. 29-30, 1960.

Investigation of the Electrochemical Characteristics of Organic Compounds—V. Heterocyclic Nitro Compounds
R. Glicksman and C. K. Morehouse: *Journal of the Electrochemical Society*, Sept., 1960.

Cells, Electric
C. K. Morehouse, R. Glicksman, and G. S. Lozier: *Encyclopedia of Chemical Terminology* (Supplement), Sept., 1960.

Evaluation and Control of Diffused Impurity Layers in Germanium
W. J. Greig and H. S. Veloric: *RCA Review*, September, 1960.

Tomorrow's Devices
E. O. Johnson: IRE Section Meeting, Cedar Rapids, Iowa, Sept. 9, 1960.

The Challenge of Visual Inspection in the Electronics Industry
E. G. Schilling: Conference on Quality Control and Statistics in Industry, Rutgers University, New Brunswick, N. J., Sept. 10, 1960.

A New Road to Index-Error Evaluation
H. R. Ronan, Jr.: AGMA Aerospace Gearing Committee Meeting, San Francisco, Calif., Sept. 26-27, 1960.

Radio-Receiver Design Considerations
J. W. England: General Electric Symposium, Utica, N. Y., Oct. 6, 1960.

Investigation of the Electrochemical Characteristics of Organic Compounds—VII. Organic Positive Iodine and Aliphatic AzO Compounds
C. K. Morehouse and R. Glicksman: Electrochemical Society Meeting, Houston, Texas, Oct. 9-13, 1960.

Investigation of the Electrochemical Characteristics of Organic Compounds—VIII. Hydrazine and Hydroxylamine Compounds
R. Glicksman: Electrochemical Society Meeting, Houston, Texas, Oct. 9-13, 1960.

The Magnesium-m-Dinitrobenzene Cell
C. S. Lozier, R. Glicksman, and J. B. Eisen: Electrochemical Society Meeting, Houston, Texas, Oct. 9-13, 1960.

A Transistorized Stereo Amplifier
C. F. Wheatley: Audio Engineering Society Meeting, New York City, Oct. 12, 1960.

The Design and Fabrication of a VHF Medium-Power Transistor
S. W. Daskam and D. R. Carley: IRE Electron Devices Meeting, Washington, D. C., Oct. 27-28, 1960.

A High-Performance AM/FM Receiver Utilizing an Autodyne Converter
L. Plus and H. Thanos: IRE/EIA Radio Fall Meeting, Syracuse, N. Y., Nov. 1-2, 1960.

Evaluation of Large Diffusion Pumps and Traps for the Ultra-High-Vacuum System of the Model C-Stellarator
C. S. Geiger, W. G. Henderson, and J. T. Mark: *Transactions of 1959 American Vacuum Society Symposium*, July, 1960.

Ceramic, Sapphire, and Glass Seals for the Model C-Stellarator
I. E. Martin, J. A. Powell, and J. A. Zollman: *Transactions of 1959 American Vacuum Society Symposium*, July, 1960.

Ultra-High-Vacuum-System Developments for the Model C-Stellarator
J. T. Mark and K. Dreyer: *Transactions of 1959 American Vacuum Society Symposium*, July, 1960.

RCA SERVICE COMPANY

Field Complaint Investigation and Assessment
T. Y. Plythe: 5th Annual Symposium on Quality Control Methods and Management, Philadelphia Sect., Sept. 10, 1960.

A Note on a Vulnerability Model for Weapon Sites with Interdependent Elements
Dr. A. Schild: Vol. III, No. 3, May, June, 1960, *Journal of the Operations Research Society of America*.

Electron Microscope Maintenance and Service
H. Taylor: Michigan Electron Microscope Forum, Henry Ford Hospital, Detroit, Mich., Oct. 5, 1960.

Electron Microscope Maintenance for the Service Engineer
E. Stanko: *Electronic Technician*, Sept. 1960.

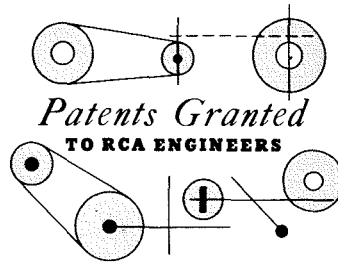

BASED ON SUMMARIES RECEIVED OVER A PERIOD OF ABOUT TWO MONTHS.

DEFENSE ELECTRONIC PRODUCTS

Explosive Release Actuator
2,938,429—May 31, 1960; Irving Scott.

Data Processing Apparatus
2,947,971—Aug. 2, 1960; M. H. Glauberman.

Electrical Connecting Device
2,949,596—Aug. 16, 1960; M. L. Levene.

Rotating Radar Antenna
2,947,989—Aug. 2, 1960; J. R. Ford, H. Perkel, and I. D. Kruger.

Thermoelectric Compositions and Devices Utilizing Them
2,953,616—Sept. 20, 1960; L. Pessel and T. Q. Dziemiandwicz.

Sweep Circuit
2,953,679—Sept. 20, 1960; J. A. Rush and E. C. Lurcott.

Tape Reeling Machine
2,951,652—Sept. 6, 1960; G. Rezek (with C. J. McBrerty).

Gating Pulse Generator
2,948,884—Aug. 9, 1960; B. Adler (with H. P. Guerber).

Switching System
2,951,236—Aug. 30, 1960; F. D. Covely III, and A. C. Stocker.

Multivibrator with Reset Timing Circuit
2,955,200—Oct. 4, 1960; H. M. Scott.

Multi-Contact Connector
2,956,260—Oct. 11, 1960; E. A. Bennett.

Radar System and Display
2,944,253—July 5, 1960; F. D. Covely III, and L. E. Haining.

Pressure Applying Means for the Tape of a Magnetic Recorder
2,957,049—Oct. 18, 1960; J. M. Uritis.

INDUSTRIAL ELECTRONIC PRODUCTS

Balanced Modulator Circuit
2,948,862—Aug. 9, 1960; F. M. Brock.

Electric Beam Controlling Apparatus
2,950,407—Aug. 23, 1960; W. H. Barkow (with M. W. Schmutz).

Amplifier Oscillator for Magnetic Recorder-Reproducer
2,957,050—Oct. 18, 1960; R. H. Barton.

Color Synchronizing Signal Separation
2,956,111—Oct. 11, 1960; R. W. Sonnenfeldt.

Gating Pulse Generator
2,948,884—Aug. 9, 1960; H. P. Guerber (with B. Adler).

Tape Reeling Machine
2,951,652—Sept. 6, 1960; C. J. McBrerty (with G. Rezek).

Magnetic Color Demodulator System
2,955,153—Oct. 4, 1960; R. W. Sonnenfeldt (with G. L. Grundmann and C. L. Cuccia).

ELECTRON TUBE DIVISION

Oxide Coated Cathodes and Method of Manufacture
2,950,993—Aug. 30, 1960; S. Umbreit.

Methods for Preparing Luminescent Materials
2,956,028—Oct. 11, 1960; J. A. Davis.

Glass Bulb Fabrication
2,956,373—Oct. 18, 1960; W. H. Earhart.

Glass Bulb Fabrication
2,956,374—Oct. 18, 1960; J. I. Nubani.

Glass Beading Mechanism for Electron Guns
2,950,568—Aug. 30, 1960; R. F. Maile and R. D. Kissinger (no longer with RCA).

Power Tubes for Operation at High Frequencies
2,950,411—Aug. 23, 1960; A. G. Nekut and M. B. Shrader.

High Power, High Frequency Electron Tube
2,951,172—Aug. 30, 1960; I. E. Smith and W. C. Griffiths, Jr.

Plural Beam Gun
2,957,106—Oct. 18, 1960; H. C. Moodey.

Pickup Tube Assembly
2,951,962—Sept. 6, 1960; L. D. Miller and E. A. Dymacek.

Magnetic Color Demodulator System
2,955,153—Oct. 4, 1960; C. L. Cuccia (with R. W. Sonnenfeldt and G. L. Grundmann).

SEMICONDUCTOR AND MATERIALS DIVISION

Semiconductor Signal Amplifier Circuit
2,955,258—Oct. 4, 1960; C. F. Wheatley, Jr.

RCA VICTOR HOME INSTRUMENTS

Burst Separating Apparatus
2,953,636—Sept. 20, 1960; G. E. Kelly.

Color Killer System
2,948,774—Aug. 9, 1960; G. W. Singleback.

Selective Amplitude Discriminatory Circuit
2,956,118—Oct. 11, 1960; H. C. Goodrich.

Frequency Converter With Oscillator Tuning Indicator
2,950,383—Aug. 23, 1960; D. J. Carlson.

Radio-Phonograph Circuits
2,950,356—Aug. 23, 1960; H. B. Stott.

Magnetic Color Demodulator System
2,955,153—Oct. 4, 1960; G. L. Grundmann (with R. W. Sonnenfeldt and C. L. Cuccia).

Electric Beam Controlling Apparatus
2,950,407—Aug. 23, 1960; W. H. Barkow (with M. W. Schmutz).

RCA SERVICE COMPANY

Stereophonic Sound for Drive-In Theatres
2,956,129—Oct. 11, 1960; R. H. Heacock.

Editor's Note: This issue features commercial digital computers systems, a product line that has become of major importance to RCA. In addition, there is and has been much RCA engineering in other phases of computer technology. The following RCA ENGINEER articles (which go back to its inception in 1955) trace many aspects of this work. Plans for future issues include articles on computers in defense systems, information processing, advanced commercial systems, engineering applications, and computer components.

1. J. W. Leas, *Engineering the RCA Bizmac System*, 1-4, Dec. 55-Jan. 56
2. W. K. Halstead, *The RCA Bizmac Electronic Accounting System*, 1-4, Dec. 55-Jan. 56
3. Ann Hathaway, *Design of Electron Tubes for Computer Service*, 2-1, June-July 1956
4. J. L. Owings, *Human Engineering the RCA Bizmac System*, 2-3, Oct.-Nov. 1956
5. D. E. Deutch, *Transistors in Digital Computers*, 2-5, Feb.-Mar. 1957
6. G. S. Hipskind and T. Q. Dziemiandwicz, *Processing and Testing of Rectangular Loop Ferrite Cores*, 2-6, April-May 1957
7. A. Katz, C. Y. Hsueh, and R. J. Spoelstra, *A Magnetic Core Memory for Digital Computing Systems*, 2-6, April-May 1957

8. Abraham Katz, *Digital Control Systems*, 3-2, Oct.-Nov. 1957
9. Z. J. Lipinski, *How to Plan a Bizmac Installation*, 3-3, Dec. 57-Jan. 58
10. Rosemary A. Johnson, *Engineering Applications for Computers*, 3-3, Dec. 57-Jan. 58
11. J. S. Baer, A. S. Rettig, and I. Cohen, *On-Line Sales Recording System*, 4-1, June-July 1958
12. J. L. Connors, *Adjoint Techniques in System Design*, 4-4, Dec. 58-Jan. 59
13. D. Wellinger, *The Analog Computer in the Design of Complex Systems*, 4-4, Dec. 58-Jan. 59
14. H. M. Elliott, *The RCA 501 System*, 4-5, Feb.-Mar. 1959
15. C. C. Eckel and D. Flechtner, *RCA 501 High-Speed Printers—The Story of a Product Design*, 5-1, June-July 1959
16. M. S. Cohen, *Space Experiments and Automatic Data Analysis*, 5-3, Oct.-Nov. 1959
17. J. J. Sacco, Jr., *Development of Square-Loop Ferrite Magnetic Memory Cores*, 5-4, Dec. 59-Jan. 60
18. T. L. Genetta, J. F. Page, and J. L. Owings, *Auto-Data-RCA's Automatic Message Switching System*, 5-5, Feb.-Mar. 1960
19. J. E. Palmer, *Transistorized MUX/ARQ-2*, 5-5, Feb.-Mar. 1960
20. W. A. Gottfried and S. W. Pike, *The Finishing Touch—Styling and Protective Coatings*, (RCA 501), 5-3, Feb.-Mar. 1960
21. R. H. Bergman and M. M. Kaufman, *Tunnel Diodes in Digital Computers*, 6-2, Aug.-Sept. 1960
22. F. Everhard, *DEE—Digital Evaluation Equipment for Multi-Missile Checkout*, 6-3, Oct.-Nov. 1960

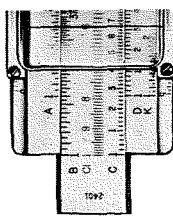

DR. SCHADE AWARDED SMPTE "PROGRESS" MEDAL

Dr. Otto H. Schade, Sr., Staff Engineer of the RCA Electron Tube Division, is this year's recipient of the *Progress Medal Award* of the Society of Motion Picture and Television Engineers, for his "... outstanding technical contributions in the engineering phases of the motion picture and television industries."

He received the award during the Fifth International Congress on High-Speed Photography, Oct. 16-22, in the Sheraton Park Hotel, Washington, D.C. The Congress was under the sponsorship of the SMPTE.

Dr. Schade entered the electrical engineering field in 1926 and has been associated with RCA's tube engineering activities since 1931. He became a Staff Engineer in 1944. Two years later, he received the *RCA Victor Award of Merit* for his contributions to television. He has been the recipient of other awards, including: the *David Sarnoff Gold Medal* of the Society of Motion Picture and Television Engineers; the *Morris Liebmann Memorial Prize* of the Institute of Radio Engineers, and the *Modern Pioneers Award* of the National Association of Manufac-



Dr. O. H. Schade

turers. In 1953, Rensselaer Polytechnic Institute conferred on Dr. Schade the honorary degree of Doctor of Engineering. He holds more than fifty patents. Dr. Schade is a Fellow of both the IRE and the SMPTE.

—T. M. Cunningham

R. F. GUY, PIONEER BROADCAST ENGINEER, BECOMES CONSULTANT

R. F. Guy, after 42 years with NBC, has retired to become an independent engineering consultant in AM, FM, TV, and international broadcasting, with headquarters in Haworth, New Jersey.

He was recently cited by the Radio and Television Executives Society for having the longest continuous experience as a broadcast engineer of any one in the world, and last year received a special citation from the Broadcast Pioneers "... for the distinguished services he has rendered to his country, his industry and his profession as a true pioneer in the establishment of broadcasting, and as a leader in its technical development for 39 years." Mr. Guy is an advisor to the *Voice of America* and recently made a trip around the world to evaluate the operation. In recent years, he was Senior Staff Engineer of NBC, after many years as Director of Radio and Allocations Engineering with responsibility for planning and building all NBC transmitting facilities. [For a detailed biography, see RCA ENGINEER Vol. 5, No. 6, p. 4.]



IEP HOLDS FOURTH ENGINEERING DINNER

More than 400 members of the IEP Engineering Staff gathered at the Ivystone Inn, Pennsauken, N. J. on the evening of October 19, 1960 to attend the fourth in a series of Engineering Dinners.

T. A. Smith, Executive Vice President, IEP, spoke briefly on IEP's current business picture and 1961 goals. Dr. George H. Brown, Vice President, Engineering, described the function of his organization and its relationship to other corporate activities.

In discussing professionalism, Dr. Brown asserted that an important element in the engineer's professional stature is his competence and ability to make his own decisions. He concluded his talk by reminiscing about the engineering problems and projects of the 1930's, and contrasted these with the technology and challenges of the 1960's.

PETERSON CITED FOR "BEST PAPER"

D. W. Peterson, RCA Laboratories, received the *Scott Hall Award* of the IRE Professional Group on Broadcasting for his paper "Television Antenna System Measurements Based on Pulse Techniques" (*IRE-PGB Transactions*, March 1960) at the PGB Symposium, Washington, D.C., September 23, 1960. It was judged the best IRE-PGB paper published between July 1, 1959 and July 1, 1960.

DR. ZWORYKIN HONORED

On October 6, 1960, the Broadcast Pioneers presented to Dr. V. K. Zworykin, of the RCA Laboratories, a special award reading "... Broadcast Pioneers citation to Vladimir K. Zworykin for his brilliant conception and development of the indispensable picture tubes which made modern television possible." In the photo, R. F. Guy (r.) makes the presentation.

"MICROWAVE SOLID STATE" LECTURE SERIES SPONSORED BY TUBE DIVISION

Because of the increasing importance of microwave solid state devices, the Harrison Microwave Engineering Education Committee, Electron Tube Division, sponsored a series of lectures on "Microwave Solid State" for Microwave engineers. The lectures were prepared by Dr. L. Nergaard and his staff of the RCA Laboratories. The committee organizer of the series was R. McMurrough of Microwave Engineering, Harrison. The topics covered and date of presentation were

1. *Band Structure*, L. Nergaard, 9/21/60.
2. *Conduction and Diffusion*, L. Nergaard, 9/28/60.
3. *Principles of Diodes*, C. Stocker, 10/6/60.
4. *Microwave Diodes*, D. Nelson, 10/13/60.
5. *General Notions of Molecular Resonance*, J. Witke, 10/20/60.
6. *Molecular Resonance Amplifiers*, H. Lewis, 10/27/60.
7. *General Properties of Ferrites*, P. Baltzer, 11/3/60.
8. *Ferrite Devices*, B. Johnson, 11/10/60.
9. *General Properties of Plasmas*, M. Glicksman, 11/17/60.
10. *Microwave Plasmas*, F. Paschke, 11/25/60.
11. *Summary*, L. Nergaard, 12/1/60.

Because of the comprehensive and thorough nature of this material, a limited number of sets of these papers are available. For information on obtaining these, contact R. McMurrough, Microwave Engineering, RCA Electron Tube Division, Harrison, N.J.

—H. J. Wolkstein

DEGREES GRANTED

The following men from Needham (Mass.) Materials Operation, Semiconductor and Materials Div., received their BBA in Engineering and Management in June 1960 from Northeastern University night school: D. Kadish, R. E. Lepore and V. Tessari. Also, A. J. Boulanger received his B.S. in Chemistry in June 1960 from Northeastern University as a co-op student with RCA.

The following men in DEP received their M.S.E.E. in June 1960 from the University of Pennsylvania: L. T. Uslin, F. W. Coffee, D. Sapp, G. Hunka, and R. Givens. Also, H. Honda, J. Drenik, and W. Kouns received their M.S.E.E. from the Drexel Institute of Technology in June 1960.

OSMAN HONORED FOR AUTHORSHIP

Mitchell G. Osman, of the RCA Victor Record Division, Indianapolis, Indiana, received the *George B. Hogaboom Memorial Nickel Plating Award* at the American Electrochemical Society convention in Los Angeles for his article "Automatic Additions to the Nickel Plating Solution." Mr. Osman is a process engineer in charge of the Factory Control Laboratory in Indianapolis. This article also appeared in the RCA ENGINEER, Vol. 5 No. 3, p. 60, under the title "Electroforming Baths—Control Via Automatic Additions."—M. Whitehurst.

ENGINEERS IN NEW POSTS

In IEP, **D. H. Kunsman**, Vice President and General Manager, Electronic Data Processing Division, announces the appointment of **D. L. Nettleton** as Chief Engineer, and **R. N. Baggs** as Administrator, Special Projects.

Also in EDP, **J. N. Marshall**, Mgr., Advanced Systems Development Engineering, announces his staff as: **H. H. Asmussen**, Staff Engineer; **J. A. Brustman**, Mgr., Electronic Systems Engineering; **R. K. Lockhart**, Mgr., Lightning Development Engineering; **K. E. Thomas**, Mgr., Engineering Administration; and **R. A. Wallace**, Mgr., Electro-Mechanical Equipment Engineering.

In the EDP Commercial Systems Dept., **H. M. Elliott**, Mgr., Engineering, names his staff as: **H. Kleinberg**, Mgr., Product Line Engineering; **M. C. McWeeney**, Mgr., Systems Operation Engineering; **W. D. Stellman**, Mgr., Engineering Administration; and **T. R. Thorpe**, Mgr., Drafting. **G. W. Dick**, Division Vice President, EDP Commercial Systems Dept., has named **H. M. Emlein** as Mgr., Operations, for the new EDP plant in Palm Beach Gardens, Fla. Mr. Emlein's staff includes: **L. B. Bureau**, Mgr., Plant Engineering; **H. N. Morris**, Mgr., Engineering; and **J. J. Toyzer**, Mgr., Manufacturing Engineering.

In the EDP Data Communications and Custom Projects Dept. (**J. W. Leas**, Manager), **R. E. Wallace**, Mgr., Marketing, is Acting Mgr., ComLogNet Project; his ComLogNet group includes **J. L. Owings** as Mgr., Autodata Engineering.

In the IEP Communications and Controls Division, **F. J. Dunleavy**, General Manager, Industrial Controls, has named **S. E. Arnett** as Mgr., Graphic Arts Products Dept.; **H. R. Swartz** as Administrator, Electro-Mechanical Program Development; and **T. J. Barlow** as Mgr., Production Dept. **N. Caplan**, Mgr., Communications Products Dept., has named **G. F. Rogers** as Mgr., Advanced Development; in this newly-created position, he will head a group that will work at the Princeton Laboratories.

In the RCA Electronic Tube Division, Entertainment Tube Products Dept. at Harrison, **H. A. DeMooy**, Mgr., Receiving Tube Operations, announces his staff to include: **K. G. Bucklin**, Mgr., New Products Engineering; **J. T. Cimorelli**, Mgr., Engineering; **G. W. Crawford**, Mgr., Operations Planning;

HILLIER RECEIVES LASKER AWARD

Dr. James Hillier, Vice-President, RCA Laboratories, was named recipient of a 1960 Albert Lasker Award by the American Public Health Association. The award was conferred jointly on Dr. Hillier and Dr. Ernst Ruska, Berlin Institute of Technology, "for the design, construction and perfection of the electron microscope as an essential tool of modern medical research." Describing the medical research award the Committee said: "Doctors Ruska and Hillier have extended the range of human vision to objects several hundred times smaller than those which can be seen with the light microscope."



H. A. DeMooy, Acting Mgr., Manufacturing; **J. W. MacDougall**, Administrator, Controls and Standards; **E. Rudolph**, Mgr., Equipment Design and Development; and **W. H. Warren**, Mgr., Quality Control. At the Cincinnati Plant, Receiving Tube Operations, **C. W. Hear**, Mgr., Tube Manufacturing announces his staff to include: **E. Van Wagoner**, Mgr., Manufacturing Equipment Projects and **J. P. Sasso**, Mgr., Production Engineering. Mr. Sasso's staff includes **R. B. Fleming**, and **J. A. Dierkers** as Mgr.'s, Miniature Tube Production Engineering; and **J. P. Sasso** as Acting Mgr., Parts Preparation Production Engineering.

In RCA Victor Company, Ltd., Canada, **J. R. Supple**, formerly in Engineering at the Indianapolis plant of the RCA Victor Record Division, has been named Plant Manager of the Smith Falls, Ontario plant.

C. M. Sinnott, Director, Product Engineering Professional Development, RCA Staff, has named **G. W. King** as Administrator, Product Engineering Professional Development.

In DEP, **A. N. Curtiss**, General Manager, West Coast Missile and Surface Radar Division, has named **M. A. Maurer** as Plant Manager, Van Nuys and West Los Angeles Manufacturing Facilities; **A. N. Collins**, Mgr., Product Assurance; and **G. F. Breitweiser** (formerly Chief Engineer) to the newly created position of Chief Engineer and Mgr., Atlas Program. **S. W. Cochran**, Division Vice President and General Manager, Surface Communications Division, has named **C. M. Ledig** as Mgr., Product Assurance and **R. V. Miraldi** as Plant Manager, of the SurfCom plant in Cambridge, Ohio, which is now converting its operations to the manufacture of communications equipment. In DEP Applied Research, **E. E. Moore** has been named Mgr., Signal Processing. He succeeds **Dr. H. N. Crooks**, who is assuming the post of Mgr., Advanced Development, at the SurfCom plant in Cambridge, Ohio.

REGISTERED PROFESSIONAL ENGINEERS

Leo Parnes , IEP	Prof. Eng. 37503, N. Y.
S. H. Winkler , DEP	Prof. Eng. 36579, N. Y.
P. J. Stadnyk , DEP	Prof. Eng. 10497, N. J.
J. C. Goldsmith , IEP	Prof. Eng. 11334, N. J.
D. M. Taylor , IEP	Prof. Eng. 11242, N. J.

CIMORELLI AND BUCKLIN NAMED TO KEY NEW ENGINEERING POSTS IN TUBE DIVISION

In the Electron Tube Division, **J. T. Cimorelli** has been named Manager, Engineering, Receiving Tube Operations, and **K. G. Bucklin** has been appointed to the newly created position of Manager, New Products Engineering. Both will report to **H. A. DeMooy**, Manager, Receiving Tube Operations for the Tube Division's Entertainment Tube Products Department.

Both men have long and distinguished experience in RCA engineering management in the Electron Tube Division, and have been contributors to the RCA ENGINEER since its inception. Mr. Cimorelli was one of the pioneers and original planners of the magazine's policies and format.

J. T. Cimorelli (l.) and K. G. Bucklin

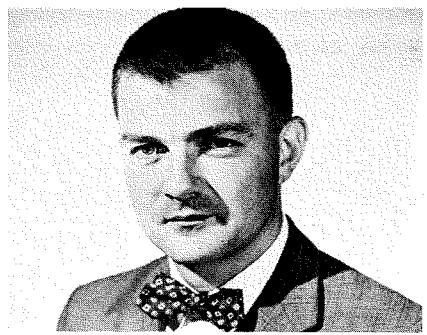

D. L. Nettleton

NETTLETON NAMED CHIEF ENGINEER OF EDP DIVISION

In the IEP Electronic Data Processing Division, **D. H. Kunsman**, Vice President and General Manager, has appointed **D. L. Nettleton** to the newly created staff position of Chief Engineer, EDP Division.

Mr. Nettleton graduated from Carnegie Institute of Technology in 1951 with a BSEE. He joined RCA Advanced Development in 1952, where he worked on the first RCA computing system, military digital systems, advanced magnetic circuits, and disk-type random-access files. He then led a team in the initial system and logic development of the present RCA 501. In 1955, he became Leader, Design and Development Engineers.

He moved to the Commercial Advanced Development Group in 1956, becoming Mgr., Data Handling Development, in 1957. There, projects included an automation system for monitoring gas pipelines, a small control computer, and logic networks for a high-speed computer.

He joined the Electronic Data Processing Division in September 1958 as Mgr., Systems and Standards. He had been named Mgr., Engineering, Data Communications and Custom Projects in September 1960, prior to becoming Chief Engineer.

In his new assignment, Mr. Cimorelli will be responsible for receiving tube engineering, nivistor engineering, and nivistor manufacturing. Mr. Bucklin will be responsible for engineering studies of new products to complement existing lines and of products and services in allied fields of electronics.





GOOD ARTICLES DON'T JUST HAPPEN . . . they're made, and Sig Dierk (l.), Technical Publications Administrator and RCA ENGINEER Editorial Board Chairman for IEP, and Tom Patterson, EDP Division Ed Rep, planned five of the computer articles in this issue, followed up with editing and much legwork.—*The Editors*

PROFESSIONAL ACTIVITIES

Record Division, Indianapolis: **Dr. A. M. Max** is to be Chairman of the Electrochemical Society Convention to be held in Indianapolis in April 1961. **E. D. Mahoney** was named Program Chairman of the SPE Central Indiana Section for 1960-61. **R. C. Moyer** spoke before the SPE on stereo records.

IEP, Camden: **E. L. Newman**, EDP Division, was re-elected President of the American Cryptogram Assn. **W. Lyons**, RCA Communications, Inc., will serve on the Panel of Experts Advisory Committee of the Dept. of State, studying methods of relieving crowding of radio operations in the band of 4 to 27.5 mc.

Tube Division, Harrison: **Eleanor M. McElwee** is teaching *Editing Techniques for Technical Writers* at Fordham U.; **H. Baum** is teaching *Fundamentals of Technical Writing* at Rutgers, New Brunswick. **E. J. Byrum** has been elected Chairman, IRE-PGEWS of the Northern N. J. IRE Section. He was also appointed Managing Editor of the Section *Newsletter*.

Service Co.: **E. Stanko** has been named to serve on the Market, Editorial, and Research Panel of *Instruments and Control Systems* magazine.

DEP-MEC, Burlington: **W. Ramsey** is Vice President and Program Chairman of the IRE-PGANE.; he also served on the publicity committee of the 1960 NEREM show, and serves on the Publicity Committee of the IRE-PGEWS.

DEP-AED, Princeton: **Dr. B. Sams** was appointed a member of the Storage Allocations Committee of the Association of Computing Machines; **Dr. J. Minker** is a member of the Information Retrieval Subcommittee.

7th Nat'l Reliability and Quality Control Symposium, Philadelphia, Pa., Jan. 9, 10, 11: RCA is well represented in this joint IRE-ASQC-AIEE-EIA symposium to be held at the Bellevue Stratford Hotel. **C. M. Ryerson**, DEP-Camden, and **A. M. Okun**, SCM Div., will be session moderators. Symposium management includes: Board of Directors, **C. M. Ryerson**, Chairman, and **G. H. Beckhart**, DEP-Moorestown. Advisory Board, **M. C. Batsel**, consultant. Management Committee, **J. B. Rivera**, DEP-Moorestown, Treasurer; **J. A. Cafare**, RCAS, Vice Chairman Registration; **V. R. Monshaw**, DEP-Camden, Vice Chairman Arrangements; Publicity Committee includes: **J. H. Goodson**, DEP-SurfCom, Chairman; **M. Raphelson**, DEP-SurfCom, Vice Chairman; and **B. D. Smith**, DEP-ASD, **J. F. Chalupa**, DEP-ASD, and **H. M. Gleason**, DEP-ASD, as Area Publicity Chairmen.



J. J. Hoehn

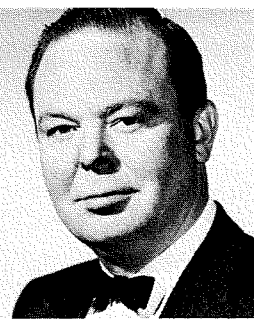

J. H. Sweer



W. C. Jackson

IEP ED REPS NAMED: HOHN FOR INDUSTRIAL CONTROLS; SWEER FOR EDP ADVANCED SYSTEMS; JACKSON FOR RCA COMMUNICATIONS, INC.

S. F. Dierk, IEP Technical Publications Administrator, has named two new Ed Rep positions and a change in a third. In newly created Ed Rep spots are **J. J. Hoehn** for Industrial Controls, Communications and Controls Division, Camden, N. J.; and **J. H. Sweer**, for the Advanced Systems Development Department, EDP Division, Camden (Pennsauken), N. J. In a change, **W. C. Jackson** has taken over as Ed Rep for RCA Communications, Inc., New York, N. Y. **D. S. Rau** had served in that spot.

John J. Hoehn is an M.E. graduate from the Winterthur Institute of Technology, Switzerland. In 1921 he came to the U.S., continuing post-graduate studies at Columbia University. He joined the Victor Talking Machine Company in Camden in 1927. In 1930, when they were formally taken over by RCA Victor Company, Inc., he was made an engineer in the Phonograph Design Section, and in 1932 on Photophone equipment. From 1932 to 1945 he was employed in the design of every phase of both film and disk recording and reproducing equipment. During this period, he moved to Indianapolis, where he was Supervisor of the Mechanical Design Section in 1945. He returned to Camden with that group in 1946, in 1947 becoming Design Coordinator for the Communications and Sound Engineering Section. He is now Mgr., Mechanical Coordination, for the Industrial Controls Engineering Section. He has 16 patents.

J. H. Sweer, Mgr., System Planning & Technical Coordination, graduated from the University of Pittsburgh with a BS in Physics and Mathematics, and from Princeton with an MA in the same fields. After work at the U.S. N.R.L. and U.S. N.O.L., he came to RCA in 1950 and served as Camden Project Engineer for "Cosmos." He directed a group in the development of a high-speed CRT output for digital computers (Bizmac, *Ultratype*), and in the development of a time-division multiplex terminal equipment using non-vacuum-tube techniques. He also directed many studies, including electro-mechanical filters and CRT resolving power. Since 1954, he has been in digital computer work. He is a member of the American Physical Society.

Wayne C. Jackson received the B.Sc.E.E. from Oregon State College in 1924. Between 1924 and 1928 he was associated with the Southern Pacific Railroad Company in block signal installation, Pacific Gas and Electric Company, in valuation engineering, and Frank Rieber Company in geophysical exploration of areas for oil production possibilities. In 1928 he joined RCA Communications, Inc., being associated with station operations and engineering activities both in the United States and abroad. At the present time he is Manager of Engineering Services and Technical Publications Administrator.

COMMERCIAL ENGINEERING, TUBE DIVISION, MARKS MILESTONE BY PROCESSING ITS 2000TH PROFESSIONAL PAPER

An indicator of the way in which engineers' interest in the publication of professional papers has grown is in a milestone recently passed by Commercial Engineering—the handling of their 2000th professional paper. **E. C. Hughes**, Manager, Commercial Engineering, noted that it took over 20 years to reach the 1000 mark (in April, 1956); the next 500 took a little over 3 years, and the additional 500 within the last two years.

[*Editor's Note:* A lion's share of the credit for this accelerating interest of tube and semiconductor engineers in publishing their work is due to Commercial Engineering itself, where effective engineering communication has long been recognized as vitally important. Technical accuracy and an un-

surpassed editorial quality are trademarks of every piece of writing handled there.]

Under **C. A. Meyer**, Manager, Commercial Engineering Technical Services (and an RCA ENGINEER Engineering Editor), three engineers are directly concerned with the professional papers activity: **Eleanor M. McElwee** (see Vol. 6, No. 1, *How to Edit Your Own Writing*), **J. F. Holahan**, and **W. A. Smith**. They review all the papers, in addition to working on other Commercial Engineering technical publications. Last, but not least, they perform a well-integrated service for the engineer-authors by handling RCA approval requirements, and then utilizing their close contacts with professional societies and trade journals to help in getting the material published.

Dr. G. R. Shaw (left, center), Chief Engineer, Electron Tube Division, congratulates co-authors W. A. Harris and R. J. Rundstedt of the 2000th professional paper handled by Commercial Engineering. Looking on are J. T. Cimorelli (l.), Mgr., Engineering, Receiving Tube Operations, and E. C. Hughes Jr., Mgr., Commercial Engineering.

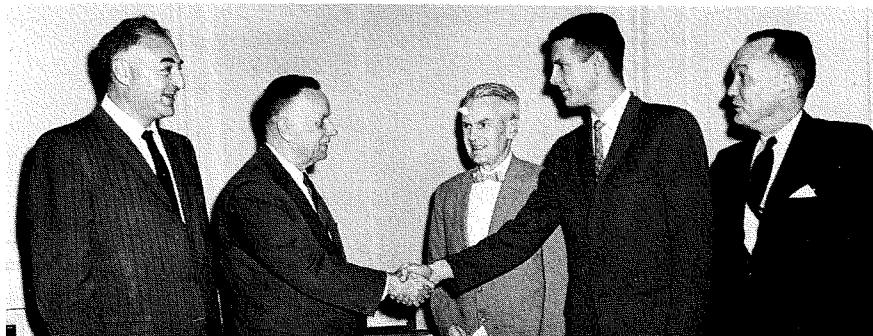

EDITORIAL REPRESENTATIVES

DEFENSE ELECTRONIC PRODUCTS

F. D. WHITMORE, *Chairman, Editorial Board*

Editorial Representatives

- JOHN BIEWENER, *Airborne Systems Division, Camden, N. J.*
R. D. CRAWFORD, *Design Development Engineering, Airborne Systems Division, Camden, N. J.*
D. B. DOBSON, *Systems Support Engineering, Airborne Systems Division, Camden, N. J.*
B. J. GOLDSTONE, *Systems Engineering, Airborne Systems Division, Camden, N. J.*
I. N. BROWN, *Missile and Surface Radar Division, Moorestown, N. J.*
D. J. ODA, *West Coast Missile and Surface Radar Division, Van Nuys, Calif.*
DR. R. C. GUNTER, *Missile Electronics and Controls Division, Burlington, Mass.*
R. E. PATTERSON, *Surface Communications Division, Camden, N. J.*
L. A. THOMAS, *Astro-Electronics Division, Princeton, N. J.*
F. W. WHITTIER, *Applied Research, Defense Engineering, Camden, N. J.*
H. L. WUERFFEL, *Central Engineering, Defense Engineering, Camden, N. J.*

INDUSTRIAL ELECTRONIC PRODUCTS

S. F. DIERK, *Chairman, Editorial Board*

Editorial Representatives

- C. E. HITTLE, *Closed Circuit TV and Film Recording Department, Broadcast and TV Equipment Division, Hollywood, Calif.*
C. D. KENTNER, *Broadcast Transmitter and Antenna Engineering, Broadcast and TV Equipment Division, Camden, N. J.*
J. H. ROE, *Broadcast Studio Engineering, Broadcast and TV Equipment Division, Camden, N. J.*
N. C. COLBY, *Communications Products Department, Communications and Controls Division, Canonsburg, Pa.*
J. J. HOEHN, *Industrial Controls, Communications and Controls Division, Camden, N. J.*
J. E. VOLKMANN, *Audio Products Engineering, Communications and Controls Division, Camden, N. J.*
M. C. KIDD, *Industrial Computer Systems Department, Electronic Data Processing Division, Natick, Mass.*
T. T. PATTERSON, *Engineering Department, Electronic Data Processing Division, Camden, N. J.*
J. H. SWEER, *Advanced Systems Development Department, Electronic Data Processing Division, Camden, N. J.*
W. C. JACKSON, *RCA Communications, Inc. New York, N. Y.*

RCA VICTOR COMPANY, LTD.

H. J. RUSSELL, *Research and Engineering, Montreal, Canada*

The Editorial Representative in your group is the one you should contact in scheduling technical papers and arranging for the announcement of your professional activities.

RCA ELECTRON TUBE AND SEMICONDUCTOR & MATERIALS DIVISIONS

J. F. HIRLINGER, *Chairman, Editorial Board*

Editorial Representatives, RCA Electron Tube Division

- W. G. FAHNESTOCK, *Conversion Tube Operations, Lancaster, Pa.*
J. H. LIPSCOMBE, *Black & White Kinescopes, Marion, Ind.*
J. D. ASHWORTH, *Entertainment Tube Products, Lancaster, Pa.*
R. J. MASON, *Receiving Tubes, Cincinnati, Ohio*
T. M. CUNNINGHAM, *Entertainment Tube Products, Harrison, N. J.*
J. KOFF, *Receiving Tubes, Woodbridge, N. J.*
H. S. LOVATT, *Power Tube Operations and Operations Services, Lancaster, Pa.*
F. H. RICKS, *Receiving Tubes, Indianapolis, Ind.*
H. J. WOLKSTEIN, *Industrial Tube Products, Harrison, N. J.*

Editorial Representatives, RCA Semiconductor & Materials Division

- E. I. SMALL, *Needham Materials Operation, Needham, Mass.*
RHYS SAMUEL, *Microelectronics, Somerville, N. J.*
HOBART TIPTON, *Semiconductor Devices, Somerville, N. J.*
J. D. YOUNG, *Findlay, Ohio*

RCA VICTOR HOME INSTRUMENTS

K. A. CHITTICK, *Chairman, Editorial Board*

Editorial Representatives

- D. J. CARLSON, *Advanced Development Engineering, Cherry Hill, N. J.*
E. J. EVANS, *Resident Engineering, Bloomington, Ind.*
F. T. KAY, *TV Product Engineering, Cherry Hill, N. J.*
J. OSMAN, *Resident Engineering, Indianapolis, Ind.*
W. S. SKIDMORE, *Radio "Victrola" Product Engineering, Cherry Hill, N. J.*

RCA SERVICE COMPANY

- W. W. COOK, *Consumer Products Service Department, Cherry Hill, N. J.*
M. W. TILDEN, *Government Service Department, Cherry Hill, N. J.*
E. STANKO, *Technical Products Service Department, Cherry Hill, N. J.*
J. J. LAWLER, *Electronic Data Processing Service Department, Cherry Hill, N. J.*

RCA LABORATORIES

E. T. DICKEY, *Research, Princeton, N. J.*

RCA VICTOR RECORD DIVISION

M. L. WHITEHURST, *Record Engineering, Indianapolis, Ind.*

NATIONAL BROADCASTING COMPANY, INC.

A. L. HAMMERSCHMIDT, *Staff Engineering, New York, N. Y.*