

## OBJECTIVES

To disseminate to RCA engineers technical information of professional value.

To publish in an appropriate manner important technical developments at RCA, and the role of the engineer.

To serve as a medium of interchange of technical information between various engineering groups at RCA.

To create a community of engineering interest within the company by stressing the interrelated nature of all technical contributions.

To help publicize engineering achievements in a manner that will promote the interests and reputation of RCA in the engineering field.

To provide a convenient means by which the RCA engineer may review his professional work before associates and engineering management.

To announce outstanding and unusual achievements of RCA engineers in a manner most likely to enhance their prestige and professional status.

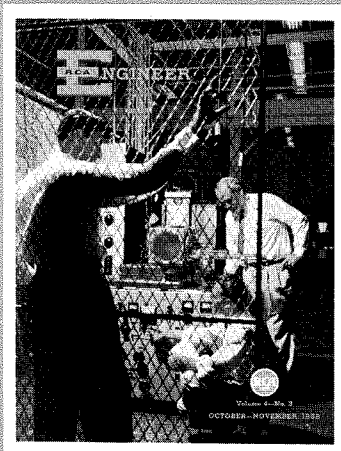

## OUR COVER

Our cover this issue features the Microwave Tube activity at the Electron Tube Division's Harrison Plant. Engineer Bernard D. Kleinman, crouched before a bell-jar test set-up, is discussing measurements with technician Joseph J. Barnack. Engineering Leader C. Louis Cuccia is examining the 1-kw developmental traveling-wave tube undergoing test of electron-gun optics.

## ENGINEERING PRODUCTIVITY

The term "Creativity" has a slightly different meaning to nearly every engineer. Yet one ingredient should be intrinsic in everyone's definition of the term . . . namely, the *effort must overcome problems and produce results* in meeting corporation objectives. If we accept this interpretation as basic — then creativity, when successfully applied, is a means to an end — *Productivity!*

What is the pattern or formula for obtaining such desirable results? As might be suspected, there isn't any "pat" way! Many engineers express their inventiveness in terms of useful, productive patents. But this is only one method among many.

For example, the product design engineer exhibits his ingenuity in the sound planning of commercially acceptable products, in his analyses of the customer's wants and needs, and in his ability to "human engineer" the product so it will have just the right "user" features. Other engineers will be creative in their abilities to devise systems or products from the astute assembly of known devices or stock items.

The equipment development or manufacturing engineer, on the other hand, will be creative in devising new, economical ways of fabricating and welding parts, in discovering unique methods of assembly and packaging, and in originating new automatic production processes. Development of revolutionary components, new materials, and the design of modern production machinery require highly creative engineering effort.

Supervisors and managers of engineers must create objectives and far-seeing plans, and present them in a way that challenges and stimulates the engineers in the activity supervised. Creativity on the part of older, more experienced engineers in guiding, teaching, and helping young engineers is necessary. We must create more effective communication and interchange of information between engineers — and between these same engineers and management.

These directed efforts comprise real engineering creativeness — and when properly combined result in true productivity, relating directly to the high quality, acceptability, and success of RCA's products.



D. F. Schmit  
Vice President  
Product Engineering  
Radio Corporation of America

## CONTENTS

A Look at Engineering Responsibility in the Space Age.....	C. C. Simeral, Jr.	2
RCA Microwave Tube Engineering.....	H. K. Jenny	4
Applications of the Versatile Traveling-Wave Tube.....	M. J. Ungar	7
Microwave Tubes—Past, Present and Future.....	M. Nowogrodzki	10
The RCA 200-KW Coupled-Cavity Magnetron.....	V. J. Stein	14
10-Watt, CW, S-Band Traveling-Wave Tube with Periodic Permanent Magnets .....	E. E. Bliss	17
Electrostatic Beam Focusing for Traveling-Wave Tubes.....	D. J. Blattner and F. E. Vaccaro	20
Cathodes for Magnetrons.....	J. Brous	23
Microwave Research at RCA Laboratories.....	Dr. S. Bloom	25
The Micromodule.....	O. B. Cunningham and B. V. Dale	29
Applications of Vacuum Metallurgy to Electronic Materials.....	C. W. Horsting	34
Second Detectors in TV.....	R. W. Sonnenfeldt	39
Design Considerations for Transistor Reflex Receivers.....	R. V. Fournier	43
RCA at Cape Canaveral (Part I).....	A. L. Conrad	47
Patents Granted to RCA Engineers .....		51
Pen and Podium .....		52
Engineering News and Highlights .....		54

VOL. 4, NO. 3 • OCT.-NOV., 1958

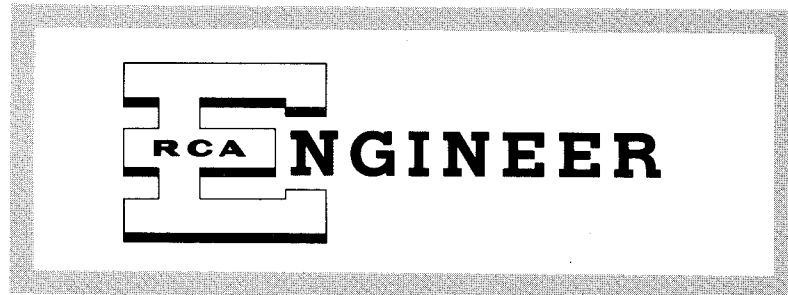

### Editorial Advisory Board

M. C. Batsel, Chief Technical Administrator  
Defense Electronic Products  
J. J. Brant, Director, Personnel  
Dr. G. H. Brown, Chief Engineer,  
Industrial Electronic Products  
D. D. Cole, Chief Engineer,  
RCA Victor Television Division  
C. C. Foster, Mgr. RCA REVIEW  
J. L. Franke, Chief Engineer,  
RCA Victor Radio & 'Victrola' Division  
M. G. Gander, Mgr. Engineering,  
RCA Service Co.  
Dr. A. M. Glover, Vice President,  
Semiconductor and Materials Division  
C. A. Gunther, Chief Defense Engineer,  
Defense Electronic Products  
J. Haber, Director,  
Community Relations & Exhibits  
D. P. Heacock, Administrative  
Engineer, Product Engineering  
J. C. Rankin, Mgr., General Employment  
H. E. Roys, Mgr., Engineering,  
RCA Victor Record Division  
D. F. Schmit, Vice Pres., Product Engineering  
Dr. G. R. Shaw, Chief Engineer,  
Electron Tube Division  
S. Sternberg, Chief Engineer,  
Astro Electronic Products Div.

### "RCA Engineer" Staff

W. O. Hadlock, Editor  
R. J. Hall, Assistant Editor  
Miss E. R. Kraus,  
Editorial Secretary  
J. L. Parvin, Art and Production  
J. O. Gaynor, Photography

### Engineering Editors

P. R. Bennett, Mgr., Radio  
& Phonograph Engineering  
RCA Victor Radio & 'Victrola' Div.  
R. S. Burnap, Mgr., Commercial  
Engineering,  
Electron Tube Division  
C. A. Meyer, Mgr., Commercial  
Engineering Technical Services,  
Electron Tube Division  
C. W. Sall, Engineering Editor,  
Industrial Electronic Products  
C. M. Sinnett, Mgr., Advanced  
Development Engineering,  
RCA Victor Television Division  
F. D. Whitmore, Engineering  
Editor,  
Defense Electronic Products

Copyright 1958  
Radio Corporation  
of America  
All Rights Reserved

PRINTED  
IN  
U.S.A.

# A LOOK AT ENGINEERING RESPONSIBILITY IN THE SPACE AGE

**I**N THIS ERA OF rapid technological advances in products for defense and the emergence of the "Space Age", the responsibility of the engineer is broadening rapidly in many directions. In addition to the startling advances in the supply of new and improved consumer and industrial products, spending for national defense and space exploration is making a formidable impact on the economy of the electronics industry and the nation as a whole. In 1958, sales of electronics devices to the military services will amount to 55% of the total electronics factory sales of \$8.4 billion and for the first time, industrial sales will exceed sales of entertainment electronics products.<sup>1</sup>

## THE PROBLEM AHEAD

One has only to leaf through any current trade journal or daily newspaper to get a grasp of the awesome undertakings in store for the engineer. Many of today's seemingly miraculous achievements pale into insignificance when compared with such programs as the anti-ballistic missile and manned space travel. But, if our country and our allies are to be successful in these endeavors, we must be capable of providing a supply of goods and services which are not only technically adequate but are manufactured at a product and facility cost level consistent with the ability of our economy to support the necessary investment. If our standard of living is to continue to improve, the available supply of government and private funds for the support of defense and space programs will always be limited to some level lower than that indicated by the total ideal requirement. As a result only the best of decisions as to which programs to follow and what compromises to make will be acceptable.

## THE ENGINEERING NEED

It seems obvious that only those well enough informed can qualify to make these decisions which will mark the

1. Electronics Business Edition, August 22, 1958.

By

**C. C. SIMERAL, JR., Mgr.**  
*Microwave Tube Engineering*  
*Electron Tube Division*  
*Harrison, N. J.*

path of success or failure. Certainly the engineering profession, the major source of technically trained and experienced personnel capable of coping with the fantastically complex problems, must be called upon to broaden the interests and understandings of its members to provide a source of understanding and guidance and, indeed, many of the decision-makers. It must be a harrowing experience for our non-technical political representatives in Washington to sit down in joint congressional committee sessions and try to make a decision between the Nike Hercules and the Bomarc ground-to-air defensive missile systems. On the other hand, would it not be equally difficult for a group of engineers to make the same decision, lacking the experience and know-how of the congressmen skilled in national and world political and military affairs, as well as in basic understanding of the various factors affecting the national economy? Committee after committee is formed to help our legislators and military people make these decisions but nothing can supplant the well rounded, well informed individual who "knows" or at least "understands" the basic elements affecting the decision to be reached.

## THE INDUSTRIAL PROBLEM

To the young engineer this need for engineering guidance and ability at the highest of policy making levels may appear to be concerned with problems so far removed from him that he sees little correlation with his present work. However, the basic concepts involved can be applied to the immediate and demanding problems facing his industry today from the highest levels of corporate management right on down the line. During World War

II and again during the Korean conflict, defense procurements were aimed largely at the quantity supply of goods and services for our armed forces. However, the advent of the "cold war" and the concept of deterrent forces has led us to an era of such rapid obsolescence that extensive production of any item for defense (except in limited cases) has been militarily unsound as well as economically unfeasible. During the "shooting wars", the American industrial genius could be called upon to produce a great many of only a few varied equipments and components. With the present and contemplated budgets for defense and space exploration at such a high level, much of the electronics and most of the aircraft industries are devoted to non-consumer and non-industrial programs in which the engineering emphasis is high and production is low.

This distorted combination of engineering and production is contrary to our past concepts of the proper employment and utilization of our industrial resources and consequently presents an extremely difficult problem to many an industrial firm. For that portion of the industrial facility doing work directly or indirectly for these defense and space age programs, quantity production can no longer be expected to earn a competitive return on the industrial investment by offsetting the relatively poor utilization of facilities and capital for engineering and development programs. On the contrary, industry now faces the problem of deriving an adequate return on its investment with limited production and huge engineering programs as the rule rather than the exception.

## THE ENGINEERING JOB

To do his job as a member of an industrial team faced with this problem, the engineer must become intimately familiar with and well grounded in the other very important areas which make up the industrial effort. Of course, the adequacy of the product to fulfill its desired function comes first.

However, for a product to be considered successful in the eyes of the customer and of the industrial establishment responsible for it, there are many other criteria that must be satisfied, not the least of which are the economical reproducibility of the product and the industrial investment required to support the manufacture of the item. In order to satisfy limited quantity production requirements for products having the utmost in reliability, it is necessary that substantially all of the basic manufacturing elements be provided. Usually, these elements will support production volumes substantially in excess of that required. Upon the engineer rests the initial responsibility of assuring sufficient flexibility of the production facilities and compatibility of product designs with existing and planned facility additions to assure maximum utilization of assets invested by the industry. When extreme reliability is an absolute necessity product cost can easily be disregarded unless a firm

hand of restraint is exercised and the best compromise of product design and facility investment is reached within the framework of the maximum reliability requirement.

Because the engineer is basically instrumental in achieving the desired result of satisfactory products consistent with maximum utilization of the industrial facility and investments, he comes into contact and works with nearly all phases of the industrial operation. The Sales and Marketing functions need engineering assistance and guidance in selecting new product programs to assure efficient utilization of existing facilities. The financial operations of industry are very much in need of accurate and detailed forecasts of fixed and current asset requirements that can only come from those well grounded in what the future holds in store. The procurement functions are greatly dependent upon engineering advice and judgment in the subcontracting of complex engineering or production programs. The

Quality Control functions are also, to a large extent, dependent upon the engineer to assure quality and reliability. In essence, there are few areas where engineering advice and guidance are not essential. But to do the best job of providing advice and guidance, the engineer must understand and appreciate these other problem areas. By including the over-all industrial outlook early in his planning, the engineer can be instrumental in bringing about the objectives of his firm.

#### THE ENGINEERING RESPONSIBILITY

Today's engineer and future engineers face a tremendous challenge in assuring the success of our country and private industry in solving the vastly complex problems of the "Space Age". To meet this challenge, the engineer must acquire a much broader understanding of the economic and political factors affecting his industry. He must be in a position to guide the efficient expenditure of huge sums of government and private capital at a rate never before reached. He must develop the capability to analyze general and specialized problems and be able to present clear and concise conclusions not only to his colleagues but also to corporate management and to military and political departments. He must provide sound advice and guidance to the allied portions of his industry and he must perform these tasks with extreme efficiency. Only by recognizing the multitudinous factors involved and broadening himself sufficiently to understand them will he be able to execute his responsibilities adequately.



**C. C. SIMERAL, JR.** received the B.S. degree in Physics in 1943 from Franklin and Marshall College. From 1943 to early 1946, he served as an officer at the Naval Research Laboratory doing development engineering and analysis work on anti-aircraft fire-control radar and computer systems. From 1946 to 1955, he worked variously in engineering, manufacturing and sales on ground based and airborne fire-control, radar, computers, and counter-measures systems at M.I.T., American Machine and Foundry Company, and Melpar, Inc. After a short venture as General Manager of a pump company, he joined the RCA Electron Tube Division in Lancaster, Pa. in November 1955 as Manager of Engineering Administration, Power Tube Engineering. In 1956, he was appointed to his present position in Harrison of Manager, Microwave Engineering, where he is responsible for all RCA microwave-tube engineering, manufacturing, equipment development, quality control, and related support activities.

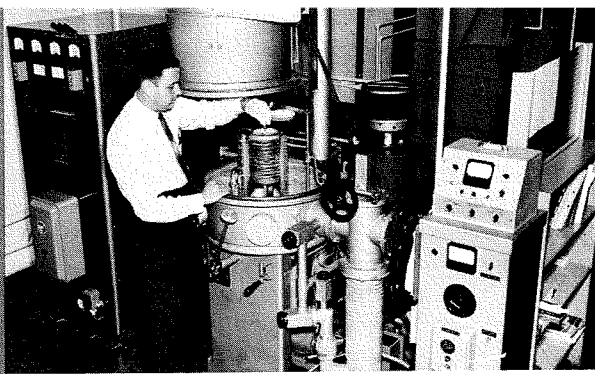

Jack Brous is shown vacuum-firing cathodes for use in magnetrons.

## **RCA MICROWAVE TUBE ENGINEERING**

*by*

**HANS K. JENNY, Mgr.**

*Microwave Design and Development  
Electron Tube Division  
Harrison, New Jersey*

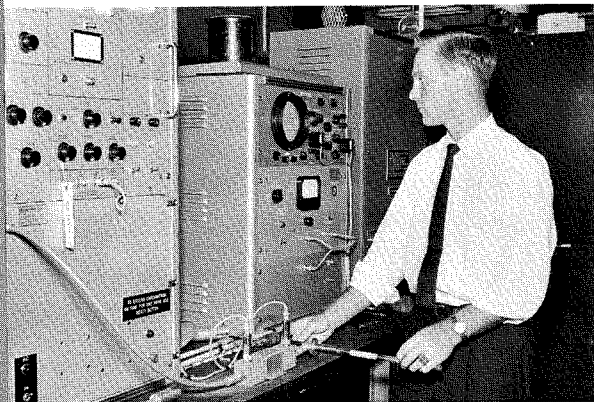

Tom Walsh, summer Engineering employe, is shown performing matching tests on helical couplers.

Hans K. Jenny, Manager of Microwave Design and Development, is shown with a series of traveling-wave tubes (foreground) and two magnetrons, designed by RCA engineers.



THE DESIGNER LOOKING for microwave tubes to use as components in new systems often finds the search for a tube meeting all his needs highly frustrating. Although numerous and extensive research and development programs are under way, the choice of products available from supplier's shelves is meager.

The reason for the limited supply of microwave tubes is two-fold. First, because new developments rapidly obsolete available products, manufacturers are reluctant to put tubes into production unless sizable orders have materialized. Second, because microwave-tube performance is largely determined by the circuitry incorporated in the tube, matching of system and tube circuitry through cooperative development is necessary to a considerable extent.

The exacting and special requirements of modern microwave systems require "customizing" of tubes to these needs to varying degrees. The present microwave-tube market, which is mainly military, consists of a large number of different systems in the research, design, and production stages. Although these systems require a multitude of microwave tube types, only moderate numbers are usually needed.

RCA has developed a flexible, fast-moving microwave organization which is well-suited to fill the individual needs of these specialized systems.

#### THE RCA ELECTRON TUBE DIVISION'S MICROWAVE ACTIVITY

RCA has established a complete Microwave Tube activity in Harrison and Princeton, New Jersey. This activity comprises the various operating and marketing functions working together as a complete business entity.

The *Advanced Development* activity of the Engineering function conceives and evolves new principles for microwave devices and determines their feasibility. This activity, which is located at the David Sarnoff Research Center in Princeton, constitutes the link between Research and Product Development. The advantages accrued through close contact with RCA's research workers in all fields of electronics and isolation from the day-to-day problems of the Product Development activity were determin-

ing factors in setting up this activity in a location some distance from Harrison.

The *Product Development* activity carries all types of Microwave tubes through the various phases of development required to prepare them for transfer to the Manufacturing activity. Certain applications require special programs to meet stringent electrical requirements, such as those for broadband multichannel communications equipment, or very severe environmental conditions, such as those encountered in modern military equipment. Usually development programs are aimed at specific system requirements of military or industrial customers. In addition, a general line of multipurpose microwave tubes is being developed to serve industry. The Product Development activity also handles sampling of "exploratory" tubes to customers, thus allowing equipment designers to get acquainted with these key elements of their systems at the earliest possible stage of system development.

A number of service functions perform the supplementary activities necessary to help the design engineers.

The *Development Shop*, which makes design samples of the various tube types, includes precision machine-shop, assembly, and processing facilities. New methods and equipments for the various stages of tube making are under continuous evaluation in this activity.

The *Chemical and Physical Laboratory* has all the tools for modern materials and process analysis work (X-ray diffraction equipment, spectrograph, chemical and metal laboratory, etc.) This activity contributes new types of cathodes, ceramic seals, attenuators, and other tube elements used by the design engineers.

The *Test Laboratory* is equipped to conduct all environmental tests required by present military specifications. In the final stages of development, all tubes pass through this extremely rough "proving" phase. In addition, tubes are evaluated for performance with the specific components to be used in the final systems, as well as in multi-purpose test equipment employed during development and fabrication phases.

The *Application Laboratory* both

counsels and seeks advice from customers concerning their application of microwave tubes. New ways of using tubes as amplifiers, mixers, multipliers, detectors, switches, and other components are being evaluated.

The Engineering function also includes a *Standardizing* activity, a *Library*, a *Technical Writing* activity, and other services which aid both the Engineering and Manufacturing activities.

#### HIGHLIGHTS OF TODAY'S RCA MICROWAVE TUBE LINE

A number of other papers in this issue describe various phases of RCA's microwave tube work in some detail. A few of the highlights are summarized here.

##### Magnetrons

The magnetron, as a high-efficiency generator, is best known as the backbone of radar systems. Other uses cover electronic countermeasures, diathermy, appliances (cooking), and industrial heating. Many tens of millions of dollars per year have been spent for procurement of magnetrons for radar systems since World War II. Improved field life and tunability have constituted a great and urgent need in this area.

*Reliable, Long-life Magnetrons:* RCA has developed, specifically for commercial airline weather radar use, a highly reliable C-band magnetron having an output of 80 kilowatts. According to recent ARINC reports, the average field life of this tube is in excess of 6000 hours. The success of this tube demonstrates that where designers are given the necessary freedom, long-life magnetrons can be developed and manufactured.

*Tunable Pulse Magnetrons:* In an effort to eliminate the performance shortcomings of conventional tunable magnetrons, RCA developed a novel principle of tuning magnetrons by use of multiple separate tuned cavities which change the tube frequency by means of their tight coupling to the magnetron structure. Striking improvements in power flatness and stability, a reduction in misfiring, and improved operation at a high rate of pulse rise have resulted in subsequent marked increase in reliability and tube life.

## Traveling-Wave Tubes

The traveling-wave tube, because of its broad, instantaneous frequency coverage and its possible uses as a high-gain amplifier, mixer, multiplier, oscillator, or detector, is the most flexible microwave device. However, structural size and fragility, as well as requirements for large focusing electromagnets (weighing up to 50 pounds and requiring up to 500 watts of power) and delicate tube adjustments, have long kept this tube from active use in modern systems.

**Small Rugged Traveling-Wave Tube Package:** In developing the first complete, rugged traveling-wave tube structure using periodic permanent magnets (a 100-watt complete S-band tube package weighing 12 pounds), RCA has pioneered a new area of extensive systems use for these devices. At present many miniaturized and ruggedized traveling-wave tube packages are being developed and fabricated, some weighing as little as one pound. Coverage of the microwave spectrum with such tubes ranging from the milliwatt to the kilowatt power level is imminent and will bring great relief to the harried systems designer.

**Low-Noise Traveling-Wave Tube:** Mention of a microwave amplifier tube usually suggests a tube for transmitter use because receiver-type amplifiers, although urgently needed, have not been available for many years. In this field, too, RCA has produced a first in the form of a low-noise traveling-wave tube. Through the design of an exponential-type transformer between cathode and r-f circuit, it has been possible to decrease the noise figures of low-level amplifiers considerably. Today a selection

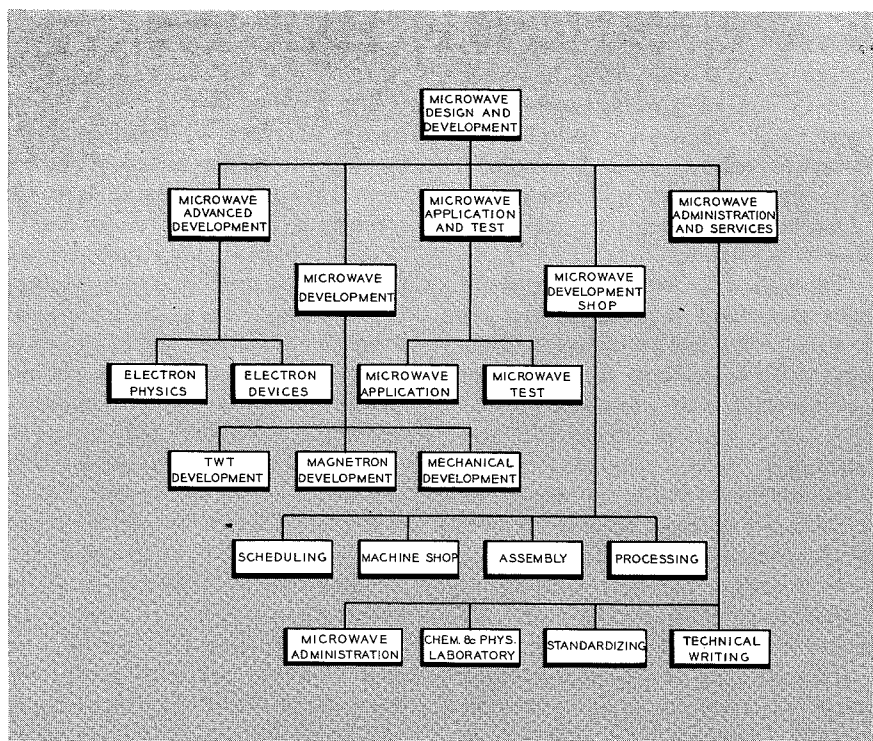

of tubes operating over the microwave band are available commercially with noise figures of 5 to 6 db, and values as low as 3 db have been observed in the laboratory.

### Estiatrons

In an effort to advance the state of the microwave amplifier tube art, RCA has developed the Estiatron, an electrostatically focused traveling-wave amplifier tube. This tube departs radically from the conventional traveling-wave tube package through complete elimination of all magnetic focusing elements and accessories. With this design, it has been possible to develop a cw S-band amplifier tube capable of providing several watts of output power in a rugged structure weighing only eight ounces.

Estiatrons using new types of structures are presently under development for operation at both low and high power levels. Indications are most promising that these tubes will replace many conventional traveling-wave tubes because of their simplicity and rugged structure.

### ACKNOWLEDGMENT

Although the specific tube types now available to customers have been developed by the Electron Tube Division Microwave activity, credit for the original research phases of the low-noise, periodic-permanent-magnet, and electrostatically focused traveling-wave tubes is due to the members of the Electron Devices Group of the David Sarnoff Research Center.

**HANS K. JENNY** received the M.S. degree in Electrical Engineering from the Swiss Federal Institute of Technology in Zurich, Switzerland in 1942. From 1943 to 1945 he continued working at the Institute as Assistant to Professor Tank, head of the "Institute of High Frequency", both instructing and carrying out research on velocity-modulated microwave tubes. This research included some of the earliest work done on cascading klystrons with multiple cavities and reduction of klystron noise figure. He

joined the Microwave activity of the RCA Electron Tube Division in February 1946, and has since been engaged in the development of various types of microwave devices, such as cw and pulse magnetrons, frequency-modulated gas-filled crossed-field devices, and traveling-wave and backward-wave tubes. He is presently Manager of the Microwave Design and Development activity at Harrison, N. J.

Mr. Jenny is a Senior Member of the Institute of Radio Engineers.

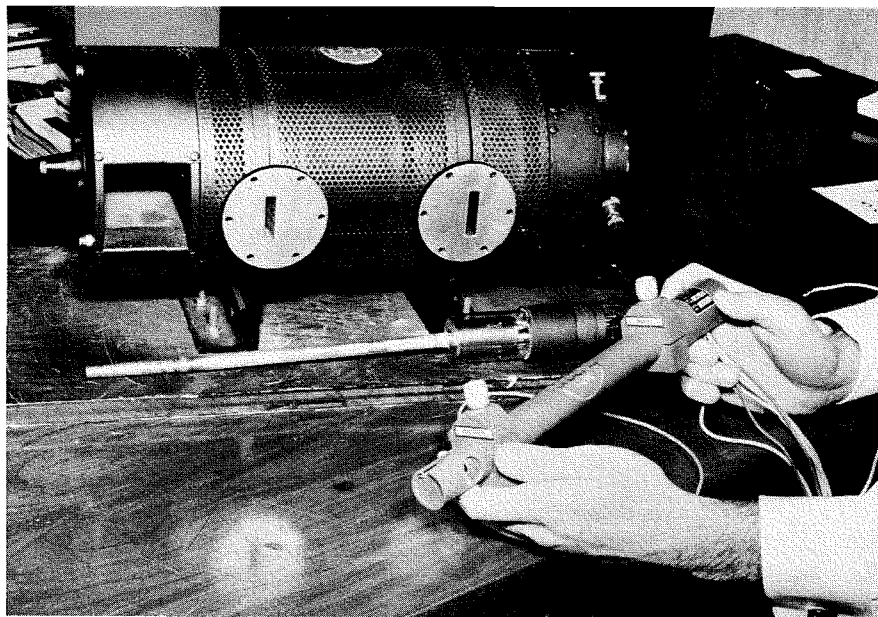

Fig. 1—Obsolete Five-Watt, C-Band Traveling-Wave Tube With Its Solenoid Compared to Modern One-Watt, S-Band, Periodically-Focused Traveling-Wave Tube.

## APPLICATIONS OF THE VERSATILE TRAVELING-WAVE TUBE

by

**M. J. UNGAR**

*Microwave Application Engineering  
Electron Tube Division  
Harrison, N. J.*

**A**MPLIFICATION WITH CONVENTIONAL vacuum tubes at frequencies above a few hundred megacycles is known to decrease as the period of the r-f frequency approaches the time it takes the electron to travel from the cathode to anode. The traveling-wave tube is a device that obtains high gain by utilizing this usually detrimental transit-time effect. This tube is best known for its ability to produce high gains over wide bandwidths without mechanical adjustments or variations in tube voltages. These properties have made possible the design of simple electrical circuits having characteristics that were previously thought unattainable.

It is only recently that the mechanical properties of traveling-wave tubes reached the stage of development where their advantages can be realized in systems designed to meet military environmental specifications. It is no longer a laboratory toy that is bulky, heavy, and power consuming. The purpose of this article is to describe some of the "unorthodox" properties of traveling-wave tubes that have come to light as a result of their application as reliable components in military systems.

### OSCILLATOR

The traveling-wave tube may be employed as an oscillator in the simple regenerative circuit shown in Fig. 2. The conditions for oscillation are the same as those of conventional oscillators. In the circuit shown, the oscillation frequency is primarily determined by the resonant frequency of the transmission cavity as it is only at this frequency that sufficient loop gain can exist. The phase shift through the tube, cavity, and phase shifter must add to a multiple of  $2\pi$ . Because the phase shift through the tube is directly affected by helix voltage changes, the frequency may be varied electronically within the bandwidth of the cavity by varying the helix voltage. The phase shifter is required so that oscillations over a wide range of frequencies can be obtained.

This feedback technique has been used in systems where conventional oscillators are not applicable. In addition, oscillators using this feedback technique have found wide use in the laboratory as a convenient and stable source of power over a wide frequency range. By this method, it is also possible to run dynamic life tests on

traveling-wave tubes without the use of signal generators.

### NOISE GENERATOR

In recent months, RCA completed the development of a chain of traveling-wave tubes that provides continuous amplification in S-band from 1 milliwatt to 1 kilowatt. Equipment manufacturers have been using these tubes as drivers in a chain under various conditions. In some applications, particularly countermeasures equipments, systems have been designed specifically to generate large amounts of noise.

A simplified expression for the noise output ( $N_o$ ) of a high-gain traveling-wave-tube chain is:

$$N_o = KT_oB + G_1 + G_2 + G_3 + \dots + F_1$$

where: K = Boltzman's constant

$T_o$  = Absolute temperature

B = System bandwidth

$G_1$  = Gain in first tube in db

$G_2$  = Gain in second tube in db

$G_3$  = Gain in third tube in db

$F_1$  = Noise figure of first tube in db

For a bandwidth of 2000 megacycles,  $KT_oB$  equals  $-81$  dbm. The noise obtained from a tube having a gain of 35 db and a noise figure of 30 db is 16 dbm. If this tube is followed by two tubes having a total gain of 70 db, the output power is  $+54$  dbm, or approximately 250 watts of jamming power. Fig. 3 shows the noise output of a chain of tubes as a function of total gain and noise figure for various bandwidths. In some systems, signal amplification is desired and a minimum signal-to-noise ratio is required; for these applications, a low-noise tube would be used.

### MIXER

The extremely wide frequency range of the traveling-wave tube has resulted in the use of these tubes as efficient mixers. Measurements on a 200-milliwatt, 1700-to-2300-megacycle, developmental traveling-wave tube showed that it possible to shift S-band frequencies by 500 to 1000 megacycles with a conversion gain of only 6 db less than the straight amplifier gain of the same tube. As is the case with a conventional mixer, when a travel-



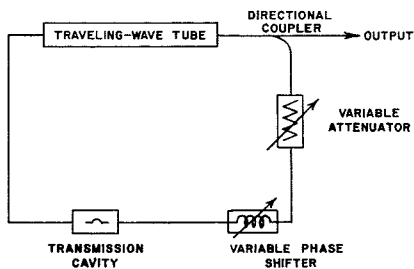

Fig. 2—Diagram of System Using Traveling-Wave Tube as an Oscillator.

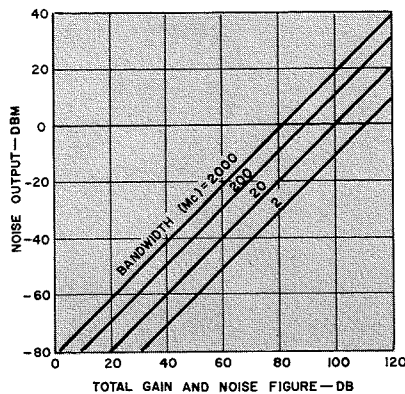

Fig. 3—Noise Output vs. Loop Gain and Noise Figure for Traveling-Wave Tube Chain.

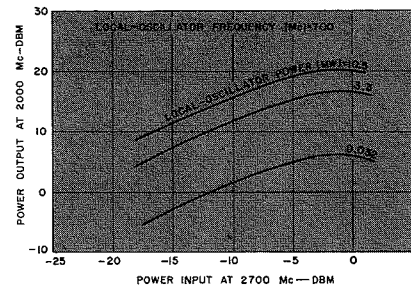

Fig. 4—Performance of Developmental Traveling-Wave Tube as Mixer.

ing wave tube is used as a mixer it is necessary for the local oscillator to drive the tube to the nonlinear region. The greater the nonlinearity, the more efficient the mixing. Fig. 4 shows the results of the mixing tests on the tube described above.

**LOW-NOISE RADAR-INPUT TUBES**

Low-noise traveling-wave tubes are especially suitable for use as input tubes in radar receivers because of three factors: (1) low initial noise figure, (2) low noise figure with life (the noise figure of an RCA-6861 operated for more than 20,000 hours remained below 7 db), and (3) traveling-wave-tube limiter characteristics which protect mixer crystals from burnout. In addition to the improvement in radar reliability, the range of a radar set is increased if the noise figure of the receiver is reduced. The radar range equation shows that

$$R^4 \propto \frac{1}{N.F.}$$

A six db reduction in noise figure will

increase the range by  $\sqrt[4]{4}$ , or 1.414. The attainment of the same range improvement by increasing the transmitter power would necessitate a four-fold increase in the transmitter power.

**FREQUENCY MULTIPLIER**

Measurements show that traveling-wave tubes generate harmonic output when operated in the non-linear region. The traveling-wave tube can be used as a frequency doubler yielding conversion gains in excess of 10 db. Fig. 5 shows the second harmonic output of a low-noise traveling-wave tube operating into a matched load. Tests on a 10-milliwatt-output, S-band showed that useful power could be obtained from the twenty-fifth and higher harmonics. The harmonic output power between 2500 and 4000 megacycles when two watts of power are applied to the r-f input connectors at 150 megacycles is shown in Fig. 6. It is possible to design the traveling-wave tube specifically so that its efficiency as a mixer is increased.

**MULTIPLIED-GAIN RE-ENTRANT SYSTEM**

The gain obtained from a traveling-wave tube can be substantially increased by taking advantage of the large bandwidth, and passing the signal through a tube more than once as shown in the block diagram in Fig. 7. In this system, the signal is amplified by the traveling-wave tube, heterodyned to a second frequency, and then reapplied to the same tube. In a system employing two traveling-wave tubes in cascade, each having a gain of 30 db and a conversion loss in mixer and filters of 10 db, a net over-all gain of 110 db is obtained when the signal is reapplied once.

**FREQUENCY SHIFTER**

The long electrical length of the traveling-wave tube provides new possibilities in transit-time, phase, or frequency modulation. Two methods are ordinarily employed in applications where it is necessary to shift microwave frequencies. A typical application would be a microwave relay system where the received signal, in

Fig. 5—Second-Harmonic Output Obtained From RCA-6861 Traveling-Wave Tube.

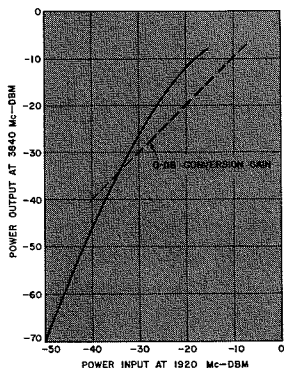

Fig. 6—Harmonic Output Power of 10-Milliwatt Output, S-Band, Developmental Traveling-Wave Tube.

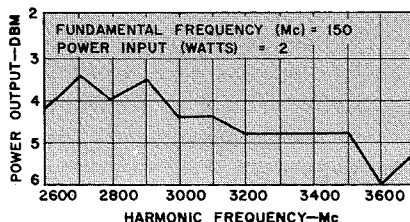
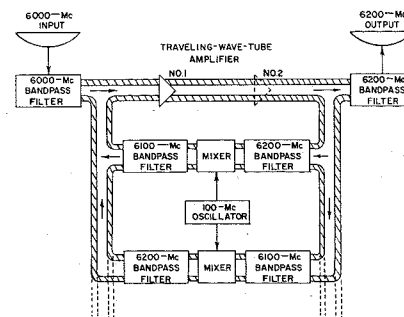

Fig. 7—Re-Entrant Traveling-Wave-Tube System for Obtaining Increased Gain.



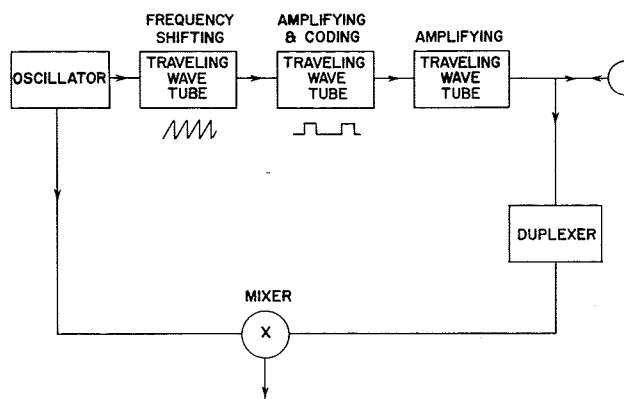

Fig. 8—Coherent System Employing Traveling-Wave Tubes in a Transmitter Chain.

addition to being amplified, is shifted in frequency before being transmitted to prevent interaction between receiving and transmitting antennas. Another application is in a transmitter chain in a "coherent system". In this application, a frequency shift in the transmitter chain eliminates the need for a separate receiver oscillator and automatically determines the intermediate frequency and insures coherence. A simplified system of this type is shown in Fig. 8.

The frequency shift is obtained in the system shown by applying a linear saw-tooth waveform to the helix. This method is called serrodyning. Although the waveship required is difficult to generate at high frequencies, serrodyning has important advantages. A single-sideband output is produced without the use of filters. Moreover, the serrodyning system theoretically can have a zero translation loss.

Sinusoidal modulating voltages of varying amplitude can also be applied to the helix of a traveling-wave tube to provide frequency shifting. The results of this method, called synchrodyning, are shown in Fig. 9. A series of upper and lower sidebands removed from the carrier by the modulating frequency are obtained. The theoretical minimum conversion loss is 4.7 db.

#### LIMITER

The properties of two traveling-wave tubes operating in tandem can be used to keep output power flat over a wide range of input powers. This characteristic greatly simplifies the design of countermeasures systems in which it is desirable to retransmit received

pulses having a wide dynamic range while maintaining maximum control over amplitude. Because of its saturation characteristics, a single traveling-wave tube can be modified to produce excellent limiting.

Work has been done at Harrison to increase the limiting range of the conventional traveling-wave tube. The best limiting behavior attained from a conventional 10-milliwatt-output, S-band, traveling-wave tube was such that the output power was above 5 milliwatts over a range of inputs of only 7 db. However, when more than one attenuator was used, it was found that the limiting characteristics could be controlled by the amount and positioning of the attenuation. A tube modified in this manner delivered an output of over 5 milliwatts over a range of inputs of about 17 db between 2000 and 4000 megacycles. A comparison of the conventional tube and a multi-attenuator tube is shown in Fig. 10.

Fig. 9—Measured Modulation Components Due to Phase Modulation of a Traveling-Wave Tube.

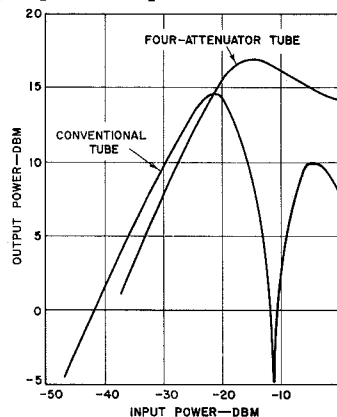
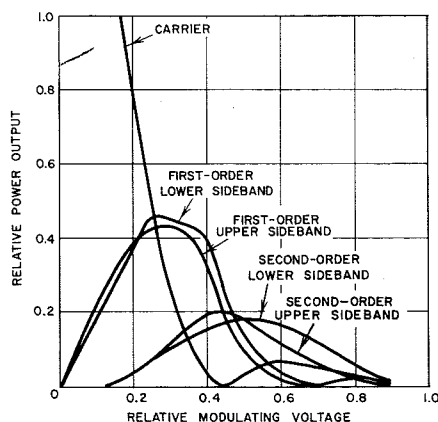
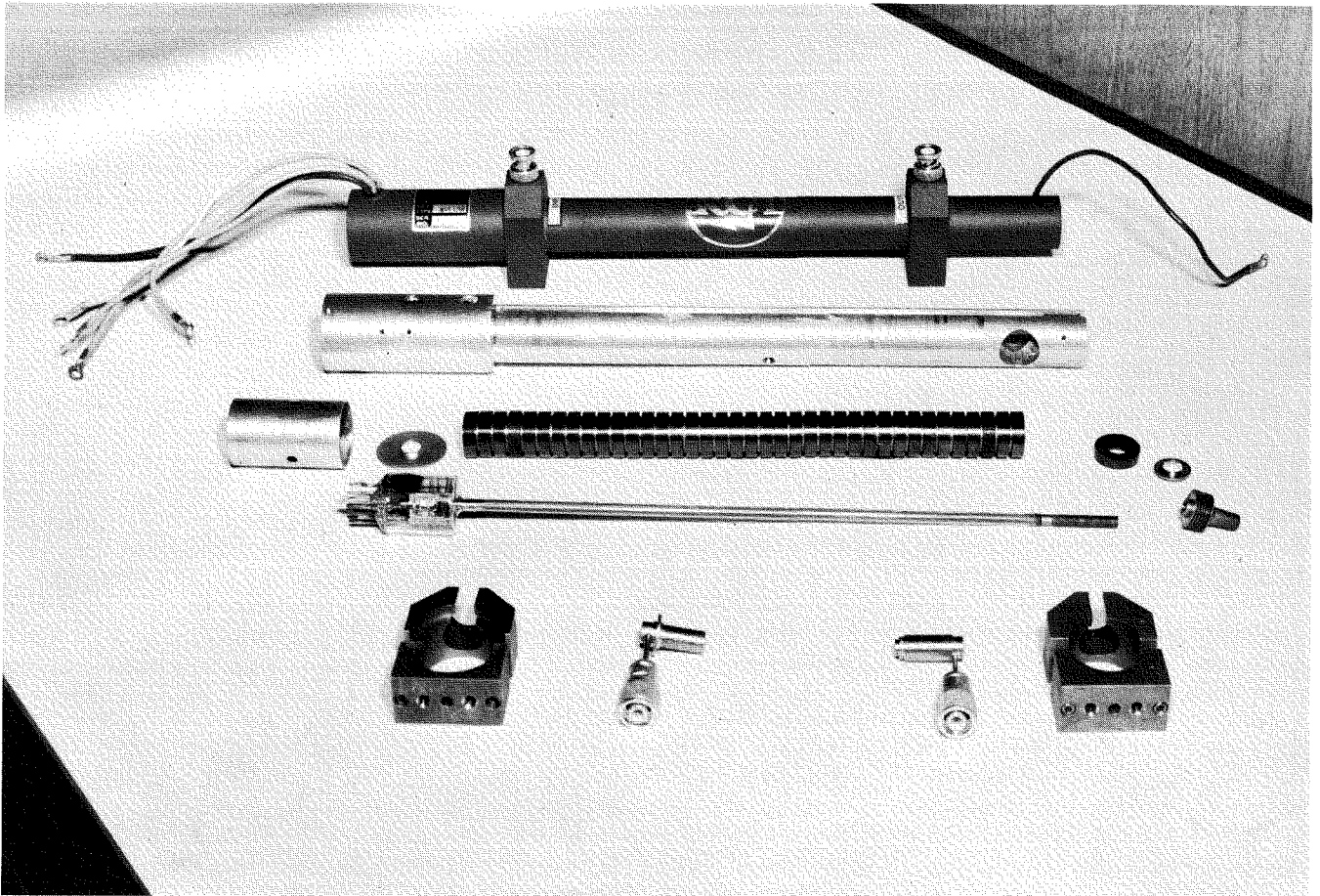

Fig. 10—Limiting Characteristics of a Conventional Traveling-Wave Tube Compared to a Multi-Attenuator Version.



**MARVIN J. UNGAR** received the B.S. degree in Electrical Engineering from the City College of New York in 1951 and the M.S. degree in Electrical Engineering from New York University in 1953. In 1951 he was a graduate assistant at New York University. From 1951 to 1955 he was engaged in work relating to magnetron and TR-tube measurement methods. In 1955 he joined the Microwave Application Engineering activity of the RCA Electron Tube Division at Harrison, N. J. His work concerns application problems of magnetrons and traveling-wave tubes, and he is presently Engineering Leader of this activity.



Components of RCA-4010 periodically focused traveling-wave amplifier tube.

## MICROWAVE TUBES—PAST, PRESENT, AND FUTURE

by

**M. NOWOGRODZKI, Mgr.**

*Microwave Development  
Electron Tube Division  
Harrison, N. J.*

THE INTEREST IN microwave tubes dates back to the days before World War II, when a new military device—radar—spurred the development of tubes operating at shorter wavelengths than had hitherto been employed. There were two reasons for the attempts to design radar equipments for shorter wavelengths: (1) the necessity to extend the portion of the electromagnetic spectrum open to modern technology; and (2) the convenience of designing smaller antennas for airborne use at the higher frequencies.

Not all tubes operating at microwave frequencies are microwave tubes in the normally accepted sense. Disc-seal triodes, pencil tubes, and the like, while operating at frequencies of several thousand megacycles per second, do not, strictly speaking, fall into the

microwave-tube category. The term "microwave tube" usually designates a device which makes use of the transit time of electrons in high-frequency fields, i.e., a tube in which the electron interaction periods are long compared to a period of a radio-frequency cycle.

Because of this mode of operation, the high-frequency circuit is normally included inside the vacuum envelope of the device, rather than being built outside it by the equipment designer. These high-frequency circuits are, in general, of two types: those having energy-storing properties (resonators), and those not displaying any resonant properties within the normal

range of operation of the tube (non-dispersive slow-wave lines). The former, when incorporated in a tube, cause the device to have a limited bandwidth and an operating frequency intimately related to the resonant frequency of the circuit. On the other hand, tubes using the distributed-type circuits frequently have bandwidth properties limited not by the circuit itself, but rather by the coupling devices employed to couple energy to and from the tubes. Because iterative, filter-like structures lie somewhere in between these two extremes, circuits using such structures can also be employed in microwave tubes.

### MICROWAVE TUBE TYPES

Microwave tubes presently in use can be divided into three broad categories:

klystrons, crossed-field devices, and traveling-wave tubes.

In a *klystron*, the electron beam is velocity-modulated under the influence of the r-f field in a "buncher" cavity, and then gives up some of its energy to the high-frequency field of a "catcher" cavity. The klystron, therefore, is a resonator-type tube.

The outstanding example of a crossed-field tube is the *magnetron* oscillator, in which an electron cloud rotates around a cylindrical cathode in a system of orthogonal electric and magnetic fields, and in which some of the potential energy of the electrons is converted into radio-frequency energy stored in a number of resonant cavities arranged symmetrically around the cathode. Like the klystron, the magnetron is a resonator-type device, whose operating frequency is determined by the composite frequency spectrum of its resonant cavities.

By contrast, *traveling-wave* tubes use non-resonant lines as the radio-frequency circuits. In these devices, the axial phase velocity of the r-f wave on the circuit and the velocity of the electrons traveling alongside the circuit are matched in such a manner as to cause interaction between the electron beam and a selected space harmonic of the wave. Both amplifiers and oscillators can be designed in this fashion.

Each of these major classes of tubes has distinct advantages and shortcomings, so that the use of one or the other may be especially suitable for a particular system application. Magnetrons have the highest efficiencies of all microwave tubes, klystrons have reached the highest powers to date and also have phase-coherence properties useful in some systems, and traveling-wave amplifiers have gain-bandwidth products expressed in numbers of the order of  $10^{12}$ . However, magnetrons are hard to tune, klystron amplifiers have limited bandwidth, and traveling-wave tubes may need beam-focusing structures having considerable bulk and weight.

RCA has concentrated its microwave-tube effort in the fields of magnetrons and traveling-wave-tube devices. The Microwave Engineering activity of the Electron Tube Division has successfully attacked the shortcomings of these tubes and has evolved

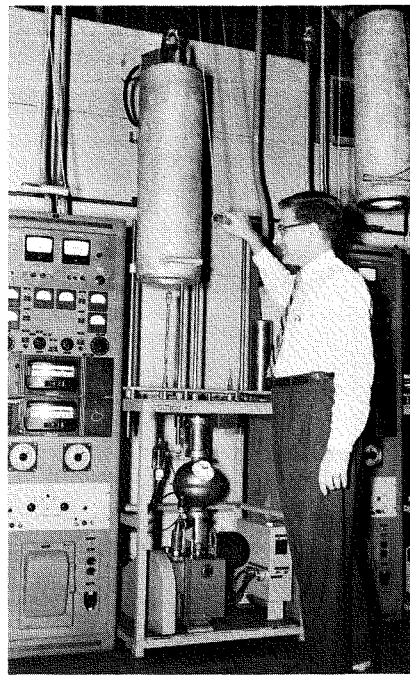

Engineer Edward Goldman is shown exhausting a traveling-wave tube during its manufacture.

designs which meet the most exacting demands of modern military and commercial systems. The coupled-cavity tuning principle in magnetrons has provided the long-sought "new look" in this class of devices while the miniaturizing of traveling-wave tube amplifiers through the use of periodic permanent-magnet focusing packages has made it possible to employ these tubes in modern airborne equipment.

#### APPLICATIONS

It is not the objective of this short review to discuss every type of microwave tube now being used in the design of complex electronic systems. It may be useful, however, to touch briefly upon some of the more important applications of these devices, and to attempt to discern trends in their development.

The *reflex klystron* is still the most important tube for use as a local oscillator in superheterodyne-type receivers. The most significant advances in this field relate to the extended frequency coverage of klystron and klystron-like oscillators (e.g., the retarding-field oscillator), namely the design of tubes operating in the millimeter-wavelength range. Another advance has been the development of reflex klystrons having great stability for use as "stalos" in modern systems.

A contender for the place of the reflex klystron is the *backward-wave oscillator*, a voltage-tunable wideband oscillator. The backward-wave oscillator, which is a member of the traveling-wave-tube family, has distinct advantages for systems in which extremely fast rates of frequency change may be required, such as counter-measures equipments.

The *magnetron*, unruly and capricious child of World War II, appears to have been tamed by the iron discipline of exact test specifications. Gone are the days when all that was required of this remarkable tube was high efficiency, and when as long as a neon bulb brought near its output did not flicker excessively, the tube was pronounced "stable". The modern *magnetron* has a power capacity ranging from milliwatts to megawatts, ranges in wave-length from 30 centimeters to a few millimeters, and is a predictably and measurably stable device. However, its tunability is mechanical in origin, and that is its weak point. But it is still the most important source of pulsed power for airborne equipment, where efficiency is of prime importance. Magnetron-like devices, crossed-field amplifiers and distributed-line oscillators, are also gaining in importance.

It is in the field of microwave amplification, however, that developments have been most significant. This field was previously held (somewhat by default) by multi-cavity klystrons, which require stagger-tuning of high-Q cavities to give strictly limited bandwidth. The *traveling-wave tube amplifier*, a new and extremely versatile systems component, has now entered this field, even though it has not yet reached the power levels of which the multicavity klystron was capable. This class of microwave tubes ranges from low-noise tubes for receiver applications to megawatt-output pulse amplifiers. Its chief drawbacks, bulky beam-focusing arrangements and weak mechanical design, have now been conquered, and the traveling-wave tube amplifier is being used in an increasing number of prototype military and commercial systems.

The applications of the various types of microwave tubes are numerous and varied. The advent of the traveling-wave tube amplifier made

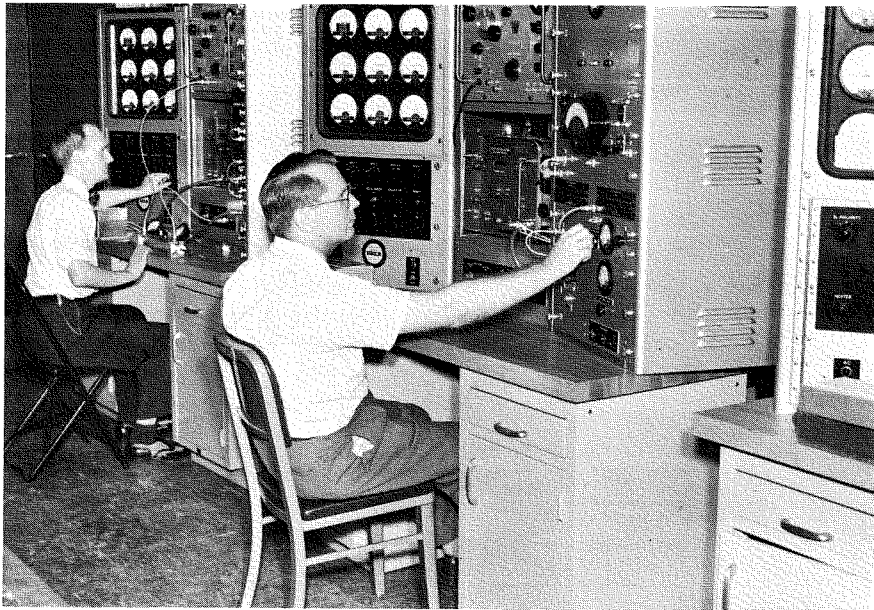

Bill Poelstra and Greg Modowanec, Engineers in the Traveling-Wave-Tube Design and Development activity, testing low-noise traveling-wave tubes.

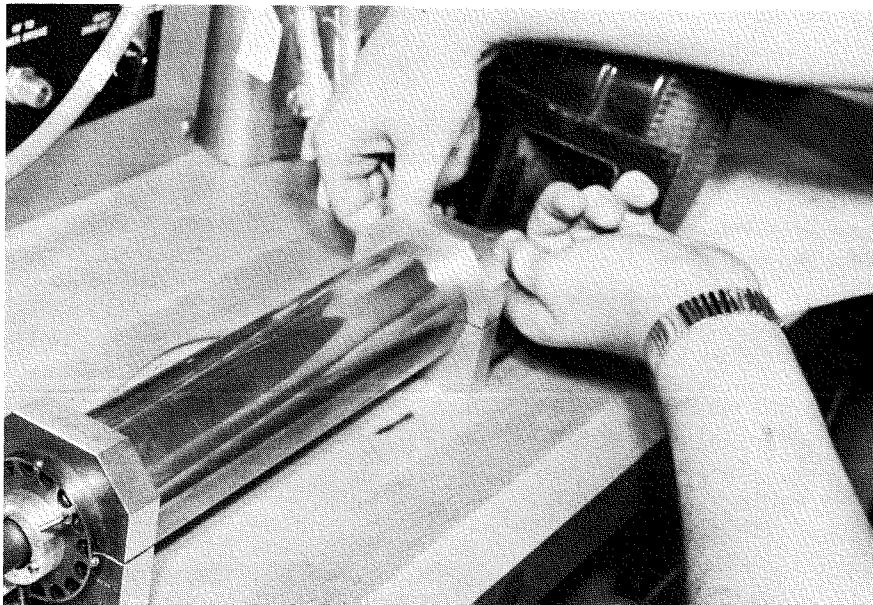

Focusing of a low-noise traveling-wave tube in a miniaturized solenoid.

possible the design of new types of equipment. For example, in microwave communication systems the traveling-wave tube amplifier obviates the necessity of translating the intelligence contained in a microwave-frequency carrier to an intermediate frequency, amplifying it, and then retransmitting it at every repeater station. Instead, a microwave signal can be amplified directly, and the

transmitter and receiver isolated by means of a frequency-shifting technique (synchrodyning or serrrodyning) to which traveling-wave tubes are very adaptable. In radar equipment, the receiver-type traveling-wave tube amplifier can be used to advantage because of its very low noise, its limiter action which simplifies duplexer design, and its tremendous bandwidth capabilities. The backward-

wave amplifier, a narrow pass-band amplifier which is voltage-tunable over a very broad frequency range, also provides useful selectivity properties. In electronic countermeasures equipments, the bandwidths of traveling-wave tube amplifiers are particularly useful.

In the magnetron field, emphasis has been placed on improvement of techniques and extension of the frequency coverage of the tubes. A higher degree of reliability is now demanded of magnetrons, whose primary use is still in radar transmitters. New pulsed MTI (moving-target-indicator) systems call for extreme repeatability in pulse-to-pulse frequency, amplitude, and starting-time characteristics, and test methods have been devised to check magnetron performance for these parameters. In commercial applications, the short life of the magnetron has been overcome to the point where the tube is no longer considered to be a major contributor to equipment "down-time".

#### A GLIMPSE INTO THE NEAR FUTURE

What, then, are the prospects for microwave tubes?

The present time appears to be a critical period in terms of tube applications, in that tubes which have been on the design boards in various laboratories for the last 5 years are beginning to find their way into prototype equipment.

There seems to be little doubt that traveling-wave devices will play a major part in military and commercial electronic systems which will be developed and placed in production within the next decade. Improvements in techniques of design and fabrication will undoubtedly lead to tubes having greatly increased power capabilities and operating over new frequency ranges (both lower and higher than those now employed for tubes of this kind). New uses for the traveling-wave tube will certainly be found. It has already been demonstrated that these tubes are capable of operation as limiters, mixers, frequency dividers, and multipliers, and the coming years will certainly see further developments along these lines.

In the field of low-noise tubes, however, the trend appears to be taking on new directions. Research is now being

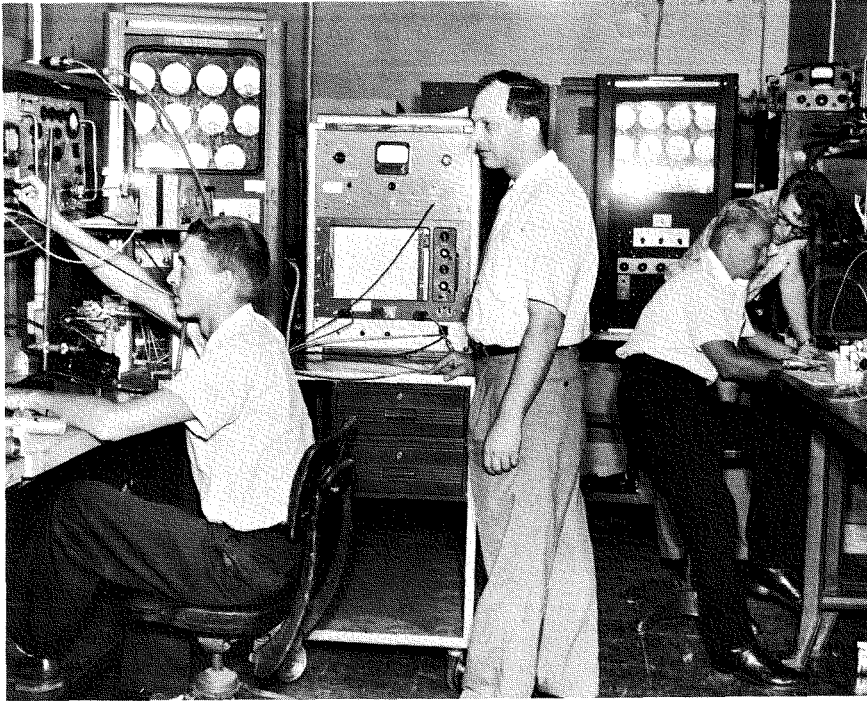

Herb Wolkstein, Engineer in Traveling-Wave-Tube Design and Development activity, watches Harold Bothner, Technician, performing tests on one-watt traveling-wave tube RCA-4010. In the background, Engineer Gene Kinaman and Technician Roy Lorentzen of the Microwave Application and Test Laboratory make laboratory measurements on tubes.

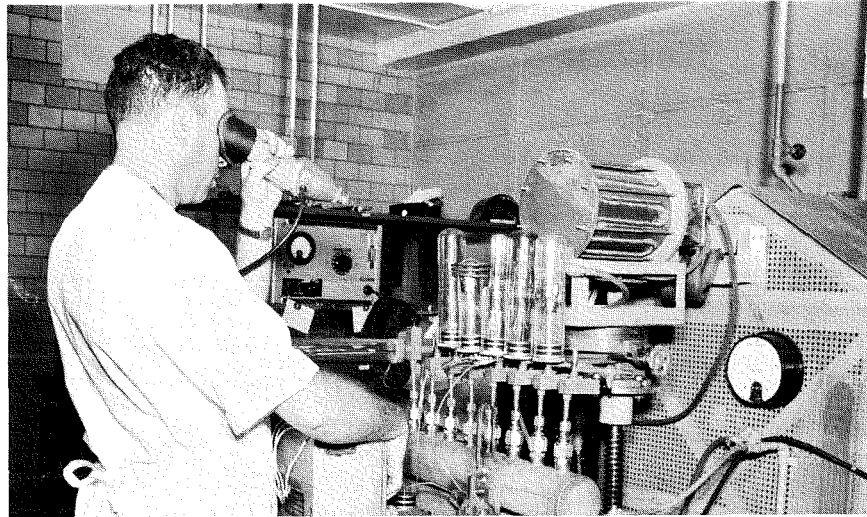

Angelo Biunno, Assembler in Microwave Development Shop, is shown vacuum-firing tantalum parts.

**MARKUS NOWOGRODZKI** received the B.S. degree in Electrical Engineering in 1948 and the M.S. degree in Electrical Engineering in 1951, both from the Polytechnic Institute of Brooklyn, N. Y. From 1943 through 1945, he served in the United States Army in Military Intelligence. From 1948 to 1951 he was employed at the Hazeltine Electronics Corporation as a Microwave Engineer working on microwave components and measurement methods in connection with IFF and telemetering, and radar test equipment. He worked at the Amperex Electronics Corporation from 1951 to 1955, first as Senior Engineer on development work on magnetrons and special microwave measurement techniques, and later as supervising engineer in charge of the Magnetron Development Department. He joined RCA in 1955 as an Engineering Leader in the Microwave Development activity in Harrison, N. J., working on the development of traveling-wave tubes and backward-wave oscillators. In 1957, he became Manager of Microwave Development, in which capacity he directs all development engineering work on magnetrons, traveling-wave tubes, and backward-wave oscillators.

Mr. Nowogrodzki is a Member of the Institute of Radio Engineers.



done on a variety of new devices designed to join the ranks of low-noise microwave amplifiers and low-level oscillators: molecular amplifiers, in which molecular resonances in the microwave region are used to obtain amplification of signals; and so-called parametric amplifiers, in which a reactance varying at a microwave-frequency rate is employed for the same purpose. These devices, as compared to more conventional microwave tubes, can also be expected to find increasing use in the computer field, where the need for ever faster switching speeds has already indicated the use of microwave circuitry and components.

Born of wartime necessity, microwave tubes have progressed from the stage of laboratory novelties, through accelerated product-development stages, to accurately controlled, quality products manufactured in quantity in specially designed factories. Equipment designers, at first bewildered by this strange component which combined within its outline the equivalent of many lumped-constant circuit configurations, have come to accept them as essential building blocks of their systems, and to respect their peculiarities and requirements for well-defined and accurately monitored driving units.

## *A High-Performance Tunable Pulsed Microwave Oscillator*

### **THE RCA 200-KW COUPLED-CAVITY MAGNETRON**

by

**VICTOR J. STEIN**

*Microwave Development  
Electron Tube Division  
Harrison, New Jersey*

**A** LONG-STANDING PROBLEM in microwave engineering has been the design of power sources which can be tuned over wide frequency ranges. Today, considerable effort is being devoted to the development of tunable microwave-oscillator tubes which can deliver large amounts of power with high efficiency and still maintain small size and weight. For many applications requiring these characteristics, the magnetron—historically the first practical microwave oscillator—still maintains a substantial edge over newer devices.

A magnetron oscillator produces r-f energy by electron excitation of high-Q resonant circuits. As in other types of oscillators, the frequency of oscillation depends upon the inductance and capacitance of the circuit and can be varied by a change in either component. In early tunable magnetrons this change was accomplished by movement of mechanical tuning elements

within the anode cavity. Examples of such elements are the "cookie-cutter" and "crown-of-thorns" shown in Fig. 1, which were used to modify, respectively, the capacitive and inductive regions of the anode cavity.

Although magnetrons using this method of tuning had fairly wide tuning ranges and were built in large numbers, they presented many serious problems which were never fully resolved. These problems were created by the complex geometries of the tuning structures, and included undesirable mechanical and electrical resonances, poor thermal dissipation capabilities, and variations in power output over the tuning range.

#### **COUPLED-CAVITY TUNING**

A very satisfactory solution to the aforementioned problems was provided by RCA's development of the "coupled-cavity" magnetron. In its basic form, shown in Fig. 2, this type

of magnetron contains a tunable auxiliary cavity coupling reactance to the anode circuit but isolated from it mechanically. Many variations of resonant cavities can be used to accomplish this tuning; a very satisfactory solution is a waveguide terminated in a movable short circuit. The problems arising from the use of mechanical tuning elements within the anode cavity are, therefore, avoided. The mechanical separation of the tuning structure and anode also permits each of these components to be designed for optimum performance.

Intensive development of coupled-cavity tunable magnetrons began in the early 1940's, when the urgent need for radar magnetrons was recognized. RCA's leadership in this development is evidenced by the fact that it has developed and produced more coupled-cavity magnetrons than any other manufacturer or organization. The first coupled-cavity magnetron produced in large quantities was the RCA 2J41, a low-power, X-band type produced during World War II. This magnetron, employed a cylindrical, piston-tuned auxiliary cavity which was used primarily to stabilize the output frequency against the effects of changes in environment, load, and power input.

#### **IMPROVED TYPES**

Since the end of World War II, RCA microwave engineers have been continuously engaged in the study and improvement of coupled-cavity tuned magnetrons. Their efforts in this field have resulted in many interesting and valuable improvements. One of the first of these was replacement of the simple waveguide-type cavity shown in Fig. 2, by the "H"-cross-section ridged waveguide cavity. Among the advantages of the "H"-type waveguide cavity are its greater compactness and stability, and the fact that it can be easily tuned by means of a simple short-circuiting plunger in the cross-arm of the "H".

Single-"H"-cross-section cavities were used successfully in several RCA

Fig. 1—Mechanical tuning elements used in early tunable magnetrons: (a) "cookie-cutter" capacitive element; (b) "crown-of-thorns" inductive element.

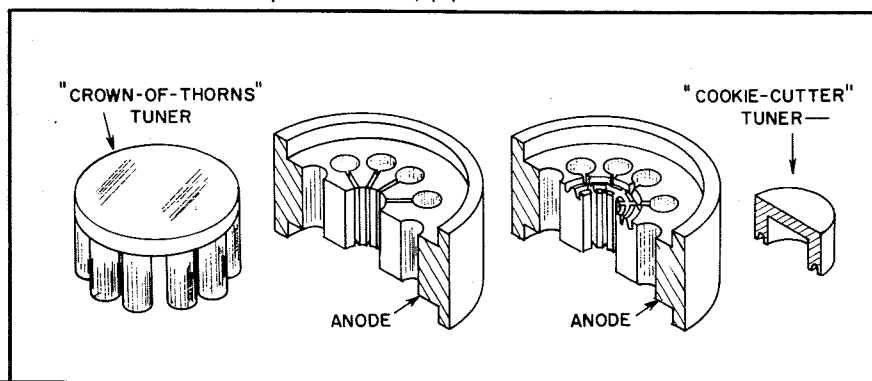

tunable magnetrons designed for CW and low-power pulsed operation. In the development of high-power pulsed magnetrons, however, it was found that the use of a single coupled cavity resulted in an undesirably narrow tuning range. Investigation showed that this difficulty was due to asymmetrical distortion of the anode r-f field by the cavity. This difficulty was remedied by the use of four "H"-cross-section cavities, equally spaced around the circumference of the anode.<sup>1</sup> The four-cavity design is shown in Fig. 3.

Also developed during this post-war period were several coupled-cavity magnetrons designed for use in frequency-modulation applications.<sup>2</sup> These magnetrons used electron beams flowing through a region of high electric field in a coupled cavity, permitting extremely rapid variation of frequency over a limited range. Although much more sophisticated tunable microwave oscillators have been developed recently, few have approached the combination of high electrical efficiency and small size achieved in these electronically tuned, coupled-cavity magnetrons. Several CW magnetrons using external coupled cavities, and having power outputs ranging from 100 watts to 10 kilowatts, were also developed by RCA during this period.<sup>3</sup>

#### RECENT DEVELOPMENTS

1953 marked the start of a program having as its objective the development of a pulsed X-band, coupled-cavity magnetron which would be tunable over a range of 1100 megacycles, and would have a minimum power output of 200 kilowatts over the tuning range. This magnetron was to be capable of use as a tunable replacement for the popular fixed-frequency 4J50—and to provide better operating characteristics and stability than that available in existing tunable magnetrons.

The resulting coupled-cavity magnetron surpassed these design objectives in every respect. In fact, the performance of this tunable tube was in many ways superior to that of the fixed-frequency prototype, due largely to the increased energy stored in the tuning cavities. Its principal characteristics are listed below:

Frequency range . . . . .8500-9600 mc  
Peak power output . . . . .220 kw  
Pulse width . . . . .2.75  $\mu$ sec

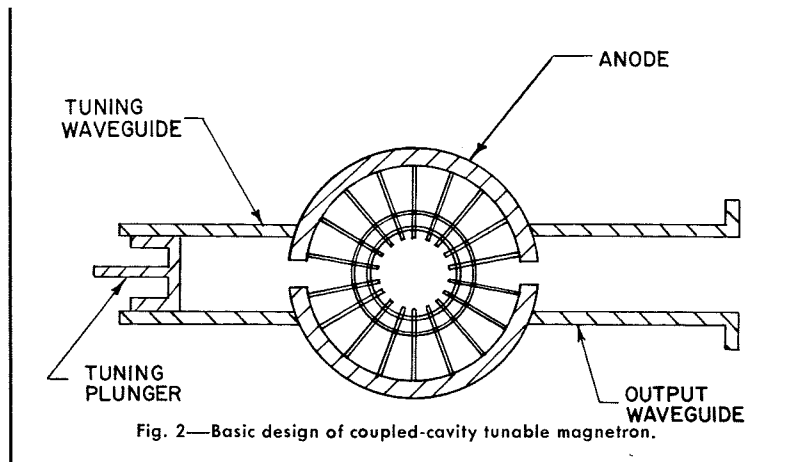

Fig. 2—Basic design of coupled-cavity tunable magnetron.

Duty cycle . . . . .0.001  
Peak anode voltage . . . . .22 kv  
Peak anode current . . . . .27.5 amps  
Rate of rise of  
voltage pulse . . . . .225 kv/ $\mu$ sec  
Stability (missing pulses)  
- Less than 0.1%  
Weight . . . . .13.5 lbs.

Typical performance curves for this magnetron are given in Fig. 4.

The operating life span and reliability of the new tube are outstanding. Whereas the life requirement for conventional magnetrons is usually not more than 250 hours, the minimum life guaranteed for the new RCA coupled-cavity magnetrons is 400 hours and many of them have continued to provide excellent performance after 1000 to 2000 hours of operation. Results obtained with these tubes in complete systems show that the field-failure rate is very low.

The wide acceptance of the new RCA coupled-cavity magnetron by system designers led to the development of a family of new magnetrons having the same basic design, but differing in such details as are necessary for compatibility with individual system designs. Such variations were ob-

viously necessary when the new coupled-cavity magnetron was to be used to replace a fixed-frequency type or an obsolete tunable type in existing equipment. In other cases engineers working on new equipments have found this magnetron to be of such vital importance in the performance of their systems that they have demanded "customized" models of the tube. In most cases, modifications required for each system have not been very extensive. Some of the members of this family of coupled-cavity, tunable magnetrons are listed below with brief descriptions of their special features.

Type	Special Features
6865-A	First commercial version of the new coupled-cavity magnetron. Hand tuned, 850 mc tuning range.
7110	Hand tuned, 1100 mc tuning range.
7111	Same as 7110 except for different tuning knob.
7112	7110 modified for remote tuning.
7008	Designed specifically for servo-tuning, 1100 mc tuning range.
Developmental	Developmental type for use at duty cycle of 0.002, and reduced peak-power levels.
Developmental	Developmental, ruggedized, high-power version of 6865-A.
Developmental	Developmental version of 7110 designed for power output of approximately 275 kw.

Fig. 3—Construction of tunable magnetron using four "H"-cross-section waveguide-type coupled cavities.

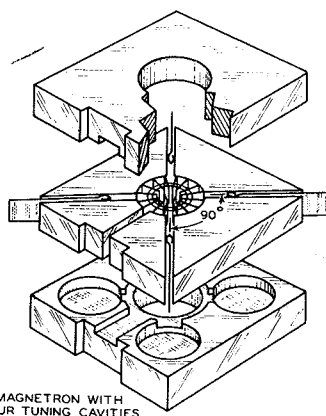

MAGNETRON WITH FOUR TUNING CAVITIES

Fig. 4—Victor J. Stein and Joseph Jacobs, engineers in the Microwave Magnetron Design and Development Activity checking a magnetron for vibration characteristics.

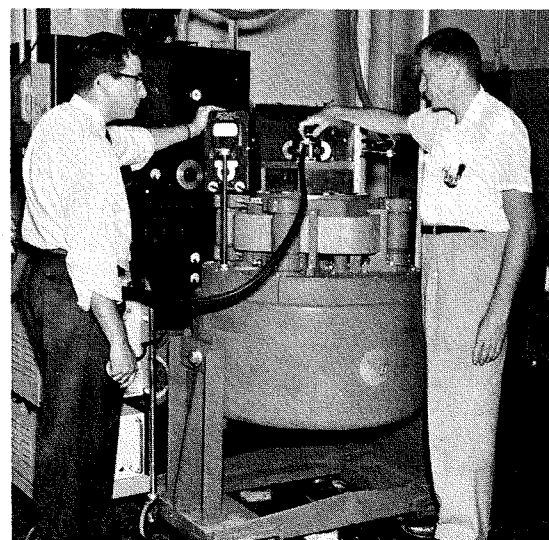



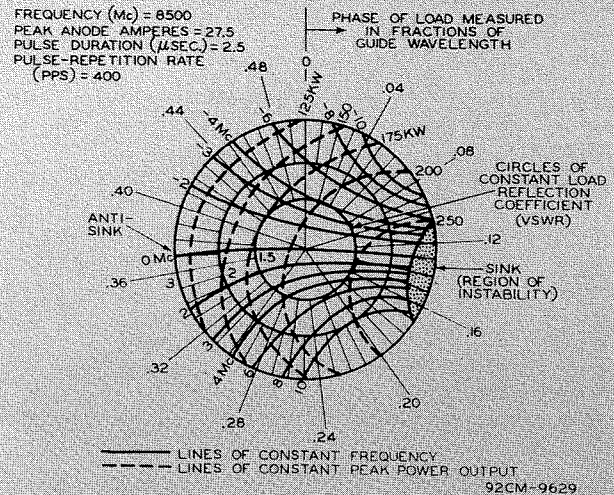
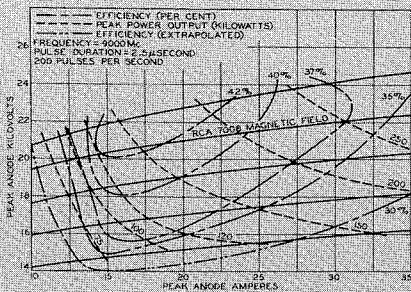
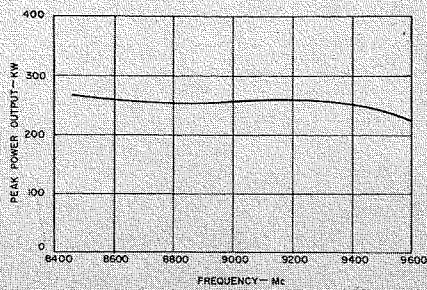

Fig. 5—Typical performance characteristics of RCA 200 kw coupled-cavity magnetron: (a) peak power output vs. frequency of oscillation; (b) Rieke diagram; (c) efficiency and peak power output as functions of peak anode voltage and current.

These, and various classified versions of the RCA coupled-cavity magnetron, are used in many different types of radar systems. They are used in the fire-control systems of the U. S. Air Force's most modern fighter planes, and in the electronic systems of various guided missiles. They are also used by the U. S. Navy and Marine Corps as replacements for obsolete tube types existing radar equipment, and in new radar systems now under development which will make use of the excellent operational characteristics of these tubes. The widespread and continuing interest shown in this family of tubes by both industry and the armed services, demonstrates that they consider the new RCA coupled-cavity magnetrons the best available X-band, tunable, pulse magnetrons.

The success of any development program can be measured in several ways. Perhaps the best measure is the degree of utilization of the end product. The RCA 200-kw coupled-cavity magnetron is now the preferred type for use in practically all new X-band applications requiring power outputs of 200 kilowatts, as well as for use as a "retrofit" to improve the

performance of existing equipment.

Another measure of the success of a development program is to compare the final results with the initial objectives. In this respect, the new RCA coupled-cavity magnetron has not only met, but exceeded each of the target specifications.

From an engineering point of view a very important measure of the success of a development program is the degree to which the "state-of-the-art" is advanced by the results. The concept of coupled-cavity tuning as embodied in the magnetrons discussed in this paper, has provided one of the greatest single improvements made thus far in tunable-magnetron performance. Furthermore, the versatility of coupled-cavity tuning permits it to be applied to magnetrons designed for operation at widely different frequencies and power levels. RCA Microwave Tube Engineering has underway several programs to develop new magnetrons of this type.

The RCA coupled-cavity magnetron has achieved an outstanding record. All indications point toward even wider acceptance of this tube as a standard for the microwave tube industry.

#### BIBLIOGRAPHY

1. "Experimental Development of an External Cavity Tunable Magnetron"—F. E. Vaccaro, et al—*Crossed-Field Microwave Devices*—Academic Press (to be published in 1959).
2. "A 7000 Megacycle Developmental Magnetron for Frequency Modulation"—H. K. Jenny, *RCA Review*—June, 1952, Vol. XIII, No. 2, pp. 202-223.
3. "Tunable CW Magnetron Designed for VHF"—D. E. Nelson, *Tele Tech*, September, 1954.

**VICTOR J. STEIN** received the B.S. degree in Electrical Engineering from New York University in 1951. From 1951 to 1954 he was employed by Amperex Electronics Corporation as an engineer in the magnetron design and evaluation group. He joined the RCA Microwave Tube Design activity in Harrison, N. J. in 1954. He is presently in charge of magnetron design engineering.

Mr. Stein is a member of the American Institute of Electrical Engineers and the Institute of Radio Engineers.

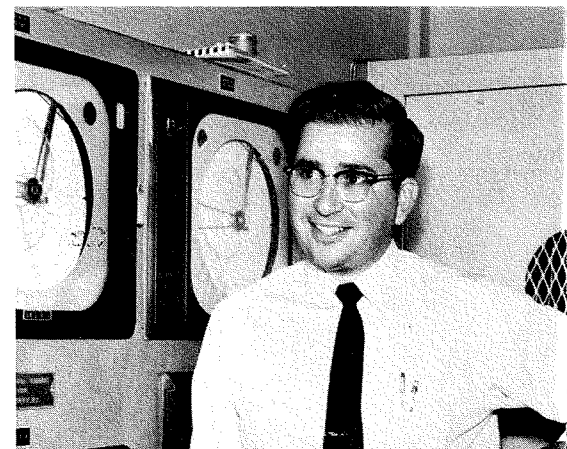

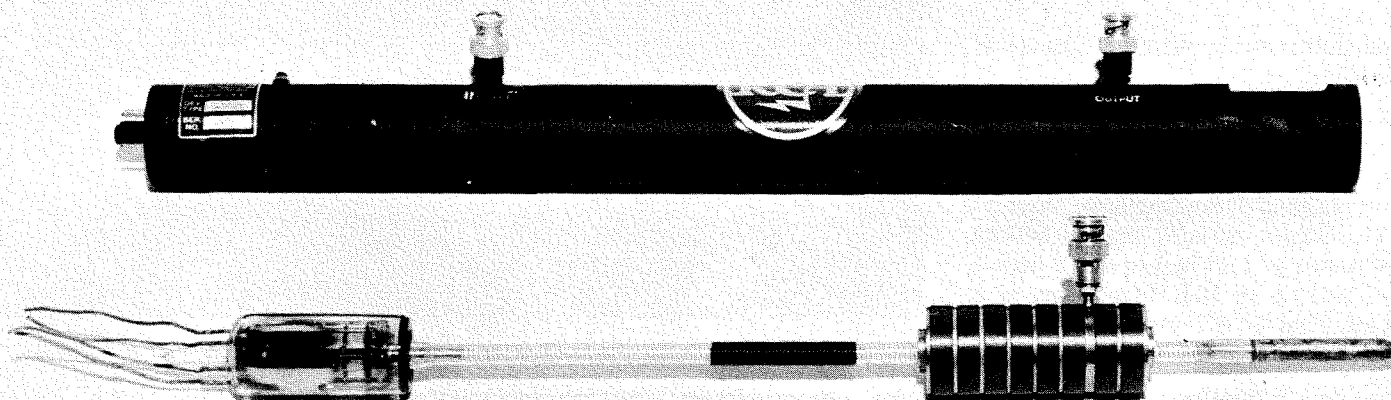

Fig. 1—Photograph of the complete packaged developmental traveling-wave tube, showing the tube, the magnets, and couplers.

## 10-WATT, CW, S-BAND TRAVELING-WAVE TUBE WITH PERIODIC PERMANENT MAGNETS

By

EDWARD E. BLISS

*Microwave Tube Engineering  
Electron Tube Division  
Harrison, New Jersey*

AIRBORNE RADAR TRANSMITTERS place demanding requirements on the design of traveling-wave-tubes for amplifier service. Such tubes must consistently provide high performance and relatively high power at very short wave lengths. Compactness, light weight, and high gain are all vital requirements. Ruggedness and stability are other factors important for high-altitude operations.

This paper describes a developmental 10-watt, cw traveling-wave-tube amplifier which fulfills these design requirements. It is focused by means of periodic permanent magnets. The complete package shown in Fig. 1, with the tube, the magnets, and the couplers, weighs only 3 pounds, 8 ounces, and measures  $1\frac{1}{2}$  inches in diameter. This lightweight assembly is ideal for airborne applications. The minimum cw r-f power output from 2250 to 3750 megacycles per second is 10 watts at a gain of 20 db. The minimum small-signal gain is 25 db. The design and construction, as well as the focusing and r-f performance of the tube, are described on the following pages.

### DESIGN

In the design of this developmental tube, electrical ruggedness was a prime requirement. The basic assemblies, including the gun, the helix structure, and the collector, are designed to have a safety factor greater than 100 per cent. During the exhaust process, a d-c beam current equal to four times the

normal operating power is drawn to insure thorough outgassing and power-handling capabilities of each tube.

### Tube

The convergent-flow electron gun is a modified "Pierce-type" which has a perveance of 1.2 micropervs, and a convergence ratio of 4:1. The oxide cathode has a conservative current loading of only 75 milliamperes per square centimeter. The gun is magnetically shielded and produces a minimum beam diameter of approximately 0.100 inch.

The helix structure<sup>1</sup> consists of a vacuum-fired tungsten helix supported directly in precision-fluted glass tubing. Use of 0.020-inch-diameter wire in contact with the three flutes of the helix bulb permits considerable r-f and beam dissipation without melting or cracking of the envelope. The  $\gamma$  of 1.7 produces a power-output curve which is symmetrical about the center frequency of 3000 megacycles.

The collector assembly is magnetically shielded to permit expansion of the beam within the collector. The shielding allows even distribution of the beam along the collector and prevents the return of secondary electrons to the helix when the collector is operated at a lower potential than the helix.

The collector is made of molybdenum and low-vapor-pressure brazing materials, and is capable of dissipating more than 500 watts of beam power without gas evolution. During processing, the collector is safely outgassed at a temperature of 850 degrees Centigrade.

Life characteristics of the tube have been improved by rigorous processing and vacuum firing of all internal parts. The highest-vapor-pressure material used inside the vacuum envelope is a gold-nickel alloy.

### Attenuators and Couplers

Coupled-helix-type attenuators and couplers are used in this developmental tube. Theoretical calculations for the couplers were based on helices having equal phase velocities.<sup>2</sup> The voltage standing-wave ratio of a representative helical coupler is shown in Fig. 2, and indicates that the couplers have excellent power-transfer characteristics. The turns of the coupling helix are rigidly supported in a grooved dielectric sleeve. Standard male BNC-type connectors are used for the r-f connections.

The attenuator is a carbonized ceramic sleeve which fits over the vacuum envelope and is coupled to the tube helix by an oppositely wound bifilar tungsten helix. A two-inch length of attenuator produces a loss of 40 to 60 db in the frequency range between 2000 and 4000 megacycles per second, as shown in Fig. 2. The external ceramic attenuator has a large power-

handling capacity and provides stable attenuation.

#### Magnets

A structure of RCA ceramic ring magnets is used for focusing of this developmental traveling-wave tube.<sup>3,4</sup> The magnet assembly has an outside diameter of 1.25 inches, and a period of 0.75 of an inch. Magnetized to a peak field of 475 gauss, the structure gives excellent focusing results.

#### PERFORMANCE

##### Focusing

Good focusing performance has been obtained by careful construction and alignment of the gun, helix, and periodic permanent-magnet structure. Under normal d-c operating conditions, the beam transmission is 99.7 per cent. With a saturated r-f power output of about 20 watts at the mid-band frequency, the transmission is 98.8 per cent. The helix interception is approximately 0.7 milliamperes, and is sufficiently small that very little power is dissipated on the helix. The low intercepted power and the low r-f loss on the helix prevent over-heating of the helix which might cause a drop in power and evolution of gas.

Both the beam current and the helix voltage can be varied widely without interruption of beam transmission. Under d-c conditions, beam currents up to 100 milliamperes can be focused with a helix interception of only 1 milliamperes. At the normal operating current of 60 milliamperes, the helix voltage can be varied from 1600 to 2600 volts before the interception rises to 1 milliamperes. Fig. 3 shows the helix interception as a function of the helix voltage both with and without r-f output. At the point marked X, the power output is 18 watts at the mid-band frequency of 3000 megacycles per second.

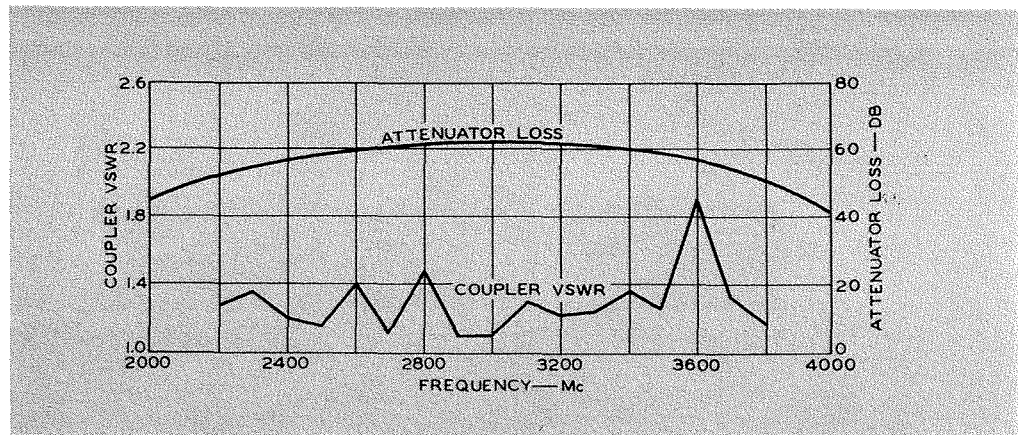

Fig. 2—Curves showing the cold loss of the developmental tube and the VSWR of a typical coupler.

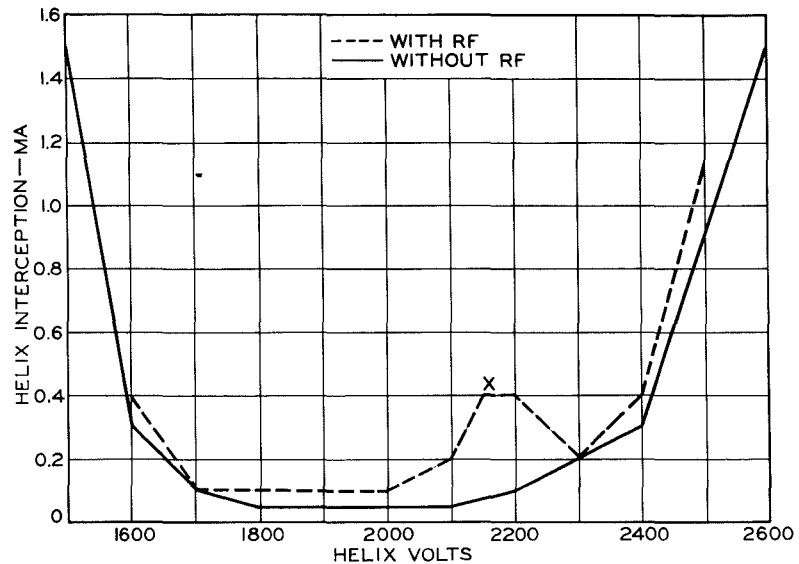

Fig. 3—Curves showing the helix interception as a function of the helix voltage at a beam current of 60 milliamperes and a collector voltage of 2000 volts. The normal helix voltage is 2150 volts.

Because the collector is magnetically shielded, very few secondary electrons return to the helix. The collector voltage can be varied widely without any noticeable effect on the helix interception. Under d-c conditions, the collector voltage can be as low as 1/5 of the helix voltage; with saturated power output, the collector can usually be operated at 2/3 of the helix voltage. The efficiency of the tube can be appreciably improved by a reduction of the

collector voltage. A low collector voltage also allows ion drainage to the collector instead of to the cathode. At present, the collector is operated at least 100 volts below the helix potential to prevent obscuring of the true helix interception by secondary electrons from the helix to the collector.

#### R-F Performance

Fig. 4 shows the power output and gain of this developmental traveling-

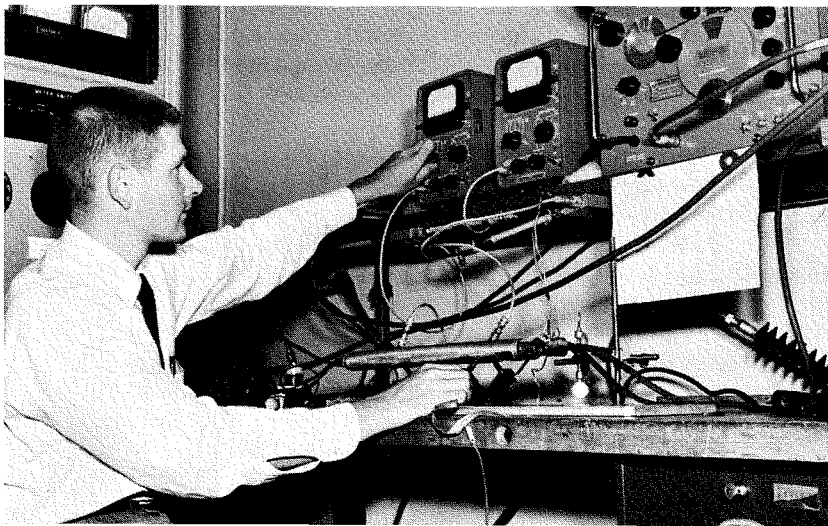

**EDWARD E. BLISS** received the B.S. degree in Physics from St. Lawrence University in 1952 and did a year of graduate work in Physics at Columbia University. He joined the RCA Microwave Engineering activity in Harrison, N. J. in 1953 as a design and development engineer on traveling-wave tubes. He has participated in many traveling-wave-tube developments, and is now responsible for the development of medium-power traveling-wave tubes designed to provide both wide-band operation and operating characteristics suitable for high-definition radio-relay systems. His work has covered detailed engineering studies relating to traveling-wave-tube design, including helix design and the design and operating characteristics of periodic permanent-magnet focusing assemblies.

Mr. Bliss is an Associate Member of the Institute of Radio Engineers.

wave tube as functions of frequency. The tube was operated at fixed voltages and a fixed power input of 80 milliwatts. The power output is greater than 10 watts over the frequency range from 2250 to 3750 megacycles. The irregularities in the curves are probably due to variations in helix pitch. Fig. 5 shows the power output as a function of power input for several frequencies. Saturation is normally reached when the power input is about 100 milliwatts. The operating conditions for the curves shown in Figs. 4 and 5 are listed in Fig. 6. No data are available showing comparative r-f performance between solenoid and permanent-magnet operation because the tube has not been operated in a solenoid.

Comparison of measured performance with calculated values of gain indicates that the effective beam diameter is half as large as the helix diameter. Although a slightly larger beam diameter may be used, this ratio provides a good balance between gain and efficiency which demand a larger beam, and low helix interception which requires a smaller beam.

Several tubes incorporating the

fluted precision helix bulb have produced consistently good r-f performance. Six earlier tubes constructed with circular precision-bore glass to support the helix had a higher dielectric loading and produced the same r-f output at a beam current of 80 milliamperes.

Cooling of the collector is accomplished by an unusually efficient radiator. Fig. 7 shows the temperature of the collector as a function of the volume of air passing over the radiator. The collector dissipation was 175 watts, or 50 watts more than the normal dissipation. An air flow of 10 cubic feet per minute at standard temperature and pressure provides adequate cooling. The blower requirements are quite moderate, since the static pressure for this volume of air is less than 0.1 inch of water.

### CONCLUSIONS

Light weight and small size make this developmental traveling-wave tube ideally suited for airborne use or other applications in which it would be difficult or impractical to supply the large amount of d-c power required by a

solenoid. A typical application would be in the amplifier chain of an airborne radar transmitter, where the light weight and high gain would be particularly advantageous. Replacement of the tube is extremely simple because no focusing or matching adjustments are necessary. For high-altitude use, flying leads may be substituted for the conventional base.

### Acknowledgment

The authors wish to acknowledge the valuable assistance of P. F. Pelka in the construction and testing of the tubes, and the support rendered by Wright Air Development Center, United States Air Force under Contract No. AF33(600)-32099.

### REFERENCES

1. J. R. Pierce, *Traveling Wave Tubes*, D. Van Nostrand Co., Inc., (N. Y.) 1950.
2. J. S. Cook, R. Kompfner, and C. F. Quate, "Coupled Helices," *Bell System Tech. J.*, vol. 35, pp 127-178; January 1956.
3. F. Sterzer and W. W. Siekanowicz, "The Design of Periodic Permanent Magnets for Focusing of Electron Beams," *RCA Review*, Vol. XVIII (March 1957).
4. J. T. Mendel, C. F. Quate, W. H. Yocum, "Electron Beam Focusing with Periodic Permanent Magnet Fields," *Proc. IRE*, Vol. 42 (May 1954) 800.

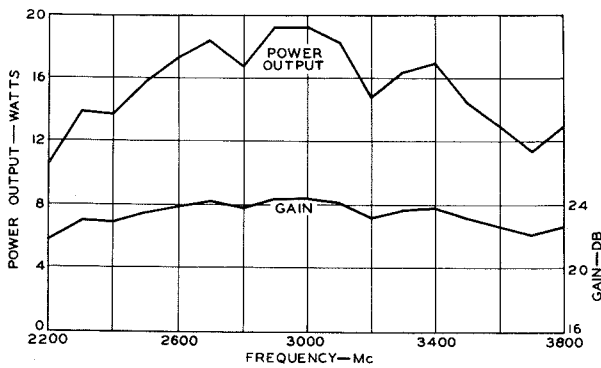

Fig. 4—Power output and gain of the developmental tube at fixed voltages and a fixed power input of 80 milliwatts.

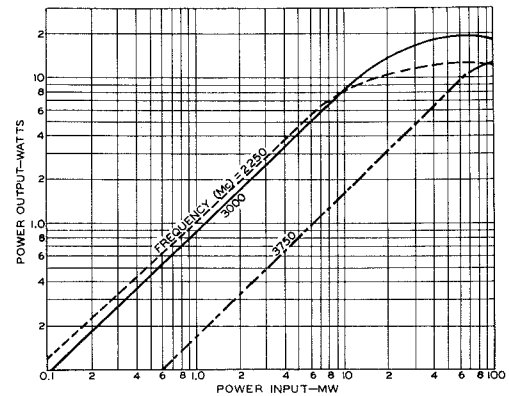

Fig. 5—Power output as a function of power input for the tube shown in Fig. 4.

### OPERATING CONDITIONS

COLLECTOR VOLTAGE . . . . .	2000	VOLTS
COLLECTOR CURRENT . . . . .	60	MA
HELIX VOLTAGE . . . . .	2100	VOLTS
HELIX CURRENT . . . . .	0.7	MA
ANODE VOLTAGE . . . . .	1500	VOLTS
ANODE CURRENT . . . . .	0	MA
CATHODE CURRENT . . . . .	60	MA
HEATER VOLTAGE (AC) . . . . .	6.3	VOLTS
HEATER CURRENT . . . . .	1.7	AMPERES
FREQUENCY RANGE . . . . .	2250 to 3750	MC
POWER OUTPUT . . . . .	10	WATTS
GAIN . . . . .	20	DB

Fig. 6—Operating conditions used to obtain data shown in Figs. 4 and 5.

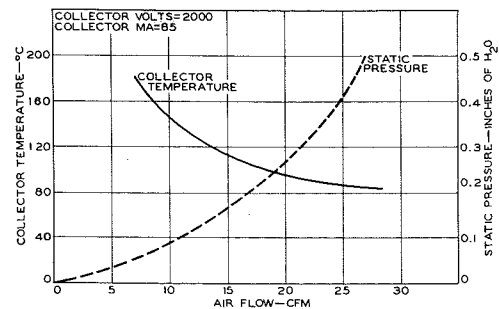

Fig. 7—Collector temperature and static pressure as functions of air flow for the radiator used with this developmental traveling-wave tube.

# ELECTROSTATIC BEAM FOCUSING FOR TRAVELING-WAVE TUBES

by

DONALD J. BLATTNER and FRANK E. VACCARO

*Microwave Advanced Development*

*Electron Tube Division*

*Princeton, N. J.*

TRAVELING-WAVE TUBES usually employ a long, thin cylindrical electron beam that must be confined continuously throughout its length by electric and/or magnetic forces. Although a somewhat similar beam is used in kinescopes and image orthicons without confining forces, the density of the beam in these applications is several orders of magnitude smaller than that required in traveling-wave tubes. The common method of overcoming the diverging space-charge forces in a high-density stream of electrons is to use an axial magnetic field, either uniform or alternating, along the axis of the beam. By using a series of small ceramic permanent magnets to provide a periodic magnetic field on the axis of the beam, the weight and focusing power required can be reduced substantially below that necessary for uniform magnetic fields. However, much of the bulk and weight in a packaged traveling-wave tube of this type is still due to the magnets. The use of electrostatic forces to focus the electron beam in a traveling-wave tube eliminates the need for a magnet structure, considerably reducing the weight

of the packaged tube and also eliminating the problem of alignment of the tube within the magnetic field.

## PERIODIC ELECTROSTATIC FOCUSING

A number of ways of accomplishing this type of focusing have been explored by several research laboratories.\* The simplest approach is to direct the electron beam through a succession of electrostatic lenses<sup>1</sup> formed by a series of rings or disks held alternately at high and low potentials ( $V_{HI}$  and  $V_{LO}$ ) with respect to cathode. Such a structure is shown in Fig. 1a. The electrostatic field resulting from the voltage between adjacent rings produces forces on an electron as shown by the arrows in Fig. 1b. The electrons move slowly when they are in the vicinity of a low-voltage ring where the radial component of electrostatic force on them is directed inward, and faster when they are near the high-voltage

\*Part of the development of the electrostatically-focused device, the Estiatron, which is discussed in this paper was sponsored by the Air Force Cambridge Research Center, Air Research and Development Command, Bedford, Mass., under Contract No. AF19 (604) -1947.

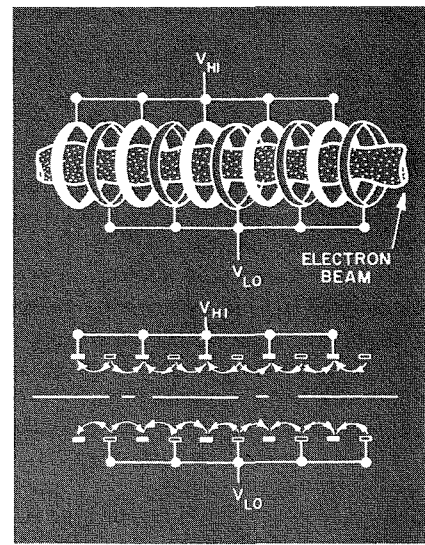

Fig. 1—Electrostatic focusing of an electron beam. (a) Electron beam flowing through a series of rings held at alternately high and low potentials. (b) The forces on an electron due to the electrostatic field.

rings where the electrostatic forces are directed radially outward. Because of this difference in velocity, the electrons spend more time in the neighborhood of the low-voltage ring. The over-all effect, therefore, is an inward focusing force on the electrons which serves to balance the space-charge repulsion in the beam. The electrostatic field which focuses the electron beam also serves as an ion trap, drawing any positive ions created in the beam out to the low-voltage rings.

Because the helix used in conventional traveling-wave tubes is a relatively simple structure that makes possible the transmission of r-f energy over extremely wide bandwidths, it is apparent that an electrostatic focusing method that utilizes the helix structure is highly desirable. A con-



Fig. 2—A packaged Estiatron.

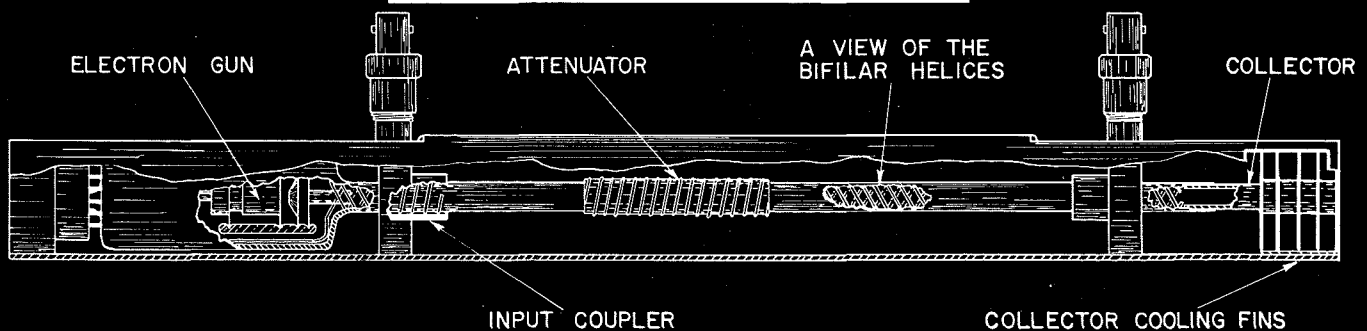

Fig. 3—Cut-away drawing of packaged Estiatron.

venient way of preserving the basic r-f properties of the helix and at the same time permitting electrostatic focusing is to interwind two helices in a bifilar manner.<sup>2</sup> An electrostatic-focusing action similar to the one described above can be obtained by operating the two helices at different potentials. The average beam velocity must be very nearly equal to the wave velocity to obtain interaction between the component of the r-f wave traveling along the tube axis and the electron beam. The average of the two helix voltages, therefore, must be approximately the voltage at which the tube would operate if focused conventionally.

### THE ESTIATRON

The bifilar helix design is used in a developmental, 10-watt, S-band "Estiatron".\* Fig. 2 is a photograph of a packaged Estiatron, and Fig. 3 is a cutaway drawing showing its construction. The convergent-flow electron gun launches the beam into the bifilar helix region where it is focused electrostatically until it reaches the hollow collector. Because the beam power is approximately 100 watts, the collector has cooling fins to radiate heat. Coupled-helix-type r-f input and output transducers external to the glass envelope of the tube provide well-matched transitions over an octave bandwidth. The attenuator, which is also an external coupled helix, is embedded in a hollow cylinder of lossy material to provide a cold insertion loss of 50 db. This arrangement prevents oscillation which might otherwise occur if the input or output were mismatched.

The focusing performance of the Estiatron is shown in Fig. 4. The curve shows that, in the absence of r-f input, over 99 per cent of a 50-milliampere beam is transmitted when the voltage difference between the two helices is 2000 volts. The effect of the r-f signal on the beam is slight. At r-f saturation (maximum possible r-f power output for this beam current), the beam transmission is still 98.5 per cent. The interception depends on the voltage difference between helices. As this voltage is decreased below 2000

\*RCA's contribution to electrostatic focusing of traveling wave tubes dates back to work in 1954 at the RCA Laboratories, by K. K. N. Chang.<sup>3</sup>

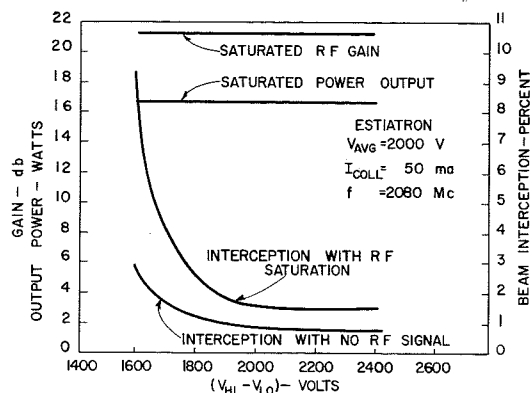

Fig. 4—Variation of gain, power output, and per-cent. beam interception with variation of voltage difference between helices of an Estiatron.

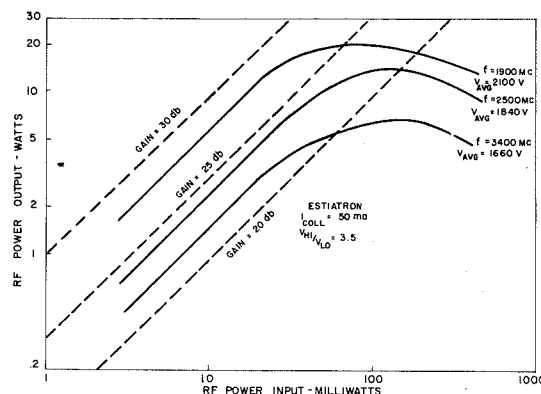

Fig. 5—R-F power output vs. r-f power input for an Estiatron.

volts, the interception increases sharply, although the power output remains constant at 16 watts cw and the gain holds steady at 21 db over a wide range of voltages. Thus, small voltage variations will not materially affect gain or power output or cause undue interception.

The gain and power output of the Estiatron are shown in Fig. 5. In this figure cw power output is plotted as a function of power input for three frequencies, the voltages being held constant at the saturation synchronous values. Dashed lines of constant gain are drawn through the figure. At 1900 megacycles, for example, the gain is constant at 28 db up to a power output of 13 watts, and saturates at a power output of 21 watts with 23 db gain.

The RCA developmental Estiatron will deliver 8 to 10 watts of cw power at 25 db gain over a 1000-megacycle bandwidth without any mechanical or electrical adjustments, and will give even more power and gain over lesser bandwidths. The Estiatron principle is not limited to intermediate power levels. Conservative extrapolation shows that a bifilar-helix Estiatron can deliver more than half a kilowatt at S-band frequencies for a 1-per-cent duty cycle. These tubes can be

designed for higher or lower frequency ranges, and can be used to particular advantage at low frequencies (VHF and UHF) where conventional traveling-wave tubes are long and their magnets heavy.

### OTHER MEANS OF ELECTROSTATIC FOCUSING

Although the periodic electrostatic focusing described above is simple and convenient, it is not the only approach. In "Harris flow"<sup>4</sup>, illustrated in Fig. 6, a small magnet over the gun region causes the annular electron beam to rotate. The centrifugal force of rotation of the electrons is then balanced by a strong radial electrostatic field between the helix and an axial electrode held positive with respect to the helix. The space-charge forces can be made negligible with respect to the electrostatic and centrifugal forces.

"Slalom" focusing,<sup>5</sup> named for the downhill ski race, is illustrated in Fig. 7. It makes use of the fact that among all the equipotential fields surrounding a parallel array of straight wires between two ground planes there is only one pair of *continuous* equipotential surfaces, the two which intersect at the midpoint between wires. If a ribbon-shaped

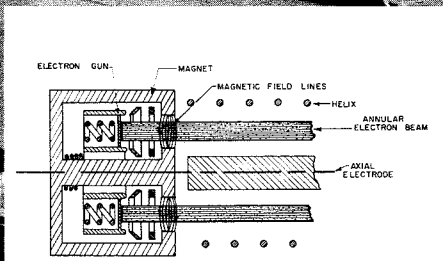
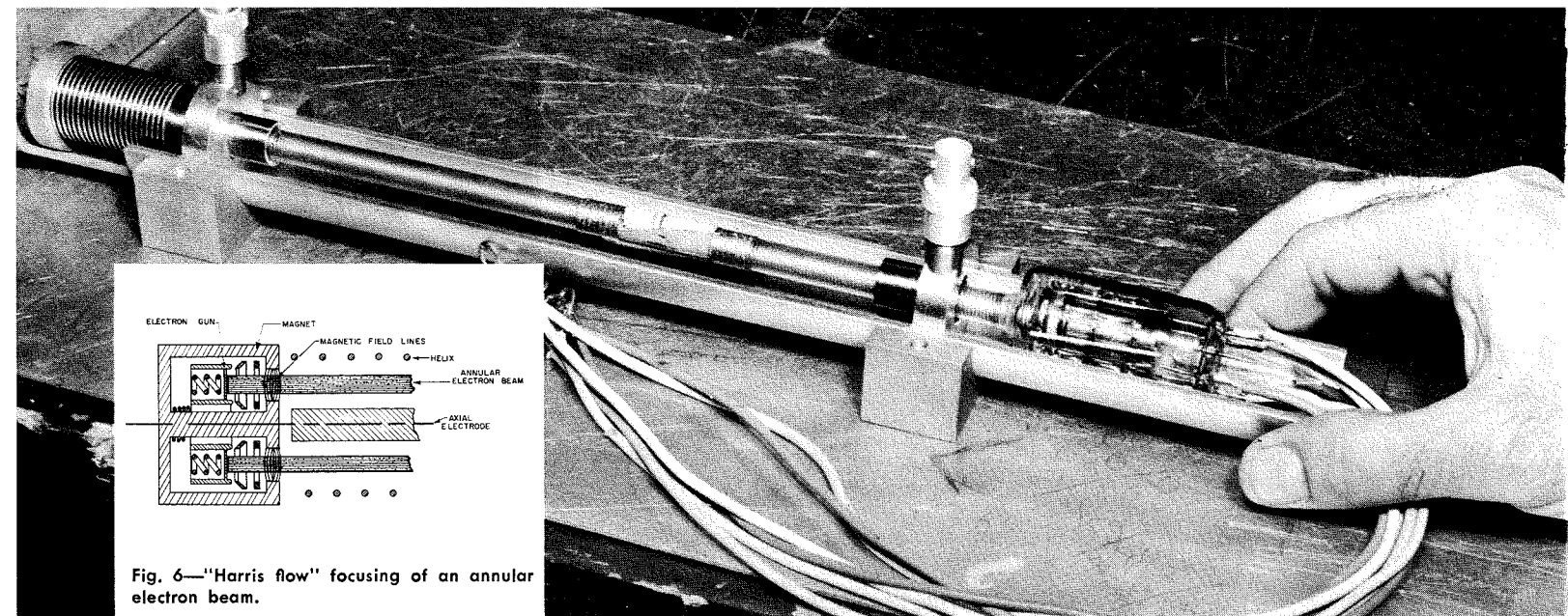

Fig. 6—"Harris flow" focusing of an annular electron beam.

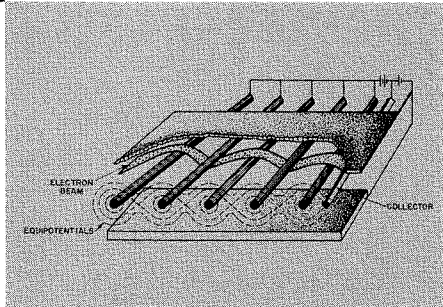
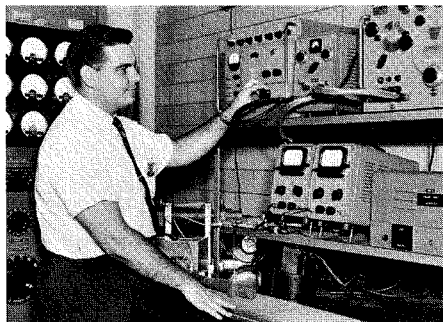

Fig. 7—"Slalom" focusing of an electron beam.



Engineer Walter Johnson is shown making laboratory measurements on a packaged Estiatron.

electron beam having exactly the right direction and velocity is launched along this equipotential surface, it will follow the surface in and out among the wires. "Slalom" focusing can in theory focus large currents at low voltage, but actually lends itself mainly to incorporation into r-f circuits of the "ladder" type—for example, those used in low-power backward-wave (voltage-tunable) oscillators.

#### ADVANTAGES OF PERIODIC ELECTROSTATIC FOCUSING

R-f circuit configurations associated with the Harris and "Slalom" focusing methods make them less desirable

than simple periodic electrostatic focusing using bifilar helices for the construction of broadband, high-efficiency tubes. The practical advantages of periodic electrostatic focusing as employed in the Estiatron have been found to be three-fold:

- a) Periodic electrostatic focusing eliminates the weight and alignment problems associated with the use of focusing magnets,
- b) Periodic electrostatic focusing removes ions from the electron beam, thus eliminating spurious signals due to ion oscillations and prolonging tube life by preventing ion bombardment of the cathode,
- c) In contrast to focusing by permanent magnets, periodic electrostatic focusing is not altered by variations in ambient temperature.

The Estiatron weighs only ½ lb. with all the "essentials," and about 1

lb. with ruggedized packaging. Thus, periodic electrostatic beam-focusing permits the size and weight of the complete tube to equal that of a conventional traveling-wave tube without a magnetic focusing structure.

#### REFERENCES

1. A. M. Clogston and H. Heffner, "Focusing of an Electron Beam by Periodic Fields," J. Appl. Phys., Vol. 25 (April, 1954) 436.
2. D. J. Blattner and F. E. Vaccaro, "The ESTIATRON, an Electrostatically Focused Medium Power Traveling Wave Amplifier," IRE Convention Record (March, 1958) Part 3.
3. K. K. N. Chang, "Confined Electron Flow in Periodic Electrostatic Fields of Very Short Periods," Proc. IRE, Vol. 47, (January, 1957) 66-83.  
"Biperiodic Electrostatic Focusing for High-Density Electron Beams," Proc. IRE, Vol. 47 (November, 1957) 1522-1527.
4. L. A. Harris, "Axially Symmetric Electron Beam and Magnetic-Field Systems," Proc. IRE, Vol. 40 (June, 1952) 700-708.
5. J. S. Cook, R. Kompfner, W. H. Yocum, "Slalom Focusing," Proc. IRE, Vol. 45 (November, 1957) 1517-1522.

**DONALD J. BLATTNER** received the B.S. degree in E.E. in 1946 and the M.A. degree in Physics in 1949, both from Columbia University. He joined RCA in 1953 as a member of the Microwave Tube Group at the Princeton Laboratories, and transferred to the Microwave Engineering activity of the Electron Tube Division in 1955. During the past five years, he has worked on low-noise and power traveling-wave tubes, backward-wave oscillators, and ultra-high-speed computer devices. He is presently a member of the technical staff in the Microwave Advanced Development activity in Princeton, N. J. He is a member of Sigma Xi and a Senior Member of the IRE.

**FRANK E. VACCARO** received the B.S. degree in E.E. from the University of Tennessee in 1949 and the M.S. degree in E.E. from Stevens Institute of Technology in 1953. He joined RCA as a Specialized Engineering trainee in January 1950. Upon completion of the training program, he was assigned to the Microwave Tube Development activity. Since then, he has been engaged in microwave measurements and advanced development work on cavity tuning of magnetrons. At present, he is Engineering Leader responsible for Electron Devices in the Microwave Tube Advanced Development activity in Princeton, N. J.

Mr. Vaccaro is a member of Tau Beta Pi, Eta Kappa Nu, and the Institute of Radio Engineers.

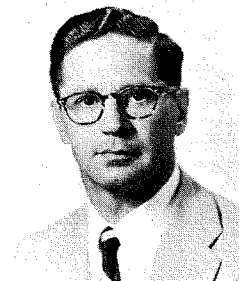
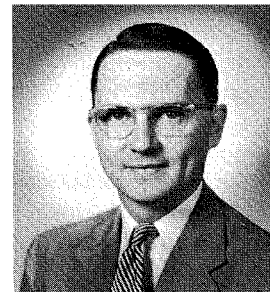

# CATHODES FOR MAGNETRONS

by

**JACK BROUS**

*Microwave*

*Chemical and Physical Laboratory*

*Electron Tube Division*

*Harrison, N. J.*

THE CATHODE OF AN electron tube, as the primary source of electrons, is usually one of the main considerations in the design of a tube. The factors which determine the type of cathode and the manner in which it is applied usually depend on the requirements of the tube. Considerations such as cathode life, required emission level, ruggedness, available heater power, noise level, and type of operation often place rigid limitations on the cathode design.

Because of their unique operation, magnetrons require cathodes which are specifically designed to meet the special requirements imposed on them. Through experience and research cathode designs have evolved which meet the requirements for ruggedness, heat dissipation, and low "end-hat" emission.

## THERMAL CONSIDERATIONS

Magnetrons, which are efficient microwave r-f generators, may be used in

pulsed, continuous-wave or frequency modulated service. Their operation depends on the interaction of electrons in motion with an r-f field within the space between cathode and anode structures in a magnetic field. Electrons which are in phase with the r-f field give up energy to the field, contributing to the usable output power of the tube. Electrons which are out of phase with the r-f field are accelerated and, in the magnetic field, are deflected back to the cathode. These electrons, on striking the cathode, give up their energy as heat. This electronic "back-bombardment" makes necessary a cathode design which is not only unique, but is in many respects in direct

opposition to design fundamentals conventionally used in vacuum tubes.

Usually, cathodes for vacuum tubes are designed to retain the heat radiated and conducted from the heater. This design enables the cathode to be operated at the required temperatures with a minimum of heater-power. Energy used to heat the cathode is considered wasted because it does not contribute to the usable output power of the tube.

In magnetrons, however, it is necessary to design the cathode to dissipate rather than retain the heat resulting from back-bombardment effects. For this purpose, the cathode emission surfaces are usually supported on sturdy molybdenum tubing which can effectively conduct the heat away. It is necessary therefore to use a large heater to heat this structure to operational temperatures within a reasonable time after the heater voltage is applied. When electron emission has reached operational

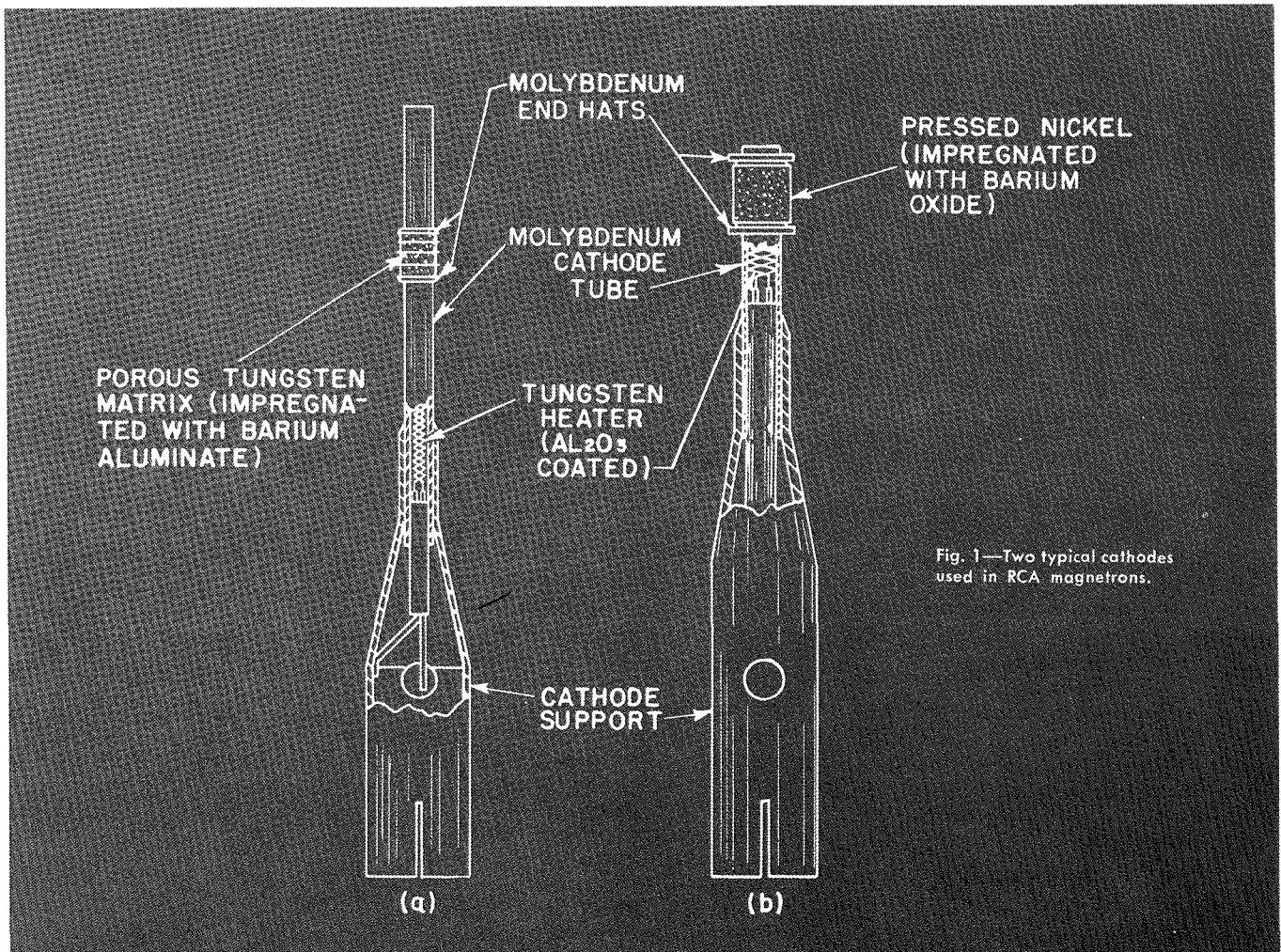

Fig. 1—Two typical cathodes used in RCA magnetrons.



levels and the other tube potentials are applied, the heater voltage can be reduced somewhat to allow for back-bombardment heating of the cathode. Under some conditions of operation, in fact, the heater voltage can be reduced to zero and the emissive area of the cathode will still be too hot under back-bombardment. In such cases, the temperature often can be lowered to a range where it can be controlled by the heater if the thermal radiation of the molybdenum cathode surfaces is increased by roughening or the application of a dark coating.

At best, the thermal design of a magnetron cathode is a compromise between the requirements for rapid warm-up time, minimum heater power, and the need to avoid excessive temperature during operation.

#### MECHANICAL STRUCTURE

Fig. 1a shows the cathode structure of a typical RCA magnetron. This cathode consists of a heavy molybdenum tube to which is brazed an emissive cathode and molybdenum "end hats." The sturdy molybdenum structure offers both ruggedness and good thermal conductivity. In this design the emissive cathode sleeve is made of a porous tungsten matrix impregnated with barium aluminate.

This cathode sleeve has three machined ridges extending from the surface. These ridges are designed to extend the emissive area a small distance further toward the anode structure. In this manner, the cathode-anode transit time for at least a fraction of the electrons is somewhat reduced. In pulsed operation, this design contributes to the sharpness of the r-f output pulses at the required frequency.

The molybdenum "end hats" have the function of confining the electron stream emanating from the emissive sleeve. The positioning of the "end hats" prevents electrons from leaking toward the magnet pole pieces, where their energy would be dissipated in heat and tube efficiency reduced. The entire molybdenum cathode structure is brazed to a monel cathode support piece by means of a localized high frequency braze in hydrogen. The heater is located within the cathode tubing as shown in Fig. 1.

The cathode structures shown in Fig. 1 in general exemplify magnetron cathodes. Other cathodes may or may not use ridged matrix designs, or may be fastened together by means other than brazing, but they are still designed in the same general form.

#### "END HAT" EMISSION

As indicated above, the "end hats" are designed to prevent leakage of electrons

to the magnet pole pieces, where their energy would be wasted. Consequently, it is necessary to build the "end hats" of a material which, when operated at cathode temperatures, will not contribute to the leakage current. Alternatively, their exposed surfaces may be clad with such a material.

The phenomenon of "end hat" emission is common to all magnetrons, although its seriousness varies with the tube design and application, as well as the degree to which it can be kept to a minimum. The level of this emission is effected by factors such as composition of the "end hats" and the presence of any foreign materials, such as evaporated deposits from the emissive sleeve, oxidation, dirt, or brazing material which may have wet the end hats during the brazing operation. The level of the "end hat" emission often increases during the life of the tube. This increase is attributable to a gradual evaporation or surface migration of barium oxide or metallic barium from the hot emissive sleeve to the end hats which lowers their work function.

A number of non-emissive coatings have been developed which inhibit the emission of the "end hats" to varying degrees. The coating used may be one of several types:

1. A dark coating improves the efficiency of thermal radiation, thereby enabling the "end hats" to operate at a lower temperature and reducing emission.
2. Coatings of an active metal such as zirconium may destroy emission by chemically reducing any barium oxide which may migrate to the "end hats" and enabling the free barium to evaporate from its hot surface.
3. A coating may be used which itself is a poison to emission.

Coatings are often applied which employ one or more of these three principles to limit the leakage current originating in primary emission from the "end hats."

#### EMISSIVE SURFACES

The emissive sleeve most frequently used in RCA magnetrons is of the impregnated tungsten matrix type. Other cathode types, however, are sometimes used. In some types, a pressed cathode is formed of nickel powder which is sintered and pressed in position and subsequently impregnated near its porous surface with barium carbonate. Also used are thoria cathodes.

At the present time, however, tungsten matrix cathodes impregnated with barium aluminate are most widely used because they have proven to be highly reliable. They combine the necessary

characteristics of ruggedness and excellent resistance to electronic back-bombardment. The impregnated matrix can be fastened to the cathode structure with little difficulty and generally meets almost all of the requirements of a magnetron emissive material. In recent years, its application to magnetrons has increased considerably.

#### CONCLUSION

Application of power is necessary to heat a magnetron cathode to a temperature high enough for the tube to become operative. After oscillation begins, however, the problem of dissipating heat resulting from electronic back-bombardment becomes more important than that of retaining it. This problem necessitates a rugged cathode design using a metal which is both refractory and thermally conducting such as molybdenum or tungsten. Improving thermal conductivity and radiation away from the cathode making it possible to reduce its temperature during oscillation of the tube to a range where the cathode is emissive but can still be controlled by the heater.

Tungsten matrix cathodes are preferred for magnetrons because they are sufficiently rugged to withstand high levels of back bombardment. "End hats" are used to confine the electron beam to the required interaction space between the cathode and anode structures. The "end hats" are also designed to minimize electronic leakage resulting from their own emission.

**JACK BROUS** received the B.S. degree in Chemistry in 1948 from the City College of New York, the M.S. degree in Physical Chemistry from the University of Chicago in 1949, and the Ph.D. degree in Inorganic Chemistry with minors in Physical Chemistry and Physics from the Polytechnic Institute of Brooklyn in 1953. From 1949 to 1952 he held a research fellowship under United States Army Signal Corps sponsorship for studies of properties and syntheses of new ferroelectric materials. From 1952 to 1956 he worked as a development engineer at the General Electric Company, both on dielectric materials in the General Engineering Laboratories, and on a variety of physical and chemical problems in the Power Tube Department, particularly in regard to cathodes, getters, and gas problems encountered in power tubes of all types. He joined the RCA Microwave Engineering activity in Harrison, N. J. in January 1957, and has worked on cathodes, getters, and metallurgical problems for magnetron and traveling-wave-tube development. He is presently supervising the Microwave Chemistry and Physics Laboratory.



# MICROWAVE RESEARCH AT RCA LABORATORIES

THE PURPOSE OF the Microwave Group at RCA Laboratories is simple to state. It is to look ahead—to dream up, to understand and evaluate, and finally to test, new ideas in the broad field of microwave devices. These tested ideas and prototype devices are then improved upon by the development groups of the Tube Division where they are given that polished practicality necessary for a final commercial product. Many of the microwave tubes described in other articles of this issue bear witness to this successful and necessary cooperation between Research and Development.

In line with its purpose of looking ahead, the microwave research group at the Laboratories is currently investigating many ideas which it believes will in the future lead to useful products. It is the purpose of this article to describe those research projects which most directly concern microwave amplification. It is hoped that some of these projects will, a few years from now, lead to another issue of the RCA Engineer devoted to radically new types of successful microwave devices.

But before looking at the present work, two examples may best illustrate how research projects of the past have helped contribute toward better microwave products of today. Both examples concern traveling-wave tubes—their noise behavior and their focusing structures.

## SOME PAST RESEARCH

It will be recalled that early traveling-wave tubes were far from being low-noise amplifiers. Indeed, a 16 db noise factor at 3000 mc, measured at RCA Labs., was considered an accomplishment in 1949. The following few years saw steady improvement, but the really precipitous drop in noise factor took place around 1952 when the Laboratories announced results in the vicinity of 8 db.<sup>1</sup> These noise factors, which were by far the lowest obtained in any laboratory up to that time, were the result of research on the highly flexible RCA "three-region gun". Just why this voltage flexibility was so important became clearer through subsequent theoretical and experimental research which resulted, in part, in the prediction of a minimum noise factor for traveling-wave tubes and in a "recipe" for realizing this minimum.<sup>2</sup> The efforts of the Electron Tube Division at this point, in cooperation with the Laboratories, produced further improvements in the design of both cathodes and electron guns—or

By DR. STANLEY BLOOM  
RCA Laboratories  
Princeton, N. J.

"beam transformers"—and have resulted in a commercial tube, the RCA-6861, with a noise factor, at S-band, of 5 db. Exceptional tubes have given even lower noise factors and it is one of the current projects at the RCA Labs. to understand more fully those properties of an electron beam near the cathode which determine the actual numerical value of the minimum noise factor. When these properties are known, so that the present partial "recipe" can be augmented by a recipe for the cathode region, traveling-wave tubes with extremely low noise factors—perhaps 1.5 or 2 db—may result by design rather than by accident.

However, even with very low noise, wide bandwidth and high gain, a traveling-wave tube's usefulness is seriously limited if it must carry along a massive, power-consuming electromagnet. A large part of past research at the Laboratories was devoted to reducing the size and weight of the beam-focusing structure through the use of periodic focusing systems. In 1953, RCA Labs. began a research program aimed at understanding and utilizing the "strong-focusing" principle described by the cyclotron group at Brookhaven. In 1954 a traveling-wave tube was constructed weighing only 5 pounds complete with periodically spaced, ceramic permanent magnets. The following year, however, saw the beginnings of an improved focusing scheme—*electrostatic* periodic focusing

—and in 1954-55 a tube was realized which used electrostatic focusing in the helix region and a small permanent magnet near the cathode. This tube, with focusing structure, weighed 2 pounds. Finally, in 1956-57 a purely electrostatic focusing system, using a hollow beam traveling between two concentric helices, resulted in a tube of less than 1 pound<sup>3</sup>. Further important improvements were achieved by the Advanced Development group of the Tube Division—in particular, the proven methods of periodic electrostatic focusing were applied to a solid beam, single-helix, system and resulted in today's highly successful 10 ounce Estiatron.

## PRESENT RESEARCH

In recent years "low" noise has taken on new meaning. Previously a microwave amplifier with a 5 or 6 db noise factor was justifiably considered a real accomplishment. But within the past year or two *Parametric Amplifiers* have been built with 2 to 3 db noise factors and *Masers* have given results of only a few tenths of a db! Spurred on by this formidable competition, the "obsolete" traveling-wave tube has achieved 3 to 4 db with promise of much better results through the use of the forementioned "cathode-region recipe" and the use of *Electron Cooling*.

In addition to its work in these fields of low-noise amplification, the Laboratories group is engaged in research on microwave power amplification, and in particular, on a novel broadband, high-efficiency *Bi-Periodic Magnetron*.

These representative topics of current

Fig. 1—PARAMETRIC GAIN results if the capacitance is decreased at a voltage maximum and increased at a voltage minimum.

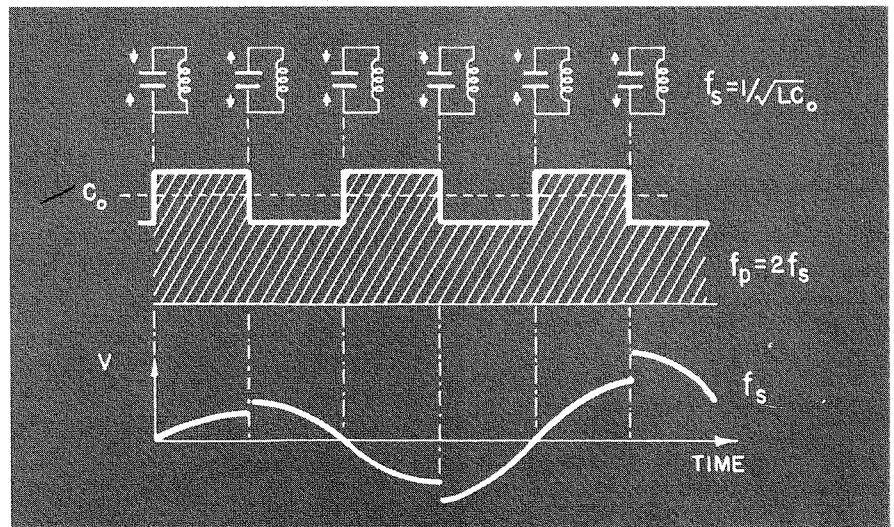

research at RCA Labs will now be described.

### Parametric Amplification

The parametric amplifier uses an energy storage element, such as a periodically varying reactance, to couple an a-c energy-supply tank to an a-c signal tank. The proper variation of this coupling reactance causes energy to be transferred from the supply, or "pump", tank to the signal tank.

This process is illustrated in Fig. 1 in terms of a simple  $LC$  tank of resonant frequency  $f_s = 1/\sqrt{LC_0}$ . The tank capacitance is varied mechanically at frequency  $f_p$ . Suppose that at the instant the voltage is a maximum, one suddenly decreases the capacity, say by pulling the capacitor plates apart. This converts mechanical energy into electrical energy and increases the voltage amplitude. Then when the voltage, and charge, reach zero no energy is exchanged as the plates are pushed back again and the capacity is raised to its initial value. As this process is repeated the signal voltage, of frequency  $f_s$ , grows in amplitude as the capacitance is "pumped" at frequency  $f_p = 2f_s$ .

In this "degenerate" example, the capacitance was pumped at just the right phase with respect to the signal. In general, however, there is a third resonant tank — the "idler" — whose frequency,  $f_i = f_p - f_s$ , differs from that of the signal. The presence of a separate idling tank obviates the need for any particular phasing between pump and signal.

In an actual device, of course, the reactance is not pumped mechanically but electrically. One uses a nonlinear capacitance or inductance driven by a local oscillator at frequency  $f_p$ . Two important examples are the nonlinear capacitance obtained with back-biased semiconductor diodes and the nonlinear inductance exhibited by electron spin precession in ferrites.

At present, at the Laboratories, attention is being focused mainly on the semiconductor diode type of parametric amplifier. Not only is it far simpler and does it require less pumping power than the ferrite version, but also there is available the materials technology gained from RCA's pioneering work on nonlinear capacitance effects in semiconductor diodes.

Using a germanium diode, the Laboratories group has built an amplifier with 30 db gain at 380 mc, having a 0.1% bandwidth and a 7 db noise factor with an unisolated load.<sup>4</sup> Although the noise factor and bandwidth are not spectacular, this particular amplifier was built to demonstrate the possibility of pump-

ing at a frequency *lower* than that of the signal — an innovation of great importance for cases of high signal frequency — and no effort was made to optimize the performance. The pump was at 300 mc and the pump power was only 20 mw. A newer version has given gain at 6.6 kmc with a 4 kmc pump. Because electronic shot noise is absent, parametric amplifiers should have very low noise factors. Indeed, theory predicts that noise factors as low as 2 db at *room temperature* are attainable and indicates the operating conditions necessary to provide this noise factor. The fact that noise measurements under present conditions of operation accord with the theory encourage the view that a noise factor of 2 db will be achieved in the near future with a lower-frequency pumped parametric amplifier.

### Masers

Masers are quantum mechanical amplifiers which use a pair of molecular energy levels whose energy difference,  $E$ , corresponds to the frequency,  $f = E/h$ , to be amplified. When an r-f field of this frequency is applied to a molecular aggregate, two things happen; some molecules jump from the lower to the upper energy level by absorbing energy from the field, while others jump from the upper to the lower level and emit energy into the field. Because, normally, there are more molecules populating the lower level than the upper there will be a net absorption of energy by the molecules. If, however, one obtains an aggregate with a greater population in the upper than in the lower level, then the applied r-f signal field will stimulate more emis-

sion than absorption. This net emission is coherent with, and adds to, the signal field thus resulting in amplification. Because in the microwave region the likelihood is very small that a molecule will spontaneously jump down out of the upper level, noise radiation arising from such spontaneous emission is nil and so masers can have exceedingly low noise factors.<sup>5</sup>

The simplest maser is a two-level affair using either a gas or a solid. In the gas case, although the population imbalance can be maintained continuously through the use of state-selecting focusers, the low gas density leads to a very low gain-bandwidth product. This product can be improved with a two-level solid-state maser because of the much larger density; however, such a system gives only pulsed amplification — the population imbalance must be restored after each amplification period.

Both a relatively large gain-bandwidth product and c-w operation are possible with three-level solid state masers. These devices use the three energy levels corresponding to three orientations of the spin of a paramagnetic ion in a crystal when the spins are subjected to a strong d-c magnetic field. With a strong "saturating" r-f field applied, of frequency corresponding to the two outermost levels, these two levels are kept equally populated (see Fig. 2). Thus, continuously, there are either more spins in the uppermost level than in the middle level, which is the case shown in the figure, or more in the middle than in the lowest level. Which case prevails depends on the respective leakage, or "relaxation", times but either case gives amplification.

Fig. 2—The high-frequency, high-power saturating field, of frequency  $f_{\text{SATUR.}}$ , equates the populations of the two outer energy levels. This allows MASER amplification between, for example, the highest level and the middle level at frequency  $f_{\text{SIGNAL}}$ .

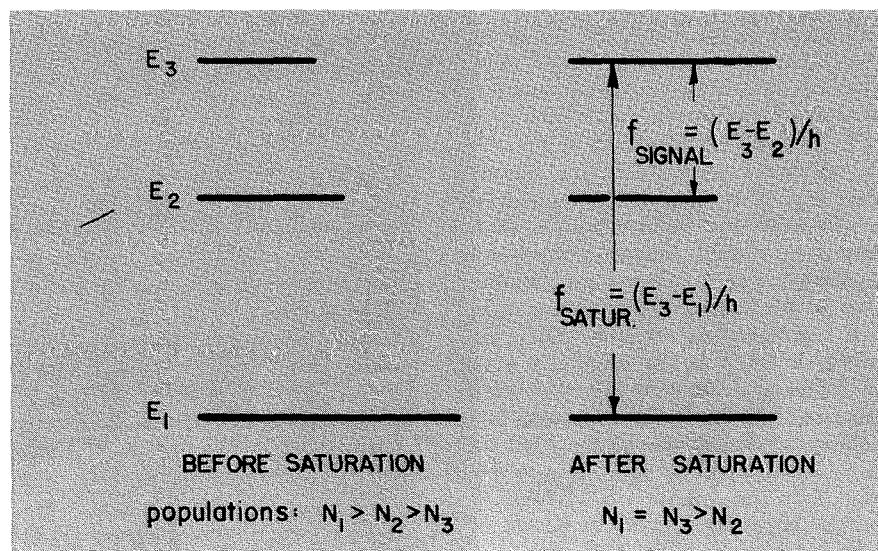

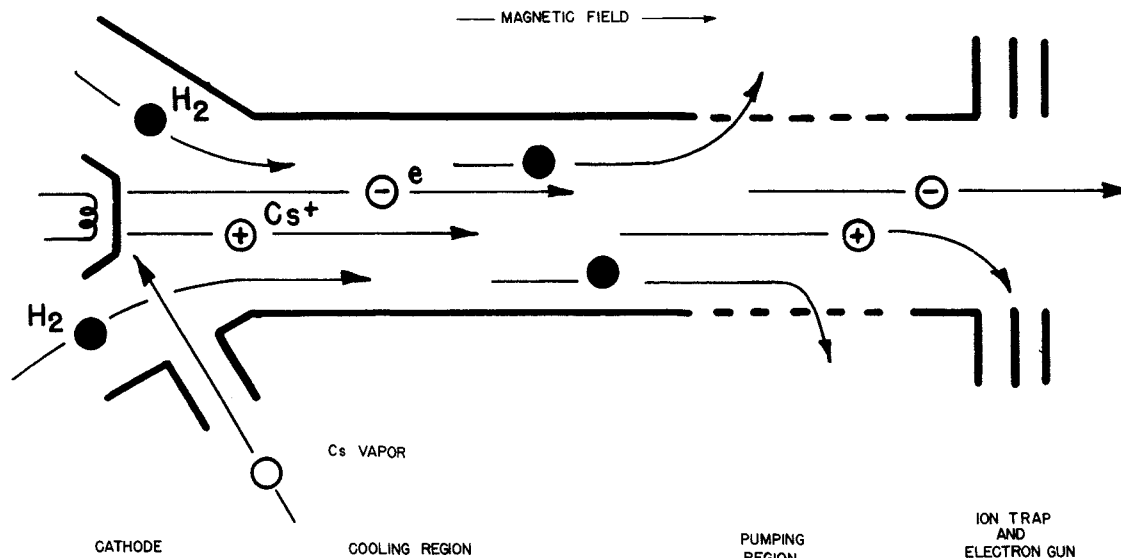

Fig. 3—ELECTRON COOLING results from heat exchange with the cool hydrogen gas. Positive cesium ions neutralize the space-charge forces and so allow the electrons to drift slowly.

Such amplifiers have been built elsewhere with noise factors better than 0.4 db with the crystal immersed in liquid helium.

Liquid helium temperatures are important for three reasons. The lower the temperature the smaller the Johnson thermal noise arising from circuit losses. Also, low temperatures increase the gain by increasing the population imbalance between the pair of amplifying levels. Finally, the colder the crystal the less frequent are the "collisions" which would lower the gain by causing the spins to relinquish their energy as heat rather than as useful radiation. Nevertheless, at RCA and at other laboratories, much research is currently devoted to finding, or even fabricating, new paramagnetic materials which will operate at more convenient temperatures without too great a sacrifice of gain or low noise.

Another active area of maser research at RCA Labs. is concerned with the dual problem of broadbanding the maser and of making it unidirectional. Both masers and parametric amplifiers are two-terminal regenerative amplifiers and in their present forms require a circulator. This is to isolate the amplifier from the load, lest noise in the load be returned, amplified, and sent back again to the load with disastrous effects on the overall noise factor. To overcome this difficulty the idea has been proposed, at RCA and at other laboratories, of using a *traveling-wave circuit*. Such traveling-wave masers or parametric amplifiers would not only lead to greater bandwidths, by eliminating resonant cavities, but would also give unidirectional amplification.

#### Electron Cooling

Although today the spotlight seems to be on masers and parametric amplifiers, the conventional traveling-wave tube must not be discounted as an answer to the problem of very-low noise, wide-band microwave amplification. Not only have TWT noise factors near 3.5 db been measured at several laboratories, but within the last year our understanding of the fundamental noise properties of a *multi-velocity* beam near the potential minimum has greatly increased. The original complex machine analyses of this critical region calculated by others are currently being replaced, at RCA Labs., by a simpler, analytic and therefore more usable model. This model promises to lead to a practical recipe for the design of the electron gun near the cathode.

Furthermore, no matter what noise reduction is achieved by changes in electron-gun configuration, a substantial further decrease can be obtained by reducing the thermal velocity spread of the beam electrons. This reduction in spread is equivalent to a lowering of the cathode temperature without a loss of current density, and leads to a lower noise factor according to  $N.F. = 1 + (const.) \times T/290^\circ$ , where  $T$  is the effective cathode temperature. (Incidentally, the recipe mentioned in the previous paragraph aims at a reduction of the "constant" in this formula.)

The idea of "electron cooling" originated at RCA Labs. some time ago and such cooling has recently been achieved. The method consists of reducing the energy spread of thermionically emitted electrons by heat exchange with a cool

gas. The processes are shown schematically in Fig. 3. The thermionic electrons from the hot cathode are sent through a cool atmosphere of, say,  $H_2$  gas. Collisions with the hydrogen molecules gradually bring the electrons into thermal equilibrium with the gas. In order to increase the frequency of these electron-molecule collisions and thereby increase the rate of cooling, the electrons must drift very slowly. To achieve this slow drift without having the electrons diverge to the walls, the electrons are accompanied by a stream of positive cesium ions which neutralize the space charge. These  $Cs^+$  ions are produced by bombarding the hot cathode with Cs atoms. In the present demountable system, the cooling section is followed by a region of differential pumping which removes the cooling gas. This is followed by a trap for the  $Cs^+$  ions and an electron gun to isothermally extract the electron beam.

In this way electron beams of up to  $1 \text{ ma/cm}^2$  have been cooled from  $1300^\circ \text{K}$  at the cathode to  $700^\circ \text{K}$  at the beam extractor.<sup>6</sup> Thus a traveling-wave tube, which without electron cooling has, say, a noise factor of 3.5 db would have with present cooling a noise factor of around 2.2 db. These results represent the present status of the work, not the ultimate results. Work is in progress to reduce the electron temperature to below room temperature and to miniaturize the system for use in an operating traveling-wave tube.

#### Bi-Periodic Magnetron

Not only is low-noise amplification under investigation at the Laboratories but also

high-power microwave amplification. In particular, a novel bi-periodic magnetron type of traveling-wave tube, first proposed at the Laboratories, promises to combine the high efficiency of the magnetron with the wide bandwidth of the traveling-wave tube to give a power amplifier capable of carrying larger-than-usual currents and having smaller-than-usual cooling difficulties.<sup>7</sup>

A cut-away sketch of this device is shown in Fig. 4. The structure is a stack of coaxial annular disks of alternately small and large inner diameter. Azimuthally spaced slots extend radially outward and project through the length of the stack. Thus there is formed a series of parallel axial delay lines together with a stack of magnetron cavities. A spiraling beam traveling through the center of the structure sees a bi-periodic r-f circuit. The beam spirals around a cylindrical conductor which is at negative potential with respect to the disks. In the azimuthal direction electron potential energy is converted into field energy with the high efficiency of the magnetron. In the axial direction electron kinetic energy is converted into field energy with the high gain and bandwidth of the traveling-wave tube.

Whereas in conventional magnetron oscillators the beam is re-entrant so that the separate input and output necessary for an amplifier are absent, in the bi-periodic magnetron the beam is injected at one end, spirals down the structure and emerges at the other end, thus separating the input and the output. In addition, the bi-periodic structure allows for less stringent mechanical tolerances than does a singly-periodic structure. This is because a wave, being now allowed to move in a second dimension, can propagate around a localized irregularity. Finally and most importantly, the present bi-periodic structure can be made quite large in diameter without running into trouble with unwanted azimuthal modes—and larger diameter structures allow larger beam perveances to be used by increasing the cooling surface. The unwanted azimuthal modes are suppressed by operating the azimuthal circuit in the stop band; the structure is then forced into the  $\pi$ -mode alone by the use of a multi-antenna coupler to introduce the signal correctly at the input.

Cold tests on this bi-periodic structure indicate that bandwidths in the order of 500 mc at S-band are obtainable, and although hot tests have not yet been made, calculations show that a 100 watt amplifier with an efficiency as high as 60% is feasible. This is to be compared to efficiencies of 10 to 30 percent obtain-

able with standard singly-periodic power traveling-wave tubes.

### CONCLUSIONS

The subjects which have been discussed are representative of those projects of the microwave group which pertain to microwave low-noise and power amplification. By no means do they exhaust the list of topics under investigation. Microwave generation, for example, is important and several interesting possibilities for penetrating the millimeter and sub-millimeter wave region have been opened by the use of lower-frequency-pumped parametric oscillators and by the use of a backward-wave oscillator in conjunction with a novel high current-density "cathode" which uses the electrons extracted from an arc-discharge plasma.

It may appear to the casual reader that most of the work described above is quite remote from commercial "hardware". It will be recalled however that the Estiaton appeared four years after work on periodic focusing started at the Laboratories. This time lapse is not the result of lack of diligence, it is rather a measure of the time required to reduce an idea to a working model and to engineer the model into the reliable, rugged device required in modern commercial and military applications. On the same time scale, present work should provide the commercial products of 1960-1965. Viewed in this light, it is believed that the present program is not in fact remote from commercial application.

What of the more remote future? Our present work is based on ideas already

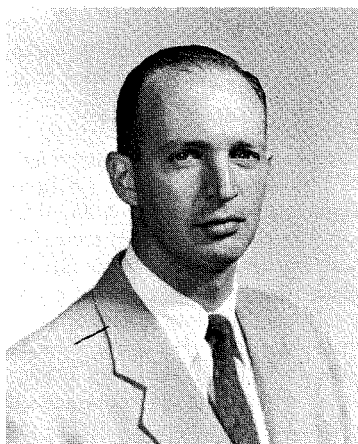

**STANLEY BLOOM** received the B.S. degree in physics from Rutgers University in 1948, and the Ph.D. degree in physics in 1952 from Yale University. His dissertation work was in the field of pressure broadening of spectral lines. In 1952, he joined the RCA Laboratories where he has worked on traveling-wave tubes, molecular amplification, plasmas, and parametric amplifiers.

Dr. Bloom received in 1953 an RCA Laboratories Achievement Award for research on traveling-wave tube noise. He is a member of the American Physical Society, Sigma Xi and Phi Beta Kappa.

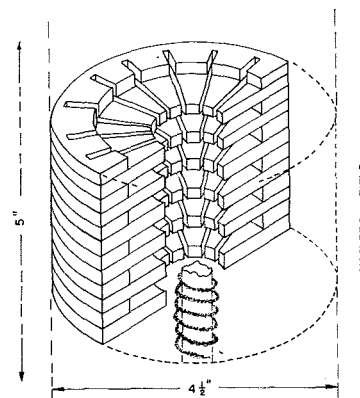

Fig. 4—BI-PERIODIC MAGNETRON type of traveling-wave tube, consisting of a series of parallel axial delay lines and a stack of magnetron cavities.

conceived. We must probe the frontiers of knowledge for new ideas to exploit. This is an exacting task. Not only must new information be uncovered but its practical import must be assayed. It must be assayed with vision so that possibilities are not overlooked, yet with a certain hard-headedness lest effort be directed up too many of the blind alleys that always appear in exploratory work. This is a phase of our work which is constantly in progress but is as hard to commit to paper as is a recipe for achieving the "stroke of genius" which is said to constitute invention.

### REFERENCES

1. R. W. Peter, "Low-Noise Traveling-Wave Amplifier", RCA Rev. XIII, 344, Sept. 1952.
2. S. Bloom and R. W. Peter, "A Minimum Noise Figure for the Traveling-Wave Tube", RCA Rev. XV, 252, June, 1954.
3. K. K. N. Chang, "An Electrostatically Focused Traveling-Wave Tube Amplifier", RCA Rev. XIX 86, Mar. 1958.
4. K. K. N. Chang and S. Bloom, "A Parametric Amplifier Using Lower-Frequency Pumping", Proc. I.R.E. 46, 1383, July, 1958.
5. J. P. Wittke, "Molecular Amplification and Generation of Microwaves", Proc. I.R.E. 45, 291, Mar. 1957.
6. W. Knauer and R. C. Knechtli, "Cooled Electron Beams for Use in Low-Noise TWT", paper presented at 1958 Conference on Electron Tube Research, Quebec.
7. J. Berghammer and F. Paschke, "Bi-Periodic Magnetron Traveling Wave Tube Study", (to be published).

**Editor's Note:** This paper was prepared as a text for a presentation given at the Electronic Components Conference at Los Angeles earlier this year. Although the talk was presented as part of the program by Messrs. Cunningham and Dale, they have expressed a wish to accredit the writing to Eugene O. Selby, of DEP's Surface Communications Engineering.

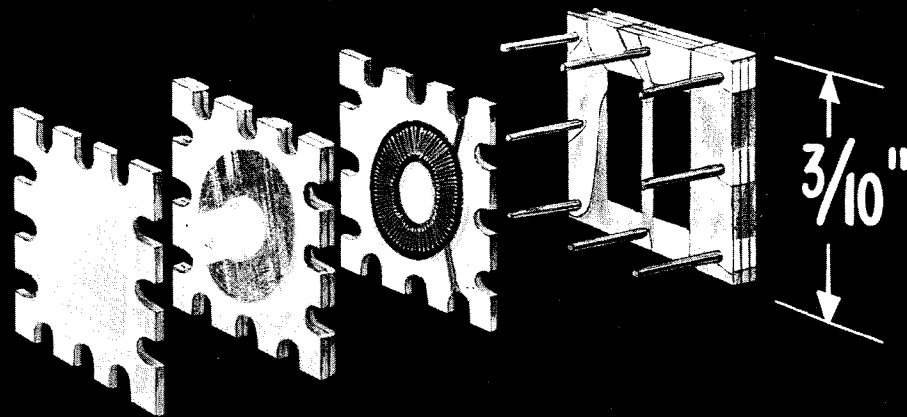

## THE MICROMODULE

*A Revolutionary  
Electronic Equipment  
Design Concept*

by

**O. B. CUNNINGHAM, Chief Engineer**

*Surface Communications Dep't.  
Defense Electronic Products  
Camden, N. J.*

and

**B. V. DALE, Mgr.**

*Modules Engineering  
Semiconductor & Materials Div.  
Somerville, N. J.*

**T**HE PAST HISTORY of electronic systems development has been characterized by continuing demands for broader application, greater capabilities, and adaption to adverse environments. These demands were never more prominent than they are today, and it can be logically assumed that the same trend will continue into the future. Certainly, industry must keep pace with these demands.

New fields of military and commercial application, changing military tactics to cope with new weapons, increased speed of weapons and transportation, need for electronic simulation of human operator and decision functions, increased communication traffic loads and radio spectrum crowding are a few factors governing modern electronic systems development.

### A NEW CONCEPT INTRODUCED

Research and development effort directed toward compliance with these demands has, in recent years, produced many technological advances in modes of communication, components, and assembly methods. Typical examples are automatic assembly, printed circuits, transistors, and magnetic applications. While many of these developments represent real advances, they are in general only extensions and improvements of existing techniques.

It is evident that future military electronic requirements will not be met by further extension of present day techniques. A major break-through

and a revolutionary new concept at component and material levels is required to achieve the necessary new orders of reliability, volumetric efficiency, and operational suitability. A long range program is envisaged which will involve new operational and circuit concepts. Present practices of component design, manufacture and assembly of both active and passive elements will be revolutionized by totally new concepts of components. Component design will be approached from the fundamentals of solid state physics of basic materials, unprejudiced by fifty-year-old habits, to provide controlled physical-electrical characteristics and properties suitable for modern needs. New orders of reliability will be attained through completely controlled processing of both active and passive elements of the systems starting with the building of basic materials from atoms and molecules and continuing on through fabrication, equipment design and into final equipment production. The meth-

ods employed will be ideally suited for automatic production which will permit maintenance of desired production quality levels. Present limitations to miniaturization including so-called irreducibles such as tuning capacitors or inductances will be superseded by application of new techniques.

### ADVANCES IN MATERIALS

The major advances are expected ultimately to be based on a merger of components as presently conceived with circuits and devices into a single unit of solid material capable of performing a multiplicity of functions. Such a device might comprise a three dimensional combination of conducting, semi-conducting, and insulating materials, along with ferrites, ferro-electrics, photo conductors, etc., combined in an ultra compact module to provide a complete circuit such as an amplifier or radio receiver.

The solid-state circuit concepts discussed up to this point may be considered too advanced for immediate implementation. However, the definite trend toward these concepts is indicated in recent research disclosures and certain applications of a number of solid-state devices are already in evidence. Examples include transistor developments, drift transistors, spacers, thyristors, cryotron amplifiers, solid state masers, semiconductor variable capacitors, Hall effect gyrators, magneto-resistive materials, multielement transistor commutators, lumines-

cence amplifiers, thermo-electro power devices and many others.

The magnetic memory plate is a typical example of solid-state circuitry application and the resulting advantages of reduced complexity, volume and power consumption. (see Fig. 1)

This illustration shows a perforated ferrite plate with the circuit printed on the plate. Each hole provides storage for a binary bit of information. A solid state configuration of this type is capable of storing over 12,000 bits per cubic inch, and improvements are being made in uniformity of the basic material. Fig. 2 shows elements of a photo-electro-luminescent amplifier, a multifunction solid-state device.

In this device, each electro-luminescent cell is in series with two mutually parallel photo-conductive cells *A* and *B*. The physical structure is shown in the lower portion of the figure. The *A* cells are responsive to input light only while the *B* cells respond to feed-

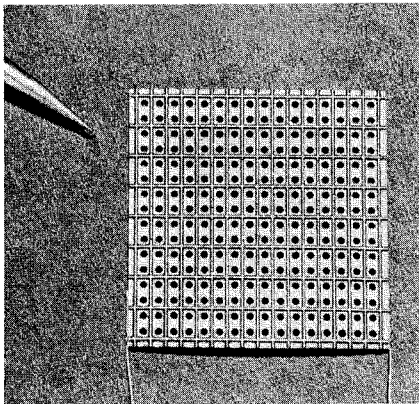

Fig. 1—Magnetic Memory Plate

back light only; and several modes of operation are possible. With the *A* switch activated each branch transmits a light signal with gain and operates as an ordinary light amplifier. With both switches activated the device operates as a regenerative storage panel responding to every input signal and storing it indefinitely. With only the *B* switch closed the device will store information available at the moment of activation from either of the two previous positions but will not respond to new information.

#### MICROMODULE PROGRAM OBJECTIVES

The implication can be drawn from the foregoing examples that the elec-

Fig. 2—Equivalent Circuit and Physical Structure of Light Amplifier Panel

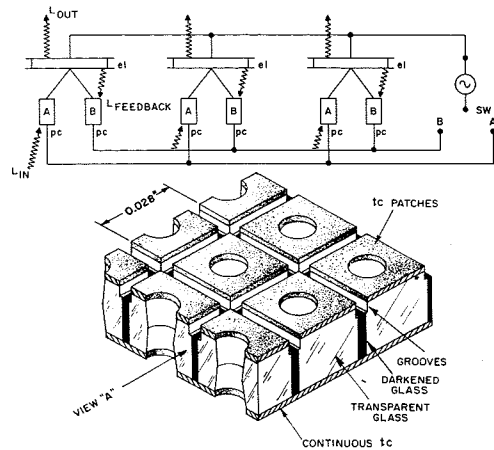

tronic industry today finds itself at the beginning of a major change in the concept of components. The day of the single-function component is passing and a multifunction miniaturized component will be a large factor in electronics tomorrow.

In order to approach implementation of this program from a practical viewpoint, the RCA micromodule concept was evolved. This concept is capable of immediate application in that it utilizes present-day capabilities. At the same time it provides for orderly expansion to embrace full advantages of solid state material utilization.

The broad objectives of the RCA micromodule concept are to provide a basic industry-wide improvement in electronic equipment processing, complying with requirements previously stated for greater reliability, reduced size and weight, improved performance, serviceability, adaption to more stringent environments, and low cost.

#### BASIC DESIGN DETAILS

Basic considerations in the approach to the RCA micromodule concept include full utilization of presently known properties of basic solid-state materials with provision for expansion to include results of research in solid-state physics of basic materials. Essentially all active circuit functions are accomplished by application of transistors and semiconductors. Circuit and operational development is concurrently planned in order to fully exploit new concepts of solid-state circuits. An integrated approach is employed for merging materials, component or circuit element design, and assembly of modules in actual equipment applications.

The design details resulting from

these basic considerations permit the implementation of a desired operational function from a group of modules which in turn are constructed from a group of wafer-shaped circuit elements (called *micro-elements*) corresponding to conventional components. The micro-elements are constructed from the basic materials best suited for the particular function of the element, and a standardized dimension of .3 x .3 x .01 inches is employed to assure optimum volumetric efficiency of the module assemblies. The design includes provision for any necessary isolation, shielding, or sealing of the micro-elements as well as provision for reliable interconnection or coupling with other circuit elements. The modules consist of a group of micro-elements selected to supply a particular circuit function. The modules are three dimensional and approximately cubic for most efficient space utilization. The modular structure is sufficiently versatile to accommodate a wide variety of materials, each optimally utilized for a given function, and a wide variety of circuit configurations with a minimum of basic shapes, materials and operations. The construction of micro-elements and modules is ideally suited for automatic manufacturing with completely controlled processes. For examples of standardized wafers, see Fig. 3.

In these units the same basic thin wafer shape is employed for all elements. The micro-elements are .3 inch square and most wafers are .01 inch thick. They are assembled in the modules with .01 inch spacing to provide for electrical decoupling, joints and tolerances. After assembly and completion of internal connections

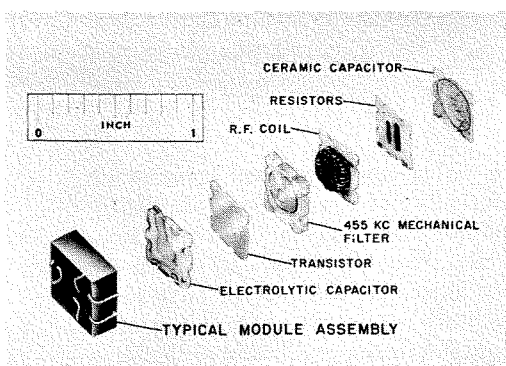

Fig. 3—Typical Wafer Elements

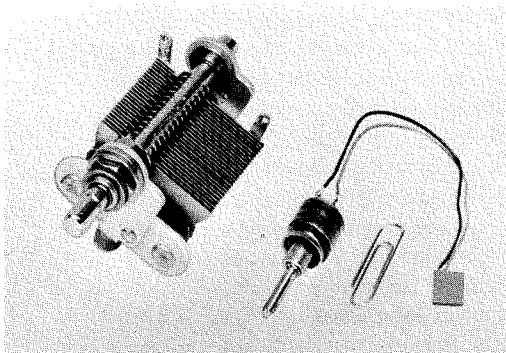

Fig. 4—Electrical Tuning, Variable Capacitance Diode Compared with Conventional Tuning Capacitor

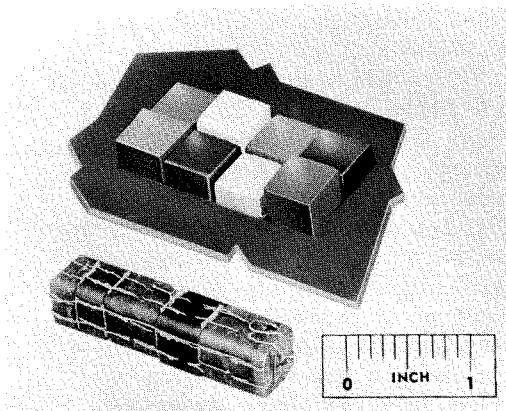

Fig. 5—Micro-Miniature Module Assembly Methods

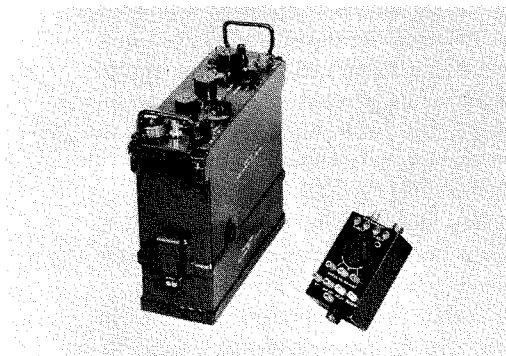
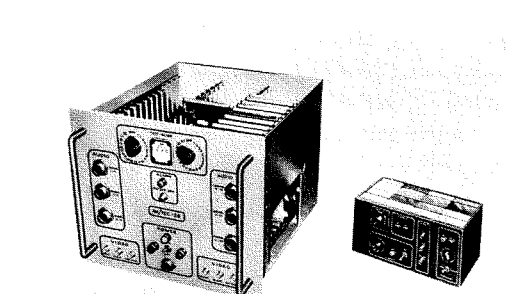

Fig. 6—AN/PRC-25 Equipment and Micro-Miniature Modular Equivalent, External Views



the modules are molded or encapsulated to form a solid body.

Since these modules are intended for broad application throughout the field of electronic systems it follows that functions of all commonly used components must be replaced in wafers.

The proposed wafer form of semiconductor construction has been considered by the RCA Semiconductor and Materials Division. Their findings indicate that the flat alloyed type of transistor construction now in use is ideally suited for the proposed wafer configuration, and working samples have been made up. A number of methods of sealing the transistor elements have been considered including ceramic or metal enclosures with glass, or preferably low-temperature indium sealing methods which have been developed by RCA.

Fixed and variable resistors present numerous possibilities of replacement or combination with other elements in semiconductor and other solid-state materials, and micro-element construction is feasible by methods of molded materials or deposited metal or carbon on .01-inch thick substrate bases. In general, resistor requirements involve need for both carbon composition quality and highly stable deposited carbon or metal precision quality in values ranging from 10 ohms to 1 megohm. Evaluations to date indicate that both types can be made with the required resistances on 0.3-inch square micro-elements.

Capacitors have been considered in two general categories: Precision applications involving close control of tolerances, stability and temperature coefficient; and utility applications filling such functions as bypassing, coupling, etc., where less accurate control of value is required. Applications conventionally accomplished with ceramic, mica, glass, paper and electrolytes must be handled.

Precision capacitor applications of values ranging from 1 to 100 micro-microfarads per micro-element can be handled by utilizing micro-elements of controlled temperature coefficient ceramic materials, the same as employed in conventional ceramic types. For higher capacitance values processes are being developed for depositing thin dielectric films on a supporting 0.01-inch thick micro-element.

For example, vacuum-deposited quartz films have shown excellent promise for low-temperature-coefficient capacitors with values up to over 1,000 micro-microfarads per micro-element. Techniques of depositing thin films of dielectric ceramics from a slurry have also been demonstrated.

Utility capacitors with values up to 0.01 microfarads can be constructed utilizing 0.01-inch thick micro-elements of conventional high  $K$  dielectric ceramics. For the value range .01 to 1 microfarad, one proposed approach utilizes the method just described of depositing thin dielectric layers on 0.01 inch thick supporting micro-elements. Another employs new dielectric materials of the reduced titanate variety in 0.01-inch micro-elements. Investigations have produced capacitors of this type up to 1 mfd.

Values from 0.1 to 10 microfarads can be obtained with electrolytic structures in thin micro-element form. Materials under consideration include aluminum, tantalum, titanium and zirconium, all with solid electrolytes.

Inductors are planned in the form of toroidal windings on ferro-magnetic cores. The toroid construction offers the advantage of restricted field, minimizing radiation and spurious coupling effects. Ferrite core materials appear advantageous for most applications. Available ferrites are capable of operating at frequencies of a few hundred kilocycles to about 100 megacycles, and in the sizes required will produce inductors from fractions of microhenries to as high as 10 millihenries. Progress is being made with development of specific ferrite compositions for precise control of temperature coefficient for the various frequency ranges. Present winding techniques for toroids are being improved through a new basic approach to the design of the toroid winding machine, and a program is under way incorporating this technique in a practical machine.

Fixed-tuned circuits are planned as being comprised of a toroidal coil and associated fixed capacitor disposed within the module in such a manner that the low potential electrode of the capacitor can be exposed after the module is encapsulated permitting adjustment by removal of part of the electrode area.

Fig. 7—AN/TCC-26 Equipment and Micro-Miniature Modular Equivalent, Internal Construction



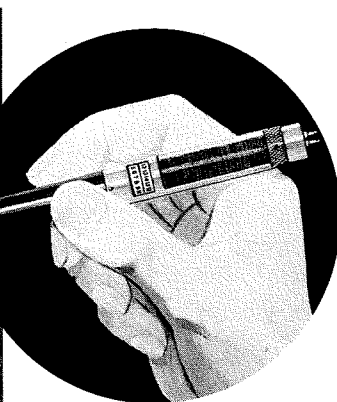
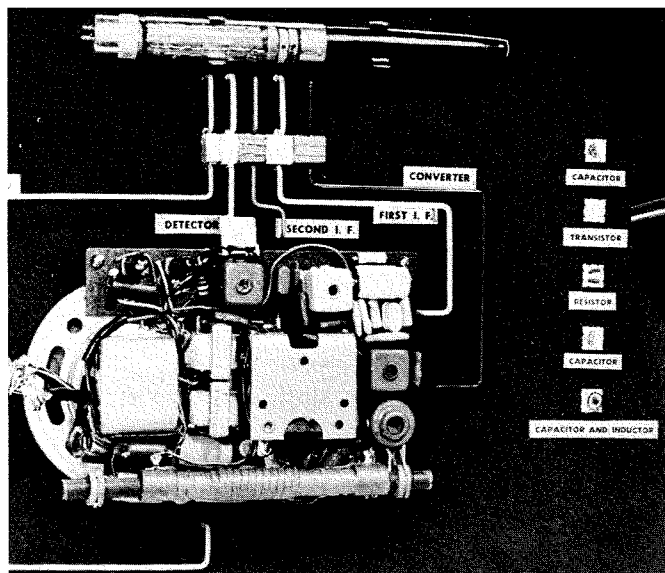
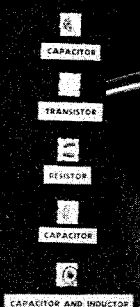

Fig. 8 — Personal Radio and a "Fountain-Pen" Micro-Miniature Modular Equivalent



Mechanical filters of piezoelectric ceramic materials offer possibilities of application for fixed tuned circuit, filters, and impedance transformation functions. The form factors are compatible with wafer construction and sample 455-kc resonators have been constructed. Recent development information indicates progress in improvement of temperature coefficient and aging characteristics.

Tuneable elements have in the past presented obstacles in equipment miniaturization attempts. In connection with the current development various electric tuning methods have been considered with a view to reducing these elements to sizes compatible with the proposed microminiature modules. Possible methods include use of ferrites, ferroelectric materials, and back-biased semiconductor. The latter device has to date offered the most promising results in that it has shown negligible temperature dependence and hysteresis effects. The comparative size of a conventional tuning capacitor and the equivalent variable capacitance diode is shown in Fig. 4.

A sample receiver has been constructed using variable capacitance diodes for the tuning elements. More conventional methods of miniaturization of variable capacitors and inductors are also under consideration.

The foregoing examples indicate that techniques are available for immediate utilization, capable of handling most basic requirements.

#### MODULE CONSTRUCTION

As mentioned previously, the modules are constructed by stacking a group of micro-elements chosen for a particular function. (see Fig. 5)

The module-to-module assembly methods are planned to provide connections as directly as possible without need for sockets and with a minimum of any form of connecting hardware. Two basic arrangements of module termination have been considered and it is probable that both will be used in various applications.

The first method employs a double-ended arrangement permitting the modules to be stacked in serial arrangement with extremely close and direct module-to-module connections. This arrangement is adapted for multistage amplifier applications such as are found in communication equipments where a well-defined signal path exists. This arrangement takes the best advantage of the inherent shielding properties of the structure to minimize interstage coupling.

The second method is a single-ended arrangement, with the modules mounted side by side on a printed circuit interconnecting board. This system is best suited to circuits such as are found in computers, where no well-defined signal path exists, but many back-and-forth connections are involved. In this case the micro-element interconnecting wires will extend beyond the encapsulation to provide terminating connectors. The module dimensions have been chosen so that all wires exit from the module on a standard 0.025-inch incremental grid for easy adaption of this method.

#### TYPICAL EQUIPMENTS

The foregoing description outlines the basic concepts and design details of the RCA micromodule concept. An all-important facet of the program, however, is the end use of the concept

in actual equipment and operational suitability of the equipment in actual service environments. The overall program, thus, includes application of the micromodule concept in typical military equipments. Since the concept is broadly applicable throughout the field of electronic systems, choice of typical applications might be made in any of the various specific applications. For example, the potentialities of the concept might be dramatically illustrated in the computer field, particularly in respect to the possibilities of miniaturization. Computer systems which now require a room full of equipment and are limited to fixed-plant applications may be reduced to proportions compatible with tactical applications, thus opening possibilities of computer application not heretofore contemplated. The impact of this concept is particularly significant in the area of missile applications, where improved reliability and miniaturization are important.

Unclassified equipment such as the AN/PRC-25 and AN/TCC-26 equipments might serve to further illustrate the concept. The AN/PRC-25 equipment was developed under Signal Corps contract for application in the combat area. Prior development of this equipment has been directed toward miniaturization and adaptation for man pack service. The equipment consists of a complete operating assembly providing FM voice communication in the 30-70 mc range. The assembly comprises a transceiver, an auxiliary monitoring receiver, power supply and necessary auxiliary equipment in a single assembly. The equipment in its present stage of development has been highly miniaturized employing transistors extensively.

The AN/PRC-25 equipment as currently designed is shown in Fig. 6 with the configuration of the same equipment in micro module form.

Although the present equipment employs 44 transistors and 1 tube, its size has been reduced to 275 cubic inches. It is estimated that application of the micro-module concept will further reduce the volume to 25 cubic inches, and at the same time provide improved reliability, improved performance, serviceability, automaticity in processing, and reduced cost.

The AN/TCC-26 equipment is currently under development on Signal Corps contract to provide small light-weight time division multiplexing of 23 or 46 voice channels for operation with existing and proposed military radio relay equipment (Fig. 7).

Previous tube versions of equipment for this application occupied several racks. The equipment in its present stage of development is completely transistorized and has been reduced to a volume of 4700 cubic inches. The complexity of this equipment can be judged by the fact that it employs 289 transistors and 536 diodes. It is estimated that application of the micromodule concept will further reduce volume of this equipment to 250 cubic inches. Fig 7 shows internal construction of the equipment.

These applications illustrate that the standardized dimensions of elements in modules used in this method of construction permit optimum volume efficiency and automatic processing.

As a sample equipment for preliminary demonstration of the micromodule concept, a broadcast personal radio receiver was constructed, as shown in Fig. 8. In this receiver the modules were housed in a structure similar to a fountain pen. The receiving set includes a ferrite core loop antenna, a variable capacitor tuning device and a hearing aid reproducer.

The circuit consists of five modules providing a converter, two stages of 455-kc i-f and an audio amplifier. The module dimensions in this receiver were worked out in accordance with the planned limits, and performance properties were realized.

#### ADVANTAGES OF THE NEW CONCEPT

Application of the RCA micromodule concept is envisaged as the reorientation of the basic principles and processing of electronic equipment design, which will ultimately provide industrial preparedness for high quantity automatic production of electronic equipment with a new order of reliability.

Reliability will be enhanced by the selection of basic materials best suited for the particular functions, by the simplified structures dictated by extreme miniaturization, and by reduction and simplification of interconnections. Mechanized and automated



**O. B. CUNNINGHAM** received his BS degree from the University of Kentucky in 1935. Shortly afterward, he joined RCA as a special tester on transmitters. His transfer into the Engineering Department in 1937 brought him into development work on mobile, shipboard and airborne communication and navigation gear.

In 1941, Mr. Cunningham entered Aviation Communications as a group leader and serves successively as unit supervisor and manager. May, 1953, saw his appointment as Chief Product Engineer, Surface Communications Engineering, and he was appointed Chief Engineer, Surface Communications Engineering in 1956. He is a Senior Member of IRE, a civil member of the American Society of Naval Engineers, and a Tau Beta Pi and Sigma Pi Sigma member.

assembly will reduce handling and variations due to human error, and the high degree of standardization of micro-elements and structures will permit standardization of assembly operations reducing possibility of error due to either machine or human failure. The modules are made small, light, solid, compact, and rugged, and subject to a minimum effect of shock and vibration. Exclusive use of semiconductor active elements improves reliability through greater inherent dependability of these elements.

Reduced size and weight are assured by capabilities of extreme miniaturization of component elements. Volumetric reductions of at least 10 to 1 over present miniaturized equipment are indicated.

Cost reduction in quantity production is assured by reduction in required quantities of basic materials through miniaturization of elements and elimination of superfluous materials in the structures. The simplified and standardized construction of micro-elements and modules will reduce manufacturing operations and permit use of simple mechanized and automated assembly equipment. The standardized construction will also permit use of relatively inexpensive data handling computing equipment for an integrated system performing such functions as storage of design data, replacing drawings, ordering,

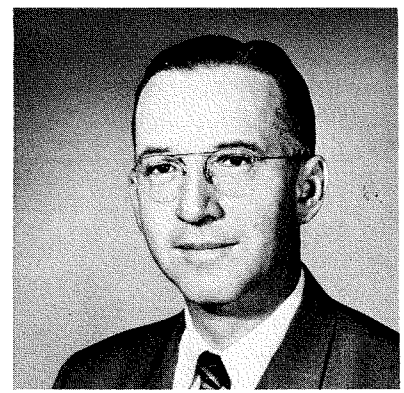

**B. V. DALE** graduated from Drexel Institute of Technology with a BS degree in EE in 1932. He came to RCA Victor the same year as a Test Maintenance man. In the following years he rose rapidly in the field of Quality Control, becoming Superintendent of this activity in 1944. From 1945 to 1952 he held various managerial posts in Manufacturing Methods, Engineering Services, Transformer Development Engineering, Test Measurements Equipment Development, and Manager of Parts Engineering. In 1953 Mr. Dale was made Manager, Engineering Section, Electronic Components Operating Division, Tube Department when this activity was transferred from RCA Victor Division. In 1956 he was appointed Chief Engineer of the newly created Components Division, a position he has held until the merger of Components Division with the Semiconductor Division earlier this year. Mr. Dale's present position is Manager, Module Engineering, Semiconductor and Materials Division.

production control, process control and other non-productive functions.

Capability of operation in more stringent environments will accrue from choice of basic materials for wider range of environment variations. Better resistance to shock and vibration is offered by the miniaturized rugged structure and the small volumes permit wider application of hermetic sealing, and shielding.

Serviceability of equipment will be enhanced by factors already mentioned. Improved reliability will in itself greatly reduce maintenance.

#### CONCLUSION

It can be readily seen that the micromodule concept opens up new horizons of application for electronic equipment not heretofore contemplated. The extreme miniaturization will permit tactical or mobile applications of equipment presently restricted to fixed plant services. It will also permit new additional functions to be furnished which have not been considered in the past because of space restrictions. The program offers a practical avenue of approach starting with application of presently available techniques and at the same time providing means for orderly expansion to embrace new techniques of current research.

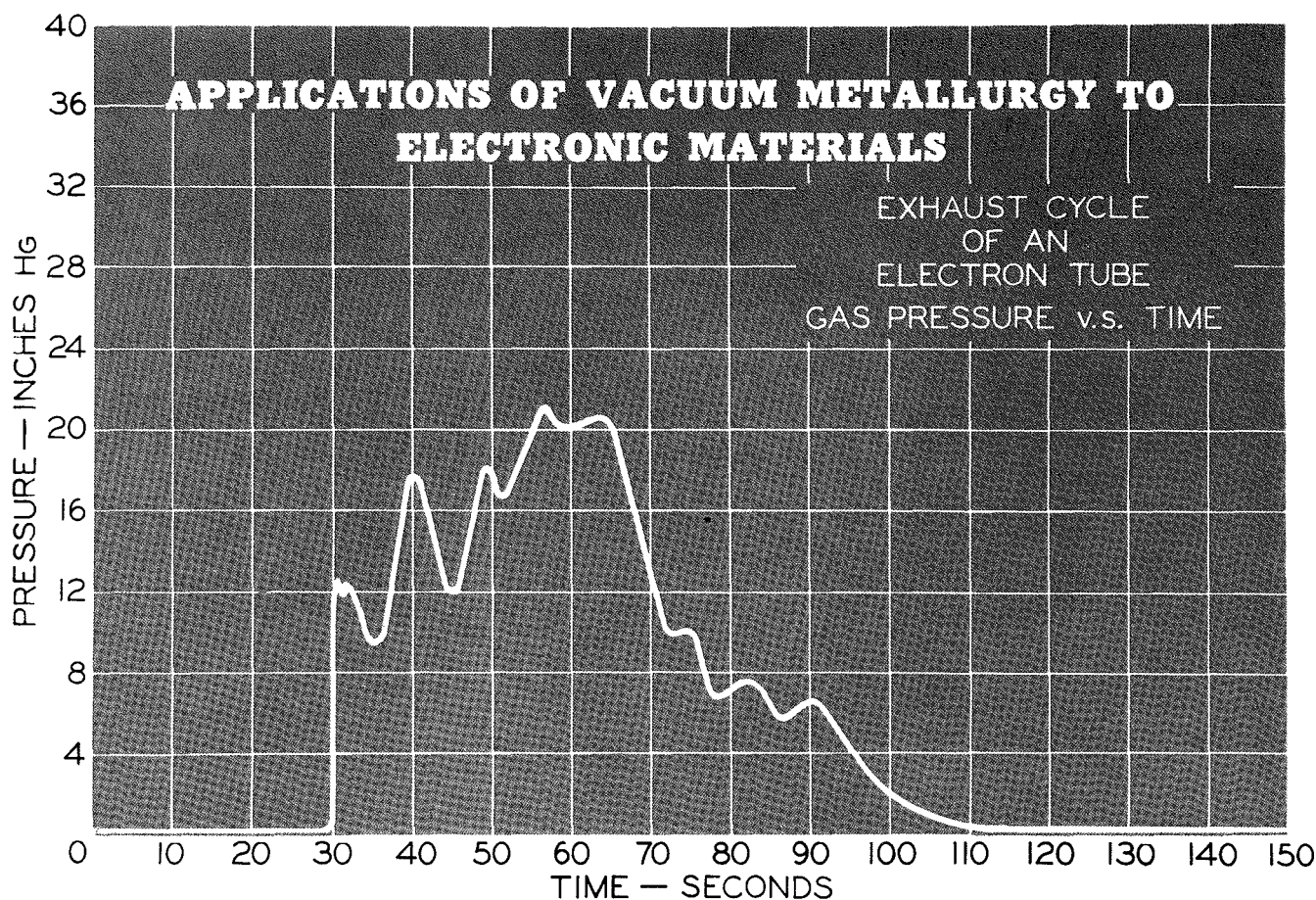

Fig. 1—Exhaust cycle of an electron tube. Temperature is maintained at 900°C.

THE TITLE "Applications of Vacuum Metallurgy to Electronic Materials" may need some clarification. In the first place, it is intended to cover applications of vacuum metallurgical processes to electronic materials, including their production and processing. Second, electronic materials are classified as those used in the construction of electronic devices and, in particular, electron tubes.

#### APPLICATIONS

In the light of these definitions applications are divided into the several categories below. Each of these categories will be commented on separately.

1. Processing of metals at high temperatures in a vacuum to drive out adsorbed and dissolved gases and thus prepare the metals for service in high-vacuum devices.
2. Vacuum-annealing processes designed to remove metal-working stresses without oxidation or other gas-metal reactions.

by

**C. W. HORSTING**

*Electron Tube Division  
Harrison, New Jersey*

3. Joining of metals-to-metals and of metals-to-ceramics by vacuum-brazing.
4. Vacuum evaporation of metals to create a metallic deposit.
5. Preparation of alloys by melting in a vacuum.

#### HIGH-TEMPERATURE PROCESSING

Metallic materials used in the construction of electron tubes generally form the main part of the internal structure. The gas content of these materials ranges from approximately 100 liter-microns per gram for bare metals like commercial nickel to about 1000 liter-microns per gram for certain types of carbon-coated plate strip. A miniature receiving tube such as type 6CG7 having a volume of approximately 12 cubic centimeters contains almost 2.5 grams of carbonized plate material and

about 1 gram of clear metal, comprising the cathode, leads, grids, and getter. The gas contained in these parts could produce a pressure of the order of 200 millimeters of Hg in the 12-cubic-centimeter volume of the envelope. Such a pressure would be about seven orders of magnitude higher than the maximum limit for vacuum-tube operation.

Because tubes usually contain metal parts in a proportion approximating the above example, it is necessary to degas these parts before they are suitable for operation in a vacuum. Gases are removed by high-frequency induction heating of the parts to approximately 900°C during the tube exhaust cycle (see Fig. 1). Adsorbed as well as dissolved gases are pumped off while the parts are at high temperature. The rate of gas development goes through a maximum during this cycle. When, subsequently, the temperature is dropped, this rate is reduced to a negligible value. With the use of a chemical "pump" called the getter, therefore, a vacuum of  $10^{-5}$  mm

Hg can be maintained without difficulty over the normal life of the tube. This method of vacuum degassing of tube parts after assembly is appropriate for small tubes and for moderate production rates.

Two circumstances, however, are tending to revise this picture. The first is the increasing trend toward higher production speeds which reduce the available outgassing time during exhaust. The second is the steadily increasing demand for quality improvement and prolongation of tube life, both of which hinge on an even more complete removal of gas from the tube. These two factors have caused a considerable amount of experimentation in the field of vacuum outgassing of tube parts prior to assembly.

Vacuum furnaces for such purposes have been developed in a variety of types. Some of these are the "batch" type having parts containers that are moved between a hot zone and a cooling chamber without breaking the vacuum. These furnaces process large numbers of parts at a time. Other furnaces are of the horizontal semicontinuous variety. They have vacuum locks at each end and a hot zone in series with a cooling zone so that boats containing parts can be moved through the furnace in the same way as in conventional hydrogen-firing furnaces. The pumping systems are generally equipped with mechanically backed booster-type diffusion pumps which allow operating pressures as high as 1000 microns. This feature is advantageous in connection with the initial gas surges which occur when parts to be outgassed are first introduced in the furnace. At the end of the outgassing cycle, the pumps should be able to pump the furnace down to a pressure in the range of 0.5 to 0.01 micron of Hg. Furnace temperatures center around 1000°C.

It can be expected that the present developmental trend toward pre-outgassing of small receiving-tube parts will gain in importance. Moreover, several other classes of electron tubes have already adopted this procedure. These include the larger tubes known as power tubes and magnetrons, which contain large masses of solid metal. For many of these types, all parts are

vacuum-fired prior to assembly. The practice has also been established in the manufacture of some recently developed ceramic and metal tubes. It has been reported in this case that all tube parts are outgassed in a vacuum at a temperature of 1200°C prior to assembly.<sup>1</sup> The traveling-wave tube is another type for which all parts are frequently vacuum-treated for periods between ½ and 1 hour at temperatures ranging from 700°C for copper to 1800°C for tantalum. For receiving tubes, a combination of pre-outgassing and automatic parts handling will ultimately lead to the fulfillment of the requirements mentioned before.

#### VACUUM-ANNEALING

The second category, vacuum-annealing, is applied where it is important that no contamination of the metal occur during removal of the stresses of work hardening. In some cases oxidation of minor elements or loss of carbon caused by reaction with a prepared protective atmosphere must be avoided. Although this technique may not be standard in production, it has been used successfully for the intermediate anneals applied during the drawing of seamless nickel tubing used for electron-tube cathode sleeves. Because of the special sensitivity of cathode material to impurities and contamination, it is felt that this technique is ideal for this case.

Caution should be exercised in regard to cleanliness of the material to be vacuum-annealed. Some carbonaceous-drawing lubricants which might be removed by a slightly oxidizing protective atmosphere may behave differently in a vacuum and diffuse into the metal with a resultant unwanted contamination.

#### VACUUM-BRAZING

The third category, joining metals to metals and metals to ceramics by vacuum-brazing, does not apply to conventional receiving tubes but does apply to several of the other classes of tubes previously mentioned. Although many power tubes are still brazed in a protective atmosphere and subsequently exhausted, there is an increasing trend to vacuum-braze subassemblies. In modern ceramic-and-metal-tube manufacture, exhaust and sealing cycles are combined into two succes-

sive steps of one and the same process. During this process, the metal and ceramic parts are first assembled with brazing material in the proper locations, and then placed in a vacuum furnace. Because the tube envelope in the unbrazed condition is still open, a vacuum is created inside as well as around the tube. The temperature is then gradually raised and, after some cathode processing, brought to the point where the brazing material melts and seals the tube envelope. It is reported<sup>1</sup> that the whole process can be accomplished within ten minutes. Many small tubes may be exhausted simultaneously.

The nature of the ceramic-to-metal brazing materials, such as the titanium-copper eutectic alloy, requires a high vacuum if reproducible results are to be obtained. The active ingredient in these alloys has such an affinity for oxygen that it will compete for oxygen with the oxides present in the ceramic and, as a consequence, wet and react with the surface layer of the ceramic part. When gaseous oxygen is present in sufficient amounts, it may react preferentially and prevent a good braze. A pressure in the order of 10<sup>-5</sup> mm Hg is desirable in such operations.

#### VACUUM EVAPORATION

The fourth category, vacuum evaporation of metals, has several applications in the electronics field. First, it is applied in the well-known process of aluminizing the phosphor screens of television picture tubes to provide increased picture contrast. A stranded tungsten-wire filament, having small pieces of aluminum attached, is inserted in the neck of the picture tube, which is subsequently evacuated to a pressure of the order of 10<sup>-5</sup> mm Hg. The tungsten filament is then heated to approximately 1400°C by passage of a current, and the aluminum is evaporated onto the screen to a thickness of about 1000 angstroms. This process has been highly mechanized and is automatic except for the insertion of the filament.

A second case of vacuum evaporation applicable to electron tubes is the evaporation of barium metal by flashing a "getter." The barium deposit in a tube is visible as a bright metallic mirror in the dome of the glass envelope. It serves, by virtue of its very

great affinity for atmospheric gases, as a chemical pump to remove any gas that may have remained in the tube after exhaust or that may be developed from tube parts during operation. The evaporation of the barium is effected during the last phase of the exhaust process by high-frequency induction heating of a small closed metal loop containing a capsule filled with either pure barium or a high-barium alloy. The flashing temperature is about 850°C, and the flashing lasts about one second.

A third example is the production of capacitor paper for so-called self-healing capacitors by evaporation of metal onto paper. A continuous jet of metal vapor is directed against a varnished paper strip as it moves past the evaporation source, and a continuous metal film about 1000 angstroms thick is deposited. A metal frequently used for this purpose is zinc. The paper moves at a speed of about 20 feet per second. A vacuum of not more than  $10^{-2}$  mm Hg is sufficient because the dense metal vapor jet prevents intruding gas molecules from penetrating its periphery and thus keeps them from getting between the jet and the paper. This process, which has evaporation-rate control and the feature of high-speed motion in a vacuum, is a true example of the progress made in vacuum technology in recent years.

A fourth example is the evaporation of a copper pattern onto a phenolic resin sheet to form the basis for a printed circuit. The copper pattern is too thin to be used as deposited, but is built up to approximately 0.015 inch by electroplating. To deposit on plastic, it is often favorable to outgas the surface by preheating, and to drive off the last traces of adsorbed water vapor and gases by means of electron or ion bombardment. A voltage of 2500 volts and a current in the milliamperage range are used for this purpose. Further examples are the manufacture of selenium rectifiers and the application of gold to quartz crystals for frequency-control devices.

#### VACUUM MELTING

The fifth category, preparation of alloys by melting in a vacuum, is in its infancy in the electronics industry, but is growing in importance. It is a well-known fact that experimentation with

vacuum melting of magnetic alloys has been carried on for many years. In addition, there is a small group of alloys like chrome-copper, titanium-copper, titanium-nickel, zirconium-silver, magnesium-silver, and magnesium-nickel, which contain relatively large amounts of highly reactive metal additions. Although some of these alloys are still made by conventional air melting, experimental evidence shows that vacuum melting would provide many advantages. Chromium, for instance, is difficult to alloy with copper because of its strong tendency to form an adherent oxide skin. The copper has to be heated almost to the melting point

tube cathode. These intricate alloys affect the operational properties of the tube as it is manufactured, as well as during operation. Their main ingredient is nickel, with additions of cobalt, silicon, magnesium, manganese, carbon, tungsten, aluminum, titanium or other elements in various amounts and combinations, most of them in quantities not larger than one-tenth to one-hundredth of one per cent. Because the cathode performance is dependent upon a reduction reaction between these alloying agents and the electron-emissive alkaline-earth oxide coating which is applied to the cathode sleeve, it is evident that the amount of these

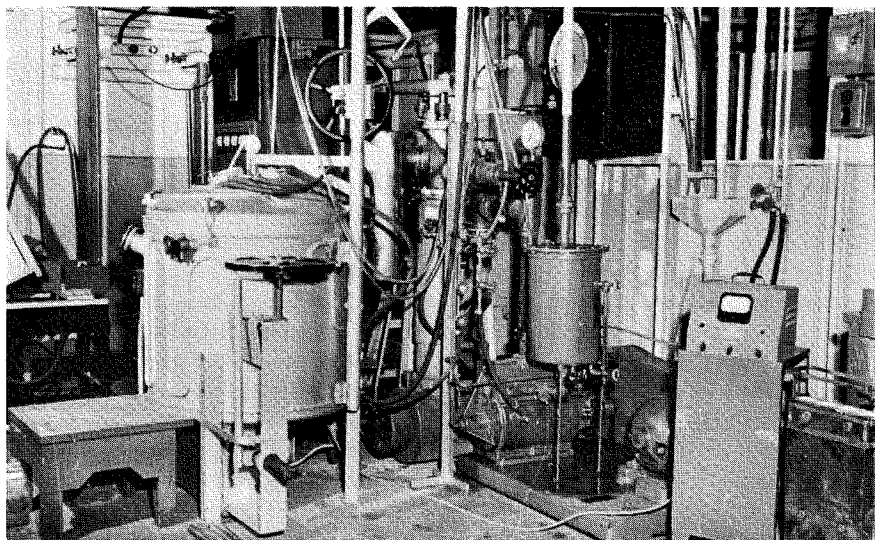

Fig. 2—Vacuum furnace and associated equipment for production of cathode alloys.

of chromium before the latter goes in solution. When melted in a vacuum, the chromium addition goes in solution without trouble as soon as the copper becomes liquid. Some difficulties have been encountered because some high-titanium alloys wet the ceramic crucible and tend to penetrate the walls and run out. A recent advancement, however, was reported<sup>2</sup> to the effect that crucibles made from zirconium oxide mixed with metallic titanium are suitable for such alloys and are not wet by them.

#### CATHODE SLEEVE MATERIALS

From the material standpoint, the first alloys to be considered are the materials used for the sleeve of the electron-

reducing agents and their state of availability in the nickel is very important. The commercial nickel alloys which have been and are still largely used for this purpose have the serious drawback that their composition is insufficiently controlled for the delicate function they serve in the electron tube. Minute amounts of impurities or small excesses of legal constituents are not significant in stainless steel or other high-nickel alloys for which most nickel is being used. However, the same slight abnormalities may adversely affect electron-tube production. Experimentation with vacuum melting was initiated to obtain the needed composition control.

At RCA, production for directly

heated filamentary-type cathode alloys has continued successfully for a number of years. Figs. 2 and 3 show views of the vacuum furnace used for this work. Because most cathodes, however, are of the indirectly heated type (which comprises the use of a cathode sleeve over a heater), it can be expected that this field will be attacked next. Experimentation in that direction is going on.

#### CRUCIBLE MATERIALS

The following material describes some of the experiences and difficulties encountered in the development of a production process for filamentary-

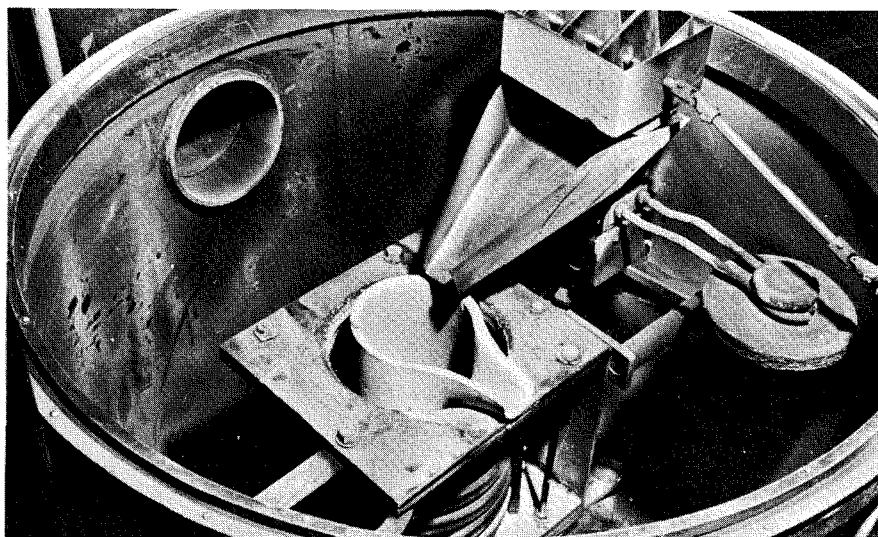

Fig. 3—Internal view of the alloying furnace.

type cathode alloys by vacuum melting. Let us first consider crucible materials. Because every crucible melting operation is essentially an act of contamination, and because strict composition control was the prime objective, it was mandatory to obtain crucible materials having sufficient inertness to reduce contamination to a harmless level. Among the available materials investigated were beryllium oxide, stabilized zirconia, zirconium silicate, aluminum oxide, and magnesium oxide. The first four materials were found to be satisfactory from the point of view of contamination, but magnesium oxide caused magnesium contamination of the order of a few hundredths of a

per cent if carbon was added to the melt. It was found that the electrically fused variety of magnesium oxide does not exhibit this defect. All materials, however, showed unsatisfactory mechanical properties and crucible life after repeated use.

This problem caused considerable initial trouble and material damage. The first improvement resulted from the change of the crucible design from a flat to a half-spherical bottom, which has a more favorable expansion-contraction pattern. It also appeared necessary to minimize shrinkage of the insulation material which directly supports the crucible from

volves the use of an ordinary ceramic melting crucible which is installed in the conventional manner by ramming insulating material between it and the high-frequency coil. However, a ceramic lining of approximately one-half-inch thickness is applied to the inside of the crucible in paste form and baked in place by the local application of a high temperature. This lining can easily be removed when it starts to suffer physical damage and replaced without removal of the crucible itself, which is a major operation. Relining is also faster and simpler than making a rammed crucible and, because very little material is used, it is simpler and faster to outgas. This procedure also allows choice of a material which is compatible with the alloy composition even if the crucible is not.

One point concerning crucibles which is of interest in connection with the pumping system is the fact that ceramics generally contain considerable quantities of water. It is not always possible to remove this water by prebaking, particularly when a lining is used. The water will escape under heat in a vacuum, and passes through the pumping system. For this reason, it is highly recommended that a gas ballast control be available on the mechanical pump to prevent reduced pumping capacity and oil changes.

#### NICKEL DEOXIDATION

Deoxidation of the molten nickel prior to introduction of the alloying agents was another subject which needed a satisfactory solution. Because carbon was used for deoxidation in the air-melting procedure, it was tried first also in a vacuum. However, it was found to be too troublesome because spitting and boiling are accentuated by the vacuum and because of the uncertainty of carbon retention. A point to be noted here is that if carbon is introduced in a vacuum melt which has been well deoxidized previously, boiling and spitting may still occur if the carbon has not been previously outgassed. The carbon can be outgassed by heating in a vacuum to a temperature of approximately 1500°C in a graphite crucible until gas development ceases.

The solution to the problem of de-

below by a proper choice of materials. Sinter shrinkage of the bottom support causes loss of contact between crucible bottom and the support and eventually results in failure of the bottom with its various undesirable consequences.

Satisfactory crucible life was not obtained, however, before a new approach was tried—that of using a lined crucible. It is believed that this method is not widely known because crucible life still seems to be an industry-wide problem. Ten to twenty melts per crucible were recently referred to as a good record in industrial vacuum melting. With a lined crucible, this number can be multiplied tenfold. This technique in-

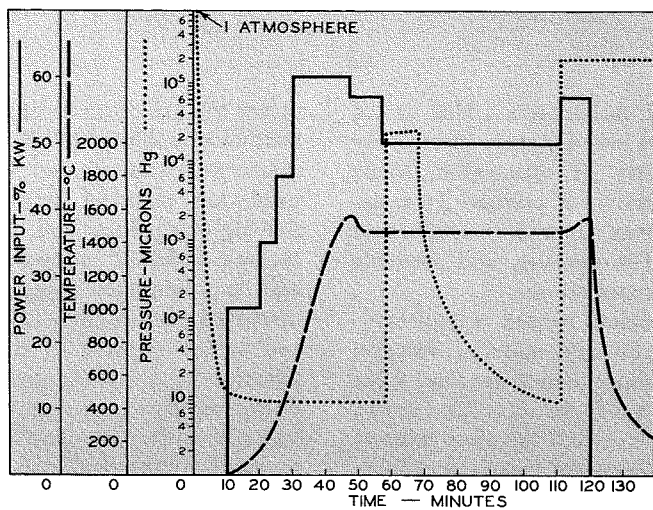

Fig. 4—Pressure, temperature, and power input record of a melting cycle for nickel used in cathodes.

oxidation of the molten nickel has been solved by allowing it to react with hydrogen. Cathode-alloy melts are presently deoxidized by holding the molten nickel at a temperature approximately 100°C above its melting point in hydrogen having a pressure of 20 mm Hg for ten minutes. Fig. 4 shows graphically the pressure, temperature, and power-input record of a melting cycle, including the deoxidation process. The mole ratio of hydrogen to nickel in the furnace volume is about one to ten, which is a large excess compared to the oxygen content of the nickel. This mole ratio is probably the reason why deoxidation is so complete that, after removal of the hydrogen, solid carbon can be introduced into the melt without the slightest gas development. The procedure is effective and simpler than the method in which hydrogen is pumped through the furnace by continuous introduction and removal. The oxygen content of the resulting cathode material is between one and two orders of magnitude lower than that produced by conventional air melting.

#### RETENTION OF ALLOYING ADDITIONS

Next, the problem of retention of alloying additions should be considered. As indicated before, the additions for cathode nickel consist mainly of silicon, carbon, manganese, magnesium, tungsten, or cobalt. Because no oxidation losses occur, retention depends mainly on vapor pressure of the addition metal, time between addition and pouring of the melt, temperature during that period,

and chemical interaction between alloying constituents. When hydrogen deoxidation was carried out effectively, it was found that silicon, carbon, and manganese are retained almost completely if added in quantities up to 0.2 per cent. Tungsten and cobalt show no losses because their vapor pressures are too low. However, magnesium exhibits a considerable loss by evaporation. If added, for instance, in an amount of 0.2 per cent, it will be retained, under certain standard conditions, in the amount of  $0.04 \pm 0.01$  per cent. There is evidence to show that magnesium evaporation is retarded by the presence of carbon in the melt. A similar condition reported<sup>3</sup> for manganese has been attributed to association of the two dissolved elements in the molten state.

Besides improved composition control, another advantage was realized for alloys drawn to extremely fine wire sizes, such as the filament alloy used in miniature tubes of the "instant warm-up" type. These wires have a diameter of 0.001 inch. Drawing them from air-melted material used to be a considerable problem because the presence of non-metallic inclusions caused breakage and high die wear. The switch to vacuum melting resulted in greatly improved wire-drawing conditions and reduced the problem to insignificant proportions.

In conclusion, it can be said that vacuum metallurgy in its relatively short existence has already found numerous applications in the realm of electronic materials. It is expected that its significance in this field will increase considerably in years to come.

#### REFERENCES

1. Data from paper by J. E. Beggs, given at I.R.E. meeting in New York, fall 1956.
2. Data from paper by B. C. Weber, W. M. Thompson, H. O. Bielstein and M. A. Schwartz, Wright Air Development Center, given at American Ceramic Society meeting, Dallas, Texas, May 1957.
3. W. J. Kroll, *Met. Ind.*, 1935, 47, 3, 29, 103.

#### BIBLIOGRAPHY

- A. U. Seybolt, *Metal Progress*, November 1946, p. 1102.  
 J. D. Nesbit, *Iron Age*, 159, 25, p. 56 (June 19, 1947).  
 R. A. Stauffer, *Chem. & Ind.*, 1948 (41), S19-S26.  
 J. D. Nesbit, *Iron Age*, 161, 79 (March 18, 1948).  
 J. D. Fast, *Philips Res. Rep.* 4, 370-374 (October 1949).  
 W. J. Kroll, *Vacuum Metallurgy*, Volume 1, No. 3 (1951).  
 Papers presented at Vacuum Metallurgy Symposium, Electrochemical Society, October 1954.  
 A. J. Martin, *Met. Ind.* 8, June 1956, p. 473.  
 J. R. Davy, *Industrial High Vacuum*, Pitman (London).  
 S. Dushman, *Scientific Foundations of Vacuum Technique*, Wiley, 1949.  
 R. C. Picard and J. E. Joy, *Electronics*, 1951, 24 (4), 126-128.  
 Transactions Vacuum Symposium, Committee on Vacuum Techniques, 1954.  
 J. Yarwood, *High Vacuum Technique*, Wiley, 1955.

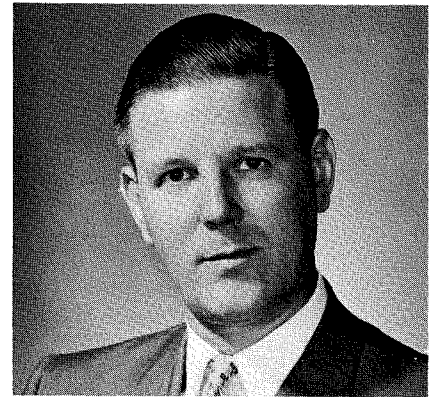

**C. W. HORSTING** received the B.S. degree in Chemistry in 1934 and the M.S. degree in Physical Chemistry in 1938, both from the University of Utrecht in the Netherlands. He came to the United States in 1940, and joined RCA two years later as a member of the Metallurgy group in the Chemical and Physical Laboratory of the Electron Tube Division in Harrison. From 1942 to 1951, he worked on problems such as carburization of thoriated-tungsten filaments, electron-tube cathode alloys having high strength at elevated temperature, metal-tube main-seal welding, and electron-emission problems. He was instrumental in the introduction of vacuum melting for the production of cathode alloys. Since 1951, he has been Engineering Leader in charge of the Metallurgy group at Harrison.

Mr. Horsting is a member of the American Society for Metals and the American Institute for Mining and Metallurgical Engineers, and a representative for RCA in the American Society for Testing Materials.

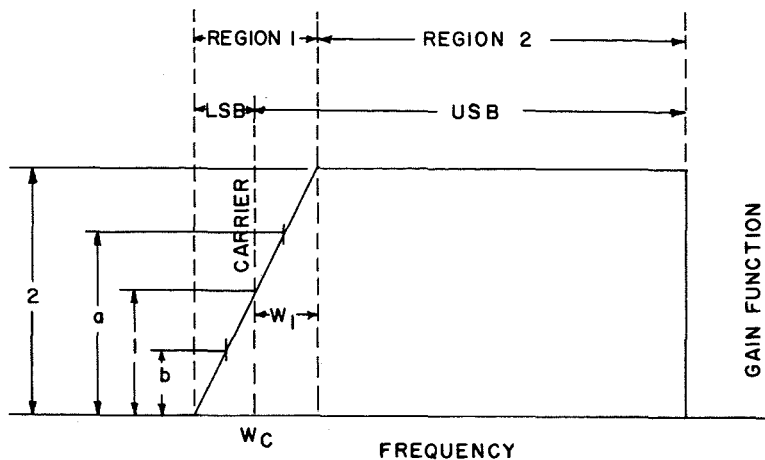

Fig. 1—System gain function of the standard US vestigial sideband TV transmission spectrum.

## SECOND DETECTORS IN TV

R. W. SONNENFELDT

Advanced Development Engineering  
Industrial Electronic Products  
Camden, N. J.

TO OBTAIN OPTIMUM performance in a communication system, the signal detector demodulation characteristic should be matched to the modulation characteristics of the signal to be received. Such matching of detection characteristics often increases circuit complexity to such a degree that, as a practical expedient, less costly or more reliable circuits with imperfect demodulation characteristics are frequently substituted. When such substitutions are made, it is important for the engineer to know precisely which performance factors are affected, quantitatively and qualitatively.

The commercial television system is an example of a system whose performance is optimum when the second detector is *matched* to the signal modulation characteristics. Because of the relative complexity of such matched detectors, the much simpler diode envelope detector is universally used in practice. The purpose of this article is to assess the improvements that can be accomplished by the use of the more sophisticated, matched circuits and at the same time give an indication of the attendant increase in circuit complexity.

### THE COMMERCIAL TELEVISION SYSTEM

The method of video modulation employed in the U.S. standard TV system is vestigial sideband (VSB).

Operationally, one may start with standard AM and then remove the higher difference frequency components of the sideband, say the lower sideband, by a suitable filter to obtain VSB operation. To equalize the video characteristics, the system gain function of Fig. 1 has been adopted. This transmission spectrum is here shown divided in two regions. Region (2) is single-sideband; Region (1) is an asymmetric sideband region. For very low modulating frequencies, operation in Region 1 is essentially AM since both sidebands are present and their amplitude difference is small. For modulating frequencies of the order of  $\omega_1$  in Region 1, operation is essentially

single sideband since the lower sideband amplitude is negligible. For single tone modulation compact mathematical expressions are obtained.

With a carrier

$$e_c = \cos \omega_c t$$

and modulation

$$-e_m = m \cos \omega_m t,$$

the result of AM is

$$e_s = e_c [1 + e_m]$$

$$= (1 + m \cos \omega_m t) \cos \omega_c t \quad (1)$$

where  $e_s$  is the modulated carrier.

By standard methods, Eq. (1) is expanded to give three terms, a carrier and two sideband terms.

$$e_s = \cos \omega_c t + \frac{m}{2} \{ \cos (\omega_c + \omega_m) t + \cos (\omega_c - \omega_m) t \} \quad (2)$$

### ENVELOPE DISTORTION IN VSB SYSTEM

Let the gain for upper and lower sideband be  $a$  and  $b$  respectively after transmission through an appropriate VSB filter. The AM wave  $e_s$  is then converted to the VSB wave  $e_s'$ .

$$e_s' = \cos \omega_c t + \frac{m}{2} \{ a \cos (\omega_c + \omega_m) t + b \cos (\omega_c - \omega_m) t \} \quad (3)$$

For convenience, assume that  $e_s'$  is the voltage actually available at the system output, i.e., at the detector terminals. The engineering problem is then to determine what operation will recover from the wave  $e_s'$  of Eq. (3) the modulating tone

$$e_m = m \cos \omega_m t$$

without distortion.

Unfortunately, we know of no general mathematical procedure to solve for this operation except in linear passive circuits. Since demodulation is an inherently non-linear process, we must adopt a trial and error philosophy. For instance, we might manipulate Eq. (3) into various forms which place in evidence the associated envelope, phase-modulation, in-phase, and quadrature component functions. By using appropriate substitutions, Eq. (3) may be rewritten

$$e_s' = \cos \omega_c t [1 + m(a+b) \cos \omega_m t] + \sin \omega_c t [m(b-a) \sin \omega_m t] = P \cos \omega_c t + Q \sin \omega_c t \quad (4)$$

Fig. 2—Square-wave response of flat staggered triple; carrier at 50 percent on selectivity curve.

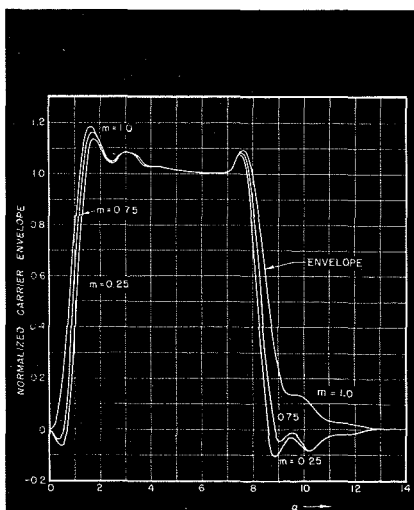



where

$$P = 1 + m(a + b) \cos \omega_m t$$

$$Q = m(b - a) \sin \omega_m t$$

$P$  and  $Q$  are the magnitudes of the in-phase and quadrature components. The envelope of  $e_s'$  is

$$E_s = \sqrt{P^2 + Q^2} \quad (5)$$

and the phase modulation is

$$\theta(t) = \tan^{-1} \frac{Q}{P} \quad (6)$$

$P$  is the magnitude of the "in-phase" component and  $Q$  the magnitude of the quadrature component.

It is now noted that only  $P$  is a linear function of the modulation,  $m \cos \omega_m t$ . Ideally speaking, this is the quantity one should detect in a VSB system. But it is worth noting that for sufficiently small  $m$ , and/or sufficiently small  $(b - a)$ , the magnitude  $Q^2$  becomes negligible with respect to  $P^2$  so that

$$\text{Lim } E_s = P \quad (7)$$

$$m(b - a) \rightarrow 0$$

An envelope detector therefore gives distortionless demodulation in VSB systems only for extremely low modulating frequencies (for which  $(b - a) \rightarrow 0$ ) or for very low depth  $m$  of modulation. For more representative modulation there will be distortion. This distortion as such is relatively unimportant in practical TV systems, where single-tone modulation is indeed a rare occurrence. But this distortion does cause difficulties with the pulse response. Fig. 2 shows how the pulse envelope response of a typical TV receiver changes with depth of modulation. Fig. 3 shows for comparison the in-phase and quadrature components which are independent of  $m$ . The responses of Fig. 3 can be compensated with standard equalizers. This cannot be done with the waveforms of Fig. 2.

#### CROSS-MODULATION EFFECTS IN VSB ENVELOPES

Wherever engineers find distortion, they also look for cross-modulation or inter-modulation effects. In the case of VSB signals, the mathematical analysis of these effects, though straightforward, is cumbersome and is therefore not undertaken here. In general, cross modulation is the un-

desired variation of the magnitude of one signal by magnitude variations of another signal. So far as the envelope of two signals in VSB systems is concerned, the cross-modulation effects are as follows:

When two signals with a large difference in magnitude are present, the envelope function is determined by the larger of the two signals, with cross modulation of the smaller by the larger, but not vice versa. At the detector output, the smaller signal (even though it may be the desired one) is effectively reduced by a factor inversely proportional to the magnitude of the larger signal. There is also phase cross modulation, i.e., changes in the amplitude and/or phase of the larger signal cause spurious phase modulation in the smaller signal. For instance, changes in a large picture carrier will produce spurious changes in the magnitude and phase of a small sound carrier in a TV receiver. This gives rise to the familiar buzz problems.

When two signals of comparable magnitude are present, each will cross modulate the amplitude and phase of the other. For instance, a change in the brightness component of a color video transmission, will cause spurious changes in the chroma component of a VSB envelope. The reverse is also true.

In Fig. 4a is shown a representative color bar video signal consisting of two bars of equal chroma amplitude but different brightness. After transmission through a VSB system, the output of an envelope detector is as shown in Fig. 4b. The higher brightness level (for the right bar) has caused a decrease in the d-c component of the carrier magnitude with resultant partial suppression of the chroma magnitude.

In distinction, analysis shows that

the in-phase component unlike the envelope is free from such cross-modulation effects. This is, of course, to be expected from the linearity of the in-phase component shown by equation (4).

In addition to steady-state cross-modulation effects, there are transient effects. The peak value of this transient envelope cross modulation often is many times the steady-state value. Again, when an in-phase component detector is used, there is no cross modulation.

Table I summarizes the distortion and cross-modulation effects.

#### NOISE CONSIDERATIONS

One way of describing fluctuation noise is to say that it consists of a very large number of sine waves, occurring at all possible frequencies in the band considered, having equal amplitudes but being randomly phased with respect to each other. In practice, little inaccuracy results when fluctuation noise is represented by a finite number, (say ten) of sine wave generators in the band considered. One can then visualize the interaction between signal and noise (or between different noise components) as cross-modulation effects. When the noise is strong and the signal is weak, the envelope, in addition to the noise and the signal, will contain (1) cross-modulation products formed by noise-to-signal interaction, (2) cross-modulation products formed by the interaction of different noise components, and (3) distortion products of the noise input.

All three of these products combine to produce excess noise, much of it at the lower frequencies. As a result, when the envelope is detected, the output signal-to-noise ratio is poorer than the detector input signal-to-noise ratio. Such excess noise is not gener-

TABLE I  
DETECTORS IN VSB SYSTEMS

Type of Signal	IPC Detector	Envelope Detector
Sine wave modulated	No distortion	Appreciable distortion for large modulation
Square wave or pulse modulated	Symmetrical transient response	Asymmetrical transient response for large modulation
Brightness + small sound carrier	No cross modulation	Sound intercarrier phase modulated by brightness
Brightness + large sound carrier	No cross modulation	Each phase and amplitude modulates the other
Brightness + color + small sound carrier	No cross modulation	Brightness and color carriers each phase and amplitude modulated by the other. Sound intercarrier phase modulated by both
Brightness + color + large sound carrier	No cross modulation	Each phase and amplitude modulates all others
Desired + large undesired signal	No signal suppression	Desired signal suppressed. Modulation transferred to undesired signal
Co-channel	Venetian blind effect can be eliminated	Weaker signal produces Venetian blinds in stronger

ated in an "in-phase" component detector, since these cross modulations and distortions do not occur.

When in-phase-component detection is used, the output signal-to-noise ratio is the same as the input signal-to-noise ratio. Fig. 5 shows plots of output signal-to-noise ratios vs. input signal-to-noise ratios for envelope and in-phase component (IPC) detectors. Note that for input signal-to-noise ratios less than 0 db, the envelope detector output signal-to-noise ratio decreases so rapidly that a virtual detection threshold exists.

In television fringe reception this excess envelope noise is often a significant factor that will determine whether or not a received picture has entertainment value. Consequently, worthwhile improvements may result when IPC (in-phase component) detection is used. Envelope and IPC detectors also perform differently with respect to impulse noise. If impulse excitation is applied to the terminals of a bandpass system, there will be a system response producing a wave: (a) at the center frequency of the excited system, (b) whose decay is related to the bandwidth of the system with wide bandwidth corresponding to rapid decay, (c) whose amplitude is related to the input shock excitation amplitude.

This response will combine with signals in the system to form an envelope. If the impulse noise is sufficiently strong, there will be complete suppression of the signal and an envelope detector will detect the envelope of the noise rather than the signal. Again, if an IPC detector is used, there is no cross modulation. The output is the signal, plus a modulated beat between the signal carrier frequency and the center frequency of the system. In VSB systems this is a relatively high frequency so that the impulse noise output of IPC detectors is all at high frequency. This has advantages for agc and sync circuit operation in television.

Table II summarizes the noise performance of envelope and IPC detectors.

#### IPC DETECTORS

In view of the apparent advantages of IPC detectors, it is now appropriate to consider practical methods of IPC detection. Such methods may be

divided into (1) carrier enhancement, and (2) sampling methods.

Carrier enhancement methods have the effect of reducing  $m$ , the depth of modulation, and also of making a desired signal relatively large compared to undesired signals. This reduces distortion and cross-modulation effects in the envelope, but proper compensation of the video characteristic is required. Fig. 6a shows a carrier-enhanced VSB characteristic and Fig. 6b the required video compensation.

While this method is effective in the reduction of cross modulation and distortion, and in lowering the threshold signal-to-noise ratio, the improvement available depends on the degree of carrier enhancement and the extent to which the difference  $(b - a)$  of the lower frequency sidebands is reduced. Because of circuit tolerances and the video matching problem, enhancements of the order of 4 to 1 are considered at the present stage of the art as near the limit. On paper a carrier-enhanced receiver looks the same as one with a conventional envelope detector, except for i-f alignment and video compensation.

Sampling methods, on the other hand, make use of product or synchronous detection techniques and do not depend on desired-to-undesired-signal or signal-to-noise ratio for their effectiveness. Consider multiplication of the VSB wave  $e_s'$  of Eq. (4) by a wave whose recurrence rate is  $\omega_c$  such as

$$e_p = a_0 + \sum_1^{\infty} a_n \cos(n\omega_c t + \theta_n)$$

so that the product is formed

$$E = e_s' \times e_p = [P \cos \omega_c t + Q \sin \omega_c t] [a_0 + \sum_1^{\infty} a_n \cos(n\omega_c t + \theta_n)] \quad (8)$$

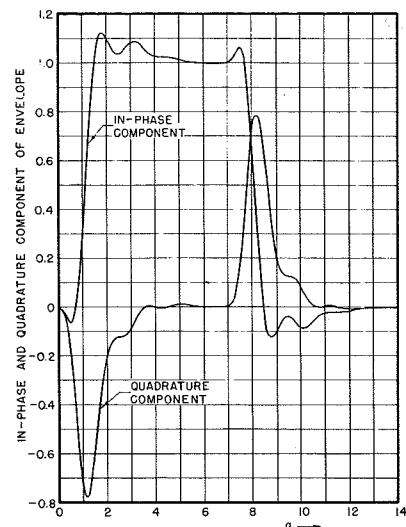

Fig. 3—Normalized square wave response of flat staggered triple carrier at 50 percent.

The low-frequency component of this product is

$$E_{LF} = P \cos \theta_1 + Q \sin \theta_1$$

$$\text{for } \theta_1 = 0, E_{LF} = P$$

$$\text{and, for } \theta_1 = \frac{\pi}{2}, E_{LF} = Q.$$

It is seen that either  $P$  or  $Q$  or linear combinations of  $P$  and  $Q$  may be detected, depending on the value of  $\theta_1$ . Any linear product detector or sampler type is suitable to perform this operation. The problem, however, resides in the generation of the synchronized pulse wave  $e_p$ . Methods of generation that have received attention are automatic phase and frequency control methods, and locked oscillator carrier generators. At this writing, their relative cost and complexity has been too great to justify their inclusion in home television receivers for the relatively small additional improvement available over the

TABLE II  
NOISE PERFORMANCE OF DETECTORS

Signal Condition	IPC Detection Output	Envelope Detection Output	Remarks
Strong signal with weak pulse noise interference	Linear combination of noise and signal. No DC and LF component generated	Same	
Weak signal with strong pulse noise interference	Linear combination of noise and signal generates whiter than white components but no DC and LF output	Signal suppressed during strong noise peaks. Generates DC and LF components. Sound suppressed on noise peaks.	Product detector needs video noise inverter. Envelope detector needs sync and agc noise inverter
Strong signal with little thermal noise	$(S/N)_o = (S/N)_i$	Same	
Weak signal with much thermal noise	$(S/N)_o = (S/N)_i$ Good sound quieting	$(S/N)_o = (S/N)_i^2$ Signal selectively suppressed by threshold effect. Poor sound quieting.	Maximum realizable advantage of product detector approximately +11 db for picture; approximately +14 db for sound

enhanced-carrier type of IPC detector. Fig. 7 shows a block diagram of an afc-locked product detector arrangement. The phase detector, oscillator-reactance tube loop forms a standard automatic phase and frequency control loop which locks the oscillator to the i-f carrier.

#### DISCUSSION

In view of all the apparent faults of envelope detection in VSB systems, one may ask, "Why have envelope detectors, nevertheless, been universally used in home television receivers?" The answer is that their simplicity and low cost have been such major advantages that it has been worthwhile to adopt special remedies in home television receivers to compensate for performance deficiencies by special trap techniques and control of subcarrier and sound carrier amplitudes. The residual deficiencies in the pulse response and chroma-to-brightness cross modulation are not considered limiting at this time, but may well become so as transmitting techniques are improved and receiver display areas are increased. There is probably little risk in predicting that in the near future we shall see more of enhanced-carrier techniques using envelope detectors to obtain approximate IPC detection. Eventually, with greatly improved frequency memories becoming available, sampling detectors may well become important in home television receiver design.

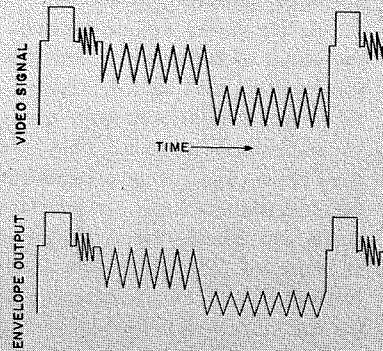

Fig. 4—(a) color bar video signal of equal chroma amplitude but different brightness; (b) shows the same signal after transmission through a VSB system.

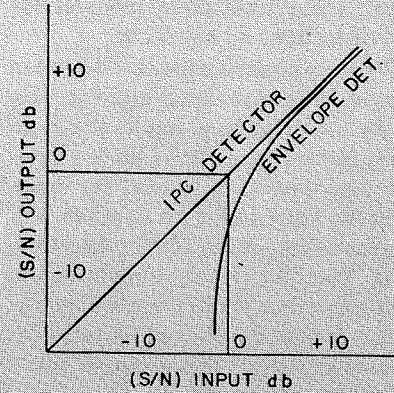

Fig. 5—Output S/N ratios vs. input S/N ratios for envelope and in-phase component detectors.

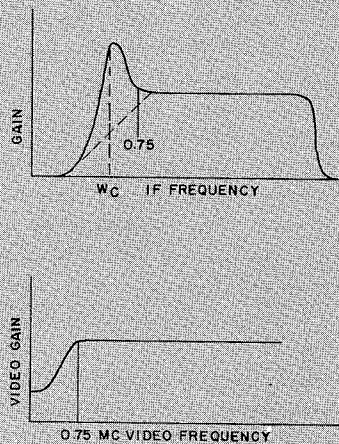

Fig. 6—(a) Carrier-enhanced VSB characteristic and (b) the required video compensation.

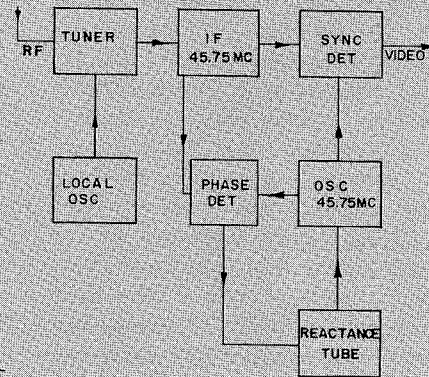
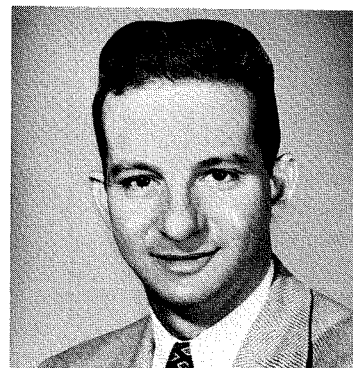

Fig. 7—Block diagram of an afc-locked product detector.

**R. W. SONNENFELDT** received a B.S. degree from Johns Hopkins University in 1949. He was engaged in industrial electronic design work from 1941-1943 and 1946-1949 for the Charles Transformer Company of Baltimore, Md. He joined RCA in 1949 as a Specialized Trainee and became a Development Engineer with the TV Circuits Group of Television Division Advanced Development section. Mr. Sonnenfeldt is currently Manager of Communications Advanced Development, Industrial Electronic Products. He is a Senior Member of the IRE, a member of Tau Beta Pi, and Omicron Delta Kappa.



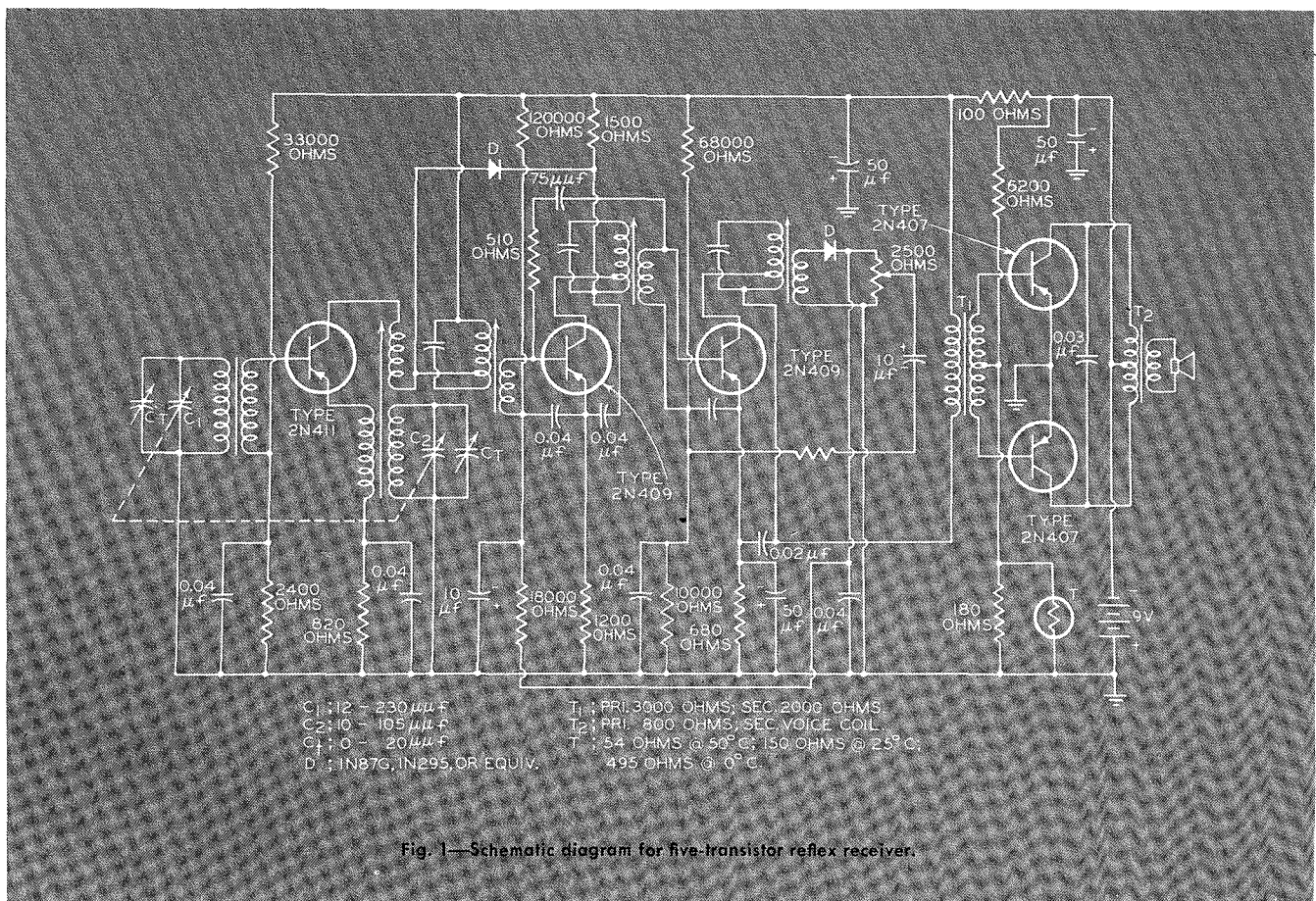

Fig. 1—Schematic diagram for five-transistor reflex receiver.

## DESIGN CONSIDERATIONS FOR TRANSISTOR REFLEX RECEIVERS

THIS paper discusses the use of reflex-amplifier techniques in transistor superheterodyne receivers, and presents practical design information on the construction and performance of such receivers.

In comparison with a standard five-transistor receiver, the reflex receiver has the advantages of high sensitivity and good frequency response made possible by negative feedback at audio frequencies. Its disadvantages, an increased tendency to overload on strong signals and a residual volume or "play-through" effect, are minimized by proper circuit design and choice of operating points.

In conventional transistor receiver designs, i-f or audio-amplifier stages are often sacrificed to reduce space, weight, and cost. The r-f, i-f, and audio quality of the reflex receiver described in this paper compare well with that of receivers having a greater number of amplifying elements and components, but its cost, space, and

By **ROGER V. FOURNIER**  
*Advanced Circuit  
 Development Engineering*  
 Semiconductor and Materials Division  
 Somerville, New Jersey

power requirements are much lower than those of the larger receivers.

### DESCRIPTION OF BASIC CIRCUIT

The reflex receiver shown in Fig. 1 employs five RCA p-n-p alloy-junction transistors as follows: a 2N411 is used as the converter unit, two 2N409's are used as 455-kilocycle i-f amplifiers (the second i-f transistor also amplifies a-f signals), and two 2N407's are used in the class B push-pull audio-output stage. (The long-lead equivalents of these transistors are, respectively, 2N412 converter, 2N410 i-f, and 2N408 audio). A 1N295 or equivalent diode is used as a second detector.

The receiver operates from a 9-volt supply with a total no-signal current

drain of 9 milliamperes, and produces a power output of 200 milliwatts at a distortion of 10 per cent and a "squawk" power output of 300 milliwatts. The sensitivity of the set is 120 microvolts per meter for a 50-milliwatt output and an AGC Figure of Merit of 60 db (a radiated signal of 500,000 microvolts per meter is used as a reference).

The antenna circuit shown in Fig. 1 is derived from a ferrite-loop type of antenna which is highly suitable for receivers of this size. Because the sensitivity of the receiver is proportional to the volume of the ferrite, the largest possible loop consistent with available space in the receiver cabinet should be employed. However, consideration must be given to the orientation of the antenna to avoid unwanted coupling with other circuit elements, particularly the oscillator coil and second-detector circuitry, and the number of ground loops should be kept to a minimum.

Harmonic tweet generation can be reduced to acceptable levels by placing critical elements away from the antenna loop, and possibly by shielding.

The converter circuit and associated coil data provide for interchangeability between individual 2N411 transistors without problems of oscillator fall-out at low battery voltage, or improper excitation, regeneration, or blocking at full voltage.

The converter is operated without AGC to avoid converter cutoff and resultant loss of local oscillation. An overload crystal diode is connected in parallel with the tuned collector circuit of the converter. Its function will be described fully during the discussion of AGC considerations.

The design of the first and second i-f amplifier stages also provides for interchangeability between individual 2N409 transistors. These stages utilize fixed unilateralization, as shown in Fig. 1. The i-f coil design provides maximum gain with excellent a-c and d-c stability at temperatures ranging from zero to 55 degrees centigrade.

The second i-f stage is a reflex amplifier which amplifies at both intermediate and audio frequencies. The operating point of this stage is critical from the standpoint of (1) overload distortion due to the possible presence at the input of relatively large audio signals which can excessively shift the quiescent operating point, and (2) play-through, i.e., the occurrence of a-f output when the volume control is set at zero. The manner in which these disadvantages are resolved will be discussed later.

The second detector diode has a dual role: it provides an additional degree of temperature compensation as well as developing an AGC voltage for the base of the first i-f stage. Although the initial bias voltage on the detector diode is approximately 100 millivolts, the bias increases with temperature so that it compensates for the increased collector current in the first i-f transistor caused by increasing ambient temperatures.

The input of the push-pull class B audio-output stage is transformer-coupled to the reflex amplifier, which serves as a driving source of excitation. A thermistor is included in the

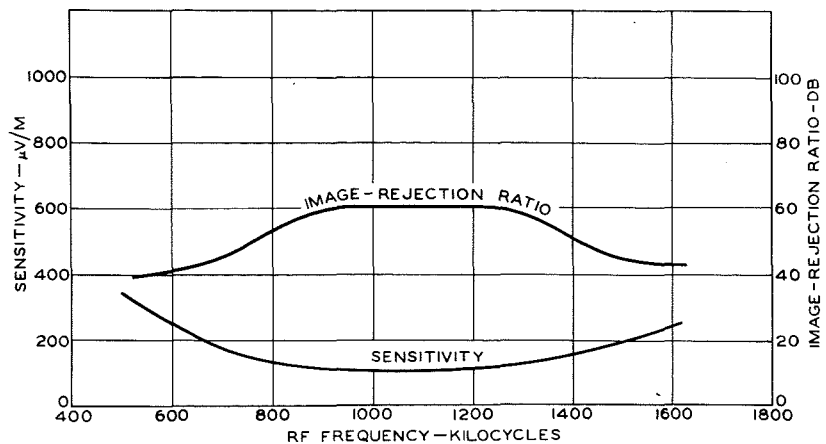

Fig. 2—Image rejection and sensitivity of reflex receiver as functions of frequency.

bias network of the output transistor to maintain essentially constant circuit performance during ambient-temperature variations. Thermistor compensation also provides stable operation at rated power output levels in excess of 150 milliwatts. The idling current of the output transistors increases as the temperature increases and can cause thermal runaway. The thermistor prevents large increases in idling current from occurring at elevated temperatures.

The impedance-transformation ratios of the driver and output transformers are given at the bottom of Fig. 1. The impedance values for the driver transformer were selected to yield optimum sensitivity at a low audio-distortion value. The output-transformer turns-ratio was selected to match the RCA high-efficiency, 2 $\frac{3}{4}$ -inch diameter, 12-ohm speaker, and to provide a primary impedance which limits the collector current to rated values at high degrees of excitation.

The performance curves shown in Figs. 2, 3, 4, 5, 6, and 7 indicate receiver sensitivity and image rejection, tracking, selectivity, AGC and signal-to-noise ratio, distortion, and frequency-response characteristics, respectively. The excellent AGC characteristics and audio-frequency response of the reflex receiver should be noted.

#### RESIDUAL VOLUME EFFECT IN REFLEX RECEIVERS

Play-through, the occurrence of an audio-frequency output with minimum setting of the volume control, may be a problem in a reflex receiver. This condition may also cause a "minimum-volume effect," in which minimum volume from the receiver is obtained when the volume control is at some setting slightly above zero. At the point of minimum volume, the output signal is very badly distorted because the fundamental frequencies are cancelled out between the normal signal and the out-of-phase play-

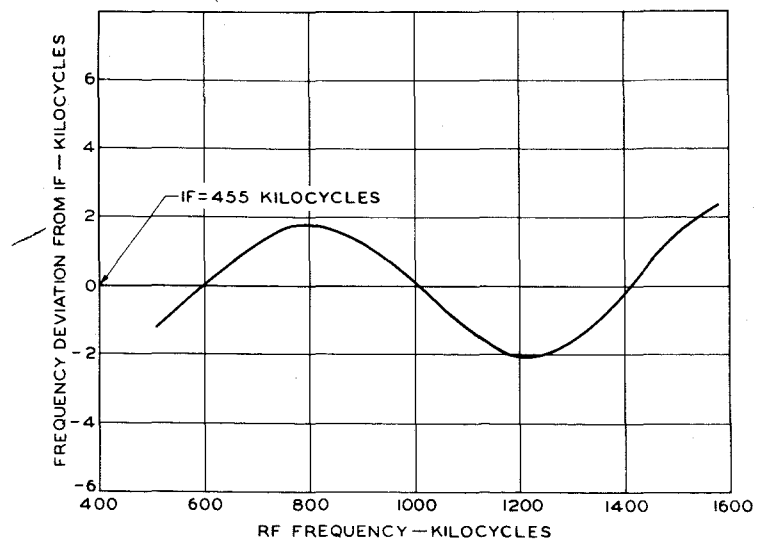

Fig. 3—Tracking curve for transistor reflex receiver.

through signal. Both play-through and, consequently, the minimum-volume effect may be reduced to practical insignificance by proper design.

The play-through effect in a reflex receiver is due to rectification caused by the curvature of the transistor transfer characteristic. Because play-through increases as the input signal is increased, the AGC system must be designed so that large signals are prevented from appearing at the input of the reflex stage. Because play-through is a function of rectification and, therefore, of the curvature of the transfer characteristic, it is a variable depending on the bias. By proper selection of the bias on the reflex stage, the play-through effect can be made practically negligible. The "minimum-volume effect" is also reduced proportionally because it is caused by the presence of play-through.

The utilization of volume controls which exhibit very little residual resistance at zero setting also helps to minimize the problem of audio output at minimum setting on the volume control. Most potentiometers employed for volume-control purposes on small receivers have a residual resistance of approximately five to ten ohms at zero setting. This resistance may be troublesome, especially when the receiver is tuned to a powerful station in a quiet room. For this reason, and because of the play-through effect mentioned above, a reflex stage is usually followed by a power-output stage rather than an audio driver or preamplifier feeding the output stage.

When the volume control of the receiver shown in Fig. 1 was set at zero, the residual resistance of 3 ohms produced an audio output of less than one milliwatt for a radiated signal of 50,000 microvolts per meter. Listening tests in a quiet room indicated that this level is not objectionable.

#### AGC CONSIDERATIONS IN THE REFLEX RECEIVER

After the appropriate bias for the reflex stage has been chosen to minimize play-through, a rapid increase in play-through and modulation distortion may be observed when input signals rise above some critical level. This effect occurs whenever the reflexed audio signals become large enough to exceed the bias on the reflex stage and thereby shift its quiescent operating point. In such a case, the AGC system must be designed to prevent signals of this magnitude from appearing at the base of the reflex stage.

Although the application of AGC voltage to the converter stage would be desirable to help control overload problems, it would also introduce the possibility of oscillator fall-outs and frequency shifts. Measurements indicate that application of the developed AGC voltage to the first i-f stage does not yield a sufficient AGC range to prevent serious play-through and distortion on strong radiated signals. This fact suggests the possibility of applying a fraction of the AGC voltage to the reflex stage.

However, a good criterion for the "proper" fraction of AGC is rather elusive. If the fractional AGC applied

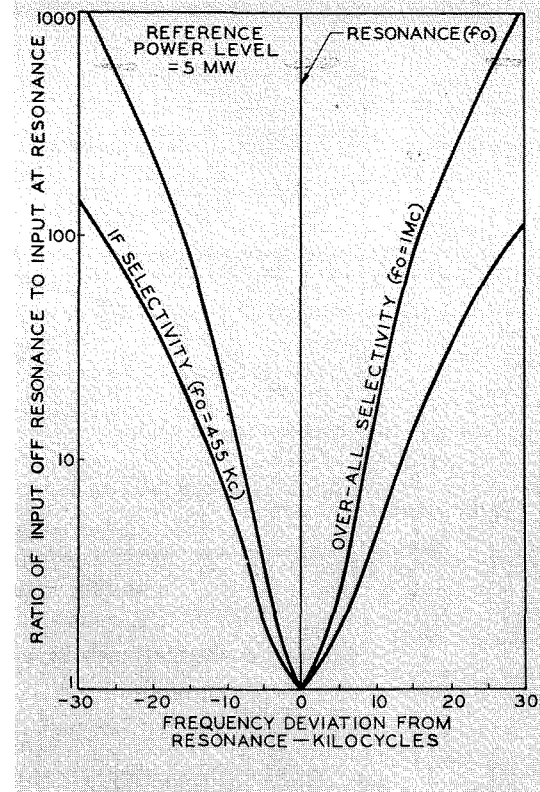
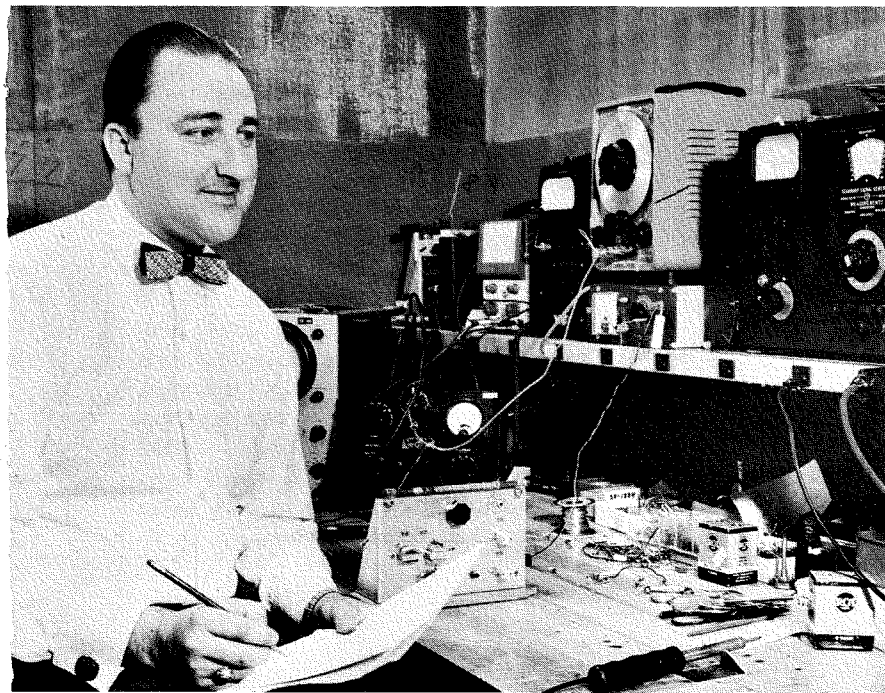

Fig. 4—Selectivity curves for transistor reflex receiver.

to the reflex stage is too small, the rectified a-f signal returned to the base from the collector of the reflex stage may exceed the bias on the transistor and cause a shift in operating point with attendant distortion. If the fraction of the AGC applied to the reflex stage is too large, the AGC characteristic will tend to reach a maximum output and then fall off with increasing radiated signals. The worst effect of excessive control is the inability of the receiver to deliver full audio output on strong stations even with maximum volume control. Also,



**ROGER V. FOURNIER** received the B.S. degree in Electrical Engineering from the University of Maine in 1950 and the M.S. degree in Electrical Engineering from the University of Connecticut in 1956. He served with the U. S. Navy from 1943 to 1946, during which time he attended naval electrical school and the Sperry Gyro-Compass school, and then served on board a destroyer escort, where he was responsible for maintaining proper operation of the ship's interior communications equipment, master gyro-compass and gyro-repeaters in fire-control, radar, and sonar equipments. From 1950 to 1956, he was employed at the U.S.N. Underwater Sound Laboratory in New London, Conn., as an electronics scientist developing new and improved electronic circuits for use in sonar equipment, as well as instrumentation systems for basic sonar research. During that time, he also designed and developed the first transistorized pre-amplifiers for use in conjunction with sonar system hydrophones. He joined the RCA Semiconductor Division in November, 1956, as an engineer in the Advanced Circuit Development activity of the Applications Laboratory.

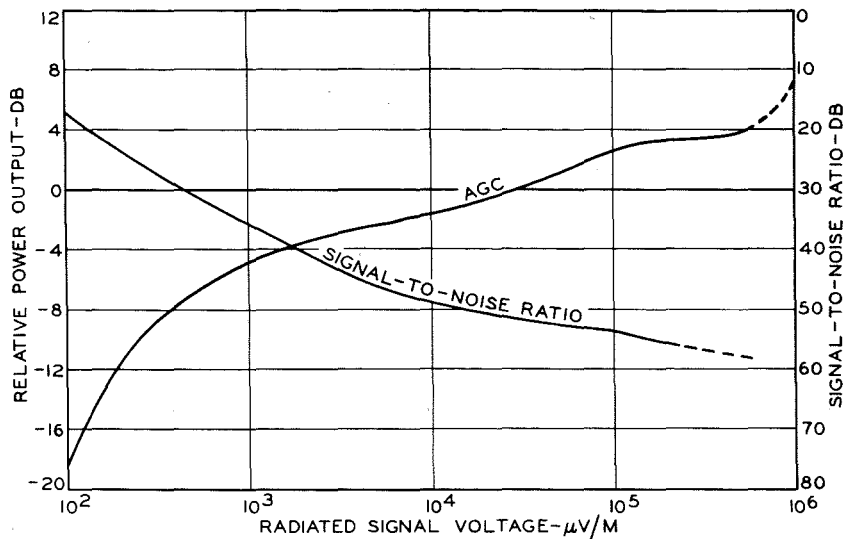

Fig. 5—AGC and signal-to-noise ratio as functions of radiated signal voltage.

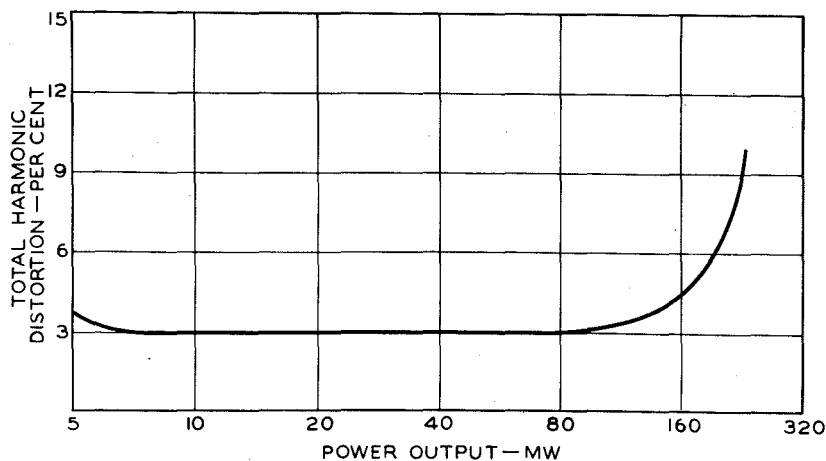

Fig. 6—Total harmonic distortion of reflex receiver as a function of power output.

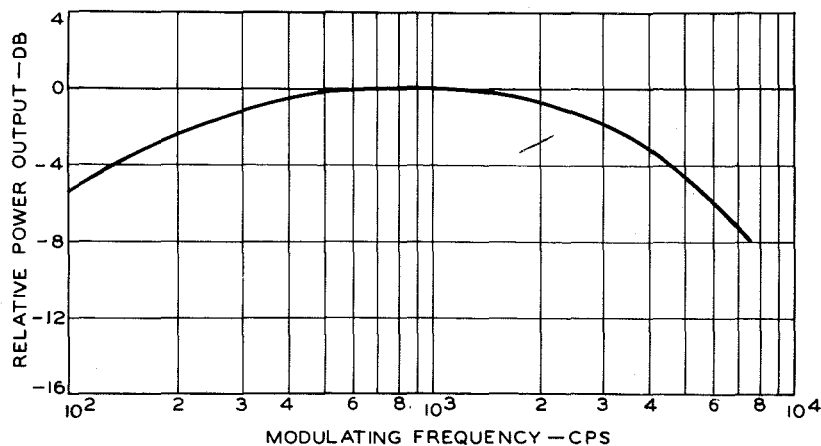

Fig. 7—Frequency-response curve for transistor reflex receiver.

in such a case, tuning directly to the carrier of a powerful station produces less output than tuning to one side of the carrier band. As a result, two adjacent tuning positions exist at which maximum volume can be obtained. The reduction in bias caused by the AGC action also produces a shift in operating point toward the curved region of the transfer characteristic and, consequently, an increase in play-through.

In view of the difficulty of applying fractional AGC to the reflex stage, a different method of control is employed. In this method, a crystal diode in the collector circuit of the converter is used to prevent overload conditions from occurring on strong signals. In effect, the diode is in parallel with the tuned collector circuit of the converter stage. As shown in Fig. 1, the diode is reverse-biased. Under moderate radiated fields, it presents a relatively high impedance to the tuned circuit. With increasing signal strength, the AGC action decreases the bias on the diode, thereby reducing its impedance. This reduced impedance effectively shunts or "loads down" the tuned collector circuit and causes attenuation of the i-f signal level. The effect of this action is to extend the range of the AGC system so that overloading does not occur when the receiver is tuned to a strong station, and yet full receiver gain can be obtained on weaker signals. The overload diode also helps to maintain a more uniform bandwidth with signal strength.

#### REFLEX GAIN STABILITY, FREQUENCY RESPONSE, AND DISTORTION

The 33,000-ohm feedback resistor in the reflex stage is used as a degenerative element to prevent excessive variations in over-all gain. The negative feedback also helps to extend the frequency range of the audio response and to reduce distortion and play-through effects. As shown in Fig. 7, the 3-db-down points on the audio-response curve occur at 150 and 3000 cycles per second, with a very slow roll-off at both ends of the spectrum. The audio distortion and frequency response of the reflex receiver compare very favorably with that of most receivers of similar size, and, in many instances, its performance is better than that of larger sets.

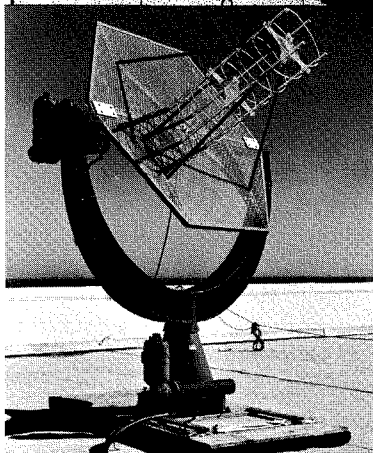
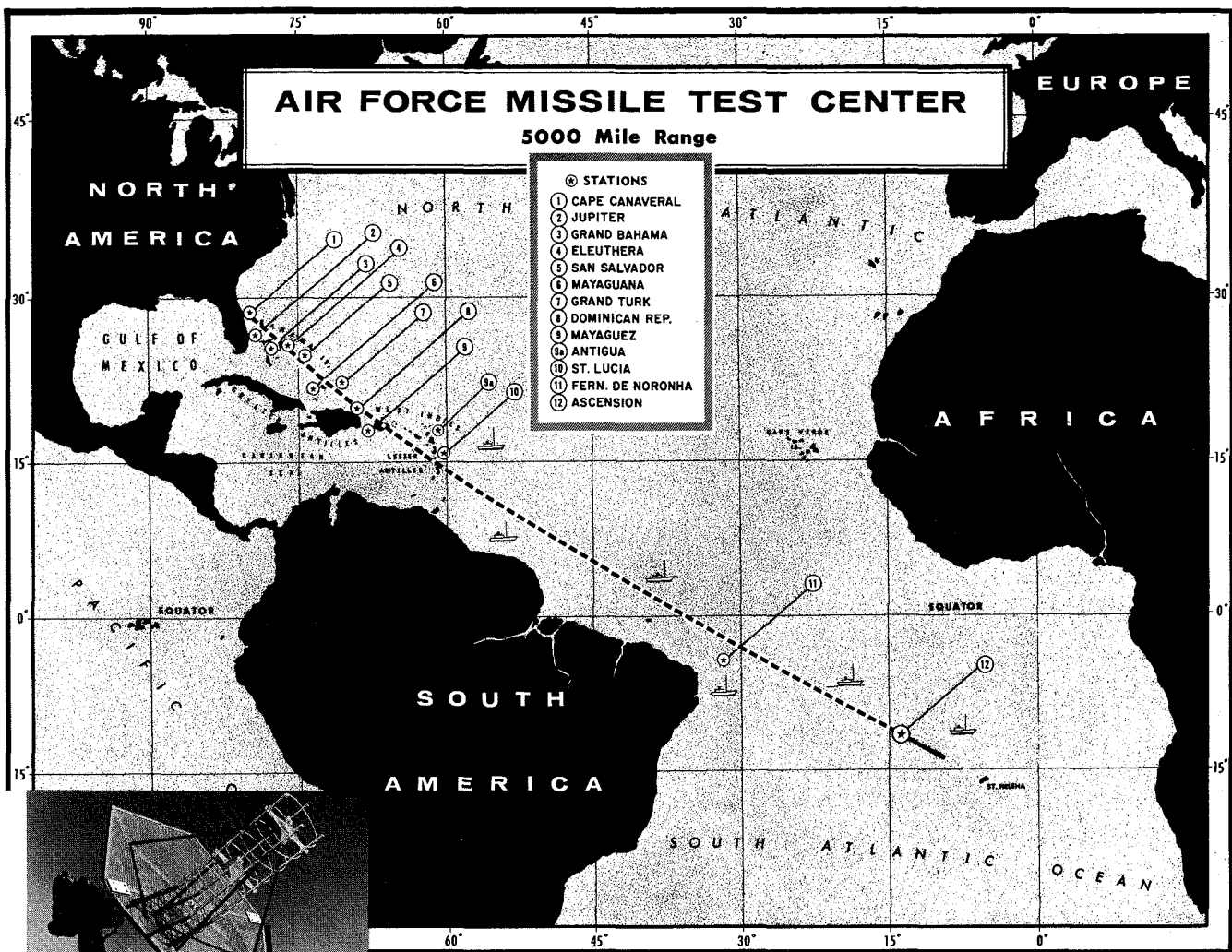

Typical telemetry antenna installation on the AFMTC Range.



The tracking telescope, such as this one shown in operation at Eleuthera AAFB, is one of many optical systems used in missile tracking.

## RCA AT CAPE CANAVERAL

### PART I — MISSILE TEST RANGE INSTRUMENTATION

By **A. L. CONRAD**

*Vice President, Government Service Department  
RCA Service Company  
Cherry Hill, N. J.*

MODERN SCIENCE HAS provided a means to minimize the number of unknown quantities in the development of a weapon system. Data on every phase of a weapon's effectiveness will be studied and fully evaluated before the weapon is accepted for production or operational use.

Application of electronics and other sciences to weapon system evaluation are best manifested in the field of Missile Test Range Instrumentation.

The 5,000 mile test range of the Air Force Missile Test Center off Florida's central east coast is much more than an open area where missiles are merely launched into space. The range is a system of land and sea

stations instrumented to acquire and record data on every possible phase of missile operation, and to transmit them to a central point where electronic computers translate them into readily understandable test results.

Missile Test Range Instrumentation technology integrates electronics and optical developments into a composite data gathering and processing system.

A Missile Test Range station involves systems of communications, timing, radar, optics, c-w tracking, and telemetry operating with complete coordination. Each system is engineered for extreme precision and reliability, and is operated and maintained by highly skilled technicians.



**Editor's Note:** Well before the frenzy of popular interest in missiles and earth satellites set off by Sputnik last year, RCA was quietly and efficiently aiding the U.S. Government's missile program at Cape Canaveral, Florida. Twenty-six hundred employees of RCA Service Company have the responsibility of maintaining and operating the electronic equipment which makes up the missile tracking, guidance, safety, and communications system of the 5000-mile missile range.

This article initiates a three-part series on RCA Service Company at the Missile Test Center. The first part will deal with Test Range Instrumentation, the second with Telemetry, and the third with Cine Theodolite Data Acquisition and Reduction.

#### COMMUNICATIONS

Communication is accomplished through a compatible network of wire and radio circuits that assure dependable data transmission and provide flexibility to accommodate simultaneous operations.

The primary link is a submarine cable system connecting each station from Cape Canaveral, Florida to Puerto Rico. The single conductor system uses carrier techniques for multi-channel operation. Unattended repeater stations, dependent upon d-c current transmitted through the cable from terminal stations, compensate for signal attenuation.

HF, VHF, and UHF radio are used for communication with island stations not served by the cable, with ship stations, and aircraft, including missiles themselves, and as backup for the cable network.

#### TIMING

Accurate timing signals are continuously transmitted to metric recording equipment along the entire range from the Master Central at Cape Canaveral. These signals, containing binary codes and electrical pulses sequenced from one to 500 per second, are received by the recorders in com-

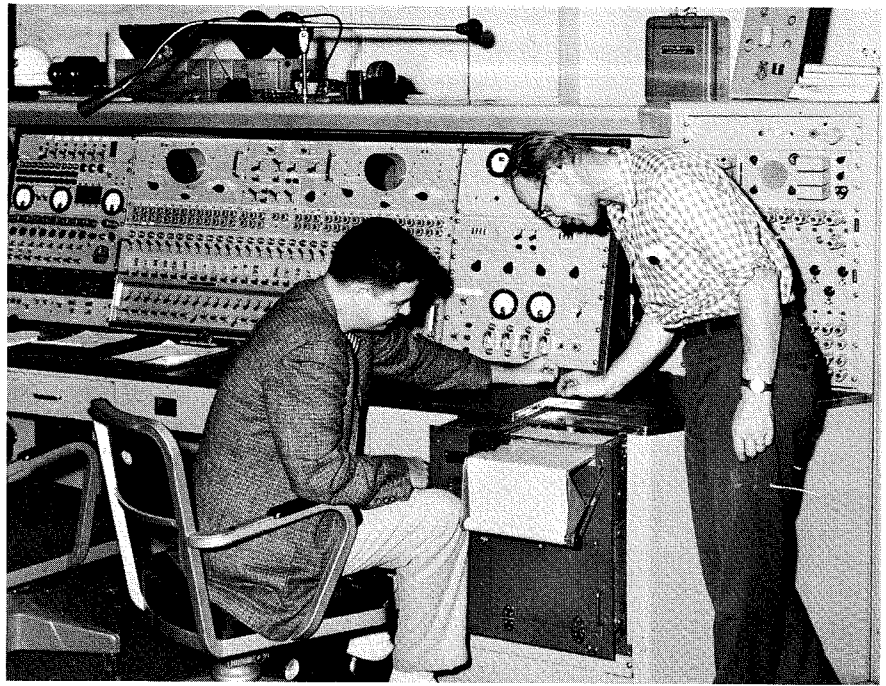

Operators observe recorded signals at the central timing console at Cape Canaveral.

plex coding groups, amplified, reshaped, and sorted into a recordable pulse code.

A firing sequencer located in the launch area provides trigger signals for missile firing functions as well as triggering the timing generator upon the initial movement of the missile.

#### TELEMETRY

Internal missile data are obtained by Telemetry. As transducers within the missile convert functions to electrical voltage analogs, sub-carriers and an r-f carrier are modulated.

Each r-f carrier accommodates 18 sub-carrier channels, nine of which may be commutated to achieve 27 channels capability. This results in a maximum of 252 functions to an r-f carrier.

Surface telemetry stations, upon receiving a composite signal from the missile-borne transmitter, separate the sub-carriers, decommutate the commutated channels and make calibrated recordings of each channel. The complex signal is also recorded directly on magnetic tape to later be fed into computers that chart each individual recorded function.

#### C-W SYSTEMS

Much of the precision tracking and position measurement required in

missile testing is accomplished by continuous wave systems. Among these systems are AZUSA, COTAR, SECOR, ELSSEE, and DOVAP.

DOVAP (Doppler Velocity and Position) is located at Cape Canaveral and at one Down Range station to record the missile's measured velocity and position near launch and terminal points. A surface transmitter sends c-w signals to a missile-borne receiver. Three surface receiver stations, located with known base line spacing, receive a signal from missile-borne transmitter keyed by the received signal. Signals received by the surface receivers are relayed to a central recording station where differences in change of "path lengths" to the receivers are correlated to show missile position coordinates.

#### RADAR

The tracking radar system consists of extensively modernized SCR-584 radars at the launching site and at each of the range stations. Associated equipment consists of coordinate converters, automatic plotting boards, digital data recorders and data transmission equipment. The system is unusually flexible.

Switching equipment and patch panels can be inter-connected in a variety of ways to fit whatever the test requirement happens to be.

The tracking radar system is capable of fully automatic beacon or skin tracking over extended ranges. It has angular smoothing circuits and high angular tracking rates to accommodate the tracking of high velocity missiles.

To extract data from the radar, azimuth, elevation, and range gate, shaft positions are converted to electrical pulses. Three types of data output are available: analog potentiometer, commutated (digital), and synchro. Random and systematic errors are corrected by boresight camera techniques in the course of data processing.

Radar position information in polar coordinates (such as azimuth, angle, elevation angle, and slant range) is converted to rectangular coordinates by potentiometers geared to shafts within the radar. Potentiometer outputs are fed to converters and thence to amplifiers which operate pens on automatic plotting boards.

The servo-driven pens trace the path of the missile on an overlay map of the test range. One pen plots azimuth as a function of ground range and another pen plots altitude as a function of ground range. Two other pens record time alongside each plot. This analog presentation provides a "quick look" system for guidance and range safety purposes.

For a more accurate radar record, a digital data recorder is used to record angular position data. These data are taken from commutators connected to the radar shafts, stored in memory circuits, and read out at half-second intervals. The outputs are recorded in code on punched paper tape which is later fed into a digital computer in the reduction process.

Using digital transmission equipment, radar position data are sent Down Range and are also distributed about the central station at Cape Canaveral to provide a continuous

plot of the missile as it passes each tracking station.

#### OPTICS

Optical instrumentation is extensively used in the recording of metric data as well as engineering sequential and documentary pictures. Use is made of both tracking and fixed cameras.

Tracking theodolites record pictures of the missile, at the same time that azimuth and elevation angles and timing codes are recorded. Thus, when a fix is obtained by two or more theodolites, position, velocity and acceleration may then be computed. The cameras are oriented by sighting on accurately surveyed target boards and pictures taken both before and after the missile tests. Each camera has two operators: one to keep the missile in the field of view in azimuth and the other in elevation.

Tracking cameras used for recording engineering sequential pictures are standard motion picture cameras

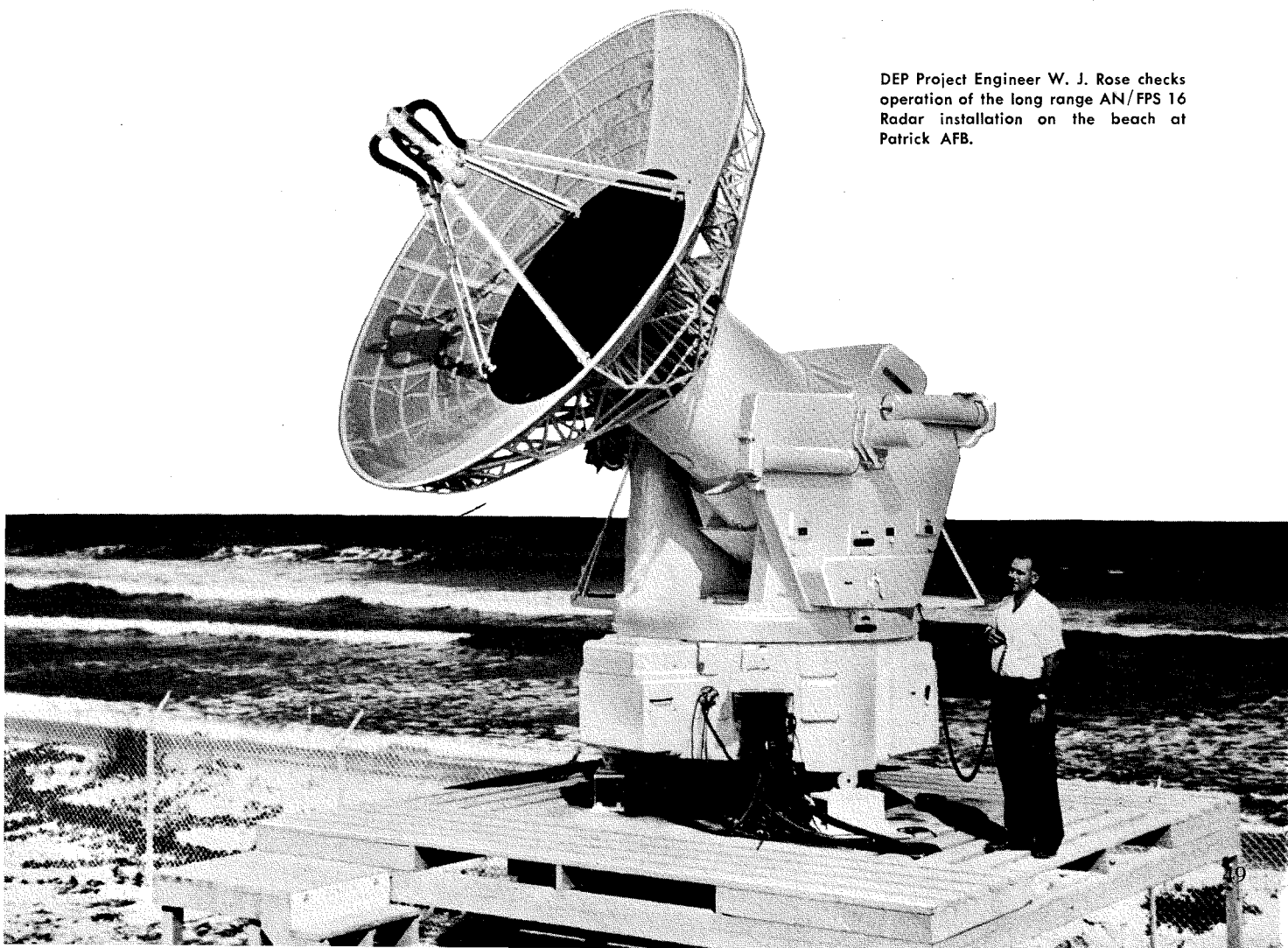

DEP Project Engineer W. J. Rose checks operation of the long range AN/FPS 16 Radar installation on the beach at Patrick AFB.

modified to present timing codes on the film along with pictures of the missile being tracked. The primary purpose of these cameras is to record specific events versus time during the missile flight.

A comparatively large tracking telescope is used near the launch site for recording trajectory and engine operation during the launch phase of missile test. In this phase of the test the missile may well be climbing as fast as 5,000 feet per second. This telescope has two long focal length lenses and a mirror that provide highly magnified images for the three attached cameras.

Fixed (stationary) camera systems also are extensively used. These record metric and engineering sequential data during the early stages of each missile flight. At launch, rapid sequence cameras photograph missile exhaust flame for subsequent analysis. Metric data at launch and for approxi-

mately the first 3,000 feet of flight are required to a very high order of accuracy. This dictates the use of a battery of carefully located fixed cameras. Such cameras are strategically placed about the launching pad in the optimum positions for coverage of the anticipated trajectory. Each camera is oriented to a previously calculated azimuth and elevation angle so that the missile will pass through its field of view. Timing codes recorded on the film enable the extraction of position, velocity and acceleration information during the data reduction process.

For missile tests performed at night, a highly accurate ballistic plate camera system determines position both during the launching and terminal phases. Ballistic plate cameras record the image of an intense flashing light carried aboard the missile against a background of star trails. When a position fix is obtained from two or more of these cameras with star trail cali-

bration, unusually accurate missile position data can be computed.

#### DATA REDUCTION

The destination of the maze of data recorded during a missile's flight is the large data reduction facility. Film and tape are rushed by air from all recording stations and raw data are fed into FLAC (Florida Automatic Computer) and IBM data translation equipment where they are converted into usable data.

The end result, processed data, provides a priceless record of the missile's functions from which deviations from predicted operation may be pinpointed.

Through Missile Test Range Instrumentation the nation's scientists are obtaining the data they need to perfect the mighty weapon systems that will compose the nation's defense arsenal in years to come.

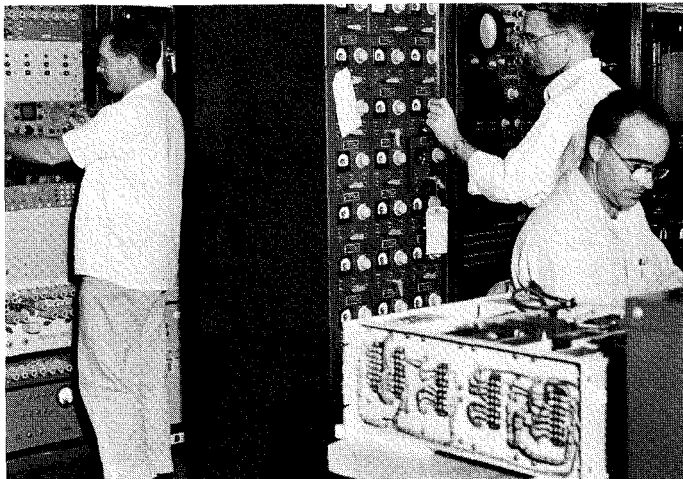

Fabrication and modification of range instrumentation systems are accomplished in modern shops.



**ANDREW L. CONRAD**, prior to his appointment as Vice President, Government Service Department, RCA Service Company, was Vice President in charge of the RCA Missile Test Project at Cape Canaveral, Florida, and was responsible for its management since its establishment in October 1953.

Joining RCA in 1946, Mr. Conrad first served as Manager of the Albany Television Service Branch, and moved to the RCA Service Company's home office in 1947. Progressing rapidly in the fields of Employment, Systems Planning, Quality Control, and Engineering, he served as Manager of Technical Operations from 1952 until the

Missile Test Project was organized in 1953. After receiving his degree in Physics at Lafayette College he undertook graduate work at Harvard University and served as an officer in the Army Signal Corps during World War II.

He is a member of the American Rocket Society; Armed Forces Communications and Electronics Association; National Security Industrial Association; and the Military Products Division's Field Support and Maintenance Committee of the Electronic Industries Association.

Mr. Conrad received the RCA Victor "Award of Merit" for distinguished service to the Corporation in 1953.

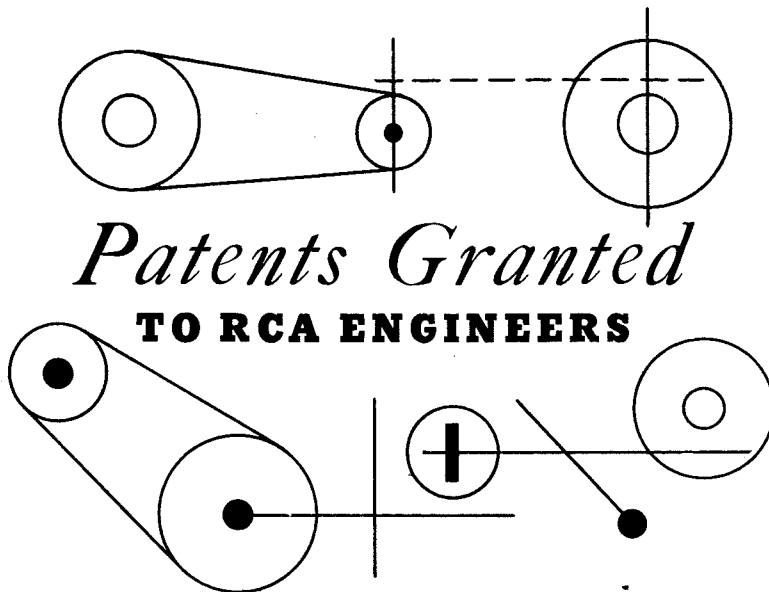

## Patents Granted TO RCA ENGINEERS

BASED ON SUMMARIES RECEIVED OVER A PERIOD OF ABOUT TWO MONTHS

### DEFENSE ELECTRONIC PRODUCTS

*Moorestown, N. J.*

#### Information Handling System

Pat. No. 2,841,707—granted July 1, 1958 to J. M. McCulley.

#### Tape Drive Mechanism

Pat. No. 2,844,369—granted July 22, 1958 to H. Singer.

#### Thyratron Circuit

Pat. No. 2,844,781—granted July 22, 1958 to H. F. Schneider and W. M. Adelman, IEP, Camden, N. J.

*Camden, N. J.*

#### Reactance Tube Circuit

Pat. No. 2,843,741—granted July 15, 1958 to A. B. Glenn and R. H. Ray.

#### Frequency Control System

Pat. No. 2,843,739—granted July 15, 1958 to A. C. Stocker.

#### Magnetic Recording

Pat. No. 2,844,434—granted July 22, 1958 to A. D. Beard.

#### Analogue Multiplication Device

Pat. No. 2,848,161—granted August 19, 1958 to H. J. Woll.

#### Color-Correction System

Pat. No. 2,848,528—granted August 19, 1958 to H. J. Woll.

#### Regulated Power Supply

Pat. No. 2,850,680—granted September 2, 1958 to H. J. Woll.

*Los Angeles, Calif.*

#### Signal Wave Generator for Recording a Control Signal

Pat. No. 2,843,446—granted July 15, 1958 to J. L. Pettus and K. Singer.

#### Motor Control System

Pat. No. 2,847,626—granted August 12, 1958 to J. L. Pettus.

### RCA VICTOR TELEVISION DIVISION

*Cherry Hill, N. J.*

#### Noise Cancelling Systems

Pat. No. 2,841,646—granted July 1, 1958 to L. P. Thomas.

#### Stabilized High Frequency Amplifier Circuits

Pat. No. 2,841,655—granted July 1, 1958 to L. A. Horowitz.

#### Oscillation Generator

Pat. No. 2,841,711—granted July 1, 1958 to W. R. Koch.

#### Color Television

Pat. No. 2,845,481—granted July 29, 1958 to R. K. Lockhart.

#### Relaxation Oscillator Circuit

Pat. No. 2,847,569—granted August 12, 1958 to M. B. Finkelstein.

### INDUSTRIAL ELECTRONIC PRODUCTS

*Camden, N. J.*

#### Electrical Protective Apparatus

Pat. No. 2,842,719—granted July 8, 1958 to W. L. Hurford, and W. J. Neely.

#### Vacuum Tube Input Circuit

Pat. No. 2,843,803—granted July 15, 1958 to F. E. Talmage and M. Feryszka.

#### Protective Circuit

Pat. No. 2,843,817—granted July 15, 1958 to L. S. Lappin.

#### Noise Reduction Circuit for Television Transmitters

Pat. No. 2,843,661—granted July 15, 1958 to R. L. Meisenheimer.

#### Thyratron Circuit

Pat. No. 2,844,781—granted July 22, 1958 to W. M. Adelman and H. F. Schneider, DEP, Moorestown, N. J.

#### Shading Voltage Generators

Pat. No. 2,845,486—granted July 29, 1958 to A. C. Luther, Jr.

#### Electromagnetic Deflection Yoke

Pat. No. 2,845,562—granted July 29, 1958 to S. L. Bendell and H. C. Sheppard.

#### Adjustable Linear Amplifier

Pat. No. 2,845,574—granted July 29, 1958 to L. Shapiro.

#### Multiple Sound Source Switching System

Pat. No. 2,846,514—granted August 5, 1958 to J. F. Byrd.

#### Synchronized Oscillator

Pat. No. 2,846,584—granted August 5, 1958 to R. N. Hurst.

#### Automatic Deflection Amplitude Control Apparatus

Pat. No. 2,846,617—granted August 5, 1958 to M. D. Nelson.

### ELECTRON TUBE DIVISION

*Lancaster, Pa.*

#### Electron Tube and Filamentary Cathode

Pat. No. 2,841,736—granted July 1, 1958 to M. B. Shrader.

#### Multi-Beam Kinescope Convergence Circuits

Pat. No. 2,842,708—granted July 8, 1958 to R. W. Hagmann and J. C. Cooper.

#### Electron Discharge Device

Pat. No. 2,844,752—granted July 22, 1958 to M. V. Hoover.

#### Cathodoluminescent Phosphors and Devices

Pat. No. 2,845,564—granted July 29, 1958 to P. G. Herold.

#### Spring Contact High Voltage Connector

Pat. No. 2,847,595—granted August 12, 1958 to P. W. Kaseman.

#### Bulb Spacer Shield

Pat. No. 2,847,599—granted August 12, 1958 to P. W. Kaseman.

#### Electron Gun Structure for Plural Beam Tubes

Pat. No. 2,847,598—granted August 12, 1958 to R. H. Hughes.

#### Cathode-Ray Tube

Pat. No. 2,846,608—granted August 5, 1958 to T. M. Shrader.

#### Tri-Color Kinescope

Pat. No. 2,847,600—granted August 12, 1958 to A. M. Morrell.

*Harrison, N. J.*

#### Protective Circuit

Pat. No. 2,841,746—granted July 1, 1958 to D. D. Mawhinney.

#### Power Supply Regulation

Pat. No. 2,843,796—granted July 15, 1958 to O. H. Schade.

### RADIO & "VICTROLA" DIVISION

#### Automatic Gain Control System

Pat. No. 2,848,603—granted August 19, 1958 to J. B. Schultz.

### SEMICONDUCTOR AND MATERIALS DIVISION

*Somerville, N. J.*

#### Pulse Method of Etching Semiconductor Junction Devices

Pat. No. 2,850,444—granted September 2, 1958 to L. D. Armstrong and P. Kuznetzoff.

### RCA SERVICE COMPANY

*Cherry Hill, N. J.*

#### Television Test Apparatus

Pat. No. 2,844,646—granted July 22, 1958 to S. Wlasuk.

**PEN** and

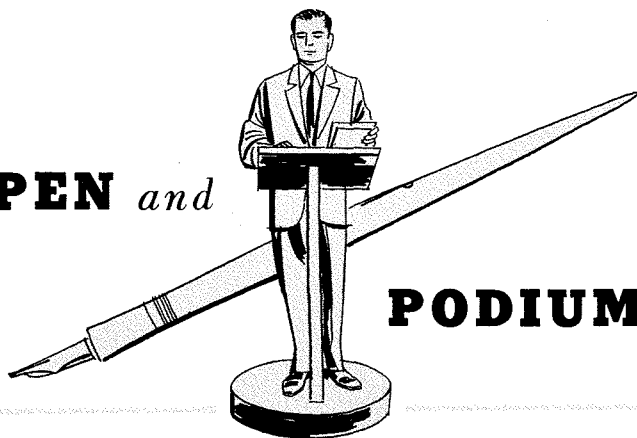

**PODIUM**

BASED ON REPORTS RECEIVED OVER A PERIOD OF ABOUT TWO MONTHS

## ELECTRON TUBE DIVISION

Harrison, N. J.

### Large Perturbations in Electron Beams from Shielded and Immersed Guns

By T. S. Chen: Published in *JOURNAL OF ELECTRONICS AND CONTROL*, June 1958. Large perturbations in cylindrical beams from magnetically shielded and immersed guns are calculated by numerical integration of the electron dynamic equations. Universal beam contours are prepared for determination of the profiles of other beams.

### Effect of Collector Potential on the Efficiency of Traveling-Wave Tubes

By H. J. Wolkstein: Published in *RCA REVIEW*, June 1958. Methods are described for increasing the overall efficiencies of traveling-wave tubes by permitting the collector potential to be depressed substantially below the synchronous helix voltage. A method is also described which can be used to estimate the minimum potential to which an axially symmetrical collector electrode can be depressed without reduction of beam current.

### Tube Noise Factor Chart

By L. P. DeBacker: Published in *ELECTRONICS*, July 18, 1958. This paper describes a graph devised to eliminate the complex calculations usually involved in computing exact values of tube noise factor.

### Let's Use Our Heads

By Rhys Samuel: Published in *IRE TRANSACTIONS on Engineering Writing and Speech*, August, 1958. The purpose of headlines and subheadings in publications is discussed, and hints are given for improving their effectiveness. Different types of heads are illustrated, and rules are given for counting heads to make sure they fit within column limits.

### Simplified Design of Pulse-Forming Networks

By K. H. ReCorr: Published in *ELECTRONICS*, August 1, 1958. Simplified procedures are described for designing a five-section pulse-forming network capable of producing acceptable pulse waveforms. This simplified design method uses straightforward, orderly technique that reduces engineering time.

### Materials for Dielectric Whiteware

By W. F. Lawrence: Presented at *Whitewares Materials Symposium*, Alfred, N. Y., June 26, 1958. The various types of ceramics used in the electronics industry are dis-

cussed, as well as the relationship between their usefulness and the properties of the raw materials used in their composition.

### Applications of Vacuum Metallurgy in Electronic Materials

By C. W. Horsting: Presented at Course in Vacuum Metallurgy, New York University, June 27, 1958. This paper covers the applications of vacuum metallurgical processes to electronic materials, including their production and processing.

### The Electronic Technician in the RCA Tube Division

By W. E. Babcock: Presented at RCA Institutes, New York City, July 1, 1958. A short summary is given of the duties of an electronic technician in the various engineering activities of the Electron Tube Division. Two typical engineering projects and the role of the electronic technician are described.

### Design of Traveling-Wave Tubes for Airborne Applications

By M. Nowogrodzki: Presented at IRE WESCON Convention, Los Angeles, Calif., August 21, 1958. The development of traveling-wave tubes from laboratory novelties to modern airborne-systems components is reviewed, and some solutions to the problems of ruggedization and miniaturization are described.

### Design and Application Considerations for Computer Tubes

By H. E. Stumman and H. Kozicki: Presented at Remington-Rand Symposium, Iliion, N. Y., September 3, 1958. The construction, materials, and specification features of premium tubes are discussed, and life-test data are given for miniature and subminiature types. The importance of operating tubes within ratings is discussed, and future requirements for military applications are outlined.

### Measurement and Effect of Cathode-Coating Impedance at Ultra-High Frequencies

By J. J. Thompson: Presented at National Conference on Tube Techniques, New York City, September 12, 1958. A method is described for determining the resistance and capacitance of the oxide coating of a cathode in a vacuum tube by means of a few uhf measurements and a knowledge of the tube geometry.

### Construction of Electron Guns for Traveling-Wave Tubes

By W. Johnson and A. J. Bianculli: Presented at Tube Techniques Conference, New

York City, September 11, 1958. The design and construction of the "glass-beaded" electron gun used at RCA is described. Design objectives of electron guns for traveling-wave tubes are discussed, and it is shown that this design satisfies electrical, mechanical, and economic requirements.

*Industrial Electronics Handbook, 1958 Edition*  
Chapters authored by: William E. Babcock, Manager, Entertainment Tube Application Laboratory at Harrison writes on "oscillators." Albert P. Kautzmann, Receiving Tube Advanced Development, Harrison, covers Rectifiers and D. P. Heacock, Product Engineering, Camden, discusses A-C Amplifiers.

Princeton, N. J.

### Propagation Characteristics of Slow-Wave Structures Derived from Coupled Resonators

By E. Belohoubek: Published in *RCA REVIEW*, June 1958. A general procedure, based on the perturbation theory for resonated cavities, is given to determine qualitatively the w-Bo diagram for slow-wave structures of the coupled-resonator type.

### The Estiatron, an Electrostatically Focused Medium-Power Traveling-Wave-Tube Amplifier

By D. J. Blattner and F. E. Vaccaro: Published in 1958 *IRE CONVENTION RECORD*, July 1958. The Estiatron, a new type of traveling-wave tube, uses electrostatic focusing rather than magnetic focusing, thus eliminating the weight of a magnet and the need for adjustment of a magnetic field. Design features of this tube are discussed, and performance data are given.

Lancaster, Pa.

### A Study of the Molded Nickel Cathode

By C. P. Hadley, W. G. Rudy, and A. J. Stoeckert: Published in *JOURNAL OF ELECTROCHEMICAL SOCIETY*, July 1958. Results are given regarding the effects on emission and life of variations in nickel powder, alkaline-earth carbonates, reducing agents, sintering and activation.

### Application of a New High-Perveance Tetrode

By W. B. Hall: Presented at ARRL National Convention, Washington, D. C., August 15, 1958, and Lancaster Radio Transmitting Society, Lancaster, Pa., September 11, 1958. The advantages of a high-perveance tube for circuit design are emphasized and the use of such tubes in typical circuits is discussed. The performance of a new high-perveance tetrode is described for specific applications.

### A New Design Approach for a Compact, Kilowatt, UHF Beam Power Tube

By F. W. Peterson: Presented at IRE Wescon Convention, Los Angeles, Calif., August 20, 1958. A developmental one-kilowatt beam power tetrode designed for uhf applications is described. Design features of the tube are discussed, and electrical and mechanical performance is evaluated.

### Image-Intensifier Developments in the RCA Electron Tube Division

By R. G. Stoudenheimer: Presented at Symposium on Photo-Electronic Image Devices, London, England, September 3, 1958. A developmental two-stage image intensifier which provides luminous-flux conversion gains of 1000 and radiant-flux conversion gains with blue light of over 800 is described. Factors limiting conversion gain and resolution are discussed.

### Evaluation of Coolants for High-Power Transmitting Tubes

By R. W. Etter, G. E. Hansell, and I. E. Martin: Presented at Conference on Tube Techniques, New York City, September 10, 1958. The investigation of fluid coolants for high-intensity-heat dissipation is described. The selection and evaluation of a fluid that is superior to water in some respects is reported.

### The Brazing of Tungsten and Molybdenum Above 1900 Degrees Centigrade

By L. C. Herman: Presented at Tube Techniques Conference, New York City, September 10, 1958. The successful use of seven metals or alloys for brazing tungsten to molybdenum at temperatures between 1900 and 2620 degrees centigrade is described. The technique described can be used to join several parts by separate successive brazes, each at a slightly lower temperature.

### Development of the Photographic-Exposure Unit for Color-Picture-Tube Screens

By N. R. Goldstein: Presented at Tube Techniques Conference, New York City, September 10, 1958. The development of the optical system used to produce phosphor screens for color picture tubes is reviewed, including the problems involved in the design of the photographic exposure unit or "lighthouse," and the work done on the three principal elements of the optical system: light sources, light collimators, and light reflectors.

### The Effect of Calcium in Thoriated-Tungsten Filaments on Emission

By P. D. Strubhar: Presented at Tube Techniques Conference, New York City, September 12, 1958. A problem of slumping emission during life tests on electron tubes using carburized thoriated-tungsten filaments is described. A description is given of the analysis and tube life tests used to determine the relationship between this slump and calcium in the wire filaments.

## SEMICONDUCTOR AND MATERIALS DIVISION

Somerville, N. J.

### Use of the RCA-2N384 Drift Transistor as a Linear Amplifier

By D. M. Griswold and V. J. Cadra: Published in IRE CONVENTION RECORD, July 1958. This paper describes the use of the RCA-2N384 p-n-p germanium drift transistor in several high frequency amplifier applications. The transistor is described in terms of the typical variation of individual parameters with temperature and operating use.

### Design Considerations for Transistorized Automobile Receivers

By R. Santilli: Published in IRE CONVENTION RECORD, July 1958. This paper analyzes the operation of drift transistors in the rf and if stages of typical automobile receivers. In addition, it reviews the overall considerations, economic as well as technical, involved in the design of a complete auto receiver.

### Spectrographic Porous-Cup Technique for Analysis of Indium Alloys

By H. M. Hyman: Published in APPLIED SPECTROSCOPY, July 1958. A quantitative spectrographic procedure is described for the determination of certain alloying constituents in indium within designated concentration ranges. A porous-cap solution

technique is used with ac spark excitation and indium as an internal standard reference.

### Design Considerations for Class B Complementary-Symmetry Audio Amplifiers

By C. F. Wheatley: Published in ELECTRONIC DESIGN, August 6, 1958. The basic complementary-symmetry principle is applied to the practical design of a class B system having optimum performance. Determination of circuit parameters is discussed, and typical values are given for a 175-milliwatt and a 10-watt circuit based on these principles.

## INDUSTRIAL ELECTRONIC PRODUCTS

Camden, N. J.

### M-87/AIC Microphone & H-143/AIC Earphone

By R. M. Carrell, F. K. Rogers, C. E. Farr: Presented at the Acoustical Society of America, Wash., D. C., May 7, 1958. These units are part of a new headset for communication in high intensity noise which RCA developed for the Air Force. The M-87/AIC is a small, noise cancelling dynamic microphone which replaces two layer and heavier types. The H-143/AIC is a 35 gram replacement for an 80 gram earphone. The weight reduction was accomplished without loss of performance.

### New Applications of the Transfluxor

By D. L. Nettleton: Presented to Phila. Chapter of the Professional Group on Electronic Components, May 20, 1958. This paper discusses the theory and application of the analog storage properties of the transfluxor. Voltage or current memory, frequency memory, or multistate counting circuits can be obtained in extremely simple configurations. The device is potentially useful in telemetering systems, frequency tracking systems, and multiplexed control systems.

### Remote Control of High Power Transmitters

By C. J. Starnier: Presented at the NAB Convention, Los Angeles, Calif., April 29, 1958. Remote control operation of the RCA BTA-50G is discussed. The BTA-50G is a 50-KW standard band AM transmitter, employing the phase-to-amplitude system of modulation. Major emphasis is placed upon design solutions utilized to satisfy the requirements imposed by remote control operation.

### The RCA Color Video Tape Recorder

By A. H. Lind: Presented NAB Convention, Los Angeles, Calif., April 28, 1958. Mr. Lind presented slides to show the new color video tape equipment and illustrated practical station layouts of this equipment.

### Writing and Speech

By Dr. G. H. Brown: Luncheon Guest Speaker at the Second Annual Symposium, IRE Professional Group on Engineering Writing and Speech, Biltmore Hotel, New York, October 1-2, 1958.

## ELECTRONIC COMPONENTS

Camden, N. J.

### Scope of the Leader Contractor's Task

By W. T. Warrender: Presented Dept. of Interior Auditorium, Wash., D. C.—Army Signal Corps Program for Micro-Modules, June 3, 1958. The scope of the leader contractor's task will be to provide the system conception, integration of industry know-

how for implementation of the system, and model fabrication and analysis. Procedures and policies which apply to the evaluation, selection and direction of subcontractors are discussed.

## DEFENSE ELECTRONIC PRODUCTS

Camden, N. J.

### A Night Television System

By C. T. Shelton, B. F. Walker, D. E. Townsend: Presented Military Electronics Convention, Wash., D. C., July 17, 1958. The Night Vision Branch of the Engineers Research and Development Laboratories, Fort Belvoir, Virginia, is at present sponsoring a program at RCA for the development of a system producing television images under night time illumination conditions. The basis of this system is an image intensifier orthicon now being made by the RCA Tube Department. The objective is to provide images on moonless, cloudy nights. A facility is being provided to evaluate the operation of tubes of this type at standard TV scanning rates. In addition a storage mode is provided which allows integration of available light for periods of up to several seconds.

### A New Role for Reliability Stress Analysis—Systematizing the Attack on Maintainability Problems

By H. L. Wuerffel, D. I. Troxel: Presented 2nd National Convention on Military Electronics, Wash., D. C., June 16, 1958. Reliability stress analysis has been established as an effective tool in solving the reliability problem. By an extension of the basic technique to include what is termed "function tracing" we not only refine our methods for identifying and evaluating reliability problems, but also introduce a highly significant new advantage. This is the ability to identify and evaluate maintainability problem. This permits concentration of the maintainability and reliability effort.

Moorestown, N. J.

### The Prediction of Derivates of Polynomial Signals in Additive Stationary Noise

By I. Kanter: Presented Wescon, Los Angeles, Calif., Aug. 19, 1958. The paper is a generalization of the work of Zadeh and Ragazzini on the same subject. It allows one to differentiate tracking radar position data e.g. to provide the velocity of a target essential to predicting the future position.

### A Broad Band Circularly Polarized C-Band Antenna

By R. M. Smith: Presented National Electronics Conference, Chicago, Ill., Oct. 13, 14, 15, 1958. The device is a hemispherical grating consisting of concentric metal fins, capable of transforming linear polarization from an antenna feed horn to circular polarization over a 10 per cent band with an ellipticity of less than 2.0 db.

### Enhanced Real-Time Data Accuracy for Instrumentation Radar by Use of Digital-Hydraulic Servos

By R. P. Cheetham, W. A. Mulle: Presented Wescon, Los Angeles, Calif., Aug. 20, 1958. The need for real-time vernier correction of Instrumentation Radar data in the presence of noise has led to the development of a high response digital servo with dynamic speed range of 100,000/1 and bandwidth of 23 cps. A basic radar instrumentation problem is defined. A system recently developed to solve this problem is described in detail.

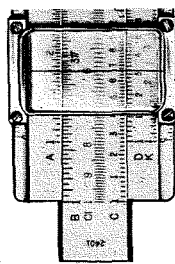

## FIRST MAJOR RCA FACILITY IN NEW ENGLAND COMPLETED AT BURLINGTON, MASSACHUSETTS

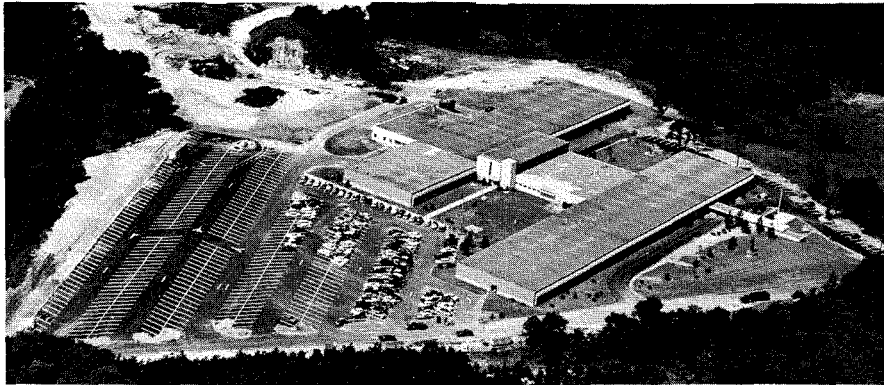

Completion at Burlington, Mass., of the Radio Corporation of America's first major plant facility in New England was announced recently by **A. L. Malcarney**, Executive Vice President, RCA Defense Electronic Products.

At the same time, Mr. Malcarney announced the establishment of a new RCA department to be known as the Missile Electronics and Controls Department, RCA Defense Electronic Products.

The new department will occupy the Burlington plant, which was dedicated October 22. Housed in a one-story building with 135,000 square feet of space, the Missile Electronics and Controls Department was described by Mr. Malcarney as "an integrated operation for the research, development and manufacturing of missile and electronic control systems."

The former Boston Airborne Systems Laboratory of RCA becomes a part of the new department. Laboratory personnel and operations already have been transferred to Burlington from temporary quarters at Waltham.

**W. B. Kirkpatrick**, who headed the Airborne Systems Department of RCA

Defense Electronic Products at Camden, N. J., will manage the new Burlington plant.

**Dr. R. C. Seamans, Jr.**, former Manager and Chief Systems Engineer of the Boston Airborne Systems Laboratory, becomes Chief Engineer of the new department.

Mr. Kirkpatrick joined RCA in 1947 and became Manager of the Airborne Systems Department of RCA Defense Electronic Products ten years later. In the interim he served in such capacities as Manager of Air Force Contracts, of Government Contracting, Government Custom Equipment and Airborne Systems Marketing. Mr. Kirkpatrick is a University of Pennsylvania engineering graduate.

Dr. Seamans received a doctorate of Science in Instrumentation from Massachusetts Institute of Technology, where from 1941 to 1949 he was instructor and then associate professor in aeronautical engineering. In 1953 Dr. Seamans became Director of the MIT Flight Control Laboratory. He joined RCA in 1955 as Manager of the Boston Airborne Systems Laboratory, of which he also was named Chief Systems Engineer in 1957.

## NEW EDITORIAL REPRESENTATIVE APPOINTED

**David J. Carlson** has been appointed to replace M. C. Kidd as Editorial Representative for Advanced Development Engineering of the RCA Victor Television Division at Cherry Hill. Mr. Kidd has moved to IEP Microwave Advanced Development at Camden.

Mr. Carlson served 2½ years with the Army Signal Corps during the last war, and received the B.S. degree in E.E. in 1950 from Rensselaer Polytechnic Institute. He received the M.S. degree in E.E. from the University of Pennsylvania in 1957.

He joined the Advanced Development section of the Television Division in 1950, and has been working on projects related to various phases of the UHF spectrum. Mr. Carlson is a member of Eta Kappa Nu and the IRE.



## ENGINEERS IN NEW POSTS

Biggest news this month was the establishment of a new department in DEP: Missile Electronics and Controls Department located in Burlington, Mass., near Boston. Formed from the Airborne Systems Department's Waltham Labs, the new department dedicated its new building Oct. 22. **W. B. Kirkpatrick** will be Dept. Mgr., with **Dr. R. C. Seamans** as Chief Engineer. **S. N. Lev** becomes ASD Mgr. in Camden, with **J. D. Woodward** continuing as Chief Engineer.

**D. H. Kunsman** is new Service Company President, succeeding **E. C. Cahill**, who is stepping aside on the advice of his physicians.



E. C. Cahill



D. W. Epstein

Astro-Electronic Products' Chief Engineer **Sidney Sternberg** has announced his organization: **M. S. Cohen**, ACSI-Matic Project Mgr.; **D. H. Fryklund**, Mgr. of Mechanical Techniques Development Lab.; **E. A. Goldberg**, Mgr. Design Engineering; **E. C. Hutter**, Mgr., Physics R & D Lab.; **S. W. Spaulding**, New Projects Analysis Mgr.; and **L. A. Thomas**, Technical Services Mgr. Mr. Sternberg will act as Mgr. of RCA Juno Project.

In the Tube Division, **R. S. Burnap** has appointed **E. C. Hughes, Jr.** Commercial Engineering Programs Administrator . . . **D. W. Epstein** moves from Princeton Labs. to Lancaster to manage Conversion Tube Engineering, to include Conversion Tube Shop under **W. T. Dyll**, Photo and Image Tube Development under **R. W. Engstrom**, Camera, Oscillograph and Storage Tube Development under **F. S. Veith**, and Engineering Services managed by **H. S. Lovatt** . . . **J. G. Woehling** appoints **T. E. Swander** Mgr. of Mechanical Advanced Development in Entertainment Tube Products' Advanced Equipment Development.



P. M. Lufkin



E. E. Moore

In IEP, **C. M. Lewis** becomes Mgr., Systems Marketing, reporting to **T. A. Smith** . . . **N. E. Edwards** is appointed Mgr., Communications Systems under Communications Chief Engineer, **E. I. Anderson**.

The Semiconductor Division appoints **Paul M. Lufkin** as resident field engineer for East Central Sales Office at Detroit.

**Edwin E. Moore** becomes Mgr. Engineering Services for Chief Engineer **J. L. Franke** in Radio and "Victrola" Division at Cherry Hill.

## MEETINGS, COURSES AND SEMINARS

The Fifth National Symposium on Reliability and Quality Control in Electronics will be held on January 12, 13, and 14, 1959, at the Bellevue-Stratford Hotel, Philadelphia.

A number of people from RCA have been named to fill various National Committee posts. Committees and appointees are as follows: Management Committee: **C. M. Ryerson**, Vice Chairman, DEP, Camden; **M. Raphelson**, Secretary, DEP, Moorestown; Advisory Board: **Max C. Batsel**, DEP, Camden; Program Committee: **R. M. Jacobs**, Vice Chairman, DEP, Moorestown; Publicity Committee: **H. L. Wuerffel**, Vice Chairman, DEP, Camden; Registration Committee: **J. Rivera**, Chairman, RCA Service Company, Cherry Hill.

**Mr. Ralph G. Fox**, development engineer, Chemical and Physical Laboratory, Engineering, RCA Victor Record Division, Indianapolis, Indiana, completed a special summer program in "Fundamentals of Strain Gage Techniques" at Massachusetts Institute of Technology.—*S. D. Ransburg*

### CREATIVITY, "ON-THE-AIR"



C. M. Sinnett

**Mr. C. M. Sinnett**, manager of Advanced Development Engineering at RCA Cherry Hill, participated in a discussion program on the creative mind and the nature of creative thinking on a half-hour broadcast over radio station WRCV, Philadelphia, on August 31st.

Mr. Sinnett is well-known by engineers throughout this area. Other panelists on the August 31st broadcast include A. M. Nixon, assistant vice president of engineering affairs at the University of Pennsylvania and consultant to the Bethlehem Corporation, and Ralph Showers, associate professor of electrical engineering at the University of Pennsylvania. Fred Harper is the regular moderator of the program.

The discussion series started July 31st, and continued until October 12th. Each week's broadcast touched on a different phase of creativity. Panelists were invited from the University of Pennsylvania, industry in the area, and experts in that field.

### NBC RADIO ENGINEER RECEIVES AWARD FROM CHIEF SIGNAL OFFICER

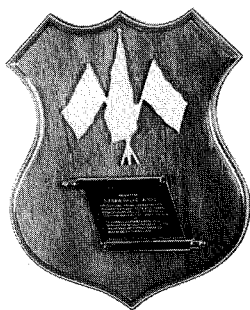

**S. Edwin Piller**, Radio Engineer in the Allocations Engineering Department of NBC, recently received an award from the Chief Signal Officer of The U.S. Army Signal Corps.

The award was an engraved plaque which read as follows: "Presented to S. Edwin Piller, A2KPQ, for exceptional personal contribution to the Military Affiliate Radio System in the planning, organization and conduct of the First United States Army MARS Single-Sideband Technical Net—by J. D. O'Connell, Lieutenant General, Chief Signal Officer United States Army at the

10th ARRL National Amateur Radio Convention, Washington, D.C., 16 August 1958."

Mr. Piller, an active radio amateur operator for over twenty-one years, conceived the idea of a single sideband technical net whose prime mission was: "The Dissemination of Technical Knowledge by Radio Communication."

The net operates on the First Army Command Channel of 4030 kc. each Wednesday at 9 PM (prevailing N.Y.C. time) and can be heard within a radius of

1000 miles of New York City. Outstanding specialists in the electronics field give periods in an on the air forum. Net members call in by radio from various parts of the northeastern United States. Starting in September six leading radio and electronics magazines will be carrying the monthly speaker schedules.

In a nation which is trying to improve its technical education effort, this type of operation has aroused great interest in government, military and industrial circles.



## COMMITTEE APPOINTMENTS

### DEP TUCSON

The Tucson Section of the Institute of Radio Engineers has elected three RCA engineers as officers for the 1958-59 term. The Tucson IRE officers are:

D. Pascoe, President	RCA Service Company
Dr. C. R. Hausenbauer, Vice Pres.	Univ. of Arizona
R. L. Patterson, Secretary	Surface Communications Systems Laboratory, DEP
J. A. Wade, Treasurer	Surface Communications Systems Laboratory, DEP

**Mr. D. W. Hudgings** has been elected to the 1958-59 term as State Director of the Arizona Society of Professional Engineers, representing the Southern Chapter from Tucson.

### ENGINEERING DEGREES

**Robert Richter**, DEP Surface Communications Engineering in Camden, received the MS in Electrical Engineering from Drexel Institute of Technology in June of this year.

**John J. Moscony**, Semiconductor and Materials Division, Camden, received the MS degree in Chemistry from St. Joseph's College in June.

The following Electron Tube Division engineers at Harrison have received advanced degrees this June: **Joseph T. Gote**, MSEE from Newark College of Engineering; **Frank M. Sespico**, MSEE from Newark College of Engineering; **William Troyanoski**, MSEE from Newark College of Engineering; **John J. Carrona**, MS in Metallurgy from Stevens Institute of Technology; **Ernest J. Hannig**, MS in Physics from Stevens Institute of Technology; **Louis J. Striednig**, MSEE from New York University; **Thomas DeMuro**, MS in Ind. Eng. from New York University; **A. C. Grover, Jr.**, MS in Computer Science from Stevens Institute of Technology.



## IT HAPPENED!

In editorial work, one tries continuously to maintain some semblance of accuracy—particularly in the professional technical engineering presentations appearing in these pages. However, the possibility of a gross error perennially hovers, like the Sword of Damocles, poised to fall when least expected.

Our readers probably are aware that the inevitable had happened, with Dionysian irony, in the text of Dr. Harry F. Olson's paper appearing in the August-September 1958 issue.

The error occurs as an omission in text continuity between pages 35 and 36. The following is the passage affected, with the omission printed in bold-face type.

Our sincere apologies to Dr. Olson and to our readers.



Dr. H. F. Olson

A schematic diagram of a binaural sound reproducing system is shown in Fig. 2. There is no widespread use of the binaural sound reproducing system. The use is limited to specific applications. The binaural sound reproducing system consists of two separate channels. Each channel consists of a microphone, transducer and telephone receiver. The microphones are mounted in a dummy simulating the human head in shape and dimensions and at the locations corresponding to the ears of the human head. The transducer may be an amplifier, a radio transmitter and receiver, a television sound transmitter or receiver, a phonograph recorder and reproducer, a motion picture recorder and reproducer, and/or a magnetic tape recorder and reproducer. **The binaural sound reproducing system is of the closed circuit type. The listener is transferred to the location of the dummy by means of a two-channel sound reproducing system.** The binaural sound reproducing system may be constructed so as to satisfy all four conditions on realism of sound reproduction.

A schematic diagram of a monophonic sound reproducing system is shown in Fig. 3. It is the most widely employed of all sound reproducing systems. Examples are the disc phonograph radio, sound motion picture, television, magnetic tape reproducer and sound systems. The monophonic sound reproducing system is of the field type, where sound is picked up by a microphone and reproduced by a loudspeaker into a field. The sound at the microphone is reproduced at the loudspeaker. **The transducer may be an amplifier, radio transmitter and receiver, a phonograph recorder and reproducer, a sound motion picture recorder and reproducer, a television transmitter and receiver, and/or a magnetic tape recorder and reproducer.** The monophonic sound reproducer may be constructed to satisfy conditions 1, 2 and 3 on realism of sound reproduction. It cannot under any conditions satisfy condition 4.

## REGISTERED PROFESSIONAL ENGINEERS

The following names have been added to the RCA ENGINEER list of registered professional engineers:

Name	State	Licensed As	License No.
<i>DEP Moorestown</i>			
Oral N. Bowen.....	Ind.	Elect. Eng.	8351
<i>IEP Communications Eng., Camden</i>			
S. S. Spiegel .....	N.J.	Prof. Eng.	10310

## ENGINEERING MEETINGS AND CONVENTIONS

October-November, 1958

**OCTOBER 14-15**  
*Institute of Printed Circuits*  
*Fall Meeting*  
*Chicago, Ill.*

**OCTOBER 20-21**  
*Aero Communications Symposium*  
*Fourth National PGCS*  
*Hotel Utica, Utica, N.Y.*

**OCTOBER 20-21**  
*USA National Committee*  
*URSI Fall Meeting,*  
*Penn State Univ.,*  
*University Park, Pa.*

**OCTOBER 20-24**  
*SMPTE 84th Convention*  
*Sheraton-Cadillac Hotel*  
*Detroit, Mich.*

**OCTOBER 26-31**  
*AIEE Fall Meeting*  
*Penn-Sheraton Hotel*  
*Pittsburgh, Pa.*

**OCTOBER 29-30**  
*Fifth Annual Computer Applications*  
*Symposium*  
*Morrison Hotel, Chicago, Ill.*

**OCTOBER 30-31**  
*Electron Devices Meeting, PGED, IRE*  
*Shorham Hotel, Wash., D.C.*

**OCTOBER 30-31**  
*Aircraft Electrical Society*  
*Pan Pacific Auditorium*  
*Los Angeles, Cal.*

**NOVEMBER 6-7**  
*Prof. Group on Nuclear Science, IRE*  
*Fifth Annual Meeting*  
*Villa Hotel, San Mateo, Cal.*

**NOVEMBER 17-20**  
*Magnetism and Magnetic Materials*  
*Fourth Annual Conf.*  
*AIEE, APS, IRE, AIME, OHR,*  
*Sheraton Hotel, Phila., Pa.*

## CLIP OUT AND MAIL TO:

EDITOR, RCA ENGINEER  
 Radio Corporation of America  
 Bldg. 2-8, Camden 2, N. J.

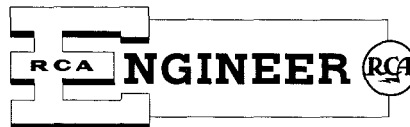

## HAVE WE YOUR CORRECT ADDRESS?

If not indicate the change below.

PLEASE INDICATE THE CODE LETTER(S) THAT  
 APPEAR NEXT TO YOUR NAME ON THE ENVELOPE.

Name \_\_\_\_\_ Code \_\_\_\_\_

Street or Bldg. \_\_\_\_\_

City and State or Plant \_\_\_\_\_

# RCA ENGINEER EDITORIAL REPRESENTATIVES

## DEFENSE ELECTRONIC PRODUCTS

F. D. WHITMORE, *Chairman, Editorial Board*

### Editorial Representatives

- I. N. BROWN, *Missile and Surface Radar Engineering, Moorestown, N. J.*  
T. P. CANAVAN, *Airborne Fire Control Engineering, Camden, N. J.*  
H. R. DYSON, *Technical Administration, Camden, N. J.*  
R. W. JEVON, *Airborne Systems Laboratory, Waltham, Mass.*  
R. D. LENDING, *Airborne Systems Engineering, Camden, N. J.*  
C. MCMORROW, *Aviation Communications and Navigation Engineering, Camden, N. J.*  
J. H. PRATT, *West Coast Engineering, Los Angeles, Calif.*  
L. M. SEEBERGER, *Development Engineering, Camden, N. J.*  
E. O. SELBY, *Surface Communications Engineering, Camden, N. J.*  
H. L. WUERFFEL, *Engineering Standards and Services, Camden, N. J.*

## INDUSTRIAL ELECTRONIC PRODUCTS

C. W. SALL, *Chairman, Editorial Board*

### Editorial Representatives

- I. F. BYRNES, *Radiomarine Engineering, New York, N. Y.*  
H. E. HAYNES, *Advanced Development Engineering, Camden, N. J.*  
C. E. HITTLE, *Hollywood Engineering, Hollywood, Calif.*  
C. D. KENTNER, *Broadcast Transmitter and Antenna Engineering, Camden, N. J.*  
T. T. PATTERSON, *Electronic Data Processing Engineering, Camden, N. J.*  
J. H. ROE, *Broadcast Studio Engineering, Camden, N. J.*  
J. E. VOLKMANN, *Industrial and Audio Products Engineering, Camden, N. J.*  
B. F. WHEELER, *Communications Engineering, Camden, N. J.*

## RCA LABORATORIES

### Editorial Representative

E. T. DICKEY, *Research, Princeton, N. J.*

## RCA SERVICE COMPANY

### Editorial Representatives

- W. H. BOHLKE, *Consumer Products Service Department, Cherry Hill, N. J.*  
L. J. REARDON, *Government Service Department, Cherry Hill, N. J.*  
E. STANKO, *Technical Products Service Department, Cherry Hill, N. J.*

The Editorial Representative in your group is the one you should contact in scheduling technical papers and arranging for the announcement of your professional activities. He will be glad to tell you how you can participate.

## RCA ELECTRON TUBE AND SEMICONDUCTOR & MATERIALS DIVISIONS

J. F. HIRLINGER, *Chairman, Editorial Board*

### Editorial Representatives, RCA Electron Tube Division

- W. G. FAHNESTOCK, *Industrial Tube Products, Lancaster, Pa.*  
J. DEGRAAD, *Black & White Kinescopes, Marion, Ind.*  
D. G. GARVIN, *Color Kinescopes, Lancaster, Pa.*  
A. E. HOGGETT, *Receiving Tubes, Cincinnati, Ohio*  
R. L. KLEM, *Entertainment Receiving Tubes, Harrison, N. J.*  
J. KOFF, *Receiving Tubes, Woodbridge, N. J.*  
F. H. RICKS, *Receiving Tubes, Indianapolis, Ind.*  
H. J. WOLKSTEIN, *Industrial Tube Products, Harrison, N. J.*

### Editorial Representatives, RCA Semiconductor & Materials Division

- T. A. RICHARD, *Needham, Mass.*  
R. E. RIST, *Somerville, N. J.*

## RCA VICTOR TELEVISION DIVISION

C. M. SINNETT, *Chairman, Editorial Board*

### Editorial Representatives

- D. J. CARLSON, *Advanced Development Engineering, Cherry Hill, N. J.*  
E. J. EVANS, *Resident Engineering, Bloomington, Ind.*  
R. D. FLOOD, *Color TV Engineering, Cherry Hill, N. J.*  
F. T. KAY, *Black & White TV Engineering, Cherry Hill, N. J.*  
J. OSMAN, *Resident Engineering, Indianapolis, Ind.*  
H. P. J. WARD, *Electronic Components, Findlay, Ohio*  
K. G. WEABER, *Engineering Services, Cherry Hill, N. J.*

## RCA VICTOR RECORD DIVISION

### Editorial Representative

S. D. RANSBURG, *Record Engineering, Indianapolis, Ind.*

## RCA VICTOR RADIO & "VICTROLA" DIVISION

### Editorial Representative

W. S. SKIDMORE, *Engineering Department, Cherry Hill, N. J.*

## ASTRO-ELECTRONIC PRODUCTS DIVISION

### Editorial Representative

E. A. GOLDBERG, *Engineering, Hightstown, N. J.*

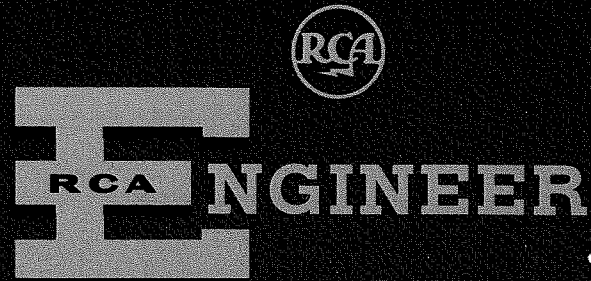

A TECHNICAL JOURNAL PUBLISHED  
BY PRODUCT ENGINEERING.  
"BY AND FOR THE RCA ENGINEER"

RADIO CORPORATION OF AMERICA