

On completion of three years of publication of your engineering journal it is our wish to recognize the active participation of—our readers, our editorial representatives, staff members, and our advisory board.

To Our Readers . . . who are also our contributors. Your enthusiastic work with respect to the RCA ENGINEER is deserving of special mention. For example, over a three-year period, you have provided for publication in your journal, more than 200 professional articles, summaries for nearly 500 papers or speeches presented elsewhere, along with the announcement of more than 700 patents granted to you. More than 3500 in the RCA community of engineering have participated in one way or another; editing, suggesting topics, furnishing captions, providing illustrations, submitting news and photos—and of course writing authoritative technical papers. Certainly, this is a definite sign that you recognize “communications” as one of your professional engineering duties, and in particular, the RCA ENGINEER as your own medium for accomplishing this within RCA.

Third Anniversary

To Our Editorial Representatives and Engineering Editors . . . who are not only readers but representatives of the journal. Voluntarily, you have helped plan, develop, and maintain a technical magazine including design and development articles, product information, as well as non-technical papers devoted to business, economics and inspirational topics. It is through your continued efforts that established objectives will be met. As model readers, you will continue to shape future content of the RCA ENGINEER.

To Our Fellow Staff Members . . . who capably provide professional art, production, photographic, and editorial services that are a vital factor in maintaining a successful publication. We take this opportunity to recognize the outstanding efforts of J. L. Parvin who directs art and production . . . P. F. Gallo and R. P. Smith who provide layout and artwork for all published articles . . . J. O. Gaynor and R. B. Allen who provide experienced industrial photographic services . . . and Russ Hall, our busy Assistant Editor, who pursues all publication phases, helps plan covers and editorial content.

To Our Advisory Board Members . . . who are our guide and counsel. As a legislative or policy determining body, your group has helped assure fulfillment of established goals. Your regular review of long-range editorial plans helps us maintain conformance with our objectives.

For the future—you, the engineer reader, can help on the road ahead by continuing to submit your suggestions for the makeup and content of your engineering journal. In this way you can help us protect your interest—“By and for the RCA engineer”!

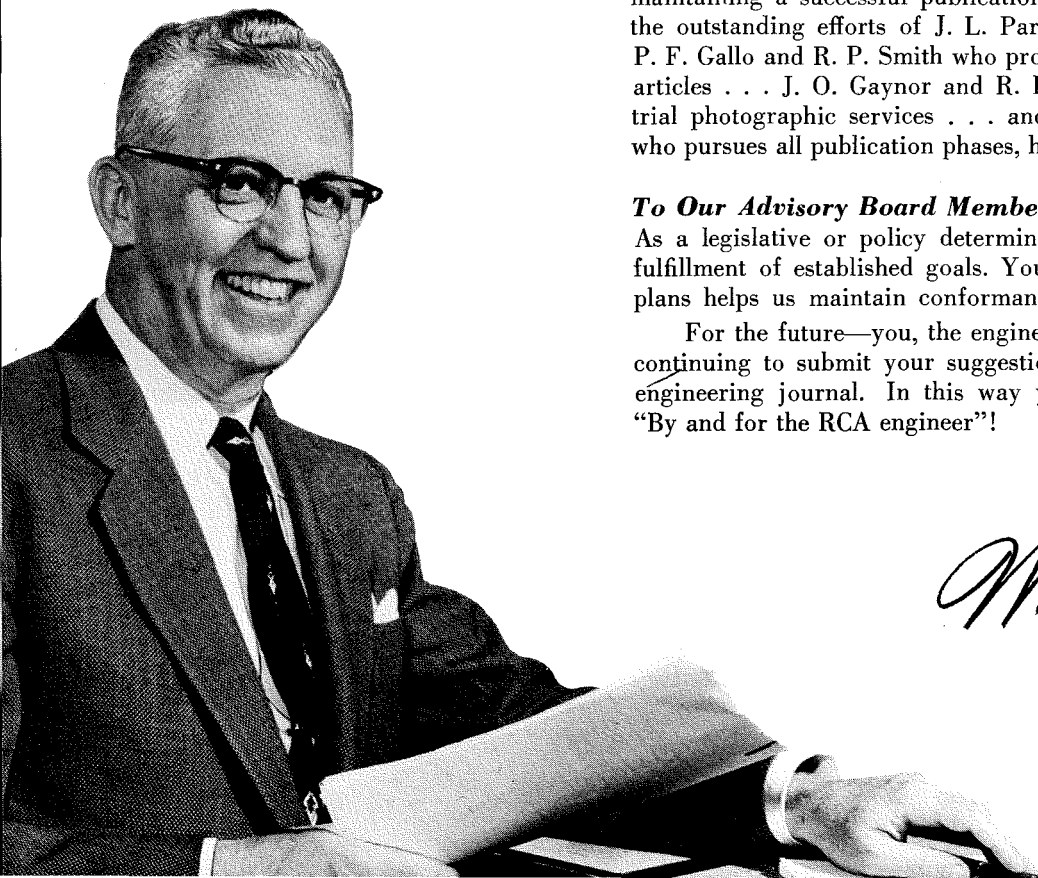

W. O. Hadlock

W. O. HADLOCK, Editor
RCA ENGINEER

CONTENTS

Research-Product Engineering—A Joint Endeavor. .Dr. Irving Wolff	2
On-Line Sales Recording System. J. S. Baer, A. S. Rettig and I. Cohen	4
Inertial Navigation—Part II, Instrumentation of Inertial Systems F. F. Daigle	9
Fiber Optics—Valuable Engineering Principle L. J. Krolak	14
Engineering Test in the Development of RCA Color Kinescopes L. I. Mengle	18
Compound Semiconductors Dr. D. A. Jenny	23
History of RCA (Part II) Dr. E. W. Engstrom	28
The AVQ-50 Lightweight Aircraft Weather Avoidance Radar M. Franco	35
The Drift Transistor I. H. Kalish	38
The SSB-30M Single-Sideband Transmitter-Receiver. .C. E. Schneider	42
Grid-Modulated Envelope Restoration High-Power Amplifier for SSB Service M. Feryszka	44
Patents and Things O. V. Mitchell	47
Patents Granted to RCA Engineers	50
Pen and Podium	51
Engineering News and Highlights	53

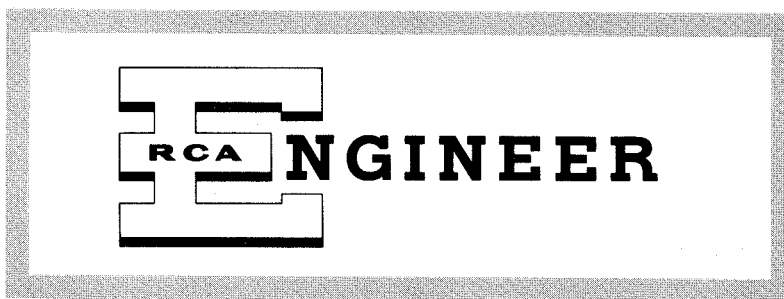

VOL. 4, NO. 1 • JUNE-JULY, 1958

Editorial Advisory Board

M. C. Batsel, Chief Technical Administrator
Defense Electronic Products

J. J. Brant, Director, Personnel

Dr. G. H. Brown, Chief Engineer,
Industrial Electronic Products

D. D. Cole, Chief Engineer,
RCA Victor Television Division

C. C. Foster, Mgr. RCA REVIEW

J. L. Franke, Chief Engineer,
RCA Victor Radio & 'Victrola' Division

M. G. Gander, Mgr. Engineering,
RCA Service Co.

C. A. Gunther, Chief Defense Engineer,
Defense Electronic Products

J. Haber, Director,
Community Relations

D. P. Heacock, Administrative
Engineer, Product Engineering

Dr. A. M. Glover, Vice President,
Semiconductor and Materials Division

J. C. Rankin, Mgr., General Employment

H. E. Roys, Mgr., Engineering,
RCA Victor Record Division

D. F. Schmit, Vice Pres., Product Engineering

Dr. G. R. Shaw, Chief Engineer,
Electron Tube Division

"RCA Engineer" Staff

W. O. Hadlock, Editor

R. J. Hall, Assistant Editor

Miss E. R. Kraus,
Editorial Secretary

J. L. Parvin, Art and Production

J. O. Gaynor, Photography

Engineering Editors

P. R. Bennett, Mgr., Radio
& Phonograph Engineering
RCA Victor Radio & 'Victrola' Div.

R. S. Burnap, Mgr., Commercial
Engineering,
Electron Tube Division

J. B. Davis, Engineering Editor,
Defense Electronic Products

C. A. Meyer, Mgr., Commercial
Engineering Technical Services,
Electron Tube Division

C. W. Sall, Engineering Editor,
Industrial Electronic Products

C. M. Sinnott, Mgr., Advanced
Development Engineering,
RCA Victor Television Division

Copyright 1958
Radio Corporation
of America
All Rights Reserved

PRINTED
U.S.A.

RESEARCH-PRODUCT ENGINEERING—A JOINT ENDEAVOR

Dr. IRVING WOLFF

*Vice President, Research
RCA Laboratories, Princeton, N. J.*

THE TRANSFORMATION OF a research development to a commercially successful product is one of the most important and difficult problems which the technical staff of RCA must solve. Very often the difficulties are both technical and economic.

A UNIFORM, ACCEPTABLE PRODUCT

We, in research, recognize that engineering for manufacturing, including uniformity and quality of product, requires much effort after our prototype has shown a desirable performance. We recognize that, because a new product must compete with other products which have gone through years of refinement and cost reduction, it is at a disadvantage economically—even though potentially cheaper than the old one. We appreciate that customer acceptance must be developed!

CLOSE LIAISON A VITAL FACTOR

None the less, the results of the intro-

duction of new products or even improvement in advance of our competition have proven so valuable that every effort should be made to expedite the adoption of worthwhile research developments.

What can we do to facilitate the transition?

There is no single answer, but I have no doubt that close liaison and understanding between the engineering staffs of the Product Divisions and Research is more important than any other factor.

A PRACTICAL PLAN FOR QUICK TRANSFER OF IDEAS

For a number of years transfer of new developments to one of the product divisions has been unusually rapid and commercially successful, one product recently being sampled to customers only one year after its conception. It seems worthwhile, therefore, to see what kind of a plan can be patterned from this desirable performance.

DR. IRVING WOLFF was educated at Dartmouth College where he received the B.S. in physics in 1916 and at Cornell University where he obtained the Ph.D. degree in 1923.

He was an instructor in physics at Iowa State College during 1919 and at Cornell University from 1920 to 1923 where he was a Hechscher Research Fellow in 1924. In October, 1924, he became associated with the Radio Corporation of America where he has since been employed.

Dr. Wolff's research was in the field of acoustics from 1924 to 1931. In 1932 he initiated a program of microwave research and in 1934 radar research in the RCA organization. In 1937, he had an S-band scanning radar in operation, and in 1938 an airborne pulse radar operating for fixed forward search and altimeter, and in 1942 a pulse doppler ground speed indicator, depending for its operation on a comparison of forward and rearward reflected signal. During the war period he supervised a number of groups conducting radar research for the military agencies. Immedi-

ately following this he and some of his associates developed the basis for the Teleran System of Air Navigation.

During 1946, Dr. Wolff was appointed Director of the Radio Tube Research Laboratory, in October, 1951, Director of Research, and in June, 1954, Vice President, Research, RCA Laboratories.

He received the IRE Fellow Award in 1942 for "basic research in centimeter-wave radio and application of it to the development of navigation instruments" and the Distinguished Public Service Award of the U. S. Navy in 1949 for pioneer research in radar.

He is a Fellow of the American Association for the Advancement of Science, the Acoustical Society of America, the Institute of Radio Engineers, and the American Physical Society and a member of Sigma Xi. He has served on many IRE committees, and was Chairman of the Philadelphia Section in 1936-37; Director of the Institute 1952-53, and Chairman of the Awards Committee 1955.

A JOINT ENDEAVOR

Above all, we may attribute the success of this operation to the mutual recognition that the process of conversion of new ideas to new products is a joint endeavor of the Laboratories and Product Divisions.

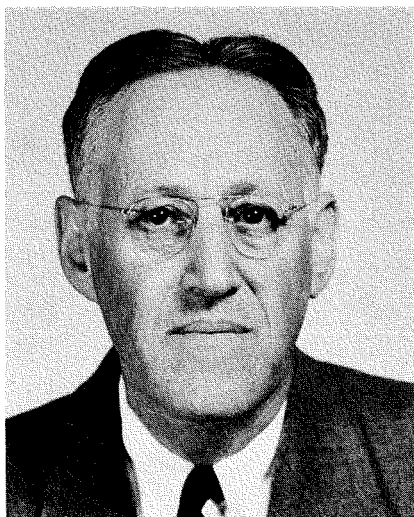

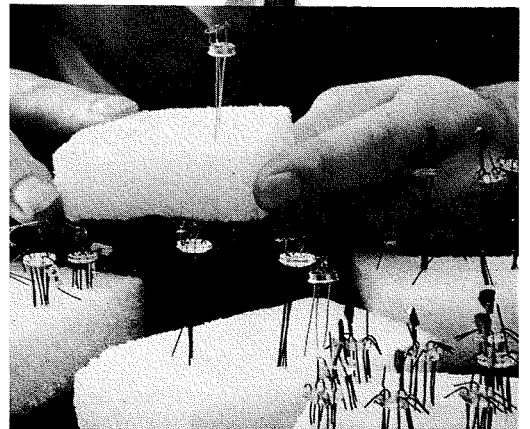
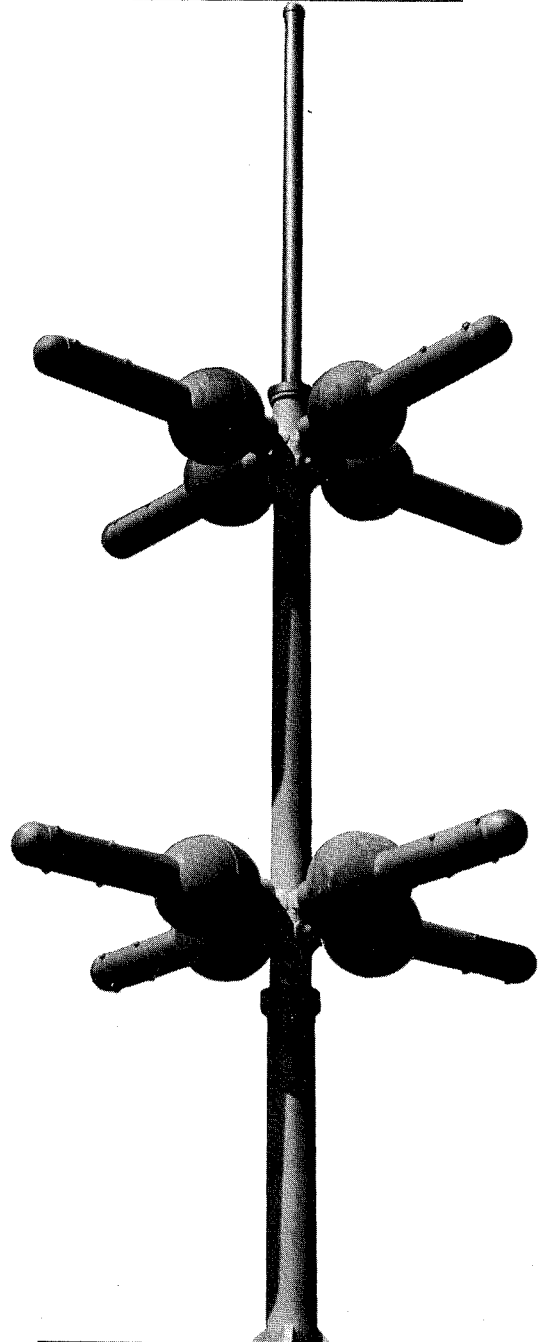
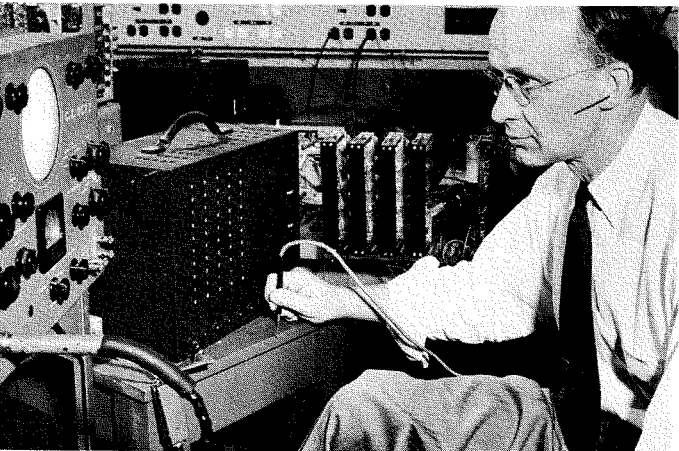
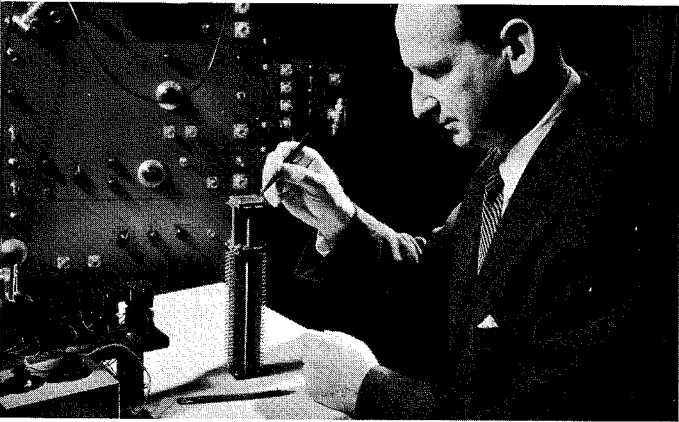
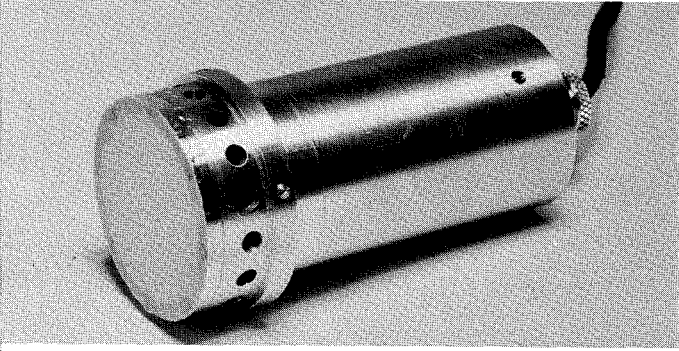
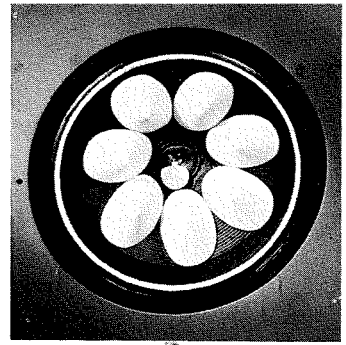

Views of RCA Scientists at work in the RCA Laboratories, Princeton, N. J.



Fig. 1—Sales Recorder.

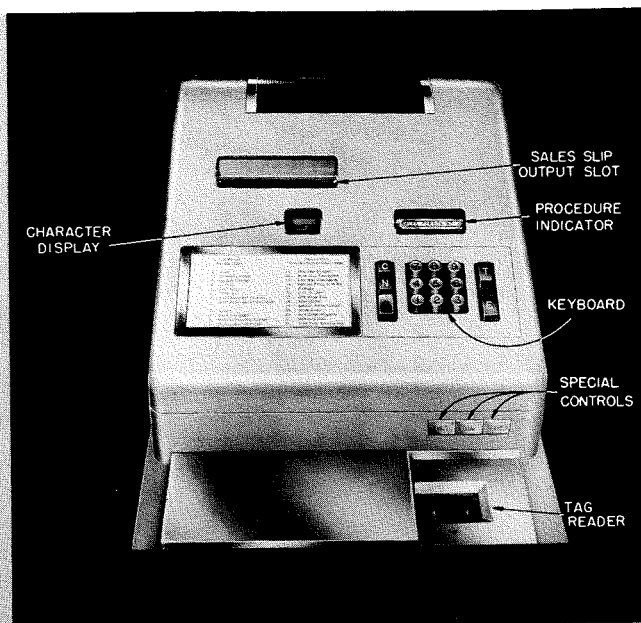

Fig. 2—Sales Recorder Controls and Indicators.

ON-LINE SALES RECORDING SYSTEM

by

JOHN S. BAER, ALBERT S. RETTIG, and IRVING COHEN

Electronic Data Processing Division

Industrial Electronic Products

Camden, N. J.

THIS PAPER PRESENTS a pilot on-line Sales Recording System currently in operation for the Associated Merchandising Corporation as part of a research project. This pilot system comprises point-of-sale units connected to a central computer by means of an Input-Output Buffer unit. The operating characteristics of this system are such that they may be extended to include, for example, inventory and production control, and the handling of transportation reservations.

Operation of the pilot unit, which started in April, 1957, has continued with highly satisfactory results. The Sales Recording system has maintained an average "up-time" record of over 97% for the past nine months.

SALES RECORDER

The point-of-sale unit or Sales Recorder (Fig. 1), consists of a keyboard for manual input, in combination with a character display, and a procedure indicator. There is a punched tag reader for automatic in-

put of the sales person number, customer number and merchandise stock number. An output printer provides for a three-part sales check at the point-of-sale. The entire unit is packaged over a cash drawer and is contained within a vented aluminum housing, which opens completely for servicing.

KEYBOARD

The keyboard (Fig. 2), is of the type commonly referred to as a ten-key keyboard. Actually, it consists of fourteen keys . . . ten numeric and four control keys. The four control keys are: Enter, Non-merchandise, Clear, and Total, and allow the operator to control the procedural input to the machine.

The keyboard is designed to provide both manual and electrical interlocks. When one key is depressed, another key cannot be depressed, and two keys cannot be depressed at the same time. The actual depression of the key is only for the first position of the key stroke. From that point on,

the key is mechanically pulled down, and is held down until the Input-Output Buffer unit has recognized the character being input as a legitimate one. When this routing is complete, the key is allowed to return to its normal position. Each time a numeric key is depressed, that number is shown in a lighted character display window of the point-of-sale unit. In this manner, a sales person can verify any item prior to striking the ENTER key, which clears the display.

The output of the keyboard is four bits with parity. These five bits, plus an additional control bit, are the information levels sent to the Input-Output Buffer. Operation of the keyboard can be at the sustained rate of six characters per second.

PROCEDURE INDICATOR

The procedure indicator provides a visual indication to the operator, of where in the procedure the operator should be, at any given time, during input of information to the Input-Output Buffer. The indicator consists of a plastic engraved drum, driven by a stepping switch. The drum advances one step each time the ENTER key is depressed. Upon depression of the NON-MERCHANDISE key, the drum advances to the non-merchandise field. Upon depression of the TOTAL key, the drum advances to its original start position.

TAG READER

The punched-tag reader was designed to accept the twenty-five column, Densnison tag, or abbreviation of it. When a sales person or customer number tag is read, the tag is returned after read-in, so that it may be retrieved by the operator. In the case of the merchandise tags, however, the tag is read and retained in the machine, which prevents littering the counter with merchandise tags. Since all of the tag information has been recorded on magnetic tape, the merchandise tags may be removed from a bin and discarded at the end of the day. The first character of any tag indicates which of the three types it is, and if the wrong tag is inserted, the logic of the machine is such that the tag reader stops, and the CLEAR key must be depressed in order to retrieve

the tag. The tags are read one step or character at a time, $7\frac{1}{2}$ characters per second. Again, as in the keyboard, the tag reader stops in a reading position and the output is verified as a valid binary number, prior to advancing to the next reading position. An electrical interlock between the tag reader and the keyboard prevents keyboard operation when a tag has been inserted in the reader. The actual reading of each character on the tag is accomplished by "sensing" the tag with five pins so connected through linkages as to actuate switches in the presence of holes.

OUTPUT

When the TOTAL key is depressed, the Sales Recorder is placed in the output mode, causing the cash drawer to open, and allowing the print-out of the sales check to begin. However, in a credit type sale, if the purchaser did not have a good credit rating, a HOLD button will light, providing a bad credit indication to the operator, and preventing print-out. Print-out will proceed if the operator presses the HOLD button.

The same mechanism that provides the character display for the keyboard is also the principal portion of the output printer. The output printer consists of ten numerical print wheels fabricated from nylon. These wheels are set up sequentially directly from the information sent by the Input-Output Buffer Unit. When a line of print has been set, a print platen is released, the line is printed, and the paper is advanced to the next print position. The speed of this operation averages about six characters per second. An automatic overprint provides a visual indication on the check for credits or C.O.D. transactions.

The paper used consists of a three-part sprocket-fed pre-printed form. The first copy is obtained through an ink ribbon impression and the back copies are carbonless paper, and require no ribbon for printing. Since the form is pre-printed, the paper feed mechanism is programmed in conjunction with the printer so as to print only in the correct blocks or spaces on the check, and not in the pre-printed portions. A typical salescheck is shown in Fig. 1.

The printer, keyboard and tag reader are all separate units that plug into the base assembly. Fig. 3 gives an exploded view of the Sales Recorder while the complete assembled unit is shown in Fig. 4.

BUFFER UNIT

The Buffer Unit is a multiplexing device which allows the transfer of data to and from as many as 10 Sales Recorders. Working on a time-sharing basis, the buffer permits independent operation of each Sales Recorder. A block diagram of the Buffer Unit is shown in Fig. 5.

The communication between the Sales Recorder and the Buffer Unit consists of information flow within a closed loop.

At both receiving ends of the loop the character is checked for parity errors. If wrong parity is sensed, the character is rejected and an error displayed at the Sales Recorder. The keyboard of the Sales Recorder remains locked until the error is cleared. As mentioned earlier, the return of the correct character from the Buffer Unit to the Sales Recorder unlocks the keyboard so that another character may be entered. This double check, together with the relatively high power used in the transmission and the low impedance at both ends, makes the system very reliable from the point of view of the data exchanged, and insensitive to noise and cross-talk.

The two information trunks are actually contained in a single cable that connects each Sales Recorder, via a junction box, to its designated input terminal at the Buffer Unit. To best describe the functioning of the Buffer Unit, its operation will be divided into two modes:

- (a) Input: receiving information from the Sales Recorder—or entering transaction data, and
- (b) Output: sending the processed information to the Sales Recorder—or the printing of the sales slip.

THE INPUT MODE

The 6-bit binary coded character in the form of voltage levels created by

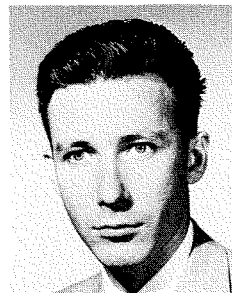

JOHN S. BAER, Leader of Design and Development Engineers, E.D.P. Engineering, graduated from Iowa State College in 1949 with the degree of BS in M.E. Following graduation, Mr. Baer was a Development Engineer for Marathon Corp. in Menasha, Wisc. In 1951, he was Senior Project Engineer, Mast Development Corp.

In 1952, Mr. Baer joined RCA as a Project Engineer in the design and development of high-speed automatic tape-handling, and film-handling equipment. He was responsible for the development of the Sales Recorder, and TAG TALLY. Presently, Mr. Baer heads up a group responsible for the execution of styling for New Electronic Data Processing Equipment.

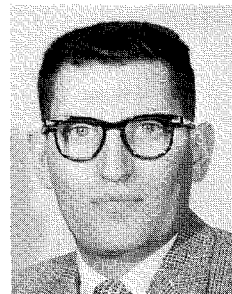

ALBERT S. RETTIG graduated from CCNY with a BEE degree and received a MSEE degree from the University of Pennsylvania in 1957. He spent a year as a Research Assistant at the Moore School, U. of P.

As a Senior engineer with Computer Control Co. during 1954-55, he was associated with the full systems operation of the Raydac Computer.

Since joining RCA's Electronic Data Processing Engineering, in 1955, he has been project engineer on the Input-Output and Recorder Central portions of the Sales Recording System, Sales Recording System extension studies, and Random Access File Buffer Unit.

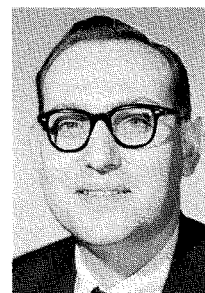

IRVING COHEN, Leader, Design and Development Engineers, E.D.P., received the A.B. in Physics from Temple U. in 1951 and the A.M. in physics from Temple U. in 1955.

In 1953, Mr. Cohen joined RCA Computer Engineering and worked in system analysis of large scale data processing systems. He worked on early logic design and was Project Engineer for the Recorder Central during development, construction, and system test—and for the Buffer Unit during construction and system test. He is currently engaged in research and development of ultra-fast computers.

either depressing a key or reading a character from a tag in the tag reader, is transmitted by cable directly to the input magnetic core bank. (See Fig. 5.) There is a bank of input cores associated with each Sales Recorder. The cores serve the dual function of noise suppression and gating.

Also associated with each Sales Recorder is a portion of a magnetic drum called a sector. That part of the drum containing all the sectors is designated as the Sector Channel. Each sector has a storage capacity of 360 5-bit characters. The sector is divided into pre-assigned fields corresponding to; (1) the times listed on the Procedure Drum for input information, and (2) those items required for output information. These variable fields, once established for the desired application, are fixed in length. Thus, for instance, there is a three-character field for the sales person number. If insertion of a fourth digit is attempted, the CLEAR light at the Sales Recorder will light, indicating that the capacity of the field has been exceeded.

A special indexing track on the drum, called the Marking Pulse Track, provides the indexing mark within each sector, to indicate the location of the character last operated on, and the field starting position.

A magnetic core shift register in synchronism with the magnetic drum, provides a read-out pulse that transfers the information from the input cores to the Input-Output Register at the time that the sector associated

with the respective Sales Recorder is accessible. Since the arrival of the information from the Sales Recorder is asynchronous with respect to the read-out pulse, core logic is provided to assure that a complete character is actually placed in the Input-Output Register. Once in this Register, the information is checked for parity, and if an error is sensed an error-control flip-flop is set.

If a numeric character is present, it will be written on the sector at the location specified by the marking pulse. However, if the character in the register is one of the six operational commands, the matrix in the control unit will be activated, so that the specified command level will be generated. These command levels will enable their related logic to perform the required function. In either event, a parity error prevents the processing of the character in the register.

The information transferred at the start of the sector cycle remains in the Input-Output Register for a time interval equivalent to a sector period, approximately 4.1 milliseconds. All operations pertaining to the character received are executed within this period. Therefore, it is the Input-Output Register that is being time-shared, allowing the sequential sampling of information in each input core bank.

Clock signals are provided so that synchronous timing with the magnetic drum occurs.

Just prior to clearing the Input-Output Register, near the end of the sector period, the contents are transferred to the output core bank. Where

the error control flip-flop was set, the Input-Output Register will be cleared before the contents are transferred, so that the output core bank will contain all zeros. Shortly thereafter, the information is read out of the cores to fire their associated thyatrons, thus forming the return character which will activate the decoding relay matrix in the Sales Recorder. This in turn terminates the transmission of the character to the Buffer unit, and also extinguishes the thyatrons by removing their plate voltage. As was the case for the input cores, there is a bank of output cores and thyatrons associated for each Sales Recorder.

The information levels transmitted by the Sales Recorder will remain present for several complete drum revolutions, about 120 milliseconds, at which time error indication will be made, unless the correct character echo is returned earlier. Since all zeros are returned to the Sales Recorder when parity error is detected, the information transfer is not interrupted. Therefore, a second or third chance is afforded to correctly process the transmitted character and thereby minimize the possibility of transient errors stopping the operation.

THE OUTPUT MODE

Let us now consider the output mode where information is being printed on the sales slip. In the output mode, the information to be transferred to the Sales Recorder originates from the sector storage. However, a character is only transmitted when a request for information is made by

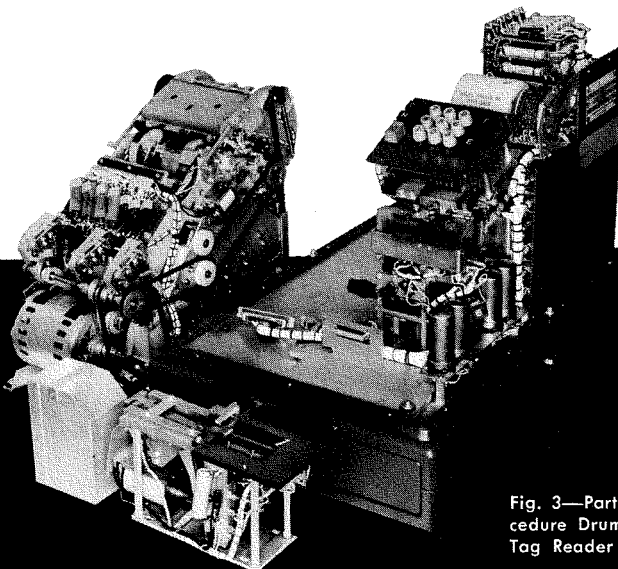

Fig. 3—Partially assembled unit with the Procedure Drum and Keyboard in place and the Tag Reader and Printer shown separately.

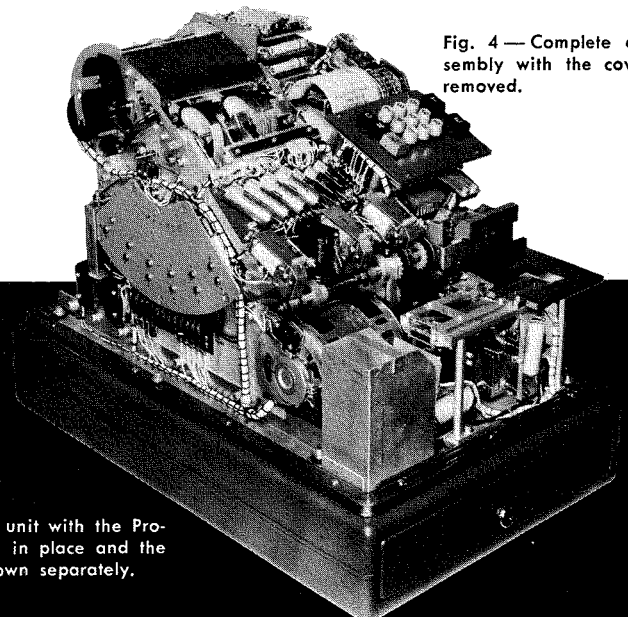

Fig. 4—Complete assembly with the cover removed.

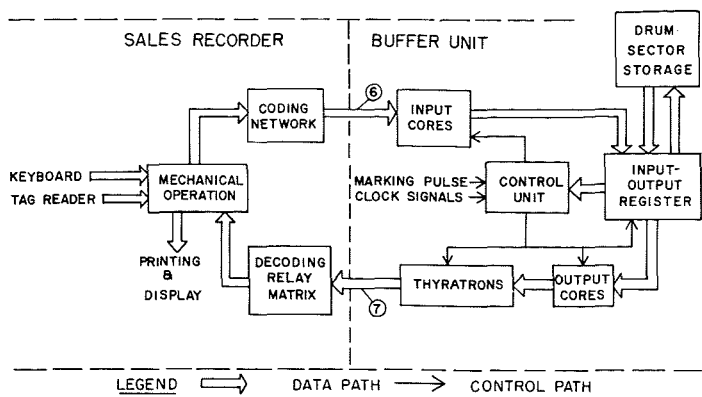

Fig. 5—Block Diagram of the Buffer Unit.

the Sales Recorder, and then only one character is transferred per request. The buffer, in processing this request, will allow a character in sequence, as indicated by the marking pulse, to be transferred from the respective sector to the Input-Output Register. Once in this register, it can be read into the output cores and the thyratrons fired in much the same manner as is done during the input mode.

The central computer will process a transaction only if the input of data from a Sales Recorder has terminated. This is signified by a TOTAL symbol entered at the beginning of the respective sector when the TOTAL key at the Sales Recorder is depressed. Before the Buffer can respond to the Sales Recorder's request for a character, the processing of its associated sector by the computer must be completed. After the central computer has signaled that this processing is completed, it has no further control over the respective sector.

The seventh line in the output trunk furnishes the Overprint Level to the Sales Recorder. Another thyatron per Sales Recorder is provided, and operated by a special control flip-flop. This control storage is activated by a program controlled character, coming from the sector storage.

Each sector may be in a different operational state at a given time independent of one another, and thus there is no interference or interruption of communication between a Sales Recorder and its associated sector storage.

RECORDER CENTRAL

The central computer, referred to as Recorder Central, is a general-purpose, internally programmed digital

device, with a fixed order code. As shown by Fig. 6, it comprises a magnetic drum, an arithmetic unit, a control unit including a clock and control pulse generator, a small high-speed magnetic core memory, and an operator console to provide program and operator control. The magnetic drum contains, in addition to the sector channel, a random access stock and credit reference file, the program storage, the work space for transaction processing, and the necessary timing tracks. The small high-speed memory of twenty character capacity is used for all operations, except transfers within the drum.

The computer is a one-address, variable word, numeric machine. An instruction word consists of an order code of two characters, and an address area consisting of four characters. The order code was specially designed to facilitate file processing as well as rapid calculation. The order code contains instructions for communication between a Sales Recorder sector and the computer, arithmetic computations, decision and control operations, file processing, and console input and output via paper tape and monitor printer.

Upon recognition of the TOTAL symbol by the computer, the entire contents of that sector is transferred to the working storage. The sequence of words and their positions within the sector remain the same. Thus, transaction processing will require a minimum of editing and rearrangement for output printing.

The input data in the working storage is analyzed to determine how the transaction is to be processed. If the transaction requires the verification of a customer's credit, the customer's charge number is processed

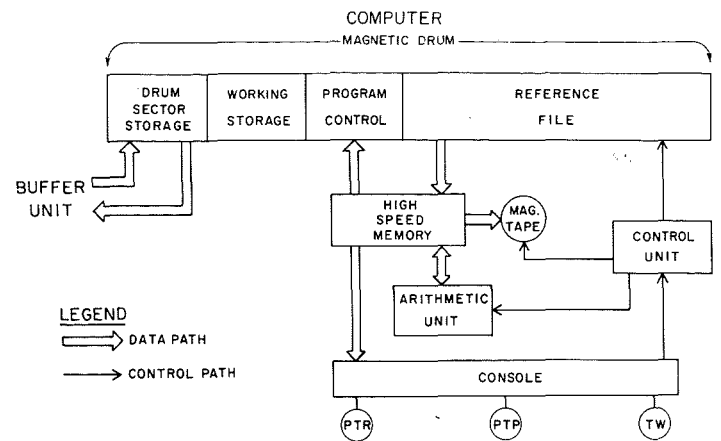

Fig. 6—Block Diagram of Recorder Central.

against a credit exception file. All stock numbers are passed against the stock reference file to determine price and city, state and federal tax information. This data is obtained for all merchandise items sold in the transaction. Prices are extended, sub-total and total calculated, and required information listed for printing on the sales slip, after which the contents of the working storage are written out to the transaction record magnetic tape. After receiving a check signal from the Tape Station, the information in the working storage is then transferred to the respective Sales Recorder sector and the Input-Output Buffer notified that transaction processing is completed. To determine the beginning and end of the variable sized items on the drum processed by the Recorder Central, item markers are used. The working storage can be changed in layout to represent any kind of sales check or business form corresponding to the Sales Recorder sector layout. The ability to vary the reference storage message sizes to conform to variable word requirements allows great efficiency in the use of the drum.

Access to the file storage is hastened by avoiding long indexing searches. Messages within the file may be either extracted, deleted, changed, or added, by separate orders. Variable sized criteria may be used with these instructions to extract desired information. Thus, one may be interested in all swim suits, in all bikini swim suits, in all bikini swim suits with blue polka dots, by adjust the criterion accordingly. To gain access to the desired data of a message, a mathematical transformation on the criterion of the message is used. This allows minimum delay in

locating the messages and thus speeds up overall transaction processing. More important, however, by avoiding the use of indexing routines, messages can be entered into the reference storage or extracted from it without the requirement of prior sorting and collating. Thus, the problems of file maintenance are considerably simplified and external processing is appreciably reduced.

The control console may be used to monitor system operation or provide means for manual control of the Recorder Central. A view of the Recorder Central is provided by Fig. 7. All control flip-flop indicators in the machine are displayed as an aid in maintenance and program debugging. All areas of the computer may be interrogated from the console. Information can be introduced either manually or by means of paper tape. A monitor printer is provided for printing the contents of the high-speed memory or any portion of the auxiliary memory when desired. Marginal checking facilities are also controlled from the console.

All transaction processing operations are carried out automatically. If information concerning daily transactions is required at any time by the Electronic Data Processing system the current transaction record magnetic tape can be remotely dis-

connected, and a new tape connected, by the Sales Recording system.

The Recorder Central contains many built-in checking features. Redundancy checking is used throughout the equipment to determine errors in transmission of characters and to isolate their sources. Arithmetic operations are repeated and results compared. Orders are checked before they are carried out. These, among others, are designed to insure against incorrect processing. However, in a system used for on-line processing the ability to maintain continuous operation is of paramount importance. Thus, the Recorder Central is designed to attempt to overcome any error a fixed number of times before it will stop operation. This will discriminate between transient errors and those due to catastrophic breakdown. In the latter case, a complete set of machine status indicators is available at the console, specifying exact portions of an order in which failure had occurred for ease and rapidity of maintenance. Plug-in type module construction is used to facilitate trouble-shooting, preventive maintenance, and replacement in case of failure.

CONCLUSION

The Sales Recording System represents a great step forward in providing the means for data integration within a department store. The As-

sociated Merchandizing Corporation's research installation has demonstrated beyond a doubt that on-line Sales Recording systems are a reality. Here, for the first time, a variety of transaction types as broad as the store desires, may be processed directly from a point-of-sale unit, with complete computation performed by a fast, accurate, and versatile high-speed computer, including an automatically printed sales slip.

But more than this, the point-of-sale unit can be used to either interrogate the reference file and thereby gain immediate access to any desired information, or actually enter new reference information, directly from its remote location.

It is important to note that this information need *not* be in any ordered form. Furthermore, a magnetic tape record, made for each transaction entered, provides a direct and reliable means of furnishing the information to an Electronic Data Processing system for data handling. The Electronic Data Processing system can have access to the magnetic tape at any suitable time without interrupting transaction processing by Recorder Central.

The authors wish to acknowledge the contributions of Messrs. Albert Burstein, Edward Damerau, Robert Grapes, Andrew Ling and Felipe Tanco in preparing this paper.

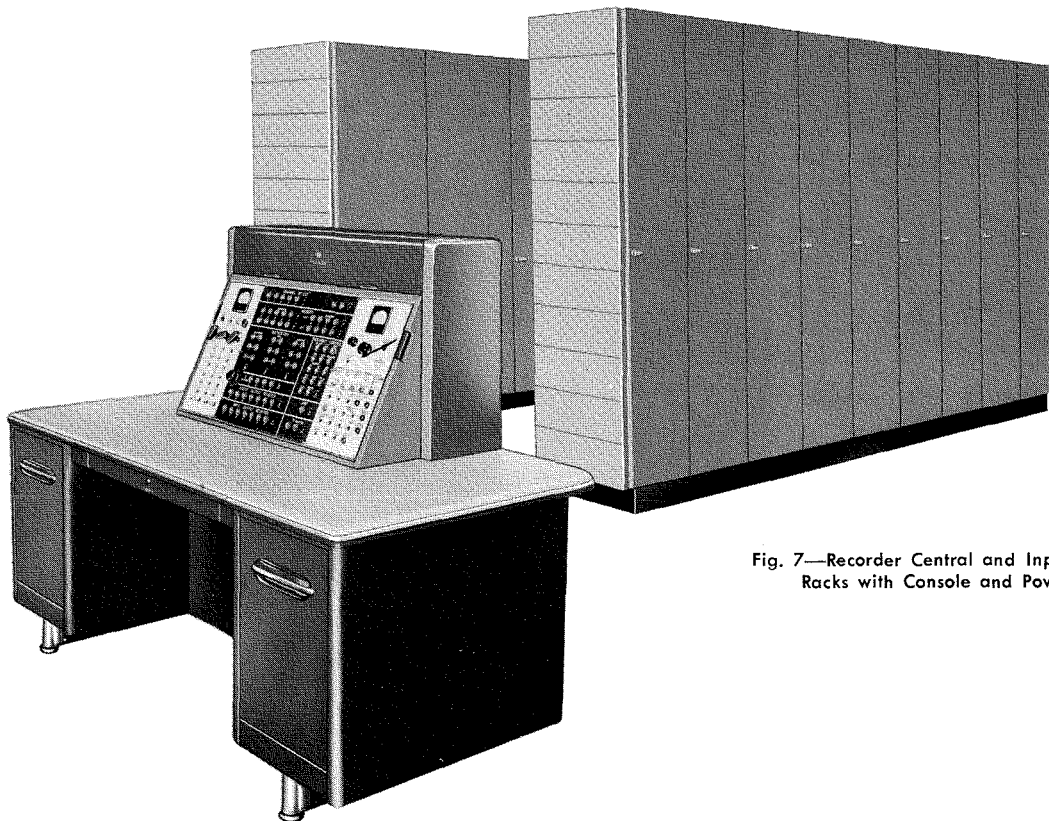

Fig. 7—Recorder Central and Input-Output Buffer Racks with Console and Power Supply.

INERTIAL NAVIGATION—PART II INSTRUMENTATION OF INERTIAL SYSTEMS

by **F. F. DAIGLE**

*Airborne Systems Laboratory
Defense Electronic Products
Waltham, Mass.*

THE FIRST ARTICLE OF this series which appeared in Volume 3, No. 2 of the RCA Engineer, Oct.-Nov., 1957, dealt with the "Principles of Inertial Navigation". The author discussed the basic means of indicating position on the earth's surface by using gimballed platforms which contained gyroscopes and accelerometers. Vertical indicating was discussed in some detail and such inertial expressions as "Schuler tuning" and "Coriolis acceleration" were explained. Too, the basic differences between Analytical and Geometric inertial navigators were covered.

This second article, entitled "Instrumentation of Inertial Systems", will deal with the gyroscope and the accelerometer, since these are the prime instruments of inertial navigation. Other inertial system elements such as synchros, resolvers, computers, etc., will not be described here, since the reader may refer to extensive literature already available with regard to these.

INERTIAL SENSORS

The two basic inertial sensors are the gyroscope and the accelerometer. The gyro senses angular disturbances, whereas the accelerometer senses changes in linear motion. Together they comprise the means whereby a navigation system can measure motion in inertial space undisturbed by wobbling of the measuring aircraft, and can deal with this measured motion in terms of travel over the earth's surface. To understand better the basic function of these sensors, each will be covered in detail.

The Gyroscope

A gyroscope is a device which contains a mass spinning at high veloc-

FERNAND F. DAIGLE, Leader, Systems Projects, Boston Airborne Systems Laboratory at DEP's Waltham Lab, received a B.S. degree in Engineering Physics at the University of Maine, 1949, and did graduate work at the University of Michigan, 1949-1951. For the past three years he has had the responsibility for the integration of inertial navigation systems into major Airborne Weapons Systems. Mr. Daigle spent two years at the MIT Instrumentation Laboratories, under the direction of Dr. C. S. Draper, where he served as liaison for RCA on a joint RCA-MIT development of an airborne weapon system. He is a member of the Institute of Navigation, and a member of the American Astronautical Society.

ity, so mounted that its spin axis has one or two angular degrees of freedom relative to a supporting structure. The gyro wheel normally spins at a very high speed (12,000-24,000-36,000 rpm) which together with the large amount of inertia of the wheel produces a large angular-momentum vector, with a high tendency to maintain a fixed direction in inertial space. When a disturbance such as a torque about an axis other than the spin axis is applied to an otherwise free gyro, the resulting vector change in the angular momentum of the gyro wheel is manifested partly as an equal opposing torque. The rotation of the spin axis about the torque axis which one instinctively expects thus does not occur. Instead, in the process of opposing the torque, the spin axis tends to align itself with the torque axis, rotating about a third axis perpendicular both to the spin axis and the torque axis. The characteristic third-axis rotation of the spin axis, as it tends to align itself with the disturbing torque axis, is referred to as "precession." Without restraint, this tendency for the spin axis to align with the torque vector continues until the spin axis and the torque axis are coincident. Conversely, an external rotation imparted to the spinning gyro wheel

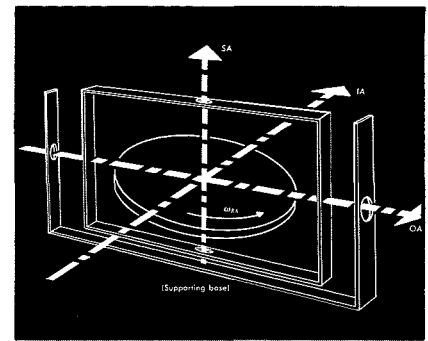

about an axis other than the spin axis results in a tendency for the spin axis to align itself with the external rotation axis. This is manifested by an ability to exert torque about a third axis perpendicular both to the spin and the rotation axes.

Practical gyroscopes used in inertial systems are provided with means, usually electromagnetic, for measuring the orientation of the spin axis, and for applying controlled torques about other axes. Although there are many types of gyros, only the single-degree-of-freedom gyro will be discussed further.

Fig. 1 shows a single-degree-of-freedom gyro supported in a gimbal structure which is free to move with respect to a supporting base about one axis only. The spin axis is labelled SA , the input axis IA , and the supporting gimbal axis (output axis) OA . When the supporting base rotates at ω_{IA} about IA , a torque T_{OA} becomes available about axis OA , as given by equation (1).

$$T_{OA} = (J_{SA} \omega_{SA}) \omega_{IA} \quad (1)$$

where J_{SA} and ω_{SA} are the moments of inertia and angular spin of the gyro wheel, respectively. The angular momentum of the wheel, $J_{SA} \omega_{SA}$, is usually held constant within very close limits and is commonly referred

to as the gyro H . Thus, equation (1) can be rewritten as

$$T_{OA} = H_G \omega_{IA} \quad (2)$$

By mounting a spring between the supporting base and the gyro gimbal about OA , the spin axis can be restrained from aligning itself fully with the input axis. The torque T_{OA} resulting from rotation of the gyro about IA then is opposed both by spring deformation and by inertial reaction to angular acceleration about OA , as expressed by

$$H_G \omega_{IA} \cos \theta_{OA} = K_s \theta_{OA} + J_{OA} \ddot{\theta}_{OA} \quad (3)$$

where θ_{OA} is the angular displacement about OA , K_s the spring constant in torque per unit angular displacement, and J_{OA} the moment of inertia of the gyro wheel about OA .

K_s is normally made so large that θ_{OA} is small ($\cos \theta \approx 1$), resulting in the following simplified equation

$$(K_s + J_{OA} p^2) \theta_{OA} \approx H_G \omega_{IA} \quad (4)$$

where p is the LaPlace Operator notation for $\frac{d}{dt} f(t)$.

The transfer function for this simple spring-restrained gyro can therefore be written as

$$\frac{\theta_{OA}}{\omega_{IA}} \approx \frac{H_G}{J_{OA} p^2 + K_s} \quad (5)$$

J_{OA} is normally much smaller than K_s , so that

$$\theta_{OA} \approx \frac{H_G}{K} \omega_{IA} = K_{SRG} \omega_{IA} \quad (6)$$

where K_{SRG} is the spring-restrained gyro sensitivity constant. Thus, the output displacement, θ_{OA} , of the gyro spin axis about the gimbal output axis, is a linear measure of the angular rate, ω_{IA} , of the supporting base about IA , so long as oscillatory effects can be neglected. It remains to provide the spring-restrained gyro with an electromechanical element which will transform the output displacement θ_{OA} into a usable analog to permit further processing, computing, etc., of the measured angle rate ω_{IA} .

Floated Gyros

The spring gyro discussed above has the serious disadvantage of requiring sturdy supporting pivots to ward against shocks, etc., which create a

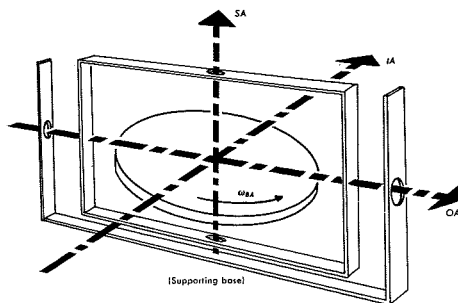

Fig. 1—Unrestrained single-degree-of-freedom gyro

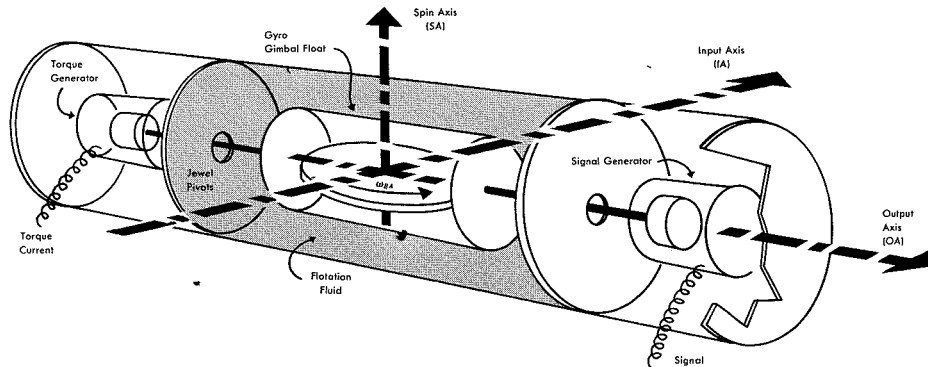

Fig. 2—Floated single-degree-of-freedom gyro

large friction load about OA . As a result, the gyro sensitivity constant K_{SRG} of equation (6) cannot be made as high as would be desired and consequently the gyro is limited in its low-angular-rate sensing.

A concept, evolved at the MIT Instrumentation Laboratory under the direction of Dr. C. S. Draper, which gets around this limitation is to mount the wheel inside a sealed gimbal "can" which is floated in a liquid whose density is made equal to the density of the gimbal float. The buoyancy of the gimbal float enables the gyro to withstand much greater shocks while not placing as great a burden on the output axis pivots, i.e., loads are distributed over the larger float surface area instead of being concentrated on the pivots. Fig. 2 schematically outlines such a floated gyro.

In this case, any output torque T_{OA} is opposed by a viscous torque due to rotation of the gimbal can in the flotation fluid and by the inertia reaction to angular acceleration, so that the transfer function of the floated gyro can be written as:

$$\frac{\theta_{OA}}{\omega_{IA}} = \frac{H_G}{Cp + J_{OA} p^2} = \frac{H_G/C}{p(1 + J_{OA}/Cp)} = \frac{H_G/C}{p(1 + \tau p)} \quad (7)$$

where C is the damping coefficient of the flotation fluid and τ is the time constant of the floated gyro. C is pro-

portional to the viscosity of the flotation fluid which if kept high brings about a small time constant τ of a few milliseconds.

Equation (7) can be rewritten as

$$\frac{\theta_{OA}}{\omega_{IA}} = \frac{H_G/C}{1 + \tau p} \quad (8)$$

which indicates the time-integrating function of the floated gyro. For this reason, the hermetically-sealed floated gyro which fulfills the high viscosity requirements discussed above is normally referred to as a HIG (Hermetic Integrating Gyro).

HIG Applications

The HIG gyro can be used in a number of ways amongst which are 1) a Rate Sensor, 2) a Displacement Sensor, and 3) an Inertial Navigation Sensor. As a rate sensor, the HIG gyro of Fig. 2, which shows a signal generator for indicating output displacements, is also provided with a torque generator about the same axis, to be used to offset gyro-transduced input angular rates which appear as torques about the output axis. Fig. 3 outlines how a HIG is instrumented to perform this rate-measuring function. The signal generator pickup coil (microsyn) is normally of high electrical and low mechanical impedance, imposing no load on the gyro, and resulting in a signal voltage, E_o , which is proportional to the time integral of the input angular rate if the feedback loop is open. The torque generator, on the other hand, is elec-

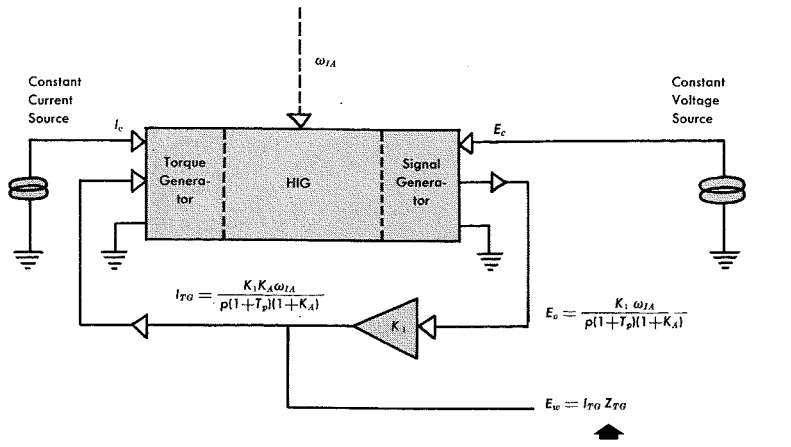

Fig. 3—Rate measuring HIG

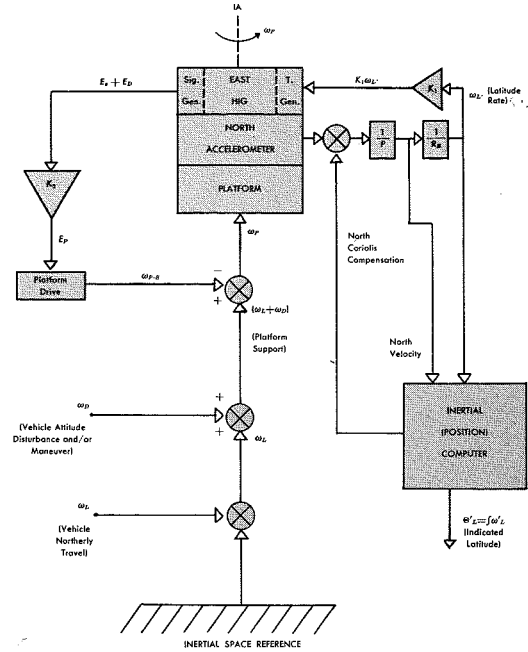

Fig. 4—Platform instrumentation for latitude channel

trically a low-impedance device and mechanically a high-impedance one, which creates a torque about OA proportional to the product of the input current I_{TG} and a constant reference current I_C . The input current I_{TG} becomes a measure of the input angular rate, ω_{IA} , about the gyro input axis, when the feedback loop is closed. It can be shown that the closed loop transfer function of the rate-measuring HIG gyro contains a term similar to the spring term $K_s \theta_{OA}$, of equation (3), which applied to the spring-restrained gyro.

As an angular displacement sensor, the HIG produces an output angle proportional to the input angle as expressed by equation (8). Since conventional HIG gyros have a low time constant τ , the output displacement about OA lags the input displacement about IA by only a few milliseconds and for most steady-state applications can be ignored. There are applications, however, where the transient behavior of the displacement gyro is of concern, and for these the time constant cannot be neglected. The frequency response of the gyro, in these cases, constitutes an upper limit on the spectrum of frequencies which can be accommodated by the system.

In the field of inertial navigation, the gyro really comes into its own in fulfilling many functions. In the analytical type of inertial navigator, for instance, the gyro is a computing element as well as an isolation refer-

ence. Consider Fig. 4, which outlines the platform instrumentation of the latitude channel of an inertial navigator. The HIG gyro acts as the second integrator in the latitude Schuler loop, while simultaneously providing the isolation reference for the platform against vehicle disturbances, ω_D . The gyro is constrained to follow the local vertical as the vehicle travels northerly over the earth's surface. Assuming no vehicle disturbances for the moment, it can be shown that the gyro output signal E_o is zero when the indicated latitude rate, ω_L , is correct and the associated instrumentation is ideal. In other words, the angular space rate of the platform, ω_P , and therefore that of the gyro is of just the right magnitude to cancel out the current-generated torque. This ideal situation can be expressed as

$$H \omega_P - K_1 \omega_L = 0 \quad (9)$$

Realistically, however, this situation exists only approximately, since some resultant torque must remain incident on the gyro to produce an output error signal, E_o , as given by equation (10).

$$E_o = \frac{(H \omega_P - K_1 \omega_L) K_{SG}}{(Cp + Jp^2)} = \frac{K_{SG} (H/C \omega_P - K_1/C \omega_L)}{p(1 + \tau p)} \quad (10)$$

During periods of large linear acceleration, a relatively large E_o results and the platform lags the true

vertical by an amount determined by the above dynamics. It should be noted that ω_L lags ω_P because of the lags in the first integrator and the remaining Schuler loop. In steady state, the error signal again reverts to a low null level.

Considering now the isolation function of the gyro, a tighter loop is available, i.e., no Schuler-loop lags are experienced in stabilizing the platform against vehicle attitude disturbances. Assuming a sudden pitch (ω_D) of the vehicle, the gyro senses the angular rate directly and produces a signal, E_D , given by

$$E_D = \frac{K_{SG} H/C \omega_D}{p(1 + \tau p)} \quad (11)$$

As discussed earlier, the gyro time constant, τ , is of the order of a few milliseconds in representative HIG's, and therefore allows for fast loop dynamics.

Gyro Limitations

Although the precision now available in gyroscopes is of a level higher than that required for fine watchmaking, mechanical and metallurgical limitations impose severe penalties on the operation of the gyro. To be truly an operational instrument, the gyro should be readily available at a moment's notice, yet should render faithful and highly precise performance over extended periods of time. Unfortunately, in both quick readiness and long-time stability, the currently available gyro falls short of its requirements. Such things as mass

unbalance, anisoelectricity, anisothermal problems, etc., all contribute to the gyro's shortcomings.

Consider Fig. 5 which schematically depicts the mass unbalance expected in a gyro. Because of present fabrication and assembly limitations, the center of mass of the gyro is not centered in the assembly, but exists at a point other than the geometric origin. Consequently, the components of the mass unbalance which fall along the three principal axes, *SA*, *IA*, and *OA*, are acted upon by forces of acceleration and gravity to produce torques which cause the gyro to drift. In a single-degree-of-freedom gyro, only those torques which act about the output axis are of concern, since without compensation displacements about *OA* are interpreted as input rates about *IA* and consequently dictate that the gyro seek, by a counter rotation, to null these fictitious rates out. These unbalance torques and therefore their equivalent drift rates, $\dot{\delta}_U$, can be expressed by

$$\dot{\delta}_U = \frac{(T_{OA})_U}{H} = \frac{1}{H}(U_{SA} \times a_{IA} - U_{IA} \times a_{SA}) \quad (12)$$

where *U* is the mass unbalance along the indicated axis, *a* is the acceleration incident along the indicated axis, and $\dot{\delta}$ is the resultant drift rate of the gyro.

The anisoelectricity limitation is determined by the degree of unsymmetrical compliance of the gyro float assembly when it is subjected to acceleration forces. Under varying accelerations, the gyro float complies unsymmetrically causing an effective center-of-mass shift, which when in

turn acted on by the acceleration force causes the gyro to drift. Mathematically, the drift rates, $\dot{\delta}_K$, due to anisoelectricity can be expressed as:

$$\dot{\delta}_K = \frac{(T_{OA})_K}{H} = \frac{1}{H}(K_{SA} \times a_{SA} \times a_{IA} - K_{IA} \times a_{IA} \times a_{SA}) \quad (13)$$

where the *K*'s are the mass shifts due to anisoelectricities and accelerations along the indicated axes.

Anisothermal effects cause unsymmetrical deformations of the float assembly with varying temperature which bring about a shift in mass of the float assembly. Attempts are made to stabilize the gyro thermally by keeping the flotation medium, which at room temperature is solid, at its liquid and viscous temperature over extended periods of time. However, some residual thermal noise remains which causes the gyro, in an acceleration field, to drift as indicated by the following:

$$\dot{\delta}_Q = \frac{(T_{OA})_Q}{H} = \frac{1}{H}(Q_{SA} \times a_{IA} - Q_{IA} \times a_{SA}) \quad (14)$$

where the *Q*'s are the mass shifts due to anisothermal effects along the indicated axes.

The parameters which cause the gyro drifts $\dot{\delta}_U$, $\dot{\delta}_K$, and $\dot{\delta}_Q$, can be evaluated with carefully controlled calibration techniques under controlled environments. Subsequently, the measured values of the parameters can be used to reduce the gyro drift in operational environments. This compensation requires that the gyro be torqued by amounts deter-

mined by the calibrated *U*'s, *K*'s and *Q*'s, and measured accelerations along the *SA* and *IA* axes as represented by equations (12), (13), (14). (Details of techniques of compensation are classified information and therefore fall beyond the scope of this paper.)

Another technique to compensate gyro drift due to mass unbalance, anisoelectricity and anisothermal effects, is to employ gyro elements in pairs along each inertial indicating axis, i.e., a total of six gyros per platform. Each gyro of a pair periodically reverses its spin while its mate assumes control during the process of reversal. Thus, over a complete gyro spin vector cycle having four operating phases for each pair, the drift of each gyro tends to null out.

The Accelerometer

Equal in importance to the gyro in the field of inertial navigation is the accelerometer. This device provides the means whereby changes in translational motion of a vehicle can be detected and measured.

The accelerometer has been instrumented in a number of ways, all of which make use of Newton's third law of an equal reaction for every action. In other words, all accelerometers measure the inertia reaction forces resulting from accelerations incident upon a body which has mass.

Fig. 6 outlines an accelerometer which restrains a mass *M* with a spring whose stiffness can be expressed by the coefficient *K_s*. As the accelerometer system is accelerated along the spring axis which is horizontal in the figure, the mass, because of its inertia, tends to remain

Fig. 5—Gyro mass unbalance

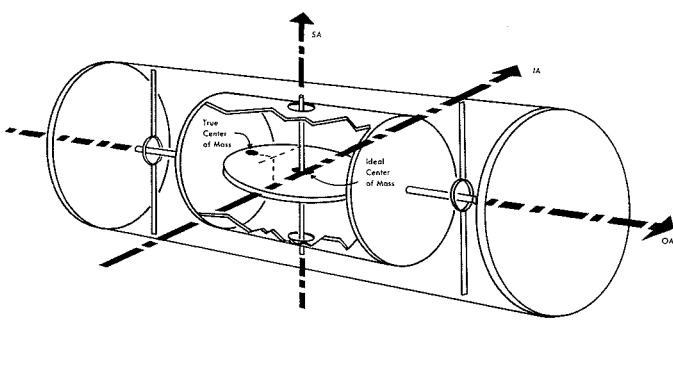
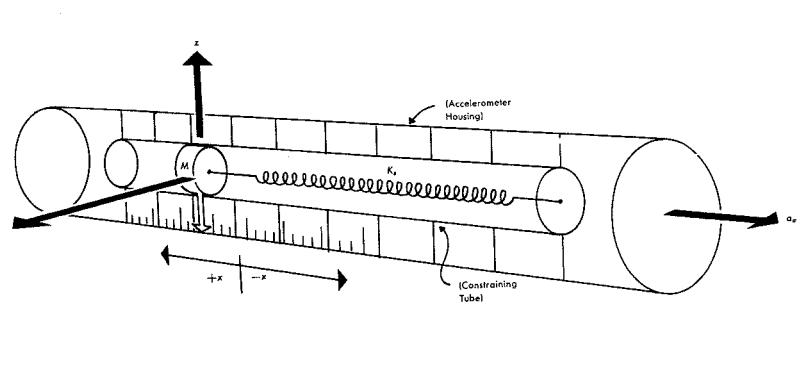

Fig. 6—Constrained linear accelerometer



unaccelerated, causing the accelerometer housing to displace itself relative to the mass.

Without the spring restraint K_s , the accelerometer would move leaving the mass "behind" until it "bottomed" within the housing. With the spring, however, the mass is coupled to the accelerometer and is therefore also accelerated. Except for unduly large accelerations, the relative mass—accelerometer displacement is limited to an amount given by the following:

$$x = \frac{m}{K_s} a_x \quad (15)$$

Thus, x is a measure of the acceleration of the accelerometer. It remains to provide a means for converting the spring elongation x into a useful analog to permit further processing and computing.

The mass is constrained by some form of guide to move in the direction of the spring axis only, thereby measuring acceleration in one unique direction. In providing such a constraint, however, such as a cylindrical tube along x to support the mass in y and z , as indicated by Fig. 6, the mass encounters a friction force along x due to the constraining support. The accelerometer is thereby limited in its sensitivity to accelerations, requiring a finite level of acceleration to produce a mass-reaction force sufficiently large to offset the starting friction force (threshold). In accelerometers of this basic design, the threshold can be made low only if the acceleration environment in y and z is to be low, thereby requiring light constraint. However, where operation in a high y and z acceleration environment is desired,

the constraint must necessarily exert greater restraining y and z forces on the mass, thus raising the friction level and the attendant threshold. In other words, the dynamic range of acceleration response of such an instrument is necessarily narrow.

In order to measure wider ranges of accelerations, numerous devices have been invented to effectively reduce the friction level and thereby lower the threshold. To cover the majority of these devices is beyond the scope of this paper. However, two notable ones will be discussed below.

The Torsion Accelerometer

The torsion accelerometer does not use a linear spring as shown in Fig. 6, but rather mounts a mass on a pivoted arm as shown in Fig. 7. As the accelerometer is accelerated along x , the inertia of the mass causes the arm to rotate, thus producing a displacement of the arm coil from its null position. The magnitude and sense of the displacement produces an error signal which after suitable amplification is fed to a torquer coil in the accelerometer housing thereby producing a torque about the rotor axis to return the arm coil to its null.

With a high-gain amplifier, K_1 , the dynamic range of acceleration measured can be greatly extended over that of the simple accelerometer of Fig. 6. However, this type of accelerometer has the undesirable feature of producing a larger error with larger accelerations to offset the mass-reaction forces. A solution to this problem is to vary the gain, K_1 , as a function of the amplitude of acceleration.

The Integrating Accelerometer

The accelerometer which currently

shows the most promise is one which makes use of a floated gyro in the following fashion. The gyro is purposely unbalanced along SA by a carefully controlled and measurable amount as shown in Fig. 8. The gyro is then mounted on a turn table with its input axis aligned with the rotation axis of the table. As accelerations occur along these coincident axes, (into the paper) the unbalanced gyro is torqued about OA resulting in an error signal. The signal is next amplified and used to drive the table at a rate (ω_T) just correct to offset the unbalance torque. Equation (16) mathematically indicates how the resultant velocity can be measured by measuring the table's angular position. A pickoff, such as a synchro or potentiometer, is normally provided for this readout.

$$v = \int a dt = \frac{H}{M_U} \int \omega_T dt = \frac{H}{M_U} \theta_T \quad (16)$$

Currently, it is possible to design the servo-amplifier to net an overall dynamic range of acceleration-measuring of several decades.

An important feature of the integrating accelerometer is the unification of acceleration sensing and the first Schuler-loop integration. Although the integrating accelerometer package is larger than the more conventional linear accelerometer, the combination of these two necessary inertial navigation functions alone more than justifies the increased size and weight of the resultant accelerometer.

(The next article, to appear in a future issue, will cover the subject of Stabilization Making Use of Inertial Platforms and Other Devices.)

Fig. 7—Torsion accelerometer

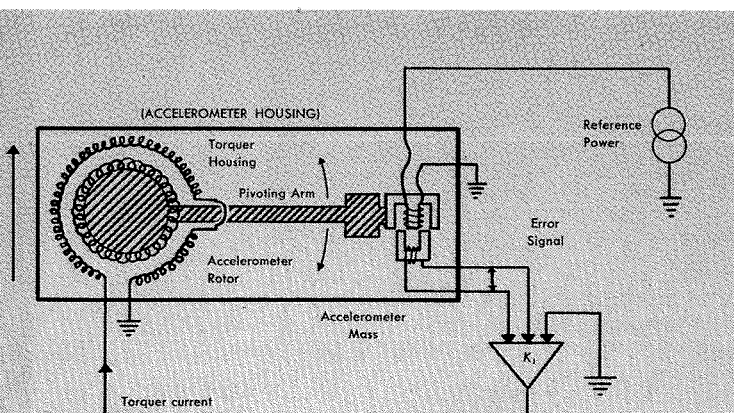
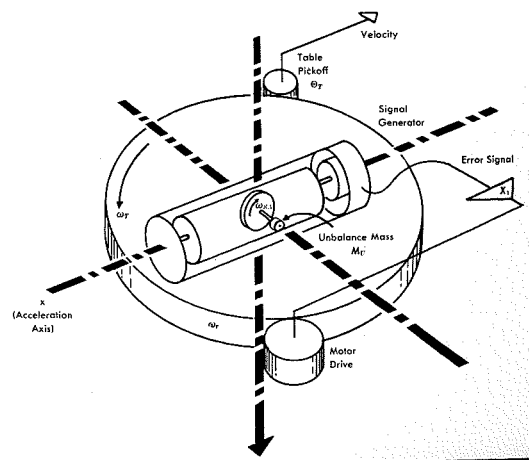

Fig. 8—Integrating accelerometer



FIBER OPTICS—VALUABLE ENGINEERING PRINCIPLE

By **LEO J. KROLAK**

*Development Engineering
Defense Electronic Products
Camden, N. J.*

NOW, BY EXPLOITING the principle of Fiber Optics, the engineer can solve many optical imaging problems that formerly perplexed him. This unique and valuable tool is helpful in conceiving electro-optical ideas for further development of future equipment—both military and commercial.

WHAT IS FIBER OPTICS? The principle of fiber optics is simply the passage of constrained light from one end of a fiber to the other. (Light is constrained in passing through the fiber by a series of total reflections from within the wall of the fiber.) A complete image can be shifted from one place to another by using a bundle of these fibers to transfer the image—*element-by-element*. These fibers can be made of glass, quartz, nylon, polystyrene, Plexiglas, and many other synthetic materials. From the standpoint of uniformity of index of refraction and light transmission, it has been found that glass and quartz are the most desirable substances to use. Fig. 1 is a photo showing a typical glass bundle.

In this article, the theory of operation for Fiber Optics, the various experiments performed by the Development Engineering Labs, and possible applications are described.

WHY FIBER OPTICS?

In electronics, the principle of transmitting light, and the arranging and re-arranging of optical information offers many possibilities. Complexity of a picture image is not necessarily a limiting factor since any number of fibers may be used. Light can be transmitted (in terms of relative degrees of light and darkness) with little loss of information. A picture element may be a light spot, dark spot or somewhere in between. What makes this phenomena even more interesting is its flexibility. Fibers can be bent around corners and shaped in various forms.

Picture images can be mixed up so that they are unrecognizable, and then unscrambled by use of the proper fiber bundle (from kinescope element to optics or vice versa). Encoding, decoding, and spiral and horizontal

scanning are possible by Fiber Optics. Image transfer with magnification and scan rectification in facsimile are other applications.

The arrangement and re-arrangement of complex picture patterns such as might be required in computers, military intelligence equipment and black-and-white and color television are other uses.

The impact of Fiber Optics on computer techniques should revolutionize present methods of recording output data. The Fiber Optics principle can avoid the time lag suffered between the production of useful information by the computer and its transformation of these data to a digestable, useful form.

Fiber Optics can be used in stabilized Airborne Television Equipment (see Fig. 2). A full-face fiber optics kinescope could be used to make contact prints of information transmitted by TV systems, requiring no special copying equipment.

Two major optical companies are now producing fibers and fiber bundles (see Figs. 1 and 2). Several research institutions are carrying on basic and applied research in this field. Development Engineering is working with the American Optical Company to produce special arrays of Fiber Optics. The RCA Research Laboratories in Princeton and the Electron Tube Division in Lancaster are helping to solve some of the problems arising in the sealing of fibers to vacuum tubes.

THEORY OF OPERATION

Rays of light enter a fiber bundle at various angles of incidence, depending upon the application. Therefore, it is important to know the limiting angle at which a ray will be accepted by the fiber and transferred to the other end. By using the following simple relationship, the limiting case can be determined.

$$n \sin \theta = n' \sin \theta'$$

The terms are defined as shown in Fig. 3, part a. Of the light incident on the air-glass interface, some will be reflected and some will enter the glass. At $\theta = 0^\circ$ and up to about $\theta = 60^\circ$, the amount of light reflected will remain approximately constant and will be equal to 4% for a glass material of index = 1.5 in air. Beyond this angle, the percent reflection increases until (at $\theta = 90^\circ$) there is 100% reflection. Some of the light will enter the glass at all angles of incidence. Once the light enters the glass fiber medium it will be transferred to the other end, assuming that the sides are straight and that the entire bundle is in air.

If the light originates within the denser medium, the same relationship holds true. However, in this case, the ray bends away from the normal in leaving the medium. Consequently, θ becomes equal to 90° ($\sin \theta = 1.0$) for some value of θ' less than 90° , and depends on the ratio of the indices of refraction. At this point, total internal reflection takes place for all rays beyond this value of θ' . The value of θ' at this particular transition is known as the critical angle. As an example, if we have a fiber of index 1.5 in air, the cone of radiation which will be constrained by the material will be a maximum of 96° because the critical angle is 42° as shown in Fig. 3, part b. It might also be noted here that a ray leaves a fiber at the same angle at which it enters and its direction will be the same or the opposite depending on whether or not the number of reflections within the fiber is even or odd respectively. In Fig. 3, part c, ray #1 leaves the fiber at the same angle and direction while ray #2 leaves in the opposite direction.

LIGHT TRANSMISSION LOSSES

Light passing through a fiber gets attenuated through absorption by the medium itself and also by "leakage" through the walls. The path length of a ray passing down a fiber is $L \sec d$ as shown in Fig. 4. This length is independent of the diameter of the fiber. The number of reflections, however, is dependent upon the diameter D and is equal to $L/D \tan a$. In a fiber of 0.001 inches diameter, the number of reflec-

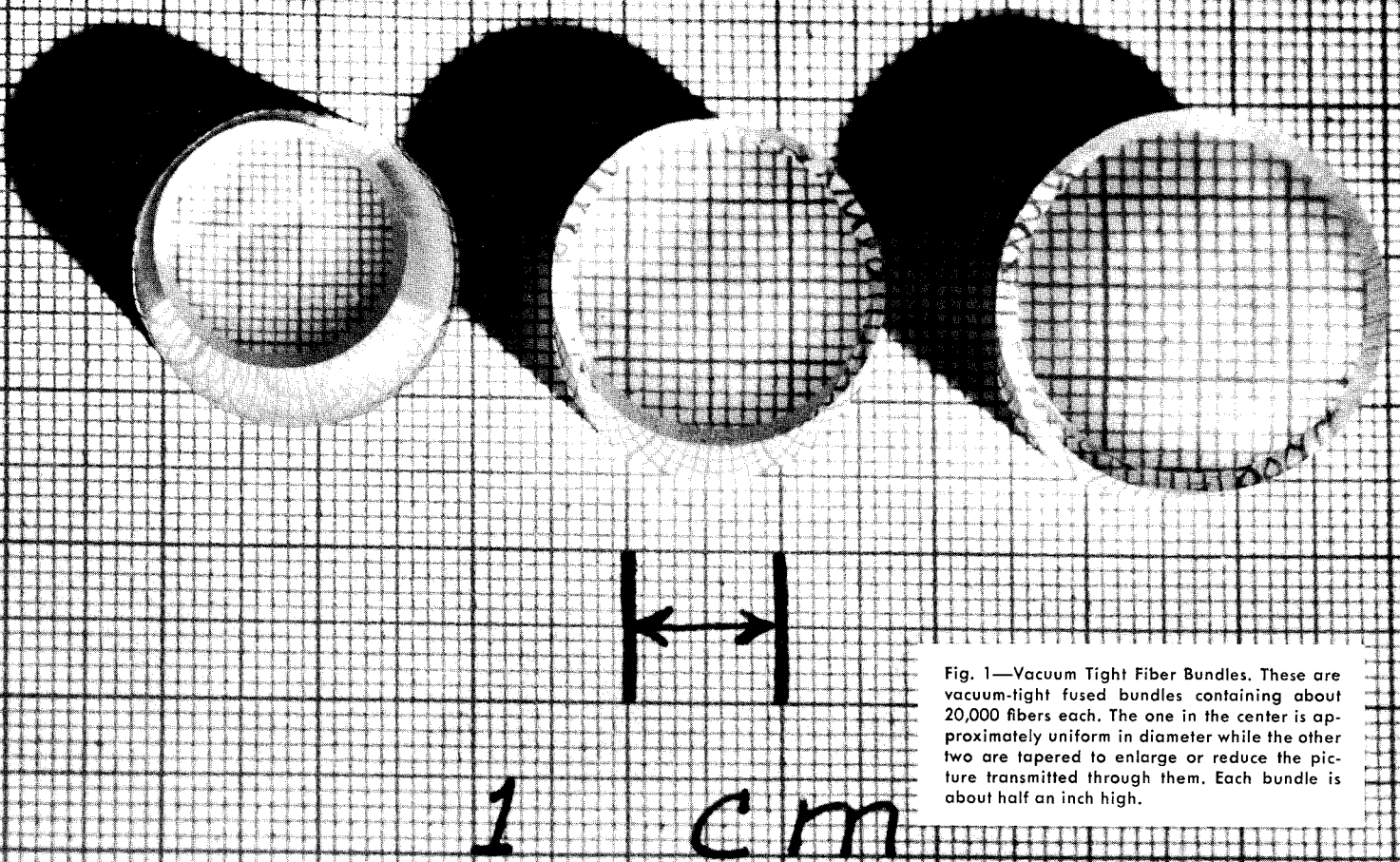

Fig. 1—Vacuum Tight Fiber Bundles. These are vacuum-tight fused bundles containing about 20,000 fibers each. The one in the center is approximately uniform in diameter while the other two are tapered to enlarge or reduce the picture transmitted through them. Each bundle is about half an inch high.



LEO J. KROLAK is Leader of the Optics Group of the Engineering Development Section of Defense Electronic Products. He received his B.S. degree in Optics from the Institute of Optics of the University of Rochester in 1949. He joined the Atomic Energy Project of the University of Rochester and while there received his M.S. degree in Optics.

In 1956, Mr. Krolak joined RCA as an engineer in the Optics Group and became a Leader of this group in 1957. He is a member of the Optical Society of America for whose journal he has written two articles.

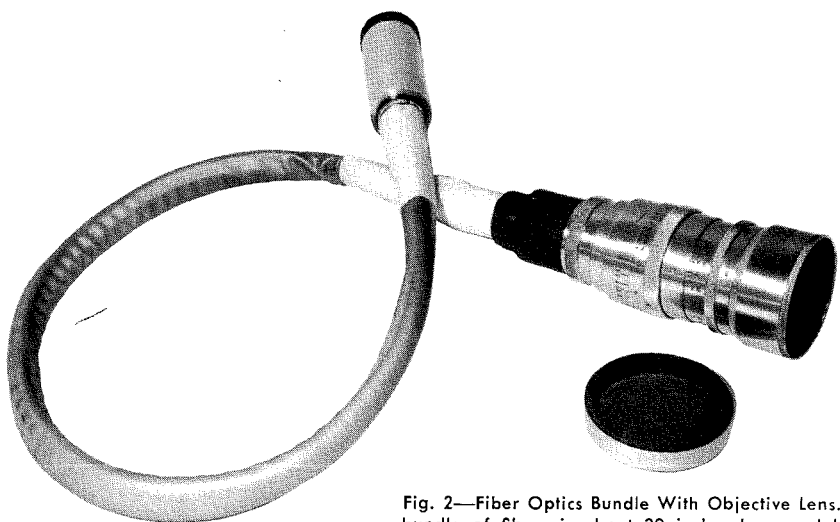
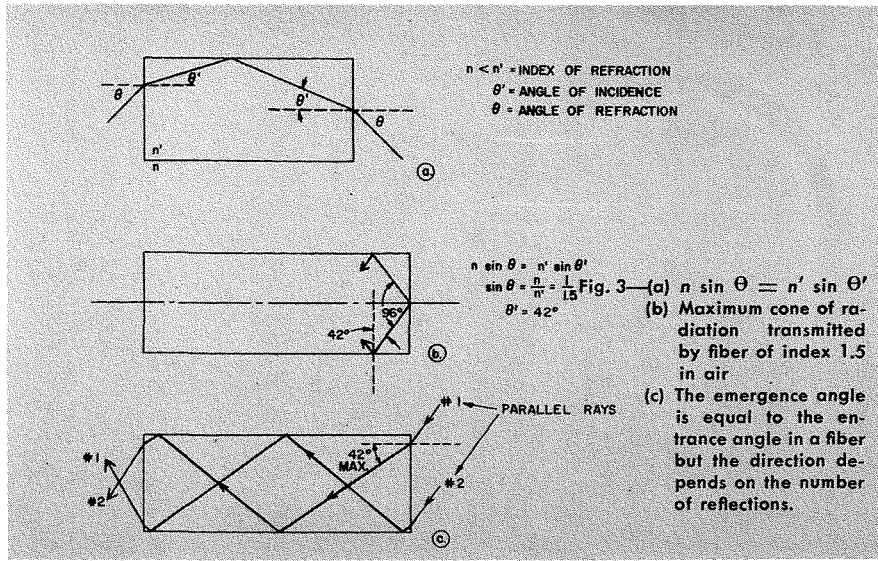

Fig. 2—Fiber Optics Bundle With Objective Lens. This bundle of fibers is about 30 inches long and has a photographic objective on one end and an eyepiece on the other. The eyepiece could be replaced by an imaging tube for use in Stabilized Airborne Television Equipment. The viewer may point the objective end in any direction while viewing the image through the other end.



tions-per-inch will be over 1000 for $a = 48^\circ$. Now, any dirt on the surface of the fiber forms an irregular surface and it is this irregular surface which causes light to "leak out" from a fiber. Because of the number of reflections which take place in a given length of fiber it can be seen how important it is to keep the surface clean. In a bundle of fibers this light will find its way down another fiber and tend to dilute the image at the output end.

RESOLVING POWER

The resolving power of a bundle of fibers is a function of the diameter of the individual fibers and also the separation of the fibers. Fig. 5 illustrates two possible geometrical arrangements of the fibers. In example (a) the centers of the fibers form squares while in (b) the centers form equilateral triangles. It is apparent that (b) would have more mechanical stability than (a). The dead area between the fibers amounts to about 22% in (a) and about 9% in (b). Case (b) is the usual array.

The least detectable size of detail through the bundles is about twice the diameter of the individual fibers. This is true because light incident on only a fraction of one fiber will emerge from the total diameter at the other end. Thus the resolving power of a bundle of fibers whose diameter is 0.001 inches would be about 500 photographic lines per inch.

FIBER BUNDLES

Fiber bundles (see Fig. 1) can be made by winding a single fiber, which has been extruded from molten glass, on a large diameter spool (about two feet in diameter) in the same way a spool of thread is wound. A section is

then cut out of this spool and the bundle tied together. If no material is placed in the interstices, the ends of the bundle may not be ground and polished. If any attempt were made to do this, foreign material would work its way into the spaces between the fibers and cause light to leak out the walls. The unground bundle could be used in this manner by protecting the end with a thin layer of transparent material. On the other hand, the interstices could be filled with a material of index between that of the fiber material and air. The acceptance angle, however, would be reduced by the $n \sin \theta = n' \sin \theta'$ relationship. For example, if the index of refraction of the fiber were 1.70 and the index of the surrounding material 1.53, the total angle, in the glass, which the fiber would pass would be 50° versus a value of 108° if the same fiber had been surrounded by air.

The spaces between the fibers sometimes do not all close up when filled with the lower index glass and microscopic holes exist. This condition would certainly not allow the kind of vacuum necessary for the Compositron tube shown in Fig. 7. Some of the samples tested however have been vacuum tight. It would be possible to make the unit vacuum tight by blowing a bubble of thin glass and fusing

it to one of the ends of the fiber bundle.

THE COMPOSITRON TUBE

The Compositron tube has made it possible to successfully transform digital information from a high-speed computer system to the form of displayed characters on a ten-inch tube. One method (Fig. 6a) used to record the displayed characters utilizes a lens system, film, and Electrofax paper. Using the Electrofax paper directly would eliminate the film and wet development. However, this is not feasible because of the inherent insensitivity of the Electrofax paper.

Fig. 6 depicts two possible methods of recording the Compositron tube display. The intensity of the light on the paper is proportional to the square of the sine of the half-angle subtended by the copying lens (used at 1:1 magnification) at the paper surface. In the case of the fiber optics, it is proportional to the sine of the half-angle bounded by the extreme rays leaving a fiber. In the case of a lens working at $f/8.0$, the half-angle is about 3.9° and for the fibers encased in the lower index glass the half-angle is about 25° . Referring to Fig. 6, it can be seen that the intensity of illumination for the fiber optics case is about 46 times that of the lens system. It has been shown that this is sufficient to make a suitable exposure directly on Electrofax.

At present, work is progressing towards building a feasible model of a line-fiber-optics face plate for a Compositron tube. The bundle of fibers is $8'' \times 0.20''$ and will be sealed to the face of the tube as shown in the schematic diagram of Fig. 7. The operation of this tube will be as follows: Characters appear at the surface of the phosphor from left to right in sequence looking at the front of the tube. Because of the fiber optics, these same characters also appear at the outer sur-

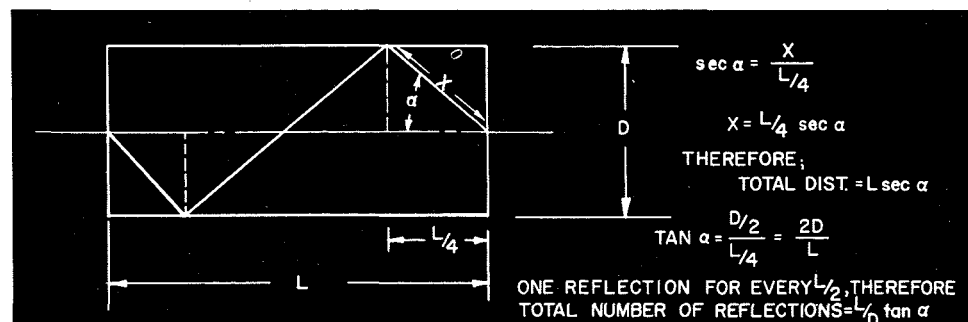

Fig. 4—Total distance a ray traverses in passing along bundle and the number of reflections encountered.

face next to the paper. The paper moves by this outer surface continuously. The slit is tilted in respect to the direction of motion so that the final printed copy will not be tilted. The "photographic" speed of the paper determines the rate at which the characters are displayed and, consequently, determines the linear speed of the paper.

Full document size prints could be made from a kinescope if the entire face were made of fibers. The number of applications which exist with this particular type of array are innumerable. Information recorded on a kinescope face could be recorded by merely placing some Electrofax paper in contact with the face of the tube. Relatively simple processing equipment could then be used to produce a permanent copy of the display.

AIRBORNE TELEVISION

In some applications of airborne television equipment, expensive and cumbersome gimbaling equipment is used to stabilize the camera against the unavoidable movements of the airplane. A fiber optics bundle with a lens at one end and the other end connected to the camera could be used. In this way, it would be necessary to stabilize only the end of the fiber optics bundle with the objective lens. Fig. 2 is a picture of a bundle which could be used in this way. This bundle was made by the Research Laboratories of the American Optical Company. This particular scheme could also be used with infrared type scanning systems if the fiber were made from an infrared transmitting material.

SCAN CONVERSION

Different arrays of fiber bundles could be used in facsimile type scanning. For instance, if a cathode ray oscilloscope display were in the form of a straight line which contained bits of information, this information could be recorded by imaging the line on photographic film, and moving the film continuously in a direction perpendicular to the line. The amount of information on the line could be increased many fold by making it into a spiral. The line could be converted to a straight line by having one end of a series of fibers conform to the spiral while the other end come out to a straight line

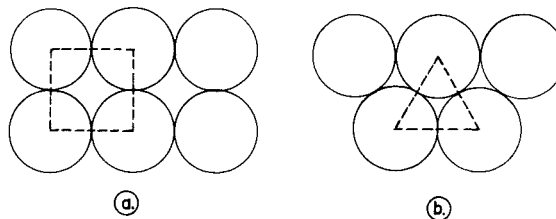

Fig. 5—Two possible packing configurations for a bundle of fibers, square (a) and triangular (b).

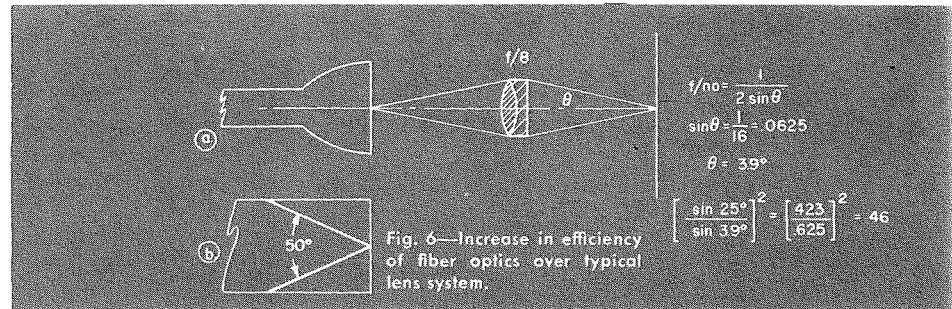

Fig. 6—Increase in efficiency of fiber optics over typical lens system.

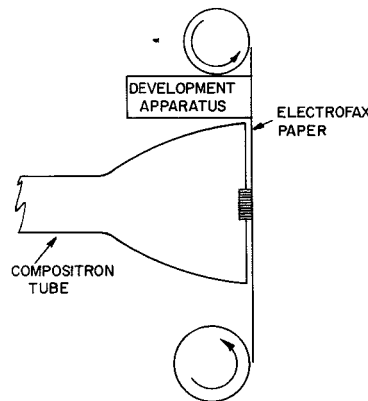

Fig. 7—Illustration of the use of fiber optics for high speed printing application using a Compositron tube.

for contact recording on Electrofax paper.

CODING AND ENCODING

Fiber bundles could be used for coding and encoding purposes. A fiber bundle with randomly scrambled fibers could be used to photograph a piece of information which is placed at one end of the bundle while the recording material is placed at the other end. With true random orientation of the fibers, no information could be gleaned from the copy. When the copy is placed at the other end of a similar bundle, or the same bundle, the information could be unscrambled and now be intelligible.

MAGNIFICATION

Image transfer can be effected with magnification by merely making the fibers larger at one end than the other, or by using fibers of uniform diameter and increasing the center-to-center distance of one end over the other. Fig. 1 is a photograph of a grid taken through a fiber bundle with plane-parallel faces. The center bundle is approximately uniform in diameter while the other two are tapered to enlarge on the grid.

CONCLUSION

Only a few of the many potential applications of Fiber-Optics have been described in this article. The very simplicity of Fiber-Optics lends itself to many applications limited only by the imagination of the resourceful engineer. Some of the basic principles of Fiber-Optics have been outlined to give the engineer a better feeling for the subject. The work being done in this field at RCA by Development Engineering, DEP, was examined.

REFERENCES

1. Hopkins, H. H. and Kapany, N. S., "Transparent Fibers for the Transmission of Optical Images", *Opt. Acta.* 1, 164 (1955)
2. Kapany, N. S., "Fiber Optics, Part I. Optical Properties of Certain Dielectric Cylinders", *Journal of the Optical Society of America*, 47, 413 (1957)
3. Kapany, N. S., et al, "Fiber Optics, Part II. Image Transfer on Static and Dynamic Scanning with Fiber Bundles", *Journal of the Optical Society of America*, 47, 413 (1957)
4. Kapany, N. S. and Hopkins, R. E., "Fiber Optics, Part III, Field Flattens", *Journal of the Optical Society of America*, 47, 594 (1957)
5. Kapany, N. S. and Pike, J. N., "Fiber Optics, Part IV, A Photorefractometer", *Journal of the Optical Society of America*, 47, 1109 (1957)

ENGINEERING TEST IN THE DEVELOPMENT OF RCA COLOR KINESCOPIES

By

L. I. MENGLE

*Color Kinescope Product Development Engineering
Electron Tube Division
Lancaster, Pa.*

ONE OF THE FACTORS which has contributed substantially to the success of RCA shadow-mask color picture tubes is the special equipment employed at Lancaster for study of the characteristics and performance of developmental types, materials, and tube components. This equipment, much of which was developed and built by the Equipment Design Group of the Color Picture Tube Development Activity at Lancaster, pro-

vides facilities for evaluation of the electron-optical characteristics, resolution capabilities, beam-landing characteristics, and over-all performance in color and black-and-white of complete tubes; for measurement of phosphor efficiencies; for observation and measurement of electrode movements and their effects on tube performance; for plotting the fields of electron lenses and lens systems; and for recording and analyzing

the variations with time of significant characteristics and performance data.

Much of this equipment does automatically or semiautomatically what would otherwise require laborious step-by-step observations, measurements, and evaluations, and thus makes it possible to incorporate very rapidly improved materials and component designs in RCA color picture tubes.

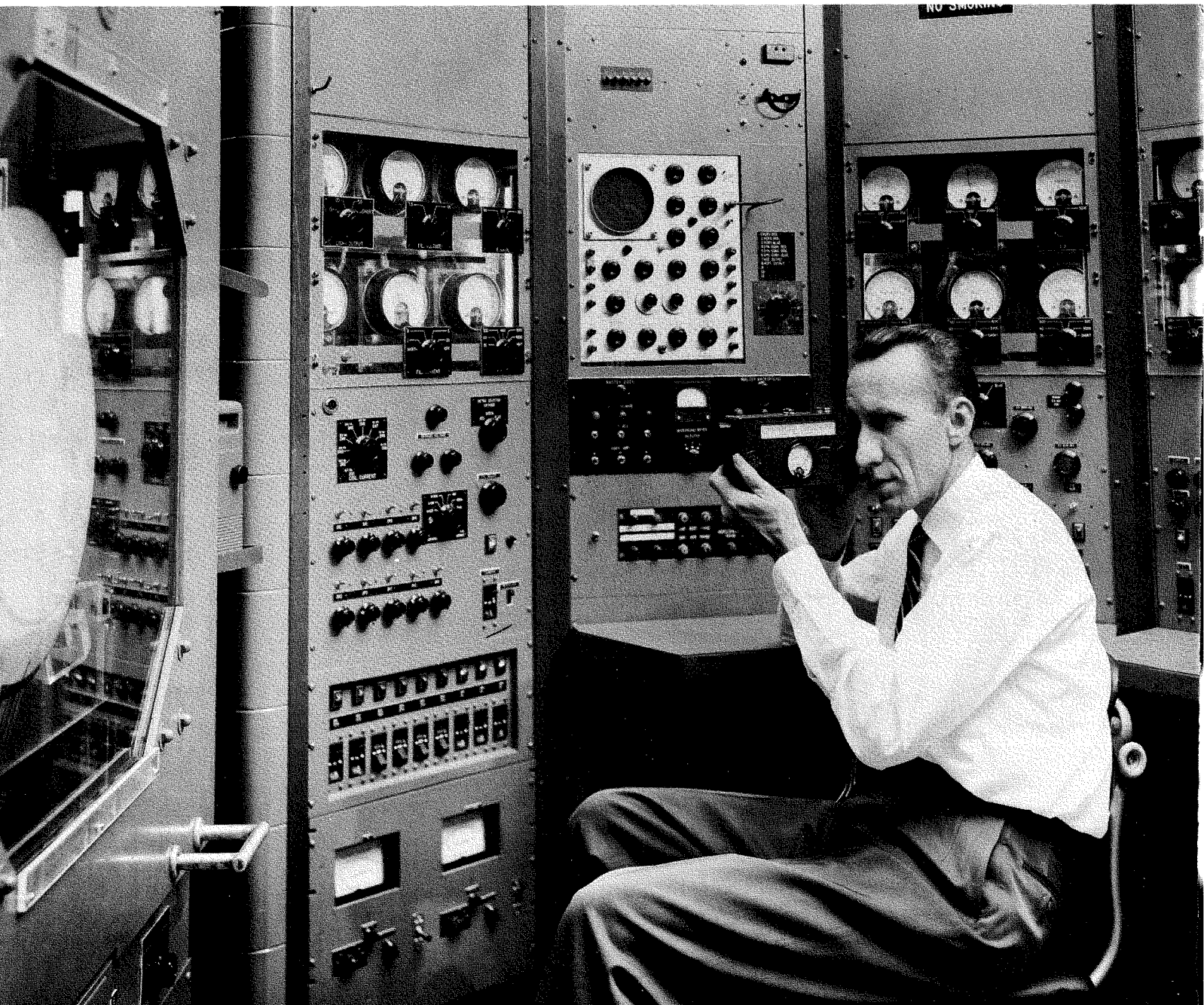

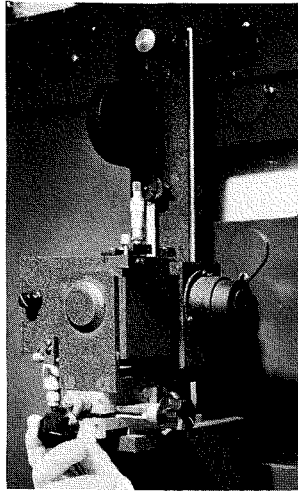

EVALUATION OF DISPLAYS

Fig. 1—Equipment for evaluation of display characteristics. The effectiveness with which developmental color picture tubes reproduce test patterns and program material in color is evaluated by subjective methods. These methods are also used to determine the maximum screen brightnesses and contrast ratios that can be achieved when the tubes are used to reproduce displays in black and white.

The racks at the left and right of center and at the extreme right contain the power supplies and generators of scanning and convergence currents for the tube being evaluated, together with control and metering facilities for each circuit. The rack in the center contains the video-signal switching and control panel which allows the operator to select the various color and black-and-white test patterns used in performance evaluations. The cathode-ray oscilloscope at the top of this rack is used to monitor the waveforms of the scanning and dynamic-convergence currents, and of the video signals applied to the three guns of the color picture tube.

In the foreground, RCA engineer R. H. Hughes demonstrates the use of a Luckiesh-Taylor spot-brightness meter for contrast-ratio and light-output measurements. These measurements are normally made at much lower ambient-light levels than that shown in the picture, or in total darkness.

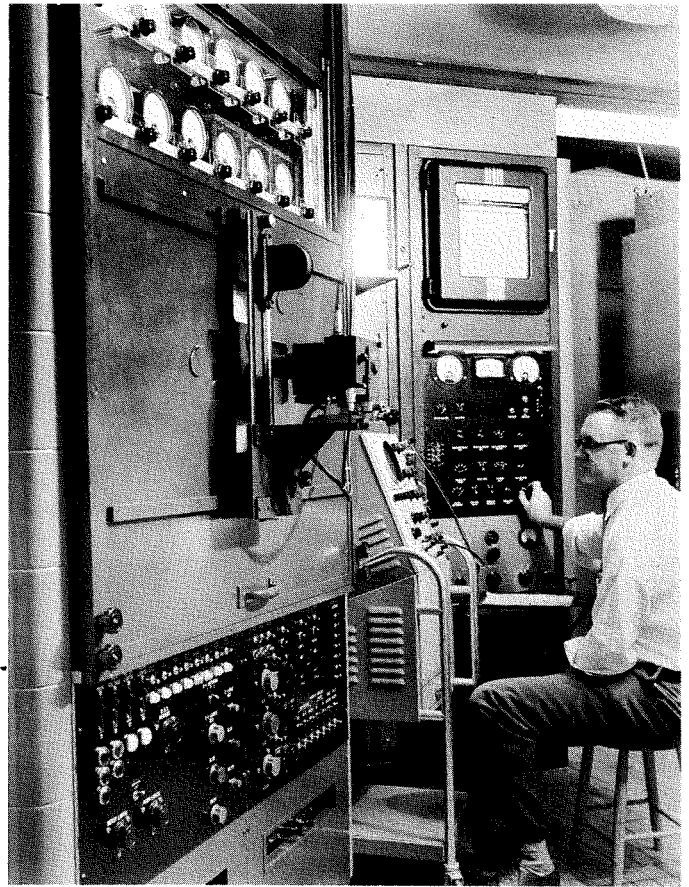

Fig. 2—Equipment for measurement of sine wave response. In these measurements, the amount of pictorial detail a color picture tube can reproduce is precisely and quickly evaluated from the response of the tube to sine-wave driving signals of various frequencies. The color tube being evaluated is installed in the center compartment of the large cabinet in the foreground. This cabinet also contains the power supplies, deflection circuits and auxiliary components for the tube, as well as control and metering facilities for each circuit. The movable carriage mounted on the front of the tube compartment contains a multiplier phototube and an optical system which are used to measure the response in critical areas of the picture tube faceplate.

For resolution measurements the picture tube is scanned at the rate of 60 cps vertically and 31.5 kc horizontally, and is driven by a sinusoidal signal voltage of constant amplitude which can be set at any integral multiple n of the vertical scanning frequency, plus 10 cps—that is, $60n + 10$ cps. The resulting display is an over-all pattern of illumination containing n sinusoidal variations of intensity from top to bottom, which drift vertically at a constant rate of 10 cps. This drifting illumination pattern is focused through a microscope-objective lens on a micrometrically adjustable slit aperture mounted directly in front of the multiplier phototube. For high-resolution tubes the slit is adjusted so that the image of only a small segment of a single row of phosphor dots passes through the slit. The output of the multiplier phototube is amplified and rectified, and the resulting direct current is applied to a chart-type recorder calibrated in per cent modulation (0-100). The gain of the amplifier is adjusted so that a 70-cps driving signal produces a 100-per cent reading on the recorder. The recorder reading at any other frequency is then proportional to the resolution capability of the tube at that frequency.

RCA engineer J. Evans, Jr. is seated at the rack containing the sine-wave driving-signal generator (bottom), the output amplifier and control panel (center), and the recorder.

Fig. 3—The multiplier-phototube unit of the sine wave response test set is focused with the aid of a built-in prismatic viewer.

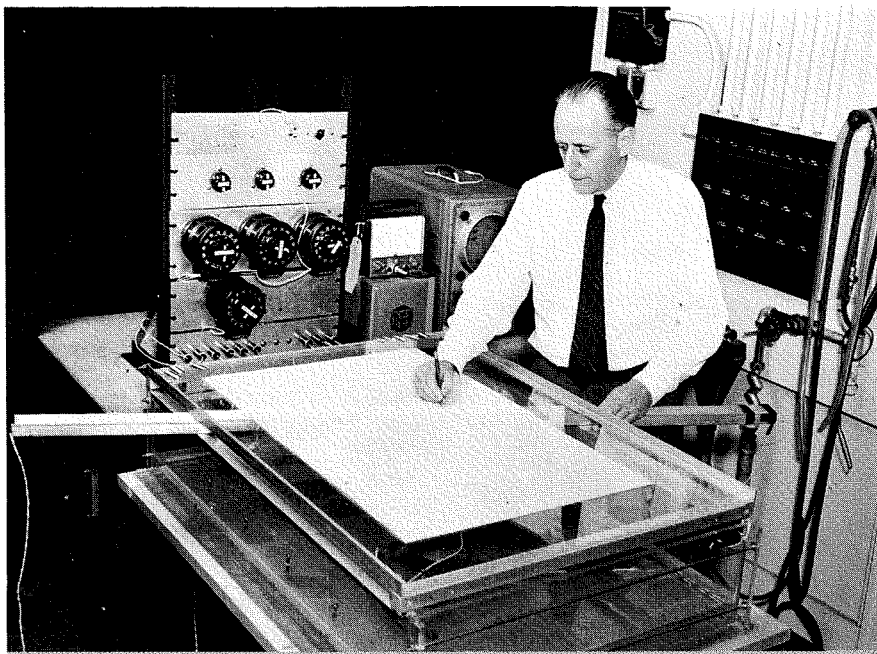

Fig. 4—Equipment used to plot internal electrostatic fields of electron lenses. Knowledge of the electrostatic fields produced by electron lenses, singly or in combinations, is of very great value in determining optimum geometry, operating potentials, and other parameters for electron-optical systems. These fields are plotted with the aid of two-dimensional scale models in a device known as an "electrolytic plotting tank". The plotting tank at Lancaster, shown being used by engineer T. M. Shrader, is made of clear Lucite, and uses tap water as the electrolyte. Mounted on Lucite supports in the tank are copper strips formed to simulate greatly enlarged cross sections of the electron-lens elements to be studied. When differences of potential are applied between the strips the potential gradient at any point in the electrolyte is directly proportional to the strength of the electrostatic field at the corresponding point in the prototype lens.

Precisely adjustable ac voltages for the strips are obtained from separate power supplies through the individual control transformers shown in the background. The voltage gradients in the electrolyte are measured by means of a crystal-diode rectifier probe and the RCA type WV-98A Senior VoltOhmyst also shown in the background. The rectifier probe is mounted on a long boom which permits it to be moved quickly from point to point within the electrolyte. In most plotting tanks the movements of the voltage-measuring device are transferred to the plotting paper through an awkward pantograph arrangement which is often a source of error. In the Lancaster tank a small lamp mounted directly above the rectifier probe projects a tiny spot of light upward through the plotting paper, permitting much more rapid and accurate mapping of equipotential lines than is possible by the pantograph method.

Fig. 5—Bench for Studies of Electrode Movements. Proper operation of a shadow-mask tube requires extremely stable spatial relationships within each gun, between the three guns, and between the guns and the shadow mask. Even the small movements which normally occur during tube warmup can have serious effects unless they can be predicted and compensated for in the design of the tube.

This specially designed electron-optical bench, not only permits observation and measurement of electrode movements, but also permits individual electrodes to be moved substantial distances in any direction desired. The bench consists of an extremely stable lathe-type bed and carriage on which is mounted a massive metal chamber. This chamber is used to hold the gun assembly being studied and is provided with a removable, vacuum-tight rear wall, and is sealed in front to a color-tube faceplate-mask-funnel assembly. The entire assembly is connected to the evacuation system capable of maintaining the internal pressure at less than 3×10^{-6} mm. of mercury.

The particular gun or gun electrode whose movements are to be varied is held in a special vise, and is moved by means of the vacuum-tight micrometer controls visible at the lower right, and similar controls at the front of the bench. Windows in the top and sides of the chamber and the special calibrated microscope being used by Engineer F. van Hekken permit precise positioning of movable electrodes, as well as continuous observation of the behavior of the gun assembly during operation.

Operating potentials and scanning power for the bench are obtained from an external unit, and are brought in through the shielded cable shown

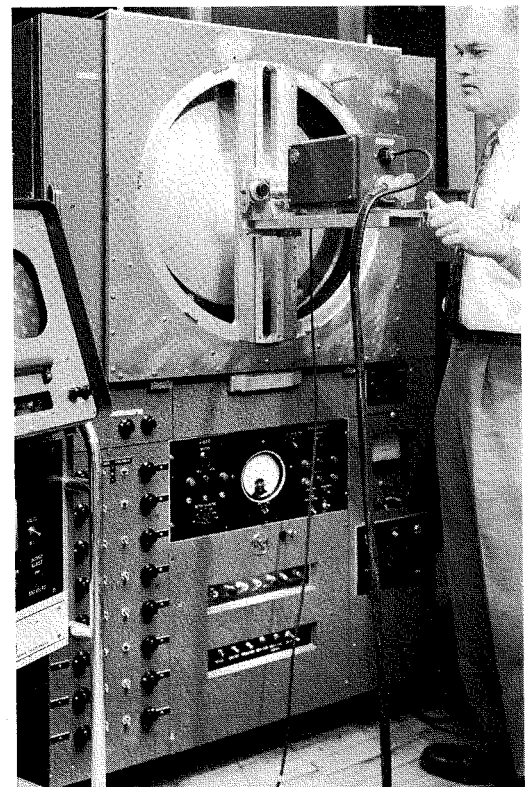

at the right, and the connector shown at the lower left.

Fig. 6—Demountable unit used to study the performance and effects of new or improved color picture tube components and materials. This unit has detachable vacuum-tight funnel, cone, and neck sections, and is connected to the same continuous-evacuation system as that used for the electron-optical bench previously described. It also uses the same external power supply unit. The photograph shows engineer F. van Hekken checking beam register on a developmental tube.

Fig. 7—High-Voltage Manual-Switching Unit used to transfer ultra and other high supply voltages of up to 50 kilovolts between the electron-optical bench and the demountable color tube unit. High voltages from the common supply unit are brought in through the top of the Lucite enclosure and fed to four connectors in the vertical center row. Plug-in jumpers such as those shown in the right foreground are used to switch these high voltages to the electron-optical bench (left) or the demountable unit (right). Safe operation is assured by a dual-interlock arrangement which prevents access to or switching of live circuits. Interlock switches connected in series in the primary circuit of the supply unit are mounted on the hinged access door and on the internal safety barrier shown in the left foreground. The latter is plugged in between the supply terminals and the unused side of the switch, and must be removed (thereby opening the primary circuit) before connections can be changed. It must then be plugged in on the opposite side of the switch and the access door closed before the power supply can be reenergized.

Fig. 5

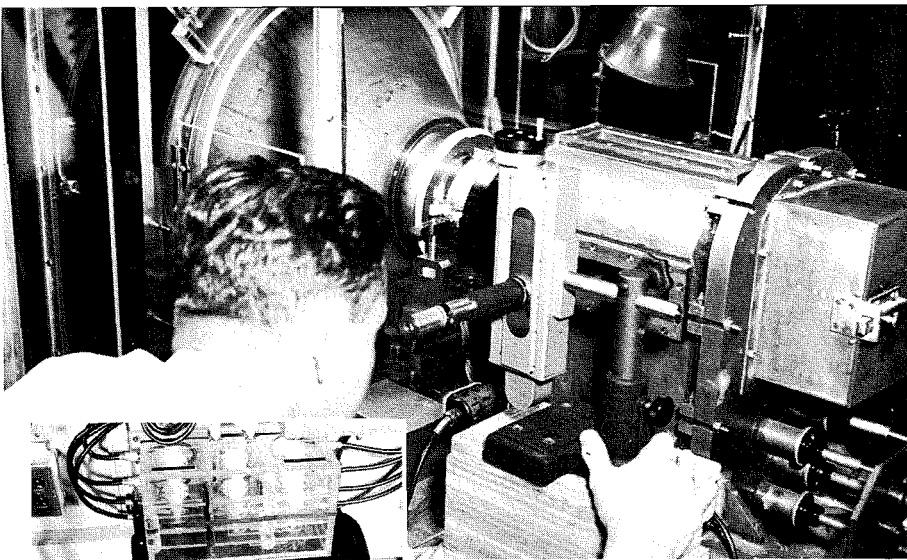

Fig. 7

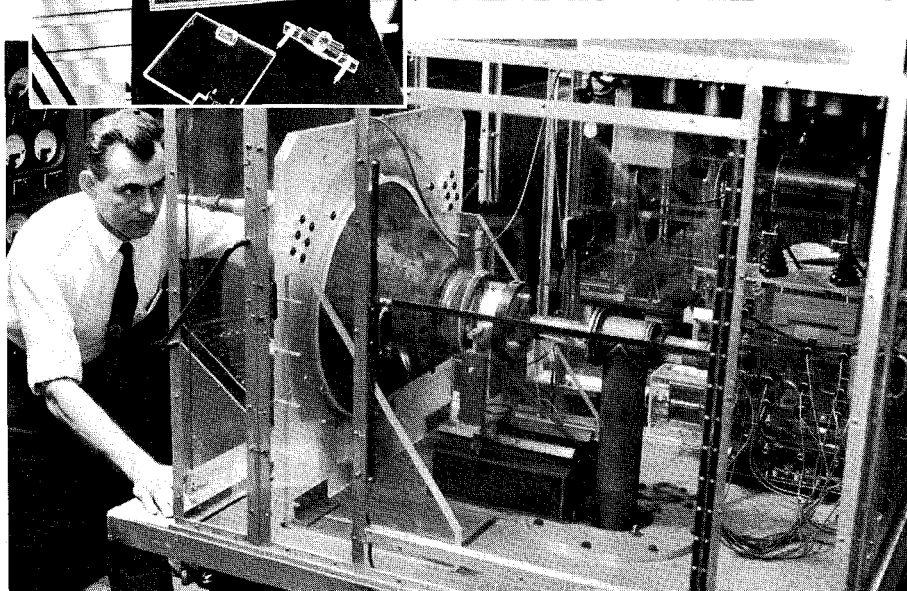

Fig. 6

Fig. 8—Equipment Used to Study Beam-Landing Characteristics. One of the most important performance requirements of a shadow-mask color picture tube is that the three electron beams land on their corresponding phosphor dots with the same degree of precision in all regions of the screen. The degree of beam-landing uniformity ("register") achieved depends not only upon the design of the tube but also upon the precision with which the effects of extraneous magnetic fields, including the field of the earth, are overcome. These extraneous fields normally vary with geographic location and local conditions, and are compensated for by external permanent magnets and electromagnetic devices which are adjusted at the time of installation.

In the early years of color picture tube development, the laboratory tech-

nician used a hand microscope to observe the individual phosphor dots and beam spots while making field-compensating adjustments. This fatiguing and cumbersome method, however, has been replaced by the high-speed, semi-automatic facilities shown, in which the desired area of the picture-tube screen is televised through a two-power microscope objective by a standard RCA Type ITV-6 television camera, and displayed on the screen of the associated monitor unit. The indexed rotating frame on which the camera is mounted permits it to be focused on any part of the picture tube screen. This system has an over-all magnification of 45, and provides a stable image of a much greater screen area than is observable through a hand microscope, which can be viewed for long periods without visual or physical fa-

ture. Engineer R. H. Godfrey is shown viewing a typical display.

Fig. 9—Closeup view of the monitor screen, showing the ease and accuracy with which the landing characteristics of a beam may be determined.

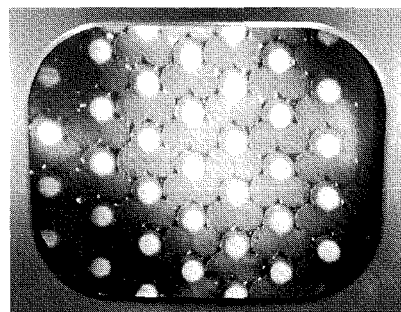

Fig. 9

Fig. 8

Fig. 10 — Two-channel recording equipment. A very important phase of color picture tube development is the plotting and study of the changes in cathode current and cutoff voltage which occur during warmup periods, and the performance changes which may occur during tube life. Studies are also necessary of drive requirements and internal temperatures as functions of time. Substantial savings of time and manpower in such studies are provided by automatic recording equipment of the type shown. The two-channel recorder shown being operated by Technician J. O. Peck has already been replaced by a four-channel system.

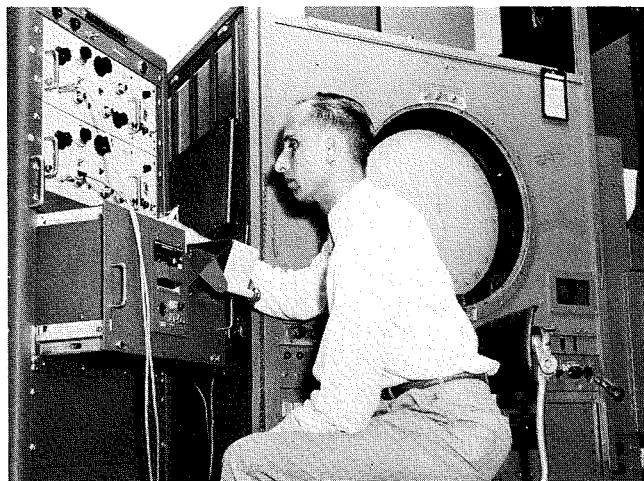
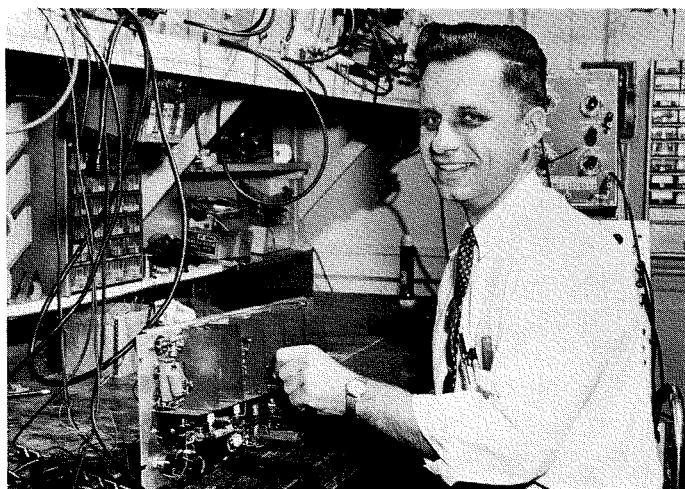
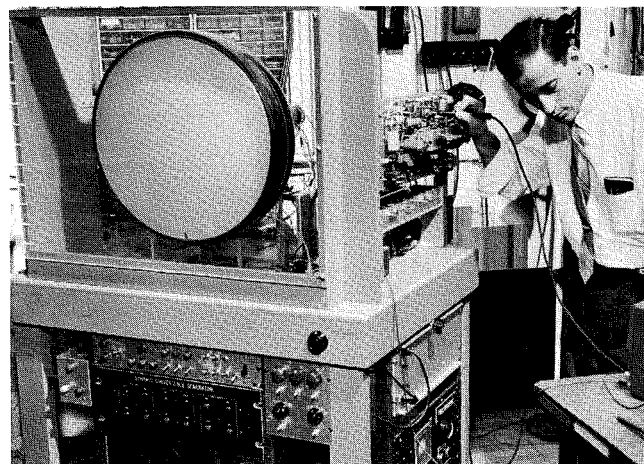

Fig. 11—Circuit-Development Facilities. In addition to its responsibility for development and maintenance of equipment such as that described above, the Equipment Design Group of the Color Picture Tube Design Activity at Lancaster is also responsible for the design of circuits for use in tube development equipment. Fig. 11 shows a typical developmental test setup, with Engineer P. P. Hatzikyriakos checking the performance of a deflection circuit for a developmental color-picture tube test set.



L. I. MENGLE received the BS degree in Electrical Engineering at Lehigh University in 1948, and joined Bell Telephone upon graduation as a Staff Engineer at Harrisburg, Pa. He came to RCA in 1951, joining the Electron Tube Division at Lancaster as an engineer in the Cathode Ray Tube Design and Development Laboratory, where he worked on black and white kinescopes. In 1955 Mr. Mengle became a Product Development Engineer on color kinescopes, and in 1956 was appointed as Acting Leader of Test Equipment Design of Color Kinescope Product Development Engineering.

Mr. Mengle is a member and Past President of the Conestoga TV Association and an Associate Member of the IRE. He is a Registered Professional Engineer in the State of Pennsylvania.

COMPOUND SEMICONDUCTORS

by **DIETRICH A. JENNY**

*RCA Laboratories,
Princeton, N. J.*

COMPOUND SEMICONDUCTORS are, as the name indicates, chemical compounds which exhibit semiconducting properties. Representatives of this vast class of semiconductors are found throughout the entire range of chemical compounds from the simple binaries to the most complex organic structures. The well known monoatomic or elemental semiconductors, such as germanium, silicon, gray tin, tellurium, selenium and others, are actually only special cases of the general class of semiconductor materials. Although by far the major systematic research efforts, both theoretical and experimental, have heretofore been concentrated on germanium and silicon, the compounds have played an important role in semiconductor research from the beginning. In fact, the earliest evidence for a conduction mechanism different from that in metals was Faraday's observation of a negative temperature coefficient of the electrical resistivity in the compound, silver sulfide, in 1833. Rectification at a contact between dissimilar materials was discovered by Braun with pyrites (iron sulfide structure compounds) and galena (lead sulfide), and almost simultaneously by Schuster with "tarnished" copper (copper oxide) in 1874. Silicon carbide and lead sulfide crystal detectors attained some importance in the early radio days, but they were soon displaced by the vacuum tube. Copper oxide has been one of the most important solid rectifier materials for power applications to this day. Early fundamental research was frustrated by the lack of a satisfactory model for the semiconduction mechanism. Even after quantum theory had come into its own and

A. H. Wilson had laid the ground work for modern semiconductor theory in 1931, experimental reproducibility problems still precluded significant conclusions. The interest in point contact semiconductor diodes, as radar and general high frequency detectors and mixers, during World War II, marked the beginning of intensive theoretical and experimental research on germanium and silicon. The tremendous progress which resulted from this increased effort is drastically documented by the discovery of the transistor by Shockley, Bardeen, and Brattain in 1948. Stimulated by this event, compound semiconductor research received renewed attention which resulted in the demonstration of a point contact transistor in lead sulfide by Henish and coworkers in England.

However, it was H. Welker's contribution in 1952, pointing out the semiconducting properties of aluminum antimonide and indium antimonide, that sparked extensive and systematic research in the compound semiconductor field. It soon became evident that the study of the compound semiconductors could contribute much to the understanding of the semiconduction mechanism, and new applications as well as improvements of the already known devices would ultimately result. Systematic compound semiconductor research is, however, still in its infancy and it will be some time before the compounds are as well understood as germanium and silicon. Although the feasibility of essen-

tially all the known semiconductor devices has been demonstrated with certain compounds, only indium antimonide and indium arsenide have attained some commercial importance in the form of the galvanomagnetic devices. Several other compound semiconductor devices are on the threshold of development, such as diodes and rectifiers made from gallium arsenide. Gallium arsenide and indium phosphide transistors as well as silicon carbide and gallium phosphide rectifiers are being worked on in the laboratory.

As it is impossible to touch upon all the known semiconductor properties and applications in this short paper, the following discussion is limited to the more important areas, such as diodes, rectifiers, transistors and galvanomagnetic devices.

SEMICONDUCTOR PROPERTIES AND DEVICE PERFORMANCE

In the evaluation of new semiconductor materials, such as the compound semiconductors for device applications, it is necessary to know the relation between the pertinent device characteristics and the specific properties of semiconductors. Experience with germanium and silicon has, fortunately, provided this knowledge which can be expressed in a few simple relations. The important semiconductor properties are defined in Table I together with their descriptive terms and symbols. As is well known, the active electronic processes in semiconductors involve two types of charge carriers, the negative electrons and the positive holes.

Although certain other material properties have a minor effect on device performance as well, they are only of

TABLE I

DESCRIPTIVE TERMS, SYMBOLS AND DEFINITIONS OF SEMICONDUCTOR PROPERTIES

DESCRIPTIVE TERM	SYMBOL	DEFINITION
Band Gap	E_g	The energy required to produce an electron-hole pair.
Impurity Activation Energy	E_i	The energy required to produce an electron or a hole
Electron and Hole Mobility	μ_n, μ_p	The drift velocity of an electron or a hole in an electric field of unity.
Dielectric Constant	κ	(Conventional)

TABLE 2

SEMICONDUCTOR PROPERTIES AND DEVICE PERFORMANCE

DEVICE PERFORMANCE	SEMICONDUCTOR PROPERTY	APPROXIMATE RELATION
Operating Temperature Range	Upper Temperature Limit T_u	Band Gap E_g $T_u \propto E_g$
	Lower Temperature Limit T_l	Impurity Activation $T_l \propto E_i$
Upper Frequency Limit F (Switching Speed)	Unipolar Devices (unipolar transistors; high frequency and switching diodes)	The higher of the two mobilities μ_{high} ; Dielectric constant κ $F \propto \frac{\mu_{high}}{\kappa^{1/2}}$
	Bipolar Devices (Transistors, n-p-n-p switches)	Electron and Hole Mobility, μ_n and μ_p ; Dielectric constant κ $F \propto \sqrt{\frac{\mu_n \times \mu_p}{\kappa^{1/2}}}$

secondary importance and shall be disregarded for the sake of clarity. Table 2 shows the important material-device relations which form the basis for the following discussion of the compound semiconductors and their devices.

A high band gap and high mobilities, in conjunction with a low impurity activation energy and a low dielectric constant, are the features generally desired for semiconductor devices. In the case of special applications, one or the other property may be of prime importance, where the others are considerably less critical. For instance, an extension of the upper temperature limit beyond that of silicon requires, above all, a material with a band gap higher than 1.1 ev (energy in electron volts).

A comparison with the vacuum tube may help to illustrate the significance of the material properties. The actual "material" in a vacuum tube, where the active electronic processes take place, is the vacuum itself. The effective band gap of a vacuum is infinite, since it is impossible to create hole-electron pairs. Similarly, the mobility of charge carriers, such as electrons, in the vacuum is essentially infinite, for they accelerate continuously in a constant electric field, without being impeded by collisions with atoms thus limiting their velocity to a finite value as in the semiconductors. Accordingly, from a "band gap" and "mobility" standpoint, the vacuum tube is in most respects superior to the solid semiconductor devices. The major disadvantage lies in the process of introducing mobile charge carriers into the vacuum. In germanium and silicon the impurity activation energy, or the energy to produce a mobile charge car-

rier in the solid, is less than 0.1 ev, whereas in the vacuum tube it is necessary to overcome the work function of the cathode which is in the order of 1 ev or more. This requires high temperatures for the thermal activation or emission process and constitutes an energy waste, and therefore a reduction in efficiency. Thermionic cathodes must be heated to at least 700°C (degrees centigrade) to provide sufficient electron emission for the efficient operation of vacuum tubes. This temperature is the lower temperature limit of the vacuum device as compared to less than room temperature for the germanium and silicon semiconductor devices. Therefore, the major advantage of the semiconductor devices over the vacuum tube is a consequence of the low impurity activation energy.

EVALUATION OF COMPOUND SEMICONDUCTORS

The recent interest in extending the upper operating temperature limit of semiconductor devices has led to the emphasis of semiconductor materials with band gaps beyond that of silicon (1.1 ev). In a search for such a semiconductor it is important to maintain, if possible, the low temperature limit at least at room temperature and to make the least sacrifice in high-frequency performance as compared to germanium. These considerations are of importance in such applications as high-speed aircraft and guided missiles, where aerodynamic heating and high engine power levels lead to high ambient temperatures. Other high-temperature applications are in compact computers and power devices where high dissipation temperatures are encountered.

Fig. 2—Binary compound evaluation table.

COLUMNS OF THE PERIODIC TABLE	IIIA B Al Ga In Tl	IVA C Si Ge Sn Pb	VA N P As Sb Bi	VIA O S Se Te Po	VIIA F Cl Br I (At)
IA Li Na K Rb Cs Fr	low MP unstable metallic	low MP unstable	low MP unstable	low μ , MP unstable	low μ
IIA Be Mg Ca Sr Ba Ra	low E_g metallic	technology low μ , E_g	technology low μ , E_g	low μ	low μ
IIIB Sc Y La RARE EARTHS	low E_g metallic	technology	technology	low μ	low μ
TRANS. ELEMENTS ACTINIUM SERIES	low E_g metallic	technology low E_g metallic	technology low E_g metallic	low μ	low μ
IB Cu Ag Au	low E_g metallic	low E_g metallic	low μ	low μ , E_g	low μ
IIB Zn Cd Hg	low E_g metallic	no compounds	low μ	low μ , E_g	low μ
IIIA B Al Ga In Tl	low E_g metallic	technology metallic	III-V COMPOUNDS	low μ , E_g	low μ
IVA C Si Ge Sn Pb		C Si Ge α -Sn Si C	technology unstable	low μ , E_g	low MP
VA N P As Sb Bi			low MP	low μ , E_g	low MP
VIA O S Se Te Po				low μ , E_g	low MP
VIIA F Cl Br I (At)					low MP

Starting out from these premises, the evaluation of compound semiconductors in comparison with germanium and silicon can be traced out briefly as follows.

The periodic table in Fig. 1 shows in a systematic fashion the elements available for synthesizing chemical compounds. Semiconductors are found among all the compound classes, ranging from those containing only two elements to the organic compounds which contain many elements. Table 3 illustrates this with a few examples of binary, ternary and multi-element organic semiconductors which are compared with some well known elemental semiconductors.

Although the band gap values in each compound class range from less than one to several electron volts, the electron mobility, which is in general higher than the hole mobility, drops off with increasing chemical complexity, except for unusually high values in the binaries. These observations have led to a concentration of the evaluation effort on the binary compounds. The results shown in Fig. 2 are in the form of an evaluation table of binary compounds. The horizontal and vertical columns are arranged according to the columns of the periodic table, so that almost all conceivable binary compounds are contained in the respective boxes.

Most of the primary compound classes, thus catalogued, do not contain promising representatives for the objectives stated above. The reasons are indicated in the boxes, such as low band gap (low E_g), low mobility (low μ), low melting point (low MP) chemical or physical instability (unstable) or technological difficulties in the preparation (technology).

PERIODIC CHART OF THE ELEMENTS

IA	IIA	IIIB	IVB	V	VI	VII	VIII	IX	X	XI	XII	IIIA	IVA	VA	VIA	VIIA	VIIIA	IXA	X	INERT GASES
1 H 1.008																			1 H 1.008	2 He 4.003
3 Li 6.940	4 Be 9.013												5 B 10.82	6 C 12.010	7 N 14.008	8 O 16.000	9 F 19.00	10 Ne 20.183		
11 Na 22.997	12 Mg 24.32												12 Al 26.97	13 Si 28.06	14 P 30.94	15 S 32.066	16 Cl 35.457	17 Ar 39.944		
19 K 39.096	20 Ca 40.08	21 Sc 45.10	22 Ti 47.90	23 V 50.95	24 Cr 52.01	25 Mn 54.93	26 Fe 55.85	27 Co 58.94	28 Ni 58.69	29 Cu 63.54	30 Zn 65.38	31 Ga 69.72	32 Ge 72.60	33 As 74.91	34 Se 78.96	35 Br 79.916	36 Kr 83.7			
37 Rb 85.46	38 Sr 87.63	39 Y 88.92	40 Zr 91.22	41 Nb 92.91	42 Mo 95.95	43 Tc (99)	44 Ru 101.7	45 Rh 102.91	46 Pd 106.7	47 Ag 107.88	48 Cd 112.41	49 In 114.76	50 Sn 118.70	51 Sb 121.76	52 Te 127.61	53 I 126.92	54 Xe 131.3			
55 Cs 132.91	56 Ba 137.36	57 La 138.92	72 Hf 178.6	73 Ta 180.85	74 W 183.82	75 Re 186.31	76 Os 190.2	77 Ir 193.1	78 Pt 195.23	79 Au 197.2	80 Hg 200.61	81 Tl 204.39	82 Pb 207.21	83 Bi 209.00	84 Po 210.	85 At (210)	86 Rn 222.			
87 Fr (223)	88 Ra 226.05	89 Ac 227.0																		
			58 Ce 140.13	59 Pr 140.92	60 Nd 144.27	61 Pm (147)	62 Sm 150.43	63 Eu 152.0	64 Gd 156.9	65 Tb 159.2	66 Dy 162.46	67 Ho 164.94	68 Er 167.2	69 Tm 169.4	70 Yb 173.04	71 Lu 174.99				
			90 Th 232.12	91 Pa 231.	92 U 238.07	93 Np (237)	94 Pu (239)	95 Am (241)	96 Cm (242)	97 Bk (243)	98 Cf (244)									

Fig. 1—Periodic table of the elements.

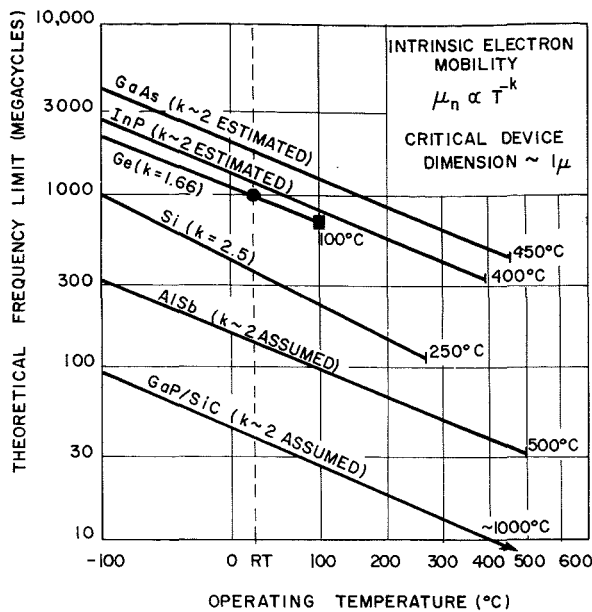

Fig. 3—Relative frequency limit versus temperature of unipolar devices in different semiconductors.

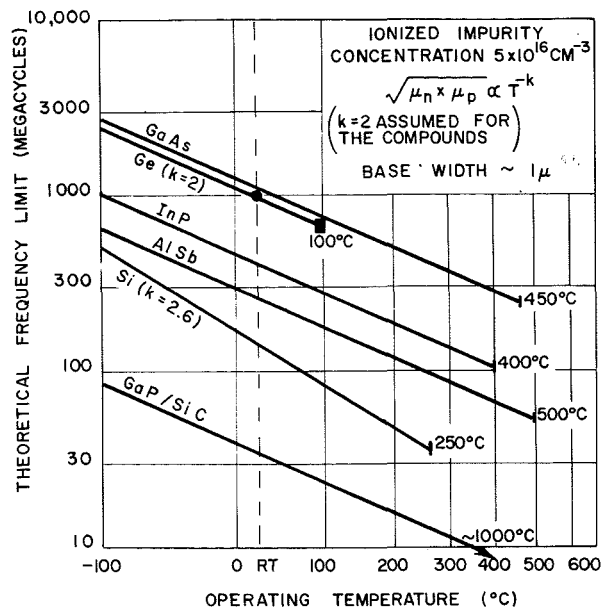

Fig. 4—Relative frequency limit versus temperature of bipolar devices in different semiconductors.

The two boxes framed with heavy lines contain the two most interesting semiconductor classes, namely, the well known IVth column semiconductors, including silicon carbide (SiC), and the so-called III-V compounds. The first group consists of elements from the IVA column of the periodic table, and the second group is composed of elements from the IIIA and VA columns. Although there are some potential possibilities among the compound boxes framed in dashed heavy lines, technological difficulties have precluded satisfactory studies.

A more detailed comparison of the IVth column and the III-V compound semiconductors can be made with the help of Table 4, where the pertinent fundamental properties are listed as far as they are known. Scanning this table, it becomes evident, that the mobilities of the III-V representatives are, in general, higher for a given band gap value than those of the IVth column semiconductors which include germanium and silicon. The ultimate mobility values are not yet known, but there are reasonable estimates which leave no doubt, that at least two of the III-V compounds, gallium arsenide (GaAs) and indium phosphide (InP), are potentially superior to germanium and silicon for most device applications. The extremely high electron mobilities of indium arsenide (InAs) and indium antimonide (InSb), although associated with very low band gaps, are of interest for galvanomagnetic devices and perhaps for low temperature devices. The relatively low hole mobilities of the III-V compounds are outweighed by the high electron mobilities, so that the mobility product, again for a given band gap, is in general higher than that of the IVth column semiconductors. Diamond

seems to be an exception to the rule, but there is some doubt about its mobility values.

Another interesting aspect of the III-V compounds is the total miscibility of some of their representatives in each other. This offers the possibility of obtaining materials of intermediate band gap values. Table 5 shows the more important mixtures with their band gap coverage. It is, for instance, possible to attain any desired band gap between 0.33 ev and 2.25 ev with mixtures of indium arsenide (InAs), indium phosphide (InP), gallium arsenide (GaAs), gallium phosphide (GaP) and germanium (Ge). The GaAs-GaP mixture has already been used in the laboratory for special device structures.

SUMMARIZING THE EVALUATION

The results of the compound semiconductor evaluation can now be summar-

ized in the following manner. Table 6 gives the galvanomagnetic figure of merit for various materials in the form of the magnetoresistance ratio and the Hall generator efficiency. Without going into the details of the meaning of these terms, it shall suffice to point out that the higher their values, the more favorable is the semiconductor material for galvanomagnetic applications. The superiority of indium arsenide and indium antimonide is immediately apparent in comparison with the best, previously considered, galvanomagnetic materials.

Probably the more important device types are, however, those known from the germanium and silicon art. These are diodes, rectifiers, and transistors. A comparison of the characteristics of these devices made from the promising compounds on one hand, and from germanium and silicon on the other, is shown in Fig. 3 and Fig. 4. Fig. 3 refers

TABLE 3
EXAMPLES OF COMPOUND SEMICONDUCTORS

COMPOUND CLASS	COMPOUND	BAND GAP (EV)	ELECTRON MOBILITY (CM ² /VOLT SEC)
Elemental	α-Sn	0.08	~ 3000
	Ge	0.7	3900
	C (Diamond)	6-7	1800
Binary	InSb	0.18	65,000
	GaAs	1.35	> 5000
	SiC	2.8	> 100
Ternary	AgTlTe ₂	0.1	—
	CuInSe ₂	0.9	~ 1000
	CuAlS ₂	2.5	—
Organic	Cyanthron	0.2	10 ⁻⁸
	Indanthracene	0.66	10 ⁻¹²
	Anthracene	1.64	10 ⁻²



DIETRICH A. JENNY received his degree of Doctor of Natural Science from the Department of Mathematics and Physics at the Swiss Federal Institute of Technology, Zurich, Switzerland, in 1951. He joined RCA Laboratories in 1947 where he did his thesis work in the field of secondary electron emission, which was published as a monograph. Dr. Jenny has also been engaged in research on color television kinescopes, thermionic cathodes and general vacuum tube problems. In 1952 he entered semiconductor research and has specialized in compound semiconductors during the past five years.

Dr. Jenny has received four RCA Laboratories awards for outstanding research and a color television award. He is a co-translator of the book "Electronic Semiconductors" by E. Spenke. Dr. Jenny is a member of the American Physical Society, the Institute of Radio Engineers and Sigma Xi.

to unipolar devices among which are unipolar transistors, high frequency and switching diodes, and the general class of majority carrier devices. The term "unipolar" refers to the fact that only one type of charge carrier (electrons or holes) participates in the active electronic mechanism of the device. Since the electron mobilities are invariably higher than the hole mobilities in the III-V compounds, Fig. 3 is based on the former. It is a logarithmic plot with the temperature on the abscissa and the relative frequency limit on the ordinate. The relative frequency values are based on the assumption that unipolar transistors, made from germanium, will ultimately be able to operate at 1000 megacycles at room temperature. This would involve a critical dimension in the device structure of about 1 micron, which is conceivable with modern techniques. In the case of high frequency and switching diodes the relative frequency scale must be multiplied with about a factor 1000 to indicate practically attainable frequency limits. Fig. 4 shows the equivalent plot for bipolar transistors and general bipolar devices, where both charge carriers (holes and electrons) participate in the electronic process. Here the electron-hole mobility product enters in the relation. The assumption for the relative fre-

quency scale values is the same as above, namely 1000 megacycles operation for germanium transistors with about 1 micron base thickness (critical dimension) at room temperature.

In both, Fig. 3 and Fig. 4, certain other assumptions had to be made. The temperature dependence of the mobilities follows a T^{-K} law where the K values are known for germanium and silicon and the best present estimates are used for the compounds. The low temperature limit is not known accurately in these compounds, since the lowest attainable impurity activation energy has not yet been determined. Nevertheless, the figures give a good idea of how the various promising semiconductors compare in device performance based on the measured fundamental properties.

Gallium arsenide and indium phosphide are clearly the most promising representatives in terms of the high temperature and high frequency objective described earlier. Higher device operating temperatures than attainable with silicon can be reached without sacrificing the high frequency performance with germanium. It must be born in mind that the calculations for these curves are based on measured mobility values and it is expected that the ultimately attainable mobilities in the compounds will be substantially higher. Aluminum antimonide could conceivably be used for somewhat higher temperatures at the cost of high frequency performance. Very high temperatures can be attained with silicon carbide at appreciably lower frequencies. Gallium phosphide is another possible compound for an extension of the upper temperature limit.

Another important application of

semiconductors lies in the microwave and switching diode field. Diodes for mixing and rectifying purposes at frequencies well above 1000 megacycles, and for switching circuits with speeds of less than 10^{-9} seconds, are possible with semiconductors. A calculation of a figure of merit as a function of the charge carrier concentration, n , and the absolute temperature, T , for such diode applications leads to the comparative picture for germanium, silicon, and gallium arsenide, shown in Fig. 5. The figure of merit is an indication of rectification efficiency, mixer conversion loss at high frequencies, and also switching speed. Again, it can be seen that gallium arsenide is capable of yielding superior diode performance to germanium and silicon in high frequency and high speed switching applications. This is in addition to significantly higher operating temperatures. Indium phosphide falls somewhere between germanium and gallium arsenide in this figure. Because of this and other disadvantages, it is of less interest than gallium arsenide.

THE PRESENT STATUS OF COMPOUND SEMICONDUCTOR DEVICE RESEARCH

Extensive material research on the compound semiconductors has led to the choice of indium phosphide and gallium arsenide as the most promising all-round semiconductors in direct competition with germanium and silicon. However, for extremely high temperature devices, aluminum antimonide, gallium phosphide and silicon carbide are more attractive possibilities. Indium antimonide and indium arsenide are the two outstanding galvanomagnetic device materials.

The superior galvanomagnetic device

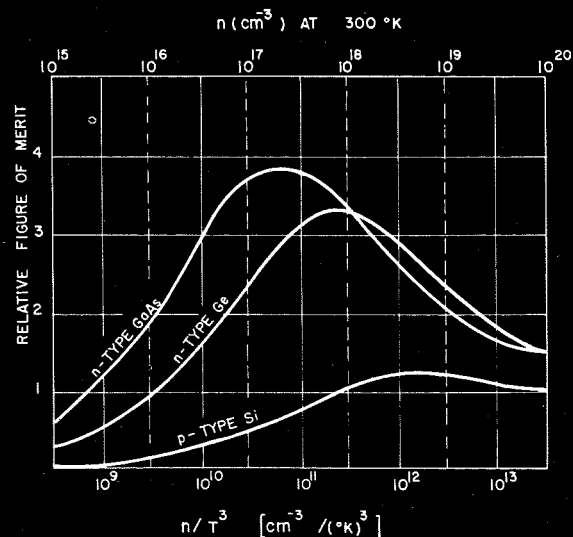

Fig. 5—Relative figure of merit versus n/T^3 of microwave and switching diodes in different semiconductors.

TABLE 4

III-V COMPOUND AND COLUMN IV SEMICONDUCTOR PROPERTIES

SEMICONDUCTOR	BAND GAP (EV)	ELECTRON MOBILITY (CM ² /VOLT SEC)	HOLE MOBILITY (CM ² /VOLT SEC)	DIELECTRIC CONSTANT	MELTING POINT (°C)
α -Sn	0.08	~ 3000	—	—	18 (transition)
Ge	0.7	3900	1900	16	958
Si	1.1	1500	500	11.8	1414
SiC	2.8	> 100	> 20	7	2700
C (Diamond)	6-7	1800	1200	5.7	> 3500
InSb	0.18	65,000	~ 1000	15.9	523
InAs	0.33	20,000	~ 200	11.7	936
GaSb	0.68	~ 4000	~ 700	14	702
InP	1.25	> 4000	> 100	10.8	1060
GaAs	1.35	> 5000	> 400	11.1	1280
AlSb	1.6	≥ 400	≥ 400	10.1	1080
GaP	2.25	> 100	> 20	8.4	> 1300
AlAs	~2.2	—	—	—	~ 1600
AlP	~2.5	—	—	—	—

TABLE 5
BAND GAP COVERAGE OF III-V
COMPOUND MIXTURES

MIXTURE	BAND GAP COVERAGE (EV)
InAs-InP	0.33-1.25
GaAs-GaP	1.35-2.25
GaAs-Ge	1.25-1.35

figures of merit for indium antimonide and indium arsenide shown in Table 6 have led, for the first time, to the commercial application of these effects. Examples of galvanomagnetic devices are: magnetometers, magnetic compasses without moving parts, dc magnetic current meters which do not necessitate breaking into the circuit, magnetic tape and record pick-up heads which operate down to zero frequency, magnetically controlled variable resistors, and amplifiers utilizing the Hall effect. Although only a few of these possibilities have become commercially available, others are in the active development stage.

In the realm of extremely high temperature devices, silicon carbide rectifiers have been demonstrated to work successfully at temperatures well above 500°C, and gallium phosphide is actively being worked on. Aluminum antimonide has also received considerable attention.

However, indium phosphide and gallium arsenide have progressed further than any of the other compound semiconductors in the realm of device applications of the type known from the germanium and silicon art. The feasibility of the following devices has been demonstrated experimentally:

1. High frequency and high speed switching diodes

2. Photovoltaic energy converters (solar batteries)
3. Photodiodes
4. Phototransistors
5. Power rectifiers
6. Unipolar transistors
7. Bipolar transistors

The high frequency and high speed switching diodes have shown superior performance to those made from germanium and silicon and are on the threshold of the development stage. General rectifiers and power rectifiers are in an advanced stage of research. Photodiodes and photovoltaic energy converters are ready for development. Unipolar and bipolar transistors are still in the research phase, but their feasibility has been clearly established. New processing methods and new device structures have become possible due to unusual chemical, metallurgical and physical properties of the compound semiconductors. The details of these devices are very similar to those made from germanium and silicon, and the early results are summarized in Table 7.

TABLE 6
FIGURE OF MERIT OF MATERIALS FOR
GALVANO-MAGNETIC DEVICES

MATERIAL	MAGNETORESISTANCE RATIO (GAUSS ⁻²)	HALL GENERATOR EFFICIENCY (GAUSS ⁻²)
Bi	.45	—
Si	< .3	< .1
Ge	.3	.1
InAs	4.5	7.8
InSb	23.6	16

CONCLUSIONS AND FUTURE OUTLOOK

The compound semiconductors have shown their potential usefulness in the applications discussed; namely, diodes, rectifiers, transistors and galvanomagnetic devices. Although most of the present activities are still largely confined to the research stage, some of these devices have already reached the commercial market and others are under development.

At least one compound semiconductor, gallium arsenide, shows promise of not only combining the favorable properties of germanium and silicon, but even of exceeding the combined features. Indium phosphide is a close second. Aluminum antimonide, and particularly gallium

TABLE 7
EARLY DEVICE RESULTS WITH
COMPOUND SEMICONDUCTORS

PHOTOVOLTAIC SOLAR BATTERY (GaAs)

Energy Conversion Efficiency.....6.5%

MICROWAVE AND SWITCHING DIODE (GaAs)

Conversion Loss at 6000 megacycles.....4.8 db

Noise Temperature Ratio at 6000 megacycles...1.25

Receiver Noise Figure (IF Noise 1.5 db)...6.97 db

Switching Speed.....< 10⁻⁹ seconds

UNIPOLAR TRANSISTOR (InP)

Transconductance.....~ 0.1 ma/volt

BIPOLAR TRANSISTOR (InP)

Maximum Gain at 4000 cycles.....36 db

Current Amplification at 4000 cycles.....13

phosphide and silicon carbide, are promising for extreme device operating temperatures at the cost of high frequency performance. Whether there are other compounds and compound classes which may have even more desirable properties than those discussed, can not be predicted at this time. It has become evident however, that the extension of semiconductor research from the elemental semiconductors into the compound area has opened up new horizons for device applications.

The possibility of gallium arsenide replacing both germanium and silicon in one single material is probably the most intriguing aspect of the findings to date. The ultimate realization of this goal depends, of course, upon the competitive cost factor.

A HISTORY OF RADIO CORPORATION OF AMERICA

THE YEARS 1938 TO 1958



Pioneering efforts by RCA contributed much to the expansion of television service into the UHF spectrum. Shown is RCA's tower and transmitter building of KC2XAK, the first licensed experimental UHF station at Bridgeport, Conn. After the experiments were completed, the tower and antenna were shipped to Portland, Ore. to be put on the air as part of KPTV, the first commercial UHF television station in the world.

by **DR. ELMER W. ENGSTROM**
Senior Executive Vice-President
Radio Corporation of America

AS A HISTORIAN writing in 1938, the late J. C. Warner, then Vice President, Radiotron Division, of the RCA Manufacturing Company, undertook to review the first 18 years of RCA's corporate life in an article appearing in this magazine. His concluding words at the time were: "... if we live up to our opportunities we will some day look back at 1938 and see that we have only started to scratch the surface." (See Part I, Vol. 3, No. 1)

None of us associated with Warner in 1938 would have disagreed with this estimate. At the same time, it is doubtful that anyone could have foreseen the phenomenal growth that has marked the second 18 years of RCA's existence. From a \$100 million corporation in 1938, RCA soared to the billion dollar corporate rank in 1955, a position it maintained in 1956 and 1957. In 18 years, its plant and equipment multiplied six times in value and the total number of employees quadrupled, to some 80,000 persons.

More significant than this impressive growth was the basic change in the nature of the Corporation itself. In 1938, RCA was in transition from a radio communications concern to a broadly diversified electronics organization with a growing interest in such new fields as radar, television, and airborne electronics. Today it has become an outstanding research, engineering and manufacturing enterprise, holding a position of leadership. The second 18 years of RCA not only have lived up to the opportunities which Warner referred to in 1938 but have created a host of new and exciting opportunities for the future.

Shortly after Warner had published his review, two events occurred which were to influence profoundly the future of the Corporation. In April, 1939, seven years of intensive research, engineering development and field testing by RCA culminated in the introduction, at the New York World's Fair, of the first public television service. Four months later, Hitler's assault on Poland and the declarations of war by England and France opened the Second World War.

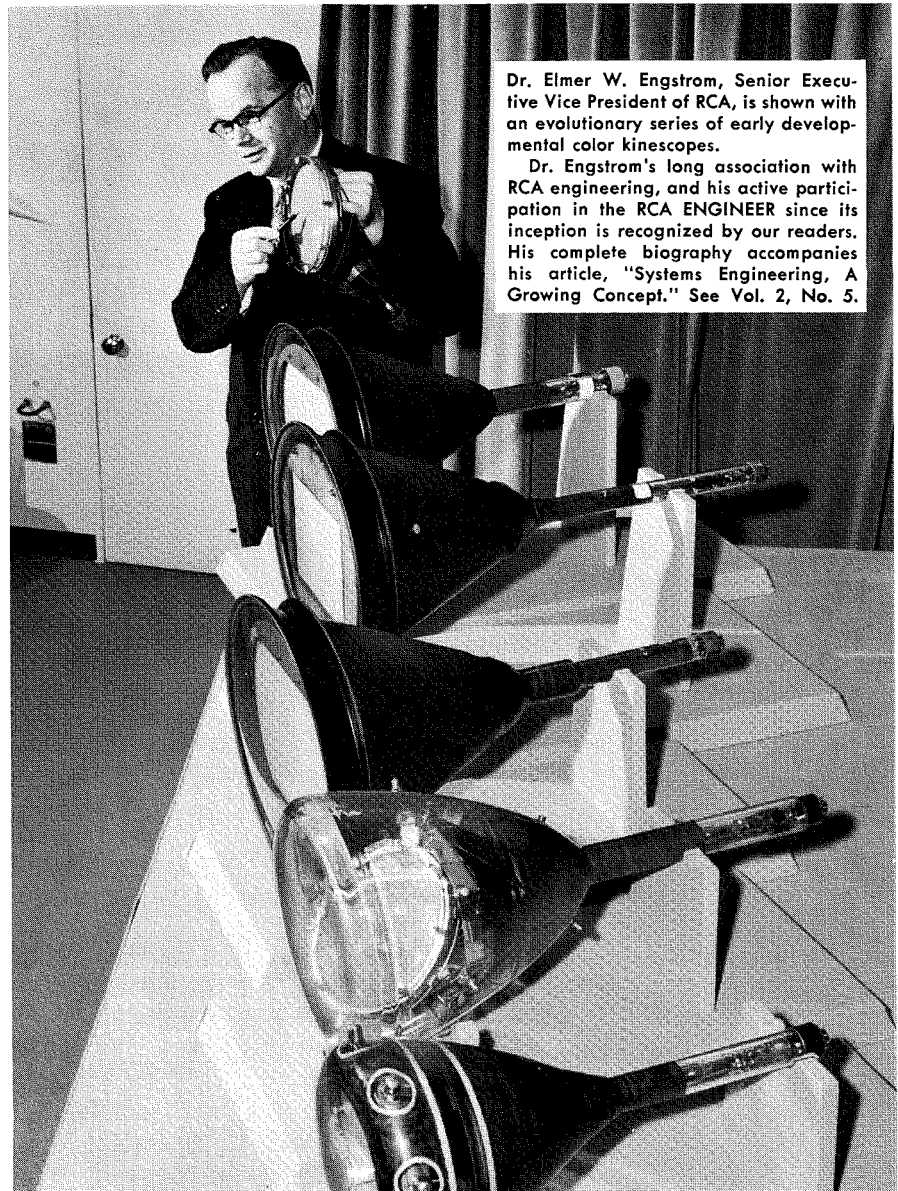

Dr. Elmer W. Engstrom, Senior Executive Vice President of RCA, is shown with an evolutionary series of early developmental color kinescopes.

Dr. Engstrom's long association with RCA engineering, and his active participation in the RCA ENGINEER since its inception is recognized by our readers. His complete biography accompanies his article, "Systems Engineering, A Growing Concept." See Vol. 2, No. 5.

The official inauguration of television service was the harbinger of a new era in mass communications, but it required a keen eye to see in the actual event the shape of the nation-wide television service we know today. It was an extremely limited service, covering only the New York metropolitan area, and operating on the "experimental" basis authorized by the Federal Communications Commission. Programs emanating from the NBC transmitter atop the Empire State Building were viewed on a relative handful of 9-inch direct view and 12-inch reflection-type receivers produced at Camden for sale in the New York area.

Standing before the Iconoscope cameras in front of the RCA Building at the World's Fair on April 20, David

Sarnoff announced the beginning of regular television service by NBC. And he added:

"Now we add sight to sound. It is with a feeling of humbleness that I come to this moment of announcing the birth in this country of a new art so important in its implications that it is bound to affect all society... This miracle of engineering skill which one day will bring the world to the home, also brings a new American industry to serve man's material welfare..."

RCA IN WAR

The outbreak of World War II effectively halted the further progress of commercial television. The clear need

Described as second only to the A-bomb as the most effective weapon to come out of World War II, the Variable-Time fuse for artillery and naval projectiles consisted of a 5-tube transceiver which detonated the shell at its moment of maximum effectiveness. RCA manufactured over half the total production of V-T fuses.

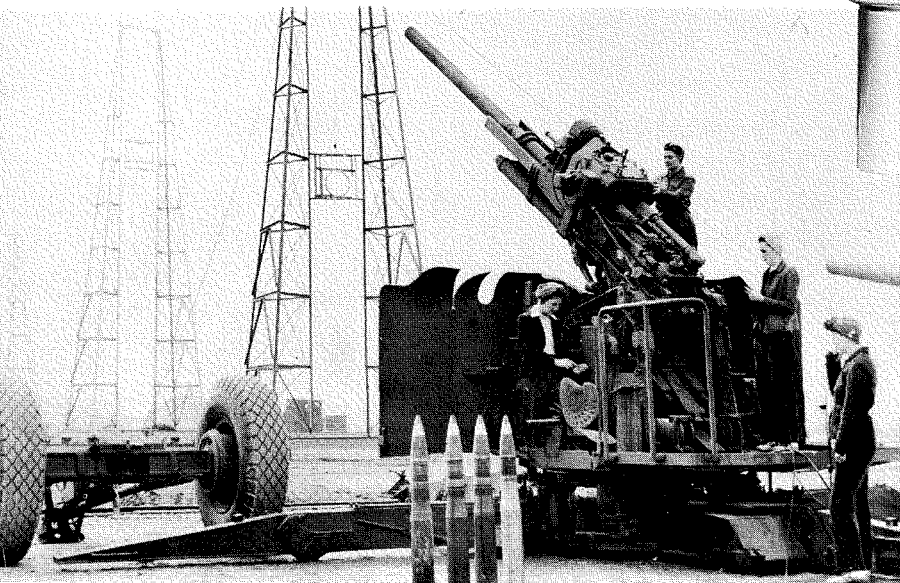
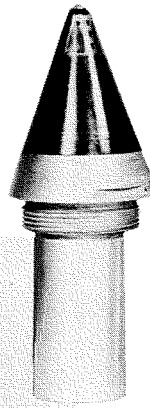

During World War II, RCA electronic equipment was used in testing muzzle velocities of large-caliber guns at Aberdeen Proving Grounds. A magnetized shell was fired through two detecting coils, and the time difference was converted into muzzle velocity.

Dedicated in September, 1942, the new building—the present David Sarnoff Research Center—provided the RCA research staff for the first time with complete modern facilities in an environment fully conducive to creative research. Further, it provided a physical as well as an administrative unity impossible under previous conditions.

In addition to the new research center at Princeton, expansion early in the war included new facilities for production. Advances in military electronics, particularly in such high-frequency applications as radar and microwave communications, led to a greatly increased demand for special purpose radio and electron tubes. To meet this need, the U. S. Navy undertook construction of a large new plant at Lancaster, Pennsylvania, to be operated by RCA. Completed in 1942, the plant operated at full capacity through the war to produce hundreds of thousands of tubes for military applications. At the war's end, it was purchased from the Navy by RCA.

A further organizational change of significance was made in December, 1942, to achieve closer coordination of all RCA manufacturing activities. The RCA Manufacturing Company, established in 1935 as a wholly owned subsidiary of RCA, was consolidated with the parent Corporation to become the RCA Victor Division, comprising all of the Corporation's tube and electronic equipment production facilities.

CONTRIBUTIONS TO VICTORY

The contributions to victory of the divisions and services of RCA, in research, engineering, production and

for military preparedness led to increasingly heavy demands through 1940 and 1941 on industrial research, engineering and production facilities both for American forces at home and for Britain and France through the Lend Lease program. RCA, with long experience in communications and with a pre-war record of major contributions in the important military areas of radar, underwater sound and airborne electronics, was in the forefront of this program from the start. By the time of the Japanese attack on Pearl Harbor in December, 1941, virtually all of the Corporation's facilities were devoted to military requirements for radio equipment, radar, special tubes, acoustical devices and navigation systems.

The increasing demand for military electronic equipment led, early in the war, to several important changes in RCA's organization and facilities to expedite research, engineering and production. The first of these related to the RCA research organization.

During the 1930's RCA's research facilities had been concentrated largely at the manufacturing plants in Camden and Harrison in addition to the communications research groups on Long Island. By late 1940, the growth of de-

fense activities had generated a need for increased staff and facilities, both for research and manufacturing. At the same time it was recognized that the research program could benefit from a separate environment in which the laboratories might physically be brought together to obtain better coordination and direction. Thus, in March, 1941, the research staffs were incorporated as a new department called RCA Laboratories. Concurrently, work was started on a new research center at Princeton, New Jersey, approximately mid-way between the Camden and Harrison operations.

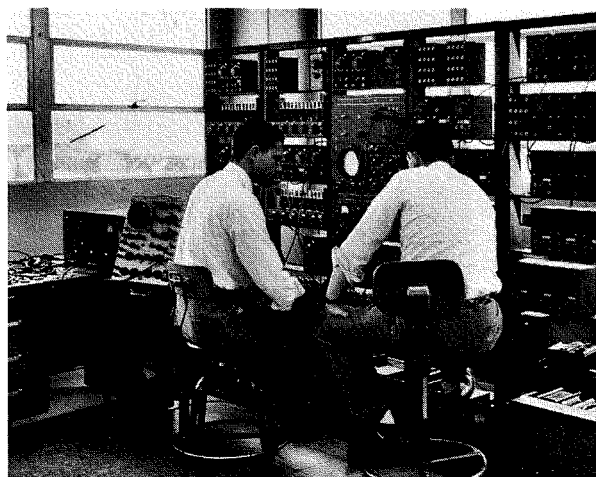

RCA has continued its active participation in military electronics in post-war years. Engineers are shown here with computer equipment at the Moorestown Missile and Surface Radar Engineering Plant.

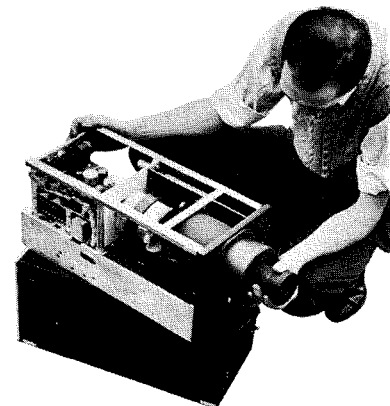

Experimental RCA "Block" television equipment was developed and tested during World War II for various airborne applications. This compact equipment was the forerunner of modern miniature television systems.

service were extensive, varied and distinguished. Although the list is too long for brief mention, they include the following:

RCA Laboratories: New devices, systems and techniques including the Shoran navigation and blind-bombing system, airborne radar equipment, electronic fire control, and airborne television equipment for aircraft, and guided missiles.

RCA Victor Division: Design and quantity production of tubes and electronic equipment including 200 types of electron tubes and 350 types of electronic apparatus. Among the large-quantity items were some 20 million miniature tubes and five million proximity fuses. Outstanding among types of equipment were radar altimeters, sound-powered telephones, battle announce equipment and R/F power generators.

RCA Communications: Initially providing the only means of communication with the war zone, RCA Communications worked closely with the Government to keep vital networks in operation.

Radiomarine Corporation: Produced more than 40,000 major units of marine radio equipment, comprising 42 different types of radio and radar apparatus for installation on merchant and supply vessels.

RCA Institutes: Trained thousands of Army, Navy and Marine servicemen in radio and electronic techniques.

National Broadcasting Company: Provided world-wide coverage of military operations for broadcast to the public and developed many special morale programs. Television facilities,

more limited than radio, were turned to morale and instruction purposes.

The outstanding performance of the various RCA divisions through the war was recognized by seven Army-Navy "E" pennants, two U. S. Navy Bureau of Ordnance Flags, the U. S. Maritime Pennant, the Victory Fleet Flag and 27 stars for continued excellence in operations.

RETURN TO PEACE

With the return of peace in 1945, RCA found itself, with all other electronics manufacturers, in a vastly changed environment. World War II had triggered a swift transformation in electronic technology. Research and engineering led to major advances in high-frequency techniques, in electronic systems development, in electron optics and in other fields of future peace-time importance.

The post-war environment for the industry was characterized by two totally novel features—a far more versatile and sophisticated technology than in the pre-war years, and a substantial increase in the number of participating and competing companies. Moreover, this greatly expanded art and industry faced a tremendous demand for its products and services from a public recently released from war-time austerity.

Plans for converting its research, engineering and production facilities to a peace-time basis were undertaken by RCA during the late stages of the war, when it had become apparent that victory was at hand. As a result, the process of conversion was rapidly carried out after V-J Day. Within eight

weeks, RCA Victor plants at Bloomington, Indiana, and Camden were producing radios for the civilian market. Before the end of 1945, commercial tube production had been resumed at Harrison. By mid-1946, production of television picture tubes and tubes for broadcast transmitters and industrial uses was under way at the newly acquired Lancaster plant.

One organizational development of importance in the conversion pattern was the establishment, in February, 1945, of the RCA International Division. In anticipation of an expanded foreign market for electronic equipment, the new division was given responsibility for distribution of products manufactured by RCA, the operation of foreign subsidiaries, and coordination of all RCA international activities.

POST-WAR TELEVISION

Full attention could now be given to the expansion of a civilian television system which literally had been nipped in the bud by World War II. The pre-war sharing with other manufacturers of RCA's television research and engineering experience and the availability of important technical developments to RCA licensees had made possible a broad manufacturing base for home receivers. By 1941, standards for the present television system also had been worked out by the National Television System Committee, an industry group, and approved by the FCC.

Thus, by the end of the war, television not only was ready for commercial application; it also was a better system, because of research and engi-

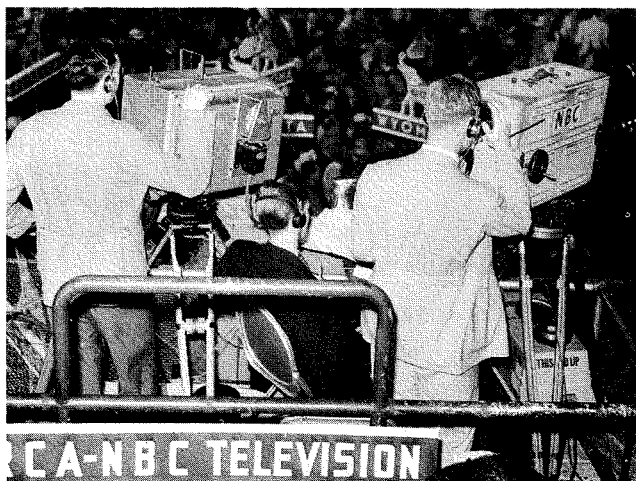

Early NBC experiments with televising on-the-spot news events provided invaluable technical and artistic experience which paved the way for the post-war television boom.



An overall view of the record-changer and amplifier assembly lines at RCA Victor's factory at Cambridge, Ohio. The plant, world's largest producer of packaged hi-fi instruments, has fifteen assembly lines capable of turning out 6,000 sets in an eight-hour shift. Inset is one of the instruments in RCA's complete hi-fi line.

neering advances achieved for military purposes. Among these were a more sensitive camera tube — the Image Orthicon; more powerful transmitting equipment operating over the full bandwidth allocated to commercial service; improved picture display techniques based on radar developments during the war, and effective network relay techniques.

Television activities resumed on a large scale during 1946, when the first network was opened, linking NBC facilities in New York and Washington by co-axial cable, and including Philadelphia and Schenectady.

It also was during 1946 that the RCA Victor Division placed the first post-war television sets on the market. The basic model was the famed 630TS, with a ten-inch picture tube. Marketed at a price of \$375, the 630TS' economy, reliability and high quality swept it into immediate popularity. The nation's first quantity produced and marketed receiver, it was television's equivalent of the "Model T." As much as any other single factor, the 630TS was responsible for the swift appearance of television in American homes during the early post-war years.

The pre-war practice of sharing with other manufacturers the results of RCA television research and engineering experience also was resumed vigorously. Engineering data relating to the 630TS was made available to other manufacturers in conjunction with industry symposia held at Camden. The result was a rapid growth of television production by many organizations in the industry.

Another factor in television growth was the initiation of large scale picture tube production at the Lancaster plant during 1946. By 1948, nonetheless, receiver sales had expanded so rapidly that a shortage in picture tubes threatened to develop. This was minimized by RCA's ability to supply tubes from the surplus accumulated at Lancaster during the previous two years in anticipation of just such an emergency.

Further expansion of RCA manufacturing facilities, extension of the NBC network, and improvements in the television system itself characterized the years after 1946. A new plant for tube manufacture was acquired at Marion, Indiana, and placed in operation during 1949. In February, 1950, the RCA

Victor Division produced its one-millionth home television receiver. At the same time, the size of the picture tube steadily grew larger, expanding in 1949 to the 16-inch metal cone, to 19 inches in 1950, to the popular 21-inch size by 1952. The NBC network, keeping pace with the growth of home television, reached rapidly across the nation to link principal cities in all of the 48 states. From the four-station network of 1946, it has grown today to more than 200 network affiliates.

COLOR TELEVISION

As the commercial television system expanded, RCA undertook an energetic post-war program of color television research and development. Although mechanical techniques offered promise in terms of early commercial advantage, RCA decided, soon after the war, to strive for an all-electronic color system fully compatible with black-and-white. Outstanding progress was achieved at RCA Laboratories during 1947 and 1948. Several demonstrations were held, showing a color system employing three kinescopes and combined with an optical system to present a composite color picture.

In 1949, the FCC scheduled a series of hearings to consider, among other matters, the establishment of standards for color television transmission. At issue were two competing systems—a non-compatible mechanical system of color, and the all-electronic compatible color system advocated by RCA.

As the hearings progressed, the research staff of RCA Laboratories, supported by engineering groups at the tube plants at Harrison and Lancaster, moved with full speed to the development of the final basic element in the compatible system—a single tube capable of producing pictures in full color. The result of this extraordinary effort, demonstrated publicly in March, 1950, was the tri-color kinescope, one of the outstanding achievements in early post-war electronics. In the words of General Sarnoff: "Measured in comparison with every major development in radio and television over the past fifty years, this color tube will take its place in the annals of television as a revolutionary and epoch-making device . . . As the master key to practical color television, it is an outstanding development of our time."

Despite the basic technical superiority of all-electronic color transmission, the FCC gave its approval to the mechanical, non-compatible system. In effect, this banned the compatible system from the market place.

Through court actions, RCA vigorously sought reversal of the FCC decision. Meanwhile, it proceeded with further refinements in compatible color transmission. In December, 1953, the FCC finally approved new and compatible standards recommended by the NTSC.

While receiver and tube production forged ahead, color broadcasting equipment was speeded to television stations. By October, 1955, 111 stations of the NBC network alone were equipped to broadcast in the new medium. Today the compatible color system embraces roughly half the stations in America and is capable of reaching 96 per cent of the nation's television homes.

In 1949, television, now firmly established as a national broadcast service, moved in a new and significant direction. Development by RCA scientists of the small and highly sensitive Vidicon pick-up tube opened vast opportunities for closed-circuit television for industry and education.

OTHER DEVELOPMENTS

If television, in all its aspects, was perhaps the most spectacular of the early post-war electronic developments, by no means was it the only one. A dramatic transformation in which RCA played a dominant role, was under way in the phonograph and recording fields. In 1949, the Corporation introduced its 45-rpm system of recorded music, including the fastest automatic record changer ever devised.

By the end of the year, 45-rpm records of unbreakable vinyl plastic were being produced at the rate of more than 25,000,000 annually and the number doubled in 1950. That year also saw the introduction, by RCA, of a three-speed record instrument.

The growth of popular interest in high-fidelity music reproduction spurred a number of other RCA contributions to the new form of home entertainment. Among these was the LCIA duo-cone speaker, placed in

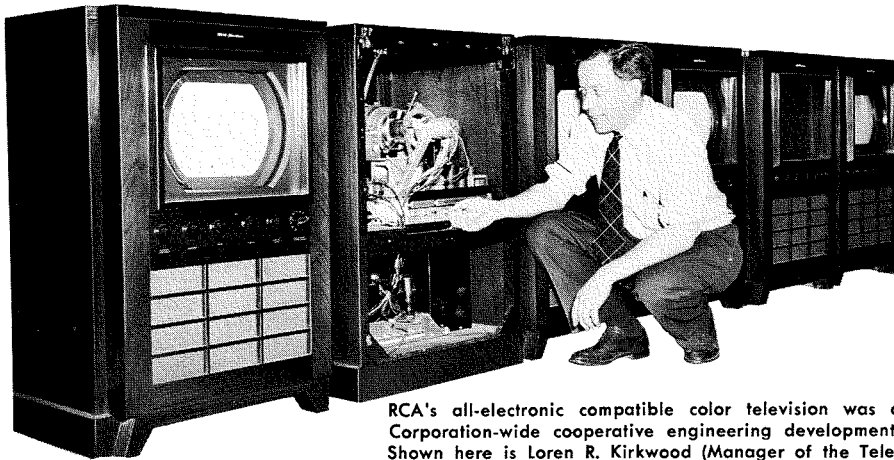

RCA's all-electronic compatible color television was a Corporation-wide cooperative engineering development. Shown here is Loren R. Kirkwood (Manager of the Television Division's Color Receiver Engineering at Cherry Hill) with a line of developmental color receivers.

production a year after its debut, in 1947, at the Berkshire Music Festival. In 1953, RCA introduced two high-fidelity "Victrola" phonographs designed for the mass market. At the same time it began to market a complete line of high quality "inter-matched" components for home assembly.

NATIONAL SECURITY

World War II, which saw the development of jet aircraft, radar, sonar, the V-2 rocket and other weapons of high complexity and growing effectiveness, presaged a new era of military technology in which electronics would play a determining role. Any doubts as to the need to maintain a strong military posture, supported by the latest technology, moreover, were dispelled by the militant aggressiveness of the Soviet Union.

Thus RCA, which emerged from the war as one of the nation's foremost contributors to military progress, continued to devote a significant proportion of its research and development to problems of advanced military technology.

Its work for the Government included a variety of development and production projects in such fields as sonar, advanced radar apparatus and fire control. In 1950, for example, RCA Laboratories completed for the U. S. Navy the development and construction of the world's largest and most accurate electronic analogue computer to evaluate the performance of guided missiles, airplanes, ships and submarines.

When war in Korea erupted in 1950, RCA's activities in the fields of mili-

tary electronics increased sharply. The Government field service activity of the RCA Service Company stepped up to such an extent that by the end of the year, approximately twice as many trained field engineers were assigned to military activities as at the peak of World War II. In manufacturing, new projects for the military included equipment in the fields of electronic sound, sonar, missiles, navigation and communications.

This, in turn, necessitated additional plant expansion, devoted wholly or in large part to defense purposes. Cincinnati; Los Angeles; Woodbridge and Moorestown, New Jersey; and a new engineering laboratory at Waltham, Massachusetts, were some of the sites for these new RCA facilities. In 1954, announcement was made of what was to become one of the most significant RCA contributions to national defense—the beginning of RCA Service Company maintenance and analysis of electronic guidance apparatus for missiles at the Air Force Missile Test Center at Cape Canaveral, Florida.

The extent and scope of RCA's military electronic activities may be gauged from some of the projects in which it was engaged during 1957, such as, instrumentation radar, the Talos Defense Unit, and the "Telemite" television camera, fitting the palm of a man's hand.

ORGANIZATIONAL CHANGES

The expansion by RCA into these many areas of electronics was paced by a comparable realignment and extension of RCA executive and administrative functions.

In July, 1947, following the retire-

ment of Lieut. General James G. Harbord, David Sarnoff was elected Chairman of the Board of Directors of RCA. The following year, Frank M. Folsom was elected President of RCA.

Keeping in step with the needs of a steadily expanding business in a constantly changing industry, 1954 saw a series of sweeping revisions of the Corporate structure. The RCA Victor Division, formerly responsible for all RCA manufactured products, became two separate groupings, RCA Consumer Products and RCA Electronic Products, each under the direction of an executive vice-president. RCA Sales and Service Subsidiaries formed a third grouping. The importance of RCA Laboratories to the progress of the Corporation was recognized by the elevation of its position in the Corporate structure. Behind these basic changes was the purpose of intensified research, expanded manufacturing capacity and greater diversity of output.

THE REVOLUTION IN MATERIALS

Underlying the Corporation's growth and change after 1950 was a revolutionary transformation in the nature of electronics itself, resulting from fundamental advances in the field of new materials and their application. These opened the way to new devices, techniques, and systems that previously were impossible of achievement, either technically or economically.

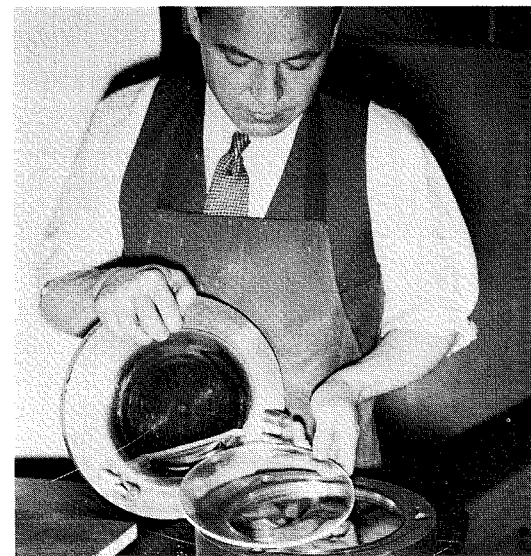

A major development which made projection television practical was the development of a molded-plastic aspherical correcting lens for the Schmidt-type optical system. Ioury G. Maloff (currently with the Television Division's Advanced Development Engineering at Cherry Hill) is shown removing a lens from a mold.

Throughout the 30's and 40's, basic research interest grew in the field of physics of the solid state. This was fundamental to the forthcoming rapid advance in the use of electronically-active solids—the semiconductors. RCA's effort blossomed first on photoconductors potentially useful in television camera tubes.

Bell Telephone Laboratories research in semiconductor materials led to development of the transistor. RCA research in this area moved at an early stage to an alloy junction type which soon became standard in receiving circuitry. Through the early and middle 1950's, the corporation's research and development work ranged ever more widely over the materials field, covering the various semiconductor materials, including photoconductors, thermoelectric materials, and materials exhibiting photovoltaic effect; and a wide variety of luminescent and magnetic materials. Among the outstanding results of this work were new types of transistors with greater power output and higher frequency performance.

Other major accomplishments have resulted from increasing application of systems engineering techniques in both military and commercial electronics. Through the early 1950's, RCA engaged in an intensive program of research and engineering related to electronic systems to compute, sort, file, and recall large quantities of data and to perform a variety of computing, clerical and other paperwork functions. Out of this program came Bizmac, RCA's electronic data-processing system. In 1955, a four-unit Bizmac system, the world's largest electronic "brain," was purchased by the U. S. Army for its Ordnance Tank-Automotive Command at Detroit, to keep track of more than 100 million tank and automotive spare parts in the Army's world-wide inventory. During 1957, major Bizmac installations were purchased by the New York Life Insurance Company and The Travelers Insurance Company, Hartford, Connecticut.

PROGRESS AND PROSPECTS

The quickened pace of electronic developments and the mounting importance of electronics to the national defense resulted in continued adaptation of the RCA organizational structure.

In 1955, two new major operational units were created, Defense Electronic Products and Commercial Electronic Products. In 1957, CEP was reorganized into RCA Industrial Electronic Products, to provide still further impetus in this rapidly expanding area of electronic development. An indication of the rapid growth of RCA activities in the transistor field was the organization of the RCA Semiconductor Division.

Meeting the demands of the coming Age of Space, RCA established in early 1958 a new Astro-Electronic Products Division for the production of satellite and space vehicle systems.

In January, 1957, John L. Burns was elected President of the Radio Corporation of America. He succeeded Frank M. Folsom who was elected Chairman of the Executive Committee of the RCA Board of Directors. In making the announcement, General Sarnoff had this to say: "The election of Mr. Folsom as Chairman of the Executive Committee and the assumption by Mr. Burns, as President, of the key operating responsibility will enable our organization to keep pace with the changing demands and great opportunities of the rapidly expanding electronics industry."

What are these demands and what are the opportunities? As America enters the Space Age, electronics assumes



A development of major importance to the field of science was the RCA Electron microscope. Shown with the device are Dr. V. K. Zworykin (seated) and Dr. James Hillier who contributed much to the development of the instrument.

a pivotal role in assuring continued national progress in the technologies of peace and security. As a leader in the industry, the Radio Corporation of America begins the third epoch of its existence with a flexibility in organization, a resourcefulness in research and a diversity of operations to meet the challenges of the years ahead.

In research, devices and systems now nearing final development point the way to new RCA opportunities for service to the consumer, to business and to industry. Participation by RCA in the cooperative nuclear reactor for industrial research in atomic energy at Plainsboro, New Jersey, will enable the Corporation to pursue fundamental electronics studies in the vital and closely related area of nucleonics. RCA research and engineering organizations are helping to explore methods for harnessing the power of the H-Bomb for peaceful uses.

In products and devices, color television, pioneered and developed by RCA, will dominate the broadcast scene as black-and-white television has done for the ten years past. On the basis of industry-wide projections, automation and electronic data processing undoubtedly will provide another great market for RCA systems, as will closed-circuit TV for industry. Out of today's research and development will come other products for the consumer, such as new forms of lighting, personal communications equipment, home television tape recording, and a variety of other novel electronic adjuncts to living.

If J. C. Warner could foresee the time when historians would look back to 1938 as a period when the surface had barely been scratched, what is there to say about the potentialities for RCA today? For all of RCA's tremendous past growth, not only is the surface of electronics still largely unscratched, but now there is the new challenge of the Space Age.

Writing in *Fortune Magazine* in 1955, General Sarnoff noted: "There is no element of material progress we know today . . . that will not seem, from the vantage point of 1980, a fumbling prelude." When that day finally comes, I am certain that some future historian will begin his review of RCA with exactly those words.

Fig. 1—Engineers responsible for the design of the AVQ-50 antenna unit are shown with their designs. Warren Perry (center), waveguide engineer, is indicating a version of the AVQ-50 antenna employing an 18-inch "dish"—a conventional 12-inch antenna is on the table, right. Donald Clarke, right, was the mechanical engineer on the antenna, and Maurice Franco, Leader, is on the left. The commercial antenna unit is shown at the inset, right.

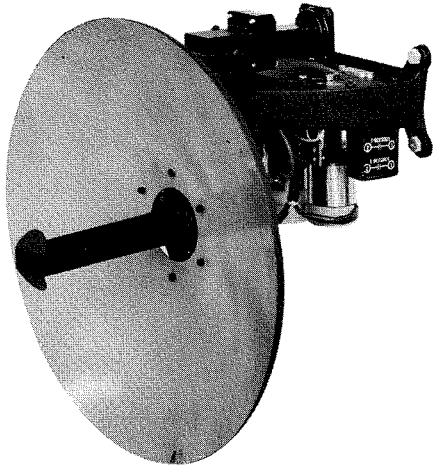

THE RCA AVQ-50 LIGHT WEIGHT AIRCRAFT WEATHER AVOIDANCE RADAR

By **M. FRANCO**
*West Coast Electronic Products Dep't.
Defense Electronic Products
Los Angeles, Cal.*

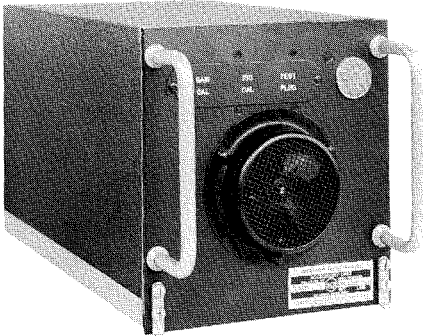

Fig. 2—Shown with the Indicator Unit are (from left) Myron Schurr (responsible for sweep deflection and timing circuits), Robert Sale (mechanical engineer for the AVQ-50 system), and Wilbur Wikholm (responsible for power supply design). Mr. Sale is holding the special three-inch cathode ray tube with an offset neck. Inset at the left shows the Indicator Unit.

AFTER THE SUCCESSFUL debut of the RCA-AVQ-10 weather radar equipment (see RCA ENGINEER Vol. No. 2, Sept., 1956), the acceptance by airlines and pilots was literally unqualified. The importance and need for weather radar in aircraft were firmly established. Its use by all major airlines both in the United States and overseas was quickly put into effect, and the AVQ-10 program was solidly entrenched in passenger-carrying aircraft.

It was soon apparent that as more and more pilots and aircraft owners became familiar with weather radar, a greater diversification of aircraft would want weather radar installations. The AVQ-10 did not lend itself to smaller aircraft because of its size and power requirements. There appeared to be a definite need for a much smaller, lighter system specifically designed for aircraft such as the Twin Beech, Piper Apache, Aero Commander, and possibly the Lodestar and DC-3.

Custom Aviation Marketing and West Coast Engineering of Defense Electronic Products formulated design and performance criteria for such a system early in 1956. Design and development were completed by the end of the year and production began in May, 1957.

CHOICE OF FREQUENCY

The decision which led to the adoption of C band (5.5cm) for use on the AVQ-10 system was discussed in the aforementioned RCA ENGINEER article. It was based primarily on the McGill studies of attenuation in heavy rain. In considering the desirable frequency for use with the AVQ-50, however, other factors had to be considered. This equipment, designed primarily for very light aircraft, would be required to enable pilots to avoid completely the regions of heavy rainfall which larger aircraft could penetrate with reasonable safety. There would not be as great a need to look through rain to find corridors of low rainfall gradient. Bearing this in mind, it was clear that a higher frequency could be considered. Again, the requirement for small size and light weight made a higher frequency attractive. The maximum desirable beamwidth of 7° could be obtained

with an antenna reflector diameter of only 12 inches if a wavelength of 3.2 cm. were utilized. It was therefore decided to use X band for the AVQ-50, and a 2J55 magnetron was chosen. This magnetron operates at 9375 mc and has a peak power output of 40 kilowatts. Even with the small 12-inch diameter antenna reflector, a range of 80 miles is obtained.

PACKAGING

In packaging the AVQ-50 every effort was made to reduce weight and size and keep down the power consumption. The equipment consists of four major units: the Receiver-Transmitter, the Accessory Unit, the Indicator, and the Antenna.

RECEIVER-TRANSMITTER

The Receiver-Transmitter is short $\frac{3}{4}$ ATR size ($7\frac{1}{2}$ " wide, $7\frac{5}{8}$ " high, and $12\frac{5}{8}$ " deep). It contains all the r-f circuits as well as the trigger generator, i-f preamplifier, and the modulator.

The transmitter uses a 2J55 magnetron which provides a 40 kw peak pulse at 9375 mc. The magnetron is pulsed at the a-c line frequency of 400 cps by a line-type modulator using resonant charging and a hydrogen-thyratron switch. The pulse length is 1.8 microseconds. The thyratron is triggered from a pulse supplied by a blocking oscillator synchronized with the 400 cycle power line frequency. This oscillator also supplies trigger pulses to the timing circuits in the Accessory Unit.

The mixer-duplexer is conventional in design. A klystron local oscillator is coupled to two crystals used in a balanced mixer for the i-f channel, and a single crystal used as the automatic frequency control mixer. An i-f preamplifier is connected directly to the i-f mixer as a plug-in unit to obtain the best possible noise figure, and the preamplifier output is fed to the main i-f amplifier in the accessory unit. I-f signals from the AFC mixer are fed directly to the AFC circuits in the Accessory Unit.

ACCESSORY UNIT

The Accessory Unit also utilizes a short $\frac{3}{4}$ ATR size. It contains the timing and sweep circuits, i-f amplifier, automatic frequency control, video

amplifier, and low-voltage power supply. These circuits are arranged on four separate chassis that are interconnected by means of plug-in cables, and may be removed from the assembly for test or repair.

The video circuits include the isoecho contour provision which has proved so useful in the AVQ-10. It gives the pilot a means of identifying regions of high rainfall gradient that experience has shown to be associated with severe turbulence.

The sweep deflection system used in the AVQ-50 is somewhat unusual. It is a resolved-sweep system using fixed deflection coils so that drive mecha-

Fig. 3—Shown with the Accessory Unit are (L. to R.) Chester Parkinson (Systems and I-F Amplifier design), Jerome Smith (Indicator and Video design) and Edward Perry (Modulator design). Inset is the Accessory Unit.

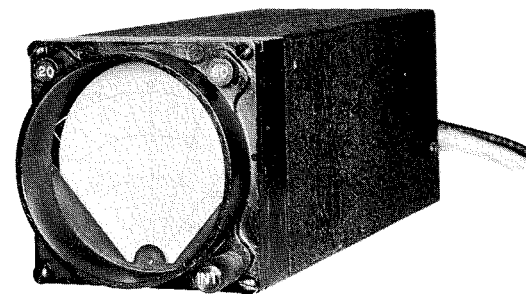

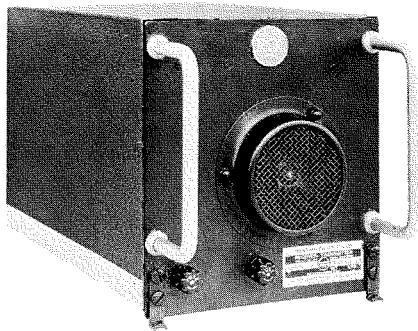

Fig. 4—The AVQ-50 Transceiver Unit.

nisms and slip rings are not required. A special 70° motor-stator-type deflection coil was designed for the 7/8-inch diameter cathode ray tube neck and is driven directly from an inductive resolver in the antenna drive system. Crystal diodes are used as current clamps and the resulting circuit is extremely simple, utilizing a minimum of components and tubes.

Other circuits are conventional. The power supply utilizes semiconductor rectifiers with a resulting saving in volume and power consumption.

INDICATOR

Two types of Indicator are available for use with the AVQ-50. One of these was designed in accordance with the general philosophy of ultra-compactness for installation in the limited cockpit space available in the light-twin aircraft. It mounts in the same space as a standard 3-inch aircraft instrument and has a 3-inch face. Outside dimensions are 3 1/4 by 3 1/4 by 10 inches deep. To obtain these dimensions required a special cathode ray tube design. The tube is unique in that it has an offset neck with a diameter of only 7/8 inch. The cathode ray tube operates at 8,000 volts, and with aluminization, gives a very bright presentation. In order to use as much of the tube face as possible, sector scan of 80° was employed. Range and azimuth markers are engraved on the Indicator cursor. This eliminates the bulk and power consumption of electronic range-mark circuits. Two ranges are provided; 20 and 80 nautical miles.

For customers who desire a larger presentation, and have space available

in their aircraft, a 5-inch Indicator is provided. This Indicator is 6 inches square by 10 inches long, and may be mounted on the instrument panel, pedestal, or overhead.

ANTENNA

Unlike the antenna used with the AVQ-10, the AVQ-50 Antenna is not stabilized. Stabilization would have increased the size and weight to such an extent that it would have been impossible to mount it in many small aircraft. The antenna scans an 80° sector ahead of the aircraft at a rate that provides 85 "looks" per minute. To allow ground mapping, and for estimating the height of storm areas, the antenna may be tilted 10° up or down from the cockpit. Usually, the 12-inch reflector is provided, but 15 and 18 inch reflectors are available.

CONTROLS

A Control Panel as such is not usually supplied with the AVQ-50. The operating controls and the Tilt Meter are generally mounted directly in whatever space is available on the instrument panel. The 5-inch Indicator includes all the operating controls grouped around the cathode ray tube.

GENERAL CHARACTERISTICS

General characteristics of the AVQ-50 Weather Avoidance Radar are as follows:

- Number of major units—4
- Weight—50 lbs. overall including shock mounts.
- Tubes—total of 36 including TR and ATR tubes.
- Semiconductor Diodes—total of 17
- Frequency—9375 mc ± 40 mc.

Fig. 5—A portion of the instrument panel of a Beechcraft E-18, a two-engine aircraft, showing the mounting of the AVQ-50 Indicator Unit.

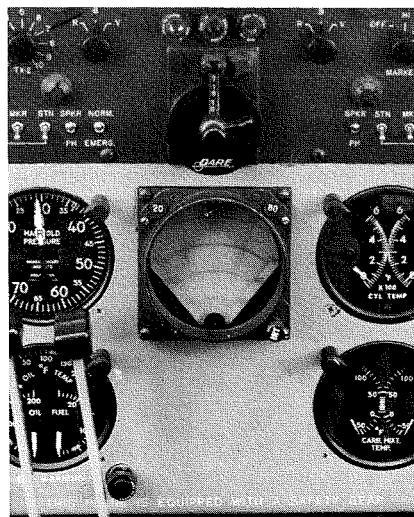

MAURICE FRANCO received the B.S. degree in Physics from the University of London, England.

His seventeen years of experience have been principally in the field of airborne radar. This experience has encompassed the design and development of such military equipments as the AN/APS-42 and the AN/APS-69 weather detection radar. He has also been engaged in various commercial projects, primarily the AVQ-10 weather radar and the lightweight AVQ-50 weather detection radar. Mr. Franco is currently a Leader in Design and Development Engineering, West Coast Engineering Products Department, DEP.

Mr. Franco is a member of the Institute of Radio Engineers and the Society of Motion Picture and Television Engineers.

R-F Power Output—40 kw
minimum peak

Pulse width—1.8 microseconds
Pulse rate—400 pps synchronized
to line frequency.

Ranges—20 and 80 nautical miles

Range Marks—5 miles on 20-mile
range, 20 miles on 80-mile
range, engraved on cursor

Display—Offset 80° sector scan.
Antenna Beam—7° (for 12-inch
reflector)

Power input—515 watts at 115
volts, 400 cycles.

CONCLUSION

The AVQ-50 Weather Avoidance Radar sets new standards of compactness, light weight, and simplicity for airborne radar equipment. It brings weather radar within the reach of the large number of executive and private aircraft operating in the United States, and already great interest has been shown in the equipment. In fact, the smaller commercial airlines (feeder routes) are also interested in the AVQ-50. The lower cost and smaller size of the AVQ-50 make it possible for them to consider the installation of radar in their fleets where a larger radar such as the AVQ-10 could not be justified.

THE DRIFT TRANSISTOR

by

I. KALISH

Semiconductor and Materials Division
Somerville, N. J.

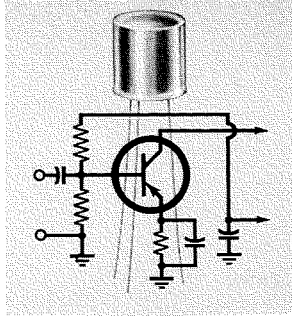

THE DEVELOPMENT and refinement of solid-state diffusion techniques have made possible the manufacture of a new high-frequency semiconductor device, the drift transistor. In this device, a built-in electric field accelerates the charges flowing from emitter to collector, thus reducing their transit time.¹ Reduced transit time, together with other parameters inherent in the drift structure, results in high-frequency performance that is almost an order of magnitude better than that of an alloy-junction transistor having comparable geometry.

ALLOY-JUNCTION TRANSISTOR FREQUENCY CONSIDERATIONS

The advantages of the drift transistor can be best appreciated by a review of some of the factors limiting the frequency at which alloy-junction transistors operate. These limitations can be illustrated through the use of Fig. 1, the "hybrid- π " transistor equivalent circuit.² In terms of the parameters shown, the frequency for unity power amplification (figure of merit) may be written as follows:

$$\text{F.M.} = \frac{1}{4\pi} \sqrt{\frac{kT}{qI_e} \frac{1}{r_{bb'} c_{b'e} c_{b'c}}}$$

where k is Boltzmann's constant, T is the absolute temperature, q is the electronic charge, and I_e is the emitter current. Hence, the maximum frequency at which a transistor will function may be increased by minimizing $r_{bb'}$, $c_{b'c}$, and $c_{b'e}$.

The resistance $r_{bb'}$ is a function of the resistivity of the base material. The collector (feedback) capacitance, $c_{b'c}$, is inversely proportional to the thickness of the collector depletion region, and hence is a function of base resistivity and collector voltage.³ Capacitance $c_{b'e}$ is proportional to the transit time from emitter to collector.⁴ In an alloy-junction transistor, this capacitance is determined primarily by the width of the base, W , between collector and emitter.

THE DRIFT FIELD

The major difference between the drift transistor and a conventional alloy-junction transistor is that the conventional transistor has a uniform base resistivity, while the base of the drift transistor has a graded resistivity due to diffusion of an impurity (arsenic) into one side of the base material (germanium). The structure of the drift transistor and the distribution of impurity atoms in the base region are illustrated in Figs. 2 and 3. At the emitter junction, the base resistivity of the drift transistor is low due to a high concentration of impurity atoms. At the collector junction the germanium is nearly pure, and hence the material has a relatively high resistivity.

Consider now an initial condition of electrical equilibrium wherein the free electrons contributed by the arsenic are located close to their parent atoms. The arsenic concentration falls off ap-

proximately exponentially with penetration into the base region. Hence, the electron density varies in the same way, and a concentration gradient is set up. Because the electrons are free to move in the base material, they tend to diffuse from the region of high concentration to a region of low concentration. The departure of electrons ionizes the immobile parent atoms and results in the formation of a net positive charge in the region of higher impurity concentration. The diffusion of electrons deeper into the base region gives the region of lower concentration a net negative charge. Hence, an electric field is created between the emitter and the collector through the base. The diffusion of the electrons continues until the diffusion forces and those due to the electric field are in equilibrium.

When a drift transistor is operated in a circuit, sufficient voltage should

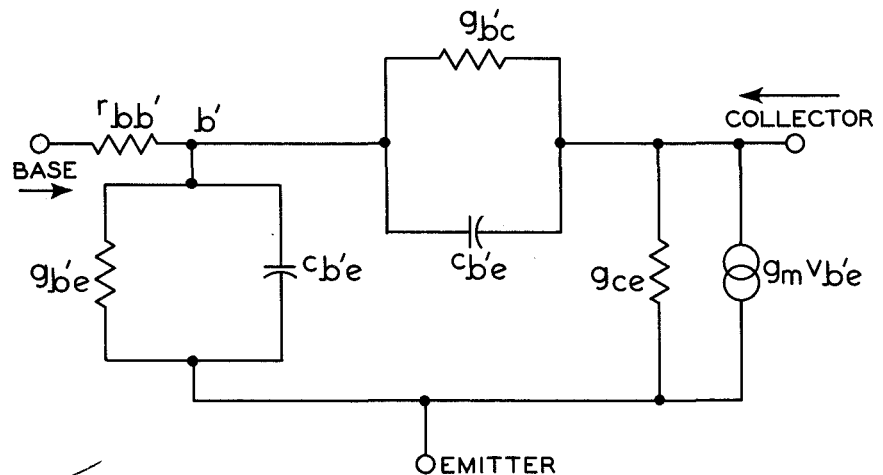

Fig. 1—"Hybrid- π " Transistor Equivalent Circuit

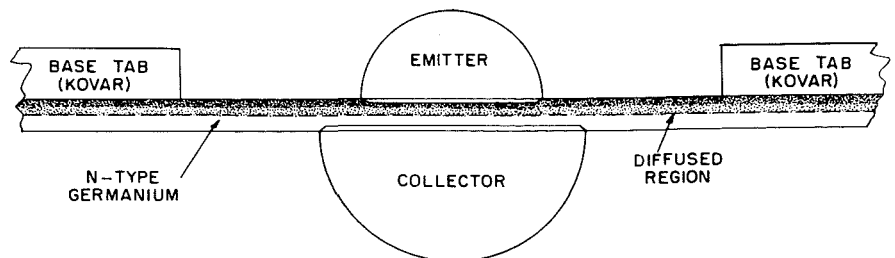

Fig. 2—Cross-Sectional View of Drift Transistor

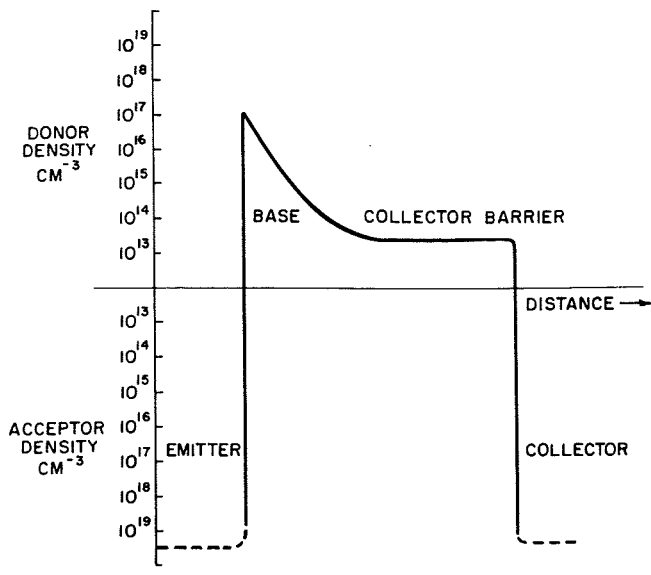

Fig. 3—Effect of Diffusing Arsenic into Emitter Side of Base Region

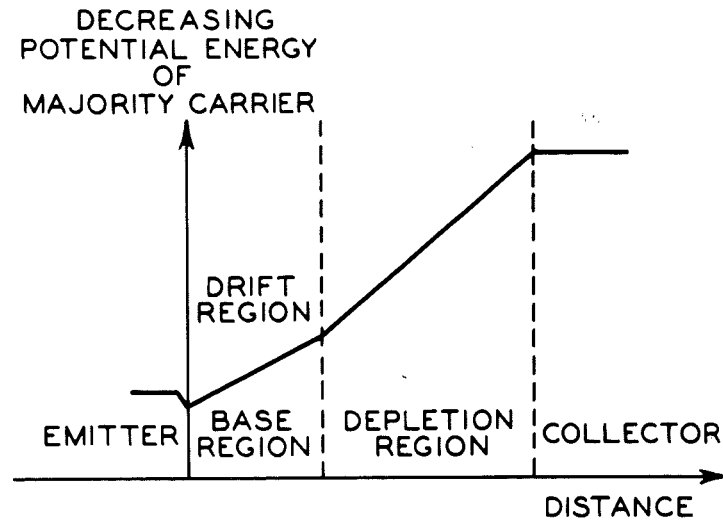

Fig. 4—Potential-Energy Diagram of Drift Transistor

be applied to the collector so that the depletion region will extend out to the end of the graded region. Because the resistivity in the region of the collector is of the order of 30 ohm-centimeters, only a few volts are necessary. The potential distribution within the transistor when this voltage is applied is shown in Fig. 4. Positive injected carriers, or holes, flow uphill in this diagram. Holes injected at the emitter are accelerated through the drift region and, upon reaching the end of the graded region, are swept rapidly through the depletion region by the high field. The greater part of the total transit time from emitter to collector is that due to traversing the drift region. The significant geometrical dimension determining transit time, therefore, is not the spacing between the emitter and collector junctions, as in an alloy-junction transistor, but the smaller spacing between the emitter junction and the end of the graded region. The effect of the electric "drift" field in this region is to reduce the transit time further to approximately one fourth of the value it would have if the hole flow were due to diffusion alone.⁵

OTHER ADVANTAGES OF DRIFT TRANSISTORS

The resistance $r_{bb'}$ is primarily a function of transistor geometry and the resistivity of the base material between the base connection and the region between the junctions. Due to the high concentration of impurities in the region of the emitter junction, the re-

sistivity here is of the order of 0.01 ohm-centimeter. Hence, by making the base connection on the emitter side of the transistor, this low resistivity can be used to obtain a low value of $r_{bb'}$.

As mentioned earlier, the collector capacitance is inversely proportional to the thickness of the depletion region. Because the collector "sits" on very high-resistivity germanium, it is possible to construct a wide depletion region with only a few volts applied to the collector. Thus, the collector capacitance of a drift transistor can be reduced to about one fifth of that possible with an ordinary transistor.

Significant gains may be made, therefore, by the use of a base having a low resistance on the emitter side and a high resistance on the collector

side. An alloy-junction transistor with a base having the same resistivity as that at the emitter of the drift transistor would have exceedingly low emitter and collector breakdown voltages and high junction capacitances; one with a base having the same resistivity as that at the collector of the drift transistor would have a very high value for $r_{bb'}$ and very low "punch-through" voltages.

LIMITATIONS

Some limitations are imposed on the uses of drift transistors by their construction. Because of the low resistivity at the emitter junction, the emitter breakdown voltage is of the order of three volts. For amplifier applications, however, this low emitter breakdown

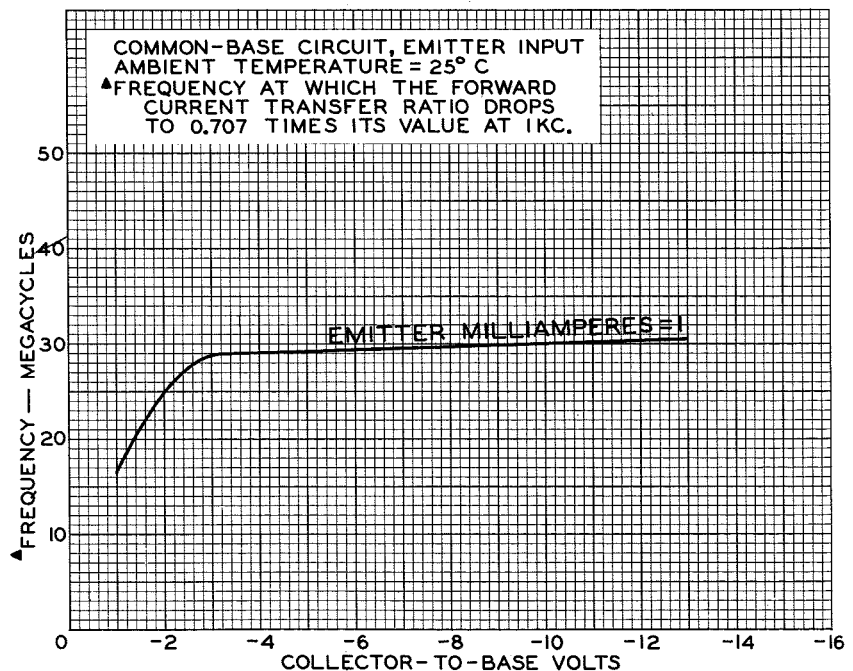

Fig. 5—Effect of Collector Voltage on Frequency Response Characteristics of RCA 2N247



ISRAEL H. KALISH received the B.E.E. degree from the Cooper Union School of Engineering in June, 1953 and the M.S. degree in Electrical Engineering from Columbia University in June, 1956. He joined the Tube Division of RCA in Harrison, N. J. in 1953 as a design engineer on semiconductor devices. He has contributed to the design of a general-purpose transistor for the Signal Corps, Class A and Class B power transistors, and drift transistors. He is currently working on the development of the Thyristor and NPN drift transistors for computer applications. Since 1954 Mr. Kalish has been an Adjunct Instructor in Physics at the Cooper Union School of Engineering.

voltage is not a serious limitation because, when operated in this manner, the emitter is invariably forward biased. For a drift transistor to operate at high frequencies, a certain minimum "starting voltage" must be applied between collector and base to extend the depletion region to the edge of the graded region. Fig. 5 illustrates the effect of collector to base voltage on the alpha cutoff frequency, that is, the frequency at which the grounded-base forward current transfer ratio drops to 0.707 times its value at 1 kilocycle. A third limitation is the relatively high saturation currents associated with the use of high-resistivity germanium. A typical collector saturation current for the 2N247 is 2 microamperes. A typical collector breakdown voltage is 100 volts.

CONSTRUCTION OF DRIFT TRANSISTORS

Except for the preparation of the base material, the fabrication of a drift

transistor is not significantly different from that of an alloy-junction transistor. However, proper preparation of the base material is critical.

High-resistivity, single-crystal, N-type germanium is the raw material of the base. This material is supplied in the form of rectangular pellets approximately 50 mils square and about three mils thick. Arsenic atoms are then diffused into the pellets. The depth and concentration of the atoms is determined by the temperature and duration of the diffusion process. The high-resistivity N-type pellets then have an N-type skin having a graded resistivity. This skin is etched from one side of the pellet, again exposing the high-resistivity pure germanium. The pellets are then mounted into base tabs and are ready for alloying.

The collector is alloyed first. The depth of penetration of the collector must be controlled because it determines the distance between the end of the diffused region and the collector, and hence affects the starting voltage and collector capacitance of the transistor. The emitter is alloyed next. Control of the emitter alloying depth is even more critical than that for the collector. Variations in emitter penetration result in variations in current gain, resistance $r_{bb'}$, and the alpha-cutoff frequency.⁶ The emitter alloying is therefore performed at a temperature lower than that of the collector. As a result, the penetration is signifi-

cantly smaller and, therefore, easier to control.

For a transistor to have a good current gain, its emitter efficiency, the ratio of emitter conductivity to base conductivity, must be high. Because the base conductivity of the drift transistor is so high on the emitter side, the P-type "doping" material must have an extremely high conductivity. Pure indium does not provide usable current gains; therefore, indium-gallium alloy is used.⁷

After alloying, the units are mounted on stems and are then etched electrolytically. The magnitude of this etch must be carefully controlled because too weak an etch results in poor breakdown characteristics, while too strong an etch significantly reduces the pellet thickness around the junctions and increases $r_{bb'}$. Finally, the units are encapsulated in a silicone resin, baked, and hermetically sealed into a silicone-filled metal case.

Fig. 6 is a photograph of two RCA Drift Transistors, the 2N247 and the 2N384. As may be seen in Fig. 6, each of these units is equipped with a fourth lead that is internally connected to the insulating envelope. Grounding of this lead will help to minimize interelectrode capacitances and coupling between adjacent circuit components.

FREQUENCY RESPONSE OF DRIFT TRANSISTORS

The following table compares some of the electrical and mechanical charac-

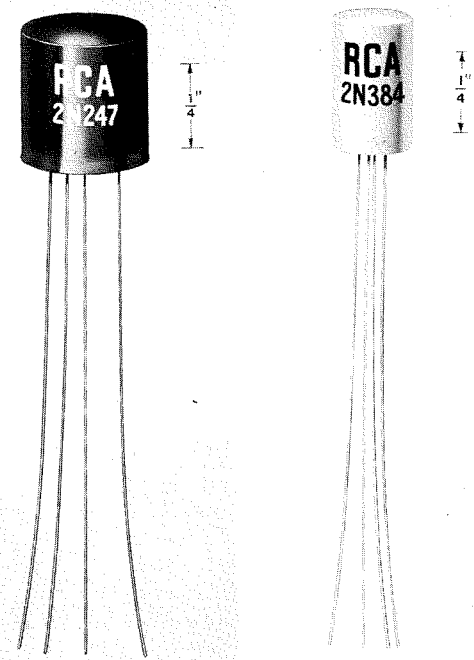

Fig. 6—Transistors, RCA Type Nos. 2N247 and 2N384

TABLE I

	2N247	2N384	
Geometrical Characteristics			
Pellet thickness	1.8	1.3	mils
Emitter diameter	11	6	mils
Collector diameter	14	11	mils
Diffusion penetration	0.8	0.3	mils
Emitter penetration	0.2	0.1	mils
Electrical Characteristics			
Alpha Cutoff Frequency (f_{ab})....	30	100	mc
"Hybrid π" Parameters			
Resistance $r_{bb'}$	40	50	ohms
Capacitance $c_{b'e}$	1.7	1.3	$\mu\mu\text{f}$
Frequency for unity power amplification (Figure of Merit)	132	250	mc

teristics of the two types of RCA drift transistors shown in Fig. 6. The basic processing is the same for both units. The mechanical differences account for the differences in electrical characteristics.

Figs. 4 and 7 illustrate the effect of bias conditions on the high-frequency performance of drift transistors. As explained above, a minimum "starting" voltage is necessary to establish a high electric field between the collector junction and the end of the graded region so that the transit time is determined primarily by the passage through the "drift" region. Until the "starting voltage" is reached, the frequency response of the transistor will be low and very sensitive to variations in voltage. After the depletion region reaches the graded region, however, the frequency response will be relatively insensitive to further variations in collector voltage.

In order to understand the variation

of frequency response with emitter current, the equivalent input circuit of the transistor, shown in Fig. 1, should be considered. In terms of this circuit, the alpha-cutoff frequency will occur when the susceptance of $c_{b'e}$ is numerically equal to the base-to-emitter conductance, $g_{b'e}$. The alpha-cutoff frequency f_{ab} is therefore equal to $\frac{1}{2\pi} \frac{g_{b'e}}{c_{b'e}}$.

However, as indicated in Fig. 8, $c_{b'e}$ is made up of two components. The first of these, c_τ , is an equivalent capacitance that describes the effects due to the transit time between emitter and collector. The second component, c_j , is the capacitance associated with a p-n junction biased in the forward direction, i.e., the transition capacitance of the emitter junction. In a conventional transistor, c_j is normally many times less than c_τ and, therefore, can be neglected when f_{ab} is computed. In the drift transistor, however, the drift field minimizes c_τ and the high conductiv-

ity of the emitter region increases c_j . Thus, both components must be taken into account.⁸ The alpha-cutoff frequency can be expressed as:

$$f_{ab} = \frac{1}{2\pi} \frac{g_{b'e}}{c_j + c_\tau}$$

The junction transition capacitance, c_j , is independent of the emitter current. Both c_τ and $g_{b'e}$, however, are directly proportional to the emitter current.

The observed variation in frequency response can now be explained. At low current levels the ratio of $g_{b'e}$ to $c_j + c_\tau$ is small. As the emitter current increases, the numerator of the fraction increases faster than the denominator and the frequency response of the transistor continues to increase until c_τ is large compared to c_j . After this point is reached, the frequency response should be independent of emitter current.

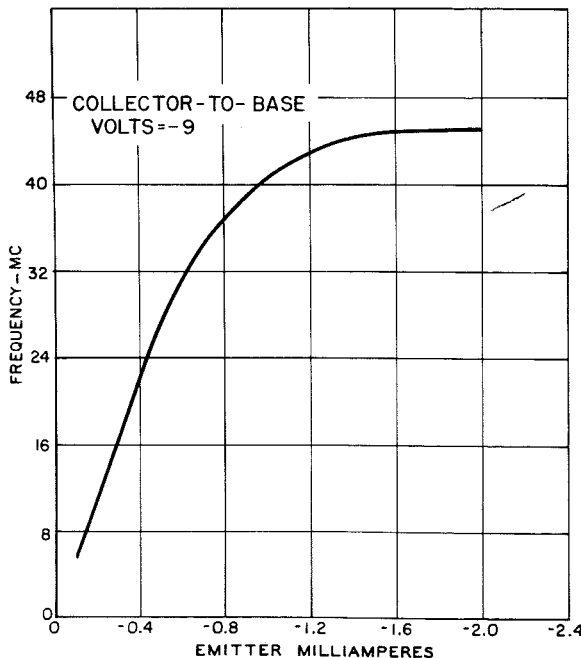

Fig. 7—Effect of Emitter Current on Frequency Response Characteristics of RCA 2N247

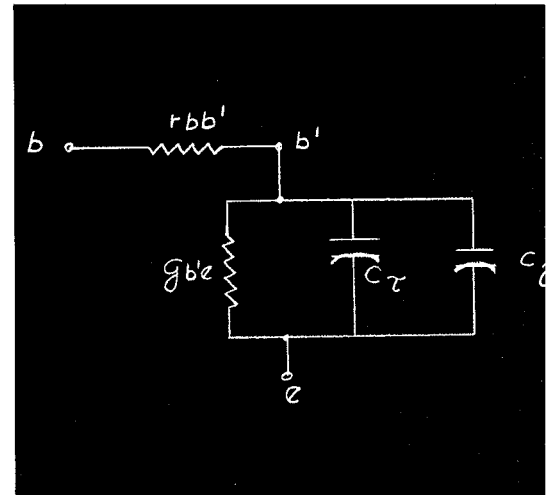

Fig. 8—Equivalent Input Circuit of Drift Transistor

REFERENCES

1. H. Kroemer, "The Drift Transistor," *Transistors I*, RCA Labs, March 1956.
2. L. J. Giacoletto, "Study of p-n-p Alloy Junction Transistor from D-C Through Medium Frequencies," *RCA Review*, Vol. 15, Dec. 1954.
3. J. M. Early, "Design Theory of Junction Transistors," *BSTJ*, Nov. 1953.
4. E. Herold, "New Advances in the Junction Transistor," *Transistors I*, RCA Labs, March 1956.
5. A. L. Kestenbaum and N. H. Ditrack, "Design, Construction, and High Frequency Performance of Drift Transistors," *RCA Review*, March 1957.
6. *Ibid.*
7. L. D. Armstrong, C. L. Carlson, M. Bentivegna, "High Emitter Efficiency Alloy," *Transistors I*, RCA Labs, March 1956.
8. H. Kroemer, *Loc. cit.*

THE SSB-30M SINGLE-SIDEBAND TRANSMITTER-RECEIVER

By **CHARLES E. SCHNEIDER**
*Radiomarine Engineering
 Telecommunications Division, IEP
 New York City*

THE SSB-30M is a complete mobile transmitting and receiving unit designed for two-way operation in the 3 to 15 megacycle band. It can be used in automobiles, trucks, boats or in any vehicle that uses or has a 6- or 12-volt battery.

The SSB-30M utilizes the principle of single-sideband transmission in which the entire output of the transmitter is concentrated in one sideband, resulting in more efficient use of power than is done in conventional AM transmitters. Effective output power is quadrupled. For example, the PEP (Peak Envelope Power) output is 30 watts nominal, for the SSB-30M, which under most conditions is equivalent to that of a 120 watt conventional AM system. The battery drain is less than that of a 30 watt AM double sideband unit.

DESIGN GOALS

Design requirements called for a Mobile Transmitter-Receiver for two-way operation between vehicles, using the successfully-designed RCA SSB-1 transmitter as a base station. The "Mobile Use" stipulation presented many problems that required solution during

the design of the SSB-30M. Overcoming noise (both vehicular and atmospheric), assuring low-battery drain, and designing a suitable antenna system were required. Compactness, high efficiency, high stability and ease of operation were also considered necessary design features.

This article gives a brief description of the SSB-30M equipment and shows how the following novel designs were accomplished: the use of a common mechanical filter operating bi-directionally for receiving and transmitting, an AGC system for SSB which in turn operates the automatic squelch and the automatic noise limiter, and remote channel selection by means of a solenoid-operated rotary switch which also selects the correct antenna loading coil inductance remotely.

SSB-30M EQUIPMENT

This equipment features four pre-tuned channels and is operated from a compact dash-mounted control unit (see photo). A switch on the control unit permits instant channel selection, even while the vehicle is in motion. Only two other controls are required on the control unit: "Volume" and

"Squelch." Power for the unit is supplied by the vehicle battery (either a 6- or 12-volt system may be used).

The SSB-30M uses three temperature-stabilized crystal oscillators, for maximum frequency stability ($\pm .0005\%$), to heterodyne the audio modulating signal up to the transmitter output frequency. The same three oscillators operate with the receiving circuits to heterodyne the received r-f down to the original audio modulating signal. By the use of conventionally balanced modulators in the heterodyning process, plus a single mechanical filter, the crystal frequencies, and hence the carrier frequency also, are suppressed. The unwanted sideband suppression and carrier suppression is better than 50 db. The distortion products using a two-tone test are down more than -32 db below the test tones.

SINGLE MECHANICAL FILTER

The use of a single mechanical filter presented a number of difficulties i.e., a means of switching the filter from "transmit" to "receive" without relays, to keep the input and output of the filter isolated for maximum skirt selectivity, to keep the insertion loss to a minimum, and to maintain a balanced condition for best suppression of opposite sideband and carrier. The filter is connected in the circuit so that it is used at all times in both the transmitter and receiver circuits.

"Send-Receive" selection is taken care of by switching the B+ from the transmitter to the receiver. Shielding

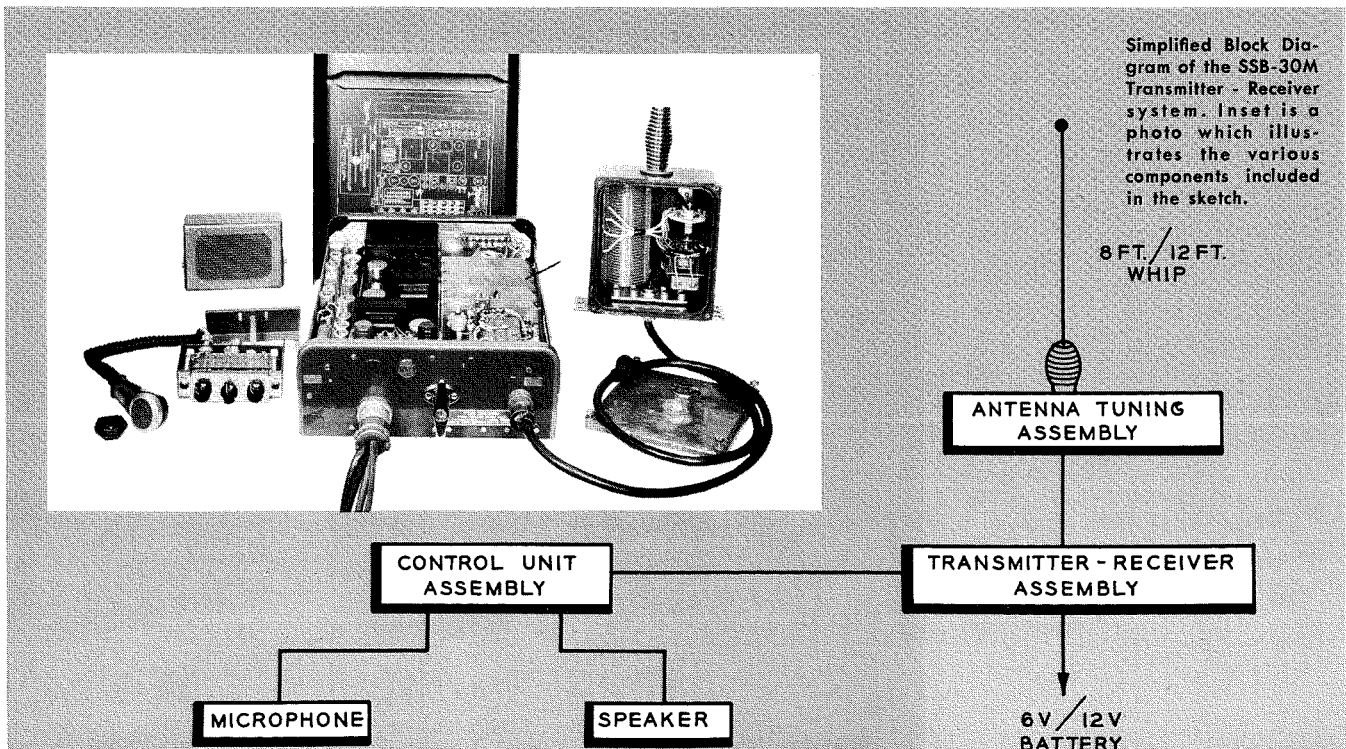

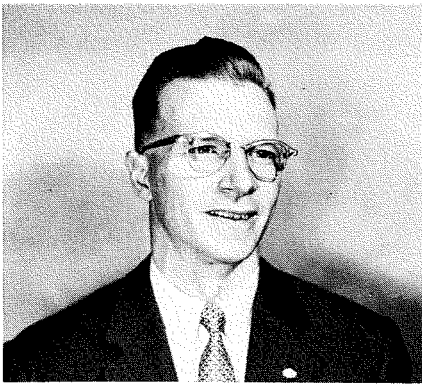

CHARLES E. SCHNEIDER joined Radiomarine Corporation of America in March 1941 where he did work in radio and radar receiver and transmitter test and development. He graduated from RCA Institutes in 1941 and Capitol Radio Engineering Institute in 1951. He served in the U. S. Air Force from 1943 to 1946 as a Communications Officer in the 7th Fighter Wing and from 1951 to 1952 as a Communications Officer in the 4th Fighter Wing in Korea.

After his release from active duty in 1952 he entered the RCA Transmitter Division and designed Radio Telephone and Telegraph transmitters. His primary interest in the past few years has been Single Sideband Transmission, co-designing the SSB-1 and designing the SSB-30M.

was used extensively to keep input and output circuits isolated.

A diode action resulted when the output of the Transmitter Balanced Modulator was connected in parallel with the input of the receiver i-f amplifier. Isolation was achieved by inserting a pad in series with the receiver i-f amplifier grids. This minimized the diode action, maintained the balanced condition, and still kept the insertion loss to a minimum.

NOISE REDUCTION AND AGC CIRCUITS

A squelch circuit was desired in this equipment, being a mobile installation, but more important, a good noise limiter was a "must." Operating controls were to be kept to a minimum and a remote volume control (in the receiver output) was all that could be used. This necessitated an effective AGC system. The squelch and noise limiter had to operate automatically with received signal levels so they were developed along with the AGC.

A very fast attack, slow release time constant was needed on the AGC because, there being no carrier available, only sideband r-f could be used. A separate i-f amplifier was used along with a diode rectifier for the AGC. A noise limiter was added to the AGC to minimize noise impulses activating the AGC. Once the AGC voltage was developed, it was applied (in addition to the r-f and i-f stages for control) to

individual squelch and noise limiter control tubes. A squelch control mounted on the Remote Control Unit, is set to cut out the received noise. This biases back the squelch tube and nothing is heard in the speaker. When a signal is received, the AGC voltage is developed, applied to the squelch control tube — removing bias from the squelch tube and allowing audio to pass thru to the speaker. With this fast attack of the AGC the squelch opens immediately on the first syllable. The slow release of the AGC keeps the squelch open between words.

NOISE LIMITER

The Automatic Noise Limiter follows the AGC voltage developed by the incoming signal. With no signal received there is maximum limiting or clipping of both positive and negative peaks of noise impulses. When a signal is received, the AGC voltage developed is applied to the noise limiter control tube which sets the level of the Noise Limiter to slightly more than the audio level, thus preventing audio clipping. Any noise impulses exceeding the audio level will still be clipped.

In order to keep operating controls to a minimum, an automatic audio level control for the transmitter was achieved by using a cathode-coupled audio limiter circuit. This circuit limits both positive and negative audio peaks. A pre-emphasis network in the audio input makes the limiter sensitive to frequency while a de-emphasis filter in the output restores the overall response of the limiting circuit. This resulted in excellent limiting of up to 20 db, minimum splatter and distortion, and good communication fidelity.

TONE OSCILLATOR

A tone oscillator is incorporated for "tune up" at installation, since there is no carrier available for this purpose. An audio generator could be used but there is always a possibility that one is

not available, whistling into the microphone could be performed but that too was ruled out as "too crude". The tone oscillator, built in, was the best solution and was achieved by making the transmitter audio stages oscillate at about 1500 cycles. This is done by a simple slide switch inside the unit.

REMOTE CHANNEL SELECTION

Channel selection is controlled by a four-position switch on the Remote Control Unit. This causes a solenoid-actuated rotary switch to connect the necessary crystal, pre-tuned inductance, and PA tank and coupling taps in the appropriate circuits. It was necessary to include a relay to operate the solenoid because of the long control lines to the Remote Control Unit. The rotary switch being of such size and having high torque required a large solenoid. The control relay allowed the use of a smaller solenoid by decreasing the length of control lines and hence the drop in voltage at the solenoid.

ANTENNA UNIT

The Antenna Unit was designed to be used with an 8 ft. or 12 ft. whip. Enclosed in the weather-tight box is the base loading coil and a solenoid-operated switch to select the appropriate taps on the loading coil. The solenoid switch is operated from a separate control wafer on the channel selector switch in the Transmitter-Receiver.

The Antenna Unit can be mounted on the bumper, side or rear of the vehicle with suitable clamps or brackets. The whip bolts into a heavy duty stainless steel spring on top of the Unit.

The author wishes to give credit to Karl L. Neumann, Manager Radiomarine Communications Engineering for his helpful suggestions and technical assistance, and to Nino Armato, Mechanical Design Division for his design and mechanical layout.

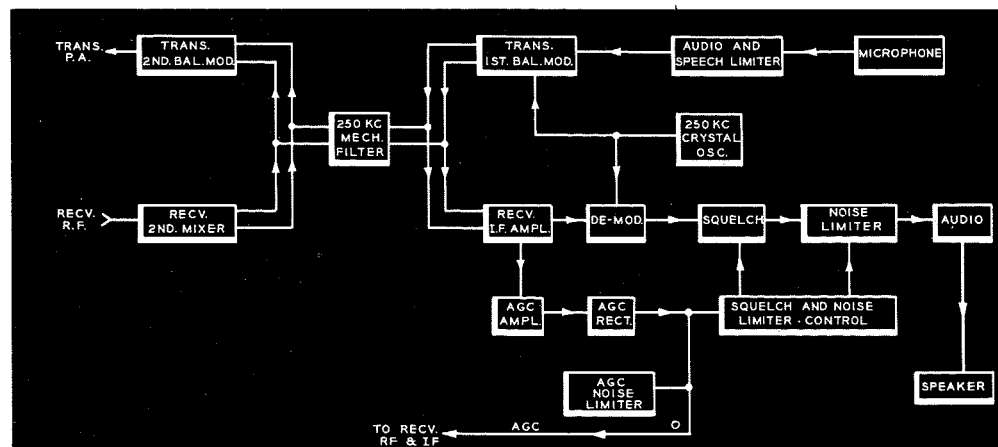

Functional Block Diagram of the stages comprising the Single-Sideband Generator.

GRID MODULATED ENVELOPE RESTORATION HIGH POWER AMPLIFIER FOR SSB SERVICE

By

MAX FERYSZKA

Surface Communications Engineering
Defense Electronic Products
Camden, N. J.

SINGLE SIDEBAND is not new in the communication field. It has been known for many decades that the whole intelligence of an amplitude modulated signal resides in one of the sidebands. It is rather unusual, however, that so many years would pass before the technique would be fully recognized for its true worth. The main problem associated with single sideband operation is the complexity of the equipment involved at the transmitting and receiving end.

This paper describes a new method of amplifying single sideband signals. The conventional single sideband system generates the desired signal at very low power level and amplifies this signal in a series of cascaded linear amplifiers. Usually all low and intermediate level amplifiers operate in Class A, and the power amplifier in Class AB₁. This results in low efficiency. Careful design and operation of the Class A and AB stages is required to minimize the generation of spurious products.

The grid modulated envelope restoration amplifier uses the basic idea of an envelope separation adapter developed several years ago in the Princeton Laboratories, but differs considerably from it in practical realization.

The basic idea of this system is to separate the phase and amplitude modulation components of the SSB signal and then combine them after amplification. One path, for phase modulation, is furnished by non-critical Class C amplifiers, and the other, for the amplitude modulation is supplied by a d-c coupled amplifier. It should be noted that the spectrum of frequencies occupied by each of the modulation components is much broader than the spectrum occupied by the original SSB signal. Both paths are broadband to insure undistorted passage of all the information contained in the amplitude and phase modulation. Both modulation paths are applied to the grid of a d-c coupled grid bias modulated stage and the amplifier output then reproduces the amplified SSB signal.

This system can be used in ultra-

high-frequency SSB amplifiers. A one-watt excitation signal at about 50 mc/s would be detected for envelope information, while phase information would be handled through limiters and a translator from 50 mc/s to ultra-high frequencies (Fig. 2). The translator would be followed by Class C amplifiers up to the grid bias modulated stage.

Advantages of this system over the transmitter using a series of linear amplifiers are: simplicity of adjustments, zero dissipated power in quiescent conditions, and adaptability to simple envelope feedback.

THEORETICAL REQUIREMENTS FOR AMPLITUDE MODULATION PATH

The most severe test in a SSB transmitter is the cross modulation pro-

duced with a two-tone equal amplitude signal input, S .

$$S = A [\cos (\omega_c + \omega_1) t + \cos (\omega_c + \omega_2) t]$$

Where ω_c is the angular frequency of the carrier, ω_1 is the angular frequency of the first tone, ω_2 is the angular frequency of the second tone, and A is the amplitude of each sideband.

S may be transformed into:

$$S = 2A \cos \left[\frac{\omega_2 - \omega_1}{2} t \right] \cos \left[\frac{\omega_2 + \omega_1}{2} t \right]$$

The amplitude modulation part separated by the envelope detector, S_{A1} is given by the expression:

$$S_{A1} = \frac{1}{2A} \left[\cos \left(\frac{\omega_2 - \omega_1}{2} t \right) \right]$$

S_{A1} can be represented by a Fourier series:

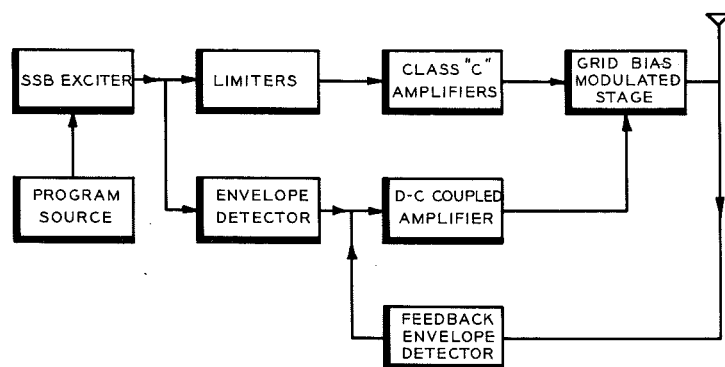

Fig. 1—Basic diagram of the Grid Modulated Envelope Restoration Amplifier.

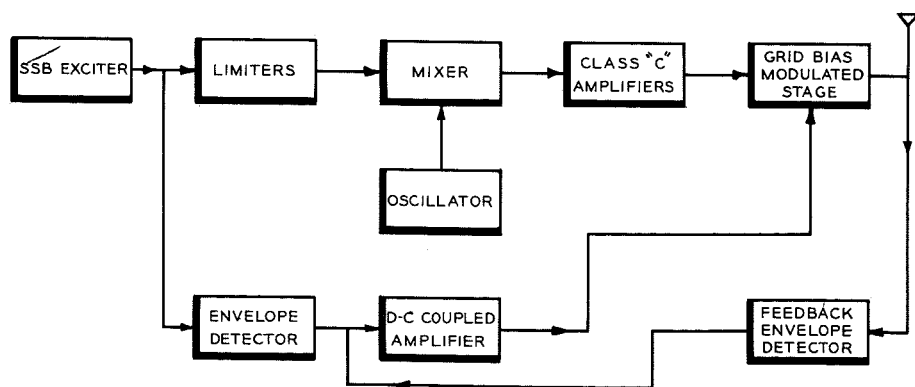

Fig. 2—Basic diagrams of the Grid Modulated Envelope Restoration Amplifier for UHF.

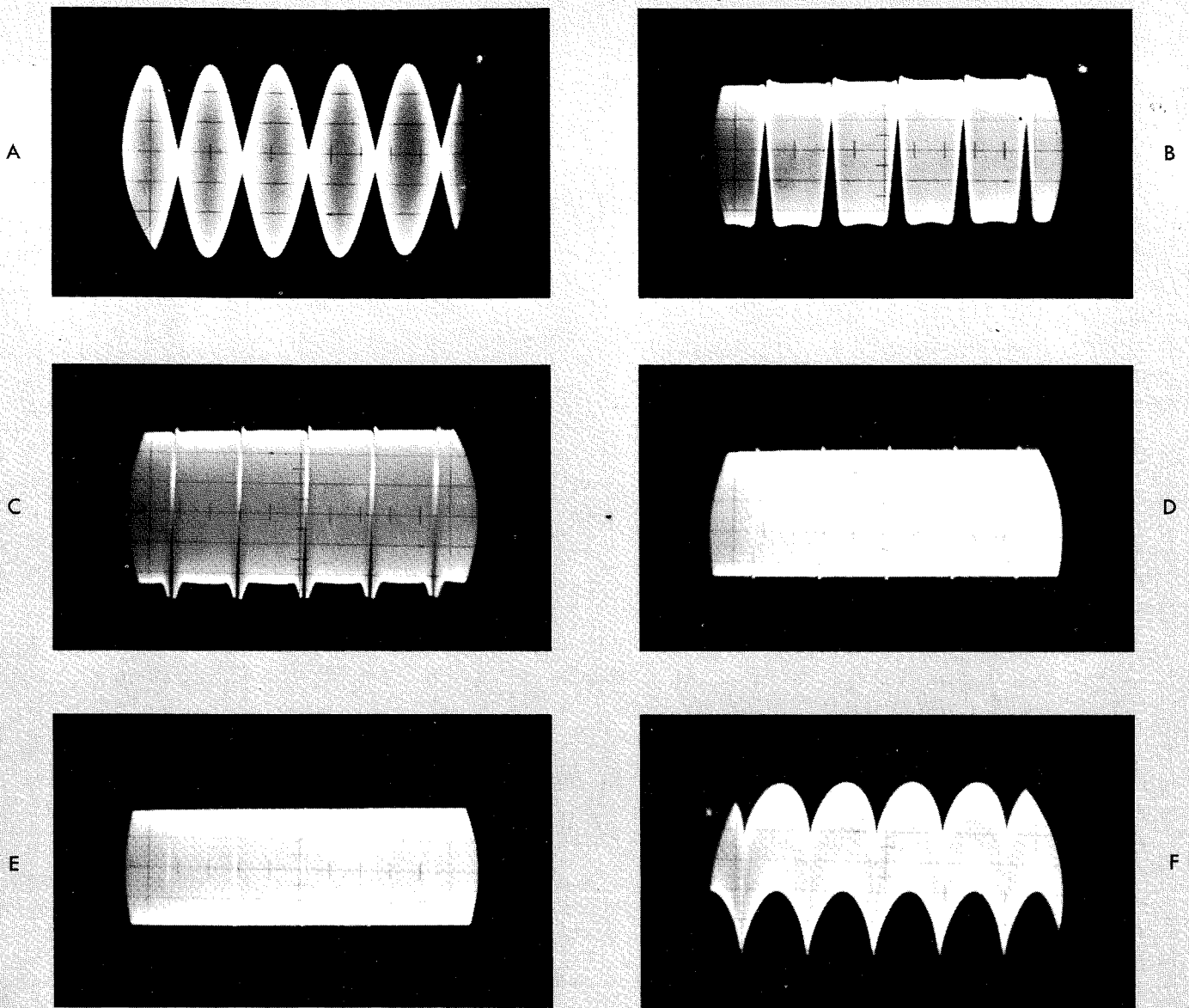

Fig. 3—The SSB wave after passing through various stages of the amplifier.

$$S_{A1} = \frac{2}{\pi} 2A \left[1 + \frac{2}{3} \cos(\omega_2 - \omega_1)t - \frac{2}{15} \cos 2(\omega_2 - \omega_1)t + \frac{2}{35} \cos 3(\omega_2 - \omega_1)t + \dots + (-1)^{n+1} \frac{2}{(2n)^2 - 1} \cos n(\omega_2 - \omega_1)t \right]$$

To evaluate the distortion caused by a finite pass band of the d-c coupled amplifier, we compute the power contained in each harmonic. The amount of power contained in frequencies that are beyond the response of the modulator may be used as an approximate rating of spurious output. We define P_{av} the average power output, when only the d-c component of the modulating voltage is present. We define P_{eff} , the effective power output, when all d-c and a-c components of the modulating voltage are present.

$$P_{av} = \left[\frac{2}{\pi} 2A \right]^2 1/R = 1.6212 A^2/R$$

$P_{eff} \leq 2A^2/R$ (P_{eff} is the power in two independent signals, both of amplitude A)

The power transmitted through the a-c amplitude modulation components is:

- | | |
|--------------------|-------------------|
| 1) fund. component | $0.3609 A^2/R$ |
| 2) 2nd harmonic | $0.01441 A^2/R$ |
| 3) 3rd harmonic | $0.002646 A^2/R$ |
| 4) 4th harmonic | $0.000817 A^2/R$ |
| 5) 5th harmonic | $0.000331 A^1/R$ |
| 6) 6th harmonic | $0.000158 A^1/R$ |
| 7) 7th harmonic | $0.0000853 A^2/R$ |

<i>Highest harmonic of envelope transmitted</i>	<i>Lost power relative to power contained in each tone</i>
---	--

- | | |
|---------------------|-----------|
| 1. fundamental | -17.3 db |
| 2. second harmonic | -23.84 db |
| 3. third harmonic | -28.28 db |
| 4. fourth harmonic | -31.76 db |
| 5. fifth harmonic | -34.74 db |
| 6. sixth harmonic | -37.5 db |
| 7. seventh harmonic | -40.3 db |

for a transmitter having all spurious radiations 40 db below each tone, the modulator must be able to pass up to the seventh harmonic of the difference between the highest and the lowest frequency signals.

EXPERIMENTAL DATA

An experimental 500-watt, 4 mc/s



MAX FERYSZKA received his degree of Diplom Engineer at Technical University of Munchen (Germany) in 1947, and the M.S. degree from the University of Pennsylvania in 1957.

From 1947 to 1951 he was employed with General Electric Company, Milan, Italy, as research and development engineer. There he was engaged in development of broadcast, short wave and f-m receiver. In 1951 he emigrated to the United States and was employed by Standard Electronics Company in development of broadcast and TV Transmitters.

In 1953 he joined RCA and was engaged at first in conversion of standard TV Transmitters for color, and later worked on applied research project in high power amplifiers. His most recent activities have been in the field of high power SSB Amplifiers in UHF region.

Grid Modulated Envelope Restoration Amplifier was built and tested. The tests were conducted with two r-f tones of equal amplitude input. Fig. 3 shows the SSB wave after passing through different stages of the amplifier. Fig. 3(A) shows the signal at the input, (B) after first limiter, (C) after second limiter, (D) after third limiter, (E) at the plate of the driver and (F) at the grid of the modulated stage. Fig. 4 (A) shows the wave at the output of the modulated stage without feedback. To linearize the transfer characteristics of the grid bias modulated stage, 14 db of envelope feedback was applied. A part of the output wave was rectified and fed back to the d-c coupled amplifier. Fig. 4(B) shows the output of the

modulated stage with envelope feedback. Fig. 4(C) and 4(D) show the envelope of the output wave without and with feedback. Fig. 4(E) and 4(F) show the linearity curve of the system (output envelope v. input envelope) without and with feedback. Maximum amplitude of spurious output (with two tone test) was found to be 37 db below each tone at 500 W peak power output. The efficiency of the modulated stage at peak power output was 60%. Quiescent plate current was zero.

ACKNOWLEDGEMENT

The author is indebted to W. C. Morrison, L. L. Koros and S. A. Olive for many helpful discussions during the work on this system.

Fig. 4—Waveform comparisons at various stages of the amplifier with and without feedback.

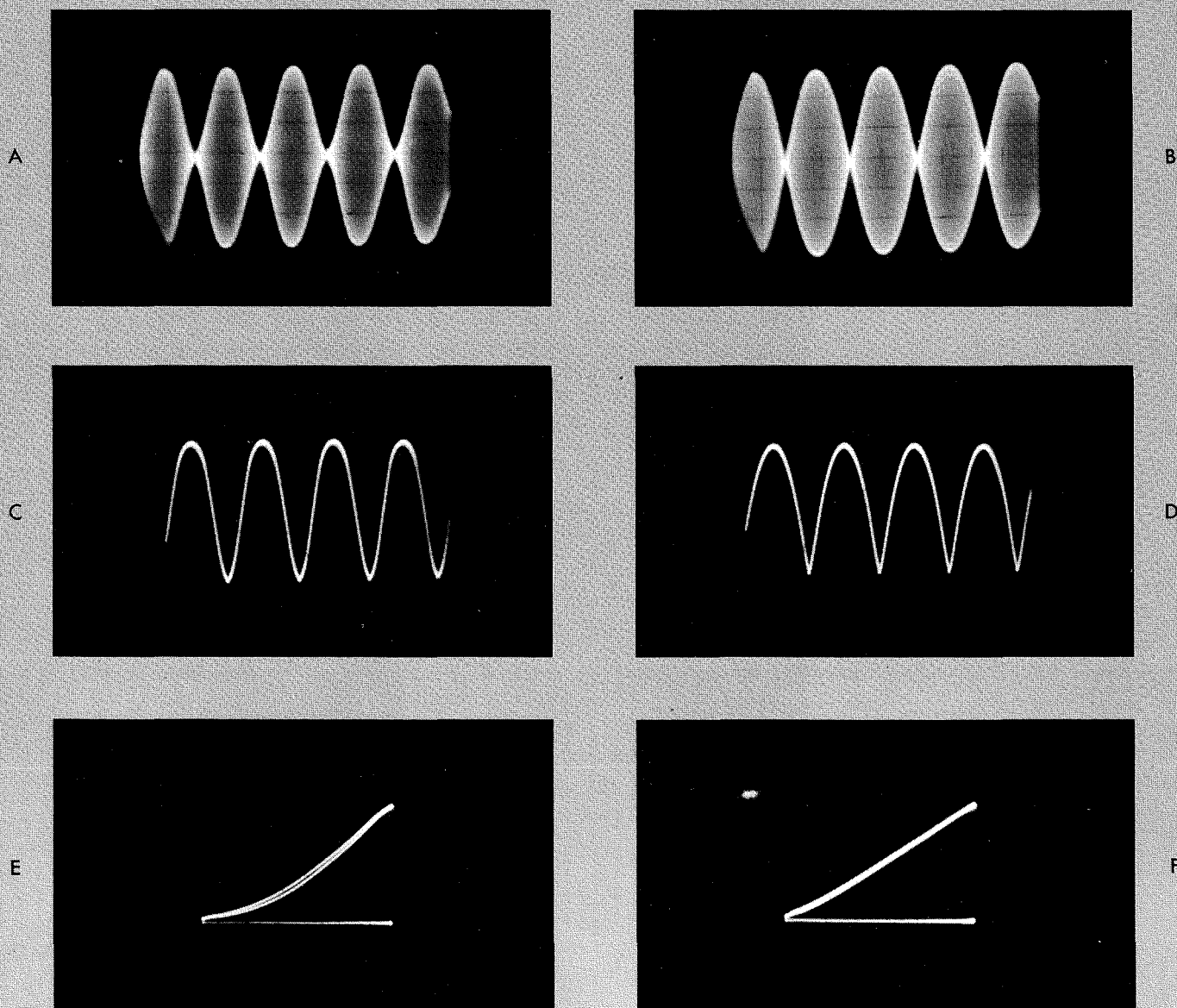

PATENTS . . . and things

by **O. V. MITCHELL**
Director, Patent Operations
RCA Laboratories
Princeton, N. J.

THE CONSTITUTION OF the United States provides the basis for the American Patent System. Article I, Section 8 provides that

The Congress shall have Power . . . To promote the Progress of Science and useful Arts, by securing for limited Times to Authors and Inventors the exclusive Right to their respective Writings and Discoveries.

The broad scope in which this provision is written forms a basis not only for the American patent system but also a basis for our copyright practices.

As early as January 1791 patent grants were issued. There was then no patent office, nor any formulated procedures, and the patent grants were signed by the President of the United States. One of these early grants was issued to Francis Bailey, a printer in Philadelphia.¹ The patent grant was for

Methods not before known or used, performing punches, by which to impress on the . . . matrices of printing types, whether such types be for letters or devices, as well as to impress on any metal or other substance capable of receiving and retaining impressions various marks which are difficult to be counterfeited, and the said invention appears to be useful and important.

These words, plus some legalistic language, constituted the entire patent. It was written in longhand, signed in Philadelphia by the Presi-

¹ These early patent grants were not numbered. Patent Number 1 issued to John Ruggles on July 13, 1836 and is directed to a cog railway.

dent, George Washington, witnessed by the Secretary of State, Thomas Jefferson, certified by the Attorney General, Edmund Randolph and delivered to the inventor on January 31, 1791.

A formalized patent system was started about 1836, and our present rules and laws are the result of normal development and codification. The present U. S. Code provides that "whoever invents or discovers a new and useful process, machine, manufacture or composition of matter, or any new or useful improvement thereof may obtain a patent therefor, . . ."²

This provision is subject to certain conditions. Among the conditions is a requirement that the invention must not have been known or used by others before the invention thereof by the applicant for the patent. This, and other provisions of the statute, are intended for the purpose of precluding the issuance of a patent to anyone other than the proper first inventor. The determination of who is the proper first inventor is in some instances a rather involved and prolonged process, particularly where a plurality of independent inventors are before the Patent Office seeking a patent on the same invention.

Another condition is that the invention must not have been patented or described in a printed publication in this or a foreign country or in public use or in public sale in this country for more than one year prior to the filing date of the U. S. Patent application. This one-year rule on use and publication has been in effect since

² 35 U. S. Code, 101; 1955 edition.

August 5, 1940. Prior to that date a two-year rule was in effect. The purpose of such a condition is to prevent the inventor from "sleeping on his rights" to the prejudice of others. Unless a patent application is filed within one year of the date of publication or public use, the invention is considered as dedicated, and neither the inventor nor anyone else may be granted a valid patent.

The one-year rule attaches when "public" use is involved. What constitutes public use can often become a ticklish question as demonstrated in the classic case of *Egbert v. Lippman*.³ In this case, the inventor Barnes learned that his wife and her friend, Miss C, were complaining of the breaking of their corset steels. Barnes made a pair of laminated corset steels for his wife and presented them to her in 1855. A second pair was presented to her by Barnes in 1858. She wore them for a long time and when the corsets in which these steels were used wore out, she ripped them open and took out the steels and put them in new corsets. The patent application was not filed until 1866. Undeniably Mrs. B. made no public display or announcement of the article of apparel, much less its specific character, yet the Supreme Court held the patent invalid. Even such invisible or private use may constitute "public" use since, in the words of the Court "If an inventor, having made his device, gives or sells it to another, to be used by the donee or vendee, without limitation or restriction, or injunction of secrecy, and it is so used, such use is public, even though the use and knowledge of the use may be confined to one person."

Experimental use and testing, however, may continue for more than one year without prejudice. The courts encourage experimentation and recognize that the nature of some inven-

³ 104 U. S. 333, 1881.

OLIN V. MITCHELL was born in Ohio and was graduated with the B.S. degree in Electrical Engineering from Carnegie Institute of Technology in 1929. He received his L.L.B. degree from Washington College of Law, Washington, D. C., in 1935.

Mr. Mitchell began his patent career with the U. S. Patent Office where he was a Patent Examiner from June, 1929 to April, 1937. He joined the RCA Patent Department in 1937 as a Patent Attorney and was assigned to the New York office. In the fall of 1947 he was transferred to Princeton. During World War II he was on part-time leave from RCA to the Office of Scientific Research and Development where he worked on the development of the proximity fuse, radar jamming equipment, and telemetering of information from rockets equipped with ram-jet motors. At the time of his appointment as Director, RCA Patent Operations, in November, 1957 he was Manager, Home Instruments, Patent Operations.

A recipient of the Bureau of Ordnance "Exceptional Service" award in 1945, Mr. Mitchell is a Registered Patent Attorney and is a member of the Bar of the District of Columbia, the Circuit Court of Appeals for the District of Columbia, and the Court of Customs and Patent Appeals. He also is a member of the American Patent Law Association, the Philadelphia Patent Law Association, the Patent Lawyers Club of Washington, D. C., Eta Kappa Nu and Sigma Nu Phi.



MACHINE

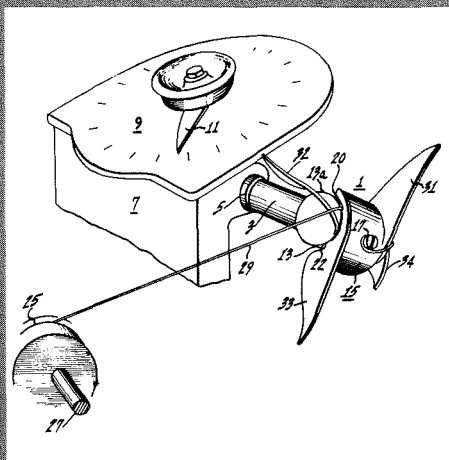

MACHINE FOR WINDING ODD-SHAPE COILS
H.V. KNAUF, JR., PAT. No. 2,448,872

PROCESS OR METHOD

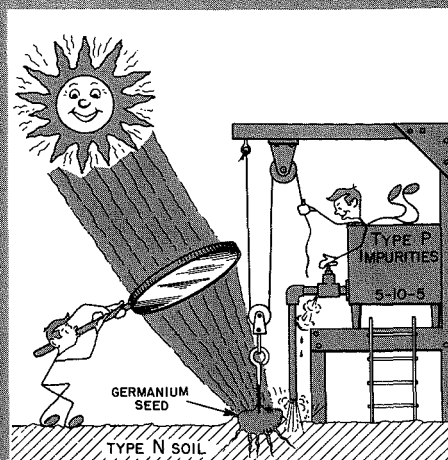

METHOD OF GROWING GERMANIUM CRYSTALS
CONTAINING P-N JUNCTIONS
A.R. MOORE PAT. No. 2,753,290
(APOLOGIES FOR LIBERTIES TAKEN)

ARTICLE OF MANUFACTURE

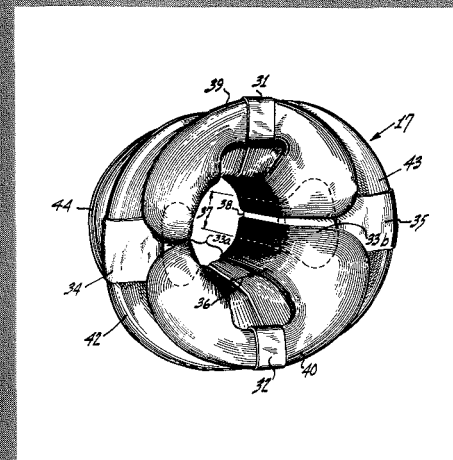

TELEVISION DEFLECTION YOKE
J.K. KRATZ AND M.J. OBERT, PAT. No. 2,821,671

tions is such that adequate testing may require public use as, for example, improvements in highways, paints for marking street surfaces, etc.⁴ So long as such circumstances prevail the one-year rule does not apply, provided there is no financial gain directly or indirectly (as by prestige) and so long as the invention is not considered completed, i.e., experimentation concluded.

A further condition of patentability is that the invention be more than a mere exercise of mechanical skill. In other words, the subject matter of the patent application must be non-obvious and must differ from the prior art in a manner which would not have been obvious, at the time the invention was made, to a person having ordinary skill in the art to which the subject matter pertains. While it is a simple matter to state that it must not have been obvious "to a person having ordinary skill," the determination of the degree of invention involved and when ordinary skill is exceeded is not a simple matter. This particular criterion not only is the main issue between the Patent Attorney and the Patent Examiner or the Board of Appeals during normal prosecution but is generally an issue in patent litigation in the courts.

It is commonly believed that the

⁴ Elizabeth v Pavement Co., 97 U. S. 126.

issuance of a patent gives the inventor the exclusive right to make, use or sell the invention throughout the United States. This is incorrect; a more accurate statement of the rights that flow with the granting of a patent is that the patentee, his heirs or assigns, has the right to *exclude others* from making, using or selling the invention throughout the United States for a term of seventeen years. The "invention" to which these rights attach is determined by the scope of the claims which form a part of the specification of the patent. Since most patents are in fact in the nature of an improvement on a prior, and generally more basic, invention, the holder of a patent directed to such an improvement has only the right to exclude others from using the invention represented by the improvement patent. The inventor of the improvement may not in fact be permitted to practice his own invention if in so doing he infringes an unexpired valid patent on the prior basic invention, unless he obtains a license from the owner of the prior patent.

A patent is considered a capital asset and may be viewed as an award in the form of a legal document given by the U. S. Government to the inventor for making his invention known to the public. If there were no patent system, many inventions would likely be kept secret, and the ad-

vancement of science would be impeded. In return for his making the invention known to the public the inventor is extended the right for a period of seventeen years to exclude others from reaping a harvest at the expense of his investment of time, money and ingenuity.

The engineer may be aware only of "mechanical patents" but a modern horticulturist is just as acutely aware of plant patents. Since May 23, 1930 it has been possible to obtain patents on plants provided the inventor asexually⁵ reproduces a distinct and new variety of plant or seedling other than tubers. Patent applications for plant patents are under the jurisdiction of the Commissioner of Patents, but the examination of such patent applications is in collaboration with the Department of Agriculture.

The patent system had not long been in existence before it was recognized that some agency was required to afford recognition for "any new, original and ornamental design for an article of manufacture." Such recognition in 1842 was the genesis of design patents. Design patents are issued for terms of three and one-half, seven or fourteen years at the election of the applicant. The fees are appropriately graduated. Design patents

⁵ Asexual: cutting, grafting, budding and layering, in contrast to sexual, i.e., pollination (self or cross) and sporegenesis.

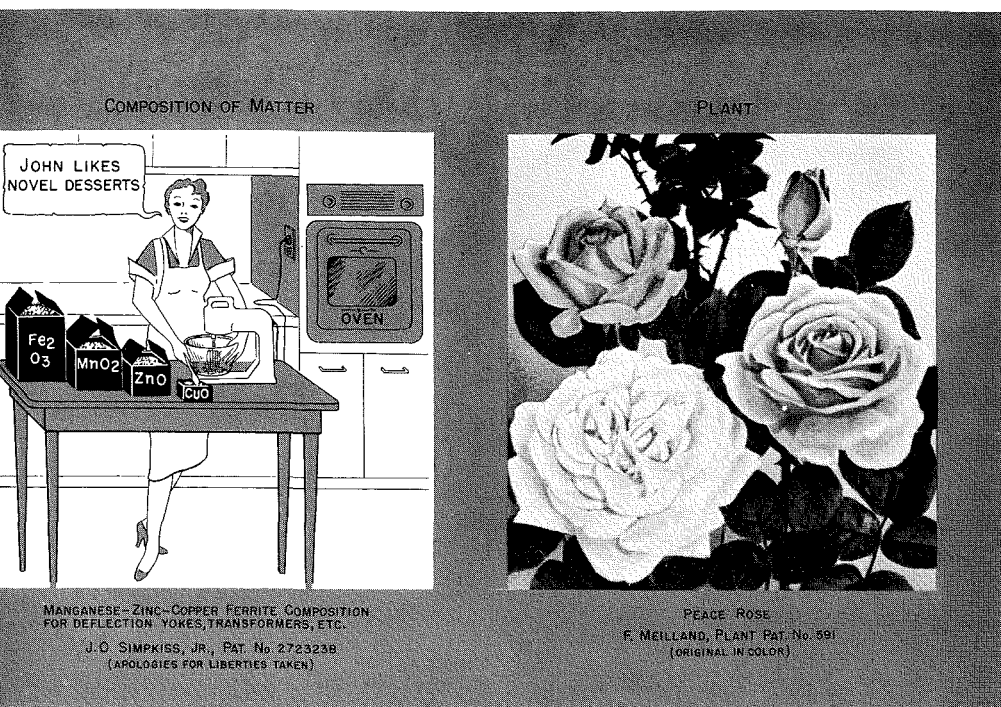

MANGANESE-ZINC-COPPER FERRITE COMPOSITION FOR DEFLECTION YOKES, TRANSFORMERS, ETC.
 J. O. SIMPKISS, JR., PAT. No. 272323B
 (APOLOGIES FOR LIBERTIES TAKEN)

PEACE ROSE
 F. MEILLAND, PLANT PAT. No. 591
 (ORIGINAL IN COLOR)

DESIGN



FOR MICROPHONE
 THE RCA "STARMAKER"
 S.W. PIKE, DESIGN PAT. No. 163477

are not intended for works of art, such as paintings or statues, even though design patents, from their inception were intended to encourage the decorative arts. A design patent will not be granted even though its subject matter possesses both originality and ornamentation unless it is also a useful article of manufacture. Dresses, shoes, silverware and the like are frequent subjects of design patents.

Trade-marks are a property right under the common law and may be registered in the U. S. Patent Office, or, in some cases, in the individual states. The sole purpose of a trade-mark is to distinguish the product of the trade-mark owner from the product of others. A good trade-mark, therefore, is one which denotes the source of the product to which it is applied and which is neither misdescriptive of the product nor so descriptive of the product as to have no distinctiveness. A trade-mark, well established and properly protected, can be an exceedingly valuable asset. Properly guarded, a trade-mark can continue indefinitely (through renewal) but, unless properly guarded, trade-marks may be lost, for example, by becoming common nouns and thus dedicated.⁶

Trade-marks and patents, particu-

⁶ As, for example, aspirin, nylon, kinescope, and cellophane.

larly design patents, should not be confused with copyrights. The only requirement to be satisfied in obtaining a copyright registration in printed matter, a work of art and the like is that it be original. It need not be novel or even useful; only the first of its kind. In fact, if the work of art is also a useful article, it may be more properly protected by a design patent than by a copyright. Copyrights were originally under the jurisdiction of the Patent Office, but were transferred to the Library of Congress on July 1, 1940. A copyright grants the author a twenty-eight year monopoly and right of action for any copying of his writing, musical composition, drawing, map, work of art, print, label, illustration or motion picture. The author, or his legal representatives, may extend the registration for another twenty-eight years. Copyrights have one important feature in common with patents, namely, that they protect the product of originality against piracy.

The late Earl Carroll is reported to have had inscribed over the stage entrance to his Vanities the words "Through these portals pass the most beautiful girls in the world." Equally appropriately, and more factually, there appears over the entrance to the Patent Office the inscription "The patent system added the fuel of interest to the fire of genius—Lincoln."

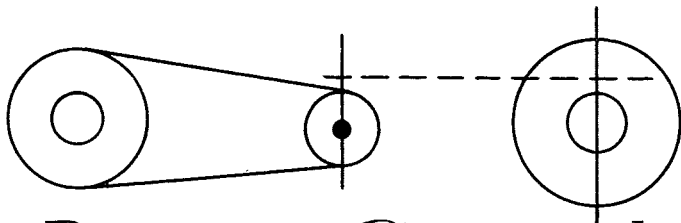

Patents Granted TO RCA ENGINEERS

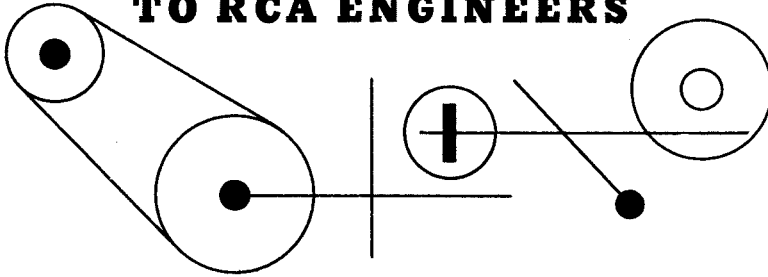

BASED ON SUMMARIES RECEIVED OVER A PERIOD OF ABOUT TWO MONTHS

DEFENSE ELECTRONIC PRODUCTS

Moorestown, N. J.

Pulse Amplifier

Pat. No. 2,828,416—granted Mar. 25, 1958 to W. R. Ayres and J. N. Smith.

Los Angeles, Calif.

Film Synchronizing Marker and System

Pat. No. 2,786,895—granted Mar. 26, 1957 to Michael Rettinger.

Camden, N. J.

Position Error Assimilator

Pat. No. 2,823,255—granted Feb. 11, 1958 to James R. Hall.

Stabilized Multivibrator

Pat. No. 2,802,107—granted Aug. 6, 1957 to J. G. Arnold.

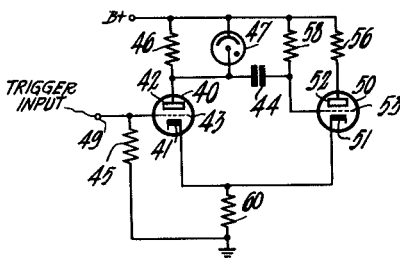

Stabilized Multivibrator—Arnold

RCA VICTOR TELEVISION DIVISION

Cherry Hill, N. J.

Noise Immunizing Circuitry for

Pulse Translating System

Pat. No. 2,823,257—granted Feb. 11, 1958 to R. W. Sonnenfeldt.

Semi-Conductor Signal Processing Circuits

Pat. No. 2,824,170—granted Feb. 18, 1958 to H. C. Goodrich.

Deflection Yoke for Multi-Beam

Cathode Ray Tube

Pat. No. 2,824,267—granted Feb. 18, 1958 to W. H. Barkow.

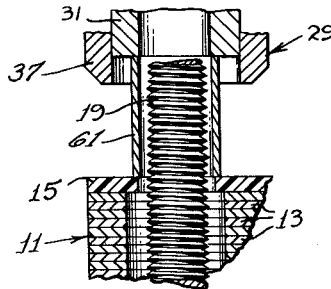

Fastening Method—Gersenson and Zilliacus

Semi-Conductor Oscillator Circuits

Pat. No. 2,824,964—granted Feb. 25, 1958 to H. B. Yin.

Cathode Ray Tube Deflection and High

Voltage Apparatus

Pat. No. 2,825,850—granted Mar. 4, 1958 to C. C. Iden.

Cathode Ray Tube Deflection and High

Voltage Apparatus

Pat. No. 2,825,849—granted Mar. 4, 1958 to P. M. Lufkin, Findlay, and C. C. Iden, Cherry Hill.

Television Receiver Noise Reduction

Pat. No. 2,829,247—granted Apr. 1, 1958 to L. P. Thomas, Jr.

Electron Beam Deflection Circuits

Pat. No. 2,830,229—granted Apr. 8, 1958 to R. W. Sonnenfeldt.

Color Television

Pat. No. 2,830,115—granted Apr. 8, 1958 to G. E. Kelly.

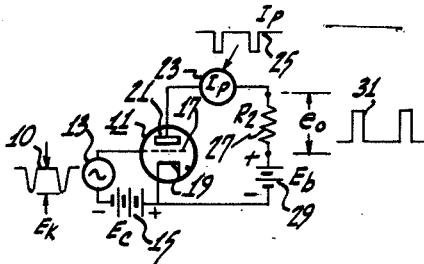

Color Television—Kelly

ELECTRON TUBE DIVISION

Lancaster, Pa.

Getter Structure for Electron Tube

Pat. No. 2,830,215—granted Apr. 8, 1958 to M. B. Shrader.

Calcium Magnesium Silicate Phosphors

Pat. No. 2,821,508—granted Jan. 28, 1958 to G. E. Crosby and H. E. McCreary.

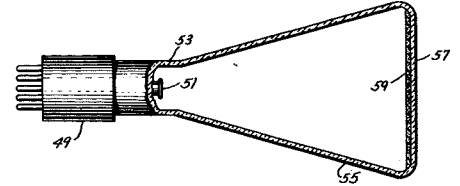

Calcium Magnesium Silicate Phosphors—Crosby and McCreary

Camden, N. J.

Fastening Method

Pat. No. 2,807,083—granted Sept. 24, 1957 to M. Gersenson and P. W. Zilliacus, no longer employed at RCA.

Harrison, N. J.

Mechanically and Electronically Tunable Cavity Resonator

Pat. No. 2,830,224—granted Apr. 8, 1958 to H. K. Jenny.

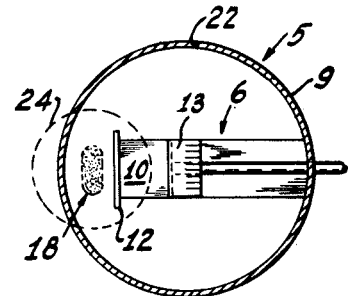

Tunable Cavity Resonator—Jenny

INDUSTRIAL ELECTRONIC PRODUCTS

Camden, N. J.

Bar Signal Generator

Pat. No. 2,824,225—granted Feb. 18, 1958 to A. C. Luther, Jr.

Television Special Effects Circuits

Pat. No. 2,825,757—granted Mar. 4, 1958 to R. C. Dennison and A. C. Luther, Jr.

Color Television Monitoring System

Pat. No. 2,828,355—granted Mar. 25, 1958 to A. C. Luther, Jr.

Switching Apparatus

Pat. No. 2,829,198—granted Apr. 1, 1958 to A. C. Luther, Jr.

Metal Detector

Pat. No. 2,830,263—granted Apr. 8, 1958 to L. Shapiro.

Signal Receiver Muting Circuits

Pat. No. 2,830,177—granted Apr. 8, 1958 to C. H. Taylor.

PEN and

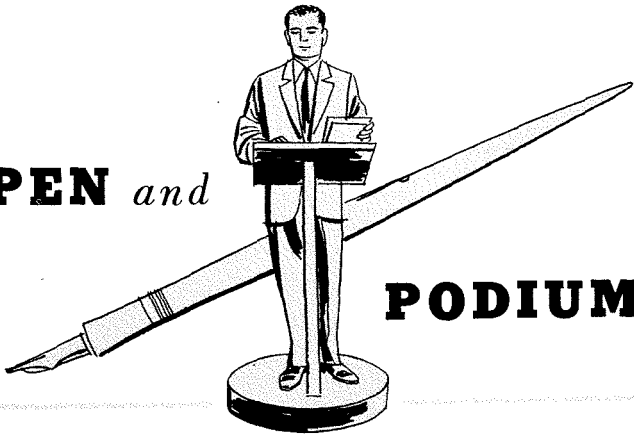

PODIUM

BASED ON REPORTS RECEIVED OVER A PERIOD OF ABOUT TWO MONTHS

ELECTRON TUBE DIVISION

Harrison, N. J.

A Pulsed-Triode Method for Measuring Oxide-Cathode Impedance

By E. J. Hannig: Presented at ASTM Meeting, Wash., D. C., Feb. 26, 1958. This paper describes a pulsed-triode test for evaluating oxide-cathode impedance. The method is simple to operate, shows acceptable correlation with other such methods, and has a high degree of reproducibility. Its simplicity and speed make it desirable for high-volume routine tests.

Toughmindedness and Tomorrow

By G. W. Crawford: Presented at Wagner College, Staten Island, N. Y., Feb. 20, 1958. This paper stresses the need on the part of management for people who are "tough-minded." The "toughness" referred to is toughness of the intellectual apparatus, and consists of the power to tackle a problem, break it down, sort out the facts, see what must be done, and then get it done. The toughminded person is not always looking for the easy answers, and is not afraid of taking risks.

Trends and Development in Receiving Tubes

By C. M. Morris: Presented at U.S.A.F. Reserve Center, Newark, N. J., March 18, 1958. This paper traces the progress of the receiving tube over the past 25 years. Various applications of electron tubes are described, and design improvements required for these applications are discussed. The effects of high frequency, high ambient temperature, shock, and vibration are also discussed.

A New High-Power Horizontal-Output Tube and Deflection System For Color Television

By J. P. Wolff and R. G. Rauth: Presented at the 1958 IRE Convention, March 24-27. This paper describes a developmental high-power horizontal-deflection and high-voltage system for color television receivers, which employs the RCA-6DQ5, a new horizontal-output tube having unique design features.

Lancaster, Pa.

Scintillation Counting

By R. W. Engstrom: Presented to Sigma Pi Sigma Club, Franklin and Marshall College, Lancaster, Pa., Mar. 21, 1958. This paper describes scintillation counting, indicating the origin of the light pulses, measurement techniques, and interpretation. Various applications are discussed, such as gamma-ray spectrometry, oil-well logging, tracer applications, and medical use. The role of multiplier phototubes in scintillation counting is described.

Film and Industrial Applications of the Vidicon

By R. G. Neuhauser: Presented at Canadian Section of S.M.P.T.E., Montreal, Canada, Feb. 20, 1958. This paper discusses the application of vidicons to both the broadcast and the industrial television field. Similarities and differences among the various types of vidicons are described to show which tubes will perform best in different usages.

The Use of Secondary Emission in Some Commercial Electron Tubes

By R. P. Stone: Presented at Colloquium on Secondary Emission, University of Minnesota, Feb. 27, 1958. This paper discusses the role of secondary emission in camera tubes such as the image orthicon and vidicon, in ordinary cathode-ray tubes, in storage tubes such as the radechon and the display storage tube, and in electron multipliers. The materials used and performance obtained are discussed, together with the characteristics of an ideal secondary emitter for each application.

Principles of Color TV for the Layman

By D. G. Garvin: Presented at Lions Club, Manheim Township, Pa., Jan. 13, 1958, and Kiwanis Club, York, Pa., Feb. 20, 1958. This paper outlines the development of compatible color television by RCA, and compares compatible color with mechanical non-compatible systems of reproduction. A brief description is given of the use of the color kinescope. The Lancaster plant where these tubes are manufactured is described.

The Creation of Light

By G. E. Crosby: Presented at Wise Men's Club, YMCA, Lancaster, Pa., Mar. 18, 1958. This paper describes the magnitude of details implicit in the biblical quotation "Let there be light, and there was light." Various methods of producing light are demonstrated, including emission reflection from a specially painted board, luminescence of materials under ultra-violet light, reaction of chemical solutions, and emission from electroluminescent panels.

SEMICONDUCTOR DIVISION

Somerville, N. J.

A Ten-Watt High-Quality Transistorized Audio Power Amplifier

By R. Minton and C. F. Wheatley: Published in IRE STUDENT QUARTERLY, Feb., 1958. This paper describes the use of transistors in the design of a high-quality, audio-frequency power amplifier. The amplifier shown consists of seven stages, and is capable of delivering ten watts of output power with low harmonic and intermodulation distortion over a wide frequency range.

Design Considerations for Transistorized Automobile Receivers

By R. A. Santilli: Presented at IRE National Convention, New York City, Mar. 25, 1958. This paper analyzes the operation of drift transistors in the rf and if stages of typical automobile receivers. In addition, it reviews the over-all considerations, economic as well as technical, involved in the design of a complete auto receiver. Performance data for an all-transistor high-performance auto receiver are also given.

Use of the RCA-2N384 Drift Transistor as a Linear Amplifier

By D. M. Griswold and V. J. Cadra: Presented at IRE National Convention, New York City, March 26, 1958. This paper describes the use of the RCA-2N384 p-n-p germanium drift transistor in several high-frequency amplifier applications. The transistor is described in terms of the typical variation of individual parameters with temperature and operating point. Performance data are included.

Plating Applications for Semiconductors and Transistors

By L. P. Fox: Presented at American Electroplaters Society, Newark, N. J., March 21, 1958. This paper describes transistors briefly and lists various applications in which they are used. Plating applications performed on various parts of the transistors are described, as well as those performed on the finished units. Ideas for future improvements are discussed.

RCA VICTOR TELEVISION DIVISION

Cherry Hill, N. J.

Voltage Sensitivity of Local Oscillators

By W. Y. Pan: Presented at the 1958 IRE Convention, March 24-27. The theory of voltage sensitivity of local oscillators is discussed. Based on this theory, the frequency characteristics under the conditions of oscillator warmup and varying operating voltages can be predicted and controlled. Particular considerations pertaining to oscillator circuits and devices are proposed, thereby a nearly perfect oscillator stability may be attained.

Tracing Distortion in Stereophonic Disc Recording

By M. S. Corrington and T. Murakami: Presented at the 1958 IRE Convention, Mar. 24-27. Tracing distortion in the 45°-45° and the vertical-lateral systems has been calculated to compare the two systems. Analysis shows that with an ideal pickup there is no cross-modulation between the two channels in the 45°-45° system of recording, if the groove angle is 90°. Curves of the amounts of distortion, cross talk and cross modulation for various groove velocities, stylus radii, and recording velocities are given for both systems.

RADIO AND "VICTROLA" DIVISION

Cherry Hill, N. J.

Low-Frequency Amplifier Design

By James J. Davidson: Presented at IRE, Phila. Chapter-Transistor Applications Lecture Series, University of Pennsylvania, Mar. 10, 1958. Transistor and audio amplifiers were covered from the circuit designer's viewpoint. Major categories were: input stages and noise; intermediate stages and linearity; and output stages, including power dissipation and distortion. Temperature effects and proper biasing were stressed.

DEFENSE ELECTRONIC PRODUCTS

Camden, N. J.

Space Environmental Conditions

By R. A. DiTaranto and J. J. Lamb: Presented at a monthly meeting of *The Scientific Research Society of America* held at Franklin Institute Laboratories, Mar. 17, 1958. The environment which U.S.A.F. equipment will encounter in the earth's space, above 75,000 feet, was discussed.

Phase Center of Helical Beam Antennas

By S. Sander, DEP, Camden, N. J. and D. K. Cheng, Syracuse U.: Presented at the 1958 IRE Convention, Mar. 24-27. The first part of this paper formulates an analytical method of determining the phase-center location of helical beam antennas based upon the expressions of the far-zone diffraction fields. The second part presents the experimental results and discusses dependence of phase center location on number of turns, pitch angle, and size of ground plane.

The Function of Side-Tone and Ambient Noise in Determining Speech Level

By W. F. Meeker and Dr. F. L. Smith, Delaware U.: Presented by Dr. Smith at meeting of Eastern Psychological Association, Phila., Pa., Apr. 11, 1958. The constant-gain side-tone was effective in controlling, and reducing individual differences in, talking level. Constant-level side-tone, however, produced relatively greater vocal effort at poor side-tone-to-noise-ratios than did constant gain.

Responsibilities-Design Engineering

By M. C. Batsel: Presented at Joint IRE Chapter and Professional Group on Engineering Management Meeting, Mar. 4, 1958, Rome, N. Y. The relative importance of research and development and that of practical equipment design are considered and suggestions given for placing responsibility for providing equipment that is reliable, maintainable, economical, and operable in the users environment.

Electroplating Silver on Magnesium Alloys

By W. A. Gottfried: Presented at Symposium on Castings (Magnesium Association) held in Phila., Pa., Apr. 24, 1958. This paper dealt with the deposition of silver plating on magnesium electronic equipment housings to provide for a highly conductive surface for prevention of electromagnetic radiation while maintaining resistance to corrosion.

The Characteristics of Airborne Digital Computers

By Adolph Baker: Presented at IRE Meeting, Boston Section held at MIT, Mar. 1958. The applications of airborne digital computers in present and possible future systems are discussed, as well as the features which distinguish this type of computer from its land-based counterpart. The penalty for equipment breakdown may be extremely high, and various means for detecting failures and taking appropriate action in real time are considered.

Preliminary Investigation of Spare Environments and Their Effect on Future U.S.A.F. Equipment

By R. A. DiTaranto and J. J. Lamb: Presented to New York Chapter of Institute of Environmental Engineers, Jan. 16, 1958. The environments which exist above 75,000 feet altitude and their possible deleterious effects on equipment was presented. Vehicles considered were: (1) Sustained Flight (2) Boost Glide (3) Ballistic and (4) Satellites.

Moorestown, N. J.

Design Reviews for Reliability

By H. C. Bryson: Presented at Joint Military-Industry Guided Missile Symposium at Point Mugu, Calif., Nov. 5, 1957. A description was given of the Electrical Design Review Program which has been in operation in Missile & Surface Radar Department over the past four years. Contributions of this program to our reliability efforts were cited.

Waltham, Mass.

Automatic Control of Aircraft

By R. C. Seamans: Presented at MIT, Feb. 20, 1958, to Boston IRE Section, Professional Group on Automatic Control. This talk described the aircraft as a controlled member, discussing the nature of its inherent stability deficiencies and some automatic means which have been used to correct these deficiencies. The need for self-adjusting systems was discussed.

Los Angeles, Calif.

The RCA Flight Data System

By C. N. Batsel, Jr., R. E. Montijo, Jr. and E. J. Smuckler: Presented at IRE Convention, by C. N. Batsel, March 24, 1958, N. Y. City. An integrated electronic system for in-flight monitoring and recording of transducer data is described. The system is designed to meet the need of modern high-performance flight vehicles for recording the outputs of a large number of transducers at high accuracy and for wide ranges of data frequency.

New York City, N. Y.

Ferrites, Ferrite Devices and Masers

By Dr. H. Boyet: Presented as the second in a series of 5 lectures sponsored by IRE-AIEE Jan. 21, 1958 in Western Union Bldg., New York City. Dr. Boyet's talk dealt with physics of Ferrites, Ferrite devices and Masers at Microwave frequencies.

Ferrites, Ferrite Devices and Masers

By Dr. S. Weisbaum: Presented as the third in a series of 5 lectures. Sponsored by IRE-AIEE, Jan. 28, 1958, in Western Union Bldg., New York City. Dr. Weisbaum's lecture dealt with Microwave ferrite devices.

Modern Communications

By Dr. Richard Guenther: Presented as the fourth of six lectures sponsored by the IRE-AIEE on "Modern Communications" at the Physical Sciences Auditorium, University of Penn., Phila., Pa., Feb. 10, 1958. Dr. Guenther's talk was concerned with "New Modulation and Detection Methods."

COMPONENTS DIVISION

Camden, N. J.

A Revolutionary Electronic Equipment Design Concept

By O. B. Cunningham and B. V. Dale. Presented by Mr. Dale at Electronic Components Conference, Los Angeles, April 23, 1958. This paper describes a revolutionary new microminiature module concept of electronic equipment design offering new orders of reliability and volumetric efficiency. The concept employs uniformly shaped circuit elements integrated into modular structures ideally suited for automatic manufacture.

INDUSTRIAL ELECTRONIC PRODUCTS

Camden, N. J.

Electronic Inspection of Beer

By R. E. Schell: Presented at AIEE-IRE-ASME Automatic Techniques Conference, Detroit, Mich., April 14-16, 1958. To meet problems of automatically inspecting bottled

beer for foreign particles a double-channel suppressed-carrier system is used. Special features include drift-compensated suppressed-carrier modulators and an automatic gain control system for maintaining the gain inversely proportional to the color density of the bottles.

Automation in the Petroleum Industry

By H. S. Wilson: Published in May 1958 "Petroleum Engineer" and presented April 29, 1958 at Dallas, Tex., at the Petroleum Industry Electrical Association Convention. This paper describes a system which, when fully developed, will provide supervisory control, data logging, alarm reporting, and facilities for control by a computer in one integrated system.

Design Methods to Improve the Stability of AM Directional Antenna System

By George H. Brown: Presented at NARTB Convention April 29, 1958, Los Angeles, Calif. Design factors which are important in achieving stability in AM directional arrays are considered. A method of inversion is displayed. Several examples are used to illustrate the method and the limitations are studied.

An Automatic Communications Switching System

By J. A. Brustman, I. Cohen and L. S. Levy: Presented at AIEE Winter General Meeting, New York City, Feb. 6, 1958. The paper describes an electronic data processing system, for a Central Telegraph Office, which receives, switches, stores, and transmits conditioned messages, and at the same time keeps a record of all traffic handled.

Color TV Recording on Magnetic Tape

By J. L. Grever: Presented at the 1958 IRE Convention, Mar. 24-27. It has been established that a practical method of recording monochrome TV signals on magnetic tape is the technique of high-speed. This paper describes some of the precise signal handling techniques and special equipment that had to be developed in order to build a broadcast quality video tape recorder, good for both color and monochrome.

Digital Data Transmission between Dissimilar Processing Centers

By J. A. Brustman, I. Cohen and H. P. Guerber: Presented at AIEE Winter General Meeting, New York City, Feb. 6, 1958. Communication between different Electronic Data Processing Centers is complicated by the necessity of code translation, message format, conversion, and accuracy required for transmission. The problems involved in each of these areas were discussed at the meeting.

A New Industrial TV System

By G. A. Senior and J. E. Dille: Presented at Winter General Meeting, AIEE, N. Y. City, Feb. 4, 1958. Current market requirements for Industrial TV equipment are reviewed in order to state the basis of design for the new equipment. The electrical and mechanical features of the system, called the TK-201, are discussed in detail.

Automatic Soldering Machine for Printed Circuit Assembly Boards

By W. L. Oates: Presented at IRE National Convention, N. Y. City, Mar. 24, 1958. This talk described an automatic machine which will solder 280 to 600 finished printed circuit board assemblies per hour. The machine applied liquid flux, preheats board, solders assembly and cleans off excess flux.

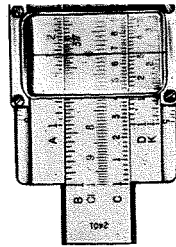

NEW DIVISION FORMED IN RECENT ORGANIZATIONAL CHANGES

RCA has recently announced the establishment of the Astro-Electronic Products Division for satellite or space vehicle programs, including associated equipment on the ground. The new unit will have research headquarters at RCA Labs in Princeton and manufacturing facilities nearby. Already it holds several classified Government contracts.

Dr. Elmer W. Engstrom will act as the new division's General Manager. The staff of the new division, as announced by Dr. Engstrom, is as follows. Barton Kreuzer, former Director of Product Planning for RCA has been appointed Marketing Manager; C. W. Zemke, former Manager of Finance and Services for DEP's Special Systems and Development becomes Manager of Operations Control for the new division; and A. W. Vance, former Chief Systems Engineer in DEP's Special Systems and Development has been appointed Chief Engineer.

Mr. Vance has announced his engineering

staff as follows: M. S. Cohen, Manager, ACSI-Matic Project; D. H. Frykland, Manager, Mechanical Techniques Development Laboratory; E. A. Goldberg, Manager, Engineering Administration; E. C. Hutter, Manager, Physics Research and Development Laboratory; S. W. Spaulding, Manager, New Projects Analysis; S. Sternberg, Manager, RCA Juno Project; and L. A. Thomas, Manager, Technical Services.

W. J. POCH HEADS PRODUCT DEVELOPMENT

According to a recent announcement made by Dr. D. H. Ewing, Vice President of Research and Engineering, a Product Development function has been established in Research and Engineering, with W. J. Poch appointed as Director, reporting to Dr. Ewing (see chart). Long associated in RCA with TV receiver and transmitter engineering, Mr. Poch was most recently Administrator, Technical Analysis, in Barton Kreuzer's Product Planning.

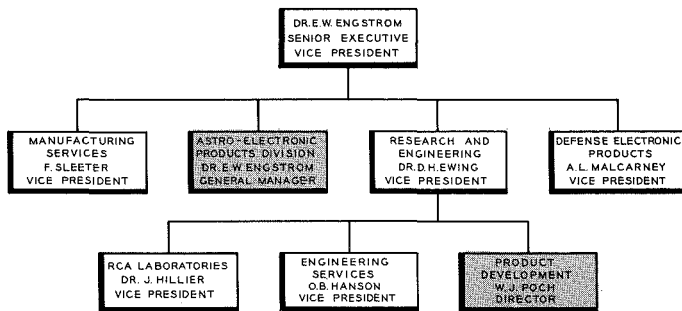

NEW SEMICONDUCTOR AND MATERIALS DIVISION FORMED



Dr. A. M. Glover

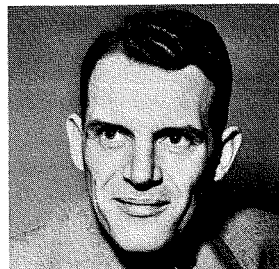

W. T. Warrender

Establishment of the RCA Semiconductor and Materials Division, responsible for the engineering, manufacturing and marketing of semiconductors and materials, as well as basic components fabricated from them, was announced recently by W. Walter Watts, Executive Vice President, Electronic Components, RCA. Mr. Watts also announced the appointments of Dr. Alan M. Glover as Vice President of the new Division, and William T. Warrender as General Projects Manager, Electronic Components.

"Recent developments in the semiconductor, special component and materials fields," said Mr. Watts, "make it desirable that these activities be more closely integrated. To accomplish this end, a single division has been established, to be called the RCA Semiconductor and Materials Division."

Headquarters of the Division will be located at Somerville, N. J., at the plant of the former RCA Semiconductor Division. The components operation, which has been centered in the RCA Components Division, will be integrated physically and organizationally into the Somerville activity. Departments will be established within the new Division to place proper emphasis on materials and special components.

ENGINEERS IN NEW POSTS

In an organizational move, DEP has realigned Special Systems and Development, with part renamed Development Engineering on C. A. Gunther's staff, and part forming Engineering for Astro-Electronic Products Div. The remaining section members are transferred to M&SR at Moorestown.

In DEP Dr. Harry J. Woll has joined C. A. Gunther's staff from SS&D as Mgr. Development Engineering. Dr. Woll's staff includes H. N. Crooks, Mgr. Circuit Development; E. S. Lowry, Administrator, Development Engineering; W. R. Isom, Mgr., Electro-Mechanical Development; and D. J. Parker, Mgr. Applied Physics . . . A. D. Beard, also from SS&D, has moved to Moorestown under Ch. Prod. Engineer George Brietweiser as Mgr. of Information Handling Electrical Engineering for M&SR . . . A. C. Gay, former SS&D Projects Engineering Mgr. now heads up Missile Range Systems Coordination for M&SR's Chief Systems Eng. N. I. Korman at Moorestown . . . G. L. Dimmick becomes Staff Engineer for Chief Engineer O. B. Cunningham, DEP Surface Communications Engineering . . . E. F. Bailey joins C. A. Gunther's Defense Engineering Department as Administrator, Value Engineering.

IEP's Norman Caplan, heading the Communications Products Departments appoints E. I. Anderson Chief Eng., Communications Engineering . . . also in IEP, R. W. Sonnenfeldt becomes Communications Advanced Development Mgr. for J. M. Marshall, heading Advanced Development for Dr. G. H. Brown. Mr. Sonnenfeldt was formerly with Gus Grundmann's TV Circuits Advanced Development under C. M. Sinnott at Cherry Hill . . . IEP Broadcast and TV Equipment Dep't's E. C. Tracy has announced M. A. Trainer as Administrator, Plans and Coordination Services.

R. W. Sonnenfeldt

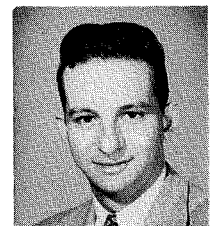

M. M. Bell

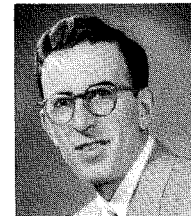

In the Electron Tube Div. H. E. Stumman is appointed Administrator, Engineering Administration reporting to G. G. Carne, Mgr. Industrial Receiving Tube Engineering . . . M. M. Bell, Mgr. of Tube Division's Receiving Tube Equipment Development Design has announced his organization to consist of S. N. Masto, Mgr. Electrical Design; J. Capo, Mgr. Electrical Production Drafting; H. C. Fioretti, Mgr. Mechanical Design; H. F. Welsh, Mgr. Mechanical Design; L. J. Schnobeck, Mgr. Mechanical Production Drafting.

SARNOFF PRESENTS ACHIEVEMENT AWARDS



Brig. General David Sarnoff is shown presenting the first David Sarnoff Outstanding Achievement Awards for Science and Engineering to Dr. Albert Rose (left) and David K. Barton. The presentations highlighted the awards program as announced in the previous issue of the RCA ENGINEER.

C. W. SALL APPOINTED IEP ENGINEERING EDITOR

Chester W. Sall, Manager of Technical Publications for Industrial Electronic Products, Camden, has been appointed Engineering Editor for the RCA ENGINEER, representing IEP. J. B. Davis will continue to represent DEP in this capacity.

Mr. Sall received the A.B. degree from DePauw University in 1935, and the A.M. degree from New York State College for Teachers in 1942. Between 1936 and 1943 he taught high school science at Saugerties and Baldwin, N. Y., coming to the RCA Industry Service Lab as a Technical Editor in 1943. Mr. Sall transferred to Camden in 1958 to assume his present position. He is a Senior Member of the IRE, a member of the Administrative Committee, PGEWS-IRE, and Transactions Editor, PGBTR-IRE.

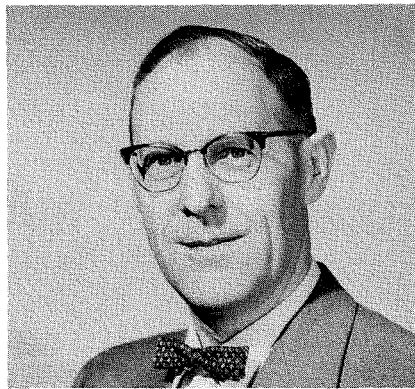

NEW EDITORIAL REPRESENTATIVES APPOINTED

Ralph D. Lending has been appointed as Editorial Representative for DEP's Airborne Systems Engineering on the activities move from Moorestown to Camden. Mr. Lending replaces Matthew Hollander, who has assumed new duties at Moorestown.

Mr. Lending received the BSEE degree from the University of Illinois in 1948. He was employed by McDonnell Aircraft from 1948 to 1951, when he became a microwave engineer in the Signal Corps. Here he served as a Senior Project Engineer on research and development projects until joining RCA. His current work is on communications and space propagation.

Marshall C. Kidd has replaced R. W. Sonnenfeldt as Editorial Representative for Advanced Development Engineering, Television Division, Cherry Hill. Mr. Sonnenfeldt has transferred to IEP Advanced Development (see "Engineers in New Posts," Page 53).

Mr. Kidd received the B.Ch.E. degree from Ohio State University in 1944. For a

year after graduation he was associated with the Bakelite Corporation, and in 1945 he joined the Allen B. DuMont Laboratories, where he worked on cathode-ray tubes. In 1946 he returned to Ohio State and received the B.E.E. degree. In 1948 he joined Advanced Development Engineering of the RCA Victor Television Division, where he is currently working on transistor circuits.

E. O. Selby has replaced T. T. N. Bucher as Editorial Representative for DEP's Surface Communications Department in Camden. Mr. Bucher has transferred to Moorestown in Missile and Surface Radar Engineering. Mr. Selby received a BS degree from the University of California in 1926 and continued graduate studies at Union College and University of Pennsylvania. He has wide experience in development, design, and production of Military communication equipment for the past 32 years. His present assignment is Administrator, Technical Projects Coordination, Surface Communications Dep't, DEP.

R. D. Lending

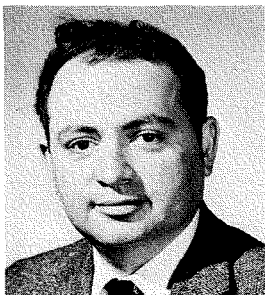

M. C. Kidd



E. O. Selby



COMMITTEE APPOINTMENTS

Francis J. Herrmann, Manager Scientific Instruments, Industrial Electronic Products was just elected Secretary, Philadelphia Alumni Chapter of Eta Kappa Nu.—*J. E. Volkmann.*

P. D. Strubhar, Metallurgy and General Chemistry Group leader in the Lancaster C & P Lab, Electron Tube Division, completed his fourth term as treasurer of the York Chapter, American Society for Metals and has been elected to the vice-chairmanship of the group.—*D. G. Garvin.*

Dr. J. C. Turnbull, Cathode Environmental Study Group Leader, Electron Tube Division, Lancaster, has been elected Chairman of the Membership Committee, Glass Section, American Ceramic Society for the third successive year.—*D. G. Garvin.*

Clark R. Morris, IEP Broadcast Engineering, has been appointed to an IRE subcommittee 3.1 on Definitions of Audio Terminology, in the Committee on Audio Techniques.—*J. H. Roe.*

Aaron G. Hogg, of the Electron Tube Division's Microwave Applications and Test activity at Harrison has been appointed Chairman of the JETEC Subcommittee on traveling-wave tubes and backward-wave oscillators. The function of the committee is to effect whatever amount of standardization is deemed necessary and practical within the industry.—*H. J. Wolkstein.*

Eugene W. Kinaman also a member of the Microwave Applications and Test activity has been appointed Program Chairman of the Northern New Jersey Section of the IRE for the Microwave Theory and Techniques Group.—*H. J. Wolkstein.*

M. S. Corrington, Advanced Development Engineering, Television Division, Cherry Hill, has been elected National Vice-President of the IRE Professional Group on Audio.—*R. W. Sonnenfeldt.*

Earl Keller was appointed RCA's representative for the Society for Industrial and Applied Mathematics. Earl Keller is leader of the Communication Systems Group of DEP Airborne Radar and Missile Engineering.—*R. D. Lending.*

DEP'S DR. SEAMANS SERVES NATIONAL AIR COMMITTEE

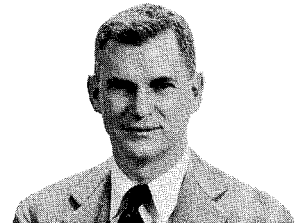

Dr. Robert Seamans, Jr., has been appointed to the subcommittee on automatic stabilization and control by the National Advisory Committee for Aeronautics.

Dr. Seamans is Chief Systems Engineer and Manager, Boston Airborne Systems Laboratory of Defense Electronic Products. He is well known in the Camden area.

He will serve on a committee with the objectives of anticipating the special problems of aeronautical science and supplying the nation's armed forces and industry with essential information for the design and production of American aircraft and missiles of superior performance and effectiveness.—*R. W. Jevon.*

MEETINGS, COURSES AND SEMINARS

Conference on Production Techniques

F. C. Collings, DEP Moorestown, was the local Arrangements Chairman of the Second National Conference on Production Techniques, sponsored by the IRE PGPT. The Conference was held at the Hotel New Yorker, N. Y. on June 4-6, 1958.

Human Relations

On April 7, 1958, Messrs. Carroll Tillman and Frank Ricks, Manufacturing Engineers at the Indianapolis Plant of the Electron Tube Division completed a six week course in Human Relations. This seminar was sponsored by the Industrial Management Club of Indianapolis and was conducted by G. Krueger, Director of Training and Safety at the Richardson Company.

Management Conference

On April 12, 1958, the 8th Annual Management Conference was held at Purdue University, Lafayette, Indiana. Among those attending from RCA were five engineers from the Indianapolis Plant of the Electron Tube Division, C. Tillman, R. Ward, W. Geaman, F. Spahr, and F. Ricks.

Communications Standards

J. R. Neubauer, IEP Communication Eng., participated in a panel discussion sponsored by the Wash., D. C. section of the IRE, Monday, Mar. 3 on the subject, "Problems encountered on the immediate implementation of the Split-Channel Technical standards as proposed in FCC Docket 12295." The panel was moderated by Curtis Plummer of the FCC.—*B. F. Wheeler.*

Advanced Electronic Techniques

Dr. A. H. Benner, Manager Product Development and Planning, DEP Airborne Radar and Missile Engineering, has instituted a series of Seminars for section personnel on Advanced Electronic Techniques. Speakers have included Dr. J. P. Mayberry on Secure (non-cryptographic) Codes, Dr. Benner on Propagation and Mr. W. A. Rose on Special Missiles.—*R. D. Lending.*

High School Electronics Lectures

In keeping with RCA's policy to encourage students to prepare for science careers, five members of the Missile and Surface Radar Department are presently contributing to the scientific advancement of our youth through a special, voluntary lecture series at Rancocas Valley High School in Mount Holly, New Jersey.

At the request of Mr. Anthony Petrillo, Physics Instructor at Rancocas Valley Regional High School, arrangements have been completed by the Training Section to furnish this special class of high school students, endeavoring to broaden their knowledge in the field of science and engineering, with a guest lecturer every Saturday morning for six weeks commencing in March. Topics covered by the lecturers are Electronics, Radar, Computers, Astronomy and Sound.

Participating in this lecture series are: J. Gorman, T. G. Greene, M. E. Hawley, J. R. Levitt and R. S. Putnam, all of Sec. 596.—*I. N. Brown.*

Radio & "Victrola" Advanced Engineering Training Program



The following engineers were awarded completion certificates for the Radio and "Victrola" portion of the Cherry Hill Advanced Engineering Training Program*:

P. Gallo	S. V. Perry
H. N. Hoffer	D. J. Poitras
L. M. Krugman	E. J. Propop
T. C. Lawson	R. J. Robinson
J. M. Link	J. R. Shoaf II
W. G. Manwiller	W. S. Skidmore
M. J. Nowlan	H. B. Stott
J. O'Donnell	R. W. Young

In the photograph, H. B. Stott receives a certificate and congratulations from J. L. Franke, Chief Engineer of the Radio and "Victrola" Division, while J. R. Shoaf, L. M. Krugman, and H. N. Hoffer look on.—*W. S. Skidmore*

*RCA ENGINEER Vol. 2 No. 4-p. 71 December 1956—January 1957.

RCA ACTIVE AT IRE CONVENTION

Developments of major importance in electronics, radio, television and high-fidelity sound reproduction were displayed publicly for the first time by RCA at the 1958 National Convention of the Institute of Radio Engineers, which opened its four-day session on March 24, 1958 at the New York Coliseum.

One of the highlights of the RCA exhibit was the first public demonstration of an experimental completely transistorized closed-circuit television system. The system, designed for battery operation, employs a portable receiver and miniaturized TV camera developed by RCA Laboratories.

RCA Engineers were active in the Convention and in the many technical sessions. Listed below are session chairmen and engineers along with papers presented.

The RCA Flight Data System

C. N. Batsel, Jr., R. E. Montijo, Jr., and E. J. Smuckler, Los Angeles, Calif.

Automatic Soldering Machine for Printed Circuit Assembly Boards

W. L. Oates, Camden, N. J.

Controlled Thermonuclear Fusion and Its Meaning for the Radio Engineer

E. W. Herold, C. Stellarator Associates, Princeton, N. J.

Stereophonic Disc Recordings

H. E. Roys, Chairman, Indianapolis, Ind.

Tracing Distortion in Stereophonic Disc Recording

M. S. Corrington, and T. Murakami, Camden, N. J.

Broadcast Transmission Systems and Communications Systems

A. L. Hammerschmidt, Chairman, New York, N. Y.

Audio, Amplifier, and Receiver Developments

M. S. Corrington, Chairman, Camden, N. J.

Design Considerations for Transistorized Automobile Receivers

R. A. Santilli, Somerville, N. J.

Voltage Sensitivity of Local Oscillators

W. Y. Pan, Camden, N. J.

The Annular Geometry Electron Gun: A New Electron Device

J. W. Schwartz, RCA Labs, Princeton, N. J.

Use of the RCA 2N384 Drift Transistor as a Linear Amplifier

D. M. Griswold and V. J. Cadra, Somerville, N. J.

Phase Center of Helical Beam Antennas

S. Sander, RCA Defense Electronic Products Div., Camden, N. J., and D. K. Cheng, Syracuse University, Syracuse, N. Y.

Apertured Plate Memory: Operation and Analysis

W. J. Haneman and J. Lehmann, RCA Labs, Princeton, N. J., and C. S. Warren, Camden, N. J.

Reduction of Bandwidth Requirements for Radio Relay Systems

D. L. Jacoby and R. H. Levine, U. S. Army Signal Eng. Labs., Fort Monmouth, N. J., and A. Mack and A. Meyerhoff, RCA, Camden, N. J.

Microwave Tubes

L. S. Nergaard, Chairman, RCA Labs, Princeton, N. J.

The Estiatron — An Electrostatically Focused Medium-Power Traveling-Wave Amplifier

D. J. Blattner and F. E. Vaccaro, RCA Labs, Princeton, N. J.

A New High-Power Horizontal-Output Tube and Deflection System for Color Television

J. P. Wolff and R. G. Rauth, Harrison, N. J.

DAVID SARNOFF FELLOWSHIPS AWARDED TO TEN RCA EMPLOYEES

David Sarnoff Fellowships for graduate study in the 1958-59 academic year have been awarded to ten employees of RCA. The Fellowships, established in honor of the Chairman of the Board of RCA, are valued at approximately \$3,500 each. The grant includes full tuition and fees, \$2,100 for living expenses, and \$750 as an unrestricted gift to the university. Although appointments are for one academic year, each fellow is eligible for reappointment.

The David Sarnoff fellows will pursue graduate studies in chemistry, physics, engineering science, electrical engineering, economics, business administration, and dramatic arts.

The recipients in science and engineering who will be on leave of absence are:

Raymond J. Campion, Harrison, N. J., who will begin studies leading to a Doctorate of Chemistry at Washington University of St. Louis. He is employed by the Electron Tube Division at Harrison.

Edward Kornstein, Boston, Mass., will continue studies toward his Doctorate in Physics at Boston University. He is employed by DEP in Camden. He received a David Sarnoff Fellowship during the year 1957-58.

Walter F. Kosonocky, Newark, who will pursue studies leading to a Doctorate of Engineering Science at Columbia University. Mr. Kosonocky is a member of the technical staff of the RCA Laboratories.

Jerome D. Sable, Maple Shade, N. J., who will begin studies toward a Doctorate in Electrical Engineering at the University of Pennsylvania. He is a systems design engineer in DEP at Moorestown.

R. A. Schmeltzer, Somerville, N. J., who will study for a Doctorate in Engineering Science at Columbia University. Mr. Schmeltzer is an applications engineer in the Semi-conductor and Materials Division at Somerville.

Hugh W. Stewart, Haddonfield, N. J., who will pursue studies toward a Master of Science degree in Electrical Engineering at Rensselaer Polytechnic Institute. He is an engineer in DEP at Camden.

Others receiving fellow awards are:

Edward L. Balinsky, Clifton, N. J., who will begin studies toward a Doctorate in Economics at Columbia University. He is a budget analyst in NBC.

Paul Potashner, Fords, N. J., who will begin studies toward a Master of Science degree in Business Administration at Harvard School of Business Administration. He is a budget analyst in International Sales at Clark, N. J.

Earl R. Sage, Findlay, Ohio, who will begin studies toward a Master of Science degree in Business Administration at Harvard School of Business Administration. He is a buyer with the RCA Victor Television Division at Findlay.

James L. Steffensen, Hollywood California, who will continue studies toward a Doctorate of Fine Arts degree in Dramatic Arts at Yale University. He has been employed by NBC in Burbank, Cal.

REGISTERED PROFESSIONAL ENGINEERS

The following names have been added to the RCA ENGINEER list of registered professional engineers:

Electron Tube Division, Harrison

Name	State	Licensed as	License No.
C. L. Christian, Jr.	N. J.	Prof. Eng.	A-8908
<i>Semiconductor & Materials Div., Camden</i>			
R. D. Gillen	N. J.	Chem. Eng.	10070
<i>Defense Electronic Products, Camden</i>			
J. W. Kauffman	Penna.	Mech. Eng.	4572E

ENGINEERING MEETINGS AND CONVENTIONS, June-August, 1958

JUNE 2-4

National Telemetering Conference, AIEE, ISA, ARS, Lord Baltimore Hotel, Baltimore, Md.

JUNE 2-4

Automation and Computers, Short Course and Conf., Univ. of Texas, College of Engineering Austin, Texas

JUNE 4-6

Armed Forces Communications and Electronic Assoc., Exhibit, Hotel Sheraton Park, Washington, D. C.

JUNE 5-6

Second Natl. Conf. on Production Techniques, IRE, PGPT, Hotel New Yorker, N.Y.C.

JUNE 9-13

Technical Writers Institute, Sixth Annual Symposium, Rensselaer Polytechnic Institute, Troy, N. Y.

JUNE 9-13

Automation Seminar, Fourth Annual, Penn. State Univ., Penn.

JUNE 10-13

Sixth Annual Meeting, Human Engineering Institute, Stamford, Conn.

JUNE 16-18

Electrical Contact Seminar Div., Penn State Univ., Penn.

JUNE 16-18

Military Electronics Second National Convention, Sheraton Park Hotel, Washington, D. C.

JUNE 17-27

Two-week Special Summer Program in Switching Circuits, MIT, Cambridge, Mass.

AUGUST 6-8

AIEE-IRE Nonlinear Magnetics and Magnetic Amplifier Conf., Los Angeles, Cal.

AUGUST 19-22

AIEE Pacific General Meeting Sacramento, Cal.

CLIP OUT AND MAIL TO:

**EDITOR, RCA ENGINEER
Radio Corporation of America
Bldg. 2-8, Camden 2, N. J.**

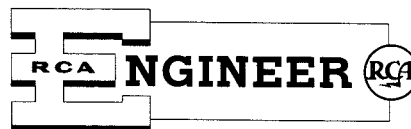

HAVE WE YOUR CORRECT ADDRESS?

If not indicate the change below.

PLEASE INDICATE THE CODE LETTER(S) THAT APPEAR NEXT TO YOUR NAME ON THE ENVELOPE.

Name _____ Code _____

Street or Bldg. _____

City and State or Plant _____

RCA ENGINEER EDITORIAL REPRESENTATIVES

DEFENSE ELECTRONIC PRODUCTS

Editorial Representatives

- I. N. BROWN, *Missile and Surface Radar Engineering, Moorestown, N. J.*
T. P. CANAVAN, *Airborne Fire Control Engineering, Camden, N. J.*
H. R. DYSON, *Technical Administration, Camden, N. J.*
R. W. JEVON, *Airborne Systems Laboratory, Waltham, Mass.*
R. D. LENDING, *Airborne Systems Engineering, Camden, N. J.*
DR. D. G. C. LUCK, *Airborne Systems Equipment Engineering, Camden, N. J.*
C. MCMORROW, *Aviation Communications and Navigation Engineering, Camden, N. J.*
J. H. PRATT, *West Coast Engineering, Los Angeles, Calif.*
L. M. SEEBERGER, *Special Systems and Development, Camden, N. J.*
E. O. SELBY, *Surface Communications Engineering, Camden, N. J.*
H. L. WUERFFEL, *Engineering Standards and Services, Camden, N. J.*

INDUSTRIAL ELECTRONIC PRODUCTS

Editorial Representatives

- I. F. BYRNES, *Radiomarine Engineering, New York, N. Y.*
H. E. HAYNES, *Advanced Development Engineering, Camden, N. J.*
C. E. HITTLE, *Hollywood Engineering, Hollywood, Calif.*
C. D. KENTNER, *Broadcast Transmitter and Antenna Engineering, Camden, N. J.*
T. T. PATTERSON, *Electronic Data Processing Engineering, Camden, N. J.*
J. H. ROE, *Broadcast Studio Engineering, Camden, N. J.*
J. E. VOLKMANN, *Theater and Sound Products Engineering, Camden, N. J.*
B. F. WHEELER, *Communications Engineering, Camden, N. J.*

RCA LABORATORIES

Editorial Representative

- E. T. DICKEY, *Research, Princeton, N. J.*

RCA SERVICE COMPANY

Editorial Representatives

- W. H. BOHLKE, *Consumer Products Service Department, Cherry Hill, N. J.*
L. J. REARDON, *Government Service Department, Cherry Hill, N. J.*
E. STANKO, *Technical Products Service Department, Cherry Hill, N. J.*

The Editorial Representative in your group is the one you should contact in scheduling technical papers and arranging for the announcement of your professional activities. He will be glad to tell you how you can participate.

RCA ELECTRON TUBE AND SEMICONDUCTOR & MATERIALS DIVISIONS

J. F. HIRLINGER, *Chairman, Editorial Board*

Editorial Representatives, RCA Electron Tube Division

- W. G. FAHNESTOCK, *Industrial Tube Products, Lancaster, Pa.*
J. DEGRAAD, *Black & White Kinescopes, Marion, Ind.*
D. G. GARVIN, *Color Kinescopes, Lancaster, Pa.*
A. E. HOGGETT, *Receiving Tubes, Cincinnati, Ohio*
R. L. KLEM, *Entertainment Receiving Tubes, Harrison, N. J.*
J. KOFF, *Receiving Tubes, Woodbridge, N. J.*
F. H. RICKS, *Receiving Tubes, Indianapolis, Ind.*
H. J. WOLKSTEIN, *Industrial Tube Products, Harrison, N. J.*

Editorial Representatives, RCA Semiconductor & Materials Division

- E. E. MOORE, *Camden, N. J.*
T. A. RICHARD, *Needham, Mass.*
R. E. RIST, *Somerville, N. J.*

RCA VICTOR TELEVISION DIVISION

C. M. SINNETT, *Chairman, Editorial Board*

Editorial Representatives

- E. J. EVANS, *Resident Engineering, Bloomington, Ind.*
R. D. FLOOD, *Color TV Engineering, Cherry Hill, N. J.*
M. C. KIDD, *Advanced Development Engineering, Cherry Hill, N. J.*
F. T. KSIAZEK, *Black & White TV Engineering, Cherry Hill, N. J.*
J. OSMAN, *Resident Engineering, Indianapolis, Ind.*
H. P. J. WARD, *Electronic Components, Findlay, Ohio*
K. G. WEABER, *Engineering Services, Cherry Hill, N. J.*

RCA VICTOR RECORD DIVISION

Editorial Representative

- S. D. RANSBURG, *Record Engineering, Indianapolis, Ind.*

RCA VICTOR RADIO & "VICTROLA" DIVISION

Editorial Representative

- W. S. SKIDMORE, *Engineering Department, Cherry Hill, N. J.*