

IN ITS TWO YEARS of publication, *RCA Engineer* has recorded the inventiveness and ingenuity that characterize RCA's engineering staff. The range of interest and the quality of work described in its pages support our belief that RCA is capable of producing better equipment faster and more economically than any other organization in the electronics business.

This happy potential can be realized in RCA, as in any large organization, only to the extent that internal communications exist and are used to full advantage. In highly simplified terms, a good internal communications network, properly used, will tell Engineer X at Camden that Engineer Y at Lancaster or Scientist Z at Princeton happens to have done successful work bearing on a problem that is currently causing X to lie awake at night. In the absence of this information X will either waste his own and the company's time in arriving, perhaps too late, at a conclusion that already has been reached, or the project will be shelved because it does not appear to justify this extra effort.

It is this type of situation that has given rise to the popular fallacy that a small company specializing in a limited area can usually out-bid and out-perform a large company whose interests extend over a number of other areas as well. The small company has the advantage only where the internal communications of the large company have failed to bring together the multitude of special talents at its disposal. Whenever this occurs, the large company is

Second Anniversary

no more than a collection of lesser organizations, no one of which is fully equipped to compete energetically in the specialized field on which the small company has concentrated.

As a pioneer in communications, RCA might logically be expected to have an outstanding record in solving the internal communications problems that occasionally beset all large and diversified organizations. As a matter of fact, the record is a good one as far as the establishment of channels is concerned.

In the technical field, we have an Engineering Services organization designed to help the engineering staff in its basic task of matching skills with needs, bringing a variety of resources to bear on any technical problem arising anywhere in the Corporation. We have a constant flow of research and engineering reports on current projects in the various divisions. We have symposia at which staff members are informed of technical developments affecting the areas in which they work.

And now we have *RCA Engineer*, reaching all members of the engineering staff with both detailed and general technical information originating in all parts of the Corporation. This is a key element in our internal communications system, designed not to divert but to inform the individual engineer, to provoke his thoughtful reaction, and to increase his awareness of the resources upon which he may draw.

The mere existence of all of these services is no guarantee of their effectiveness. Unemployed, they are no more useful than a public address system at a convention of deaf mutes. Conversely, their full employment by members of the engineering staff provides the best assurance that RCA will realize in all cases the tremendous potential which it possesses in the technical field.

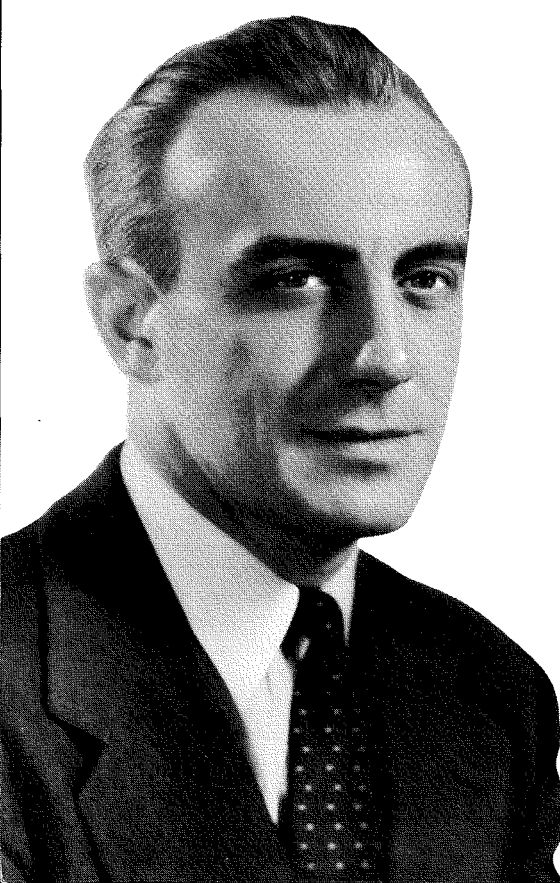

Douglas H. Ewing
DOUGLAS H. EWING, Vice President
Research and Engineering,
Radio Corporation of America.

CONTENTS

| | | |
|--|------------------------------|----|
| Introduction to "History of RCA"..... | Dr. E. W. Engstrom | 2 |
| History of RCA—The Years to 1938..... | J. C. Warner | 3 |
| Application of Power Transistors to Class B Output Stages of Auto Radios..... | Robert Minton | 10 |
| DEP Value Engineering Program | R. H. Baker | 14 |
| Processing and Test of Ceramic Permanent-Magnet Materials | George Katz & G. S. Hipskind | 15 |
| The Decade Ahead—Outlook for the Overall Economy.. | F. S. Hutzel | 20 |
| AGC Video Gain Control Amplifier..... | J. O. Schroeder | 23 |
| A Transistorized Image Orthicon Camera for Military Use | C. H. Chandler | 28 |
| Medical Electronics from the Engineering Standpoint | Dr. V. K. Zworykin | 32 |
| Protecting Dates of Invention..... | J. B. Johnson | 38 |
| Air Conditioning in the Home..... | H. W. Timmerman | 42 |
| Patents Granted to RCA Engineers..... | | 45 |
| Pen and Podium..... | | 48 |
| Engineering News and Highlights..... | | 52 |

VOL. 3, NO. 1 • JUNE-JULY 1957

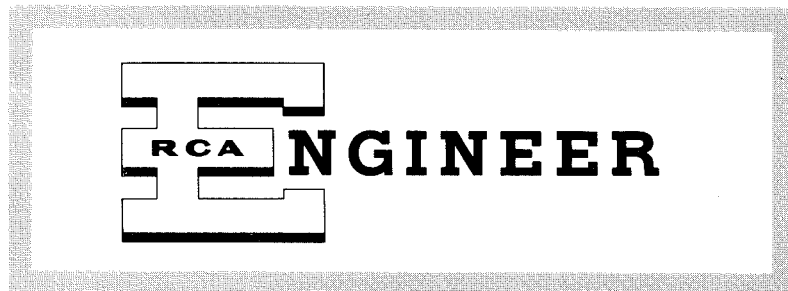

Editorial Advisory Board

M. C. Batsel, Chief Technical Administrator
Defense Electronic Products
J. J. Brant, Director, Personnel
Dr. G. H. Brown, Chief Engineer,
Commercial Electronic Products
D. D. Cole, Chief Engineer,
RCA Victor Television Division
B. V. Dale, Chief Engineer,
Components Division
C. C. Foster, Mgr. RCA REVIEW
J. L. Franke, Chief Engineer,
RCA Victor Radio & 'Victrola' Division
M. G. Gander, Mgr. Engineering,
RCA Service Co.
C. A. Gunther, Chief Defense Engineer,
Defense Electronic Products
J. Haber, Director,
Community Relations & Exhibits
D. P. Heacock, Administrative
Engineer, Product Engineering
Dr. L. Malter, Chief Engineer,
Semiconductor Division
J. C. Rankin, Mgr., General Employment
H. E. Roys, Mgr., Engineering,
RCA Victor Record Division
D. F. Schmit, Vice Pres., Product Engineering
Dr. G. R. Shaw, Chief Engineer,
Electron Tube Division

"RCA Engineer" Staff

W. O. Hadlock, Editor
R. J. Hall, Assistant Editor
Mrs. J. A. Allwein,
Editorial Secretary
J. L. Parvin, Art and Production
J. O. Gaynor, Photography

Engineering Editors

P. R. Bennett, Mgr., Radio
& Phonograph Engineering
RCA Victor Radio & 'Victrola' Div.
R. S. Burnap, Mgr., Commercial
Engineering,
Electron Tube Division
J. B. Davis, Engineering Editor,
Defense and Commercial
Electronic Products
C. A. Meyer, Mgr., Commercial
Engineering Technical Services,
Electron Tube Division
C. M. Sinnett, Mgr., Advanced
Development Engineering,
RCA Victor Television Division

Copyright 1957
Radio Corporation
of America
All Rights Reserved

PRINTED
IN
U.S.A.

By **DR. ELMER W. ENGSTROM**
Senior Executive Vice President, RCA

IT IS UNUSUAL for an organization that is only thirty-seven years old to possess a proud tradition. However, this is true for the Radio Corporation of America, which has played a pioneering role in an art and industry which itself has compressed within a short span of years a degree of growth that seldom is achieved in less than a century.

The article on the following pages is thus more than a simple account of RCA in its first two decades. It is also a story of dynamic industrial growth, encouraged largely by the imaginative leaders and the enterprising staff of RCA. Among the various actions by RCA which stand as milestones in the forward march of electronics are the establishment of network broadcasting, the successful combination of the radio and the phonograph, the development of television, and the support of research.

The account that follows was written nearly twenty years ago. It was prepared and delivered as one lecture of a series in an indoctrination course for employees of the manufacturing division. I had the good fortune to hear the presentation. Emphasis is largely on the technical accomplishments of the early days, as related to the growth of RCA. It is written *by an engineer for engineers!*

So rapid has been the evolution of both RCA and the electronics industry that many of the events described read like ancient history. Even the trade names familiar to a large public in the 1920's have vanished almost beyond recollection today. Very few will recall, for example, the Graphanola, a highly popular phonograph produced by the Columbia Talking Machine Company around 1922. When this article was written in 1938, television was still a daring experiment, the ultra-high frequencies were in their infancy, and the vast area of solid-state electronics was yet to be opened for exploitation. Yet even then, the dynamic character of both corporation and industry were clearly

visible, revealing great growth potential in any direction chosen.

The author of the article was himself an intimate part of the scene which he describes. John Chester Warner was Vice-President of the Radiotron Division, RCA Manufacturing Company, at the time of his tragic and untimely death in an automobile accident in 1938, at the age of forty-two. Born in Freeport, Illinois, in 1896, he studied at Washburn College, the University of Kansas, and Union College, earning the degrees of master of arts and master of science in electrical engineering. In 1919, he joined the research staff of the General Electric Company in Schenectady. Through the 1920's, he was associated closely with the receiving tube research. In 1932, following the separation of RCA from the General Electric and Westinghouse companies, Warner was appointed Manager of the research and development laboratory of the RCA Radiotron Company at Harrison. He was named Vice-President of Radiotron in 1934, a year before the organization became the Radiotron Division of the new RCA Manufacturing Company.

Warner himself possessed a large share of the energy and vision which characterize RCA as a corporation. It is remarkable to find, in an official

memorandum which he prepared in 1934, a list of recommendations including the following:

"There are some additional speculative possibilities in semiconductive devices which we cannot afford to overlook because of their possible competition with thermionic tubes. The prediction has been made by some that these devices will some day perform all the functions of a vacuum tube without enclosure in a vacuum."

This was only one of many recommendations, but one which leads to interesting speculation. What if the limited facilities available in the depression year of 1934 had permitted full concentration on semiconductor devices as well as upon the television and high-frequency studies whose greater immediate importance was recognized by Warner and associates?

But the history of RCA is an account not of opportunities missed, but of opportunities consistently seized with vigor and imagination to create the new products and services upon which a great corporation and a great industry have been built. Because the story carries on into the present and looks to the future, a subsequent article covering the period from 1938 to the present day will be published in an early issue of RCA ENGINEER.

The purpose of these articles is more than simply orientation for the members of RCA's engineering staff. The record is a proud one. It is an advantage for us to be aware of the pioneering tradition which is ours today.

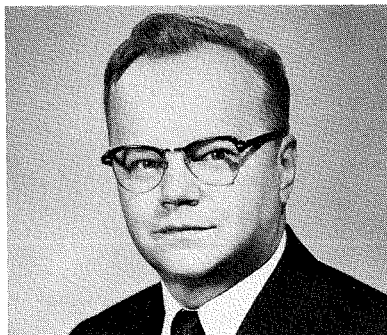

DR. ELMER W. ENGSTROM'S biography, which is familiar to many readers of the RCA ENGINEER, is included in his paper, *Systems Engineering—A Growing Concept*, Vol. 2 No. 5. The Editors are fortunate in having an author with Dr. Engstrom's long experience in research and engineering devote his time, not only to introducing the first part of the *History of RCA* series, but to continuing Mr. Warner's story up to the present in the concluding article, to be published in a future issue.

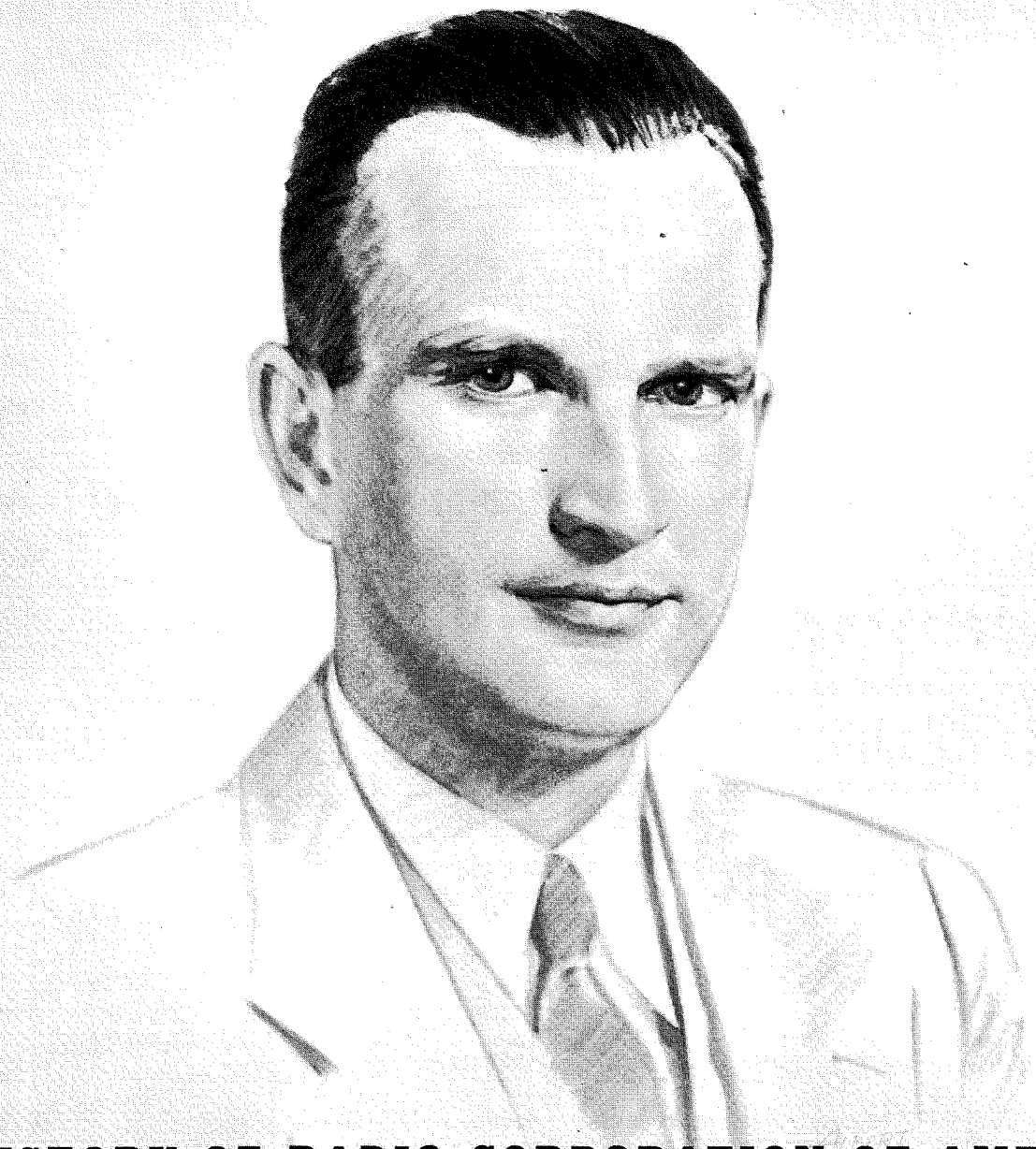

A HISTORY OF RADIO CORPORATION OF AMERICA

— THE YEARS TO 1938

By J. C. WARNER

*Vice President (1934-1938), Radiotron Division,
RCA Manufacturing Company, Inc.*

IT WOULD BE misleading for me to imply that anything approaching a complete history of the Radio Corporation of America could be covered in the brief time which we can spend together. While the company is only a little over 18 years old several volumes would be required to do a really thorough job. However, I shall try to review some of the high points in the history of the company, and to cite the progressive changes in organization

and their relation to the progress of the company in radio and allied fields.

It has often been said that "the story of the Radio Corporation of America outlines the larger story of the radio era," i.e. the era of radio broadcasting. Peculiarly enough the company was not organized with radio broadcasting in mind, although it is significant that the man whose name is so closely associated with the history of RCA and who has for many

years been its active head, had clearly visualized the possibilities of radio broadcasting service and even "electric tuning" long before broadcasting made its first appearance. I refer, of course, to Mr. David Sarnoff.

RADIO—A NEW COMMUNICATIONS SERVICE

At the close of the war the only company in a position to handle commercial transatlantic radio communi-

cations was the Marconi Wireless Telegraph Company of America, although the stations which it had operated before the war were in the hands of the Government who had taken over all such stations for wartime purposes. This company was an offshoot of the British Marconi Co. and was largely owned by English interests.

At this time the best known means of long distance transmission was the Alexanderson high frequency alternator, the patents on which were owned by the General Electric Company. Negotiations between General Electric and the American Marconi Company, which had started several years previous, but had been interrupted by the war were resumed in 1919 for the purpose of transferring patent rights as well as alternators to the Marconi Company which was anxious to expand its transatlantic services.

Certain high officials of the Government learned of these negotiations and were unwilling to see a growing communications service under foreign control, particularly since the transatlantic cables were in the hands of foreign, though friendly, nations. Consequently they suggested to the General Electric Company that negotiations be suspended until after discussion with the Navy Department. This was in April 1919 and it is interesting to note that the letter to the General Electric Company was written by Mr. Franklin D. Roosevelt, then Acting Secretary of the Navy.

FORMATION OF RCA

As a result of conferences with the Navy a plan was developed for forming a new American company to take over the assets of the American Marconi Company. So, on October 17, 1919, the Radio Corporation of America was incorporated, and on November 20, 1919 the entire business of the Marconi Company was taken over.

GE held a substantial interest in the new company, and immediate arrangements were made between RCA and GE to cross-license each other to use the radio patents of the GE Company and the patents RCA had just acquired from Marconi. Work was started at once on new high power alternator stations in California, Massachusetts and Hawaii.

But another patent deadlock soon appeared particularly with respect to vacuum tubes. The possibilities of long distance shortwave communications were unknown at this time. In fact, wavelengths under 200 meters were relegated to the supposedly unimportant use of amateurs. But, tube transmitters were needed for medium power services and, of course, tube receivers were essential.

Strong patents on vacuum tubes were held by both GE and the Western Electric Company, but neither could make effective use of its own patents without infringement of the other's. Again the Navy lent a hand and persuaded the GE Company and AT&T Company to come to an understanding "For the good of the public." This was in January 1920.

TRANSOCEANIC SERVICE BEGINS

In February 1920, the stations which had been taken over from the Marconi Company by the Government during the war were turned back to the new RCA, and a foreign communications service were inaugurated. One of the principal stations was in New Brunswick, N. J., and the long-wave antenna there has no doubt been seen by a great many of you. During that year, foreign service was established with England, Germany, France, Norway, Japan and Hawaii.

In July 1920 an agreement was reached between RCA, GE, and AT&T which permitted RCA to proceed with the use of all radio patents of these companies.

BEGINNING OF BROADCASTING

During the first year of the RCA attention was directed almost exclusively on communications, but in 1921 the first rumblings of what soon was to become a broadcasting boom began to be heard. A number of experimenters had been playing with the idea of transmitting phonograph music over somewhat crude telephone transmitters.

WESTINGHOUSE JOINS RADIO GROUP

Westinghouse had done a certain amount of radio experimentation in its laboratories, and shortly after the formation of RCA began to consider going into the radio field. A subsidiary company was set up known as The

International Radio Telegraph Company which had acquired a large group of Fessenden patents from the old National Electric Signaling Company. Consideration was given to going into the communications business, but difficulties were encountered in that the important European stations were all tied in with the stations of the Marconi Co. now held by RCA.

To strengthen their position Westinghouse acquired a group of Armstrong and Pupin patents, among which was the Armstrong "feed-back" patent later to become quite famous. Finally, in 1921, a cross-license agreement was made between RCA, GE and Westinghouse, and Westinghouse now became a member of the radio group.

BROADCASTING BEGINS

Meanwhile, strenuous efforts were being made to get broadcasting started. The pioneer licensed station of the United States, and of the world, was KDKA, of the Westinghouse Company, in Pittsburgh, licensed by the Department of Commerce on October 27, 1920. This station broadcast election returns in November of that year. RCA first entered this field on July 2, 1921, when a one-day broadcast was made from a temporary station at Hoboken, N. J., on the occasion of the Dempsey-Carpentier fight. Soon after, RCA opened station WJZ at Roselle Park, N. J., which continued for some months, when it was shut down on account of interference with station WJZ of the Westinghouse Company in nearby Newark. RCA then went in as halfpartner with Westinghouse in the management of WJZ. Broadcasting was really on its way.

WIRELESS SPECIALTY COMPANY

Another corporate element entered the picture in 1921, the Wireless Specialty Apparatus Company. This was a Massachusetts concern largely occupied in making apparatus for the Tropical Radio Company, which in turn was a subsidiary of the United Fruit Company, and which operated coast and ship service for the large United Fruit fleet. GE bought into Wireless Specialty, and again made license arrangements which cleared up a few more of the patent obstacles to RCA's progress.

A FORMATIVE PERIOD

These first two years cover what might be called the formative period of RCA. It was a period during which all of the important American companies which could play a part in the development of the radio field of that time were brought into a workable relationship.

It was a fortunate coincidence that the end of this two year period came just at the threshold of the development of the new broadcasting industry. In fact it is a fair statement that without the removal of the many previous obstacles, broadcasting itself would never have developed on a national scale in such a short time.

RCA ENTERS MERCHANDISING FIELD

Just prior to the start of broadcasting RCA had given thought to furnishing apparatus to radio amateurs both for reception and transmission. As broadcasting appeared, the line of amateur apparatus was expanded as quickly as possible to include home broadcast receiving equipment, and RCA now entered the merchandising field with GE and Westinghouse as manufacturers

son with the present. For that reason I shall digress for a few moments to describe some of the things which were offered for sale. The catalogue was entitled "Radio Enters the Home," and since in this period every man had to be his own serviceman all the accessories imaginable were included as well as many parts for the experimenter to make his own set.

The cheapest receiver listed was a steel box containing a single-circuit tuner and crystal. This sold for \$25.50 with headphones, antenna equipment and "full instructions." More elaborate crystal sets were available at \$32.50 and \$47.50. The cheapest tube set was the one-tube "Aeriola Senior" made by Westinghouse—it used a WD-11 tube in a regenerative circuit and sold for \$75.90 with batteries and antenna, and for \$65.00 without the accessories. This was a very popular set in its day and it is quite likely that a few of them are still in use.

GE supplied a set made in steel boxes. The two units comprised a tuning system in one box and a three-tube

were four ballast tubes to avoid use of a filament rheostat. No emphasis was placed on the number of tubes since the practice of stressing this had not yet appeared. This set sold for \$401 with all accessories.

The only load-speaker shown was similar to a brass automobile horn with a telephone receiver on the end—which sold for \$30.00. It is interesting to note that a phonograph attachment was available at \$18.00 which consisted of a telephone receiver element to be attached to the tone arm of the phonograph so as to get the equivalent of a loadspeaker. There were two models—one for Victrolas and the other for Graphanolas.

FIRST RADIO TUBES

At this time RCA sold four types of receiving tubes. Two were made by Westinghouse and two by GE. The Westinghouse tubes were designed and manufactured in East Pittsburgh and the GE tubes were designed in their Research Laboratory at Schenectady and manufactured in two of the GE lamp factories, one at Nela Park,

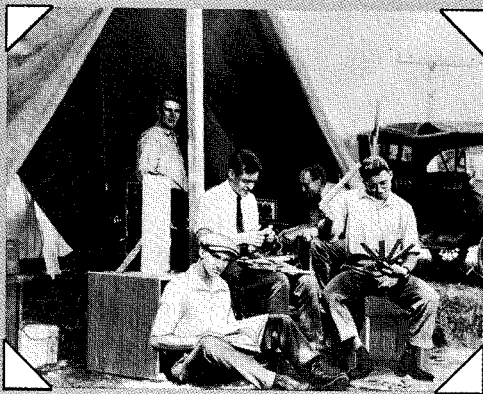

First RCA laboratory (1919) was located at Riverhead, Long Island

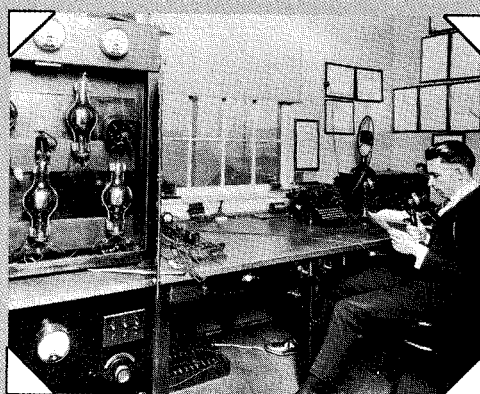

Broadcast stations in the formative years were crude by present standards



Early recording sessions were waxed without electronic processing methods

(Wireless Specialty also furnished a small amount of apparatus for a time). As later developed, this arrangement had many disadvantages but remember that at the time it was probably the only way in which the RCA could get started. It was, so to speak, a condition of RCA's birth.

In 1922, RCA got out a catalogue of radio equipment which well illustrates the conditions of that day in compari-

son with the present. For that reason I shall digress for a few moments to describe some of the things which were offered for sale. The catalogue was entitled "Radio Enters the Home," and since in this period every man had to be his own serviceman all the accessories imaginable were included as well as many parts for the experimenter to make his own set.

The most elaborate set was the "Aeriola Grand" made by Westinghouse. This had four tubes, a regenerative detector and, in addition, there

detector-amplifier in the other box, and sold complete for \$250.00. Westinghouse supplied a somewhat similar receiver in a wooden box at \$261.75. This also comprised two elements, one of which was a single circuit tuner, the other a detector-amplifier.

Cleveland, and the other in the Edison Lamp Works at Harrison, the same plant which is now the Radiotron Works of our own company. Tubes were also sold by E. T. Cunningham, Inc., first on the West Coast, and later throughout the country. Mr. Cunningham for some years had been making tubes for amateurs on the West Coast, and seeing the possibilities of merchandising tubes on a large

Early radio transmitter towers of station WJZ, Bound Brook, N. J.

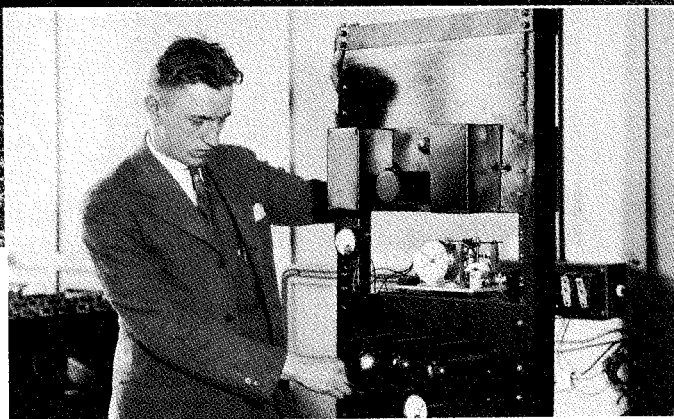
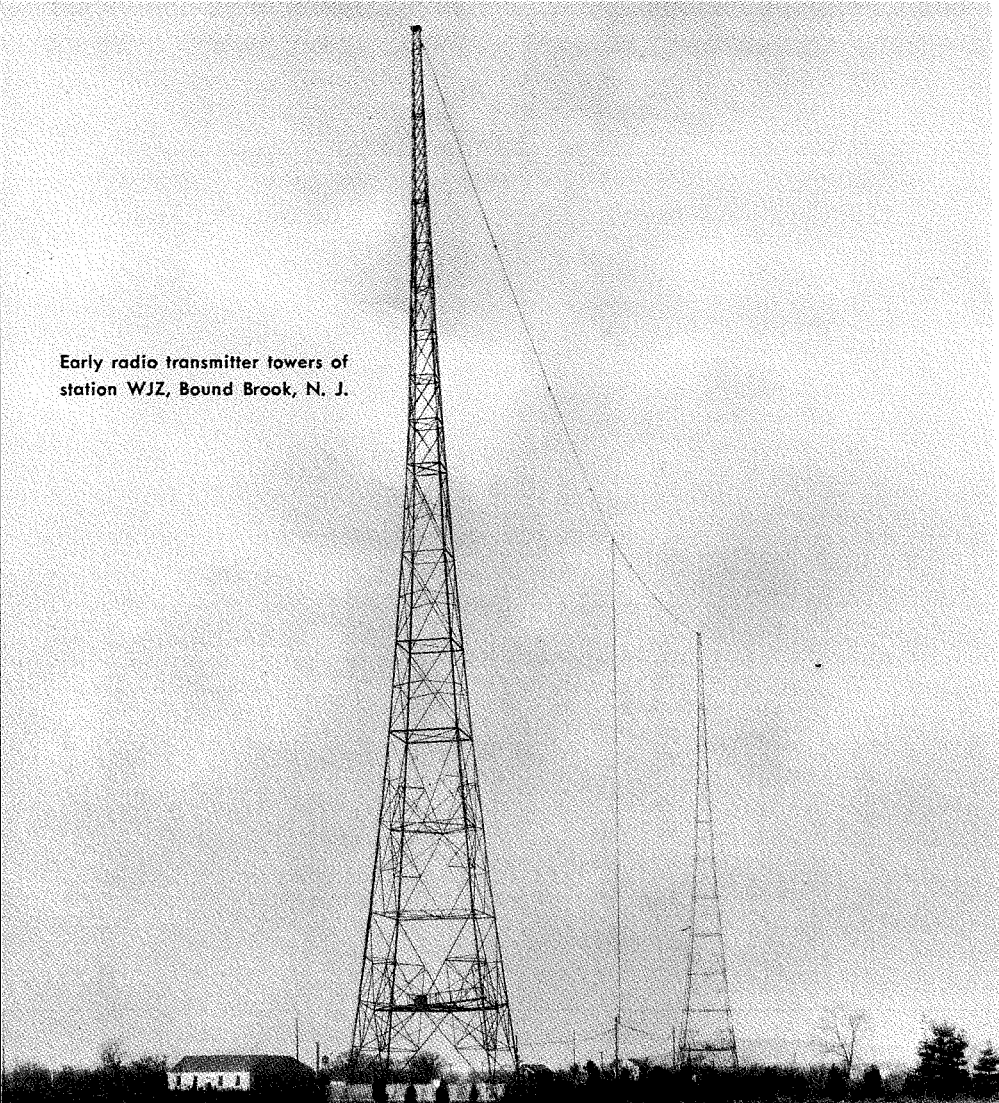

Lester J. Wolf, currently in DEP Radar Projects at the Moorestown plant, is shown with a developmental quartz crystal frequency standard at Westinghouse, 1928-29.



Original studio and operating room, station WBZ, Springfield, Mass., in 1921. Horace R. Dyson, Staff Engineer in DEP Technical Administration, is the operator in the background.

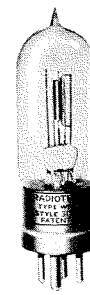

WD-11 Detector Amplifier—1920

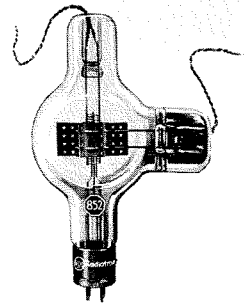

852 Transmitting triode—1927

scale he entered into an arrangement with RCA in 1920 which gave him the right to sell tubes under his own name. They were the same as RCA tubes but had different type numbers.

RCA PROGRESSES IN ALL FIELDS

The years 1923, 1924 and 1925 brought numerous advances in the RCA fields. To mention only a few—in 1923 two broadcasting stations were opened by RCA in New York and one in Washington. In 1925 the first WJZ transmitter was installed at Bound Brook, N. J. Short-waves came into use for long distance communications, first to supplement the high power long-wave transmitters, and later to take over practically all of the long distance service. Trans-oceanic communications were extended to additional European and South American countries. The first superheterodyne receiver was brought out in 1924. In 1925 a receiver was sold with accessories permitting it to be operated from alternating current. In the same year the electrodynamic loud speaker was brought out. Apparatus was developed for recording and reproducing records electrically. Improvements were made in tubes greatly reducing the power consumption.

In 1925, RCA furnished certain components to the Victor Talking Machine Company which were built into a radio-phonograph combination employing a single speaker. This is significant as the first step in very important later developments.

RCA ONLY A SELLING AGENCY

Remember, that during this period and for several years after, in the merchandising field RCA itself was only a selling agency. The manufacturing was done entirely by the electric companies. Receivers were made at Schenectady by GE and at East Pittsburgh by Westinghouse. Receiving tubes were engineered at East Pittsburgh and Schenectady, and were made in GE lamp factories at Cleve-



UX-222 Sharp-Cutoff Tetrode—1927

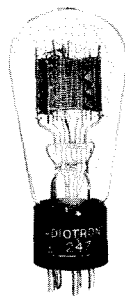

247 Power Pentode 1931

land, Harrison, and later at Newark—also in Westinghouse factories, at East Pittsburgh, Bloomfield, N. J., and later at Indianapolis (in what is now our Indianapolis Plant).

It must already be evident that the problems of coordination began to be tremendous. RCA first utilized the electrical laboratory of the City College of New York, which was in charge of Dr. Alfred N. Goldsmith, to test new models of apparatus. This was quickly outgrown and the Technical and Test Department of RCA was established in its own building at the edge of Van Cortlandt Park in New York. Here samples of apparatus were submitted independently by GE and Westinghouse, tested and reported back to the manufacturing companies, with approval or suggested changes.

It soon became necessary for RCA to have the same apparatus regardless of which company made it. In the case of tubes it was particularly essential to have uniform designs from all factories so they could be interchangeable in any receiver. Of course, this was long before the time tubes were shipped in sets.

EFFORTS ON COORDINATION

In an attempt to accomplish this necessary coordination, "design" or "standardization" committees were set up separately for receivers and tubes, comprising representatives of GE and Westinghouse. The tube committee which started in 1924 perhaps best serves to illustrate the unwieldiness of such an arrangement, which I will describe in some detail.

This committee was known as the Radiotron Standardization Committee. It was made up of representatives from East Pittsburgh, Cleveland, Schenectady, Bloomfield, and Harrison—two and sometimes three from each. It met once a month around the circle and attempted to arrive at agreements on tube designs, ratings, characteristics, and even some production problems. It had no direct rep-

resentation from the receiver divisions so the coordination with them was supposedly handled by the East Pittsburgh and Schenectady tube representatives, and the ideas and needs of the receiver engineers carried to the tube meetings. The main committee carried with it a train of sub-committees and coordination groups intended to handle specific technical items. Needless to say this kind of an arrangement was in many ways unsatisfactory, yet it is difficult to visualize any better method under the then existing company relationships.

The "Design" committee on receivers operated in much the same way as the tube committee, but with some advantage in having only two groups involved. It finally became necessary to set up an additional receiver coordination committee which included RCA representation. One of their first subjects of discussion in 1927 was the "Radiola 16," and another model which became the "Radiola 17," which was the first real a-c receiver using a-c tubes.

The loss of time inherent in the inter-company committee method of coordination was a major handicap to progress in engineering, manufacturing, and sales, but it remained until new major changes in organization came to pass, as we shall see later.

FORMATION OF NATIONAL BROADCASTING COMPANY

Going back to 1924, the AT&T was actively developing the use of wire lines for furnishing programs to broadcast stations and they set up WEAf as the source of these programs. In 1926 RCA and its associates took steps to integrate a complete broadcasting service and formed the National Broadcasting Company. This was a recognition by RCA officials that this new service had the possibilities of an important industry and that a specialized organization was necessary to develop programs, to install new stations and to maintain a satisfactory continuous service to their own as well as other stations.

The new company acquired station WEAf from the AT&T, and also took over the stations owned by RCA and thereby created the real beginning of the network broadcasting industry.

RCA LICENSES OTHER RADIO COMPANIES

In 1927, a major step was taken in a new direction, the licensing of other manufacturers under RCA patents. It was inevitable that the demand for broadcast receivers would lead other companies into the business, and a large number had by this time become established. The granting of licenses to these companies strengthened their position, but at the same time gave RCA a rightful return for its huge investment in patents obtained through the research and engineering of the radio group and also by purchases from other inventors.

At first the superheterodyne patents were not included in the licenses. Also it was not until two years later that tube licenses were granted, although a number of lamp and other manufacturers were actively making tubes.

RADIOMARINE COMPANY FORMED

Late in 1927, the ship-to-shore telegraph business of the RCA, which had been growing steadily, was segregated into a new subsidiary company—the Radiomarine Corporation of America.

RCA PHOTOPHONE ORGANIZED

In 1928 a new offshoot of the radio business appeared. For several years work had been going on in the GE laboratories to perfect a system of recording sound on film. This was now ready for commercial exploitation in the motion picture industry and RCA Photophone Company was organized to handle this business.

RCA PURCHASES VICTOR COMPANY

1929 was a year of far-reaching changes in the organization of the RCA group which constituted the first major step towards integration of the company into a self-contained, self-controlled radio business.

I have mentioned already some of the handicaps inherent in the arrangements whereby RCA did the selling while the other companies manufactured. This method was wholly inadequate to meet the quick moves of the independent competitor. Furthermore, the electric companies naturally wanted to make a profit and so did RCA. This seriously handicapped the coordination of sales and production which is so essential to the success of an entire operation. RCA needed its own manufacturing facilities.

The "Radiola II", an early radio marketed by RCA at the start of the '20's. The word "Radiola" was coined by Dr. Alfred N. Goldsmith in a note to General Sarnoff supporting his concept of a "Radio Music Box" for home entertainment.

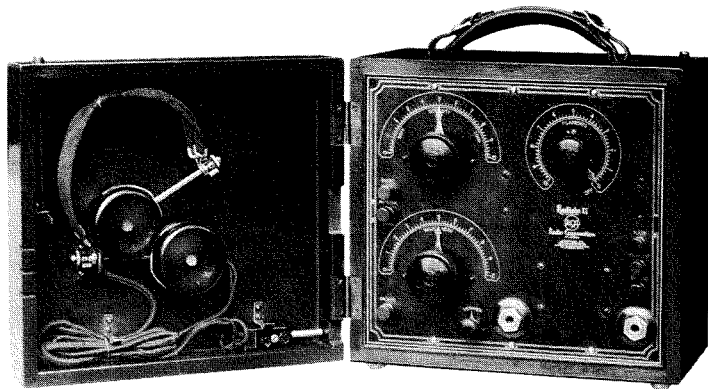

The Victor Talking Machine Company at Camden had been seriously affected by the growth of radio and had not been particularly successful in its attempts to enter the radio field. In order to obtain manufacturing facilities RCA purchased the Victor Company including the manufacturing plant, what was left of the phonograph business, and the Victor dog trademark. Arrangements were also made whereby RCA took over tube manufacturing from GE and Westinghouse. RCA acquired the entire Edison Lamp Works property of the GE at Harrison, and also the Westinghouse factory at Indianapolis, and at the end of the year the RCA Victor Company and the RCA Radiotron Company were organized.

RCA COMMUNICATIONS FORMED

In this same year the RCA Communications Company was formed to take over all of the business in trans-oceanic communications.

CONSOLIDATED RESEARCH, ENGINEERING, MANUFACTURING AND SALES

In 1930 RCA completed the consolidation in the RCA Victor and Radiotron companies of all facilities of research, engineering, manufacturing, and sales

of RCA products which now for the first time included phonographs and records. Somewhat later, in 1932, the Photophone business also was taken over by the RCA Victor Company.

Licenses were now being granted to tube manufacturers and the super-heterodyne patents were included in the set licenses. Agreements had also been made with a number of foreign radio manufacturers giving RCA rights under their patents and in some cases access to their laboratories.

CUNNINGHAM COMPANY BOUGHT

In 1931 the E. T. Cunningham Company was taken over by RCA and consolidated with the RCA Radiotron Company, giving RCA rights to the use of the Cunningham brand and bringing Mr. Cunningham into the RCA organization.

ELECTRIC COMPANIES WITHDRAW

The second and final step toward an independent RCA took place in 1932. In 1930 the Government had brought suit against RCA attacking certain exclusive features of the inter-company agreements, and as the result of a consent decree all the stock interest of GE and Westinghouse in RCA was disposed of by those companies. AT&T

had disposed of its stock interest in RCA some years before. Modified cross-license patent agreements were entered into with the approval of the Attorney General and the sanction of the Court. RCA now became a completely self-contained organization with wholly owned subsidiary companies operating a broadcasting business, a communications business, a marine radio business, a radio school, and a manufacturing and merchandising business.

DE FOREST COMPANY PURCHASED

In 1934 the tube business was augmented by the purchase of certain patents from the defunct De Forest Radio Company. This brought about the beginning of transmitting tube manufacturing by RCA Radiotron.

RCA VICTOR AND RCA RADIOTRON MERGE

In 1935, the manufacturing and merchandising business was further consolidated by the merger of the RCA Radiotron and RCA Victor Companies which now became the RCA Mfg. Co.

IMPORTANCE OF DIVERSIFICATION

Before concluding I want to emphasize one phase of the history of RCA which so far I have mentioned only indirectly, yet which stands out with clearness and significance in the whole course of the 18 years of RCA's life. I refer to product diversification. A study of the history of RCA is well worth while if it does no more than demonstrate the value of diversification, and its paramount importance to us in looking toward the future.

The corporate history is a sort of family tree in which certain elements contributed at the start, but which were later separated from the new growth. I shall use another horticultural analogy to illustrate product diversification.

Certain varieties of trees are responsive to wide differences of training. Two plants may sprout from the ground exactly alike, side by side. One of them may be trained to grow perfectly straight with a central trunk and beautiful symmetry. The other may be trained into a large bush-like growth with many branches.

Two companies may also start in

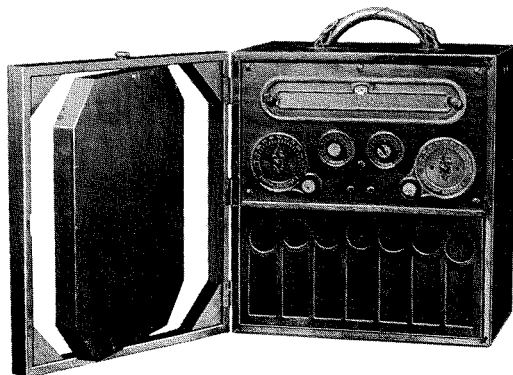

The "Radiola 26", an early superheterodyne portable receiver. The lid contained a rotatable loop antenna which was also dial-tuned for maximum sensitivity.



John B. Coleman inspecting a transmitter in Camden, ca. 1936. Mr. Coleman is presently Administrative Engineer, Product Engineering, RCA

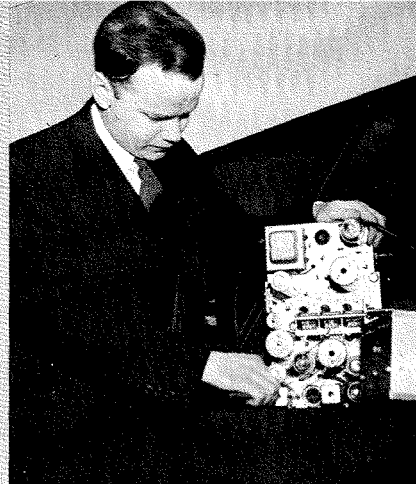

Dr. Elmer W. Engstrom working on a radio receiver in a Camden research laboratory in 1934



Clarence A. Gunther is shown making receiver tests in a Camden laboratory, ca. 1935. Mr. Gunther is now Chief Defense Engineer, DEP

the same way from small beginnings. One may be concerned with a single product or a narrow field while the other grows many branches, large and small. We may have a great admiration for the tall straight tree, but if a storm comes along and breaks off the top it may be years before it recovers its original form. The same storm has little effect on the other tree. It may pass over without harm or even if a few branches are broken they may be trimmed off without showing.

The one-product company may do admirably in times of prosperity and we may envy its simple operation. But if it meets with changing conditions or times of depression the "one product" may no longer be in demand and the company has nowhere to turn.

Suppose that back in 1921 RCA had said "No, we aren't interested in radio entertainment, we are in the commercial communications business." Again

suppose RCA had looked at talking pictures and said "No, we aren't interested, we are in the radio business." Again, after acquiring the Victor Company suppose RCA Victor had said "We will let the phonograph business die. It doesn't amount to much and we want to sell radio receivers." There are several obvious answers to these suppositions, but the uppermost in our minds probably is that if these things had happened most of us wouldn't have our jobs.

PUBLIC SERVICE IS PARAMOUNT

The strength of a company is in a large measure proportional to its service to the public. The RCA has grown as it has extended its fields of public service. It will continue to grow just so long as it utilizes its variety of resources to give the public new or better services, or new or better products.

It should never be forgotten that a

by-product often becomes a main product. Again, the limitations of a product or service today may turn into advantages of tomorrow. The often alleged lack of secrecy in radio communication was once talked of as a handicap, but broadcasting, as its name implies, made good use of this so called handicap.

RESEARCH INSURES PROGRESS

Research has played a major part in the evolution of the RCA and must continue to do so. I use the term not alone in a technical sense but broadly—research in sales methods, in advertising, in relations with the public, in better understanding and organization of our personnel, as well as in engineering and manufacturing of our products.

Research provides the new food which the tree needs when the old is exhausted or no longer suitable. The tree must grow or it will die and a company must go ahead or back. It never stands still. RCA has made good use of its resources to expand its fields of activity. But it is a safe prediction that if we live up to our opportunities we will some day look back at 1938 and see that we have now only started to scratch the surface. Facsimile is barely started. Television is still ahead of us. Commercial Sound applications are getting under way. A multitude of ultra-high frequency applications are certain. And outside the radio or entertainment fields the field of electronic devices is in its early infancy.

I hope that this brief story of the RCA has served to show something of how far we have come but more important, how much farther we can go in the future.

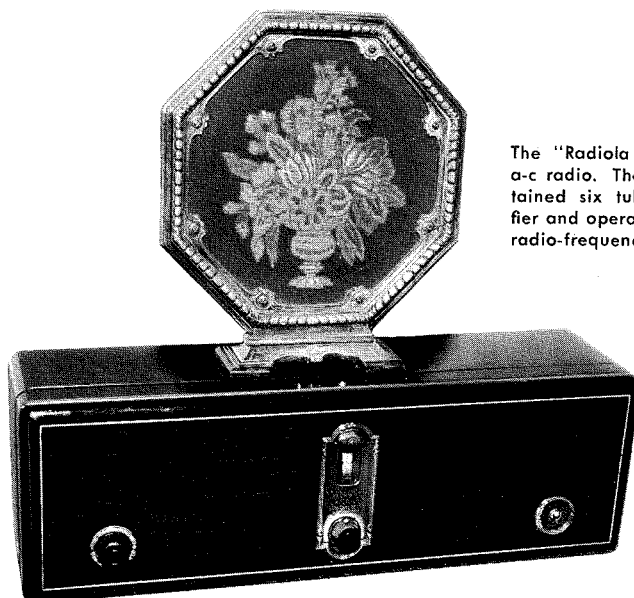

The "Radiola 17"—the first a-c radio. The receiver contained six tubes plus rectifier and operated on a tuned radio-frequency principle

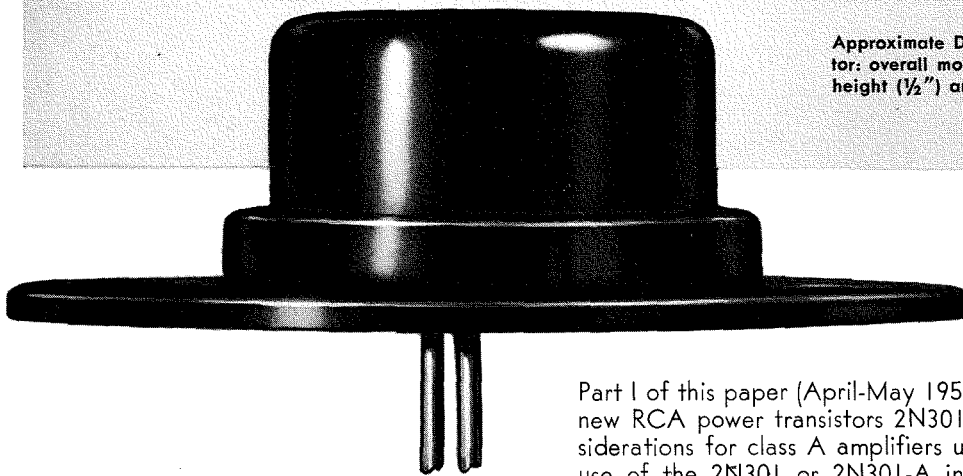

Approximate Dimensions of 2N301 Power Transistor: overall mounting flange length ($1\frac{1}{2}$ "), overall height ($\frac{1}{2}$ ") and shell diameter ($\frac{3}{4}$ ").

Part I of this paper (April-May 1957 issue, pages 23 to 26) described the new RCA power transistors 2N301 and 2N301-A and gave design considerations for class A amplifiers using these types. Part 2 discusses the use of the 2N301 or 2N301-A in class B amplifier circuits. Figures 1 through 7 are used in Part I dealing with Class A Amplifiers. Thus, the illustrations in this article begin with Fig. 8.

APPLICATION OF POWER TRANSISTORS TO CLASS B OUTPUT

PART NO. 2— CLASS B AMPLIFIER

By

ROBERT MINTON

*Application Engineering
Semiconductor Division
Somerville, N. J.*

CLASS B PUSH-PULL POWER AMPLIFIERS

CONSIDERABLY MORE POWER output or power efficiency can be obtained from power transistors in class B operation than in class A operation. In a class B push-pull audio-frequency amplifier, the transistors are biased approximately to cutoff. This type of amplifier is characterized by high collector-circuit efficiency and relatively high power output in proportion to average dissipation in the transistors. During periods of zero signal, power-supply drain and collector dissipation are very low.

In the design of class B push-pull amplifiers, the following transistor characteristics are of importance to the circuit designer:^{1,2} (1) maximum collector dissipation, (2) maximum peak collector current, (3) maximum collector voltage, (4) input characteristics, and (5) base-to-collector current transfer characteristics.

DESIGN OF CLASS B POWER-AMPLIFIER STAGES

In most cases, the supply voltage, power output, power gain, and maximum distortion limits are specified for a particular application (for example, the output stage of an automobile receiver). The first step in the design of

the class B amplifier, therefore, is the choice of the zero-signal operating point for the transistor. Class B operation implies that the transistors are biased to cutoff so that the static operating collector current and collector dissipation are reduced to zero. It is impractical to use zero bias, however, because the nonlinearity in the small-signal region causes a high percentage of nonlinear or crossover distortion, especially at low signal levels.

For any given transistor type, there is a particular value of base bias that results in a good balance between crossover distortion and collector-circuit efficiency. Fig. 8 shows the composite transfer characteristic for two 2N301 or 2N301-A transistors in class B operation. As shown on the curve, a convenient method for determining the operating point is to project the main part of the transfer characteristic curve in a straight line to the cutoff point. The use of this projected cutoff bias appreciably reduces crossover distortion. The remaining distortion can then be reduced by the use of negative feedback.

CHOICE OF LOAD IMPEDANCE

For a given supply voltage, the factors which influence the choice of the load impedance are maximum power-dissipation and peak-collector-current ratings. The optimum value of collector load impedance should be used to achieve high power gain and good output-circuit efficiency.

Fig. 9 shows a class B push-pull audio power-amplifier stage designed for use as the output stage of an automobile receiver. The transistors used in this circuit must have fairly well matched large-signal characteristics. The average input resistance in the circuit is very low and is extremely nonlinear over the operating range. With a collector supply voltage of -14.4 volts, low values of load impedance must be used to produce appreciable power output. The minimum value of load impedance is determined by the maximum peak-collector-current ratings of the transistors.

Fig. 10 shows the curves of maximum power output at a total harmonic distortion of 10 per cent for various values of collector-to-collector load impedance. For the supply voltages shown, the minimum value of load impedance is determined by the maximum peak-collector current rating of the transistor. Therefore, the maxi-

Fig. 8. Composite transfer characteristic for two 2N301 or 2N301-A power transistors in push-pull class B operation.

imum power output is essentially independent of all transistor characteristics except the peak-collector current capabilities of the transistors.

The power gain of junction-transistor class B amplifiers is a function of input resistance, load impedance, and large-signal current transfer ratio. The power gain can be expressed as follows:

$$\text{Power Gain} = A_{cb}^2 (R_L/R_{IN})$$

where A_{cb} is the large-signal d-c forward current transfer ratio, R_L is the a-c load impedance in ohms, and R_{IN} is the a-c input resistance of the transistor in ohms.

Although there is considerable variation in the input resistance, the power gain may not vary appreciably because the magnitude of the large-signal current transfer ratio increases at low values of collector current. This

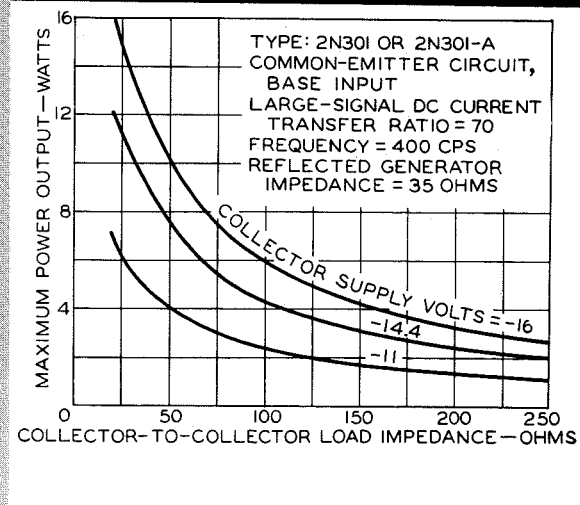
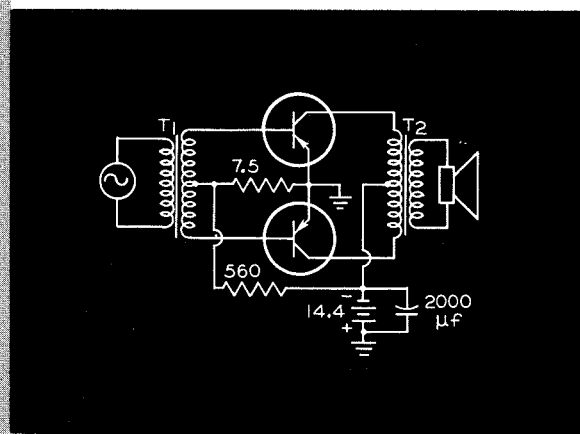
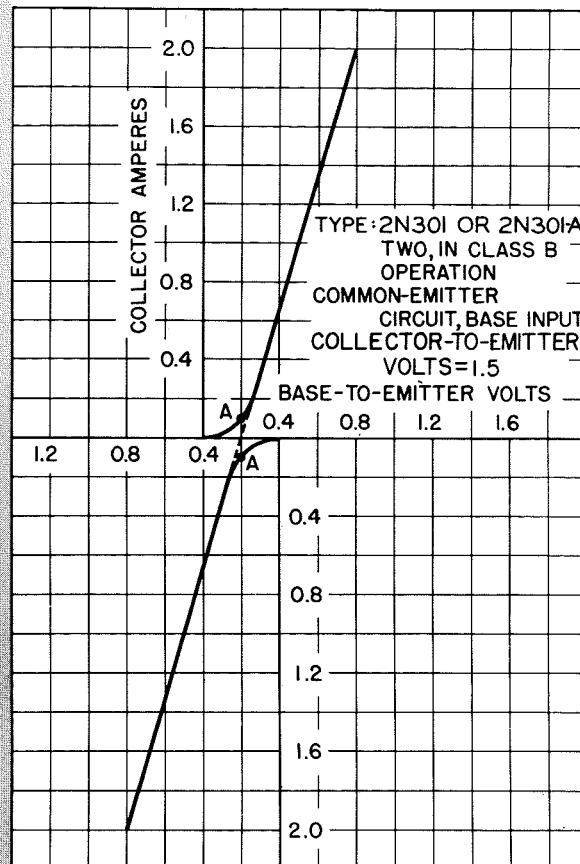

Fig. 9. (Top) Typical base-input, common-emitter push-pull class B circuit.

Fig. 10. (Bottom) Maximum power output of class B circuit as a function of collector-to-collector load impedance.

STAGES OF AUTO RECEIVERS

increase tends to offset to some extent the reduction in power gain which results from an increase in input resistance at low signal levels. The power gain of the common-emitter circuit depends to a large extent upon the load impedance and the large-signal amplification factors. As the load impedance is increased the power gain increases, as shown in Fig. 11.

DISTORTION IN CLASS B PUSH-PULL AMPLIFIERS

Distortion in transistor class B amplifiers is a function of power output, supply voltage, driving source, load impedance, and the large-signal current transfer ratio of the transistor. The effects of these factors are more severe in common-emitter circuits which employ no internal degeneration. Fig. 12 shows the variation of total harmonic distortion with power output. The low-power-level distortion depends primarily on the zero-signal operating point. If the bias point is not chosen properly, the distortion will increase considerably, as shown by the curve for a collector supply of -11 volts. The extent to which the distortion increases at high power levels depends on the degree of mismatch in the current transfer ratio of the transistor, the load impedance, and the collector supply voltage.

EFFECTS OF SOURCE IMPEDANCE ON DISTORTION IN CLASS B PUSH-PULL AMPLIFIERS

The source impedance presented to the input of the class B stage is determined by the type of driving device and the impedance transfer ratio of the driver transformer used. Fig. 13 shows the variation in total harmonic distortion as a function of the ratio of the reflected source impedance and input resistance of the transistor. As the source impedance is increased, the total harmonic distortion increases considerably. The effects of driving-source impedance on distortion in

class B push-pull amplifiers is minimized by the use of a low value of reflected source impedance.

EFFECTS OF TEMPERATURE ON ZERO-SIGNAL OPERATING CONDITIONS

The transfer characteristic curves shown in Fig. 14 illustrate the effects of temperature upon transistors in the common-emitter class B circuit. The operating point is designated by point A on the 25°C curve. If the common-emitter circuit is operated with a constant base-to-emitter bias voltage, an increase in temperature causes an appreciable increase in quiescent output

current and a consequent decrease in the maximum power output and output-circuit efficiency. As the temperature decreases, the quiescent collector current decreases almost to zero. Although there is an increase in maximum power output and a slight increase in efficiency, the crossover distortion becomes appreciable at low signal levels because the transistor operates over the nonlinear portion of the transfer characteristics.

Fig. 15 shows three practical methods of establishing the bias voltage for transistors in class B operation.³ The resistive bias network of circuit A maintains a constant base-to-emitter voltage which is invariant with temperature changes. In this circuit the quiescent collector current increases with an increase in temperature, as shown by curve "A." For optimum performance from a class B power-amplifier circuit over a wide temperature range, some means must be provided to adjust the base-to-emitter bias voltage so that the collector current will remain constant. A temperature-sensitive element may be used in the bias network so that the required change in bias voltage is obtained with changes in temperature.

Circuit "B" incorporates a germanium junction diode designed to provide the required change in bias voltage.⁴ This diode has a resistance-versus-temperature curve whose slope approximates that of the transistor input characteristic. Curve B shows the variation in collector current with temperature for a class B stage using the "compensating" diode in the bias network.

The bias network of circuit C uses a thermistor in conjunction with other

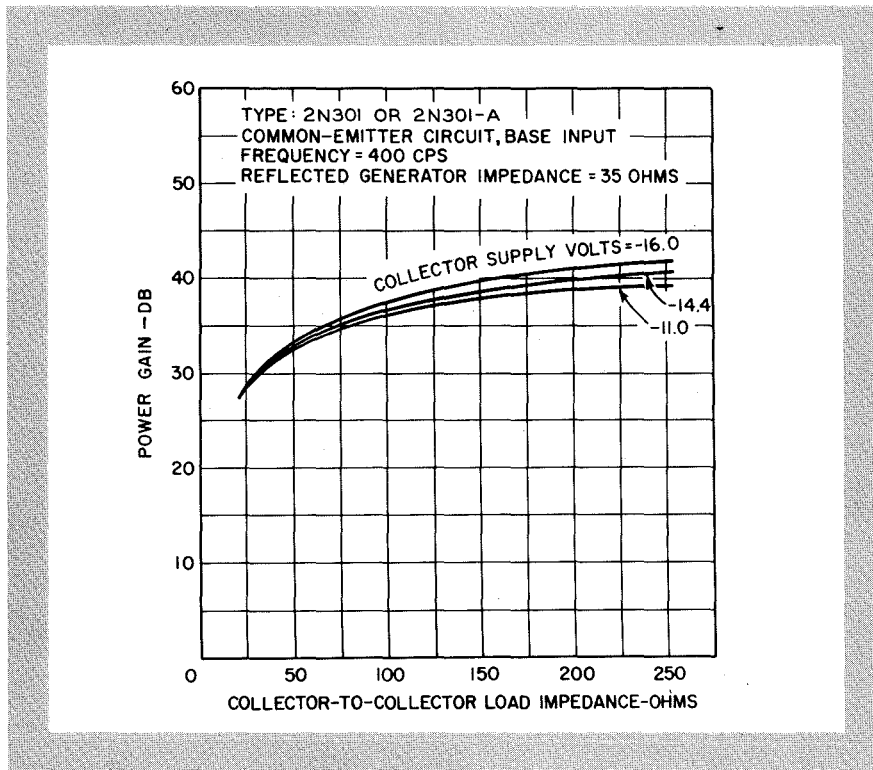

Fig. 11. Power gain of class B circuit as a function of collector-to-collector load impedance.

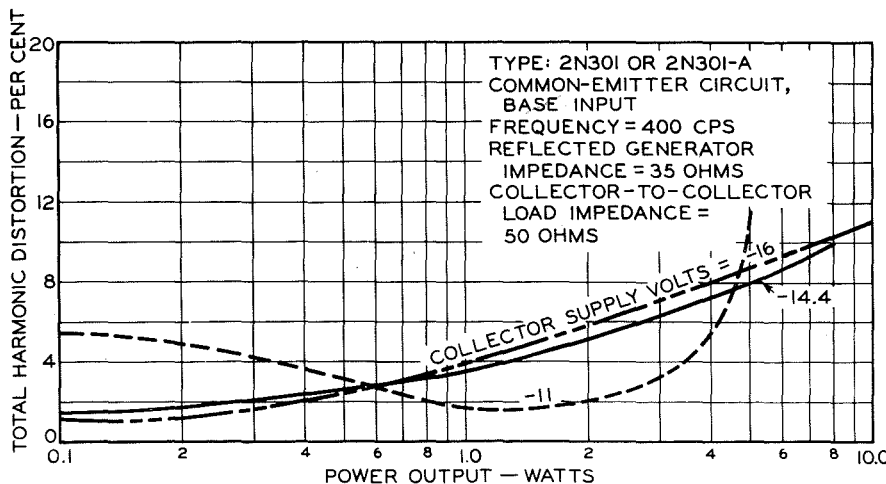

Fig. 12. Total harmonic distortion in push-pull class B circuit as a function of power output.

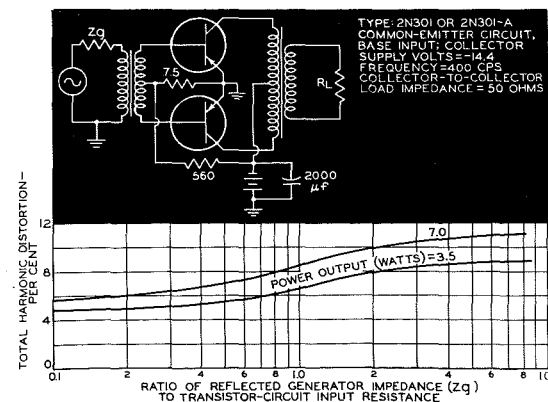

Fig. 13. Total harmonic distortion in push-pull class B circuit as a function of the ratio of reflected source impedance to input resistance.



ROBERT MINTON received his B.S. degree in Electrical Engineering from Howard University in 1951 and his M.S. degree in E.E. from Stevens Institute of Technology in 1956. Mr. Minton joined RCA as a specialized engineering trainee in 1951. At the completion of the engineering training program, he was assigned to Tube Test Engineering in Harrison, New Jersey from 1951 to 1953. From 1953 to 1954, he worked in Semiconductor Test Engineering Laboratory. At the present time, he is a member of the Semiconductor Application Laboratory and is engaged in the design and development of audio frequency circuits.

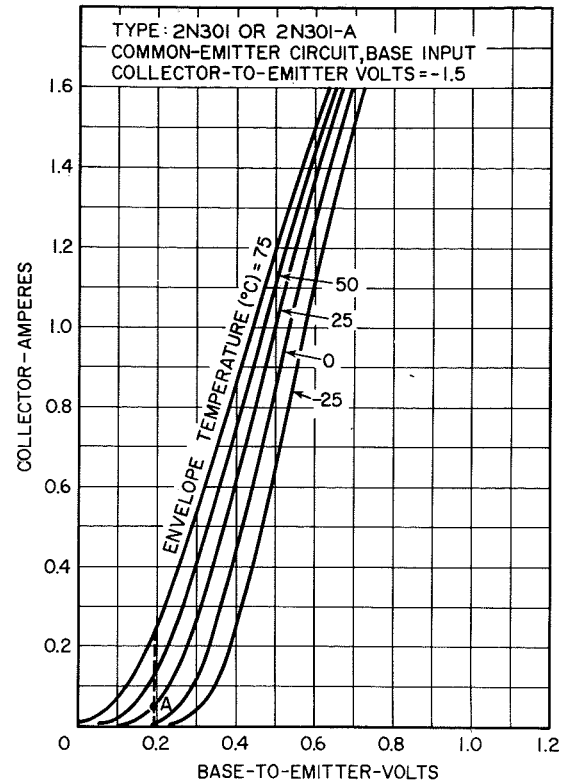

Fig. 14. Curves showing effects of temperature variations on performance of class B circuit.

resistive components.⁵ The desired change in bias voltage is obtained when the resultant network resistance of the bias circuit provides a resistance-versus-temperature curve having a slope approximating that of the transistors input characteristic. Curve C shows the variation in collector current with temperature for a class B stage using the thermistor bias network.

FREQUENCY RESPONSE OF TRANSISTOR POWER AMPLIFIERS

The frequency response of class A and class B power amplifiers is determined

primarily by the characteristics of the transformers and the transistors. The low-frequency response depends on the primary inductance of the transformer. The high-frequency response depends on the leakage reactance and winding capacitance of the transformers and the frequency at which the current transfer ratio of the transistors drops to $\frac{1}{2}\sqrt{2}$ or 0.707 times 1 kc value. Because of the high currents and low supply voltages used, the d-c resistance of the primary of the output transformer should be as low as possible to retain high efficiencies.

REFERENCES FOR CLASS B PAPER

1. W. Hasenberg—"Evaluation of Transistors For Class B Power Output Amplifiers," *Transistors I*, RCA Laboratories, March, 1956
2. K. E. Loofbourrow—"Class B Operation of Transistors"—*Electrical Design*, Vol. 3, p. 28, July, 1955
3. Lo, Endres, Zowels, Waldhauer and Cheng—"Power Amplifiers," *Transistor Electronics*; Prentice Hall Inc. Sept., 1955, pp. 221-224
4. C. F. Wheatley and R. E. Kleppinger—"Transistor Stabilization By Diode Biasing," *RCA ENGINEER*, Vol. 2-No. 5, Feb.-Mar. 1957, pp. 16-19
5. A. J. Wheeler—"Thermistors Compensate Transistor Amplifiers," *Electronics*, Vol. 30, No. 1, Jan. 1957, pp. 169-171

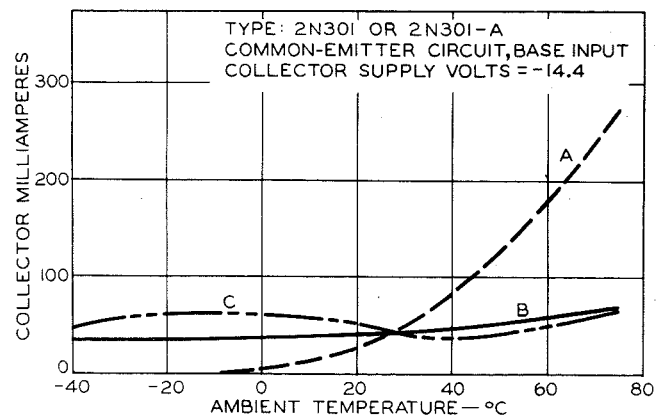
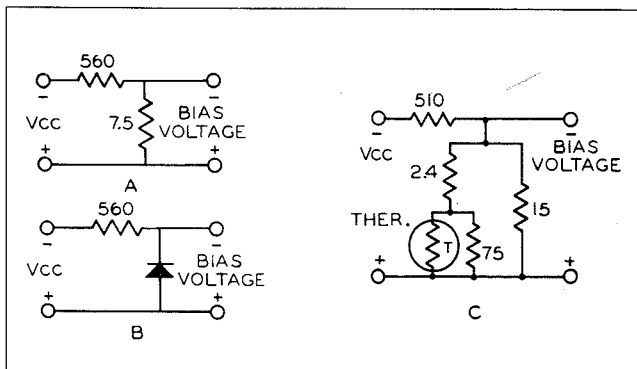

Fig. 15. Collector current as a function of ambient temperature for class B circuits using three types of bias networks.

DEP VALUE ENGINEERING PROGRAM

AS A BUSINESS becomes more complex, the procedures and the nomenclature of the past may require modernization. For example, it is reasonably accurate to state that the present-day function called Value Engineering has evolved naturally from a constant desire on the part of Industry to improve engineering and production efficiency. The dominant theme is greater value per dollar.

COSTS ARE CAREFULLY WATCHED

The high cost of supporting our military programs is a matter of interest to everyone on a nationwide scale. Our attention, as electronic engineers, is focused on this problem for two primary reasons. First, the greatly increased complexity of modern electronic systems has sky-rocketed equipment costs during recent years. Second, the proportion of the defense budget makes it a significant part of our gross national product and hence has a great influence on our economic picture.

Our relative position in American Industry is affected significantly by the relationship of our costs of doing business compared to those of our competitors. Value Engineering is a method of making a frontal assault on this problem. It is important to recognize that as we solve our cost problems we also contribute to a resolution of problems associated with the cost of defense programs.

VALUE ENGINEERING

Mr. T. A. Smith, Executive Vice President, Defense Electronic Products, in establishing and announcing the DEP Value Engineering Program, stated:

"This program is established to accomplish cost reduction action that is vital to DEP in maintaining its position of leadership in the military electronics industry, to assure reasonable growth and opportunities for our people."

In planning the DEP Value Engineering Program it has been recognized that cost reduction is a normal function of

By **R. H. BAKER**, Administrator
Value Engineering
Defense Electronic Products
Camden, N. J.

the organization. The following quote from an article by Mr. L. D. Miles, a pioneer in Value Analysis work at the General Electric Company emphasizes this point, "Value Engineering is not a substitute for the engineering and cost reduction work being done by every progressive company. It's a supplement—it focuses the attention of engineering, manufacturing and purchasing on one objective: equal or better quality, or performance at lower cost."

VALUE ENGINEERING COUNCIL

One of the first steps taken was to establish the DEP Value Engineering Council. This council consists of representatives from each of the line operations of DEP who have been given primary responsibility for Value Engineering within their respective organizations. The function is:

1. Advise and assist the DEP Administrator in planning the program.
2. Develop and coordinate programs to train personnel in Value Engineering.
3. Interchange cost reduction ideas.

A basic premise of the program is that its results will be accomplished through proper action within the product departments. Staff support is for planning and coordination purposes and not for primary execution of the task. It is recognized, however, that important contributions will come from the Central Services and Engineering Activity through proper use of the special talents of its people.

The need for accomplishment in this area of Value Engineering is urgent and again quoting from Mr. T. A. Smith's announcement of the program we find two more fundamental thoughts about it.

"A Value Engineering program can be successful only if its importance is

realized and if contributions are made by all those participating. Since the essential element of American enterprise is competition, and since our progress depends upon being competitive, it is important that we utilize the benefits of Value Engineering to the fullest extent."

AN INDUSTRY PROGRAM

At least twenty major industrial organizations now have Value Engineering Programs. Some have been in effect for several years. All have been found highly effective in achieving savings of major proportions. The Navy Bureau of ships has pioneered Value Engineering in the military services and there is service-wide interest in it. A Navy specification on Value Engineering has been issued and there is evidence that it may be extended to cover other services.

CONCLUSION

We at "RCA-DEP" have a major challenge to face, in finding ways to reduce costs. The policy has been set by our management. The resources to do the job are available. The rate at which we succeed is now entirely up to us.

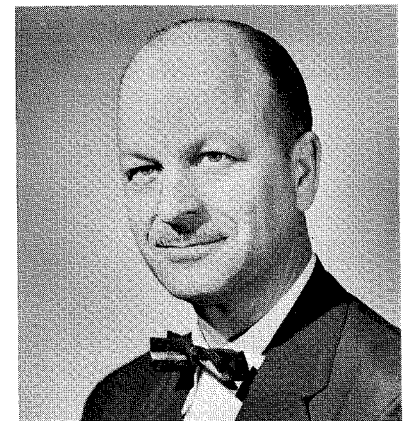

RICHARD H. BAKER is Administrator, Value Engineering, RCA Defense Electronic Products, responsible for planning, promoting, and coordinating the program to provide greater value per dollar in the equipment produced by DEP.

He received his BSME from Case Institute of Technology in 1936. Before joining RCA in 1954 he was Project Engineer for the Vitro Corporation, and was responsible for armament test range design, and management of test support organization. From 1946 to 1951, he served as Assistant Director, Component Test Department, U. S. Naval Air Missile Test Center where he was engaged in guided missile testing. Mr. Baker has also worked in Engineering and Supervision at the Murray Corporation and at Chrysler Corporation.

Mr. Baker is a Senior Member of IRE and a member and chairman of several Electronics Committees. Mr. Baker is a registered professional engineer in the state of California.

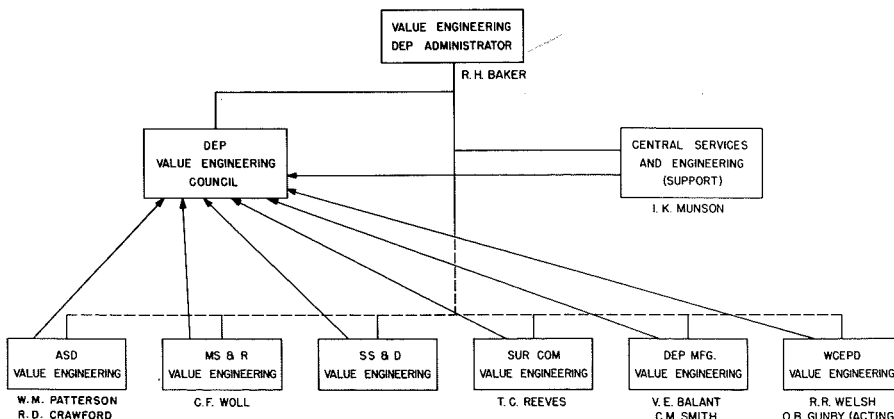

PROCESSING AND TEST OF CERAMIC PERMANENT MAGNET MATERIALS

by
G. S. HIPSKIND and G. KATZ
Components Division, Camden, N. J.

DURING THE LAST five or six years, a number of companies, including RCA, have produced on a commercial scale permanent-magnet materials composed mainly of barium and iron oxides (BaO and Fe_2O_3) or lead and iron oxides (PbO and Fe_2O_3). These magnet materials are called ceramic because the materials and processing methods used are essentially those of the ceramic industry. The fact that these materials contain no nickel or cobalt, in contrast to most other permanent-magnet materials, is of great economic importance because these metals are both hard to obtain and expensive.

PREPARATION OF MATERIAL AND TEST SPECIMENS OF BARIUM FERRITES

Chemically, the ceramic permanent magnets described here can be identified by the formula $\text{Ba Fe}_{12}\text{O}_{19}$. The material is generally prepared in the following manner:

The constituent raw materials are weighed and then mixed, either by dry or wet milling, for a period of $\frac{1}{2}$ to 3 hours. The mixed materials are dried when necessary and loaded into suitable porcelain containers for pre-firing or calcining. The temperature of pre-firing is approximately 2200°F for a period of from 1 to 3 hours. The calcined material is pelletized, after which it is wet-ground in steel mills for periods varying from 24 to 96 hours. The milled oxides are then dried and pelletized. Organic lubricants and binders are added, and the material is separated by pellet size for molding. After the cores are molded, they are sintered in air for a period of 1 to 2 hours. The fired sizes most commonly used for evaluation were 1 inch by 1 inch by $\frac{1}{8}$ inch and $\frac{1}{4}$ -inch diameter by $\frac{1}{2}$ -inch long.

The magnetic properties of ceramic magnets can be made to vary over a

wide range by changes in the basic oxide constituents, purity of BaO and Fe_2O_3 , additives, milling time, calcining and sintering temperatures and time. These processing variations and the resulting properties will be discussed later.

TESTING PROCEDURE

1. *Definitions of important criteria*—Permanent magnets are used to produce an external magnetic field of considerable strength and constancy. Almost all practical magnetic circuits in which permanent magnets are used contain air gaps. When these gaps are not deliberately incorporated in the circuit, they result from imperfect mating of the soft iron used to complete the magnetic circuit. Because of the air gaps, the magnet operates under the influence of a demagnetizing field and not at residual induction value but at some lower value. Thus, the important curve for a permanent-magnet material is that portion of the hysteresis loop that lies in the second quadrant, between residual induction (also, known as remanence or remanent flux density) and coercive force. This portion is called the *demagnetization curve*. Magnetization and demagnetization curves for a material of high coercive force are shown in Fig. 1.

The quantities most useful in the evaluation of materials are the coercive force, H_c , the residual induction, B_r , and the products $B_r H_c$ and $B_d H_d$, the latter being the maximum value of the product of B and H for points on the demagnetization curve (negative sign omitted). Fig. 2 shows a typical BH versus B curve.

Other properties of interests are resistivity, density, strength and curie temperatures. The importance of physical factors, such as magneto-

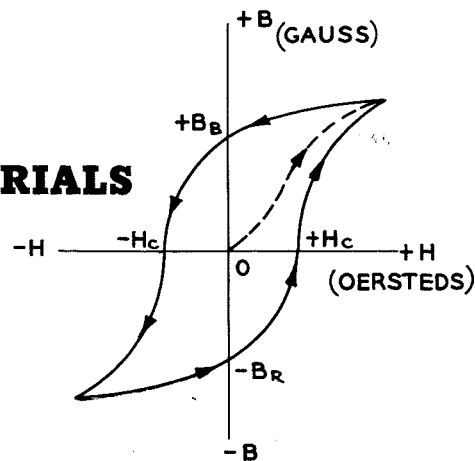

Fig. 1—Magnetization and demagnetization curve of a material having high coercive force (H).

striction, internal strain and so on, will not be discussed in this paper.

In applications such as loudspeakers, the permanent magnet is assembled in the structure, magnetized in place, and supplied to the customer for use. The field strength in the gap should then be as insensitive as possible to shock or vibration, to variation in ambient temperature, or to the presence of external magnetic fields, and should not change with time due to structural or metallurgical aging of the material. After magnetizing, the magnetic circuit is usually "stabilized" to minimize the above changes by the momentary application of a small field in the reverse direction which sets the operating induction some distance down the demagnetization curve.

2. *Energy Product*—A given volume of magnetic material will produce the highest field in a given air space when the induction B in the material is that for which the energy product BH is a

Fig. 2—Demagnetization curve and energy-product curve for metallic magnet.

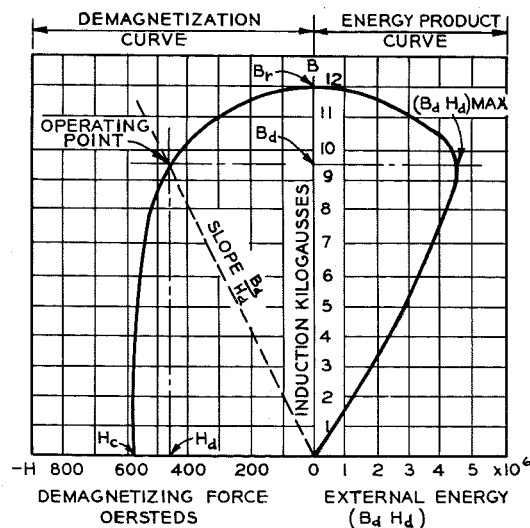

maximum. Consider the ring magnet of Fig. 3, in which L_m , L_g , A_m , and A_g are the lengths and cross-sectional areas of the specimen and the air gap. Because there is no field due to external sources,

$$\int H dL = 0 \quad (1)$$

when the integration is made around the closed path, including the gap, determined by the lines of induction. If H and B represent the field strength and induction, respectively, in the specimen, and H_g the field in the gap, if these values are assumed constant, and if leakage is neglected

$$HL_m + H_g L_g = 0 \quad (2)$$

Also, because the lines of induction are continuous,

$$H_g A_g = BA_m \quad (3)$$

These relations combine to give

$$H_g^2 = -BH (V_m/V_g) \quad (4)$$

where V_g and V_m are the volumes of the gap and specimen. Thus, H_g is a maximum for given volumes of material and air gap when BH is maximum. The product BH is called the energy product because it is proportional to the magnetic energy of unit volume of the material, $BH/8\pi$, and also to the energy stored in a unit volume of the gap, $H_g^2/8\pi$.

The shape of the demagnetization curve between B_r and H_c is fixed by

what is often called the *fullness factor* defined by:

$$K = \frac{(B_d H_d)}{B_r H_c} \quad (5)$$

Theoretically, K must lie between the limits 0.25 (for a linear demagnetization curve) and 1.0 (for a rectangular loop); practically, it varies from about 0.3 to 0.71. For Alnico 5, the value of K is about 0.65; for Vicalloy, values of K of 0.71 have been observed.

3. Description of measuring equipment—The demagnetization curves were obtained from measurements made with a d-c recording fluxmeter. This meter consists of two galvanometers, two photoelectric amplifiers, two integrating networks, an X-Y recorder, and a power supply all mounted in a standard relay rack, together with an electromagnet weighing approximately 125 pounds, mounted separately.

The method of flux measurements employed in this equipment is based on the fact that the integral of the voltage e generated in a coil of N turns by a changing flux ϕ is proportional to the flux changes.

$$e = -N \frac{d\phi}{dt} \quad (6)$$

$$-\Delta N \phi = \int_0^t e dt \quad (7)$$

If the coil is connected to a capacitor C through a resistor R , as shown

in Fig. 4, then, where i is the current flowing into the capacitor, e is the voltage generated across the coil S by a changing flux, and V is the voltage appearing across the capacitor C . If the capacitor is assumed to have an initial voltage of zero, it can be shown that the following relationship exists:

$$\Delta N \phi = RCV + \int_0^t V dt \quad (8)$$

If the time constant of RC is very long with respect to t , then the last term may be neglected and the voltage appearing across the capacitor is a measure of the flux change that has occurred.

Therefore,

$$\Delta N \phi = RCV \times 100 \quad (9)$$

and,
$$B = \frac{RCV}{NA} \times 100 \quad (10)$$

where R = resistance in ohms

C = capacitance in microfarads

V = voltage across capacitor

N = number of turns of coil S

A = area of cross-section of sample in cm^2

B = flux density in gauss

ϕ = lines of flux in maxwells

If a time of one minute is required for the integration, then a time constant about 60 times as great will allow the last term to be neglected with an error not exceeding about one per cent; however, an RC circuit having a time constant of one hour would

Fig. 3—Ring with air gap.

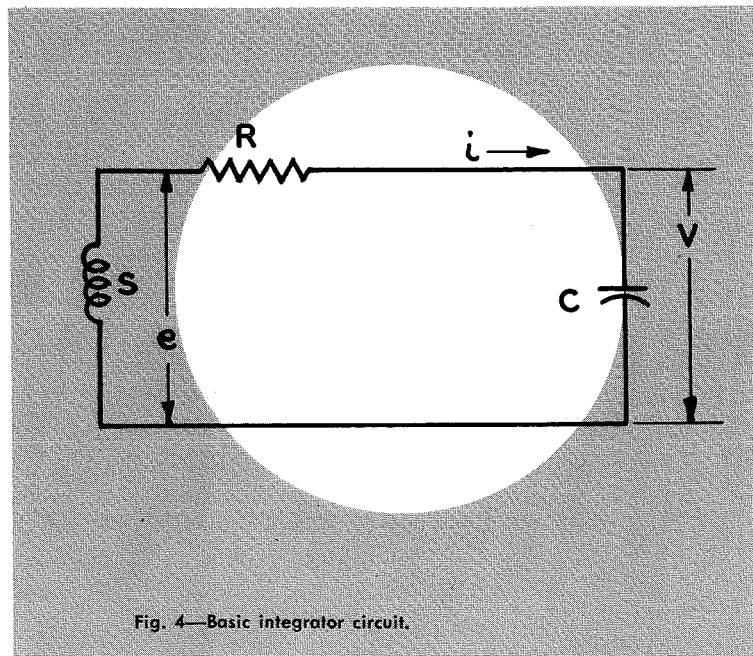
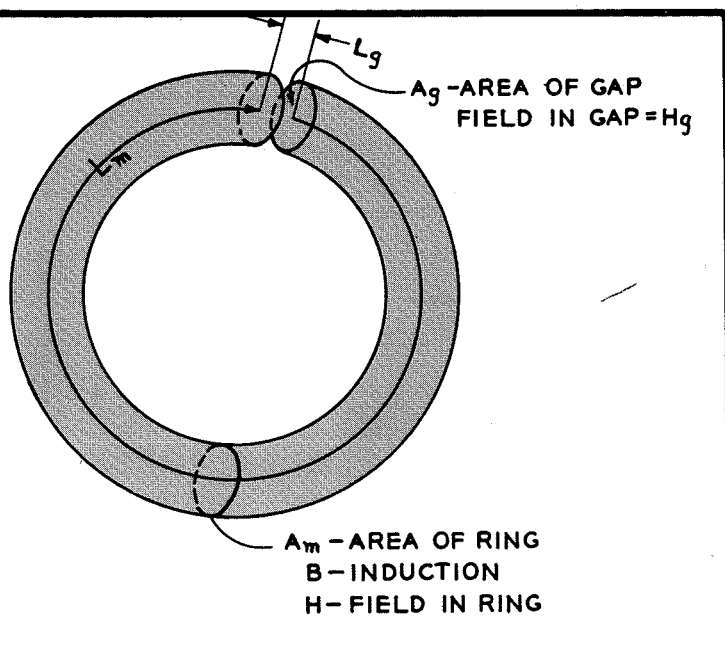
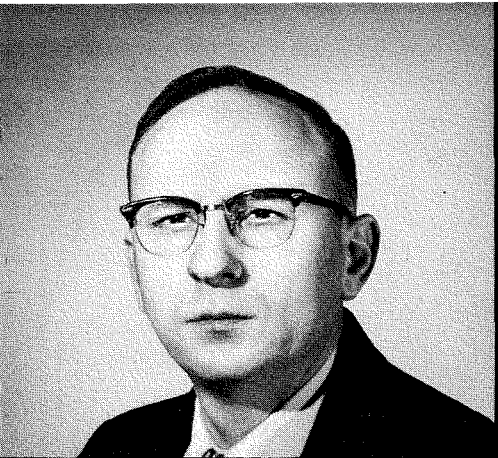

Fig. 4—Basic integrator circuit.



GLYNDON S. HIPSKIND received the B.S.E.E. Degree in 1942 from Indiana Technical College, and continued his studies in the graduate school at the University of Notre Dame.

From 1943 to 1946 he served as an aircraft maintenance officer in the Armed Forces. From 1946 to 1948, Mr. Hipskind was associated with G.E.'s Fort Wayne works in the fractional horsepower motor developmental test section. He joined RCA in 1950, and is presently associated with Ferrite Engineering in the Component Division.

GEORGE KATZ received the B.S. degree in Chemistry in 1935 from Geneva College and the M.S. degree in Chemistry in 1939 from the University of Pittsburgh. He has taken numerous courses since graduation in Chemistry, Metallurgy and Electronics.

Before coming to RCA in 1949, Mr. Katz held positions in Chemical and Metallurgical research and analysis in the U.S. Civil Service, U.S. Navy and Trutest Laboratories. Since joining RCA he has been working on development of ferromagnetic materials for the Tube Division and Component Division.

have a sensitivity too low for practical application. One solution to this problem is to use a high gain d-c amplifier, the output of which charges a capacitor through a resistor which is in the input circuit, with the direction of the charging current opposing the current due to the input signal.

The effect of the feedback applied in this manner is to multiply the time constant RC by the gain of the amplifier. By the use of a relatively low R ,

in this case 55 ohms, a relatively high voltage appears across the capacitor.

If the gain of the amplifier were infinite, the input voltage would be zero, and the voltage across C and the output voltage of the amplifier would be equal.

However, if the gain of the amplifier is high enough (100×10^6) the difference in voltage is negligible and the output voltage may be taken as a measure of the voltage across C . With

$R = 55$ ohms, $C = 1.0$ microfarad, and the gain $G = 100 \times 10^6$, the time constant equals 5500 seconds or about $1\frac{1}{2}$ hours.

4. Use of Equipment—In the case of low-permeability, permanent-magnet material, it is not feasible to use a magnetizing coil wound directly on the sample. Generally, it would not be physically possible to obtain enough ampere-turns. In this case, the sample is made in the form of a bar or cylinder about 0.4 inch long and 0.25 inch in diameter. This bar, as shown in Fig. 5, is wound with a pickup coil of about 5 to 10 turns and placed between the pole pieces of the electromagnet. The magnetizing force, H , is supplied by the electromagnet, and the voltage Δe_B developed across the pickup coil by the change in flux in the sample is fed into the B integrator. The voltage Δe_H from an air-core coil placed adjacent to the magnetic sample in the gap between the pole pieces is fed into the H integrator. The pen servo of the recorder is actuated by the output of the B integrator through a d-c amplifier; the drum servo is actuated by the output of the H integrator, also through a d-c amplifier.

By increasing the current in the electromagnet to some value sufficient to saturate the test sample, then reducing this current and then reversing it again, the complete hysteresis loop of

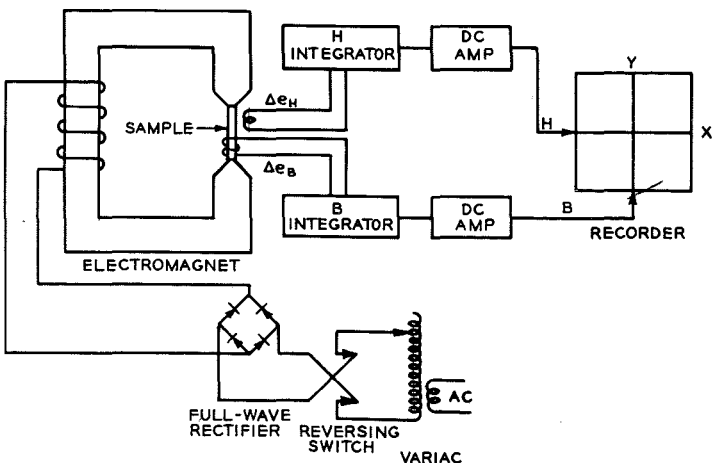
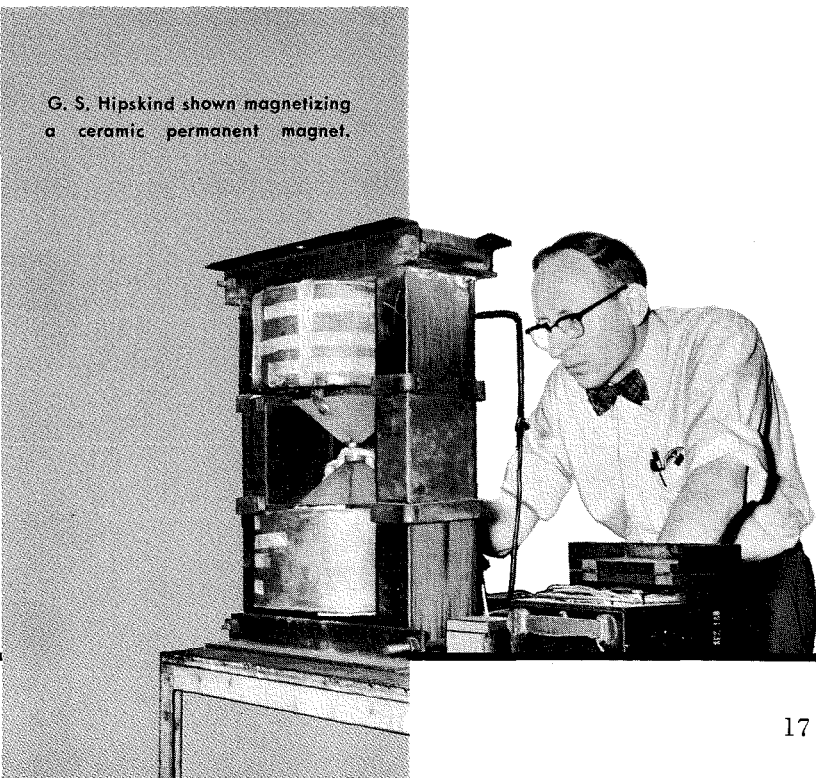

Fig. 5—Schematic of recording fluxmeter.



G. S. Hipskind shown magnetizing a ceramic permanent magnet.

the sample can be traced by the X-Y recorder. The voltage change appearing at the output of the B integrator is measured on a VoltOhmyst when the current through the electromagnet is varied from zero to a maximum, and the maximum flux density is calculated from equation 10.

The voltage change appearing across the H integrator is also measured on a VoltOhmyst when the current through the electro-magnet is varied from zero to a maximum and the maximum magnetization force H_m is calculated by means of the relation

$$H_m = \frac{\Delta e_H RC}{N_A A_A} \quad (11)$$

where N_A is the number of turns of the air-core coil (H pickup) and A_A is the cross-sectional area of the coil. Thus, the complete hysteresis loop is traced and the maximum values of B and H are calculated by means of equations 10 and 11.

FORCE OF ATTRACTION

Sometimes it is desirable to get a quick evaluation of a magnetic material. This evaluation can be made by measuring the force necessary to pull two magnets apart. The following relation may be used to calculate this force provided there is no appreciable air gap between the magnets:

$$P = \frac{B_r^2 A_m}{72,140,000} \quad (12)$$

Fig. 7—Effect of firing temperature, particle size and additives on pull strength.

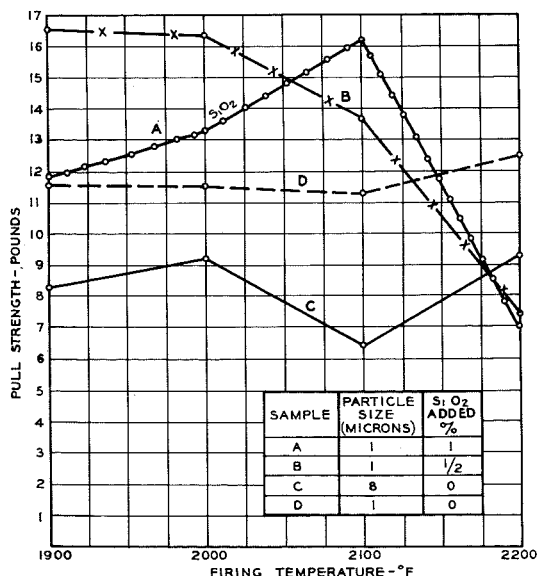

where P is the strength in pounds, B_r in gauss, A_m in inches. This value of pull indicates only the value of residual flux density and not the value of BH maximum.

RESULTS

(a) *General methods of processing*—As stated earlier, the magnetic properties depend upon the processing conditions. As an example, the energy product has been varied from approximately 0.25×10^6 gauss-oersteds to 1.5×10^6 gauss-oersteds by changing the process conditions. Generally, the optimum values of energy product are sought, but in some cases a much lower value is acceptable. An example is the "corrector" magnet used in the deflecting yoke for color kinescopes. This magnet has an energy product of 0.25×10^6 gauss-oersteds.

Based on the end product desired, the preparation of magnetic ferrite powder can be modified to achieve reduced manufacturing cost. To produce a low-cost magnet, dry mixing of the raw oxides whenever possible is desirable. One method of preparation consists in dry mixing the raw oxides from one to four hours after which lubricants and binders are added. Cores are then molded and sintered at approximately 2400° F for 1 to 2 hours.

This method results in magnetic material having increased residual induction. This process, although low in

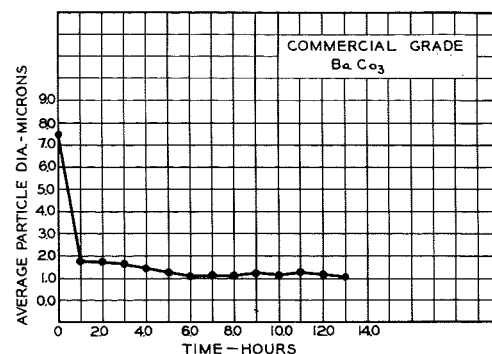

Fig. 6—Effect of attrition or milling on particle size of $BaCO_3$.

cost, results in warpage and dimensional instability. It is, therefore, necessary to resort to pre-firing or calcining of dry-mixed oxide and subsequent wet-milling.

(b) *Effects of different grades of $BaCO_3$ and Fe_2O_3* —It has been found that the particle size of $BaCO_3$ is important in determining the final magnetic and shrinkage values obtained.

Samples of $BaCO_3$ measured for average particle diameters have varied from 0.3 to 7.0 microns. The large particles can be reduced to approximately 1.0 micron by wet-milling the carbonate for 6 hours. Fig. 6 shows the results of such milling. The essential importance of small particle raw oxides is that it eliminates the need for excessive milling time and increased sintering temperatures.

Small particles mix more intimately, and chemically the reaction is more complete. Two batches processed identically except for the different size of $BaCO_3$ used resulted in breakaway- or pull-strength test 45% greater for the batch using smaller $BaCO_3$ particles. (See Fig. 7). Chemically, the $BaCO_3$ should have a purity of not less than 98%. Small quantities of impurities, such as sodium, aluminum, calcium, or magnesium oxides, are not critical and do not generally impair the properties obtained.

The purity of the Fe_2O_3 used is generally higher than 99% and the particle size about $1/2$ micron. Different grades of Fe_2O_3 have been tested in the mixes with little appreciable differences in the end results.

(c) *Additives*—Additions of small amounts of carbonates or oxides, such as $CaCO_3$ or SiO_2 , can result in improved magnetic properties. As an ex-

Samples A & B represent magnets produced with $BaCO_3$ with particle size approx. 1 micron.

Sample A represents magnets produced with 1% SiO_2 added.

Sample B represents magnets produced with $1/2$ % SiO_2 added.

Sample C represents magnets produced with $BaCO_3$ with large particle size—approx. 8 microns.

Sample D represents magnets produced with 0% SiO_2 added.

| Sample | Firing Temp. °C | B _r gaussses | H _c oersteds | B _d gaussses | H _d oersteds | B _d H _d × 10 ⁶ gauss-oersteds | Fulness Factor (K) |
|--------|-----------------|-------------------------|-------------------------|-------------------------|-------------------------|--|--------------------|
|--------|-----------------|-------------------------|-------------------------|-------------------------|-------------------------|--|--------------------|

TABLE I

| | | | | | | | |
|---|------|------------------|------|------|-----|-------|-------|
| E | 2237 | 2070 | 1070 | 1078 | 881 | 0.95 | 0.428 |
| F | 2237 | 1950 | 1560 | 1000 | 793 | 0.793 | 0.260 |
| | | E had SiO added. | | | | | |

TABLE II

| | | | | | | | |
|---|------|---------------------------------|------|------|-----|-------|-------|
| G | 2237 | 2175 | 1525 | 1100 | 806 | 0.885 | 0.268 |
| F | 2237 | 1950 | 1560 | 1000 | 793 | 0.793 | 0.260 |
| | | G was milled for a longer time. | | | | | |

TABLE III

| | | | | | | | |
|---|------|------|------|------|-----|-------|-------|
| A | 1900 | 1760 | 1425 | 880 | 712 | 0.626 | 0.250 |
| | 2000 | 2037 | 1350 | 1000 | 661 | 0.661 | 0.240 |
| | 2100 | 2160 | 1712 | 1030 | 855 | 0.880 | 0.238 |
| | 2200 | 2060 | 1860 | 1030 | 816 | 0.842 | 0.220 |

TABLE IV

| | | | | | | | |
|------------|--|------|------|------|-----|-------|------|
| Oriented | | 2310 | 1920 | 1220 | 992 | 1.210 | .273 |
| Unoriented | | 1970 | 1560 | 1000 | 793 | .793 | .260 |

ample, breakaway-test strength, which is related to the remanent induction B_r , has been increased 43% by the addition of small quantities of SiO_2 . The silica acts as a fluxing agent increasing the value of B_r . (See Fig. 7).

It is always important to interpret and correlate the effects of additives with the crystal size of the calcined powder and the final firing temperatures. The addition of SiO_2 will increase the pull strength at relatively low sintering temperatures (2100° F) but will decrease it at higher temperature. The greater effect of the additives is observed with powders milled for a shorter time and, therefore, having larger constituent particles.

All the mixes shown in Fig. 7 were similarly processed, except that A and B had 1% and 1/2% of SiO_2 added,

respectively. All materials were milled for approximately 1 hour and fired at temperatures shown.

Further experiments were conducted with materials milled for 24 hours. Two batches E with 1/2% SiO_2 added and F with 1% SiO_2 added were fired at 2237° F for one hour. Table I shows the effects of SiO_2 on the various magnetic properties listed. It will be observed that the addition of SiO_2 increased the energy product approximately 20%.

(d) *Effects of Milling*—There are two methods of milling, wet and dry with variations. The raw oxides or calcined powder are placed in steel cylindrical mills containing steel balls with or without a liquid and rotated for different periods of time. Dry milling is essentially a mixing operation with very little actual grinding and consequent reduction in particle size. With soft, small particles in the order of a few microns or less, dry milling is not feasible because the powder will pack and adhere to the sides of the vessel and result in very little grinding.

A vibratory ball mill is an improved variation of dry milling. This mill, as the name implies, vibrates and creates an oscillating motion which reduces the tendency for the powder to cling to the sides. Conventional dry mixing can be used effectively in the initial mixing of raw oxides, particularly if the particles are in the order of 1/2 to 1.0 micron in diameter.

The most effective milling or grind for both the raw oxides and calcined powder is obtained by wet ball mill-

ing. The general procedure is to ball-mill the raw oxides for 24 hours. The material is then calcined and ball-milled again from 24 to 96 hours. Calcined milling can be extended for longer periods of time although little advantage is to be gained beyond 96 hours.

Table II shows the effects obtained on two batches of material processed in the same manner except for milling. Mix G was milled for 24 hours, and F for 48. The increased milling time resulted in an energy product higher by about 12%.

(e) *Effects of Sintering Temperature*: Table III shows the effects of different firing temperature on the magnetic properties. It is obvious from the results that the maximum energy product is optimum at 2100° F. This temperature varies somewhat with composition. It is, therefore, important to find this optimum temperature for each different composition.

(f) *Effects of Orientation*: Table IV gives some idea of what effects orientation has on the magnetic properties. This orientation is accomplished by placing the powder in a magnetic field while molding, the field being perpendicular to the direction of molding.

The oriented sample has higher B_r , H_c , and energy product than the same material unoriented. Work done in this field has been very limited, and there is much more to be accomplished along these lines.

Fig. 8 shows a typical demagnetization curve and energy-product curve along with the value of B and H for the maximum point on the energy-product curve. This curve is a reproduction of a portion of the hysteresis loop taken on the equipment described earlier. The fulness factor of 0.378 is a high value for an unoriented ceramic magnet.

REFERENCES

1. "Preparation and Properties of a Ceramic Permanent Magnet" by Irwin Gordon, American Ceramic Society Bulletin, 35 (s 173-175 (1956).
2. "Ferromagnetism," by R. M. Bozorth, D. Van Nostrand Co., Inc.
3. "Permanent Magnet Design Manual," General Electric Publication.
4. "Indiana Permanent Magnet Manual No. 4," Indiana Steel Products Co.
5. "Properties and Applications of Ceramic Permanent Magnets," RCA Engineer, II, (4) 52-55, 1956-1957.

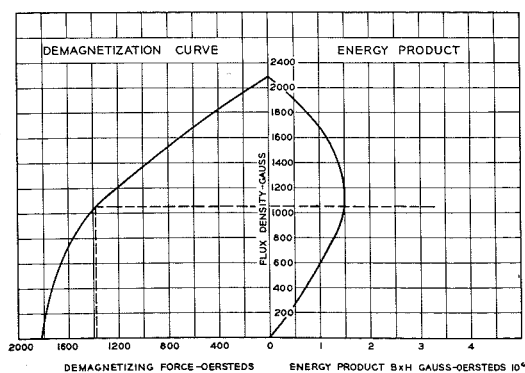

Fig. 8—Demagnetization curve and energy-product curve of ceramic magnet.

DURING THE PERIOD 1946-1956, the economy, measured in terms of the generally accepted barometer—gross national product—grew at a faster clip than the growth registered throughout the preceding period of almost four score years—before which economic benchmarks are not available.

To most realistically appraise the growth during any period of our economic history, it is necessary to use as a measuring stick, dollars which are expressed in terms of the same purchasing power. In other words, we should measure only the increase in physical volume of output during the past ten years. On the basis of 1956 purchasing power, the overall economy has expanded over 40%.

GNP (gross national product) is divided into three general spending segments: consumer, government, and business expenditures. In appraising the relative importance of each, it is significant that consumer spending for durable goods, non-durables and services currently comprise about two-thirds of total GNP. Government spending, (federal, state and local) is a 20% factor. The third area of the economy's spending—by business for plant and equipment, new private housing, and inventory accumulation, represents the remaining approximate 15% of total spending.

Now, let us consider the movement of each of these segments of our total economy over the past decade.

GROWTH IN THE PAST TEN YEARS

Consumer spending has risen by slightly more than one-third in the past ten years. Notable here is the fact that the percentage increase in the rate of consumer spending for durable goods is more than double that for non-durables and services. This, of course, highlights the growth during the past ten years in such industries as autos, appliances, and electronics. It points up the very significant contribution of research and development to the improvement in our standard of living during the past decade.

Government spending has increased 70% over the past decade—and in view of the prospect of a continuing cold war, it promises to be a substantial factor in our total economy over the next several years. In the area of state and local government spending, demands for augmented public works

Editor's Note: The February-March issue of the RCA ENGINEER carried the first of a three part series designed to inform our readers on the growth potential of our industry over the next ten years.

In the initial article, E. Dorsey Foster analyzed the international scene, and indicated that we should plan on a continuation of the cold war status. This assumption provides the basis for the formulation of national and industrial economic trends in this, the second article in the series—Frank Hutzet's appraisal of the economic growth likely to be achieved in the next decade.

THE DECADE AHEAD

THE OUTLOOK FOR THE OVERALL ECONOMY

By **FRANK S. HUTZEL, JR.**

Economic Planning, Radio Corporation of America, Camden, N. J.

FRANK S. HUTZEL, JR. graduated from La Salle College in 1939, majoring in accounting and economics, and continued in graduate work at the University of Pennsylvania. He came to RCA in Camden in 1940, working in various accounting activities until 1946, when he transferred to the Audit Staff of the RCA License Division, New York. Mr. Hutzet returned to Camden in 1951 on the staff of the Director of Mobilization Planning, and was appointed Administrator, Economic and Mobilization Planning in 1954. Acts as Corporation Industrial Preparedness Representative on Industrial Mobilization Planning Program of the Department of Defense.

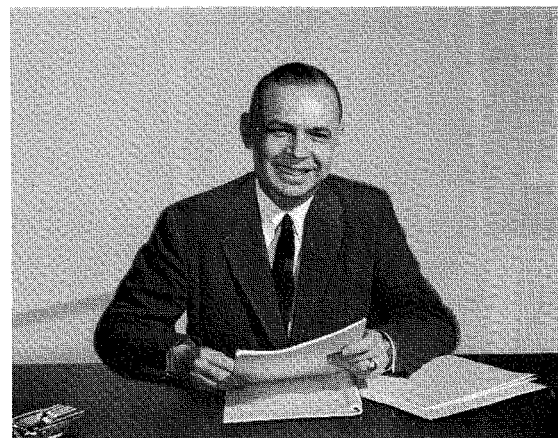

programs insure a continuing increase in expenditures by other than the Federal government.

While the growth in the rate of government spending for defense and for other Federal purposes in the past ten years has been substantial, this rate of expansion has been considerably exceeded in the area of state and local government spending, as the aftermath of curtailed public works spending during World War II.

The third area of the economy's spending—business spending—has registered a 35% increase in the past ten years—partially brought about by accumulative demand which could not be satisfied during World War II, but largely the result of research and the development of new products and productive methods which necessitate new and improved productive facilities.

Growth during the past ten years has been phenomenal, despite periods of mild recession.

SHORT-RANGE BUSINESS OUTLOOK

The downturn in the economy in late 1953 was largely attributable to the dip in defense spending following Korea, and to the fact that inventories required to support the military and

civilian economy could not rapidly be reduced to the post-Korea level of demand. The resulting readjustment was completed late in 1954.

The 1955 upturn was vigorous. Dollar volume gain in total spending for goods and services, 1954 to 1955, was the second highest of any year in the post-World War II era. Consumer spending reached a new record level in 1955, partially the result of the more than 20% gain from the preceding year in the level of consumer spending for durable goods. Unprecedented expansion of installment credit and mortgage debt stimulated the 1955 upturn.

The prime mover of the economy in 1956 was capital spending for new plant and equipment, which recorded a 22% year-to-year gain. Total consumer spending also increased commensurate with the gain in the standard of living and the growth in population. These plus factors more than offset the 25% cutback in auto production and the approximate 15% curtailment in home building.

Slight advances in almost all segments of the economy are projected for this year with government spending replacing capital spending as the segment likely to record the biggest

600
Millions

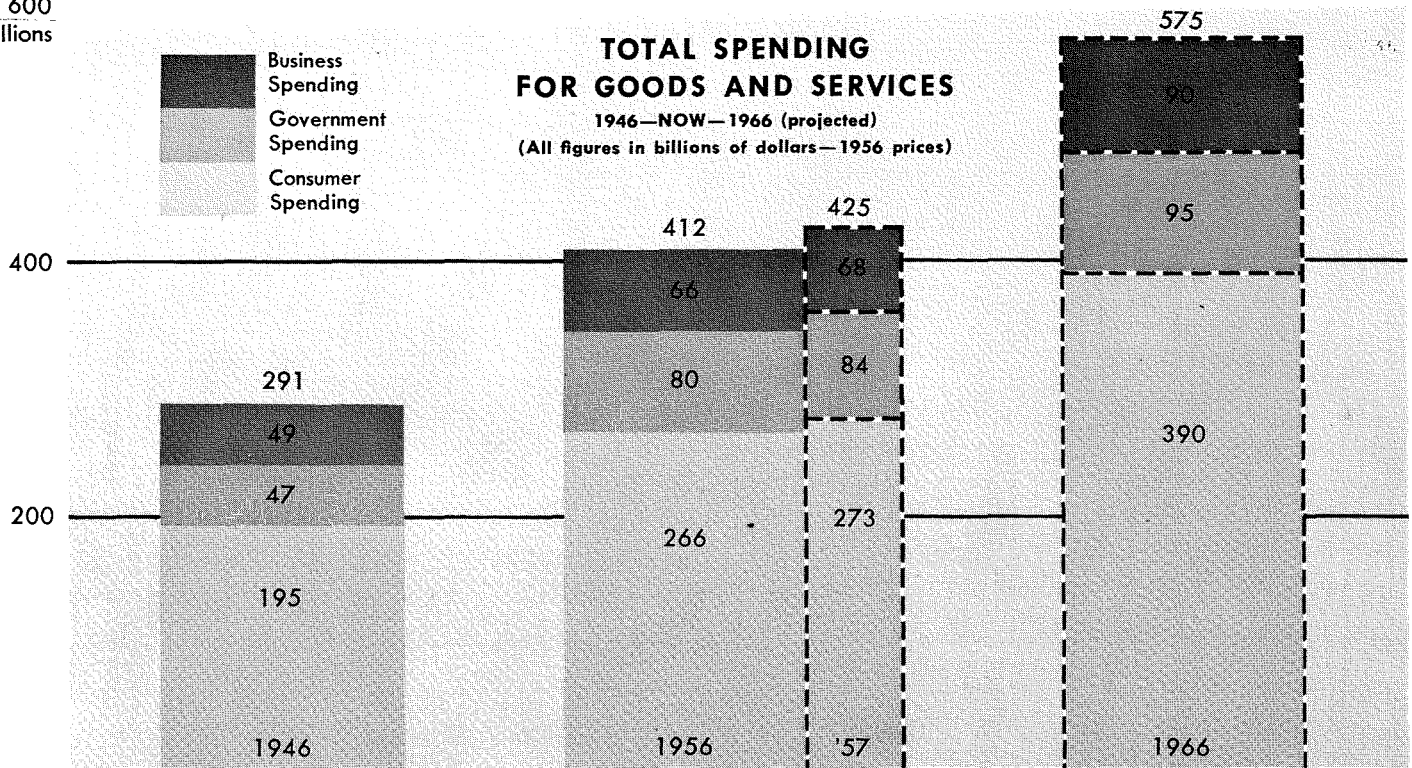

Total spending by all segments of the economy (GNP) increased over 40% in the last ten years, and in the next ten years an increase of just slightly less than 40% is projected. In dollars, the approximate \$137 billion increase, 1946-1956, compares to a projected \$163 billion, 1956-1966.

year-to-year percent gain. Consumer spending for durables is estimated this year to about equal the record level of 1955, and gains are likely in the non-durables and service segments of spending by the consumer. New housing starts this year will likely fall below the depressed level of 1956, but some pickup in housing is expected later in the year, since more favorable mortgage terms are anticipated as the year progresses. Despite the new lower rate of housing starts, increases in business and public construction likely will result in a 3-4% gain in total construction activity this year. The rate of inventory accumulation which slowed somewhat last year from the 1955 level is expected to further decline this year. Industry appears to be limiting buying to current needs, creating a breathing spell that will likely last until sales expand to justify a higher level of stocks—an entirely healthy situation.

Overall, in terms of 1956 prices, we expect the economy this year to exceed that of last year by approximately 3%.

THE LONG RANGE OUTLOOK

Now to look at our economy in 1966.

Total spending by then is projected in terms of 1956 prices at \$575 billion,

a 40% increase from the 1956 level—comparable percent-wise to the increase registered over the past ten years. It is to be pointed out that the growth rate each year will not likely be uniform. There may be minor downturns over the period, such as was experienced in 1954, and the rate of growth may be greater in some years than in others.

CONSUMER SPENDING UP 45%

Consumer spending is estimated to increase over the next ten years at a faster clip than that of the past ten years, and faster than the increase projected for the overall economy. Our conclusion is based on appraisal of growth of these influencing factors:

1. An increase in population is basic to increase in overall demand on the part of the consumer. Over the next ten years we expect the population to rise by about 25 million—a 15% increase. While this total increase is very significant, the likely increase by age group is particularly pertinent. The “under 25” group is expected to grow by almost 25% in the next ten years, pointing up so far as RCA products and RCA developments are concerned, the desirability of being especially

cognizant of this expanding youth market—and a strong position in the youth market will additionally serve later to enhance our share of the adult market. The “65 and over” group will have grown by 25% in the 1956-1966 decade. This indicates a growing demand for products which are of particular appeal to this age group—new products designed with the oldest in mind. Only a 6% increase is envisaged in the 25-64 age classification. The low rate of growth in our “productive” population might well suggest a threat to continuance of the pattern of increase over the past years in our standard of living. Offsetting this factor, however, are the forces at work in the area of technological progress, automation, heavy capital investment, improved worker skills, greater annual increases in man-hour output, all of which will make possible continually higher living standards despite the likely curtailment in the percentage of “productive” age population in relation to total population.

2. Households are projected to increase from the 1956 level of 49 million to over 56 million by 1966—a 15% increase. In terms of consumer spending in the area of particular in-

terest to RCA, this means an expanding demand for durable goods of all types—television, radio, and records, as well as a demand for servicing electronic products.

3. The ability of the consumer to enjoy a constantly higher standard of living is evident from our projection of average per household income after taxes in terms of 1956 purchasing power — currently \$5,850 per household — by 1966 over \$6,500. The rise in family income over the past ten years has already resulted in a large scale migration to “suburbia” with greater concentration on home life, and greater demand for household appliances and consumer durables of all types. The next several years should produce even greater demand for suburban living, higher demand for newer and larger homes, more two-auto families, and more 2-3 TV receiver homes.

4. The increase in spending income just described becomes especially significant to us in RCA when it is realized that most of the expected increment in family income over the next ten years will be spent for other than the necessities of life, since incomes are already sufficiently high to meet basic needs. As pointed out by the editors of FORTUNE in “The Changing American Market” the luxury market is expanding—all except the rarest luxuries are becoming merely necessities that are less necessary than some other items.

The approximate 45% increase projected in consumer spending is, we believe, conservative. The confidence of the consumer in the future of our economy is bulwarked by governmental social legislation and by assurance of continuing relatively full employment. The bigger, wealthier consumer market by 1966 is estimated to be spending in terms of 1956 prices at \$124 billion more than in 1956.

GOVERNMENT—20% PLUS FACTOR

The area of government spending for goods and services is perhaps the most difficult segment of the economy to project. There are, however, certain criteria which have been carefully evaluated in projecting government spending by 1966 at \$95 billion:

1. In 1956 slightly more than half of total government spending was for national security. In the years through 1966, it is expected that the same pat-

tern will continue. Our projection assumes a continuing cold war status with greater emphasis on research and production on the newer weapons, and less spending for the conventional weapons. As pointed out by Dorsey Foster in the preceding article in this series, the projected growth in overall national security spending does not truly reflect the significance of this segment of total spending to the electronics industry. The increasing emphasis placed by the military upon the use of electronics means that electronics will comprise a larger portion of the defense dollar. Whereas total spending for national security is estimated to increase by 1966 by only about 15%, defense electronics spending will be double the 1956 rate.

Any major change in the international climate would, of course, directly affect the level of national security spending, but for business planning purposes, no change from the current status is projected.

2. Other Federal government spending will increase somewhat with expanded social security benefits and “pump-priming” in any segment of the economy which from time to time shows signs of weakness.

3. The projected growth in population and the urge to improve our standard of living mean greater demand for educational facilities, and for all types of public service supplied by state and local governments. Augmented road building and other public works programs insure a higher level of state and local government expenditures.

Whereas the overall economy is expected by 1966 to be 40% bigger than at present, government expenditures are projected to increase by only about 20%. The lesser rate of increase in government spending, than for the economy overall, is, of course, more than offset by the advance projected in consumer spending.

BUSINESS SPENDING UP 35%

The third major segment of the economy, investment in homes, in inventories, and in new productive facilities, must, out of necessity, follow the pattern set by the level of consumer and government spending. Overall, the business spending segment of the economy is expected to increase from the 1956 level of \$66 billion to an approximate \$90 billion in 1966.

1. As we previously pointed out,

the increase in population and the growth of the middle income group provide the demand and the wherewithal for more and better homes.

2. Inventories will expand at a pace at least sufficient to meet the expanding consumer and government demand, as well as the demand of business for new productive facilities.

3. A larger labor force, greater productivity per worker, technological advances, and the forces of competition all spell a higher level of spending by business for new productive plant and equipment facilitation. To RCA this means greater demand for industrial and commercial electronics — greater utilization of equipments such as the electron microscope, BIZMAC, and constant pressure on our engineers by industry to produce facilities which can perform electronically many of the jobs which today are accomplished much less efficiently by other means. More and more is being spent by industry on research; an estimated \$2.9 billion was spent in 1950, \$6 billion in 1956, and by 1966, a figure of close to \$15 billion is certainly not overly optimistic. This means continuous improvement in production techniques and for the most part requires a higher level of spending for plant facilities. More and better production machines make possible an increased volume of output, usually at reduced prices. The increased volume and the new products and industries created combine to expand employment. More employment and higher wages increase total income, more income means more purchasing power, and more purchasing power increases the overall standard of living which again activates the cycle.

TOTAL ECONOMY UP 40% BY 1966

The approximate \$165 billion increase in total GNP which we are projecting over the next ten years, represents a very substantial 40% growth, and comes on the heels of a very imposing \$120 billion increase, about 40% over the past ten years. That the projected rate of growth is reasonable and is capable of achievement has already been demonstrated. That it will be achieved is dependent in large measure on the continuing ingenuity of our engineers to design and produce products and services at a price and of such appeal as to insure a continuing increase in demand for the output of American industry.

A VIDEO AUTOMATIC GAIN CONTROL AMPLIFIER

JOHN O. SCHROEDER

Development Group
NBC Engineering Dept., New York, N.Y.

AUTOMATIC AUDIO gain control amplifiers or "limiters" have attained widespread use in broadcasting and recording to maintain output signal levels more or less constant in the presence of varying input levels. However, there has been little use of similar techniques for handling video signals in television transmission systems until now.

This paper discusses some of the problems involved in designing equipment suitable for television broadcast purposes, and describes a video AGC (Automatic Gain Control) amplifier which has been used by NBC with very gratifying results. This device enables signals originating from all over the country to be transmitted with relative ease and freedom from level fluctuations. Shows such as "Wide Wide World" depend heavily on video AGC equipment to maintain the level

of the signal fed to the transmitter and network lines within acceptable limits. This is done despite wide variations in the level of signals received from the incoming telephone company lines.

WHY VIDEO AGC IS DESIRABLE

Just as in audio transmission, whenever the video signal is transmitted from one location to another via coaxial cable or other methods, there exists a standard level which the transmission engineer attempts to maintain rather closely. This utilizes the transmission facilities properly and provides a picture with proper brightness and contrast on the home viewer's screen. This level is standardized at 1-volt peak-to-peak, as measured from the tip of sync to the peak white picture components. This composite signal is composed of 0.7 volts of video and 0.3 volts of sync.

Here are several reasons why it is necessary to maintain both the total peak-to-peak amplitude and the ratio of sync-to-video correctly:

1. Video amplifiers are not generally designed as conservatively as audio amplifiers. Usually a 100% increase in level can be tolerated in audio equipment whereas serious picture degradation would result if double level video signals were fed to video distribution amplifiers. This is especially significant in connection with color television signals since requirements imposed on video amplifiers are extremely severe with regard to differential gain and differential phase distortion.
2. Clamp circuits may perform unsatisfactorily and cause severe damage to the signal.
3. Unless white peak clipping is installed at the transmitter, carrier may be over-modulated and cause audible "sync buzz," and possible adverse effects visible on home receiver screens. Improper sync-to-video ratio can cause faulty sync separation and

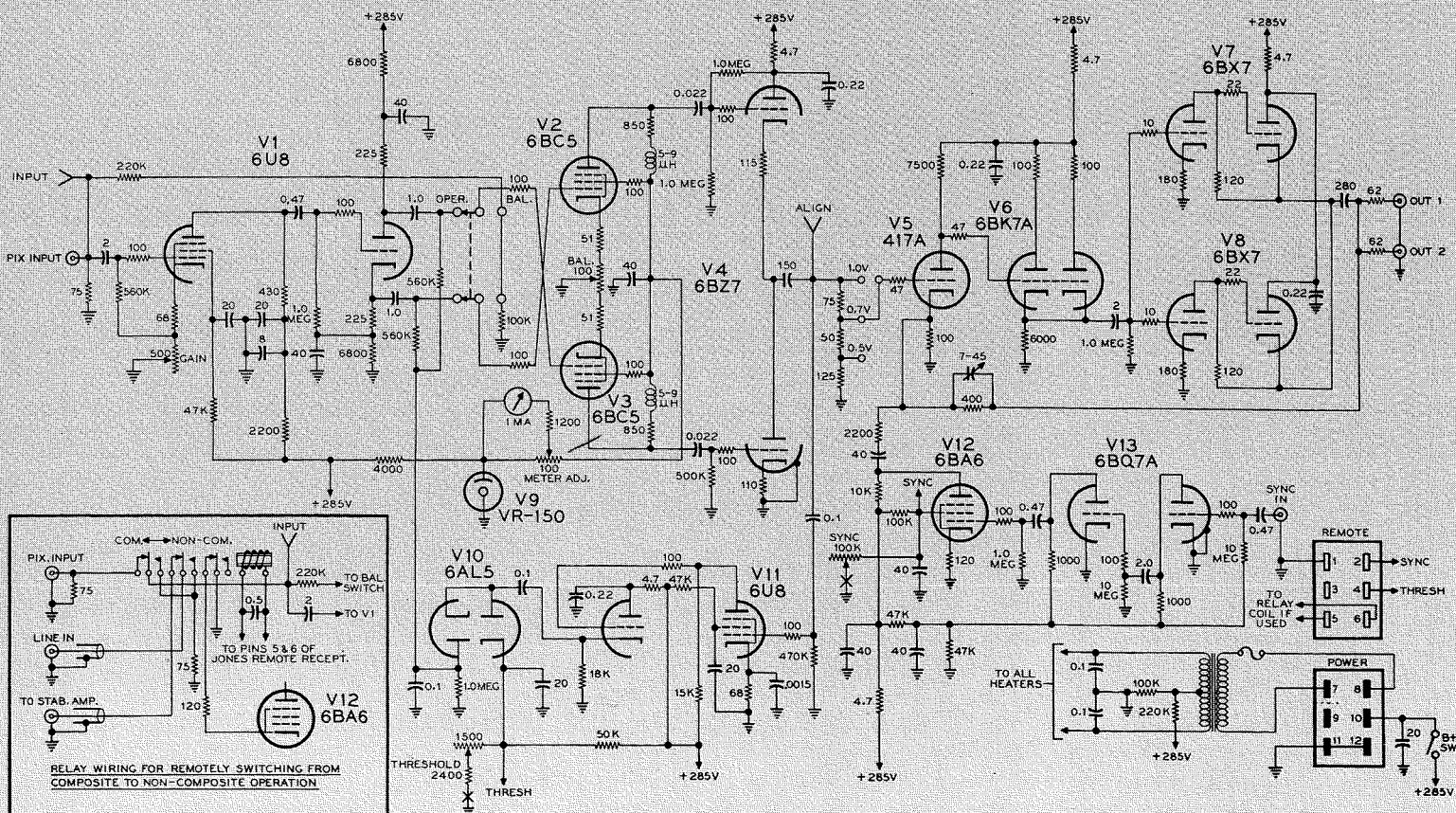

Figs. 1 and 2—Diagram of the Video Automatic Gain Control Amplifier, and inset a sketch of the arrangement for remotely switching from composite to non-composite operation.

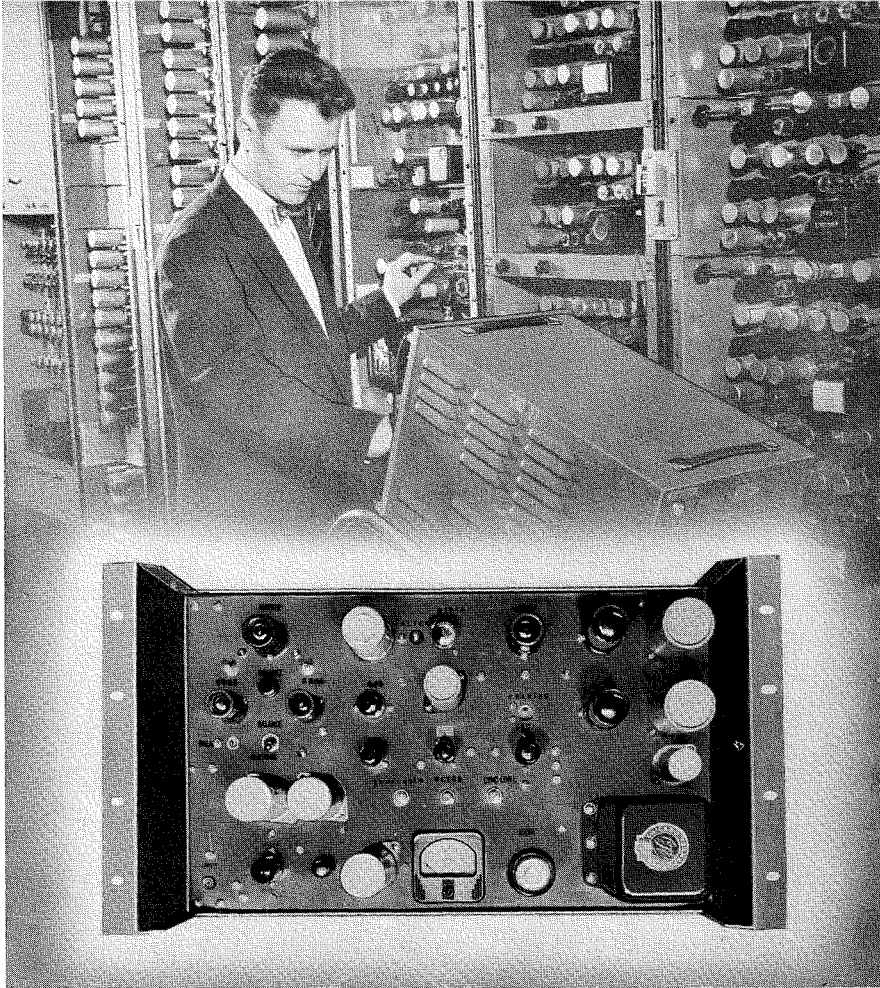

The author is shown in Radio City TV equipment room making adjustments to the video AGC circuits. Inset is a closeup of the Video AGC panel.

incorrect picture brightness, since most receivers employing d-c restoration use the sync tips as black reference level.

FUNDAMENTAL DESIGN CONSIDERATIONS

The first decision was to determine whether the system would handle composite signals (video plus sync) or non-composite signals (video only) since this determines in which direction the designer must proceed. If composite signals only are considered, some of the design problems might be eased by employing keyed clamps whose keying pulses could be derived from the sync portion of the incoming composite signals. However, if this were to be the final decision, the system would be completely useless for handling non-composite signals. On the other hand, if the system were designed to work on non-composite signals, we could not use keyed clamps because properly timed horizontal drive pulses might not be available.

After a little study it became apparent that the most flexible system would result from a video AGC amplifier designed to handle non-composite

video. It then became a simple matter to precede the AGC amplifier with a television stabilizing amplifier such as the RCA Type TA-5C. This delivers a "video-only" signal and a sync signal when fed a composite input signal. The "video-only" output can be fed to the AGC amplifier and after it has been gain controlled, the sync from the TA-5C can be added back to form a composite signal again. By means of a simple relay switching arrangement, the video AGC system then becomes capable of handling both composite and non-composite signals.

Another factor is the maximum deviation from standard level which is likely to be presented to the AGC equipment. Although audio equipment can be designed to control a fairly wide range of input levels, this is not practical for television purposes, since the AGC equipment would attempt to maintain a normal 100% output level when the picture is faded to black level. This would cause the home receiver picture to fade to a bright grey instead of black. Therefore, it is necessary to limit the amount of gain increase provided by the AGC equip-

ment. Operating tests have indicated that good results are produced if this increase is limited to 6 decibels.

REQUIREMENTS

Consideration of these factors led to the conclusion that video AGC amplifiers for use at NBC should perform the following functions:

1. Accept a non-composite video input signal at a nominal level of 0.7 volts and deliver a video output signal at a level of 0.7 volts regardless of input level variations between 0.35 and 1.4 volts. Once the input signal drops below 0.35 volts, the output signal should follow linearly.
2. Automatic video gain control must be achieved without use of keyed clamp circuits. Special attention must be given to reduction of "bounce" or d-c shift in output signal.
3. There should be no appreciable differential gain or differential phase distortion introduced. Frequency response should remain flat regardless of the amount of gain reduction taking place.
4. 60-cycle square-wave tilt must be essentially zero and constant regardless of gain reduction. This indicates the need for extended low-frequency response which multiplies the importance of (2) above manyfold.
5. Facilities should be provided to add sync to the video output signal when desired.
6. A method of remotely switching the video AGC equipment from non-composite operation to composite operation with a TA-5C stab-amp should be provided.

GENERAL DESIGN OF THE VIDEO AGC AMPLIFIER

With these design goals in mind, it becomes possible to plan a method of achieving the desired results. Referring to Fig. 2, a scheme similar to that used in audio practice has been employed. The input is split into a push-pull signal and gain controlled by a pair of balanced variable gain amplifiers whose bias is obtained from a delay-biased rectifier. Output signals are fed through a side amplifier to achieve the required amount of loop

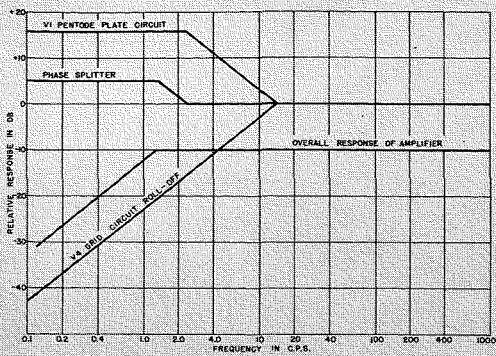

Fig. 3—Graph showing the staggering of low-frequency characteristics.

gain. The push-pull signals after being gain controlled are combined in a differential amplifier stage. The resulting signal is fed to two 75-ohm outputs by means of a very stable negative feedback output amplifier with sync mixing facilities. Since the amplitude of the signal at the output of the differential amplifier is accurately controlled by AGC action, it is highly desirable that the gain of all following circuits be rigidly stabilized so as not to destroy the inherent self-regulating action of the device.

CIRCUIT DESCRIPTION

The non-composite video signal is first applied to the input amplifier, pentode section of V1, whose gain is adjustable by means of a variable cathode degeneration potentiometer (see Fig. 2). Plate signal is coupled to the grid of the triode section and the coupling constants are chosen to produce a controlled, rising, low-frequency response starting at about 14 cycles. Thus, a complimentary low-frequency roll-off can be employed following the gain-controlled stages to reduce low-frequency "bounce" and d-c shift in the final output signal. Frequency characteristics of the various circuits which effect low-frequency response are staggered so as to obtain an overall flat and tilt-free amplifier (see idealized form in Fig. 3).

The triode section of V1 produces balanced push-pull signals at its cathode and plate since equal impedances form the load for both elements. These signals are coupled to the grids of variable gain stages V2 and V3, 6BC5 pentodes (grid bias is derived from rectification of the output signal).

The 6BC5 plate and screen voltages are regulated so as to minimize d-c

output shift. A d-c milliammeter is included in the circuit to indicate the total space current of V2 and V3, and facilitate initial adjustment of the AGC amplifier. It provides a continuous visual indication of proper AGC performance.

Push-pull signals at V2, V3 plates are coupled to the control grids of a series-connected type of differential amplifier comprising the dual triode V4, a type 6BZ7 with proper low-frequency roll-off provided by the choice of interstage coupling time constant. The differential amplifier provides an output which is proportional to the two grid signals as long as they are in push-pull but provides zero output for grid signals which are in phase. Due to this action, the distortion normally produced by the variable gain tubes operating at high grid bias is greatly reduced, and "bounce" components appearing in-phase at the two grids of the differential amplifier are cancelled out.

The video signal from the differential amplifier is fed to (1) the output and sync-mixing amplifier and, (2) the side-amplifier and rectifier circuits. Considering first the side amplifier, the pentode section of a 6U8 is utilized as a restricted bandwidth video amplifier stage with a circuit gain of about 45. The 0.5 volt peak-to-peak signal at its grid is amplified to a level of about 22 volts. High frequency response is rolled-off starting at about 1.0 megacycle by the stray circuit capacitance in shunt with the relatively high value of the plate load resistance. Thus, gain reductions caused by video signal components of very short duration and high frequency content are avoided. This prevents the overall signal level from being reduced by specular reflections or other unimportant white "spikes."

The 22-volt video signal is directly coupled to the triode section of V11 which functions as a cathode follower with fairly low source impedance for properly driving the 6AL5 rectifier. The two diodes of this tube are connected in a peak-to-peak rectifier arrangement, with a positive delay bias of about +17 volts applied to the input diode cathode to prevent any rectification until the peak-to-peak signal exceeds the bias voltage. Once this occurs, the negative d-c output voltage

produced across the storage capacitor C21 and applied to V2, V3 control grids is roughly equal to the amount by which the peak-to-peak video exceeds the delay bias (in this case —5 volts, the difference between 22 volts and 17 volts). The absolute value of the delay bias voltage is variable over a narrow range by use of the "threshold" potentiometer. This permits the level of the gain controlled video to be precisely set at 0.5 volts-peak-to-peak, at the output of the differential amplifier.

This regulated signal is then fed to the output and sync-mixing amplifier (comprising tubes V5, V6, V7, V8, V12 and V13) through a simple 3-position attenuator. The attenuator loss is 0, 3, or 6 db depending upon the tap selected. Since gain of the negative feedback output amplifier is exactly 2 times, and regulated video at the attenuator input is 0.5 volts, the regulated video at the output of the complete unit may be set to 1 volt, 0.7 volts, or 0.5 volts. This provides a choice of composite outputs of 1.4 volts, 1.0 volts, or 0.7 volts after sync has been added.

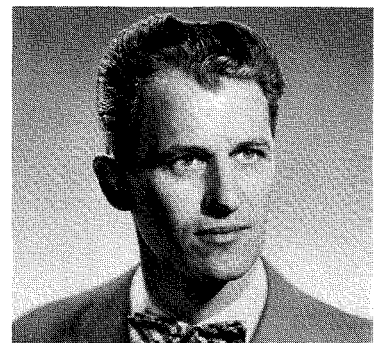

JOHN O. SCHROEDER'S interest and activity in electronics began in 1933. He was first employed by the Link Radio Corp. in Receiver and Transmitter Test from 1940 to 1944. During 1944 to 1946 Mr. Schroeder was in the U. S. Navy and completed the Radio Material Course at the Naval Research Labs. He rejoined Link Radio Corp. as a Design Engineer in 1946 and was responsible for the design of several mobile and fixed station FM transmitters. Later, he became Project Engineer in their government development group, where he was responsible for a 12-jump FM radio repeater system. In the fall of 1950, he became Assistant Chief Engineer with Muzak's Transcription Studios where he was instrumental in developing special electronic equipment for the processing of lacquer masters.

Mr. Schroeder joined NBC in 1951 as a Design Engineer in the Engineering Development Group and is responsible for various types of widely used television terminal equipment, including negative feedback video distribution amplifiers, pulse distribution amplifiers and lap dissolve amplifiers.

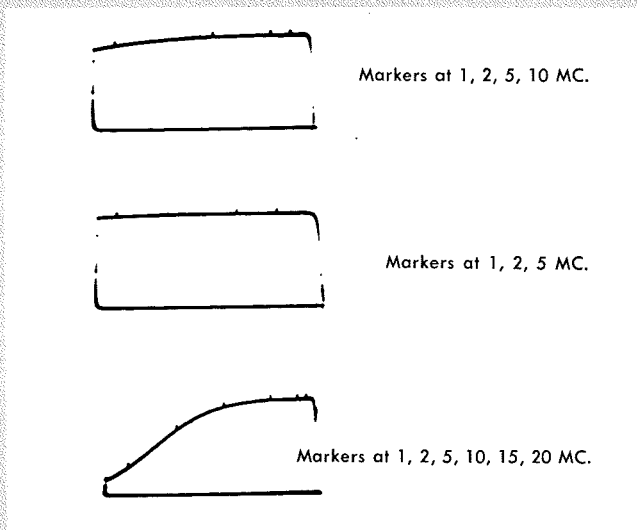

Fig. 4A—Frequency response

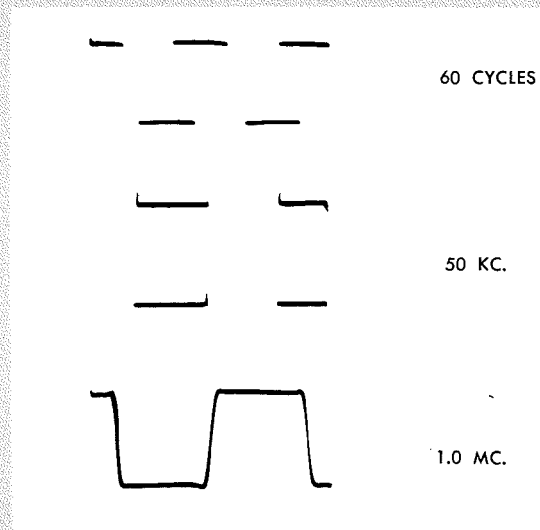

Fig. 4—Waveforms showing frequency and square wave response.

Fig. 4B—Square wave response

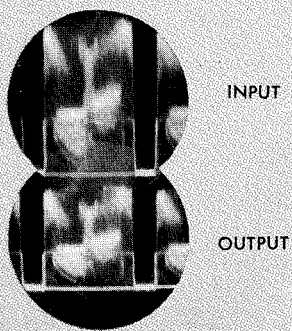

Fig. 5a—Double input level.

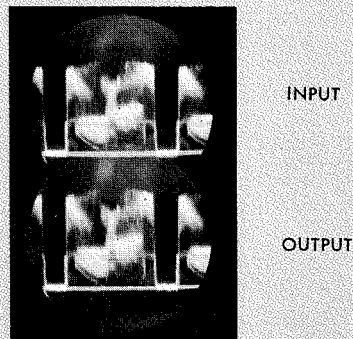

Fig. 5b—Standard input level.

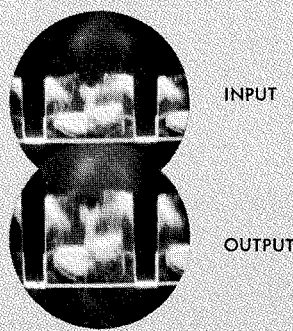

Fig. 5c—Input, 3db below standard level.

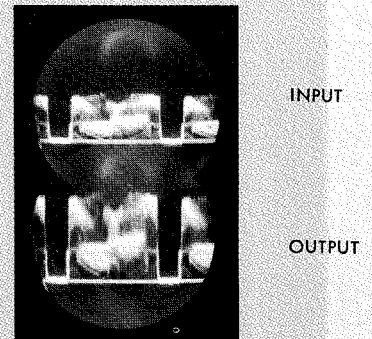

Fig. 5d—Input, 6db below standard level.

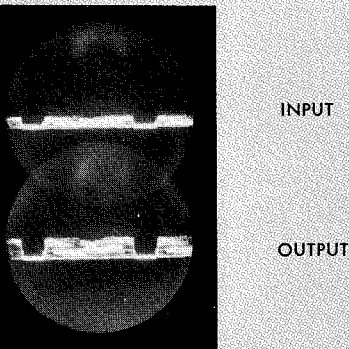

Fig. 5e—Input, 20db below standard level.

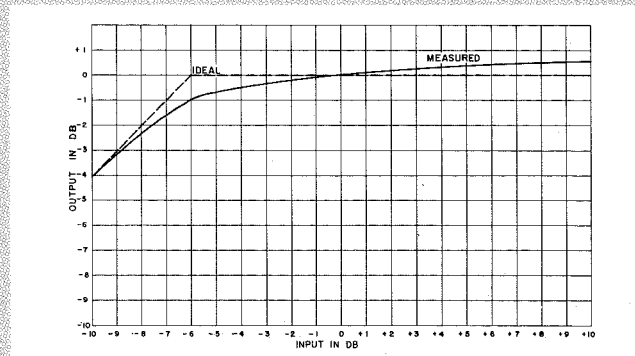

Fig. 6—Curve showing input vs output levels (0db = 1 volt).

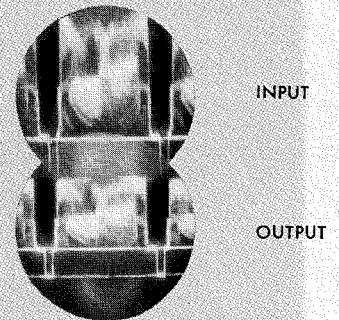

Fig. 7a—Double input level.

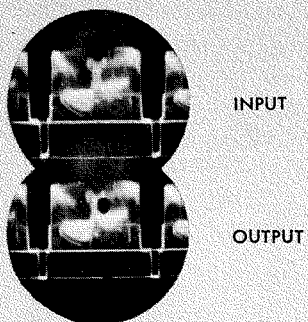

Fig. 7b—Standard input level.

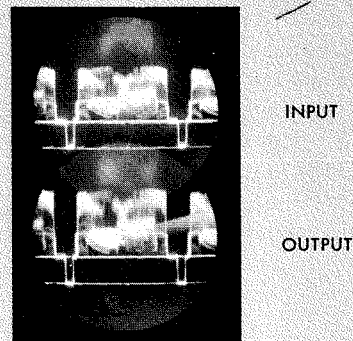

Fig. 7c—Input, 3db below standard level.

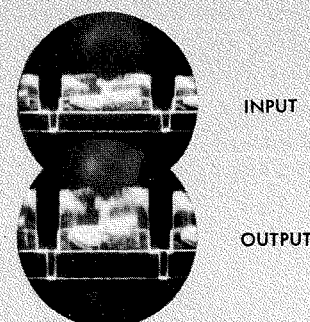

Fig. 7d—Input, 6db below standard level.

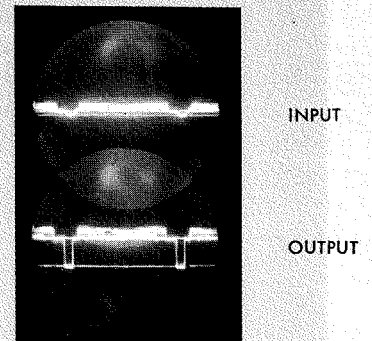

Fig. 7e—Input, 20db below standard level.

The sync-mixing channel of the video AGC amplifier is comprised of stages V12, a 6BA6, and V13, a 6BQ7A. The external source of 4-volt sync pulses which have been derived from the incoming composite signal by the stabilizing amplifier are applied to the first section of the 6BQ7A which functions as a clipper, eliminating any irregularities or overshoots which may be present on the tips of the sync input. The second half of the 6BQ7A operates in a similar manner, removing any irregularities or overshoots from the base-line region of the sync waveform. This cleaned-up sync signal is coupled to the grid of V12, a 6BA6 pentode, which injects it into the cathode circuit of the feedback amplifier input tube where it is mixed with the video to produce a composite signal at the AGC amplifier output. Amplitude is adjustable from zero to over 0.5 volts by means of a potentiometer which controls the screen voltage of the 6BA6.

Push-pull amplifiers must be fairly well balanced to assure a maximum reduction of "bounce" and a minimum differential gain distortion. Therefore, a switch has been incorporated in the video AGC amplifier which permits the incoming signal to be applied to the control grids of the 6BC5 variable gain stages in parallel. When this is done, precise circuit balance is achieved by adjusting the potentiometer in the cathode circuit of the 6BC5's for complete cancellation of the signal at the output of the amplifier.

As previously mentioned, for maximum flexibility it is desirable to be able to switch the video AGC system from a remote point so as to handle either composite or non-composite signals. The three-pole, double-throw relay (see circuit inset in diagram) makes this possible. In its normal (de-energized) position, composite signal from the incoming line is fed to the input of the "stab-amp" and picture signal from the "stab-amp" output is fed to the input of the video AGC amplifier. The sync-adding channel is energized by completing V12's (6BA6) cathode return circuit. When the relay is energized, the "stab-amp" is bypassed, and the incoming non-composite signal is fed directly to the AGC amplifier whose sync-adding

Fig. 8—TV Master Control at Radio City. Transmission engineer makes video AGC adjustments by means of remote control panel.

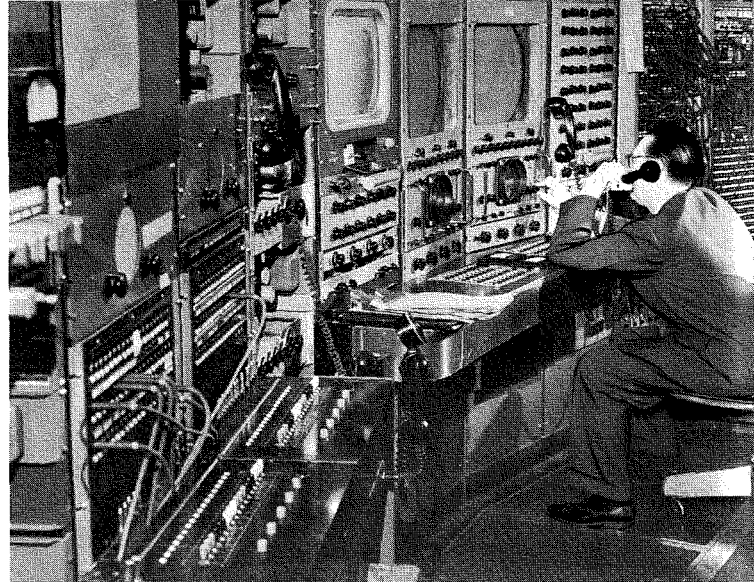

channel is disabled by opening V12's cathode return circuit. This prevents any spurious hum or noise from being mixed with the video signal.

Both the sync level and the regulated peak-to-peak video level may be controlled remotely by locating the "Sync" potentiometer, P5, and the "Threshold" potentiometer, P4, any required distance from the amplifier. To provide complete flexibility, the switch that operates the relay and the "stab-amp" sync clipping level control have also been located at the remote location.

OPERATION AND PERFORMANCE

In order to show clearly the performance characteristics of the video AGC amplifier as used on both composite and non-composite signals, a series of photographs was taken of the input and output signals under various conditions.

Fig. 4A shows the wide frequency response of the video AGC amplifier by itself (no stab-amp involved) while Fig. 4B shows the excellent square wave response of the unit, good overall phase response being indicated by the freedom from overshoot or tilt on any of the waveforms.

The manner in which the output signal is controlled in the presence of varying non-composite input levels is shown by the waveforms of Fig. 5, while the measured input versus output characteristic over a wide range of inputs is indicated by the curve shown in Fig. 6.

The photographs in Fig. 7 show the performance of the complete video AGC system, including the "stab-amp," when used on composite signals. While the video portion of the

signal is controlled to the same degree as that indicated by Fig. 6, the composite input signal can drop to one-tenth its normal level and the AGC system will still be completely stable and provide normal-level sync output even though video is down to 20% of normal. Certain modifications to the RCA TA-5C "stab-amp," which will not be dealt with at this time, have made it possible for this unit to operate over exceptionally wide ranges of input signals.

At an input level which produces 6 decibels of gain reduction, the maximum differential gain distortion produced by the AGC amplifier is about 2% for any duty cycle between 10 and 90%, while the differential phase distortion measured under the same conditions amounts to about 1°.

CONCLUSION

The video AGC amplifier described in this paper, has been used over a period of several years in NBC's television master control room where two complete installations, each capable of handling both composite and non-composite signals have been made.

These devices have proven invaluable for use on television shows containing material originating "remotely" from various parts of the country—or program material comprising newsreels or other films which must sometimes be put on the air without any "run-through" or rehearsal at all. Some of the better known programs which have benefited from the use of video AGC are the "Today" show, "Camel Newsreel," "Calvalcade of Sports," "Wide Wide World," and the 1956 political convention coverage.

A TRANSISTORIZED IMAGE ORTHONIC CAMERA FOR MILITARY USE

by

CHARLES H. CHANDLER

*Surface Communications Engineering
Defense Electronic Products, Camden, N. J.*

THE USE OF television techniques in military equipment and operations is by no means new; it dates back at least to some time before World War II. RCA's experience in the development of this field is of comparable duration. Instances of television applications pioneered by RCA during the war were its use as an "eye" for guided bombs and glide missiles, and the "Block" TV reconnaissance system. Recent television equipment developed by RCA under military contract includes, for example, several mobile systems for Army tactical evaluation and use. These systems incorporate airborne, truck-borne and man-carried camera chains, radio links for conveying televisual information to rear areas, and facilities for selecting, viewing and recording such information. Further applications in these and related fields are being actively explored.

In 1954, in the light of the experience cited, it was decided that a greatly improved camera for military use could and should be developed, and RCA General Engineering and Development funds were allocated for the purpose. Criteria were readily established for the new camera design. Savings in size, weight and power consumption were obvious goals. Placement of all functions in a single package, thus avoiding the mechanical entanglements and reliability hazards of interconnecting cables and plugs, was also felt desirable. Proper selection of primary power requirements, so as to require a minimum of power conversion, was necessary as well. At the same time, the best performance afforded by existing camera tubes (in respect to pickup sensitivity, "latitude" or ability to handle a large range of light levels within a picture, and general picture quality) was also sought as a design goal. No unnecessary compromise of these factors could be tolerated. The choice of an image

orthicon pickup tube, with fully transistorized associated circuits, was thus determined.

This choice did not represent an easy path to follow. The deflection fields required for the image orthicon are large; numerous stable, well bypassed voltages are required for the multiplier section. Rapid and precise switching of heavy currents is necessary for good synchronization and acceptable flyback times. Adequate video gain and bandwidth must be provided. In these and many other areas there was serious question as to whether transistors capable of the required performance were then available, or would be available when needed. As it turned out, progress in transistor capabilities just about kept pace with the requirements of the project. There were moments of alarm, but no serious delays were caused by lack of suitable semiconductor devices.

The result of the project was a completely self-contained, fully transistorized camera chain with properties particularly suitable for military use. It affords substantially all the advantages of the image orthicon pickup tube, at a saving of at least ten to one in weight, volume and power consumption over available equipment of generally comparable performance. The camera will be described more fully in the remainder of this article.

DESCRIPTION

An exterior photograph of the camera is given in Fig. 1, and a view with sideplate removed is shown in Fig. 2. It may be seen that the major portion (about five-eighths) of the internal space is taken up by the pickup tube with its focusing and deflection components. The remaining three-eighths is not very tightly packed, and in later development the camera chain could readily be made somewhat smaller than this one. For the record, the

dimensions of the camera, excluding lens and control box, are 6" x 9" x 18". Total weight is 31 pounds. Power required is approximately three amperes at 27 ± 2 volts d-c. It is noteworthy that only two cable connections to the device are required: power in, and video out.

The choice of 25-29 volts d-c for primary power follows from the fact that such power is used in many military equipments; it can be expected to be present, or readily available, when required. This is especially true in the case of military aircraft, for which the small size and light weight of this camera are attractive. If maximum convenience in design, or absolute-minimum power drain, had been sought, a somewhat lower voltage (such as 15) might have been preferred. With 27 volts there is some power loss in series resistors at several points in the circuit.

Fig. 3 provides an outline chart of the camera's contents, from which the functional modules visible in Fig. 2 may be located and identified. A brief description of each of these modules follows.

1. Sync Generator and Pulse Former

Starting from a 31.5 kc crystal oscillator, the customary count-downs by 2 and 525 are made. Binary dividers are used, and have exhibited excellent stability. Where necessary, pulse shaping stages have been added to sharpen wavefronts, improve triggering sensitivity, or perform such operations as mixing or differentiating. A total of 46 transistors are used in this module.

The resulting sync output produces a 525-line, 60 fields-per-second, interlaced picture. The pulse pattern is somewhat simplified as compared to RETMA standards, in that no equalizing pulses, or serrations within the vertical blanking interval, are used. In a closed-loop system, or one contain-

ing an r-f link with reasonable signal strength, this simplification causes no difficulties and probably enhances circuit reliability. Excellent results have been obtained consistently with this type of synchronization. A reconstructed sync pattern conforming to broadcast standards could of course be obtained by the auxiliary use of standard equipment. Such reconstruction has in fact been done, using the RCA TG-2A studio sync generator; no difficulties were encountered.

2. Deflection Generators

The vertical deflection output stage employs two transistors in a complementary-symmetry configuration. Five more transistors, for a total of 7, are employed as pulse shapers and drivers. This module requires a power source giving plus and minus 15 volts in order to maintain d-c balance in the



Fig. 1—Transistorized Image-Orthicon Camera—Exterior View.



Fig. 2—S. W. Cochran, Manager, DEP Surface Communications Department, points out the synchronization generator of the transistorized camera to T. A. Smith, Executive Vice President, Defense Electronic Products.

deflection yoke. The vertical deflection provided by this circuit can readily be made very linear.

The horizontal deflection circuit proved to be one of the system's toughest development problems. For full deflection it was necessary to interrupt a current of more than an ampere in ten microseconds or so, and hold off the voltage surge resulting from the collapse of the deflecting field during this time. The use of an output transformer gave little comfort; one could trade surge voltage for switched current or vice versa, but either of these quantities burned out transistors about equally well. It was not until rather late in the development cycle that a transistor with both current-handling capacity and fast switching time appeared on the market. With this unit mounted on an air-cooled heat sink, acceptable results were obtained. It is expected that future developments in the field of semiconductor devices will permit improved linearity and a desirable further reduction in fly-back time.

A total of 5 transistors are used in the horizontal deflection module.

3. Video Amplifier

This unit, folded into a "U" shape to fit around the pickup tube socket assembly, occupies the bottom rear space in the package. It contains 18 transistors.

Overall video bandwidth is roughly 6.5 megacycles. The circuit incorporates keyed clamping at horizontal frequency, and a mixer to provide a com-

posite output signal containing video, blanking, and sync. Output is approximately 0.6 volt peak-to-peak into a 75 ohm line.

4. Power Supplies

Most of the camera's power needs are well served by the primary power supply. However, two d-c-to-d-c converters are used: one to supply electrode potentials for the image orthicon tube, and one providing 30 volts, balanced to ground, for the vertical deflection generator. These are of a type which in the current state of the art may be considered as conventional, i.e., transistor power oscillators working into step-up transformers whose output is rectified by silicon or selenium diodes and filtered.

The high-voltage converter's basic output is +1300 and -500 volts. The positive voltage, from which the pickup tube dynodes are operated, is impressed upon a voltage dividing network housed in the same module. Each tap of the divider is by-passed for video frequencies.

5. Control Box

This unit contains the electronic controls commonly used in operation: beam current, beam focus, target voltage, and photocathode voltage. These controls are grouped in a separate small box roughly 2" x 2" x 5", which plugs into an 18-terminal connector at the rear of the camera. (This figure includes several spare contacts.) Since all control potentials are d-c, remote control may readily be provided by

the addition of an intervening cable and connectors. Length of such a cable is not critical.

6. Miscellaneous

Lens and focusing mount are, of course, necessary accessories and may be chosen according to light levels expected and angle of view desired. As a result of the compactness and light weight of the camera chain, suitable tripods, pan heads and the like are not hard to find.

PERFORMANCE

The over-all performance of the transistorized image orthicon camera chain was most gratifying. In many ways it exceeded expectations. The pictures obtained had that "image orthicon quality" which, one suspects, comes partly from its resolution and gray-scale capabilities, and partly from its latitude, or resistance to blocking up in small bright areas.

As for more specific factors, a conservative figure for horizontal resolution would be at least 400 lines. Pick-up from a back-lighted test pattern transparency showed all steps of the gray scale well reproduced. Sensitivity, of course, was determined by the pick-up tube itself; this was not limited in any way by the associated circuitry.

Operation of this camera chain is not appreciably different from that for any camera employing the image orthicon tube. The same controls are provided and their effects are normal. For reasons of simplicity, such adjustments as optical focus and aperture stop were not brought back to the body of the camera. Placement of these controls is a matter of mechanical convenience, whereas circuit development was the primary objective of this project. In future embodiments, controls may be provided and placed as governed by the application in view.

Finally, it should be mentioned that, as of the time of this writing, the transistorized camera has performed with negligible maintenance effort through many hours and days of demonstrations—truly an acid test. The outlook for a reliable and trouble-free equipment appears exceedingly good.

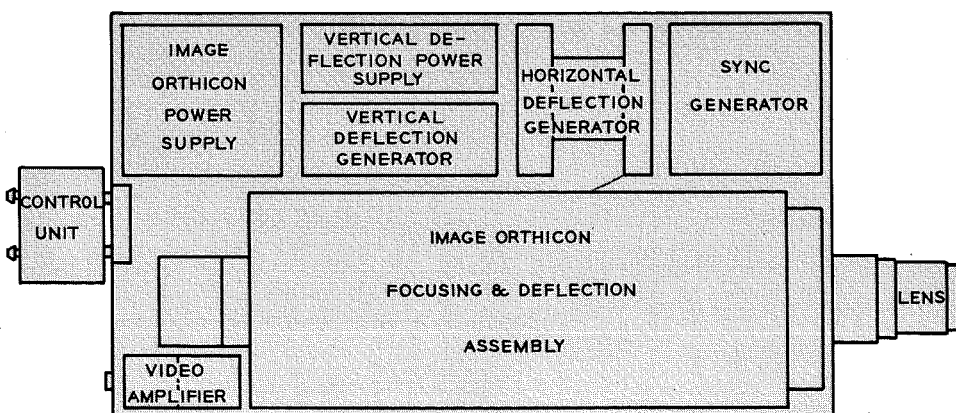

Fig. 3—Physical layout of Transistorized Image-Orthicon Camera Chain.



CHARLES H. CHANDLER received a B.A. degree in physics and mathematics from the College of Wooster, Ohio, in 1940, and an M.S. degree in electrical physics from Ohio State University in 1946. During World War II he served as a Signal Corps officer. In 1946 he joined RCA Laboratories, Princeton, where he engaged in research on microwave radar scanners and displays, propagation in dielectric materials, color television, ultra-wide band amplifiers and military communication and data-processing systems. In 1955 he came to Camden, as an Engineering Leader associated with the development of high-precision circuitry for military equipment. Since early 1956 he has been in charge of the Military Television Development activity of DEP Surface Communications. Mr. Chandler is a Senior Member of IRE, a member of the Professional Group on Audio, a member of Sigma Xi, Sigma Pi Sigma, and the American Association for the Advancement of Science, and the American Ordnance Association.

DISCUSSION

The success of the transistorized image orthicon camera chain development is well attested by the gratifying performance already mentioned. No less important, its small size, low weight and modest power consumption underline its suitability for military applications. Where a high quality television picture is required, this camera affords easy handling, quick setup, and operation from power sources such as are normally found in and about military aircraft and ground vehicles. Moreover, it permits operation earlier into dawn and later into dusk than would the simpler but less sensitive cameras employing photoconductive devices—and from the tactical standpoint, these are important parts of the day.

It is of interest to touch upon some of the implications of the transistorized camera's properties as related to some specific military applications.

One appropriate area, for example, is that of tactical aerial reconnaissance. Consider here, in addition to the favorable physical size and similar factors, the high sensitivity of the image orthicon tube. This sensitivity, in addition to "lengthening" the useful day as already noted, would allow the use of relatively dense optical filters which could improve haze penetration, or enhance discrimination of objects against backgrounds of comparable reflectivity but different hue. As another example, take the use of the camera on the ground. Here its lightness and compactness would make it easy to handle and use, by one man if need be. In close-range tactical situations its low power drain would make battery operation feasible, thus avoiding the noise and complication of a power plant. Finally, the sensitivity of the device would encourage the use of long-focus lenses or telescopic devices, not ordinarily noted for their "speed," in many circumstances. Other advantages mentioned relative to airborne operation also apply in this connection.

Due to limitations of space and considerations of security, the list of features given above cannot be a complete one. The reader who has interests and experience in the tactical uses of such a device can hardly fail to make some significant additions.

To complete the discussion, a few words about future developments along this line are in order. In the first place, the experience gained so far has pointed the way to many circuit simplifications and improvements. Fewer components, but equal or better performance, may be expected. Some size reduction is possible; at the same time, accessibility and ease of maintenance can receive a larger portion of design efforts. Packaging appropriate to special requirements or unusual applications is also entirely feasible. Finally, a number of accessory units could be developed, engineered to the same design criteria as was the camera itself. These might include: compact electronic viewfinder; radio link for open-loop operation; small, transistorized monitor. (In the last connection, excellent results have been obtained with the camera connected into the video channel of an RCA "Personal

Portable" receiver, but this mode of operation leaves portions of the receiver unused, and two different power sources are involved. A monitor of matched design is a worthy goal.) A synchronizing generator providing the RETMA synchronization standard would be a desirable extension of the present work. Another helpful feature would be a lens-changing turret, where required. The remote control cable already mentioned is a minor but useful accessory; still other auxiliaries may be developed as needs appear.

Above all, the objective in future development is that of keeping pace—with the requirements of the Services, on the one hand, and the evolution of the state of the art, both in transistor circuitry and in semiconductor devices themselves, on the other. The work described here, taken as background, provides a valuable, perhaps unique, basis for future progress.

ACKNOWLEDGEMENT

Every effort has been made to secure a complete listing of those who made significant contributions to the image orthicon camera project; but the number of workers is large, and because of this and the passage of time, there may be omissions. If so, these are sincerely regretted, the more so since the credit for any part of this work is so well merited. It is, however, a pleasure to acknowledge the work of the contributors whose names follow. Engineering and technical project coordination were performed by A. F. Flacco in the earlier stages of the work, and by William Ussler, Jr. in the concluding phases. Early design work was done by James Potts, assisted by Michael Ross in the electrical areas, James Shoffner in the mechanical, under the supervision of E. C. Lindenberg. Subsequent contributions to design, development and construction were made by Ray DeCredico, Thomas Keefe, John Smiley, George Trebing and John Wolfinger. Much of the final assembly and checkout was performed by Sebastian Greif. Helpful suggestions in the transistor area were received from Brooks Griffiths and P. M. Toscano. Finally, the valued support and encouragement of H. J. Laiming and O. B. Cunningham is gratefully acknowledged.

MEDICAL ELECTRONICS FROM THE ENGINEERING STANDPOINT

by **DR. V. K. ZWORYKIN***
*RCA Laboratories
Princeton*

THERE IS PERHAPS nothing of more universal concern to us than our health. Not only are we emotionally involved with it as individuals, but the health of employees is a major economic consideration of every business enterprise. Consequently, we should expect every technical advance of this electronic age to serve medicine, both in its preventive and curative aspects.

Any engineer examining techniques employed in medical research and practice will confirm that this desirable condition is not realized at present. Part of the technological lag can be ascribed to a completely justified conservatism of the physician in applying new methods in the treatment of human beings. New techniques can be adopted only after exhaustive tests demonstrate their usefulness and indicate what precautions are required by deleterious side-effects.

LANGUAGE BARRIER EXISTS

This is not the only difficulty, however. There is a barrier of language! The medical man and biological research worker are rarely prepared to

* Honorary Vice President, RCA. Technical Consultant, RCA Labs.

understand electronic engineers or to comprehend the operation of electronic gear. Similarly, most experts in electronics are soon lost when confronted with medical terminology.

Several groups have lately addressed themselves to the problem of improving this situation. The IRE Professional Group on Medical Electronics is at the center of this effort.

The wide-spread interest in medical electronics is reflected in the rapid growth of the Professional Group on Medical Electronics. On December 31, 1956 its membership was 1542 with local chapters in 11 cities. So far, the great majority of the membership is made up of electronic engineers. By and large, medical men have been reluctant to join since they have not regarded themselves as qualified engineers and have found little use for the



DR. VLADIMIR K. ZWORYKIN, Honorary Vice-President of RCA and Technical Consultant to RCA Laboratories, joined RCA in 1929. He received his undergraduate training at the Petrograd Institute of Technology, which granted him an E. E. degree in 1912. This was followed by postgraduate work in physics with Langevin in France. After the first World War Dr. Zworykin came to the United States and joined the research staff of Westinghouse in Pittsburgh, where he made important contributions in photoelectricity, facsimile, and sound movies. He was granted a Ph.D. by the University of Pittsburgh in 1926. In 1929 he was transferred from Westinghouse to RCA, where he was placed in charge of the Electronic Research Laboratory, whose continu-

ously expanding activities he directed, first in Camden and, since 1942, in Princeton, until 1954. In this capacity Dr. Zworykin was concerned not only with the perfection of all-electronic television, for which he had created the basis during his Westinghouse period by the invention of the iconoscope and kinescope, but of a multiplicity of other important electronic devices, such as the secondary emission multiplier, the image tube, and the electron microscope. Since 1954 Dr. Zworykin has assumed, in addition to his responsibilities at the RCA Laboratories in Princeton, the direction of a Medical Electronics Center at the Rockefeller Institute for Medical Research in New York. In this capacity and as National Chairman of the Professional Group on Medical Elec-

tronics of the Institute of Radio Engineers he has been particularly concerned with an extension of the use of electronic methods in medicine and the life sciences. In recognition of his important contributions Dr. Zworykin has been awarded an honorary degree of Doctor of Science from Brooklyn Polytechnic Institute; the Medal of Honor and the Morris Liebmann Memorial Prize of the I.R.E.; the Edison Medal and the Lamme Medal of the A.I.E.E.; the Progress Medal Award of the S.M.P.T.E.; the Rumford Medal of the American Academy of Sciences; the Potts Medal of the Franklin Institute; the Presidential Certificate of Merit; the Chevalier Cross of the French Legion of Honor; and a multiplicity of other honors and awards.

tronics of the Institute of Radio Engineers he has been particularly concerned with an extension of the use of electronic methods in medicine and the life sciences. In recognition of his important contributions Dr. Zworykin has been awarded an honorary degree of Doctor of Science from Brooklyn Polytechnic Institute; the Medal of Honor and the Morris Liebmann Memorial Prize of the I.R.E.; the Edison Medal and the Lamme Medal of the A.I.E.E.; the Progress Medal Award of the S.M.P.T.E.; the Rumford Medal of the American Academy of Sciences; the Potts Medal of the Franklin Institute; the Presidential Certificate of Merit; the Chevalier Cross of the French Legion of Honor; and a multiplicity of other honors and awards.

NERVE STUDIES

What are some of these problems? To begin with, we have the extremely interesting study of nerve activity. An understanding of neurophysiology may lead to better methods of combating neurological disorders resulting from degenerative, inflammatory or other physical causes. Bio-physicists have been able to shed considerable light on processes involved by the application of electronic measuring techniques and circuit analysis. Useful analogies have been drawn between delay line signal transmission and nerve impulse conduction.¹ The analogy between the functioning of the brain and that of digital computers is quite real. Computer specialists should be able both to contribute to neurology and derive ideas for computer operation from brain studies.²

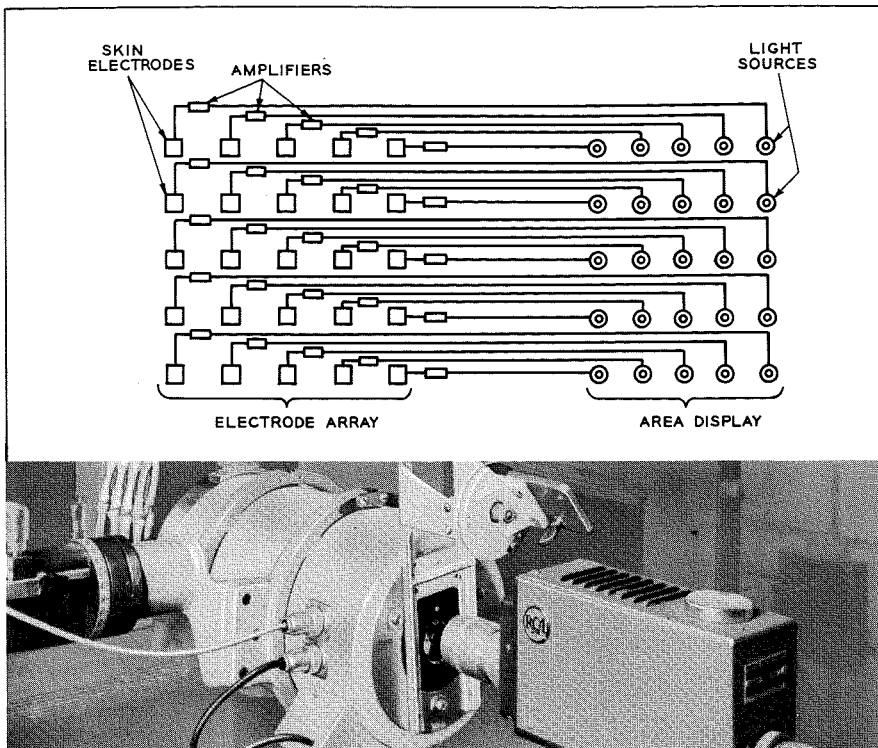

Fig. 1 (Top)—Area Display for the Representation of the Distribution of Skin Potentials (J. C. Lilly)

Fig. 2 (Bottom)—Employment of Image Intensifier in Conjunction with Vidicon Television Camera for Fluoroscopy (Temple University)

Closely related to this subject are electroencephalography and electrocardiography, widely employed as diagnostic tools. Here the variation of skin potentials, on the skull or elsewhere on the body surface, is correlated empirically with normal and abnormal activity of the brain and the heart. The more recent technique of area displays of skin potentials, employed by Stanford Goldman³ and his coworkers at the Massachusetts Institute of Technology and by John C. Lilly⁴ at the National Institutes of Health, appears particularly promising. Here, the potentials of a grid of electrodes attached to an area of the chest, the skull, or, in animal experiments, the exposed cortex, are represented continuously by brightness values on a cathode ray tube screen or an indicator lamp panel (Fig. 1). Potential waves which sweep over the surface can be viewed directly.

It is highly desirable to increase both the space and time resolution of such systems. Since very low signal levels are to be measured, this demands great care in the selection of electronic components and design of circuits.

ELECTRONICS IN SURGERY

In surgery, too, the potential role of electronics goes far beyond the function of teaching the art through the medium of television. Electronics in medicine is not confined to the use of the radio knife, or the employment of high-frequency techniques in sur-

gery.⁵ Quite the opposite, the surgeon and anesthesiologist are greatly in need of improved electronic techniques for monitoring the condition of the patient. Respiration, electrocardiogram and electroencephalogram, oxygen content of the blood and rate of blood flow are some of the relevant data. Various techniques have been suggested and tried for presenting such information to the surgeon or anesthesiologist with minimum distraction from his work. One of these is the installation of alarms triggered by serious deviations from normal. Another is the large-scale television presentation of recordings. Still another, realized in the Electrocardiophone, is the translation of the electrocardiogram into an auditory signal. This enables the surgeon to hear (while concentrating visually on surgery) deviations from the normal electrical activity of the heart.

If monitored by the anesthesiologist alone, it enables him to keep continuous check of the heart condition with minimum distraction. Feedback of electroencephalograph signals has been used to control anesthesia levels automatically for long periods.

DIAGNOSIS BEFORE SURGERY

Electronic techniques should play a particularly valuable role in the many diagnostic procedures preceding surgery. The electronic brightness intensi-

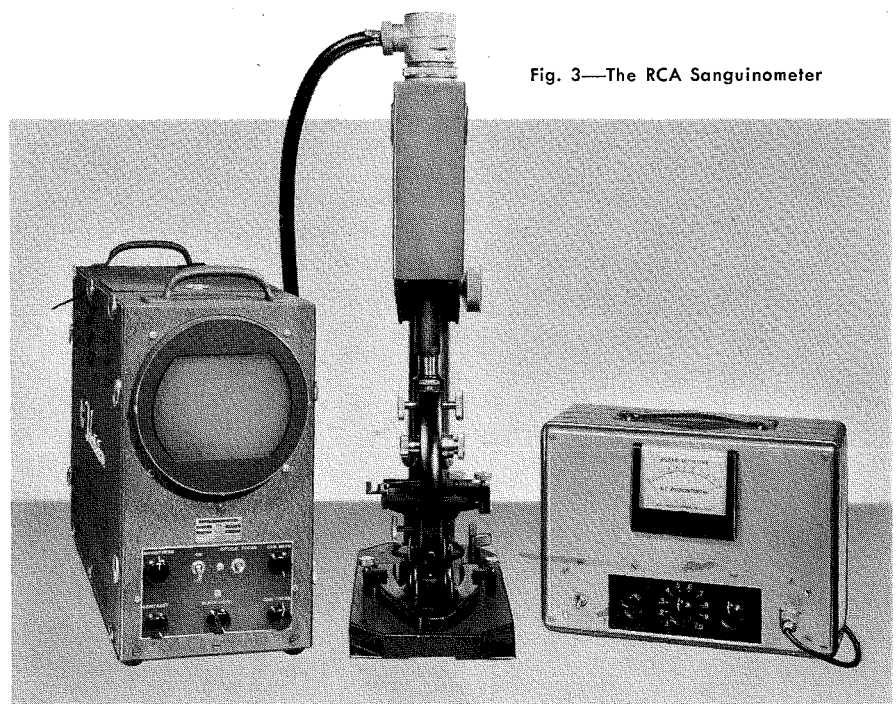

Fig. 3—The RCA Sanguinometer

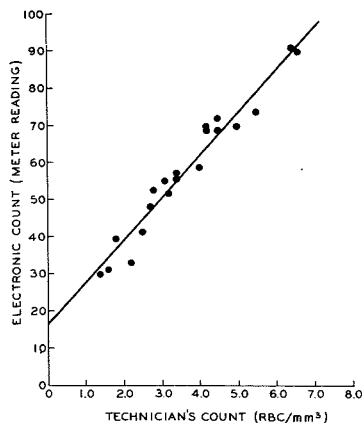

Fig. 4—Comparison of Manual Counts and Sanguinometer Counts on Red Blood Cell Suspensions

fication of the fluoroscopic image, aided by the image intensifier and closed-circuit television, reduce the radiation exposure of the patient and the radiation hazard to personnel. The detail of the observed x-ray shadowgram is greatly increased. Fig. 2 shows an experimental installation of an image intensifier employed in combination with an RCA industrial television camera at Temple University. The addition of scanning permits an increase in contrast as well as remote viewing. A great increase in the effectiveness of fluoroscopy should result from these electronic innovations.

Biology and medical sciences derived from it are still largely descriptive rather than quantitative in nature. For this reason many diagnostic procedures rely on visual examination. Automatic electronic data processing of this visual information holds great promise in quantitating (formerly visual estimates) number, size, color and intensity of a diagnostic sample.

THE SANGUINOMETER

In many instances particle counts play important roles in diagnosis. The red blood cell count, in particular, is a standard means for checking excessive radiation exposure of personnel and testing for anemia. To prepare a red blood cell count, a drop of blood is diluted with physiological saline solution in a standard ratio. This is introduced into a counting chamber, having a fixed separation between slide and cover glass and a prescribed area. The technician inserts the chamber in a high-power microscope and counts the number of cells in this area; cell diameters range from 0.1 to 0.5 mil.

This is a time-consuming and tedious task, subject to human error. Ac-

cordingly, numerous efforts have been made to carry out the task by mechanical or electronic means. An example is the Sanguinometer, developed at the RCA Laboratories. This consists essentially of a television microscope combined with an electronic counting device (Fig. 3). The cell field is focused and adjusted in magnification on the monitor of the television microscope. Since dark-field illumination is employed, the blood cells appear on the screen as luminous disks. The signal output of the television camera is applied to two counter circuits. One counts the total number of pulses corresponding to transits of the scanning beam across cell images. The result is applied (in the form of a voltage developed across a capacitance) to the count rate meter. The second circuit compares individual pulse lengths to the time interval corresponding to an adjustable delay line. The delay line adjustment is arranged so that the count rate meter reading is automatically compensated for the most probable size of the blood cells.

The measurement of any suspension reveals the presence of a certain fraction of "noise pulses," which do not correspond to transits across blood cells. Hence it is customary to check the Sanguinometer with a standard fixed suspension, which has been counted manually. Fig. 4 shows a comparison of Sanguinometer counts with manual counts on the same specimens. The plot shows both the noise pulse intercept and the linear relationship between the results of the two counting methods. It is thus a convenient calibration curve.

Fig. 5—Unstained Kidney Tissue as Observed on TV Microscope Monitor with 4000 Å and 2537 Å Illumination

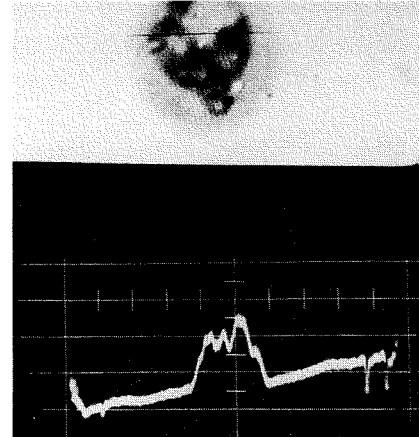
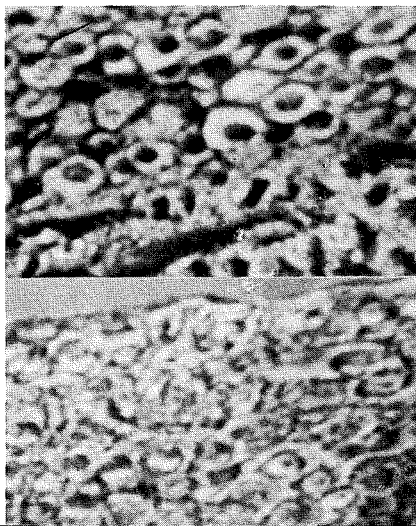

Fig. 6—Quantitative Measurement of Cell Absorption with Television Microscope and Line-Selecting Oscilloscope (Dr. G. Z. Williams, National Institutes of Health)

IDENTITY OF CANCER CELLS

Another very important problem in cell counting and cell identification has been attacked by Walter Tolles and his associates⁶ at the Airborne Instrument Laboratory, following some pioneering studies by Drs. Mellors and Silver⁷ of the Sloan-Kettering Institute. It is the recognition of cancer cells in so-called Papanicolaou cervical smears. This plays a vital role in the early diagnosis of the disease. A large scale use of the method depends on reducing the load of routine examinations which it imposes on the cancer pathologist by some automatic means of rejecting specimens without questionable cells.

In the "Cytoanalyzer" cancer cells are distinguished from normal cells by the greater optical density and the larger dimensions of their nuclei. A mechanical flying-spot scanning system with a multiplier phototube as detector explores the specimen and generates pulses corresponding to the transits of the light beam across the cell nuclei, which are about 0.5 mil in diameter. These are measured with respect to duration and amplitude and are recorded on the screen of an oscilloscope, and photographed by an open-shutter camera. Smears causing an appreciable number of dots outside a preestablished range are referred to the pathologist for visual examination.

The problem is complicated by the fact that particles other than cells, cell clusters, and folded cells may give rise to abnormal counts unless they are eliminated. To eliminate them as far as possible, gating circuits are provided. This prevents recording unless the cytoplasm absorption on either side of the nucleus falls between two

prescribed limits. Or, unless the ratio of the nuclear absorption to the cytoplasm absorption exceeds a certain value. It is thus evident that we are dealing here with a relatively complex problem of electronic computation.

STORAGE OF HEALTH RECORDS

Electronic computation techniques have unquestionably many other valuable applications in medicine. One of these is the storage of health records for large groups—eventually the entire population—and their utilization for statistical studies. An example would be the correlation of the incidence of leukemia of infants with the

is an unrivaled tool for the visualization of fine structural detail and has become an indispensable aid in biological research. Both its electron-optical design and the stabilization of its power sources lay claim to a high degree of skill in engineering.

THE TELEVISION CAMERA

The use of television methods in studying the structure and contents of the living cell is an interesting application. Conventional methods of studying cells and tissues involve killing them as rapidly as possible in an attempt to fix the physico-chemical structure, with subsequent chemical

known to have characteristic absorption bands in the ultraviolet—particularly in the range between 2500 and 3000 Angstrom units—while they are transparent and hence indistinguishable in visible light. Fig. 5 illustrates this by comparing pictures of identical unstained kidney tissue sections photographed from the monitor screen of a television microscope, for illumination with 4000 Angstrom and 2537 Angstrom radiation. In the second picture the cell nuclei stand out clearly, owing to the strong absorption of the 2537 Angstrom radiation by nucleic acid. The television camera employed in this ultraviolet television microscope was a standard industrial television Vidicon Camera using an experimental tube with an ultraviolet-transmissive window and ultraviolet-sensitive photoconductive layer.

Dr. George Z. Williams at the National Institutes of Health employs a line selector oscilloscope to represent the absorption along a particular scanning line through a cell and photographs the oscillogram together with the cell picture on the monitor (Fig. 6). A dark line on the cell picture indicates the position of the selected line. From such pairs of pictures and diagrams the distribution of absorbing material in the cell can be inferred quantitatively.¹⁰ Similar studies, with either the flying-spot technique or conventional television cameras, have been carried out by Loeser and Berkeley at Western Reserve University.

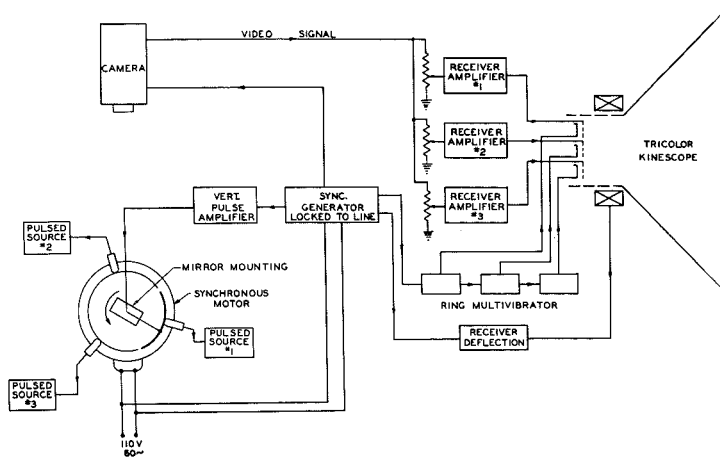

Fig. 7—Schematic Diagram of Color Translation Television Microscope (Rockefeller Institute)

prenatal x-irradiation of the mothers, which has been accomplished by much more tedious methods recently. Another is the preparation of an Index Medicus for specific fields of medicine, correlating symptoms with diseases; it might serve as a mechanical memory aid to the physician, supplementing his direct experience. Both possibilities are receiving serious attention.⁸

ELECTRON MICROSCOPY

So far we have considered primarily some of the newer applications of electronics in medicine. However, we must not overlook well-established techniques, which are continuously expanding their field of usefulness. Perhaps the oldest of these is the application of x-rays to diagnosis and therapy. Another, somewhat more recent, technique in which RCA has played a pioneering role is electron microscopy. The electron microscope

and morphological analysis. The direct study of living tissues avoids the possibility of structural modification incidental to the preparation.

A number of benefits can be realized by replacing the observer's eye by a television camera and studying the picture of the specimen on the viewing screen of the television monitor. One of these is simply the greater ease of viewing and the possibility of simultaneous viewing by larger groups. It has obvious applications in the teaching of biology. Another is the possibility of enhancing contrast or cellular outlines by electronics.⁹

TELEVISION MICROSCOPE

Another advantage of the television microscope is the ability to examine living, unstained specimens (illuminated by ultraviolet or infrared radiations) which cannot be seen by the human eye. Cell constituents are

COLOR TRANSLATION

My own effort in this field has been directed primarily toward development of an instrument which would reveal the presence of materials with different characteristic absorptions at a glance, permitting the rapid examination of large quantities of material to locate abnormalities. As already indicated this may have obvious applications in the cancer problem. To attain this goal, we adopted the principle of color translation, suggested in 1939 by Brumberg and applied since then to a photographic technique by Land and his associates.¹¹ In color translation the three primary colors, red, green, and blue, are correlated with radiations of three different wavelengths in the ultraviolet for

which constituents of the specimen have characteristic absorptions. Thus a certain color will indicate at once the presence or absence of a certain absorbing material.

In the photographic technique, as worked out by Land and his associates and more recently by Hovnanian and Holt¹² the three separate pictures are exposed through an ultraviolet microscope on three successive film frames. These are developed, and the negatives are projected in superposition on a screen, by separate light sources provided with red, green, and blue color filters. While this method has the advantage of providing a permanent record, it suffers from the time delay inherent in photographic processing, difficulties in standardizing the chemical treatment, and the usage of much photographic material.

"TV" VERSUS PHOTOGRAPHY

When television representation replaces photography, the time delay in the observation of the specimen is eliminated and nothing is consumed apart from the electrical power required to operate the equipment. In the apparatus constructed at the Rockefeller Institute in New York (Fig. 7) three pulsed mercury arc sources supply illumination (at selected ultraviolet wavelengths) to the specimen for successive television frames in the ultraviolet television

microscope. The video signal from the camera unit is applied in turn to the red, green, and blue guns of a color kinescope, so that the red, green, and blue component pictures are seen in rapid succession and fused into a color picture by persistence of vision.

Fig. 8 shows the illuminating system. The use of individual grating monochromators with each mercury arc light source makes it a simple matter to change the ultraviolet wavelengths selected for illuminating the specimen. The illuminating system and the power supplies are mounted in a desk. The microscope, with reflective condenser and objective to provide sharp focus for all wavelengths, plus the camera and monochrome monitor are mounted on the surface of a desk. The color monitor is a modified color television receiver.

The equipment shown in Fig. 7 has been tested and was found to perform in the expected manner. Its chief drawback was a certain persistence of the pictures from one field to the next, which resulted in low-saturation colors. This difficulty has now been remedied by the replacement of the Vidicon with a special orthicon with ultraviolet transmissive front end.

The work on the color-translating television microscope is being carried out at the Medical Electronic Center of the Rockefeller Institute for Medical Research in New York.

THE RADIO PILL

Another problem which has claimed the attention of the Medical Electronic Center is that of studying the functioning of the gastro-intestinal tract along its entire length. In the past, the introduction of probes into the tract to assist in such studies has been severely hampered by the need for external leads connecting the probes with measuring apparatus. To overcome this difficulty, RCA's Commercial Electronics Division has developed for the Rockefeller Institute a "radio pill" which radiates the desired information in the form of varying electromagnetic fields, picked up by apparatus external to the patient. The radio pill should make it possible to explore the gastro-intestinal tract with little discomfort to the patient.

The essential feature of the pill is a transistor oscillator (Fig. 9a) whose frequency is modulated by the parameter to be measured. In the present realization this parameter is the pressure within the tract. Modifications in construction would permit the measurement of other parameters, such as temperature and, eventually, pH.

In greater detail, the pill is a plastic capsule, approximately 1 1/8 inches in length and 0.4 inch in diameter (Fig. 9b). At one end the capsule is sealed by a flexible rubber membrane which encloses an air space and thus transmits pressure variations to a diaphragm supporting the armature of a ferrite cup inductance core. Displacements of the diaphragm change the inductance, which controls the frequency within the oscillator. The transistor and the remaining circuit components are in the middle of the pill, which contains a miniature battery.

The leakage field of the ferrite core is picked up by an external f-m de-

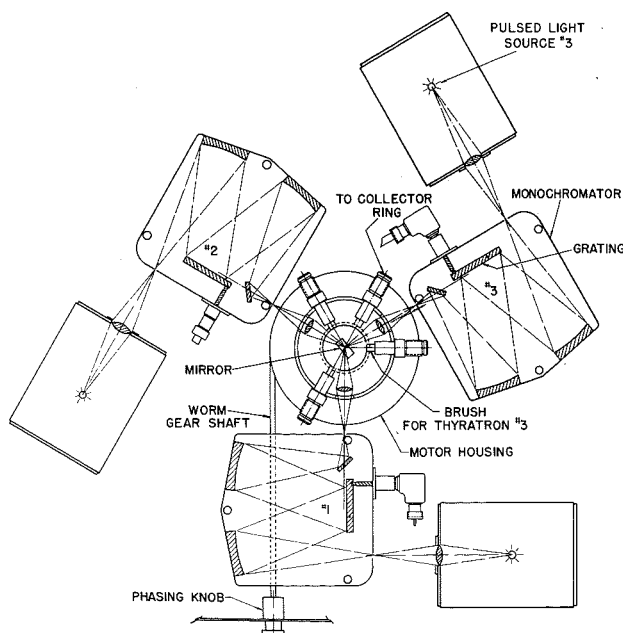
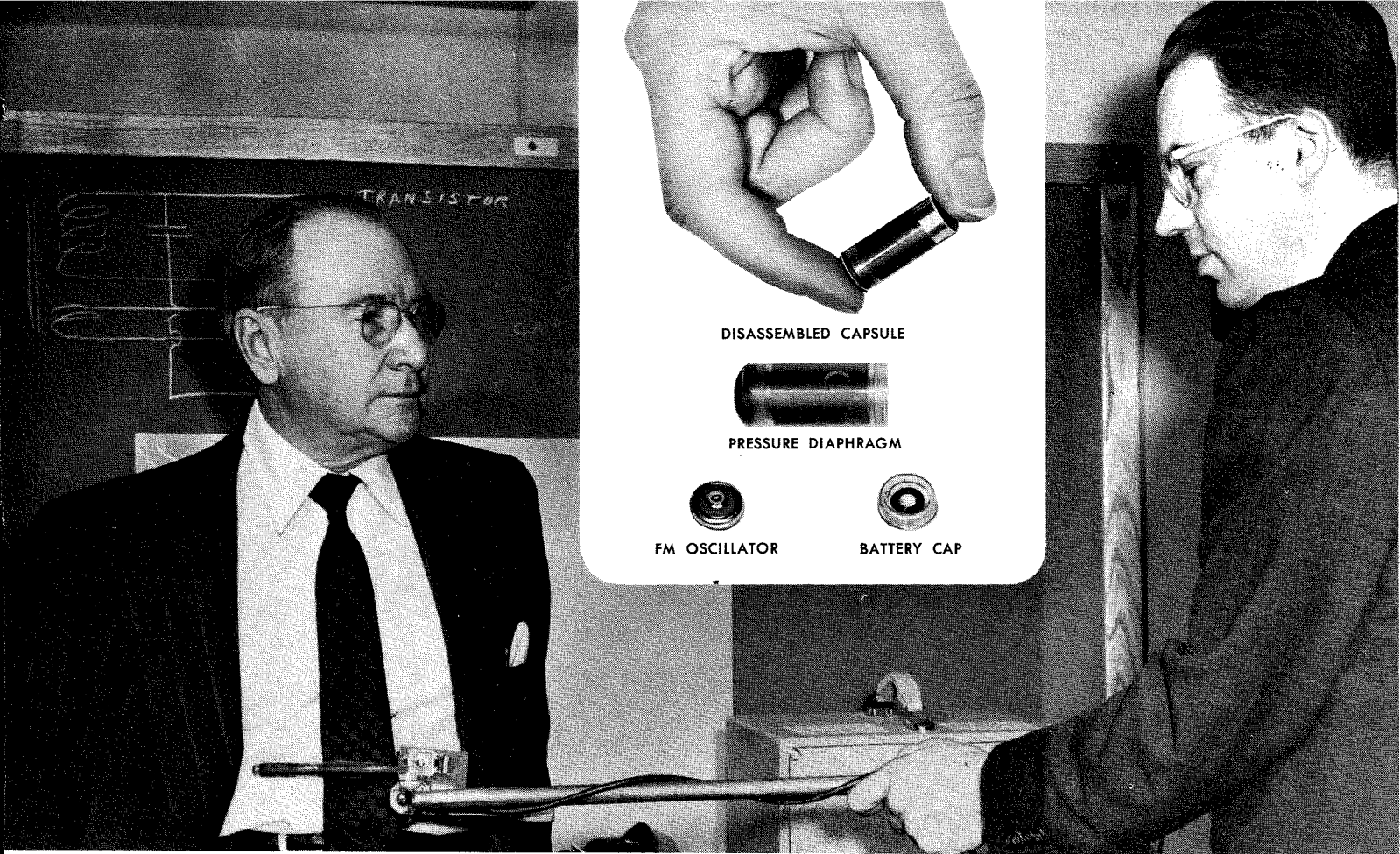

Fig. 8—The Illuminating Unit of the Color-Translating Microscope

- | | |
|--------------------|---------------------------|
| 1. Perforated cap | 7. Transistor |
| 2. Rubber membrane | 8. Other circuit elements |
| 3. Diaphragm | 9. Battery |
| 4. Armature | 10. Screw-on cap |
| 5. Ferrite magnet | |
| 6. Lucite housing | |



An FM radio antenna is held against Dr. Zworykin (left), Affiliate in Biophysics in the Medical Electronics Center of the Rockefeller Institute and Honorary Vice President of RCA, to demonstrate how FM waves are picked up from the pill as it passes through the human body. Operating device is Dr. John T. Farrar, Chief of Gastroenterology, New York Veterans Administration Hospital.

detector with a ferrite rod antenna. The frequency variations of the signal—a one-megacycle oscillation—are recorded by a recording galvanometer connected to the detector. These variations, which measure the variation in pressure within the gastro-intestinal tract, may be correlated with the position of the pill as established by fluoroscopy or, eventually, electromagnetic triangulation.

CONCLUSION

These are just a few examples of problems in medical research and practice

to which the electronic engineer can make a significant contribution. Any engineer who maintains close contact with the medical profession will soon become aware of numerous others. Once he has fully familiarized himself with the medical problem, his professional experience will suggest solutions to him which, for want of parallel experience, may never occur to the medical man or biological researcher. An effort to master the rudiments of medical terminology and to keep in close touch with men engaged in medical practice and research can thus

be extremely fruitful, both in furthering the work itself and in providing the satisfaction derived from aiding a worth-while effort.

BIBLIOGRAPHY

1. O. H. Schmitt, IRE Transactions on Medical Electronics, *PGME-6*, 3-27 (1956).
2. W. S. McCulloch and W. Pitts, Bull. Math. Biophys., 5, 115 (1943).
3. S. Goldman, W. E. Vivian, C. K. Chien, and H. N. Bowes, *Science* 108, 720-723 (1948).
4. J. C. Lilly, *Elec. Eng.*, 69, 68-69 (1951).
5. Symposium on Physiologic and Pathologic Effects of Microwaves, IRE Transactions on Medical Electronics, *PGME-4*, 1-51 (1956).
6. W. E. Tolles, R. C. Bostrom, and H. S. Sawyer, IRE Convention Record 4 (9), 17-23 (1956).
7. R. C. Mellors and R. Silver, *Science* 114, 356-360 (1951).
8. V. K. Zworykin, IRE Convention Record 4 (9), 99-102 (1956).
9. A. K. Parpart, *Trans. Amer. Micr. Soc.* 71, 311-313 (1952).
10. G. Z. Williams, IRE Convention Record 3 (9), 131-137 (1955).
11. E. H. Land, E. R. Blout, D. S. Grey, M. S. Flower, H. Husek, R. C. Jones, C. H. Matz, and D. P. Merrill, *Science* 109, 371-374 (1949).
12. H. P. Hovnanian and R. B. Holt, IRE Transactions on Medical Electronics, *PGME-5*, 3-12 (1956).

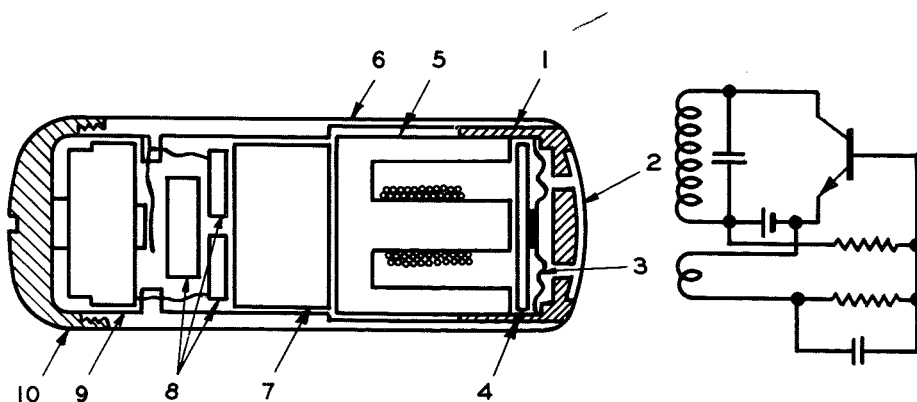

Fig. 9—Sketch and Circuit Diagram of the Radio Pill

S. F. B. MORSE
JUNE 20, 1840

Example 7

Fig. 2

Example 8

Fig. 1. Straight Barb Needle



**PROTECTING
 DATES OF INVENTION**

By **JOEL B. JOHNSON**
Domestic Patent Operations
Princeton, N. J.

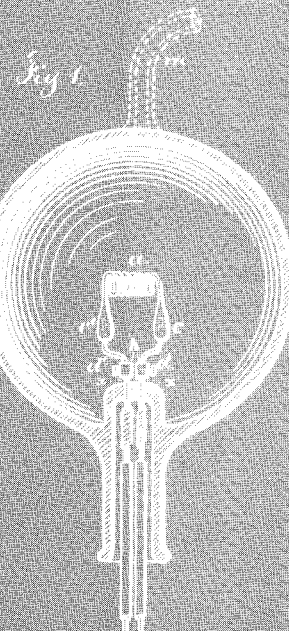

T. A. EDISON
JAN. 27, 1880

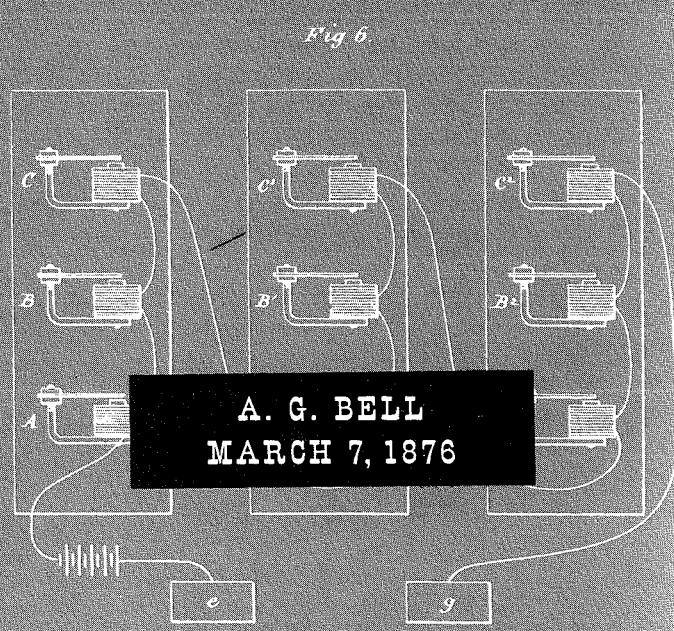
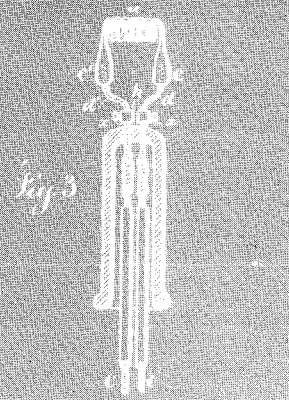

A. G. BELL
MARCH 7, 1876

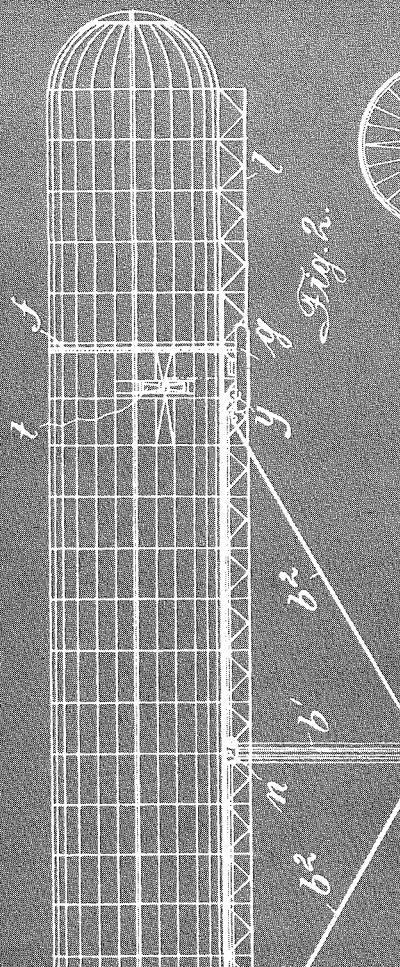

F. GRAF ZEPPELIN
MARCH 14, 1899

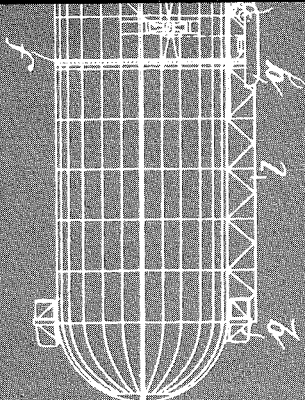

Fig. 1.

A WRITTEN DESCRIPTION of an invention made by an RCA engineer is normally submitted in the form of a patent disclosure to RCA Patent Operations. Here the invention is evaluated and, if approved, is prepared in the form of an application for a patent. The application, consisting of drawings, a written description, and claims defining the invention, is then filed with the United States Patent Office in Washington.

The Patent Office gives the application a thorough examination to determine whether or not it properly describes and claims patentable subject matter. If so, the Patent Office issues a "Letters Patent" based on the invention, granting to the owner of the patent the right to exclude others from making, using and selling the invention throughout the United States for a period of seventeen years.

PROPER RECORDS ARE VITAL

Whether the engineer knows he is inventing or not, there is a great need for proper records in the form of drawings, sketches, notebook descriptions, and shop orders. Such records first come into play when the engineer files a patent disclosure describing his invention. The disclosure form submitted to the RCA Patent Operations requires such critical dates as: when the invention was conceived, when construction of the device incorporating the invention was completed, and when the completed device was first successfully tested. A full disclosure helps the patent attorney to obtain a complete picture of the invention, which he must describe in detail in the patent application. The attorney will need to know specifically what kind of device contained the invention, the problems necessitating the invention, ranges of the normal or usable components or ingredients or the optimum range of dimensional values, especially those which may be critical in carrying out the invention.

PRIORITY OF INVENTION

The most important dates of invention are those which are necessary to determine the priority of the same invention between RCA inventors and one or more outside inventors. The determination of priority is an official pro-

cedure called an "Interference." This is set up by the United States Patent Office to determine who is the first inventor. For this determination, *the inventor's records are of great value*, since it is by these records that a patent award to one of the inventors will be made.

In determining priority of the invention among several applicants who are parties to an interference, the Patent Office considers these specific acts of each inventor: (1) his conception of the invention; and (2) his reduction to practice of the invention, which is the successful construction and operation of a device incorporating his invention. In certain situations the Patent Office may also consider the diligence exercised by the inventor after his conception of the invention.

After comparing the proven dates on all these points for each of the parties of the interference, the Patent Office will be able to determine the first inventor of a common invention.

CONCEPTION MUST BE PROVED

Merely wishing for a result is not inventing, but conceiving of a practical way to accomplish the result, is a conception of the invention. The conception of the invention is completed, according to Patent Office practice, when the means or process, by which the invention can be successfully carried out, is fully realized by the inventor.

In one case, the Court has stated:†

"If confined to the above statement of facts, it seems to us that at the time Hartt claims to have disclosed his invention to O'Donnell, he did not have a conception of the completed invention of the counts at bar. If he did not have a complete conception of the invention, he could not have disclosed it to O'Donnell. Since a conception must consist 'in the complete performance of the mental part of the inventive act' . . ."

Conception must be manifested or proved by exterior acts or declarations. A preliminary statement filed by each party sets forth, in addition to other dates, the date of the first drawing, the date of the first dis-

† *O'Donnell v. Hartt*, 22.C.C.P.A. 958; 1935 C.D. 322; 456 O.G.7.

closure to others, and the date of the first written description of the invention. These are the acts upon which the inventor relies to prove his conception. For this reason, earliest sketches are invaluable, since when properly dated and corroborated, they enable the inventor to establish a date of conception.

The engineer's first written description should completely set forth the invention, and the manner in which he proposes to make and utilize the invention. Although the invention may not be completely conceived the first day, or even the second, the written description should be continuous until the invention has been fully set down in sufficient detail. Then at some future date, a reader skilled in the art will know how to practice the invention.

AN EXAMPLE OF INTERFERENCE

A recent interference, in which an RCA party was involved, concerned a metal shell with a large rectangular open end to which a spherical glass face plate could be sealed. The shell tapered to a round smaller end, to which a glass funnel and neck assembly could be sealed. The metal shell was designed for optimum strength and rigidity when used as the bulb portion of a rectangular metal kinescope.

Three inventors outside of RCA also filed applications on a metal shell for the same purpose. To determine priority of invention among the four parties it was necessary to determine the earliest dates of conception for the RCA inventor.

FAILURE TO FIND EARLIEST EVIDENCE OF INVENTION

This proved relatively difficult, since the earliest dates obtainable were those which could only be verified through the memory of associated engineers.

One thing that jogged their memories was the availability of a requisition issued by the Tube Development Shop to the Metal Working Shop as follows: "Make metal kinescope models as per instructions." It was recalled by several engineers that the requisition was accompanied by a sketch or drawing showing the desired configuration of the required model.

However, no trace of this drawing could be found. The person who made the metal model recalled that he made it, but to save time agreed with one engineer not to make the model exactly as described in the sketch. The actual model was never found!

For the eight months following the construction of the model, the files showed various records relating to "metal kinescopes," "Rectangular Cones," "spinning of a rectangular cone," "cold or hot forging the straight spun cone," as well as references to "A 6-inch rectangular cone of 430 metal" having an estimated completion date.

These references were found in trip reports, progress reports, memoranda from one engineer to another, and in minutes of departmental meetings. None ever sufficiently described the design or shape of the proposed shell. Nor were any drawings, which were made during this period, ever found. Several engineering groups worked on the project and much effort seemed to be trial and error, without complete success.

The first tangible proof of conception was an engineering drawing made eight months after the original sketch had been made and after the metal model had been completed. This drawing was the first evidence showing the critical design which enabled the metal shell to utilize a spherical face plate, and withstand tube processing and evacuation without failure. Although the lapse between conception and tangible proof of conception did not change the final outcome of this interference, eight months is a long time to be lacking proof of invention . . . and in some cases would be fatal. A careful recording of invention is extremely important to substantiate conception.

REDUCTION TO PRACTICE

The second important act of invention is that of successfully reducing the invention to practice. In the Electron Tube Division, for example, this is normally the date when a tube, incorporating the invention, has been successfully constructed and tested. The Patent Office also accepts the filing date of an application as the date of a "constructive" reduction to practice

of the invention. However, the tube is frequently successfully tested before the patent attorney has filed an application for the patent. This constitutes an earlier reduction to practice.

Reduction to practice should be made by the inventor or by another under his direction. This must consist of a successful testing of the device incorporating the invention in order to demonstrate the practicability or utility of the invention.

In the interference dealing with the metal kinescope shell, reduction to practice involved the construction of the metal shell in the manner conceived by the inventor and its use in the fabrication of a metal kinescope bulb, which was incorporated in a successfully tested television tube.

The completion of the tube was verified by a Development Shop ticket. This ticket indicated that the tube was processed and sealed off. Initials and dates on this Tube Ticket made it possible to identify witnesses who had actually constructed the tube. The actual testing of the tube was successfully undertaken by one of the design engineers. That the test was successful, was indicated only by an "OK" notation on a test sheet followed by the signature of the test engineer. It took considerable explanation by affidavits of several people, to verify that this simple notation represented many things: that there was a successful operation of the tube; that appropriate voltages were put on the tube electrodes; that video signals representing an RCA test pattern were applied to the tube, and that the testing engineer himself observed both the test pattern and a picture during the tube's operation.

Even a brief notebook notation by the test engineer setting forth the conditions under which the tube was tested and what observations he made would have greatly simplified the proof that the test was successful. Certainly, better records at this critical point were in order.

DILIGENCE

Where an inventor is the first to conceive of an invention, but is not the first to reduce it to practice, the Patent Office will then consider proofs of his diligence. Diligence consists "in

reasonable effort directed toward embodiment of an invention in physical form or toward filing an application for the patent."[†] For such an inventor to be successful in proving priority of his invention, he must have started his activities before his rival entered the field, and must have continued them until he had reduced his invention to practice. This critical period is considered by the Patent Office in determining priority. Lapses of diligence in this critical period are not necessarily fatal, but must be accounted for to the satisfaction of the Patent Office tribunals.

JOEL B. JOHNSON graduated in 1932 from Princeton University with an A.B. degree in Physics. In 1933-1941, he took additional work in Science and Education at Allegheny College, Wayne University and the University of Michigan. From 1935-1941, Mr. Johnson was instructor of Mathematics and Science at the Detroit Country Day School. In 1941, he joined the United States Patent Office, and from 1941-1945 was an Examiner in the Patent Office in the fields of Automatic guns and aeronautics.

In 1946, Mr. Johnson joined the Patent Operations of RCA, and was assigned to the Harrison Plant where he remained until the Patent Operations was consolidated at Princeton. At the present time, he is a Senior Patent Agent in the Tube Group of Domestic Patent Operations. His work in RCA Patent Operations has been almost entirely in the cathode ray tube field, including tube machinery and equipment.

Once an invention has been conceived and properly recorded, there are often lapses of time between the period of conception and the first successful testing of the embodiment of the invention. It is recognized that delays will exist, such as a lapse of time between placing an order and receiving parts, or when other work takes precedence over and interrupts progress on the invention. Some delays may be explained, but they are dangerous and may be ruled by the Patent Office as unwarranted. To protect the invention, the inventor must be diligent and retain in his

[†] Eclipse Machine Co. v. J. E. Krieger and Son, Inc., 32 USPQ 527; 87 Fed. Rep. (2nd) 755.

notebook a chronological accounting of the events relating to his invention, from the first conception to the time that the invention is successfully tested. He should describe where records, such as orders, statements, or memoranda, can be found.

"BEST EVIDENCE" RULE

There is a "best evidence" rule, which means that the best proof of a fact is the proof that provides the greatest certainty of the fact. For example, best primary evidence would be a sketch of the invention. Secondary evidence would be a copy of the sketch and, in

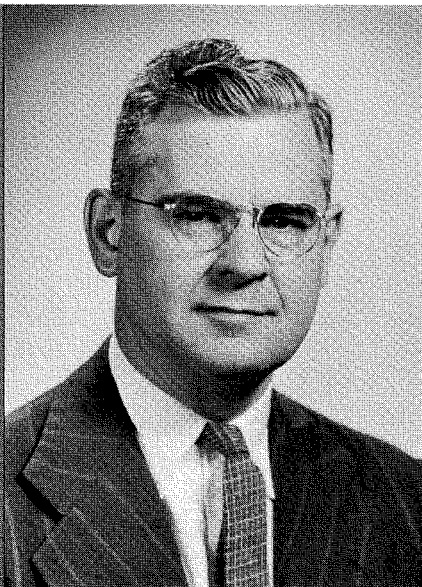

most cases, would not be acceptable unless good and sufficient reason could be given to show why the original was not produced.

Oral evidence is the verbal testimony of witnesses and is primary evidence. Tangible or physical evidence, in contrast, are notes, documents, letters and orders. Oral evidence alone is not as good as oral evidence accompanied by tangible evidence. When dates and events, which occurred years ago, are recalled by a witness without tangible supporting evidence, there is frequently a doubt about complete accuracy.

The important dates of invention, conception, reduction to practice, and diligence must be corroborated by

others than the inventor. Although the inventor is a competent witness on his own behalf, the facts and dates on which he will rely will not be accepted as sufficient proof, without corroboration.

The manner of corroboration may be in any acceptable form, such as oral and written testimony of other witnesses, and tangible evidence. To substantiate our witnesses, RCA relies particularly upon tangible evidence, such as notebook records of the inventor, devices which incorporate the invention, orders on the Development Shop, fabrication records of the Development Shop, test records of the design engineer, as well as life test records. These tangible records are supported by oral testimony either in the form of direct oral response by the witness or by written testimony sworn to by witnesses.

COMPETENT WITNESSES

A corroborating witness "may be any competent witness with the exception of the party to the interference himself." †† The question often arises as to what constitutes a competent witness. There appears to be some confusion on this point. It is not entirely clear whether a person, who is incapable of understanding the invention, constitutes a competent witness. The Commissioner of Patents in a decision, *Kirkegaard et al v. Ries*, † refused to give the inventor Ries the benefit of a drawing, and the Commissioner stated:

"Exhibit No. 3 shows all the features of the issue and is dated December 4, 1903. The witnesses to the drawings are stenographers who were accustomed to visit the office of Ries. It appears from the testimony of these witnesses that their names were placed on the drawings at the dates following the same. It does not appear, however, that any one of these witnesses understood the invention in issue except in a general way that the invention related to bottle-stoppers which could be taken off and again replaced."

†† *Interference Law and Practice*, Rivise and Caesar, pp. 2149.

† 1906 C.D. 485; 125 O.G. 1700.

Yet, on the other hand, in an interference, in which an RCA engineer was involved, RCA contested the sufficiency of a notebook record relied upon by the opposing party to prove a conception date of his invention. The notebook record was made by the opposing party's secretary in her writing and constituted several pages copied from hand written notes of the opposing party. The original notes were never produced, and only the stenographer's copy was available. The Board of Interference Examiners, in ruling on this point, stated:

"We regard this subject matter, at least that which the writing and sketch clearly show, as corroborated by (name of secretary) because it is in her handwriting as of that date and she is competent to testify upon that basis as to anything it is, in the original condition of that date. It is, therefore, immaterial, or at least unnecessary, that it be shown that she understood the material."

The best rule in our case, is that the witnesses of any portion of an invention should be those who fully understand what is going on, and can perhaps years later explain the tangible evidence presented. It is necessary to know what is inside a "little black box," as well as to understand how the "little black box" fits in with the rest of the device. If an engineer is to witness someone's engineering notes, he should fully understand the written material. If an engineer is witnessing a drawing, he should understand the basic portions of the drawing and be able to competently explain them. All witnesses should thus be "understanding witnesses" to avoid misunderstanding.

CONCLUSION

It is important that an engineer, who has made an invention, forward a disclosure to RCA Patent Operations. A very important part of inventing is a good record of the invention, whereby conception, reduction to practice and diligence are substantiated by sufficient proof. If we are entitled to a patent for an invention, it should not be lost by lack of proof due to careless record keeping.

AIR CONDITIONING THE HOME

by **H. W. TIMMERMAN**

Administrator, *Appliance Quality
Quality Department
RCA Service Company, Inc.
Cherry Hill, N. J.*

THE AVERAGE American home today is heated in the winter with some air filtering and moisture control. This represents only part of a complete comfort air conditioning system. The truly modern home has a more complete air conditioning system which includes heating in the winter, cooling in the summer and moisture, dust, pollen and fresh air control the year around.

CALCULATING NEEDS IN THE HOME

Basic principles of load calculation are common to all types and methods of air conditioning. Generally a heating load calculation and a cooling load calculation are treated separately. A summer cooling load calculation must consider:

Heat gain from the sun, people, electrical and fuel consuming equipment.

Moisture content of the air.

Air Movement within the air conditioned space.

Air pollution by dust, pollen and other foreign particles.

Odors which require dilution by providing fresh air.

A winter heating load calculation must consider *heat loss* to the outside air in addition to the above items.

In the residential air conditioning field the industry has developed load calculation forms which can be used by the application technician to determine equipment size required for a given application. The form provides a short method for determining equipment size required and yet provides a method which is within practical accuracy limits acceptable for residential use.

The form is based upon heat transfer and construction details including: 1) Heat transfer coefficients through construction materials; 2) Heat emission factors of people engaged in various activities; 3) Heat emission of electrical and fuel consuming equipment; 4) Air leakage and ventilation allowances, and 5) Geographical location design temperature requirements.

The physical location of the home and space to be air conditioned must be taken into consideration also, and an evaluation must be made of influencing factors including: direction of the sun, type and amount of shading, and the direction and amount of prevailing wind.

A typical example of a room air conditioner cooling load calculation form is illustrated in Fig. 1. This form is in general use for calculating the size room air conditioned unit required to cool a single

room in the summer season and represents a load calculation in its simplest form.

Electrical equipment covered in Item 6 can put heat into the room in various amounts depending upon the equipment, size and load. Examples of some small appliances commonly found in the home that contribute to the overall heat gain are shown in Table 1:

| | Watts | BTU/Hr. |
|--|-------|---------|
| Coffee brewer, 8 cup . . . | 660 | 2,240 |
| Meat grill, 10" x 12" area | 3000 | 10,200 |
| Sandwich grill, 12" x 12" area | 1650 | 5,600 |
| Toaster, pop up type, 2 slice | 1225 | 4,150 |
| Waffle iron, 7" dia. . . . | 750 | 2,480 |

Other appliance heat gain characteristics in BTU per hour can be determined by multiplying the rated watts by 3.4.

People add heat to a room Item 7 as both sensible and latent heat in an amount dependent upon their activity. The value of 900 BTU per hour was arrived at by assuming moderate activity in a residence and provision for 15 cfm per person of outside fresh air for ventilation.

Variations in emission of sensible and latent heat (known as metabolic rate),

| Activity | Adult male metabolic rate (BTU/hour) |
|-----------------------------------|--------------------------------------|
| Seated at rest | 390 |
| Office worker | 475 |
| Standing—walking slowly | 550 |
| Light bench work | 800 |
| Moderate dancing | 900 |
| Walking, 3 MPH | 1,000 |
| Bowling | 1,500 |

Fig. 1.—Air Conditioner Cooling Load Calculation Form

| ITEM | QTY. | MULTIPLYING FACTORS | | COOLING UNITS (BTU/hr.) |
|--|-----------|---------------------|-----------------|-------------------------|
| | | DAY | NIGHT | |
| 1. Windows Exposed to Sun, Facing* | | Inside Shades | Outside Awnings | |
| A. East | — sq. ft. | 45 | 25 14 | |
| B. Southeast | — sq. ft. | 45 | 25 14 | |
| C. South | — sq. ft. | 45 | 25 14 | |
| D. Southwest | — sq. ft. | 65 | 40 14 | |
| E. West | — sq. ft. | 100 | 60 14 | |
| F. Northwest | — sq. ft. | 35 | 25 14 | |
| *USE ONLY LARGEST LOAD | | | | |
| 2. Windows Facing North or in Shade (Include windows not in item 1) | — sq. ft. | 14 | 14 | |
| 3. Walls (based on lineal ft. of wall) | | | | |
| A. Light construction exposed to sun* | — ft. | 90 | 30 | |
| B. Heavy construction exposed to sun* | — ft. | 50 | 30 | |
| C. Shaded walls or partition (include walls not in 3 (a) or 3 (b)) | — ft. | 30 | 30 | |
| *USE ONLY FOR EXPOSURE IN 1 | | | | |
| 4. Roof or Ceiling (Use one only) | | | | |
| A. Roof, uninsulated | — sq. ft. | 16 | 3 | |
| B. Roof, with 1 inch or more insulation | — sq. ft. | 7 | 3 | |
| C. Ceiling, with occupied space above | — sq. ft. | 3 | 3 | |
| D. Ceiling, with attic space above | — sq. ft. | 10 | 3 | |
| 5. Floor | — sq. ft. | 3 | 3 | |
| 6. Electrical Equipment in Use | — Watts | 3.4 | 3.4 | |
| 7. People and Ventilation (number of people) | — | 900 | 900 | |
| 8. Doors and Arches open to unconditioned spaces (width) | — ft. | 300 | 300 | |
| 9. Total load in cooling units (Add items 1 to 8) | | | | |
| 10. Number of Room Air Conditioners Required = $\frac{\text{Cooling Units}}{\text{Unit Capacity}}$ = _____ Quality _____ Model _____ | | | | |

from people exposed to temperatures within the limits of the comfort zone, are illustrated in Table 2 on page 42.

The metabolic rate is composed of both sensible and latent heat. This means a person not only raises the dry bulb temperature (sensible) of the air by heat radiation and conduction, but also raises the wet bulb temperature (latent) by evaporation of moisture into the air while perspiring. The ratio of sensible and latent heat gain will vary with room temperature for a given activity. See Table 3.

TABLE 3

| Room Temperature | Room heat gain | | |
|------------------|----------------|--------|--------|
| | Sensible | Latent | Total |
| 82°F | 450 | 1,000 | 1,450* |
| 70°F | 605 | 845 | 1,450* |

*The average male and female metabolic rate during bowling is 1450 BTU/hour.

Note that the total heat gain remains the same at either temperature; however the sensible and latent heat gains change.

The latent heat gain increases as the room temperature rises, while the sensible heat gain actually decreases. It is well known that a temperature rise causes a person to perspire more freely. Table 3 is a demonstration of its effects. During perspiration, moisture on the surface of the body removes heat from the body by evaporation of the surface moisture. The amount of heat removed from the body depends upon the latent heat of evaporation of water as well as the rate of evaporation. Since perspiring increases the ability to remove heat from the body by latent heat of evaporation, the amount of heat removal required by sensible means, radiation and conduction, is reduced. A comprehensive discussion of this subject may be found in the current ASHAE Guide.*

COMFORT ZONES DEFINED

A comfortable environment from a temperature and humidity viewpoint can best be illustrated by referring to a psychrometric chart. Fig. 2 illustrates the range of dry bulb temperature and humidity conditions known as the comfort zone on a typical psychrometric chart. There are actually two comfort zones, one for summer comfort (ABCD) and one for winter comfort (EFGH). These comfort zone data have been developed and can be found in more detail in the ASHAE guide. The data has been developed by subjecting a group of persons to various dry bulb temperatures and humidities and noting the percentage of

*ASHAE Guide, published annually by the American Society of Heating and Air Conditioning Engineers, 51 Madison Avenue, New York 10, N. Y.

persons who feel comfortable. A maximum number (98%) of people feel comfortable under dry bulb temperature and humidity conditions in the *summer* when the values fall on the average *summer* comfort line. A maximum number (97%) of people feel comfortable under dry bulb temperature and humidity conditions in *winter* when the values fall on the average *winter* comfort line.

As these values move away from the average comfort line and finally fall outside the average comfort zone boundaries, less than 50 percent of the people will feel comfortable. The average winter comfort line applies to central heating systems of the convection type. The average summer comfort line applies to homes and offices where occupancy is continuous for over three hours, and this line also applies to cities in the northern portion of the United States.

CENTRAL AND ROOM UNITS COMPARED

Residential air conditioning equipment is designed with the specific objective of meeting the requirements indicated in the psychrometric comfort chart when the load is calculated in accordance with load calculation forms similar to those illustrated. This objective is being met today by three general methods of equipment application.

1. In homes where hot water or steam heating systems already exist, cooling and air circulation can be added either as a central system including a duct system, or as individual room units including the required electrical circuits.
2. A home that already has a forced hot air heating system installed can have added to it either a cooling unit which ties in with the existing duct system or individual room units including the required electrical circuits.
3. The new home has the option, in addition to the above methods, of using a central system designed to include both heating and cooling in one unit and a duct system de-

signed to handle both heating and cooling.

Room air conditioning units are designed to furnish the needs of an individual room. Multiple installation of these units is not intended to compete with central systems. To illustrate this, assume that a six room house requires 33,000 BTU per hour unit capacity:

A representative remote type 3 H.P. air cooled central system unit delivers 33,300 BTU per hour. Typical initial cost including installation (duct work, wiring, etc.) will be about \$1,700. Power consumption at ASRE conditions would be 4.4 KW per hour.

Six average 1/2 H.P. room air conditioner units will deliver 33,000 BTU per hour. Initial cost including installation (installation in window, wiring, etc.) will be about \$1,850. Power consumption at ASRE conditions will be 5.7 KW per hour.

Primary advantages of the two systems above are: *Central System*—lower initial and operating cost, better air distribution, and quieter operation. *Room Unit System*—Unit portability, no duct system required, and only one room affected during unit shutdown.

PERFORMANCE FACTORS

Capacities and performance of air conditioning units are, in general, rated according to American Society of Refrigerating Engineers (ASRE) standard test conditions of room air temperature at 80°F dry bulb, 67°F wet bulb, and outside air temperature at 95°F dry bulb, 75° wet bulb. ASRE along with ARI (Air Conditioning and Refrigeration Institute) have set up Standards ASRE 16—56 and ARI 620—56 respectively, which cover specifications for published ratings for residential air conditioners.

The typical performance table for an air-cooled room air conditioner in Table 4 illustrates the need for fixed test conditions.

It will be noted in Table 4 that the maximum temperature drop across the evaporator occurs near ASRE condi-

TABLE 4

| Air Inlet Temperatures °F | | Inlet-Outlet Temp. Differential °F | Total Watts to Unit | Pressures lbs./sq. ft. gauge | |
|---------------------------|-----------------------|------------------------------------|---------------------|------------------------------|-----------|
| Condenser (dry bulb) | Evaporator (wet bulb) | | | Low Side | High Side |
| 110 | 67 | 20 | 1780 | 74 | 380 |
| 100 | 67 | 20 | 1670 | 69 | 360 |
| *95 | 67 | 22 | 1600 | 67 | 340 |
| 90 | 67 | 23 | 1510 | 64 | 330 |
| 80 | 67 | 17 | 1430 | 54 | 260 |
| 70 | 67 | 15 | 1330 | 45 | 225 |

*A 1 H.P. 230 volt unit that delivers 9,700 BTU/hour at ASRE conditions.

tions. The pressures and wattages increase above and decrease below ASRE conditions. It will also be noted that the 1 H.P. unit does not deliver one ton of refrigeration (12,000 BTU/hr.), but 9,700 BTU/hr.

Ratings of residential air conditioners are no longer rated by horsepower only or by tons of refrigeration, but by BTU/hour. The spread of BTU/hour capacity rating according to ASRE conditions for a given compressor motor horsepower is illustrated in Table 5. These data cover models produced by fourteen manufacturers this year.

TABLE 5
ASRE BTU/hour Rating

| | Minimum | Maximum | Mean |
|------------|---------|---------|--------|
| 1/2 H.P. | 4,400 | 5,500 | 5,000 |
| 3/4 H.P. | 5,400 | 8,200 | 6,700 |
| 1 H.P. | 7,800 | 10,700 | 8,850 |
| 1 1/2 H.P. | 10,400 | 15,500 | 13,000 |
| 2 H.P. | 14,100 | 16,600 | 15,800 |

This table (which covers room air conditioners only) points out that the assumption there is a relationship between unit compressor motor horsepower and tons of refrigeration capacity of the unit is not an accurate one.

Power consumption of an air conditioning unit will vary widely with load conditions including: thermostat setting, house construction, house orientation with sun and shading, and geographical location and time of year.

Examination of a representative line of residential air conditioners show power consumption rates under ASRE conditions as illustrated in Table 6.

TABLE 6

| Horsepower | 1/2 | 3/4 | 1 | 1 1/2 |
|------------|-------|-------|-------|--------|
| BTU/hour | 5,000 | 7,800 | 9,700 | 12,800 |
| KW/hour | .9 | 1.2 | 1.5 | 2.3 |

Central Systems

| Horsepower | 2 | 3 | 5 |
|------------|--------|--------|--------|
| BTU/hour | 16,000 | 33,300 | 57,500 |
| KW/hour | 2.6 | 4.4 | 7.0 |

Manufacturers are making surveys on a national basis regarding power consumption and other operating characteristics of their equipment. A very general observation is that it costs about as much to cool a house as it does to heat it.

INDUSTRY TRENDS

The trend of equipment costs have been downward as the industry has grown and expanded. A group of manufacturer's list prices have been averaged over the years 1953, 1955 and 1957, and are listed in Table 7 by horsepower of the compressor motor.



H. W. TIMMERMAN graduated from South Dakota State College with a BS in Mechanical Engineering in 1943. He joined the G.E. Company and worked in Field Service Engineering and Quality, Refrigeration Division. Mr. Timmerman joined RCA in 1952 as Air Conditioning Field Service Administrator for RCA Service Company and assumed his present position in 1955.

Mr. Timmerman is a member of the Refrigeration Service Engineers Society and the American Society for Quality Control.

TABLE 7

| | 1953 | 1955 | 1957 |
|------------|-------|-------|-------|
| 2 H.P. | | \$600 | \$480 |
| 1 1/2 H.P. | | 500 | 440 |
| 1 H.P. | \$570 | 450 | 375 |
| 3/4 H.P. | 400 | 360 | 360 |
| 1/2 H.P. | 320 | 290 | 280 |
| 1/3 H.P. | 230 | 200 | |

These recommended list prices cover room air conditioners only. The trend as this table illustrates is a reduction in price and an increase in horsepower size

of the compressor motor. The wide spread in BTU/hour capacity of a given horsepower unit makes it necessary, however, to carefully determine BTU/hour capacity based on ASRE conditions when comparing prices and models.

There are predictions in the industry that production of central residential systems will reach 250,000 to 270,000 units in 1957, and room air conditioner production will reach 1,500,000 units. There will be a wide selection of capacities and features including: thermostats, single and two-speed fan motors, electric heating elements, reverse cycle heating, disposable/permanent/electronic filters, pushbutton/rotary switches and controls, mounting methods and voltages. The air conditioning industry feels that residential air conditioning has arrived, and as many as 78 firms have announced residential air conditioning equipment for 1957.

BIBLIOGRAPHY

- ASHAE Guide*, published annually by the American Society of Heating and Air Conditioning Engineers, 51 Madison Ave., New York 10, N. Y.
- Air Conditioning Refrigerating Data Book*, Design Volume, published biennially by the American Society of Refrigerating Engineers, 234 Fifth Ave., New York 1, N. Y.
- Design and Installation of Summer Air Conditioning*, published by National Warm Air Heating and Air Conditioning Association, 145 Public Square, Columbus 14, Ohio.
- Air Conditioning and Refrigeration News*, published weekly by Business News Publishing Co., 450 West Fort St., Detroit 26, Michigan.

Fig. 2—Psychrometric chart

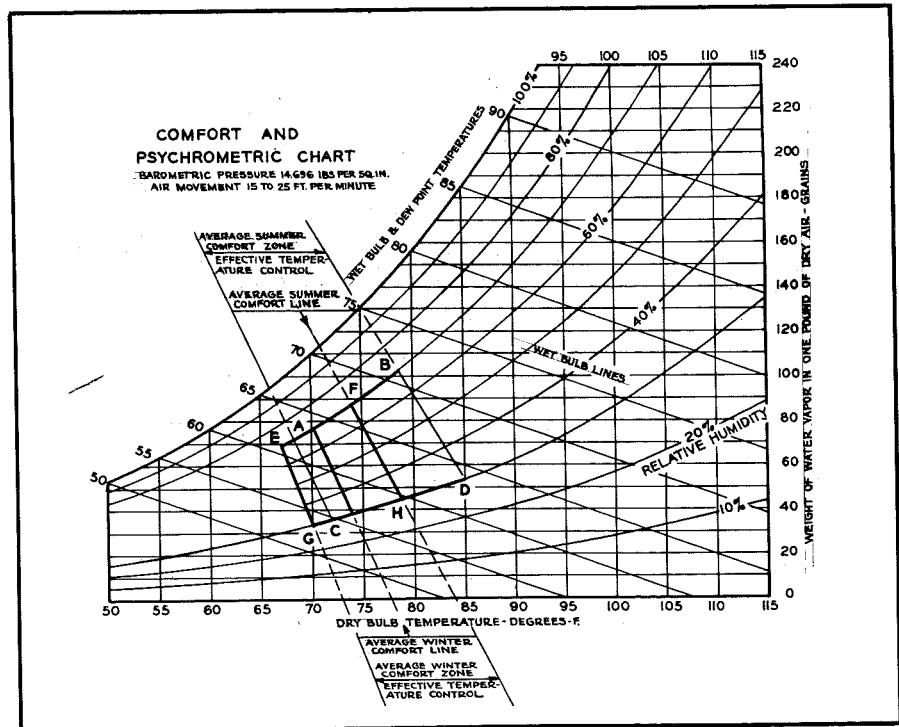

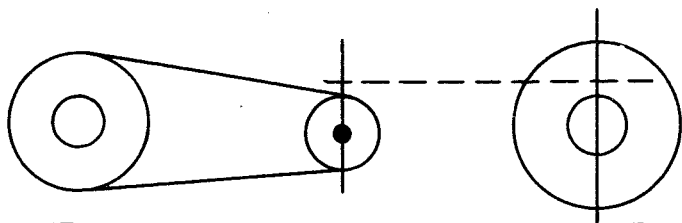

Patents Granted TO RCA ENGINEERS

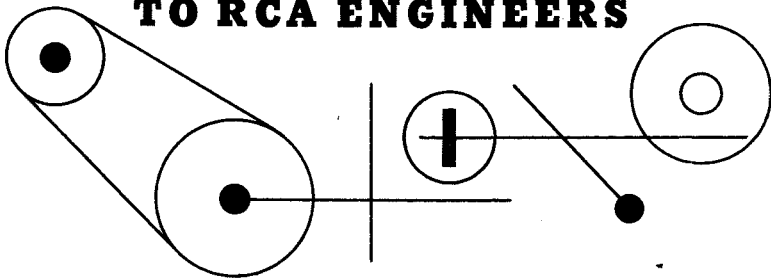

BASED ON SUMMARIES RECEIVED OVER A PERIOD OF ABOUT TWO MONTHS

APPARATUS FOR AND METHOD OF MEASURING THE QUALITY OF OPTICAL DEVICES (Patent No. 2,773,413)—granted December 11, 1956 to OTTO H. SCHADE, ELECTRON TUBE DIVISION, Harrison, N. J. Apparatus for measuring the optical equivalent pass-band N_e of an optical device comprising means for cooperating with said device to form a plurality of successive line-images, means to convert said line-images into a first series of uniformly spaced electrical impulses, means to derive from said first series of electrical impulses a second series of electrical impulses having intensities equal to the square of said first series, and means to measure said second series of electrical impulses.

SOUND CHANGEOVER SYSTEM (Patent No. 2,774,824)—granted December 18, 1956 to JOHN F. BYRD and JAMES D. PHYFFE, COMMERCIAL ELECTRONIC PRODUCTS, Camden, N. J. To avoid use of volume control rods across the front wall of a sound picture projection booth in theaters in order to vary the volume being reproduced, an exciter lamp is maintained partially energized so that it may be quickly brought up to proper energization when its sound reproducer is to be used. Individual volume control units are switched between a voltage and a power amplifier. A shunt resistor is used across one lamp to partially energize it while the other lamp receives the full energizing current. The use of triple pole double throw switches controls the position of the shunt resistor and the position of the respective volume control units in the circuit.

SPEED CHANGING MECHANISMS FOR PHONOGRAPH TURNTABLES AND THE LIKE (Patent No. 2,756,603)—granted July 31, 1956 to W. H. TSIEN, COMMERCIAL ELECTRONIC PRODUCTS, Camden, N. J. The idler wheel is adapted for use in connection with a stepped motor driven roller which has a plurality of coaxial driving surfaces of difference diameters, and the inner surface of a pendant turntable flange. A cam element which has a planar elliptical configuration is affixed to the side of the idler wheel facing in the direction of the large diameter end of the motor driven roller. The major axis of the elliptical cam element is equal to the diameter of the idler wheel. The idler wheel is spring biased toward the larger diameter steps of the roller and suitable manually control means are provided to retain the wheel in engagement with the desired driving surfaces. Upon release of the manual control means the cam element engages the larger driving surface and causes the idler wheel to move away from the pre-engaged smaller diameter surface whereupon the idler wheel is moved axially along the roller by the biasing force until the periphery of the idler is in engagement with the larger step portion of the roller.

PROCESS FOR MANUFACTURING SMALL PARTS FROM THIN METALS (Patent No. 2,735,763)—granted February 21, 1956 to ALFRED E. HEATH, DEFENSE ELECTRONIC PRODUCTS, Camden, N. J. In the manufacture of small parts from very thin metals by the photo-etch process, a backing must be provided which supports the metal sheet during etching and which permits easy removal of the parts after etching. The metal sheet is backed with wax before etching. After etching, the wax, with small metal parts adhering, is placed in a supercooled liquid. The metal parts are caused to separate from the wax due to different rates of contraction.

RADIO FREQUENCY AMPLIFIER SYSTEM (Patent No. 2,747,029)—granted May 22, 1956 to ROY C. ABBETT, COMMERCIAL ELECTRONIC PRODUCTS, Camden, N. J. Between the master antenna and the line going to the

subscribers there is provided a low gain broadband amplifier for amplifying all channel signals, a voltage divider pad, separate high gain channel amplifiers for each channel, and recombining means. This arrangement is better than only a broadband amplifier or only narrow band amplifiers.

TEST PROBE ADAPTOR HEAD (Patent No. 2,732,446)—granted January 24, 1956 to J. P. GILMORE, DEFENSE ELECTRONIC PRODUCTS, Moorestown, N. J. The invention relates to a test probe adaptor head, of the type employing a fuse, and means to plug an ammeter or a voltmeter into the circuit containing the fuse for testing purposes.

CATHODE RAY TUBE DEVICES (Patent No. 2,761,989)—granted September 4, 1956 to WILLIAM H. BARKOW, COMPONENTS DIVISION, Camden, N. J. In conjunction with an internal-pole-piece tri-color kinescope, present invention provides a shield assembly for preventing flux from the scanning deflection yoke from affecting the convergence magnet fields. Prior arrangements employed a ferrite disk and a copper disk. This invention involves a copper disk and a pair of grain-oriented magnetic disks, the grain-oriented disks disposed such that their grains are perpendicular.

COAXIAL SWITCH (Patent No. 2,762,881)—granted September 11, 1956 to LLOYD A. BROCKWELL and W. N. MOULE, COMMERCIAL ELECTRONIC PRODUCTS, Camden, N. J. Piston rod with alternate conducting and insulating sections is caused to move back and forth by gas pressure acting on pistons at ends of rod. As rod moves back and forth, adjacent ones of three parallel coax lines are either interconnected to or insulated from each other. The line not interconnected at any time is short-circuited.

COLOR TELEVISION TUBE (Patent No. 2,755,405)—granted July 17, 1956 to JOHN F. WILHELM, ELECTRON TUBE DIVISION, Harrison, N. J. Either the mask, or the mask and phosphor, are supported in a color kinescope by at least three springs that engage supporting means within the envelope. The springs determine the spacing between the mask and the phosphor as well as the angular orientation of the mask.

SIDE-LOBE REJECTION CIRCUIT FOR PULSE RADAR SYSTEM (Patent No. 2,781,509)—granted February 12, 1957 to JOHN N. MARSHALL, COMMERCIAL ELECTRONIC PRODUCTS, Camden, N. J. In one form of the invention, the pulses received by a beacon transponder are peak detected and used to bias a gate stage between the transponder transmitter and receiver stages. The d.c. bias is such that received side lobe pulses are prevented from triggering the transmitter, whereas received main lobe pulses are not. In another form of the invention, the d.c. bias which is developed is proportional to the side lobe pulses and is used to bias the gated stage to a point such that the side lobe pulses are discriminated against.

CIRCUIT FOR CONTINUOUSLY CORRECTED STORAGE (Patent No. 2,781,445)—granted February 12, 1957 to ARTHUR C. STOCKER, DEFENSE ELECTRONIC PRODUCTS, Camden, N. J. A circuit for smoothing intermittently applied stored data. The difference in values between the anticipated and stored data is sensed and continuously applied to the

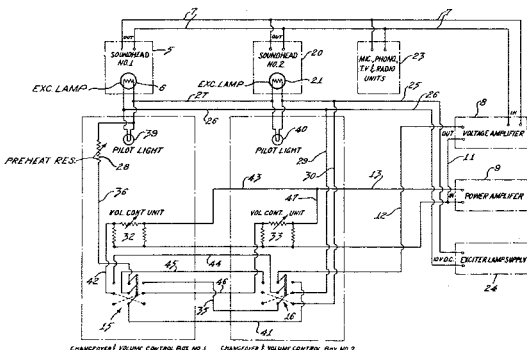

stored data in a sense to reduce the difference between the anticipated and stored data.

EXTENDED RANGE HIGH-FREQUENCY TUNING DEVICE AND CIRCUIT (Patent No. 2,733,194)—granted December 4, 1956 to WILLIAM F. SANDS, RCA VICTOR TELEVISION DIVISION, Cherry Hill, N. J. The tuning inductor comprises a pair of helical windings in end to end relation on a common axis. Capacitor means are interposed between the adjacent ends of the windings, and the inductor is tuned by a core which is longitudinally movable with respect to the windings.

JUNCTION TRANSISTOR OSCILLATOR CIRCUITS (Patent No. 2,769,906)—granted November 6, 1956 to MARSHALL C. KIDD, RCA VICTOR TELEVISION DIVISION, Cherry Hill, N. J. To provide a negative resistance characteristic for a junction transistor, in accordance with this invention, both the collector and emitter electrodes are reverse biased with respect to the base electrode. By connecting an R-C time constant network with either the emitter or collector this negative resistance may be exploited to provide relaxation oscillations.

TRANSISTOR MULTIVIBRATOR CIRCUIT (Patent No. 2,770,732)—granted November 13, 1956 to CARLOS F. CHONG, DEFENSE ELECTRONIC PRODUCTS, Camden, N. J. The multivibrator circuit comprises a pair of opposite conductivity transistors with means to interconnect the electrodes so that both transistors are simultaneously conducting and both are rendered simultaneously non-conducting on the application of an input pulse. The inter-connecting means includes a storage element connected between the collector of one transistor and the base of the other, and a unilateral conducting element is connected with the collector of one of the transistors. (The unilateral conducting element provides more rapid discharge of the storage element.)

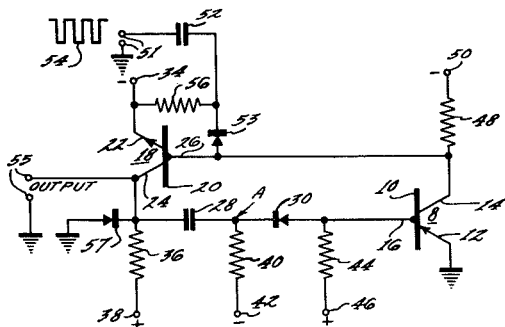

ELECTRON BEAM CONTROL MEANS (Patent No. 2,769,110)—granted October 30, 1956 to MAXIMILIAN J. OBERT, COMPONENTS DIVISION, Camden, N. J. A threaded magnet is mounted exteriorly of the cathode ray tube neck over the electron gun which furnishes the blue component of the television picture. The threaded magnet is mounted in a holder comprising a permeable flux conductor member, the ends of which rest on the tube neck adjacent to internal portions of a pole piece element. The design and arrangement of the magnet enables the forming of a magnetic field which may be varied or adjusted to correct for misconvergence of the blue beam at the target.

TRANSISTOR SIGNAL AMPLIFYING CIRCUITS (Patent No. 2,773,945)—granted December 11, 1956 to GERALD E. THERIAULT, RCA VICTOR TELEVISION DIVISION, Cherry Hill, N. J. The application of AGC to transistors will vary their input resistance as their gain is varied in the desired manner. These variations in input resistance will also vary the loading on the coupling circuits of the amplifier. Hence, a variable frequency response results. To provide a flat response for such circuits, single tuned coupling circuits are provided between predetermined transistor amplifiers and the remaining coupling circuits are of the double tuned type.

INDIRECTLY HEATED ELECTRON EMITTER FOR POWER TUBES AND THE LIKE (Patent No. 2,768,321)—granted October 23, 1956 to FRED W. PETERSON, TUBE DIVISION, Lancaster, Pa. A metal tubular member is coaxially disposed in a metal cup to form an annular chamber. A heater coil within this chamber around the tubular member has one end connected to the tubular member and its other end to a rod conductor coaxial with the structure. The outer peripheral wall of the cup is coated with electron emissive material.

POWER SUPPLY (Patent No. 2,772,371)—granted November 27, 1956 to BETHEL E. DENTON, RCA VICTOR TELEVISION DIVISION, Cherry Hill, N. J. In a power supply of the type wherein a pair of input terminals is connected to a voltage doubling circuit for rectifying and doubling an input A.C. voltage, and having means for applying said rectified doubled voltage across a load, the combination therewith of means comprising a pair of heater output terminals for connecting a series-connected heater string there between, means including a capacitor to connect one of said pair of heater output terminals to one of said input terminals, and means connecting the other of said pair of heater output terminals to said voltage doubler circuit.

APPARATUS FOR A METHOD OF TESTING A PROJECTION OPTICAL SYSTEM (Patent No. 2,771,004)—granted November 20, 1956 to LAWRENCE T. SACHTLEBEN, DEFENSE ELECTRONIC PRODUCTS, Camden, N. J. A method of testing an optical system, having a focal surface and an image surface, for aperture response comprising the steps of cyclically scanning a conjugate portion of said image surface with a plurality of light images during each cycle, transducing the light from said light images derived at a corresponding conjugate portion of said focal surface into electrical signals, detecting said signals, amplifying said detected signals, and transducing the resulting signals into visual signals.

MULTIPLE MOTOR DRIVE FOR CAMERAS (Patent No. 2,771,814)—granted November 27, 1956 to WARREN R. ISOM, DEFENSE ELECTRONIC PRODUCTS, Camden, N. J. To permit the use of a large film drive motor for a kinescope recording camera and provide a uniform shutter speed, a motor is used to wind the film on the takeup reel, a second motor is used to drive the shutter, and a third motor is used to drive the film advancing mechanism, the shutter motor bringing the film advancing mechanism and its motor practically up to full speed before the film advancing motor is energized. The use of separate motors for the various units of the camera provides good speed regulation for

advancing film, while a pin and slot mechanism permits the shutter motor to operate independently of the film advancing motor while preventing loss of synchronism between them.

AUTOMATIC RADAR TARGET TRACKING SYSTEM (Patent No. 2,774,964)—granted December 18, 1956 to FRANK D. COVELY, DEFENSE ELECTRONIC PRODUCTS, Camden, N. J. and RICHARD E. BAKER (formerly with RCA). Relates to a system for automatically tracking a selected moving target. Radar video signals are converted to television video signals in a graphecon. The television video is then monitored on a television kinescope. Television vertical and horizontal drive signals key phantastron circuitry which subsequently generates wave signals producing a small rectangular target tracking raster which is also displayed on the kinescope. When a selected target is centered within the rectangular raster, a video signal corresponding to this visual indication is centered upon a sawtooth wave signal. As the target moves in one direction or the other the video signal is situated higher or lower on the sawtooth signal as the case may be. Suitable voltages are produced in response to this displacement actuating a drive motor geared to the phantastron circuitry and maintaining centering.

ELECTROSTATIC FOCUSED GUN FOR CATHODE RAY TUBE (Patent No. 2,760,098)—granted August 21, 1956 to ROMAIN SAUNDERS, JR., ELECTRON TUBE DIVISION, Marion, Indiana and LLOYD E. SWEDLUND (formerly with RCA). The invention is directed to an electrostatic focusing section of an electron gun consisting of a pair of electrode members having cup-shaped portions 34 and 60 which are mounted oppositely facing each other as shown specifically in Figure 2. Mounted between these cup-shaped members is a third electrode 44 adapted to be operated at a lower potential than the common potential applied to the cup-shaped members. This particular structure provides

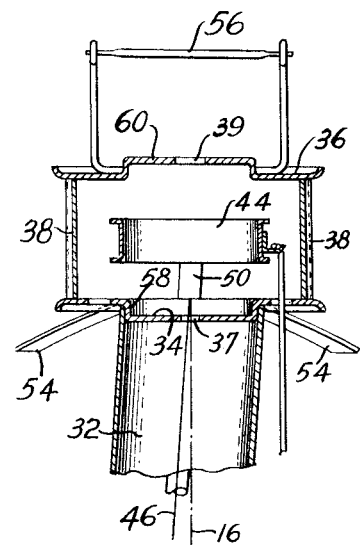

a large diameter focusing field between the cup-shaped members and thus eliminates aberration effects which would result from the large diameter electron beam passing through a small diameter lens field.

HIGH FREQUENCY AMPLIFIER WITH ANODE TO GRID INPUT AND ANODE TO CATHODE OUTPUT (Patent No. 2,770,720)—granted November 13, 1956 to TOMOMI MURAKAMI and RICHARD W. SONNENFELDT, RCA Victor Television Division, Cherry Hill, N. J. The amplifier has a first tube (driver) and a second tube (grounded-grid amplifier), and the anode of the driver tube has a direct current connection to the cathode of the grounded grid tube. The cathode of the driver tube and the grid of the second tube are grounded at signal frequencies. The input signal is applied between the anode and grid of the driver tube and the output signal is derived from the anode of the grounded grid tube.

METHOD OF MAKING METAL CONES FOR CATHODE RAY TUBES (Patent No. 2,767,466)—granted October 23, 1956 to RICHARD D. FAULKNER, ELECTRON TUBE DIVISION, Lancaster, Pa. The invention is in the process of spinning a metal cone to provide a reinforcing band near the sealing lip of the cone to reinforce the cone at that point. The method is that in which the cone is spun from a disc by using a roller pressed against a conical form with sufficient force to reduce the original thickness of the disc during the spinning. Near the larger end of the cone the pressure of the roller against the form is relieved to provide a thicker conical portion for reinforcing.

VIDEO FROM SYNC AND SYNC FROM SYNC SEPARATOR (Patent No. 2,736,768)—granted February 28, 1956 to SIMEON I. TOURSHOU and GORDON E. SKORUP, RCA VICTOR TELEVISION DIVISION, Cherry Hill, N. J. A form of synchronizing signal separator is disclosed embodying two tube sections, one having a short time constant in its cathode circuit for horizontal sync separation, the other having a long time constant for vertical sync separation. Invention lies in providing a resistance connection between cathodes so that the level of vertical sync separation is made a function of horizontal sync amplitude while divorcing the horizontal separation level from influence by vertical sync amplitude. Clipping level also may be controlled by AGC.

MANGANESE FERROSPINEL COMPOSITIONS INCLUDING COPPER OXIDE (Patent No. 2,723,238)—granted November 8, 1955 to JOHN O. SIMPKISS, JR., COMPONENTS DIVISION, Camden, N. J. A manganese-zinc ferrosphenel having added copper oxide to improve permeability.

TELEVISION COLOR SYNCHRONIZATION (Patent No. 2,758,155)—granted August 7, 1956 to LOREN R. KIRKWOOD and ALTON J. TORRE, RCA VICTOR TELEVISION DIVISION, Cherry Hill, N. J. Piezoelectric crystal is employed to stabilize the color oscillator and the incoming color synchronizing burst is applied to the crystal.

CERAMIC MOSAIC FOR CAMERA PICK UP TUBE (Patent No. 2,727,170)—granted December 13, 1955 to WILLIAM G. RUDY, ELECTRON TUBE DIVISION, Lancaster, Pa. The target electrode for an iconoscope pickup tube is made of a ceramic formed of a mixture of titanium and zirconium oxides. The amount of titanium and zirconium oxides as well as the amount of magnesium and barium present are used to provide the optimum dielectric constant for the material.

CATHODE RAY TUBE GUN STRUCTURE (Patent No. 2,728,007)—granted December 20, 1955 to DAVID D. VAN ORMER, ELECTRON TUBE DIVISION, Lancaster, Pa. The invention is to a simple structure in which the heater cathode and grid parts are mounted on spaced insulator sheets fitted into an electrode cylinder.

SLOT COUPLING FOR TANGENT CIRCULAR WAVEGUIDE STRUCTURES (Patent No. 2,770,778)—granted November 13, 1956 to WILLIAM N. PARKER, ELECTRON TUBE DIVISION, Lancaster, Pa. The invention provides a novel coupling arrangement for use between cavity resonators or waveguide structures. According to the invention, the walls of the waveguide structures are arranged to be tangential at a point where the directions of current flow on the respective walls are non-parallel or inclined to each other. The walls of each structure have, at the point of tangency, an elongated slot parallel to a similar slot in the other wall through the point of tangency. The long dimension or length of the slots is inclined at an angle to the direction of current flow in each of the walls. The coupling between the waveguide structures is arranged to include these slots as by a metallic walled passageway through which one waveguide space communicates with the other waveguide space.

ELECTRON LENS FOR MULTIPLIER PHOTOTUBES WITH VERY LOW SPHERICAL ABERRATION (Patent No. 2,728,014)—granted December 20, 1955 to RICHARD C. STOUDEHEIMER and RALPH W. ENGSTROM, ELECTRON TUBE DIVISION, Lancaster, Pa. The envelope of an end-on photomultiplier tube is provided with a faceplate having a convex shape made up of a combination of spherical surfaces. The photocathode was formed on the inner surface of the face plate. The particular shape of the faceplate permits better focusing of the photoemission into the mouth of the multiplier section.

MULTIPLE BEAM ELECTRON GUN (Patent No. 2,726,347)—granted December 6, 1955 to ROBERT E. BENWAY, ELECTRON TUBE DIVISION, Marion, Indiana. An electron gun for providing a plurality of electron beams in which the accelerating electrode is formed with a plurality of cup-shaped portions one in the path of each beam to provide a prefocusing lens for the respective electron beams.

MULTIPLE BEAM GUN (Patent No. 2,726,348)—granted December 6, 1955 to ROBERT E. BENWAY, ELECTRON TUBE DIVISION, Marion, Indiana. An electron gun having a plurality of cathode electrodes including a plurality of common accelerating electrodes through which the beams pass. The electrostatic field between the last two accelerating electrodes provides a common field for focusing and converging the electron beams. An intermediate electrode between the last two electrodes is utilized to shape the electrostatic field. The next to the last electrode is closed by an apertured plate, the apertures of which provide the beam focusing portion of the lens. Changes in the convergence of the common electrostatic field provides little change in the focusing effect of the field.

IMAGE ORTHICON (Patent No. 2,723,360)—granted November 8, 1955 to A. A. ROTOW, ELECTRON TUBE DIVISION, Lancaster, Pa. In the image section of an image

orthicon, a second mesh is mounted between the target collector mesh and the photocathode to provide a uniform electrostatic field adjacent to the target electrode and which will more closely conform with the magnetic focusing field in the same region.

MULTIPLE BEAM GUN (Patent No. 2,721,287)—granted October 18, 1955 to D. D. VAN ORMER, ELECTRON TUBE DIVISION, Lancaster, Pa. An electron gun having a plurality of cathode electrodes, a common control grid having a plurality of apertures, one overlying each cathode, and a common accelerating electrode is operated to provide an electron beam from each cathode. The cathode surfaces and the control grid are so shaped that the first crossover points of the several electron beams are made to coincide at a common point. This common point is focused on the screen by a single common focusing and converging electron lens.

METHOD OF MAKING GLASS-TO-METAL SEAL (Patent No. 2,768,475)—granted October 30, 1956 to WILLARD E. ANTHONY, ELECTRON TUBE DIVISION, Marion, Indiana and HARRY R. SELEN, ELECTRON TUBE DIVISION, Lancaster Pa. In the method of sealing a glass plate 11 (or plates 11 and 12) to a metallic frame member having land and wing portions 15 and 17, a glaze coating 19 is first applied to the land 15 and wing 17. Glass frit putty 20 is then applied to the glazed surfaces and the glass plate 11 is sealed thereto. In making the seal, the glass plate 11 and metallic frame are heated to a temperature near the strain point of the glass, and then the metallic frame member is heated further to expand it away from the glass. On cooling, the frame, glass frit 20 and glass plate 11 contract at predetermined rates to form a compression seal which, by reason of the lubricating action of the frit putty 20, is free of excessive strains. Also the frit putty 20 is squeezed to fill the interstices.

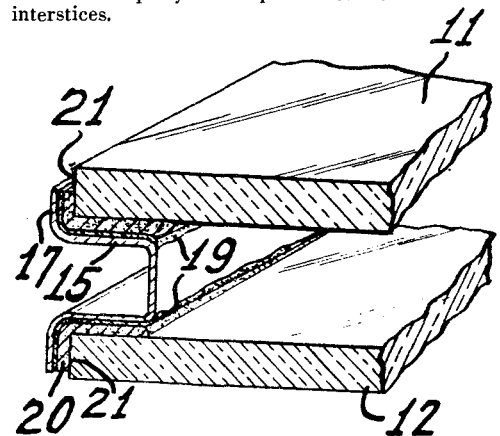

ELECTRODE LOADING APPARATUS (Patent No. 2,760,254)—granted August 28, 1956 to JOHN A. CHASE, FRANK J. PILAS and ROY K. WOLKE, ELECTRON TUBE DIVISION, Harrison, N. J. A loading apparatus for automatically loading cathode sleeves to form an electrode cage, comprises a housing forming a hopper for sleeves and including a portion snugly receiving a drum slotted along its periphery. The portion of the housing referred to has a slotted aperture. Means are provided for rotating the drum first in one direction and then in the other for jostling the sleeves in the hopper to insure entrance of a sleeve into the housing slot. A chute communicating with the slot directs the sleeve to a suitable position on a jig.

PEN and

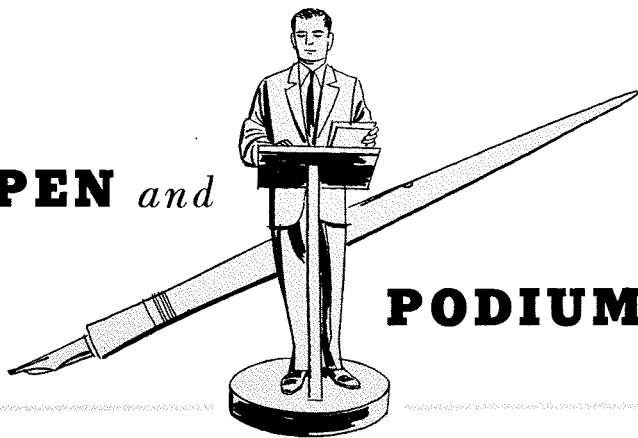

PODIUM

BASED ON REPORTS RECEIVED OVER A PERIOD OF ABOUT TWO MONTHS

LOW NOISE TRANSISTOR MICROPHONE AMPLIFIER . . . By J. J. DAVIDSON, RCA VICTOR RADIO and "VICTROLA" DIVISION, Cherry Hill, N. J. Presented on March 20, 1957 at the IRE National Convention. The attraction of transistors for use in low-level amplifiers has long been obvious. Such factors as size, weight, power consumption, and economy have indicated the potential superiority of transistors over vacuum tubes. Until recently, however, the prime requirement of low noise factor could not be met with any consistency. Some trends and criteria for low-noise design are discussed, including results on some experimental transistors. An experimental microphone amplifier is utilized as the embodiment of the design requirements.

A TRANSISTORIZED HORIZONTAL DEFLECTION SYSTEM . . . By H. C. GOODRICH, RCA VICTOR TELEVISION DIVISION, Cherry Hill, N. J. Presented on April 27, 1957 at the IRE Spring Technical Conference on Television, Cincinnati, Ohio. The bidirectional switching characteristics of the junction transistor make it well suited to horizontal deflection applications. Pertinent characteristics of present power transistors are presented together with the improvements desirable for this application. A circuit capable of producing 90° deflection and an ulior voltage of 10 kv is described.

A NEW TIME DIVISION MULTIPLEX SYSTEM . . . By W. J. BIEGANSKI and L. M. GLICKMAN, COMMERCIAL ELECTRONIC PRODUCTS, Camden, N. J. Presented at the 1957 IRE National Convention, New York, on March 18. A new time division, pulse position modulation, voice multiplex system has been developed. The system is completely transistorized. Transistor matrix techniques are used in the distributor resulting in highly accurate timing without any adjustments. Transistor circuitry constituting the system is described in some detail.

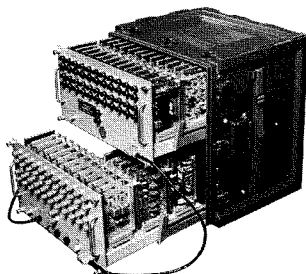

Multiplex System — Bieganski and Glickman.

TRANSISTOR RECEIVER VIDEO AMPLIFIERS . . . By M. C. KIDD, RCA VICTOR TELEVISION DIVISION, Cherry Hill, N. J. Presented on April 27, 1957 at the IRE Spring Technical Conference on Television, Cincinnati, Ohio. Improvements in transistors using diffusion techniques have resulted in practical transistor video amplifiers. Transistors supply sufficient drive and output voltages of 80 to 100 volts have been obtained with experimental transistors. Circuit design is discussed including the associated system requirements.

HIGH POWER LOW-FREQUENCY APPLICATION OF TRANSISTORS . . . By M. B. HERSCHER, DEFENSE ELECTRONIC PRODUCTS, Camden, N. J. Presented on April 8, 1957 at the IRE Transistor Applications Lecture Series, University Museum Auditorium, Phila. Advantages and limitations of transistors in high-power applications are discussed. Class A and class B push-pull amplifiers, techniques for minimizing distortion in class B amplifiers, and circuits taking advantage of complementary symmetry are described. Techniques for temperature compensation and for minimizing thermal runaway are also considered.

A LOGICAL ANALYSIS OF SORTING . . . By S. KAPLAN, COMMERCIAL ELECTRONIC PRODUCTS, Camden, N. J. Presented on April 13, 1957 at the Central Ohio Association for Computing Machinery, Columbus, Ohio. Sorting is the arrangement of messages such that their keys (sorting criteria) will be in one-to-one correspondence with a segment of the natural numbers. With the growth of computing and data-processing, many sorting techniques have been advanced. Some methods preserve the original order and increase it on succeeding passes; others destroy the original order. Some avoid merging of tapes (or cards); others require a final merging. Sorting in commercial data processing is discussed.

DEVELOPMENTS IN HIGH POWER UHF TELEVISION . . . By L. L. KOROS, J. E. YOUNG, COMMERCIAL ELECTRONIC PRODUCTS, Camden, N. J. and I. E. MARTIN, Electron Tube Division, Lancaster, Pa. Presented by Mr. Young on March 19 at the 1957 IRE National Convention, New York. Latest developments in high power UHF television transmitters and antennas are described, including installations of 1 megawatt effective radiated power now in operation, and experimental tubes, circuits, and antennas which have produced effective radiated powers in excess of 5 megawatts. Performance characteristics of television transmitters using these components are given.

ABSTRACT OF THE AUDITORY DISPLAY OF TRACKING RADAR RETURN . . . By M. E. HAWLEY, DEFENSE ELECTRONIC PRODUCTS, Moorestown, N. J. Presented on January 23, 1957 at the Johns Hopkins University, Composite Design Research Panel. It has been found that radar returns from an aircraft possess characteristics not normally used in visual displays, but which can convey information when converted to audible form. The origin and use of these characteristics is described.

AN RCA HIGH-PERFORMANCE TAPE TRANSPORT SYSTEM . . . By S. BAYBICK and R. E. MONTIJO, COMMERCIAL ELECTRONIC PRODUCTS, Camden, N. J. Presented by Mr. MontiJo at the Western Joint Computer Conference, Los Angeles on February 27, 1957, and the IRE National Convention on March 20, 1957. The transport design uses only semiconductors and magnetic devices. It is capable of handling any size tape from 1/2" wide to 1 1/8" wide. Magnetic tape can be stopped or started in less than 2 milliseconds. 50 KC non-return to zero recordings are made on this device, and a repetition start-stop rate up to 7200 per minute without resonance is featured.

ERASING MAGNETIC FILM FOR POP-FREE SPLICES . . . By CARL SHIPMAN and CARL HITTLE, COMMERCIAL ELECTRONIC PRODUCTS, Hollywood, California. Presented on May 3, 1957 at the 81st SMPTE Convention, Washington, D. C. When magnetic soundtracks are edited and then reproduced for motion-picture re-recording or other purposes, the splices in the track frequently cause audible pops to be heard in the reproduced program material. Among the causes of pops is improperly erased magnetic film or tape. Pop elimination from this cause is achieved by use of eraser which does not produce "spokes."

CONTROL LOGIC IN DIGITAL COMPUTERS . . . By D. L. NETTLETON, COMMERCIAL ELECTRONIC PRODUCTS, Camden, N. J. Presented on March 4, 1957 at the Symposium on Digital Computers, University of Pa., Phila. This paper was the final one of a series of six weekly lectures which formed a symposium on various aspects of digital computers. The paper was directed first, toward achieving an understanding of the functions of internal control in a digital computer and how such control may be accomplished and secondly, toward an examination of the decisions, which must be made in the design of a machine, and the range of compromise available.

TREND OF MODULARIZATION IN ELECTRONIC EQUIPMENT . . . By GEORGE W. K. KING, DEFENSE ELECTRONIC PRODUCTS, Moorestown, N. J. Presented before a group of management and engineering personnel at the Waltham Laboratories on April 4, 1957. Slides were shown pointing out the good and bad points of industry modularization method from the time the survey started in November of 1955 to the present date. The subject matter was divided into three main work areas: Structural Reliability, Thermal Problems and Packaging Techniques with emphasis placed on the characteristics desirable in an ideal electronic system.

ADAPTING 16MM TELEVISION-FILM PROJECTORS FOR MAGNETIC SOUND REPRODUCTION . . . By W. F. FISHER and R. E. MAINE, COMMERCIAL ELECTRONIC PRODUCTS, Camden, N. J. Presented by Mr. Fisher on May 3, 1957 at the 81st SMPTE Convention, Washington, D. C. The means used to reproduce magnetic sound from film with the RCA line of 16 mm television projectors are described. The problems introduced by the necessity of working within the boundaries established by existing designs are discussed; solutions are presented which make the field installation of this feature a simple task.

AN OPERATIONAL METHOD OF CHECKING COLORIMETRY IN COLOR TV SYSTEMS . . . By H. N. KOZANOWSKI and S. L. BENDELL, COMMERCIAL ELECTRONIC PRODUCTS, Camden, N. J. Presented on May 2 at the 81st SMPTE Convention, Washington, D. C. An optical color bar pattern using Wratten filter strips is introduced in the light path of a color TV chain, producing an electrical signal display. This is compared directly with an "ideal" color bar signal produced electronically, giving quantitative measurement of colorimetric performance. Tests show that electronic masking can compensate for colorimetric system limitations, using this comparison color bar technique as a rapid and accurate tool.

LABORATORY RESEARCH CONCERNING DISPLAY PARAMETERS INVOLVED IN VISUAL RECOGNITION . . . By W. R. BUSH, DEFENSE ELECTRONIC PRODUCTS, Moorestown, N. J. Presented on April 4, 5 at the Symposium on Form Discrimination as Related to Military Problems, Tufts University,

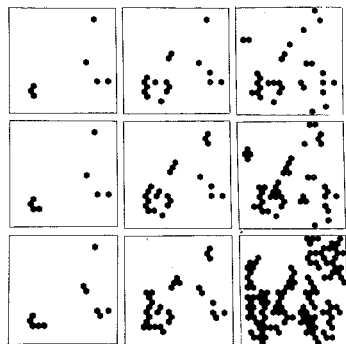

Parameters in Visual Recognition — Bush.

Medford, Mass. An experimental program to investigate the parameters involved in matching two visual displays was presented, and possible results were discussed. Primary emphasis was given to the generation of the stimulus materials, consisting of a series of displays originating from a family of matrices, statistically intercorrelated.

VARIABLE WORD LENGTH TAPE OPERATIONS IN THE NEW BIZMAC II COMPUTER . . . By HARRY KLEINBERG, COMMERCIAL ELECTRONIC PRODUCTS, Camden, N. J. Presented on March 7, 1957 at the 4th Annual High-Speed Computer Conference, Baton Rouge, La. The RCA BIZMAC II Computer incorporates new flexibility of magnetic tape handling while maintaining the complete variable word length operation of the RCA BIZMAC I. Output to magnetic tape may take place simultaneously with computation

or any magnetic tape operation. Up to fifteen tape machines may be connected to the computer at the same time, with electronic switching under the programmer's control.

RCA BIZMAC II COMPUTER—CHARACTERISTICS AND APPLICATIONS . . . By J. A. BRUSTMAN, H. M. ELLIOTT and A. S. KRANZLEY, COMMERCIAL ELECTRONIC PRODUCTS, Camden, N. J. Presented by Mr. Kranzley on March 1, 1957 at the Western Joint Computer Conference, Los Angeles. This paper describes the RCA BIZMAC II Computer with emphasis upon functional enlargements which enhance its capabilities over the present RCA BIZMAC Computer. Special features are described. Characteristics of commercial data processing which are handled by the RCA BIZMAC II Computer in a unique and efficient manner are presented.

A CONSTANT INPUT-IMPEDANCE RF AMPLIFIER FOR VHF TV RECEIVERS . . . By H. B. YIN and H. M. WASSON, RCA VICTOR TELEVISION DIVISION, Cherry Hill, N. J. Presented at the Cincinnati Section of the IRE 11th Annual Spring Television Conference, April 26 and 27, 1957. The variation of input-impedance of television tuners at different frequencies across a channel and with changes of age bias causes "holes" within the passband when a "typical" antenna installation is used. A description of the formation of these holes is given and an r-f amplifier design is presented which, because of its constant input-impedance properties, solves this problem.

THE COLOR TELEVISION SYSTEM AT THE WALTER REED ARMY MEDICAL CENTER . . . By A. F. INGLIS, COMMERCIAL ELECTRONIC PRODUCTS, Camden, N. J. Presented at the NARTB Convention, Chicago, April 5 to 12, 1957. The installation of a Color Television System at Walter Reed Army Medical Center represents the first large-scale application of compatible television for medical education. This is by far the largest such installation in the world, and represents a pioneering effort on the part of both the Army Medical Service and RCA. It should be a source of satisfaction to all of us who have been associated with the broadcasting industry for many years to see the equipment and techniques which we have developed used in an application which will be so valuable to the progress of the medical profession.

OBSERVATIONS OF COMPONENT-PART DEBUGGING IN COMPLEX ELECTRONIC EQUIPMENTS . . . By F. A. HARTSHORNE, DEFENSE ELECTRONIC PRODUCTS, Camden, N. J. and J. A. Connor (formerly with RCA). Presented by Mr. Hartshorne at the 1957 Electronic Components Symposium, Chicago, Ill., May 1, 2 and 3. Empirical Data indicate that the population of initial defectives in electronic systems diminishes so that 1/e of the original number remain in about 25 hours of normal "burn-in" operation. It has been concluded that, on the basis of this observation, a "first order" debugging theory can be established for complex electronic systems.

PROGRESSIVE STEPS TOWARD AUTOMATION IN TELEVISION PROGRAMMING . . . By A. H. LIND, COMMERCIAL ELECTRONIC PRODUCTS, Camden, N. J. Presented at the NARTB Convention, Chicago, on April 11, 1957. Possibilities for automatic operation

of program signal producing equipment in TV studios are attracting the growing interest of broadcasters. Greater efficiency, increased performance and reduced operating costs are all potential products of the application of automation techniques. This paper discusses problems of mechanization and logical, progressive steps toward the goal of a high degree of automation. System concepts and equipment requirements are presented.

MODERN THEATRE SERVICE PROCEDURES . . . By EDWARD STANKO, RCA SERVICE COMPANY, Cherry Hill, N. J. Presented on May 2, 1957 at the 81st SMPTE Convention, Washington, D. C. With the development of improved theatre sound and projection equipment, the professional theatre sound service engineer must keep pace with the technical and engineering developments by constantly improving and, when necessary, revising service procedures. The subject paper deals with the requirements of modern theatre service procedures, the methods and equipment used and their overall results.

BIZMAC — A DIGITAL DATA PROCESSING SYSTEM . . . By J. C. HAMMERTON, COMMERCIAL ELECTRONIC PRODUCTS, Camden, N. J. Published in ELECTRONIC ENGINEERING, April 1957. The paper describes the RCA BIZMAC System with reference to the task which it performs at the Ordnance, Tank and Automotive Command, Detroit. The machines in the system are described from a functional standpoint. The manner in which they are integrated and controlled is also described.

TERMINAL STUD ASSEMBLY FOR MAXIMUM RELIABILITY . . . By G. H. LINES, DEFENSE ELECTRONIC PRODUCTS, Camden, N. J. Published in the April 1957 issue of ELECTRICAL MANUFACTURING. Terminal board assemblies using tubular rivet-type terminal studs in glass-silicone laminate, unimpregnated and impregnated phenolic terminal boards were investigated to determine suitable mounting hole tolerances and to evaluate the effect of knurling on the terminal shank. Torsional resistance, both before and after soldering, was determined with terminals inserted into boards in combinations resulting in fits ranging from .007 inch interference to .007 inch clearance.

INSTRUMENTATION FOR MEASURING THE OPTICAL SINE-WAVE SPECTRUM OF IMAGE FORMING DEVICES . . . By OTTO H. SCHADE, ELECTRON TUBE DIVISION, Harrison, N. J. Presented at the Optical Society of America Meeting, M.I.T., Cambridge, Mass., May 2, 1957. Sine-wave response measurements require basically a source generating electrical or spatial sine-wave test signals of known amplitude, frequency, and direction; and in addition a nonselective detector to measure amplitude (and phase) in the transduced sine-wave image. It is shown that the same apparatus can be used to measure a variety of image forming devices, such as lenses, photographic film, television camera tubes, and kinescopes.

TRANSISTOR APPLICATION TO VIDEO & BANDPASS AMPLIFIERS . . . By G. E. THERIALT, RCA VICTOR TELEVISION DIVISION, Cherry Hill, N. J. Presented on April 15 at the Philadelphia Section IRE, Transistor

Application Lecture Series. Equivalent circuits, power gain data, and other fundamental characteristics of transistors for high frequency operation were presented. These transistor characteristics were considered for use in bandpass and video amplifier design. Practical circuit designs were discussed with respect to such problems as unilateralization in bandpass amplifiers, and feedback and peaking in video amplifiers.

PROPOSAL FOR ACCURACY CLASSIFICATION OF RADAR CONTROL GEARING . . .

By P. LEVI, DEFENSE ELECTRONIC PRODUCTS, Moorestown, N. J. Presented on March 12 at the Radar Control Gear Committee Meeting, Boston, Mass. This paper discusses the requirements of control gearing and the need for more complete specifications. The appendix of the paper contains a rough draft of a proposed new AGMA Standard of the Inspection of Control Gears.

THE APPLICATION OF AUTOMATIC TESTING TECHNIQUES TO RELAY EVALUATION . . .

By J. J. O'DONNELL, DEFENSE ELECTRONIC PRODUCTS, Camden, N. J. Presented on April 23 at the First National Conference on Electromagnetic Relays, Oklahoma A & M College. This paper describes a project undertaken in the Components and Materials Evaluation Laboratory which has resulted in the development of a new approach for the performance of evaluation work. This should result in a reduction in test and evaluation costs.

A PROPOSED REFERENCE SIGNAL FOR BROADCAST TELEVISION TRANSMISSIONS . . .

By J. W. WENTWORTH, COMMERCIAL ELECTRONIC PRODUCTS, Camden, N. J. Presented on March 19 at the 1957 IRE National Convention, New York and on April 8 at the NARTB Convention, Chicago. This paper describes a proposal for using a portion of the vertical blanking period of a television signal for the transmission of a special reference waveform to facilitate routine tests and adjustments. If properly generated and introduced, the reference signal causes no observable effects in the televised pictures, and permits the testing of TV facilities while they are actually in service.

TRI-PARTITION OF A SOUND STAGE . . .

By MICHAEL RETTINGER, COMMERCIAL ELECTRONIC PRODUCTS, Hollywood, Calif., and D. J. BLOOMBERG, Republic Studios, Studio City, Calif. Presented at the SMPTE Spring Convention in Washington, D. C. The paper discusses the partition of an existing sound stage on the Republic Studios lot into three equally large television stages. The original stage was 120' wide, 200' long, and 57' high. Partitions between stages are of the double-wall type, each wall resting on a separate foundation. Various means are discussed to increase the sound insulation between adjacent stages so that it is possible to construct sets in any one stage while sound recording takes place in any of the adjacent stages.

HOME MEASUREMENT OF PHONOGRAPH SYSTEM PERFORMANCE . . .

By W. H. ERIKSON, DEFENSE ELECTRONIC PRODUCTS, Camden, N. J. Presented on March 19, 1957 at the IRE National Convention. Measurement techniques are described with the objective

of performance improvement. Major emphasis is on the thorough evaluation of pickup cartridge performance and living room acoustical measurements on loudspeakers. Methods of improving loudspeaker performance by equalization are discussed and illustrated. Many performance curves of pickups and loudspeakers are shown.

COLOR TV PROGRAM RECORDING EMPLOYING LENTICULAR FILM . . .

By RAY D. KELL, RCA LABORATORIES, Princeton, JOHN M. BRUMBAUGH, DEFENSE ELECTRONIC PRODUCTS, Camden, N. J. and E. DUDLEY GOODALE, NBC, N. Y. Presented by Mr. Brumbaugh at the Cincinnati IRE Spring TV Conference on April 13, 1957. Nationwide broadcasting of feature programs requires a three-hour "storage" medium. Of several being investigated for color programs, this is the first to be used commercially. A black-and-white emulsion, requiring only normal processing, is used on a 35-mm film base, the opposite of which is embossed into tiny horizontal cylindrical lenses. R, G and B "separation images," each coming from a different lens segment and consisting of ultraviolet light only, are focused in registry, in the base. The R, G and B information thus appears as separate emulsion strips behind each lenticule, and can be recovered by projection through similar topics.

INFRARED APPLICATIONS TO AIRBORNE MILITARY SYSTEMS . . .

By J. T. WHISONANT, DEFENSE ELECTRONIC PRODUCTS, Camden, N. J. Presented on April 30, 1957 at the Philadelphia Chapters of the Professional Group on Aeronautical and Navigational Electronics—Professional Group on Military Electronics, Radio Corp. of America, Camden, N. J. Considerable advancement has been made since World War II in the effective use of equipment which utilizes that portion of the electromagnetic spectrum designated "infrared." Advantages and limitations of infrared techniques to the solution of operational and tactical problems of present day Airborne Weapons Systems are covered by a review of the principal parameters of infrared detection.

DESIGN OF THE BIZMAC II SYSTEM . . .

By T. M. HUREWITZ, COMMERCIAL ELECTRONIC PRODUCTS, Camden, N. J. Presented on April 3 at the Local Chapter of the IRE Professional Group on Electronic Computers, Washington, D. C. An idealized Systems philosophy was developed and extended into the design of the BIZMAC System. Systems concepts, the implementations of these concepts in equipment design, and modifications leading to BIZMAC II are described.

BIZMAC CIRCUITS . . .

By W. SAEGER, COMMERCIAL ELECTRONIC PRODUCTS, Camden, N. J. Presented on April 3 at the Local Chapter of the IRE Professional Group on Electronic Computers, Washington, D. C. The objective of the BIZMAC circuit design program is to attain maximum reliability by design rather than by chance. The methods and standards which were developed to design this reliability into the circuits are presented. In addition some typical logic configurations and circuits used to implement them are presented.

CASE HISTORY OF TWO MILITARY CONSOLES . . .

By W. C. MACPHERSON, DEFENSE ELECTRONIC PRODUCTS, Moorestown, N. J. Presented on April 19 at the First South-eastern Conference on Industrial Design, Georgia Institute of Technology, Atlanta, Ga. Two consoles are presented to illustrate how operation and production requirements determine the recommended design program. The shipboard console must meet the severest environmental requirements and space limitations. In the landbased console the environment is easier to control and emphasis is placed on the greater work capabilities of one or more operators.

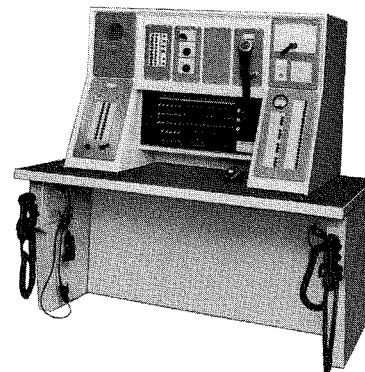

Military Consoles — MacPherson.

NOISE LEVEL REDUCTIONS OF BARRIERS . . .

By MICHAEL RETTINGER, COMMERCIAL ELECTRONIC PRODUCTS, Hollywood, Calif. Presented at the SMPTE Spring Convention in Washington, D. C. The paper discusses the sound level reductions of barriers such as solid walls and fences interposed between the source of noise and the point of observation. The formulas for the calculations are obtained from the optical case in which light is directed against a knife edge and the light intensity is measured in the shadow (penumbra).

THE ANALYSIS OF POST-DETECTION INTEGRATION SYSTEMS BY MONTE CARLO METHODS . . .

By E. ACKERLIND, DEFENSE ELECTRONIC PRODUCTS, Los Angeles, Calif. and R. DILWORTH, CALIFORNIA INSTITUTE OF TECHNOLOGY. Presented at the IRE National Convention on March 18, 1957. By means of a random sampling procedure the cumulative probability distribution of threshold crossings has been determined for the cases of: 1. IF amplifier, square-law detector, and post-detection integration, and 2. IF amplifier, linear detector, and post-detection integration. Various signal-to-noise ratios and various durations of signal are considered.

AIRBORNE FIRE CONTROL . . .

By A. J. SKAVICUS, DEFENSE ELECTRONIC PRODUCTS, Camden, N. J. Presented before the student members of AIEE and IRE, University of Massachusetts on February 6, 1957. This talk on Airborne Fire Control covered the past history and development of Airborne Fire Control including the changes that have occurred in the aircraft, electronics and weapons as far as speed, altitude, maneuverability and complexity are concerned. Due to the increased complexity, a definite approach to developing the fire control system is required. This includes systems analysis, development (including the flyable breadboard) and design of the prototype equipment.

RELIABILITY AND THE STANDARDS ENGINEER . . . By C. M. RYERSON, DEFENSE ELECTRONIC PRODUCTS, Camden, N. J. Presented on March 26, 1957 at the New York Section of the Standards Engineering Society. A tremendous challenge faces Standards Engineering in the Reliability area. This article presents the general problem, defines a standard, and explains its relation to reliability. Details of the challenge and how the standards engineer might best contribute to reliability control are discussed.

AN ANALYTICAL APPROACH TO THE DETERMINATION OF NUCLEAR RADIATION EFFECTS ON SEMICONDUCTORS . . . By D. B. KRET, DEFENSE ELECTRONIC PRODUCTS, Camden, N. J. Presented on May 1 at the 1957 Electronic Components Symposium, Chicago, Ill. This paper discusses changes in semiconductor materials due to nuclear radiation. The effects of each type of radiation particle and ray are determined independently. An analytical discussion of the expected changes in electrical characteristics is also included.

THE PHOSPHOR-SLURRY PROCESS FOR COLOR-KINESCOPE SCREENING . . . By D. J. DONAHUE and T. A. SAULNIER, ELECTRON TUBE DIVISION, Lancaster, Pa. Presented at the Electrochemical Society Meeting, Washington, D. C., on May 13-16, 1957. Phosphor powders are dispersed in a photosensitive binder to form slurries. The phosphor slurries are applied to tube assemblies by a spinning technique. General methods of preparation of the photosensitive slurries are outlined.

CALIBRATION OF KINESCOPE TEST SETS FOR COLOR BALANCE AND LIGHT OUTPUT . . . By G. P. KIRKPATRICK and A. E. HARDY, ELECTRON TUBE DIVISION, Lancaster, Pa. Presented at Electrochemical Society Meeting, Washington, D. C., May 13-16, 1957. The routine calibration of color kinescope test sets for color balance and light output is achieved by means of spectroradiometrically calibrated kinescopes. The operation of these kinescopes is checked by means of a three-filter colorimeter.

THE USE OF STATISTICAL METHODS IN CERAMIC-BODY FORMULATION . . . By G. V. GLOWACKI, ELECTRON TUBE DIVISION, Harrison, N. J. Presented at American Ceramic Society Meeting, Dallas, Texas, May 6-9, 1957. This paper describes a unique application of statistical methods to the formulation of ceramic bodies having predetermined properties. Three important factors involved in the statistical analysis are discussed: (1) study of materials to ascertain that they are related to the required properties, (2) range of variation of each constituent material, and (3) relationship of each property investigated to composition.

ALUMINA CERAMICS FOR ELECTRON TUBE CONSTRUCTION . . . By MORRIS BERG, ELECTRON TUBE DIVISION, Lancaster, Pa. Presented at American Ceramic Society Meeting, Dallas, Texas, May 6-9, 1957. This paper reviews various applications of alumina ceramics for electron-tube construction with emphasis on the ceramics used for making vacuum-tube envelopes. Results of RCA evaluations of approximately twelve commercial high alumina compositions are included.

BLACK LEVEL—THE LOST INGREDIENT IN TELEVISION-PICTURE FIDELITY . . . By R. G. NEUHAUSER, ELECTRON TUBE DIVISION, Lancaster, Pa. Presented at S.M.P.T.E. Convention, Washington, D. C., May 2, 1957. This paper outlines television-system improvements instituted in recent years which produce and maintain the ability to reproduce proper black level (or d-c restoration) in the television receiver. The necessity for proper black-level control in the production of television pictures having good fidelity is discussed. The entire television system, from the studio to the television receiver, is considered. A suggested waveform standard that can be used to achieve day-to-day and station-to-station uniformity of black-level reproduction is illustrated.

INTERFEROMETRIC CALIBRATION OF KINESCOPE ALUMINUM-FILM THICKNESS METERS . . . By G. P. KIRKPATRICK and T. A. SAULNIER, ELECTRON TUBE DIVISION, Lancaster, Pa. Presented at Electrochemical Society Meeting, Washington, D. C., May 13-16, 1957. The application of multiple-beam interferometry to the calibration of aluminum-film thickness meters used to monitor aluminized kinescope screens is discussed. Comparison of interferometrically observed and calculated values of aluminum thicknesses leads to the conclusion that the latter are reliable in the range from 1300 to 5000 angstroms. It is emphasized that the interferometric check is far superior to that obtainable by quantitative chemical analysis.

CIRCUIT CONSIDERATIONS FOR HIGH-FREQUENCY AMPLIFIERS USING DRIFT TRANSISTORS . . . By J. W. ENGLUND and A. L. KESTENBAUM, SEMICONDUCTOR DIVISION, Somerville, N. J. Presented at the IRE National Convention, New York City, March 20, 1957. This paper describes design considerations for high-frequency circuits using new drift transistors in which the useful frequency response has been increased by an order of magnitude over conventional junction transistors without changing the configuration of the alloy structure. Circuits are presented showing the use of these transistors in a two-stage unneutralized 455-k-c amplifier, a neutralized single stage i-f amplifier, a two-stage i-f amplifier operating at 10.7 mc, and a three-band portable radio receiver covering the broadcast band and shortwave bands.

AN IMAGE CONVERTER FOR HIGH-SPEED PHOTOGRAPHY . . . By R. G. STOUENHEIMER and J. C. MOOR, ELECTRON TUBE DIVISION, Lancaster, Pa. Presented at the IRE National Convention, New York City, March 21, 1957. A developmental image converter tube having electrostatic focus, a shutter grid, and electrostatic deflection is intended for multiple frame photography of high-speed events with exposures as short as ten millimicroseconds. The image converter and its operating characteristics are described.

PULSE-FIRING AND RECOVERY-TIME CHARACTERISTICS OF THE 2D21 THYRATRON . . . By J. A. OLMSTEAD and M. ROTH, ELECTRON TUBE DIVISION, Harrison, N. J. Presented at IRE National Convention, New York City, March 21, 1957. This paper describes the physical processes which occur within the 2D21 thyatron during pulse firing and recovery of grid control. Both of these characteristics depend upon retention or loss of

grid control. This grid control is greatly reduced when positive ions are present within the tube. The positive ions surround the grid, forming a space-charge sheath which tends to neutralize the effect of external potentials applied to the grid. Illustrative data for both of these characteristics are presented.

COMPARISON OF TRANSISTORS MADE FROM DIFFERENT MATERIALS AND BY VARIOUS TECHNIQUES . . . By W. M. WEBSTER, SEMICONDUCTOR DIVISION, Somerville, N. J. Presented at the IRE Lecture Series, Boston, Mass., on May-7, 1957. This talk is oriented about design theory and existing methods of transistor fabrication. Silicon and germanium transistors which are either available or have been reported in the literature are used as examples. An attempt is made to predict on a semi-theoretical basis ultimate performance characteristics for silicon and germanium transistors.

SUPER-POWER GRID-CONTROLLED TUBES FOR RADAR APPLICATIONS . . . By M. V. HOOVER, ELECTRON TUBE DIVISION, Lancaster, Pa. Presented at Colloquium on Ballistic Missile Detection and Radar, M.I.T. Lincoln Laboratories, April 30-May 1, 2, 1957. This talk describes how new electron-optical systems have been developed for power tubes, and rugged new ceramic envelopes are employed. The philosophy of practical double-ended tubes and circuitry has been proven in conjunction with large power tubes. A ten megawatt experimental super-power hard-tube modulator system has been developed, and has been operating in experimental service requiring high-duty-factor power, e.g., in the order of 5% with pulse durations in the order of several milliseconds.

VIDICON TUBES . . . By W. H. ROBINSON, ELECTRON TUBE DIVISION, Los Angeles, Calif. Presented at J. A. O'Connell Vocational and Technical Institutes, San Francisco, Calif., on April 2, 1957. This presentation describes the Principles of Operation of the Vidicon, and points up (temperature, dash current, and scanning protection) considerations that should be observed.

AUTOMATIC PRODUCTION TESTING OF PRINTED WIRE MODULES . . . By E. D. DAVIS and H. S. DORDICK, DEFENSE ELECTRONIC PRODUCTS, Camden, N. J. Presented by Mr. Davis on May 3, 1957 at the Electronics Components Symposium, Chicago. Six techniques for testing the printed wire module as a component are described and evaluated for effectiveness, reliability, and cost as well as for capability of mechanization and inclusion in an automatic test system. These techniques are resistance-capacitance measurement, impedance comparison, measurement of the real and quadrature components of impedance, simultaneous frequency measurements, simplified dynamic testing and transient response comparison.

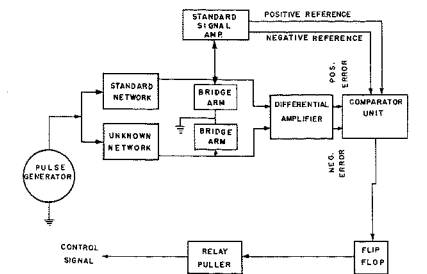

Automatic Testing Printed Wire Modules—Davis and Dordick.

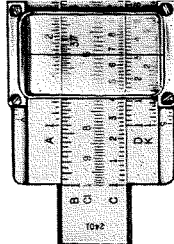

TWO EXECUTIVE CHANGES ANNOUNCED



T. A. SMITH



A. L. MALCARNEY

Theodore A. Smith has recently been appointed Executive Vice President, Industrial Electronic Products, and **Arthur L. Malcarney** was elected by the Board of Directors to succeed him as Executive Vice President, Defense Electronic Products.

In his new capacity, Mr. Smith will have responsibility for RCA computer systems, telecommunications systems including RCA Communications, Inc., industrial control systems and other commercial products.

Mr. Smith will continue to be active in RCA's defense planning, and will be Chairman of the RCA Defense Coordination Guidance Committee, the Corporation's top policy and planning group on defense matters.

As Executive Vice President, Industrial Electronic Products, he will report to John L. Burns, President of RCA. His appointment became effective June 15.

Mr. Malcarney, who has been Vice President and General Manager, Commercial Electronic Products since June, 1956, will assume direction of the Defense Electronic Products unit on the same date. He will report to Dr. E. W. Engstrom, Senior Executive Vice President.

Mr. Smith has headed RCA's Defense Electronic Products unit since October, 1955, and has been an Executive Vice President for the past year. Before taking over the Defense Products assignment, he had been Vice President in charge of the Engineering Products Department of the former RCA Victor Division. Associated with RCA since 1925, Mr. Smith was a member of the original staff of RCA's Technical and Test Laboratories at Van Cortlandt Park, New York. In 1928, he supervised the construc-

NAME CHANGED TO RCA ELECTRON TUBE DIVISION

Effective April 8, 1957, the RCA Tube Division will be known as the RCA Electron Tube Division. The change was announced by D. Y. Smith, Vice-President and General Manager. The change has been made, he said, to define more precisely the type of products manufactured and merchandised by the Division.

tion of RCA's pioneer television station W2XBS, New York, and later held sales, engineering and administrative posts of increasing responsibility at RCA Camden, N. J., headquarters. He is a Senior Member of the Institute of Radio Engineers.

Mr. Malcarney, who joined RCA in 1933, became General Manager, Commercial Electronic Products, in October, 1955. Previously, he had been for two years Manager of Production of the former Engineering Products Department. From 1947 to 1953, he was General Plant Manager of the Department, and earlier he had engaged in component manufacturing and quality control activities of RCA. He served in the United States Air Force from 1930 to 1933.

NEW EDITORIAL REPRESENTATIVE APPOINTED

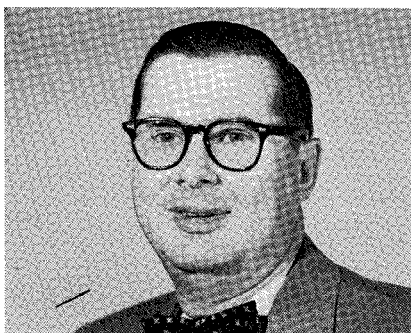

Warren M. Kitter, Standards Editor, Standards Engineering, DEP, has been appointed to succeed H. E. Coston as a member of the DEP-CEP Editorial Board.

Mr. Kitter joined RCA in October, 1954. He obtained an A.B. degree in Psychology from Temple University in 1951. Prior to joining RCA, he was an instructor in Applied Electronics, Radio-Electronics Institute; wrote and prepared training courses and programs for Philco Corporation; became field engineer for Philco Corporation.

Mr. Kitter is a member of the Standards Engineering Society.

A NOTE FROM YOUR EDITORIAL STAFF

Your continued interest in the RCA ENGINEER journal is encouraging to all of us. Naturally, we believe that it is important to keep you advised on our publication schedules.

We regret that during 1957 you will receive only five copies of the RCA ENGINEER due to a combination of delays beyond our control. These include shortages of editorial help caused by illnesses and summer vacations, as well as "author time" lost due to plant shut-downs.

Therefore, the next issue you will receive will be the October-November number, Vol. 3 No. 2 (eliminating the August-September issue for 1957).

ABRAHAM KATZ WINS FELLOWSHIP

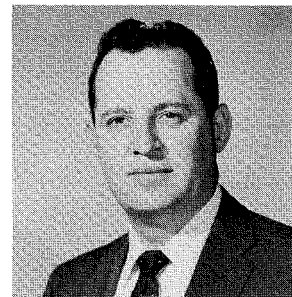

The Massachusetts Institute of Technology has announced fellowship grants from the Alfred P. Sloan Foundation for 1957-58. These fellowships are a part of the Executive Development Program of the School of Industrial Management at M.I.T. The Program is designed for a small number of exceptionally able young men whose employers nominate them because they show marked promise of growth into major executive responsibilities. In a national competition, some 40 men are chosen for fellowships. Listed among these for 1957-58, is Mr. Abraham Katz, of Radio Corporation of America, Camden.

Mr. Katz received the degree of BS in Electrical Engineering from M.I.T. in 1950, and a Masters Degree in the same field from M.I.T. in 1952. He has, in addition, taken further work in mathematics, physics, and computer techniques.

From 1950 to 1953 he worked at the M.I.T. Digital Computer Laboratory, first as a research assistant and later as a research engineer. Much of his work there was concerned with digital control systems and magnetic core devices.

In 1954 he joined the staff of the Computing Systems Section of BIZMAC Engineering, where he worked on the development of magnetic-core memory devices. Mr. Katz was promoted in 1956 to his present position as head of the High-Speed Memory group of BIZMAC Computer Engineering.

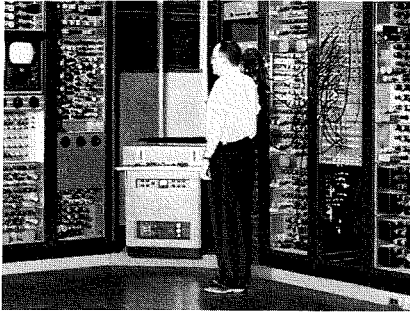

**G. M. DALY SUCCUMBS
AFTER LONG ILLNESS**

George M. Daly, a development engineer with Advanced Development Engineering, Television Division, Cherry Hill, died after a long illness on May 12, at the Hospital of the University of Pennsylvania. He was 49 years old.

Mr. Daly joined the Radio Corporation of America in 1931, working in the Test Methods and Equipment Section, and then in the Manufacturing Engineering section and the Electronic Musical Lab. He was in charge of the TV production line for TRK receivers and later was associated with the TRK field tests.

He joined Home Instruments Advanced Development in 1945, and since that time was engaged in TV engineering development, including work on monochrome and color projection TV receivers. Mr. Daly was responsible for the layout and installation of signal generation facilities for Advanced Development, when the group moved to Cherry Hill in December, 1954.

Mr. Daly was a senior member of the IRE and had five patents. He received his 25 year pin in July, 1956.

George Daly will be missed by his co-workers and many friends for his ability to "get things done," his wide knowledge of RCA procedures and personalities, and his way with a good story.

To commemorate his passing, George Daly's friends and associates raised a fund to be used in furtherance of the education of his boys. A bank check for \$857.00 was presented to his widow as a final tribute to George M. Daly. —R. W. Sonnenfeldt

TECHNICAL CORRECTION

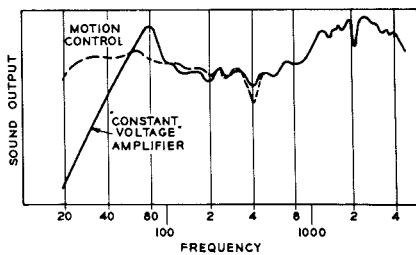

"Motion Control of Loudspeakers" by S. V. Perry, Page 48-52 of the April/May issue.

On page 51, column two, line 8, add the word "by", making the sentence read "Now let us assume that an additional voltage E_x is inserted in series with the loudspeaker (see Fig. 8A), by allowing the loudspeaker cone to move in its normal manner."

On page 52, the dashed line in Fig. 10 is incorrect, having been traced inadvertently from another unrelated graph. The corrected line, showing virtually "flat" sound output, from near 20 cps to about 700 cps, is printed herewith.—S. V. Perry

A NEW BOOK BY C. D. TUSKA

"Inventors and Inventions", by Clarence D. Tuska (McGraw-Hill, 174 pp., \$3.75) has been published as a manual to stimulate inventive tendencies, and will prove a valuable aid to engineers.

Mr. Tuska, Director of RCA Patent Operations located at Princeton, writes in an absorbing style, yet purposefully in conveying his reasons for writing the book:

"Our American way of life has come, at least in part, from the resourcefulness and ingenuity of our people. The current tide in the affairs of the world is hardly the time to lose our technical initiative or to become complacent about our scientific progress. It is, therefore, a matter of national concern that we find a measurable reduction in the annual rate of scientific creativity, discovery, and inventiveness in the United States."

In reviewing the book, Dr. E. W. Engstrom has this to say:

"The text presents the circumstances surrounding many classical inventions and discoveries in a manner designed to make you more conscious of the varying paths leading to scientific creativity. It will alert you as to inventions that are frequently made during the course of your work and not infrequently escape notice.

"While the book was not designed to tell the reader 'what to invent' or 'how to invent', it does stimulate thoughts and thus may lead

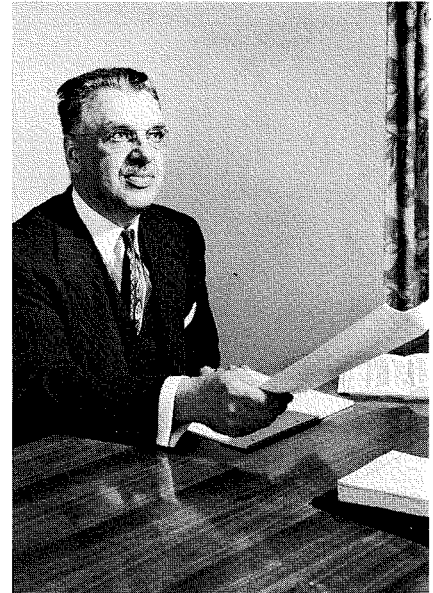

to inventions. Finally, the purpose is not to increase the quantity of disclosures of inventions, but rather to increase their quality."

NEW LABORATORY FOR MILITARY AIRBORNE EQUIPMENT IN BOSTON AREA

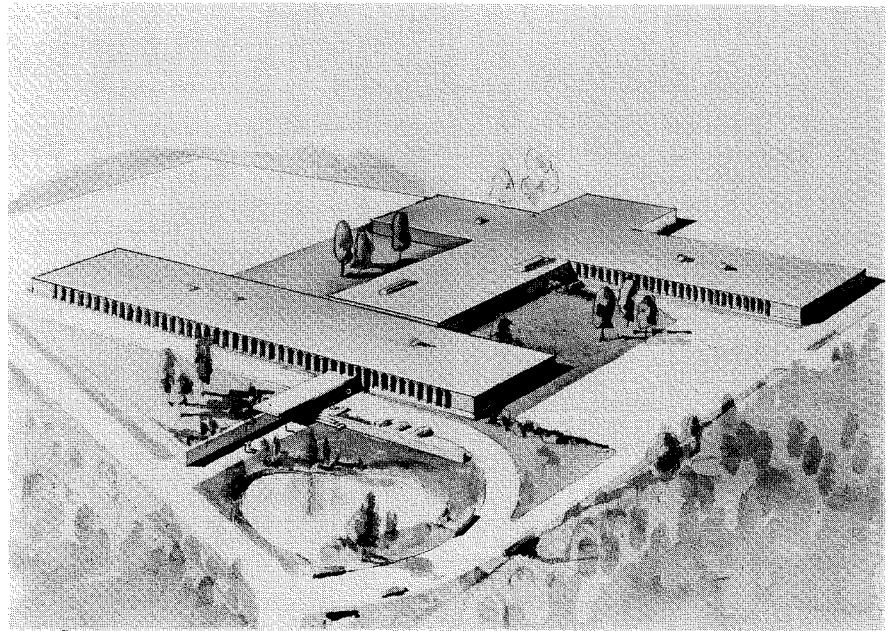

A major electronics laboratory for military airborne equipment and systems will be established by RCA in the Greater Boston area this year, it was announced recently by Dr. E. W. Engstrom, Senior Executive Vice President, RCA.

Construction of the 132,000-square-foot, single-story laboratory is getting under way and is scheduled for completion by June, 1958, according to present plans.

The new building is expected to be sufficiently advanced by late this year to permit gradual transfer of personnel and equipment from RCA's present Airborne Systems Laboratory at Waltham, Massachusetts.

The new RCA center will provide engineering space and developmental facilities

for approximately 300 electronics engineers and scientists and an equal number of supporting personnel. The Boston laboratory's engineering areas will be more than three times larger than those at the Waltham facility which it will replace.

The new Laboratory will be operated by RCA's Airborne Systems Department, Defense Electronic Products, and will be under the management of Dr. Robert C. Seamans, Jr., who now is Manager of the RCA Waltham laboratory, and who was for 13 years on the teaching staff of the Massachusetts Institute of Technology. Prior to joining RCA in 1954, Dr. Seamans served also as Director of the M.I.T. Flight Control Laboratory.

MEETINGS, COURSES AND SEMINARS

CREATIVITY

C. M. Sinnett, Mgr. of TV Division's Advanced Development Engineering is conducting an eleven-session course in "Creative Problem-Solving" for managers in Radio and "Victrola" and Television Division Engineering groups.

The course, initiated on April 30th, is sponsored jointly by Television Division Engineering and Personnel.

TRANSISTORS AND NUCLEAR RADIATION

Two ten-week courses in Transistor Fundamentals are being offered in Spring, 1957 by DEP. These courses are taught by **K. E. Palm** and **F. L. Putzrath**, and will include transistor physics and basic transistor electronics.

A twelve week course in Transistor Switching Circuits, taught by **D. E. Deutch**, is presently in progress. This course is for those engineers who have completed the fundamental course or who have equivalent experience in the field.

A twelve week course in Nuclear Radiation Effects has been completed. The instructor, **J. E. Lindsay**, presented fundamentals of nuclear physics, particle accelerators, reactor operation, and radiation effects on matter.

All instructors are members of DEP Special Systems and Development, Camden.

M. E. Malchow, Communications Engineering, CEP, is teaching in RCA after-hour courses in "Transistor Fundamentals."

RCA AT NARTB SHOW



These are the Broadcast engineers who set up and "worked" the RCA part in the NARTB show. Front row, left to right are J. W. Wentworth, A. F. Inglis, H. N. Kozanowski, J. H. Roe, L. E. Anderson, and A. H. Lind. Second row, left to right, C. C. DeWitt, S. L. Bendell, T. Shipferling, N. P. Kellaway, N. L. Hobson, A. V. Litwak, B. F. Melchionni, P. W. Wildow, and C. R. Monro. Missing from picture is V. E. Trouant.

The first public showing of more than 15 new RCA developments in studio and transmitting equipment for radio and television broadcast stations featured the participation of RCA in the 35th annual trade show of the NARTB in Chicago, April 8-11, 1957.

Among the new equipments featured were a vidicon camera for studio use, a professional 2x2 slide projector, and several new audio and video equipments for studio modernization, along with a new VHF high-gain, high-power traveling wave antenna.

A two-day Color Seminar was conducted by RCA following the show, in which equipments and techniques were discussed. The seminar was attended by approximately 160 broadcasters, military personnel and educators.

RCA broadcast engineers active in the program were: W. J. Derenbecker, E. E. Gloystein, N. L. Hobson, A. F. Inglis, A. H. Lind, B. F. Melchionni, N. J. Oman, J. H. Roe, J. W. Wentworth, and H. N. Kozanowski.

RUSSELL O. DREW—A TRIBUTE

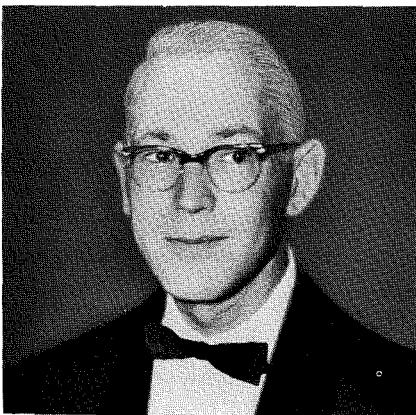

To the many friends of Russell O. Drew, it came as a shock and a sense of deep personal loss to learn of his untimely death. During the 24 years of his connection with the Radio Corporation of America, many of us had the privilege of close association with him as fellow workers. On the technical side he was a meticulous worker and resourceful experimenter in whose findings all could have confidence, because of the quality of the work on which they were based. He was a forceful advocate of what he believed in, with high standards and objectives. These qualities made him a greatly appreciated member of the various inter-company committees on standards and

photographic procedures in which he was RCA's representative.

Many as were his accomplishments along the lines of his work, he will live in our memories as a friend. If there is such a thing as a gift for friendship, Russell had it. The first element is of course, that warmth of affection and appreciation that makes one *be* a friend. There are certainly gifts that contribute to the making of new friends, and these he had in exceptional degree. It is an observation that in any group in which Russell was present it was certain that interesting conversation was going on. A wide range of interests, coupled with desire to know the thoughts, experiences, and reactions of others resulted in raising many questions of mutual or common interest, and a quick perception of the picturesque or droll, seasoned conversations with much humor. His humor was of the Yankee brand, but contagious. To be able to tell ones own troubles in a way that elicits laughter is an especially delightful trait. In the past few months Russell was called upon to endure much pain and discomfort, which he bore with courage and a smile.

Those of use who have had the privilege of knowing his splendid family experienced an additional bond, for with the background of mutual devotion, harmony and understanding, a visit never failed to be refreshing and stimulating. —E. W. Kellogg

Mr. Drew graduated from Wentworth Institute, Boston, Massachusetts, in Electrical

Engineering. Following this, he was a student engineer at the Westinghouse Company in Pittsburgh for two years. He joined RCA in 1933 as a member of the Test and Quality Control group, and in 1937, he joined the Photophone Advanced Development Section. In both of these groups his work centered on motion picture equipment and he made important contributions to the art of sound recording and reproducing. In 1941 the Advanced Development Section moved to Indianapolis, Indiana, at which time Mr. Drew was made Supervisor of the Engineering Photographic Laboratory.

After the war, he directed investigations which led to the successful use of ultraviolet radiation in the making of photographic recordings of television pictures. This work was nominated as one of the outstanding technical developments of television in 1955 by the Academy of Television Arts and Sciences. A more recent development of his photographic laboratory has been the recording of color television pictures on lenticular film.

During the past two years Mr. Drew was an active participant in a classified military study. In this work he made important contributions to the use of photography for aerial reconnaissance. He was a Fellow of the Society of Motion Picture and Television Engineers and an active member of the Photographic Engineers Society. He was a member of Committee PH22 on Photography of the American Standards Association.

MEETINGS, COURSES AND SEMINARS

Harold Addison and **Frank Ricks**, Manufacturing Engineers at the Indianapolis Tube Plant, have recently completed a Management Development Seminar sponsored by the Industrial Management Club of Indianapolis in cooperation with the YMCA, and entitled, "The Supervisor's Role in Labor Relations." The Seminar was conducted by Mr. Wayne Loer, Labor Relations Consultant with 21 years experience in the field of Labor and Management Relations for Public Utilities, Industry, and Government.

F. H. Ricks, RCA ENGINEER editorial representative for the two Indianapolis Electron Tube plants, attended the "Seventh Annual Conference on Better Management" held at Purdue University, Lafayette, Indiana on April 12, 13, 1957. This conference was sponsored by Purdue University, Divisions of Education and Adult Education in cooperation with the National Management Association, Central Council of Industrial Management Clubs affiliated with the YMCA, Indiana Manufacturers Association, Indiana State Chamber of Commerce, and National Association of Manufacturers.



On April 8, 1957, **Miss Ann Hathaway**, Associate Engineer, Receiving Tube Engineering participated in a panel discussion sponsored by the "New Jersey Engineer's Committee for Student Guidance." This panel discussion was held at Saint Aloysius High School in Jersey City. Miss Hathaway represented the Electrical Engineering Profession and presented a brief talk on the requirements and opportunities for Electrical Engineers.—*R. L. Klem*

COURSE FOR HIGH SCHOOL STUDENTS COMPLETED AT MOORESTOWN



Pictured at one of the training sessions is T. G. Greene (left) discussing a circuit diagram with students James Liddell (center) and Wilbur Hurst.

The DEP Moorestown Engineering Plant recently invited twenty seniors from the Moorestown (N. J.) High School to participate in a course designed to acquaint the students with careers in the expanding electronics field.

The course was arranged through the cooperation of Harry R. Wege, Manager of RCA's Missile and Surface Radar Department, and Mr. Paul R. Jones, Superintendent of Moorestown schools. The students, selected on the basis of achievement in the field of physics and interest in electronics, participated in practical demonstrations and laboratory work as well as lectures.

The twelve weekly sessions, held at the Moorestown plant, were designed to give the student a general working knowledge of electronics as well as to better enable him to consider engineering as a profession.

The course began with a tour of the Moorestown engineering facilities, after

which the class met for three evenings to discuss "Engineering As a Profession" and "Basic Principles of Mechanical and Electrical Engineering." A session on "Laboratory Techniques" afforded practical instruction in wiring, crimping, and soldering and the proper use of related shop equipment.

Subsequent meetings actually allowed the student to employ his knowledge and ability. The project for these sessions was to make a five tube AC-DC radio from the ARKAY kit supplied to each student by RCA.

Mr. Thomas G. Greene, an RCA Moorestown engineering leader in electronic development and design, served as class instructor. He was assisted by Mr. James R. Schietinger who discussed career opportunities in mechanical engineering, and Mr. Earl R. Adams, laboratory technician in the Missile & Surface Radar Department.

RCA ENGINEERS ACTIVE AT IRE SYMPOSIUM

A group of RCA engineers participated in the IRE Biennial Electronic Materials Symposium held June 4 and 5 in Philadelphia. Headquarters were at the Penn-Sherwood Hotel, sessions at the University of Pennsylvania Museum auditorium. J. J. Newman, Components Division, Camden, was symposium committee chairman. Others participating in the program and on committees were: D. C. Bowen, Corporate Standardizing, Camden; J. R. Hendrickson, J. A. Clanton and J. J. Jakabcin, of DEP Engineering Standards and Services, and Henry Schrule, of Components Division, Camden.

WAITE SPEAKS ON COMPUTERS AND MATHEMATICS



John H. Waite, Jr. of CEP BIZMAC Engineering, was the speaker at the annual meeting of the Operations Research Society of America held May 9 and 10 at the Moore School of Electrical Engineering, University of Pennsylvania. Mr. Waite's topic was "The Use of Computers in Computer Design."

He will discuss how computers may be used as engineering tools to prepare wiring schedules, tests, anticipate errors and modify existing computers. The use of a computer to assist with the time-consuming and tedious use of valuable engineering talent would be a great service in the designing of complex computing systems.

Mr. Waite meets with Camden County honor math students at Collingswood (N. J.) High School to encourage their interest. They learn about Applied Math, such as binary arithmetic, number theory, elementary logic probability, and other interesting aspects of mathematics. He is also a member of the Association for Computing Machinery and the Franklin Institute.

Mr. Waite received the degree of BA in Mathematics from the University of Virginia in 1942 and did graduate work at M.I.T., University of Penna., University of Vienna and Cambridge University. He joined RCA in 1953 and has since been engaged in advanced work on the application and design of computing systems as a member of the Analysis and Programming Group of BIZMAC Engineering.

CORRECTION

WALTER K. HALSTEAD was erroneously announced in the last issue as transferring to Somerville from BIZMAC Engineering in Camden. Mr. Halstead transferred to the Electron Tube Division in Harrison as Manager, Automation Systems Planning.—*Ed.*

COMMITTEE APPOINTMENTS

COMMERCIAL ELECTRONIC PRODUCTS

H. E. Gihring, CEP Broadcast Transmitter Engineering, Camden has been appointed to the TASO Antenna Committee.—*C. D. Kentner*

Communications Engineering

D. R. Marsh, CEP Communications Engineering, has been appointed to the National Committee on Communication Systems of the AIEE representing the Philadelphia Section.

W. J. Culp, CEP Communications Engineering, has been appointed to the RETMA TR-8.5 Committee on Mobile Selective Calling.

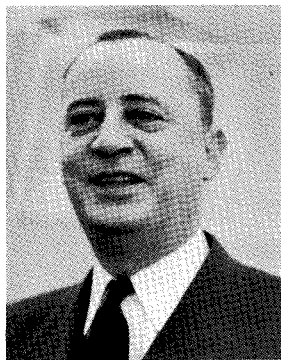

J. C. Walter, Chief Engineer, Communications Products Department, CEP, has been appointed to serve on a new AIEE Committee on Periodicals and Transactions. The Committee will deal with policy matters concerning the monthly publication Electrical Engineering and the Transactions of the Institute.

H. S. Wilson, Communications Engineering, CEP, has been appointed Chairman of the Program Committee for the Philadelphia Section, AIEE Communications Technical Division.

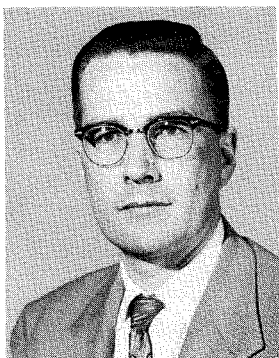

J. R. Neubauer, Communications Engineering, CEP, has been appointed a member of the IRE Sub-Committee on Mobile Radio Interference.—*B. F. Wheeler*

SERVICE COMPANY

L. D. Cochran, Field Engineer, Technical Products Service Department, RCA Service Company, has been elected President of the Washington (D.C.) Society for Electron Microscopy for 1957-58. Mr. Cochran began his term June 1, 1957.—*E. Stanko*

RECORD DIVISION

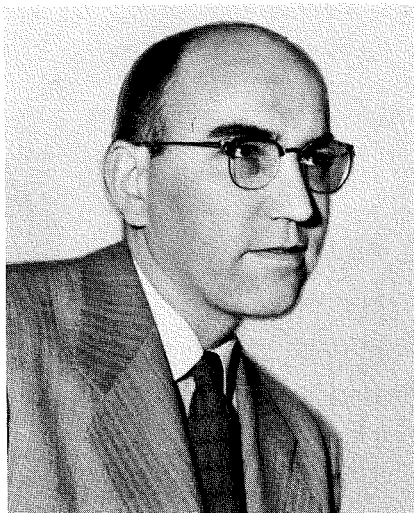

S. D. Ransburg, of the Record Compound Group, Engineering, RCA Victor Record Division, Indianapolis, was elected Vice President of the Central Indiana Chapter of the Society of Plastic Engineers.

R. C. Moyer, Manager, Recording Development, Engineering, RCA Victor Record Division, Indianapolis, was appointed Vice Chairman of IRE 19, Recording and Reproducing Committee for the 1957-58 term. He is presently Chairman of IRE 19.1, Subcommittee on Magnetic Recording and Reproducing.

DEFENSE ELECTRONIC PRODUCTS

Dr. George R. Arthur, Airborne Systems Engineering, DEP, has been elected First Vice President of the American Astronautical Association for 1957. He is also Chairman of the Regional Section Committee of the Association and in this capacity has been instrumental in the organization of the Los Angeles, San Francisco, and New York Regional Sections. He is presently organizing the Philadelphia and Washington, D. C. Sections of the Association.—*D. G. C. Luck*

ELECTRON TUBE DIVISION

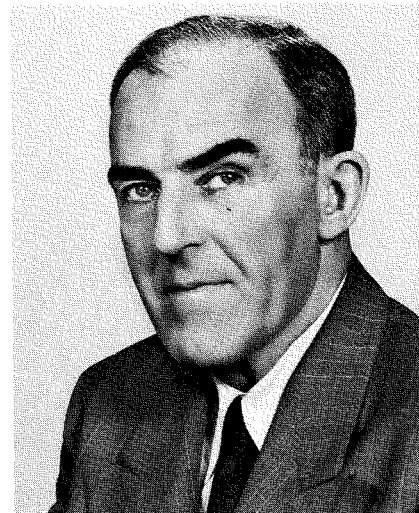

R. S. Burnap, Manager, Commercial Engineering, Electron Tube Division, has been reappointed as alternate on the ASA Electrical Standards Board for the term which expires December 31, 1960.—*R. L. Klem*

Lancaster

Dr. L. B. Headrick, Staff Engineer, Color Kinescope Engineering, was recently appointed Chairman of the Committee on Research of the Lancaster Chapter of the Society for the Advancement of Management. In this capacity, he will cooperate with a national research group to determine specific areas of need in interest of better management. Surveys of local and national requirements will be conducted in an effort to outline the projects to be undertaken.

I. M. Rehm, Packaging Engineer, Color Kinescope Engineering, has been elected President of the Central Pennsylvania Division of the Society of Industrial Packaging and Materials Handling Engineers and in addition, a member of the Board of Directors of the National Group.—*D. G. Garvin*

MEETINGS AND CONVENTIONS

June-August, 1957

JUNE 10-11

Second RETMA Symposium on Applied Reliability, Mature Design/Reliable Design, Hotel Syracuse, Syracuse, N. Y.

JUNE 17-19

First National Meeting of PGMIL of IRE, Sheraton Park Hotel, Washington, D. C.

JUNE 19-21

Twelfth Annual Meeting, Association for Computing Machinery, University of Houston, Houston, Texas

JUNE 27-29

Thirteenth Annual Meeting, Institute of Navigation, Sheraton-Park Hotel, Washington, D. C.

JUNE 27-JULY 1

British IRE Convention, "Electronics in Automation," University of Cambridge, England

AUGUST 20-24

WESCON, IRE, WCEMA, Cow Palace, San Francisco, Calif.

AUGUST 22-SEPTEMBER 5

International Scientific Radio Union, Twelfth General Assembly, Boulder, Colo.

AUGUST 28-SEPTEMBER 7

National Radio & Television Exhibition, Earls Court, London, England.

RCA ENGINEER EDITORIAL REPRESENTATIVES

DEFENSE & COMMERCIAL ELECTRONIC PRODUCTS

P. J. HERBST, *Chairman, Editorial Board*

Editorial Representatives, Defense Electronic Products

- J. A. BAUER, *Missile and Surface Radar Engineering, Moorestown, N. J.*
T. T. N. BUCHER, *Surface Communications Engineering, Camden, N. J.*
T. P. CANAVAN, *Airborne Fire Control Engineering, Camden, N. J.*
H. R. DYSON, *Technical Administration, Camden, N. J.*
M. HOLLANDER, *Airborne Systems, Moorestown, N. J.*
R. W. JEVON, *Airborne Systems Laboratory, Waltham, Mass.*
W. H. KITZER, *Engineering Standards and Services, Camden, N. J.*
DR. D. G. C. LUCK, *Airborne Systems Equipment Engineering, Camden, N. J.*
C. McMORROW, *Aviation Communications and Navigation Engineering, Camden, N. J.*
J. H. PRATT, *West Coast Engineering, Los Angeles, Calif.*
L. M. SEEBERGER, *General Engineering Development, Camden, N. J.*
W. W. WAGNER, *Camden Engineering Personnel, Camden, N. J.*

Editorial Representatives, Commercial Electronic Products

- I. F. BYRNES, *Radiomarine Engineering, New York, N. Y.*
H. E. HAYNES, *Advanced Development Engineering, Camden, N. J.*
C. E. HITTLE, *Hollywood Engineering, Hollywood, Calif.*
C. D. KENTNER, *Broadcast Transmitter and Antenna Engineering, Camden, N. J.*
T. T. PATTERSON, *BIZMAC Engineering, Camden, N. J.*
J. H. ROE, *Broadcast Studio Engineering, Camden, N. J.*
J. E. VOLKMAN, *Theater and Sound Products Engineering, Camden, N. J.*
B. F. WHEELER, *Communications Engineering, Camden, N. J.*

RCA VICTOR RECORD DIVISION

Editorial Representative

S. D. RANSBURG, *Record Engineering, Indianapolis, Ind.*

RCA LABORATORIES

Editorial Representative

E. T. DICKEY, *Research, Princeton, N. J.*

The Editorial Representative in your group is the one you should contact in scheduling technical papers and arranging for the announcement of your professional activities. He will be glad to tell you how you can participate.

RCA ELECTRON TUBE, COMPONENTS & SEMICONDUCTOR DIVISIONS

J. F. HIRLINGER, *Chairman, Editorial Board*

Editorial Representatives, RCA Electron Tube Division

- W. G. FAHNESTOCK, *Cathode Ray & Power Tubes, Lancaster, Pa.*
J. DEGRAAD, *Black & White Kinescopes, Marion, Ind.*
D. G. GARVIN, *Color Kinescopes, Lancaster, Pa.*
A. E. HOGGETT, *Receiving Tubes, Cincinnati, Ohio*
R. L. KLEM, *Receiving Tubes, Harrison, N. J.*
J. KOFF, *Receiving Tubes, Woodbridge, N. J.*
F. H. RICKS, *Receiving Tubes, Indianapolis, Ind.*

Editorial Representatives, RCA Components Division

- E. E. MOORE, *Electronic Components, Camden, N. J.*
T. A. RICHARD, *Materials Advanced Development, Needham, Mass.*
R. VELLEUX, *Electronic Components, Findlay, Ohio*

Editorial Representative, RCA Semiconductor Division

R. E. RIST, *Semiconductors, Somerville, N. J.*

RCA VICTOR TELEVISION DIVISION

C. M. SINNETT, *Chairman, Editorial Board*

Editorial Representatives

- E. J. EVANS, *Resident Engineering, Bloomington, Ind.*
R. D. FLOOD, *Color TV Engineering, Cherry Hill, N. J.*
F. T. KSIAZEK, *Black & White TV Engineering, Cherry Hill, N. J.*
J. OSMAN, *Resident Engineering, Indianapolis, Ind.*
R. W. SONNENFELDT, *Advanced Development Engineering, Cherry Hill, N. J.*
K. G. WEABER, *Engineering Services, Cherry Hill, N. J.*
-

RCA VICTOR RADIO & "VICTROLA" DIVISION

Editorial Representative

W. S. SKIDMORE, *Engineering Department, Cherry Hill, N. J.*

RCA SERVICE COMPANY, INC.

Editorial Representatives

- W. H. BOHLKE, *Consumer Products Service Department, Cherry Hill, N. J.*
J. F. HOLLABAUGH, *Government Service Department, Cherry Hill, N. J.*
E. STANKO, *Technical Products Service Department, Cherry Hill, N. J.*