

CONTENTS

(Ideas)"—Is There a Limit?.....	C. M. Sinnett	2
The Role of the Equipment Development Engineer in the Tube Division.....	H. V. Knauf	5
The Radiomarine Engineer at the National Motor Boat Show.....	I. F. Byrnes	10
The Design of Single-Sideband Radio Communication Equipment	N. L. Barlow	14
Color Demodulator Analysis.....	R. W. Sonnenfeldt	20
Operational Testing in Color Television.....	E. E. Gloystein	23
Trends in Thinking About Thermionic Emitters.....	L. S. Nergaard	28
Role of Broadcast Engineers in Customer Relations.....	J. H. Roe	34
Design of D-C Tractive Electromagnets.....	M. R. Alexy	38
Scientific and Technical Societies Associated with Electronics	J. B. Davis	46
Linearity Considerations in Feedback Pair Amplifiers.....	W. L. Hurford	50
Patents Granted to RCA Engineers.....		55
Pen and Podium.....		58
Engineering News and Highlights.....		61
Volume No. 1 Index.....		67

VOL. 1, NO. 6

APRIL-MAY, 1956

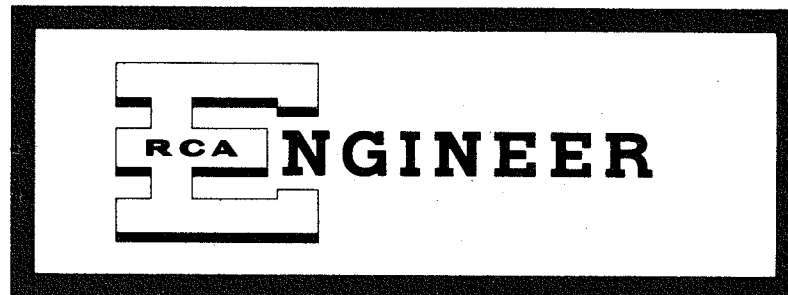

Editorial Advisory Board

M. C. Batsel, Chief Technical Administrator
Defense Electronic Products

J. J. Brant, Director, Personnel

I. F. Byrnes, Vice President,
Engineering, Radiomarine Corp.

J. T. Cimorelli, Administrative
Engineer, Product Engineering

D. D. Cole, Chief Engineer,
RCA Victor Television Division

C. C. Foster, Mgr. RCA REVIEW

J. L. Franke, Chief Engineer,
RCA Victor Radio & 'Victrola' Division

M. G. Gander, Mgr. Engineering,
RCA Service Co.

C. A. Gunther, Chief Engineer,
Defense Electronic Products

J. Haber, Director,
Community Relations & Exhibits

Dr. J. Hillier, Chief Engineer,
Commercial Electronic Products

Dr. L. Malter, Chief Engineer,
Semiconductor Division

F. L. McClure, Dir., Organization Development

H. I. Reiskind, Mgr. Engineering,
RCA Victor Record Division

D. F. Schmit, Vice Pres., Product Engineering

Dr. G. R. Shaw, Chief Engineer, Tube Division

"RCA Engineer" Staff

W. O. Hadlock, Editor

R. J. Hall, Assistant Editor

M. L. Malfaro, Editorial Secretary

J. L. Parvin, Art and Production

J. O. Gaynor, Photography

Engineering Editors

P. R. Bennett, Mgr., Radio
& Phonograph Engineering
RCA Victor Radio & 'Victrola' Div.

R. S. Burnap, Mgr., Commercial
Engineering, Tube Division

J. B. Davis, Engineering Editor,
Defense and Commercial
Electronic Products

C. A. Meyer, Mgr., Commercial
Engineering Technical Services,
Tube Division

C. M. Sinnett, Mgr. Advanced
Development Engineering,
RCA Victor Television Division

Copyright 1956
Radio Corporation
of America
All Rights Reserved

PRINTED
U.S.A.

OBJECTIVES

To disseminate to RCA engineers technical information of professional value.

To publish in an appropriate manner important technical developments at RCA, and the role of the engineer.

To serve as a medium of interchange of technical information between various engineering groups at RCA.

To create a community of engineering interest within the company by stressing the interrelated nature of all technical contributions.

To help publicize engineering achievements in a manner that will promote the interests and reputation of RCA in the engineering field.

To provide a convenient means by which the RCA engineer may review his professional work before associates and engineering management.

To announce outstanding and unusual achievements of RCA engineers in a manner most likely to enhance their prestige and professional status.

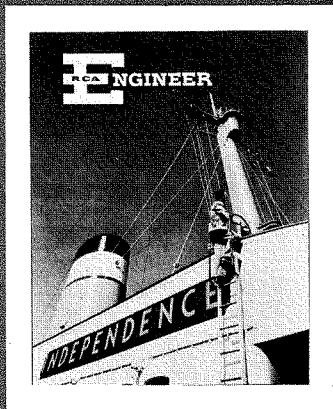

OUR COVER

Our cover this issue goes "maritime" with an assist in the form of fair weather Radiomarine engineers. (Anthony Napoli atop mast near radar antenna and William Turnow on ladder) are shown during a "radar call" to the S. S. INDEPENDENCE of the American Export Lines. The ship is completely RCA equipped with Radiomarine radar, loran, direction finder and radiotelephones/radio-telegraph gear. For descriptions of Radiomarine equipment designs, see articles in this issue by J. F. Byrnes and Niles Barlow.

DISSEMINATING

TECHNICAL INFORMATION

The Electronics Industry is the only modern one which not only improves the performance and efficiency of its products, but in addition devises new equipment and systems for use in completely new fields. RCA, because of its continuing success as one of the foremost companies in this field, must have a wealth of new information along technical lines.

Among the objectives of the RCA ENGINEER which recognize this need are: to disseminate technical information of a professional nature and to publicize the new products of RCA. Too often we are quick to visualize only the advantages we receive as readers and overlook the benefits we derive as writers. Only as a writer

can the engineer make a permanent record of his accomplishments and apprise his colleagues. This applies particularly to the younger engineer because it gives him an opportunity early in his career to review his progress for the benefit of everyone.

In some respects your professional growth can be measured by your ability to inform others effectively. Of course, some of this must be done verbally, but to have lasting value and to reach the maximum number of engineers it also should take the form of a technical report or paper.

The RCA ENGINEER has been provided for this purpose. Its stature as a publication depends upon you—the Engineer!

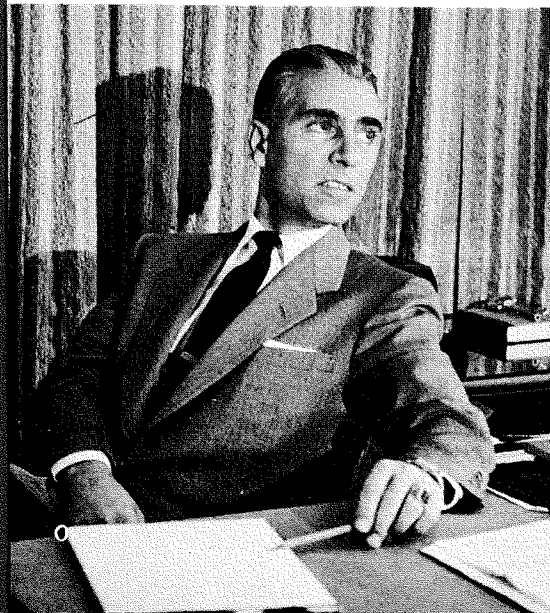

D. D. Cole

Chief Engineer,
RCA Victor Television Division
Radio Corporation of America
Cherry Hill, N. J.

(IDEAS)ⁿ—Is There a Limit?

IN A NEWS release of December 27, 1955, and as part of the YEAR-END STATEMENT, General Sarnoff made the following observation. "Progress is born of change as illustrated by the fact that during 1955, 80% of RCA's total sales will be in products and services which did not exist or were not commercially developed only ten years ago."

At first glance this is an amazing statement. On second thought, however, one realizes that this progress was the result of teamwork involving the engineer, the research scientist, and a management which was both forward-looking and which deliberately encouraged change. If it were not for the demands from management for new ideas and new approaches, we would not have these all-important new products and services to which General Sarnoff refers. To be able to make the same statements about our products in the next decade it is obvious that our engineers and scientists must generate ideas at an ever increasing rate.

WHAT CAN WE DO ABOUT IT?

While we have been very successful in the past, if we are to obtain even better results in the future we should take a good look at some of the modern techniques for increasing the output of new ideas. Several large companies actually have established courses which will raise the output of ideas. These courses are variously known as "Creative Engineering," "Creativity," "Applied Imagination," etc. Exceptional results have been obtained ranging from increased business for well-to-do companies to rejuvenating ailing companies with entirely new lines of products.

DEVELOPING CREATIVITY

Much has been written about this subject and there are several excellent books available (see bibliography at end of article). A little reflection on this matter will show that much of this material is relevant to the generation of engineering ideas. Professor Arnold of M.I.T. has

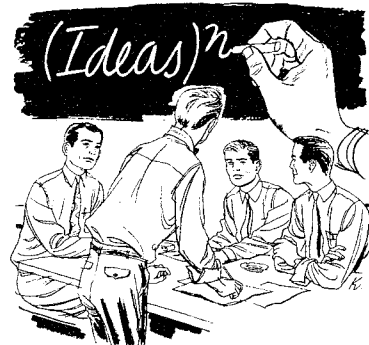

by **C. M. SINNETT, Manager**
Advanced Development Engineering
RCA Victor Television Division
Cherry Hill, N. J.

applied some of these approaches to engineering problems. In fact, he told the writer on one occasion that he believed creativity could be developed in anyone having normal intelligence. He also said that a follow-up on students who had taken his course in Creative Engineering indicated that on the average they were much more creative as engineers than the regular engineering graduates.

"BRAINSTORMING" TECHNIQUE

One successful technique for increasing creativity is known as "brainstorming."* This will yield a greater quantity of ideas in a given time than any other known method. In other words, brainstorming encourages free play of the imagination—evaluation of the ideas takes place at a later date. This permits free-thinking during the session without the dampening effects of such judicial comments as "That won't work," "Are you crazy?," "That's been done before," etc. The reader should realize, however, that brainstorming is a supplement to and not a substitute for other types of creative activity within an organization.

In general, the ground rules for effective brainstorming are very simple:

1. We should not jam up our mental functioning by trying to think creatively and judicially at one and the same time.

* See "Applied Imagination" by Osborn

2. We should pile up a maximum quantity of tentative ideas and suggestions. The more possibilities we pile up the more likely we are to arrive at the best solution.

3. As a proper follow-up to the brainstorming session our judicial power can be turned on with full force so that we may evaluate objectively and decide realistically.

BRAINSTORMING SESSIONS AT CHERRY HILL

Now that you have some idea of the objectives of brainstorming, you may be interested in the results of two such sessions held in the Advanced Development Section of the Television Division at Cherry Hill, N. J. They covered widely different subjects but in each case produced a quantity of suggestions and ideas.

The first session formed part of the activity on Engineering Creativity as a sub-committee of the RCA Engineering Training Committee. The first task was "to develop a good working definition of what is meant by engineering creativity." This appeared to be an excellent opportunity to try out the brainstorming technique and to determine whether it actually could produce a quantity of ideas.

The engineers of the Advanced Development Section were divided into two groups of twelve each, including supervisors. After a preliminary discussion of the ground rules and a few warm-up questions the first group was presented with the problem, consisting of three parts.

1. What is creative engineering?
2. What are the basic characteristics of the creative engineer?
3. How can these characteristics be spotted during an interview?

The second group was given the same problem. Tape recordings were made of both sessions and the results are shown in the accompanying tabulation. It is interesting to note the similarity of characteristics suggested by both groups. The author conducted both sessions and deliberately refrained from indicating to the sec-

Photo showing a group of TV Division engineers from Advanced Development Engineering during a "Brainstorming" session at Cherry Hill, N. J. From left to right are: G. M. Daly, W. G. Murdock, G. B. Waters, M. B. Finkelstein, C. W. Fensch, R. L. Libbey, G. E. Theriault, M. C. Kidd, and the author standing near blackboard.

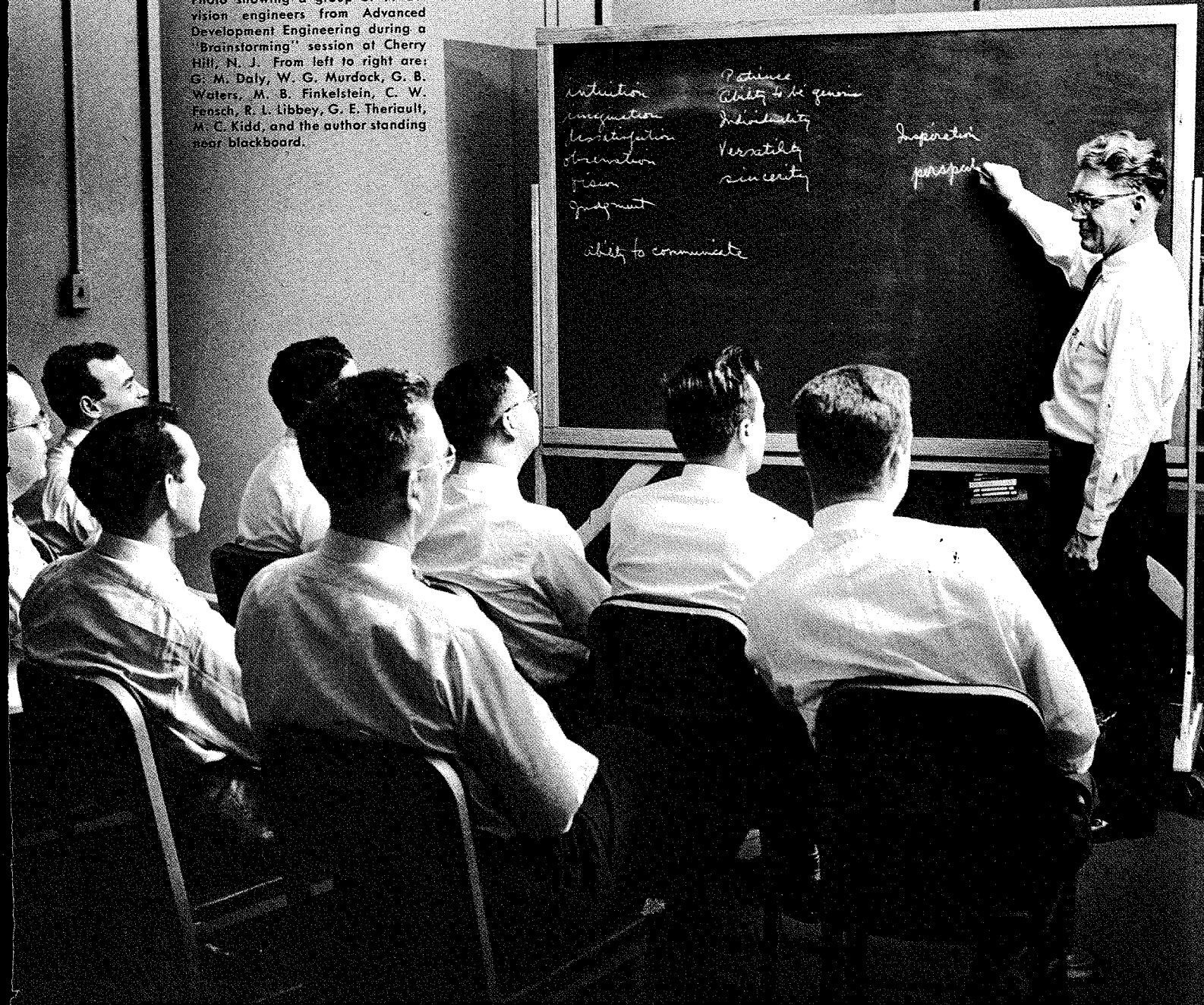

TABULATION

Both Groups	Group 1	Group 2
Imagination	Dissatisfaction	Joy in doing things
Curiosity	Fearlessness—mental	Attitude
Originality	Open mindedness	Pride in accomplishment
Intuition	Departure from tradition	Patience
Judgment	Vision	Well-informed
Drive—Motivation	Perspective	Recognition of a break
Willingness to be different	Reward	Analysis
Observation	Laziness—economy of effort	Ability to be generic
Acceptance of luck	Willingness to gamble	Concentration
Confidence in self and others	Ability to sift facts	Recognition of new avenues
Persistence—perseverance	Artistry	Organization of approach
Knowledge	Sincerity	Individuality
	Ability to evaluate the unusual	Self-discipline
	Ability to communicate	Flexibility
		Versatility
		Inspiration

(IDEAS)²—continued

ond group any of the ideas which may have been proposed by the first group. No attempt was made in this tabulation to arrange the items in the order of their occurrence or importance. It is obvious that very few engineers possess all these characteristics. It is also obvious that the desirability of possessing certain of these characteristics will depend upon the type of work in which the engineer is engaged.

Nevertheless, the results indicate without question that the highly creative engineer is indeed an unusual individual. Those who feel that they are creative might use this tabulation of characteristics as a check list. Unfortunately we know no weighting factors which will permit you to assess a number to your particular creative ability.

OVER 200 IDEAS—BY ONLY 36 MEN

The second brainstorming session was held in an attempt to obtain a quantity of ideas on the subject "Gadgets and Sales Appeal Devices for TV Receivers." This time the Advanced Development Section was divided into three groups of about twelve each, including supervisors, engineers, engineering trainees and laboratory technicians. About one hour was spent by each group in brainstorming the subject. No at-

tempt will be made here to tabulate the ideas suggested. Suffice to say that over 160 different items, from cabinet styling to circuit functions, were suggested plus many which were common to all groups. The total number of ideas was over 200. As one might suspect, since judicial comment was ruled out, among these 200 ideas were some ridiculous ones. On the other hand, there were many practical ideas and suggestions. As a minimum return, the sessions did indicate the possibilities inherent in the brainstorming technique as a producer of ideas.

ADVANTAGES OF BRAINSTORMING

Several important features of brainstorming have been observed as a result of these two sessions:

(1) Brainstorming tends to develop a strong team spirit among the engineers of a group or section.

(2) It puts the younger engineer on an equal footing with his older associates in producing ideas.

(3) Since it is a group operation it tends to trigger ideas which might not be suggested on an individual basis or would be suppressed when judicial opinion is imposed on creative thought.

(4) It teaches the engineer rather forcefully that often there are many good solutions to any engineering problem. In his daily work he will be less likely to be satisfied with the first solution he thinks of, but will seek others.

(5) Since the sessions are conducted in an atmosphere of informality and free competition, it forces each participant to search his memory and experience for new attributes or ideas. In other words, it tends to break the circle of confinement which can result from individual thought and judgment.

MORE IDEAS IN LESS TIME

In conclusion it can be stated that the brainstorming technique has merit in the generation of multiple ideas for the solution of problems. Certain ground rules must be observed, but, above all, judicial thought must be ruled out during the session. The problem to be brainstormed should be specific rather than general. If care is not taken in this respect, it will be impossible to keep the group on the subject at hand. Taken as a whole, brainstorming will produce the maximum number of ideas in the minimum time. Within the limits of its capabilities it could make a decisive contribution to the creation of new products for the future. Remember the quotation at the start of this article "Progress is born of change . . . etc."

BIBLIOGRAPHY

- "Applied Imagination" by Alex Osborn
- "The Techniques of Creative Thinking" by Robert P. Crawford
- "The Art of Clear Thinking" by Rudolf Flesch
- "Creative Engineering" PEM 568 by R. H. Anderson

C. M. SINNETT is actively interested in creativity and methods of increasing it. He is an IRE Fellow, a member of Tau Beta Pi and has 30 patents to his credit in the fields of audio and acoustics. Mr. Sinnett serves as an Engineering Editor on the staff of the RCA ENGINEER and is chairman of the Cherry Hill Editorial Board. For a more detailed biography of Mr. Sinnett see issue no. 5, page 31.



THE ROLE OF THE EQUIPMENT-DEVELOPMENT ENGINEER IN THE TUBE DIVISION

THE EQUIPMENT-DEVELOPMENT activity of the Tube Division specializes in the design, development, and construction of special-purpose machinery and devices for the manufacture of Tube Division products. Although a large portion of such projects stem from the design of new products, many are also originated to effect cost reduction and/or to improve quality and uniformity of existing products. This continuous search for new and better ways to manufacture our products maintains our competitive position in an increasingly competitive field. This article describes the activities of the equipment-development engineer and points out the importance of continued cooperation between all phases of engineering.

THE EQUIPMENT-DEVELOPMENT ENGINEER

The mechanization of tube-manufacturing equipment has advanced to a great degree since the introduction of the UV-200 detector and the UV-201 audio amplifier tubes about 35 years ago. In the early years of the electronics industry, such equipment was essentially an adaptation of machinery used in the production of incandescent lamps, which were the forerunners of electron tubes. Most of the early tube-making equipment was developed by a relatively few individuals having much ingenuity and a broad background of practical experience as machinists and toolmakers. Although the equipment-development activity of the present day stems from this background, it has since become a highly specialized field of engineering.

In many ways, the machine-design engineer has one of the most difficult jobs in modern industry—that of bridging the gap between product design and development and efficient production. Because the time allowed to bridge this gap often does not permit extensive exploration of all possible approaches, the machine designer must have a broad practical knowledge of all phases of engineer-

by

H. V. KNAUF

*Administrator, Equipment Development
Tube Division, Harrison, N. J.*

ing. Current equipment projects, however, are rarely the "brain child" of one individual, but usually represent the combined contributions of a group of individuals, each having a particular interest in the project.

At the present time, mechanical engineers are more prevalent than electrical engineers in the electron-tube equipment-development activity. Be-



HARRY V. KNAUF started his career in 1926 as a radio test man with the Victor Talking Machine Company. Since the Victor Talking Machine Co. was taken over by RCA in 1930 as its manufacturing center for equipment, he has acquired broad experience in all phases of manufacturing process engineering and tool and equipment development. His work has been primarily in the mechanical field and has included such specialized fields as speakers, microphones, printed circuits, special relays, deflection and high voltage tube components and transformers. He is the holder of a number of patents covering processing methods and special machines, among which are the method of winding television deflecting coils. From 1948-53, Mr. Knauf was the manager of Equipment Development Engineering for the Component Parts activity of the Tube Division in Camden, N. J. In January 1953 he became Manager of Equipment Developing Engineering at Harrison for the entire Tube Division. Since November 1953 he has held his present position of Administrator, Equipment Development, Chief Engineer's Staff.

cause of the increasing importance of automation, however, electrical engineers specializing in electronic control and programming systems are destined to play an ever-increasing part in the field of equipment design.

MACHINE DESIGN— A DIVERSIFIED FIELD

The equipment engineer specializing in the machine-design field encounters a wide diversification of applications. For example, he may be called upon to design a device to make and assemble parts such as those used in transistors, some of which are almost invisible to the naked eye. Or he may have to develop a large machine such as the straight-line exhaust machine used for processing black-and-white or color kinescopes. Each equipment he works on is designed for a specific purpose or application, and each is a separate and complete engineering development in itself.

SOURCE OF NEW-MACHINE IDEAS

Ideas for special equipment originate within the Equipment-Development activity, manufacturing activities, or other activities. For example, it may be that the profit situation on a particular product is unfavorable. In such a case, management may request an analysis of the present method and the development of a more efficient approach. Engineering changes in the design of a product frequently necessitate new special-purpose equipment. Ideas may come from manufacturing employes or their supervisors. Members of Sales, Marketing, and Quality-Control groups may also make suggestions which lead to new equipment design and development. Often, techniques developed for one product can be applied to an entirely different type of product. The sources of ideas are unlimited.

CONSIDERATIONS IN MACHINE DESIGN

The machine-design engineer must consider many factors to establish sound specifications for the design of special machines. Although the primary objective is to minimize pro-

duction costs, objectives such as improved quality, reduction of operator fatigue, and the elimination of safety hazards are also important. In addition, the designer must consider the attitude of production managers in the operating department where the new equipment will be installed. It is extremely important that these managers participate in the initial design meeting, and that their suggestions and opinions be considered. The availability of competent personnel to maintain the equipment adequately after it is installed and operating must also be determined.

At design meetings, ideas usually flow freely. In "screening" these ideas to weed out those which are not practical from an economic standpoint, many factors must be analyzed. Initially, labor savings (based on the best production forecast available) and the cost of the new equipment must be roughly estimated. Provided these figures appear favorable, a detailed analysis is then required, covering the following other factors:

1. the potential long-range production anticipated over a given period, as estimated by Marketing and Sales representatives.

2. the stability of the product as presently designed, based on the opinions of Product Design and Development personnel.

3. the desirability of product-design changes to facilitate mechanization. Various tests may be necessary to determine the effect of proposed changes on product performance.

4. the effect of the new method on quality and uniformity of the product. The machine-design engineer should be familiar with previous data on the same or similar products.

5. the relative economy of flexible machines as compared to multiple single-purpose machines. The provision for flexibility in a new machine may involve so many complications that the cost become prohibitive, or it may decrease operating efficiency because of increased maintenance and excessive "down time." An over-all economy may be effective by the use of multiple single-purpose machines.

6. type of skill required to operate, maintain, and adjust the new equipment. The equipment should incorporate features which minimize the skill levels required for operation and maintenance, consistent with the over-all economy. Every effort must be made in the initial design stage to provide accessibility for maintenance and simplified adjustment controls, where possible.

7. additional costs which may be incurred due to requirements for tighter tolerances. Every variable that might conceivably occur on parts or materials which the equipment must handle should be checked to assure that adequate safety factors are provided in the final design. If the use of such safety factors is not possible, additional costs which may be incurred in holding parts and materials within acceptable limits must be evaluated.

8. considerations for installing new

equipment. The installation of larger types of special equipment may involve the use of special types of handling equipment, special ventilation or air-conditioning, or other improved or additional facilities. Consideration must be given to the cost of power and of services providing high- and low-pressure compressed air, steam, and water, and to the type of gas available from the local source for burners, ovens, kilns, and the like.

9. effect of increased "overhead" percentages resulting from the use of special equipment. The extensive use of special machines for labor-savings purposes increases the plant burden because all other costs must be prorated against a lower direct-labor cost. Although this factor is relatively insignificant for any one machine, it must be considered when the direct-labor-to-expense ratio is measurably affected within one operating section.

DESIGN OF EQUIPMENT

The most economical place to correct mistakes is on the drawing board. The first design conference should be held as soon as the first rough layouts are made so that any flaws in the initial design are discovered in the early stages. The design conference is usually a trying ordeal for the machine designer because each of the interested participants examines the layout critically. However, the experienced machine-design engineer realizes the importance of being critical at this point. It is better to modify the design, or even to start anew, at

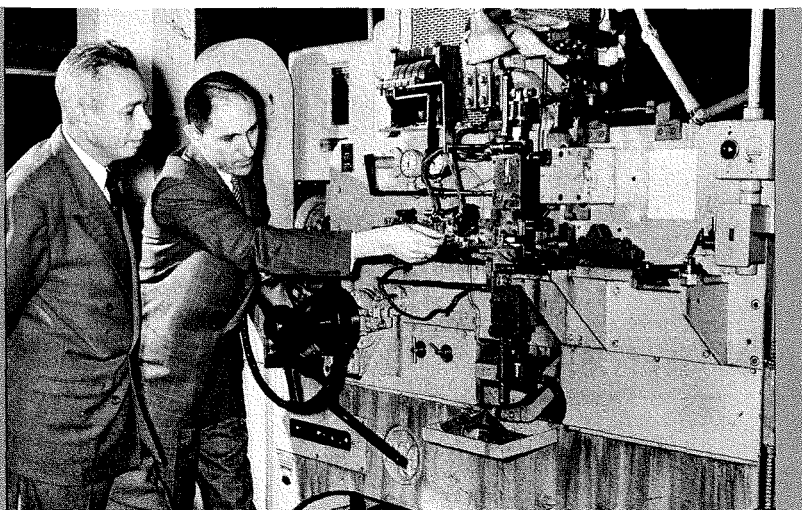

Mechanical engineer G. Samuels is shown explaining to author H. V. Knauf recent improvements in the automatic welded-grid machine. This machine manufactures finished receiving-tube grids from multiple spools of wire.

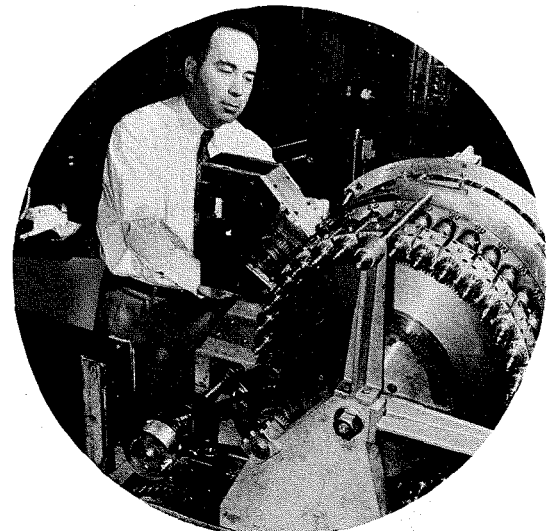

Engineer Charles Lindsley is shown making a preliminary check of a high-speed universal pin-straightening machine used for 7- and 9-pin miniature tubes.

this stage than to change or dispose of physical parts, or perhaps the whole machine, at a later date. He also realizes the importance of keeping production personnel acquainted with the proposed equipment, and has them take an active part in the design conference. Selling "down the line" to the user is just as important as selling "up the line" to the approver.

At the design conference, questions often arise as to the feasibility of the designer's approach. Methods which differ radically from conventional techniques may be difficult to visualize. The machine-design engineer must be prepared to explain, or actually demonstrate, the practicability of his approach. It may be necessary for him to construct a working model of some intricate portion of the proposed machine which involves a new or unconventional approach. Depending on the complexity of the problem, he may use any number of appropriate methods ranging from cardboard models simulating unusual linkage motions up to complete construction and development of the sub-assembly in question.

Occasionally, construction of a crude model will suggest new ideas for a much better approach. One such personal experience of the writer was the development of the method for winding television deflecting-yoke coils. In pre-war production methods, these coils were wound flat, and were then subjected to a series of post-forming operations which caused se-

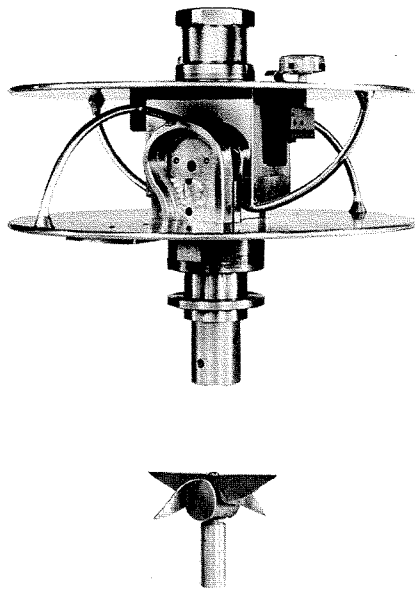

Production arbor (top) for winding television deflecting coils, and miniature arbor (bottom) constructed during development.

vere stress on the winding and resulted in a high percentage of shorted turns and open circuits. The only apparent solution to the problem was to design a machine which would produce the reciprocating motions necessary to feed the conductor wire into the slots of an oscillating winding mandrel. A major problem in the design was to minimize the mass of the reciprocating mechanism to obtain the highest possible winding speed.

A miniature winding arbor was constructed to simulate the arbor

which might be used on such a machine. When this simple device was completed, it was noted that continuous rotation in one direction on a certain axis necessitated only that the conductor wire be deflected from side to side in order to feed it into the slots. Because it was obvious that the smallest mass which could be subjected to a reciprocating motion was the conductor wire itself, the idea of deflecting vanes as an integral part of the rotating member was born. Simple rotary motion deflected the wire into the slots of the arbor, providing a relatively simple and efficient means for accurately winding these so-called "saddle-shaped" coils.

This winding method, which has been generally adopted by the industry, is covered under U. S. Patent No. 2,448,672, which is based on the original miniature arbor. Fig. 1 is a photograph of the original arbor, together with a modern production arbor for winding television deflecting coils. The principles employed in the two arbors are identical.

Depending on the nature of the problems which arise during the initial design conference, it may be necessary to make minor modifications, or to change the concept of the original design completely. Several subsequent meetings may be necessary, therefore, before final agreement is reached. After the design is established, the final design layouts can be completed, and detail drawings of parts and subassemblies and wir-

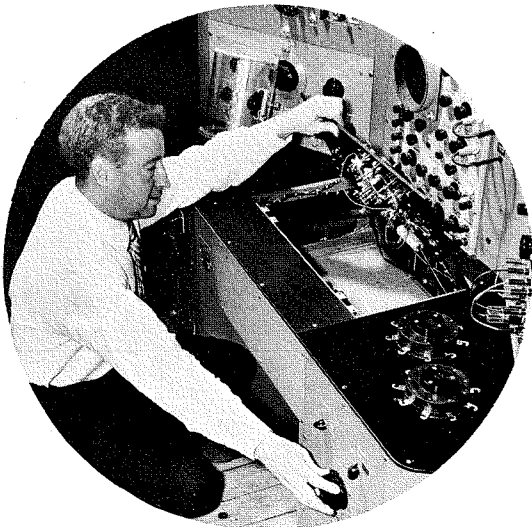

Electrical engineer William Stonaker is shown performing final check-out of Pulse-Interface-Measuring Test Set for receiving-type tubes. Equipment Development Shop, Harrison, N. J.

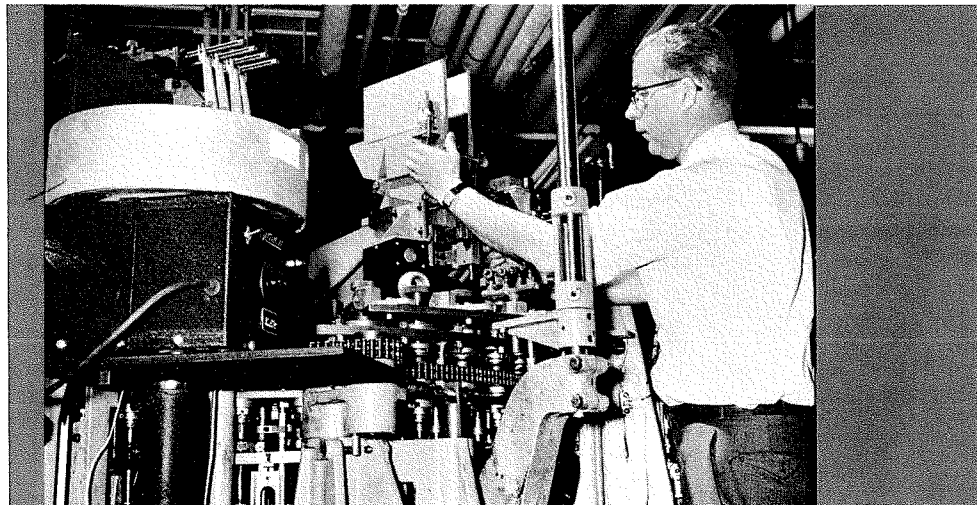

P. Maurer is shown adjusting the automatic exhaust-tubulation loader on a new type of completely automatic stem-making machine for 1-inch button stems. Equipment Development Shop, Harrison, N. J. This machine automatically manufactures a finished stem for glass tubes.

ing diagrams can be prepared. During the detailing period, the necessary approvals to begin construction are obtained.

CONSTRUCTION OF MACHINE

Actual construction of special machines may take place either in the Equipment-Development Shop or in some shop outside the plant. If a considerable amount of development is to be done during the construction stage, it may be desirable to build the machine internally. On the other hand, the number of projects scheduled in the Equipment-Development Shop may make it impossible to complete the job within a reasonable time, or the size of the machine may be beyond the limited facilities available. As a result, the machine parts may be fabricated in an outside shop and only the assembly operations performed in the Equipment-Development Shop, or the entire machine may be completed outside. Regardless of where the machine is built, the machine-design engineer must follow the construction to detect any minor faults of his design, and to correct drawings so that similar mistakes are avoided during subsequent duplication of the machine.

FINAL DEVELOPMENT

Because the "prove-in" faults which may be found in the first machine of any kind are generally unpredictable, the time and cost required for final development are very difficult to estimate during the initial planning stage. Past experience has shown that this cost may be from 10 to 100 per cent above the cost for construction, depending on the extent of the complications which develop. Over a number of years, however, the statistical average has been approximately 20 per cent.

During the final development stage, the engineer must guard against two dangers—the tendency to make radical changes in the machine which are not justified, and the reluctance to make changes that are actually necessary. To people who are not experienced in the problems of "debugging" a new machine, it often seems that the engineer in charge does not know what he is doing. He seems to know what is wrong today, but tomorrow

it is something different. He is always on the verge of "getting it going." Actually, "de-bugging" a machine requires patient analysis and a careful step-by-step procedure to eliminate the contributing faults one by one. It is usually a slow process, and may extend over a considerable period, but the Equipment-Development activity seldom comes up with a failure.

INSTALLATION

The installation procedure for new equipment depends on the size, complexity, type of services required, and similar factors. In the case of very large machines, it may be necessary to deliver machine parts and sub-assemblies to the production departments, and erect the machine on location. For example, a concrete foundation may be required, or special water lines, drains, or other services may be necessary. For some machines, elaborate exhaust ducts and blowers must be installed. When equipment requires masonry work such as large tile tanks or high-temperature kilns, it is usually necessary to secure the services of an outside contractor.

Installation involving any of these considerations requires that the Plant Engineering function be consulted on the project. They must determine that safety regulations are adhered to, and that the Fire Insurance Association codes are met. The entire installation must also be planned and scheduled to avoid any unnecessary interruption to production. The Equipment-

Development engineer must arrange the planning and scheduling meeting, and must provide adequate installation instructions to assure that the machine parts and subassemblies are installed in the proper sequence to minimize construction difficulties and maintain proper alignment of critical parts.

OPERATIONAL AND MAINTENANCE TRAINING

The operators must be completely sold on a new machine before they will accept it as a better means for producing. Selling the operator on the new machine requires a sincere, honest, and factual explanation of why it was built, what it does, how it does it, the advantages of doing it this way, and what his or her function is in the operation of the equipment. The operator must understand that each evolutionary step toward improved efficiency in manufacturing provides added advantage in meeting the demands of keen competition, and indirectly strengthens the position of every employe. This approach, properly handled, will usually stimulate a keen interest and a desire to take an active part in the development project. Merely telling the operator what to do, and not giving an explanation as to the reasons why, often breeds an indifferent attitude and complete lack of cooperation.

The person assigned to training personnel in the use of special machines must understand people and their moods as well as he understands the machines and their movements.

A conveyor type machine which automatically bakes, exhausts, electrically processes to remove harmful gases and seals television picture tubes up to 27" rectangular size. Consists of double track cars with completely self-contained electrically driven pumping system which travel automatically through the entire cycle of processing. Tubes are manually loaded but automatically unloaded for conveyance to the next operation.

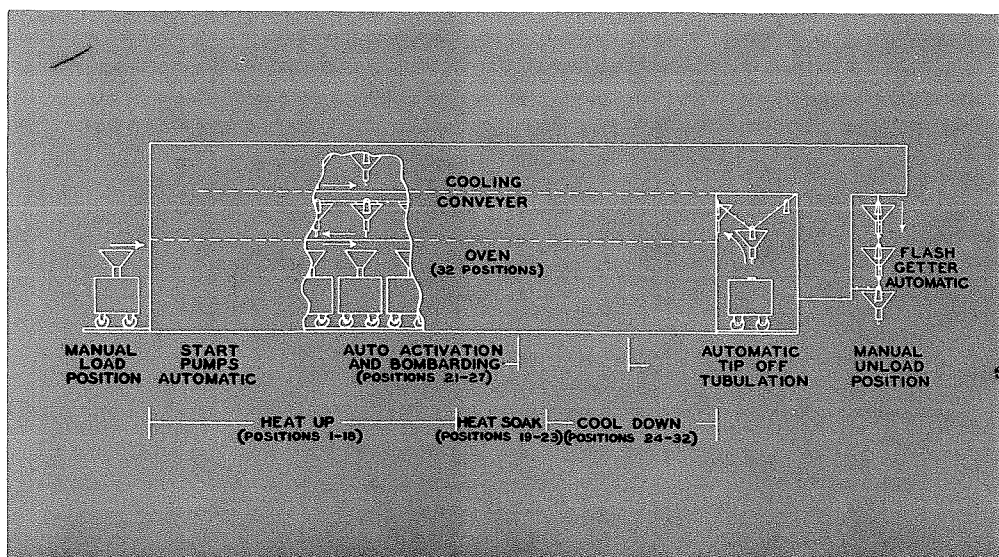

Depending on the circumstances, the operator trainer may be a factory representative who is skilled in the art of training personnel and has been thoroughly instructed by the engineer in the functions and uses of the new machine, or it may be necessary for the Equipment-Development engineer to follow this phase directly.

The Equipment-Development engineer must also train factory maintenance and set-up personnel. In many cases, it is necessary only to provide instruction on unusual features of adjustment and the critical points which are susceptible to wear and require periodic preventive maintenance. Maintenance personnel are usually very competent and thoroughly familiar with the general problems common to all new machines. If, however, equipment is complex, or employs unconventional principles in its operation and adjustment, the training must be concentrated and may extend over a considerable period.

OTHER ACTIVITIES

Equipment-Development engineers are often called upon for other services than machine design. They may be requested to give advice on the types of commercial equipment best suited to a particular application. They may be required to analyze specific problems causing difficulty in a production process, or to assist in the design and development of a new product for which their experience and particular talents provide some advantage.

Occasionally, it may be necessary to conduct extensive tests to determine the extent to which certain variables in existing processes affect the performance of the equipment, and the effect these variables may

have on the quality of a product. For example, Mr. W. Henderson, an Equipment-Development engineer at Lancaster, conducted oil-contamination tests on the straight-line exhaust machine used for kinescopes. Kinescope life is largely dependent on the efficiency of the exhaust process. In the summer of 1954, extensive tests were made under actual exhaust conditions to determine the effect of variations in the temperature of the water used to cool the vacuum pumps. During the summer months, the temperature of this water often rises above 80°F. The effect on tube life, as evidenced by increased cathode warm-up time, indicated possibility of contamination of the cathode elements by oil, possibly introduced into the tube from the diffusion pumps. A quantity of tubes were run through the machine under conditions in which either warm water (above 80°F) or chilled water (60°F) was used to cool the pumps. The results of these tests showed a 2 to 1 gain in vacuum when the chilled water was used.

Simultaneously, a quantity of copper-tubulation samples was taken from compression heads in the exhaust machine to determine the amount of oil residue collected from vapor back-streaming. In the Chemical and Physical Laboratory, each tubulation was rinsed with ether, and the residue was accurately weighed after evaporation. Quantities of oil found on these parts was in the order of tenths of a milligram. These weight readings were statistically analyzed by the Quality-Control group. The analysis showed that a reduction in water temperature to 60°F reduced

the oil contamination by approximately one half.

As a result of these findings, a thorough investigation was made as to a suitable means for controlling water temperature, and a commercial unit was procured, installed, and placed in operation in May, 1955. Preliminary reports on production during the summer of 1955 indicated a marked improvement in cathode warm-up time for this period as compared with the 1954 summer period. Further work is now in progress to provide additional means for reducing the back streaming of oil vapors, and to determine the effect of such reduction on tube life.

THE EQUIPMENT-DEVELOPMENT ENGINEER AND AUTOMATION

Although the subject of "automation" is certainly worthy of separate coverage, the story of Equipment Development and its engineers would not be complete without some mention of it. In certain areas, a concentrated effort is being made to automatize production. Some receiving-type tubes have proven to be long-term, high-volume items with good design stability. New automatic machines to perform certain operations in the production of these types have increased the output per direct-labor operator to as much as ten times that of the previous methods. Machines currently in development for other operations look feasible for the near future. As each element is completed and integrated into one continuous process, significant progress is made toward the goal of complete automation.

Because the design principles of many Tube Division products are dictated to a large degree by the functions which they perform, the current approach to automation is the design of automatic equipment based on existing product designs. In the future, however, it is anticipated that technological advances will make possible Tube Division product designs specifically adapted to automation principles. The Equipment-Development engineers are accepting the challenge of automation enthusiastically, and each activity is developing plans and establishing firm objectives for both the immediate and the long-range approach to insure continued progress in this field.

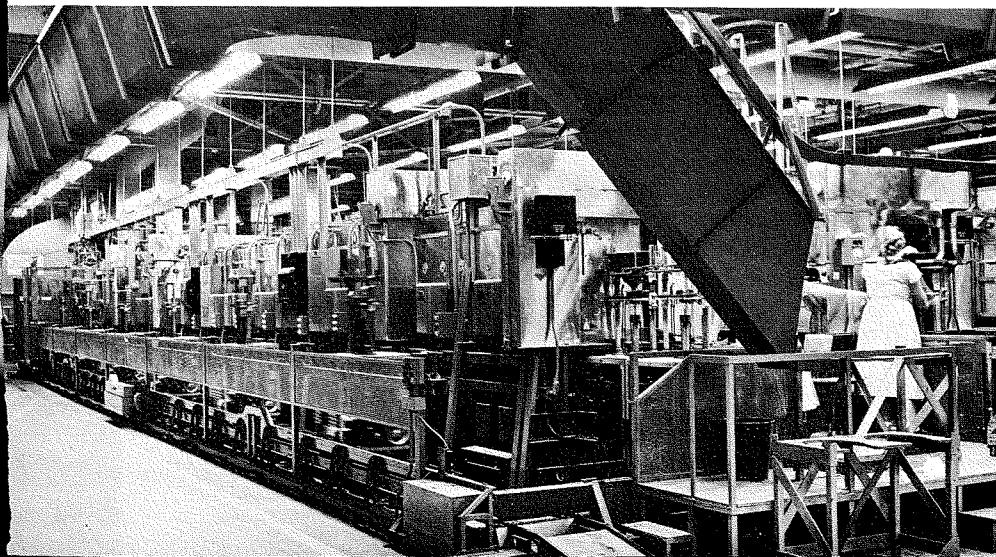

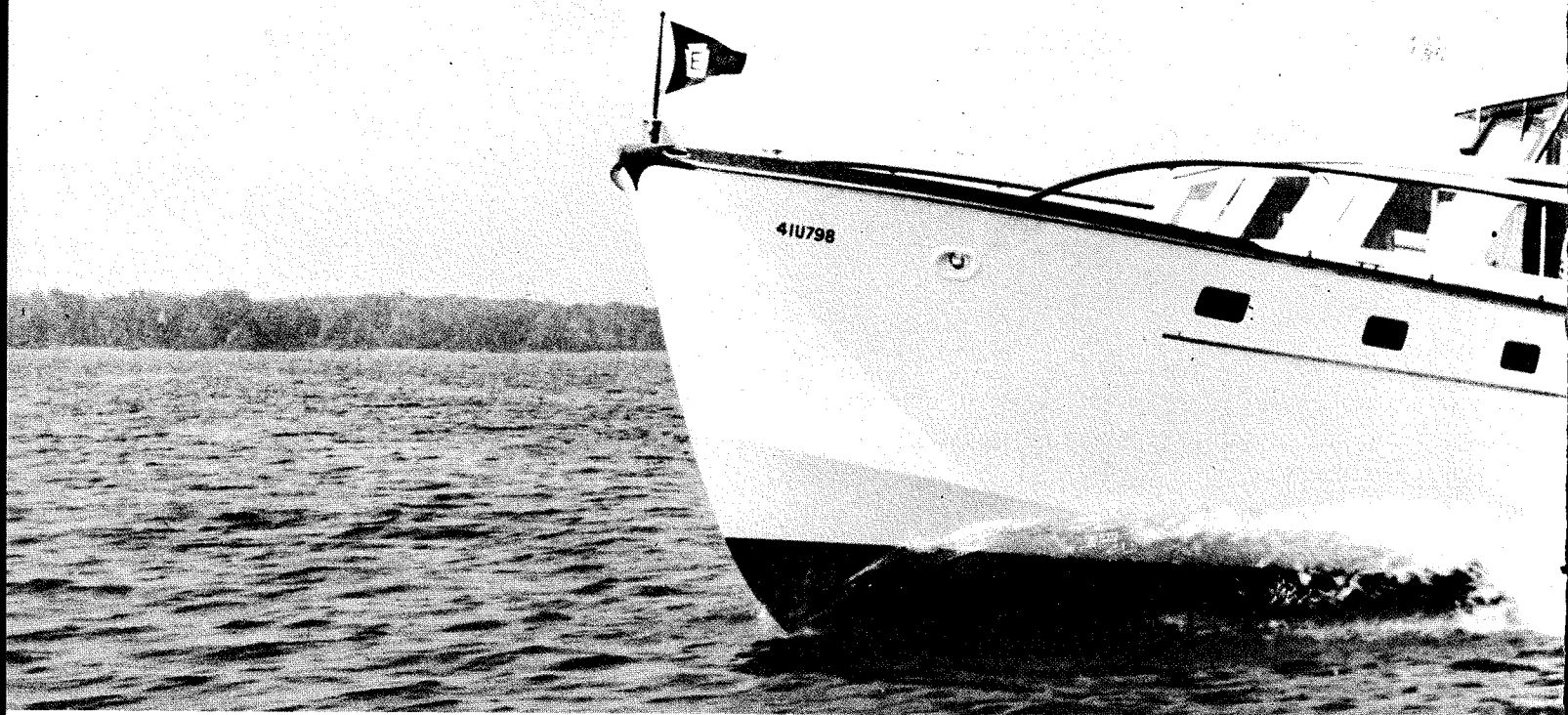

THE RADIOMARINE ENGINEER AT THE NATIONAL MOTOR BOAT SHOW

PICTURE OVER 200,000 boating enthusiasts and Radiomarine dealers whose searching questions must be answered and interests stimulated on a continuing basis over a 10-day period. This is what greeted the Radiomarine engineer at the National Motor Boat Show at Kingsbridge Armory, New York, January 13-22, 1956.

Among the thousands of visitors it was evident that many were well acquainted with the part that the marine-electronic engineer is taking in the pleasure craft field. This is not too surprising when it is realized that about 45,000 small boats are already equipped with radiotelephone sets for ship-to-shore and ship-to-ship communication.

However, the majority of engineers at RCA are probably unfamiliar with this phase of Marine Electronics which requires close contact between the Radiomarine engineer and the boating trade.

FAMILY INFLUENCE APPARENT IN SMALL CRAFT CLASS

In the early days of marine electronics the engineer was chiefly concerned with the needs of commercial

By **I. F. BYRNES**

*Vice President, Engineering
Radiomarine Corporation
New York City*

vessels. These included passenger and cargo ships, tugs and fishing craft.

Today, with highways crowded, the average family is taking to the water and investing in boats of various sizes. This change has injected a still greater need for equipment designed specifically to meet the requirements of the small boat owner. Equipment must possess utility and have features that help to promote the safety of the small boat owner and his family. The radiotelephone set, the radio direction finder or any other electronic device for small craft must not only be a well designed product, but also fit the decor of modern craft. Both man and wife take a keen interest in the styling and appearance of the equipment, and in simplified operating controls.

ROLE OF THE RADIOMARINE ENGINEER IN CUSTOMER RELATIONS

All these factors must be considered by the Radiomarine engineer in the

laboratory while a set is undergoing development. However, consideration of the needs of the boat owner does not end in the laboratory. The engineer, to sample consumer opinion, must contact the public. What better opportunity to do this than through discussions with visitors at the National Motor Boat Show. This is particularly helpful because today's information seekers are tomorrow's buyers.

Many of Radiomarine's key engineers, who are responsible for determining the design program, attend the National Motor Boat Show to learn the requirements of customers, to examine competitive equipment and to renew their acquaintance with the dealer organization. The engineers work closely with Radiomarine Sales personnel and the dealers, and thereby acquire valuable data concerning future products.

INTEREST IS INTENSE AND VARIED

Intermingled with the thousands of visitors are those vitally interested in procuring equipment. These are boat owners or potential boat buyers, many of whom have questioned competitors and evaluated similar prod-

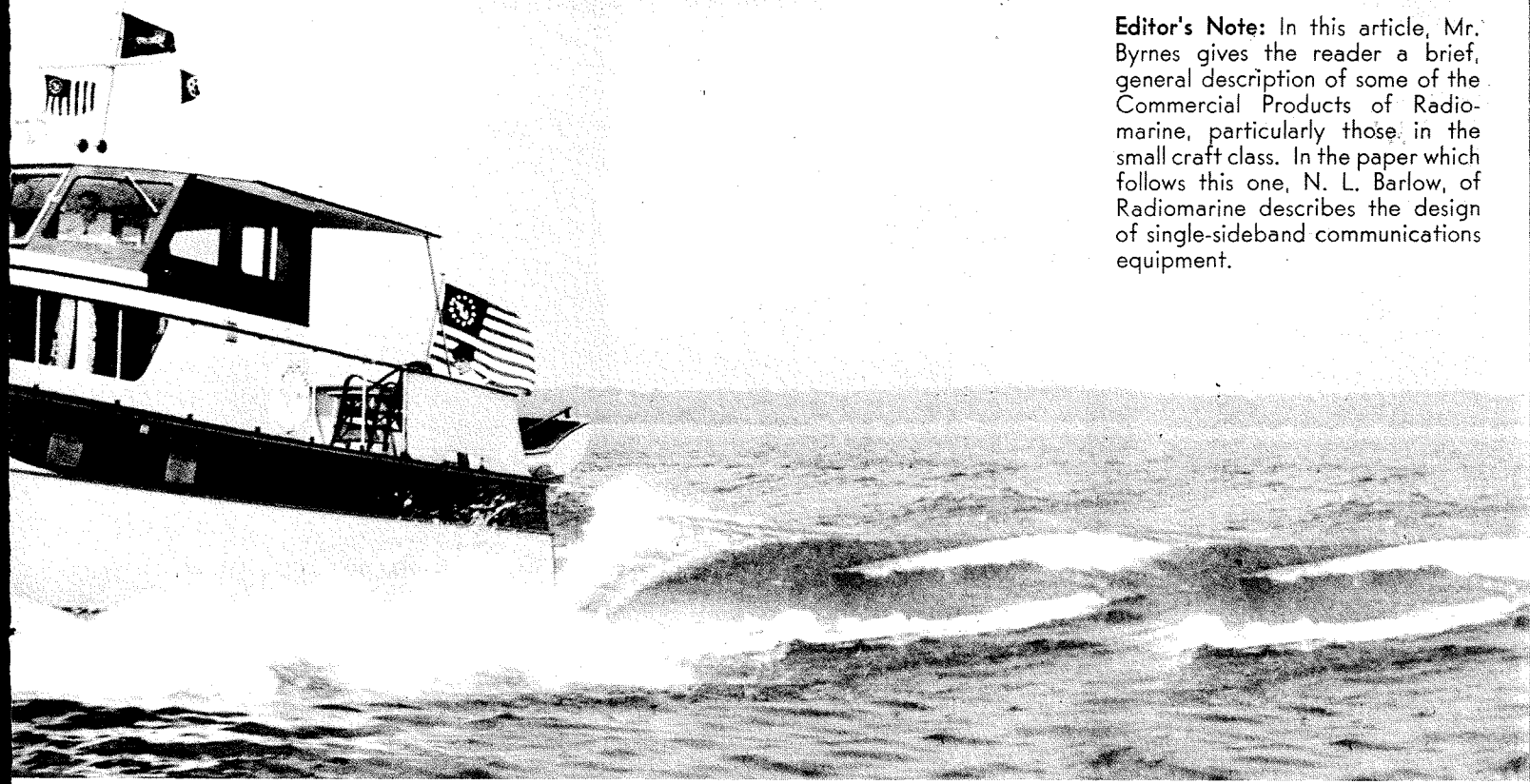

Editor's Note: In this article, Mr. Byrnes gives the reader a brief, general description of some of the Commercial Products of Radiomarine, particularly those in the small craft class. In the paper which follows this one, N. L. Barlow, of Radiomarine describes the design of single-sideband communications equipment.

ucts before reaching the Radiomarine exhibit. At this point, the visitor is thoroughly familiar with what is on the market and will approach the engineer with a "show-me" attitude. The Radiomarine engineer must have a thorough knowledge of his own products and also be familiar with competitive equipment so that he can meet the verbal challenge of the prospective customer and convince him of the advantages of Radiomarine's equipment.

Questions range from technical factors, such as transmitter power and number of channels, to such matters as installation, service and the ranges obtainable with the equipment. Since cost is an important consideration with the small boat owner, a nice balance is required between the type of equipment chosen and the size of the boat.

Up to this point we have covered primarily the aspects of electronic equipment for the pleasure boat owner. Of course, Radiomarine equipment encompasses the large commercial and passenger vessel classes in which the Radiomarine engineer plays an active part. Such items as radar, loran and the higher powered radiotelephone sets are also displayed at the Motor Boat Show. This equipment,

although primarily for commercial craft, is also installed on many of the larger private yachts.

EQUIPMENT "ON DISPLAY"

The Radiomarine exhibit at this year's show featured the new "Golden Series" line of radiotelephone sets including the very popular "Golden Guide" portable direction finder. Also shown were the eleven-channel, 150 watt, model ET-8050 radiotelephone; the Echograph three-range depth recorder and various standard receivers.

The "Golden Series" (see photos) consists of the new "Golden Sentry," a 20 watt radiotelephone; the "Golden Courier," a 35 watt set; the "Golden Herald," a 100 watt set; and the three-band portable direction finder, the "Golden Guide."

CONCLUSION

In summary, the Radiomarine engineer is becoming more active than ever before in his direct contact with the small-craft customer. Not only does he get first-hand information from prospective buyers, but he studies the changing trends and preferences from year-to-year. These observations are directly reflected in his designs of radio equipment to meet the needs of a growing marine and small craft market.



IRVING F. BYRNES has been associated with Radiomarine Corporation since 1930. He entered the General Electric Test Department in 1918 and was later engaged in radio development in the Engineering Laboratory. He completed extension courses in Electrical Engineering at Union College, and in 1922 participated in the development and design of early ship-to-shore radiotelephone equipment. He has been granted several U. S. patents for radio devices, and in 1940 he received the Modern Pioneers Award from the National Association of Manufacturers for his contributions in the art of marine radio communication. The U. S. Navy Bureau of Ships awarded Mr. Byrnes its Certificate of Commendation in 1947. He is the author of many technical papers on radio equipment, and is a Fellow of IRE. Mr. Byrnes is a member of "RCA Review," Board of Editors and the RCA Institutes Board of Technical Advisors.

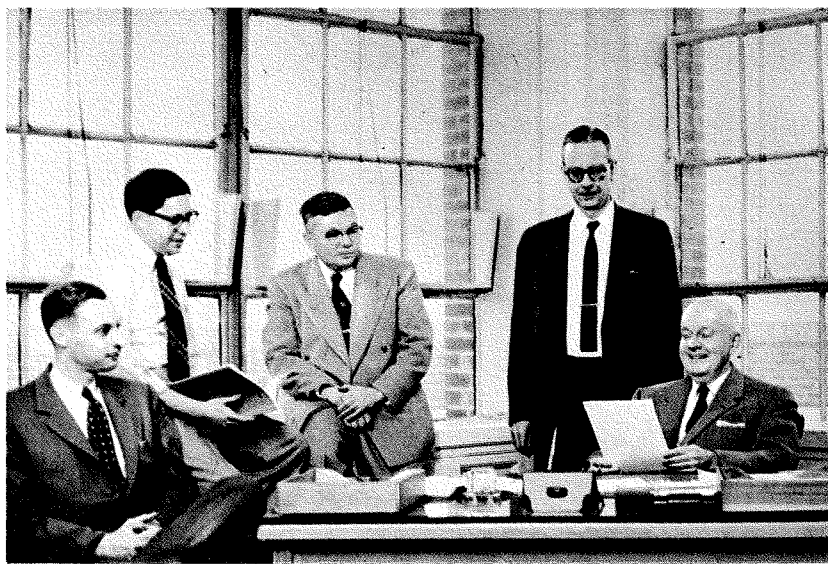

View taken in I. F. Byrnes' office during an engineering planning meeting. Seated from left to right are: R. W. Ugel, Mgr. Sales and Service of St. Louis, Mo., and A. M. Lapping, Section Chief, Design Layout, C. E. Moore, Supervisory Engineer, Radar Division, H. B. Martin, Assistant Chief Engineer and Mr. Byrnes, all of Radiomarine, New York City.

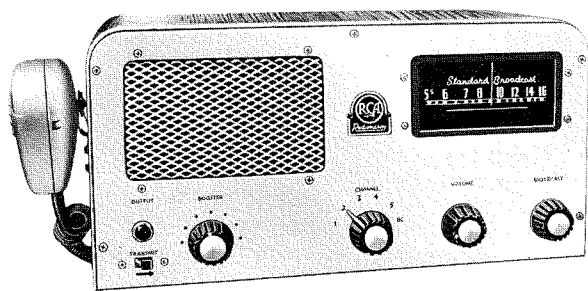

GOLDEN COURIER (MODEL ET-8056)—35 watt plate input, 20 watt antenna power transmitter with five crystal controlled channels in the 2-3 Mc band. Receiver has five crystal controlled channels and also may be tuned over the standard broadcast band. A press-to-talk "Mike" or optional handset may be used. Golden anodized front panel with simulated mahogany finish metal cabinet. For medium size cruisers having 6, 12 or 32 volt power supply. Typical salt water ranges 35 to 50 miles. Price \$379.50.



GOLDEN HERALD (MODEL ET-8057)—100 watt plate input, 50 watt antenna power transmitter with eight crystal controlled channels in the 2-3 Mc band. Receiver has eight crystal controlled channels. A press-to-talk "Mike" or optional handset may be used. Golden anodized front panel with simulated mahogany finish metal cabinet. Designed for larger cruisers and yachts having 12, 32, 115 volts DC or 115 volts AC power supply. Typical salt water ranges 50 to 100 miles. Price \$615.00.

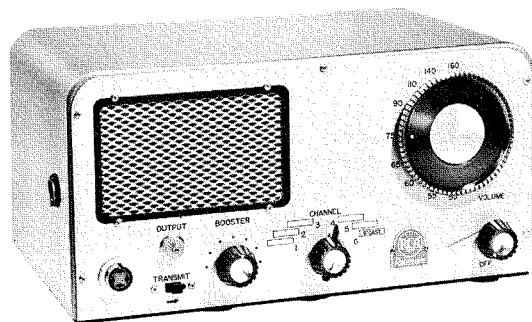

GOLDEN SENTRY (MODEL ET-8059)—20 watt plate input, 10 watt antenna power transmitter with five crystal controlled channels in the 2-3 Mc band. Receiver uses printed circuit, has five crystal controlled channels and also may be tuned over the standard broadcast band. Furnished with press-to-talk hand microphone and 4" x 6" oval speaker. Golden anodized front panel with bronze hammer-tone cabinet. Suitable for the smaller cruisers with 6 or 12 volt batteries. Typical salt water ranges 20 to 30 miles. Price \$295.00.

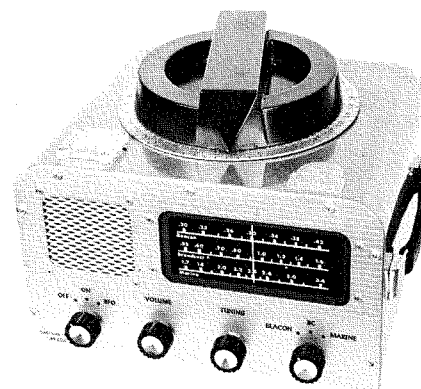

GOLDEN GUIDE (MODEL AR-8712)—Self contained combination direction finder, marine radiotelephone and broadcast band receiver. Three frequency bands—200-415 kc, 540-1600 kc and 1700-3400 kc. Has rotatable shielded ferrite loop mounted over azimuth scale for taking bearings. Includes null meter, loudspeaker and beat frequency oscillator for CW reception. Operates from self contained battery or from 115 volts AC/DC. Weight with batteries, 13½ pounds. Six tube superheterodyne. Golden anodized front panel with hammer-tone grey metal cabinet. Price \$169.50 less battery.



Lawrence Greenberg, Radar Engineer (right), explaining the theory of radar to a "potential customer."

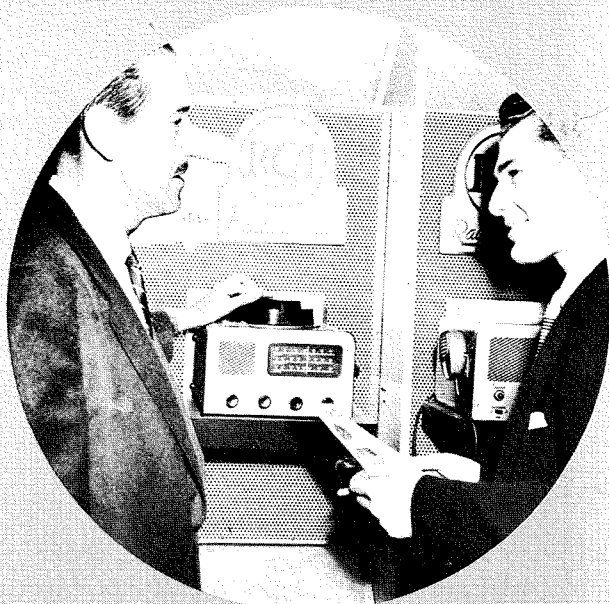

Kenneth V. Hayes, Sales Engineer (left), explains the function of the ferrite loop on the "Golden Guide" Model AR-8712 Direction Finder to a visitor.



Charles E. Moore, Supervisory Engineer, Radar, discusses the CR-105A Radar with naval cadets.



Virgil K. Lewis, Assistant General Sales Manager (right), Field Sales, demonstrating the LR-8803 Loran to Lester T. Gates, Assistant to Executive Vice-President.

ENGINEERS "ON DUTY" AT THE 1956 NATIONAL MOTOR BOAT SHOW

I. F. Byrnes, Vice President, Engineering

C. E. Moore, Supervisor, Radar Engineering

G. G. Bradley, Supervisor, Radiotelephone Engineering

H. F. Mohr, Radiotelephone Engineering

L. Greenberg, Radar Engineer

M. Schoenfeld, New Products Engineer

K. V. Hayes, Sales Engineer

W. J. Cole, Technical Supervisor, Service Operations

THE DESIGN OF SINGLE-SIDEBAND RADIO COMMUNICATION EQUIPMENT

By **NILES L. BARLOW**
Engineering Dept.—Radio Division
Radiomarine Corporation
New York City

HIGH-FREQUENCY RADIO services, both fixed and mobile, are faced with a communications "traffic jam" of global proportions. This problem, which is common to private, public and government agencies alike, results from an acute shortage of the number of channels available in the limited high-frequency portion of the radio spectrum. The ever-increasing demand for, and use of, these channels has led to extremely crowded conditions, resulting in objectional interference.

An important forward stride toward the solution of these problems has now been accomplished through the design of the RCA "SSB-1" (Single-Sideband) equipment which has reduced bandwidth requirements by one-half. The new equipment may be used for telephony, telegraphy, and teleprinter operation over short and medium distances. Although great economy in bandwidth has been achieved through the use of single-sideband techniques, both cost and simplicity are comparable to that found in ordinary AM systems which require twice the spectrum space.



NILES L. BARLOW graduated from Brown University in 1946 with a B.S. degree in Electrical Engineering. He joined the Radiomarine Corp. of America Engineering Department, Radar Division, in December 1946 as a radar technician, assisting in the setup of the production test facility for Radiomarine's first commercial radar equipment. Mr. Barlow served as an instructor in radar techniques in classes for service personnel while a member of the Radar Division. In 1948 he transferred to the Radio Division of Radiomarine, working on shipboard radio equipment. He has been associated with the engineering development of modern "console" types of shipboard stations and specialized installations, including equipment for the superliner, S. S. UNITED STATES.

EARLY ATTEMPTS

Numerous methods had been investigated in the industry in an attempt to increase the traffic handling capabilities of a radio channel of given bandwidth. Nevertheless, very few methods were effective when voice channels were involved due to the fixed-bandwidth requirement for intelligibility. Restriction of the audio range to a maximum frequency of 3000 cycles-per-second in the radio transmitter did achieve conservation of bandwidth requirements and also produced an intelligible, commercial signal. However, during the modulation process (when the audio and radio frequencies were combined) both sum and difference frequencies were produced. The transmitted signal then occupied a band of frequencies 6-kc wide, and consisted of a high-power carrier frequency, and two sideband frequencies, each separated from the carrier frequency by the audio modulating frequency. In light of these facts, the single-sideband technique seemed to offer possibilities for appreciable bandwidth reduction.

SINGLE-SIDEBAND OPERATION—WHAT IT IS

The single-sideband, suppressed-carrier system of radio transmission is a method which has been in use for many years in high-power, fixed-frequency, point-to-point networks. In this arrangement, a special modulation process is used wherein the carrier frequency of the transmitter is suppressed and only one of the sidebands is transmitted. This modulation process is done at a very low level, the single sideband signal being heterodyned to the final output frequency and then amplified by linear power amplifiers to the desired power level. The transmission of only one sideband with a restricted audio range results in a transmitted bandwidth of less than 3 kilocycles, less than half that

required for a normal double-sideband speech channel.

Until the advent of the RCA SSB-1 Single-Sideband Communication System, the benefits of single-sideband operation were not available for low-power fixed station operation, due to the complexity of the circuits required for reliable SSB generation. However, the recent development of small, stable, temperature controlled crystals has eliminated the frequency stability problems previously encountered, and made possible the design of RCA SSB equipment without elaborate Automatic Frequency Control circuits.

DESIGN GOALS

A small SSB exciter built by the Radio Division of Radiomarine aroused the interest of the RCA International Division as having definite commercial possibilities. Subsequently, a development order came to Radiomarine from RCA International. It stated simply: Design a single-sideband, suppressed-carrier, radiotelephone unit to meet or surpass the following specifications:

- Peak Envelope Power Output
20 to 50 watts
- Frequency Range4 to 15 mc
- Channels2 or 3.
- Transmitter and receiver channel frequencies to be selected simultaneously by means of a front panel switch. All tuning to be internal, pre-set by service personnel.
- Carrier Suppression
Better than 36 db
- Unwanted sideband suppression
Better than 36 db
- Type of OperationSimplex (transmit and receive on same frequency) with "push-to-talk" control on handset.
- Remote Operation
Provisions for 3 remote positions with suitable signal lights.
- Antenna
Single wire, same antenna to be used on all channels.

Added to the above specifications, was the requirement that the Single-

Sideband (or SSB) equipment be the same physical size as a conventional 50-watt AM radiotelephone such as the RCA type ETM-50. This unit had been well accepted for airline-ground, point-to-point, police and other low-power radio communications.

Compatibility with existing AM equipment was also of great importance in order to tie in with established radiotelephone networks. This meant that the SSB receiver would have to receive AM as well as SSB, and that the transmitter must incorporate a method of carrier insertion in order to make its signal intelligible when received on a standard receiver. Most important of all, the SSB unit had to be designed and built in such a manner as to be competitively priced with existing AM radiotelephone equipment.

AM POWER VS. SSB POWER

The power output requirement of 20 to 50 watts does not seem impressive at first, but a look at Fig. 1 will quickly show how a single-sideband signal of 50 watts peak envelope power equals, in desired sideband power, a signal from a conventional transmitter rated at 200 watts carrier power. This is a 6db improvement, favoring the single-sideband transmitter. A 200 watt AM transmitter 100% modulated will have a total antenna power of 300 watts (carrier plus sidebands). Comparing this total power output with the 50 watt peak output of the SSB transmitter shows that six times, or approximately 8 db more antenna power is required with an AM transmitter to produce the same desired sideband power as the single sideband transmitter.

Fig. 1 illustrates the frequency bandwidth and power output advantages of a single-sideband communications system over an AM System. Another advantage is that, for a given system efficiency, the line power requirement is lower, a major factor in remote locations where small gasoline powered generators may be used. The equipment weight and space requirement is decreased, and the operating cost is lowered. Add to this the more intangible items, such as 1) better signal-to-noise ratio and less interference pickup due to the reduced receiver bandwidth, 2) almost com-

plete absence of distortion due to selective fading over long distance paths, 3) conversation privacy afforded by the inability of the average AM receiver to satisfactorily detect the SSB signal, and the system improvement obtained is far higher than the 8 db shown for the transmitter alone.

OVERALL SYSTEM

Preliminary design of the equipment mainly involved work with block diagrams in an effort to arrive at a system design that would meet the specification. Recent developments in mechanical filters, with their inherent narrow-bandpass characteristics, made them an ideal choice for single-sideband generation. A filter with a bandpass of approximately 250.3 kc to 253.2 kc was selected. This filter was designed for SSB use with a carrier frequency of 250 kc and having a 25 db attenuation to this frequency.

The filter choice established the first intermediate frequency at approximately 250 kc, making possible

the use of standard 262 kc i-f transformers with slight external padding.

Perhaps the most important single factor in the initial design of equipment of this type is the choice of intermediate frequencies, to insure that a minimum amount of spurious mixer products appear in the output. The problem is made more difficult when a large continuous frequency coverage is required. Fig. 3 is a block diagram of the final system. The frequency range of the set was extended to cover 3 to 15 mc. A second intermediate frequency of 1400 kc was used, obtained by mixing the 250 kc signal with an 1150 kc signal. It was decided to use the difference frequency output of the last balanced modulator, which would result in less trouble from spurious mixer outputs than if the sum frequency was used. The worst possible spurious frequencies that could appear in the transmitter output were the second and third harmonics of the second intermediate frequency, and the high-frequency oscillator output at the high

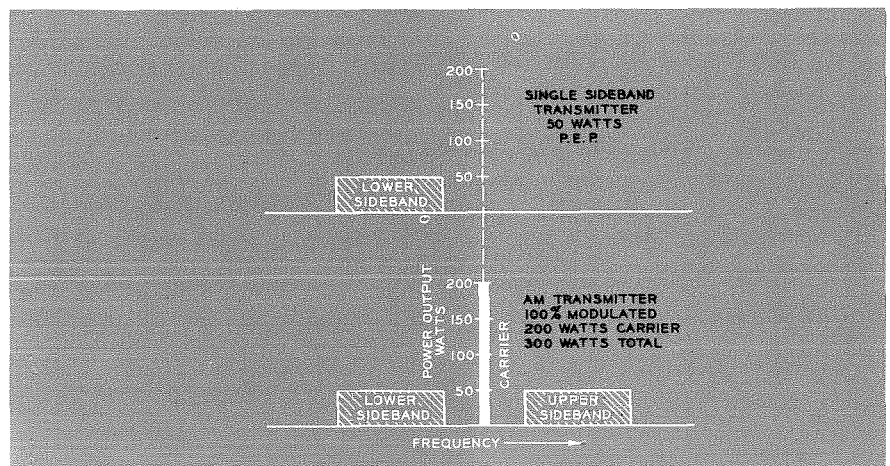

Fig. 1—Charts showing comparative frequency-power spectra for Single-Sideband transmitters and AM transmitters of equal sideband power.

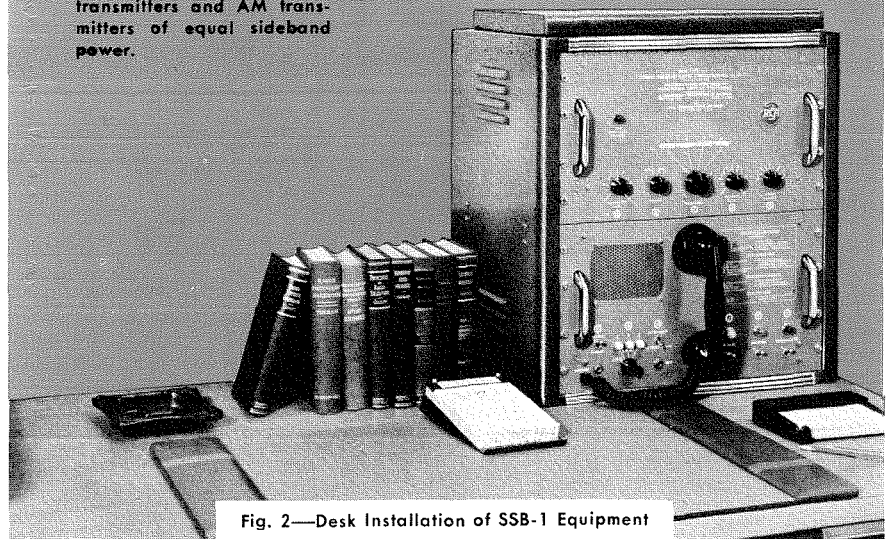

Fig. 2—Desk Installation of SSB-1 Equipment

SINGLE-SIDEBAND EQUIPMENT—continued

end of the frequency range. Subsequent measurements showed an attenuation of over 60 db for the i-f second harmonic, when the transmitter was tuned for 3 mc, and for the h-f oscillator frequency of 16.4 mc when the transmitter was tuned for 15 mc output. Difficulty was experienced in obtaining sufficient suppression of the i-f third harmonic when the transmitter output was tuned for it. Finally, an engineering compromise was reached between mixer frequency response over the frequency range of 3 to 15 mc, and the mixer distortion products, resulting in an i-f third harmonic attenuation of 26 db. Since this was the only spurious output of any magnitude it was deemed reasonable for the proposed type of service for which the equipment was to be used.

TRANSMITTER CIRCUITS

Search for a desirable tube for use as the linear power amplifier led to the recently developed RCA type 6146 Beam Power Amplifier. A unique feature of this tube is its ability to deliver almost as much power in class AB₁ as in class AB₂. Class AB₁ operation was desirable both for

reduced drive power requirements and for simplified grid circuitry—important considerations when a low cost, continuous frequency coverage design is contemplated. Tube manual ratings indicated an approximate power output, per pair, of 82 watts in class AB₁ audio service, using a plate voltage of 600 volts and neglecting all losses. The choice of 6146's proved to be a good one. Final power output to the antenna was between 55 and 68 watts depending on the frequency and the antenna impedance. A top view of the transmitter-receiver chassis is shown in Fig. 5.

SPEECH CLIPPER

The low-level audio circuits were designed to operate from three remote desk telephones and one local handset into the SSB-1. The audio levels are adjusted to permit the connection of a standard 600-ohm telephone pair to provide audio input directly to the transmitter unit. A speech clipper (see Fig. 4) built as a plug-in package complete with two tubes provides 20 db of clipping to transmitted speech. This clipping action greatly increases the average voice power transmitted. Audio harmonics generated in the clipping process are filtered out by the mechanical filter, after conversion to 250 kc.

TELEGRAPH OPERATION

A 1000-cycle audio oscillator in the

SSB-1 equipment is keyed by an external telegraph key to provide c-w telegraph operation. This single audio tone appears in the transmitter output as a single radio frequency and is detected in the receiver in exactly the same fashion as voice modulation, heterodyning with 250 kc in the last mixer to provide a 1000-cycle tone in the receiver. Reception of this signal with a standard AM receiver is possible by use of the receiver's BFO, in the same fashion as any c-w signal.

OSCILLATOR CIRCUITS

The same intermediate frequencies used in the transmitter are used in the receiver, in the reverse order. In this manner common oscillators are used for both receiver and transmitter. Crystal control of all oscillators was possible since four preset frequencies are provided rather than a continuously variable coverage. Small crystals in type HC-6/U holders are used. The 250 kc and 1150 kc crystals fit into a single, small, plug-in oven which holds the crystal temperature at 75°C. The four channel crystals are in two separate ovens. These small crystal ovens hold the crystals to a frequency tolerance of $\pm 0.0005\%$ over an outside ambient temperature range of -30°C to $+70^{\circ}\text{C}$. With an operating frequency of 15 mc, ± 75 cycles is the maximum frequency drift of the unit. To compensate for this drift, which would show up as dis-

Fig. 3—SSB-1 Block Diagram.

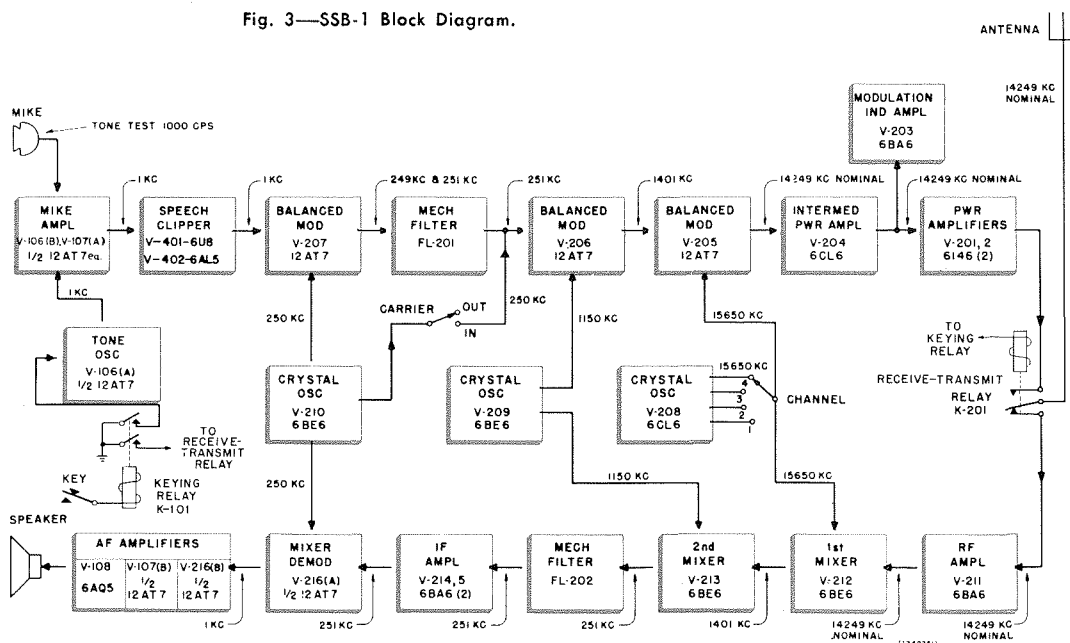



Fig. 4—Speech Clipper. The plug-in design permits ready removal for servicing. Substitution of a dummy plug is possible if operation without clipped speech is desired.

Author shown making tuning adjustment on the SSB-1 Transmitter-Receiver Chassis. This chassis contains all units except the power supplies and audio stages.

SINGLE-SIDEBAND EQUIPMENT—continued

torted voice during transmission (the so called "Donald Duck" sound of incorrectly tuned SSB reception) a front-panel control called the "Voice Clarifier" was incorporated into the SSB-1. This control consists of a small trimmer capacitor in parallel with the 1150 kc crystal, changing the resonant frequency of the oscillator ± 75 cycles no matter what output channel frequency is in use. Because the 1150 kc oscillator is common to both receiver and transmitter (as are the other oscillators) adjustment of the Voice Clarifier for most natural voice when receiving automatically adjusts the transmitted signal for best reception, at the far end of the circuit. With normal ambient temperature changes, the Voice Clarifier is used only to compensate for longtime crystal aging.

RECEIVER CIRCUITS

A receiver sensitivity of better than 1 microvolt with a signal-to-noise ratio of 6 db for 50-milliwatts output is obtainable over the entire frequency range. Audio gain is fixed at its maximum value, receiver gain being adjusted by an r-f gain control which varies bias on the r-f amplifier and the 1st i-f amplifier. A similar mechanical filter to that used in the transmitter is used in the receiver. All stages of i-f amplification follow the filter with its narrow bandpass, thereby amplifying only the desired signals passed by the filter. This greatly reduces the possibility of receiver overload due to strong interfering signals with frequencies close to those of the desired signals. A triode detector is used as the final demodulator. This type of circuit proved most satisfactory with the high level of carrier injection required for single-sideband reception, without overloading.

COST CONSIDERATIONS

A most important requirement in the original specification was to keep the SSB-1 cost and size close to an existing, comparable AM equipment. Conforming to the latter requirement was a relatively simple problem. The space

gained by elimination of modulator tubes, transformers and their required power supply components was utilized to accommodate the more involved circuitry of single-sideband generation. The need for keeping component costs down was constantly kept in mind. If a tuned-load circuit could be replaced by a resistive load this was done, since carbon resistors are less expensive than coils and capacitors.

Replacing coils and capacitors usually resulted in elimination of a tuning adjustment, simplifying the alignment procedure. All meters were eliminated. The only indicating device on the equipment is an inexpensive neon bulb. The neon gives a much faster and more reliable indication of peak voltages during modulation than a meter could.

The power supply was designed around standard "jobber item" components. All filter capacitors are electrolytic, including those in the high-voltage, power amplifier plate supply. In this circuit, high-capacity units are connected in series, giving ample voltage rating and the high filter output capacity required for good dynamic regulation of the supply under the rapidly varying load conditions of single sideband operation. The choice of class AB₁ operation of the PA stage allows the use of a very simple bias supply, since there is no load current drawn. Aside from the PA plate circuit, the only stages that required individually tuned circuits for each channel were the receiver r-f amplifier, the 1st mixer grid circuits, the transmitter 3rd balanced modulator plate, and IPA plate circuits. Identical slug tuned coils are used in all of these stages, except the transmitter 3rd balanced modulator. In this stage it was found that the tuning slug capacity affected the circuit balance over the frequency range, resulting in poor h-f oscillator rejection. Instead, a fixed coil—variable capacitor method of tuning was substituted.

Other important factors in cost reduction were the use of a standard, welded steel cabinet, and of easily fabricated metal parts throughout the equipment. Careful consideration of these details resulted in a sizable saving.

FINAL SPECIFICATIONS OF THE SSB-1

Listed below are the final specifications for the production units of the SSB-1 equipment. A comparison between these ratings and the original design requirements shows that the original specifications were exceeded in all respects.

Peak Envelope Power Output	60 watts
Frequency Range	3 to 15 mc
Channels	4
Carrier Suppression	50 db
Unwanted Sideband Suppression	50 db
Type of Operation	Simplex Emission
Single sideband suppressed carrier, single sideband with carrier, A1, A2 keyed tone.	
Keying Speed	
Break - in operation —	30 wpm
Teletype operation—	60 wpm
Speech Clipping	20 db
Two Tone Test:	
Distortion products	—26 db
Frequency Stability . $\pm 0.0005\%$	
Receiver Sensitivity	
Better than 1 μv for 50 mw output with 6 db signal to noise ratio.	

The front panel controls of the SSB-1 have been reduced to a minimum, thus simplifying its operation. The unit can be operated by inexperienced personnel. Installation and channel alignment can be done with a millimeter and a small screw driver.

FIELD TESTS

Two model SSB-1 equipments were built under the development contract so that field tests could be conducted with two-way circuits. The first of these field tests was conducted between New York and Radiomarine Station WCM located near Pittsburgh, Pa. in March 1955. Frequencies used were 4067 kc, 6455 kc, and 8205.5 kc.

The New York end of the circuit was operated under a special FCC authorization with the assigned call of KE2XQH. The circuit was operated intermittently for a period of two weeks. Excellent comparisons were obtained between the SSB-1 and the normal station transmitters at WCM,

Fig. 6—Karl L. Neumann, Supervisory Engineer of Radiomarine Engineering (at left) and C. E. Schneider of the Engineering Department, Radio Division are shown in the Lab during engineering performance tests on the "SSB-1" Single-Sideband equipment.

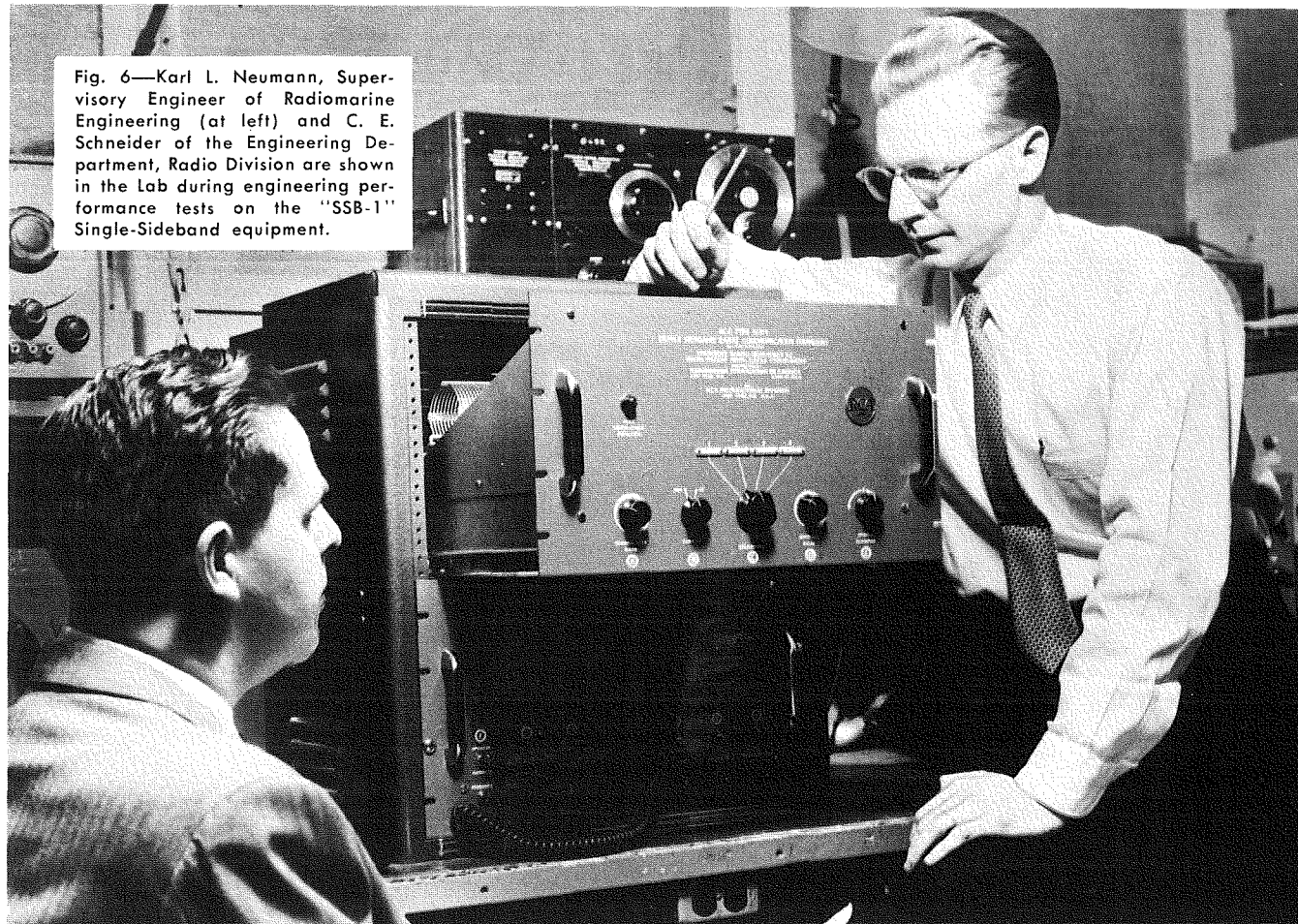

one of 150-watts, carrier power, the other of 1000-watts carrier power. Although the New York location was extremely noisy due to machinery located in the same building the tests were very satisfactory. The reports from the Pittsburgh end of the circuit were excellent with no difficulty being experienced at any time with reception. The results of these tests were used as a basis for acceptance of the equipment by RCA International.

In June 1955, the SSB-1 was installed on board the M/V *VALVOLINE*, a river tow boat, owned and operated by the Ashland Oil and Refining Company. C. E. Schneider of Radiomarine operated the equipment on the vessel during a run on the Ohio River between Ashland, Ky. and Mt. Vernon, Ind. Traffic was worked through station WCM in Pittsburgh. The SSB-1 consistently outperformed the 150-watt transmitter at WCM and under conditions of interference and atmospheric outperformed the 1000-watt station transmitter. The absence of selective fading effects with accompanying distortion of the received signal was especially gratifying when using single sideband.

The SSB-1 operated very satisfacto-

rily under the heavy vibration conditions present on board the diesel-driven *VALVOLINE*. Frequency stability proved excellent, with no distortion evident due to drift effects.

FCC DEMONSTRATIONS

The Federal Communications Commission, in a Public Notice dated October 5, 1955, expressed the expectation that users, manufacturers and professional groups with expert knowledge of single-sideband techniques would conduct "tests, studies, and analyses to provide a sound technical background" for future consideration of proposals to increase the use of single-sideband operation by a variety of services now using radiotelephone on frequencies below 25,000 kc. In line with this Public Notice, the US Coast Guard, using Radiomarine SSB-1 equipment, conducted demonstrations for the benefit of Commissioners of the FCC and personnel of other interested Government agencies during the week of December 5, 1955.

A four-station network was set up, with SSB-1 equipments located at Rocky Point, L.I., USCG Station Wildwood, N. J., USCG Headquarters Washington, D. C., and USCG Station

Alexandria, Va. All four installations were operated simultaneously on the same frequency as a network with excellent results. There were no blocking or heterodyning effects as would have been present if conventional AM equipment were used. The equipment was highly praised by all who witnessed the tests, with interest in single-sideband in general and the SSB-1 in particular being stimulated. In summary, the design of SSB-1 equipment is a great step toward the solution of the world-wide traffic problem in high-frequency communications.

CREDITS

To E. A. LaPort, then Chief Engineer of RCA International and now Director of Communications, RCA Engineering goes credit for arousing interest within the company for the SSB-1. Karl L. Neumann, Supervisory Engineer of the Radiomarine Radio-Engineering Division, C. E. Schneider, and the author of this paper were responsible for the successful completion of this project. Irving Linker helped in the development work on the transmitter. Bill Autry, Mechanical Design Division, helped in the layout and mechanical design of the equipment.

COLOR DEMODULATOR ANALYSIS

by

R. W. SONNENFELDT

Advanced Development Engineering

RCA Victor Television Division

Cherry Hill, N. J.

IN THE STANDARD FCC approved system of color TV, the color information is transmitted by means of a sub-carrier. So-called color-difference signals, the I and Q signals, are modulated onto the subcarrier by two phase, suppressed-carrier amplitude modulation. The result is simultaneous amplitude and phase modulation of the sub-carrier, allowing transmission of two independent signals in this channel.¹

In the receiver it is necessary to recover the I and Q signals. This article is concerned with an analysis of the modulation and recovery processes as a basis of receiver demodulator circuit design.

When the I and Q signals modulate their two-phase carrier, the resultant signal is, when the I carrier is $\cos \omega t$, and the Q carrier $\sin \omega t$,

$$e_s = I \cos \omega t + Q \sin \omega t = \sqrt{I^2 + Q^2} \cos (\omega t + \phi) \quad (1)$$

where ϕ , the phase modulation is given by

$$= \tan^{-1} \left(-\frac{Q}{I} \right) \quad (2)$$

While the right side of equation (1) correctly expresses the physical fact that the two quadrature signals combine into a single electrical wave, it is more convenient to use the left side of the equation for further mathematical manipulations. This results in greater simplicity in the following analysis. If equation (1) is multiplied by $2 \cos \omega t$ the result is

$$\begin{aligned} e_s \times 2 \cos \omega t &= 2 (I \cos \omega t + Q \sin \omega t) \cos \omega t \\ &= 2 (I \cos^2 \omega t + Q \sin \omega t \times \cos \omega t) \\ &= I (1 + \cos 2\omega t) + Q (\sin 2\omega t) \quad (3) \end{aligned}$$

When the terms of frequency $2\omega t$ are removed, by filtering, there remains

$$\text{Low Frequency component of } 2e_s \cos \omega t = I \quad (4)$$

Similarly, one can show that

$$\text{Low Frequency component of } 2e_s \sin \omega t = Q \quad (5)$$

The L.F. component of this multiplication is conventionally obtained from a balanced modulator followed by a low-pass filter. This circuit is entirely appropriate

1. H. Nyquist, "Certain topics in telegraph transmission theory," Trans. AIEE, vol. 47, p. 624, February 1928.

as a receiver demodulator but it has certain (mainly economical) disadvantages. These are:

1. Additional circuitry is usually required to establish and maintain balance.
2. Push-pull feed of signals is required.
3. At least two identical modulating elements are required.

Receiver designers have, therefore, turned to other circuits that have good performance without introducing balancing problems. All of the unbalanced circuits are essentially switches or gates actuated in synchronism with the subcarrier frequency. Fig. 1 shows a diagram of such a switch.

Suppose that this switch closes once during every cycle of the subcarrier frequency for a period of T seconds, that is from a time $t_1 = -T/2$ to a time $t_2 = +T/2$.

We shall show that the average value or equivalently the low frequency content of the output is proportional to I .

$$\text{When } t = t_1 \quad \text{let } \omega t = \omega t_1 = -\alpha$$

and

$$\text{when } t = t_2 \quad \text{let } \omega t = \omega t_2 = +\alpha$$

Then, the average value of e_o per cycle is

$$\begin{aligned} e_o \text{ ave} &= \frac{1}{2\pi} \int_{-\alpha}^{+\alpha} e_s d(\omega t) \\ &= \frac{1}{2\pi} \int_{-\alpha}^{+\alpha} [I \cos (\omega t) + Q \sin (\omega t)] d(\omega t) \\ &= \frac{1}{2\pi} \left[I \sin \omega t - Q \cos \omega t \right]_{\omega t = -\alpha}^{\omega t = +\alpha} \\ &= \frac{1}{2\pi} [I(2 \sin \alpha)] = \frac{\sin \alpha}{\pi} I \quad (6) \end{aligned}$$

R. W. SONNENFELDT received a B.S. degree from Johns Hopkins University in 1949. He was engaged in industrial electronic design work from 1941-1943 and 1946-1949 for the Charles Transformer Company of Baltimore, Md. He joined RCA in 1949 as a Specialized Trainee and is now a Development Engineer with the TV Circuits Group of Television Division Advanced Development Section. Mr. Sonnenfeldt is a Senior Member of the IRE, a member of Tau Beta Pi, and Omicron Delta Kappa.

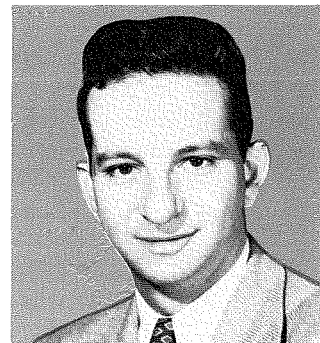

If on the other hand the switch is closed from $\omega t_1' = (\pi/2 - \alpha)$ to $\omega t_2' = (\pi/2 + \alpha)$ the output voltage is

$$\begin{aligned} e_{o \text{ ave}}' &= \frac{1}{2\pi} \int_{\frac{\pi}{2}-\alpha}^{\frac{\pi}{2}+\alpha} [I \cos(\omega t) + Q \sin(\omega t)] d(\omega t) \\ &= \frac{1}{2\pi} \left[I \sin \omega t - Q \cos \omega t \right]_{\omega t = -\alpha}^{\omega t = +\alpha} \\ &= \frac{1}{2\pi} \left\{ -Q \left[\cos \left(\frac{\pi}{2} + \alpha \right) - \cos \left(\frac{\pi}{2} - \alpha \right) \right] \right\} \\ &= \frac{\sin \alpha}{\pi} Q \end{aligned} \quad (7)$$

We note that the output obtainable becomes a maximum when $\alpha = \pi/2$.

Then,

$$e_o = \frac{I}{\pi} \quad (8)$$

and

$$e_o' = \frac{Q}{\pi} \quad (9)$$

This means the switch is closed for one half of each complete subcarrier cycle. This method of detection is known as pulse sampling. The operation of the switch is equivalent to multiplication by a pulse of unit amplitude, recurrence frequency ω and width 2α . Such a pulse can be expressed as a Fourier Series.

$$e_p = \frac{1}{\pi} + \frac{2}{\pi} \sum_{n=1}^{\infty} \frac{1}{n} \sin(n\alpha) \cos(n\omega t) \quad (10)$$

The switching process is the same as taking the product

$$e_p \cdot e_s = e_o \quad (11)$$

$$= \left[I \cos \omega t + Q \sin \omega t \right] \left[\frac{1}{\pi} + \frac{2}{\pi} \sin \alpha \cos \omega t \right]$$

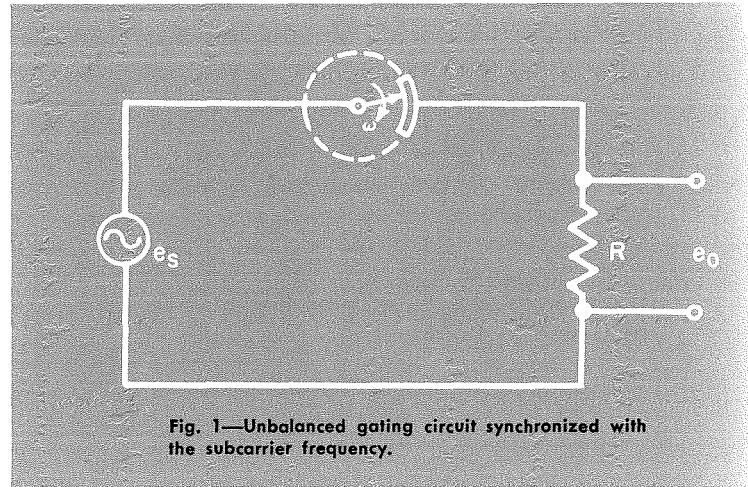

Fig. 1—Unbalanced gating circuit synchronized with the subcarrier frequency.

$$+ \frac{1}{\pi} \sin 2\alpha \cos 2\omega t + \frac{2}{3} \pi \sin 3\alpha \cos 3\omega t + \dots \quad (12)$$

of all these terms only the product $I \cos \omega t \cdot 2/\pi \sin \alpha \cos \omega t$ makes a low frequency contribution. It is

$$e_{o \text{ ave}} = \frac{\sin \alpha}{\pi} I \quad (13)$$

exactly the same as equation (6).

Similarly, if we displace the pulse by $\pi/2$ we find that

$$e_p' = \frac{1}{\pi} + \frac{2}{\pi} \sum_{n=1}^{\infty} \frac{1}{n} \sin(n\alpha) \cos n \left(\omega t + \frac{\pi}{2} \right) \quad (14)$$

If the product

$$e_p' \cdot e_s \text{ is taken, one finds}$$

that

$$e_p' \cdot e_s = e_{o \text{ ave}}' = \frac{\sin \alpha}{\pi} Q \quad (15)$$

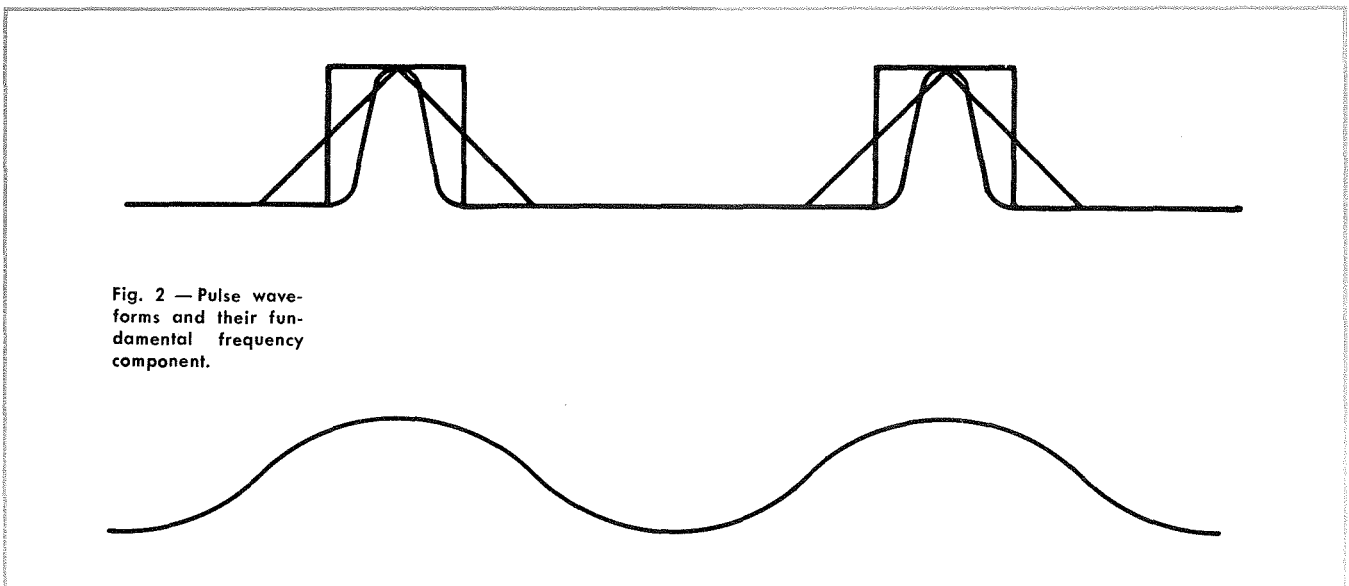

Fig. 2 — Pulse waveforms and their fundamental frequency component.

Now, it is a truly astounding fact that this pulse need have neither steep sides, nor a flat top to get exactly the same result. *Only the fundamental frequency component* of the sampling pulse makes a contribution to the desired output. *Any other* pulse with the same fundamental frequency component as those of equations (10) and (14) will give exactly the same output quite irrespective of what the harmonic terms in the series look like. It is obvious, therefore, that sine wave sampling as described by equations (4) and (5) is but a special case of pulse sampling. Fig. 2 shows a number of pulse waveforms with their fundamental frequency component.

It is now easy to examine several circuits suitable for receiver demodulation.

THE GATED AMPLIFIER PENTODE

Fig. 3 shows a suppressor switched pentode and Fig. 4 is the equivalent circuit. If the plate current is a linear function of the subcarrier voltage e_s (linear operation

of grid #1) then the output will be undistorted quite independent of the suppressor grid non-linearity, since generation of harmonics not present in e_p do not affect the result. Fig. 5 shows the circuit of Fig. 3 with e_s and e_p interchanged.

In this case the suppressor grid must be operated linearly, but the linearity of grid #1 is unimportant.

Fig. 6 shows a plate switched triode. Here, linear operation of the signal grid is required but the plate voltage-plate current relationship need not be linear. Notice that the value of the battery voltage enters into the process only in as far as it affects μ , and g_m and in its effect on the grid-voltage plate current relationship.

Many other circuit configurations are possible and have been used. The analysis of this article shows that there is a wide choice of sampling waveforms possible, and accordingly the design of color demodulators presents unusual opportunities to the circuit engineer.

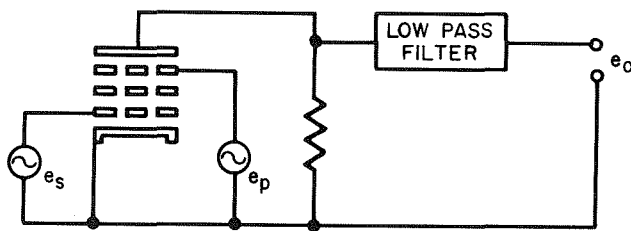

Fig. 3—A suppressor-switched pentode circuit.

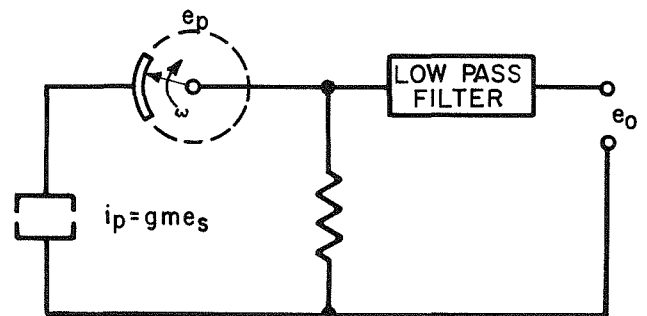

Fig. 4—Equivalent circuit of Fig. 3.

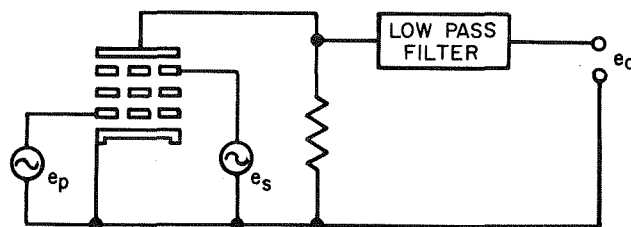

Fig. 5—Suppressor-switched pentode circuit of Fig. 3 with e_p and e_s interchanged.

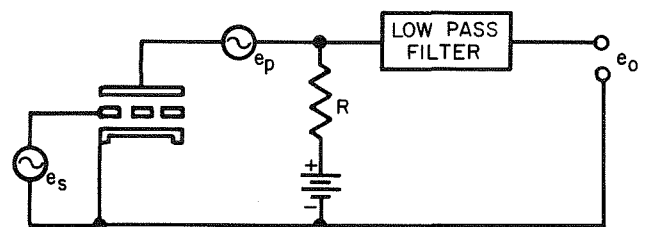

Fig. 6—A plate-switched triode.

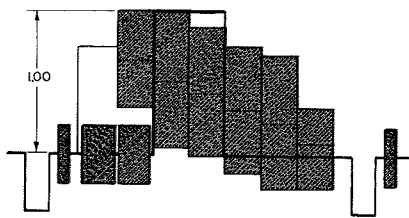

Fig. 4—Color bars reduced to 75% level

flexibility, it is a practice to design color bars with means for splitting the image area into two horizontal bands so that additional test information may be inserted without decreasing the width of the basic color bars. The design we are to consider is set up to produce the colorplexed pattern shown in Fig. 1. The basic color bars are confined to the top half of the raster, leaving the bottom half for transmission of special test pulses. Basic timing information is derived from the standard blanking signal. Trigger pulses derived from the trailing edges of the blanking signal are used in one of two places, determined by the state of conduction of a keyer tube which may be controlled by a 60 cycle multivibrator, triggered by vertical drive, to provide either color bars or test pulses over the complete raster.

The basic color bar pattern is produced by a group of three multivibrators as shown in Fig. 4. The remaining circuitry is necessary to provide the additional test pulses and to produce the 60 cycle electronic keyer information. The signals from the three sets of multivibrators are coupled directly to the 75-ohm output lines through diodes which serve both to regulate the output levels (producing the desired peak-to-peak output voltage independent of tube parameters) and to stabilize the timing action of the multivibrators.

USE OF THE COLOR BAR SIGNAL FOR TEST

As was intimated earlier in the discussion, a colorplexed color bar signal provides a very convenient, recognizable test signal for checking the performance of a color system. To facilitate testing of a system several test instruments have been designed especially for use with a color bar test pattern. The most straightforward of these is the conventional

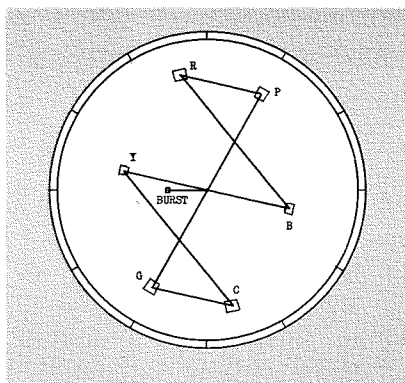

Fig. 5—Sketch of a typical vector display oscilloscope pattern showing how tolerance limits may be indicated

cathode ray oscilloscope used for visual inspection of waveforms. Trained personnel can usually evaluate circuit or system performance with a fairly high degree of proficiency by analyzing the waveforms presented on an oscilloscope. For a closer inspection however, especially of the amplitudes and phases of the subcarrier corresponding to the various colors, certain new instruments offer advantages over the conventional oscilloscope. One of the most convenient of these new instruments is the vector display oscilloscope.

When used with color bar signals, the vector display oscilloscope produces a pattern of lines or dots which indicate the tips of the vectors corresponding to the various colors. The sequence of the scope pattern produced by the particular color bar sequence used is shown in Fig. 5. This figure also shows how boxes indicating phase and amplitude tolerance limits may be drawn on the scope face to provide a very convenient indication of the signal. The particular tolerance limits shown in the figure correspond to $\pm 3^\circ$ in phase and $\pm 5\%$ in amplitude. It must be remembered that these tolerances refer only to the subcarrier information since the luminance information is rejected by the 2.5 mc bandpass filter.

Fig. 6 is a simplified block diagram of a typical vector display oscilloscope. While several different versions of this device have been developed, most of them employ a pair of demodulators comparable to those

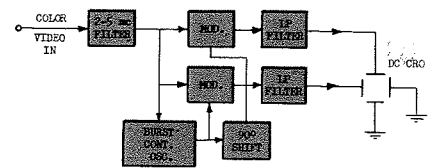

Fig. 6—Simplified block diagram of a typical vector display oscilloscope

used in color monitors or receivers. The outputs of these demodulators are applied to the two pairs of plates of a d-c oscilloscope or an a-c oscilloscope with provision for restoring the d-c component at the deflection plates. Most versions of the device also include a burst-controlled oscillator to derive a reference carrier from the color synchronizing bursts contained in the signal under test. Some experiments with a vector display oscilloscope indicate that it may become a useful tool for monitoring actual camera signals, since its display gives an objective indication of the hue and saturation of the colors being transmitted. It may help in matching the characteristics of color cameras, and may prove useful to program directors as an aid in choosing colors for costumes and sets.

Another specialized instrument for the analysis of color bar signals is the color signal analyzer. This instrument, shown in simplified block diagram form in Fig. 7, may be used as an auxiliary to an oscilloscope to permit more accurate measurements of the various amplitude and phase relationships in a color signal. This could be at any point in a color television system: the output of the colorplexer, the output of the distribution system, or anywhere along the entire path. The same is also true when using the vector display oscilloscope.

Discussing the operation of the color signal analyzer, the synchronous detector permits the measurement of relative phase angles between

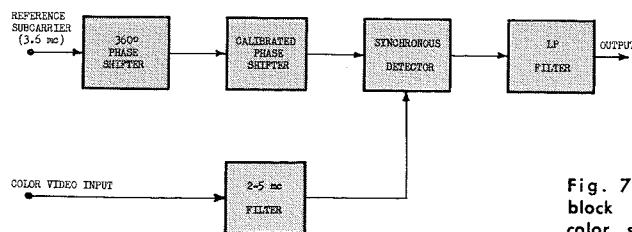

Fig. 7—Simplified block diagram of a color signal analyzer

any of the color bar intervals, even including the color synchronizing burst. The detector output for any given bar interval can be set at zero or for a null by means of the uncalibrated 360° phase shifter, and the relative angle between it and any other bar or burst interval can be determined by adjusting the calibrated phase shifter to bring the second bar interval to zero or a null. Since the detector is used only as a null indicator, the accuracy of measurement is determined primarily by the calibrated phase shifter which usually has an accuracy of better than 1°.

The output of the color bar generator-colorplexer combination, in addition to providing a convenient signal for checking a color system, has proven to be a very useful operational test signal for adjustment and performance check of a color monitor or receiver. Sufficient intelligent information is contained in the test signal to make quite a comprehensive check on such items as phasing and matrix circuits, brightness adjustments, subcarrier oscillator lock in performance, and relative gain adjustments of the demodulator and luminance channels. Some form of video modulator operating on a standard carrier frequency is necessary with such a test signal, however, to be useful for adjustment of a color receiver.

CONVERGENCE DOT GENERATOR

In monochrome television a grating pattern generator has been used for some time by broadcasters to check and adjust deflection linearity in both cameras and picture monitors. With the advent of color television this test device sometimes has been called upon to perform still another important function—the convergence of the three beams in a shadow mask tri-color tube, or the registration of three separate images in any form of the three tube display device. Although the grating generator signal has proven adequate, a signal comprising a dot pattern (breaking up the lines of a grating pattern into dots) might be more helpful for adjusting convergence because it would show not only the convergence errors but also it would show more readily in which direction correction should be ap-

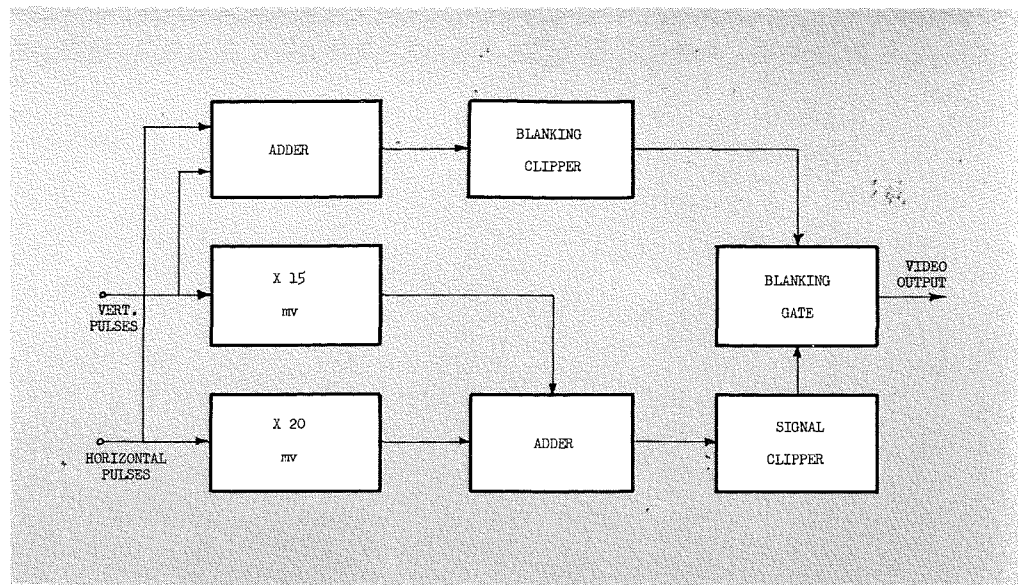

Fig. 8—Simplified block diagram of a typical dot generator

plied to achieve proper registration. The dot pattern has been quite widely accepted as the recommended pattern for adjusting kinescope convergence. Lack of convergence or registration shows up in the color kinescope as color fringes around the area of the dot.

The circuitry for a grating and dot generator, shown in Fig. 8, is relatively simple. Horizontal and vertical pulses obtained from the respective windings of the deflection yoke in the receiver under test or from some external signal source such as a standard synchronizing generator may be used to trigger multivibrators

or blocking oscillators operated at harmonics of the line and field frequencies. The patterns generally used are produced by combining pulses at about 20 times the horizontal frequency and 15 times the vertical frequency and passing the resultant signal through a clipper. If the clipping level is adjusted so that the clipper puts out a signal only when the horizontal and vertical pulses coincide, a dot pattern results. By providing sufficient range of bias adjustment in the clipping circuitry of the dot pattern generator, a grating pattern can also be produced. It is then desirable, however, to clip the signal at both ends of the amplitude range so that the lines are not intensified at their points of intersection. In a practical dot generator a video modulator operating on a standard television picture carrier frequency may be included so that the output signal may be inserted directly into the antenna terminals of the receiver under test. Controls for adjusting the number and size of lines or dot are usually provided where dots on the order of 10 to 12 lines square are usually considered most useful for checking color kinescope convergence.

PORTABLE COLOR TEST SIGNAL GENERATOR FOR RECEIVER ADJUSTMENTS

The majority of television stations now have monochrome program service during most of the daylight hours so there is little opportunity for service technicians to use "off the air" color test signals to provide a signal suitable for color receiver adjustment. A device capable of satisfying receiver

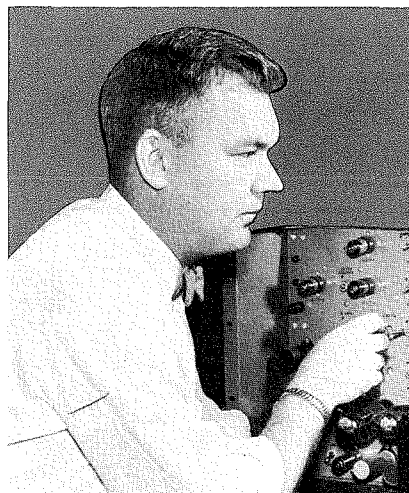

ELROY E. GLOYSTEIN received his BS-EE degree from the University of Nebraska in 1951. He joined RCA as a specialized trainee and was assigned to the Broadcast Studio Section of Engineering Products Department. Since that time, he has been engaged in color television design and development, specializing in studio equipment. He became project engineer in July 1954 and project leader in July 1955. He is a member of Sigma Tau and associate member of IRE.

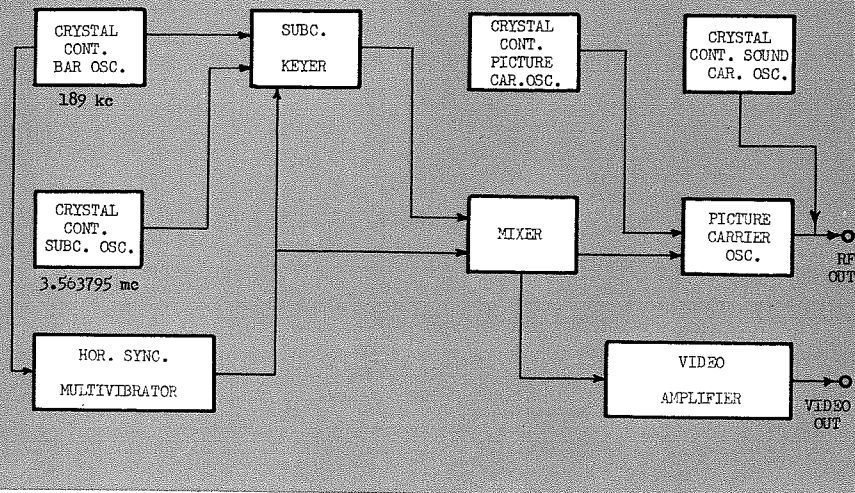

Fig. 9—Simplified block diagram of the WR-61-A Color Bar Generator

adjusting requirements has recently been developed and is the next test instrument to be discussed — the *WR-61A Color Bar Generator*.²

A block diagram of this color bar generator is shown in Fig. 9. The heart of the generator is a crystal oscillator which operates at a frequency 15.75 kc below the color subcarrier frequency. Another oscillator running at 189 kc (12 times the horizontal frequency) provides pulses which chop the output of the first oscillator into 12 bursts during each line period. One of these bursts is keyed out to provide a gap for the insertion of a horizontal synchronizing pulse which is derived from a 12 to 1 divider controlled by the 189 kc oscillator. The first burst following the synchronizing pulse serves as the color synchronizing burst, while the remaining ten are visible in the picture area. In the present version of the color bar generator an r-f oscillator operating on one of the standard carrier frequencies is used to provide a carrier upon which the test signal may be modulated. Still another oscillator is employed to provide a sound carrier signal. Both the r-f and sound oscillators are also crystal controlled to provide the necessary frequency stability. If both sound and picture carriers are provided the color bar test signal can be injected into the receiver at the antenna terminals. When the color bar generator signal is applied to a color television receiver, the subcarrier oscillator in the receiver "side-locks" on the signal and operates at the correct color subcarrier frequency. The output of the bar generator is

actually bursts of subcarrier of constant phase and at a frequency of 3.563795 mc. The color receiver sees this as a signal equivalent to a 3.579545 mc signal which varies continuously in phase such that it slips by 360° during each line period. Successive color synchronizing bursts (those that appear immediately after the sync pulses) therefore appear to be in phase with each other, although the signal actually passes through a complete phase sequence from one line to the next. The afc circuits in the receiver lock in on the average phase of the subcarrier, during the synchronizing burst gating interval. Since the bursts are transmitted at the rate of 12 per line there is a phase separation of 30 degrees between successive bursts. The bursts, however, are usually adjusted to have a duty cycle of about 33%, so that from beginning to end of each burst is a variation of only 10°.

The receiver or monitor's horizontal oscillator is controlled by the color bar generator's synchronizing pulses so a stable pattern appears on the kinescope face. The bar signal has no vertical information, however, so the vertical oscillator of a receiver under test is simply left free running. If it were not for the burst gating circuit in the bar generator, a continuous rainbow pattern would appear, passing through a complete range of hues across the raster. The chopping action produced by the 189 kc oscillator breaks up the continuous rainbow pattern into ten separate bursts or bars of color, which can be used for accurate adjustment of phasing and matrixing circuits. The only

luminance or monochrome information in the color simulator signal consists of horizontal sync pulses, and the "spikes" resulting from transient effects in the signal gate. No attempt is made to suppress these spikes, since they serve a useful purpose in checking the relative delays of the monochrome and chrominance information. If the relative delays between chrominance and luminance signals are correct, the band of color in each bar fits properly between the sharply defined edges produced by the spikes.

COLOR STRIPE GENERATOR

Actually, two problems confront the serviceman who is installing color television receivers. The first problem of setting up a receiver properly for color and monochrome operation was solved by the *WR-61A Color-Bar Generator* previously discussed. The other problem which faces the serviceman is how to determine whether the receiver, even though correctly adjusted for color, will receive a satisfactory color picture at a particular location. Field test experience has shown that an antenna and transmission line installation that is satisfactory for monochrome reception may be quite inadequate for color. Certain types of antennas may be so sharply tuned that the color subcarrier is considerably attenuated even when the main picture signal is quite strong. It is also possible for multi-path transmission effects or reflections in the transmission line connecting the antenna to the receiver, to cause a partial cancellation or null at the subcarrier frequency that may preclude satisfactory color reception. Consequently, it is highly desirable

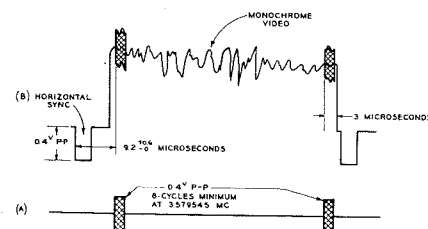

Fig. 10—(a) Color bursts produced by stripe generator (b) Composite signal from stripe generator

to make a final check on the installation of a color television receiver by actually viewing an "off the air" color signal which must pass through the antenna and transmission lines. In the absence of a color signal a satisfactory "off the air" color test signal for performing this check can be obtained by the use of a device known as the "color stripe generator." This device inserts several test bursts at the color subcarrier frequency into normal monochrome signals. The added bursts are relatively invisible in monochrome pictures (because of the frequency interlace effect), but may be utilized in a color receiver to make a test indicating whether the antenna and transmission line installation is satisfactory for color reception. Fig. 10 shows a sketch of the color stripe generator test signal indicating the relative timing of the test bursts, with respect to the monochrome picture information.

The first test burst immediately on the left side of the picture in the video interval is the information used to lock in the color receiver subcarrier oscillator to the proper phase as does the color synchronizing burst in a standard color television signal. With this signal configuration the color killer circuits in a color receiver will keep the chrominance channel disabled. In other words, a viewer can continue to watch a monochrome program on a color receiver even though the color stripe generator is being used, and see only a monochrome picture. He will not be disturbed by the two "color" stripes on the left and right side of the kinescope. However, when a technician wishes to check out a receiver installation he needs only to make a minor

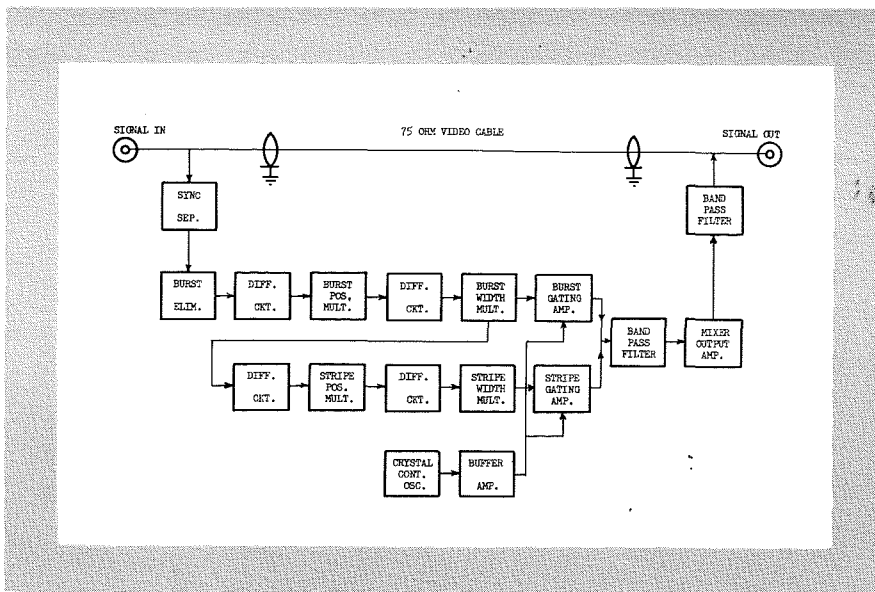

Fig. 11—Block diagram of a typical color stripe generator

adjustment in the horizontal oscillator of the color receiver which alters the timing of the burst gating pulse sufficiently to be coincident with the first test burst. The receiver subcarrier and oscillator will become locked in and the color killer circuits will become disabled. Both test bursts then appear as narrow stripes of greenish-yellow on the extreme right and left-hand sides of the picture respectively (the burst phase corresponds to a greenish-yellow hue). On a monochrome receiver the addition of the color stripe signal will have little or no effect because the subcarrier is frequency interlaced and essentially cancels out due to the persistency vision of the eye. In addition, most monochrome receivers have relatively low response at 3.6 mc making the stripe even less visible. The test bursts contain insufficient information to permit a complete alignment of a color receiver, but they do provide an effective "go—or no go" type of test to indicate whether the "air path," the antenna and the transmission line are satisfactory for color reception.

A block diagram for a typical color stripe generator is shown in Fig. 11. The device is intended for insertion in the video line feeding a television transmitter. Provision is made for passing the video straight through the device without intervening tubes or circuits so as to give it "fail-safe" operation. The sync separator obtains timing pulses from the sync information in the monochrome picture signal. These pulses, in turn, trigger two sets of position and width multi-

vibrators. Subcarrier information is provided by an oven-controlled crystal oscillator which does not necessarily have to be locked in to the scanning frequencies as long as its absolute frequency falls within the tolerance prescribed by the FCC ($3.579545 \text{ mc} \pm 0.0003\%$). The output of the subcarrier oscillator is applied to two gate amplifiers which are normally cutoff but are made operative by the pulses derived from the multivibrators. The bandpass filter which couples the signal to the main video line rejects all components produced during the gating process except the actual test bursts. These bursts are simply added to the normal monochrome video signal, as shown in Fig. 10. Since these bursts do not contain luminance information they position themselves on the average of the luminance value present in the monochrome signal at that particular time.

SUMMARY AND CONCLUSION

The test instruments described represent a group of the items which facilitate adjustment of some of the specialized circuitry used in color television equipment. As the state of the art of color television progresses simpler and more ingenious techniques will be discovered which will aid the broadcaster or technician materially in checking the performance capabilities of his equipment.

The author gratefully acknowledges the contribution by J. W. Wentworth in granting permission for the use of a portion of his written material for this paper.

REFERENCES

1. *Color Test Techniques for the TV Broadcaster*
By: J. W. Wentworth
Electronics, November 1954.
2. *WR-61A Color-Bar Generator Design*
By: Steven Wlasuk
RCA Engineer, August-September 1955.
3. *Color Stripe Added to Stations Monochrome Signal*
By: E. E. Gloystein
Broadcast News, Volume 80.
4. *Color Equipment Planning*
By: L. E. Anderson
Broadcast News, Volume 82, February 1955.
5. *RCA Color Television System*
By: J. W. Wentworth
Broadcast News, Volume 77, January-February 1954.

TRENDS IN THINKING ABOUT THERMIONIC EMITTERS*

By
L. S. NERGAARD
RCA Laboratories
Princeton, N. J.

THOSE WHO ARE regarded by their fellows as cathode experts are frequently approached by tube experts and asked to produce a cathode which meets the following requirements.

1. The cathode must have mechanical stability and must be capable of manufacture to very close mechanical tolerances.
2. The cathode must be capable of a steady-state emission of amperes per square centimeter.
3. The cathode should yield the high emission density at a low temperature so that the thermal noise in the tube in which the cathode is to be operated will be low.
4. The emission should be microscopically uniform over the cathode surface.
5. The cathode should have a reasonable life, say 100,000 hours.
6. The cathode should not evaporate its constituents and foul up other electrodes and impair their operation.
7. The cathode should be immune to poisoning so that it can operate in a rough vacuum and will not be sensitive to contaminants arising from the envelope and other electrodes.

In response to this request, the "cathode expert" probably mumbles something unintelligible in his beard and, if prodded, will offer to think about the problem. He will then lapse into his normal stupor. For those interested, what he mumbles to himself is "Does this chap know what his request implies?"

If the "cathode expert" were still

* An invited paper presented at the First Annual Technical Meeting of the I. R. E. Professional Group on Electron Devices, Washington, D. C., October 24, 1955.

rational and could be persuaded to give a brief simple discussion of the implications of the request, the discussion might be as follows.

MECHANICAL STABILITY AND TOLERANCES

The requirement of mechanical stability and precision implies the use of a solid. Now a solid is an aggregation of atoms held together by interatomic forces. Because the aggregations are orderly, i.e., crystals form, the force field which holds the atoms in the regular array is periodic. This is illustrated in Fig. 1 which shows the energy of an atom as a function of distance through a crystal. At the crystal surface where the orderly array stops, the energy shows a discontinuity. The atoms may be thought of as trapped in potential wells. They oscillate in these wells and it is the energy stored in these oscillations that is responsible for the specific heat of the crystal. As the temperature of the crystal is raised, the oscillations become more violent, and now and then an atom in a well near the surface acquires enough energy to surmount the barrier and escape. This process is evaporation and the energy required for escape (ΔH in Fig. 1) is the latent heat of evaporation of the atom. If there is a vacant potential well in the crystal, an adjacent atom will now and then acquire enough energy to surmount the potential hill and jump into the vacant site, leaving a vacancy behind. This process is one of the mechanisms for self-diffusion and the height of the hill between potential minima (E_D in Fig. 1) is the activa-

tion energy for this kind of self-diffusion.

If the solid is an ionic crystal, such as BaO, the same picture may be drawn except that ions instead of atoms are trapped in potential wells and the force field is a periodic electric field. If a voltage is applied across such a crystal, the periodic electric field becomes tilted as shown in Fig. 2. Then the probability of a negative ion jumping to the right is somewhat greater than probability of the ion jumping to the left. If there are vacancies in the negative ion lattice, the difference in probabilities gives rise to a drift of negative ions toward the right. This process is electrolysis. Positive ions tend to move in the opposite direction under the same field, of course.

Evaporation, diffusion, and electrolysis all play roles in cathodes. These roles, some good, some bad, will be discussed under other headings. However, their existence is assured by the choice of a solid to satisfy mechanical requirements.

EMISSION

The requirement of high emission density implies something else — a means of replenishing the emitted electrons. If the electrons were not replenished, the cathode would charge up until the coulomb forces between emitted electrons and the electron deficits in the cathode stopped emission of further electrons. The easy means of replenishing electrons is an electrode in contact with the emitter. However, this is not enough; the emitter must have a high enough conductivity to transport electrons from the contact to the emitting surface easily. This problem may seem trivial, but the fact is that it is not trivial in some

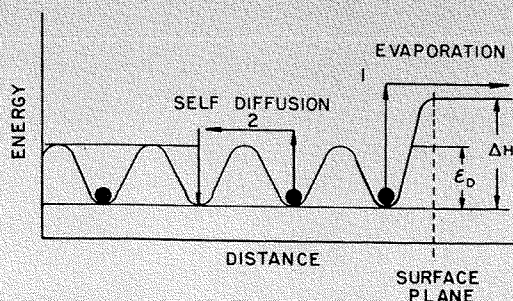

Fig. 1—Energy of an atom as a function of distance through a crystal.

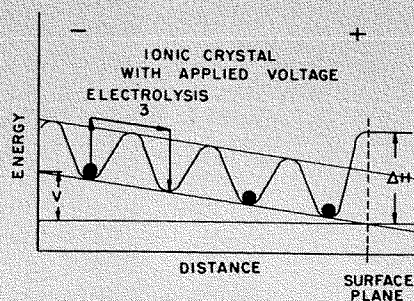

Fig. 2—Periodic electric field with a voltage applied to an ionic crystal.

cathodes and, in particular, it is not trivial in the oxide cathode.

CONDUCTIVITY

Before pursuing this matter it is pertinent to consider how conductivity in solids arises. An atom in free space consists of a compact nucleus carrying an integral number of positive electronic charges surrounded by an equal number of electrons. To free each electron from the nuclear field requires a specific amount of energy. This is illustrated in Fig. 3a which shows the energy level diagram of a simple atom containing two electrons. The energy level of the electron most loosely bound is shown as at 1. in the figure together with an excitation level for this electron at 1e. To raise the electron into the bottom of the continuum of free energy states requires the ionization energy I_1 . When atoms are compacted into a crystal, the forces between atoms shift the electron energy levels in much the same way that coupling two isochronous tuned circuits changes the resonant frequencies. Just as the resonant frequencies of a pair of coupled circuits must be ascribed to the circuits in combination and not one to each circuit, the energy levels of the atoms "split" to form a band of permitted levels which must be associated with the crystal as a whole instead of with individual atoms. The "splitting" of the uppermost atomic level and its excitation level may occur in one of two ways depending on the atoms involved. (1) The "splitting" may occur in such a way that the resultant bands of levels overlap one another and the free electron continuum above the surface potential barrier. This is illustrated in Fig. 3b. In this case, there are about as many free electrons as there are atoms and the material is metallic. Such materials have high conductivity. To be emitted, an electron needs to acquire an energy ϕ

equal to the energy difference between the uppermost occupied energy level and the height of the surface barrier. ϕ , in this case, is the work function of the metal. (2) The "splitting" may occur in such a way that the resultant bands of occupied and unoccupied levels do not overlap. This is illustrated in Fig. 3c. Then there is a region of width E_G which cannot be occupied by electrons, the so-called forbidden gap. Materials with a gap between the occupied and free electron bands are semiconductors or insulators. To obtain conductivity, electrons must be thermally excited across the gap into free electron levels. Thermodynamic considerations show that the activation energy for conduction is $E_G/2$. Once an electron is in free energy states (the conduction band), to evaporate it must acquire an additional energy X equal to the energy difference between the lowest conduction band levels (the only ones occupied at reasonable temperatures) and the surface barrier. Thus the thermionic work function is $X + E_G/2$.

Whereas a metal has many free electrons at all temperatures (about 10^{22} cm^{-3}), a semiconductor may have only 10^{10} free electrons per cm^3 at 1000°K . Obviously the conductivities are greatly different, so why bother with semiconductors. The answer is that the work function for metals is usually much greater than the work function for semiconductors, so that the high conductivity is offset by the low emission. It is true that some metals have low work functions; cesium, for example. However, the low work function metals also have low latent heats of evaporation so they emit atoms almost as freely as electrons. Furthermore, it is possible to introduce foreign atoms into the semiconductor which produce energy states in the forbidden gap and thus increase the number of conduction electrons

and reduce the work function. Before examining this matter in more detail, it seems best to examine some of the evidence that the resistance of the cathode is of consequence in a practical sense.

CATHODE RESISTANCE

If the resistance of the cathode is of consequence, it should absorb part of the voltage applied to a diode and should cause an apparent departure from the Child-Langmuir law. That it can absorb a considerable fraction of the applied voltage was demonstrated by Eisenstein in a set of measurements in which he measured the velocity distribution of electrons emerging from an aperture in the anode of a diode having an oxide cathode. The retarding potential required to stop electrons is equal to the potential drop in vacuum through which the electrons have fallen. Hence, the applied voltage minus the stopping voltage is the potential drop through the cathode. Fig. 4 shows a set of Eisenstein's data. The lower curve is the measured diode characteristic. The upper solid curve is the diode characteristic corrected for the cathode voltage drop. The dotted curve is the computed perveance line. It appears that the current is in fact space-charge limited and that diode characteristic is deformed by the cathode voltage drop which amounts to 275 volts with about 1500 volts applied voltage.

Eisenstein's measurements were made with short pulses and an emission of about 9 amperes cm^{-2} was obtained before sparking set in. Coomes has reported pulse currents as high as 100 amperes cm^{-2} from oxide cathodes, and Matheson and Nergaard reported pulse currents of 40 amperes cm^{-2} . A pertinent question is: Why can't these current densities be maintained under dc conditions? The reason is cathode resist-

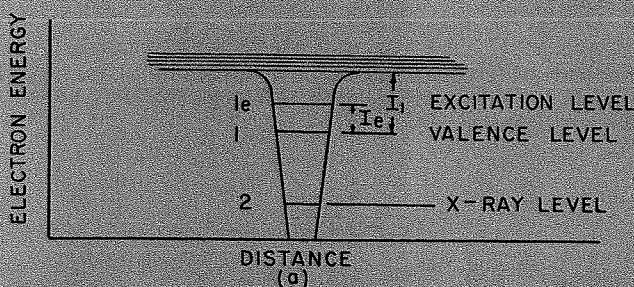

Fig. 3a—Energy level diagram of a simple atom containing two electrons.

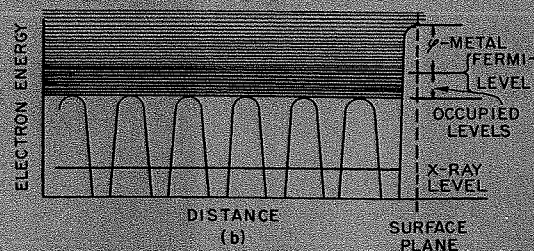

Fig. 3b—"Splitting" of energy levels of atoms in a crystal may result in an overlapping of energy levels; such materials have a high conductivity.

ance; Eisenstein's current of 9 amperes cm^{-2} with a cathode drop of 275 volts gives a cathode dissipation of about 2.5 kw per cm^2 of cathode surface, far more than a cathode can stand. However, even if the peak current is greatly reduced, it is observed that the peak pulse current of an oxide cathode is not maintained. This effect diminishes as the peak current is reduced, but can still be observed at current levels as low as 25 ma cm^{-2} . This effect is a major source of trouble in dc amplifiers operating at frequencies below one cycle per second. On application of a long pulse to such an amplifier, the current will decay a few per cent in a matter of seconds. This pulse decay effect is due to the electrolysis discussed in the previous section. The oxide cathode is "activated" by introducing foreign atoms into the cathode, thus producing impurity levels in the forbidden gap. These atoms are easily ionized to provide conduction electrons. However, when ionized, they move towards the base metal of the cathode electrolytically and thus deplete the region near the emitting surface of the very atoms which provide conduction electrons. To maintain space charge neutrality, the number of conduction electrons in this depleted region falls correspondingly. As a result, the resistance near the emitting surface increases when current is drawn. This gradual increase in resistance is responsible for the current decay. The thickness of the insulating layer which results from donor depletion will be of concern in later considerations. Measurements by Loosjes and Vink

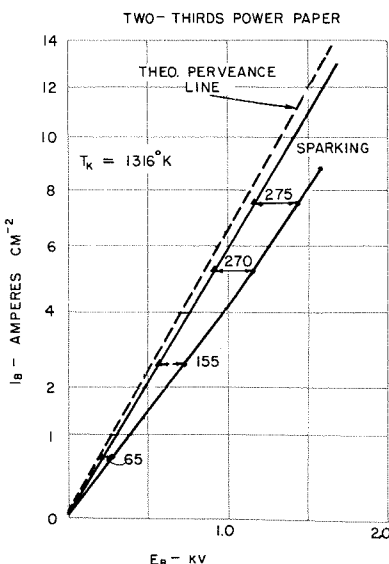

Fig. 4—Eisenstein's data on cathode resistance.

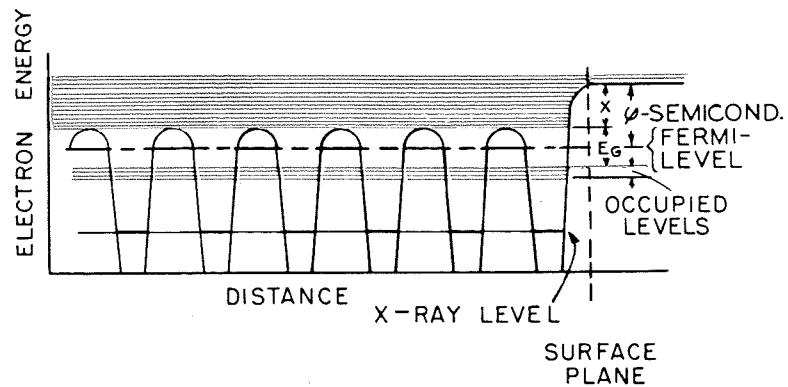

Fig. 3—"Splitting" of energy levels of atoms in a crystal may result in energy bands that do not overlap, producing a forbidden gap characteristic of semiconductors or insulators.

and by Matheson and Nergaard of the potential distribution within a cathode coating by means of platinum probes imbedded in the coating indicate that the thickness of the layer is about 10^{-4} cm.

CATHODE RESISTANCE AND TUBE LIFE

The effect of cathode resistance on tube life is illustrated in Fig. 5. The data pertain to eight tubes and the data for the eight tubes have been averaged for each point on the curves. The curve labeled I/I_0 is the ratio of emission to the emission at the beginning of life, both measured in a factory emission test set. The curve labeled P/P_0 is the ratio of power output into a standard load to the power output at the beginning of life. If it is supposed that the drops in emission and power output are due to an increase of cathode resistance, it is possible to compute the change in cathode resistance with life from the I/I_0 curve and then compute a P/P_0 curve for comparison with the experimental curve. The resistance change was computed from:

$$R_K = \frac{I_0^{2/3} - I^{2/3}}{\alpha^{2/3} I}$$

where α is the perveance of the tube. Because the cathode resistance acts as a negative feedback resistor, it reduces the apparent transconductance according to the relation

$$\frac{G_m}{G_{m0}} = \frac{1}{1 + G_{m0} R_K}$$

Finally, the ratio of power output to initial power output is

$$\frac{P}{P_0} \sim \left(\frac{G_m}{G_{m0}} \right)^2$$

When this computation was carried out, the computed values of P/P_0 were in agreement with the measured values. At the end of life, the cathode resistances of the tubes were measured and found to agree with the

resistances computed from I/I_0 . Finally, an attempt to measure emission was made. When the cathode resistance was corrected for, there was no evidence of emission limitation up to an ampere per cm^2 . It appears that these tubes failed solely because of an increase of cathode resistance with life. It also appears that the factory test set did not measure actual emission; it measured a current limited by cathode resistance.

These examples suffice to show that cathode resistance can be a matter of practical concern. A natural question is: Is it possible to reduce cathode resistance? For oxide cathodes the answer is yes; two methods have been exploited for a long time. The first method is "activation" of the cathode, a method that is taken for granted. "Activation" has been believed to be due to production of excess barium in the cathode. The excess barium atoms were thought to produce levels in the forbidden gap, thus increasing the density of thermally excited electrons in the conduction band. Activation certainly produces more electrons in the conduction band; the role of barium will be commented on later. The second method of increasing the conductivity of the cathode which has long been exploited is to make the coating porous. Then electrons are evaporated into the pores of the cathode where they have very long mean free paths so a few electrons can carry a considerable fraction of the total cathode current. The complaint with

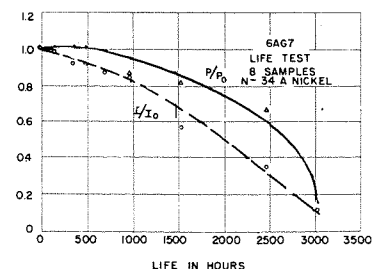

Fig. 5—The effect of cathode resistance on tube life.

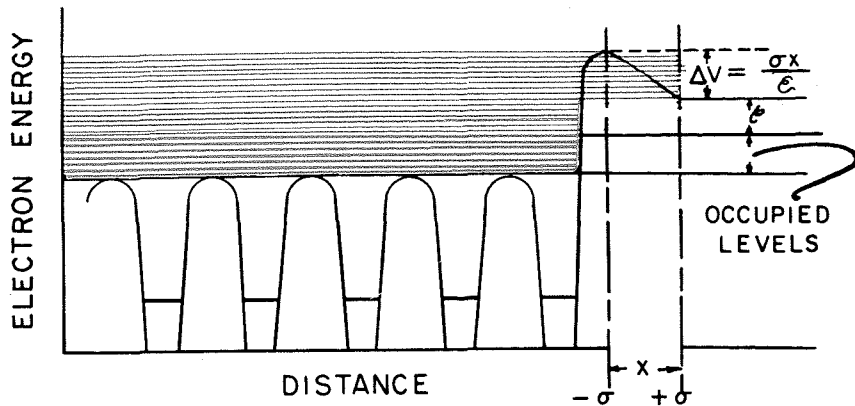

Fig. 6—Reduction of the work function of a metal by building an electret on the cathode surface.

this artifice is that it makes the emitting surface "patchy" and violates the requirement that the emission be microscopically uniform over the surface.

Another method of increasing the conductivity of an oxide cathode is to intersperse metal with the emitting oxides so that much of the current path through the cathode is metallic. This end can be achieved by making a porous metal matrix which is impregnated with the oxides or by mixing a finely divided metal powder with the oxides and then pressing the mixture into the desired form. These methods have the advantage that they yield cathodes of high mechanical strength and cathodes which may be held to close mechanical tolerances. The reduction in cathode resistance is appreciable but not spectacular. Because of the relatively high work function of the exposed metallic surfaces, the emission occurs at the oxide surfaces. To reach these surfaces, the current must flow into the oxide from the metallic particles and pass through some thickness of oxide before reaching the emitting surfaces. If the path length in the oxide exceeds the thickness of the donor depletion layer, the

effect of the metal in increasing the apparent conductivity will be small. Hence it comes as no surprise that matrix and so-called B-N cathodes display pulse decay and appreciable cathode resistances.

METALLIC EMITTERS

In view of the many deficiencies of the semiconducting cathodes, perhaps metallic emitters should be used. As has been noted earlier, the high work functions of metals limits their use to applications where their mechanical and electrical stability are required, and emission efficiency and noise are not primary considerations.

As is well known, the work function of a metal can be reduced by building an electret on the cathode surface as illustrated in Fig. 6. This is done by means of a dipole layer consisting of a monolayer of oxygen on the metal surface covered by a monolayer of some low work function metal, such as cesium or barium. The oxygen underlayer binds the low-work-function metal to the base metal so that the evaporation rate of the low-work-function metal is greatly reduced. However, the evaporation rate is still appreciable. Furthermore, the dipole

layer is easily removed by ion bombardment so that any gas in a tube has a serious effect on the emitter. To mitigate these difficulties, A. W. Hull invented the dispenser cathode in which a reservoir of active material replenishes the dipole layer as it is lost by evaporation or bombardment. In recent years the dispenser cathode has again received much attention. The Lemmens ("L") and Katz ("M-K") cathodes are familiar examples. In some of these cathodes, alkaline earth oxides and a reducing agent are stored in a reservoir. The reducing agent reacts with the oxides to produce free metals which proceed to the emitting surface through a porous plug by surface diffusion or by Knudsen flow through the pores. If the reducing agent reacts rapidly, the porosity of the plug controls the rate of replenishment; if the reducing agent reacts slowly, the rate of reaction controls the rate. In other versions, alkaline earth compounds (oxides, silicates, and aluminates are used) are compacted with finely divided metal powder to form the emitter. These cathodes are mechanically stable and can be made with precision. Because any loss of dipole layer is replenished, they can be operated at temperatures where they yield emissions of amperes per cm^2 . However, the increased temperature also increases the thermal noise so these cathodes have their limitation in low noise tubes.

SUMMARY OF CATHODE PROPERTIES

To sum up:

1. The pure metal cathodes with a latent heat of evaporation high enough to make them useful have a low internal impedance and a high work function.

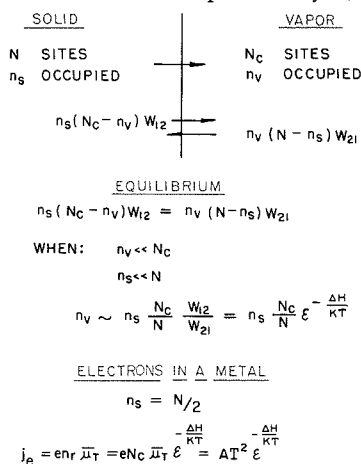

Fig. 7—Solid-vapor relationships in the equilibrium between cathode and a "vacuum."

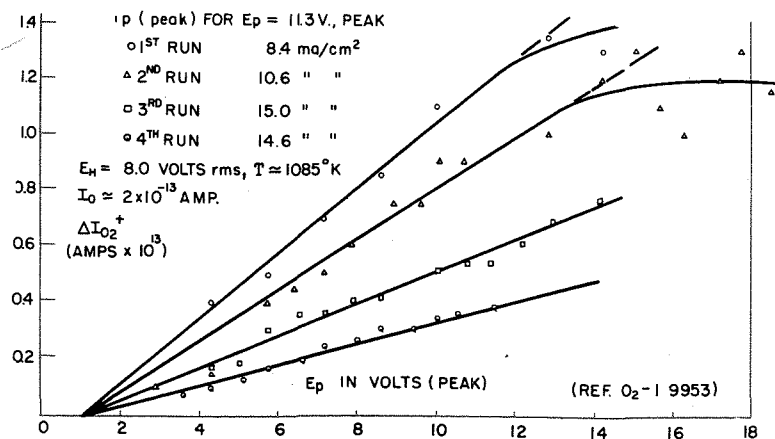

Fig. 8— O_2 evolution from BaO cathode.



LEON S. NERGAARD received the B.S. degree in Electrical Engineering from the University of Minnesota in 1927, the M.S. degree from Union College in 1930, and the Ph.D. degree from University of Minnesota in 1935. From 1927 to 1930, he was in the research laboratory and vacuum-tube engineering department of the General Electric Company; from 1930 to 1933 a teaching assistant in the department of physics at the University of Minnesota; from 1933 to 1942 in the research and development laboratory of the RCA Manufacturing Company; and since 1942 at the RCA Laboratories in Princeton, N. J. Dr. Nergaard is a member of Sigma Xi, Fellow of the American Physical Society, member of the American Association for the Advancement of Science, and a Fellow of the Institute of Radio Engineers.

2. The metal cathodes with a dipole layer on the surface have a low internal impedance, a lower work function than the pure metals, can be operated at temperatures where emission densities of amperes per cm^2 are available if the dispenser principle is used, have a thermal noise lower than that of pure metal emitters but higher than that of semiconductors, at least in the frequency range above a few tens of cycles per second.

3. The semiconducting cathodes have a very low work function, a higher internal resistance than the metallic cathodes, yield emission densities of tens of amperes per cm^2 under microsecond pulse conditions, and about an ampere per cm^2 under dc conditions, both at a temperature lower than that of the metallic cathodes, show pulse decay, are apt to have patchy surfaces if the internal resistance is reduced by making the emitter porous, have the low noise that goes with a low temperature except in the very low frequency range where flicker effect dominates the noise.

It appears that no one cathode has all of the desirable attributes. Hence

the choice of cathode is determined by that compromise which meets the requirements of the particular application most closely.

LIFE, EVAPORATION, AND POISONING

Life, evaporation, and poisoning are so closely related that they are best discussed together.

The first and most important thing to be said on this subject is that a cathode does not live in a vacuum. In a "vacuum" of 10^{-7} mm. of mercury about 3×10^{-2} monolayers of atoms are deposited upon the emitting surface every second. If all of this material accumulated, the thickness of the cathode would increase about 2 mils (0.005 cm) in a 1000 hours. This would play hob with the spacings in a closed-spaced tube, to say nothing of what would happen to the emission of the cathode. The real point is that the material does not accumulate; it evaporates. Thus, the cathode lives in dynamic equilibrium with the gases which surround it.

It is worth while to explore the equilibrium between a cathode and its surroundings in more detail. Consider a solid in equilibrium with vapor as suggested in Fig. 7. The solid contains N sites where atoms of the vapor can reside and n_s of these sites are occupied by atoms of the vapor. The "vacuum" contains N_c sites where the vapor atoms can reside and of these sites n_v are occupied. N_c is a number per cm^{-3} which can be computed from kinetic theory and is the same N_c computed by Shockley for the apparent number of states in the conduction band of a semiconductor. There are n_s vapor atoms in the solid and $(N_c - n_v)$ places they can go in the vacuum so the rate at which these atoms move to the vapor phase is

$$n_s(N_c - n_v)W_{12}$$

where W_{12} is the probability that an atom will make the transition. Similarly, the rate at which atoms move from the vapor phase into the solid is

$$n_v(N - n_s)W_{21}$$

where W_{21} is the probability that an atom will make the transition. In thermal equilibrium, these two rates must be equal, i.e.,

$$n_s(N_c - n_v)W_{12} = n_v(N - n_s)W_{21}.$$

W_{12} and W_{21} are difficult to determine

individually, but kinetic theory states that the ratio W_{12}/W_{21} is related to the energy difference between the two states by the relation

$$\frac{W_{21}}{W_{12}} = e^{-\frac{\Delta H}{kT}}$$

With present sign convention ΔH is the latent heat of evaporation, i.e., the energy to move an atom from the solid to the vapor phase. :

It frequently happens that

$$\begin{aligned} n_v &<< N_c \\ n_s &<< N \end{aligned}$$

Then the equilibrium equation may be written

$$n_v \sim n_s \frac{N_c}{N} e^{-\frac{\Delta H}{kT}}$$

When this relation holds, the atoms of the vapor phase are said to form an ideal solution with the atoms of the solid.

Because the partial pressure of the atoms under consideration is proportional to the density of these atoms in the vapor phase, this relationship says that the partial pressure of these atoms is directly proportional to the density of the same atoms in the solid. Conversely, it says that to maintain a given concentration of specific atoms in a solid requires a definite partial pressure of these atoms in the vapor phase. The latter conclusion has a very embarrassing consequence: It requires a barium partial pressure of 10^{-6} mm of mercury to maintain that excess barium content in an oxide cathode which has been believed necessary for an active cathode. Hence if excess barium were responsible for cathode activity, an active cathode would be impossible in a tube which is pumped to the usual pressure of 10^{-7} mm mercury or better. This dilemma is not wholly resolved as yet, and it must suffice to say that there are possibilities other than excess barium which may account for the activity of the cathode and which are produced by chemical reactions resembling those that produce excess barium.

While the content of a cathode is proportional to partial pressures of the constituents in the gas phase, the constant of proportionality depends on the latent heat of evaporation of the constituent. If the latent heat is high, it requires a very small partial pressure to maintain a constituent in the cathode or in any other electrode.

This applies equally to electrons, and the Richardson equation can be derived directly from the thermal equilibrium equation.

Obviously, the latent heat of evaporation of electrons ΔH must be small for high emission at a given temperature, i.e., the energy required to remove an electron from the cathode should be small. In chemical terms, the cathode should be a strong reducing agent. When the cathode is thought of as a reducing agent, it is apparent that a cathode is by its very nature subject to poisoning.

These considerations suggest that a search for a highly emitting cathode that will not poison will be fruitless. The best that can be hoped for is a cathode that will recover rapidly when the oxidizing agent is removed.

ACTIVATING MECHANISMS

So far, thermal equilibria have been touched upon. There remain the dynamic equilibria which occur in "vacuum tubes." These occur because of chemical reactions which do not reach a static equilibrium within the life of tube or because of power sources external to the tube. An example of a non-equilibrium chemical reaction is the action of the reducing agents used in some oxide cathodes and in dispenser cathodes.

The dynamic equilibria which result from external power sources are just coming under study. The mass spectrometer studies of Plumlee show that the concentration of many constituents of a cathode are altered by the application of a field. The case of O_2 is shown in Fig. 8. The cathode was a BaO cathode mounted within an anode which was apertured to permit evaporation products from the cathode to enter the mass analyzer. The total pressure was about 10^{-7} mm of mercury of which about one tenth was due to O_2 . When voltage was applied to the diode in the inactive state, the height of the oxygen peak was observed to increase with voltage as shown by the top curve in Fig. 8. If voltage was left on for a period, the cathode activated and the dependence of the oxygen peak on voltage fell to a lower curve.

Studies of the kind described immediately above have not been carried to the point where it is possible to assay

the role of power sources external to the tube in maintaining favorable dynamic equilibria. However, present results suggest that the field enhanced evolution of oxygen and the concomitant activation of the cathode may in part be responsible for the long life of oxide cathodes. These studies also suggest that not enough is known about the behavior of a cathode in its natural habitat to establish just what determines its life. For metals in a good vacuum, evaporation of the metal determines the life; if gas is present, sputtering or chemical erosion may determine the life. For dispenser cathodes, exhaustion of the reservoir will determine life and the rate of exhaustion may well be increased by the presence of gas in the tube. For semiconducting cathodes, the end of life may be determined by complete evaporation of the semiconductor; usually it is determined by a loss of the donors which make the cathode active. The rate of loss of donors is in part determined by the cleanliness of the tube and, in tubes where great care has been exercised to assure cleanliness, tubes still survive after hundreds of thousands of hours.

CONCLUSION

This brief glimpse into the world in which the "cathode expert" lives may give the impression that this world is

gloomy and unproductive. The inhabitants view it in a different light. They realize that the 100 known elements taken n at a time yield a staggering number of possibilities for new cathodes. However, they are greatly encouraged by the fact that their present meager knowledge greatly reduces the field to be explored and they are thus impelled to seek the further knowledge which will delimit the field more closely.

On the positive side, the increasing knowledge of the physics and chemistry of solids brings closer the day when it will be possible to predict the electron affinity of a semiconductor or insulator (the energy required to remove an electron from the conduction band to infinity) from physical and chemical data on the constituent atoms and to predict what additives will produce chemically stable donor states close to the bottom of the conduction band in a given solid. It may well be that this knowledge will develop rapidly enough so that better cathodes will be achieved in this way rather than by exhaustion of all possibilities.

At the same time, "cathode experts" are realistic and do not seek a universal cathode appropriate to every application. If they can arrive at a satisfactory compromise cathode for each cathode application, they will be as happy as a "cathode expert" can be.

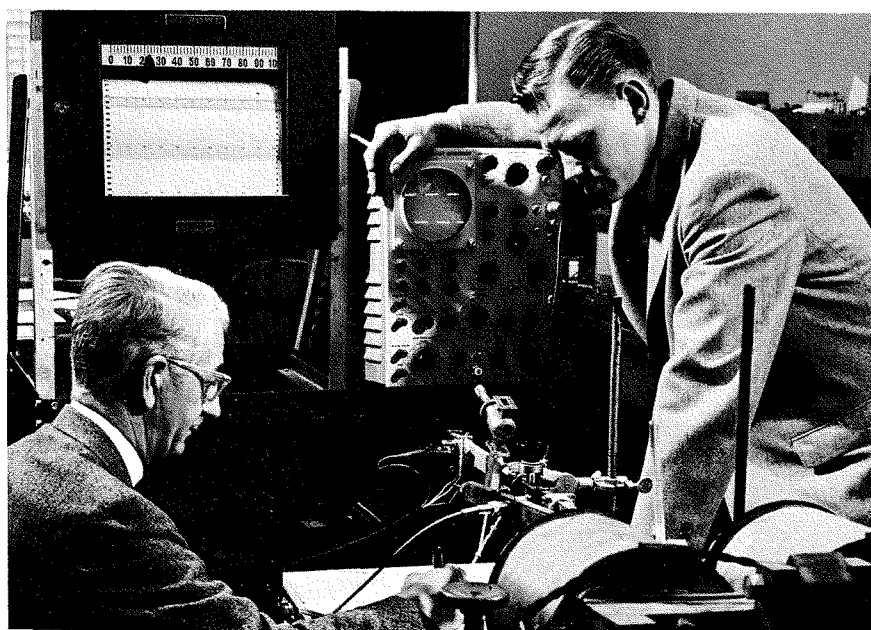

Dr. L. S. Nergaard and B. E. Tompkins with paramagnetic resonance equipment to be used in the study of the active centers in oxide cathodes.

ROLE OF BROADCAST ENGINEERS IN CUSTOMER RELATIONS

by **JOHN H. ROE**, *Manager,*
TV Camera Engineering
Commercial Electronic Products
Camden, N. J.

STRANGE AS it may seem, the establishment of television broadcasting as an accepted public service in the United States is now largely a matter of history. But it is recent history, having taken place within the past decade, and it is one of the most amazing developments among the technological advances in human society. There are several reasons why the average citizen has taken it so readily into his home and his life, reasons which include both entertainment and education, as well as a tremendous flow of information which advertising brings to him about products he can buy to increase the richness and pleasure of living.

EARLY NEED SEEN FOR COMBINING ENGINEERING SKILLS

The rapid development of such a complex and far-flung service has been possible only through the interlocking of the talents and efforts of people in many different arts and

trades. Not the least among these have been the highly trained scientists, engineers, and technicians who first conceived and developed the telecasting system and the equipment, and then provided the information and training for the army of skilled people who install, operate, and maintain that equipment.

During the years after World War II when the TV industry was going through its birth pangs, the enormity of the problem of educating the prospective owners of television stations became apparent. Many were already experienced owners of AM radio stations, and thus had a nucleus of operating technicians who were familiar with basic radio circuits and equipment. However, the operation of television transmitters and studio

equipment required an extension of their knowledge into a whole new field involving not only vastly more complex equipment, but also many new exacting techniques and even a new vocabulary of technical terms.

TECHNICAL TRAINING PROGRAM PROVIDES THE ANSWER

Realizing that the most effective way of transferring the needed information to the broadcasters was to put them into direct contact with the design engineers, RCA instituted a series of training programs, or seminars, to which were invited selected groups of engineers and station managers who either had bought, or were planning to buy, studio and transmitting equipment. These students, in this new kind of school, spent a period of five days in Camden, absorbing from the design engineers a concentrated dose of information, embracing technical subjects all the way from the philosophy of the system,

TYPICAL LIST OF PARTICIPATING ENGINEERS

(This list includes lecturers for the 21st TV Training Program and is typical of the contribution by Engineering.)

SPEAKER	ENGINEERING SPECIALTY
L. E. Anderson . . .	Monochrome and Color TV Systems
A. Banks	TV Control Room Equipment
W. M. Baston (NBC)	
	Microphones & Microphone Techniques
R. R. Davis (NBC) . . .	Network Technical Operations
R. C. Dennison	TV Stabilizing Amplifiers
W. J. Derenbecker	TV Color Camera
W. T. Douglas	VHF Broadcast Transmitters
O. O. Fiet	UHF Broadcast Antennas
T. U. Foley	UHF Filterplexers
H. E. Gihring, Mgr.	Broadcast Antennas
E. E. Gloystein	TV Test Equipment
I. E. Goldstein	TV Systems
J. L. Grever	Television Monitors
P. C. Harrison	TV Terminal Auxiliary Equipment
N. L. Hobson	TV Vidicon Cameras
R. S. Jose	VHF Television Transmitters
J. E. Joy	UHF Television Transmitter
E. Keith	Audio Systems & Custom Design
D. Kentner, Mgr.	Broadcast Transmitters
A. H. Lind, Mgr.	Broadcast Audio

SPEAKER	ENGINEERING SPECIALTY
A. L. Luther	Sync Generators
R. J. Marian	Film Cameras
W. N. Moule	Transmission Line
C. R. Myers	VHF Broadcast Antennas
N. J. Oman	Color Broadcast Transmitters
E. H. Potter	UHF Broadcast Transmitters
J. H. Roe, Mgr.	Television Studio Equipment
C. Rosencrans	Microwave Equipment
D. F. Schmit, Vice President	Product Engineering
E. H. Shively	UHF Broadcast Antennas
R. J. Smith	Television Switching Equipment
C. J. Starner	High-Power Transmitters
F. E. Talmage	VHF Broadcast Transmitters
D. M. Taylor	Colorplexers
R. G. Thomas	Switching & Distribution Equipment
J. Wentworth, Mgr.	Color TV Equipment
H. Wescott	VHF Broadcast Antennas
L. Wetzel	UHF Broadcast Antennas
L. J. Wolf	Custom Antennas
H. G. Wright	TV Projectors



Fig. 1—Photo taken during one of thirty or more TV Technical Seminars conducted by RCA Broadcast engineers.

through details of circuits and mechanisms, to informal sessions on questions such as "How does this work?" and "What should I do if that happens?" Typical subjects were: "Historical Sketch," "Fundamental Concepts," "Video Amplifier Circuits," "Deflection Circuits," "Image Orthicon Cameras," "Iconoscope Film Cameras," "Switching Systems," "Station Layout," "Transmitter Circuits," "Antennas," "Pick-up Tubes," "Significance of FCC Standards," "Television Film Projectors," and "Microwave Relay Equipment."

At most of these meetings, as many as forty to fifty technical topics were discussed in detail over a five-day period. Lectures on studio equipment usually occupied from 1½ to 2 days, followed by a day of tours of engineering laboratories, and demonstrations of actual operating equipment in experimental studios. During these tours, the visitors were assembled into relatively small groups which permitted active questions and

answers, and in many cases opportunities to "twist the knobs" and to learn from actual "feel" how to operate successfully. This was followed by two days of a similar program on transmitters and antennas.

RCA ENGINEERS CHOSEN AS LECTURERS

Probably one of the most effective features of these seminars has been the assignment of development and design engineers to present all of the lectures and demonstrations. This close contact between engineers and customers has had a many-sided effect. First of all, it has provided a direct channel for unadulterated information to and from the broadcasters. Then it has served to establish even further the feeling of cordial friendliness between engineers and customers, and has encouraged a desirable continuation of such friendship over the years. Next, it has emphasized an often-neglected aspect of engineering, the need for developing the art of effective self-expression. Perhaps most important of all, it has made the en-

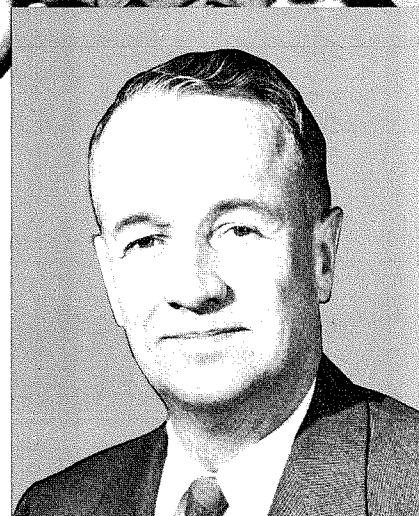

JOHN H. ROE received his BS in EE in 1930 and his MS in EE in 1932 from University of Minnesota. He did research work at the University until 1933. He then joined RCA as a Tester for returned photophone equipment and became a Student Engineer in 1935. From 1936 to 1947 he worked on TV studio equipment and in January of 1947 became Unit Supervisor in the TV Terminal Engineering. In July 1948 he was made Supervisor of Camera Engineering in the TV Terminal Section. He has held his present position, Group Manager, TV Cameras and Microwave, since 1952. In this capacity he is responsible for development and design engineering on all types of TV cameras for broadcast stations, microwave equipment for TV program relaying, and on kinecope recording and large-screen TV projection.

Mr. Roe is a Senior Member of IRE, Member of SMPTE, Tau Beta Pi, Eta Kappa Nu, and Sigma Xi.



Fig. 2—C. R. Monro and R. T. Ross of Television Terminal Engineering describe technical operation of new TV control console to group of Television Station engineers.

Fig. 3—H. G. Wright and R. D. Houck of TV Film and Projector Engineering describe design features of Professional TV projector.



gineers much more conscious of the commercial aspects of the business and of the customer's point of view with respect to both techniques and standards of performance. Becoming familiar with this point of view, of course, equips the engineer with knowledge of technical station operations which leads to better products.

To add interest and to round out the program, it has been customary to include special lectures on pickup tubes by engineers of the Tube Division, lectures on TV receivers by the Television Division, and lectures on the use of microphones and audio techniques, as applied to television studios, by experienced operating engineers from NBC. A guest lecture of unusual interest, also given by NBC engineers, has been an outline of studio lighting problems and methods. A further feature has been an afternoon or evening guided tour to some center of interest outside of Camden such as the NBC studios in New York, the David Sarnoff Research Center in Princeton, or one of the television stations in Philadelphia.

AUTHORITATIVE TECHNICAL MANUAL ESSENTIAL

During the formative stages, brief technical manuals were well received by TV station engineers at the early training meetings. Further seminars and additional experience revealed a definite need for a wide-scale expansion of this information. Nearly sixty RCA design engineers provided sufficient source material for the publication of a comprehensive 500-page training manual. The descriptive material was written particularly for television station personnel concerned with maintenance, design or planning of equipment. Made up of four sec-

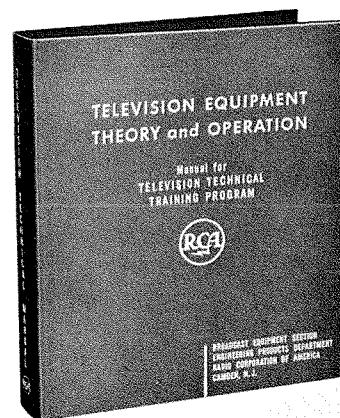

tions (Transmitters, Antennas, Video and Audio), the content paralleled the seminar lectures. Theory and operation of each class of equipment was described and practical equipment layouts illustrated. Data and specifications were included at the end of each section.

The technical manual became the most complete individual reference source available to TV station engineers. Its popularity extended to colleges and schools which placed sufficient orders on RCA to warrant reprinting.

OVER 50 ENGINEERS PARTICIPATE IN MORE THAN 30 MEETINGS

The first Television Technical Training Seminar was held in May 1947. Since that time there have been 31 seminars for broadcasters at an average frequency of more than three per year. Four of these were presented on the West Coast. With the advent of color, it became desirable to initiate some special seminars, on color only, during the early phases of development. These special sessions on color were held for two-day periods. As color has gained stature and become more thoroughly integrated with existing black-and-white systems, the training programs have been reorganized to present a consolidated view of the complete system. It is expected, however, that the two-day color short-course will be continued as color activity expands in the stations. In addition to serving the broadcasters in this way, RCA has provided similar training to professional consultants in a series of five special seminars.

Altogether, more than 2500 persons in the industry have attended the seminars including representatives from over 20 foreign countries. More than 50 engineers have participated in this training activity. (See list of speakers for 21st Training Program which typifies the wide scope of meetings.)

CONCLUSION

The mutual benefits of these get-togethers have been obvious to RCA as an excellent channel for obtaining practical operating viewpoints and for cementing good customer relationships, and to the customer as a means for a liberal and rewarding education in a new and profitable business.

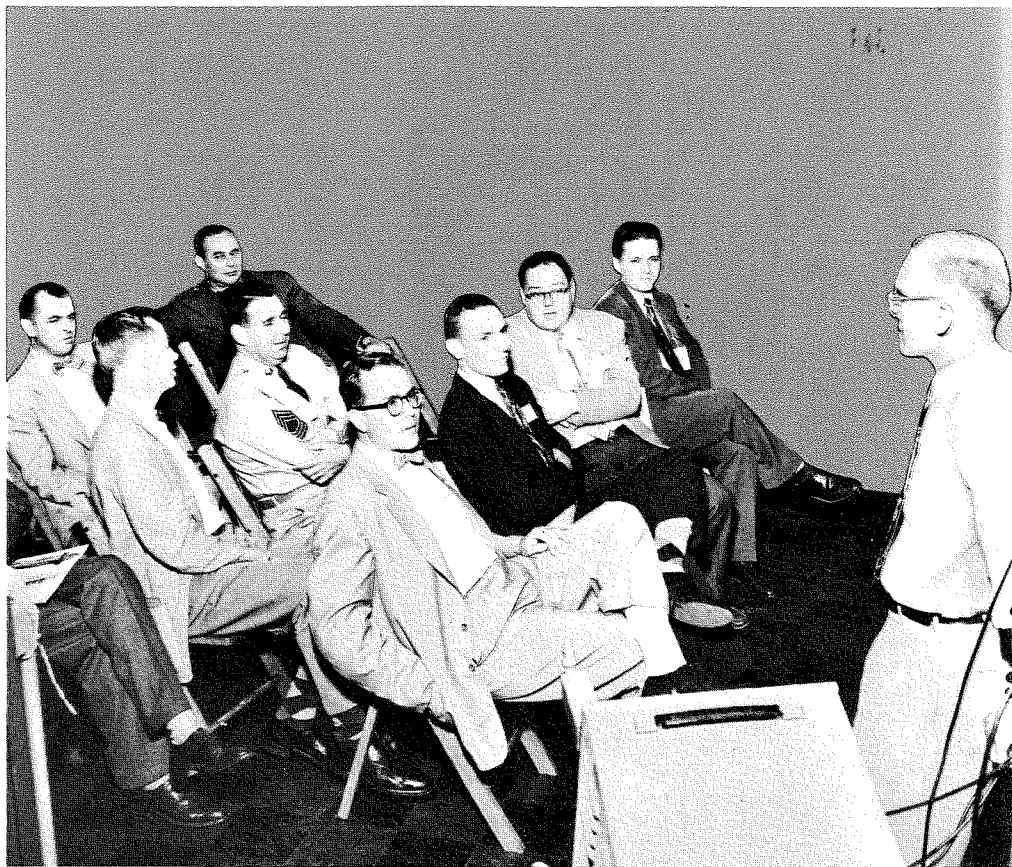

Fig. 4—J. B. Bullock of TV Microwave Engineering answers the questions of TV station engineers concerning new Microwave equipment used for color and black and white television.

AUTHOR'S NOTE

Though engineers have been responsible in large measure for the effectiveness and success of these training seminars, a great deal of credit is due to members of the Broadcast Marketing organization who have coordinated the many details of the programs from their inception. In particular, Mr. E. T. Griffith, Manager of Broadcast Customer Relations, and the members of his staff are to be congratulated on their efforts.

The comprehensive nature of the seminars reflects the close contact maintained by the Customer Relations Group with both TV Station Engineers and RCA Design Engineers. The basic planning and growth of these meetings is under the direction of Mr. E. T. Griffith, who joined RCA in 1929 in the Office Services Department.

Mr. Griffith worked several years in

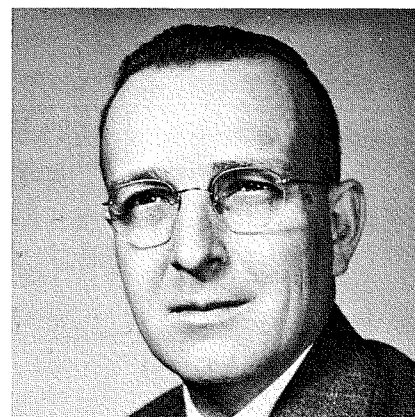

Accounting and Auditing activities and in 1942 joined the Engineering Products Division. He was active in Broadcast Sales and Commercial work and in 1952 became Manager of Broadcast Customer Relations.

Mr. Griffith is a graduate of Temple University, School of Commerce, and a member of Pi Delta Epsilon.

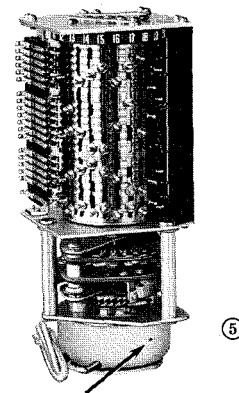
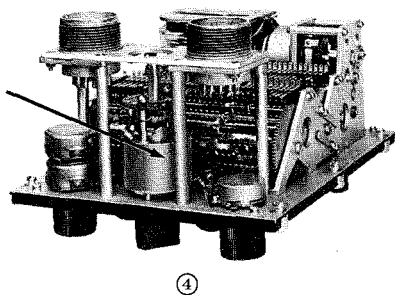
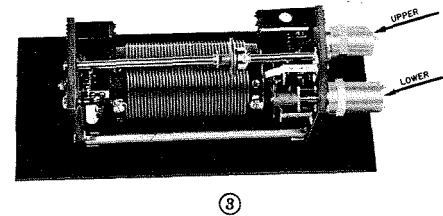
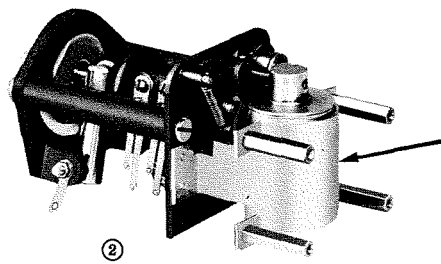
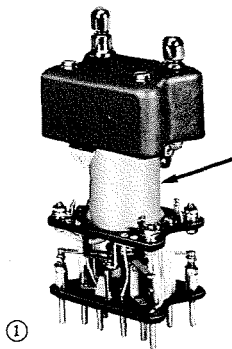

DESIGN OF D-C TRACTIVE ELECTROMAGNETS*

by **M. R. ALEXY**

*Aviation Electronics Engineering
Defense Electronic Products
Camden, N. J.*

Several components designed by the author using typical d-c tractive electromagnets are illustrated in Figs. 1 to 5. These electromagnets were designed using the method described and the curves. Pertinent data on these electromagnets are listed in Table I. Several general types of electromagnets are shown in cross section in Figs. 6 through 10 and include the following:

1. Flat-faced armature type (Fig. 6) is primarily intended to produce a large force through a short stroke. It offers a large holding surface due to its multiple working air gaps, consequently it is used extensively as a lifting magnet.

2. Horseshoe or bipolar type (Fig. 7) is also of the armature type, but with two working gaps. It is used for smaller loads than the flat-faced type. The stroke is about the same.

3. Flat-faced cylindrical plunger type (Fig. 8) is designed to produce a smaller force for a longer stroke than the armature type.

4. Conical-faced plunger type (Fig. 9) is similar to No. 3, except it produces still smaller forces through longer strokes.

ALL BUT the most complex types of d-c electromagnets may be designed using well established mathematical formulas. However, the calculations involve terms not readily manipulated by the engineer who designs such a device only occasionally. To ease the task, a simplified design method has been developed. It makes use of a series of measurements made on practical electromagnets of several different sizes under various conditions. Since the magnets measured were representative of those encountered in practice, all factors that might affect the design are inherently accounted for.

Force developed by the magnet plunger was measured for various air gaps between the plunger and the core, for plungers of different diameters, for a range of values of ampere-turns, and for flat-faced and conical shaped plungers. By the use of these measurements, and consideration of the basic design considerations discussed in the following paragraphs, it is possible to design d-c tractive magnets to suit the needs of a variety of purposes. As an aid in using this design method, the step-by-step solution of a typical problem is presented using data that might normally be expected.

ELECTROMAGNETS (arrows) in the devices illustrated were all designed using the method described in this article. Fig. 1—High voltage relay having a lateral motion. Fig. 2—High voltage relay having a rotary motion. Fig. 3—This revolving coil is stopped by a brake operated by "Upper" electromagnet and is shorted and removed from circuit by high voltage relay marked "Lower". Fig. 4—Control Switch. It is manually latched and electrically unlatched. Fig. 5—Coding device in which electromagnet produces a rotary motion.

5. Conical-faced core type (Fig. 10) is, from the theoretical standpoint, the most efficient type of small force, long stroke design.

This article is primarily concerned with electromagnets having cylindrical flat-faced plungers (Fig. 8) and those having conical-faced plungers (Fig. 9). The curves of developed force vs. length of air gap shown in Figs. 11 to 14 were plotted from data obtained from electromagnets of these types. Before the curves can be used properly, it is necessary to consider a number of design factors discussed in the following paragraphs.

MATERIAL SELECTION

The material used for the magnetic circuit (plunger, core, shell) in these electromagnets is SAE 1113. This is a high sulphur, cold finished, free cutting bar steel with reasonably high permeability at low flux densities. The

*Originally published in the July, 1955 issue of "Electrical Manufacturing." Reprinted with permission.

force-gap curves are based on the use of this steel.

It was selected because of its ease of procurement, cost, ease of machining and good magnetic properties as related to the average requirements of tractive electromagnets.

Other materials exhibit better magnetic characteristics than SAE 1113. However, all have disadvantages that would tend to make their use less desirable. Such materials as the various grades of electrical steel, Swedish iron, Permalloy, Alnico, Cunife, etc. may be expeditiously used in certain critical applications where a particular characteristic is desired. The application might call for a material with a high permeability (low reluctance), lack of retentivity (residual magnetism), ease of saturation, etc. In such special cases it might be better to use one of the materials mentioned.

Pure iron has very desirable magnetic properties when it has no occluded air. It has almost infinite permeability with zero hysteresis. Yet the force applied through a given air gap is not materially greater than for SAE 1113. A decided disadvantage of such iron is that its properties are affected by the presence of minute quantities of impurities.

Another example is the case of Permalloy which saturates with very

low flux densities. This means that with a lower value of ampere-turns than with SAE 1113 it will reach its maximum magnetism. For a slight increase in ampere-turns, the same force will be available in both materials. Also, SAE 1113 need not be annealed or ground to shape.

Almost all materials could be discussed along these lines, tending to support a conclusion that SAE 1113 or any other material in this family is a good overall material to use.

Heat treatment of magnetic materials is important in order to obtain optimum results. Annealing and other heat treatments will reduce the lattice distortions tending to increase the permeability, decrease the reluctance, decrease the retentivity, improve the machinability, etc. This is particularly true in the case of the special magnetic materials, but is not important with SAE 1113. In fact, it has been demonstrated that the force or pull across a gap will be reduced in the order of 10 per cent when the magnetic circuit using SAE 1113 is annealed. It is true that the retentivity has decreased, but this is generally of secondary importance in an electromagnet.

PLUNGER AND CORE SHAPE

The shape of the plunger and core is perhaps the most important consideration in tractive electromagnet design.

The shape will determine the slope of the force-gap curves. The requirements of the electromagnet will dictate what shape to use. For instance, if the problem involves a large force in conjunction with a small stroke, then the proper choice would be the flat-face plunger and core. On the other hand, if a small force over a long stroke is required, then the conical plunger and core should be selected.

The curves indicate the force to be expected when flat-faced plungers and conical plungers having included angles of 30, 60, and 90 deg are used. Theoretically, in the case of the flat-faced shape, the force should vary inversely as the square of the gap. A considerable discrepancy exists between the theoretical and actual values of force *vs.* gap. This is logical, however, when one considers that established laws disregard, at least to some extent, such important factors as (1) magnetic concentration, (2) magnetic leakage, (3) air gap location within the coil, (4) proportions (length to diameter ratio) of the coil and (5) friction between plunger and bearings. Since the curves were established by actual measurements and include the effects of these factors, they can be used with more success to determine the plunger shape than resorting to a mathematical solution.

Table I—Characteristics of Electromagnets in Applications Illustrated in Figs. 1-5

Fig. No.	Shell Size (in.)	Plunger Stroke (in.)	Shape & diameter of cylindrical plunger	Duty cycle	Plunger Movement	Load Movement	Incidental features	Applications
1	1 diam 1 $\frac{1}{16}$ long	$\frac{1}{4}$	$\frac{7}{16}$ in. diam, conical, 75 deg included angle.	Continuous	Lateral	Lateral	Includes holding switch actuating external resistor.	High voltage relay. 11,000 volts 24 m.c.
2	1 diam 1 $\frac{3}{8}$ long	$\frac{3}{64}$	$\frac{7}{16}$ in. diam flat $\frac{1}{8}$ in. hole in center.	Continuous	Lateral	Rotary	Includes holding switch actuating external resistor.	High voltage relay. 19,000 volts 24 m.c.
3 upper	1 $\frac{7}{32}$ diam 1 $\frac{1}{32}$ long	$\frac{1}{64}$	1 $\frac{5}{32}$ in. diam, flat.	Intermittent	Lateral	Rotary	Plunger mounted with ball bearings.	Brake for revolving coil.
3 lower	1 $\frac{31}{32}$ diam 1 $\frac{1}{16}$ long	$\frac{7}{32}$	$\frac{3}{8}$ in. diam, 60 deg included angle.	Continuous	Lateral	Lateral	Includes holding switch actuating external resistor.	High voltage coil-shortening relay. 9000 v., 24 m.c.
4	1 $\frac{3}{8}$ diam 1 $\frac{1}{4}$ long	$\frac{7}{64}$	$\frac{3}{4}$ in. diam, conical, 1 $\frac{1}{32}$ in. hole in center 60 deg included angle.	Intermittent	Lateral	Rotary	Manually latched. Electrically unlatched.	Switch for control panel.
5*	1 $\frac{7}{8}$ diam 1 long	$\frac{3}{64}$	$\frac{7}{8}$ in. diam flat $\frac{1}{4}$ in. hole in center.	Intermittent	Lateral and Rotary	Rotary	Provides exceptionally high torque.	Coding device.

NOTE—All electromagnets operate over a voltage range from 20 to 30 volts d-c. The ambient temperature range varies from -55 C to +85 C.
*—The electromagnet element in this illustration is basically one developed and manufactured by the G. H. Leland Co., Dayton, Ohio.

DESIGN OF D-C TRACTIVE ELECTROMAGNETS

continued

In general, it can be stated that flat shapes work best when the gap between plunger and core is small. The force rapidly diminishes as the gap is increased. Tapered plungers will straighten the force-gap curve, tending to permit the force to remain constant over a long stroke. It is even possible to increase the force as the gap increases, as shown on Fig. 11 for the 30-deg plunger.

It should be noted that the force available at the smaller gaps is greatest for the flat plunger and decreases the sharper the plunger is made. This is because, with tapered plungers, the permeance of the air gap is caused to increase less rapidly with motion of the plunger than would be the case if it were flat. Hence, as the air gap gets smaller, the effective force is decreased relative to the flat arrangement. This is especially so for gaps smaller than 1/16 in.

SHELL AND MAGNETIC CIRCUIT

The magnetic circuit is the metallic path for the magnetic flux generated by the coil. In the illustrations of Figs. 1 to 5 this path or shell assumed the shape of a cylinder. This was a choice of convenience rather than necessity. The shape of the shell has only a minor effect on the efficiency of the electromagnet. It can be almost any shape, providing sufficient material is present to insure flux conduction without attenuation or concentration.

The factor governing size is that the cross-sectional area of the shell must be no less than that of the plunger. For purely mechanical reasons it might in some instances be desirable to have the shell larger in cross section than the plunger. This, however, will not help the magnetic characteristics. In fact, it has been shown that an electromagnet with a shell completely surrounding the coil was only approximately 50 per cent better than one without a shell.

Small air gaps at the joints of the shell are of little consequence because of the relatively large air gap between

the plunger and the core. For all practical purposes they can be disregarded, and no attempt should be made to design a "gapless" shell. The air gap between the plunger and the shell in the area where the plunger enters the shell can be made quite large and still not materially affect the performance. The electromagnets shown have a total clearance of 0.040 in. (0.020 each side). To reduce this clearance to a very small value will cause trouble in lining up the plunger and shell with the possibility of severe flux concentrations causing magnetic or even mechanical friction. These undesirable forces can assume values that will sharply decrease the force available.

AIR GAP LOCATION

The location of the air gap within the coil is a very important factor and, strangely, one that is overlooked to a considerable extent. This factor has been analyzed by testing an electromagnet similar to that shown in Fig. 12. The test consisted of varying the location of a constant air gap from one extreme of the coil length to the other. The force developed across this air gap for different locations of the air gap was measured for various shaped plungers and various values of ampere-turns. The conclusions indicated that the optimum air gap location should be in the middle third of the coil length.

Considerable importance should be attached to gap location since variations of as much as 50 per cent were measured. This means that a design which places the air gap in the approximate center of the coil will exert in the order of 10 to 50 per cent more force than one where the air gap is near either end of the coil.

Electromagnets with smaller potential forces, and hence lower values of ampere-turns, seem to vary less with air gap location with the variations being about 10 per cent. If in the same electromagnet the ampere-turns value is increased by increasing the voltage, the potential force will increase and the location will become more important. The latter instance is the case where as much as a 50 per cent variation in force or pull will exist.

COIL DESIGN AND IMPREGNATION

There are many options open to the engineer in selecting the method of fabrication of the coil. The following is a partial list of possible choices: (1) Paper section, (2) cotton interwoven, (3) form wound, (4) ribbon wound, (5) strap wound and (6) bobbin wound. The bobbin wound coil adapts itself best to the small electromagnet and is the method used in those illustrated in Figs. 1 to 5.

Bobbin wound coils can be inexpensively made with the wire, (generally fine wire AWG No. 24 to No. 36) wound directly on the bobbin in random layer fashion. The author has used nylon bobbins molded to size with success. Nylon can be molded in very thin sections (0.012 in. thick) and still retain sufficient strength to hold the winding together and without collapse of the bore. It is not affected over a temperature range from -55°C to $+125^{\circ}\text{C}$.

There are many choices of wire. Each type has a peculiarity that makes it desirable for some special requirement. Below are listed some of the possible choices, the basic wire being copper: (1) Enamelled, (2) enamelled nylon covered, (3) enamelled silk covered, (4) enamelled cotton covered, (5) enamelled silicone coated, (6) Thermaleze, (7) nylon resin coated, (8) Teflon resin coated, (9) Kel-F resin coated, (10) Formvar coated, nylon covered and (11) Formvar coated.

Formvar (polyvinyl acetal) coated wire was used in the components of Fig. 1 to 5. Formvar possesses characteristics making it a good choice for many conditions. It can be used con-

Fig. 6—Electromagnet with flat-faced armature. Fig. 7—Horseshoe electromagnet. Fig. 8—Flat-faced cylindrical plunger electromagnet. Fig. 9—Conical-faced cylindrical plunger electromagnet. Fig. 10—Conical-faced cylindrical core electromagnet.

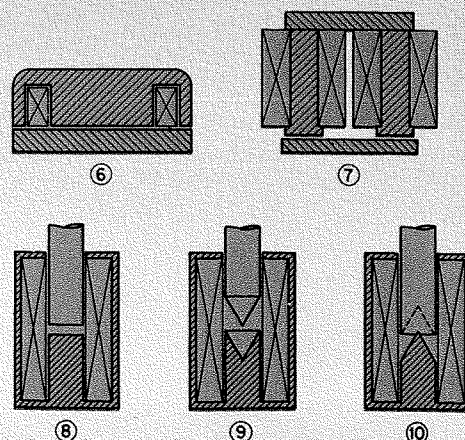

tinuously for temperatures as high as 130C, adds very little to the overall diameter of the wire, is inexpensive and is readily available.

The proportions of the coil, that is, the ratio of coil length to mean coil diameter will affect to some extent the efficiency of the electromagnet. In general, a long coil with a small diameter, and vice versa, will not be as efficient as one with the proper proportions. For small stroke (up to 1/2 in.) electromagnets, the optimum proportions are those where the length is about 1 1/2 times the mean diameter.

Assuming that the ampere-turns necessary to satisfy the problem has been determined, it becomes necessary to calculate the coil values. The total number of turns will be the product of the number of turns per layer times the number of layers. Approximate formulas to arrive at the number of turns are not recommended.

It is also important in this calculation to use the maximum overall diameter of the wire. If this precaution is taken then no difficulties will be experienced in production, since there is always the possibility that the wire used for models may be smaller than the wire procured for production. Coated wire has a tolerance of approximately 10 per cent and therefore the variation between model coils and production coils can vary to this degree. If one is designing closely this variation is of considerable importance.

To compensate for the assumption that the wires lay exactly against one another, an allowance of 3 per cent of the calculated number of turns should be introduced. From experience the author has found this factor to be satisfactory.

If parameters have been established prior to coil calculations in regard to the mean diameter of the coil, then for a given wire size the ampere-turns will remain constant regardless of the length of the coil. One may be misled into modifying the length in an effort to increase or decrease the ampere-turns. The factors that will vary under these conditions are the resistance, current and consequently input power.

Except where it is absolutely necessary, a generous clearance should be provided between the bore of the coil bobbin and the plunger. Total

clearances of 0.030 in. are suggested to eliminate binding caused by an accumulation of tolerances, particularly those that occur in production over and above the expected variations.

The selection of a proper coil impregnation is governed by the application. Accordingly the problem can be simple or complicated. The principal purpose of impregnating is to insure that effects of moisture will not corrode the wire to cause a short circuit within the coil.

Typical processes may vary from coating the outside of the coil with a suitable coil lacquer using a brush to

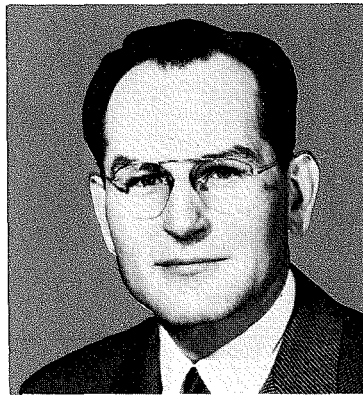

M. RAYMOND ALEXY Mr. Alexy is a graduate of the Drexel Institute Evening School. He joined RCA in 1936 and was engaged in work on the Automatic Record Changer Design in the Home Instrument Division. In 1945 he transferred to E.P.D. and at present is an "AA" Mechanical Engineer in the C&N Section of the Aviation Department, DEP. Mr. Alexy has had several technical articles published in trade magazines, and has six patents to his credit.

casting the coil in any of a number of formulations.

The illustrated components were designed to meet the requirements of a specification invoking protection against 30-day humidity (100 per cent relative with condensation), 50-hr salt spray, a temperature environment over a range from -61 C to +85 C with the maximum hot spot temperature not to exceed +121 C.

The choice made here was a process involving the vacuum impregnation of the coil with Stypol. This process is quite involved, but with results that completely satisfy the requirements. It also has the advantage of building up only a thin film, rather than a very heavy layer as found in some

other compounds that are otherwise satisfactory.

HEAT DISSIPATION

Electromagnets are designed with the heating losses (copper losses) as one of the major limitations. The significance of this statement cannot be overstated. A satisfactory magnet for ordinary conditions can be unsatisfactory at elevated temperatures if it has not been properly derated. Derating the magnet involves many factors, the most important of which are: (1) Loss in ampere-turns when the ambient temperature is increased causing the wire resistance to increase and the current to decrease; (2) loss in ampere-turns due to the increase in coil resistance because of power absorption; (3) loss in ampere-turns due to the configuration or general structure of the magnet. Items (1) and (2) can be calculated and item (3) can be introduced into the formula on an empirical basis.

In this regard a coil completely surrounded by an impregnating compound of high thermal conductivity, cast in a shell, dissipates more heat than any other and is the most efficient.

A coil impregnated as a separate element and then assembled within the shell will dissipate about the same amount of heat as an open coil without any enclosure or shell. This may seem ambiguous, but when one considers that an air space exists between the coil and shell, with the air functioning as an insulator, the statement becomes logical. Further, the ends of the shell with the bobbin wound coil are shielded thermally by both an air gap and the thickness of the bobbin ends. This immediately renders the shell ends ineffective as radiating surfaces. In addition, the coil is insulated from the core by the thickness of the bobbin obviating the core as a good heat conductor.

A value of 1 1/2 watts per sq. in. of radiating surface (sides only) is the approximate maximum safe value of power that a magnet can dissipate continuously. If the duty cycle is of an intermittent nature the dissipating ability of the magnet will vary accordingly. If the duty cycle is about 10 sec on and 60 sec off, a value of 6 watts per sq. in. of radiating surface (sides only) is safe. These val-

DESIGN OF D-C TRACTIVE ELECTROMAGNETS

continued

ues, 1½ and 6 watts, are based on a maximum hot spot temperature of 125 C.

There are circumstances where the engineer cannot, because of space limitations, design into the magnet sufficient radiating area to control the temperature rise. This is especially true with the continuous duty, long stroke magnet. Several methods of making a small magnet handle a large amount of power are available. Among these are the double coil and the external resistor method. The double, or tapped coil design, incorporates a double winding in series and an external switch actuated by the plunger. The windings are usually of two different wire sizes. At the beginning of the stroke a large number of ampere-turns is required to initiate the action, therefore only that portion of the winding with the least resistance is used to generate the required ampere-turns. Since the number of ampere-turns needed at the end of the stroke is considerably less both windings are introduced causing the resistance to increase and the power to decrease to a suitable level. A switch actuated by the plunger connects the windings as needed.

The external resistor method is basically the same. A single winding capable of generating the initial ampere-turns required is used. By means of a switch, an external resistor is connected in series with the winding near the completion of the stroke.

The latter method is often preferable since the magnet can generally be made smaller with the external resistor placed in any convenient location. It is also advantageous to be able to modify the resistor value without changing the coil. The electromagnets of Figs. 1, 2 and 3 (lower) use this method to get continuous operation from a small coil.

GENERAL MECHANICAL FEATURES

The plunger guide bushing (see Fig. 15) serves in the dual capacity of reducing mechanical, as well as magnetic friction. Friction can be an over-

whelming factor in the small magnet. As much as 50 per cent of the total force available can be absorbed by binding between the plunger and shell. Without a guide bushing extreme care must be exercised to line up the plunger with the shell when small clearances, of the order of 0.001 to 0.005 in., are used. This is because the flux in this area will tend to cock the plunger towards the side with the minimum clearance, setting up a condition of flux concentration (magnetic friction). The flux with improperly supported plungers may reduce the clearance to zero to cause

it can be extended with a nonmagnetic plunger pin confined by another guide bushing on the opposite side of the shell (see Fig. 15). The illustrations of Figs. 1 and 2 reflect this type of design.

One of the components (marked "upper" in Fig. 3) has a plunger where the action is one of translation accompanied by rotation at high speeds and does not use a guide bushing. The high speed rotary motion prohibited the use of a guide bushing, and dictated the external ball bearing type of plunger support. The plunger shell clearance, however, was made

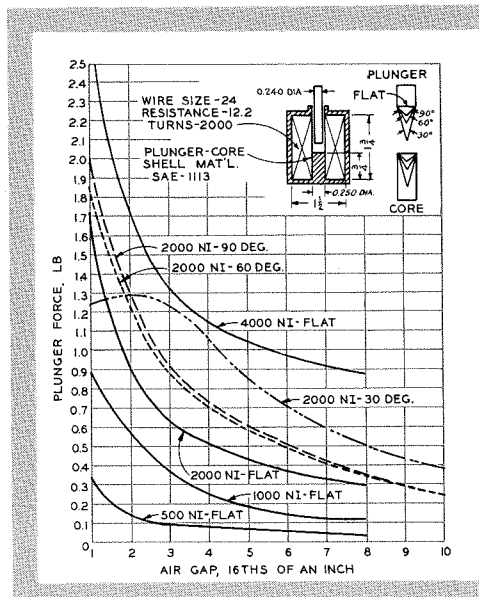

Fig. 11—Force-gap curves for electromagnets having ¼-in. plunger.

binding or scoring (mechanical friction).

The best way to eliminate this is to use a guide bushing. The tendency to set up magnetic friction will be greatly reduced and the chance for mechanical friction will be eliminated. The total available force will theoretically be reduced, but in general the practical available force will be increased because of the elimination of friction.

The bushing should be made of some nonmagnetic material with a wall section about 0.010 in. thick. Oilite bronze serves very well. The plunger can then be a close fit with the guide bushing, but will be constrained from being other than concentric with the shell. If the plunger is not further externally guided, then

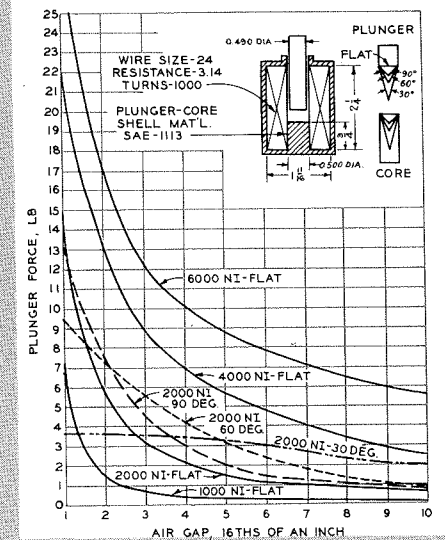

Fig. 12—Force-gap curves for electromagnets having ½-in. plunger.

adequate (0.015 on each side) for the application. It performed almost as well as if a guide bushing had been used.

It should be mentioned that in the conical plunger arrangement, it is important to guide the plunger properly. If one is working with a small final gap, the contour of the core will overlap the plunger to cause severe cocking unless adequately constrained.

A small overall package can be achieved by including the return spring within the shell. Fig. 15 shows an example of this. The spring material should be non-magnetic with phosphor bronze, beryllium copper, or stainless steel being very satisfactory.

The plunger in some cases, if it is

flat faced, is stopped when it engages the core. (Never permit tapered plungers to do this.) Other designs call for an air gap after the plunger has traversed its full stroke with the stop being accomplished by additional elements. Metal-to-metal contact is sometimes used. However, since the plunger accelerates at a fast rate, this arrangement will cause a clacking noise. The action also tends to peen the engaging surfaces. It is therefore better to interpose a dampening material between the metal surfaces. Materials such as hard rubber, nylon, cork etc. can be used satisfactorily. If the final

ing the cork dense and stable under all working conditions.

MATHEMATICAL DESIGN EQUATIONS

The four basic equations for the mathematical design of d-c tractive electromagnets are given below. The primary purpose of presenting them is to show that their use requires a designer familiar with assumptions that must be made to assign values to some of the factors used. The diagram of Fig. 16 illustrates some of the terms used in the equations which follow.

(3) Heating Equation

$$\theta f = \frac{q p}{2k f (r_3 + r_2)} \left[\frac{NI}{h} \right]^2$$

where

- θf = Final temperature rise of coil (deg. C.)
- q = Fraction of total time coil is energized
- p = Volume resistance of wire (ohms per in.)
- k = Heat dissipation coefficient
- h = Gross length of coil (in.)

(4) Voltage Equation

$$E = \frac{4p(r^3 - r^2) NI}{d^2}$$

where

- E = Coil voltage (volts)
- d = Diameter of bare wire (in.)

These basic formulas can be expanded according to the type of magnet under consideration. They may at times become quite complicated.

TYPICAL DESIGN PROBLEM

The typical electromagnet design problem solved in the following paragraphs is arranged in such a manner that a practical set of requirements are listed and a procedure is set forth dealing with those requirements. The procedure is flexible and can be arranged in accordance with the known requirements.

When using this design procedure it is necessary to refer only to the force-gap curves. The formulas used are elemental to the extent where every phase of the design is clearly analyzed. It is true that some of the expressions could be combined into more complex arrangements, but it is believed that this tends to make the factors lose their significance.

It should also be mentioned that when the curves are used the characteristics, both electrical and mechanical, of the illustrated electromagnets on each curve should be completely disregarded. The electromagnet designed by the procedure may in no way resemble those illustrated in the curve.

The solution has been simplified by disregarding voltage tolerance and other considerations such as clearance between plunger and bobbin etc. The engineer, however, must be concerned with these variations and should introduce them into the design. The design data are given in Table II and the shell and coil data of the solution are shown in Table III. The step-by-step solution follows.

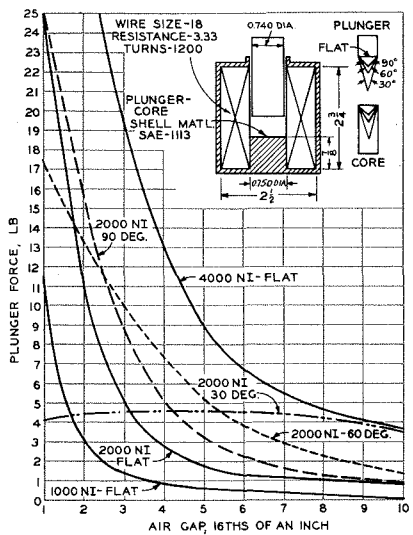

Fig. 13—Force-gap curves for electromagnets having $\frac{3}{4}$ -in. plunger.

air gap is small (0.005 in.) rubber or materials such as nylon might cause trouble due to cold flow caused by the repeated hammering of the plunger.

Cork has been successfully used for this application. The cork must be dense and it should be treated in an environment exceeding the application. Since the cork element is generally cemented to hold it in place, the very process of cementing will automatically give the required properties. For example, if the maximum temperature to be expected is 125 C and the maximum force is 30 lb., then the cork should be cemented under a pressure of perhaps 50 lb. at a temperature of 150 C. This will reduce the thickness about 25 per cent mak-

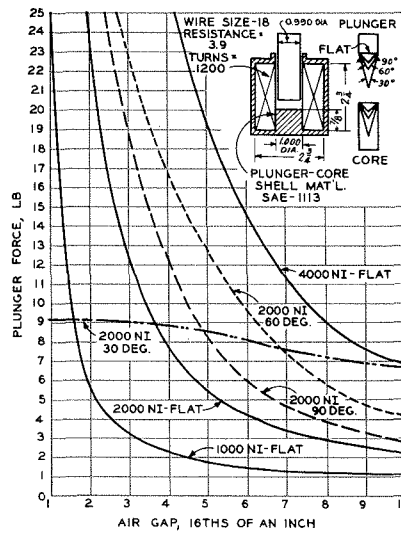

Fig. 14—Force-gap curves for electromagnets having 1-in. plunger.

(1) Force Equation

$$F = \frac{\pi B_g^2 r_1^2}{2\mu}$$

where

- F = Plunger force (lb.)
- r_1 = Plunger radius (in.)
- B_g = Flux density of working gap (kilomaxwells per sq. in.)
- μ = Permeability of air gap (webers per ampere-turn in an in. cube)

(2) Magnetic Circuit Equation

$$NI = \frac{B_g G}{\mu} + \sum H_i L_i$$

where

- NI = Ampere-turns
- G = Length of air gap (in.)
- $\sum H_i L_i$ = Magnetomotive force necessary to establish flux in iron portions of magnetic circuit (ampere-turns). 1 ampere-turn = 0.4 gilbert

DESIGN OF D-C TRACTIVE ELECTROMAGNETS

continued

STEP 1. Determine the diameter and shape of plunger and number of ampere-turns required.

Examination of the curves shows that the flat-faced 1/2-in. diam. plunger meets Requirements 3 and 4 (see Table II), that is, stroke of 1/16 with a plunger force of 14 lb. The force requirement has eliminated the 1/4-in.

Hence

$$r = 0.572 \text{ in. (shell sides will therefore be } 0.053 \text{ in. thick)}$$

STEP 3. Determine the winding radii.

Assume that the winding is to be confined with a bobbin. If the bobbin is made from nylon, a wall and end thickness of 0.025 in. will be satisfactory. Further, allow a clearance of 1/64 in. between the bobbin OD and the shell ID. The winding radii will then be:

$$R \text{ (outside winding radius) = Inside shell radius - clearance}$$

Substituting

$$R = 0.572 \text{ (From Step 2) - } 0.015$$

$$\begin{aligned} \text{Total wire length} &= \text{Total turns} \times \text{mean length of one turn} \\ &= 1600 \times 2.618 \text{ from (a) and (b)} \\ &= 4190 \text{ in. (c)} \end{aligned}$$

$$\begin{aligned} \text{Total coil resistance} &= \frac{\text{Voltage (nominal)}}{\text{Current (nominal)}} \\ &= \frac{27 \text{ (Req. 1)}}{1.25 \text{ (Req. 5)}} \\ &= 21.6 \text{ ohms (d)} \end{aligned}$$

$$\begin{aligned} \text{Resistance per in. of wire} &= \frac{\text{Total Coil Resistance}}{\text{Total Wire Length}} \\ &= \frac{21.6 \text{ From (d)}}{4190 \text{ From (c)}} \\ &= 0.00516 \text{ ohms/in. (e)} \end{aligned}$$

Table II—Design Data of Typical Problem (Requirements)

1—Input voltage, nominal, d-c.....	27 (Range, 24 to 30)
2—Ambient temperature, nominal.....	23 C (Range, -55 C to +75 C)
3—Plunger force, (including force of return spring) lb.....	14
4—Plunger stroke, in.....	1/16
5—Current, max (at 27 volts) amp.....	1 1/4
6—Outside shell diameter, max, in.....	1 1/4
7—Shell length.....	Design for minimum
8—Duty cycle.....	Intermittent, 10 sec on, 60 sec off
9—Coil hot spot temperature, max at 75 C ambient.....	125 C

Table III—Shell and Coil Data of Typical Problem (Solution)

Magnetic Structure	
Material	SAE 1113 steel
Plunger diameter.....	1/2 in. (flat-faced cylind.)
Shell diameter, outside, in.....	1 1/4
Shell thickness, in.....	0.053
Shell end thickness, (ea. end), in.....	0.125
Length of shell, in.....	1.545
Coil	
Resistance, ohms	21.6
Turns	1600
Wire size, AWG No.....	28
Len. of coil (winding only), in.....	1.230
Layers	19
Turns per layer	85
Inner winding radius, in.....	0.275
Outer winding radius, in.....	0.557
Ampere-turns (at 27 volts d-c).....	2000

diam. plunger since the value of ampere-turns necessary is beyond practical consideration. Even though the 3/4-in. diam. plunger could be used, and give the proper force, it would provide very little winding space when Requirement 6 is invoked.

The 1/2-in. diam. flat-faced plunger working in a coil able to generate 2000 ampere-turns is the best choice.

STEP 2. Determine the thickness of the shell sides.

The minimum cross-sectional area of the shell need not exceed the cross-sectional area of the plunger.

$$\text{Therefore } \pi(R^2 - r^2) = \pi r_1^2$$

where

$$R = 5/8 \text{ in. (outside radius of shell, Req. 6)}$$

$$r = \text{inside radius of shell}$$

$$r_1 = \text{radius of plunger}$$

Substituting

$$\pi(0.625^2 - r^2) = \pi \times 0.250^2$$

Hence

$$R = 0.557$$

Also

$$r \text{ (inside winding radius) = Plunger radius + thickness of bobbin.}$$

Substituting

$$r = 0.250 \text{ (from Step 1) + } 0.025$$

Hence

$$r = 0.275$$

STEP 4. Determine the wire size.

It is decided here to use a heavy Formvar coated copper wire. This wire will satisfy all requirements, and in particular 2 and 9.

Since

$$\begin{aligned} \text{Total turns} &= \frac{\text{Ampere-turns}}{\text{Current}} \\ &= \frac{2000 \text{ (from Step 1)}}{1.25 \text{ (Requirement 5)}} \\ &= 1600 \text{ (a)} \end{aligned}$$

$$\begin{aligned} \text{Mean length of one turn} &= \pi \times \text{mean diameter of 1 turn} \\ &= \pi \times 0.832 \text{ (calculated from Step 3)} \\ &= 2.618 \text{ in. (b)} \end{aligned}$$

Reference to a suitable handbook will indicate that No. 28 wire (bare diameter of 0.0126 in.) most nearly approaches the calculated requirement of 0.00516 ohms/in.

STEP 5. Determine the winding length.

For this calculation it is necessary to add to the bare wire diameter the thickness of the coating. For the type of wire previously selected, the nominal overall wire diameter will be 0.0145 in.

$$\begin{aligned} \text{Layers of wire} &= \frac{\text{Thickness of windingspace}}{\text{Overall diam. of wire } 0.282 \text{ (calculated from Step 3)}} \\ &= \frac{0.0145}{19.4 \text{ use 19 (a)}} \\ &= \text{Total turns} \end{aligned}$$

$$\begin{aligned} \text{Turns per layer} &= \frac{\text{Layers of wire}}{1600 \text{ From Step 4 (a)}} \\ &= \frac{19 \text{ From (a)}}{84.3 \text{ use 85 (b)}} \end{aligned}$$

$$\begin{aligned} \text{Length of winding} &= \text{turns per layer} \times \text{overall diam. of wire} \\ &= 85 \text{ (b)} \times 0.0145 \\ &= 1.230 \text{ in. (c)} \end{aligned}$$

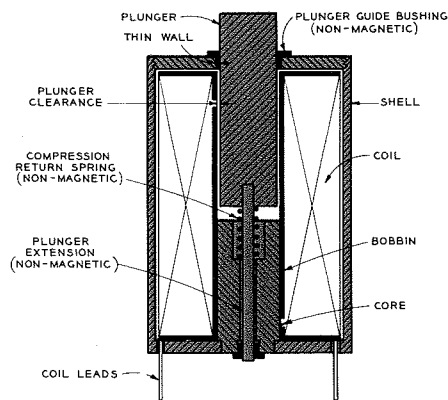

Fig. 15—Typical flat-faced cylindrical plunger electromagnet having a compression return spring.

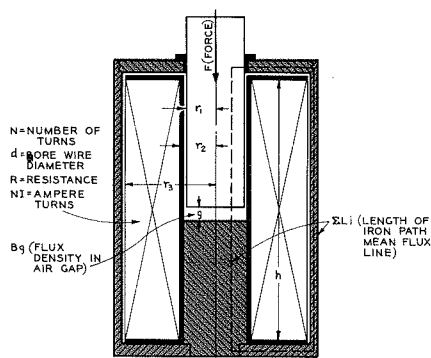

Fig. 16—Diagram of electromagnet showing dimensions used in mathematical analysis.

STEP 6. Determine length of shell.

The length of the shell will be the sum of the following factors:

- 1.230 = Length of winding from Step 5 (c)
- 0.050 = Total thickness of bobbin ends (from Step 3)
- 0.015 = Clearance between bobbin and shell (from Step 3)
- 0.250 = Total thickness of shell ends (See explanation below)
- 1.545 = Length of shell (a)

The minimum cross sectional area of the shell need not exceed the cross sectional area of the plunger. For this calculation the cross sectional area of the shell at the point where the plunger enters the shell, must be considered.

$$2\pi r_1 t = \pi r_1^2$$

where

- t = thickness of shell end
- r = radius of plunger

Substituting

$$2\pi \times 0.250 t = \pi \times 0.250^2$$

$$t = 0.125 \text{ in.}$$

And also

$$0.250 \text{ in.} = \text{Total thickness of shell ends}$$

STEP 7. Determine heat dissipating ability.

The electromagnet that has now been designed has met all requirements except Requirements 8 and 9.

It has been mentioned that if the total power in watts is less than 6 watts per sq. in. of radiating surface, the hot-spot coil temperature will not exceed 125 C if the electromagnet has an intermittent duty cycle of 10 sec. on and 60 sec. off.

Since

$$\text{Power to be dissipated} = \frac{\text{Voltage} \times \text{Current}}{\text{Req. 1}} \times 1.25 \text{ (Req. 5)}$$

$$= 33.7 \text{ Watts (a)}$$

Also since Watts per sq. in. to dissipate

$$= \frac{\text{Power to dissipate}}{\text{Side area of shell}}$$

$$= \frac{33.7 \text{ From (a)}}{6.08 \text{ calculated from Req. 6 and Step 6 (a)}}$$

$$= 5.54 \text{ (b)}$$

Requirements 8 and 9 have now been met, since the value 5.54 (b) is less than 6.

If the value of (b) had been resolved to a value more than 6, then it would be necessary to modify the design as follows:

1. Maintain all characteristics, except increase the number of turns which will (a) increase the resistance, (b) decrease the current, (c) decrease the power, (d) maintain the ampere-turns, (e) increase the length of winding and shell and (f) decrease the watts per sq. in. to dissipate to an acceptable level. This completes the design.

SUMMATION

The following is a summary of design considerations evaluating the many variables encountered in electro-magnetic design.

1. Plunger force or pull is approximately proportional to the cross sectional area of the plunger and the ampere-turns in the coil.
2. Plunger force vs. gap deviates considerably from the theoretical law of inverse squares.
3. Plunger force will decrease approximately 10 per cent if the magnetic circuit (shell, core, plunger) material is annealed, assuming the use of SAE 1113.
4. Plunger force is influenced by the location of the air gap within the coil.

This may be of the order of 50 per cent from extreme ends to the center.

5. Plunger force varies slightly with the ratio of coil length to coil diameter. The optimum ratio is about 1½.

6. Plunger force is influenced by the plunger and core shape. Flat shapes are better for larger forces over a small stroke. Tapered shapes are better for small forces over a large stroke.

7. Plunger forces will decrease with higher ambient temperatures and inherent power losses in the coil. The decrease in ampere-turns causes this.

8. Plunger force will not be materially affected by making the shell and core cross-sectional area larger than the plunger area. (Note that the minimum relation is where they are equal.)

9. Plunger force will be substantially unaffected by the type of enclosure used. The enclosure can be a shell or bracket, the only restriction being Item 8.

10. Plunger force with a good magnetic circuit completely enclosed by a shell with small series air gaps, will be approximately 50 per cent greater than if the enclosure were completely eliminated.

11. For continuous duty, an electromagnet of average design will be capable of dissipating 1½ watts per sq. in. of radiating surface. This surface only includes the sides of the shell, excluding the ends. The hot spot temperature will not exceed 125 C.

12. For an intermittent duty cycle of the order of 10 sec. on and 60 sec. off, the magnet will be able to dissipate approximately 6 watts per sq. in. of radiating surface. The maximum hot spot temperature will then not exceed 125 C.

13. SAE 1113 (cold finished high sulphur steel) or one of the steels in this general category is recommended for the plunger, core, shell.

ACKNOWLEDGMENT

The author wishes to give credit to J. C. Clark, whose empirical investigations, in regard to electromagnets served to a considerable degree to establish the curves included in this report. The author further recommends the excellent book "Electromagnetic Devices," by Herbert C. Roters (John Wiley & Sons, 1941). This book has, on many occasions, been used as a reference.

SCIENTIFIC AND TECHNICAL SOCIETIES ASSOCIATED WITH ELECTRONICS

by

J. BURGESS DAVIS

Engineering Editor

*Defense & Commercial Electronic
Products*

Camden, N. J.

SCIENTIFIC AND TECHNICAL SOCIETIES provide engineers with some of the best opportunities for self development and for enhancing their professional prestige by encouraging them to share responsibilities with others in a common cause. Membership in a scientific or technical society implies the dedication of a scientific mind to a chosen profession and the willingness of members to work together for the good of the profession.

More than fifteen hundred scientific and technical societies in the United States are listed by the National Academy of Science. The list of those directly or indirectly associated with electronics is impressive and indicates the extent to which the industry is indebted to the numerous branches of science and technology for its development.

The names of most of the societies listed in this article were submitted by RCA Engineer Editorial Representatives as those in which RCA engineers are actively interested.

Information on the majority of these societies was abstracted from the book entitled "Scientific and Technical Societies of the United States and Canada" published by the National Research Council—National Academy of Science (publication 369), 1955 edition, available in the RCA Camden library.

The number preceding the name of the society is the reference number by which the society is listed in the academy publication. Names of societies not preceded by a number are not listed by the academy. Societies are listed alphabetically.

Only information of general interest is included in this article. For information regarding the history of societies, size of membership, research funds and awards, subscription price of publications, and names of current officers, the reader is referred to the National Academy of Science publication 369, previously mentioned.

Local chapters or sections of some societies do not have permanent headquarters but rotate their meetings between available auditoriums and conduct their transactions from the business addresses of their officers. If these addresses are not known, they and other information regarding chapters or sections may be obtained from the society's National Headquarters, or Local Engineers Clubs.

11. ACOUSTICAL SOCIETY OF AMERICA . . . 57 East 55 Street, New York 22, N. Y. Purpose: To increase and diffuse the knowledge of acoustics, and to promote its practical application. Meetings: Two per year. Publications: "Journal," bimonthly, and "Noise Control."

60. AMERICAN ASSOCIATION FOR THE ADVANCEMENT OF SCIENCE . . . 1515 Massachusetts Ave., Washington 5, D. C. Purpose: To further the work of scientists, to facilitate cooperation among them, to improve the effectiveness of science . . . etc. Meetings: Annual, December 26-31 plus numerous regional meetings. Publications: "Science," weekly, and "Scientific Monthly."

AMERICAN ASSOCIATION OF INDUSTRIAL EDITORS . . . 24 Fairfield Street, Montclair, N. J. Executive Secretary, James Linner. Meetings: Monthly. Purpose: To promote the interests of Industrial Editors throughout the United States. Publication: "Editor's Notebook," monthly.

111. AMERICAN CERAMIC SOCIETY, INC. . . . 4055 North High Street, Columbus 14, Ohio. Purpose: To promote the art, science and technology of ceramics. Meetings: Annual plus Division meetings. Publications: "Journal," "Bulletin," and "Ceramic Abstracts," all monthly.

112. AMERICAN CHEMICAL SOCIETY . . . 1155 16th Street, N. W., Washington 6, D. C. Purpose: To encourage in the broadest and most liberal manner the advancement of chemistry in all its branches; to promote research in chemical science and industry; . . . etc. . . . etc. Meetings: Semi-annual. Publications: "Chemical and Engineering News," weekly, "Chemical Abstracts," and "Journal of the American Chemical Society," semimonthly, and "Journal of Physical Chemistry," "Journal of Chemical Education," "Analytical Chemistry," and "Industrial & Engineering Chemistry," all monthly—"Journal of Agriculture and Food Chemistry," biweekly, "Chemical Reviews," bimonthly, and "Rubber Chemistry and Technology," quarterly.

141. AMERICAN ELECTROPLATERS' SOCIETY, INC. . . . 445 Broad Street, Newark 2, N. J. Purpose: An educational society for the advancement of the science of electroplating and metal finishing. Meetings: Annual. Publication: "Plating."

177. AMERICAN INSTITUTE OF CHEMICAL ENGINEERS . . . 25 West 45th Street, New York 36, N. Y. Purpose: The advancement of chemical engineering in theory and practice and the maintenance of a high professional standard among its members. Meetings: Four meetings annually. Publications: "Transactions," monthly.

178. AMERICAN INSTITUTE OF CHEMISTS . . . 60 East 42nd Street, New York 17, N. Y. Purpose: To advance the profession of chemistry in the United States. Meetings: Annual for Institute; monthly for chapters. Publication: "Chemist," monthly.

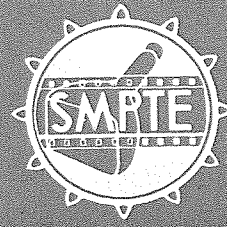
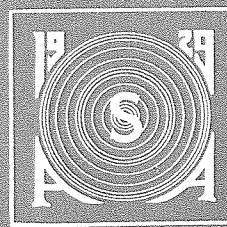
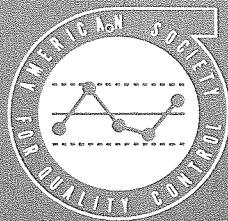

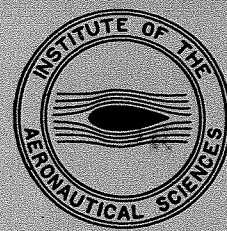
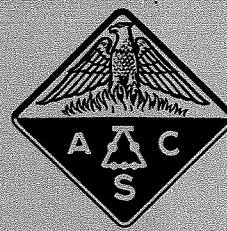
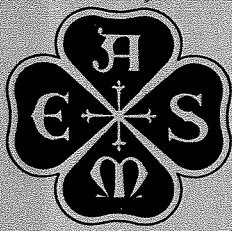

180. AMERICAN INSTITUTE OF ELECTRICAL ENGINEERS . . . 33 West 39th Street, New York 18, N. Y. Purpose: The advancement of the theory and practice of electrical engineering and of the allied arts and sciences and the maintenance of a high professional standing among its members. Meetings: Four annual meetings, also district and local meetings. Publication: "Electrical Engineering," monthly.

183. AMERICAN INSTITUTE OF MINING AND METALLURGICAL ENGINEERS . . . 29 West 39th Street, New York, N. Y. Purpose: To promote the arts and sciences connected with the economic production of the useful mineral and metals and the welfare of those employed in these industries. Meetings: Annual. Publications: "Mining Engineering Journal," "Journal of Metals," and "Journal of Petroleum Technology," all monthly. "Transactions," annual.

187. AMERICAN INSTITUTE OF PHYSICS, INC. . . . 57 East 55th Street, New York 22, N. Y. Purpose: The advancement and diffusion of knowledge of the science of physics and its applications to human welfare . . . etc. . . . Meetings: Regular meetings are not held, this being one of the normal functions of the five member societies. Occasional conferences are held under auspices of the Institute in particular fields. Publications: "Review of Scientific Instruments," "Journal of Chemical Physics," "Journal of Applied Physics," and "Physics Today," all monthly.

198. AMERICAN MATERIAL HANDLING SOCIETY, INC. . . . 638 Phillips Avenue, Toledo 12, Ohio. Purpose: To promote study and advancement of the science of material handling, to develop programs, to publish technical data, etc. Meetings: Semiannual. Publications: "Journal," published in "Modern Materials Handling Magazine," monthly.

199. AMERICAN MATHEMATICAL SOCIETY . . . 80 Waterman Street, Providence 6, R. I. Purpose: The encouragement and maintenance of an active interest in mathematical research. Meetings: Eleven meetings annually. Publications: "Bulletin," "Proceedings," and "Transactions," all bi-monthly. "Mathematical Reviews," monthly except August.

Author's Note: The author wishes to express his appreciation to Editorial Representatives, throughout the Corporation, who submitted names of many of the societies listed in this article.

202. AMERICAN SOCIETY OF NAVAL ENGINEERS, INC. . . . 605 F Street, N. W., Washington 4, D. C. Purpose: The advancement of naval engineering, including motive, hull, ordnance, navigational aeronautical, electrical and electronic engineering, and naval architecture. Meetings: Annual. Publication: "Journal," quarterly.

205 AMERICAN MICROSCOPICAL SOCIETY . . . Department of Zoology and Entomology, Montana State College, Bozeman, Mont. Purpose: The encouragement of research in biological fields where the microscope is utilized. Meetings: Annual. Publication: "Transactions," quarterly.

229. AMERICAN PHYSICAL SOCIETY . . . Columbia University, New York 27, N. Y. Purpose: The advancement and diffusion of the knowledge of physics. Meetings: Annual plus six to eight other meetings each year. Publications: "Bulletin," 6 to 8/year. "Physical Review," semi-monthly, and "Reviews of Modern Physics," quarterly.

243. AMERICAN RADIO RELAY LEAGUE, INC. . . . 38 LaSalle Road, West Hartford 7, Conn. Purpose: The promotion of interest in amateur radio communication and experimentation; the relaying of messages by radio; and the advancement of the radio art. Meetings: Annual. Publications: "QST," monthly, "Radio Amateur's Handbook," yearly.

261. AMERICAN SOCIETY FOR METALS . . . 7301 Euclid Avenue, Cleveland 3, Ohio. Purpose: The promotion of the arts and sciences connected with the manufacture and the treatment of metals. Meetings: Annual; monthly chapter meetings. Publications: "Transactions," annual; "Metal Progress," and "Review," monthly.

264. AMERICAN SOCIETY FOR QUALITY CONTROL . . . 50 Church Street, New York 7, N. Y. Purpose: To create, promote and stimulate interest in the advancement and diffusion of knowledge of the science of quality control and of its application to industrial processes. Meetings: Annual. Publication: "Industrial Quality Control," monthly.

266. AMERICAN SOCIETY FOR TESTING MATERIALS . . . 1916 Race Street, Philadelphia 3, Pa. Purpose: The promotion of knowledge of the materials of engineering, and the standardization of specifications and methods of testing. Meetings: Annual; twenty to thirty district meetings; about 1,500 meetings of technical committees. Publications: "Book of ASTM Standards," triennial, "Proceedings," annual, "Bulletin," eight per year.

289. AMERICAN SOCIETY OF MECHANICAL ENGINEERS . . . 29 West 39th Street, New York 18, N. Y. Purpose: To promote the art and science of mechanical engineering and the allied arts and sciences; to encourage original research; to foster engineering education; to advance the standards of engineering; to promote inter-course of engineers among themselves and with allied technologists. Meetings: Four a year. Publications: "Mechanical Engineering," monthly, "Transactions," 8 per year, "Applied Mechanics Review," monthly.

303. AMERICAN SOCIETY OF SAFETY ENGINEERS . . . 425 North Michigan Avenue, Chicago 11, Ill. Purpose: To promote the arts and sciences connected with engineering in its relation to accident prevention and the conservation of life and property to attain a high standard in safety engineering and to encourage the development of safety engineering as a profession. Meetings: Annual. Publication: "Engineering for Safety," monthly.

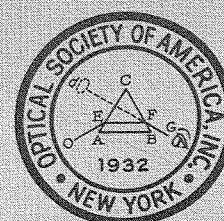
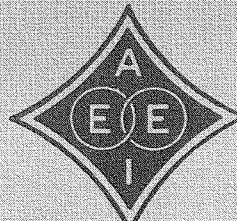
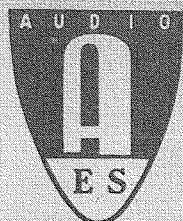
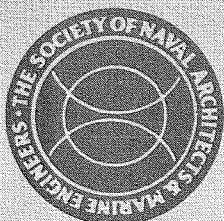

SCIENTIFIC AND TECHNICAL SOCIETIES

—continued

307. AMERICAN SOCIETY OF TOOL ENGINEERS . . . 10007 Puritan Avenue, Detroit 38, Mich. Purpose: The advancement of scientific knowledge in the field of tool engineering and the means and methods of applying such knowledge in practice. Meetings: Semi-annual. Publications: "Tool Engineer Magazine," monthly, "ASTE Technical Papers," annual.

311. AMERICAN SPEECH AND HEARING ASSOCIATION . . . Speech Clinic, Wayne University, Detroit 1, Mich. Purpose: To encourage basic scientific study of the processes of individual human speech and hearing . . . etc. Meetings: Annual. Publication: "Journal of Speech and Hearing Disorders," quarterly.

312. AMERICAN STANDARDS ASSOCIATION, INC. . . . 70 East 45th Street, New York 17, N. Y. Purpose: To provide systematic means by which organizations concerned with standardization work may cooperate in establishing American standards in those fields in which engineering methods apply . . . etc. Meetings: Annual. Publications: "Magazine of Standards," "Approved American Standards," "List of American Standards."

313. AMERICAN STATISTICAL ASSOCIATION . . . 1108 16th Street, N. W., Washington 6, D.C. Purpose: To encourage the improvement of basic statistical data and statistical methods in many fields of knowledge, etc. Meetings: Annual. Publications: "Journal," quarterly, "American Statistician," bi-monthly.

324. AMERICAN WELDING SOCIETY . . . 33 West 39th Street, New York, N. Y. Purpose: To advance the science and art of welding; to afford its members opportunities for the interchange of ideas with respect to welding . . . etc. Meetings: Annual fall and spring meeting. Sections meet monthly, September through May. Publication: "Welding Journal," monthly.

353. ARMED FORCES COMMUNICATIONS ASSOCIATION . . . 1624 I Street, N. W., Washington 6, D. C. Purpose: To maintain and improve the cooperation between the Armed Forces and industry in the design, production, maintenance and operation of communications, electronic . . . etc. Meetings: Annual. Publications: "Signal," bi-monthly, "Newsletter," monthly.

356. ASSOCIATION FOR COMPUTING MACHINERY . . . Two East 63rd Street, New York 21, N. Y. Purpose: To advance the science, design, development, construction and application of modern machinery for performing operations in mathematics, logic, statistics and kindred fields . . . etc. Meetings: Annual. Publication: "Journal," quarterly.

360. ASSOCIATION FOR SYMBOLIC LOGIC . . . Rutgers University, New Brunswick, N. J. Purpose: To promote research and critical studies in the field of formal or mathematical logic and immediately related fields; to provide meeting ground for mathematicians and philosophers and to encourage cooperation and mutual criticism among various groups. Meetings: Annual. Publication: "Journal of Symbolic Logic," quarterly.

377. ASSOCIATION OF CONSULTING MANAGEMENT ENGINEERS, INC. . . . 347 Madison Avenue, New York, N. Y. Purpose: The maintenance of high standards of professional conduct, the dissemination of information about the nature and benefits of management engineering service, and the exchange of experience among members. Meetings: Three or more held annually.

ASSOCIATION OF TECHNICAL WRITERS AND EDITORS . . . Anaconda Copper Mining Company, 25 Broadway, New York 4, N. Y. Elsie Ray, Secretary. Purpose: To advance the profession of technical writing and editing and to exchange information on principles and techniques in these fields. Meetings: Local and National.

404. ATOMIC INDUSTRIAL FORUM, INC. . . . 260 Madison Avenue, New York 16, N. Y. Purpose: To foster and encourage the development and utilization of atomic energy in accordance with the best traditions of American democracy and free competitive enterprise. Meetings: Annual. Publication: "Memo to Members," monthly.

405. AUDIO ENGINEERING SOCIETY . . . P. O. Box 12, Old Chelsea Station, New York 11, N. Y. Purpose: To diffuse and increase educational and scientific knowledge in audio engineering . . . etc. Meetings: Semi-annual. Publication: "Journal," quarterly.

DELAWARE VALLEY INDUSTRIAL EDITORS' ASSOCIATION . . . Penn Mutual Life Insurance Company, Washington Square, Philadelphia. Secretary: Miss Mary E. Eastburn. Purpose: To raise and continually improve the standards of industrial editing . . . etc. Meetings: 9 per year. Publication: "Byline," monthly.

574. ELECTROCHEMICAL SOCIETY, INC. . . . 216 West 102nd Street, New York 25, N. Y. Purpose: The advancement of the theory and practice of electrochemistry, electrometallurgy, electrothermics and allied subjects . . . etc., etc. Meetings: Semi-annual. Publication: "Journal," monthly.

599. ENGINEERS' CLUB OF PHILADELPHIA . . . 1317 Spruce Street, Philadelphia 7, Pa. (and various other locations). Purpose: To promote the arts and sciences connected with engineering. Meetings: Annual; monthly, October to May. Publication: "Announcer," 8 per year.

FRANKLIN INSTITUTE OF PENNSYLVANIA . . . 20th Street and Benjamin Franklin Parkway, Philadelphia, Pa. Purpose: Promotion of the mechanical arts and the dissemination of scientific knowledge. Meetings: Annual and monthly. Publications: "Journal of the Franklin Institute," monthly, "Institute News."

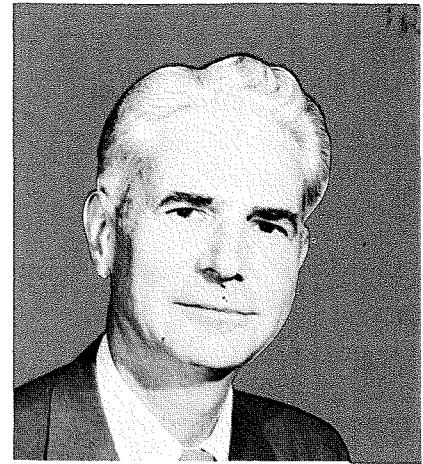

J. BURGESS DAVIS has been active in technical editorial work for more than 20 years. During the past 10 years, he has been responsible for administering RCA Standard Procedure Instructions for the control and approval of technical papers for presentation before technical societies, as well as for publication. See *Vol. 1, No. 5 for biography of Mr. Davis.*

715. ILLUMINATING ENGINEERING SOCIETY . . . 1860 Broadway, New York 23, N. Y. Purpose: The achievement of the theory and practice of illuminating engineering and the dissemination of knowledge relating thereto. Meetings: Annual. Publication: "Illuminating Engineering," monthly.

730. INSTITUTE OF NAVIGATION . . . University of California, Los Angeles 24, Calif. Purpose: To insure and further the advances made in the science of navigation; to establish centers of navigation research; to promote the highest standards for navigation to insure safety by air and sea. Meetings: Annual; quarterly on regional basis. Publication: "Navigation," quarterly.

731. INSTITUTE OF RADIO ENGINEERS, INC. . . . One East 79th Street, New York 21, N. Y. Purpose: To advance the theory and practice of radio and allied branches of engineering and its related arts and sciences, and to maintain a high professional standing among its members. Meetings: Annual; monthly. Publications: "Proceedings," monthly, "Transactions of the IRE Professional Groups," irregular.

732. INSTITUTE OF THE AERONAUTICAL SCIENCES, INC. . . . Two East 64th Street, New York, N. Y. Purpose: To facilitate by all available means the interchange of technical ideas among aeronautical engineers throughout the world. Meetings: Annual plus section and branch meetings. Publications: "Journal of the Aeronautical Sciences," monthly; "Aeronautical Engineering Review," monthly, "Aeronautical Engineering Catalog," annual.

734. INSTRUMENT SOCIETY OF AMERICA . . . 1319 Allegheny Avenue, Pittsburgh 33, Pa. Purpose: To advance the arts and sciences connected with the theory, design, manufacture and use of instruments in the various sciences and technologies. Meetings: Annual. Publication: "ISA Journal," monthly.

830. MATHEMATICAL ASSOCIATION OF AMERICA . . . University of Buffalo, Buffalo 14, N. Y. Purpose: The promotion of collegiate mathematics. Meetings: Semiannual. Publication: "American Mathematical Monthly."

913. NATIONAL ACADEMY OF SCIENCES—NATIONAL RESEARCH COUNCIL . . . 2101 Constitution Avenue, Washington 25, D. C. Purpose: To promote science and its applications to human welfare, and to investigate and report upon any subject of science or technology whenever called upon by the Government of the United States. Meetings: The Academy meets semiannually. Numerous meetings of committees, boards and other groups are held during the year. Publications: "Annual Report"; "Proceedings," monthly, "News Report," bimonthly, "Mathematical Tables and Other Aids to Computation," quarterly, "Summary Tables of Biological Tests," bimonthly, "Prevention of Deterioration Abstracts," monthly, "Artificial Limbs," quarterly.

925. NATIONAL ASSOCIATION OF POWER ENGINEERS . . . 176 West Adams Street, Chicago, Ill. Purpose: To provide cooperative action on problems affecting power plant operators and executives; to broaden the engineer's ability . . . etc. Meetings: Annual. Publication: "National Engineer," monthly.

931. NATIONAL BOARD OF FIRE UNDERWRITERS . . . 85 John Street, New York 38, N. Y. Purpose: To further education, engineering and statistics as they are related to fire prevention. Meetings: Annual. Publications: "Fire Insurance Facts and Trends," bimonthly, "Special Interest Bulletins," semimonthly.

945. NATIONAL INSTITUTE OF CERAMIC ENGINEERS . . . 2525 North High Street, Columbus 2, Ohio. Purpose: To promote the professional status of ceramic and other engineers engaged in all branches of the ceramic industry, etc. Meetings: Annual, in April with American Ceramic Society.

950. NATIONAL MICROFILM ASSOCIATION . . . 19 Lafayette Avenue, Hingham, Mass. Purpose: The advancement of the micro-techniques of documentary reproduction. Meetings: Annual. Publication: "Proceedings," annual.

952. NATIONAL NOISE ABATEMENT COUNCIL . . . 36 West 46th Street, New York 36, N. Y. Purpose: To promote a national consciousness in noise abatement and control; to disseminate information to the public relating to the causes and effects . . . etc. Meetings: Semiannual.

958. NATIONAL SAFETY COUNCIL . . . 425 North Michigan Avenue, Chicago 11, Ill. Purpose: To reduce the number and severity of all kinds of accidents. Meetings: Annual. Publications: "Transactions of the National Safety Congress," annual; "Accident Facts," annual. Ten magazines and 42 news letters are published monthly.

965. NATIONAL SOCIETY OF PROFESSIONAL ENGINEERS . . . 1121 15th Street, N.W., Washington 5, D. C. Purpose: To promote the professional, social and economic interests of the engineer by means of education, legislation and public relations; to establish and maintain state professional engineering societies and chapters throughout the United States; and to advance the interests of the public in matters pertaining to engineering. Meetings: Annual; local state and chapter meetings. Publication: "American Engineer," monthly.

NEW JERSEY INDUSTRIAL EDITORS ASSOCIATION . . . Affiliate of American Association of Industrial Editors. William C. North, Mutual Benefit Life Insurance Company, 300 Broadway, Newark 1, N. J. Purpose: To promote the interests of industrial editors of New Jersey. Publication: "Garden State Editor," eight/year.

1123. OPTICAL SOCIETY OF AMERICA, INC. . . . Prince and Lemon Sts., Lancaster, Pa. Purpose: To increase and diffuse the knowledge of optics; to promote the common interests of investigators of optical problems of designers and users of optical apparatus of all kinds; and to encourage cooperation among them. Meetings: Annual in October; usually one special meeting in March or April. Publication: "Journal," monthly.

1199. RADIO CLUB OF AMERICA, INC. . . . 11 West 42nd Street, New York 36, N. Y. Purpose: The protection of the interests of radio amateurs, experimenters, etc., and the dissemination of scientific information concerning radio art and its current development. Meetings: Monthly, except July and August. Publication: "Proceedings," monthly.

1235. SCIENTIFIC RESEARCH SOCIETY OF AMERICA . . . 56 Hillhouse Avenue, New Haven, Conn. Purpose: To encourage original investigation in science, pure and applied. Meetings: Annual. Publication: "American Scientist," quarterly.

1257. SOCIETY FOR EXPERIMENTAL STRESS ANALYSIS . . . P.O. Box 168, Cambridge 39, Mass. Purpose: To promote and encourage the furtherance of knowledge pertaining to experimental stress analysis . . . etc. Meetings: Semiannual. Publication: "Proceedings," biennial.

1258. SOCIETY FOR INDUSTRIAL AND APPLIED MATHEMATICS . . . 100 West 40th Street, Wilmington 99, Del. Purpose: To provide media for the exchange of information and ideas among mathematicians and other scientific and technical personnel . . . etc. Meetings: Annual. Publications: "SIAM Journal," quarterly, "Newsletter," monthly.

1277. SOCIETY OF AMERICAN MILITARY ENGINEERS . . . 808 Mills Building, Washington 6, D. C. Purpose: To promote the national defense by the advancement of knowledge of the science of military engineering; and to procure, preserve, perpetuate, and disseminate knowledge and information relating to military engineering and the objects for which the Society is formed. Meetings: Annual, semiannual, and regional meetings. Publication: "Military Engineers," monthly.

1294. SOCIETY OF INDUSTRIAL PACKAGING AND MATERIALS HANDLING ENGINEERS . . . 111 West Jackson Boulevard, Chicago 4, Ill. Purpose: The dissemination of packaging and materials handling information. Meetings: Annual. Publications: "Trends," bimonthly, "Proceedings," annual.

1297. SOCIETY OF MOTION PICTURE AND TELEVISION ENGINEERS . . . 55 West 42nd Street, Suite 1004, New York 36, N. Y. Purpose: The advancement and coordination of technical and engineering information for motion picture film production and use, and for related aspects of the television industry. Meetings: Semiannual; section meetings monthly except during summer months. Publication: "Journal," monthly.

1299. SOCIETY OF NAVAL ARCHITECTS AND MARINE ENGINEERS . . . 74 Trinity Place, New York 6, N. Y. Purpose: The promotion of the art and science of shipbuilding, both governmental and commercial, in the United States of America. Meetings: Semiannual. Publications: "Transactions," annual, "Society Bulletin," three times a year, "Year Book."

1304. SOCIETY OF PLASTICS ENGINEERS, INC. . . . Suite 116-18 34 East Putnam Avenue, Greenwich, Conn. Purpose: To promote the arts, sciences, standards and engineering practices connected with the use of plastics. Meetings: Annual. Publication: "SPE Journal," 10 per year.

1366. SPEECH ASSOCIATION OF AMERICA . . . Louisiana State University, Baton Rouge 3, La. Purpose: The Association serves as a professional organization for individuals interested in speech. Meetings: Annual. Publications: "Quarterly Journal of Speech," "Speech Monographs," quarterly, "Speech Teachers," quarterly.

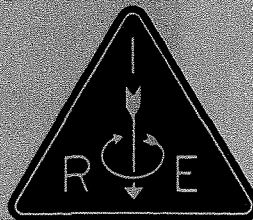
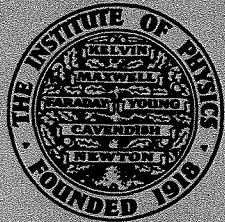

LINEARITY CONSIDERATIONS IN FEEDBACK PAIR AMPLIFIERS

by **WINSLOW L. HURFORD**

*Broadcast Studio Engineering
Commercial Electronic Products
Camden, N. J.*

SOME OF THE more stringent requirements being placed on feedback amplifiers for recent video-frequency applications are treated in this paper. To design amplifiers to meet these requirements results in improved overall performance.

The linearity of any amplifier will be improved by incorporating the design relationship developed here.* This is true whether the amplifier is employed for audio service, servo-mechanisms, or in pulse applications. Engineers designing servo-mechanisms may find viewpoints developed here to be helpful in solving problems of overload, frequency, and transient response. There are also, no doubt, many other fields in which the more commonly recognized advantages of negative feedback may be coupled with the control of linearity and phase variation, as discussed here, to effect a considerable improvement in performance.

Concurrent with recent advances there is an ever increasing emphasis on these design objectives: (1) achieving stability of gain in amplifiers with tube changes, (2) reduction of the susceptibility of equipment to changes in supply voltage, and (3) the improvement of the linearity of transfer characteristic. Within the compass of the requirements placed on linearity of transfer characteristic is included not only a constancy of differential gain but also an independence of relationship between signal level and the phase angle of the transfer ratio. Negative feedback, of itself, is helpful in the attempt to achieve all of these desirable objectives except that of independence of phase angle.

In addition to the applications of negative feedback in stabilizing the circuit performance, are the equally important applications where the driving point impedance is modified

*For detailed mathematical proofs, refer to 1955 Proceedings of the National Electronics Conference in which an unabridged version of this paper appears.

by the return difference. In the single-loop, feedback amplifier, with negligible direct transmission, which is the subject of this discussion, the return difference is equal to the quantity $(1 + \mu\beta)$. Feedback may be used to increase or to decrease the driving point impedance by multiplication or division by the return difference.

DESIGN CRITERIA

If all the advantages of the use of negative feedback are to be obtained

without incurring any of the disadvantages which sometimes accompany the application of such circuits, it will be necessary to use considerable care in the choice of tube types, gain distribution between stages, and time constant ratios.

Some of the significant relationships have been investigated by Brockelsby and Mayr^{1,2} who state the condition on maximal flatness. Maximal flatness requires that the ratio of the time constants determining the high-frequency cutoff of a *feedback pair* be equal to twice the loop gain. A feedback pair is a feedback amplifier in which there are two time constants limiting the high-frequency

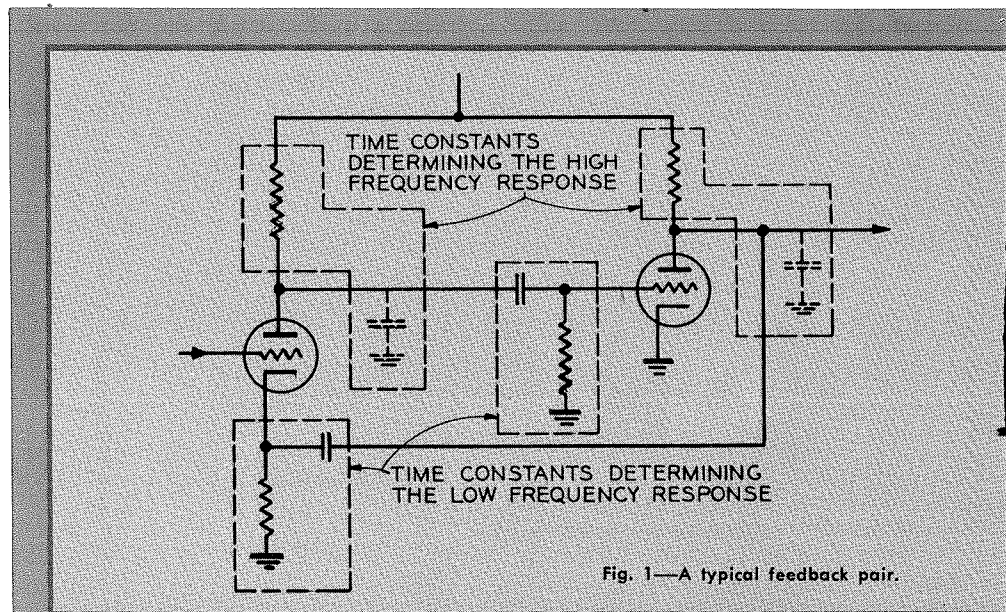

Fig. 1—A typical feedback pair.

LIST OF SYMBOLS

The symbols are listed below in the order of their appearance in the paper:—

- μ —gain of the forward circuit
- β —feedback factor (voltage or current ratio)
- gm_1 —transconductance of first tube of feedback pair
- RL_1 —plate load of the first tube of feedback pair
- gm_2 —transconductance of second tube of feedback pair
- RL_2 —plate load of the second tube of feedback pair
- $G(\omega)$ —transfer ratio, a function of omega
- R —equivalent interstage resistance
- C —equivalent interstage capacity
- R' —equivalent interstage resistance of narrow band interstage
- C' —equivalent interstage capacity of narrow band interstage

The balance of symbols used are defined in the text at their point of introduction.

Photo showing the author making engineering measurements to determine amplifier linearity characteristic.

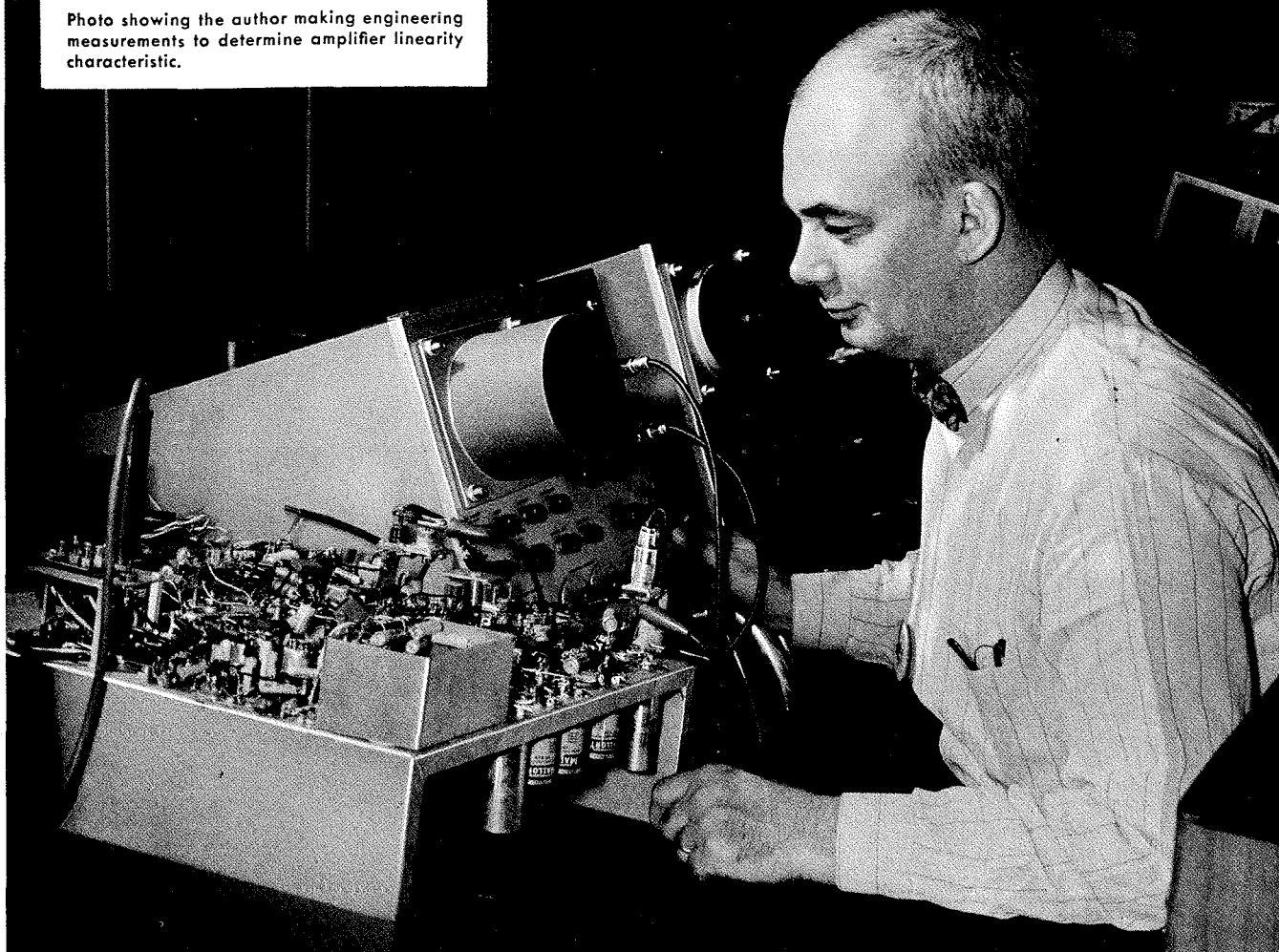

response and two time constants limiting the low-frequency response. In like manner, the ratio of the time constants determining the low-frequency cutoff of the feedback pair must also be equal to twice the loop gain. A typical feedback pair is shown in Fig. 1. The maximally flat response is not the most desirable condition for pulse amplifiers, and Flood³ has shown that the condition of monotonic, step-function response requires that the cutoff-frequency ratios of the feedback pair be equal to four times the loop gain.

The first of these criteria is concerned with the steady state amplitude-frequency response and is an adequate criterion for audio-frequency work. The second criterion is concerned with the transient response of the amplifier and is adequate for such applications as pulse distribution amplifiers. It does not in itself, however, guarantee that the transfer characteristic will be linear or that the phase angle of the transfer ratio will be independent of the signal level. These criteria are, hence, not sufficient to allow the design of feedback

amplifiers which will fulfill the critical requirements of modern video-frequency applications.

It is evident that, if the loop gain may be made indefinitely large throughout the entire frequency band of interest, then the transfer ratio may be made equal to the reciprocal of the feedback factor, beta, within any desired tolerance. There are many reasons, other than economic, why this utopia may not be achieved. In the first place, when negative feedback is applied to very-wide-band amplifiers, it is imperative to keep the feedback loops short. This is so because of the difficulty in suppressing feedback through other than the desired paths. The total phase shift around the loop should generally be kept to a limit of 180 degrees. In other words, it is desirable, in such amplifiers, to limit the number of RC networks, determining both the high-, and the low-frequency cutoffs, to two. That is, they should be feedback pairs. If only two tubes are employed and the bandwidth covers many megacycles, high-mu circuit gain and hence high loop gain will be very

difficult to obtain. Wide-band feedback pairs will then have low loop gain and other means must be resorted to in order to reduce the effects of varying return ratio on the linearity of the transfer characteristic and on the phase angle of the transfer ratio of the amplifier.

LINEAR DEVELOPMENT

For the high-frequency end of the band, where the mu-circuit response is determined by the plate load resistances and the shunting capacities, it may be shown that the transfer ratio of the amplifier is given by

$$G(\omega) = \frac{(g_{m1} R_{L1})}{(g_{m1} R_{L1}) (g_{m2} R_{L2}) \beta} \frac{(g_{m2} R_{L2})}{+ (1 + jM) (1 + jMN)} \quad (1)$$

where

$$M = \frac{\omega}{\omega_{c2}} \quad (\text{normalized in terms of the higher frequency cutoff at the high end of the pass band.})$$

$$N = \frac{f_{c2}}{f_{c1}} > 1. \quad (\text{ratio of cutoff frequencies.})$$

A similar expression holds for the low-frequency end of the band.

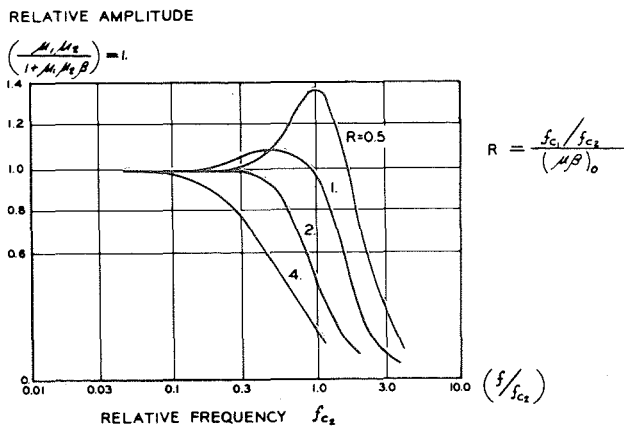

Fig. 2—The effect of the staggering ratio and the loop gain on the amplitude response.

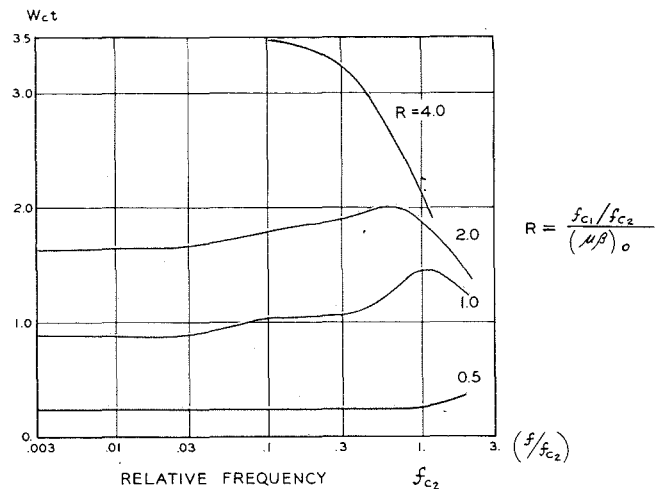

Fig. 3—The effect of the staggering ratio and the loop gain on the phase delay.

The magnitude and the phase delay of this transfer ratio may be plotted for various ratios of the cut-off frequency ratio to the midband loop gain. If the cutoff frequency ratio, N , is large compared with unity, these relationships may be normalized to give plots of relative amplitude, and of time delay, versus relative frequency with the ratio of the staggering of the cutoffs to the loop gain as parameter. This is shown in Figs. 2 and 3.

It may also be shown that for a return ratio greater than zero and for frequencies within the pass band (M less than unity) there will always be a reduction in gain variation due to the use of negative feedback. This is not the case for the phase angle of the transfer ratio, however, where it is easy to conceive of a situation where the gain of the mu-circuit may change appreciably without any significant change in the phase shift of the mu circuit. When this happens the phase angle of the return difference, and hence of $G(\omega)$, will change and the effect of negative feedback will be to produce changes in the phase angle of the transfer ratio even when there is no change in the phase angle of the mu-circuit stages. It is thus evident that, although negative feedback always helps to reduce mu-circuit gain

variations within the pass band, it actually may even introduce phase shifts when there are none in the mu-circuit. A further refinement in technique is thus needed to meet modern linearity requirements. In order to reduce phase shifts arising from variations in the return difference, it is necessary to stabilize the value of the mu-circuit gain against changes in signal level. An obvious and very wasteful method of accomplishing this is to make the variational current of each stage a very small part of the total plate current of the stage. In this way, the transconductance, and hence the stage gain, will be essentially constant over the signal swing. A more economical way is to take advantage of the fact that a feedback pair may be so arranged that an increase of gain in one stage is balanced by a decrease in gain of the other stage, so that the product of the two, which is the circuit μ , remains essentially constant. This objective may be obtained, even though the transconductance of each stage changes over wide limits, if the mu-circuit stages are so chosen that the ratio of the grid bases of the two stages is equal to the stage gain of the first stage of the pair. The difference in grid voltage between the limits of zero bias and plate current

cutoff is referred to as the grid base. The stage with the longer grid base is made the second stage of the feedback pair. If the ratio of grid bases is chosen in accordance with this rule in the interests of best linearity of transfer characteristic and of constancy of phase angle of the transfer ratio, any overload condition will occur simultaneously in both stages of the pair. When this condition is satisfied, it is immaterial whether the narrow-band stage is the first or the second stage to be encountered in the signal path through the mu-circuit. If, however, the grid base ratio is not at least equal to the gain of the first stage of the pair then, as has been pointed out by Flood,⁴ the narrow-band stage must be the first inter-stage to be encountered in the signal path through the mu-circuit. Otherwise the feedback signal, which is delayed by *both* time constants will not rise rapidly enough to limit the effective drive signal on the first stage and the second stage will be driven into overload by pulses of short rise time even when the peak signal swing is less than the maximum which could be handled, short of overload, when the rise time is longer.

The advantages to be obtained from proper gain distribution between stages and the benefits of select-

ing two tubes having a grid base ratio equal to the gain of the first stage is shown in Fig. 4. This graph shows three possible conditions. First a feedback pair consisting of two identical tubes is shown as the curve marked, beta equal $\frac{1}{4}$ and identical tubes. The second curve is for two tubes so chosen that the ratio of the grid bases is equal to the gain of the first stage, but no feedback is employed. This is the curve marked, beta equal zero. Finally, the pair of tubes employed in the second curve is used with a feedback factor of beta equal $\frac{1}{4}$. The curves have all been normalized for relative gain and drive voltages to facilitate comparison. The effect of the first stage gain in overdriving the second stage is immediately apparent in the case where identical tubes are used for the two stages. In fact, the proper choice of tubes, even without feedback, produces a considerable improvement in the transfer characteristic. The effect of a proper choice of tubes and the use of feedback is to make a marked improvement in the transfer characteristic.

It should be particularly noted that this grid base ratio is optimum from three different points of view. First it leads to the most linear voltage transfer curve. That is the differential gain is most nearly constant. Second it is the optimum choice for constancy of phase angle of the transfer ratio; and finally it is the proper choice maximizing the pulse handling capability of the feedback pair.

VARIATIONS IN CIRCUIT ELEMENTS

This analysis, as so far developed, has considered that the R's and C's of the circuit are invariant with signal level. Such an assumption is not justified in critical applications.

The interstage couplings between amplifying stages are RC networks having both low- and high-frequency cutoffs. If these coupling networks were absolutely independent of the signal voltage, then the only source of phase variation would be the changes in loop gain over the signal voltage range as just discussed. Examination of a typical interstage coupling shows several possible sources of parameter variation associated with the signal voltage, e_{pl} . Specifically, the plate resistance of

the driving stage, r_{pl} , or the transconductance, g_{mb} , varies rather widely with plate current changes and hence with signal swing. Secondly, C_{in2} , the input capacity of the driven stage, will vary over the signal voltage range if Miller effect capacitance is present and the stage gain varies. The remaining elements are, at least to a first approximation, invariant with e_{pl} .

An obvious first step in reducing phase changes is to eliminate the variations in C_{in2} . This may be done either by using a pentode in order to reduce C_{gp} to very small values, or by neutralizing if a triode is used for the second stage. (This might be accomplished by cross neutralization of a push-pull second stage.)

The effects of variations in r_{pl} may also be minimized by noting that r_{pl} may be considered as being in parallel with R_{L1} and hence, if $r_{pl} \gg R_{L1}$, large variations in r_{pl} produce only small changes in the equivalent R which forms the coupling time constant. For this reason the use of a pentode is indicated for the driving stage. In video amplifiers, even in the first stage which should be the narrow band stage, R_{L1} will rarely be more than 10,000 ohms so that r_{pl} for a pentode would normally be 10 to 100 times as great as R_{L1} .

Note that, for the higher frequencies, the significant factors of the

interstage coupling may be represented by an equivalent interstage containing a single R and C.

The R is r_{pl} in parallel with R_{L1} and R_{g2} ; and C is $C_{o1} + C_s + C_{in2}$. The ratio of e_o to e_i is

$$\frac{e_o}{e_i} = \frac{1}{1 + j\omega RC} \quad (2)$$

The phase angle of this transfer ratio is

$$\theta = -\tan^{-1} 2\pi fRC \quad (3)$$

Unless the bandwidth with the loop closed is to be very great, one of the high-frequency cutoffs will be well inside the range of significant signal frequencies. In this case, θ may be expected to exceed 60° , even if only moderate loop gains are employed. The other (wide-band) interstage must be beyond the nominal band edge and hence beyond the range of significant signal frequencies, in which case θ will be very small. The variation in θ as a function of variations in R and C is given by the expression

$$\Delta\theta^\circ = \frac{-180}{\pi} \left(\frac{\Delta R}{R} + \frac{\Delta C}{C} \right) \sin \theta \cos \theta \quad (4)$$

which, for small θ , reduces to

$$\Delta\theta^\circ = -360 f [(\Delta R)C + (\Delta C)R] \quad (5)$$

(Note, for small θ , $\theta \cong \tan \theta \cong \sin \theta$ and $\cos \cong 1$.)

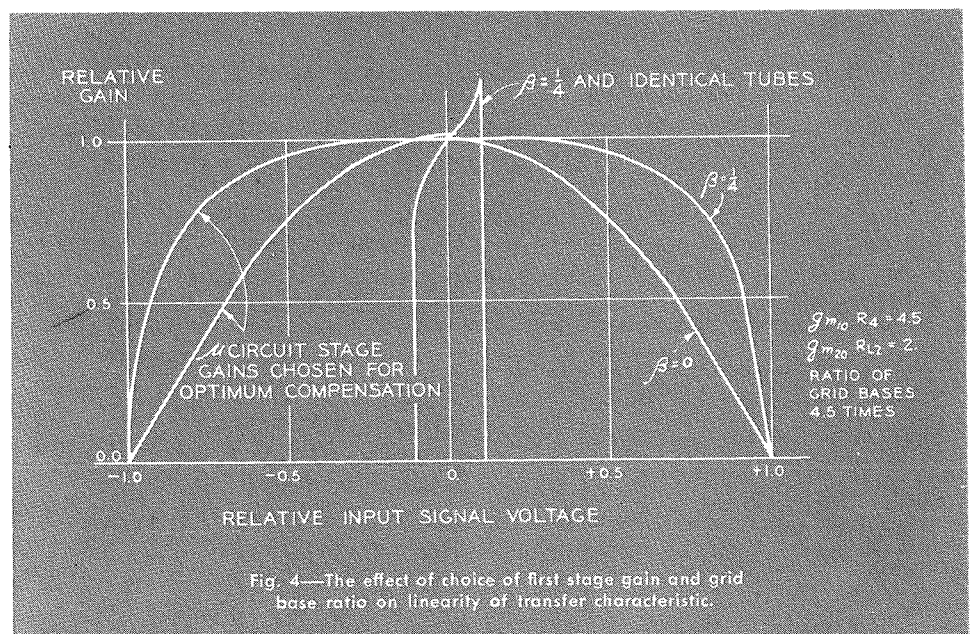

Fig. 4—The effect of choice of first stage gain and grid base ratio on linearity of transfer characteristic.

This last expression applies in particular for the effects of the wide band interstage. For the narrow band interstage, this approximation is invalid and we must return to a consideration of (4) which may be written as

$$\Delta\theta^\circ = \frac{-180}{\pi} \left(\frac{\Delta R}{R} + \frac{\Delta C}{C} \right) \frac{2\pi fRC}{1 + (2\pi fRC)^2} \quad (6)$$

Comparison of (6) with (5) shows that the effect of variations in R or C in this case is reduced by division by $1 + (2\pi fRC)^2$. We should note that no penalty in phase variations is paid for having one of the coupling time constants shorter than the period of the frequency where the phase variation is to be evaluated. In fact, there is actually a reduction in the effect of ΔR and ΔC in this case as compared with the wide-band interstage.

The discussion to this point, has been concerned with the effect of but one interstage network on the phase variations of the amplifier. Actually, in a feedback pair, there will be two interstage networks contributing to the overall effect. It is not necessary that the effects of the two networks add in their overall effect in the amplifier. In fact, it is conceivable that they may be arranged so that their effects, at least partially, cancel each other out. For this desirable condition to be achieved, it is necessary that the contributions to $\Delta\theta$ from (5) and (6) be equal in magnitude and opposite in sign. From this requirement

$$-\left(\frac{\Delta R}{R} + \frac{\Delta C}{C} \right) = \frac{1}{1 + (2\pi f'R'C')^2} \left(\frac{\Delta R'}{R'} + \frac{\Delta C'}{C'} \right) \quad (7)$$

Since one grid is driven up as the other is driven down, the signs of the increments may be expected to be opposite and it should be possible to find a combination of values which will produce a null at some one frequency. (Since frequency appears on one side of (7) but not on the other, this balance condition will not be maintained over a wide band.) If the frequency for which the phase variation is important is near the top

WINSLOW L. HURFORD received a B.S. degree in Electrical Engineering from Lehigh University in 1948, and the M.E.E. degree from Syracuse University in 1953. In 1948 he joined Broadcast Studio Engineering at General Electric where he also taught after-hour courses in Network Theory. In 1953 he joined Broadcast Studio Engineering where he is now employed in the design of Monochrome Vidicon Cameras. Mr. Hurford has authored several technical papers dealing with Television Studio Equipment and Amplifier Theory and holds numerous patents in this field. He is a member of Tau Beta Pi, Eta Kappa Nu, the Scientific Research Society of America and the Institute of Radio Engineers.

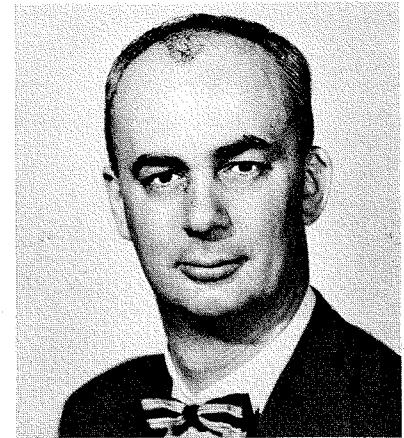

of the important frequency spectrum but far inside the band edge of the feedback pair, then the factor $(1 + 2\pi f'R'C')^2$ is approximately equal to unity and a null is obtained when

$$-\left(\frac{\Delta R}{R} + \frac{\Delta C}{C} \right) = \left(\frac{\Delta R'}{R'} + \frac{\Delta C'}{C'} \right) \quad (8)$$

The balance will be broad band, but the design will not be very economical because of the excessive bandwidth requirement of the amplifier.

If the narrow-band interstage cut-off is at, $1/n$ of the frequency for which the phase variation is important, then the factor

$$1 + (2\pi f'R'C')^2 = 1 + \left(\frac{f}{f_c'} \right)^2 = 1 + \left(\frac{1}{1/n} \right)^2 = 1 + n^2 \quad (9)$$

and it is evident that the variation $\Delta R'$ or $\Delta C'$ of the narrow-band stage would have to be fairly great to match the ΔR and ΔC of the wide-band stage. In fact, if the frequency for which the phase variation is of interest is near the band edge and the loop gain is very much greater than unity, then the effect of phase varia-

tions in the narrow-band interstage will be small in comparison with the phase variations of the wide-band interstage. In other words, emphasis should be put on reducing the phase variations in the wide-band interstage. This interstage should, therefore, be driven by a pentode.

The particular frequency at which it is desired to control the phase variation, and the other requirements placed on the stage performance, will determine the specific values of components in the final configuration. However, application of the ideas outlined here should make possible a considerable improvement in the design of feedback pair amplifiers.

REFERENCES

1. C. F. BROCKLESBY, "Negative Feedback Amplifiers; conditions for Maximal Flatness," *Wireless Engineer*, Volume 26 Page 43, February 1949.
2. H. MAYR, "Feedback Amplifier Design; conditions for flat Response," *Wireless Engineer*, Volume 26 Page 297, September 1949.
3. J. E. FLOOD, "Negative Feedback Amplifiers; conditions for critical damping," *Wireless Engineer*, Volume 27 Page 201, July 1950.
4. J. E. FLOOD, "Negative Feedback Amplifiers; Overloading under Pulse Conditions," *Wireless Engineer*, Volume 29 Page 203, August 1952.

PATENTS GRANTED

continued

scope face with lenses parallel to scanning lines. The lenses "spread" each scanning line toward the adjacent lines, thereby eliminating the visible dark stripes between lines.

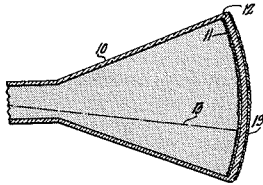

Pat. No. 2,728,013

REELING SYSTEM (Patent No. 2,730,309)—granted January 10, 1956 to J. S. BAER, COMMERCIAL ELECTRONIC PRODUCTS, Camden, N. J. There has been provided a reeling system wherein the tape 14 is stored on a pair of reels 2 and 4. Motor means 10 are provided for driving the reels. Separate driving means 16 responsive to any desired control signals is provided for the tape. Means 26, 34, 36 in accordance with the invention responsive to the demand of the tape driving means is provided which controls the reel driving means to maintain preferred tape storage conditions and thereby to permit free feed of tape without inertia effects of associated mechanism.

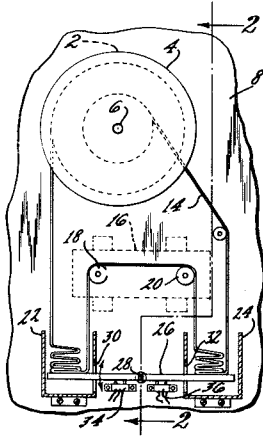

Pat. No. 2,730,309

MAGNETIC SOUND RECORD ERASING METHOD AND HEADS THEREFOR (Patent No. 2,730,570)—granted January 10, 1956 to MICHAEL RETTINGER, COMMERCIAL ELECTRONIC PRODUCTS, Hollywood, California. To improve the erasing of magnetic records, two high frequency erasing energies are applied in tandem (about one-tenth of a second apart). Two spaced heads with gaps 54 and 59 on same side of tape 50 are employed. Head constructions of Figs. 1 and 2 may also be used, Fig. 1 showing two opposing heads with single gaps 8 and 14, which use both direct and leakage flux.

Fig. 2 shows a triple gap head having "E"-shaped cores 28 and 29, the tape 47 passing between the three gaps in serial order.

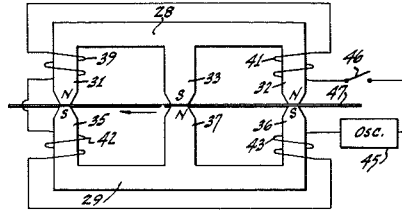
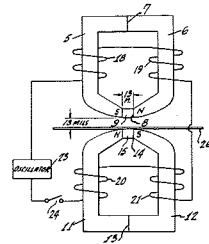

Pat. No. 2,730,570

OSCILLATOR CIRCUITS (Patent No. 2,728,853)—granted December 27, 1955 to W. Y. PAN, RCA VICTOR TELEVISION DIVISION, Cherry Hill, N. J. The tunable high frequency oscillator includes input and output circuits which are suitably coupled to sustain oscillation. Where high frequency oscillators are tunable over a wide frequency range the efficiency of the oscillator, that is the oscillator signal amplitude, falls off near the high frequency end of the range. To maintain the output signal amplitude from the oscillator more uniform, a resistance element is connected between the oscillator tube and an oscillator output circuit. As the operating frequency of the oscillator increases, the electromagnetic coupling to the resistance element increases tending to stabilize the voltage output.

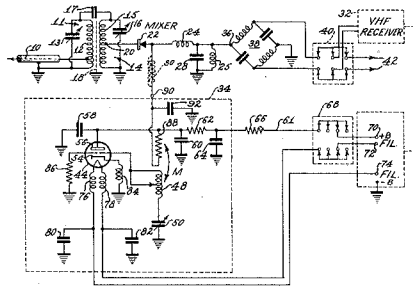

Pat. No. 2,728,853

SIGNAL TRANSFER NETWORKS FOR MULTI-RANGE HIGH FREQUENCY RADIO OR TELEVISION SYSTEMS (Patent No. 2,728,818)—granted December 27, 1955 to DONALD MACKAY, TUBE DIVISION, Camden, N. J. and E. J. SASS, RCA VICTOR TELEVISION DIVISION, Cherry Hill, N. J. The signal transfer circuit comprises a double pi network with series inductance and shunt capacitors. One of the inductors is variable in unison with the tuning means to effectively shift different portions of the center shunt capacitor in shunt with the input and output capacitances. The input capacitance may comprise that of an elevator transformer, and the output capacitance of the signal transfer circuit may be an amplifier input capacitance.

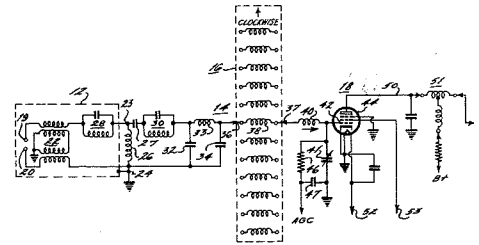

Pat. No. 2,728,818

MODULATOR CIRCUIT (Patent No. 2,728,892)—granted December 27, 1955 to T. M. GLUYAS, JR., DEFENSE ELECTRONIC PRODUCTS, Camden, N. J. In cathode-modulated television transmitter, video currents fed back in negative sense from modulator to video amplifier. In a grid-modulated arrangement, degenerative feedback from modulated stage to video amplifier is used.

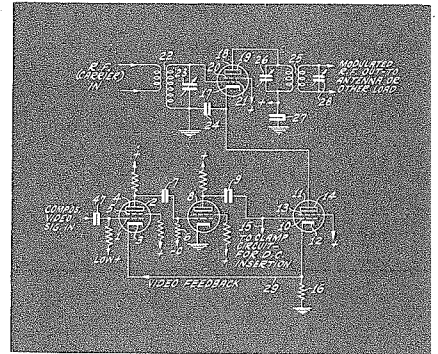

Pat. No. 2,728,892

ANTENNA FOR MOBILE COMMUNICATIONS (Patent No. 2,725,473)—granted November 29, 1955 to WOODROW DARLING, COMMERCIAL ELECTRONIC PRODUCTS, Camden, N. J. A whip antenna consisting of a terminal half-wave radiating section and a quarter-wave radiating section at the base, the two sections being connected together by means of a nonradiating phase reversing section. All sections may be made of a single conductor, the phase reversing portion being formed by two 180 degree bends in the conductor.

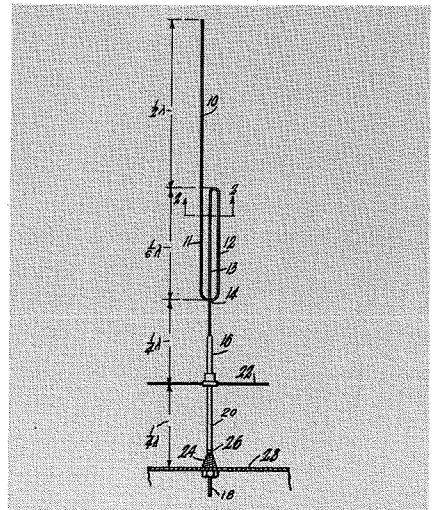

Pat. No. 2,725,473

HIGH GAIN TUNED LOOP ANTENNA CIRCUIT (Patent No. 2,725,466)—granted November 29, 1955 to W. F. SANDS, RCA VICTOR TELEVISION DIVISION, Cherry Hill, N. J. The loop antenna is tuned by a variable capacitor or other similar variable impedance circuit. A series resonant circuit is then used to couple the tuned antenna circuit and a receiver input or other signal utilization circuit. To maintain the frequency of the coupling circuit resonant at the optimum gain value for incoming signals of all frequencies within the tuning range, it is variably tuned in unison with the variable capacitor.

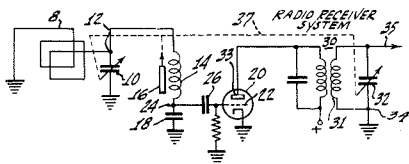

Pat. No. 2,725,466

METHOD OF REMOVING ADHERENT MATERIALS (Patent No. 2,726,180)—granted December 6, 1955 to J. A. STANKEY, TUBE DIVISION, Marion, Indiana. When face plate is sealed to enameled metal shell, elements of enamel are driven into molten seal area and deposited a minute distance beneath inner surface of face plate. Then when chemical agents such as ammonium bifluoride or hydrofluoric acid are used to remove defective phosphor screen or graphite coating, these agents also remove a minute layer of face plate glass, thus also exposing the enamel elements to chemical attack. Because of the difference in the solubility rates of the enamel elements and face plate glass in the acid, an objectionable white ring stain develops. To overcome this ring etch, hydrofluosilicic acid is used in place of the chemicals formerly used. The new acid does not attack the glass so readily.

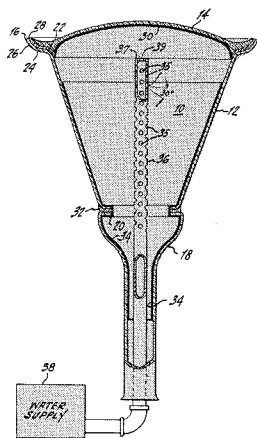

Pat. No. 2,726,180

INTERFERENCE FREE MULTI-MAGNETIC TRACK SYSTEM (Patent No. 2,726,286)—granted December 6, 1955 to J. L. PETTUS and A. C. BLANEY, DEFENSE ELECTRONIC PRODUCTS, Los Angeles, Calif. By placing thin mumetal shields parallel with and between planes passing through the center of and perpendicular to the gaps of the heads, inductive coupling and parasitic recording are prevented.

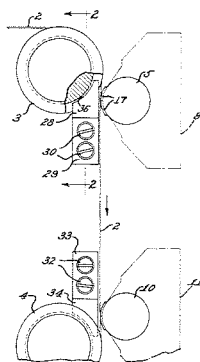

Pat. No. 2,726,286

CROSS-TALK PREVENTION SYSTEM (Patent No. 2,726,287)—granted December 6, 1955 to T. C. SHARP, COMMERCIAL ELECTRONIC PRODUCTS, Hollywood, Calif. To prevent inductive coupling and parasitic recording in multi-track magnetic recorders and reproducers, the drum is constructed of non-magnetic sections separated by thin mumetal discs, the discs being in planes parallel to and between planes passing through the center of and perpendicular to the gaps in the heads.

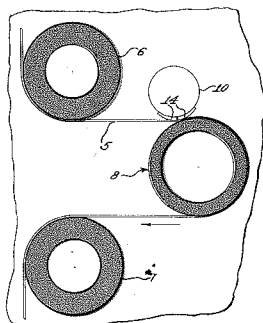

Pat. No. 2,726,287

DYNAMIC BEAM CONVERGENCE SYSTEM FOR TRI-COLOR KINESCOPE (Patent No. 2,726,354)—granted December 6, 1955 to JOHN STARK, JR., RCA VICTOR TELEVISION DIVISION, Cherry Hill, N. J. A parabolic wave is derived from the cathode of the vertical deflection output tube and is impressed upon the convergence apparatus by means of a transformer connected in series with a shunt regulator tube for the high voltage power supply.

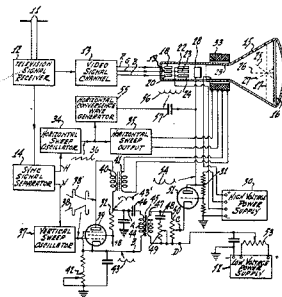

Pat. No. 2,726,354

CARRIER-OPERATED RELAY CIRCUIT (Patent No. 2,726,325)—granted December 6, 1955 to R. A. BEERS and J. R. NEUBAUER,

COMMERCIAL ELECTRONIC PRODUCTS, Camden, N. J. Noise in receiver keeps transmitter off and noise-quieting effect of received signal in receiver turns on transmitter. Another circuit is provided for preventing transmitter from being turned on when receiver fails (which failure would also cause a decrease in receiver noise).

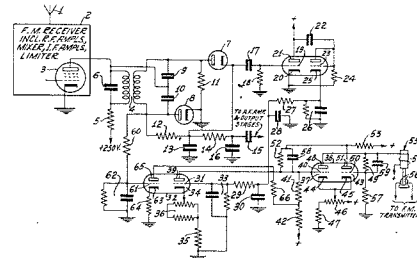

Pat. No. 2,726,325

SEALING APPARATUS FOR CATHODE RAY TUBES (Patent No. 2,725,678)—granted December 6, 1955 to M. R. WEINGARTEN, TUBE DIVISION, Lancaster, Pa. A sealing machine having utility in sealing a rectangular face plate (10) to a metal cone (21) of a cathode-ray tube comprises a plurality of burner segments (12 to 19) mounted for oscillatory movements, for uniformly heating a region to be sealed.

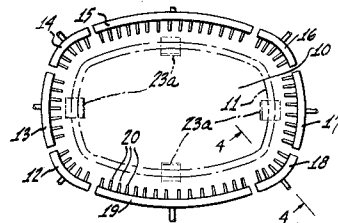

Pat. No. 2,725,678

CARBONIZED COMPOSITE METAL (Patent No. 2,725,617)—granted December 6, 1955 to T. A. STERNBERG, TUBE DIVISION, Harrison, N. J. As a substitute for nickel, a composite metal is provided that is cheaper than nickel although serving the same function as nickel in tube parts. The composite metal includes a steel core 10, an outer carbon coating 12, and an intermediate nickel coating 11. From .05 to 2.5 aluminum is included in the core and the nickel coating has a mass about 10% of the mass of the core.



Pat. No. 2,725,617

Special Request: L. J. Reiger of Patents Operations, Princeton, has requested that all engineering personnel be reminded of the following:

- (1) Only the original or ribbon copy of patent disclosures should be submitted to Patent Operations.
- (2) Duplicates should be retained by the employee or activity.
- (3) The disclosure should include the proper data, clock number, current occupation number and title, and a signature of a witness.

PEN and

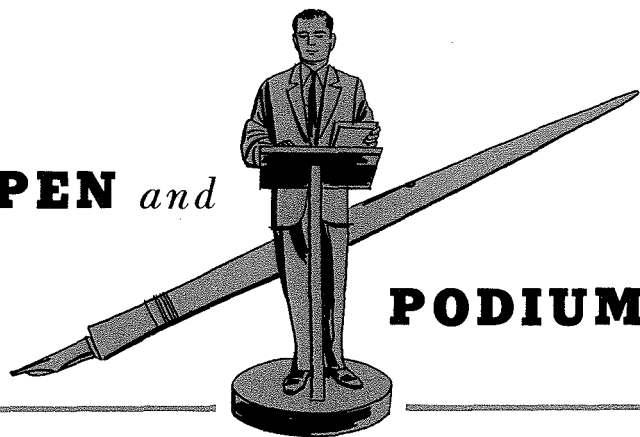

PODIUM

BASED ON REPORTS RECEIVED OVER A PERIOD OF ABOUT TWO MONTHS

NEW DEVELOPMENTS IN ELECTRONICS . . .

By C. C. OSGOOD, DEFENSE ELECTRONIC PRODUCTS, Camden, N. J. Presented to the Pennsville, N. J. Rotary Club on January 16, 1956. Mr. Osgood used slides to compare transistors with vacuum tubes. Transistorized radios, the metal detector, the atomic battery, electron microscope, and television receivers were other subjects described to about 35 club members.

RELATIONS OF MATERIALS AND PROCESSES TO RELIABILITY . . .

By C. EDDISON, TUBE DIVISION, Camden, N. J. Presented to the Electronics Committee, Fire Control Instrument Division of the American Ordnance Association, Pentagon, Washington, D. C., February 10, 1956. This paper discusses the demand for improved reliability of electronic equipment in terms of preservation of the pertinent chemical and physical properties of the materials used in tubes and other components. This fundamental approach recognizes that there can be no electrical or mechanical change in the equipment without a change in the chemistry or physics of the materials or components used. The relationship between reliability and material purchasing specifications is discussed.

TRANSISTORS—TODAY AND TOMORROW . . .

By L. MALTER, SEMICONDUCTOR DIVISION, Harrison, N. J. Presented at IRE Section Meeting, Washington, D. C., February 13, 1956. This paper describes technical advances in the semiconductor field in the past year, and takes a brief look at the future for transistors. The construction and theory of operation of alloy-junction transistors are discussed briefly. The use of gallium as a p-type alloy impurity in such transistors is described as a means of increasing emitter conductivity, and thus injection efficiency, and improving linearity and distortion characteristics of commercial audio transistors. New processing techniques and controls which have made it possible to raise the operating-frequency limit of transistors to one megacycle per second are also described.

COLOR TELEVISION BROADCASTING . . .

By J. L. GREVER, COMMERCIAL ELECTRONIC PRODUCTS, Camden, N. J. Presented on February 3, 1956 at Charlotte, North Carolina, at a meeting of the Virginia-North Carolina Section of IRE. This talk was delivered to an audience generally unfamiliar with television techniques. From a technical point of view, the paper was simplified as far as possible. It was intended to convey only a general picture of color

telecasting. The talk was divided into two categories; principles of colorimetry and color television, and typical studio systems.

THE RCA BIZMAC ELECTRONIC ACCOUNTING SYSTEM . . .

By W. K. HALSTEAD, J. W. LEAS, J. N. MARSHALL, E. E. MINETT, COMMERCIAL ELECTRONIC PRODUCTS, Camden, N. J. Presented at the AIEE Winter General Meeting, New York, February 3, 1956. This paper outlines the BIZMAC System in its present product design form and stresses functional innovations. Features of the System are related to the characteristics of the business data-processing problems for which the Bizmac equipment has been designed. Overall performance characteristics of the system are stated. System flexibility and the handling of high-volume business operations are emphasized.

THE V.T.V.M.—HOW IT WORKS, HOW TO USE IT . . .

By RHYS SAMUEL, TUBE DIVISION, Harrison, N. J. 224 pages, approx. 175 illustrations. Gernsback Library, Inc. Paper cover, \$2.50; hard cover, \$4.60. Describes design features and operation of service-type v.t.v.m.'s, probes, and cables. Important features of various commercial models are illustrated and discussed. Other chapters are devoted to application of the v.t.v.m. in television, am and fm receivers, audio equipment, and amateur-radio servicing. Also included is a section on troubleshooting and repair of the v.t.v.m. The book is intended for experimenters, service technicians and engineers.

MAGNETIC TAPE FILE IN THE RCA BIZMAC SYSTEM . . .

By J. A. BRUSTMAN, R. E. MONTIJO, and J. M. URITIS of COMMERCIAL ELECTRONIC PRODUCTS, Camden, N. J. Presented on February 3, 1956 at the AIEE Winter General Meeting, New York. One of the innovations of the RCA Bizmac System has been the extensive use of magnetic tape stations for short and long time record file. Individual tape stations are assembled into a central Tape File, accessible to all data-processing devices in the system. Tape stations and data-processing machines are interconnected in a matter of seconds. The magnetic tape stations consist of a tape-transport unit, an amplifier-control unit, and a power supply. Fast start and stop times, and a simple and inexpensive reel servo system are features. The magnetic recording system associated with the Tape File features a novel method of dual recording.

FREQUENCY STABILITY OF TRANSISTOR OSCILLATORS . . . By C. C. CHENG (formerly Tube Division, Harrison, N. J., now teaching in Singapore). Published in PRO-

CEEDINGS OF THE I.R.E., February, 1956. Frequency-stability properties of oscillators using both point-contact and junction transistors are investigated both analytically and experimentally. The point-contact-transistor "two-terminal" oscillators are analyzed by means of non-linear differential equations of the Van der Pol type. Duality relationship is demonstrated between oscillators using the voltage-controlled, negative-admittance, base-input characteristics and oscillators using the current-controlled, negative-impedance, emitter-input or collector-input characteristics. As a result, the general stability criterion derived for the former can be applied directly to the latter. The junction transistor "four-terminal" oscillators are investigated by means of linear circuit analysis. Stabilization techniques are derived and impedance-stabilized oscillators are illustrated. Temperature effects on performance of oscillators are investigated.

RECEIVING-TUBE DEVELOPMENT . . .

By R. C. FORTIN, TUBE DIVISION, Harrison, N. J. Presented at Student AIEE-IRE Meeting, Lehigh University, Bethlehem, Pa., January 19, 1956. This paper describes the development of a receiving tube, beginning with the initial idea for a new product. The decision to develop a tube is made after consideration of factors such as practicability, manufacturability, marketability, and profitability. The tube development culminates in announcement to prospective customers and concurrent production.

3-VIDICON COLOR TELEVISION CAMERA FOR LIVE PICKUP . . .

By L. E. ANDERSON, COMMERCIAL ELECTRONIC PRODUCTS, Camden, N. J. Presented on February 2, 1956 at the New York City AIEE Meeting. A 3-vidicon color camera is described which is useful for applications where sufficient light can be made available. The camera has been used in several closed circuit demonstrations of medical television and has been field tested by NBC. Broadcast commercials involving well lighted product displays or opaques and outdoor pickups on bright days are practical. Because of its small size and low operating cost the camera will extend color television to applications in education and industry.

A DEVELOPMENTAL WIDE-BAND, 100-WATT, 20-DB, S-BAND TRAVELING-WAVE AMPLIFIER UTILIZING "PERIODIC" PERMANENT MAGNETS . . .

By W. W. SIEKANOWICZ and F. STERZER, TUBE DIVISION, Harrison, N. J. Published in PROCEEDINGS OF THE I.R.E., January 1956. Previously presented at Electronic Components Conference, Los Angeles, California, May 27, 1955, and published in PROCEED-

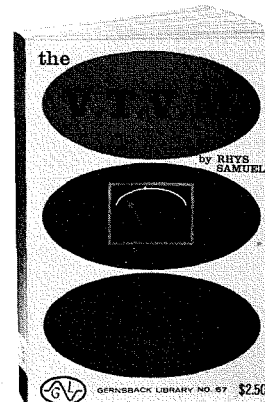

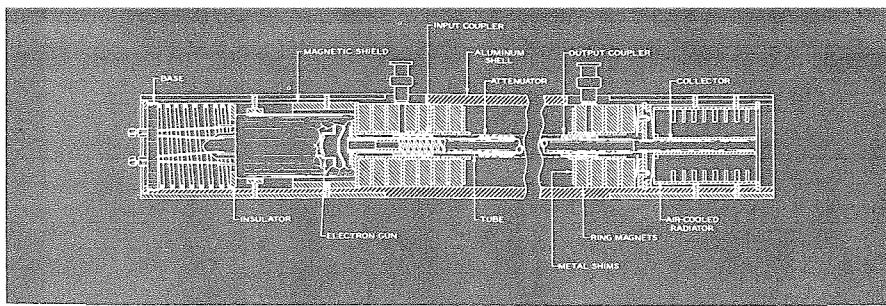

Cross-sectional drawing showing details of S-band Traveling Wave Amplifier

INGS of Conference, August 1955). A developmental, 100-watt, S-band traveling-wave amplifier utilizing ceramic "periodic" permanent magnets to focus the electron beam is described. Their use in place of conventional solenoids or permanent magnets producing uniform fields effects a considerable reduction in the weight and size of focusing systems. Constructional features of the tube which permit operation with the "periodic" magnet are discussed.

THE RCA BIZMAC SYSTEM . . . By W. K. HALSTEAD, COMMERCIAL ELECTRONIC PRODUCTS, Camden, N. J. Mr. Halstead presented an informal tutorial seminar regarding application of the RCA Bizmac System to business problems at the Moore School of Electrical Engineering, University of Pennsylvania, on January 18, 1956. This seminar was presented as part of the Moore School evening course on Business Applications of Electronic Computers. Beyond a brief presentation of the system, a stock control operation was discussed.

FUNCTIONAL ORGANIZATION OF DATA IN THE RCA BIZMAC SYSTEM . . . By A. D. BEARD, W. K. HALSTEAD, J. F. PAGE, COMMERCIAL ELECTRONIC PRODUCTS, Camden, N. J. Presented on February 9, 1956 at the Western Joint Computer Conference, San Francisco. This talk covers the characteristics of business data and the influence which these characteristics have had on the basic planning of the RCA Bizmac System. It was found desirable to provide complete variability of data-item and message length in storing information on magnetic tape. This led to compression factors as high as five in the storage of certain files when compared with the earlier fixed-word, fixed-block concept. This radical departure has had some specific influences on design of data-processing equipment.

HOW MUCH AND WHAT KIND OF EDITING . . . By C. A. MEYER, TUBE DIVISION, Harrison, N. J. Presented at Society of Technical Writers and Editors, New York City, February 8, 1956. This paper describes the Commercial Engineering activity of the RCA Tube Division as an example of how much and what kind of editing is done in a specialized type of editorial activity. The advantages to the company, the author, and the magazine editor are mentioned. The engineering editor's responsibilities are enumerated, and his relationship to the ultimate reader and to the author are discussed. The importance of personal contact between the editor and the author is emphasized, and some time-tested techniques for establishing and maintaining friendly relations with the author are described.

THE FIELD OF TELECASTING FROM A PRODUCTION VIEWPOINT . . . By F. C. BRUNNER, SEMICONDUCTOR DIVISION, Harrison, N. J. Presented at Vocational Guidance Program, Madison, N. J., January 25, 1956. This paper describes the basic groups required to organize a television show (studio personnel, network and advertising agencies, and actors and performers), and explains how these three groups affect one another. A brief description is given of the functions of such studio personnel as di-

rectors, floor managers, script girls, property men, art directors, camera crews, lighting directors, film editors, audio and video engineers, etc. The field of telecasting is shown to include such other major fields as electrical engineering, photography, law, and script writing.

ELECTRONIC METAL DETECTORS FOR AUTOMATIC INSPECTION, COUNTING AND CONTROL . . . By R. A. HADDAD, COMMERCIAL ELECTRONIC PRODUCTS, Camden, N. J. Presented at the Conference on Instrumentation and Control in the Process Industries, Armour Research Foundation, on January 25, 1956. The ever increasing demand of industry for tools and methods that will reduce labor costs, increase production efficiency and simultaneously protect product quality has been met in many instances by the development of special electronic devices. One of these is the electronic Metal Detector, widely useful in automatic inspection, counting and control. The purpose of this paper is to explain the principle of operation of the electronic metal detector; its use in automatic inspection, counting and control; and its service to numerous industries.

A 50-KW AMPLIPHASE BROADCAST TRANSMITTER . . . By T. J. BOERNER, COMMERCIAL ELECTRONIC PRODUCTS, Camden, N. J. Presented on February 2, 1956 at the AIEE Winter General Meeting under the sponsorship of the Communications Division, Committee on Television and Aural Broadcasting Systems. A new standard band 50-KW broadcast transmitter embodying the phase-to-amplitude modulation system is described with particular emphasis on the use of circuitry and mechanical arrangements to assure ease of installation, economical operating cost and good reliability. The system is one in which the r-f signal is phase modulated by the audio intelligence at a low level and then amplified by high gain class "C" amplifiers to the desired power. The high power phase modulated signal is then converted to an am signal by means of a suitable output network.

THE SYSTEM CENTRAL CONCEPT IN THE RCA BIZMAC SYSTEM . . . J. A. BRUSTMAN, P. T. O'NEIL, J. L. OWINGS, COMMERCIAL ELECTRONIC PRODUCTS, Camden, N. J. Presented on February 9, 1956 at the Western Joint Computer Conference, San Francisco. The purpose of the System Central is to integrate the elements of a Bizmac System and to provide for controlling the performance of each element so that the combination functions in proper concert. As the tasks for electronic business machines have grown the equipments required for handling these tasks have become more varied and complex, and the problem of economical operation has become increasingly important. In the Bizmac System, specialized supervisory equipments have been designed to apply over-all control and direction. This permits low cost of operation, high utilization of data-processing equipment, effective control of the accuracy and efficiency of operation.

PURPOSE AND APPLICATION OF THE RCA

BIZMAC SYSTEM . . . By W. K. HALSTEAD, J. W. LEAS, E. E. MINETT, J. N. MARSHALL, COMMERCIAL ELECTRONIC PRODUCTS, Camden, N. J. Presented at the Western Joint Computer Conference, San Francisco, on February 9, 1956. The RCA Bizmac System has been designed specifically to meet the data processing needs of large business operations. Its features were established on the basis of very thorough studies of representative classes of business problems. It was found that, in most clerical operations of a large scale, a cyclic processing of data against a basic reference file is the bulk of the data-handling job. To meet this requirement and satisfy a number of others, several novel features were incorporated into the RCA Bizmac System. These include a new concept of data-recording variability, a higher level of system integration than heretofore provided, and several special-purpose machines which take the burden off the major computer.

MILITARY AND INDUSTRIAL RECEIVING TUBES . . . By R. N. PETERSON, TUBE DIVISION, Harrison, N. J. Presented at Rome Air Development Center, January 11, 1956. This paper discusses the major categories of RCA industrial receiving tubes, including "Special Red," pencil-type, computer, and premium tubes. RCA's philosophy toward the manufacture of industrial tubes is evaluated through consideration of construction techniques, materials, quality-control procedures, and specifications, and the relationship of these items to the requirements of the equipment designer. The intended application of each category of tubes is described briefly. Certain industrial tubes now in development or planned for development in 1956 are discussed.

DEVELOPMENT AND COMMERCIAL JUNCTION TRANSISTORS AND FUTURE DEVELOPMENT PROGRAMS . . . By J. W. ENGLUND, SEMICONDUCTOR DIVISION, Harrison, N. J. Presented at the Air Force Cambridge Research Center, Lexington, Mass., February 20, 1956. This paper describes the general characteristics and applications of available commercial transistors, including the 2N77, 2N104, 2N105, 2N109, 2N139, and 2N140. The desirability of certain modified characteristics for special applications is mentioned, and several transistor designs presently in the developmental stage are described. Future Semiconductor development programs are discussed.

GRAPHICAL AIDS FOR FREQUENCY RESPONSE ANALYSIS . . . By H. D. ECKHARDT, DEFENSE ELECTRONIC PRODUCTS, Waltham, Mass. Published in January, 1956 Issue of the JOURNAL OF THE AERONAUTICAL SCIENCES. The paper discusses a graphical method for the direct construction or modification of gain-phase plots to account for the cascading of any linear elements and demonstrates how a single template can be used to perform this graphical construction quickly and easily, directly on the gain-phase plot. In addition to providing a quick, easy construction method, the use of this template allows a vivid visualization of the effects of "shaping networks."

LIMITLESS HORIZONS IN TELEVISION . . . By A. INGLIS, COMMERCIAL ELECTRONIC PRODUCTS, Camden, N. J. Presented on January 18, 1956 to the Pittsburgh Radio & Television Club, Pittsburgh, Pa. New technical developments which are now in the laboratory and which will have a significant effect on the progress of television during the next ten years are described.

CHARACTERISTICS OF THE RCA BIZMAC COMPUTER . . . By A. D. BEARD, L. S. BENSKY, D. L. NETTLETON, G. E. POORTE, COMMERCIAL ELECTRONIC PRODUCTS, Camden, N. J. Presented on February 9, 1956 at the Western Joint Computer Conference, San Francisco. The RCA Bizmac Computer, which is a variable word length machine designed primarily for the processing of business data, is described. Its input and output data are stored on magnetic tape stations. Five input and ten output trunks are available. The Computer has a magnetic-core high-speed memory of 4,096 characters, and an auxiliary memory of 32,000 characters, which serves as the main instruction storage. The machine has an instruction complement of twenty-two different instruction types, many of which can be subject to minor variations at the discretion of the programmer.

PROGRAMMING THE VARIABLE-ITEM-LENGTH RCA BIZMAC COMPUTER . . . L. S. BENSKY, T. M. HUREWITZ, A. S. KRANZLEY, R. A. C. LANE, COMMERCIAL ELECTRONIC PRODUCTS, Camden, N. J. Presented at the Western Joint Computer Conference, San Francisco, on February 9, 1956. The design characteristics of the computer were arrived at after a careful study of the processing needs of business problems. The most important of these characteristics is the fully variable length of data items on magnetic tape. The manner in which the computer handles variability in all of its aspects has provided a uniquely adaptable tool for commercial applications. The writing of programs for the Bizmac Computer is therefore also unique in many ways.

A NEW HIGH-GAIN MULTIPLIER PHOTOTUBE FOR SCINTILLATION COUNTING . . . By W. WIDMAIER, R. W. ENGSTROM, and R. G. STOUDEHEIMER, TUBE DIVISION, Lancaster, Pa. Presented at 5th Scintillation Counter Symposium, Washington, D. C., February 28, 1956. This paper describes the RCA-6810, a head-on type of multiplier phototube having an S-11 response and intended for use in high-speed scintillation counting. This tube features a 2-inch-diameter, semi-transparent cathode, and has a fourteen-stage, inline, electrostatically focused, silver-magnesium dynode structure. The mechanical construction of the tube and the method of assembly are described.

With a supply voltage of 2000 volts, the 6810 is capable of multiplying feeble pulses 12.5 million times and has a luminous sensitivity of 750 amperes per lumen. Speed of response, after-pulses, and time-resolution capability are discussed, and effect of magnetic field on performance described.

THE ELECTRON TUBE . . . By L. H. URDANG, TUBE DIVISION, Indianapolis, Indiana. Presented at a Luncheon Meeting of the Indianapolis Section of the American Chemical Society, Indianapolis, Indiana, February 7, 1956. This paper reviews typical applications of vacuum tubes, including rectifiers, amplifiers, oscillators, picture tubes, phototubes, and other special applications. Basic elements of electron tubes are described, and their functions are discussed. Typical materials used for various elements are evaluated. Consideration is given to processing of parts prior to assembly, handling of parts during assembly, sealing and exhaust procedures, and aging and testing of tubes. Samples of various parts are shown.

A SCATTER PROPAGATION EXPERIMENT AT 400, 250, AND 2820 MC . . . By H. R. MATWICH and S. P. BROWN, DEFENSE ELECTRONIC PRODUCTS, Camden, N. J. Presented on February 3, 1956 at the IRE Symposium on Microwave Techniques, University of Pennsylvania, Phila. Scatter propagation tests which have been run over two test circuits of 73 miles and 153 miles length are described. The frequencies tested have been 400 megacycles, 2250 megacycles and 2820 megacycles. The largest antennas used are 28' diameter parabolas. 6' antennas have occasionally been used for individual experiments demanding portability. Transmissions thus far have used both pulses and continuous waves. A correlator is in use to facilitate the taking of space diversity data. Observations were taken using pulse radar transmission. These gave information on the band width restriction imposed by both the scatter medium itself and the medium in combination with aircraft interference. This data was taken with both broad and narrow beam antennas indicating the improvement resulting from the use of narrow beam antennas.

HOW TO MAKE LIVE COMMERCIALS USING RCA 3-V COLOR FILM CHAIN . . . By S. L. BENDELL, H. KOZANOWSKI and T. J. SHIPFERLING of COMMERCIAL ELECTRONIC PRODUCTS, Camden, N. J. Published in February, 1956 BROADCAST NEWS. This paper describes how film equipment, originally designed for handling opaque reproduction, has demonstrated the ability to handle live color commercials. The ability to work directly from artwork, printed matter or sponsors' product provides an inexpensive method of producing color commercials.

THE TRAVELING-WAVE TUBE: APPLICATIONS AND APPLICATION CONSIDERATIONS . . . By F. R. ARAMS and M. MAGID, TUBE DIVISION, Harrison, N. J. Presented at Meeting of Northern New Jersey Section of IRE Professional Group on Microwave Theory and Techniques, Montclair, N. J., January 18, 1956. This paper describes the operation of a typical traveling-wave tube. The application of various types of traveling-wave tubes is discussed, including their use as amplifiers, electronically tunable amplifiers, oscillators, electronically tunable oscillators, frequency multipliers, limiters, low-noise radar input tubes, single-sideband modulators, mixers, and frequency shifters, and in amplitude, phase, and pulse-modulation service. Special considerations involved in the use of traveling-wave tubes, such as stability of voltages, matching effects, magnetic-field considerations, and distortion are also discussed.

A REVIEW OF SURFACE BASED ANTI-AIRCRAFT GUIDED MISSILES AND THEIR GUIDANCE PRINCIPLES . . . By N. I. KORMAN, DEFENSE ELECTRONIC PRODUCTS, Moorestown, N. J. Presented February 21, 1956 before Naval Reserve Aviation Company 4-3, Naval Air Station, Johnsville, Pa. A description of various missiles, such as Terrier, Talos, Nike, Bomarc, Hawk and guidance phases, such as capture, mid-course, and terminal was given. Missile launching was also considered, pointing out the necessity for trainable launchers in some cases, and the possibility of fixed vertical launchers in other cases. The presentation included a discussion of terminal guidance, including such factors as the possibility of merely extending a mid-course phase with tightened servos and the use of various homers employing passive means, semi-active radar means and active radar means.

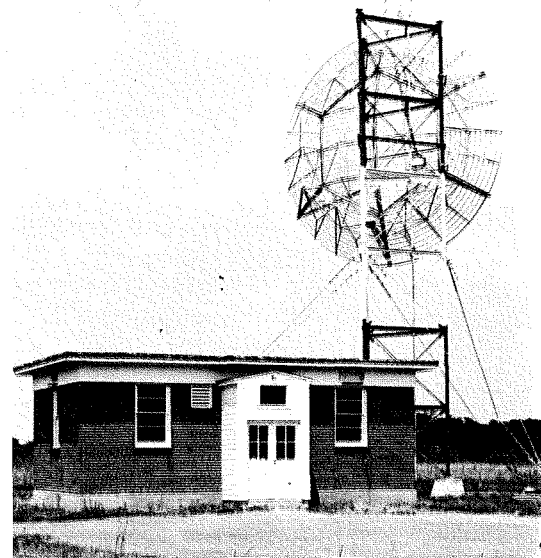

View of "Scatter" Test Site

NEW SIGNAL HANDLING TECHNIQUES SIMPLIFY CONTROL OPERATIONS FOR COLOR TV . . .

By I. BOSINOFF, A. C. LUTHER, F. W. MILLSPAUGH and H. M. POTTER of COMMERCIAL ELECTRONIC PRODUCTS, Camden, N. J. Published in February, 1956 BROADCAST NEWS. This paper describes the RCA processing amplifier which is used with RCA Color Studio Camera and Film equipment. It has both simplified and standardized control operations. Its compact design provides (1) centralized equipment, (2) easy, accurate setup of camera chains, (3) system simplicity and reliability, and (4) very stable circuitry.

A NEW SUBMINIATURE THYRATRON FOR AIRBORNE APPLICATIONS . . .

By H. J. PRAGER, TUBE DIVISION, Harrison, N. J. Presented at AIEE Winter General Meeting, New York City, January 31, 1956. This paper describes a new developmental subminiature thyatron intended especially for airborne equipment. The geometry of the tube is discussed and testing procedures are shown. Ratings and various thyatron characteristics are given, and performance in pulse modulator service is evaluated. The effects of peak cathode current (up to 10 amperes) and the relationship between maximum trigger frequency and the anode supply voltage are considered.

GAS TUBES PROTECT HIGH-POWER TRANSMITTERS . . .

By W. N. PARKER and M. V. HOOVER, TUBE DIVISION, Lancaster, Pa. Published in ELECTRONICS, January, 1956. (Previously presented at the IRE National Convention, New York City, March, 1955, and published in the IRE CONVENTION RECORD.) This paper describes high-speed electronic circuits capable of microsecond response which have been developed to minimize the possibility of damage to power tubes resulting from "flash-arc" or "Rocky Point Effect." The circuit detects fault conditions in a power tube or its circuitry and triggers a gaseous conduction device connected in shunt with the dc power supply. Fault currents are rapidly bypassed from the faulting tube by means of the gaseous conduction device. Thus, the "flash-arc" in the protected tube is extinguished, avoiding damage.

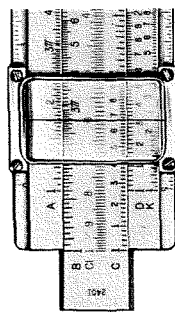

INTRODUCING THE CHIEF PRODUCT ENGINEERS IN COMMERCIAL ELECTRONIC PRODUCTS

Engineering in Commercial Electronic Products encompasses a wide variety of product and research activities in the broad areas of commercial and industrial electronics. Engineering and equipment design are grouped into four major product areas, each under the leadership of a Chief Product Engineer.

BIZMAC ENGINEERING, under J. Wesley Leas, Chief Product Engineer, encompasses the area of the RCA Bizmac Data Processing System (see the *RCA ENGINEER*, Vol. 1 No. 4).

BROADCAST AND TELEVISION EQUIPMENT ENGINEERING, with V. Elmer Trouant as Chief Product Engineer, includes design in Broadcast Audio, TV Studio and Relay Equipment, Color TV Development, AM, FM, TV Transmitters and Antennas, and Special Purpose Transmitters.

COMMUNICATIONS ENGINEERING, headed by John C. Walter, Chief Product Engineer, includes Mobile Communications and Microwave Relay Equipment as major engineering areas.

THEATRE AND SOUND ENGINEERING, under Norman M. Brooks, Chief Product Engineer, performs design work in the following areas: Sound and Visual, Theatre Equipment, Instruments and Speakers, Measurement and Test, Scientific Instruments, and Industrial Equipment.

J. WESLEY LEAS received a BSEE degree from Ohio State University in 1938. Following three years of sales engineering work, Mr. Leas entered military service and went to England with the Electronics Training Group in 1942. He later joined the RAF Radar Laboratory. In the United States, he became Assistant Head for Engineering of

the Combined Research Group at the Naval Research Laboratory.

At war's end, Mr. Leas was appointed Airborne Radar Chief of the Airborne Instruments Laboratory. He afterward transferred to the Air Transport Association. In 1949, he joined the Air Navigation Development Board. He came to RCA in June, 1951. Mr. Leas was appointed head of Computer Engineering in 1952, and became Chief Product Engineer, Bizmac Engineering in 1955.

A senior member of IRE, Mr. Leas also belongs to Eta Kappa Nu, the Institute of Navigation, the Armed Forces Communication Association and the American Ordnance Association. He is a Lieutenant Colonel in the Air Force Reserve.

V. ELMER TROUANT, Chief Product Engineer for Broadcast and Television Equipment Engineering, received his BSEE from the University of Maine in 1921. With Westinghouse Electric, he specialized in automotive ignition systems and later transferred to radio transmitter engineering. Coming to RCA in 1933, Mr. Trouant designed one of the early 50-kilowatt broadcast transmitters. He continued as a supervising engineer until his 1945 appointment as Manager of the Communication and Radio Frequency Section. In 1951, he was appointed Chief Design Engineer for Standard Products.

Typical of RCA developments under Mr. Trouant's guidance are high-power transmitters with high-level modulating and air-cooling and grounded-grid amplifiers. He has also directed the design of a complete line of broadcast transmitters for AM, FM and television—plus apparatus and test equipment for color television broadcasting.

Mr. Trouant is a member of the American Institute of Electrical Engineers, the Society of Motion Picture and Television Engineers

and is a senior member of the Institute of Radio Engineers.

J. C. WALTER, Chief Product Engineer of Communications Engineering, was graduated from the University of Notre Dame, in 1924. Following three years of radio-telegraph work in Central America, he designed high-power carrier current systems.

Mr. Walter began his RCA career in 1936 by designing 50-500 kw broadcast transmitters. During World War II, he served with the Navy's Bureau of Ships and in the Pacific. Back with RCA in 1946, Mr. Walter supervised design of equipments such as a 150 kw international broadcast transmitter, a 1000 kw Navy telegraph transmitter and a color TV transmitter incorporating the first UHF transmission at 1000 kw ERP. He was appointed to his present position in 1955.

Mr. Walter is a member of the AIEE, American Society of Naval Engineers, Franklin Institute, NSPE and a senior member of IRE. He holds posts on AIEE Committees on Electronic Power Converters and Hot Cathode Power Converters. Mr. Walter is a Commander, USNR.

NORMAN M. BROOKS, Chief Product Engineer, Theatre and Sound Engineering, graduated from Virginia Polytechnic Institute in 1927 with a BSEE degree. During three years at the General Electric Company, he designed test equipment.

Transferring to RCA in 1930, Mr. Brooks continued designing special test equipment and in 1945 he became Manager of Test Equipment Engineering. Under his direction, engineers developed the first equipment for mass-testing television receivers.

In 1948 Mr. Brooks was named Manager of Communication and Sound Engineering. He was appointed Manager, Theatre and Industrial Equipment Engineering in 1953, when his responsibilities were broadened to include management of Industrial and Scientific Equipment Engineering. He assumed his present duties in 1955.

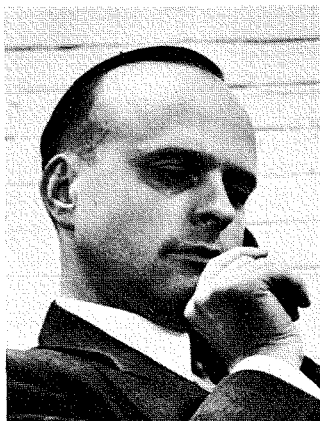

J. Wesley Leas

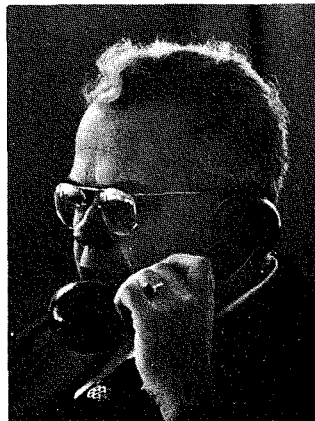

V. Elmer Trouant



John C. Walter

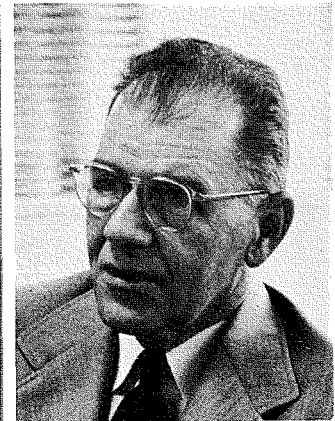

Norman M. Brooks

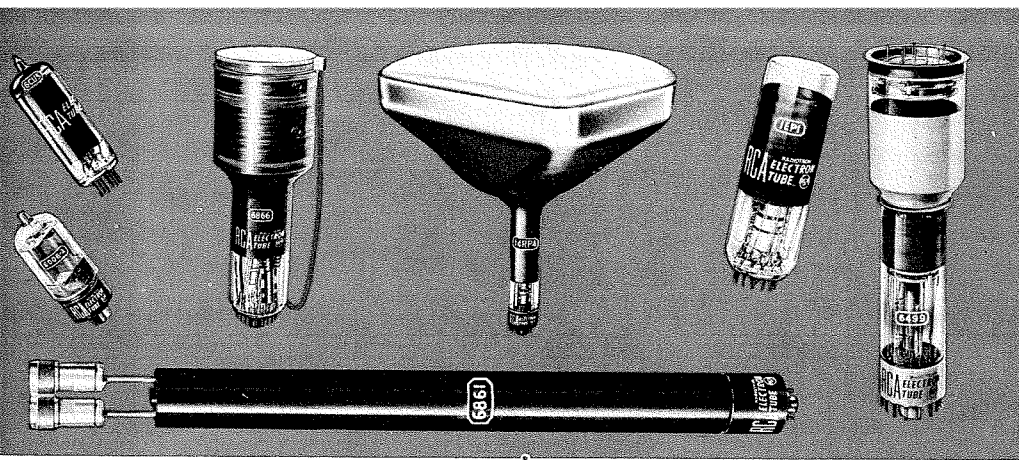

NEW RCA SEMICONDUCTOR AND TUBE TYPES

RCA-6866 is a 5-inch display storage tube of the direct-view type designed for use in applications where it is desired to have a bright, non-flickering display of stored information for about 60 seconds after writing has ceased. Practical applications of the 6866 include: fire-control radar; airplane-cockpit radar display; airport surveillance; transient studies; data transmission including half-tones; and visual communications requiring steady, non-flickering, narrow bandwidth transmission over telephone lines.

RCA-6861 is a low-noise, low-level traveling-wave amplifier tube of the helix-transmission-line type intended for use in the input stage of radar and scatter-propagation receivers, in other microwave receivers, and in i-f amplifier stages of receivers for millimeter waves. Operating in the frequency range from 2700 to 3500 Mc, the 6861 is particularly suitable for tunable-system applications.

RCA-6850 is a small, sturdy, twin beam power tube designed primarily for service as a push-pull rf power amplifier or as a frequency tripler in the uhf range between 450 and 470 Mc. Having a 12.6-volt heater, but otherwise like the type 6524, the 6850 is intended especially for use in mobile equipment operating from a 12-volt storage battery.

RCA-6499 radechon is a charge storage tube of the barrier-grid type for use in a variety of information-processing systems. Information in digital or analogue form may be introduced to the active elements of the tube, stored for a period of time controllable from microseconds to minutes, and then extracted at a rate the same as or different from the writing-rate.

RCA-14RP4 is a picture tube intended primarily for low-cost, lightweight, transportable TV receivers. The tube is a short, lightweight, directly viewed, rectangular, glass picture tube of the low-voltage electrostatic-focus and magnetic-deflection type. This type has a spherical Filter-glass faceplate, a screen $12\frac{1}{2}'' \times 9\frac{3}{8}''$ and a typical projected screen area of 108 square inches, employing wide-angle (90°) deflection.

RCA-6DQ6-A and **RCA-12DQ6-A** are high-perveance glass-octal type beam power tubes. They are intended especially for use as horizontal deflection amplifier tubes in deflection circuits of television receivers.

Designed with a large reserve of power capability, these tubes have ratings which are substantially higher than those of the 6DQ6 and 12DQ6 and can deflect fully picture tubes having deflection angles in excess of 90 degrees. The 6DQ6-A and 12DQ6-A are unilaterally interchangeable with the 6DQ6 and 12DQ6, respectively.

RCA-6CU5 and **RCA-12CU5** are two new beam power tubes of the 7-pin miniature type intended particularly for use in the audio output stage of television receivers.

Because of their high power sensitivity and high efficiency at low plate and screen voltages, the 6CU5 and 12CU5 are capable of providing a relatively high power output. For example, in class A1 amplifier service, either tube operated with a plate voltage of 120 volts and a grid-No. 2 voltage of 110 volts, can deliver a maximum-signal power output of 2.3 watts. The 12CU5 is like the 6CU5 except that it has a 12.6 volt/0.6-ampere heater having controlled heating time for series-heater string arrangements.

RCA-5CG8 and **RCA-6CG8** are 9-pin miniature tubes each containing a medium-mu triode and a sharp-cutoff pentode in one envelope. They are designed especially for use as a combined oscillator and mixer tube in television receivers utilizing an i-f in the order of 40 Mc. The 5CG8 and 6CG8 also offer versatility to designers of AM/FM receivers. The 5CG8 is like the 6CG8 except that it has a 4.7 volt/0.6-ampere heater.

RCA-2BN4 and **RCA-6BN4** are two new 7-pin miniature medium-mu triodes designed especially for use as rf amplifiers in grounded-cathode circuits of vhf television tuners. The design of these tubes includes double base-pin connections for both cathode and grid to reduce effective lead inductance and lead resistance with consequent reduction in input conductance. In addition the 2BN4 and 6BN4 each have a high transconductance of 6800 micromhos to permit high gain and reduced equivalent noise resistance. The 2BN4 is like the 6BN4 except that it has a 2.1 volt/0.6 ampere heater having controlled heating time for a series-heater string arrangements.

RCA-2N175 is a new hermetically sealed, germanium alloy-junction transistor of the p-n-p type. It is designed especially for use in the preamplifier or input stages of transistorized audio equipment operating from extremely small input signals.

Because of its exceptionally low noise factor of 6 db max., and its freedom from microphonism and hum, the 2N175 makes possible higher small-signal sensitivity of transistorized audio equipment such as hearing aids, microphone preamplifiers, and recorders.

RCA-1EP1 is a new oscillograph tube having a diameter of $1\frac{1}{4}''$. It is intended primarily for use in lightweight portable equipment, in aircraft, or in continuous monitoring service for large electronic equipment. The 1EP1 utilizes electrostatic focus and electrostatic deflection. It has a flat face, a minimum useful screen diameter of $1\frac{1}{16}''$ inches and a maximum overall length of only $4\frac{1}{16}''$ inches.

NEW PRODUCTS

RCA STARTS PRODUCING ITS FIRST HI-FI TAPE RECORDERS . . . Start of production on a new high fidelity tape recorder—first to be manufactured by RCA was announced by RCA Victor Radio and "Victrola" Division. The model now in production at RCA's Cambridge, Ohio, plant is the "Judicial" (Model 7TR3), a 3-speaker, push-button portable that incorporates a number of new engineering advances developed by RCA engineers. The "Judicial" is to be the forerunner of a complete line of RCA Victor tape recorders.

An extensive addition to the Cambridge plant, more than doubling the present floor space, is now underway to provide increased facilities for the manufacturing of tape recorders and high fidelity instruments.

4-VOLT MERCURY BATTERY FOR HYBRID RADIO SETS . . . A new 4-volt mercury battery (Type VS400), especially designed for battery-operated radio receivers using circuits with both tubes and transistors, has been introduced by the RCA Tube Division. The VS400 is $1\frac{1}{32}$ inches in diameter and $1\frac{31}{32}$ inches high, and has flashlight-type terminals.

BIZMAC MICROFILM ENLARGER . . . On February 14 through 17, BIZMAC Engineering (CEP) displayed to invited customer prospects a new printing machine using the RCA Electrofax process. It can work either from strip film or from individual film frames mounted on business machine cards ("Filmsort" cards). The demonstration was handled jointly with the Filmsort Division of the Dexter Folder Company and the Recordak Division of Eastman Kodak. Invited guests represented government agencies and manufacturing concerns. The BIZMAC Microfilm Enlarger can produce 900 enlargements per hour of size $17'' \times 22''$ and can produce automatically up to 24 copies of a single given Microfilm frame. See *RCA Electrofax in the Graphic Arts*, M. L. Sugarman, Vol. 1, No. 5.

NEW 'PERSONAL' TELEVISION RECEIVER SLIGHTLY LARGER THAN TABLE MODEL RADIO SET ANNOUNCED . . . A newly-designed portable television receiver—only slightly larger than a table model radio—has recently been placed on the market.

Production is now underway following more than a year of intensive development and design. The instrument, which operates on standard electric current, features a completely new RCA-engineered chassis, specially designed components, and a newly-developed RCA-8DP4 picture tube having an outside diagonal measurement of $8\frac{1}{2}''$ inches.

The "Personal" (Model 8PT703) measures $10\frac{1}{4}''$ inches high, $9\frac{1}{4}''$ inches wide and $12\frac{7}{8}''$ inches deep, and without its stand weighs slightly more than 22 pounds.

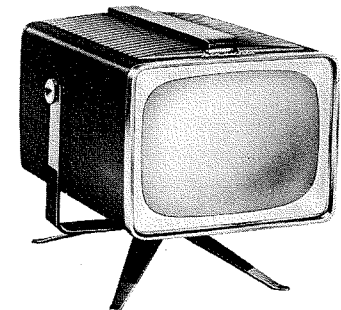

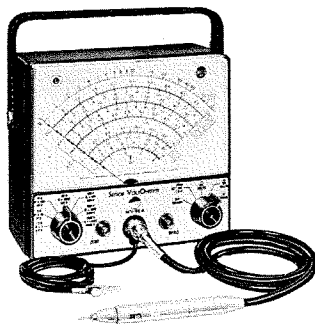

THE WV-98A, RCA's new Senior *VoltOhmyst*, is a vacuum tube voltmeter designed for all-round testing and trouble-shooting of TV, FM, AM and audio circuits. The WV-98A includes an improved, negative feedback circuit, and an extra-large meter face. A new single-unit dc/ac-ohms probe with a built-in switch for selection of dc, ac, or resistance functions is provided. Overall accuracy of the WV-98A on its a-c and d-c voltage scales is plus-or-minus 3%. Input resistance on d-c scale, including 1 megohm in the probe, is 11 megohms. On a-c scales, input resistance is at least 0.83 megohms.

RCA DEVELOPS 'MIDGET' POWER SUPPLY FOR TELEVISION STUDIO EQUIPMENT THAT REDUCES TUBE AND SPACE NEEDS BY 70 PER CENT . . . Development of a revolutionary power supply unit, for use with television studio equipment, which reduces tube and space requirements by more than 70 per cent was announced by Dr. James Hillier, Chief Engineer, RCA Commercial Electronic Products. The "midget" power-house, produces 1,500 milliampere output, requires only 10½ inches of rack space, and provides more than 250 per cent more usable power than previously available RCA types. This new power supply (WP-15) is designed for both commercial and closed-circuit television applications and will have a wide range of uses in the industrial and laboratory field.

NEW HI-FI AM/FM RADIO TUNER . . . a new RCA hi-fi AM/FM tuner, which features an electronic "eye" to facilitate pin-point radio tuning, was announced by the Theatre and Sound Products Department. The AM/FM tuner (ST-4) is electrically matched for plug-in use with associated RCA hi-fi components in home assembled music systems; features an extended frequency range of 20 to 15,000 cycles per second; and provides an audio output of 1.5 volts.

"THUMB-SIZE" MICROPHONE IS SMALLEST DYNAMIC TYPE DEVELOPED FOR BROADCAST USE . . . The smallest dynamic microphone ever developed for radio and television broadcasting has been placed on the market by the Broadcast and TV Equipment Department. The "thumb-size" microphone (BK-6B) is so small that it can be carried completely concealed in the hand. It plugs directly into studio consoles and requires no tubes or special power supply. The miniature "mike" is engineered with a frequency response of 80 to 12,000 cycles.



J. deGraad

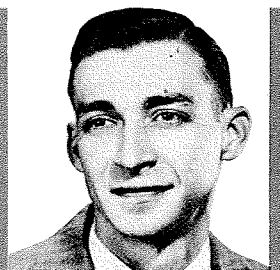

F. H. Ricks

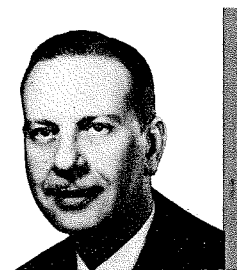

H. B. Martin

NEW EDITORIAL REPRESENTATIVES APPOINTED

New Editorial Representatives have been appointed at Marion, Indianapolis and at Radiomarine, New York.

JAN DEGRAAD, former Assistant Editorial Representative at the Marion Tube Plant has been appointed to replace Morris N. Slater, who has transferred to Lancaster. (See *News and Highlights*, Vol. 1 No. 2 for Mr. deGraad's biography.

F. H. RICKS has replaced L. H. Urdang in his Editorial duties at the Indianapolis Tube Plant. Mr. Urdang has recently been promoted to Superintendent of the Indianapolis Miniature Tube Factory.

H. B. MARTIN has replaced Melvin Schoenfeld as Editorial Representative for the Radiomarine Corporation at New York. Mr. Schoenfeld has taken a position with the Belock Instrument Company at College Point, N. Y.

The editors wish to extend their thanks to Messrs. Schoenfeld, Urdang and Slater for their constructive efforts during early planning on the magazine.

F. H. Ricks graduated from Purdue University in 1948 with a BS degree in Chemical Engineering. After graduation he was employed in Brazil, S. A. by Condor Oil Tintas as a chemical engineer in connection with the extraction and processing of vegetable oils and waxes in the manufacture

of paints and varnishes. After returning to the U. S. in 1949, he was employed by the Cities Service Oil Company at their East Chicago Refinery. In 1950, Mr. Ricks joined the RCA Tube Division as a manufacturing-development engineer at the Indianapolis Receiving Tube Plant. At present he is assigned to both glass and miniature tube types. Mr. Ricks is a member of the American Chemical Society and the American Institute of Chemical Engineers.

H. B. Martin received a BS degree in E. E. from the University of Illinois in 1928. Following a short period as a student engineer at Westinghouse, E. Pittsburgh, he was employed at the Signal Corps Procurement Office, New York City and transferred to Radio Research at the Signal Corps Laboratories in 1929. In 1930 he joined Radiomarine Corporation for flight test work at Roosevelt Field and marine radio development at the New York laboratory.

From 1932 to 1935 he was on the instruction staff at the RCA Institutes New York School. He returned to the Engineering Department of Radiomarine in 1935 and has since been active in development and administrative engineering, becoming Assistant Chief Engineer in 1939.

Mr. Martin has six patents and has written several papers for the RCA Review and other publications.

REGISTERED PROFESSIONAL ENGINEERS

Continuing our practice of publicizing Registered Professional Engineers at RCA, the following additional names have been submitted:

<i>RCA Institutes, Inc.</i>	Section	State	Licensed As	License No.
G. F. Maedel	N.Y.	Prof. Eng.	17003
C. G. Dietsch	N.Y.	Prof. Eng.	14233
C. Michas	N.Y.	Prof. Eng.	14416
J. Silverman	N.Y.	Prof. Eng.	19627
M. A. Walsh	N.Y.	Prof. Eng.	19800
R. A. Welke	N.Y.	Prof. Eng.	1163

<i>RCA Victor Television Division</i>	Section	State	Licensed As	License No.
D. K. Obenland	Ill.	Prof. Eng.	12739

<i>Commercial Electronic Products</i>	Section	State	Licensed As	License No.
J. B. Bullock	587	N.J.	Prof. Eng.	8639
J. S. Baer	598	Iowa	Mech. Eng.	2843 PE

<i>Defense Electronic Products</i>	Section	State	Licensed As	License No.
A. N. Curtiss	N.J.	Elect. Eng.	7304
H. F. Baker	596	N.J.	Prof. Eng.	8113
H. A. Brelsford	596	N.J.	Prof. Eng.	5538
R. P. Dunphy	577	Wash D.C.	Prof. Eng.	2283
F. A. Fuhrmeister	581	N.J.	Prof. Eng.	5797
F. A. Fuhrmeister	581	Penna.	Mech. Eng.	13543
J. Nestory	577	Ind.	Eng.-in-Trng.	6532
T. H. Story	585	N.J.	Prof. Eng.	7836

<i>Tube Division (Lancaster)</i>	Section	State	Licensed as	License No.
A. W. Comins	511	Pa.	Elect. Eng.	11808
J. L. Folly	514	Pa.	Mech. Eng.	14153
C. Hart	512	Pa.	Elect. Eng.	11501
P. G. Herold	523	Mo.	Mining Eng.	E-658
J. C. Johnson	512	Pa.	Prof. Eng.	2275-E
A. L. Lucarelli	512	Pa.	Mech. Eng.	11877
D. N. Myers	512	Pa.	Prof. Eng.	2812-E
J. L. Quinn	565	Pa.	Elect. Eng.	10677
M. R. Weingarten	514	Pa.	Mech. Eng.	12069

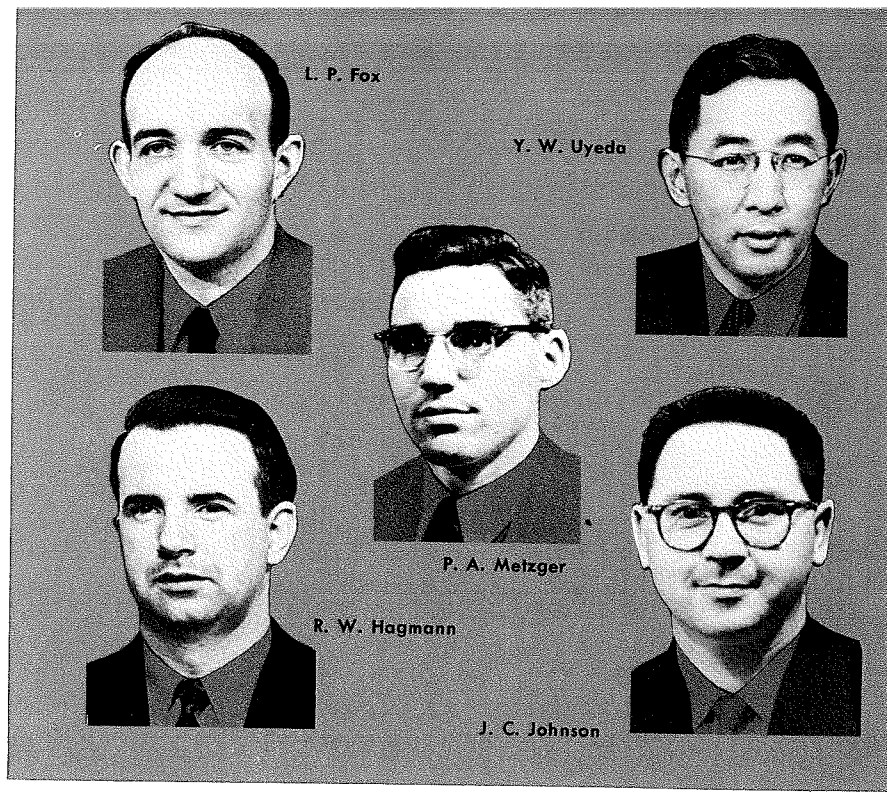

COMMITTEE APPOINTMENTS

J. WESLEY LEAS, Chief Product Engineer, BIZMAC Engineering, CEP, has been appointed Program Chairman for the 1956 Eastern Joint Computer Conference. This conference is sponsored jointly by the AIEE, IRE, and the Association for Computing Machinery. Papers will be presented by invitation only. The Program Committee is composed of representatives of the prominent computer manufacturers and several government agencies who are very active in the computer field.

W. H. RICHARDSON, Manager, Defense Planning and Projects Coordination, DEP, has been elected to serve on the Membership Committee of the national IRE Professional Group on Military Electronics.

A. N. CURTISS, Manager West Coast Electronic Products Department, DEP, has accepted the responsibility of Professional Group on Engineering Management representative on the Technical Program Committee of the Western Electronic Show and Convention to be held in Los Angeles, August 21-24, 1956. The program will be arranged to focus the attention of engineering management on the problem of interesting more high school students in an engineering career.

J. L. PETTUS, Manager, Film Recording Engineering, Hollywood, CEP, has been re-appointed for the fourth straight year to serve on the Progress Committee of the SMPTE. The purpose of the Committee is to report to the Society the progress attained during the preceding year by the Society membership and sustaining members on Theatre and Drive-in Sound Systems.

R. A. C. LANE, Computer Engineering, CEP, has been appointed to the Task Group 3 on Data Processing within Subcommittee A-5 on Systems Control Standards of RETMA. This group is concerned with standardization in the field of electronic data processing and has established a Computer Study Group. A survey of available input-output devices is currently under way, on which other Computer manufacturers are already represented.

H. N. KOZANOWSKI, Broadcast and TV Equipment Engineering, CEP, has been appointed to serve on the Television Committee of the SMPTE. The purpose of the committee is to develop standards and recommended practices on the television field, and to keep them current.

H. J. BENHAM has been appointed to the Screen Brightness Committee of the Society of Motion Picture and Television Engineers. Mr. Benham is Leader of the Theatre Projection Group, Detroit, Theatre and Sound Products Engineering.

ALLEN D. GORDON, Engineer representing RCA International at Lancaster, was voted Outstanding Jaycee of the Lancaster Junior Chamber of Commerce for 1955. The award was presented at the Annual Inaugural Ball at the Hotel Brunswick on March 24, 1956. He was cited for his work in organizing a Junior Achievement program in Lancaster.

GARVIN APPOINTS ASSISTANTS AT LANCASTER

Because of the wide scope of activities in Color Kinescope Engineering at Lancaster, D. G. Garvin has appointed five assistants throughout the Engineering activity in order to assure fullest representation in the RCA ENGINEER.

In Color Kinescope Engineering at Lancaster, Product Engineering will be covered by Leonard P. Fox, Robert W. Hagmann and Paul A. Metzger; Production Engineering and Quality Control by Y. W. Uyeda; Equipment Development by John C. Johnson.

Leonard P. Fox attended Lehigh University, where he received the BS in Ch.E. in 1948 and the M.S. in Ch.E. in 1949. He has been employed at RCA since 1949. At present, Mr. Fox is a Chemical Process Engineer in the Chemical and Physical Laboratory. He is a member of the Phi Eta Sigma (freshman honorary), the Sigma Pi Sigma (physics honorary), the American Chemical Society and the American Electroplaters' Society.

Robert W. Hagmann graduated from the University of Minnesota in 1948 with a BEE degree, and has been employed at RCA since graduation. He is currently engaged as a Product Development Engineer in circuit application work in the Application Engineering Laboratory. Mr. Hagmann is a member of the Sigma Pi Sigma (physics honorary society) and the IRE.

Paul A. Metzger graduated from Ohio State University in 1949 with a BS in EE and started with RCA in 1951. At present he is Engineering Manager in the Color Tube Development Shop. Mr. Metzger is a member of the IRE and is Membership Chairman in the Lancaster Sub-section of the IRE.

Y. W. Uyeda received the BS degree from MIT in 1951 and started with RCA the same year in the Cathode Ray Laboratory. At present he is Manager, Finishing Engineering, Color Kinescope Production Engineering. Mr. Uyeda is a member of the IRE.

John C. Johnson graduated from the University of Nebraska in 1951 with the BS in EE degree, and started with RCA upon graduation. At present he is a Design Engineer in Equipment Development. Mr. Johnson is an Associate member of the AIEE, the Lincoln Chapter of the Pennsylvania Society of Professional Engineers, and a member of the Eta Kappa Nu and Pi Mu Epsilon honorary societies.

GOKHALE PARTICIPATES IN AWARD TO FLANDERS . . . Madhu S. Gokhale, Administrator of Mechanical Standards, RCA Staff Standardizing, recently participated in a ceremony awarding Honorary Fellowship in the STANDARDS ENGINEERS SOCIETY to Honorable Ralph E. Flanders, U. S. Senator from Vermont. The ceremony was held in the Senate Caucus Room, Washington, D. C., on January 11, 1956. Mr. Flanders was selected for this honor as a result of his contribution to standardization while a member of American Standards Association Committee B-1 on Screw Threads. Mr. Flanders is also past-president of the American Society of Mechanical Engineers. Others participating in this event are (left) William L. Healy, General Electric Company, Philadelphia and (right) Roger E. Gay, Director of Cataloging and Standardization, Department of Defense, Washington, D. C. Mr. Gokhale is President of the STANDARDS ENGINEERS SOCIETY.

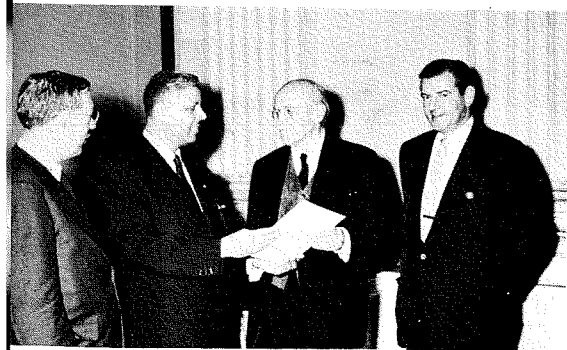

MEETINGS, COURSES AND SEMINARS

F. B. Dailey, National Office specialist in Electronic Engineering group of the Technical Products Engineering of RCA Service Company recently completed training a group of Philadelphia District field service engineers on the RCA 6A type television projection equipment at Cherry Hill.

L. W. Leidy, Manager, Electronic Engineering, Technical Products Service Department, RCA Service Company, represented the National Office at the announcement and demonstration of the 20th Century-Fox Cinemascope 55 film process. Representing the field were E. D. Clifton and H. H. Burgess, who subsequently supervised demonstrations on a national scale.

J. S. Silen and **Harry Taylor**, Technical Products Service Department, RCA Service Company, recently completed field training activities on Industrial Television (ITV), Metal Detectors and Electronic weighing devices at Atlanta, Chattanooga, Cleveland and Cincinnati. Similar activities were conducted in the Boston area by J. S. Silen and J. D. Hodge who covered Beverage Inspection Equipment.

RCA ESTABLISHES TEN DAVID SARNOFF FELLOWSHIPS FOR GRADUATE STUDIES BY COMPANY EMPLOYEES . . . Establishment of ten graduate fellowships for employees in honor of Brig. General David Sarnoff, Chairman of the Board of RCA, was announced by Dr. C. B. Jolliffe, Vice-President and Technical Director of RCA.

Dr. Jolliffe, who is Chairman of the RCA Education Committee, said each fellowship is valued at approximately \$3,500, and includes a grant to the fellow, tuition fees and an unrestricted gift to the college or university selected. The awards will be made in the fields of science, business administration and dramatic arts.

First Fellowship in Medical Electronics

RCA is also awarding ten college and university graduate fellowships in the fields of science, physics, electrical engineering and dramatic arts, including RCA's first fellowship in medical electronics, which has been established at Johns Hopkins University, Baltimore, Md., with a grant of \$3,500 to be made in the Fall of 1956.

RCA Scholarships

"In addition to the fellowships, RCA has granted 33 undergraduate scholarships in the fields of science, dramatic arts, music and industrial relations at designated colleges and universities throughout the country," Dr. Jolliffe said. "The recipients of these scholarships are selected by the respective colleges and universities. Each scholarship provides a grant of \$800 to the student."

PAPERS PRESENTED ON BIZMAC SYSTEM

. . . A series of papers on the RCA BIZMAC System and its constituent equipments was presented at several recent conferences and conventions. At the AIEE winter meeting members of BIZMAC Engineering spoke on the BIZMAC System Concept and the Magnetic "Tape File." At the Western Joint Computer Conference

FORTY-TWO RCA ENGINEERS PRESENT TWENTY-FIVE PAPERS AT 1956 IRE CONVENTION

. . . A total of twenty-five technical papers, covering a wide range of advances in radio, television and electronics (see list below) were presented by RCA at the national convention of the Institute of Radio Engineers in New York during the week of March 19, 1956. Abstracts of papers presented by RCA product engineers will be published in *Pen and Podium* in the next issue of the RCA ENGINEER.

Trends in TV Equipment

A Pedestal Processing Amplifier for Television, R. C. Kennedy, NBC, New York.

A New Color Camera for Closed-Circuit Applications, L. E. Anderson, RCA, Camden, N. J.

Microwave Tubes

Design and Performance of Low Noise Guns for Traveling Wave Tubes, R. C. Knechtli and W. R. Beam, RCA, Princeton, N. J.

TV Transmitting Equipment and Techniques

A Pack Type Television System, W. B. Harris, RCA, Camden, N. J.

Electron Tubes

Image Orthicon for Pickup at Low Light Levels, A. A. Rotow, RCA, Lancaster, Pa.

Heat-Flow Considerations in the Design of High-Dissipation Receiving Tubes, O. H. Schade, Jr., RCA, Harrison, N. J.

Color Television Tape Recording

A Magnetic Tape System for Recording and Reproducing Standard FCC Color Television Signals—General Considerations—H. F. Olson, RCA Laboratories, Princeton, N. J.

Electronic System, W. D. Houghton, RCA Laboratories, Princeton, N. J.

The Magnetic Head, J. A. Zenel, RCA Laboratories, Princeton, N. J.

The Tape Transport Mechanism—A. R. Morgan and M. Artzt, RCA Laboratories, Princeton, N. J.

Audio Systems, J. G. Woodward, RCA Laboratories, Princeton, N. J.

Broadcast and Television Receivers

Application of Transistors to Battery-Powered Portable Receivers, J. W. Englund, RCA, Tube Div., Harrison, N. J.

Stability Considerations in Transistor IF Amplifiers, D. D. Holmes and T. O. Stanley, RCA Laboratories, Princeton, N. J.

Electronic Computers—1

Logic Design of the RCA BIZMAC Computer, A. D. Beard, L. S. Bensky, D. L. Nettleton and G. E. Poorte, RCA, Camden, N. J.

five papers were presented covering the Purpose and Application of the BIZMAC System, the Organization of Data in the BIZMAC System, the System Central Concept, the Characteristics of the BIZMAC Computer, the Techniques of Programming for the Computer. At the IRE National Convention two papers were presented (see above).

R. SERREL of the David Sarnoff Research Center gave a paper at a seminar on Micro Programming sponsored by the Industrial Liaison Office of MIT. The paper was "On A Property Of Natural Language And Its Use For The Design Of Improved Machine Languages." The seminar was concerned with advanced approaches to the control and programming of digital computers. Members of BIZMAC Engineering also attended the seminar and participated in the discussion.

Input and Output Devices in the RCA BIZMAC System, J. A. Brustman, K. L. Chien, C. T. Cole and D. Flechtner, RCA, Camden, N. J.

Design Approaches with Printed Wiring

Principles of Circuit Design for Automation, H. S. Dordick, Engineering Div., RCA, Camden 2, N. J.

Color Television

Recent Improvements in the 21AXP22 Color Kinescope, R. B. Janes, L. B. Headrick, J. Evans, RCA, Lancaster, Pa.

Focusing Mask Color Kinescopes—E. G. Ramberg, H. B. Law, H. S. Allwine, D. C. Darling, C. W. Henderson and H. Rosenthal, RCA Laboratories, Princeton, N. J.

Industrial Electronics

High Frequency Shields, R. E. Lafferty, NBC, N. Y.

Field-Intensity Measurements on Induction-Heating Equipment, T. E. Nash, Tube Division, RCA, Lancaster, Pa.

Circuits—III—

Network Synthesis Techniques

Chairman: M. S. Corrington, RCA Victor TV Div. Building 204-2, Camden 2, N. J.

Synthesis of Tchebycheff RC Band Pass Filters, D. Helman, RCA Computing Systems, Camden, N. J.

Pulsed RC Networks for Sampled Data Systems, J. Sklansky, RCA Labs., Princeton, N. J.

Solid State Devices

Investigation of Power Gain and Transistor Parameters as Functions of Both Temperature and Frequency, A. B. Glenn and I. Joffe, RCA, Aviation C&N Engineering, Camden, N. J.

Where Is Medical Electronics Going?

A Symposium in Prediction

V. K. Zworykin, RCA Research Labs., Princeton, N. J. Medical electronics will provide technical facilities with which life scientists will implement their work.

Information Theory—III

Multipath Distortion of TV Signals and the Design of a Corrective Filter, A. V. Balakrishnan, RCA, Camden, N. J.

S. KAPLAN, AA Engineer in BIZMAC Engineering (CEP) is teaching a course in College Algebra at the Drexel Institute of Technology.

A. S. KRANZLEY, Manager of Computer Analysis and Programming, BIZMAC Engineering (CEP) is teaching a course in Business Electronics at the Drexel Institute of Technology. This is the third year that Mr. Kranzley has given this course in the spring term at Drexel.

L. H. URDANG, formerly Production Engineering Manager at the Indianapolis Receiving Tube Plant, presented a talk entitled, "The Vacuum Tube" on February 7, 1956, at the weekly meeting of the Indiana section of the American Chemical Society. Mr. Urdang has recently been promoted to Superintendent of the Indianapolis Miniature Tube factory.

ENGINEERING EXPANDS AT RCA

RCA TO DOUBLE SPACE FOR ENGINEERING AT WALTHAM, MASS., LABORATORY . . . Plans were announced to enlarge RCA's engineering laboratory at Waltham, Massachusetts, to provide engineering space and research facilities for more than double the present staff of engineers and scientists. The DEP laboratory, opened about a year ago, is devoted to the development of electronic fire-control systems for military aircraft. It occupies modern office and laboratory quarters in the Waltham Watch building.

FLIGHT LABORATORY FOR AIRBORNE ELECTRONICS ESTABLISHED AT NEW CASTLE, DELAWARE . . . A Flight Laboratory for air and ground testing of airborne electronic equipment and systems has been established by DEP at the New Castle County Airport, New Castle, Delaware.

The new facility is now in limited operation and will be completely equipped by May. It will be used for pre-flight and in-flight testing of RCA airborne equipment and fire control systems for military aircraft and for flights in connection with operational tests of RCA ground radar systems.

Charles L. Sharp, veteran test pilot and aeronautical engineer, has been appointed manager of the RCA Flight Laboratory. He will be responsible for all flight operations and maintenance of RCA aircraft and of military planes furnished by the Defense Department for test purposes.

RCA TO OPEN DEVELOPMENT LABORATORY AT NEEDHAM, MASS., FOR WORK ON FERRITES . . . Plans for the establishment of an Advanced Development Laboratory in the New England Industrial Center at Needham, Mass., were announced recently by D. Y. Smith, Vice-President and General Manager, RCA Tube Division.

A modern one-story brick building, comprising 20,000 square feet, has been leased from Cabot, Cabot and Forbes Co., developers of the Center. Occupancy is planned for April. The Needham plant will be utilized for advanced developmental work on ferrites under the direction of Dr. Francis E. Vinal.

ENGINEERING DATA AND CATALOGUES

RCA ISSUES REVISED EDITION OF TECHNICAL BOOKLET ON RECEIVING TUBES FOR AM, FM AND TELEVISION . . . An up-to-date, revised edition of the technical booklet, "RCA Receiving Tubes for AM, FM, and Television Broadcast," has been published by the RCA Tube Division. The 28-page booklet gives the characteristics of more than 600 RCA receiving tubes including picture tubes. Picture tube information is presented in a chart which lists and describes 75 types. Base and envelope connection diagrams are supplied for all tube types.



A group photo of some of the speakers at the Lancaster Review are (l. to r.): E. E. Spitzer, Manager, Power Tube Engineering, Lancaster; F. S. Veith, Manager, Pickup Tube Development, Lancaster; Dr. R. B. Janes, Manager, Color Kinescope Development, Lancaster; W. G. Fahnestock, Manager, Life Test and Data, Lancaster; W. O. Hadlock, Editor, RCA ENGINEER, Camden; B. B. Brown, Manager, Microwave Development, Harrison, and C. P. Smith, Manager, Color Kinescope Engineering, Lancaster.

ENGINEERING SECTIONS HOLD REVIEW . . . In a recent joint meeting, the 1955 Cathode Ray and Power Tube and Color Kinescope engineering activities (Lancaster) were reviewed for more than 400 plant engineering personnel and guests in the new Demonstration Room at Lancaster. C. P. Smith, Manager, Color Kinescope Product Engineering, and E. E. Spitzer, Manager, Cathode Ray and Power Tube Engineering, opened their respective portions of the program.

Other engineering managers reported on

their 1955 activities: R. B. Janes, A. E. Smith, R. H. Zachariason, H. S. Lovatt, F. S. Veith, W. T. Dyall, A. G. Nekut, W. G. Fahnestock, B. B. Brown, L. P. Garner. Mr. Spitzer gave the Marion plant story for H. T. Swanson, who was unable to attend. W. O. Hadlock, Editor of the RCA ENGINEER, gave background history on the magazine and described the extent of Lancaster's participation. Over 90 slides were used to illustrate the various talks. C. C. Simeral and D. G. Garvin coordinated the review for the two engineering sections.

ENGINEERING MEETINGS AND CONVENTIONS

April-June, 1956

APRIL 16-18-19

NARTB Tenth Annual Broadcast Engineering Conference, Conrad Hilton Hotel, Chicago, Ill.

APRIL 17-19

Fourth National Conference on Electromagnetic Relays, Oklahoma Institute of Technology, Stillwater, Okla.

APRIL 19-20

Second Annual Meeting, Environmental Equipment Institute Sheraton Hotel, Chicago, Ill.

APRIL 23-25

Protective Relay Engineers, 9th Annual Conference, A&M College of Texas, Electrical Engineering Department, College Station, Texas.

APRIL 23-24

New England Radio Engineering Meeting, IRE, Sheraton Plaza, Boston, Mass.

APRIL 23-25

International Conference on Electron Physics, NBS, College Park, Md.

APRIL 25-27

Symposium On Nonlinear Circuit Analysis, II, Polytechnic Institute of Brooklyn, N. Y.

APRIL 26-27

Conference On Recording and Controlling Instruments, AIEE, ASME, ISA, Bradford Hotel, Boston, Mass.

APRIL 29-MAY 3

Fourth Annual Semiconductor Symposium, Electrochemical Society, Mark Hopkins Hospital, San Francisco, Calif.

APRIL 29-MAY 8

Hanover Germany Industries Fair, Hanover, Ger.

APRIL 29-MAY 4

79th Convention of the Society of Motion Picture and Television

Engineers, Hotel Statler, New York City

APRIL 30-MAY 3

URSI Spring Meeting, NBS, Wash., D. C.

MAY 1-3

The 1956 Electronic Components Symposium, U. S. Department of Interior Auditorium, Washington, D. C.

MAY 7-3

Joint Electronic Components Conference, I.R.E., National Bureau of Standards, Washington D. C.

MAY 14-16

National Aeronautical & Navigational Conference PGANE, Biltmore Hotel, Dayton, Ohio

MAY 14-17

The Design Engineering Show and Conference, Philadelphia, Pa.

MAY 21-24

Electronics Parts Distributors Show, Conrad Hilton Hotel, Chicago, Ill.

MAY 22-23

RETMA Symposium on Reliable Applications of Electron Tubes, Irvine Auditorium, University of Penna., Philadelphia, Pa.

MAY 24-26

Tenth National Convention Armed Forces Communications and Electronics Association

JUNE 17-23

Second International Congress on Acoustics, Registration at Mass. Inst. of Technology, Cambridge, Mass.

JUNE 18-29

Special Summer Program in Switching Circuits, M.I.T., Cambridge, Mass.

INDEX TO VOLUME I

June-July 1955 to April-May 1956

The number preceding the dash denotes the issue. The number following the dash indicates the page number in that issue. Issue numbers are as follows:

- 1 June-July 1955
- 2 August-September 1955
- 3 October-November 1955
- 4 December 1955-January 1956
- 5 February-March 1956
- 6 April-May 1956.

Occasionally an (ED) will be noted following an article title, with no page reference. This is an editorial on the inside front cover of the issue indicated.

<p>Alexy, M. R. <i>Design of D-C Tractive Electromagnets</i> 6-38</p> <p>Allen, R. W. (W. D. Clement, H. J. Hamlin) <i>Project Turnkey: A Tropospheric Scatter Circuit</i> 5-7</p> <p>Amplifiers, Feedback Pair <i>Linearity Considerations in Feedback Pair Amplifiers</i> 6-50</p> <p>Antennas</p> <p style="padding-left: 20px;"><i>The Ultra-Gain, High-Power UHF Antenna</i> 1-10</p> <p style="padding-left: 20px;"><i>The Hill-Tower Antenna System</i> 2-13</p> <p style="padding-left: 20px;"><i>Project Turnkey: A Tropospheric Scatter Circuit</i> 5-7</p> <p>Audio</p> <p style="padding-left: 20px;"><i>High-Gain Transistor Amplifier</i> 1-28</p> <p style="padding-left: 20px;"><i>RCA Engineers Design First Air-Force Equipment Using Transistors</i> 2-58</p> <p style="padding-left: 20px;"><i>Application of Carbon Microphones to Narrow-Band Speech Transmission</i> 3-14</p> <p style="padding-left: 20px;"><i>A Transistorized Output Meter</i> 4-22</p> <p>Automatic Gain Control <i>Some Problems Associated with Television AGC Circuits</i> 3-18</p> <p>Barkow, W. H. (B. V. Vonderschmitt) <i>Applications of Ferrites to Deflection Components</i> 4-24</p> <p>Barlow, N. L. <i>The Design of Single-Sideband Radio Communication Equipment</i> 6-14</p> <p>Barton, L. E. (IRE Fellow, Biography) 5-28</p> <p>Batsel, M. C. <i>Biography</i> 1-26</p> <p style="padding-left: 20px;"><i>Broader Training of Engineers Required to Meet Challenge of System Concept</i> 3-17</p> <p>Bauer, J. A. <i>Biography</i> 3-30</p> <p>Bennett, P. R. <i>Biography</i> 5-30</p> <p>Bennett, W. P. <i>A 15-Kilowatt Beam Power Tube for UHF Service</i> 1-16</p> <p>Benway, R. E. (R. H. Hughes) <i>Gun Development for the RCA-21AXP22 Color Kinescope</i> 2-48</p> <p>Bianculli, A. J. (Collins, Kinaman, Novak) <i>Low-Noise Traveling-Wave Tubes</i> 3-4</p> <p>Biewener, J. F. <i>Biography</i> 3-30</p> <p>Bigler, R. R. (E. M. Washburn) <i>Crystal Selection in Stabilized Frequency Control</i> 4-5</p> <p>Bizmac</p> <p style="padding-left: 20px;"><i>Engineering the RCA Bizmac System</i> 4-10</p> <p style="padding-left: 20px;"><i>The RCA Bizmac Electronic Accounting System</i> 4-12</p> <p style="padding-left: 20px;"><i>RCA Electrofax in the Graphic Arts</i> 5-42</p> <p>Bodgett, E. D. <i>Biography</i> 3-30</p> <p>Bocciarelli, M. <i>Biography</i> 3-30</p> <p>Bolke, W. H. <i>Biography</i> 4-31</p> <p>Broadcast Engineering</p> <p style="padding-left: 20px;"><i>Introduction to "Engineering the World's First 1000-KW TV Station"</i> 1-6</p> <p style="padding-left: 20px;"><i>The Ultra-Gain, High-Power UHF Antenna</i> 1-10</p> <p style="padding-left: 20px;"><i>World's First 25-KW UHF Transmitter</i> 1-7</p> <p style="padding-left: 20px;"><i>A 15-Kilowatt Beam Power Tube for UHF Service</i> 1-16</p> <p style="padding-left: 20px;"><i>The Hill Tower Antenna System</i> 2-13</p> <p style="padding-left: 20px;"><i>Application of Carbon Microphones to Narrow-Band Speech Transmission</i> 3-14</p>	<p style="padding-left: 20px;"><i>Technical Standards for Color Television</i> 3-34</p> <p style="padding-left: 20px;"><i>Operational Testing in Color Television</i> 6-23</p> <p style="padding-left: 20px;"><i>Role of Broadcast Engineers in Customer Relations</i> 6-34</p> <p>Brosene, W. G., Jr. <i>Biography</i> 1-26</p> <p>Bucher, T. T. N. <i>Biography</i> 3-30</p> <p>Burnap, R. S. <i>Biography</i> 5-30</p> <p style="padding-left: 20px;"><i>The Philosophy of JETEC Tube Type Designations</i> 1-20</p> <p>Byrnes, I. F. <i>Biography</i> 1-27</p> <p style="padding-left: 20px;"><i>The Radiomarine Engineer at the National Motor Boat Show</i> 6-10</p> <p>Cain, E. B. (Merit Award, Biography) 5-4</p> <p>Carrell, R. M. <i>Application of Carbon Microphones to Narrow-Band Speech Transmission</i> 3-14</p> <p>Cathode Interface Resistance <i>Trends in Thinking About Thermionic Emitters</i> 6-28</p> <p>Chemistry</p> <p style="padding-left: 20px;"><i>Chemistry at RCA</i> 3-8</p> <p style="padding-left: 20px;"><i>Chemistry of Color Television</i> 3-10</p> <p>Cherry Hill <i>Engineering at Cherry Hill</i> 1-34</p> <p>Clay, B. R. <i>The Effect of Magnetic Fields on Color Television Receiver Performance</i> 5-16</p> <p>Clement, W. D. (R. W. Allen, H. J. Hamlin) <i>Project Turnkey: A Tropospheric Scatter Circuit</i> 5-7</p> <p>Cole, D. D. <i>Biography</i> 1-27</p> <p style="padding-left: 20px;"><i>Disseminating Technical Information (ED)</i> 6</p> <p>Color-Bar Generator</p> <p style="padding-left: 20px;"><i>WR-61A Color-Bar Generator Design</i> 2-44</p> <p>Color Corrector <i>The RCA Color Corrector</i> 2-38</p> <p>Color Kinescopes See <i>Kinescopes</i></p> <p>Color Television</p> <p style="padding-left: 20px;"><i>WR-61A Color-Bar Generator Design</i> 2-44</p> <p style="padding-left: 20px;"><i>Chemistry of Color Television</i> 3-10</p> <p style="padding-left: 20px;"><i>Technical Standards for Color Television</i> 3-34</p> <p style="padding-left: 20px;"><i>The Effect of Magnetic Fields on Color Television Receiver Performance</i> 5-16</p> <p style="padding-left: 20px;"><i>Color Demodulator Analysis</i> 6-20</p> <p style="padding-left: 20px;"><i>Operational Testing in Color Television</i> 6-23</p> <p>Collins, R. M. (Bianculli, Kinaman, Novak) <i>Low-Noise Traveling-Wave Tubes</i> 3-4</p> <p>Communications</p> <p style="padding-left: 20px;"><i>RCA Engineers Design First Air-Force Equipment Using Transistors</i> 2-58</p> <p style="padding-left: 20px;"><i>Land-Mobile Communications</i> 3-41</p> <p style="padding-left: 20px;"><i>The Design of Single-Sideband Radio Communication Equipment</i> 6-14</p> <p>Corrington, M. S. <i>Why Engineers Should Write Technical Papers</i> 1-2</p> <p>Coston, H. E. <i>Biography</i> 3-30</p> <p>Coyle, D. J. (B. J. McHugh) <i>Graphical Reproduction of Flux Patterns</i> 2-3</p> <p>Creativeness <i>Increasing Creativeness in Engineers (Ideas) — Is There a Limit?</i> 6-2</p> <p>Davidson, J. J. <i>High-Gain Transistor Amplifier</i> 1-28</p> <p>Davis, J. B. <i>Biography</i> 5-31</p> <p style="padding-left: 20px;"><i>Scientific and Technical Societies Associated with Electronics</i> 6-46</p> <p>Dickey, E. T. <i>Biography</i> 4-31</p> <p>Dimmick, G. L. <i>Optical Engineering at RCA</i> 2-6</p> <p>Direction Finders <i>New Portable Direction Finder for Pleasure Craft</i> 1-32</p> <p>Donahue, Dr. D. J. <i>Chemistry of Color Television</i> 3-10</p> <p>Electrofax <i>RCA Electrofax in Graphic Arts</i> 5-42</p> <p>Electromagnets <i>Design of D-C Tractive Electromagnets</i> 6-38</p> <p>Electron Guns See <i>Kinescopes</i></p> <p>Engstrom, Dr. E. W. <i>Introduction to the RCA ENGINEER (ED)</i> 1</p> <p style="padding-left: 20px;"><i>Biography</i> 1-25</p> <p>Epstein, D. W. <i>Principles of Light Amplification</i> 1-42</p> <p>Equipment Development</p> <p style="padding-left: 20px;"><i>Nylon for Test-Socket Covers Increases Efficiency</i> 4-50</p> <p style="padding-left: 20px;"><i>Human Relations and the Manufacturing Engineer</i> 5-2</p> <p style="padding-left: 20px;"><i>The Role of the Equipment Development Engineer in the Tube Division</i> 6-5</p> <p>Fellowships</p> <p style="padding-left: 20px;"><i>Four RCA Product Engineers Elected IRE Fellows</i> 1-61</p> <p style="padding-left: 20px;"><i>Three-Point Educational Aid Program Underway</i> 2-56</p> <p style="padding-left: 20px;"><i>Eight RCA Engineers Elected IRE Fellows</i> 5-28</p> <p>Field Engineering</p> <p style="padding-left: 20px;"><i>The RCA Field Engineer in National Defense</i> 4-46</p> <p>Fleckenstein, E. D. <i>Biography</i> 2-36</p> <p>Flood, R. D. <i>Biography</i> 4-31</p> <p>Ford, T. H. <i>Biography</i> 1-27</p> <p>Forward Scatter (see Scatter)</p> <p>Franke, J. L. <i>Biography</i> 1-27</p> <p style="padding-left: 20px;"><i>(Merit Award, Biography)</i> 5-4</p> <p>Fulmer, J. W. <i>Underwriters' Laboratories—Their Importance to the Design Engineer</i> 3-24</p> <p>Gander, M. G. <i>Biography</i> 1-27</p> <p>Garvin, D. G. <i>Biography</i> 2-36</p> <p>Gaseous Conduction <i>Looking Ahead in Research on Gaseous Conduction Processes</i> 3-46</p> <p>Gilmore, J. P. <i>Biography</i> 3-31</p> <p>Glover, A. M. (IRE Fellow, Biography) 5-28</p> <p>Gloystein, E. E. <i>Operational Testing in Color Television</i> 6-23</p> <p>Goodrich, H. C. <i>Transistorized Sync Separator Circuits</i> 5-11</p> <p>Greene, T. G. <i>The Role of the Mechanical Engineer in Electronic Equipment Design</i> 2-18</p> <p style="padding-left: 20px;"><i>Biography</i> 3-31</p> <p>Haber, J. <i>The Engineer in Civic Affairs</i> 3-2</p> <p>Hadlock, W. O. <i>Introduction to "Engineering the World's First 1000-KW TV Station"</i> 1-6</p> <p>Hall, R. J. <i>Engineering at Cherry Hill</i> 1-34</p> <p>Halstead, W. K. <i>The RCA Bizmac Electronic Accounting System</i> 4-12</p> <p style="padding-left: 20px;"><i>Biography</i> 3-31</p> <p>Hamlin, H. J. (R. W. Allen, W. D. Clement) <i>Project Turnkey: A Tropospheric Scatter Circuit</i> 5-7</p> <p>Hanson, O. B. <i>Biography</i> 1-25</p> <p>Harris, W. A. (IRE Fellow, Biography) 1-61</p> <p>Harrison, P. C. (T. G. Greene) <i>The Role of the Mechanical Engineer in Electronic Equipment Design</i> 2-18</p> <p style="padding-left: 20px;"><i>Design</i> 2-36</p> <p>Hirlinger, J. F. <i>Biography</i> 2-36</p> <p>Hodge, J. D. (J. J. Lawler) <i>A Transistorized Output Meter</i> 4-22</p> <p>Hoggett, A. E. <i>Biography</i> 2-36</p> <p>Hollabaugh, J. F. <i>Biography</i> 4-32</p> <p>Horizontal Oscillator Control <i>The Synchroguide: A Design History</i> 2-28</p> <p>Hughes, R. H. (R. E. Benway) <i>Gun Development for the RCA-21AXP22 Color Kinescope</i> 2-48</p> <p>Hurford, W. L. <i>Linearity Considerations in Feedback Pair Amplifiers</i> 6-50</p> <p>Hyde, J. V. (R. H. Wright) <i>The Hill-Tower Antenna System</i> 2-13</p> <p>Janes, R. B. (IRE Fellow, Biography) 1-61</p> <p>Jacobs, L. <i>Mechanical Engineer's Role in Development of Electronic Equipment</i> 5-36</p> <p>Johnson, E. O. <i>Looking Ahead in Research on Gaseous Conduction Processes</i> 3-46</p> <p>Johnson, H. <i>Progress in Experimental High-Frequency Transistors</i> 4-41</p> <p>Jolliffe, Dr. C. B. <i>Biography</i> 1-25</p> <p>Joy, J. E. <i>World's First 25-KW UHF Transmitter</i> 1-7</p> <p>Kidd, M. C. <i>Transistor Video Amplifiers</i> 4-34</p> <p>Kinaman, E. W. (Bianculli, Collins, Novak) <i>Low-Noise Traveling-Wave Tubes</i> 3-4</p> <p>Kinescopes</p> <p style="padding-left: 20px;"><i>Gun Development for the RCA-21AXP22 Color Kinescope</i> 2-48</p> <p style="padding-left: 20px;"><i>Biography</i> 2-37</p> <p style="padding-left: 20px;"><i>Biography</i> 2-37</p> <p style="padding-left: 20px;"><i>(IRE Fellow, Biography)</i> 5-28</p> <p>Kornstein, E. <i>Graphical Solution of Simple Lens Problems</i> 5-50</p> <p>Knauf, H. V. <i>The Role of the Equipment Development Engineer in the Tube Division</i> 6-5</p> <p>Krieger, H., Jr. <i>Biography</i> 3-32</p> <p>Ksiazek, F. T. <i>Biography</i> 4-32</p>
---	---

Lawler, J. J. <i>A Transistorized Output Meter</i>	4-22	Quality Control <i>Product Quality as Influenced by Field Data</i>	1-39	Technical Societies See Societies	
Leas, J. W. <i>Engineering the RCA Bizmac System</i>	4-10	<i>Nomographs for Determining Significant Differences</i>	4-38	Technical Writing <i>Why Engineers Should Write Technical Papers</i>	1-2
Leverenz, H. W. (IRE Fellow, Biography)	5-29	Ransburg, S. D. Biography	4-32	Test Equipment <i>An Immittance Sweep</i>	1-3
Li, Dr. C. H. <i>Nomographs for Determining Significant Differences</i>	4-38	Rappaport, P. (E. G. Linder, J. J. Loferski) <i>The Generation of Electricity Directly from Radiation</i>	2-52	<i>WR-61A Color-Bar Generator Design</i>	2-44
Light Amplifiers <i>Principles of Light Amplification</i>	1-42	Record Engineering <i>Engineering in the RCA Victor Record Division</i>	1-45	<i>A Transistorized Output Meter</i>	4-22
Linder, E. G. (P. Rappaport, J. J. Loferski) <i>The Generation of Electricity Directly from Radiation</i>	2-52	Reiskind, H. I. Biography	1-27	<i>Operational Testing in Color Television</i>	6-23
Loferski, J. J. (E. G. Linder, P. Rappaport) <i>The Generation of Electricity Directly from Radiation</i>	2-52	Rhoads, W. D. (L. Pessel) <i>Whiskers on Gangs</i>	2-32	Thermionic Emission <i>Trends in Thinking About Thermionic Emitters</i>	6-28
Loofbourrow, K. E. (J. E. Stolpman) <i>Hybrid "Pocket" Radio Receiver</i>	5-47	Ritcey, J. W. Biography	2-37	Thomas, L. P. <i>Some Problems Associated with Television AGC Circuits</i>	3-18
Luck, Dr. D. G. C. Biography	3-32	Roe, J. H. Biography	3-33	Thompson, L. E. <i>Communication by Tropospheric Scatter Propagation</i>	5-5
Lufkin, P. M. Biography	2-37	Roys, H. E. (IRE Fellow, Biography) <i>Role of Broadcast Engineers in Customer Relations</i>	6-34	Tolson, W. A. (IRE Fellow, Biography)	5-30
Malter, Dr. L. <i>Semiconductors and Transistors</i>	5-22	Sachtleben, L. T. <i>Optical Projection of Radiant Power</i>	2-8	Tourshou, S. <i>The Synchroguide: A Design History</i>	2-28
Manufacturing Engineering <i>Human Relations and the Manufacturing Engineer</i>	5-2	Scatter <i>Communication by Tropospheric Scatter Propagation</i>	5-5	Transistors <i>High-Gain Transistor Amplifier</i>	1-28
<i>The Role of the Equipment Development Engineer in the Tube Division</i>	6-5	<i>Project Turnkey: A Tropospheric Scatter Circuit</i>	5-7	<i>RCA Engineers Design First Air-Force Equipment Using Transistors</i>	2-58
Marine Radio <i>New Portable Direction Finder for Pleasure Craft</i>	1-32	Schmit, D. F. <i>Biography</i>	1-25	<i>A Transistorized Output Meter</i>	4-22
<i>The Radiomarine Engineer at the National Motor Boat Show</i>	6-10	<i>Introduction to the RCA ENGINEER (ED)</i>	1	<i>Transistor Video Amplifiers</i>	4-34
Maris, E. S. <i>New Slide-O-Matic "Victrola" Attachment</i>	2-25	<i>Objectives of the RCA ENGINEER (ED)</i>	2	<i>Progress in Experimental High-Frequency Transistors</i>	4-41
Mastran, J. L. <i>How RCA Organizes to Meet Changing Needs</i>	5-32	<i>The Interchange of Technical Information (ED)</i>	3	<i>Transistorized Sync Separator Circuits</i>	5-11
McElrath, G. (IRE Fellow, Biography)	5-29	<i>A Community of Engineering Interest (ED)</i>	4	<i>Semiconductors and Transistors</i>	5-22
McHugh, B. J. (D. J. Coyle) <i>Graphical Reproduction of Flux Patterns</i>	2-3	Schoenfeld, M. Biography	4-32	<i>Hybrid "Pocket" Radio Receiver</i>	5-47
McMorrow, C. F. Biography	3-32	Scholarships <i>Three-Point Educational Aid Program Underway</i>	2-56	Transmitters <i>Introduction to "Engineering the World's First 1000-KW TV Station"</i>	1-6
Mechanical Engineering <i>The Role of the Mechanical Engineer in Electronic Equipment Design</i>	2-18	Scientific Societies See Societies		<i>World's First 25-KW UHF Transmitter</i>	1-7
<i>New Slide-O-Matic "Victrola" Attachment</i>	2-25	Seebarger, L. M. Biography	3-33	<i>Project Turnkey: A Tropospheric Scatter Circuit</i>	5-7
<i>Mechanical Engineer's Role in Development of Electronic Equipment</i>	5-36	Shackelford, B. E. <i>The Engineer and His Professional Society</i>	2-2	Tubes <i>The Philosophy of JETEC Tube Type Designations</i>	1-20
<i>The Role of the Equipment Development Engineer in the Tube Division</i>	6-5	Shapiro, L. <i>The RCA Color Corrector</i>	2-38	<i>A 15-Kilowatt Beam Power Tube for UHF Service</i>	1-16
Melroy, P. P. <i>The RCA Field Engineer in National Defense</i>	4-46	Shaw, Dr. G. R. Biography	1-27	<i>Low-Noise Traveling Wave Tubes</i>	3-4
Meyer, C. A. Biography	5-31	<i>Reviewing Professional Accomplishment (ED)</i>	5	Tube Design <i>Trends in Thinking About Thermionic Emitters</i>	6-28
Microphones <i>Application of Carbon Microphones to Narrow-Band Speech Transmission</i>	3-14	Shively, E. H. <i>The Ultra-Gain, High-Power UHF Antennas</i>	1-10	Tuska, C. D. <i>Increasing Creativeness in Engineers</i>	1-50
Mobile Communications <i>Land-Mobile Communications</i>	3-41	Shumaker, D. E. <i>RCA Engineers Design First Air-Force Equipment Using Transistors</i>	2-58	Underwriters' Laboratories <i>Underwriters' Laboratories—Their Importance to the Design Engineer</i>	3-24
Mohr, H. F. <i>New Portable Direction Finder for Pleasure Craft</i>	1-32	Single-Sideband Communications See Communications		Urdang, L. H. Biography	2-37
Moore, E. E. Biography	2-37	Sinnett, C. M. (IRE Fellow, Biography)	1-61	Van Ormer, D. D. (Merit Award, Biography)	5-4
Nergaard, L. S. <i>Trends in Thinking About Thermionic Emitters</i>	6-28	<i>Biography</i>	4-33	Victrolas See Mechanical Engineering	
Neubauer, J. R. <i>Land-Mobile Communications</i>	3-41	<i>Biography</i>	5-31	Vonderschmitt, B. V. (W. H. Barkow) <i>Applications of Ferrites to Deflection Components</i>	4-24
Novak, G. (Bianculli, Collins, Kinaman) <i>Low-Noise Traveling Wave Tubes</i>	3-4	<i>(Ideas)—Is There a Limit?</i>	6-2	Walter, J. C. <i>The Registered Professional Engineer</i>	4-2
Optics <i>Optical Engineering at RCA</i>	2-6	Slater, M. N. Biography	2-37	Washburn, E. M. <i>Crystal Selection in Stabilized Frequency Control</i>	4-5
<i>Optical Projection of Radiant Power</i>	2-8	Skele, A. <i>Human Relations and the Manufacturing Engineer</i>	5-2	Weaber, K. G. Biography	4-33
<i>Graphical Solutions of Simple Lens Problems</i>	5-50	Skidmore, W. S. Biography	4-33	Weiss, I. <i>Nylon for Test-Socket Covers Increases Efficiency</i>	4-50
Organization (RCA) <i>How RCA Organizes to Meet Changing Needs</i>	5-32	Smith, Dr. A. L. <i>Chemistry at RCA</i>	3-8	Westworth, J. W. <i>Technical Standards for Color Television</i>	3-34
Osman, J. Biography	4-32	Societies <i>Scientific and Technical Societies Associated with Electronics</i>	6-46	Wheeler, B. F. Biography	3-33
Patterson, W. M. Biography	3-32	Stanko, E. Biography	4-33	Whisker Growth <i>Whiskers on Gangs</i>	2-32
Pessel, Dr. L. (W. D. Rhoads) <i>Whiskers on Gangs</i>	2-32	Stolpman, J. E. (K. E. Loofbourrow) <i>Hybrid "Pocket" Radio Receiver</i>	5-47	Wlasuk, S. <i>WR-61A Color-Bar Generator Design</i>	2-44
Pettus, J. L. Biography	3-32	Solar Batteries <i>The Generation of Electricity Directly from Radiation</i>	2-52	Wood, L. A. (Merit Award, Biography)	5-4
Poch, W. J. (IRE Fellow, Biography)	5-29	Sonnenfeldt, R. W. <i>An Immittance Sweep</i>	1-3	WR-61A Color-Bar Generator <i>WR-61A Color-Bar Generator Design</i>	2-44
Portables <i>Hybrid "Pocket" Radio Receiver</i>	5-47	<i>Biography</i>	4-33	<i>Design</i>	2-44
<i>See Direction Finders</i>		<i>Color Demodulator Analysis</i>	6-20	Wright, R. H. (J. V. Hyde) <i>The Hill-Tower Antenna System</i>	2-13
Pratt, J. H. Biography	3-33	Sonntag, W. A. Biography	4-33	Writing See Technical Writing	
Product Quality See Quality Control		Spitzer, E. E. (IRE Fellow, Biography)	5-30	Zaun, W. J. <i>Product Quality as Influenced by Field Data</i>	1-39
Professional Engineer, The <i>The Registered Professional Engineer</i>	4-2	Sugarman, M. L., Jr. <i>RCA Electrofax in the Graphic Arts</i>	5-42		
		Sweep Generator <i>An Immittance Sweep</i>	1-3		
		Synchroguide <i>The Synchroguide: A Design History</i>	2-28		
		Systems Engineering <i>Broader Training of Engineers Required to Meet Challenge of System Concept</i>	3-17		

RCA ENGINEER EDITORIAL REPRESENTATIVES

DEFENSE & COMMERCIAL ELECTRONIC PRODUCTS

P. J. HERBST, *Chairman, Editorial Board*

Editorial Representatives, Defense Electronic Products

- J. A. BAUER, *Missile and Surface Radar Engineering, Moorestown, N. J.*
DR. D. C. BEAUMARIAGE, *Airborne Systems, Moorestown, N. J.*
MARY BOCCIARELLI, *Assistant Engineering Editor, Camden, N. J.*
T. T. N. BUCHER, *Surface Communications Engineering, Camden, N. J.*
H. E. COSTON, *Engineering Standards and Services, Camden, N. J.*
DR. D. G. C. LUCK, *Airborne Systems Equipment Engineering, Camden, N. J.*
C. McMORROW, *Aviation Communications and Navigation Engineering, Camden, N. J.*
W. M. PATTERSON, *Airborne Fire Control Engineering, Camden, N. J.*
H. POLISH, *Camden Engineering Personnel, Camden, N. J.*
J. H. PRATT, *West Coast Engineering, Los Angeles, Calif.*
H. E. ROYS, *General Engineering Development, Camden, N. J.*
L. M. SEEBERGER, *General Engineering Development, Camden, N. J.*
DR. H. J. WETZSTEIN, *Airborne Systems Laboratory, Waltham, Mass.*

Editorial Representatives, Commercial Electronic Products

- W. K. HALSTEAD, *Computer Engineering, Camden, N. J.*
C. E. HITTLE, *Hollywood Engineering, Hollywood, Calif.*
J. H. ROE, *Broadcast Engineering, Camden, N. J.*
J. E. VOLKMAN, *Theater and Sound Products Engineering, Camden, N. J.*
B. F. WHEELER, *Communications Engineering, Camden, N. J.*

RADIOMARINE CORPORATION OF AMERICA

Editorial Representative

H. B. MARTIN, *Assistant Chief Engineer, New York City, N. Y.*

RCA VICTOR RECORD DIVISION

Editorial Representative

S. D. RANSBURG, *Record Engineering, Indianapolis, Ind.*

The Editorial Representative in your group is the one you should contact in scheduling technical papers and arranging for the announcement of your professional activities. He will be glad to tell you how you can participate.

TUBE AND SEMICONDUCTOR DIVISIONS

J. F. HIRLINGER, *Chairman, Editorial Board*

Editorial Representatives, Tube Division

- J. DEGRAAD, *Black & White Kinescopes, Marion, Ind.*
D. G. GARVIN, *Color Kinescopes, Lancaster, Pa.*
A. E. HOGGETT, *Receiving Tubes, Cincinnati, Ohio*
R. L. KLEM, *Receiving Tubes, Harrison, N. J.*
J. KOFF, *Receiving Tubes, Woodbridge, N. J.*
P. M. LUFKIN, *Electronic Components, Findlay, Ohio*
E. E. MOORE, *Electronic Components, Camden, N. J.*
C. C. SIMERAL, *Cathode Ray & Power Tubes, Lancaster, Pa.*
F. H. RICKS, *Receiving Tubes, Indianapolis, Ind.*

Editorial Representative, Semiconductor Division

R. E. RIST, *Semiconductor Engineering, Harrison, N. J.*

RCA VICTOR TELEVISION DIVISION

C. M. SINNETT, *Chairman, Editorial Board*

Editorial Representatives

- R. D. FLOOD, *Color TV Engineering, Cherry Hill, N. J.*
F. KSIAZEK, *Black & White TV Engineering, Cherry Hill, N. J.*
J. OSMAN, *Resident Engineering, Indianapolis, Ind.*
R. W. SONNENFELDT, *Advanced Development Engineering, Cherry Hill, N. J.*
W. A. SONNTAG, *Resident Engineering, Bloomington, Ind.*
K. G. WEABER, *Engineering Services, Cherry Hill, N. J.*
-

RCA VICTOR RADIO & "VICTROLA" DIVISION

Editorial Representative

W. S. SKIDMORE, *Engineering Department, Cherry Hill, N. J.*

RCA SERVICE COMPANY, INC.

Editorial Representatives

- W. H. BOHLKE, *Consumer Products Service Department, Cherry Hill, N. J.*
J. F. HOLLABAUGH, *Government Service Department, Cherry Hill, N. J.*
E. STANKO, *Technical Products Service Department, Cherry Hill, N. J.*
-

RCA LABORATORIES

Editorial Representative

E. T. DICKEY, *Research, Princeton, N. J.*
