

*Editorial Advisory Board*

- M. C. Batsel, Chief Engineer,  
Engineering Products Division
- W. G. Brosene, Chief Engineer  
RCA Estate Appliance Dept.
- I. F. Byrnes, Vice President,  
Engineering, Radiomarine Corp.
- J. T. Cimorelli, Administrative  
Engineer, Product Engineering
- D. D. Cole, Chief Engineer,  
RCA Victor Television Division
- T. H. Ford, Mgr. Engineering,  
Air-Conditioning Department
- C. C. Foster, Mgr. RCA REVIEW
- J. L. Franke, Chief Engineer,  
RCA Victor Radio & 'Victrola' Div.
- M. G. Gander, Mgr. Engineering,  
RCA Service Company
- J. Haber, Director,  
Community Relations & Exhibits
- H. Metz, Director, Personnel
- H. I. Reiskind, Mgr. Engineering,  
RCA Victor Record Division
- D. F. Schmit, Vice President,  
Product Engineering
- G. R. Shaw, Chief Engineer,  
Tube Division
- A. K. Weber, Director,  
Organization Development

*"RCA Engineer" Staff*

- W. O. Hadlock, Editor
- R. J. Hall, Assistant Editor
- M. L. Malfaro, Editorial Secretary
- J. L. Parvin, Art and Production

*Engineering Editors*

- P. R. Bennett, Mgr., Radio  
& Phonograph Engineering,  
RCA Victor Radio & 'Victrola' Div.
- M. Bocciaelli, Assistant Editor,  
Engineering Products Division
- R. S. Burnap, Mgr., Commercial  
Engineering, Tube Division
- J. B. Davis, Engineering Editor,  
Engineering Products Division
- C. A. Meyer, Mgr., Commercial  
Engineering, Technical Services,  
Tube Division
- C. M. Sinnett, Mgr. Advanced  
Development Engineering,  
RCA Victor Television Division

VOL. 1, NO. 1 JUNE-JULY, 1955

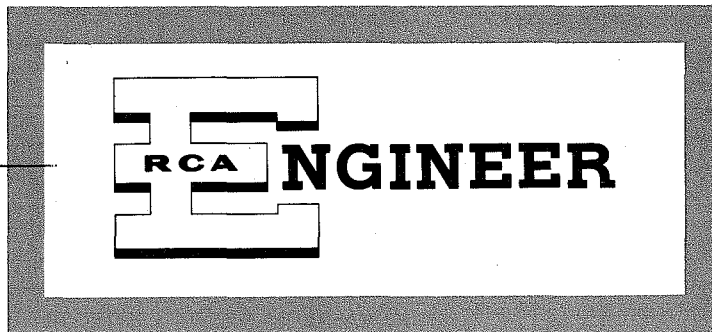

A Technical Journal  
Published By  
Product Engineering,  
Radio Corporation  
of America.

**CONTENTS**

Why Engineers Should Write Papers.....	M. S. Corrington	2
An Immittance Sweep.....	R. W. Sonnenfeldt	3
Introduction to ... "Engineering the World's First 1000-KW TV Station".....	W. O. Hadlock	6
World's First 25-KW UHF Transmitter.....	J. E. Joy	7
The Ultra-Gain, High-Power UHF Antenna....	E. H. Shively	10
A 15-Kilowatt Beam Power Tube for UHF Service.....	W. P. Bennett	16
The Philosophy of JETEC Tube Type Designation.....	R. S. Burnap	20
Introducing Your Engineering Leadership.....		25-27
High-Gain Transistor Amplifier.....	J. J. Davidson	28
New Portable Direction Finder for Pleasure Craft. .	H. F. Mohr	32
Engineering at Cherry Hill.....	R. J. Hall	34
Product Quality as Influenced by Field Data.....	W. J. Zaub	39
Principles of Light Amplification.....	D. W. Epstein	42
Engineering in the RCA Victor Record Division. .	H. I. Reiskind	45
Increasing Creativeness in Engineers.....	C. D. Tuska	50
Patents Granted to RCA Engineers.....		54
Pen and Podium.....		57
Engineering News and Highlights.....		61

Copyright 1955  
Radio Corporation  
of America  
All Rights Reserved

PRINTED  
IN  
U.S.A.



DR. ELMER W. ENGSTROM

## INTRODUCTION TO THE "RCA ENGINEER"

The appearance of the RCA ENGINEER is a significant event both for RCA and for engineers throughout the corporation.

The products and services of RCA have their roots in science and engineering. Our fields of endeavor have continually expanded through the application of the results of our research and engineering developments. As the scope of RCA's activities has increased, the engineer has assumed ever greater responsibility. With this growth has arisen a clear need for just such a medium as this for exchanging the ideas of research, development and production.

In addition to this function, the RCA ENGINEER formally marks RCA's recognition of the engineer as a key member of a remarkably successful industrial team. To a large measure, good engineering has assured the continued advance of RCA and the electronics industry. It is to encourage and assist the engineer to perform his complex task with increasing success in the future that this new magazine is dedicated.

It is a privilege and a pleasure to introduce the "RCA ENGINEER," our new bi-monthly engineering magazine. It is the outgrowth of careful planning and study carried on to satisfy the long felt need for a communicative medium, "by and for the RCA engineer."

Just as this slogan implies, RCA engineers are both the readers and the contributors. Your magazine staff and Engineering Editorial representatives alike, intend to produce a technical journal, of professional stature, that will stimulate and maintain your interest.

It is planned to devote the pages of this magazine exclusively to engineering and design topics. You are urged to contribute your articles, ideas and suggestions—since it is from these funds of information that we seek to publish the "RCA ENGINEER." Through it, you may share these ideas with associates.

In addition to providing you with a convenient medium of interchange of information, our objectives include the creation of a community of engineering interest within the company, and increased recognition for the engineer. Look for specific and detailed objectives of the "RCA ENGINEER" in future issues. But, in the meantime, remember that the "RCA ENGINEER" is your Technical Journal—give it your complete and continuing support!

*Executive Vice-President  
Research and Engineering  
Radio Corporation of America*

*Vice President  
Product Engineering  
Radio Corporation of America*



D. F. SCHMIT

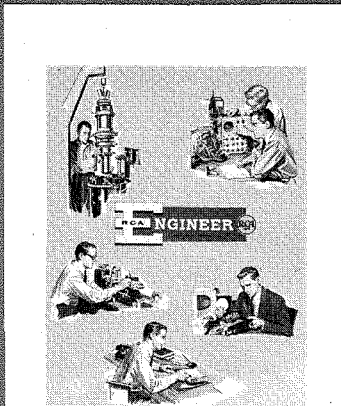

### OUR COVER

Our cover for the introductory issue of the RCA ENGINEER is an artist's conception showing the wide and varied activities of engineering throughout RCA. The artwork for the cover was produced through the facilities of our Art and Production Department.

# WHY ENGINEERS SHOULD WRITE TECHNICAL PAPERS

by **M. S. CORRINGTON**

*Advanced Development Section*

*RCA Victor Television Division, Camden, N. J.*

AT A RECENT meeting of the national Administrative Committee of the Professional Group on Circuit Theory of the IRE we were trying to think of people to nominate for membership on this Committee. One of the members of the Professional Group had taken trouble to write to the Editor and tell him what was wrong with one issue of the *Transactions*. In accord with the usual attitude of such organizations, that anyone who has a good idea is chairman of the committee, he is now being considered for a nomination. This bit of writing brought him to the attention of officers looking for help, and he may soon achieve national recognition.

## RECORD YOUR ACCOMPLISHMENTS

Technical reports and papers are about the only sure way the younger engineers in a Company as large as RCA have of bringing their work to the attention of top engineering management. It may take many years of work in the laboratory before one is in charge of an experimental project big enough to attract equal attention. When the Company is looking for someone to promote to a position of great responsibility they are sure to think of those people who have regularly demonstrated, with a continuous stream of reports, technical papers, and well-written letters that they are able to think clearly and write

clearly. If someone has shown that he can reduce complex problems to a simple explanation, he will inspire confidence in his ability. It is necessary to present a record of accomplishment that is seen regularly before someone opens the door that starts you up the road to your goal.

## TECHNICAL PAPERS HELP YOU AND SOCIETY

In a Company as large as RCA most engineers can build the kind of a future they want. It should never be necessary to keep a man on a job he doesn't like, over a long period of time. If you would like to become an internationally-known engineer or scientist you are limited only by your own ability. However, many engineers feel that personal publicity is not necessary and that the world will soon discover their real ability. Sometimes it does not work out this way. The man who writes up the scientific knowledge is the one who often gets credit for having created it, even though he may have done no more than edit the copy. This may seem to be unfair, but actually it is not. By making the knowledge available to the public in a published paper he may have provided a far greater service to society than the engineer who created the knowledge but did not write it up for others. Be sure you get the proper credit for your work by finishing the job.

## MURLAN S. CORRINGTON

received his M.S. Degree in 1936 from the Ohio State University. Since 1942, Mr. Corrington has been engaged in Mathematical Engineering as Manager of Audio, Acoustics and Antennas in the Advanced Development Section of the RCA Victor Television Division. He is the author of two textbooks and many technical papers on audio, frequency modulation and circuit theory.

Mr. Corrington is a member of several local and national technical committees, Sigma Pi Sigma, the Acoustical Society of America, the Society for Industrial and Applied Mathematics, and a Fellow of the IRE.



*The author points up  
sound and  
practical  
reasons why  
engineers  
should author  
professional papers*

## NEGLECT LEADS TO WASTE

I have known some very good engineers who have done so much valuable research and development work but who never write reports about their discoveries. In a short time the Company has a big pile of obsolete equipment, with circuits partly unknown, and all of the information in the mind of one man. This is a very dangerous situation. If the man dies, retires, leaves the Company, or is transferred to other work, the great investment in the experiment is lost.

## YOU ACQUIRE BROADER PERSPECTIVE

It is often said that the best way to learn is to teach. The first time a new course is given the teacher will learn far more than the students. When an engineer writes a technical paper which describes his work he may find loose ends that need further study. If the paper is to appear in a leading journal, and stand the test of time, it is important that it be written as clearly as possible. The review and careful study that leads to the finished paper always gives the author a much better understanding and perspective.

## TALK TO ASSOCIATES

The amount of knowledge written is only a very small part of that available. To get at the unwritten part it is necessary to sit down with other workers in the same field and talk things over. Often it is possible to learn more in an hour this way than you could work out for yourself in weeks. The life of experts in science is often a lonely one, and you will be welcomed when you ask to talk to them, if you have shown by your writing that you are thoroughly competent and will not waste their time.

## HELP IS AVAILABLE

The engineering management of RCA wants to improve the number and quality of the technical papers and reports written. They will do everything possible to help you. Draftsmen, photographers and technical writers are available. The first paper is the hard one to write. How long should it be? Who will make the drawings? What is the approved form for typing the manuscript? Once you have done one paper, these questions are easy.

The responsibility for your development and advancement is entirely yours. Why not start now?

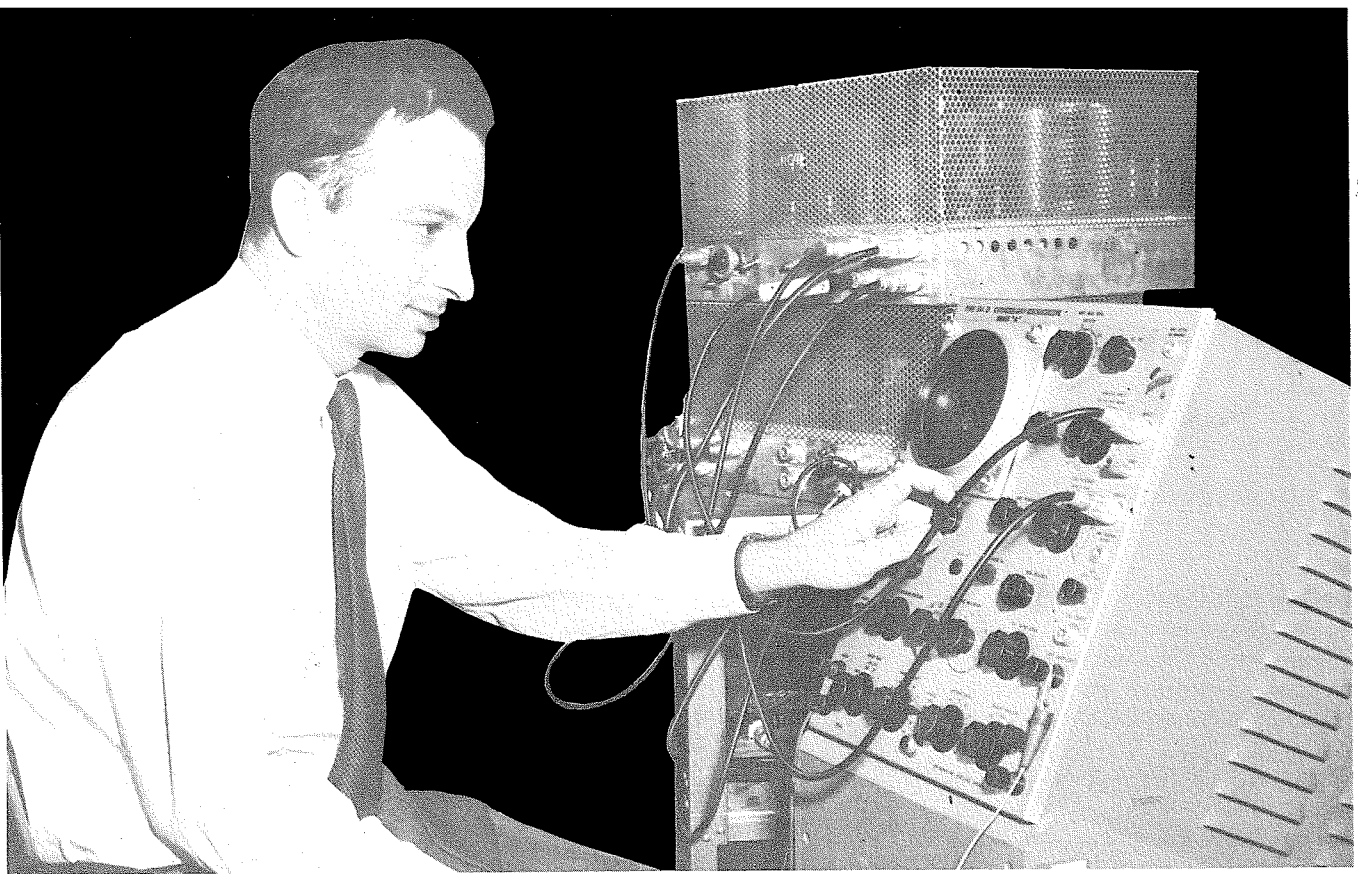

R. W. Sonnenfeldt making measurements with the immittance sweep



## AN IMMITTANCE SWEEP

The Amplitude and Phase Functions of Complete Systems are Displayed Simultaneously on a Cathode Ray Tube

by **R. W. SONNENFELDT**

*Advanced Development Section  
RCA Victor Television Division  
Cherry Hill, N. J.*

**E**NGINEERS MUST often determine how an impedance or admittance (immittance for short) varies with frequency. For instance, it may be required that an immittance have a maximum value for one band of frequencies while having a minimum value in another band. In the design and evaluation of such circuits, a sweep frequency generator is now almost a standard tool and in many applications has superseded the earlier, time-consuming, point-by-point methods. The advantage of the sweep frequency generator is that it displays the entire story all at once. What it shows on the scope is the absolute

value or the selectivity of the networks under test.

When minimum transient distortion is also required in the circuits to be designed, the phase as well as the selectivity function must be considered. For this reason an immittance sweep has been developed to display both functions simultaneously over a wide band of frequencies to tell the whole story at once. As such, the relation between the immittance sweep and conventional bridge meth-

ods may be compared to the similarity between the sweep frequency generator and "point-by-point" testing methods.

The immittance function displayed may be an input, output, or transfer function. The amplitude or selectivity is displayed as the radius vector of a polar diagram while the phase angle is read directly from a calibrated overlay. The complete equipment consists of a special sweep generator, the immittance detectors, a marker system, and a d-c coupled oscilloscope.

To understand the operation of the immittance sweep, consider Fig. 1.

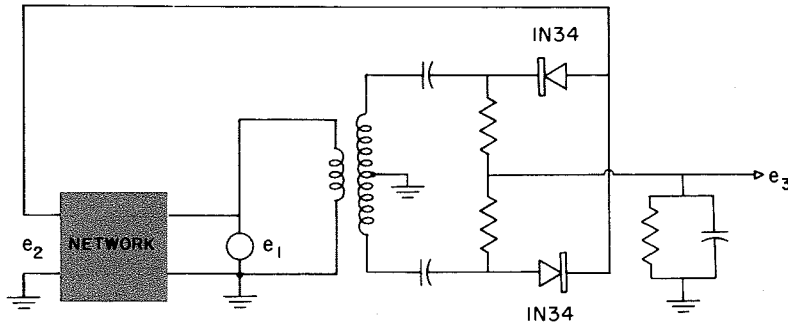

Fig. 1—Product detector and network

Suppose that a sinusoidal input,  $e_1$ , is applied to a linear network. At its output will be found a voltage,  $e_2$ , of the same frequency but which, in general, will be shifted in phase from the input voltage. The amplitude of  $e_2$  may show either gain or attenuation.

It has been known for some time that a balanced modulator will multiply two voltages instantaneously. When so used, the modulator is called a product detector. If we apply the quantities  $e_1$  and  $e_2$  to such a product detector, its output will be  $E_1 \times E_2 \cos \theta$  where  $E_1$  and  $E_2$  are the amplitudes of the two sine waves  $e_1$  and  $e_2$  and where  $\theta$  is the phase shift of the network. The voltage  $e_1$  can be kept at a unity value by driving the network from a constant voltage generator. When this is done, the output of the product detector will be simply  $e_3 = E_2 \cos \theta$  which can be shown to be equal to

$$S(\omega) \cos \theta \quad (1)$$

which is the selectivity function times the cosine of the phase displacement. Suppose that there is also available a voltage,  $e_1'$ , which is the same as  $e_1$  except that it is shifted  $90^\circ$  in phase. When  $e_1'$  and  $e_2$  are applied to a product detector, the output will be

$$e_3' = S(\omega) \sin \theta \quad (2)$$

If the voltage (1)  $S(\omega) \cos \theta$  and (2)  $S(\omega) \sin \theta$  are applied to the horizontal and vertical plates respectively of an oscilloscope, the display will show  $S(\omega)$  as the radius vector and the phase displacement  $\theta$  can be read directly. Fig. 1 shows the simple product detector used in this equipment. For proper operation,  $e_1$  should be made several times as large as  $e_2$  (by proper attenuation of  $e_2$ , if necessary).

The voltage  $e_1'$  can be obtained by passing  $e_1$  through a  $90^\circ$  phase shift network. However, the  $90^\circ$  shift must be obtained over the entire band of frequencies to be swept, and Fig. 2

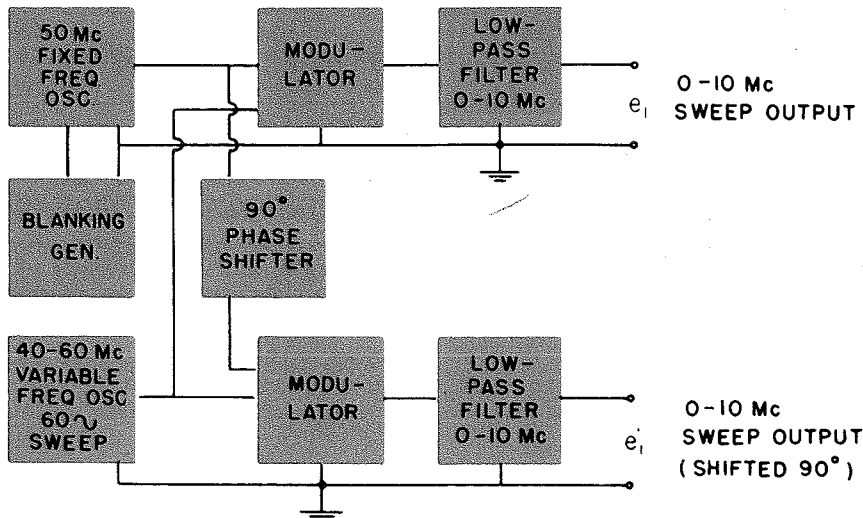

Fig. 2—Block diagram of sweep generator

shows how this is accomplished. To cover a frequency band, a fixed frequency and a variable frequency generator are normally used to produce a varying beat, the sweep frequency. In this equipment, the fixed frequency generator is provided with two outputs of equal amplitude shifted  $90^\circ$  from each other, and two separate mixers are used to obtain two sweep frequency outputs displaced  $90^\circ$  from each other at all frequencies. Normal sweep blanking is used.

When the sweep generator drives the network with the voltage  $e_1$ , and the voltages  $e_1$ ,  $e_2$ , and  $e_1'$  are applied to the product detector circuits, the display will then show  $S(\omega)$  and its phase angle  $\theta$ . They will assume different values as the sweep deviates over the swept band. It is desirable to mark different frequencies on the resulting immittance display. This is done by intensifying the beam with progressive frequency marking pulses at 500 kc intervals. In addition, a single marker is also provided which can be set to any frequency to check selected points on the curve.

Fig. 3 shows the complete set-up in block form. The block marked "network under test" may be any linear passive system including amplifiers, converters, detectors, or any other circuitry as long as it is linear. It does not matter whether the circuit impedances are lumped or distributed, and gain and attenuation are allowable. On the other hand, the network under test might be a simple coupling network or, for instance, the input impedance of a transistor.

Consider a resistance-coupled amplifier. It is well known that when a resistor is shunted by a capacitor, such as tube and wiring capacities, the impedance decreases with frequency and the phase eventually goes to  $90^\circ$ . Fig. 4 is a photograph of the display resulting from such a network. The trace starts at the right of the diagram on the horizontal axis at  $0^\circ$  for extreme low frequencies and then proceeds counter-clockwise to the origin for high frequencies. It has the shape of a semi-circle. Note especially the 3 db down response at  $45^\circ$  and the crowding of the frequency markers at the higher frequencies showing the asymptotic approach to  $90^\circ$  phase. Fig. 5 shows

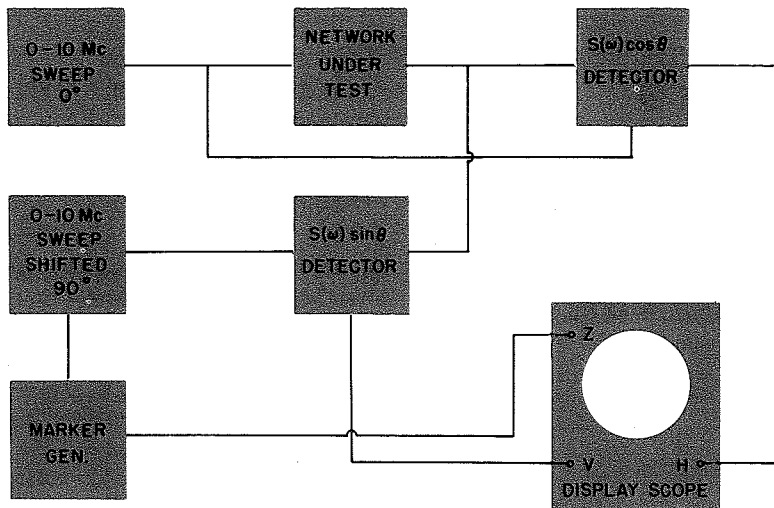

Fig. 3—Complete immittance sweep equipment

what happens when a series peaking coil is added to the circuit. Note that the low-frequency gain is unchanged, that the total phase shift is now  $180^\circ$ , that the 3 db frequency has been moved out considerably, and that the phase linearity is much improved. This latter fact is evident from the nearly equi-angular spacing of the markers. Fig. 6 shows what happens when a trap is added to the circuit and the phase oscillation at the trapped frequency is very apparent.

Fig. 7 is the display of the immittance of a properly terminated transmission line. Notice especially the constant amplitude of the radius vector and equi-angular spacing of the frequency markers which show the phase to be proportional to frequency. Fig. 8 indicates what happens when the same line is incorrectly terminated; amplitude is no longer constant as evidenced by the scallops on the circular locus and the phase oscillation is quite apparent.

The usefulness of this equipment can be greatly extended by several pieces of auxiliary equipment. Perhaps the most important of these is a high-gain, high-impedance probe-amplifier so that readings can be taken at any point in a circuit while in actual operation. Other pieces of auxiliary equipment include frequency shifters to obtain displays in the range from 10 to 200 mc. Finally, it is also possible to use this equipment to display directly the deviation from constant time delay. This application is important when

the desired objective in design is constant delay over a band of frequencies.

It is apparent that an immittance sweep of this sort is a valuable aid in the design of networks, amplifiers and complete systems; when properly used it can furnish results to the designer which are normally available only after time-consuming calculations or long series of intricate bridge measurements. One of the important advantages of this equipment is that measurements are practically instantaneous and that the entire picture is seen at one glance. This makes it possible to study what effect different circuit adjustments have over the entire frequency band. In other cases it makes it possible to study developmental equipment which may not have long-term stability since the readings can be taken so quickly. This is particularly important in the case of some transistor circuits with high-temperature sensitivity. Another application of this equipment is production testing, since two parameters may be displayed simultaneously. If anything is wrong, not only will the magnitude of the display change, but its shape will be altered drastically. This is an important advantage in i-f alignment.

A paper entitled, "A Complete Specification of a Network by a Single Parameter," RCA REVIEW, September 1954, pp. 389 to 444, by M. S. Corrington, T. Murakami, and R. W. Sonnenfeldt discusses in greater detail the theory and the operation of this equipment.

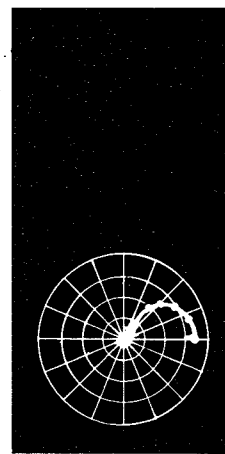

Fig. 4—R-C circuit response

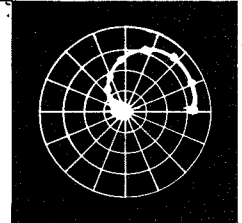

Fig. 5—R-L-C circuit response

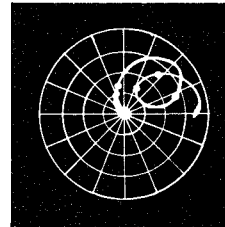

Fig. 6—Trap circuit response

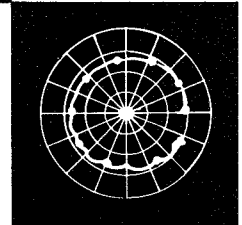

Fig. 7—Properly terminated transmission line

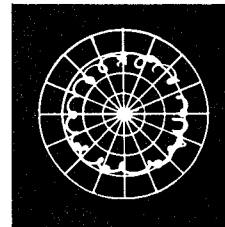
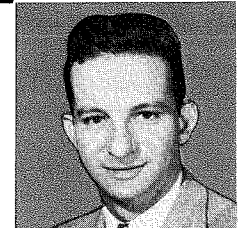

Fig. 8—Improperly terminated transmission line



**RICHARD W. SONNENFELDT** received a B.S. degree from Johns Hopkins University in 1949. He was engaged in industrial electronic design work from 1941-1943 and 1946-1949 for the Charles Transformer Company of Baltimore, Md. He joined RCA in 1949 as a Specialized Trainee and is now a Development Engineer with the TV Circuits Group of Television Division Advanced Development Section. Mr. Sonnenfeldt is a Senior Member of the IRE, a member of Tau Beta Pi, and Omicron Delta Kappa.

# ENGINEERING

## THE WORLD'S FIRST

### 1,000 KILOWATT

## TELEVISION STATION

by **W. O. HADLOCK**, *Editor*

FOR SOME TIME, RCA engineers have recognized the need for higher effective radiated power in achieving UHF coverage comparable to that provided at VHF. Long before the design of transmitter and antenna equipment for a one-million watt UHF television station was completed, RCA engineers had established themselves as leaders in the television field. They pioneered and developed 1- and 12½-kw UHF transmitters, UHF tubes, and UHF antennas with gains up to 27. The success of these designs is attested to by the large number of TV stations on-the-air today using this equipment. Before "million-watt" timetables were finalized, RCA transmitter and antenna engineers, as well as tube engineers, had been planning for high power, and had preliminary developments underway. Each group had specific programs lined up for completing the high-power design work, based on ambitious, yet reasonable and workable schedules.

Then, on a "crash" basis, came the demand for transmitting equipment that would provide the maximum power permitted by the Federal Communications Commission. The request was more than challenging! Considerably "stepped-up" engineering schedules were indicated, and WBRE-TV, Wilkes-Barre, Pa., was to receive the first equipment.

In order to maintain its customary position as "first" in all major Television design and developments, it was logical that RCA should be first with 1,000,000 watts at UHF. In the light of the urgent demand for coverage comparable to that provided by VHF, this called for concentrated and thorough rescheduling of all trans-

mitter-antenna engineering work to be done. Engineers were called upon to carry out accelerated schedules that would effect completion of all design work within an exceptionally short period of only three months. Delivery was slated for the end of 1954.

While the transmitter design work was underway, an antenna development site had to be acquired and constructed for pattern testing and engineering the high-gain antenna. The site finally selected at Gibbsboro, N. J. required bull-dozing roads, constructing test buildings and installing equipment. All schedules had to be coordinated with those of other groups. "Around-the-clock" schedules were a routine requirement. Much of the rugged, outdoor development work was conducted and completed under adverse weather conditions. Freezing temperatures, causing ice on equipment, were common.

The overall engineering project, known as "Operation M x M," was conducted on a company confi-

This is an introduction to a design and engineering teamwork story. Divided into three parts, two of the articles which follow deal with the technical activities of transmitter and antenna groups, and the third article covers the tube design.

dential basis. Engineering teams maintained contact with one another at all times. Each of the engineering steps along the way is a complete story in itself. Each step represents a design achievement carried out in an unbelievably short time. The engineering supervision of measurements, final tests, packing and shipping, and finally the supervision of installation, adjustments and tune-up of the equipment was mandatory.

The million watts of Effective Radiated Power was achieved by use of the high-power transmitter and high-gain antenna combination. In this instance, a 25-kw transmitter was used in conjunction with the 40-gain antenna (the product resulting in 1,000,000 watts).

The 25-kw transmitter design story is covered in greater detail as a separate article on the following pages, as are the design programs which were carried out by antenna engineering and tube engineering teams. These articles describe the engineering and design from early work in September 1954 to shipment of the 25-kw transmitter and 7½-ton antenna, three months later. This comprehensive team project involved a great number of contributing engineers, electrical and mechanical (see honor roll below).

### HONOR ROLL

#### ANTENNA ENGINEERS

S. BAZAN  
L. A. BROCKWELL  
V. J. CARITA  
O. O. FEIT  
H. E. GIHRING  
J. Z. GRAYUM  
K. S. LEWISON  
J. J. MATTA  
N. NIKOLAYUK  
R. L. PHARES  
E. H. SHIVELY  
L. D. WETZEL  
S. YUAN

#### TUBE ENGINEERS

W. P. BENNETT  
J. L. HOLMES  
H. F. KAZANOWSKI  
F. G. MCNEES  
R. A. NOLAND  
F. W. PETERSON  
R. E. REED  
E. E. SPITZER  
A. L. YOUNG

#### TRANSMITTER ENGINEERS

T. J. BOERNER  
J. W. CHASTEEN  
R. N. CLARK  
W. M. DURIS  
D. H. EBERLIN  
J. E. JOY  
G. W. KLINGMAN  
R. L. MEISENHEIMER  
G. J. ROGERS  
J. C. WALTER

# WORLD'S FIRST 25-KW UHF TELEVISION TRANSMITTER

ONE OF THE most important factors contributing to the success of a television broadcasting operation is coverage. When the UHF TV bands were opened in 1951, the maximum effective radiated power was established by the FCC as 1000 kw.

Our first UHF TV transmitter design was the TTU-1B. During 1952 and 1953, over one hundred of these transmitters were placed in operation throughout the country. The average gain of the antennas used with these one-kilowatt transmitters was in the order of 21, which provided an effective radiated power of 21 kw. While this power was adequate to get the UHF industry started, it was soon recognized that higher power would be essential to the establishment of a competitive UHF service.

The generation of high power in the UHF region of 470 to 890 mc presented many unusual engineering problems. A complete investigation and evaluation of all methods of producing high power at high frequency had to be undertaken and completed

by **J. E. JOY**

*Broadcast Transmitter Engineering  
Engineering Products Division  
Camden, N. J.*

before major design decisions could be made. The time required for this period of investigation was reduced to a minimum by the excellent cooperation and assistance provided by the Tube Division Engineers.

### PREVIOUS EXPERIENCE GAINED

Engineering evaluation resulted in the choice of the RCA-6448 beam tetrode (described in a subsequent article) to be used in a 12½ kw amplifier. This tube offered many advantages over all other methods of generating high power at ultra-high frequencies. It is small, weighs only 25 lbs. and its coaxial type of construction made possible the design of conventional cavities which were simple in construction, and easy to handle.

The engineering experience and

"know-how" gained with the development and design of the 12½ kw power amplifier was of considerable help in tackling the design of the high-power 25 kw transmitter. This previous experience gained with the 12½ kw design was especially helpful in meeting the extremely tight schedule which had to be planned in order to effect delivery within three months.

Close coordination between engineering development, engineering design, drafting and manufacturing had to be maintained. A group of engineers was organized as a "task force," each man assigned to a particular portion of the transmitter, and all working toward a common goal under co-ordinated direction. This group was a portion of the Special Purpose Transmitter Group, Building 53, managed by T. J. Boerner. The difficult and complicated task of supervising and co-ordinating all transmitter engineering efforts was the responsibility of J. C. Walter.

Each participating engineer had definite assignments, and the overall

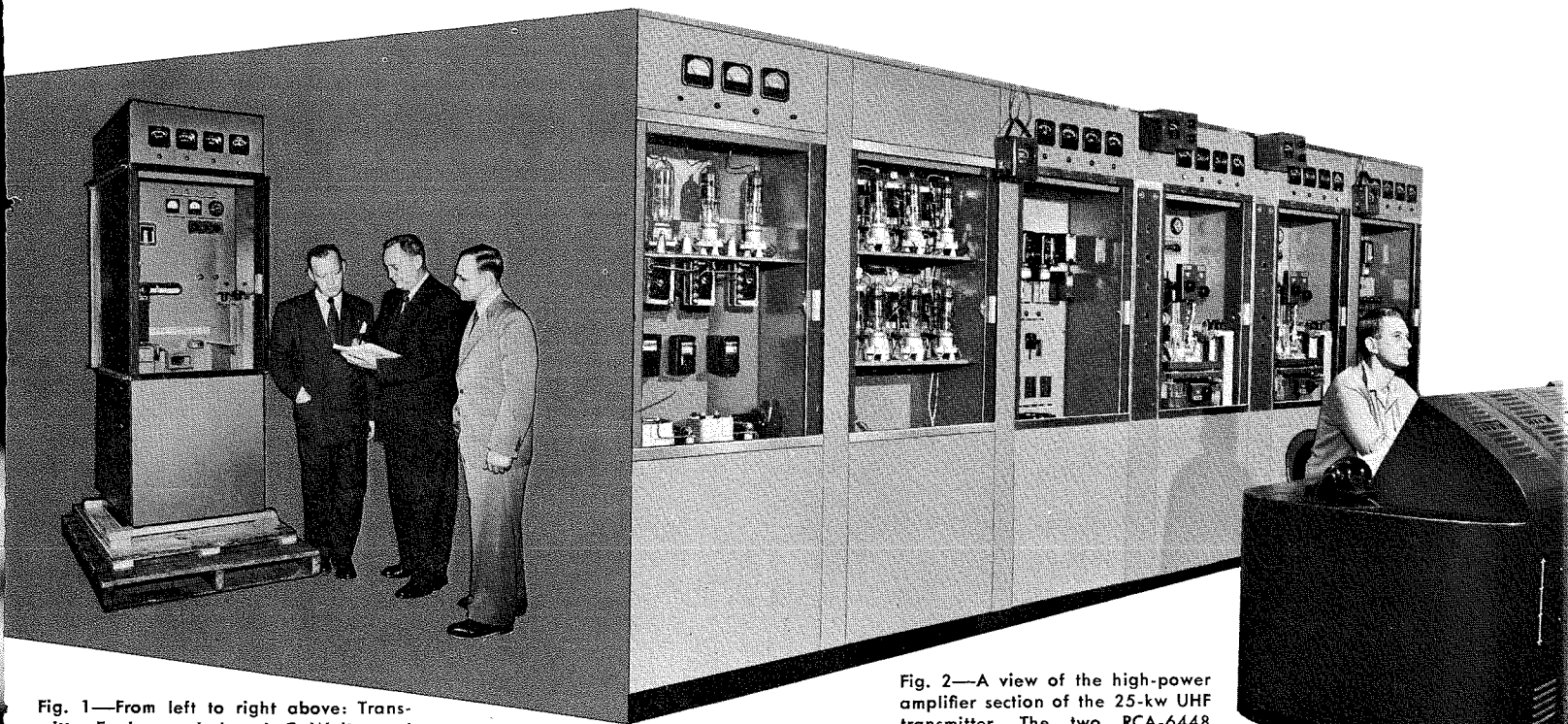

Fig. 1—From left to right above: Transmitter Engineers, J. Joy, J. C. Walter and M. W. Duris shown releasing one of the 25-kw transmitter cabinets for shipment.

Fig. 2—A view of the high-power amplifier section of the 25-kw UHF transmitter. The two RCA-6448 cavities are directly behind the WBRE operator.



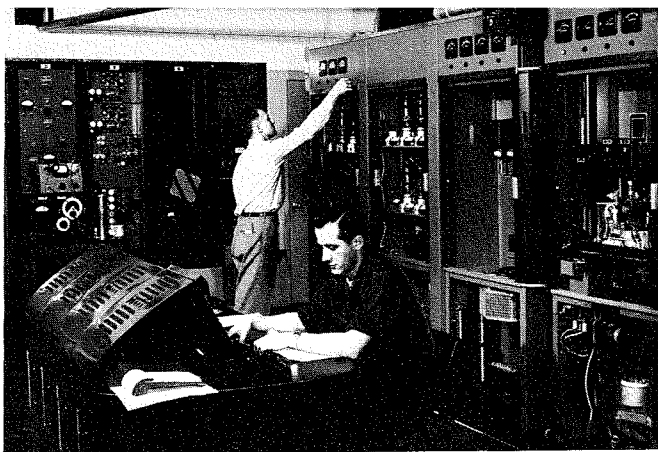

Fig. 3—WBRE-TV station personnel shown making tuning and test adjustment before going "on-air."

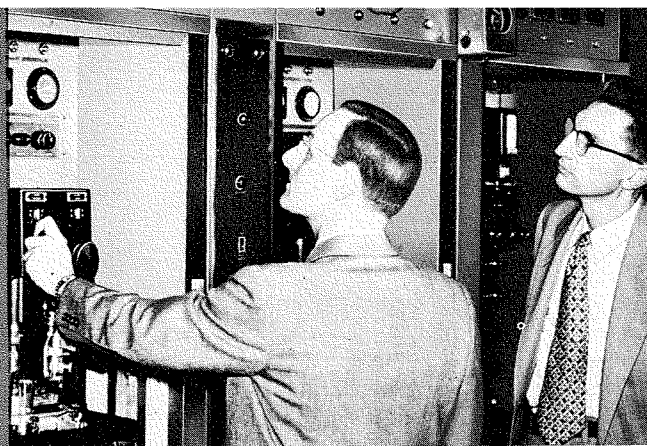

Fig. 4—RCA Transmitter Engineers, M. W. Duris and L. D. Wetzel shown making final checks.

project was subject to weekly review, in order to reschedule activities as required by ever changing circumstances. A large portion of the WBRE-TV station layout was actually performed "on location," the work being done during the station's "off the air" time. Water lines were run, transmission lines re-routed, auxiliary cooling systems installed, and preliminary power and control wiring completed. RCA engineers worked directly with the WBRE station personnel, taking advantage of every available spare moment so that as much of the installation as possible would be accomplished before the arrival of the transmitter.

**PARALLEL SCHEDULING**

While this work was going on, the transmitter was being assembled in Camden. This was an important part of the operation, since the complete equipment had to be installed and thoroughly tested before shipment to WBRE.

After two months of intensive engineering and manufacturing activity, a complete transmitter had been assembled, installed, and ready for test. During this short period of time many new records of accomplishment were set. The co-operation of our purchasing department in obtaining the required short time delivery on numerous items was a major factor contributing to the success of the overall project. Manufacturing and model shop personnel contributed their share by accelerated schedules based on the time allowable.

Two months after the initiation of the crash program for a million watts of radiated power, a complete transmitter was installed and ready for test. Three weeks was the allotted

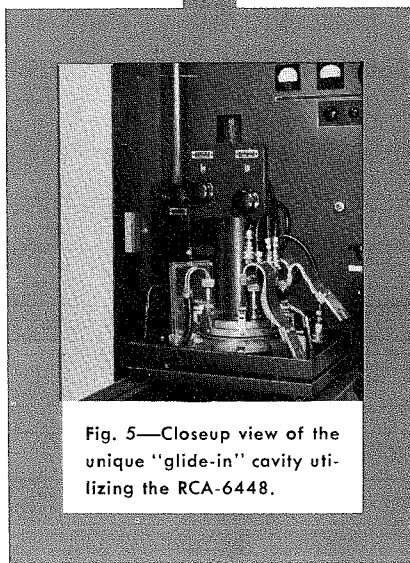

Fig. 5—Closeup view of the unique "glide-in" cavity utilizing the RCA-6448.

time for completing all tests. This included testing of all control circuit functions as well as all the performance characteristics of the transmitter. Here again the cooperation of the test department and the model shop proved to be of prime importance. As testing progressed, some design changes had to be made "on the spot."

**PERFORMANCE**

The performance data obtained during test was more than satisfactory. The required power output was easily obtained under broadband conditions, frequency response was flat out to 4.5 mc, and incremental gain was well within specifications. The transmitter was delivered to WBRE in November, 1954 with reasonable assurance that it would be in operation before December 31. The engineering activities for the next three weeks centered around installation and test of the transmitter at WBRE, in such a manner as to not interfere with the

station's normal broadcasting schedules. By the 9th of December, all of the transmitter cabinets had been installed, wired and operationally tested. Transmission lines and associated equipment were in position ready for connection to the high-gain antenna.

Preliminary performance tests were run on December 10, which indicated that the transmitter would more than meet all the requirements of the FCC and RETMA standards for color and monochrome transmission. This was substantiated on December 31 when WBRE began its first day of maximum power commercial programming.

First reports from outlying districts showed complete coverage fill-in of previously unsatisfactory areas. Snow free pictures were reported from distances of over one hundred miles. Color picture quality was more than satisfactory. The objectives of "Operation M x M" had been successfully achieved.

**GENERAL DESCRIPTION OF TRANSMITTER**

The TTU-25A is a 25 kw UHF television transmitter designed for the transmission of black and white and color television signals. When used in conjunction with a high-gain antenna, it is capable of producing the maximum power output permitted by the FCC in the UHF channels.

The equipment is contained in fifteen cabinets, which, together with associated power supplies and distribution components, occupy a floor area of about 200 sq. ft. The accompanying photographs show the cabinets comprising the high-power amplifier and some of the power and control units. The simple block diagram shows the transmitter tube line up.

A TTU-1B 1 kw transmitter is used as an exciter for the TTU-25A. Power from the visual side of the 1-B provides the required power to drive an intermediate RCA-6448 power amplifier to about 5 kw. One half of this power is used to drive each of two high-power RCA-6448 amplifiers to produce about 13 kw. These two outputs are then paralleled—the resultant 26 kw being fed to the high-gain antenna.

On the aural side, the output of the 1-B is used to drive a single high-power RCA-6448 amplifier to the required aural output of 15 kw. The transmitter has many interesting and unusual features.

**THE R-F POWER AMPLIFIER**

The four power amplifiers utilize the compact tube and cavity assembly shown in the illustration. This simplified arrangement stems from the coaxial construction of the RCA-6448 power amplifier tube itself. Coaxial cavities are assembled directly above and below the tube, the entire unit being arranged on a "glide-in" shelf to provide simple installation and interchangeability. Portable dollies are supplied to transport the power amplifier cavity assemblies.

**GRID AND PLATE CAVITIES**

The grid cavity is a  $\frac{3}{4}$  wave resonator, about one half of which is entirely within the RCA-6448 tube. External to the tube is a low-impedance coaxial element (about 2 ohms), having a telescopic section which is adjustable for tuning the cavity to resonance. Power from the preceding stage is capacitively coupled to the grid cavity at a point of higher impedance (about 50 ohms). The cavity is broadbanded by absorbing a portion of the driving power in an absorbing load.

The plate cavity is a half-wave coaxial resonator, the first quarter wave mostly within the tube. The second

quarter-wave portion is utilized for tuning by the proper positioning of a short, low-impedance section within it. This tuning element not only serves to tune the cavity to resonance, but by virtue of its low impedance, reduces the circulating current in the cavity so that broadbanding without stagger tuning is obtained. The tapered section of the plate cavity is used to transform the cavity impedance up to 50 ohms for connection to a standard size transmission line. An r-f output loading transformer is permanently mounted in each power amplifier cabinet.

**POWER SUPPLIES**

Plate voltage for the transmitter is produced by two power supplies, each using six type RCA-5563A tubes to provide about 6000 volts for the amplifiers. Separate power supplies are used for the screen and the control grids.

Electronic overload protection is used to remove plate or screen voltage from any of the power amplifier tubes in the event of a temporary tube fault. This high-speed device was developed during the design of the 12½ kw amplifier. By its use, the power amplifier tubes are relieved of short circuit current burden in less than ten microseconds after the fault occurs.

The complete control circuit of the TTU-25A was especially designed to permit flexibility of operation. All control functions are monitored, and all important circuits are metered. Interlocking systems for equipment protection and personnel safety are included.

**CONCLUSION**

Extended area coverage and achievement of maximum power at UHF has been made possible by the design and production of the TTU-25A. Another important economic need of the UHF television industry has been thus fulfilled.

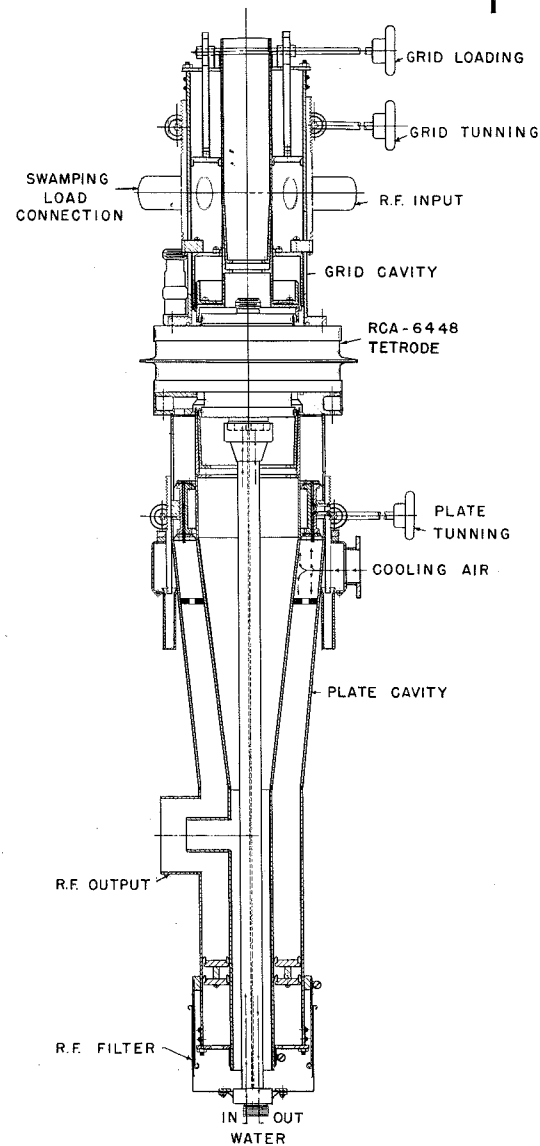
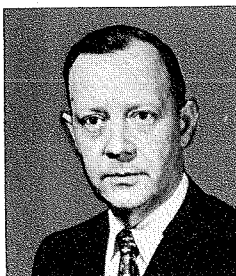
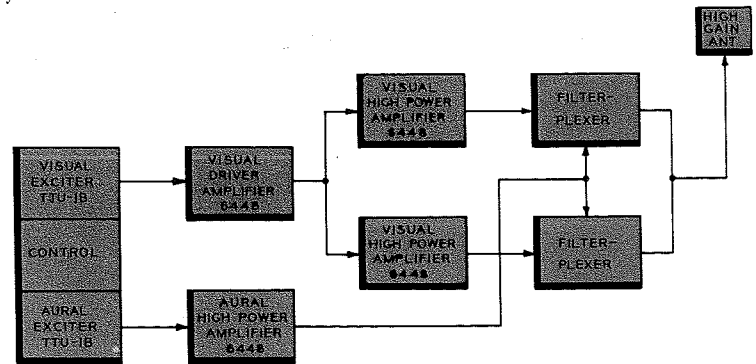

Fig. 6—Cross-sectional view of the RCA-6448 tube and cavity. A rugged, simplified mechanical design was utilized.



**JOSEPH E. JOY** has had more than twenty-five years of experience in the technical and engineering fields. One of his important designs was the high-frequency generator now widely used in the garment industry as an electronic sewing machine for "seaming" plastic materials. As one of the engineers on the TTU-12A and TTU-25A transmitters, he was responsible in large measure for the accelerated design and production of these highly successful equipments.



BLOCK DIAGRAM TTU-25A

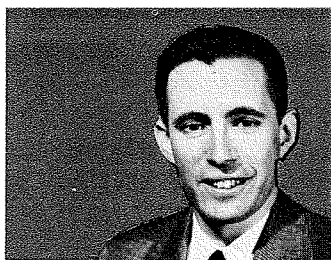

**EDWARD H. SHIVELY**—Mr. Shively received his B.S. in E.E. from Purdue University in 1949 and is presently attending classes at the University of Pennsylvania for his M.S. in E.E. From 1949 to 1951 he was engaged in design and development work on the Crosley Broadcasting Company inter-city television link and later as transmitter supervisor for WLW-D, Dayton, Ohio. He joined RCA in 1951 and is presently a Project Engineer on UHF TV Antennas. Mr. Shively is a member of the IRE, the AIEE, Tau Beta Pi and Eta Kappa Nu.

by **E. H. SHIVELY**

*Broadcast Antenna Engineering  
Engineering Products Division  
Camden, N. J.*

**T**O ACHIEVE a Million Watt UHF television station utilizing a 25-kw UHF transmitter came the requirement for a UHF antenna with nearly twice the power gain of any similar unit heretofore engineered.

One of the early problems confronting the UHF antenna design engineer, as gains were increased, was the lack of adequate close-in coverage. The way was paved for a solution to this problem on the very-high-gain UHF antenna by the pat-

## THE ULTRA-GAIN, HIGH-POWER UHF ANTENNA

Fig. 1 — A closeup view of the high-gain antenna being raised up the inside of the WBRE-TV tower.

tern shaping work on the 24-gain, slotted-cylinder pylon. In this case, it was demonstrated that a high-gain antenna may adequately provide close-in coverage if the lower side of the pattern be contoured to avoid deep nulls. During the summer of 1953, engineering effort was expended on pattern shaping to eliminate the "coma"\* upper sidelobe which with large amounts of electrical beam tilt reached an amplitude as high as 50% of the main beam radiation intensity and represented a reduction of gain through wasted power.

In the fall of 1953 it was suggested that if the gain of the antenna might be raised (without appreciably narrowing the main beam) by elimination of unwanted upper hemispherical radiation, the effective radiated power of transmitters might be increased at the upper end of the band where power was difficult to obtain.

In order to achieve maximum radiated power, it is desirable to utilize an antenna with as high a power gain as is consistent with adequate coverage. In 1954 the maximum transmitter power which could be achieved in a practical design was 12½ kilowatts. At this time the idea of combining two existing 12.5-kw transmitters to provide 25 kw was hit

\*Coma is a term used to describe that pattern distortion effect due to a cubic phase error over the antenna aperture.

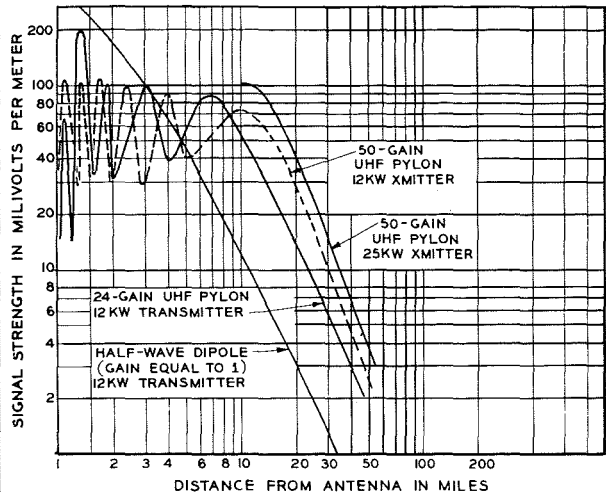

Fig. 2—Signal strength vs. distance from antenna. Antenna height is 1000 feet and transmission line efficiency is 70%.

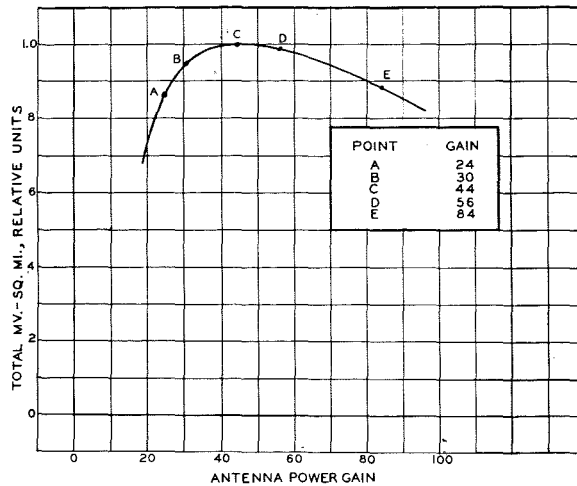

Fig. 3—Relative coverage effectiveness of various gains with constant transmitter power. Transmitting antenna height is 1000 ft.

upon and the demand for a 40-gain UHF antenna became immediate.

**PRELIMINARY INVESTIGATIONS**

Of course, no one could say with certainty that a 40-gain antenna would work, much less predict the exact coverage pattern it would provide. A preliminary investigation was begun in January, 1954.

Some estimates on the required length of array were quickly made; the antenna would have to be approximately twice the height of the 24-gain variety. With the lengthening of the array go "hand-in-hand" the problems of impedance bandwidth and pattern bandwidth, for the input impedance must be matched to the transmission line so that the VSWR over the television channel is 1.10 or better, and the gain must not vary appreciably over the channel. First calculations showed these conditions possible for a uniform series-fed array 30 wavelengths long (approximately the half-length of the antenna) if the layers were coupled to the transmission line much more tightly than in the case of the 24-gain antenna. It was immediately apparent that we were about at the end of our rope on bandwidth, but the job was far from impossible.

Separate from bandwidth considerations were those of pattern slope and coverage. Would the signal be stable under conditions of tower sway, and if so, would coverage be correct? It was found that by correct pattern shaping slope could be held to a figure not appreciably higher than that of hundreds of successful UHF antennas already in service. The answer to the

‡Slope is the rate of change of radiated field with vertical angle.

second question was that a gain-of-forty antenna would serve more people with a better signal than would a 20-gain antenna in those installations where the population extends to a considerable distance from the transmitter location.

**FORMULATION OF THE PRODUCT**

By April, 1954, several horizontal patterns had been calculated for various workable combinations of slots and pipe sizes and a choice based on structural considerations had to be made. A pair of standard pipe sizes of different wall thicknesses with the same bore were chosen, permitting the pole to be tapered in two steps, and the necessary iron was ordered. The weight of iron was no small item, as the lower section consists of 16-inch O.D. tubing with a 1 5/8" wall thickness!

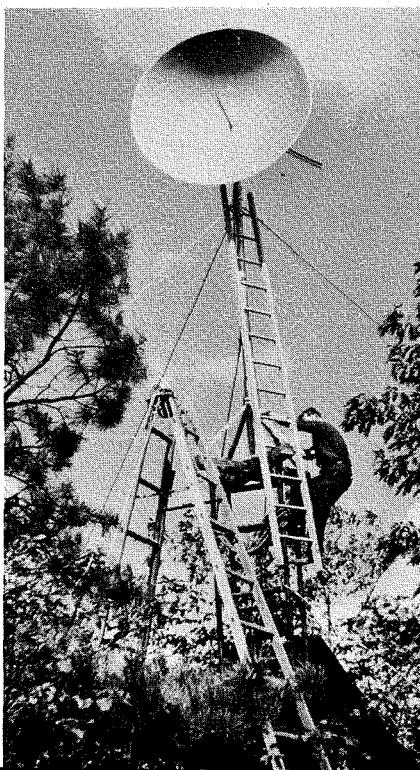

At this time also, the number of layers of slots and of slots-per-layer for the three sub-groups to cover the UHF band were chosen, along with the approximate gains for the groups. A vertical pattern to approximate the "ideal" was synthesized. An important feature of this pattern was the control of the array coefficients to eliminate the large upper sidelobe.

With these preliminary studies providing encouragement, the green light on further development was given in April, and the high-gain antenna was announced as a product at the 1954 NARTB convention.

**THE PATTERN MEASUREMENT PROBLEM**

It had been known for some time that we were rapidly outgrowing the pattern testing facilities at Medford, N. J. For a given degree of accuracy in pattern testing the separation between transmitting and receiving points increases with the square of the length of the antenna under test, and we already had Fresnel zone† troubles at Medford. Accurate pattern measurement of the big antenna there was out of the question.

The plan had been to move the facilities to Moorestown and there construct a turntable large enough to carry the ten tons of antenna involved. However, a large housing project being planned immediately adjacent rendered the location useless for our purpose.

A location in the pine barrens east

†Fresnel zone or "near-field" zone is the region in which rays from the various array elements to the receiving point cannot be considered parallel.

Fig. 4—N. Niyolayuk, engineer climbing, and assistant during "exploratory" tests to locate a suitable engineering test site.

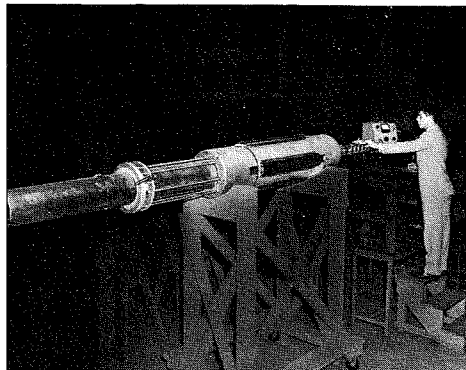

Fig. 5—Lab setup for impedance check on single-layer section. James Bloxsom, student engineer, is making measurements.



Fig. 6—A view of the engineering development site during the early stages when roads were being bull-dozed.

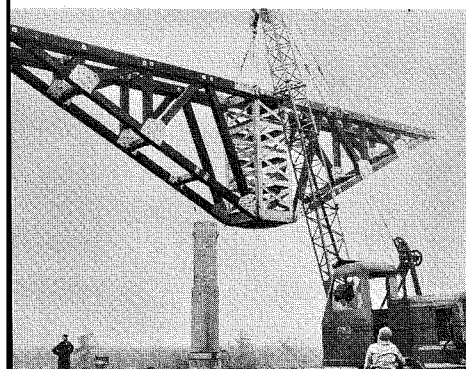

Fig. 7—View of the turntable bridge being lifted over the kingpost during installation at the Gibbsboro, N. J. location.

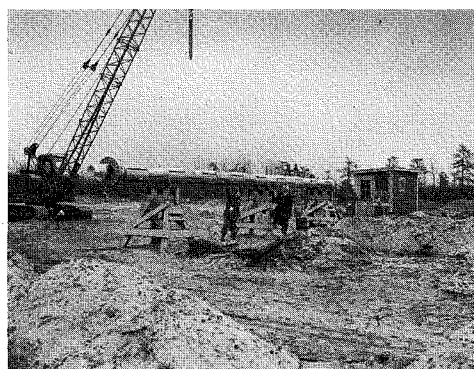

Fig. 8—S. Yuan and H. E. Gihring, Antenna engineers, shown inspecting lower section of antenna during assembly.

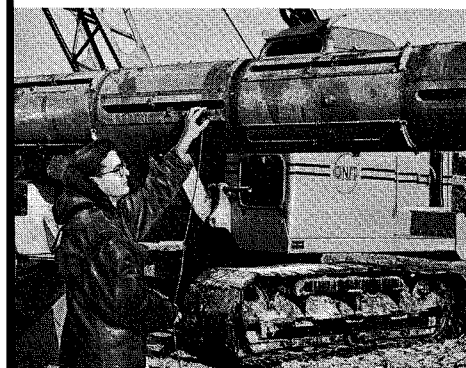

Fig. 9—S. Bazan, engineer, shown setting probe on slot to measure the radiation current amplitude and phase.



Fig. 10—L. to R.: J. E. Grayum, H. Phoenix, and S. Yuan, engineers, with current-measuring gear in "skid-shack" near antenna.

of Gibbsboro, N. J., the highest point in the area, had been under study as a pattern test site for large VHF antennas, and accordingly, a series of tests were begun both by a radar method in which unwanted reflections were detected on a scope by their

time delay, and by rotating a parabola of known pattern on a short tower to determine the trueness of the received wave front.

We had hoped to measure the wave front directly by carrying a dipole along a track over the proposed turn-

table location and simultaneously recording the amplitude and phase of the received wave. A look at the site quickly convinced us that the forest would be in the way, so these tests were postponed until such time as the land might be cleared. Since the other tests looked favorable, it seemed this might not involve a long wait.

It appeared an antenna could be built by fall, and with a site at hand the problem of a turntable was the next step. We had been very successful in setting up pattern testing facilities at Medford, and the preliminary design of a turntable for a 20,000 lb. antenna had been completed. Now it appeared there would be no time to divert engineering from the large scale antenna development program to design a turntable for the big antenna. Consequently, outside help was enlisted for the design, construction, and installation to our specifications.

#### BASIC DEVELOPMENT

During the summer an intensive development program was carried out on the characteristics of the slot radiators through measurements on a 16-inch pipe originally fabricated for development of another antenna. The resistance and reactance characteristics as a function of slot length were measured, and the "Q" of the loop determined as a function of the closeness of coupling. Horizontal and vertical pattern measurements were made at Medford and the cross-polarized radiation component determined to be negligible. A lab transmitter was set up to provide for power testing the components.

Early in the summer it became apparent that the heavy-wall pipe previously referred to would be extremely difficult to obtain, with a very long delivery cycle. It could be had on special order from National Tube Co. in lots of 90 tons, but no one at this time wanted to place a firm order for 90 tons of iron. For lab measurements, a double-wall pipe, simulating the heavy-wall section, was ordered from a local fabricator.

#### THE COMMERCIAL PROGRAM

The decision on a commercial program was made in June, 1954. It included (1) the construction of a microwave model of the full scale antenna with a scale factor of about

4 to 1; (2) Construction of one engineering model high-band antenna; (3) Construction of one engineering model low-band antenna. Channel 71 was chosen for the high-band because of WTPA, Harrisburg, and Channel 28 because of WBRE, Wilkes-Barre, both of which had shown some interest in the antenna.

Accordingly, a lab setup was made in the 2000 mc range on a single layer of the microwave model, whose scale factor was 3.425 to 1. Both thin-wall and thick-wall pipes were measured to duplicate the two pipes used in the full-size antenna, and coupling data was taken to determine slot length and layer spacing for the full scale model. An interesting side-light was the development of a special inner conductor for the Hewlett-Packard slotted line to change the characteristic impedance from 50 to 26.5 ohms to match the model.

At this same time a single layer full-size model was fabricated and tested alongside its pint-sized brother. The correspondence was good, considering the extreme difficulty of handling and setting the tiny coupling loops.

**MODIFICATIONS TO MEET  
A CHANGING MARKET**

At this point the commercial picture took a sudden turn; the interest was focusing on WBRE so rapidly that the Ch. 71 program was shelved in favor of the Ch. 28. Shortly thereafter the station placed an order for delivery early in 1955. Both the microwave and full-size lab setups



Fig. 11—Antenna engineers shown during a group planning meeting. Left to right: L. D. Wetzel, H. E. Gihring, V. J. Carita, K. S. Lewison, E. H. Shively, R. L. Phares, J. Grayum, S. Yuan, S. J. Bazan, T. Foley, and J. Matta. Missing from photo are O. O. Fiet and N. Nikolayuk.

were changed to four-slot pipes and data begun.

It soon became apparent that if RCA were to maintain its position of leadership in the broadcast field, a megawatt should be accomplished in 1954. The delivery date for WBRE thus became December 1, and the rush program turned into a crash program. The lab measurements on the microwave model and the full size pipes were put on a heavy overtime basis, extra engineers were enlisted, and an extremely tight engineering schedule was put into effect.

Through extreme efforts of both purchasing and engineering, a source of supply was found for the heavy lower-section pipe in the form of forgings which were turned and bored to size. All efforts to use the double-wall pipe for lab measure-

ments failed due to dimensional inaccuracies, and a piece of the forged pipe was quickly fabricated for the lab. The contract for the turntable was given to Met-Pro, Inc. of Lansdale, Pa., who agreed to design and build in record time to meet the schedule.

The planning of the Gibbsboro site had to be stepped up to the feverish pace of the antenna development. As soon as tests indicated we could proceed, the leasing negotiations had to be carried out, the land cleared by bulldozer for roads and turntables, and locations staked out.

**SOME LAST MINUTE PROBLEMS**

By Nov. 12 the coupling data for the microwave model was complete and cutting of the full-scale model pipe had begun. In correcting the data for the velocity of propagation in the

Fig. 12—Final assembly and checkout of antenna on ground prior to hoisting atop turntable for pattern tests.

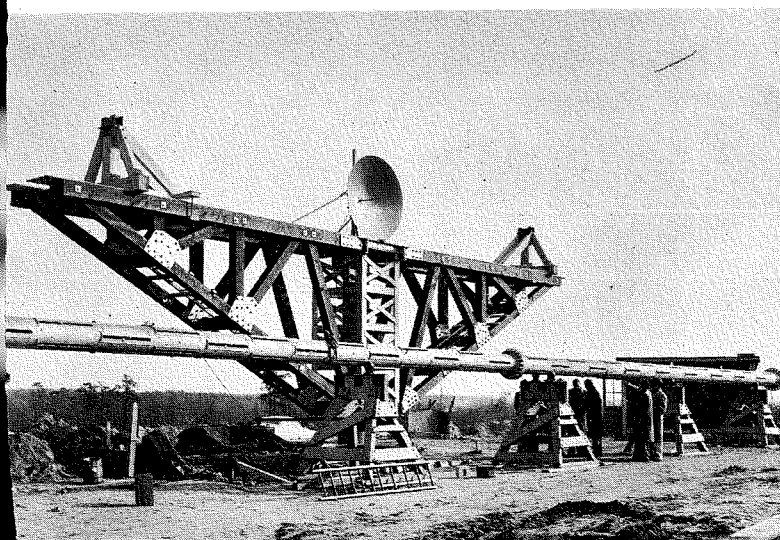
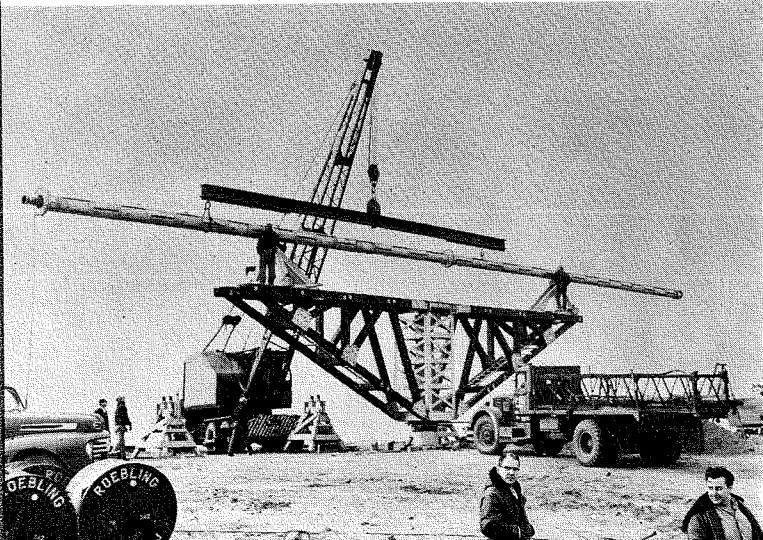

Fig. 13—Placement of the high-gain antenna on the test turntable for the first time.



pipe, two basically incompatible theories had to be reconciled without time for further investigation of either. Through a hastily constructed lab setup the relation of currents inside and outside the pipe was measured and the question resolved. On Nov. 15, data was released for cutting the full-size pipe.

Meantime the full-scale microwave model antenna was delivered and lab tests proceeded. The fact was immediately apparent that something was wrong with the coupling system. In certain regions of the antenna the currents on the two halves of a slot differed by as much as 10 db whereas they should have been equal. The trouble was found to be due to unwanted electrostatic coupling to the magnetic loop which did not appear

a radial drill and two operators hired from the vendor and drilling of 272,  $\frac{3}{16}$ -inch holes quickly proceeded in the rain under a hastily rigged canopy. This continued throughout Saturday night and Sunday morning.

The harness is a 100 ft. length of 8-inch copper pipe made up of two 50 ft. sections weighing a total of 1550 lb. It is fragile and extreme care was required in handling. Since no special crane sling was available, the antenna was unloaded by a group of men, standing shoulder-to-shoulder over the entire length of the open truck trailer.

The input impedance of the full size pipe was much nearer to theoretical than was the model, though considerable adjustments had to be made on the coupling loops in order to approximate the amplitude and phase relations of the radiation currents at the various elements. Here, as with the model, neutralizing probes were required. At this stage crews worked on an "around-the-clock" basis and schedules were more or less meaningless. As work progressed, firm schedules were re-established and by December 1 the two halves of the antenna were taken to the hilltop beside the turntable and joined.

**FIRST PATTERN TESTS**

With the antenna completely assembled for the first time the input impedance was measured and found to be broadbandable. This was indeed good news! The current ratios over the entire length were not as good as expected and required further work. When the current distribution was improved as much as possible, the entire antenna was hoisted onto the turntable and then pattern checked. Surprisingly enough, it had a main beam and the tilt was approximately correct! However, the null fill was not considered good enough and more work had to be done on adjusting and changing coupling loops. There was a power unbalance between lower and upper halves which could not be corrected in the time allotted.

The antenna was removed from the turntable in what was considered the best condition obtainable without further development. The upper and

lower sidelobes were approximately balanced, the beam tilt was acceptable, but the gain was 43 instead of the desired "goal" of 46. Impedance measurements were taken for design of the two matching transformers, and the first was quickly fabricated, installed and measured. The impedance was exactly as calculated and so the antenna was readied for shipment, the second transformer to be installed at Wilkes-Barre. Two trucks, each carrying half the antenna, departed from Gibbsboro on Dec. 17, bound for the Pocono Mountains.

**THE WORK ON WYOMING MOUNTAIN**

The delicate giant was removed from the trucks next morning, set up on horses near the transmitter building and the two sections bolted together.



Fig. 14—N. Nikolayuk, operating controls during a "checkout" of the turntable.

in the measurement of a single layer section. Almost as quickly as it appeared a method of neutralization by capacitive probes was found and the experiment of the model completed.

**ASSEMBLY AT GIBBSBORO**

The upper section pipe was delivered to Gibbsboro, and assembly had no sooner begun when we found the loop bracket holes were drilled in the wrong location. They had to be re-drilled and quickly; only one thing stood in the way: there was no electric power at the site! Lines were not installed and our only mobile generator had a frozen engine. An electric plant was rented from a contractor,

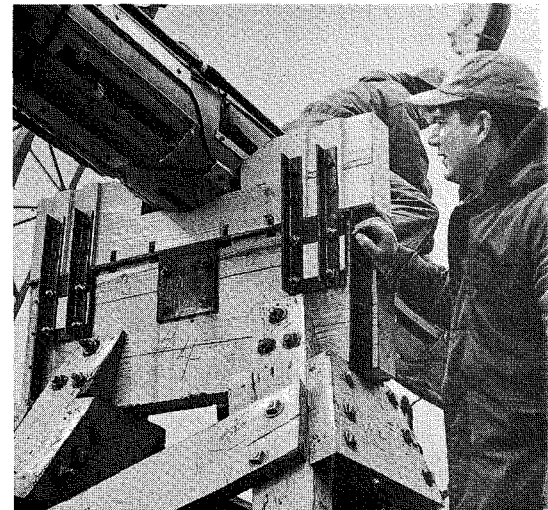

Fig. 15—V. J. Carita, shown inspecting the cradles on the truck during shipping.

During the joining of the harness sections, the lead thread was damaged and had to be re-scraped; but by nightfall the assembly was complete. The input impedance with one transformer in place was measured and found to be exactly as read at Gibbsboro. Good news again!

Next day, during the installation of the second transformer, one of the feedline joints inside the harness was broken, leaving forty feet of feedline and two transformers inside. These had to be unscrewed from the endseal at the center of the antenna before removal. A fishing tool was devised which, together with considerable luck, allowed us to remove the dam-



Fig. 16—View at Wilkes-Barre, Pa., showing the placement of the high-gain antenna on "horses" for ground checkouts.

aged section. Repairs were made, the second transformer adjusted for a match, and the ground check was completed.

Because of strength considerations, the antenna had to be hoisted up the inside of the tower; accordingly, the upper half was secured inside the tower while a set of improved feed-line joints was forwarded from Camden and installed in the lower half to prevent a recurrence of the previous day's accident. On December 22 the two sections were joined in vertical position inside the tower and the input impedance measured. The VSWR at the highest point in the channel was 1.12 which was very good, considering the proximity of the steelwork. On December 23 preparations were made for hoisting but two difficulties prevented this: (1) the wind was high; (2) the riggers wanted to go home for Christmas. So the attempt to radiate a megawatt before Christmas fell through.

On the following Monday the antenna was set and the tower panel removal begun. This was necessary since the upper 50 ft. of the tower was too weak to support the antenna load. By December 30 the panels were down, the transmission line connected and the impedance read at the input to the transmission line. It was too high, and icing of the antenna was suspected. The sleetmelters were operated, and by evening the VSWR was low enough to permit operation at 12 kw. Throughout the evening the impedance gradually returned to normal, as indicated by the transmitter reflectometers.

#### ONE MEGAWATT!

After signoff, the 25-kw hookup was made and by 3 A.M. on December 31 the full power was applied. One megawatt had been achieved, putting RCA high-power UHF ahead of the rest of the field! Reports of excellent distant reception were received.

A fine picture was also received "close-in" at the WBRE studio in Wilkes-Barre, Pa. As far as the full commercial impact a megawatt will make on the industry, only time can tell, but the technical aspects had been accomplished and the megawatt is a reality.

#### TECHNICAL DESCRIPTION

The antenna consists of a long seamless galvanized steel tube in two sections in which longitudinal slots are cut, each closed by a weathertight plastic cover. There are four slots equally spaced circumferentially in one radiating element, or layer, and thirty-four layers of elements stacked vertically. Adjacent layers are staggered 45 degrees to provide almost perfect horizontal pattern circularity.

The pipe together with the harness inside form a coaxial transmission line and the driving voltage is applied to each slot at its center by a coupling loop which extends into the interior of the pipe and picks up energy from the magnetic field. Radiation results from currents flowing on the surface of the pipe. Energy is fed into this coaxial line at the center of the array from the lower half of the harness, which itself acts as a coaxial line and contains another inner conductor.

The outer conductor of the harness is broken at the array center to allow energy to flow from the inside of the lower harness section into the region between the pipe and the harness. The gap in the outer conductor is closed by a "Teflon" endseal and the interior of the lower harness section is pressurized by dry gas from the transmission line. This section also contains the matching transformers.

The inductance of the coupling loops is tuned out by a series capacitor at the loop center, and control of the relative phase of the radiation currents is accomplished by varying the tuning of the loops. Amplitude of the currents is controlled by varying the depth of penetration of the loops into the interior of the transmission line.

The result is an extremely simple and rugged antenna having a very long structural life and permitting great flexibility in pattern shaping.

\*Reg. T.M. of DuPont for tetrafluoroethylene resin.

Fig. 17—At left, the surface current distribution on the slot antenna is shown, and at right is a cutaway view of the UHF antenna. Each layer of the antenna is fed by three small coupling loops which pick up part of the signal in the pipe and produce current on the outer surface of the pipe.

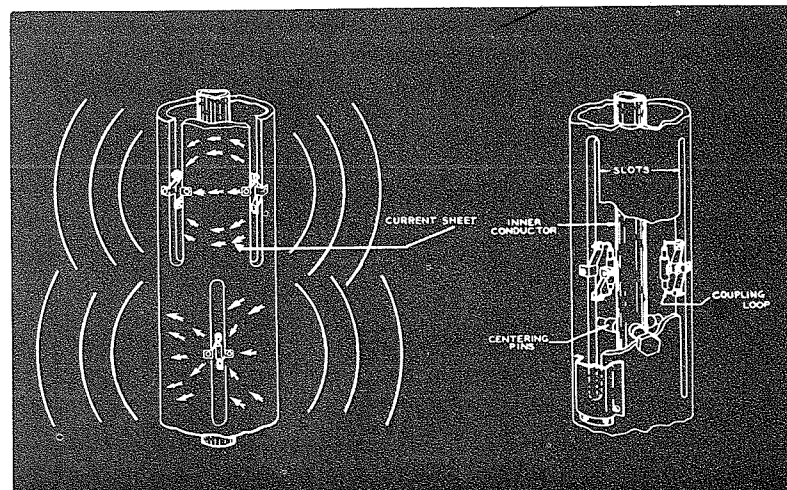



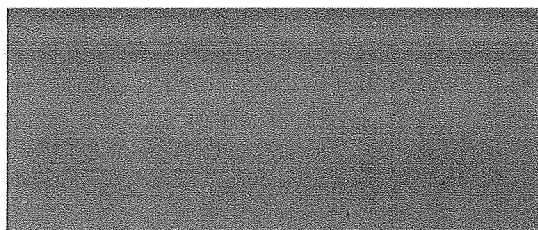

## A 15-KILOWATT BEAM POWER TUBE

### FOR UHF SERVICE

by **W. P. BENNETT**

*Power Tube Engineering,*

*RCA Tube Division*

*Lancaster, Pa.*

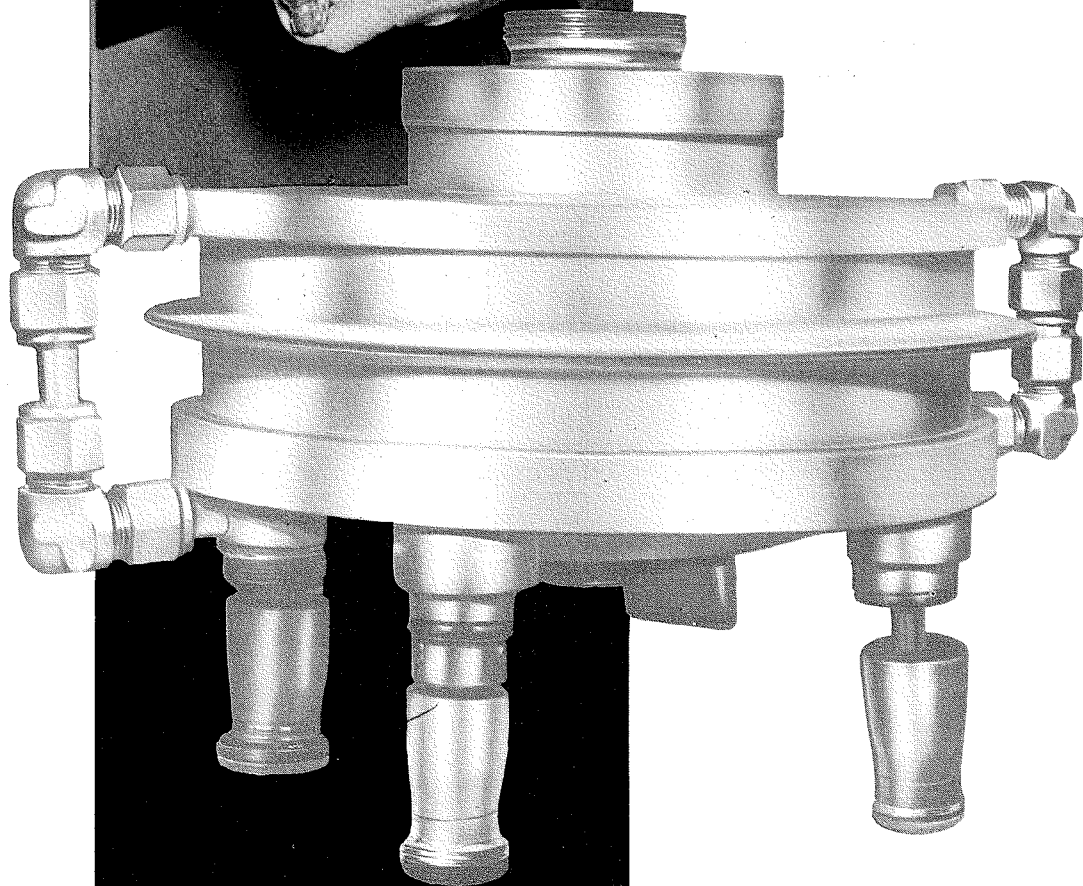
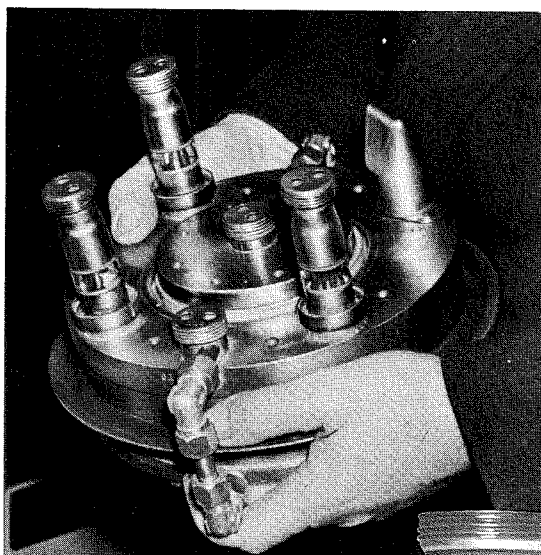

Fig. 1—RCA-6448  
UHF Ceramic-seal,  
water-cooled beam  
power tube.

**Editor's Note:** The author describes the 15-kw UHF beam power tetrode (RCA-6448) which is mentioned by Mr. Joy in a preceding article on the high-power transmitter. The design of this tube plus that of the RCA-6181 used in the 1-kw driver have contributed greatly to the all-around success and acceptance of the transmitter equipment.

**INTRODUCTION AND HISTORICAL  
BACKGROUND**

Shortly after World War II, it became evident that television broadcasting would eventually expand into the UHF bands, and that the transmission of color as well as black-and-white pictures would eventually be required. Transmitting tubes available at that time were inadequate for the generation of the required high-power signals for UHF propagation. Although parallel operation of tubes could be used to obtain higher powers,<sup>1,2</sup> the use of a single tube for each chosen power level was desirable technically, as well as economically sound. Development work was started, therefore, on a transmitting tube capable of delivering a power output of 5 to 10 kilowatts in UHF color or black-and-white television service.

The tube was designed as a grid-driven tetrode for use as either a linear amplifier or a high-level, grid-bias, modulated amplifier, rather than as a triode or a cathode-driven tetrode. Although the grid-driven tetrode tube is somewhat more complicated and requires more ingenuity in its execution, it has the following advantages:

1. It provides greater flexibility in meeting the unknown color-television requirements.
2. It is suitable for a wider range of services, such as linear amplifier or grid-bias modulation amplifier.
3. It has higher power gain.
4. It requires relatively simple circuits for operation.
5. It introduces minimum coupling between input and output circuits.

Early models of the RCA-6448, which used glass as the insulating material in the envelope, yielded suitable black-and-white television performance at an operating frequency of 525 megacycles per second. These tubes, however, were not compatible with the circuitry required for 900 megacycles per second operation. Tubes using shorter glass seals were made, but the shorter glass sections failed when r-f power was applied. Since satisfactory ceramics and ceramic-to-metal seals had been developed by this time, these were subsequently used in the tubes to permit application of suitable 900-megacycle-per-second circuits.

At about the time that 525 megacycle-per-second performance was obtained, it became evident that the power levels for which tubes should be developed for television service were 1.2 kilowatts and 12 to 15 kilowatts. Therefore, the objectives of the tube development program were altered somewhat to include the development of a 1200-watt driver tube, the RCA-6181.<sup>3</sup> The associated RCA 1-kilowatt transmitter was known as the TTU1B.

**DESCRIPTION OF TUBE**

The beam power tube, RCA-6448, meets all the requirements for the transmission of a high-quality 12-to-15-kilowatt color or black-and-white television signal over the entire UHF television band. It has a power gain greater than 15, and can be driven adequately by a single RCA-6181 or similar 1-kilowatt tube. The RCA-6448 is also well suited to all types of amplifier service both at lower frequencies and at frequencies up to 1000 megacycles per second.

A photograph of the RCA-6448 ceramic-seal, water-cooled, UHF beam power tube is shown in Fig. 1. Two ceramic insulators are located at opposite ends of the central cylindrical metal housing. The lower or input end of the tube, which contains the cylindrical r-f control-grid terminal, is almost hidden from view in the photograph. The upper or output end contains the anode and cathode terminals. The projections at the input end of the tube include the electrical and water connections for the filament and the screen grid. These connections project through the main metal housing on insulated bushings. The main

metal housing of the tube is at cathode or ground potential.

The view of the input end of the tube in Fig. 2 shows the cylindrical symmetry of the r-f terminals and the nature of the conveniently threaded combination electrical-and-water connectors provided for the screen grid, the two filament sections, the cathode, and the control grid. Water paths are provided in all the internal electrode-supporting parts, as well as in the two metal end plates, to provide complete and efficient cooling.

The external metallic portions of the tube are silver-plated to provide high-conductivity r-f contact areas, as well as to maintain a good appearance.

**DESIGN FEATURES**

In the photograph of a RCA-6448 tube shown in Fig. 3, a portion of the external shell has been cut away to show the internal construction. A cross-sectional drawing of the tube is shown in Fig. 4. The most unusual feature about the construction of the RCA-6448 is the inverted-electrode structure. The internal anode, which is bombarded on its outer surface, is surrounded in turn by the screen grid, the control grid, and, finally, the cathode elements. The active input-electrode region consists of an array of 40 identical-unit tetrode electron-optical systems arranged in a cylindrical symmetrical array about the centrally located single cylindrical anode.

The internal bypass capacitors, in conjunction with the inverted-electrode arrangement and the arrangement of the supporting structures and r-f terminals, make the grid-driven feature practical, without feedback or

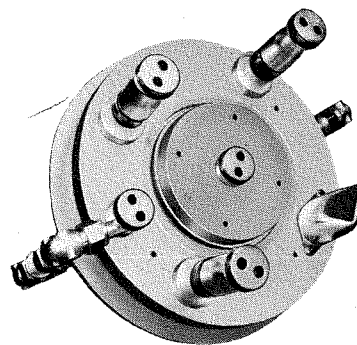

Fig. 2—Input end of RCA-6448 showing r-f terminals and combination electrical and water connections for filament, cathode, and grids.

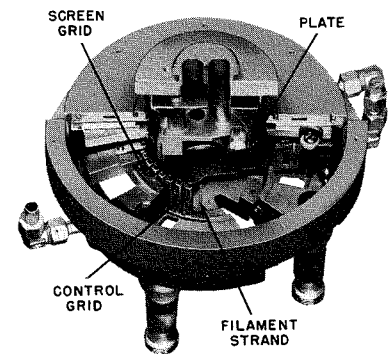

Fig. 3—Cut-away view of RCA-6448 showing internal construction.

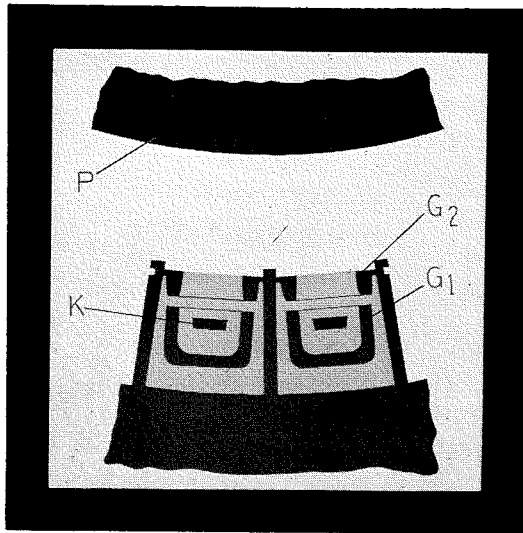

Fig. 4—Cross-section drawing of RCA-6448.

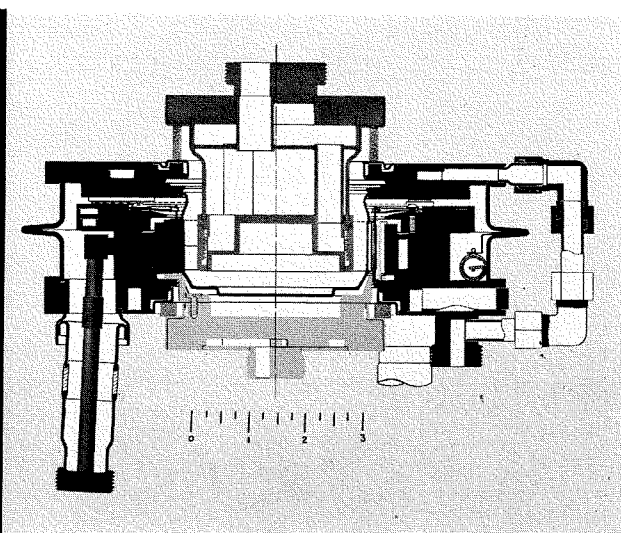

Fig. 5—Enlarged drawing of two unit tetrodes in RCA-6448.

need for neutralization. Although one of the output terminals is conveniently at d-c ground or cathode potential, it is in effect a screen-grid connection so far as r-f is concerned because of the internal screen-to-ground bypass capacitor. When this arrangement is used, there are no current paths common to both input and output circulating currents.

Another important feature of the RCA-6448 is the use of individually supported, directly heated, thoriated-tungsten filaments. It is believed that this tube is the only large power tube for UHF service which employs the type of emitter which is the standard of the industry for long service life—thoriated tungsten.

The 40 tetrode units are disposed in a circular array about the central anode, whose center line is indicated in Fig. 4. The filaments of the 40 units are clipped into V-groove slots in a water-cooled copper ring which serves as the input cathode terminal of the tube. The cathodes are held in place at the top by 40 individual spring members which constantly apply tension to the filaments and keep them straight and in place as they expand when they are heated.

#### CERAMIC-TO-METAL SEALS

A further important feature of the tube construction is the use of high-strength, low-loss, alumina ceramics for the insulating members in the two envelope seals at which r-f voltages are

applied. To date, no failures resulting from overheating or thermal shock of the ceramic insulators have been reported. The ceramic-to-metal seals used follow a design proposed by P. T. Smith.<sup>4</sup> The seals are made as follows: the ends of the ceramic cylinders are metalized, i.e. a thin metal coating consisting of a finely powdered mixture of molybdenum and manganese is applied. High-temperature firing is used to cause the metal coating to adhere to the ceramic. The ceramic is then nickel-plated, and is brazed to a 0.020-inch copper envelope part to complete the vacuum seal. Because the copper member is relatively thin and the ceramic is relatively strong, the difference in thermal expansion between the ceramic and the copper is taken up by deformation of the copper. This type of seal provides an almost ideal circuit configuration having no discontinuous inductive flanges.

#### UNIT ELECTRODES

Fig. 5 is an enlarged scale drawing showing a cross section of two of the 40 unit tetrodes. A detailed description of the internal construction of the tube must begin with the description of one of these units. The central member of the unit is the thoriated-tungsten filament. The trapezoidal cross-sectional shape of the filament provides the greatest possible flat emitting-surface area in the direction of the anode.

The unit filament is surrounded by the unit control-grid electrode. The grid consists of a channel-shaped copper member, across the open side of which 0.0036-inch diameter platinum-clad molybdenum wires are wound at a pitch of 36 turns per inch and peened into place. The spacing between the grid wires and the cathode is about 0.020 inch. Because the open space in back of the cathode is about three times the space in front, and because the field from the screen voltage reaches through the openings in the front wire section of the control grid, most electrons leave the wide face of the filament and pass through the grid and screen to the anode region. Very few electrons are drawn from the back of the cathode to the opaque grid box.

The unit screen grid, which surrounds the unit control grid, con-

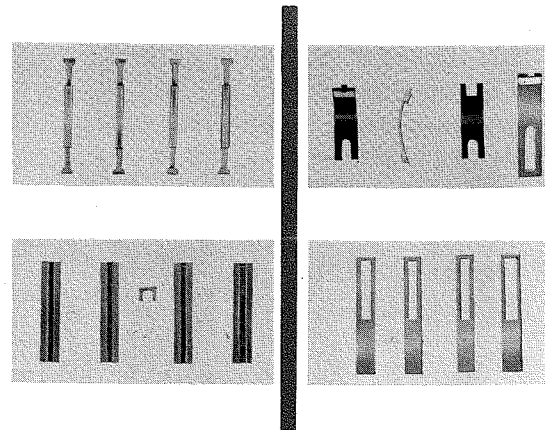

Fig. 6—Active unit electrode parts used in RCA-6448.



**WILFRED P. BENNETT** Mr. Bennett received the B.S. Degree in Electrical Engineering from Michigan State College in 1944. Upon graduation, he was engaged by the Radio Corporation of America at Lancaster, Pa., where he is at present in the Power Tube Engineering Group working on the design and development of tubes for uhf television and pulse applications. Mr. Bennett is a Member of the IRE and of Tau Beta Pi.

sists of radial fins attached to the massive water-cooled copper block and a front window panel on which lateral wires are wound and peened as in the unit control grid. During the assembly of the tube, the wires of each screen window are adjusted so that they are aligned with the wires of the corresponding control-grid unit. The screen-grid wires are then permanently brazed in place to the radial fins.

The electrode geometry of each of these units is similar to that of beam power tubes such as the RCA-61L6 and RCA-807.

The active unit electrode parts are shown in Fig. 6. The thoriated-tungsten filaments contain a temperature-correction section at each end of the 3/4-inch long central emitting portion. This end section has a reduced cross-sectional area which compen-

sates for the heat conducted out at the ends of the filaments in contact with the cooled supporting structure. Thus, a uniform temperature is maintained over the active emitting portion of the filament so that equal availability of electrons is provided.

The filament spring members, also shown in Fig. 6, consist of copper strips having slots and V-grooves which hold the filaments, and steel spring members which maintain their spring action at the required elevated operating temperatures. The majority of the metal parts in the tubes are made of copper to provide high electrical and thermal conductivity.

#### ELECTRODE ASSEMBLIES

The control-grid assembly is shown in Fig. 7. The 40 unit channels are brazed to a sturdy copper support which, during subsequent assembly of the tube, is bolted to the water-cooled copper member which forms the external r-f contact surface.

Fig. 8 shows the complete screen-grid assembly. The massive outer copper ring is provided with a water channel for efficient removal of heat generated at the active wire surface of the screen. This heat is conducted through the copper fins to the main block.

A high-dissipation anode is required to handle the high unit anode losses associated with compact high-frequency tubes. Anode losses are normally higher in tubes for UHF service, especially when broad-band operation is required. The rated anode dissipation of the RCA-6448 is 26 kilowatts.

An anode assembly is shown together with the complete tube mount

in Fig. 9. The 40 individual filament springs and the filament heads can be seen. The flat copper ring in the center of the picture is the output screen-to-ground bypass capacitor, which is fastened during final tube assembly to the 40 screen tabs projecting from the mount. This ring is held against the flat surface of the mica and anode header by means of springs.

#### ACKNOWLEDGMENT

In acknowledgment it should be made clear that a development program such as this is the result of a team or group effort of many people including engineers, technicians, shop supervisors and engineering management as well as hourly personnel. Many individuals have made important contributions to the success of this development.

#### REFERENCES

- (1) "Method of Multiple Operation of Transmitting tubes particularly adopted for television transmission in the Ultra-High-Frequency Band." G. H. BROWN, W. C. MORRISON, W. L. BEHREND and J. G. REDDECK. RCA Review June 1949 Vol. 10 No. 2 Pg. 161
- (2) "A new Ultra-High-Frequency television transmitter." J. R. BENNETT and L. S. LAPPIN. RCA Review June 1950 Vol. 11 No. 2 Pg. 190
- (3) "One-Kilowatt Tetrode for UHF Transmitters." W. P. BENNETT and H. F. KAZANOWSKI. Proceedings of the I.R.E. No. 1 January 1953 Vol. 41 Pg. 13
- (4) "Some New Ultra-High-Frequency Power Tubes." P. T. SMITH. RCA Review June 1952 Vol. 13 Pg. 224

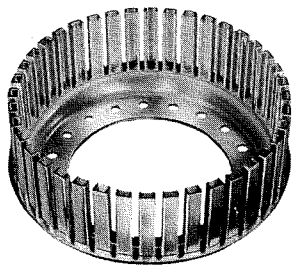

Fig. 7—Control-grid assembly used in RCA-6448.

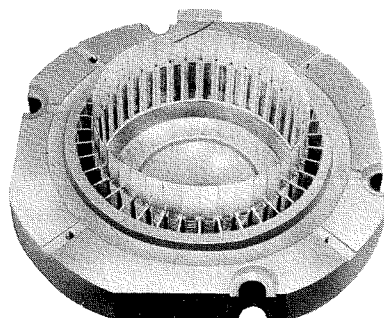

Fig. 8—Screen-grid assembly used in RCA-6448.

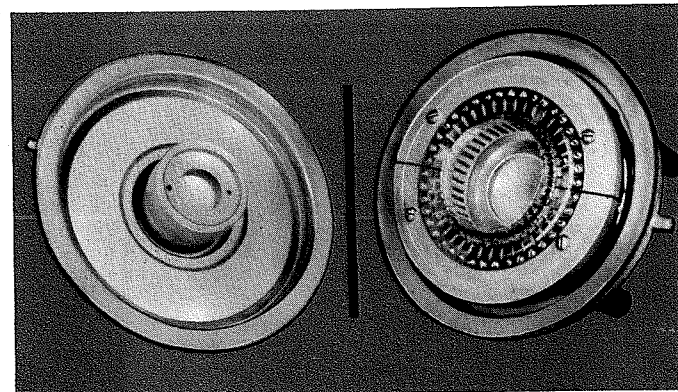

Fig. 9—Anode assembly and complete tube mount assembly.

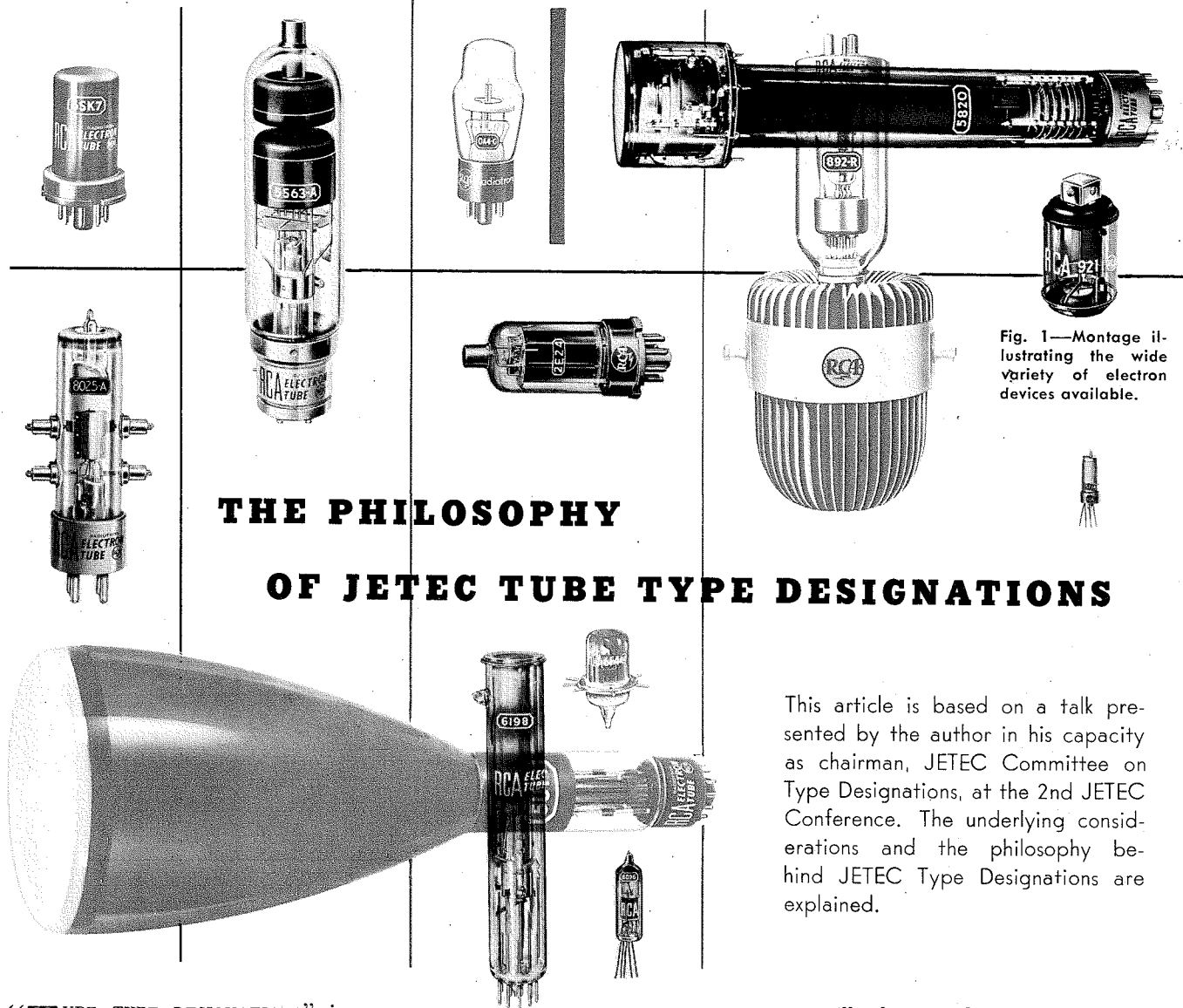

Fig. 1—Montage illustrating the wide variety of electron devices available.

## THE PHILOSOPHY OF JETEC TUBE TYPE DESIGNATIONS

This article is based on a talk presented by the author in his capacity as chairman, JETEC Committee on Type Designations, at the 2nd JETEC Conference. The underlying considerations and the philosophy behind JETEC Type Designations are explained.

“TUBE TYPE DESIGNATIONS” is a topic very much like politics. It is a subject on which almost everyone has ideas and a willingness to state them and to argue for them vigorously. But as to whether the ideas are workable is often another matter. As in politics, the test of practicality is not talk but the results. That is where the members of the JETEC COMMITTEE (Joint Electron Tube Engineering Council) are at a decided disadvantage. We talk, and in our sessions talk at great length, but we also have to live with the results of our talking.

Most of us on the committee have had experience in developing and administering company designation systems in addition to our experience on an industry-wide basis. However, most of our knowledge on this subject has been taught us by our mistakes. We have learned that, too often, the apparently obvious solution quickly develops grievous faults, and that hindsight is no substitute for

by **R. S. BURNAP**, *Manager*  
*Commercial Engineering*  
*Tube Division*  
*Harrison, N. J.*

foresight. The committee operates as a seeker of the truth. But what is the truth? As in politics, the truth can present many fronts depending on the observer’s viewpoint and background, the nature of the matter with which he has to deal, and what he considers to be the important objectives.

### CONSIDERATIONS COVER A WIDE AREA

In our subject of type designations for electron devices, we have an extraordinarily complicated problem. First, we must consider a product which can take many forms. With some of these we are already familiar; with others, we may suspect that they will be made some day. With

still others, we have as yet no inkling of their possibility. It is no accident that the electronic industry is one which frequently makes people ask “what will they do next?”

But, in addition to these purely technical considerations, we must consider a user group which has a tremendous variety of interests and needs. Users can range from the casual purchaser of a renewal tube for his portable radio to the man who expects to determine the basic features of an unknown tube from its type designation. Consideration must also include tube manufacturers having only a few product lines, as well as those with many; large and small equipment manufacturers with their wide diversity of product lines and their highly specialized requirements; military users with their intricate equipment, elaborate procurement and spare parts provisioning procedures, and difficult maintenance problems.

Thus, establishment of a satisfactory designation system involves not only engineering but also commercial and psychological considerations. There is no easy solution. There is probably no solution that will be completely satisfactory to anyone, let alone to everyone.

What, then, is the philosophy of the current JETEC type designation system? First, it is an evolving philosophy, and one which today must take into account factors which either were not important, or were unknown when the first RMA system for receiving tubes was formulated in the early 1930's.

#### WORK BY EARLY COMMITTEES

At that time, only tube types designed primarily for use in home-entertainment equipment were involved; pentodes were just coming into use, multi-unit tubes were not even considered, metal and miniature tubes with their different basing arrangements were not even dreamed of, and the need for exact interchangeability of types bearing the same designation but made by different manufacturers was of minor significance. Circuits for early radio sets were not as critical as modern electronic equipment. The volume control, abetted by the fact that the average ear is very uncritical of large changes in volume, considerably simplified tube interchangeability requirements.

Under these circumstances, the first designations committee came up with what appeared to be a simple and logical system. It comprised 3 symbols; a first number indicative of the filament or heater voltage of the tube, a letter assigned in sequence starting with A except for rectifiers which started backwards from Z, and a second number which indirectly identified the type as a diode, triode, tet-

rode, or pentode as the case might be. Of course, even in those early days, it was necessary to remember that a first-number 1 identified 2-volt filament types, that a first-number 2 identified 2.5-volt heater types, that heater types added one to the second number of the designation, and that full-wave rectifiers followed special rules.

This receiving tube system is still in use today but chiefly as a method of assigning distinctive designations to receiving types rather than as a method of identifying the specific characteristics of a particular tube type. Over the past 20-odd years, the changes in and diversification of receiving tube design have made necessary a great many new rules to keep the system workable and to assist in its administration, but the amount of information which can be gleaned from these modern-day designations is relatively small and quite often misleading.

#### OBJECTIVES OF A JETEC SYSTEM

What should be the philosophy, or the objectives of a JETEC types designation system?

First, the primary objective is to provide designations which unequivocally distinguish the products they identify from each other.

Second, the designation should be brief so that it can be easily memorized, quickly stated, and legibly printed on a small product such as a subminiature tube or a transistor. As a practical matter, the designation should comprise 3 to 5 symbols.

Third, it is important that the system provide for stability and continuity in its administration; require a minimum of changes in its rules with changing situations; and be free from administrative errors whether they be caused by differences in interpre-

tation of the rules, or just human mistakes.

And finally, it is desirable to provide a system or combination of systems which provides useful information to assist in remembering individual designations and their significance.

#### HOW PHILOSOPHY EVOLVES

In evolving the philosophy of a type designation system, it is on this final objective that we find the greatest diversity of opinion. Some might make it the No. 1 objective. Some are willing to settle for broad classifications; others want rather specialized information. Many of those who have had to deal with a multiplicity of tube types and a wide variety of their applications doubt that the amount of accurate and useful information which can be incorporated in a type designation and remembered is in the long run worth the trouble. Systems intended to accomplish even a little in this direction are cumbersome in their administration and require constant patching. They require the memorizing of many complex rules as well as constant alertness for exceptions which are sure to occur. Moreover, regardless of how complicated a mnemonic system is, it can never, of course, take the place of tube classification charts and technical data sheets.

A further and not-to-be ignored difficulty common to industry systems for assigning type designations is one inherent to all community activities. Reference is made to the fact that participation in a community activity even on a voluntary basis may require giving up some of one's preferences for the common good; and, of course, participation in the Types Designation System is entirely voluntary.

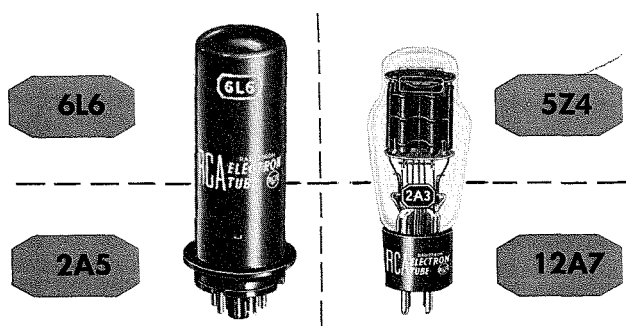

Fig. 2—The first numbering system comprised 3 symbols, alphabetical and numerical.

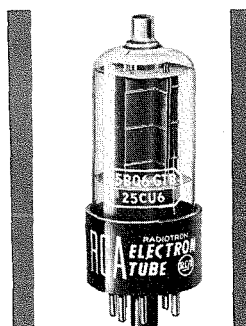

Fig. 3—Objectives are to achieve simplicity, flexibility, keeping designations to 3, 4, or 5 symbols.

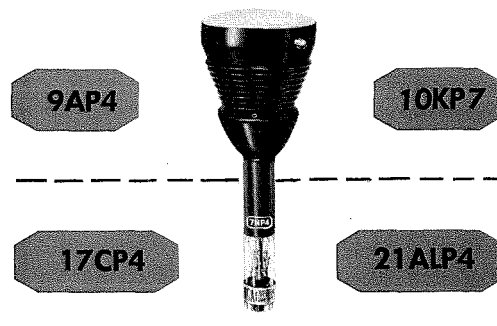

Fig. 4—The "JETEC" system adopted for cathode-ray tubes involved a "P" term to identify phosphor.

It would be very difficult to evolve a workable industry designation system which would provide the flexibility of a company-administered system. Furthermore, the use of an industry-system designation detracts in the minds of some from the prestige of the company originating the new product. On the other hand, the availability of an industry designation system which electron device manufacturers can utilize any and every time they develop a new tube type does make it easier for a user to buy a tube product from several manufacturers with assurance that it will work properly in his equipment.

#### JETEC SYSTEM FOR CATHODE-RAY TUBES

The second JETEC system established just before World War II was intended to cover picture tubes, although it was quickly extended to include oscillograph types as well. Again, we had initially, as we did with the receiving-types system, a line of products specialized for a particular field of application. In this case, it was decided that important characteristics of such tubes were the size of the faceplate and the nature of the viewing surface.

Thus, a system was established which used a first number to identify the tube size in inches, a letter symbol assigned in sequence, and a P term to identify the phosphor. Since then, of course, we have encountered the problems of overscanning, rectangular faceplates, projection types, use of light absorbing faceplate glass, glare-proofing, aluminizing, built-in capacitors, and other refinements not anticipated when the system was set up. Because of the basic simplicity of this system, it has survived these

changes quite well so far as picture tubes are concerned, although there are rumblings of difficulties on the front represented by oscillograph and allied tube types.

#### JETEC "WAR" SYSTEM

During the war, a third system was introduced as a war measure to take care of all tubes other than receiving and cathode-ray types. This system was based on the use of a first-number indicative of the filament or heater power, a letter symbol indicative of the structural or functional class of the device, and a second number assigned in numerical order.

While this system served its immediate purpose, not everyone was happy with it. The first number of the designation had size and power-handling significance only when the type was intended for power applications, and even in those cases fell down on cold-cathode and pool tubes; the first assignment of letter symbols was inadequate, necessitating new assignments every time new classes of tubes evolved; and types were developed involving two classes requiring arbitrary classification of these types in one class or the other.

A fatal defect of this particular system was the difficulty of anticipating and controlling the assignment of new class letters. Every new variety of device called for a new class letter regardless of its future importance. At the end of the war, we had used up practically all of the letters of the alphabet and were faced with the problem of compound coding-letters. Since it was usually impossible to foretell future developments until they were presented for type designations, the choice of suitable

class letters presented serious administrative problems.

#### JETEC NUMERIC SYSTEM

As a result, one of the first assignments of the JETEC types designation committee following the war was the formulation of a new system for tubes and devices other than receiving and cathode-ray types. Faced with the problem of evolving a system capable of handling all classes of non-receiving tubes and all classes yet to come, as well as one which would not require more than 5 symbols, the committee came to the conclusion that a *straight numeric system* offered the maximum of simplicity and stability with a minimum of administrative problems.

True, such a system would give the user no help in interpreting the type designation, but on the other hand neither would it supply any incorrect information or information likely to misinterpretation.

Furthermore, it was the committee's considered opinion at the time this system was recommended that no system of designation coding could take the place of tabulations and charts for grouping tubes according to function and fields of application. Such charts and tabulations could be revised and expanded as the need developed, whereas a grouping incorporated in the type designation would be both incomplete and inflexible.

The straight numerical designation was chosen in place of arbitrary letter or letter-digit combination to avoid the garbled oral transmissions so common with similar letter sounds. This choice was made in spite of the fact that use of letters in place of digits would have provided enough

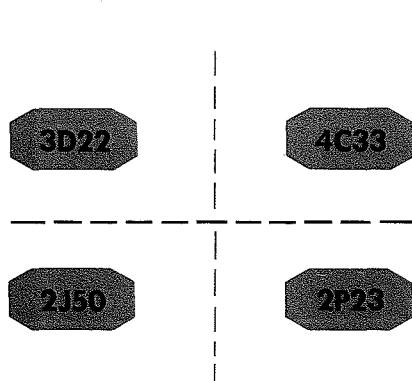

Fig. 5—As a war measure, a third type designation system was introduced to accommodate all tubes other than receiving and cathode-ray types.

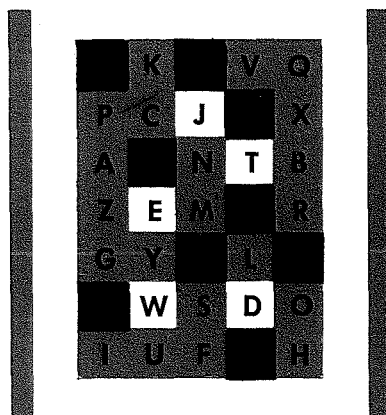

Fig. 6—A weakness of this system (Fig. 5) was the need of a new "class" letter for each new variety of device, regardless of its future importance.

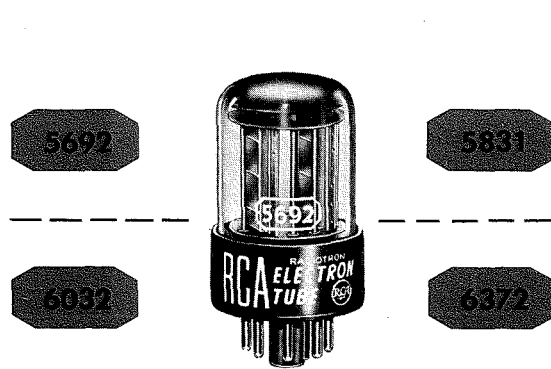

Fig. 7—The "JETEC" straight numeric system was adopted following the war in place of letter or "letter-digit" combinations.

combinations to have made it feasible to use a 3-letter designation system instead of the recommended 4-digit designation system.

#### JETEC SYSTEM FOR SOLID-STATE DEVICES

In the case of solid-state devices a system is being used which will identify this particular class of products and give some idea of their complications in terms of the element count. Difficulties cannot be minimized of writing definitions in such a new field; in addition, there are difficulties of writing rules which can be consistently interpreted and followed under expanding and as yet unforeseen situations.

#### USE OF SUFFIXES

Another and very important phase of this subject of type designations systems is the use of suffix letters to indicate modifications in the prototype. There are two schools of thought on this subject. One school puts emphasis on suffix letters; the other believes that suffix letters should be used primarily to indicate that the suffix version can completely replace the prototype in any application. The first school wants to use suffix letters chiefly to identify variants of the prototypes; in other words to identify types that are similar but with structural, electrical, or performance differences. The second school would confine its use of suffix letters to show that the new version will do everything that the prototype does plus something more.

#### "VARIANT" SUFFIXES

The first method, which may be called the variant-identification method, usually has its biggest vogue when a tube class is in its pioneering stage. At this stage, when tube and equipment

manufacturers are still struggling with problems of evaluating and measuring performance, and of designing and building their products to give optimum results, there is a strong tendency for equipment manufacturers to design and build liberal tolerance for component variations into their products. In addition, at this stage, the user of the equipment has a strong tendency to be less critical of the performance of the new devices than he will later on.

As a result, the equipment itself, and its user will accept during this period tubes having in some cases rather large differences in electrical and mechanical characteristics, and in performance. An example of this kind of interchangeability has been the use of metal tubes and their G and GT counterparts interchangeably in radio receivers and other low-frequency equipment. It is highly unlikely, however, that such interchangeability would have been feasible had the receivers of the thirties included circuits as critical as those in television receivers or modern-day industrial and military equipment. Today, we are struggling with somewhat the same kind of a problem in picture tubes. Tomorrow, we will undoubtedly face similar problems with transistors.

In general, it can be assumed that the variant will work in the socket for which the prototype was designed, but that the degree to which the variant will replace the prototype will usually be a matter of personal opinion. Either the tube manufacturer expects that minor changes will have to be made in the equipment to accommodate his variant, or the tube user may have to accept a product different in

his opinion in some respect from the prototype.

#### "MODIFICATION" SUFFIXES

The second method, the modification-identification method of assigning suffix letters, usually becomes important after the tube class and its associated equipment have passed their early pioneering stage and have entered what might be called the refinement stage. In such cases; the use of suffix letters to identify prototype modifications better adapted to the application, serves the useful purposes of preserving the family line, simplifying the replacement problem, and informing the user, that based on engineering judgment, the replacements will do everything the prototype would do in this particular socket and do it without adjustment not normal to the prototype. In this case, the user gets the same kind of performance that the prototype supplied although the new version may provide greater capability of performance.

#### BOTH METHODS HAVE MERIT

As has been pointed out, both methods can be used under appropriate circumstances. However, it is essential that the suffix letters used definitely identify which of the two methods applies. When the first method is involved, the user is entitled to know that the new version differs in some respect from the prototype and that he may not be getting a suitable replacement tube for his particular socket.

The more critical the application, the more important it is to observe this distinction between variants and actual superseding modifications. That is the chief reason why the JETEC

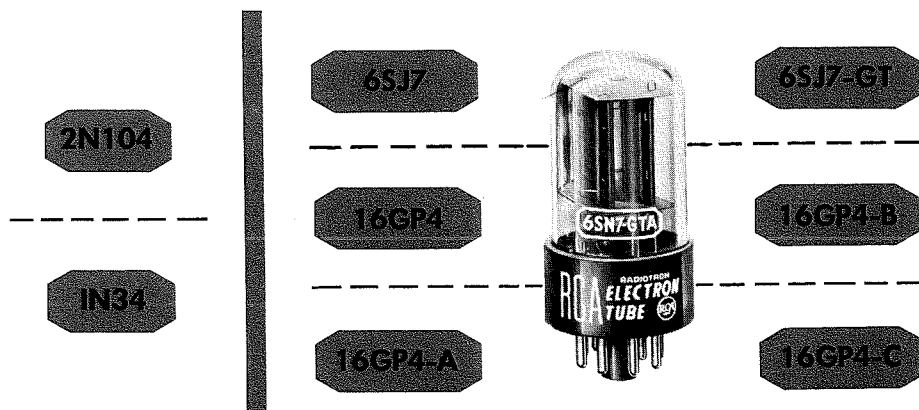

Fig. 8—Solid-state devices required special considerations to identify this class of product.

Fig. 9—"Variant" suffixes are used to signify that the variant will work in the prototype socket but may require equipment changes.

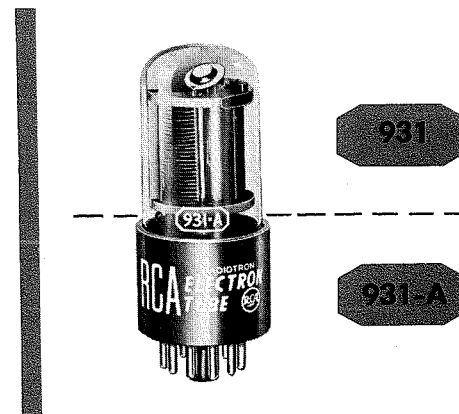

Fig. 10—"Modification" suffixes inform the user that the replacement will work in the prototype socket without equipment changes.



Type Designations Committee has been slow to give its whole-hearted support to the use of suffix letters with the numeric designation system.

#### SEPARATE AND DISTINCTIVE DESIGNATIONS FAVORED

As a general rule, it is safer when a variant version is involved to use a designation completely different from that of the prototype, because as soon as the prototype is accurately defined and the personal preference of the user properly evaluated, it will be apparent that two separate and distinct tube types are involved. In the case of variants, the assignment of separate and distinctive designations has the advantage of protecting tube manufacturers against mistakes in initial judgment. If the two types do turn out to be interchangeable, it is always possible to double brand the versions with both numbers, whereas a mistake in assigning a letter suffix is very difficult to correct and causes confusion for years.

This general rule of using distinctive designations for variant versions has been almost universally practiced by industry for many years. This rule applies in the cases of variants designed for special civilian applications requiring characteristics and performance not needed for normal application of the prototype. In such cases, which include "premium" versions, it is advisable to break the family line so far as the type designation is concerned.

#### "PREMIUM" TYPE CONSIDERATIONS

"Premium" types as a rule are specially designed, specially built, specially rated, specially priced, and specially distributed. They are not intended to be replacements in sockets

for the home-entertainment applications for which the prototypes were originally designed and priced. In fact, it should be pointed out that the "premium" version may not give premium performance in the prototype socket, and may give in some sockets poorer performance than the prototype. For example, a cathode material chosen for a premium tube for a special service may not be the best cathode material for the prototype service. The more "premium" versions are refined to meet special requirements the less likely they will be successfully interchangeable in prototype sockets, or even for that matter in various "premium" sockets.

On this particular matter, the military point of view differs from the civilian point of view in that for procurement and distribution reasons the military services normally want a "premium" version which will completely eliminate the prototype. They, therefore, consider it very important to preserve the family line in the type designation of the "premium" version. Whether doing so will be feasible over a period of years of new developments may be questioned, but we should recognize that needs of the military services are not always compatible with needs of industry when the subject is type designations.

#### THE "W" SUFFIX SOLVES A PROBLEM

Another phase of the suffix-letter problem is the "W" suffix. Several times in this article the military services and their special needs have been mentioned. One of these is to be able to identify (from the type designation) a product made under a revised specification in order to segregate stocks and channel shipments.

To accomplish this, the services started the use of suffix letters A, B, C, etc. with disastrous results so far as commercial designations were concerned, since many changes did not affect products for civilian uses. As a result, our committee was faced with

the problem of finding a solution which would give the Services the flexibility they desire and yet would not tie civilian products to the military kite.

The solution was the W-suffix which, when employed by the Services, identifies the type to which it is assigned as a military version subject only to military purchase specification for its further identification. Once having added the W-suffix, the Services can add suffix letters A, B, C, etc. at will to identify further modifications of the military version. To preserve the flexibility provided by the W-suffix, it is important that its use be reserved to types produced and sold against military specifications.

#### COMPLEXITY DEMANDS SIMPLE SYSTEMS

The preceding description has given you some idea of just how complicated and involved the formulation and administration of types designation system for industry use can be. We are dealing with an evolving philosophy in which the very multiplicity and complexity of electron devices are forcing us to greater and greater simplicity in our systems. The JETEC Committee considers that the paramount requirement is to be able to *assign simple distinctive designations quickly* and with a minimum of administrative problems and difficulties; that *stability and continuity are essential* ingredients of an industry designation system; and that descriptive information in the designation is desirable but only when it can be kept accurate and within the ability of the average tube user to remember the rules by which the information is coded into the designation. Currently, there are three such JETEC systems. Is the average tube user sufficiently interested to learn and remember more? Certainly, on that course, the committee is faced with the law of diminishing returns even if the supply of distinctive symbol combinations should prove adequate.

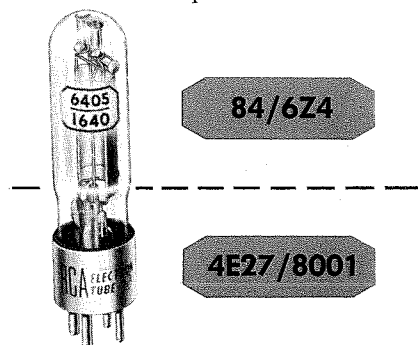
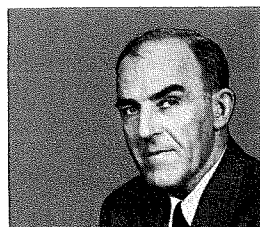

Fig. 11—The assignment of separate designations permits later "double-branding" when types prove to be interchangeable.



Fig. 12—The "W" suffix identifies the type as a military version subject only to military specifications.



**ROBERT S. BURNAP**—Mr. Burnap received the S.B. degree from Massachusetts Institute of Technology in 1916, and continued as Research Assistant for the next year. From 1917 to 1930 he was employed by the Edison Lamp Works of the General Electric Company except for a year's service in the U.S. Signal Corps during World War I. Since 1930, he has been Manager of Commercial Engineering for the Tube Division. Mr. Burnap is a Fellow of the IRE, SMPTE, and the AIEE. He has been active over a long period in both professional and trade association standardization activities.



DR. E. W. ENGSTROM

**DR. E. W. ENGSTROM**

Dr. E. W. Engstrom, Executive Vice President, Research and Engineering, joined RCA in 1930. He received a B.S. in E.E. degree at the University of Minnesota in 1923.

In the early thirties, Dr. Engstrom directed RCA's television research toward a practical service. He was responsible for development and construction of apparatus used in field tests, and in the planning and coordination, which lead to the reality of black-and-white television. Since then, he and his associates have conducted research on television in color. Dr. Engstrom was a member of the NTSC at the time TV standards for broadcasting were

Assistant to the President of RCA; Vice President and Chief Engineer of the RCA Victor Division, and Executive Vice President in Charge of the RCA Laboratories Division. Dr. Jolliffe is a member of Sigma Xi, Phi Beta Kappa, Fellow of the American Association for the Advancement of Science, AIEE, and the IRE.

**DOMINIC F. SCHMIT**

Dominic F. Schmit, Vice President, Product Engineering, has held important engineering posts in RCA since he joined the Corporation in 1930.

A native of Port Washington, Wisc., Mr. Schmit graduated in 1923 from the University of Wisconsin with a B.S. in E.E. degree. Before joining RCA, he worked as an engineer with G.E. Co. and with the E. T. Cunningham Company of New York.

Upon joining RCA, Mr. Schmit became manager of Application Engineering and later became Manager of Research and Engineering in tube manufacture at Harrison, N. J. In 1939, he was named Manager of the New Products Division, and four years later was appointed Assistant Chief Engineer of the RCA Victor Division. He was closely associated with the development of RCA's first pre-war commercial television receivers. He was promoted to Director of Engineering in March, 1945 and was elected Vice President in Charge of the RCA Victor Division Engineering Dept. in March, 1946. High on the list of his post war projects were the RCA Victor "45" Record Player and Records. Mr. Schmit also directed development engineering work which placed RCA in the pioneering position in Compatible Color Television.

Mr. Schmit joined IRE as an Associate Member in 1925 and in 1951 received an IRE Fellow Award.

**O. B. HANSON**

As Vice President, Operations Engineering, Mr. O. B. Hanson is responsible for engineering matters pertaining to broadcast and communications, and for the direction of the RCA Frequency Bureau.

Mr. Hanson's early education was acquired in England where he studied electrical engineering at Hillyer Institute. In 1915 he became a student at Marconi School (now RCA Institutes). In 1917, Mr. Hanson transferred to the Engineering Department of the Marconi factory. In 1921, Mr. Hanson entered the broadcasting field and operated and programmed WAAM, Newark, N. J. until 1922 when he joined the engineering staff of WEAf. Mr. Hanson became Plant Manager for WEAf and was active in developing the Red Network. In 1926 WEAf became a part of the newly formed National Broadcasting Co. and Mr. Hanson continued in his capacity of Plant Manager.

In 1934 Mr. Hanson became Chief Engineer and in 1937 was appointed Vice President and Chief Engineer of N.B.C. In this position he supervises technical developments and technical operations, including development of black and white and color television. On June 1954, Mr. Hanson assumed his present position.

Mr. Hanson has been a member of IRE since 1918 and a Fellow of IRE since 1941. He is also a Fellow of Acoustical Society of America, and of the Society of Motion Picture and Television Engineers. He is a member of the Radio Pioneers.

**INTRODUCING.....**

established and a member of the Radio Technical Planning Board. He was a member of the NTSC which developed technical signal specifications for color television transmissions, adopted by the F.C.C. December 17, 1953.

In 1942 when all research activities of RCA were brought together at Princeton, N. J., Dr. Engstrom became Director of General Research and in 1943, Director of Research of RCA Laboratories. On December 7, 1945, he was elected Vice President in Charge of Research of the RCA Laboratories Division; on September 7, 1951, he was elected Vice President in Charge of RCA Laboratories Division; on January 11, 1954, he was elected Executive Vice President, RCA Laboratories Division; and on June 4, 1954, he was elected to his present position.

The honorary degree of Doctor of Science was conferred on Dr. Engstrom in June, 1949, by New York University. In August, 1949, Dr. Engstrom received a silver plaque from the Royal Swedish Academy of Engineering Research. In October of 1950 he received the Outstanding Achievement Award gold medal from the University of Minnesota.

Dr. Engstrom is a member and past President of the Princeton Chapter of Sigma Xi, science research honor society; a Fellow of the IRE, of which he was a director in 1949, and of the AIEE.

**DR. CHARLES B. JOLLIFFE**

In his post of Vice President and Technical Director, Dr. Jolliffe is responsible for development of long-range plans for pioneering and research projects.

Dr. Jolliffe assumed his present duties in September, 1951, after serving for nearly six years as Executive Vice President in Charge of RCA Laboratories Division. Dr. Jolliffe received his Bachelor of Science degree in 1915, his Master's degree in 1920 from West Virginia University, and his Ph.D. from Cornell in 1922. He was awarded an honorary LL.D. degree from West Virginia University in 1942.

In 1922, he joined the Radio Section of the Bureau of Standards and served as a physicist. In 1930, Dr. Jolliffe was appointed Chief Engineer of the Federal Radio Commission (later became FCC) and held that position until 1935, when he joined RCA.

Dr. Jolliffe has held the successive positions of Engineer in Charge, RCA Frequency Bureau; Chief Engineer, RCA Laboratories;



DR. CHARLES B. JOLLIFFE

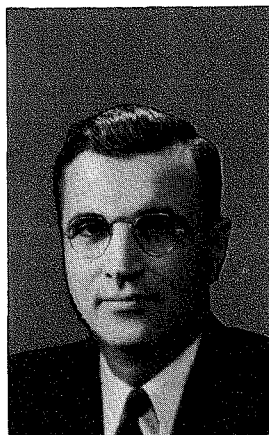

DOMINIC F. SCHMIT

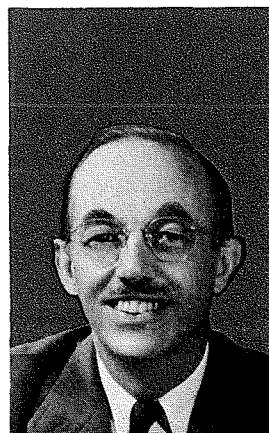

O. B. HANSON



J. L. FRANKE



I. F. BYRNES

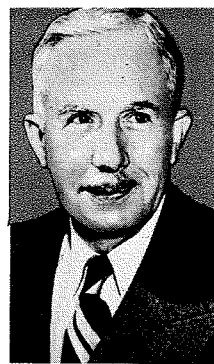

M. C. BATSEL

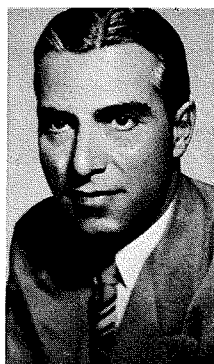

D. D. COLE

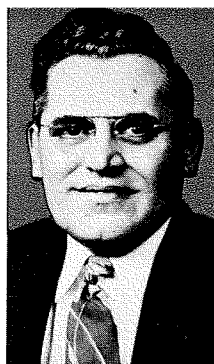

M. G. GANDER



W. G. BROSENE, JR.



T. H. FORD



H. I. REISKIND



DR. G. R. SHAW

## INTRODUCING YOUR ENGINEERING LEADERSHIP AT THE VARIOUS PRODUCT AND SERVICE LOCATIONS

**M. C. BATSEL**, *Chief Engineer  
Engineering Products Division  
Camden, N. J.*

To his present post, Max C. Batsel brought 30 years of engineering experience. After his graduation with a BME degree from the University of Kentucky in 1915, Mr. Batsel worked with Western Electric Company and the National Bureau of Standards. As a World War I Signal Corps officer, he helped plan and equip the Corps' Radio Development Laboratories. In 1921, with Westinghouse Electric, Mr. Batsel took part in designing the first receivers specifically built for broadcast programs. He soon advanced to Section Engineer in charge of receiver development. From Westinghouse, he came to RCA's Photophone Division as Chief Engineer in 1929. In 1932, Mr. Batsel became Manager of the Sound Section of RCA's Engineering Division. From 1941 until his appointment in 1945 as Chief Engineer of Engineering Products, he served as Chief Engineer at RCA, Indianapolis.

Mr. Batsel is a member of Tau Beta Pi, a Fellow of the IRE, a Fellow of the Society of Motion Picture and Television Engineers, a member of the American Society of Naval Engineers and of Radio Pioneers. Mr. Batsel received a Letter of Commendation from the Navy after World War II. He has received the Modern Pioneers Award of

the National Association of Manufacturers.

**DR. G. R. SHAW**, *Chief Engineer  
Tube Division  
Harrison, N. J.*

Dr. G. R. Shaw possesses approximately 35 years of experience in the electron tube design and electronic fields (with more than 25 years of RCA experience alone to his credit). He graduated from Washington and Lee with AB and AM degrees and from Wisconsin with a PhD degree in 1920. He served as an instructor in chemistry at both Universities. In the first World War his assignment was "Chemical Warfare Service," U. S. Army. Dr. Shaw was with the GE National Lamp Works at Cleveland from 1920 until 1929 when he joined the RCA Manufacturing Company Radiation Division as head of the Chemical Section. Successively, Dr. Shaw held positions as Manager of the Research and Engineering Department, Manager of Harrison Engineering, and in 1945 became Chief Engineer for the RCA Tube Division, which is his present post.

Dr. Shaw is a member of the American Chemical Society, American Physical Society, and the IRE (member 1940, Senior member 1943, Fellow member 1954). He received the "Coffin Award" while employed at GE, and in 1950-51 received the RCA Award of Merit. Dr. Shaw has five patents to his credit dealing with electron tubes.

**W. G. BROSENE, JR.**, *Chief Engineer  
RCA Estate Appliance Department  
Hamilton, Ohio*

William G. Brosene, Jr. has been associated with technical and engineering fields since 1936. He completed engineering courses at the University of Cincinnati Evening College in 1939 and graduated from the College of Engineering in 1943 with an M.E. degree. At the University of Cincinnati, in the Department of Physics, Mr. Brosene carried on research on laboratory instruments, and performed general development work on mechanical and electronic apparatus for use in the pharmaceutical field. Several patents were granted as a result of this work, one of which has become a standard process in medical fields. This work covered a period of nine years during which time outside consultation was conducted on Special Machine Design, Product Design and Tool Design. Subsequently, he organized a consulting service which performed work for RCA Estate, with whom he became associated as Chief Engineer the following year. In this capacity, Mr. Brosene supervises the design and development of Gas and Electric Ranges, and has applied for several patents in conjunction with these appliances.

He is a member of the Ohio Society of Professional Engineers and the American Society of Mechanical Engineers.

**I. F. BYRNES,**  
*Vice President, Engineering*  
*Radiomarine Corp. of America*  
*New York, New York*

Irving F. Byrnes has been associated with Radiomarine Corporation since 1930. He entered the General Electric Test Department in 1918 and was later engaged in radio development in the Engineering Laboratory. He completed extension courses in Electrical Engineering at Union College, and in 1922 participated in the development and design of early ship-to-shore radiotelephone equipment. He has been granted several U. S. patents for radio devices, and in 1940 he received the Modern Pioneers Award from the National Association of Manufacturers for his contributions in the art of marine radio communication. The U. S. Navy Bureau of Ships awarded Mr. Byrnes its Certificate of Commendation in 1947. He is the author of many technical papers on radio equipment, and is a Fellow of IRE. Mr. Byrnes is a member of "RCA Review," Board of Editors and the RCA Institutes, Board of Technical Advisors.

**D. D. COLE,** *Chief Engineer*  
*RCA Victor Television Division*  
*Cherry Hill, N. J.*

Mr. Cole, possessor of more than twenty-five years of experience in radio and electronic engineering, graduated from the University of Michigan in 1926 with a B.S. in E.E. degree. Early schooling also included studies in Electrical Engineering at the Michigan College of Mines. In 1928 he completed the GE Test Course and became a design engineer in 1929. In the same year he transferred to the Radio Corp. of America at Camden where he also served as design engineer on radio equipment.

From 1931 to 1934 Mr. Cole served as Staff Assistant and subsequently held posts as Section Supervisor and Sales Engineer for the RCA Victor Division. In 1943 he was appointed to the position of Chief Engineer, Instrument and Standard Parts Engineering. In 1954 he became Chief Engineer of the Home Instrument Division, later organized and named RCA Victor Television Division.

Mr. Cole is a Member of the IRE and the State Board of Professional Engineers and Land Surveyors.

**J. L. FRANKE,** *Chief Engineer*  
*RCA Victor Radio & "Victrola" Div.*  
*Cherry Hill, N. J.*

Mr. J. L. Franke can claim approximately 30 years of experience in the radio and electronic fields. His early work started at the Edison School of Drafting and at the General Electric Company, where he was a graduate of

the GE Apprentice Course. Later he joined the Photophone Division and in 1930 transferred to RCA at Camden as a draftsman. During the years following Mr. Franke continued engineering studies by attending evening classes.

In 1935 he became a mechanical engineer in the Auto-Radio Engineering Division, where he was employed until the war in 1941. Throughout the war period Mr. Franke was employed as Engineering Supervisor on a secret Navy project which was later announced publicly as the Proximity Fuse. "After-the-war" activities included work as Supervisor of Mechanical Engineering in Radio and Phonograph at Camden, and work as Section Manager of the Radio Engineering Group. In 1954, Mr. Franke was named Chief Engineer of Radio & "Victrola" upon the formation of that Division.

He is a Senior Member of IRE.

**M. G. GANDER,**  
*Manager of Engineering*  
*RCA Service Company,*  
*Cherry Hill, N. J.*

M. G. Gander's technical and engineering experience covers a period of approximately twenty years. Mr. Gander graduated from the Drexel Institute of Technology in 1933 with B.S. in E.E. He did post-graduate work at the University of Pennsylvania in 1934. Early experience included work with the Philadelphia Electric Company and with the Atwater Kent Company. In 1937 Mr. Gander was employed by RCA to work on Manufacturing Test Processes and Equipment Maintenance. His later work included experience in the Standards Laboratory; Television Field Test. In 1940 he was employed in Government Service for Navy Training Schools. This Training work took Mr. Gander to all parts of the country. He engaged in installing experimental altimeter equipment at Pearl Harbor during the attack of December 7, 1941. During 1946 he became associated with the RCA Service Company Television Engineering Section, and received the company's Merit Award. He remained in this capacity until 1949 when he became Manager of the Engineering Department, RCA Service Company's Consumer Products.

An outstanding highlight is the fact that 4 of 19 engineers in Mr. Gander's group are company Merit Award winners.

**H. I. REISKIND,**  
*Manager of Engineering*  
*RCA Victor Record Division*  
*Indianapolis, Ind.*

Mr. Reiskind, who has over 25 years of experience in the radio and record en-

gineering field, graduated from Rensselaer Polytechnic Institute with an E.E. degree in 1928. His first employment was with the Paramount Pictures, Inc., Long Island, New York, as a recording engineer on both disc and film. In 1936 Mr. Reiskind joined RCA and worked as liaison between field and engineering on motion picture recording equipment. His activities included the layout and supervision of recording equipment installations at Twentieth Century Fox in New York and at the Brooklyn Studios of Warner Brothers. Later, Mr. Reiskind also served as Technical Supervisor of RCA Rental Film Recording Operations in Hollywood. During 1939 and 1940 he carried on development work on multiple speaker reproducing systems for theatres (he was liaison engineer on the recording of "Fantasia" for Walt Disney). In 1942 Mr. Reiskind organized the Recording Engineering Group in Indianapolis, which was part of Sound Engineering. In 1945 he was appointed Manager, Engineering, RCA Victor Record Division.

Mr. Reiskind is a Senior Member of IRE, a Fellow in the Audio Engineering Society, a member of the SMPTE, and a member of the ASA. He is Chairman of the R7 Committee on Phonograph Combinations & Home Recordings, RETMA. Mr. Reiskind is an Associate Member of Sigma Xi.

**T. H. FORD,**  
*Manager of Engineering*  
*Room Air-Conditioning Department*  
*Camden, N. J.*

Mr. Ford has over 10 years experience in the air-conditioning and refrigeration field. He graduated from Rensselaer Polytechnic Institute with a B.S. degree in Mechanical Engineering. In 1949 Mr. Ford completed a two year business course at the Alexander Hamilton Institute, and in 1954 received his M.S. degree in Mechanical Engineering from Columbia University.

From 1945 to 1951 Mr. Ford was employed in air-conditioning design engineering, first with the E. E. Ashley Consulting Engineers, New York City, and later with the Westinghouse Electric International Company, New York City. He also worked in refrigeration and air-conditioning design engineering with the Vilter Manufacturing Company, New York City, until he assumed his present position with RCA as Engineering Manager for Room Air Conditioning Department.

Mr. Ford is a member of the American Society of Refrigerating Engineers.

by **J. J. DAVIDSON**  
*Advanced Development Engineering*  
*RCA Victor Radio and "Victrola" Division*  
*Cherry Hill, N. J.*

**A**N ASPECT of the transistor often overlooked in its application is the tremendous voltage gain available when the unit operates into a high impedance. The design engineer often considers the use of tubes exclusively, or transistors exclusively, with little thought toward the advantages to be gained by using both units as companions.

Transistor art and economics have advanced to the point where transistors should seriously be considered in low-level applications where the input loading is not a serious drawback. The transistor appears inherently capable of a lower noise factor than vacuum tubes. This is due to the absence of microphonics, and the complete elimination of heater problems. In combination with a voltage gain of the order of 1000 to 1500 times over the complete audio-frequency range, the transistor offers wide possibilities in such low-level applications as dynamic microphones and phonograph pickups.

#### THE BASIC CIRCUIT

A very simple and basic circuit which will demonstrate the advantages and disadvantages of high-gain transistor amplifiers is shown in Fig. 1. The circuit diagram is presented in a simple straightforward manner solely for the purpose of illustrating the fundamental considerations of the high-gain amplifier. Therefore, no attempt is made to compensate for temperature effects, which severely alter the behavior of the transistor in this circuit unless the ambient temperature is kept within the range of 20° to 25° C. The subject of compensation will be treated subsequently.

In terms of familiar vacuum tube parameters, the most startling difference between tubes and transistors is in the range of transconductance. While the customary values of tube transconductances lie in the range of 3000 to 8000 micromhos, with special types of tubes going as high as 11,000, ordinary transistors exhibit characteristic values in the range of 30,000

to 40,000 micromhos. This remarkable property, in combination with an output impedance of the order of 100,000 ohms yields unusual audio voltage gain figures. For example, assuming an output impedance of 100,000 ohms, a  $g_m$  of .03 mho, and a load resistance of 100,000 ohms, the gain

$$K = g_m \frac{(R_o R_L)}{(R_o + R_L)}$$
$$= .03 (50,000) = 1500$$

The measured gain of Fig. 1 is 1300, and is down 3 db at 23 kc. The input impedance is 2000 ohms.

#### DISTORTION COMPARISONS

In most applications, the linearity of the stage is an important factor. For small input signals, the input characteristic offers no trouble, but, unfortunately, the same cannot be said for the output. Fig. 2 shows a family of collector curves for 3 microamp increments in base current. The slope of each line represents the dynamic output impedance of the unit, as the bias is varied. As is clearly indicated, the impedance decreases from 200,000 ohms to about 60,000 ohms as the base current increases from zero microamps to 24 microamps. Although impedance variations resulting from col-

## HIGH-GAIN

The author shown with the AM-FM High Fidelity tuner which incorporates the transistor preamplifier



lector current changes do contribute to distortion, the problem is not serious in most cases. When the load impedance is small, such as that presented by another transistor, an output impedance as low as 60,000 ohms will be negligible compared to the load impedance of 2000 ohms or less. When the load impedance is high, the collector-current swing is quite limited. This reduces the impedance swing to a very small value, as indicated by the 100,000 ohms load line in Fig. 2. In any case, this form of distortion is comparable with the nonlinearities found in vacuum tubes.

Another, and far more serious source of distortion, is indicated in Fig. 3, and is peculiar to the transistor as a device, and the application in particular. When dealing with gains of 1000 and above, it is desirable to maintain an appreciable signal-handling capacity. For example, a 15 millivolt rms input signal, when amplified 1000 times, requires a 42.5 volt peak-to-peak output swing. In order to accommodate this swing, the collector quiescent voltage must be above 20 volts. As indicated in Fig. 3, the transistor begins to break down in the region of 30 to 40 volts, with resultant bending of the output characteristics. This bending will con-

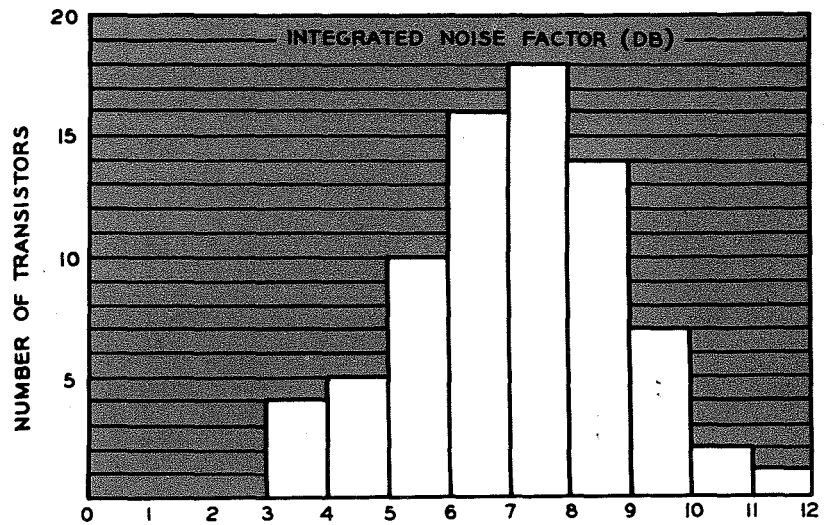

Fig. 4 — Representative production spread: RCA type 2N104 transistor (77 units tested)

tribute the major share of distortion to an amplifier operating over voltage swings of 40 volts. Quantitatively, a unit, operating at 20 volts, 1 milliamp, into a load of 100,000 ohms, and handling an a-c output of 39 volts peak-to-peak, will generate about 3% total harmonic distortion.

#### NOISE CONSIDERATIONS

With the input limited to 10 to 15 millivolts maximum, the next consideration is the minimum usable input, or noise level. In the matter of noise, transistors, within a very few years,

have established their superiority over vacuum tubes. The RCA type 2N104 transistor is a controlled-noise unit with a maximum Noise Factor of 12 db. A representative spread of Noise Factors is shown in Fig. 4, which indicates that an average unit will run about 7 db. The optimum source impedance for noise considerations is about 500 ohms,\* at which value the units were measured. As-

\* P. M. BARGELLINI and M. B. HERSCHER, *Investigations of Noise in Audio Amplifiers Using Junction Transistors*, Proc. IRE, p. 217, Feb. 1955.

## TRANSISTOR AMPLIFIER

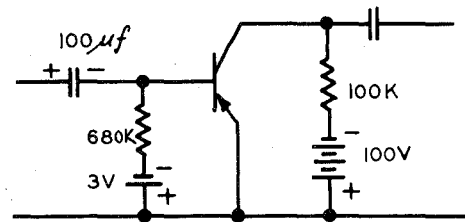

Fig. 1 — Basic high-gain transistor amplifier

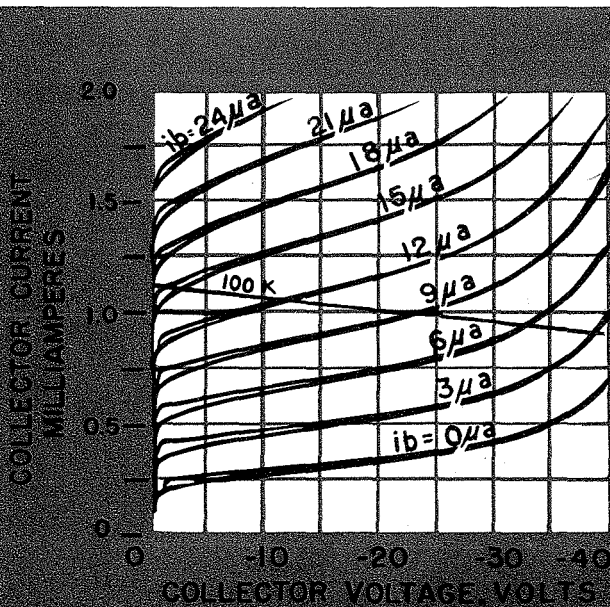

Fig. 2 — Normal collector characteristics

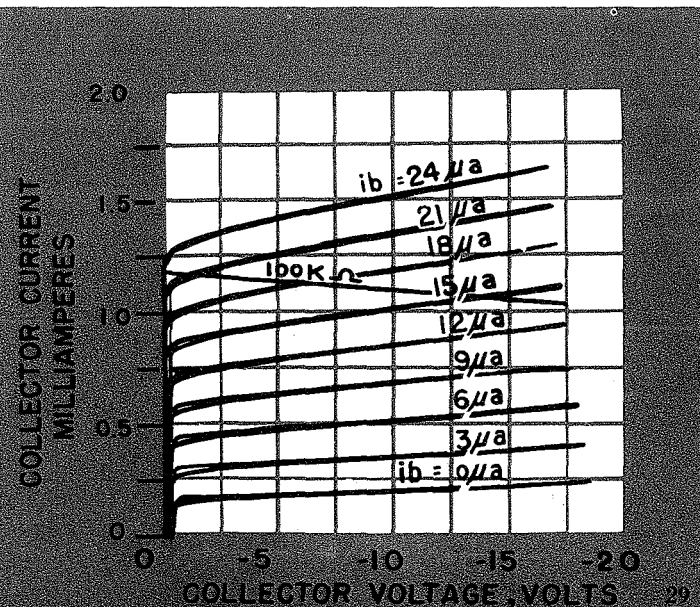
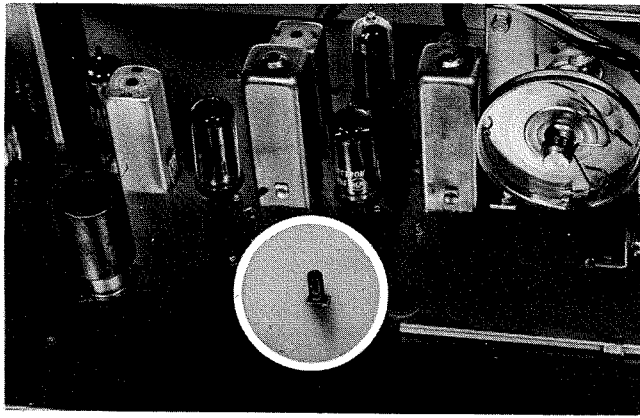

Fig. 3 — Collector characteristics showing the effect of breakdown



Chassis mount of the transistor used as a high-gain preamplifier in the RCA High Fidelity consoles

suming this value and substituting in the noise equation,

$$E_{\text{Noise}} = \sqrt{4KTR(f_2 - f_1)}$$

Where  $K = 1.374 \times 10^{-23}$   
Joule/degree Kelvin  
(Boltzmann's constant)

$$T = 300^\circ \text{ Kelvin}$$

$$R = 500 \text{ ohms}$$

$$f_2 = 23,000 \text{ cps}$$

$$f_1 \approx 0$$

the generator noise is 0.436 microvolt. A 2N104 transistor having a Noise Factor of 12 db,† has an equivalent noise input of 1.69 microvolts. If an average unit, with a 7 db Noise Factor is chosen, the input can be as low as 0.872 microvolt for unity signal-to-noise ratio. For an average unit, therefore, the input may range from 1 microvolt to 10 millivolts, a range of 80 db.

#### TEMPERATURE STABILITY

Having established the basic operating parameters of the circuit in Fig. 1, attention is next devoted to develop-

†  $V_c=4 \text{ V.}, I_c=.7 \text{ ma.}, \text{NBW}=12.3 \text{ kc.}$

ing a circuit which will eliminate the gross temperature dependence. Because of the wide collector swings, it is desirable to stabilize the operating point as firmly as possible. This can be done by utilizing a combination of several stabilizing schemes, all of which are known to the art. Fig. 5 shows a completed circuit which combines three methods: current-voltage bias, constant emitter-current stabilization, and d-c feedback. With the circuit constants shown, the stability factor, defined as the change in collector current ( $I_c$ ) for a given change in cutoff current ( $I_{co}$ )

$$(S_F = \frac{\partial I_c}{\partial I_{co}})$$

is equal to 1.37.‡ This means that the change in  $I_{co}$  (which is unavoidable when the junction temperature changes) is multiplied only by 1.37 as a change in collector current rather than by  $\beta$  (40 or 50), as in Fig. 1. In this way, the collector voltage is held surprisingly constant, varying from -22 volts at -79° C (dry ice temperature) to -17 volts at 65° C.

‡ Assuming  $\beta=44$ , per specifications.

In addition to excellent temperature stability, the gain is quite independent of transistor parameter variations, changing only  $\pm 1$  db from its normal gain of 60 db. This proves to be true with nearly any transistor in good working condition.

A disadvantage of using d-c feedback (as established by  $R_2$ ) arises from the presence of a-c, which is also fed back. In this case, the amount of degeneration is determined by the generator impedance, across which the feedback voltage is developed. For the case of resistive source of 500 ohms, the voltage division is in the ratio of 100,000 to 500, or 200 to 1. Therefore, the gain of 1000, without feedback is reduced by 15.5 db. The situation can be avoided by splitting  $R_2$  and inserting a bypass to ground.

#### VOLTAGE SUPPLY

Since the most logical use of the circuit of Fig. 5 will be to feed a vacuum tube grid, the use of negative 250 volt supply is a practical handicap. In order to utilize the positive supply already available where tubes are present, the ground point may simply be shifted, as indicated in Fig. 6. The new circuit is identical to that in Fig. 5, except that it now utilizes a positive supply, and the input is floating at 25 volts above ground, necessitating the use of a two-wire shielded cable input. The only new consideration is the capacity to ground of the source, which can be a problem in the case of a-c operated oscillators and signal generators. It is of less significance in applications utilizing phonograph pickups, microphones, or other such transducers.

#### FINAL PHONOGRAPH PREAMPLIFIER CIRCUIT

With the modifications shown in Fig. 7, this circuit is in current production as a phonograph preamplifier in two RCA high fidelity consoles, models 6HF1 and 6HF2. The pickup is of the moving-coil dynamic type, having excellent frequency response and very low distortion. Its average level output is on the order of 1 millivolt, and its impedance is less than 2 ohms. Because of the unusually low output voltage, when the pickup is used with tube preamplifiers, noise becomes a severe problem. Normally, an input transformer is required to overcome

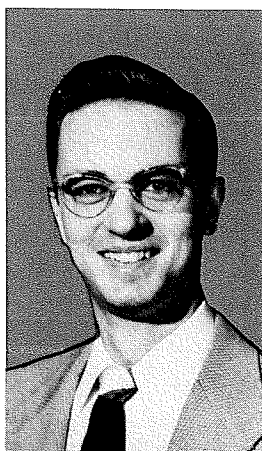

**JAMES J. DAVIDSON** joined RCA in June, 1952 as a Specialized Trainee after graduation from the Massachusetts Institute of Technology with a B.S. Degree in Electrical Engineering. He was a member of the Home Instruments Advanced Development Section until June 1954, at which time Mr. Davidson transferred to the Radio and "Victrola" Advanced Development group. He is presently working on transistor applications.

Fig. 5—Temperature stabilized high-gain amplifier

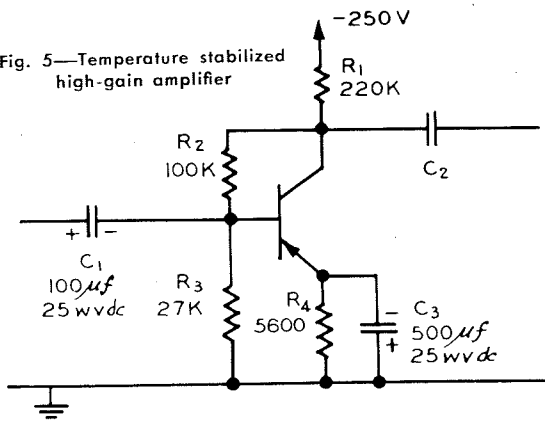

Fig. 6—Inverted amplifier with the same characteristics as Fig. 5

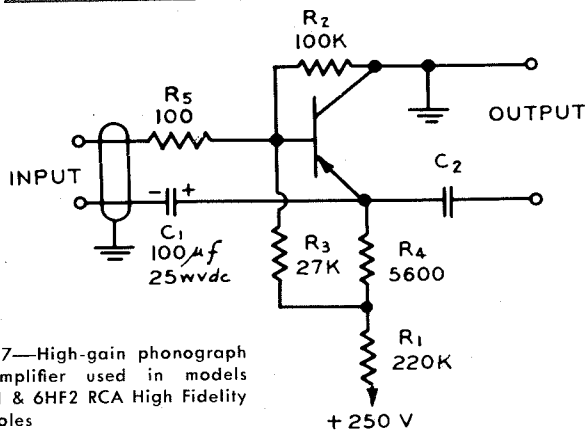
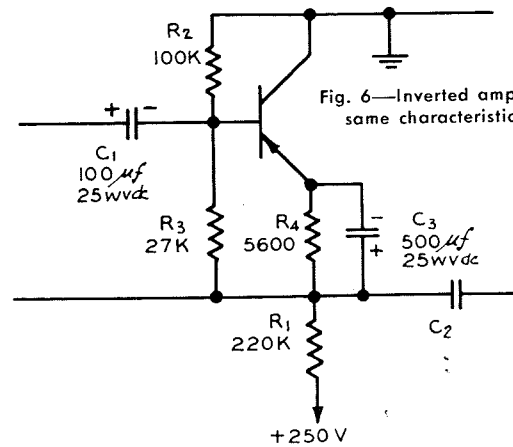

Fig. 7—High-gain phonograph preamplifier used in models 6HF1 & 6HF2 RCA High Fidelity consoles

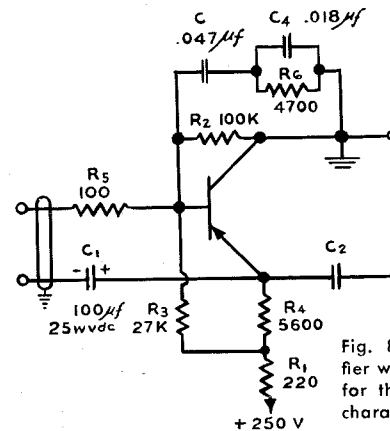

Fig. 8—Phonograph preamplifier with complete compensation for the R.I.A.A./N.A.R.T.B. recording characteristic

it. With the transistor, on the other hand, the noise level is 55 to 60 db below average level, which is completely satisfactory.

The circuit of Fig. 7 was designed with this type pickup in mind.  $R_5$  was inserted to introduce controlled degeneration. Since the absolute peak recording level of modern micro-groove records is 26 db above average level, the maximum output from the pickup will be 26 db above 1 millivolt, or 20 millivolts rms. As outlined previously, the preamplifier cannot handle inputs as high as this, and the easiest way to solve the problem is by the use of feedback. In this case, with a gain of 1000, and a division between  $R_2$  and  $R_5$  of 100,000 to 100, the gain is cut 6 db. Additionally, the feedback reduces the total harmonic distortion for peak level (20 millivolts) input to less than 2% and extends the frequency response to 38 kc.  $R_5$  is only effective, however, because of the very low impedance of the pickup. Normally, it is impractical to use feedback on the input circuit, since variations of the source impedance with

frequency would upset the loop. Where the source impedance is negligible in comparison with 100 ohms, this scheme makes it possible to control fully the degeneration.

Since the input is already floating, it is desirable to connect one side directly to the emitter, rather than the junction of  $R_4$  and  $R_1$ . This removes  $R_1$  as a source of a-c. degeneration, eliminating the need for a bypass capacitor, while retaining its very valuable function of temperature stabilization. Capacitor  $C_1$  is placed in the emitter lead for protection of the pickup. If it were in the base lead, in series with  $R_5$ , and the pickup became shorted to ground, somewhat more than 1 ma would flow through the pickup. Placing the capacitor in the emitter lead effectively ties the base to the collector when there is a short, making the transistor just a forward-biased diode. Therefore, most of the current is shunted through the transistor, and a negligible current of 250 microamps flows into the pickup.

Figure 8 shows the phonograph preamplifier with the addition of fre-

quency selective feedback to compensate for the R.I.A.A./N.A.R.T.B. recording characteristic.\* Because of the large amount of low-frequency equalization necessary, the gain at 1000 cycles is reduced to 44 times, and the distortion is reduced correspondingly, to a few tenths of a percent. Since the signal is "flat," however, only one succeeding stage of amplification is necessary to bring the signal up to the two-volt level required by many power amplifiers.

#### CONCLUSION

Transistors, when operated as low-level, high-gain amplifiers, offer distinct advantages over tubes from a noise standpoint. When it is considered that at least two, and usually more, tube stages are required to produce comparable gain figures, the transistor is also in a favorable competitive position from the standpoint of economy.

\* RCA Victor "New Orthophonic" recording characteristic. See "RCA Victor Record Engineering" by H. I. REISKIND in this issue.



The RCA-AR-8712 "Golden Guide" Portable Radio Direction Finder.

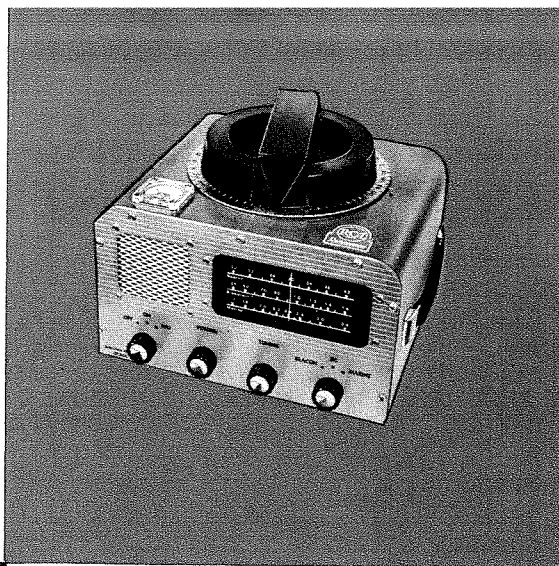

Finder to provide small boat owners with an instrument which is inexpensive, but still capable of performance approaching that of its costlier "big brothers."

**"THREE-WAY" PORTABLE**

The AR-8712 is essentially a "three-way" portable radio receiver with a rotatable loop antenna. The three-band receiver is conventional in design, with one r-f and one i-f stage except that a beat frequency oscillator is also provided for cw reception.

**NEW**

**PORTABLE DIRECTION FINDER FOR PLEASURE CRAFT**

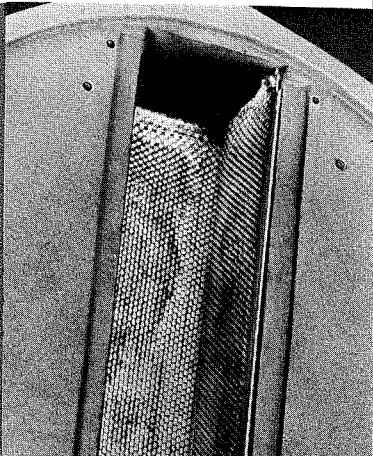
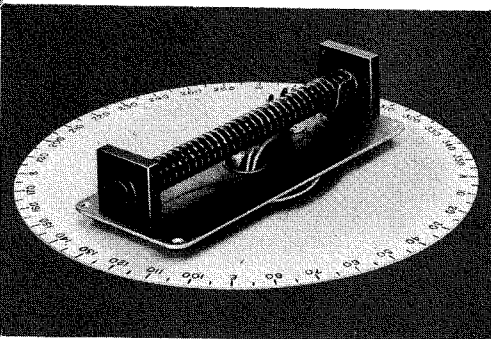

Fig. 2—Close-up showing electrostatic shield underneath loop cover.

Fig. 1—Detail of ferrite loop antenna.



Miniature 1.4 volt tubes are used throughout. Power can be derived either from the self-contained battery pack or a 115 volt a-c or d-c line. A "null meter" is an added direction finder feature.

- The three frequency ranges covered by the receiver are:
- 200 - 415 kc (Beacon Band)
  - 540 - 1600 kc (Standard Broadcast)
  - 1700 - 3400 kc (Marine Radiotelephone)

The beacon band covers the homing service provided along the nation's coastal areas and navigable inland waterways. For example, there are four beacons in the New York harbor area ranging from the northern tip of Long Island to the middle of the New Jersey coast. A small boat equipped with a direction-finder can get a "fix" on two or three beacons and with the aid of a navigational map, pinpoint his location. Each beacon transmits modulated cw call letters in the 285-325 kc beacon spectrum. Boat users can also use the standard broadcast band for homing by obtaining "fixes" on local broadcast stations. Other boats are located by tuning in on the marine radiotelephone band.



**HARRY F. MOHR**, a Radiomarine engineer since 1944, is actively engaged in the development and design of marine radiotelephone receivers and direction finders. Before joining the Radiotelephone group, his assignments included receiver testing and radar development. Mr. Mohr was born and educated in New York and received his technical training at the RCA Institutes. He has been an Associate Member of the I.R.E. since 1945.

by **HARRY F. MOHR**

*Radiotelephone Engineering  
Radiomarine Corporation of America  
New York, N. Y.*

**T**HE INTRODUCTION of the outboard cruiser and "build-it-yourself" boat kit has brought power boating within the reach of the average man. This greatly expanded market has brought with it a demand for reasonably priced electronic equipment, such as radio-telephones and radio direction finders.

The Radiomarine engineers have developed the AR-8712 "Golden Guide" Portable Radio Direction

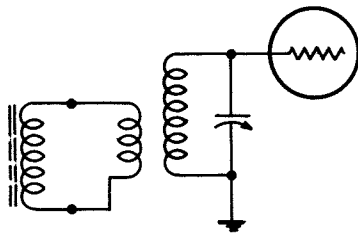

Fig. 3a—Input transformer (beacon band)

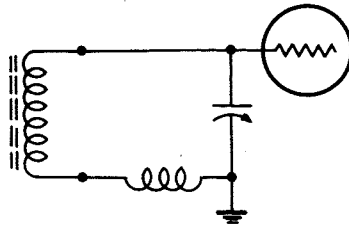

Fig. 3b—Series loading (broadcast band)

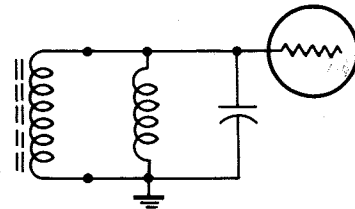

Fig. 3c—Shunt loading (Radiotelephone band)

#### DESIGN CONSIDERATIONS

It was apparent from the outset of the development work that a sensitivity of 100  $\mu\text{V}/\text{meter}$  or better was required to make the instrument useful for small-boat navigation. At the same time, it was considered essential to use a loop of the ferrite core type to keep the overall dimensions of the receiver down to "portable radio" size. These requirements seemed to conflict hopelessly, since the ferrite rod antennas used in ordinary portable and table model broadcast receivers did not provide the required "pick-up" efficiency.

The readily available  $\frac{1}{4}$ " ferrite rod was tried on the loop and found unsatisfactory in reaching the minimum 100  $\mu\text{V}/\text{meter}$  required. At slight additional cost,  $\frac{1}{2}$ " ferrite cores were found to increase the height of the loop to within specifications. Loop detail is shown in Fig. 1. At this point, excellent sensitivity could be obtained by designing the loop winding for one band and tuning it directly, but no compromise design would produce the required sensitivity over three bands. Many different tapped windings were tried, but all suffered from absorption troubles, which caused "deadspots" within the tuning range.

#### LOOP PROBLEM SOLVED

The loop problem was finally solved by using an input transformer for the 200-415 kc band (Fig. 3a). The transformer employs a ferrite slug, which produces a good coefficient of coupling, and provides a voltage step-up of over 200:1 from antenna to grid. A small amount of series loading is employed on the broadcast band (Fig. 3b), while a shunt inductor permits the loop to be tracked in

the 1700-3400 kc range as shown in Fig. 3c. The loop inductance is a compromise value at 50  $\mu\text{h}$ . The required inductances for matching all bands are as follows: beacon band, 1200  $\mu\text{h}$ ; broadcast band, 180  $\mu\text{h}$ ; marine radiotelephone band, 28  $\mu\text{h}$ .

#### ELECTROSTATIC SHIELDING

In a device such as radio direction finder, elimination of "antenna effect" produces the desired directivity, and is conventionally accomplished by electrostatic shielding of the antenna. Early attempts at electrostatic shielding of the loop winding in the portable direction finder resulted in considerable reduction in "Q." The first shield experimentally tried was constructed of copper sheet, with a suitable air-gap to avoid the shorted-

turn effect. The eddy-current loss, however, was severe, resulting in a very low "Q" in the 1700-3400 kc region. In its final form, the electrostatic shield was constructed of a woven mesh cloth, having copper wire in one direction and cotton thread in the other. With this construction, the shielding causes no appreciable reduction in "Q" or effective antenna height. A detail of the electrostatic shield construction is shown in Fig. 2. Electrostatic pick-up has been reduced to a value low enough to produce near-perfect nulls, even near the upper frequency limit of the tuning range.

Field tests indicate that the AR-8712, despite its small size and low cost, is capable of doing a man-sized job as a navigational instrument.



Fig. 4—Walter S. Glazar, associate project engineer, taking sensitivity measurements, using a transmitting loop.

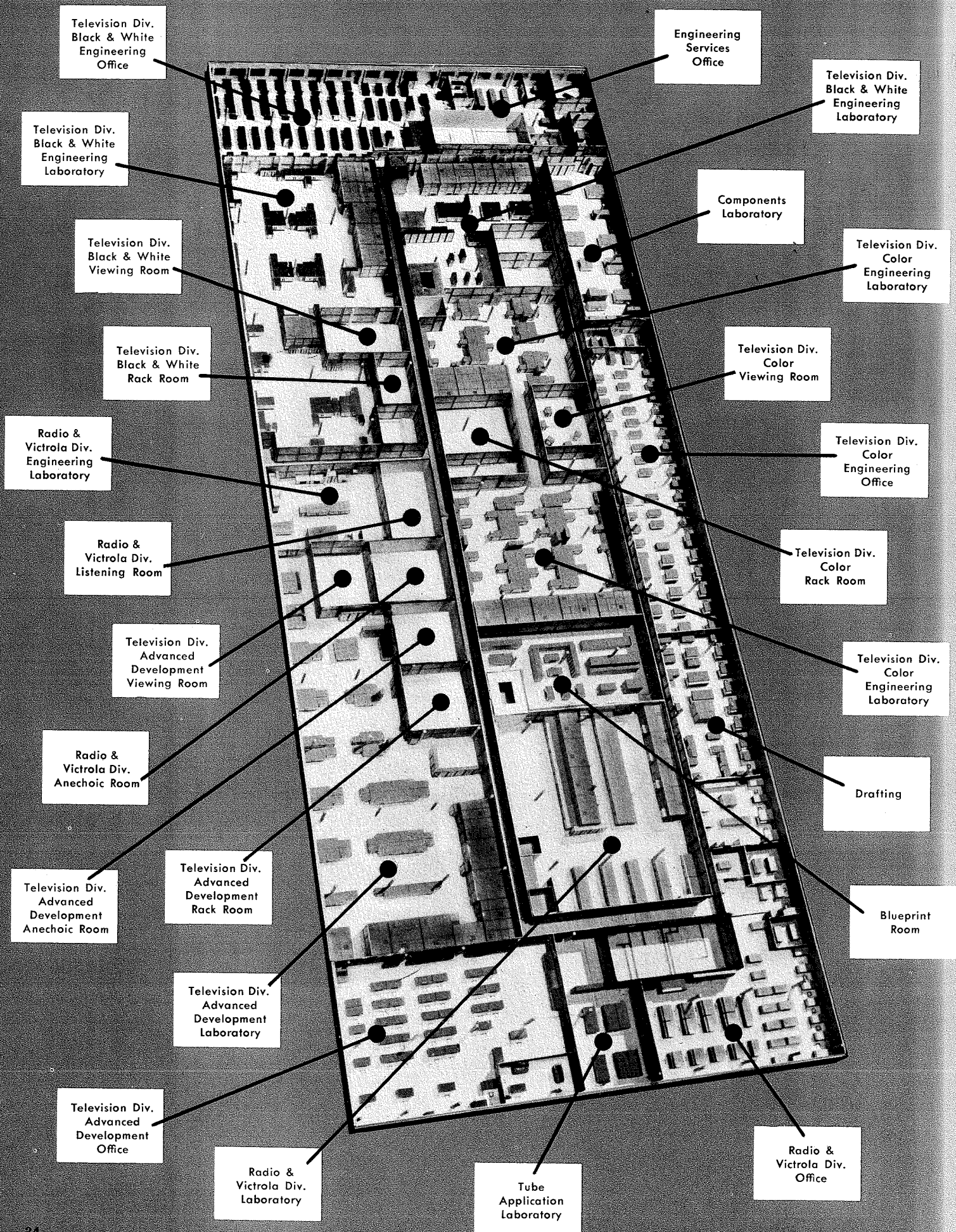

Scale model of the second floor of the large center building at top of next page

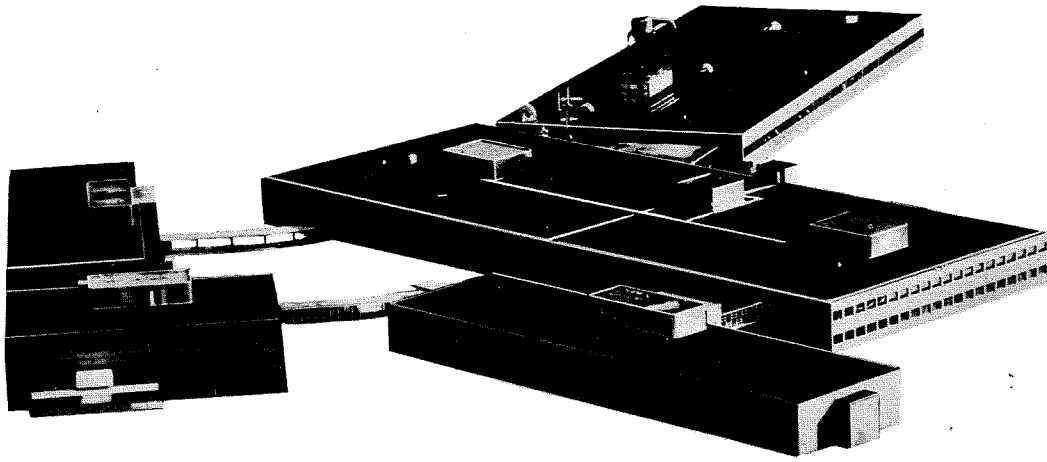

## ENGINEERING . . . at Cherry Hill

by R. J. HALL, Assistant Editor

**R**CA-CHERRY HILL, an integrated project of five inter-connected buildings, was placed in operation in early 1955. Facilities accommodate the home offices, engineering laboratories and supporting services of three major RCA operational activities: (1) the RCA Service Company, Inc., (2) the RCA Victor Radio and "Victrola" Division, and (3) the RCA Victor Television Division.

Located on a 58-acre site in Delaware Township, N. J., RCA-Cherry Hill is only seven miles from the Corporation's Camden Plant. An important consideration in selecting the site was its convenience to major concentrations of associated engineering and staff home locations in the suburbs surrounding Camden.

### UNIQUE BUILDING DESIGN

As for building design and construction, the Cherry Hill plan represents a new concept in commercial offices and engineering facilities. Building construction is such that no internal wall or partition is permanently fixed except the stair-wells and lavatories. This permits maximum flexibility of space division within the buildings. All buildings are sound- and light-engineered, air conditioned, and equipped with large expanses of glare-reducing glass. Desk locations, wherever possible, are located near windows and are separated from laboratories and shops by ceiling-high, movable walls.

### CENTRALIZED ENGINEERING

For the sake of convenience in

communicating between engineering groups and properly utilizing signal sources, all engineering facilities at Cherry Hill are centralized in one building. Concerted planning by the various engineering divisions was started a year and a half before the moving date. The scale model shown on the facing page indicates to a small measure the infinite attention given to detail during early space and facilities planning. Notice how the offices lie on the building perimeter, surrounding the laboratories.

There are 45 antenna mounts built into the roof above for antenna test and for expanding the signal facilities. All commercial television signals are supplied to the bench locations through an RCA Antenaplex amplified distribution system.

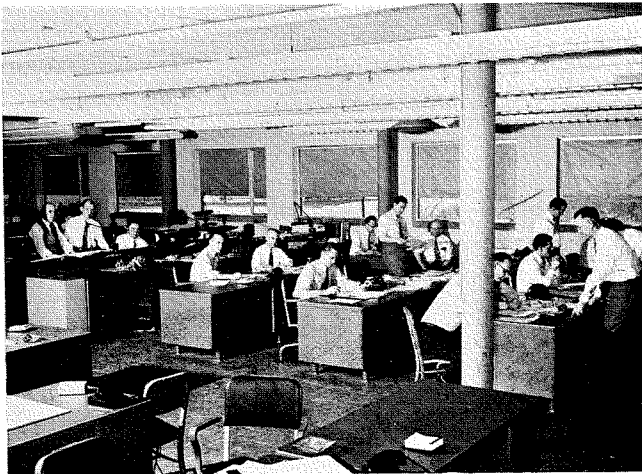

Fig. 1—Engineering office facilities are located near windows, with laboratories located at the center of the building. The Black and White Television Engineering offices are typical of those throughout the building.

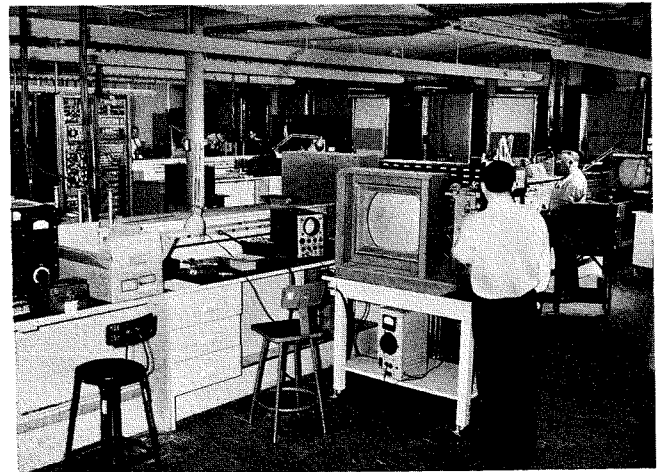

Fig. 2—The Color Television Engineering Laboratory typifies overall lab facilities. Engineer M. Kolesnik in foreground and Lab. Technician J. E. McCafferty right center. A signal substation is seen at left.

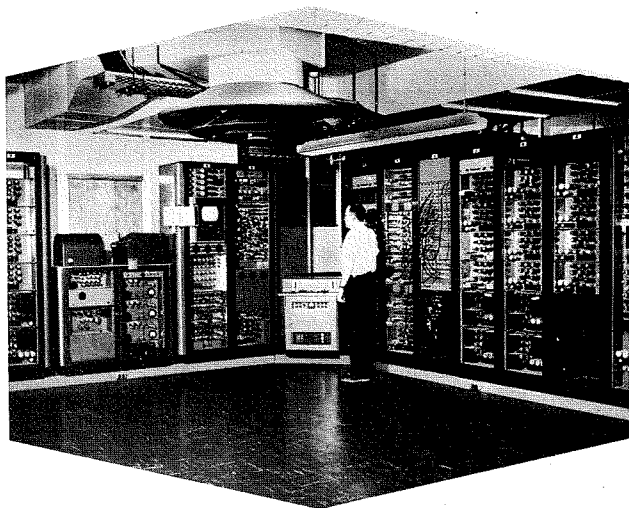

Fig. 3—Engineer G. M. Daly in the rack room of Advanced Development Engineering, RCA Victor Television Division.

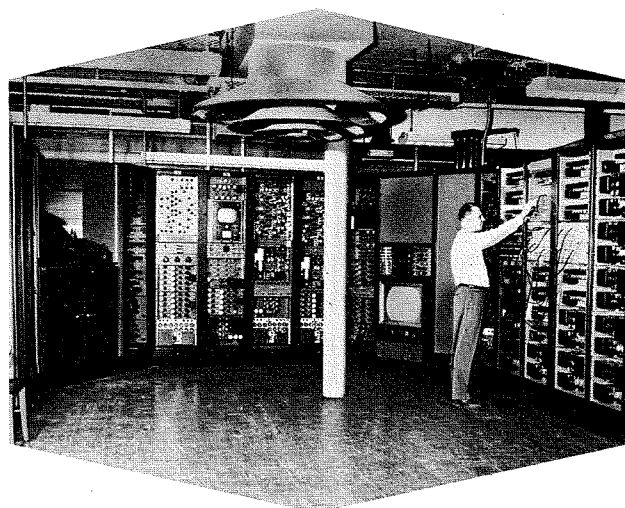

Fig. 4—Laboratory Technician L. J. Draus making adjustments in the Color Television engineering rack room, RCA Victor Television Division.

### THREE GROUPS MOVED

The mass movement of any group of appreciable size from one location to another is a complex and tedious task, to say the least. These problems of relocation are multiplied many-fold when the movement includes engineering facilities such as signal sources, laboratories, cages, special sound rooms, the model shop and other complicated electronic and mechanical equipment. The new accommodations at Cherry Hill required the re-establishment of *three* engineering groups: RCA Victor Television Division, RCA Victor Radio-Victrola Division and RCA Service Company.

### SIGNAL SOURCES

The Television Division is divided into three main engineering groups: Advanced Development Engineering, Color Television Engineering and Black-and-White Television Engineering. Each of these groups has its own complete signal generating equipment, piped from centralized locations to substations or benches in the laboratories. Advanced Development Engineering has both color and black-and-white signal sources, while Color and Black-and-White Engineering produce their own color and black-and-white signal sources, respectively. All three signal sources are completely interconnected by six lines each way. In case one source is out of operation for equipment changes, etc., either remaining group can supply signal to the inoperative laboratory positions.

The complete signal system was

constructed and tested in Camden previous to installation at Cherry Hill . . . even to the extent of cutting all coaxial cables to the exact length needed for "runs" between various signal racks. No system changes have been necessary!

The Advanced Development signal source is equipped with the following signal generating outputs for color: a color bar pattern, flying-spot scanner, a grating generator which can supply either dots or bars, and a linear step-generator for checking gamma correction and setting up the flying-spot scanner. A black-and-white monoscope signal can be switched through the red, green or blue color channels, collectively or individually. For black-and-white, a monochrome flying-spot scanner, two grating generators (one for vertical bars and one for horizontal bars to eliminate switching from one to the other) and a monoscope are available signal outputs.

In addition to the inter-divisional connections, Advanced Development supplies all signals to RCA Service Company Engineering, located on the floor directly below.

The Advanced Development signal source supplies twenty-two positions in the laboratory: seventeen bench positions and five engineering test cages. There are three lines at each position, and all signals are on a "call-demand" basis. There is no permanent signal patching anywhere! The engineer merely makes the necessary

connections for the signal he requires. In the lab there are ten portable mixing amplifiers available. With these, an engineer can call for separate sync and video, and mix them at will at the bench location. The signal source also maintains three mixer amplifiers to provide tailor-made signals on demand.

There are two color-signal substations in the Advanced Development lab, with a third substation position located in the listening room. The main signal source supplies the substation with color bars or a scanner signal, which in turn can be adjusted at the substation. One substation can be patched up in the listening room to supply all signal requirements for tests there.

The Color Television Engineering signal source is similar to the Advanced Development one, except, of course, with primary emphasis on color signals. In addition to the bar pattern, flying spot scanner, grating and linear step generators that duplicate those of Advanced Development, Color Engineering supplies in addition two monoscope signals: one is the standard Indian Head pattern, and the other signal has a cross-hatch superimposed over the Indian Head pattern. Additional equipment includes a separate dot generator in addition to the grating generator, and a vestigial sideband filter to duplicate on-the-air signals. A 21CT55 color receiver is built into the source racks as a convenient color monitor.

The Color Engineering source supplies each of five substations, and each substation in turn feeds eight bench locations. The bench positions have five signal outputs: on-air signal from an amplified distribution system (Antenaplex), three substation signals and one outlet from the source racks.

All benches throughout the building are portable, with a-c supply patched from an overhead trolley-duct. Each bench has its own a-c circuit breaker.

#### ANECHOIC ROOMS

The three sound rooms at Cherry Hill are particularly interesting since they are located on the second floor, with limited floor loading and overhead clearance, and yet they are efficiently engineered. The Radio & "Victrola" Division and Television Division Advanced Development Sections each have an anechoic room, and a listening room is available to both groups.

Each room consists of a masonry room within a masonry room to provide best possible isolation from outside noises. The inner rooms are constructed with concrete slab floors and cinder-block walls, all suspended

on steel springs under the floor. Each ceiling is concrete and plaster and is suspended from the roof by springs. The independent ceiling suspension was done for two reasons: (1) the load limits of the floor would not permit the added weight of the ceiling, and (2) hanging the ceiling achieved maximum height within the rooms by eliminating joists and otherwise necessary overhead bracing. The rooms are mechanically resonant at five cycles per second.

All three rooms are air conditioned through plenum chambers (large boxes filled with rectangular tubes and lined with Fiberglas) between the walls. This eliminates noise transmitted from the air conditioning system to the anechoic rooms. There are no air conditioning returns from the anechoic rooms, with circulation only occurring when the doors are open. Shutting the doors eliminates noise of air movement when the room is being used for tests. It is not necessary for the rooms to be air conditioned while tests are being run, since the engineer can conduct all tests from the outside. The rooms are connected to automatic curve drawing equipment, and all

necessary instrument control is provided at a console.

The Fiberglas wall and ceiling wedges are two feet deep, with proper air spacing behind, and are especially effective at quieting above 120 cycles. Optimum quieting below this frequency would have necessitated longer wedges, which would reduce the available headroom. The floor is covered with five inches of Fiberglas of varying density, which in turn is covered with expanded-metal gratings to permit walking across the floor. There are independent soundproof doors in the inner and outer walls. The outer door provides a 45 db sound attenuation and the inner door provides 35 db of attenuation—each wall attenuates 40 db from inside to outside. Noise within the anechoic is below available meter measurement—engineers are not sure exactly how quiet the rooms really are, since their most sensitive meter reads to 20 db above the threshold of hearing. The meter does not register in the closed room!

The anechoic and listening rooms are used to set sound pressure curves for all radio and television receivers and phonographs for RCA. Engineer-

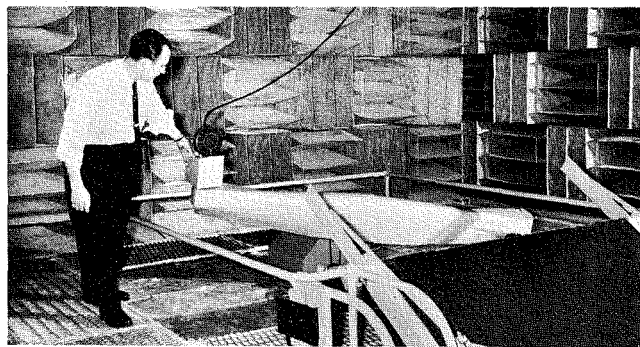

Fig. 5—Technician M. DiLorenzo cycling the microphone boom in the anechoic room of RCA Victor Radio & "Victrola" Division.

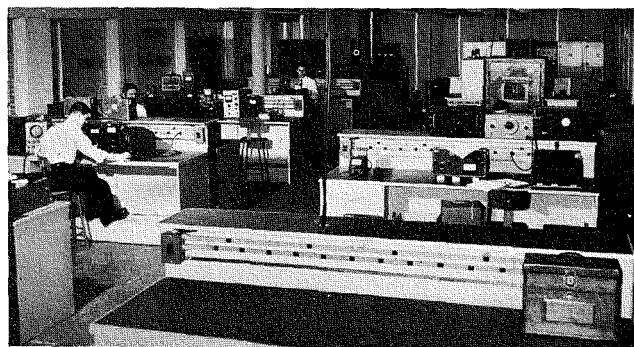

Fig. 6—Technicians making tests in the Components Laboratory. Equipment for conducting heat and humidity tests in the right background.

Fig. 7—The plastics and metal-working Model Shop located in the Utility Building, adjoining the Engineering Building.



Fig. 8—S. Wlasuk (left) and J. H. Fisher in the Special Projects Laboratory, RCA Service Company Engineering (see Fig. 9).



ing samples of all such instruments must be tested and approved in these rooms before being approved for production. The rooms are also used for high-fidelity research and acoustics development.

#### COMPONENTS LABORATORY

The Components Group of Engineering Services provides testing and research facilities for all components designed into RCA home products. Components are purchased against an engineering specification, and samples are submitted to the Components Lab for checking against the specification. Facilities are available for heat runs, humidity checks, high-voltage breakdown test, gain and bandwidth measurement, component tolerances, and mechanical life tests of switch detents, variable controls, on-off switches, etc.

A large percentage of the service of the Components Lab is coil development work. Design engineers will submit a coil specification to the Components Lab, where the coil is developed under the guidance of the design engineer. When the design is approved, it is submitted to vendors for

manufacture. This service saves time and expense of having the vendor do the development work.

#### MODEL SHOPS

The model shops are located in an adjoining building. One provides complete cabinet-making facilities for television, radio and "Victrola" cabinets in wood. The other provides complete model building services in metal and plastics. Complete plastic radio cabinets, knobs and plastic parts can be fabricated to specification, along with chassis bases, brackets and special metal fixtures. This model shop also will purchase all chassis and wiring components so that at the time of chassis delivery to the engineer the complete model can be assembled by a wireman.

#### RCA SERVICE COMPANY ENGINEERING

The Service Company accommodations provide office, laboratory and complete stock-room facilities for a very versatile engineering group. Their function includes product design in test equipment for RCA Consumer Products, amplified distribu-

tion systems (Antenaplex, Master-tenna, etc.) special equipments as door openers, remote control units for television receivers, special receiving antennas for television including coupling and phasing networks, transmission lines and associated hardware, and other specialized equipment to meet the needs of the Service Company field program. Modifications are made to existing RCA Consumer Products for installation in airplanes, vessels, trains and autos and other custom installations.

RCA Service Company engineers are available for supervisory or training purposes, and have traveled the world in assisting facilities set-up, TV station surveys, area performance checks, planning of electronic courses at various universities, and giving talks and demonstrations to various independent service organizations.

Although much of the work done by RCA Service Company engineering is actively accomplished away from Cherry Hill, the home facilities provide an adequate base for engineering that will advance the technical program of the RCA Service Company.

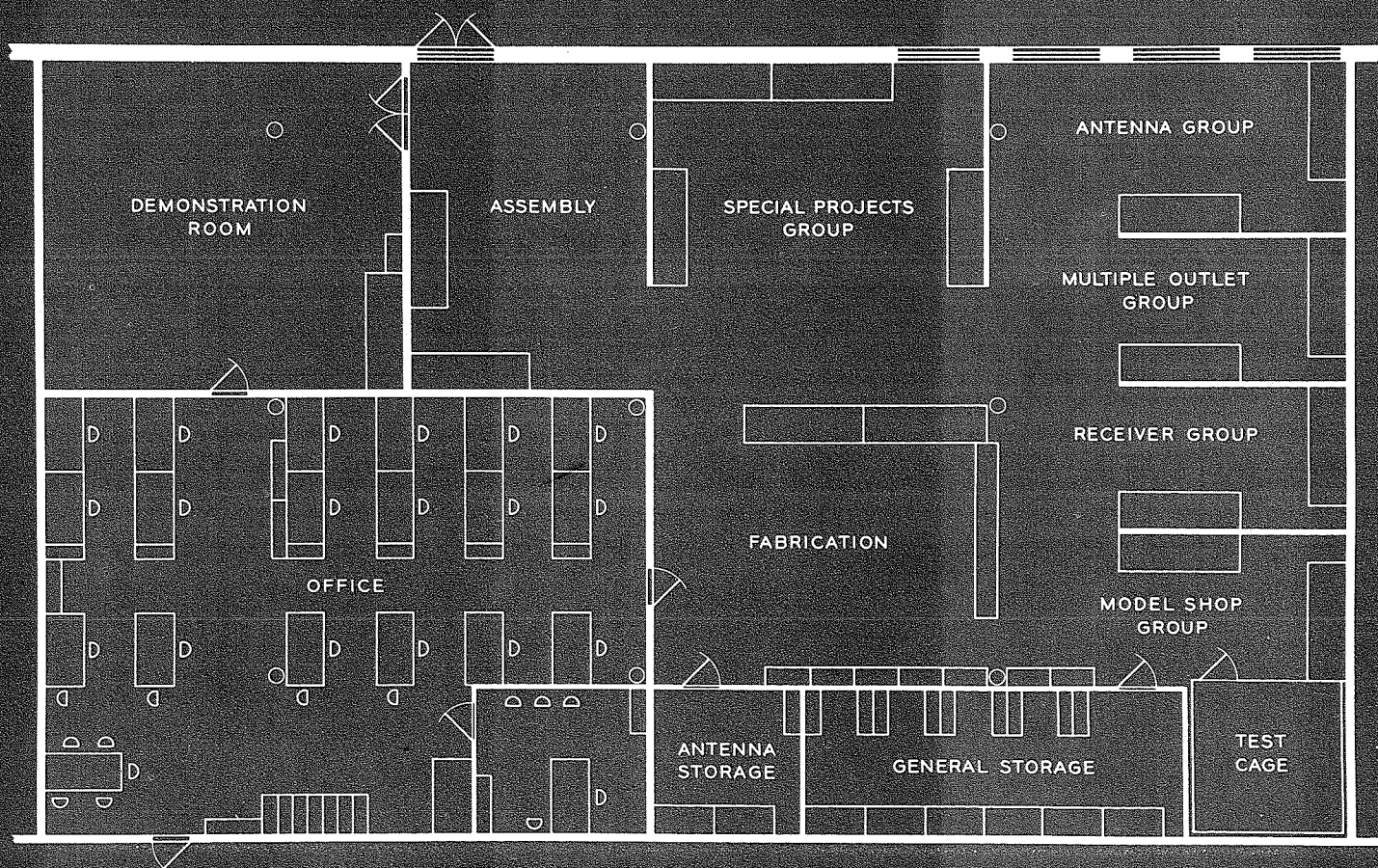

Fig. 9—RCA Service Company Engineering facilities, located on the first floor of the Engineering Building.

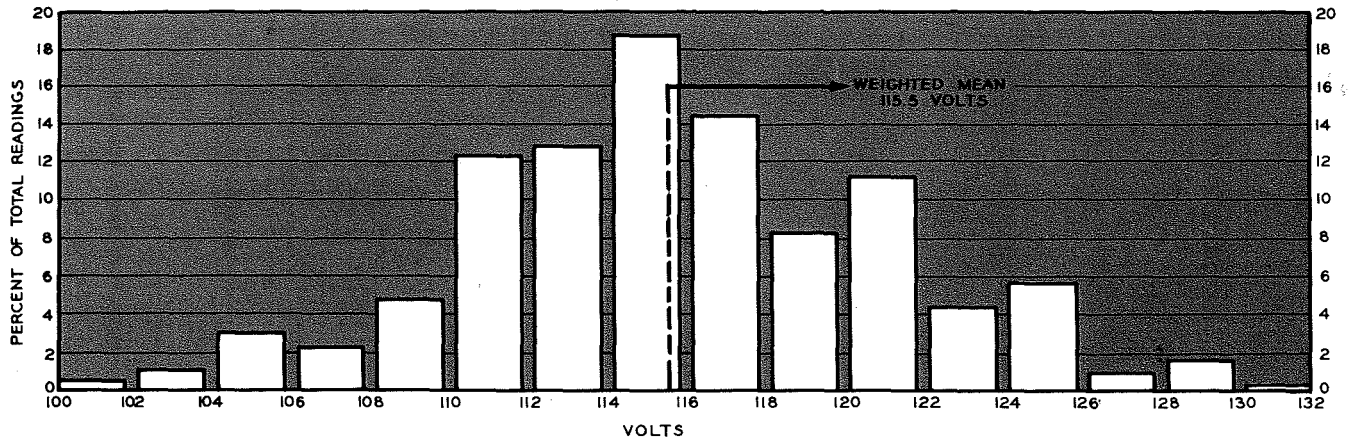

Fig. 1A—Distribution of power line voltages in typical suburban homes 12 Noon-6:00 P.M.

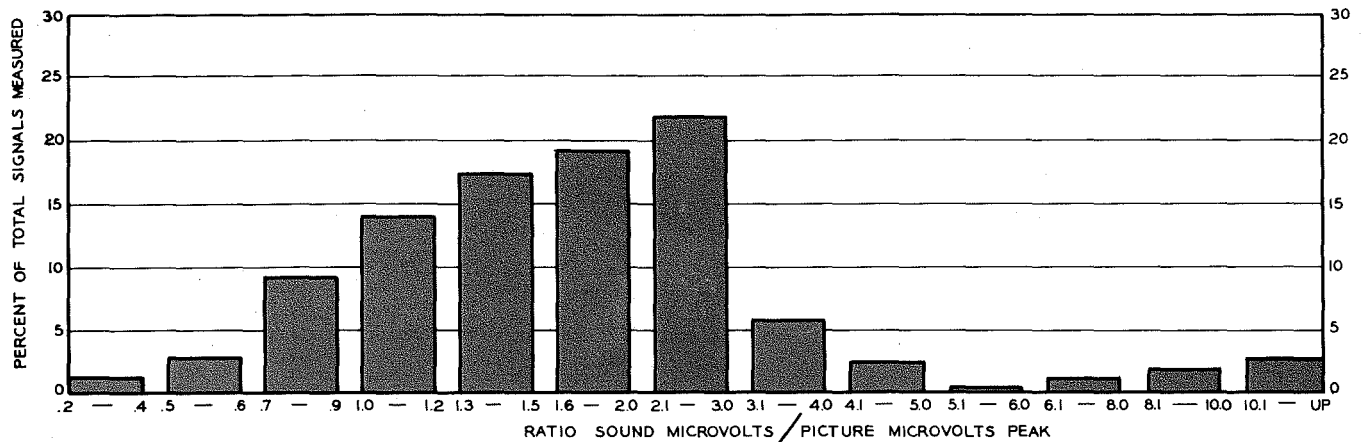

Fig. 1B—Signal conditions encountered on typical receiving antennas, from various stations in scattered areas.

## PRODUCT QUALITY AS INFLUENCED BY FIELD DATA

by **W. J. ZAUN**  
*Manager, Quality Division  
 RCA Service Company, Inc.  
 Cherry Hill, N. J.*

ALTHOUGH THE measurement and control of product quality is ordinarily handled by the inspection and quality control organizations within a manufacturer's plant, in the case of RCA Victor, additional surveillance of quality is maintained by the QUALITY DIVISION of the RCA Service Company. This group is responsible for evaluating quality from the field and customer's point of view. Problems associated with shipping and handling, aging, line voltages, unusual signal conditions, and similar factors are thus given more comprehensive consideration.

The field-quality program outlined in this article, as applied to television receivers, is typical of the attention given to various RCA Victor products.

### QUALITY MUST BE ALL INCLUSIVE

The realistic judging of quality should take into account certain overall objectives relating to the suitability of the basic product design, assembly workmanship, as well as early and long-life component mortality. The following requirements are therefore indicated:

- Inherent performance conforming to a high standard, and meeting the needs of all potential customers.
- Freedom from initial flaws or defects at time of delivery.
- Minimum of early-life, or

"within warranty" failures.

- Continued reliability, without excessive or premature failures during extended life.
- Availability of good service to restore operation in the event of random early-life failures, and subsequent normal maintenance necessitated by age and use.

### ENGINEERING CONSULTATION

During the early phases of design of a new receiver, periodic consultations are held with the design engineers to assure that the performance standards specified measure up to field requirements dictated by past experience. A review is made of surveys covering new or questionable field conditions, such as are typified in



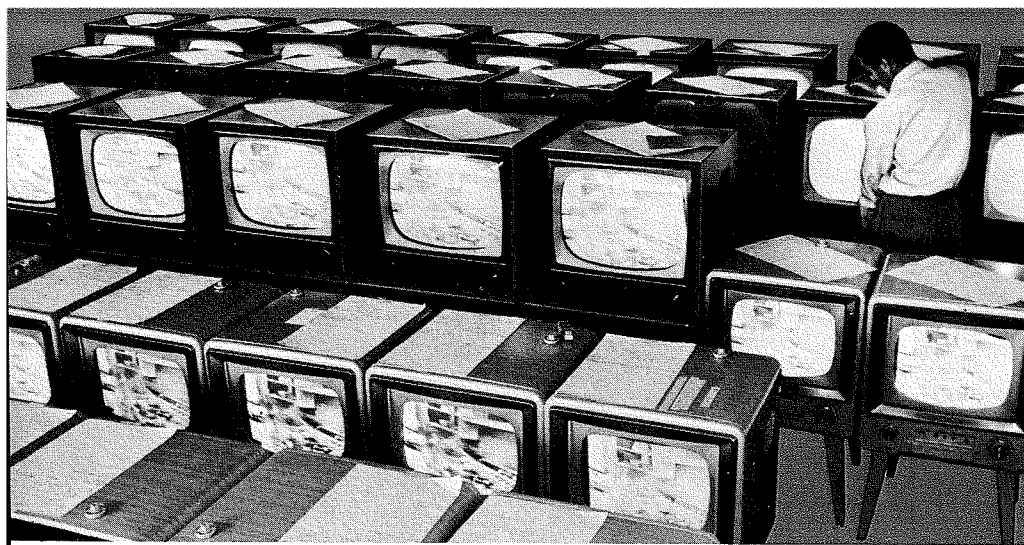

Fig. 2—Television receivers are subjected to controlled "cooking" tests.

Fig. 1. Also, performance and other design features are related to the quality of competitive products. Every effort is made to avoid the repetition of previous troubles or shortcomings. Guidance is given on the selection and application of components and tubes, based on the records of field failures of these items on previous models.

#### FIELD TESTING

An engineering sample of each newly-designed receiver is tested under varied field conditions. The receiver is checked on low line voltage, high line voltage, on very strong signals, on very weak signals, in the presence of different forms of interference, etc.—and each performance feature evaluated against accepted standards, previous RCA Victor models, and the best competitive makes.

#### CHECK OF PILOT PRODUCTION

Samples of early-production instruments are shipped to a number of RCA Service Company Branches for test and observation under typical field conditions, prior to release to the trade. These same sets are then

given a 50-hour "run-in" check, to determine stability of circuits and adjustments; and to note any failures that may occur.

Coincident with the checking of receivers by the field service stations, a sample lot is shipped to a field *Quality Testing Laboratory* located at Browns Mills, N. J., where controlled tests may be made under a variety of conditions typical of home use. Here the units are thoroughly examined and tested as they are unpacked. After this initial check, an operational test is conducted. This is accomplished by placing the receivers in operation on-the-air, and allowing them to "cook" for 100 hours or more, cycled "ON" and "OFF"—automatically, every three hours. These checks are typified in Fig. 2. Performance is continuously watched 24 hours per day, and immediate diagnosis made of any trouble evidenced. Service corresponding to the first 30-60 days in the customer's home is duplicated by this check.

#### RECHECK OF PRODUCTION SHIPMENTS

Sample lots of 50 and 100 of regular production instruments are taken

from each television plant weekly and put through the critical acceptance and extended operation tests just described. Particular care is taken to duplicate typical field operating conditions. Some sets are operated at high line voltage, some on low voltage; reception on weak and strong signals is noted. Data resulting from the tests are teletyped daily to the manufacturing plants.

While the field laboratory tests are timely and on a controlled basis, a broader sampling and more comprehensive coverage of field conditions is considered desirable. Accordingly, a system has been established for collecting quality information on new receivers at the time of installation. For this purpose thirty of the RCA Service Company factory service branches, in scattered locations representing various reception, humidity, and shipping conditions—are designated as *Quality Control Branches*. Technicians at these branches execute a special quality report on every new set installed, airmailing these reports to the home office daily. The individual reports are tabulated and forwarded to the Quality Control Manager of the plant involved, who reviews the information with the factory staff, and initiates corrective action where necessary. Summaries of the information received by this method are compiled and circulated weekly to all concerned, and as a means of keeping the management informed.

#### EARLY-LIFE QUALITY

An index of the durability of the product during its early life is obtained from the "cooking" tests in the field Quality Testing Laboratory. This information is supplemented by case-history studies of a sufficient number of receivers under actual use in customers' homes. Analyses of

**WILLIAM J. ZAUN**, a graduate of Virginia Polytechnic Institute, B.S. in E.E., joined RCA in 1929 in the first Student Engineering Group. In 1941 he set up and managed the Government Field Service Organization for the entire period of the war. A merit award winner in 1947, Mr. Zaun is Division Manager of the RCA Service Company in charge of Quality/Consumer Relations.



Fig. 3—Plant-wide committee concentrates on control of quality.



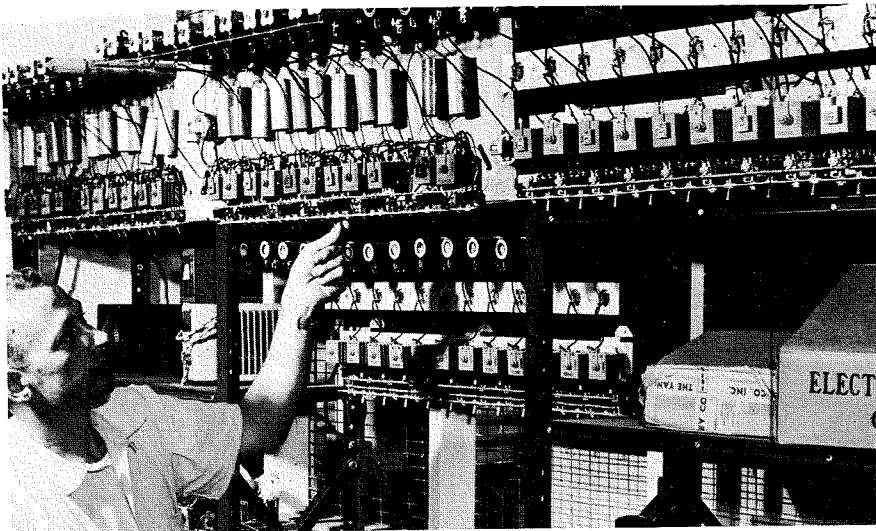
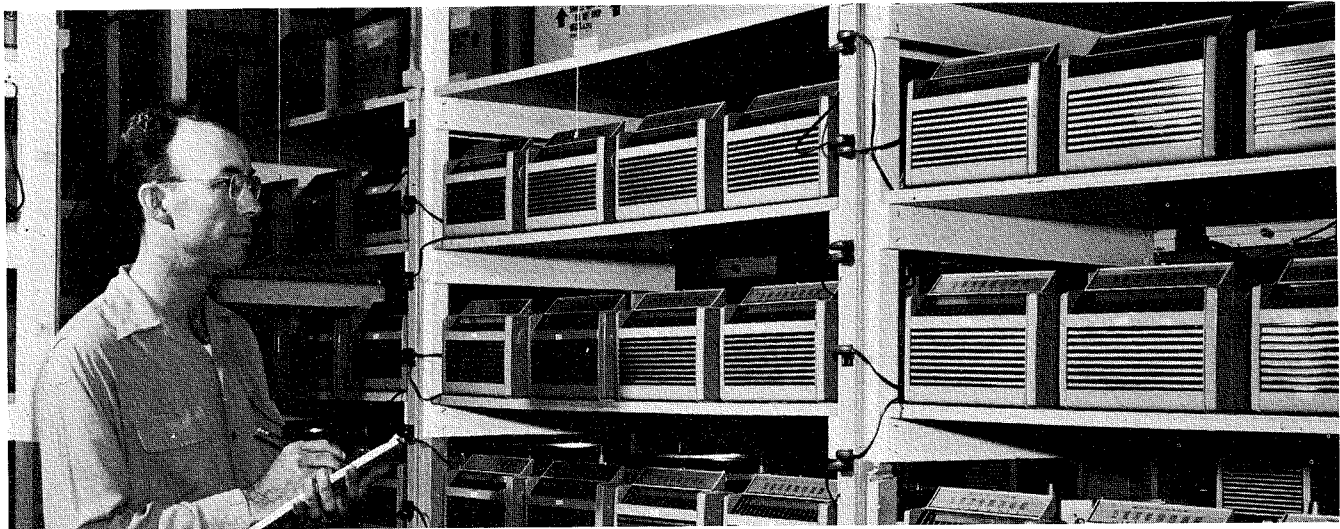

Fig. 4—Extended life reliability of selenium rectifiers are compared under typical operating conditions.

Fig. 5—Portable radio receivers being observed during 100 hour life test. Units are cycled "on" and "off" every three hours.



this sort are made at about the sixth week of age, and periodically thereafter, through the first year. A further confirming check is obtained by following the demand for and usage of replacement parts and tubes. Those items found to be out of line receive the required attention to bring about improvement.

#### EXTENDED-LIFE QUALITY

The long-term, or beyond warranty quality requires consideration if excessive service and maintenance are to be avoided. Specific effort is made to attain a good reputation in this regard. Periodic analyses are accordingly made of "Reasons for Service" covering all models in use, old and new. Failures that occur too frequently or prematurely, are classified

as projects for design improvement.

#### CUSTOMER REACTION

While essential that the true quality of a product be dealt with in terms of pure facts, the opinions (especially the negative) of the consumer must be considered, interpreted as factually as possible, and used as a guide in Quality Control. Comments on product quality from consumers, both solicited and unsolicited, are therefore cleared through the field Quality Division. Reactions are classified, summarized, and investigated to indicate where attention is needed.

#### PERFORMANCE RECHECK

Periodically, during the production period of a given line of instruments, detailed field performance tests are

repeated to assure that changing standards and new competitive factors are not overlooked.

#### QUALITY IS PERIODICALLY REVIEWED

A committee composed of Plant Quality Managers, Engineering, Merchandising and Service Representatives meets periodically to assure that emphasis is maintained on quality, to review overall levels and trends, and to give specific attention to unusual problems. Through this personalized review, as well as from the regular detailed reports reflecting Quality in all of its aspects, those responsible for product design and Quality are kept well informed—and can exercise judicious control and take proper action when required.

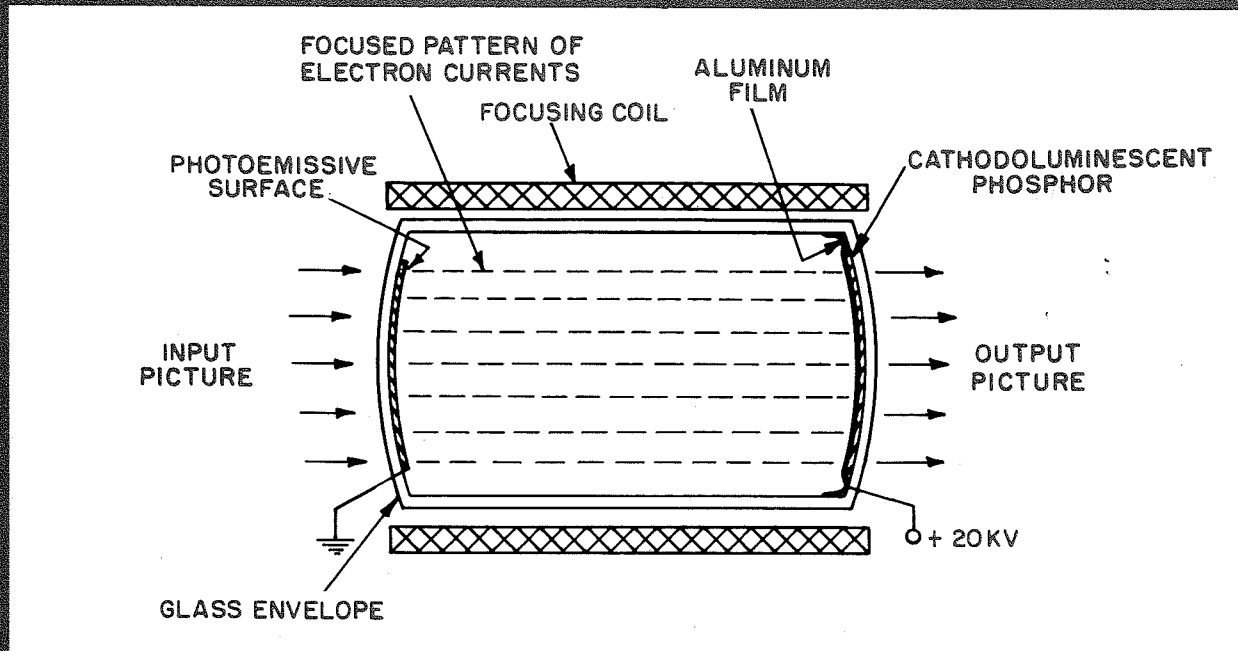

Fig. 1—Representation of an early type of Light Amplifier

## PRINCIPLES OF LIGHT AMPLIFICATION

THE PURPOSE of this paper is to outline briefly some of the general notions and elementary principles that may aid in the understanding of (1) what is an amplifier of light and (2) how it operates.

Perhaps one of the reasons for the greater confusion in the understanding of light amplifiers than that experienced with electrical amplifiers, is that the word *light* has a number of connotations.

### PRINCIPLES OF LIGHT

From the purely physical point of view, light is specified by giving the radiant power in watts per unit wavelengths as a spectral distribution and within the wavelength region of 4000 to 7000 Angstroms. This specifies the stimulus to which the eye is sensitive.

From the psychophysical point of view, light is described in terms of luminance (measured in lumens), dominant wavelengths, and purity, which take into account the *eye characteristics* and are quantitatively measurable.

by **D. W. EPSTEIN**

*RCA Laboratories*

*Princeton, N. J.*

From the psychological point of view, light is described in terms of brightness, hue and saturation which are descriptive of the sensations of light, and are not directly measurable, but correspond reasonably well to luminance, dominant wavelength and purity.

All these concepts of light are used and, generally, are the cause of considerable confusion. To add to this, light has been extended to include "black" light that is the radiation in regions of the spectrum outside the visible range such as the ultra-violet and infra-red.

For the purposes of this discussion light will be considered as radiant power specified by a spectral distribution giving watts per unit wavelength. The device used in the am-

plification of light is, thus, essentially a power amplifier. It requires (1) an input consisting of a spot of light or a picture, (2) an output, again consisting of another spot of light or picture and (3) a source of power which supplies the larger amount of power required in order that the output be greater than the input.

In an electrical amplifier the input, output and power source are all electrical. In the amplifier of light, the input and output are, of course, light, but the power source is electrical. It is, therefore, necessary that the input light control the conversion into light of the larger amount of power supplied by the power source. As a result, there are the following two requirements of such an amplifier of light: (1) a method of converting electrical energy into light, and (2) a method of controlling, by means of light, the amount of energy converted.

There are, of course, many ways of converting electrical energy into light. Of these, two will be men-



Fig. 2—Photograph of a Laboratory Setup showing the Light Amplifier.

tioned. (1) is cathodo-luminescence whereby power of an electron beam on striking a phosphor is converted into light, (2) is electro-luminescence whereby the power of an a-c or d-c source on application to a suitable phosphor is converted into light.

The amount of electrical energy converted into output light using these methods may be controlled by the input light level with the aid of materials which are photo-sensitive.

#### A BASIC LIGHT AMPLIFIER

An older type of light amplifier which demonstrates these basic principles is shown schematically in Fig. 1.

This device operates as follows: the input light controls the number of electrons emitted by the photoemissive surface. These electrons are then accelerated to a high velocity by the 20-kv power supply. The amount of electrical energy converted into light by the phosphor is determined by the

number of high velocity electrons striking it. The output light is thus controlled by the input light incident upon the photo-emissive surface.

If the efficiency of the photosurface is adequately high and if a sufficiently high voltage power supply is used, the output light is greater than the input, and a gain greater than unity is obtained. The aluminum film on top of the phosphor is transparent to electrons, but opaque to light and serves to prevent regenerative feedback of output light into the input.

This form of light amplifier has many practical limitations, among which are: (1) the requirement of high vacuum, (2) the limitation in size, and (3) the need for a high voltage power supply.

#### A PANEL AMPLIFIER OF LIGHT

Another type of amplifier which does not have the previously mentioned limitations has been developed and can be made in the form of a thin panel of any size. Fig. 3 shows schematically such a panel amplifier of light. It is seen that besides the electroluminescent sheet which converts the a-c electrical power into light, there is a photoconductive sheet, which by controlling the amount of light incident upon it, determines the amount of electrical power converted into light. In addition, there is included a sheet which is opaque to light in order to prevent feedback of light from output to input. Such feedback, if excessive, would completely prevent the reproduction of half-tone pictures.

The principle of operation of this amplifier will be presented with the aid of Fig. 4. Fig. 4a represents a single element of the amplifier. Fig. 4b gives the equivalent circuit of the amplifier element. The variable resistor corresponds to the photoconductor and the capacitor to the "EL" (Electroluminescent) phosphor. The opaque sheet having negligible impedance is not included. The light output from the phosphor increases rapidly with the voltage across it as shown in Fig. 4c. The conductivity of the photoconductor varies with the input light, approximately, as shown in Figure 4d.

In the operation of the amplifier, a fixed alternating voltage is applied across the photoconductor (R) and

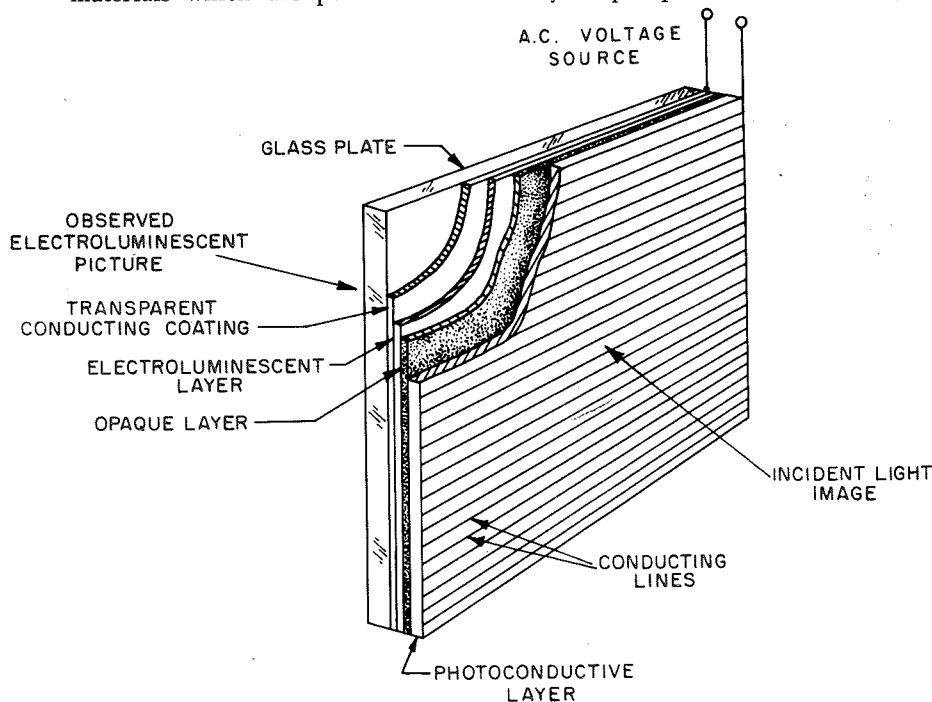
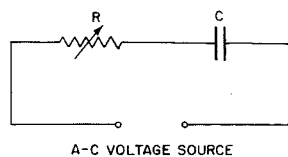
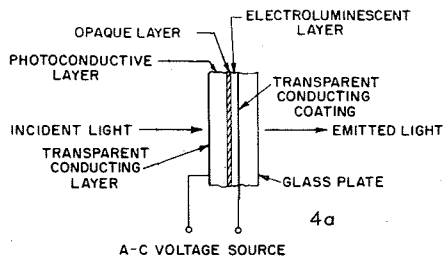
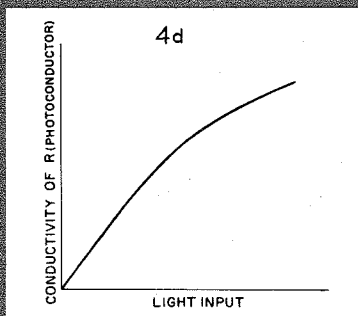
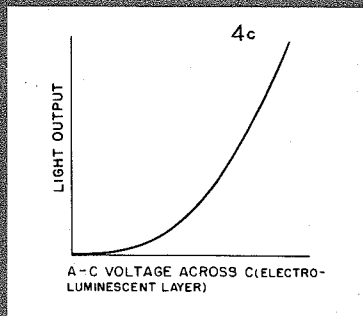

Fig. 3—Schematic showing a newly developed thin-panel Light Amplifier.



**DAVID W. EPSTEIN.** Dr. Epstein is the holder of a B. S. degree in Engineering Physics from Lehigh University and an M.S. and D. Sc. Degree in Electrical Engineering from the University of Pennsylvania. In 1930 he joined the Research Department of the RCA Victor Co., Inc., and transferred to the Research Department of the RCA Manufacturing Co. in 1935. Since 1942 he has been associated with the RCA Laboratories at Princeton, N. J. Dr. Epstein is Associate Director of the Electronic Research Laboratory and is primarily concerned with picture pick-up and reproducer devices. He is a Fellow of IRE and a member of the American Physical Society, the Optical Society of America and Sigma Xi.



Figs. 4a, b, c, and d—Diagrams and Curves illustrating the principles of operation of the Light Amplifier. Figs. 4a and 4b give circuit representations, and Figs. 4c and 4d are curves showing light output and conductivity characteristics, respectively.

“EL” phosphor (C). In the dark, the resistance of the photoconductor is very high and only a very small fraction of the applied a-c voltage will appear across C and “EL” phosphor will essentially not emit any light. If there is light incident on the photoconductor, the resistance R is reduced and an appreciable fraction of the applied voltage appears across C and the “EL” phosphor emits light.

#### COMPARISON OF CHARACTERISTICS

The spectral, decay and transfer characteristics of a light amplifier correspond in a general way to the frequency, delay and transfer characteristics of an electrical amplifier. There are, however, significant differences. Whereas, within the pass band of the electrical amplifier, the output is similar to the input, or, at least, has a fundamental component of identical frequency in the output and input, this need not be so in the amplifier of light, since the frequency or color of the output light generated need have no direct relation to the frequency or color of the incident light. As a result, the light amplifier is characterized by an input frequency characteristic (photo-sensitivity spectral response) and an output frequency response (spectral emission of luminescence).

In the case of the amplifier of Fig. 1, the decay characteristic is pri-

marily determined by the phosphor. The decay characteristic of the light amplifier of Fig. 3 is presently determined primarily by the photoconductor.

The transfer characteristic of the light amplifier of Fig. 1 is essentially linear. The transfer characteristic of the panel amplifier shown on Fig. 3 is non linear, i.e. the gain is a function of the light input which is shown on Fig. 5.

In general, the brightness gain of a light amplifier need not correspond to power gain. However, if an amplifier of light is defined as one wherein the color of the output light is approximately the same as the color of the input light, the brightness gain does often correspond to

the power gain. If the input and output colors are substantially different and there is a power gain, as in the case where the input is in the deep blue and the output is, say, green, it is more appropriate to call the device an amplifier-converter. If the device merely converts invisible light such as ultra-violet or infra-red into visible light such as green without power gain, it merely acts as a converter. A simple example of a converter is a phosphor excited by ultra-violet light.

In conclusion, it should be pointed out that the panel amplifiers of light developed at RCA Laboratories have been made up to 12" square and having a thickness only slightly larger than the supporting glass plate. The resolution of this type of amplifier is, in general, limited by the thickness of the layers used. In the case of the 12" panel built, the resolution was found to be over 500 television lines, and has been tested with a television picture input. The amplified picture did not suffer in resolution or contrast range, but because of the transfer characteristic shown on Fig. 5, the “gamma” of the amplified picture was greater than that of the input picture. Using the panel as an amplifier, a maximum power gain of about 20 was obtained.

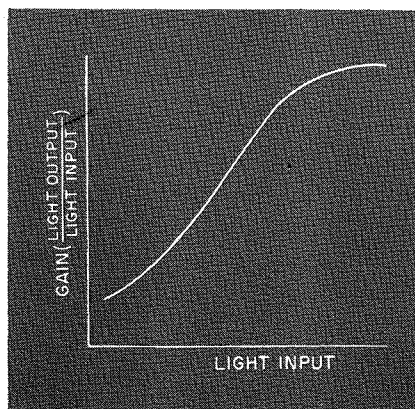

Fig. 5—Gain is a function of Light Input.

# ENGINEERING IN THE RCA VICTOR RECORD DIVISION

by **H. I. REISKIND**

*RCA Victor Record Division, Indianapolis, Ind.*

SINCE ONE of the objectives of this magazine is to familiarize the engineering personnel of the several product lines with the work of the other lines, I appreciate this opportunity to introduce our organization and its operation to the rest of RCA engineering. While some of you may be familiar with the record manufacturing operation, I believe that it will be best, for the majority, to assume only a layman's knowledge of records and the processes of making them.

The objectives, organization, and program of an engineering group is largely determined by the requirements of the product it services. In common with all of the Product Engineering Groups, we have, as major objectives, the improvement of product quality, the reduction of product cost, and the development of new products. Equally important to us, however, are developments to reduce the manufacturing time cycle and increase factory flexibility. Program

emphasis, to achieve these objectives, is placed more on material and process development, than on product design. The reasons for this lie in our product and in the nature of our business.

Underlying all else is the fact that we are selling recorded entertainment—"The Music You Want When You Want It." To satisfy customer requirements, we maintain a catalog of over 15,000 albums and single records. Each week we bring out a release of about 10 new popular records, and each month we introduce some 120 new albums and single records. Some of these selections sell for a long time, some are short-lived; some sell in large quantities and others in modest numbers. Sales of a particular selection can change rapidly; in the case of a popular hit, demand may increase many times over in a few days. To meet the requirements of this fast moving business, our distributors order daily, and

we make shipments to every distributor every day. In almost every case, complete orders of popular hits are shipped within 24 hours after receipt; all other merchandise, within 48 hours. It would be impossible to give this type of service, while maintaining inventories at a reasonable level, without a fast and flexible manufacturing operation.

Quality has always been important in our business and has become doubly so in this era of "High Fidelity." It may be divided into three areas: (1) sound quality (brilliance, definition, balance, etc.); (2) fidelity (frequency range, distortion, noise, etc.); and (3) physical quality (strength, resistance to warpage, and life). Sound quality is determined primarily by studio acoustics, microphones, and microphone placement. Recording equipment is, of course, important in fixing fidelity. The materials and processes used in manufacturing are of equal importance, and they are also the controlling factors for physical quality.

Finally, product cost is determined to a major degree by materials and processes. Through continuing improvements in this area, we are able to reduce the cost of our product to the consumer, as we did this last January, and thus reach a larger market.

With this as background it is not surprising to find that material and process development is a major portion of our work, and that close coordination with the operating groups—both recording and factory—is essential.

Our laboratory facilities consist of a small scale, but complete, duplicate of the recording and manufacturing operation supported by more conventional laboratory test and measuring equipment. It is staffed with 37 people, of whom 21 are engineers and supervisors, and organized as shown in Fig. 1.

Probably the best way to outline the operations of our group is to review the record manufacturing operation, stopping along the way to describe the function of engineering in each area.

In Fig. 2 is sketched the record operation divided into major functions. The incoming "raw materials"

## RCA VICTOR RECORD DIVISION

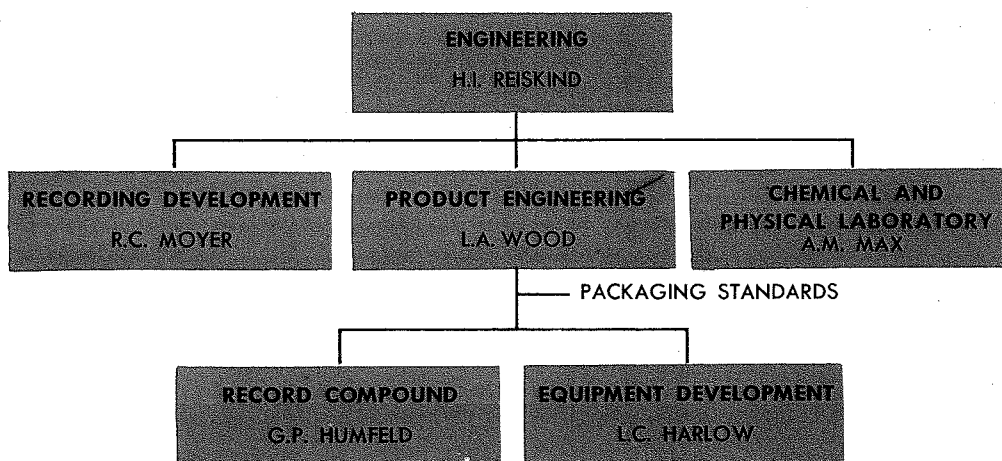

Fig. 1—Record Engineering Organization

and the product of each function are indicated. Under each block are listed the types of engineering involved.

#### RECORDING DEVELOPMENT

The first step is, of course, that of recording. Present techniques are to do all original recording on magnetic tape. This permits editing and recording where it is desirable to adjust balance, room tone, etc. The final tape master is re-recorded onto a lacquer disc of the speed and size of the desired finished record. These lacquer masters are sent to the manufacturing plants. The final tape master may also be duplicated and sent to the International Division in those cases where they intend to release that selection.

Engineering work in this area is the responsibility of our Recording Development Group under R. C. Moyer. Their interests include disc and magnetic tape recording and reproduction, both with respect to equipment and techniques.

Wherever possible, commercially available equipment is employed in our recording operations. In some cases, however, standard equipment does not meet our needs, and engineering modification is required. Tape recording mechanisms are a case in point. The flutter content of the better commercial machines is entirely adequate to meet normal demands. In many instances, however, the preparation of the final master tape requires several successive re-recordings in addition to the original recording operation. Since flutter is cumulative, it is essential that our machines have better than average motion, and methods of achieving this has been a responsibility of this group.

In other cases, it has been necessary to develop special equipment such as the Automatic Variable Pitch Control used in making the lacquer disc masters from the final master tapes. This device controls the spacing between grooves in accordance with the amplitude of the sound and thus permits increased playing times without requiring a reduction in level.

The question of recording and reproducing characteristics has claimed its share of attention. Those of you

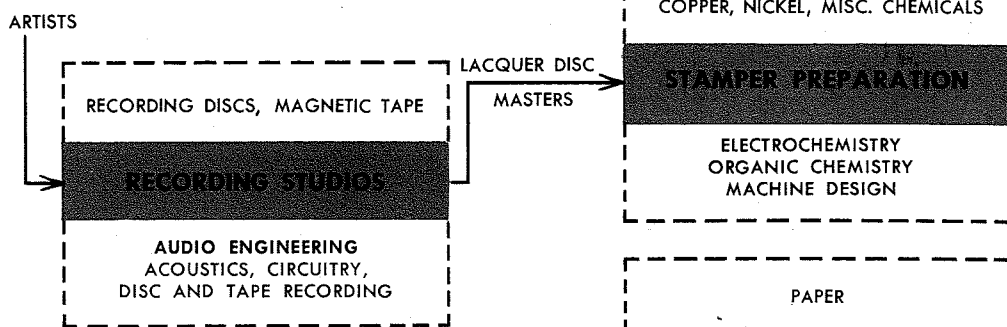

Fig. 2—Major Functions of Record Operation

who are interested in "High Fidelity" records and reproducers are familiar with the many characteristics used by the industry and the confusion this has caused. After a study of the various characteristics in use, we introduced the RCA Victor "New Orthophonic" recording characteristic. The success of this characteristic is evidenced by the fact that it has been generally adopted by the industry. It was accepted by the National Association of Radio and Television Broadcasters as their standard recording characteristic, by the Record Industry Association of America, and by the Audio Engineering Society. It is being employed by most of the domestic record companies, and we hope that in the near future it will be used universally and thus eliminate the need for providing multitudinous reproducing characteristics on phonographs.

#### METALIZING AND PLATING ACTIVITY

To continue with the production of our record, I mentioned before that the lacquer disc recordings represent the starting point for factory operations. From these lacquers, electroplating techniques produce stampers (these are metal negatives with ridges rather than grooves), which are used to mold finished records. The operations of making stampers are very important to final record quality. Mechanical cleaning of the intermediate parts (rubbing with an abrasive) can result in a loss of high frequencies and the introduction of distortion; plating defects result in ticks and pops and increased surface noise in the finished records.

Process requirements are much more severe than for either decorative

or protective plating. Low record noise requires extremely fine crystal structure and minimum porosity in the deposit. The deposit must have both high ductility and tensile strength to permit forming the stamper to the contour desired in the finished record and to withstand the large forces encountered in molding. We must be able to produce thick deposits (up to 10 mils in nickel and 20 mils in copper) which have low internal



Fig. 3—Corner of the recording room of the Record Development Laboratory. H. D. Ward is at bench preparing a stylus heating coil; B. J. White at recording machine.

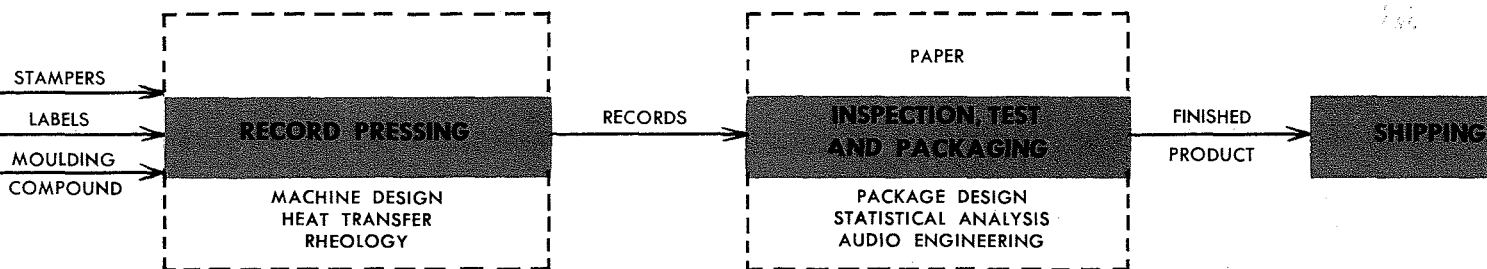

stress and are free of nodules. Finally, we want to produce stampers rapidly so as to reduce the time between recording and getting to market with the finished record.

The many problems in electrochemistry, organic chemistry, and metallurgy that arise from these varied requirements are the province of the Chemical and Physical Laboratory managed by Dr. A. M. Max. These problems will include such things as a study of methods of measuring and controlling stress in the electroformed nickel deposits; cooperative work with the Equipment Development group and Factory Engineering personnel to provide new equipment, or the development of a faster process to produce stampers.

An example of a faster method is the "plastic mold process," which permits the production of large quantities of stampers in a matter of hours and which has reduced the time required to reach peak production on

a new selection by 12 hours. Development of the process involved the modification of plating solutions, molding compositions, and press tooling, and thus required the coordinated team approach of several groups.

While stampers are being prepared, labels are being printed, and the plastic composition from which the records are molded is prepared. Surprisingly enough, labels introduce some interesting engineering problems. Paper must be strong enough to withstand the molding forces and, in the case of "45's," must have the proper surface characteristics to provide adequate friction between records. Inks must not decompose under molding temperatures or attack the plastic of the record.

#### RECORD COMPOSITIONS

Each of our record products ("45's," "78's," long play, children's, transcription, etc.) is made from a composition designed to fit the con-

ditions under which it will be played and the quality and cost requirements of that product.

All modern record compositions are thermoplastic molding compounds. They consist of thermoplastic resins, such as the vinyls or ethyl cellulose, combined with stabilizers, lubricants, colorants, and in some cases diluents and mineral fillers. The resin mixture affects the strength, warpage resistance, and wearing characteristics of the finished record. The amount and type of mineral filler will determine the surface noise as well as affect strength and wear. The temperature-viscosity characteristics of the composition controls the length of time it takes to mold a record and has some effect on quality.

The Compound Development Group is under the direction of G. P. Humfeld. The facilities provided include a Banbury mixer, roll mills, and record presses together with physical, chemical, and audio test equipment.

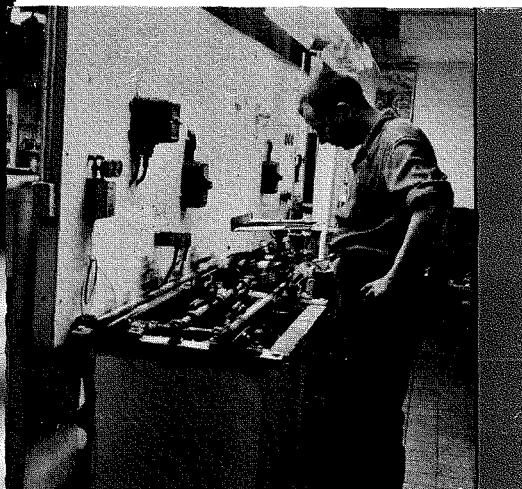

Fig. 4—The study of the control and methods of measuring electroformed nickel deposits are vital functions. Here, E. J. Duke is shown at work in the plating laboratory.

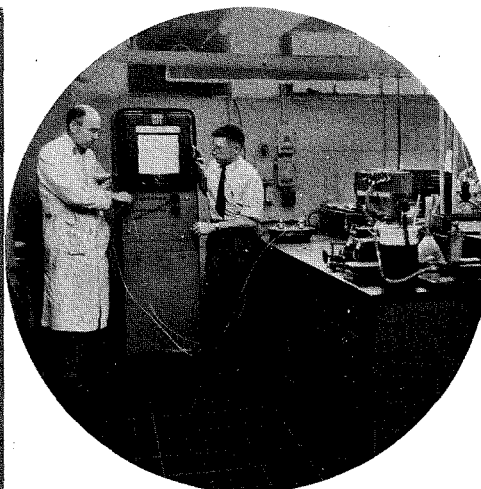

Fig. 5—Chemical and Physical Lab. left to right, S. D. Ransburg and R. G. Fox running heat transfer test on experimental high speed mold; M. L. Whitehurst is in back of equipment for measuring impurities in plating solutions.

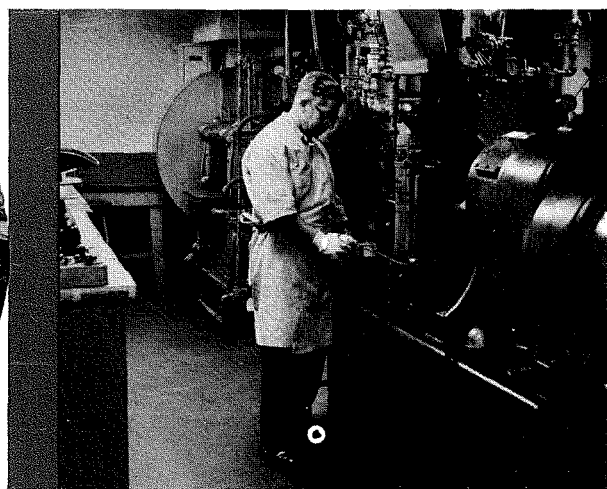

Fig. 6—Photograph of the compound preparation laboratory. Paulo Sickert is shown at Banbury mixer measuring the temperature of a compound just prepared—roll mill in center background.



In designing a composition for a specific application, a chemical engineer will specify a series of formulations which are prepared by laboratory assistants. Temperature-viscosity tests are run; records are molded and tested for noise and wear characteristics; tests are made of strength, flexibility, warpage resistance, etc.

Laboratory tests can determine whether or not a particular composition will produce good records. Unfortunately, we do not yet have sufficient basic knowledge of molding and plastics to evaluate compounding and molding performance from laboratory measurements and thus predict the effect of a new composition on factory operations. For this reason, the introduction of a new formula requires close coordination between laboratory and factory personnel.

Following laboratory work, a small pilot run, generally 1000 pounds, of the new composition is prepared in the factory and run in production under the joint supervision of Laboratory and Factory Engineering personnel. If analysis of the compounding and molding performance and tests of records made in this run fail to disclose any quality or production shortcomings, a larger run, generally 20,000 pounds, is made by Factory Engineering. With satisfactory performance of this run, the composition is standardized.

We do not carry on development of resins but rather depend on the major chemical and rubber companies and maintain close relations

with them. The rubber companies enter the picture because many of them are applying their knowledge of synthetic rubber to the plastics field. New resins, and modifications to existing resins, are being developed in great quantity, and we evaluate any that have any likelihood of being useful in a record composition. To paraphrase a famous saying, "Many are tested, but few are chosen."

#### RECORD PRESSING

In RCA Victor operations, records are molded, or pressed, by compression methods employing a flashing mold. The stampers are mounted on molds—platens cored for steam and water to provide heating and cooling. Preheated plastic compound is loaded between the heated stampers; pressure is applied while the record is molded and cooled.

Superficially, this appears to be a simple operation. Actually, it is a complex one, presenting difficult technical problems, and receives attention from essentially all of our laboratory groups.

The molding problem must be approached from the standpoints of (1) reducing the incidence of defective records so as to improve quality, and (2) increasing speed so as to improve order service and reduce cost.

I have already mentioned the importance of the temperature-viscosity characteristic. However, it is only a crude measure of molding performance. This is due to the viscoelastic properties of plastics; the fact that the stress-strain relation is time-depend-

ent. To illustrate this, consider the action of metal under compression or tension within its elastic limit. The mechanical analogue would be a spring whose deflection is proportional to load. Complete recovery occurs with removal of the load. In the case of a plastic, the comparable analogue is a spring in series with a dash-pot; the constants of the elements varying with temperature.

This factor of delayed elasticity introduces serious complexities into both theoretical and experimental studies of the molding operation. It is also a major factor in fixing the stresses set up in the record by the reproducing stylus and thus has a bearing on record life. For these reasons, rheology (the study of non-Newtonian flow of materials) is receiving attention in our Chemical and Physical Laboratory.

An obvious limitation to molding speed is the time required to heat and cool the stampers. Because of the high molding pressures (1800 psi), the cored platens must be strong and, in the case of the 12" long play record, we must heat and cool 50 pounds of metal in order to heat and cool the plastic material. Experimental work resulted in the designs which have been in production use for some time. These molds swing their surface temperature 260° F (between 350° and 90° F) in 9.5 seconds. Several years ago we decided to start a theoretical study of heat transfer. This study indicated a different approach to platen design and has re-

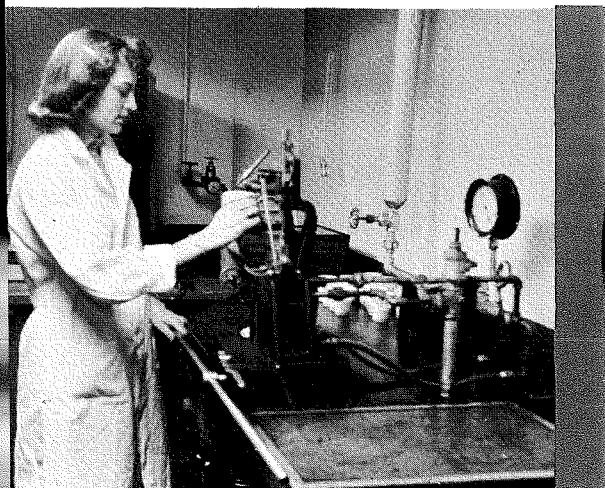

Fig. 7—Mary Cockerham running temperature viscosity characteristic of a plastic composition to determine its general suitability for production use.

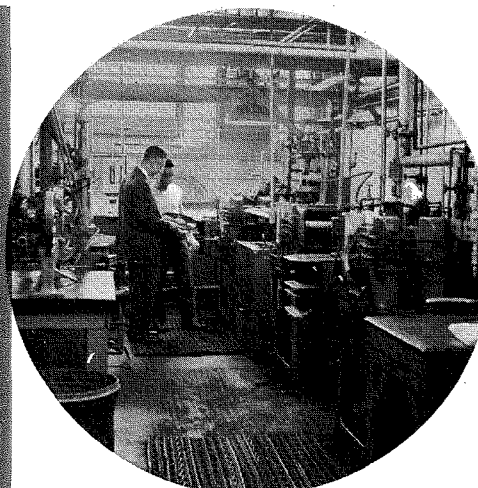

Fig. 8—G. P. Humfeld and Lysle Masters in laboratory press room. These presses are equipped with steam tables. Hopper for pre-form heater is in upper left.

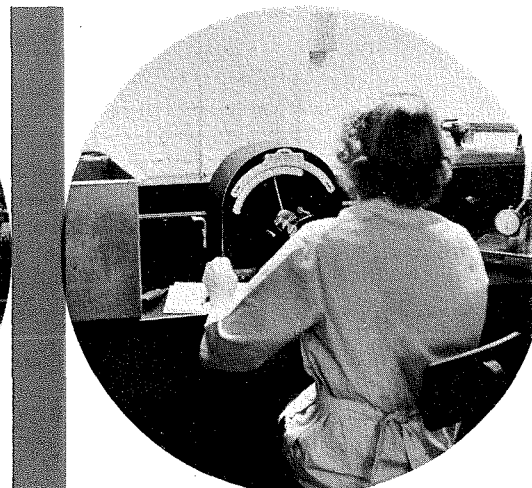

Fig. 9—Stress, strain and elasticity are all important characteristic to test. Helen Johns running flexural strength test on experimental record composition.

sulted in units, now under production test, which will swing the 260° F in 5.7 seconds. We expect these faster platens to reduce the pressing cycle of long play records from the present 50 seconds to 35 seconds.

#### EQUIPMENT DEVELOPMENT

The design of manufacturing equipment, such as record presses, and the development of new equipment to provide increased mechanization, is the responsibility of the Equipment Development Group under L. C. Harlow. They are a mechanical engineering and machine design group with experience in plastics and record molding.

The extruder preheaters which have replaced steam tables for preheating the plastic compound prior to molding were developed by this group. The traditional method has been to prepare the record compound in slabs, each the proper quantity for the type record being produced. These slabs were then heated on a large hot plate, located next to the record press (a cored, steam heated platen), and loaded into the press after they reached plastic temperature. To provide sufficient heating time, the steam tables were large enough to handle a number of slabs of compound—known in the industry as “biscuits.”

The extruder preheaters are similar to the injection cylinder of an injection molding press. They are steam heated, hydraulic actuated, piston extruders specifically designed for our operations. The vinyl resins used

to mold “45’s” and long play records tend to decompose under prolonged exposure to high temperatures and for that reason, among others, are not considered suitable for injection machine use. In the preform heaters, it was necessary to consider this decomposition characteristic. Special alloys were used for cylinder walls and piston, and the heating cylinder was designed for the proper time-temperature relation to minimize decomposition.

These units feed an accurately measured quantity of compound, heated to the correct temperature, at the correct time in the molding cycle and have resulted in a large increase in press output. Because they control compound temperature and shot weight better than was possible with biscuits, some of the pressing operation variables have been removed.

The Equipment Group has developed an automatic press to produce “45’s,” and we now have several in pilot operation.

The completed record must be packaged, and here we work closely with our Merchandising and Purchasing Groups and our suppliers. The major requirements of the package are that it be attractive, and adequately protect the record. The materials from which it is made, primarily the adhesive, must not attack the plastic record; and it must not be too expensive. The ideal record package has yet to be designed; but the problem is receiving a great deal of attention.

The end objective of our work is to provide specifications for products, materials, and processes, which are used primarily by Purchasing, Manufacturing, and Accounting. To do this, we employ a standardizing system, modeled after the Tube Division system, which has worked out very satisfactorily.

#### RECENT PRODUCTS

Throughout this review, I have been concerned primarily with materials and process development for the reasons outlined at the start. However, the development and introduction of new products and the redesign of existing products also are essential to assure continuing leadership and an expanding market. Here again, we must be concerned not merely with the

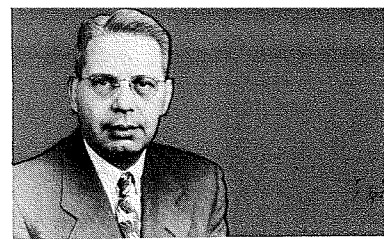

**H. I. REISKIND**, Chief Engineer, RCA Victor Record Division, has had over 25 years of experience in the motion picture and record engineering field, and is an authority on this subject. Mr. Reiskind's technical biography may be found in this issue. See "Introducing Your Engineering Leadership at the Various Product and Service Locations."

design of the new product, but also with the materials, processes, and equipment to produce it.

The “45” extended play record resulted from improvements in recording techniques worked out by our Recording Development Group and the Recording Studios.

The Gruve/Gard design has materially improved the long play record by reducing susceptibility to surface scuffing. The selection of the final contour and the reduction to practice of this design involved molding tests, the redesign of press tools, the development of methods of forming the stamper, a warpage evaluation, and field testing to assure that operation on changers would be satisfactory. At some point in the work, each group in the laboratory was involved.

Magnetic tape phonograph records, both single channel and stereophonic, were introduced in May, 1954 and are the newest product of the RCA Victor Record Division. Duplicating equipment had previously been developed and built by the Recording and Equipment Development Groups, and production has continued under their supervision.

One of the advantages that RCA has in the field of recorded entertainment is that we produce recording equipment, records, and reproducers. Liaison with the other interested product lines, so that records and equipment are coordinated, is important and a close relationship is maintained.

Most important is the fact that engineering developments do not pay dividends until they become part of the product. For this, we depend on our manufacturing people, who have been both imaginative and cooperative in putting our developments into production.

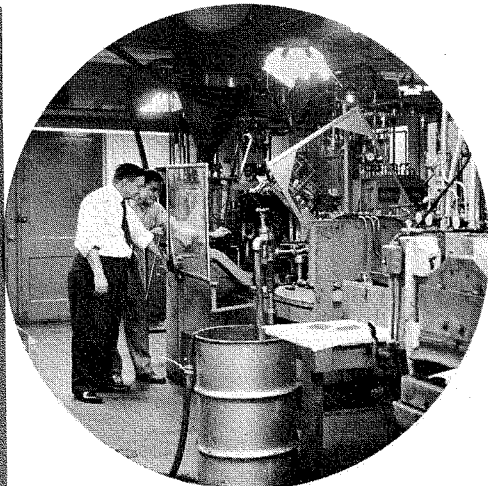
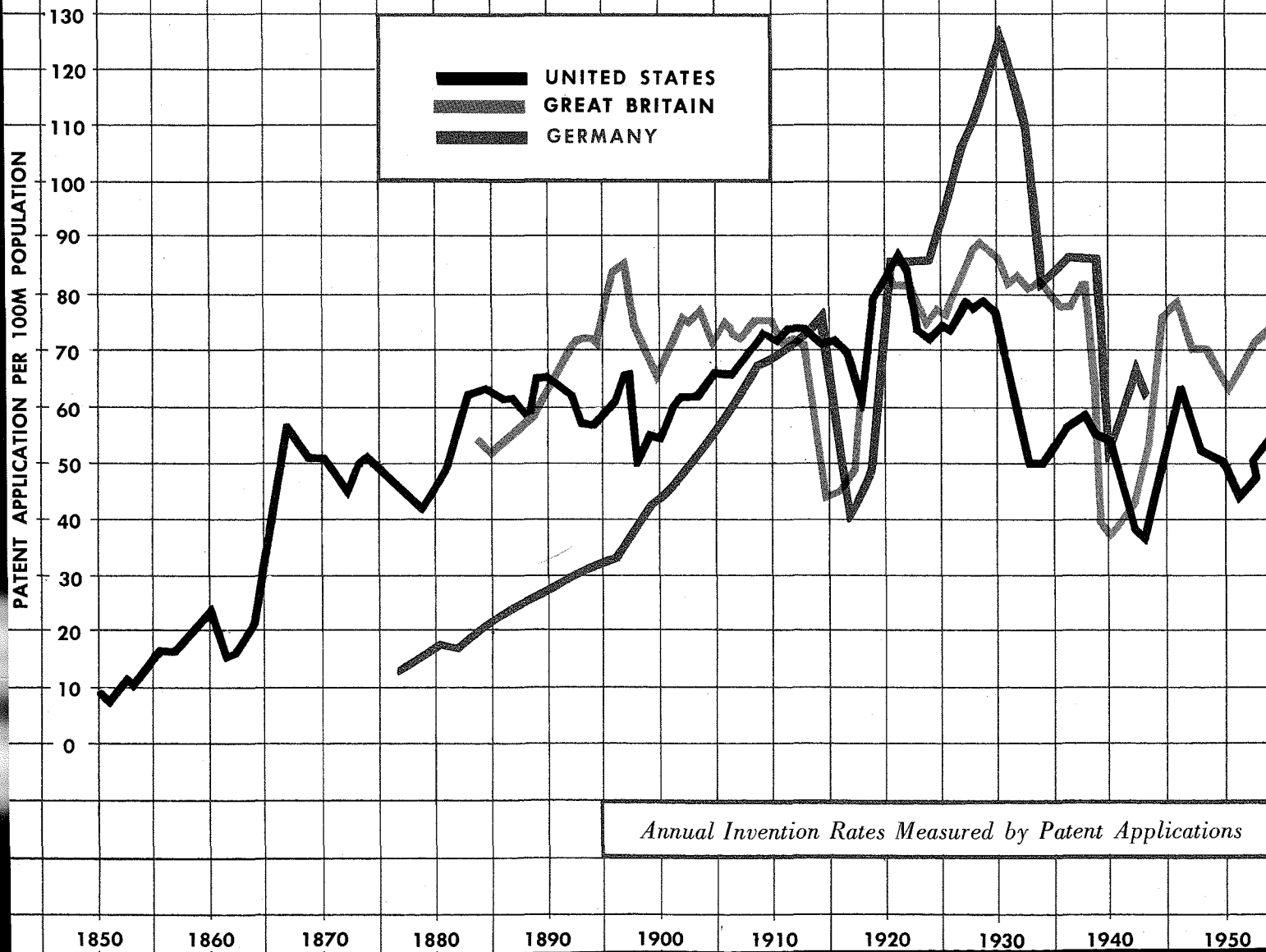
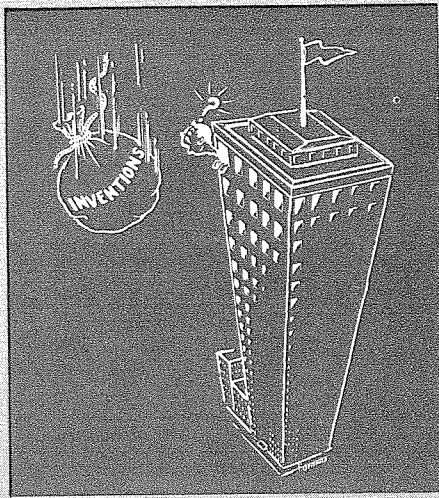

Fig. 10—Equipment laboratory. J. J. Kimbro and S. W. Liddle (left to right) at automatic press.

# INCREASING CREATIVENESS IN ENGINEERS



*Annual Invention Rates Measured by Patent Applications*



Invention Rate Falling

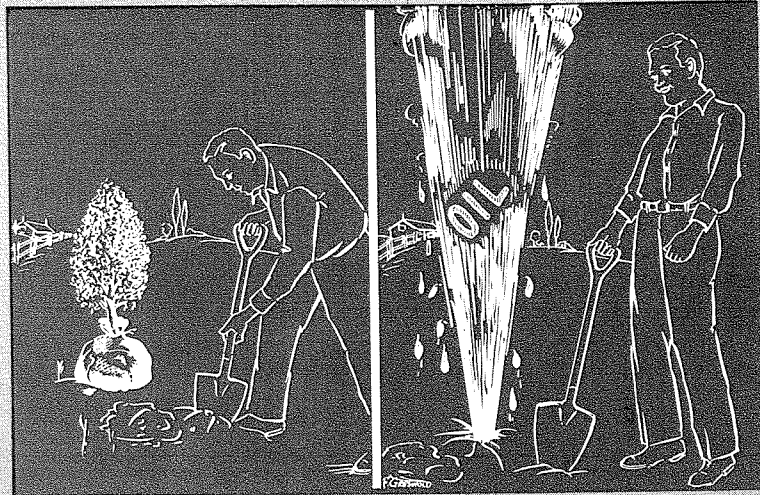

Serendipity

by **C. D. TUSKA**, *Patent Operations*  
*RCA Laboratories, Princeton, N. J.*

**E**NGINEERING CREATIVENESS, like inventiveness in any field, requires the appearance of certain fundamental acts; a mental act, an element of skill, and a requirement of novelty. This is invention, pure and simple. This article will attempt to treat these fundamentals and expand a few to point out where a *little* more effort in the right place might produce a *lot* more creativeness in your work.

The only true barometer of creative endeavor is patents and patent applications. Inventiveness per capita per year in the United States, measured by patent applications, shows a peak after World War I and thereafter a decline of 40 percent to date. The inventive rate in Great Britain, measured by a similar scale, is only down 17 percent from the 1928 peak. The per capita patent applications in Great Britain now exceed that of the United States. Germany's per capita patent applications in the early 1940's were down about 50 percent from their 1930 peak which exceeded the United States and Great Britain. (These figures do not exactly indicate the national invention per capita rate for United States, Great Britain or Germany, because in each case foreign origin patent applications are included.) The latest figures for Germany are not available. While it is not known what effect the division of Germany may have, I expect that the recovery noted in other fields also

applies to invention, at least in Western Germany.

A Bill (H. R. 4267) recently introduced in the Congress by Representative Hosmer proposes that a Commission be established to investigate and study our patent laws. The Commission is to determine "what changes . . . are necessary . . . to promote a greater contribution to continued technological advancement by the United States, with particular regard to the problem of how to stimulate an increased contribution on the part of the individual inventor." Let us hope that the proposed Commission does not conclude that an increasing *number* of U. S. Patent Applications means that we do not have a falling *rate* per capita. In these times of international stress, I believe, we should be concerned with relative international rates, and especially with our own declining rate.

Now that it has been pointed out that quantity of inventiveness appears to be falling, there is no need to use much space looking for explanations. Neither should we blame the Republicans or the Democrats because most of us are one or the other (or neutral) so in the final analysis it is our own fault. Rather than to place blame, I want to illuminate a few points. Some of the crannies may be obvious, some may be forgotten, but there is always a chance that a shot in the dark will start you on a path to invention.

**ADVERSITY:** Most of us have heard or read that necessity is the mother of invention. According to my theory, adversity also helps. If my theory is correct, the curve for Germany should take, or probably already has taken, an upward trend. Anyway, apply the adversity theory and you'll find that not a few inventions were begat under that kind of stress. If you demand examples, study Morse's invention of the telegraph, Bell's telephone, Goodyear's vulcanization of rubber, Holland's submarine, and there are many more. Please do not think I advocate poverty, ill health, or any other misfortune just to advance invention. You may have adversity in the form of apparently insoluble problems at home. Direct your mind toward invention. Not only will mental concentration in another field lighten your burdens, but you may make a discovery or invention of great merit.

**SERENDIPITY:** That tinkling word was coined by Walpole. It means the gift of finding valuable or agreeable things *not sought for*. Serendipity is certainly a happy state of being when it leads to invention. In seeking a super high-frequency amplifier do not let surprise brush away a discovery of a very stable and powerful super high-frequency oscillator. True you were not looking for the latter, but be sagacious enough to examine what you found. There was plenty of serendipity in Thomas Edison for I believe it was that state which brought him to the phonograph! Don't overlook what you were not seeking!



Curiosity



Synthesis



Recognizing the Problem



**CLARENCE D. TUSKA.** Author of text books on the subject of patents and an authority in his field, Mr. Tuska also has numerous articles to his credit. He has had 45 years of experience in the radio, electronic, and broadcast engineering fields. He has been associated with the Patent Department of RCA since 1935 and became Director of it in 1947. Mr. Tuska has 18 U. S. Patents to his credit (15 sole inventions and 3 joint inventions).

**CURIOSITY:** The word curiosity has a connotation implying meddlingness. "Curiosity" herein has the sense of "careful attention" and "disposition to inquire." Newton's formulation of the laws of gravity may have been started by curiosity. Don't you suppose that curiosity was the important factor first in Zacharias Jansen's and later in Anton Leeuwenhoek's inventions of the microscope? Perhaps it was an ingredient in the invention of the stethoscope. If you would invent, be curious! When you observe the unusual, ask yourself "why?," not "so what?" Furthermore, you may not observe, unless you pay careful attention. Nature has a way of sometimes hiding her secrets; pry into them. Cultivate scientific curiosity!

**NONIMITATIVE:** If you would invent, be nonimitative. The important discoveries and inventions are more apt to occur when exploring a new path. Be sure to keep your mental scouts alert. Do not travel an uncharted path so fast that the scouts cannot, *on proper occasion*, mentally trod an attractive byroad. Even a "dead-end" street could have a treasure at the end; then perchance it may not be a dead end. T. Brown seemed to express the point when he wrote: "Not picked from the leaves of any author, but bred amongst the weeds and tares of mine own brain." Avoid imitation—it stifles invention!

**SYNTHESIS:** In an article in the February 1955 issue of *Nation's Business*, titled "Here's How to Train Your Own Inventors," Richard Gehman identified two approaches to solve a problem—analysis and synthesis. He then defines synthesis as "a solution that is based on hunch or intuition." Gehman's article states that the analytical approach "examining each aspect step-by-step rarely leads to creation." Felix Morley, in the same publication, while discussing the problems of personnel and public relations wrote ". . . And where solutions will not come out of test tubes, or off drawing boards, mere technical efficiency sometimes seems more of a handicap than an asset."

It may be true that asymmetrical scientific training may discourage invention. One who foresees only all of

the difficult technical problems, can too easily conclude that the problem at hand has no practical solution. However, many with all the essential scientific facts tucked away in their minds can, sometimes without conscious effect, emerge with an almost complete solution of a baffling problem. You can call it synthesis, intuition or hunch. Distinguish it from analytic, if you wish, but do not overlook the mental process of "forgetting the problem for a while." If you do, you may suddenly be surprised by having a workable, ready-made invention pop out of your "unknown" mental excursions. In urging that you be mindful of the "subconscious" approach to invention, please do not get the notion that I am against excogitation, for I am not.

**RECOGNIZING THE PROBLEM OR THE NEED:** Dr. John M. Miller, who was awarded the Institute of Radio Engineers Medal of Honor in 1953, once told me that recognition of the problem was not infrequently the royal road to invention. If the problem is stated very clearly, the solution may come almost automatically. Recognizing an unsatisfied public need for a particular device, can often inspire one to make the required invention. When we have the clearly stated problem or have visions of the desirable but unavailable article, the mental approach may be analytic or synthetic. Apparently the patent conscious inventor need not be too concerned as to the manner\* in which he made the invention. Anyway see if you can't recognize some problems or needs, and then persistently seek the solution.

**THE HAPPY ACCIDENT:** When Robert Burns wrote: "The best laid schemes o' mice an' men gang aft a-gley," he did not have in mind a "happy accident." But I say to you, when your experiment "gang aft a-gley," most carefully examine the unexpected, and even the undesired. Therein you may find "a happy accident" or a great invention. Serendipity, curiosity, and sagacity should join hands with you if you are to discover something important, in your failures to reach the original target of your quest.

\* ". . . Patentability shall not be negated by the manner in which the invention was made." 35 USC 103.

Recently, Dr. Harry Olson recited that he was hard at work on his ribbon or velocity microphone. (Olson U. S. Patent 1,885,001 "Apparatus for Converting Sound Vibrations Into Electrical Variations"). He did not understand why the rear response was practically non-existing. He had expected non-directional response pattern. Searching for the cause he found that the mechanic, in building the model, had failed to cover a hole. A finger over the hole clearly demonstrated the error.

Many might have remedied the mistake and moved on to the desired result. Dr. Olson not only found the cause but recognized the invention or discovery of an improved microphone (Olson U. S. Patent 2,301,638 "Sound Translating Apparatus") in which the response pattern could be readily changed. It takes a sagacious inventor to recognize and to profit by the happy accidents.

Charles Goodyear said it this way: "I was encouraged in my efforts by the reflection that what is hidden and unknown and cannot be discovered by scientific research, will most likely be discovered by accident, if at all, by the man who applies himself most

hastily conceived and hurriedly built a rubber band powered toy ornithopter. The device was presented and the unexpected happened: it actually flew and attained an altitude higher than its launching point. Spencer then decided he had something. He reasoned that if he carefully constructed a second model, it would perform better. The second model was made with all the precision he could command. The well constructed model failed to fly! After recovering from the surprise, Spencer started to reason, and to compare the precise model with the earlier model. He discovered that the first model had included, albeit unintentionally, misaligned pivots or bearings for the main wing spars. The misalignment caused the wing to sweep to the rear on the up stroke and forward on the down stroke. This wing motion, quite by accident, produced "lift." In the precise model the wings simply rose and fell but did not lift. Spencer had made a discovery—a patentable invention (Spencer U. S. Patent 1,907,887 "Toy Aircraft").

IMAGINATION: Thus seven circumstances of invention have been

have cultivated it but you certainly have not lost it. Emerson wrote: "Imagination is not a talent of some men but is the health of every man."

I could write at length on constructive imagination, creative imagination, productive imagination, and many other forms of visionary thinking. Fortunately, that is not necessary because I can refer to "Applied Imagination—Principles and Procedures of Creative Thinking" by Alex F. Osborn. Read this recent book or one of Mr. Osborn's earlier works if you would awake or stimulate your imagination.

#### CREATIVE IMAGINATION X PROPER EFFORT = SUCCESS

Favorable circumstances, and an abundance of creative imagination will surely stimulate invention. You can even throw in luck, but certainly the essential ingredient has not been named. Unfortunately, I do not know the word for it. A recent newspaper article stated that Dr. Harrison G. Gough, a research psychologist at the University of California, discovered a way to test for "it." He tackled the problem—"why some gifted persons make a place for themselves in the world and why others with equal gifts wander aimlessly and let their gifts go to waste." Dr. Gough provided the name "psychological persistence." However, I shall call the essential ingredient "effort."

Frequently the difference between success and failure in invention is "effort." Surely few inventions are born without effort. You may go through all the mental steps, but do no more, and your invention will die aborning. An invention, if it is to have the slightest patentable significance, must be disclosed to others. That takes effort. The disclosure should be in writing. That too takes effort. Constructive reduction to practice, i.e. filing a patent application, takes more effort. Actual reduction to practice takes still more effort.

Perhaps a summary in algebraic equation form might be helpful:

(Surround yourself with favorable circumstances) + (Exercise creative imagination) × (Apply effort . . . + apply effort!) + (k, where k = good luck) = One approach to invention.

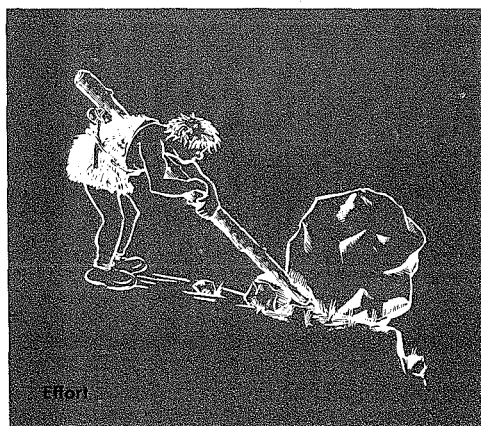
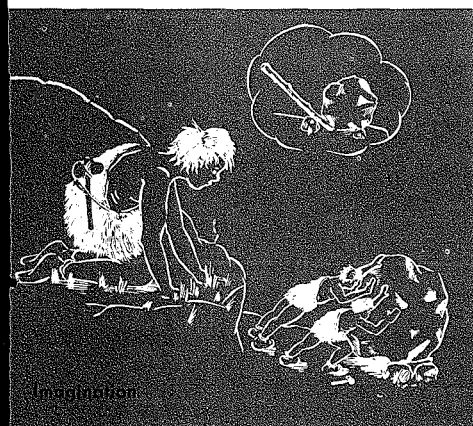

perseveringly to the subject and is most observing of everything related thereto."

Perhaps you would like another example of the "accidental" invention. My good friend P. H. Spencer, the inventor-son of a Yankee inventor of great note, suddenly realized that "tomorrow" would be his child's birthday. He had forgotten to buy a present. The stores were closed. He hastened to his shop and equally

characterized. Doubtless there are many others. Mere circumstances, however, are not sufficient to foster invention. Invention requires something more. Some mental act must be applied. The invention must be "conceived." Let us avoid problems of psychology and semantics by calling the mental act "imagination." You may protest that you don't possess imagination. Most children have it to a high degree. You may not

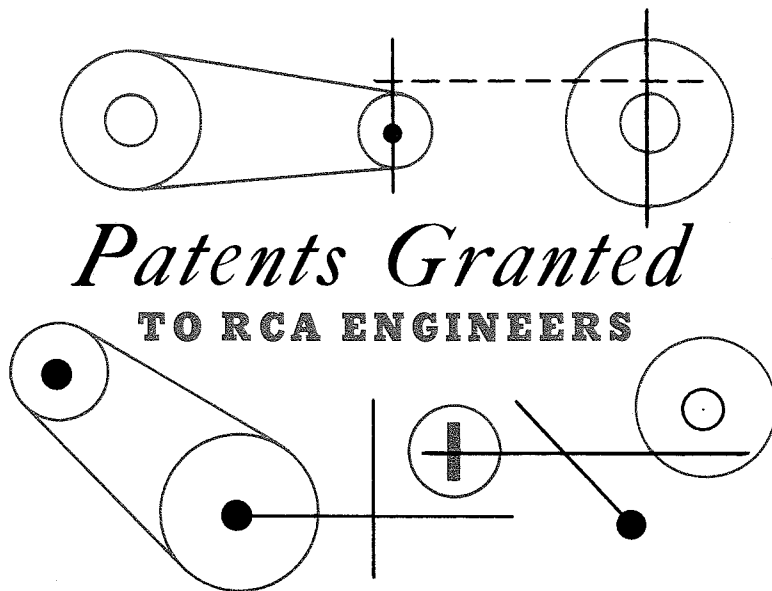

**FREQUENCY MODULATION** (Patent No. 2,703,387)—granted March 1, 1955 to O. B. DUTTON, ENGINEERING PRODUCTS DIVISION. The invention concerns the frequency modulation of crystal oscillator by connecting an LC parallel resonant circuit across crystal and a reactance tube across the parallel circuit. The r-f excitation for the reactance tube grid is supplied by way of a coil inductively coupled to the L of the LC circuit.

**FILM DRIVE MECHANISM FOR MOTION-PICTURE APPARATUS** (Patent No. 2,702,705)—granted February 22, 1955 to J. L. PETTUS, ENGINEERING PRODUCTS DIVISION, Hollywood, California. This invention relates to an automatic clutch starting unit or adjunct for the film driving system of a recorder or reproducer. To accelerate a film-pulled drum flywheel shaft at the same rate as a sprocket, a solenoid connects a positively driven clutch to the flywheel shaft during the acceleration period.

**DATA TRANSLATING SYSTEM** (Patent No. 2,702,380)—granted February 15, 1955 to J. A. BRUSTMAN and KUN LI CHIEN, ENGINEERING PRODUCTS DIVISION, Camden, N. J. This invention relates to a translating system for reading information stored on a first data storage medium, supplementing that information, rearranging the sensed and supplementary information, verifying the rearranged information, converting the verified information into a different code, and recording that information on a second data storage medium. For example, the first storage medium may be punched cards and the second storage medium may be mechanical tape. The cards are sensed at one sensing station and the signals so obtained are supplemented by signals from a special signal generator. The information is rearranged by means of a plug board and stored on a mechanical drum. The same card is then sensed a second time. The data on the drum is compared with this second reading for accuracy, while being converted at a code translator and recorded on mechanical tape.

**METHOD OF MAKING FINE MESH METALLIC SCREENS** (Patent No. 2,702,270)—granted February 15, 1955 to D. J. DONAHUE and A. M. RENNIE, TUBE DIVISION, Lancaster, Pa. The invention relates to an improved method of making metallic screens of very fine mesh and having a gossamer-like thinness. A ceramic master having a network of ruled grooves is coated with a very thin layer of wax, then a thin coating of sputtered metal, such as palladium. Sputtered metal and wax is removed from all of the raised areas between the grooves and the remaining sputtered metal is electrodeposited with an additional metal such as nickel. The screen is subsequently separated from the master.

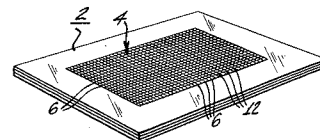

Pat. No. 2,702,270

**DOUBLE-TUNED FILTER STRUCTURE** (Patent No. 2,702,373)—granted February 15, 1955 to WEN YUAN PAN, TELEVISION DIVISION, Cherry Hill, N. J. This invention relates to a resonant structure suitable as a signal band-pass filter and tunable over a portion of the ultra-high-frequency range. As shown in the illustration, the filter structure consists of two circuit structures 10 and 11, each being equivalent to a series resonant circuit. Each series resonant circuit has two capacitances formed between the coatings, 13, 14, and an associated tuning core. Furthermore, each circuit structure comprises inductance represented by the inductors 15, 16. The width of the pass band is determined by the distance between the two circuit structures 10 and 11. The width of the pass band is constant throughout the tuning range because the coefficient of coupling is uniform.

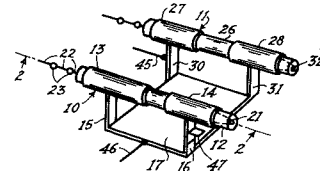

Pat. No. 2,702,373

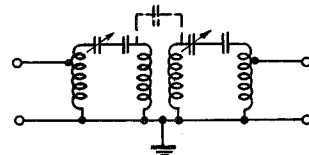

**SIGNAL SELECTING CIRCUITS FOR UHF TELEVISION RECEIVERS AND THE LIKE** (Patent No. 2,702,344) granted February 15, 1955 to L. A. HOROWITZ and D. J. CARLSON, TELEVISION DIVISION, Cherry Hill, N. J. The structure comprises pairs of flat arcuate strip inductors located on opposite sides of a shield wall. The wall has apertures for permitting a controlled degree of coupling between the tuner circuits. Two different UHF channels may be selected by the selector switch that is connected with the two inductors via the tap connections. Low cost, as well as uniform performance characterize this construction which was used in the U-2 converter or the u-h-f television band.

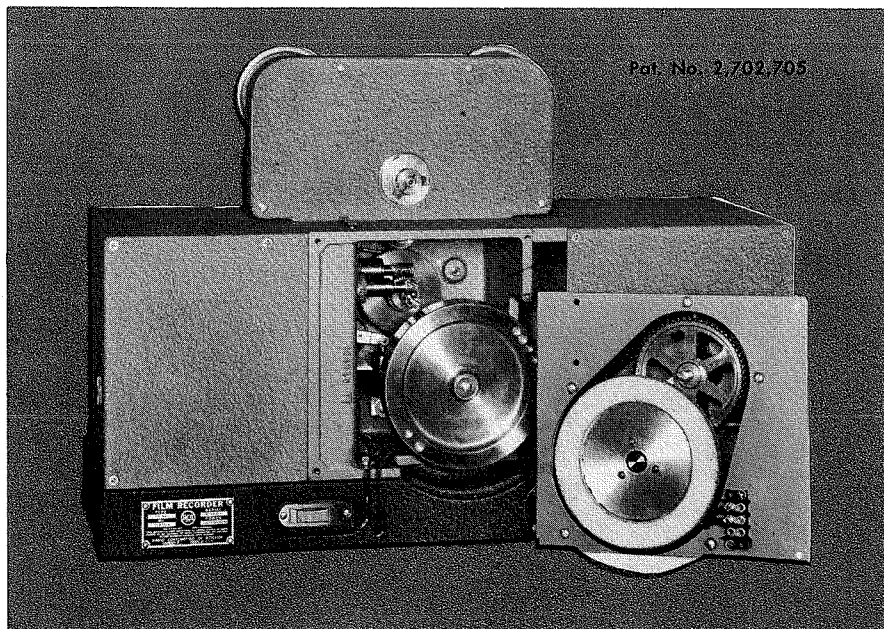

Pat. No. 2,702,705

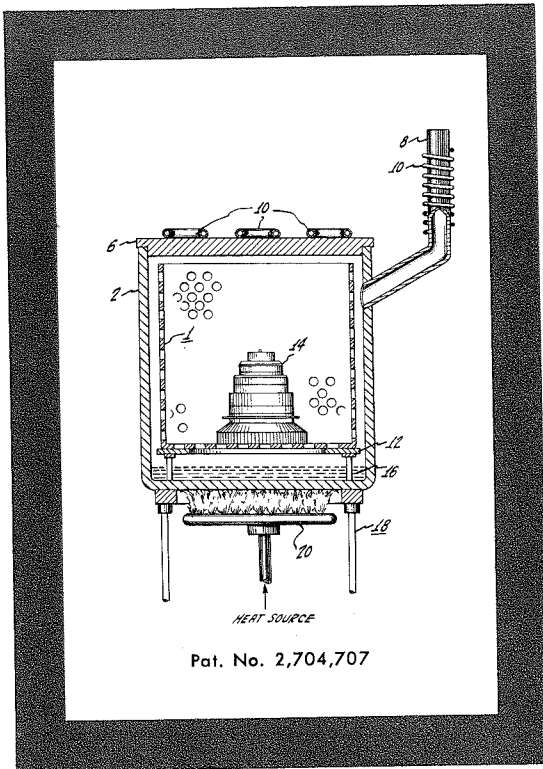

**METHOD OF SALVAGING BRAZED ASSEMBLIES** (Patent No. 2,704,707)—granted March 22, 1955 to M. B. LEMESHKA, TUBE DIVISION, Lancaster, Pa. This invention provides improved methods of separating “brazed-together” metal parts. A brazed-together high-power tube is immersed in mercury vapor. The brazes are dissolved by the vapor so that the tube parts are readily salvaged for re-use.

**DELAY LINE** (Patent No. 2,704,829)—granted March 22, 1955 to B. R. CLAY, TELEVISION DIVISION, Cherry Hill, N. J. This invention relates generally to an electrical delay line which provides phase velocity compensation for different frequency components of signals propagated. It is an improved compensated time-delay line which is light, strong, compact, and easily fabricated. A pair of dielectrically insulated helices are capacitively coupled to each other, and the helix having the greater diameter serves as a shield for the delay line. Spacing between successive turns is selected to provide the correct ratio of shunt capacity-to-distributed capacity for phase-velocity compensation.

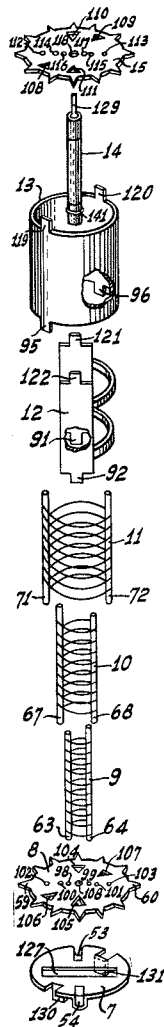
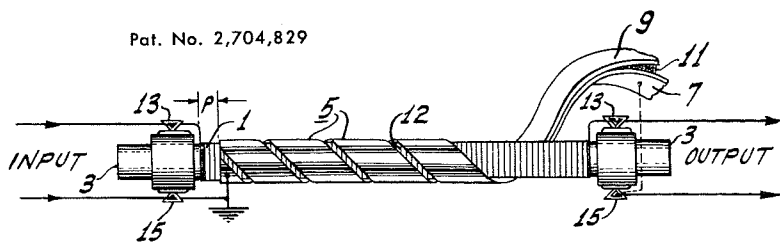

Pat. No. 2,706,232

**COMBINATION JIG AND WELDING APPARATUS** (Patent No. 2,706,232)—granted April 12, 1955 to F. J. PILAS, TUBE DIVISION, Harrison, N. J. This invention pertains to an apparatus for assembling the components of an electron discharge tube and particularly to a novel combination of means for retaining components in assembled relationship and, while so retained, welding the components together. It reduces the number of manual operations, danger of upsetting the spatial relationships between components, or damage to parts during assembly and welding operations. A pair of pivoted arms bearing welding electrodes are so designed that welding can take place automatically on the jig while the tube components are retained in assembled relationship.

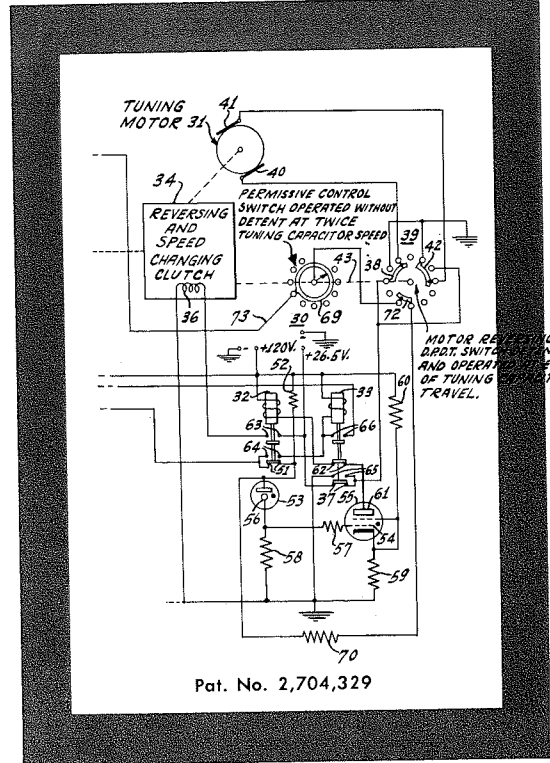

Pat. No. 2,704,329

**FREQUENCY CONTROL SYSTEM** (Patent No. 2,704,329)—granted March 15, 1955 to C. K. LAW, ENGINEERING PRODUCTS DIVISION, Camden, N. J. This invention relates to a system for controlling the frequency of a variable-frequency oscillator which is used as a master oscillator for heterodyning purposes in a communications radio transmitter-receiver. Outputs of final oscillator and final mixer are compared in a phase discriminator whose output controls both a tuning motor and a reactance tube. The latter functions to very rapidly tune “captive” oscillator to correct selected frequency.

**METHOD FOR PRODUCING A FLUORESCENT SCREEN AND PRODUCT** (Patent No. 2,704,726)—granted March 22, 1955 to J. A. MARKOSKI, TUBE DIVISION, Lancaster, Pa. This invention relates to improved phosphors and screens which result from use of the following improved method. Phosphor particles are coated with a film which corresponds in composition to zinc metasilicate and then a film of zinc phosphate while suspended in an aqueous medium. The coated phosphor particles are thereby deaggregated during the manufacture of luminescent screens by the settling technique.

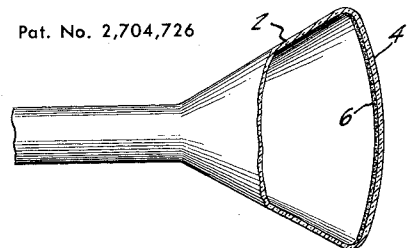



**PATENTS GRANTED**

*continued*

**ELECTRON DISCHARGE DEVICE** (Patent No. 2,705,294)—granted March 29, 1955 to M. B. SHRADER, TUBE DIVISION, Lancaster, Pa. This invention relates to power tubes designed to operate at very high frequencies. It provides an improved power tube capable of operation and of high power output at v-h-f. An anode shield comprising a flat circular ring is mounted on the inside diameter of the anode. It protects the envelope from bulb bombardment and thermal radiation yet permits short leads essential to v-h-f circuits. A two-piece molybdenum filament cap, and a channel beam former are other novel features.

Pat. No. 2,705,294

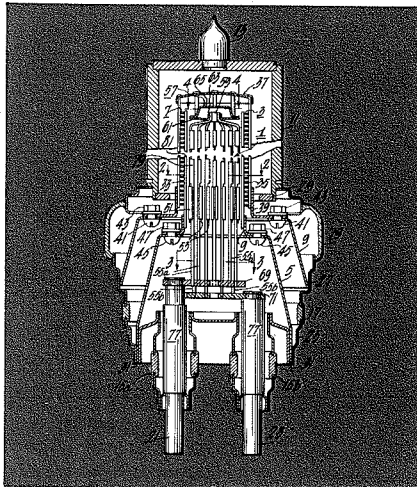

**NULL DETECTOR** (Patent No. 2,702,854)—granted February 22, 1955 to W. E. WOODS, ENGINEERING PRODUCTS DIVISION, Camden, N. J. This invention relates to a null detector circuit for producing an output signal at the instant one or more input signals pass through a predetermined voltage. The null detector of the present invention is particularly useful in electronic locating, telemetering, and radar systems generally. Operation is essentially as follows: The null detector comprises a difference amplifier wherein the cathodes of triodes 14 and 22 are connected to each other and to a source of negative potential through resistor 28. An input signal applied to input terminal 10 is fed to grids of tubes 14 and 22 through two parallel branches providing positive and negative polarity limiting, respectively. When the input signal passes through ground potential, an output signal is derived from the anode of the triode 22.

Pat. No. 2,702,854

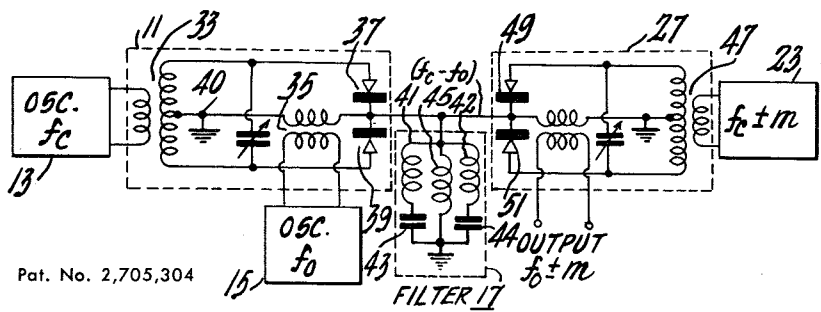
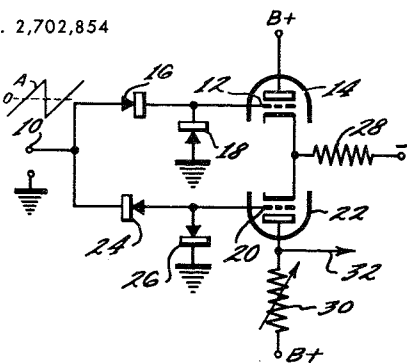

Pat. No. 2,705,304

**BRIDGE DEMODULATOR CIRCUIT** (Patent No. 2,705,304)—granted March 29, 1955 to O. O. FIET, ENGINEERING PRODUCTS DIVISION, Camden, N. J. This invention pertains to an improved demodulating system and more particularly to a monitor system wherein double heterodyning is employed utilizing two bridge-type or balanced mixer circuits. The figure above shows a demodulator of the offset-frequency, oscillator type, including two balanced-bridge mixers. Each balanced mixer is constructed of coaxial conductors arranged as a split balun bridge (G. H. Brown, Patent No. 2,454,907) and including crystal diode rectifiers to provide balanced mixer operation.

**TRAFFIC CONTROL BY RADAR** (Patent No. 2,702,342)—granted February 15, 1955 to N. I. KORMAN, ENGINEERING PRODUCTS DIVISION, Moorestown, N. J. This invention relates to traffic control and more particularly to vehicular traffic control. The invention may be used for the control of traffic in other than railway traffic control systems, wherever it is desirable to establish an assured clear distance for the vehicles or objects, the traffic of which is to be controlled. It provides a method and system for controlling the traffic of vehicular objects generally, whether along an established right of way or not.

Pat. No. 2,702,342

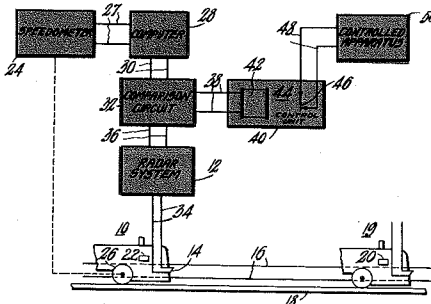

**TUNING MEANS FOR DIELECTRIC FILLED CAVITY RESONATORS** (Patent No. 2,704,830)—granted March 22, 1955 to C. A. ROSENCRANS, ENGINEERING PRODUCTS DIVISION, Camden, N. J. This invention relates to cavity resonators used in the microwave region. It provides a cavity resonator of improved stability. The resonator is a solid dielectric type and is capable of adjustment in its resonant frequency (1) by orientation of cavity with respect to the exciting field, (2) by adjustment of the area of the dielectric which couples the cavity and the exciting field, (3) by varying effective volume of the solid dielectric, and (4) by bringing an exposed area of dielectric into adjustable field-coupled relation with an external tuning element.

Pat. No. 2,704,830

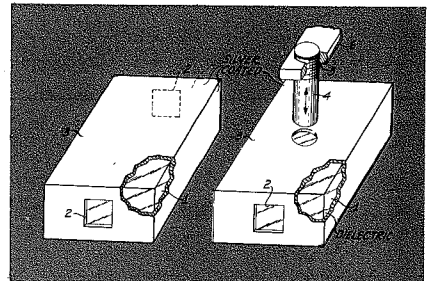

**AMPLIFIER WITH ADJUSTABLE PEAK FREQUENCY RESPONSE** (Patent No. 2,704,792)—granted March 22, 1955 to R. O. ENDRES and E. EBERHARD, ENGINEERING PRODUCTS DIVISION, Camden, N. J. This invention provides a semi-conductor amplifier having a peak frequency response which may be adjusted over a wide-frequency range. Results are achieved as follows: A transistor exhibits a capacitive input impedance which is variable with applied bias. An inductor is connected in series with the base electrode of the transistor and inductance is selected to resonate with the capacitance of the transistor. The resonance of the combination is, therefore, variable with applied bias to vary the frequency response of the system.

Pat. No. 2,704,792

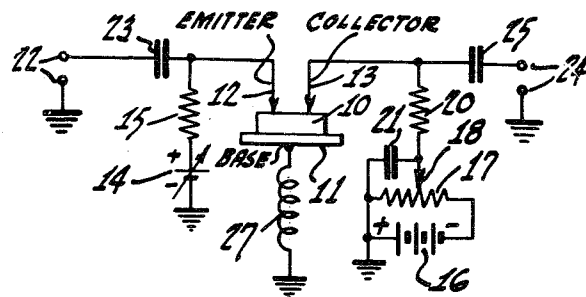

**PEN** and

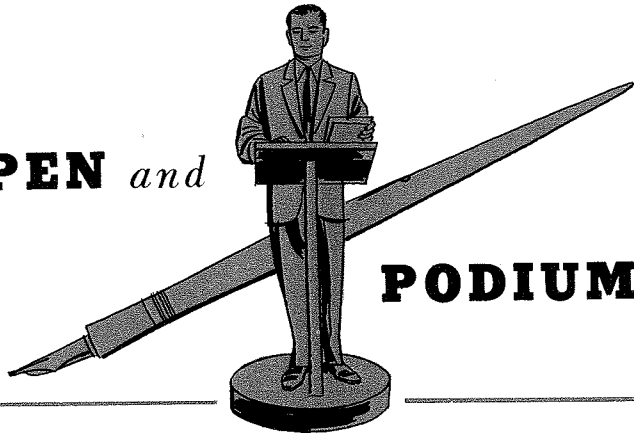

**PODIUM**

**DESIGN PROBLEMS OF VHF REPEATER STATIONS . . .** By J. R. NEUBAUER, ENGINEERING PRODUCTS DIVISION, Camden, N. J. Presented at IRE Convention, March-55. Mr. Neubauer discussed the physical and electrical design considerations which determine the functional effectiveness and operating reliability of stations employing simultaneous operation of transmitter and receiver as a control or re-radiating system. Consideration was given to requirements for station location, power control and regulation, antenna supports and radio equipment control and supervision. Slides were used to illustrate pertinent circuit considerations.

**EQUIPMENT FOR EVALUATING LENSES OF TELEVISION SYSTEMS . . .** By EDGAR HUTTO, JR., ENGINEERING PRODUCTS DIVISION, Camden, N. J. This paper appeared in the March-55 issue of the SMPTE JOURNAL. A lens bench has been developed incorporating a nodal slide and a flat-field indicator which permits rapid determination of square-wave flux response of a lens both "on" and "off-axis." A synchronously driven test object is used, and a plot of response vs. line number is presented on an oscilloscope. Lenses up to 24" in focal length and 3 7/8" diameter may be tested.

**ELECTRONIC LENS TESTING . . .** By D. J. PARKER, ENGINEERING PRODUCTS DIVISION, Camden, N. J. This talk was presented by Mr. Parker in March-55 to the Society of Photographic Engineers, Washington Chapter. The talk covered a non-mathematical description of Aperture Response theory, and a discussion of practical merits for

lens testing. Then, the RCA Lens Tester was described by use of slides.

**A STUDY OF RELAY RELIABILITY . . .** By T. J. BUROOJY, ENGINEERING PRODUCTS DIVISION, Camden, N. J. This presentation was made at Oklahoma A & M Relay Symposium March, 1955. Electronic communications equipment and the effects of a reliability study on this equipment were described. Equipment in question is used in long-range military aircraft.

**LARGE-SCREEN COLOR-TELEVISION PROJECTION . . .** By LOUIS L. EVANS, ENGINEERING PRODUCTS DIVISION, Camden, and R. V. LITTLE, JR. (formerly of the Engineering Products Division). Published in April 1955 issue of the SMPTE JOURNAL. The authors describe the technical features of the equipment and application information. The projector described produces a picture 15 by 20 ft. with good highlight brightness. It operates on standards recently adopted by FCC for color-television broadcasting.

**CORRECTIONS TO THE THEORY OF THE GROUNDED-GRID TRIODE . . .** By W. A. HARRIS, TUBE DIVISION, Harrison, N. J. Presented at IRE National Convention, New York City, March 21, 1955. In available literature on the theory of the grounded-grid triode, it has been assumed that the input conductance includes the "square-of-the-frequency" term caused by transit time in a grounded-cathode circuit and that feedback can be neglected. Even at moderate frequencies, use of these assumptions leads to inconsistencies between calculated and realized

performance. This paper describes an exact method of treatment based on four-pole circuit equations. Expressions derived for the short-circuit admittances, using the Llewellyn-Peterson equations, are compared with measured data.

**STANDARDS FOR AUTOMATION . . .** By J. J. GRAHAM and F. B. ILES, ENGINEERING PRODUCTS DIVISION, Camden, N. J. Presented at the IRE Convention, March 1955. The paper discusses the need for and development of guide lines for mechanization and eventual automatization of the assembly and construction of electronic equipment.

**HYDROGEN TREATMENT OF LEAD GLASS FOR HIGH-VOLTAGE ELECTRON TUBES . . .** By J. L. GALLUP and L. D. MOCEY, TUBE DIVISION, Harrison, N. J. Presented at American Ceramic Society, Chicago, Illinois, April 26, 1955. This paper discusses hydrogen treatment of lead-glass bulbs used in high-voltage rectifier tubes such as the RCA-1B3-GT to minimize the harmful effects of high-voltage electron bombardment and thereby extend the life of the tube. The treatment provides a layer having lowered electrical resistance which dissipates localized high potentials. This layer has increased resistance to mechanical shock and abrasion and to weathering and chemical attack. It also retards the emission of gas in the operating tube and thus prevents gas arcs during life. Results of hydrogen treatment and tests are described.

**A LARGE-DIAMETER, HIGH-CONDUCTIVITY LEAD FOR SEALING TO SOFT GLASS . . .** By D. L. SWARTZ and J. C. TURNBULL, TUBE DIVISION, Lancaster, Pa. Presented at IRE National Convention, New York City, March 21, 1955. High-conductivity leads having diameters larger than 0.030 inch have long been desired in the power-tube industry for increased rf-current-carrying capacity. This paper describes a 0.060-inch, high-conductivity lead which was developed by careful matching of radial and axial thermal-expansion coefficients. In this lead, relative copper volume is about one-quarter to one-third that found in conventional dumet leads. Relative merits of three techniques for producing high-conductivity leads are given.

**PRINTED CIRCUITS AND AUTOMATION . . .** By D. MACKAY, TUBE DIVISION, Camden, N. J. Presented at IRE Section Meeting, Lancaster, Pa., March 9, 1955. Desirability of printed circuits for use in television rf tuners is discussed. Characteristics for satisfactory tuner performance are evaluated, and methods for production of suitable printed circuits are described. Processes listed in the survey include painting, metal spraying, chemical deposition, vapor deposition, powder pressing, dusting, die stamping, electroplating, and metal etching. The photo-etch process using copper-foil-clad phenolic is described. The contribution of printed circuits to automation is evaluated.

**THE EVER-INCREASING IMPORTANCE OF TOOL ENGINEERING IN THE ELECTRON-TUBE INDUSTRY . . .** By J. R. GATES, TUBE DIVISION, Harrison, N. J. Presented at American Society of Tool Engineers, Newark, N. J., March 8, 1955. This talk described the need for tool engineering in the increasingly complex machine-design field in the electron-tube industry. A simple,

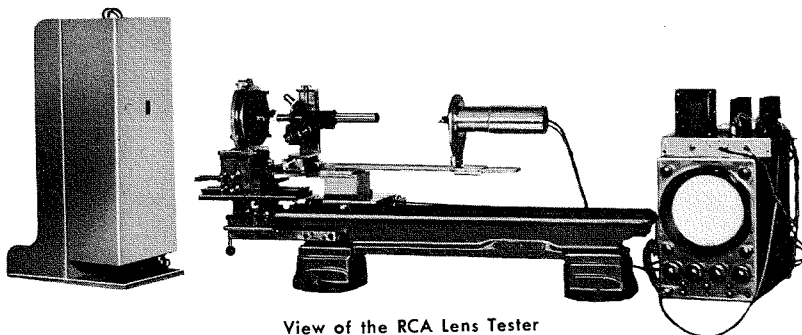

View of the RCA Lens Tester

## PEN and PODIUM continued

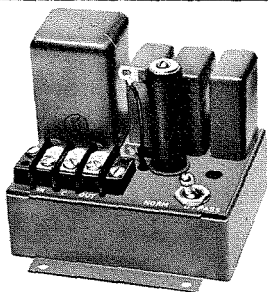

Sound-Effects Noise-Suppressor

illustrated approach explained the operation of the vital parts of an electron tube. A comparison was drawn between the tube type 27 developed in the early 1930's and a present-day triode, type 6C4. Critical dimensions, spacings, and methods of obtaining and controlling them were discussed.

**SOUND EFFECTS TRACK NOISE-SUPPRESSOR . . .** By J. F. BYRD, ENGINEERING PRODUCTS DIVISION, Camden, N. J. Presented at the SMPTE 77th Convention April-1955. A simplified noise-suppressor for the effects track in CinemaScope reproduction was described. The unit operates in the speaker line, thus using the full gain of the system, and uses two tuned circuits. One accepts and rectifies the 12-kc control tone to operate a speaker relay, and the other rejects the 12-kc tone from the wanted program material in the effects speakers. Unit uses no tubes or power supply.

**NEW TV AND RADIO TEST EQUIPMENT . . .** by RHYS SAMUEL, TUBE DIVISION, Harrison, N. J. Published in RADIO AND TELEVISION NEWS, March, 1955. This paper presents a review of service-type test equipment for audio, radio, and TV servicing. Different types of test instruments are discussed, and features and performance capabilities are outlined. Emphasis is placed on requirements for color TV. Accessories and new instruments are described.

**A SANDWICH-TYPE METAL-TO-CERAMIC VACUUM-TIGHT SEAL . . .** By N. E. PRYS-LAK, TUBE DIVISION, Harrison, N. J. Published in CERAMIC AGE, March, 1955. This paper describes the sandwich-type metal-to-ceramic seal which was designed primarily for use in the construction of vacuum-tight output windows for magnetrons and other microwave electron tubes. The seal consists of a rectangular ceramic wafer, properly processed, interposed be-

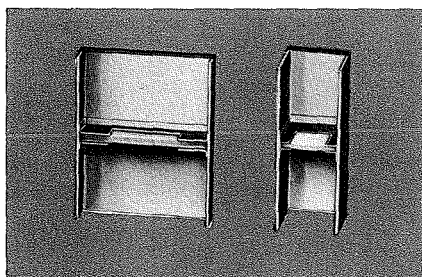

Sandwich-Type Seal

tween two window frames and brazed to the inner walls of a rectangular waveguide. The ceramic window, window frames, and waveguide are assembled onto a jig and brazed in a hydrogen furnace. Windows of this type will withstand temperatures as high as 750°C. This seal provides advantages in its processing and in its operation.

**COHERENT AND NON-COHERENT DETECTION OF A PULSED SIGNAL OF UNKNOWN FREQUENCY IN THE I-F PORTION OF THE RECEIVER . . .** By P. NESBEDA, ENGINEERING PRODUCTS DIVISION, Camden, N. J. This paper was presented at the IRE Convention (March-55) and involves the optimum detection procedure in the I-F portion of the Receiver. The use of statistical methods in the theory of detection of pulsed signals in noise was shown to be very fruitful. Mr. Nesbeda's report extended previous work in that the cases of coherent and non-coherent detection of a signal of unknown frequency were considered.

**RADIO AND THE SMALL BOAT . . .** By GEORGE G. BRADLEY, RADIOMARINE CORP., New York City. Presented before an April-55 meeting of the Bayside Power Squadron. Mr. Bradley explained how "ship-to-shore" radiotelephone aids the small boatman in time of distress. He described qualities to look for when buying a radiotelephone and explained the FCC license requirements. Installation problems were covered with emphasis on importance of a good antenna and ground system. He stressed necessity of proper maintenance.

**PROPERTIES OF SOME LOW-TEMPERATURE SOLDER GLASSES . . .** By J. L. GALLUP, and A. G. DINCWALL, TUBE DIVISION, Harrison, N. J. Presented at American Ceramic Society, Chicago, Illinois, April 26, 1955. A general survey is made of uses of some low-temperature-softening "solder"

glasses in electron tubes. Properties important in these uses are discussed. Viscosity curves and chemical analyses for a number of glasses were determined. Thermal expansions, indices of refraction, densities, solubility, and weather-resistance values are also presented.

**SOME THOUGHTS ON TECHNICAL WRITING . . .** by J. H. ROE, ENGINEERING PRODUCTS DIVISION, Camden, N. J. Published in the March-April issue of ENGINEERS DIGEST. Mr. Roe outlines a few basic rules for making technical papers easier to read and more digestible. Specific attention is given to writing technical reports, records of meetings, and letters.

**A 35mm MOTION-PICTURE PROJECTOR FOR COLOR TELEVISION . . .** By W. F. FISHER and W. R. ISOM, ENGINEERING PRODUCTS DIVISION, Camden, N. J. Presented at the SMPTE 77th Convention, April, 1955. A 35mm motion-picture projector for use with the three-vidicon film camera for color TV was described. It employs a modified Geneva intermittent that permits long application of light and nonlocked synchronous operation. Compensation for variation in film density, without affecting color balance, is provided. Accommodation of 24-frames/sec film rate to the 30-frame TV system makes the projector adaptable for all storage and semi-storage film pick-up systems.

**CONTROL OF LIGHT INTENSITY IN TELEVISION PROJECTORS . . .** By B. F. MELCHIONI and K. SADASHIGE, ENGINEERING PRODUCTS DIVISION, Camden, N. J. Presented at the SMPTE 77th CONVENTION, April, 1955. RCA's television projectors used with vidicon film cameras are equipped with a light-intensity control unit which control video output level of the camera by varying intensity of the projector light source to compensate for varying film

### "VACUUM TECHNIQUES" SEMINAR HELD AT MARION, INDIANA

Recent sessions of a Seminar on "Vacuum Techniques" were organized and presented by Tube Division Engineers at the Marion, Indiana Plant. Presentations by Marion design, development and manufacturing engineers featured a variety of topics relating to Vacuum Techniques. A list of the talks which were given from January 10 to May 2 is included below. Mr. G. P. Gerow, Assistant Research Director, Consolidated Vacuum Corporation, Rochester, New York, twice delivered talks on "Diffusion Pumps and Gauges," as a guest speaker.

SPEAKER	SUBJECT
J. F. STEWART	<i>Preliminary Considerations in the Design of a Vacuum System</i>
T. Y. WANG	<i>Gas Theory</i>
L. B. HALL, D. J. SMITH	<i>Gas Flow</i>
D. M. KRAMPE, M. N. SLATER	<i>Marion Plant Practices; Other Vacuum Systems</i>
L. T. SMITH	<i>Mechanical Pumps I. Theory</i>
A. A. SZAKALY	<i>Mechanical Pumps II. Practice</i>
P. J. BURNS	<i>Diffusion Pumps I. Theory</i>
P. J. BURNS	<i>Diffusion Pumps II. Practice</i>
L. M. CLUTTER, M. N. SLATER	<i>Vacuum Pump Fluids</i>
D. FRYE, L. M. WHITCOMB	<i>Vacuum Gauges</i>
D. J. SMITH	<i>Traps, Baffles and Other Elements of Vacuum Systems</i>
R. A. BERGMAN	<i>Getters</i>

density. Angular position of a continuously-variable neutral density filter wedge placed in the condenser lens system of a projector is remotely controlled by means of a servo-mechanism. Signal-to-noise ratio is maintained at its optimum value.

**OPERATIONAL TESTS FOR COLOR TELEVISION . . .** By E. E. GLOYSTEIN, ENGINEERING PRODUCTS DIVISION, Camden, N. J. Presented at IRE Spring Technical Conference in Cincinnati, April, 1955. The paper describes the need for several new types of test instruments to facilitate adjustment of specialized circuits required for generating, transmitting and receiving color TV signals. A group of test instruments, which are particularly useful in broadcasting plants and receiver service shops, are described.

**COLOR TELEVISION . . .** By DR. G. L. BEERS. Presented at the meeting of Dayton Engineers Club, Dayton, Ohio, March, 1955. Dr. Beers' talk reviewed the technical developments which made it possible to achieve a compatible color television system capable of producing high-quality color television images within the confines of a six megacycle channel. The talk was interspersed with demonstrations of the fundamental principles of color television which were given by Mr. C. N. Hoyle of the RCA Laboratories Division. In concluding his talk Dr. Beers commented briefly on the status of color television in Europe as observed during his trip through Europe last fall.

**A PRECISION DEFLECTION YOKE . . .** By H. J. BENZULY, ENGINEERING PRODUCTS DIVISION, CAMDEN, N. J. Presented at the IRE Convention (March 1955). The presentation pointed out the importance of the deflection yoke in registration of several TV images such as required in the present RCA Color TV Camera. Complete uniformity between units used together is essential and it was shown how this controlled precision can be easily obtained through the use of printed coils. A technique for constructing a deflection coil assembly suitable for use with a camera pickup tube and the results obtained from a unit built for an image-orthicon camera were described. Preliminary tests show attractive possibilities.

**DEFLECTION AND CONVERGENCE OF THE 21-INCH COLOR KINESCOPE . . .** By M. J. OBERT, TUBE DIVISION, Camden, N. J. Published in RCA REVIEW, March, 1955. This paper describes new deflection and convergence components and circuitry used to achieve successful operation of the 21AXP22 21-inch color kinescope. The effects of deflecting-yoke characteristics on the performance of horizontal- and vertical-deflection circuits, and circuitry required to energize the dynamic-convergence assembly, are discussed. Various methods of presenting information on flux distribution of deflecting yokes are reviewed.

**DEVELOPMENT OF A 21-INCH METAL-ENVELOPE COLOR KINESCOPE . . .** By H. R. SELEN, H. C. MOODY, D. D. VAN ORMER, and A. M. MORRELL, TUBE DIVISION, Lancaster, Pa. Published in RCA REVIEW, March, 1955 and ELECTRICAL ENGINEERING, April, 1955, and presented by D. D. VanOrmer at AIEE New York Section, April 5, 1955. This paper describes the major features of the RCA 21-inch metal-envelope color kinescope, and discusses con-

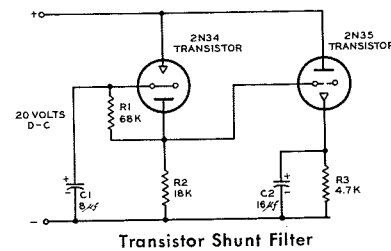

Transistor Shunt Filter

siderations involved in the choice of the size and construction used. Basic principles of the tube are explained, and geometrical relations governing design dimensions given.

**TRANSISTOR SHUNT FILTER . . .** By DR. H. J. WOLL, ENGINEERING PRODUCTS DIVISION, Camden, N. J. Published in ENGINEERS DIGEST March-April. Mr. Woll describes the "transistor shunt filter" (or "electronic capacitor") which can be built with different effective capacities and can be designed to operate at widely different d-c voltages. The filter is an electronic circuit, using two transistors, resistors and capacitors, it has a high resistance to d-c and a low impedance to a-c.

**HIGH PRECISION TRACKING RADAR . . .** By N. I. KORMAN, ENGINEERING PRODUCTS DIVISION, Moorestown, N. J. This paper was presented by Mr. Korman before the Patrick Air Force Base in April-55 for Signal Corps Personnel. The subject dealt with limitations of World War II vintage tracking radars with regard to precision. Technological development in the period following World War II, which have made improvement possible in tracking accuracy, were outlined. A precision tracking radar and its performance was then described.

**RELIABILITY ENGINEERING . . .** By C. M. RYERSON, ENGINEERING PRODUCTS DIVISION, Camden, N. J. Presented at the SMPTE 77th Convention, April, 1955. Recent advances in the field of "reliability engineering" were reviewed. These include specialized work in four areas: equipment reliability, component reliability, design and use aspects, and reliability program administration. Present status of equipment and part reliability was reviewed, and facts given on measurement methods. Reliability calculation and prediction were treated.

**A NOVEL UHF TELEVISION HIGH POWER AMPLIFIER SYSTEM . . .** By L. L. KOROS, ENGINEERING PRODUCTS DIVISION, Camden, N. J. March-55 IRE Transactions on Broadcast Transmission Systems. The author describes a novel type power amplifier designed for high-power UHF monochrome and color television transmitters. It employs the type 6448, 15-kw beam power tetrodes.

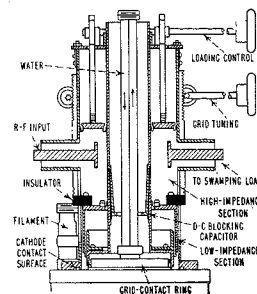

Sketch of Power Amplifier

**TUBE APPLICATION PROBLEMS IN TV RECEIVERS . . .** By W. E. BABCOCK, TUBE DIVISION, Harrison, N. J. Presented at Bendix Radio and TV Service Seminar, Baltimore, Md., April 5, 1955. Television servicing problems resulting from specific tube applications are discussed. Tube deficiencies which can not be detected on conventional tube testers, include heater-cathode shorts in cascode circuits, snow and overload in a-c circuits, and interference due to radiation from horizontal-deflection circuits. Problems encountered when tubes are used in series-string arrangement in TV receivers are discussed as are methods used by the tube industry to produce reliable series-string tubes. Series-string tubes are concluded to be comparable in reliability to tubes operated from a power transformer.

**CALCULATION OF RADIANT PHOTOELECTRIC SENSITIVITY FROM LUMINOUS SENSITIVITY . . .** By R. W. ENGSTROM, TUBE DIVISION, Lancaster, Pa. Published in RCA REVIEW, March, 1955. This paper describes a simple method by which the luminous sensitivities usually specified for commercial photoelectric devices may be converted to radiant sensitivities. Mathematical expressions are presented to illustrate derivation of the relationship, and tables are given to facilitate conversion.

**VARIATIONS OF THE CONDUCTIVITY OF THE SEMI-TRANSPARENT CESIUM-ANTIMONY PHOTOCATHODE . . .** By W. WIDMAIER AND R. W. ENGSTROM, TUBE DIVISION, Lancaster, Pa. This article appeared in the March 1955 issue of the RCA REVIEW. At low temperatures, phototubes having semi-transparent cesium-antimony cathodes appear to yield subnormal photoresponse. It has been found that this effect is due to the resistance of the thin cathode, and not to a reduction in photoemission. Even at room temperature and normal operating voltages, the photocurrent may be resistance limited. When the tube is placed in operation after a period of idleness, the cathode conductivity is low initially but increases with operating time to a normal value. The rate of increase in conductivity at different temperatures satisfies an exponential equation.

**DESIGNING RELIABILITY INTO CIRCUITS . . .** By A. H. BENNER and BEVERLY E. MEREDITH, ENGINEERING PRODUCTS DIVISION, Camden, N. J. Published in ENGINEERS DIGEST March-April. The authors describe design techniques to aid in improving equipment reliability. In particular, the designer may (a) quantitatively compute reliability, (b) compare circuits on basis of reliable operation, and (c) set component specifications in statistical terms to meet requirements.

**A PHASE ROTATION SINGLE-SIDEBAND GENERATING SYSTEM . . .** By J. R. HALL, ENGINEERING PRODUCTS DIVISION, Camden, N. J. Published in the March 1955 issue of the RCA REVIEW. This paper describes a new system of phase rotation single-sideband generation which eliminates critically-adjusted 90° radio-frequency phase-shift network. Undesired sideband suppression is adjusted by a simple audio-level control in one phase branch of the audio modulating signal, thus reducing to a single control the balancing out of undesired sideband for normal changes in operating frequency.

## PEN and PODIUM

continued

### HIGH SPEED ELECTRONIC FAULT PROTECTION FOR POWER TUBES AND THEIR CIRCUITRY . . .

By W. N. PARKER AND M. V. HOOVER, TUBE DIVISION, Lancaster, Pa. Presented at the IRE Convention (March, 1955) and published in *Convention Record*. The paper deals with high-speed electronic circuits capable of microsecond response, which have been developed to minimize the possibility of damage to power tubes resulting from "flash-arc" or "Rocky Point Effect." The circuit detects fault conditions in a power tube or its circuitry and triggers a gaseous conduction device connected in shunt with the d-c power supply. Fault currents are rapidly by-passed from the faulting tube by means of the gaseous conduction device. Thus, the "flash-arc" in the protected tube is extinguished, avoiding damage.

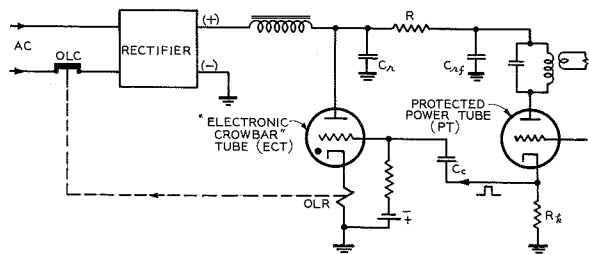

Protection Circuit for Power Tubes

### ADDITIONAL NOMOGRAPHS FOR SIGNIFICANCE TESTS . . .

By C. H. LI, TUBE DIVISION, Harrison, N. J. Published in *ASTM BULLETIN*, April 1, 1955 (No. 205). This paper presents three additional nomographs for evaluating the significance of attributive test results on two equal-size samples. These graphs cover sample sizes from 80 to 100,000. The charts are extensions of the nomograph given in a previous paper by Dr. Li published in the Dec., 1953 *ASTM Bulletin*.

### TUBE DESIGN AND MANUFACTURING CONSIDERATIONS . . .

By H. J. PRAGER, TUBE DIVISION, Harrison, N. J. Presented at Bendix Radio and TV Service Seminar, Baltimore, Md., April 5, 1955. This paper presents an introduction to tube design, construction, and manufacturing considerations. The chemistry and physics involved in tube fabrication are discussed. Tube parts are described, and reasons are given for the use of particular designs, materials, and manufacturing processes. A movie of a plant tour is used to demonstrate equipment.

### RELIABILITY OF COMPONENTS . . .

By R. H. BAKER, ENGINEERING PRODUCTS DIVISION, Camden, N. J. Published in *ENGINEERS DIGEST* March-April. Mr. Baker's discussion sets forth specific steps for attacking the component reliability problem on a broad basis. Major emphasis was given to the recognition of fundamental conditions responsible for inadequate components. Courses of action designed to bring about tangible improvements were described.

### CAMERA TUBES FOR COLOR TELEVISION . . .

By R. G. NEUHAUSER, TUBE DIVISION, Lancaster, Pa. Presented at IRE Subsection Meeting, Milwaukee, Wis., March 17, 1955. A brief review was made of tubes currently used in TV camera systems and of tubes which have been found basically unsuitable for color camera work. Requirements of tubes for color TV pickup were discussed, and performance characteristics that limit the pickup field to several tubes for color TV were evaluated. Performance characteristics of vidicons and image orthicons now used were compared with the required characteristics.

### PRACTICAL ELECTROACOUSTICS . . .

By MICHAEL RETTINGER, ENGINEERING PRODUCTS DIVISION, Hollywood, California. Mr. Rettinger's book, *PRACTICAL ELECTROACOUSTICS*, was published in March 1955. It concerns chiefly a description and analysis of the essential units of audio-communication equipment—microphones, moving-coil loudspeakers, mixers, studios, magnetic recording devices, as well as related subjects, such as crossover networks, attenuators, magnets, and vibration isolation.

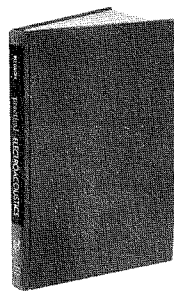

### THE CHEMISTRY OF COLOR TELEVISION . . .

By D. J. DONAHUE, TUBE DIVISION, Lancaster, Pa. Presented at American Association of Physics Teachers, Central Pa. Section, Wilson College, Chambersburg, Pa., April 1, 1955. The role of a chemist in an electronics industry such as color television is discussed. Principles of color television are reviewed briefly, and chemical aspects of various components are examined. Chemical processes involved in the manufacture and operation of image orthicon and vidicon tubes are outlined. Detailed attention is given to chemistry involved in manufacture of tricolor kinescopes. The description includes the fabrication of both glass and metal envelopes, aperture masks, phosphors, tricolor screens, stems cathodes, and getters.

### RELIABILITY STARTS AT THE MATERIALS LEVEL . . .

By CLIFFORD EDDISON, TUBE DIVISION, Camden, N. J. Published in *ELECTRICAL MANUFACTURING*, March, 1955. This paper discusses the demand for improved reliability of electronic equipment in terms of preservation of the pertinent chemical and physical properties of the materials used in tubes and other components. This fundamental approach recognizes that there can be no electrical or mechanical change in the equipment without a change in the chemistry or physics of the materials or components used. Fundamentals of reliability are found in behavior of materials (as components or in other forms) when submitted to conditions of electrical or mechanical stress and imposed environments.

### LUMINESCENCE . . .

By G. E. CROSBY, TUBE DIVISION, Lancaster, Pa. Presented at Covenant Brotherhood (E.U.B. Church) Lancaster, Pa., March 7, 1955. Luminescence is defined, and bio-, tribo-, chemi-, electro-, photo-, and cathodo-luminescence are demonstrated and explained. Different properties of luminescent materials are shown, such as fast and slow "build up," fluorescence, phosphorescence, IR sensitivity and quenching, and freezing of light. A simplified theory is given to explain why luminescence occurs. A cubic zinc sulfide lattice is shown, and the effect of an activator atom is discussed. The atom is described as a nucleus about which electrons revolve in definite orbits, as planets revolve about the sun. Excitation is described as removal of an electron to an orbit of higher energy, and luminescence as the return of the electron to its normal orbit.

### DELAYED COLLECTOR CONDUCTION, A NEW EFFECT IN JUNCTION TRANSISTORS . . .

By M. C. KIDD, W. HASENBERG, RCA VICTOR TELEVISION DIVISION, Cherry Hill, N. J. and W. M. WEBSTER, TUBE DIVISION, Harrison. Published in the March, 1955 issue of the *RCA REVIEW*. A new mode of operation for junction transistors called "delayed collector conduction" (DCC) is found at higher-than-normal collector voltages. At these voltages, the collector current suddenly rises, as though a breakdown had occurred. This effect can be controlled, however, by adjustment of the base current, and is nondestructive. The low output impedance of DCC operation has been applied in amplifiers, switches, and controllable voltage regulators. Pulse and sine-wave oscillators and astable, monostable, and bistable multivibrators have been designed utilizing the negative characteristic.

### CLASS B OPERATION OF AUDIO-FREQUENCY JUNCTION TRANSISTORS . . .

By K. E. LOOFBOURROW, TUBE DIVISION, Harrison, N. J. Presented at IRE, Cleveland Section (March 1955). The author points out several advantages gained by operation of a-f junction transistors in class B in the power-output stages of battery-operated portable amplifiers. Among the most important are high collector-circuit efficiency, low stand-by idling current, and a higher ratio of power output to collector dissipation per transistor can be realized from operation of the same transistors as class A power amplifiers.

### CHARACTERISTICS OF THE "PERFECT" LENS AND THE "PERFECT" TELEVISION SYSTEM . . .

By OTTO SCHADE, TUBE DIVISION, Harrison, N. J. Presented at the SMPTE 77th Convention, April, 1955. A "perfect" image was defined optically as an image in which light-intensity distribution is determined by diffraction alone. In this case the finite boundary (lens stop) of a lens acts as a low-pass filter which determines the sine-wave spectrum of the perfect lens. A perfect TV system can hence be defined as a system in which the performance is limited only by the electrical cutoff filter of the system and optical filter requirements imposed by the raster process. It is shown that performance of a "perfect" TV system differs in many ways from that of a perfect lens and photographic system and that a close approach to its performance is possible with practical systems.

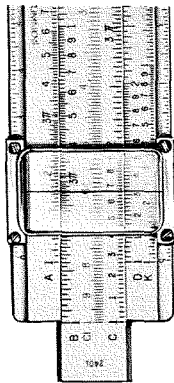

## FOUR RCA PRODUCT ENGINEERS ELECTED IRE FELLOWS

**C. M. SINNETT**, MANAGER, ADVANCED DEVELOPMENT ENGINEERING, RCA VICTOR TELEVISION DIVISION, Cherry Hill, N. J. Elected IRE Fellow, 1955 "for his contributions in the field of Electronic circuitry." Mr. Sinnett graduated with a B.S. in E. E. from the University of Maine in 1924 and joined Westinghouse Electric and Manufacturing Co., Engineering Department in July of the same year. He transferred to RCA Manufacturing Co., Camden, N. J. in November, 1929 as Manager of Phonograph Development and Design Section, and later became manager of the Loudspeaker and Phonograph Section. In 1935 Mr. Sinnett was appointed Manager of the Home Instrument Advance Development Section, which in 1954 became the Television Division Advanced Development Section. Mr. Sinnett is the holder of 30 patents in the fields of audio and acoustics. He is Senior Past Chairman of the Philadelphia Section of the IRE, and a member of Tau Beta Pi.

**WILLIAM A. HARRIS**, ADVANCED DEVELOPMENT, RECEIVING TUBES, TUBE DIVISION, Harrison, N. J. Elected IRE Fellow, 1955 "For his contributions to the development of frequency converter tubes and to the understanding of fluctuation phenomena in electronic tubes." William A. Harris is a native of Indiana. He graduated from Rose Polytechnic Institute at Terre Haute in 1927 receiving a Bachelor of Science in Electrical Engineering. He worked in the radio department of the General Electric Company at Schenectady from 1927 through 1929 and was then transferred to the RCA Victor Company at Camden in 1930 when he worked in the Receiver Design Laboratory. Since 1931, he has been with the RCA Tube Division at Harrison in the Receiving Tube Engineering Department. From 1931 to 1948, Mr. Harris worked on application engineering problems on receiving tubes and was active in work on frequency-converter tubes, on high frequency tubes and circuits, and on noise in electron tubes. Since 1948 he has been in Receiving Tube Advanced Development working on the performance measurements on UHF tube designs, on admittances of UHF amplifiers, and on tube

noise at UHF. He is author or co-author of numerous published papers on frequency-conversion, noise theory, and UHF amplifier theory.

**DR. R. B. JANES**, MGR., COLOR KINESCOPE DEVELOPMENT, TUBE DIVISION, Lancaster, Pa. Elected IRE Fellow, 1955 "For his contributions to the development of improved camera tubes." Robert B. Janes received the B.S. degree in physics from Kenyon College in 1928. He did graduate work in physics at Harvard and at the University of Wisconsin where he received a Ph.D. in 1935. From 1929 to 1931 he served as instructor in physics at Colgate University and from 1931 to 1935 as research assistant at the University of Wisconsin. From 1935 to 1943, Dr. Janes was an engineer at the Harrison, N. J. plant of RCA where he worked on television camera tubes and phototubes. Since 1943 he has been in the Tube Division of RCA at Lancaster, Penna. He was in charge of the development and design of television camera tubes until 1950 when he was appointed Manager of the Development Group responsible for camera tubes, storage tubes, and phototubes. In 1953, he was appointed Manager, Color Kinescope Development, of the Color Kinescope Engineering Activity.

**HENRY E. ROYS**, MANAGER, RECORDING AND MECHANISM DEVELOPMENT IN OPTICS, SOUND AND SPECIAL ENGINEERING, ENGINEERING PRODUCTS DIVISION, Camden, N. J. Elected IRE Fellow 1955 "For his contributions to the improvement of disk and tape recording." Mr. Roys received his B. S. degree in electrical engineering from the University of Colorado. He served with General Electric Company before joining RCA's phonograph section in 1930. Mr. Roys, who has 10 patents to his credit, became a member of the Advanced Development Group of the Photophone Section in 1937. From 1941 to 1946 he worked on disk recording and reproducing problems in Indianapolis. For the last nine years he has been in the Camden plant where he now serves as a manager in Optics, Sound, and Special Engineering. Mr. Roys is a member of Tau Beta Pi and Eta Kappa Nu.

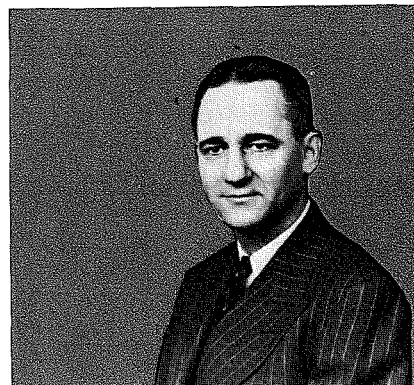

### GLENN L. DIMMICK HONORED FOR DISTINGUISHED SERVICE IN ENGINEERING

... GLENN L. DIMMICK, Manager of General Engineering Development, Engineering Products Division, is the eighteenth person to be honored by the University of Missouri with the Award for Distinguished Service in Engineering. The University of Missouri Distinguished Service Medal was presented to Mr. Dimmick at the Engineering Convocation held at the University, March 14th to 19th, 1955.

The award was established in 1951 to honor Alumni members and others for outstanding work in engineering.

Mr. Dimmick graduated from the University of Missouri in 1928 with the degree of B.S. in Electrical Engineering. While an undergraduate he was a member of Tau Beta Pi honorary engineering fraternity, and shortly after graduation became a member of Sigma Xi, honorary scientific society. Upon graduation he entered the employ of the General Electric Company as an engineer on talking motion picture equipment. In 1930 he was transferred to the RCA Victor Plant in Camden as a development engineer in the field of sound recording. During the following eighteen years he was active in the development of sound recording methods, sound powered telephones, recording galvanometers, and dichroic mirrors. He has eighty-seven U.S. Patents to his credit.

In 1948 Mr. Dimmick was made an Engineering Group Manager and in 1953 he became Section Manager of Optics, Sound and Special Engineering, working on television and other electronic equipment. Early in 1955 he was appointed Manager of General Engineering Development for the Engineering Products Division of RCA.

Mr. Dimmick is a Fellow of the Society of Motion Picture and Television Engineers. His many technical papers in the S.M.P.T.E. Journal won him the Progress Medal Award of the Society for the year 1941. In 1949 Mr. Dimmick received the RCA Victor Award of Merit, and in 1952 the Academy of Motion Picture Arts and Sciences presented him with the Award of Merit for outstanding achievement.

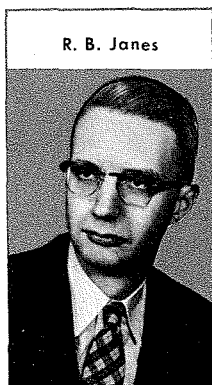

*Engineering*  
**NEWS and HIGHLIGHTS**  
*continued*

**NEW EPD ENGINEERING LAB AT WALTHAM, MASS. . . .** The newly established Aviation Systems Engineering Laboratory at Waltham, Mass., will be devoted to the development of specialized electronic fire-control systems for military aircraft. Now in its initial operating stage, it is expected to employ by year's end approximately 100 scientists, engineers and laboratory personnel. Manager of the new installation is Dr. Robert C. Seamans, Jr., nationally known authority on airborne electronics. The new laboratory will be equipped with elaborate computing facilities enabling engineers to simulate actual performance of airborne electronic systems under flight conditions. Modern jet aircraft will also be at the disposal of the scientists for full scale flight tests and studies.

**SIX RCA FELLOWSHIPS AWARDED TO GRADUATE ENGINEERING STUDENTS . . .**

Six RCA Fellowship awards by the Radio Corporation of America to young scientists and graduate engineering students for the current academic year were announced recently by Dr. C. B. Jolliffe, RCA Vice-President and Technical Director. Students who have received the RCA awards are:

**STUART RUDIN**, Bronx, New York, will study toward his master's degree in electronics at New York University. Mr. Rudin received a Bachelor of Electrical Engineering degree from N.Y.U. in 1954. He is a member of Eta Kappa Nu, honorary engineering society, and the Institute of Radio Engineers.

**WINSLOW F. BAKER**, Brockton, Mass., will work toward a doctorate in the Physics Department at Columbia University. His major field of study is nuclear physics. The RCA Fellow was graduated from Bowdoin College in 1950. He is a member of the American Physical Society.

**EDWARD F. DAVIS**, Sierra Madre, Calif., will do graduate work in Electrical Engineering at the California Institute of Technology. He received his Master of Science degree from the Institute in 1953. The RCA Fellow is a member of Tau Beta Pi, Sigma Xi, and the Institute of Radio Engineers.

**CARL HENRY OSTERBROCK**, Cincinnati, Ohio, is pursuing graduate studies in Electrical Engineering at the University of Illinois. Mr. Osterbrock received his Bachelor of Electrical Engineering degree from the University of Cincinnati in 1954. He is a member of the American Institute of Electrical Engineers and the Institute of Radio Engineers, as well as Eta Kappa Nu, Tau Beta Pi, and Sigma Xi.

**EDWARD STABLER**, New York City, will continue graduate work in Electrical Engineering at Princeton University. Mr. Stabler is a graduate of Swarthmore College and received his Master of Science degree from Princeton University. The RCA Fellow is a member of Sigma Tau, and Sigma Xi and the Institute of Radio Engineers.

**RALPH STEVENS, JR.**, Chatham, N. J., will pursue graduate studies in Engineering Physics at Cornell University. In 1954 he received his Bachelor of Engineering Physics from Cornell. The RCA Fellow is a member of Tau Beta Pi.



Speakers' Table, Dinner Meeting, Harrison Engineering Orientation Program, April 26, 1955, Hotel Robert Treat, Newark, N. J. Left to right—Dr. Alan M. Glover, Manager, Semi-Conductor Operations Department; Dr. G. R. Shaw, Chief Engineer; Dr. D. H. Ewing, Administrative Director, RCA Laboratories; Mr. H. J. Prager, Toastmaster and Chairman of the Harrison Engineering Orientation Program Committee; Mr. D. Y. Smith, Vice President and General Manager, Tube Division; Mr. P. R. Wakefield, Chairman, Harrison Education Committee and Mr. H. F. Randolph, Manager, Receiving Tube Operations Department

**DINNER MEETING CONCLUDES HARRISON ENGINEERING ORIENTATION PROGRAM . . .**

New engineers who joined the RCA Tube Division at Harrison during the past two years were honored at a dinner meeting held April 26, 1955 at the Robert Treat Hotel, Newark, N. J. For these engineers, the meeting also marked the conclusion of a 25-session lecture-discussion Engineering Orientation Program sponsored by the Harrison Engineering Education Committee. In this Program, the new engineers were informed regarding the technical and marketing aspects of Tube Division products together with organizational responsibilities. In addition to the 140 new engineers, key engineering personnel and operations and marketing management members also attended making some 250 in all.

Following an informal "get-acquainted"

period and the dinner, H. J. Prager, Chairman of the Orientation Program and Toastmaster for the evening, introduced the speakers. D. Y. Smith, Vice President and General Manager of the Tube Division, formally welcomed the new engineers and in his remarks emphasized the importance of engineering to the company's commercial operations. Dr. D. H. Ewing, Administrative Director of the RCA Princeton Laboratories, spoke on the subject "The Way Ahead in RCA Research." Dr. Ewing emphasized that a close relationship must be maintained between research and product development almost from the beginning of any research project. P. R. Wakefield, Chairman of the Engineering Education Committee, closed the meeting with thanks to the speakers and the committee members for their contributions to the success of the entire program.

**REVOLUTIONARY NEW HIGH-EFFICIENCY AM TRANSMITTER . . .**

RCA's recently developed amplitude-modulated 50-kw broadcast transmitter represents a significant advance in transmitter design. It will require half the space of comparable equipment and will reduce operating costs by about 50%. The new transmitter, designated the RCA "Ampliphase" (type BTA-50G) utilizes two RCA-5671 air-cooled power triodes in the output stage. The RCA

"Ampliphase" transmitter uses phase-modulation principles to produce high-efficiency, standard broadcast amplitude modulation. It has an electronic circuit enabling two phase-modulated amplifiers to produce a combined power equal to the output of appreciably larger AM transmitters. The circuit has been used successfully in foreign equipment and is particularly advantageous for high-power transmitters operating at 50 kw and above.

**SLOAN FELLOWSHIP AWARDS TO ENGINEERS**

**John R. Gates and James F. Walsh have received the 1955-1956 Sloan Fellowships in the Executive Development Program at the School of Industrial Management, Massachusetts Institute of Technology, Cambridge, Mass.**



J. R. Gates

Mr. John R. Gates received a B.S. in E.E. from University of Nebraska in 1942, and joined the Tube Division as an Electrical Equipment Design Engineer at Harrison, N. J. the same year. At present he is Manager, Mechanical Equipment Design, responsible for design and development of mechanical equipment required for production of radio tubes and semi-conductor products.

Mr. James F. Walsh was graduated from Lafayette College in 1949 with a B.S. degree in Mechanical Engineering, and has been working toward an M.A. degree in Industrial Management at Temple University. Mr. Walsh came with Engineering Products Division in 1952, and in two years was appointed Manager, Mechanical Standards Engineering.

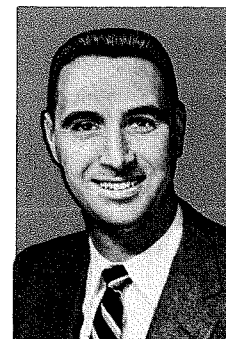

J. F. Walsh

**PLASTICS SOCIETY VISITS RECORD ENGINEERING . . .** On April 26, 1955, eighty-two members and guests of the Central Indiana Chapter of The Society of Plastic Engineers visited the Indianapolis Record Plant and Development Engineering Laboratory. Mr. H. I. Reiskind, Manager, Engineering, gave the welcoming address, which was followed by a brief dissertation on record manufacture by S. D. Ransburg.

**WATSON KINTNER FETED AT RETIREMENT DINNER . . .** Tube Division engineers and management personnel from Lancaster, Harrison, and Camden attended a banquet at the Stockyard Inn in Lancaster in honor of Watson Kintner's retirement. Mr. Kintner has been with the company for twenty-five years. He graduated from the University of Pennsylvania in 1916 with a B.S. in Chemical Engineering and began working for Westinghouse Electric the same year in Tube Design and Development. In 1930, when RCA began manufacturing tubes, Mr. Kintner joined the company and continued in the same line of work. At the time the plant at Lancaster was built in 1943, Mr. Kintner became Manager of the Standardizing Group and held this position until Feb-

ruary, 1954, when he assumed the post of design and development engineer in power tube engineering. Mr. Kintner was presented with binoculars.

**MOORESTOWN ENGINEERING FACILITIES EXPANSION UNDER WAY . . .** New building construction at RCA Moorestown, N. J. Engineering Plant is under way to expand plant engineering, laboratory, and office facilities at the location. The construction program, which is divided into two phases, is slated for completion some time in the fall. Phase #1 expansion includes the Model Shop and High Bay Laboratory slated for June completion, with Phase #2 covering the engineering offices and laboratory additions to be completed in the fall.

**ENGINEERING ORIENTATION DINNER . . .** Sixty-five Tube Division engineers gathered in Lancaster in March 29 to launch the 1955 Orientation series. In addition to welcoming the new engineers, the courses are designed to better acquaint them with the technical work, functions and activities of the various groups. Lectures were slated for May 3, 5, 10, 12, 17, 19, 24, 26, and 31.

**FOUR IN ONE . . .** WITH THE AWARD OF MERIT ACCORDED TO HENRY J. CRAVENS IN 1954, Merrill Gander's nineteen-man engineering section at RCA Service Company, Cherry Hill, can look with pride of achievement to four Award of Merit winners (see cut).

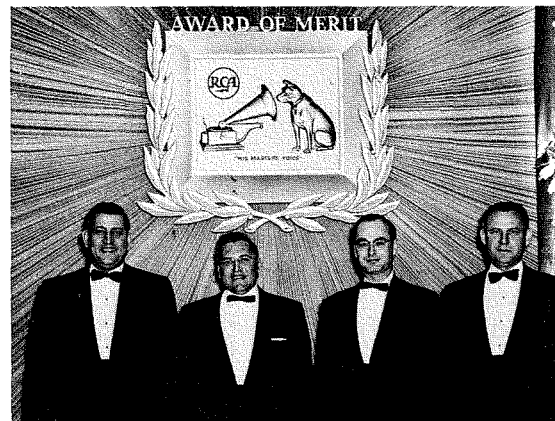

Award winners are: From left to right, Henry J. Cravens, Electronic Equipment Specialist, 1954; Merrill G. Gander, Manager of Engineering, 1946; J. David Callaghan, Manager, Antenna group, 1952; Steven Wlasuk, Manager, Special Projects, 1953.

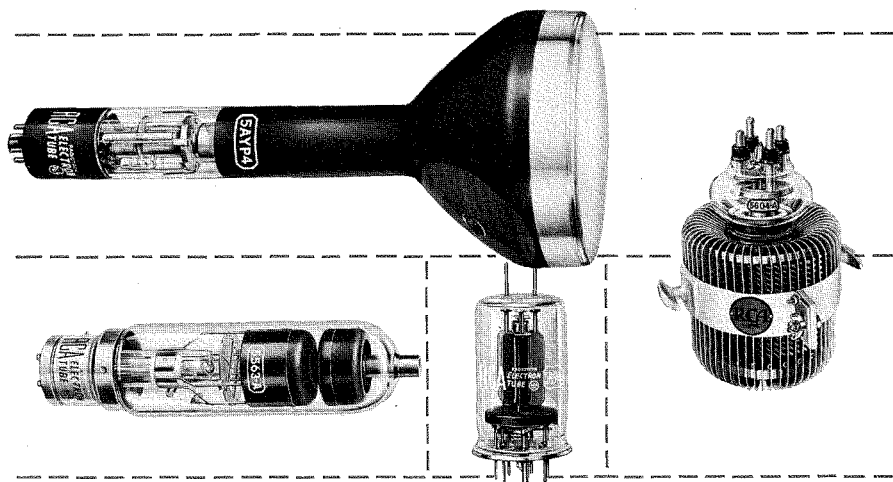

### NEW RCA TUBE TYPES

RCA-5AYP4 is a directly viewed, 5-inch cathode-ray tube designed for view finder service in connection with portable TV cameras. It provides a 3¾-inch by 2½-inch view of the televised scene. Electrostatically focused and magnetically deflected, the 5AYP4 employs an electron gun designed to provide high resolution and good uniformity of focus over the entire picture area. The 5AYP4 has a practically flat face with a high-efficiency, aluminized, white fluorescent screen. The maximum design-center rating for the ultor is 10,000 volts and for the focusing electrode is 1,500 volts, respectively.

RCA-5563-A is a high-voltage, three-electrode, mercury-vapor thyratron with a negative control characteristic. It is designed primarily for power control applications, but is also suitable for use in load-circuit protection. This new tube supersedes the RCA-5563 and has greater power-handling capability.

RCA-5604-A is a general-purpose, forced-air-cooled power triode for communication and industrial service. It has a maximum

plate-dissipation rating of 10 kw and can be operated with full ratings at frequencies as high as 25mc. This new tube is unilaterally interchangeable with the RCA-5604, but requires substantially less air flow and has appreciably less weight.

RCA-5894 is a small, sturdy, twin beam power tube. It is intended primarily for use as a push-pull r-f power amplifier or as a frequency tripler in fixed and mobile equipment operating in the UHF range between 450 and 470 mc. The RCA-5894 has a maximum plate dissipation rating of 40 watts under CGS conditions. Under these conditions in class C telegraphy and frequency-modulated amplifier service at 470 mc, the RCA-5894 can deliver to load of output circuit a useful power of approximately 55 watts.

**NEW VACUUM PHOTOTUBE . . .** RCA-6570 A new vacuum type phototube suitable for industrial applications such as electronic beverage-inspection and ampul-inspection equipment. It is designed for uses where a

low order of microphonics and high sensitivity in the red and near-infrared region of the spectrum are required. Because of this spectral response the tube is especially suitable for use with an incandescent light source. The RCA-6570 has a maximum anode supply voltage rating of 500 volts, a maximum average cathode current rating of 5µa, and an average luminous sensitivity of 30 µa/lumen.

**FIVE NEW MINIATURE TUBES FOR USE IN TELEVISION RECEIVERS . . .** RCA-5AM8 and RCA-6AM8 general purpose, multi-unit 9-pin miniature tubes. Each contains a high-perveance diode and a sharp-cutoff pentode in one envelope. The diode applications include video detector, d-c restorer, and a-c delay diode. The pentode unit is useful as an i-f, video or a-c amplifier. The RCA-5AM8 heater operates at 4.7 volts 0.6 ampere and is controlled for warm-up time to insure dependable performance in TV receivers utilizing a 600-ma series-heater string arrangement. The heater of the RCA-6AM8 operates at 6.3 volts 0.45 ampere.

RCA-6AW8 a general-purpose multi-unit 9-pin miniature type containing a high-µ triode and a sharp-cutoff pentode in one envelope. Warm-up time of its 6.3 volt 0.6 ampere heater is controlled for use in a 600-ma series-heater string arrangement. The pentode unit may be used as a video or a-c amplifier or for a reactance tube. The triode unit is well suited for use in sync-separator, sync-clipper and phase-splitter circuits.

RCA-6BZ6 a remote-cutoff 7-pin miniature pentode tube for use particularly in the gain-controlled picture i-f stages of TV receivers.

RCA-12CA5 A 9-pin miniature beam-power tube for particular use in the audio output stages of TV and radio receivers. Its 12.6 volt 0.6 ampere heater is designed with controlled warm-up time for 600-ma series heater string circuits.



*Engineering*  
**NEWS and HIGHLIGHTS**

*continued*



**NEW ORTHOPHONIC HI-FI INSTRUMENT FOR VICTROLA-PHONOGRAPH LINE . . .** The first of a planned series—a new Orthophonic High-Fidelity "Victrola" phonograph has recently been announced. It contains one 6-inch loudspeaker, handling low and mid-range frequencies, and two smaller speakers, mounted at a 90 degree angle to each other for room-wide dispersion of high frequencies. This new acoustical system provides for uniform quality in every part of the room and virtually eliminates dead spots. The design features a smooth operating 3-speed changer with one control for all speeds, with a fidelity range of from 70 to 20,000 cycles. Undistorted output is three watts. A Master Control panel houses the three controls for loudness, bass and treble in a simplified grouping making for easier operation. The tone arm is balanced with a flip-over ceramic pickup, which has twin-manufactured sapphire styli, one for extended play records and the other for 78 rpm.

**NEW EDITION OF "RCA HEADLINERS FOR HAMS" . . .** The new edition of RCA HEADLINERS FOR HAMS (Form HAM-103B) recently published by the Tube Division, is designed especially for radio amateurs. This completely revised publication contains up-to-date technical information on leading RCA tubes for amateur service.

**NEW RCA PICKUP TUBE FOR COLOR TV CAMERA . . .** A revolutionary new type of color television camera tube, known as the TRI-COLOR VIDICON, that generates simultaneously the red, green and blue signals of color TV has been developed at RCA Laboratories, Princeton. The developmental Tri-color Vidicon combines all of the color pickup functions for the first time in a single tube used in black-and-white cameras. Since all of the color signals are generated simultaneously in the same tube, precise optical and electrical registry is ensured, thus avoiding any danger of overlapping or "fringing" of color signals. In addition, use of a single tube will permit greater simplicity and compactness in color camera design.



**BIG TWIN ANTENNA DESIGNED FOR DALLAS-FORT WORTH . . .** A giant VHF television antenna to be supplied to the Dallas-Fort Worth area is being custom designed by RCA's Broadcast Antenna engineers. The RCA installation includes a 75-foot wide platform and two full-sized 82-foot

superturnstile antennas mounted on top a 1500-foot tower. To accomplish the job, a scale model was set up by RCA Broadcast engineers at the Moorestown Plant. This permitted full data to be collected by use of the model before the final product was put into production.

**COMMITTEE APPOINTMENTS**

**EPD COMMUNICATION ENGINEERING . . .** N. S. PARKS has been appointed as a member of RETMA committee TR-8.1.

D. HOCHMAN has been appointed as a member of the Program Committee Philadelphia Professional Group on Microwave Theory and Techniques of the IRE.

D. R. CROSBY is repeating again this spring his instruction of the Rutgers University review course on the New Jersey Professional Engineering Examination for Electrical Engineering.

J. W. LEAS, Chief Product Engineer, Computer Engineering, EPD, has been appointed to the Advisory Group on Computers of the Department of Defense. This group is attached to the office of the Assistant Secretary for Research and Development. It is the task of the group to review the programs of the military services as they relate to the

technical aspects of electronic computers, and to advise the Assistant Secretary of Defense of such aspects as application feasibility, suitability, design criteria, and the like. This advice would be used not only to aid the services in weapon development, but also in inventory control problems of the Department of Defense. In this connection, the advisory group is also available for technical advice to the so-called Kelly Committee recently set up by the Deputy Secretary of Defense for the purpose of considering applications of data processing machines to accounting and inventory control problems.

**TUBE DIV. MANUFACTURING ENGINEERING . . .** LYMAN B. HALL, Tube Division Manufacturing Engineering, Marion, received his Professional Engineer's license in Mechanical Engineering in the State of Indiana on December 12, 1954.

**ENGINEERING MEETINGS AND CONVENTIONS**

*June-August, 1955*

MAY 31-JUNE 3

*3rd Basic Materials Exposition  
Convention Hall  
Philadelphia, Pa.*

JUNE 2-3

*IRE Materials Symposium  
Convention Hall  
Philadelphia, Pa.*

*(Sponsored by the Phila. section of the Professional Group on Components)*

JUNE 1-11

*British Plastics Exhibition  
Olympia, London, England*

JUNE 6-8

*National Community Television  
Association Convention  
Hotel Muehlebach  
Kansas City, Mo.*

JUNE 6-8

*National Community Television  
Association Convention  
Park Sheraton Hotel  
New York, N. Y.*

JUNE 6-10

*Human Engineering Institute  
Course in Human Engineering  
Dunlap and Associates, Inc.  
Stamford, Conn.*

JUNE 11-14

*The Third U.S. National Congress  
of Applied Mechanics  
Brown University  
Providence, R. I.*

JUNE 20-24

*American Society for Engineering  
Education—Annual Meeting  
Penna. State College  
State College, Pa.*

JUNE 25-JULY 1

*58th Annual Meeting ASTM  
Atlantic City, New Jersey*

JUNE 27-JULY 1

*AIEE Summer General Meeting  
New Ocean House  
Swampscott, Mass.*

JUNE 14-16

*AIEE-APS-AIME-CIT Conference  
on Magnetism and Magnetic  
Materials  
William Penn Hotel  
Pittsburgh, Pa.*

JUNE 20-23

*Second International Powder  
Metallurgy Congress  
Reutte, Tyrol, Austria*

JUNE 20-25

*Symposium on Electromagnetic  
Wave Theory  
University of Michigan  
Ann Arbor, Mich.*

*(Sponsored by Commission VI of URSI and  
and University of Michigan)*

JULY 12-14

*Second Western Plant Maintenance  
Show  
Pan Pacific Auditorium  
Los Angeles, Cal.*

AUGUST 15-19

*AIEE Pacific General Meeting  
Butte, Montana*

AUGUST 23-SEPT. 3

*British National Radio Show  
Earls Court  
London, England*

AUGUST 24-26

*1955 IRE Western Electronics  
Show and Convention  
Civic Auditorium  
San Francisco, Cal.*

# **RCA ENGINEER**

## **EDITORIAL**

### **REPRESENTATIVES**

---

#### **ENGINEERING PRODUCTS DIVISION**

E. D. BLODGETT, *Chairman, Editorial Board*

##### **Editorial Representatives**

- J. A. BAUER, *Theater & Industrial Engineering, Camden, N. J.*
- J. BIEWENER, *Aviation Systems Development, Moorestown, N. J.*
- T. T. N. BUCHER, *Surface Communications Engineering, Camden, N. J.*
- H. E. COSTON, *Engineering Administration, Standards & Services, Camden, N. J.*
- J. P. GILMORE, *Shoran & Specialties Engineering, Camden, N. J.*
- T. G. GREEN, *Missile & Radar Engineering, Moorestown, N. J.*
- W. K. HALSTED, *Computer Engineering, Camden, N. J.*
- H. KRIEGER, JR., *Engineering Personnel, Camden, N. J.*
- D. G. C. LUCK, *Aviation Electronics Engineering, Camden, N. J.*
- C. McMORROW, *Aviation Engineering, Camden, N. J.*
- W. A. PATTERSON, *Aviation Engineering, Camden, N. J.*
- J. L. PETTUS, *"EPD" Engineering, Hollywood, Calif.*
- J. H. PRATT, *"EPD" Engineering, Los Angeles, Calif.*
- J. H. ROE, *Broadcast Studio, Antenna & Transmitter Engineering, Camden, N. J.*
- H. E. ROYS, *Optics, Sound & Special Engineering, Camden, N. J.*
- L. M. SEEBERGER, *General Engineering Development, Camden, N. J.*
- B. F. WHEELER, *Communications Engineering, Camden, N. J.*

---

#### **TUBE DIVISION**

J. F. HIRLINGER, *Chairman, Editorial Board*

##### **Editorial Representatives**

- E. D. FLECKENSTEIN, *Cathode Ray & Power Tubes, Lancaster, Pa.*
- D. G. GARVIN, *Color Kinescopes, Lancaster, Pa.*
- A. E. HOGGETT, *Receiving Tubes, Cincinnati, Ohio*
- R. L. KLEM, *Receiving Tubes, Harrison, N. J.*
- J. KOFF, *Receiving Tubes, Woodbridge, N. J.*
- P. M. LUFKIN, *Electronic Components, Findlay, Ohio*
- E. E. MOORE, *Electronic Components, Camden, N. J.*
- J. W. RITCEY, *Semi-Conductors, Harrison, N. J.*
- M. N. SLATER, *Black & White Kinescopes, Marion, Ind.*
- L. H. URDANG, *Receiving Tubes, Indianapolis, Ind.*

The Editorial Representative in your group is the one you should contact in scheduling technical papers and arranging for the announcement of your professional activities. He will be glad to tell you how you can participate.

---

#### **RCA VICTOR TELEVISION DIVISION**

C. M. SINNETT, *Chairman, Editorial Board*

##### **Editorial Representatives**

- R. D. FLOOD, *Color TV Engineering, Cherry Hill, N. J.*
- F. KSIAZEK, *Black & White TV Engineering, Cherry Hill, N. J.*
- R. W. SONNENFELDT, *Advanced Development Engineering, Cherry Hill, N. J.*
- K. G. WEABER, *Engineering Services, Cherry Hill, N. J.*

---

#### **RCA VICTOR RADIO & "VICTROLA" DIVISION**

##### **Editorial Representative**

W. S. SKIDMORE, *Engineering Department, Cherry Hill, N. J.*

---

#### **RCA SERVICE COMPANY, INC.**

##### **Editorial Representatives**

- W. H. BOHLKE, *Consumer Products Service Department, Cherry Hill, N. J.*
- J. F. HOLLABAUGH, *Government Service Department, Cherry Hill, N. J.*
- E. STANKO, *Technical Products Service Department, Cherry Hill, N. J.*

---

#### **RADIOMARINE CORPORATION OF AMERICA**

##### **Editorial Representative**

M. SCHOENFELD, *New Products Engineering, New York City, N. Y.*

---

#### **RCA ESTATE APPLIANCE DEPARTMENT**

##### **Editorial Representative**

H. D. BROSIER, *Product Engineer, Electric Ranges, Hamilton, Ohio*

---

#### **RCA VICTOR RECORD DIVISION**

##### **Editorial Representative**

S. D. RANSBERG, *Record Engineering, Indianapolis, Ind.*

---

#### **RCA LABORATORIES**

##### **Editorial Representative**

E. T. DICKEY, *Research, Princeton, N. J.*