

# BROADCAST NEWS



**PLANNING A  
RADIO STATION**

**VOL. No. 97    OCTOBER 1957**



## Planning a Radio Station ?

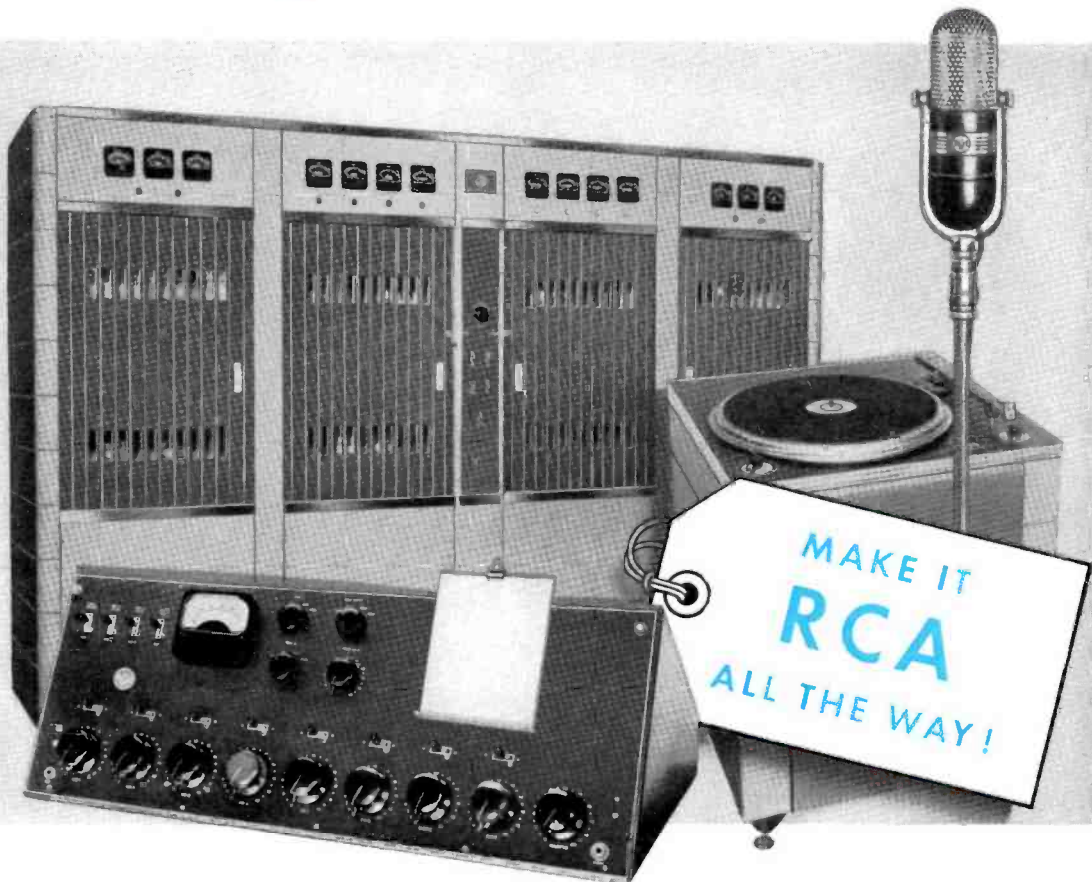

**You'll benefit by using this single source  
of equipment and experienced assistance**

For your complete equipment package, for help in planning, and for technical service—RCA can give you everything you need. From RCA you can get a full line of equipment—from microphone to antenna—designed to fill the widest range of station requirements. The practical assistance of RCA station-trained engineers is available for complete planning of your installation. And through the facilities of RCA Service Company, Inc., you can get technical field service in strategic locations throughout the country.

One source for all your station requirements means faster service and delivery to meet your specialized needs . . . pre-releasing if necessary. By coming to RCA, all your sources are coordinated automatically—you don't have to make all these time-wasting arrangements yourself. You can get on-air faster . . . stay on-air longer . . . reduce costly off-air time. And the many benefits will be reflected in increased profits throughout your entire operation. Why not call your RCA Broadcast Representative today?

**RCA** . . . *your first source of help in station planning*



**RADIO CORPORATION of AMERICA**

Broadcast and Television Equipment • Camden, N. J.

In Canada: RCA VICTOR Company Limited, Montreal

Vol. No. 97

October, 1957

# BROADCAST NEWS

*published by*

**RADIO CORPORATION OF AMERICA  
BROADCAST & TELEVISION EQUIPMENT DEPARTMENT  
CAMDEN, NEW JERSEY**

**PRICE**      *In U.S.A. - - - \$4.00 for 12 issues*  
                  *In Canada - - - \$5.00 for 12 issues*

## C O N T E N T S

	Page
PLANNING A RADIO STATION—PART I, THREE BASIC PLANS . . . . .	6
MINIATURE MOBILE STUDIO—KRMG . . . . .	28
TRANSMITTER ON A MOUNTAINTOP—WLOS-TV . . . . .	32
IMPACT NOISE ISOLATION IN TELEVISION STUDIOS . . . . .	38
CONTROL OF COLOR APPEARANCES IN TV STUDIO LIGHTING . . . . .	42
PROPOSED REFERENCE SIGNALS FOR BROADCAST TELEVISION TRANSMISSION . . . . .	46
THE LITTLE RED SCHOOLHOUSE WAS NEVER LIKE THIS . . . . .	50
GUIDED MISSILE INSTRUMENTATION RADAR . . . . .	52
MULTIPLE ANTENNA SYSTEMS . . . . .	60
PREDICTING PERFORMANCE OF CANDELABRA ANTENNAS BY MATHEMATICAL ANALYSIS . . . . .	63

---

*Copyright 1957. Radio Corporation of America, Broadcast & Television Equipment Department, Camden, N. J.*

PRINTED  
IN  
U.S.A.

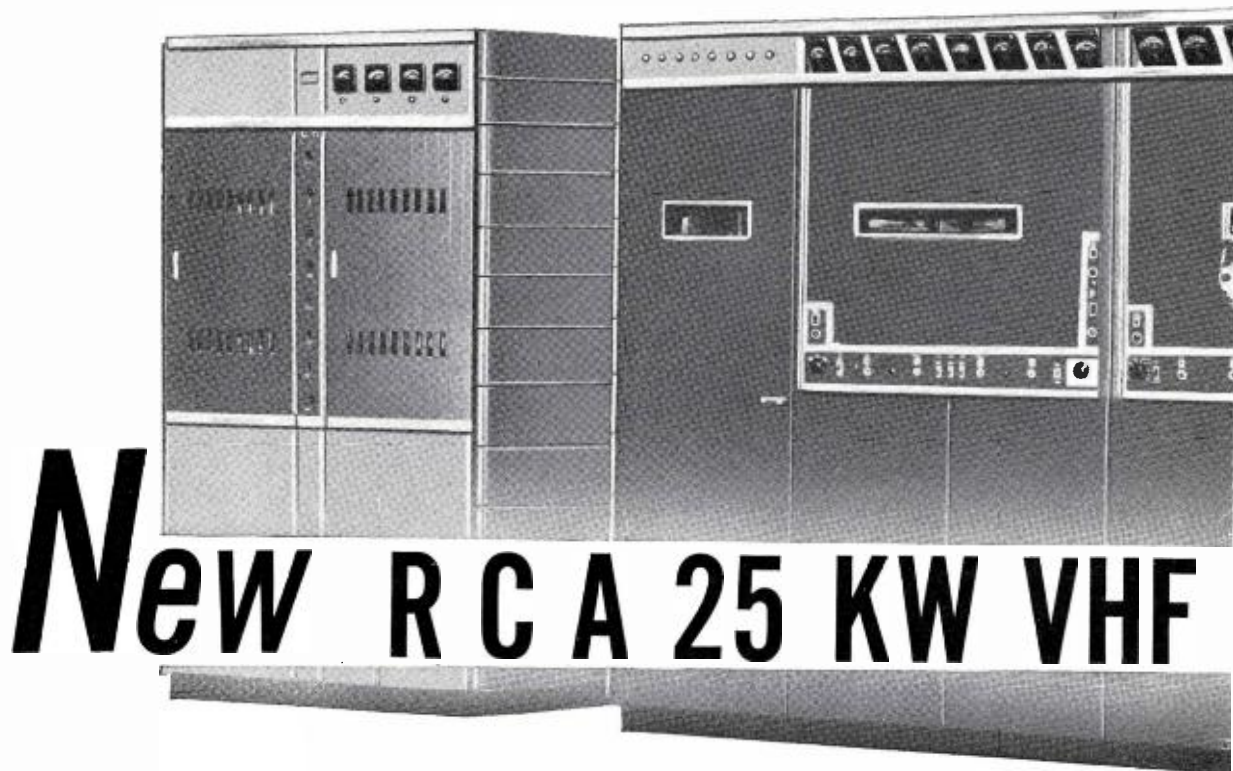

## *Assures flexible arrangement for economical floor plan*

Combining all the newest design features of the recently announced RCA 6 KW TV transmitter and the enviable performance record of RCA's famous 25 KW power amplifiers, the new TT-25CL is today's best value! No other transmitter in this power class embraces so many advantages... advantages that engineers and station managers have asked to have incorporated in a single transmitter.

**FLEXIBLE FLOOR PLAN**—The "block build" design of the TT-25CL permits several combination arrangements. The layout may be as illustrated in the accompanying floor plan, or a modification of this general plan. The 6 KW Driver and P.A. Rectifier and Control Cabinets can be arranged in "U" fashion with the P.A. tanks moved forward and the driver power supply enclosure placed at a remote location to further conserve space.

**PRECISE COLOR PERFORMANCE**—Built-in linearity correction circuits and intercarrier frequency control, which accurately maintains frequency separation between aural and visual carriers, assure excellent color signal transmission.

**EXCELLENT ACCESSIBILITY**—Broadband tuning controls in the 6 KW Driver are accessible without opening any doors. All important driver circuits are adjusted from

the front of the unit. Exciter and modulator units have "tilt-out" construction for quick, complete accessibility.

**THERMOSTATICALLY CONTROLLED HEATERS**—for rectifier tubes are suited to ambient temperatures as low as 0° C. Designed for attended or remote-control operation.

**ECONOMICAL OPERATION**—A well-chosen tube complement affords lower power costs. Complete overload protection with "grouped" indicator lights makes troubleshooting quick and certain.

**TIME-PROVED TUBES**—Long life RCA 5762 tubes in both P.A.'s and Driver. Many broadcasters using other RCA transmitters which employ the 5762 tubes report "extra dividends" due to their long-life, economical operation. Over 100 RCA 25 KW amplifiers have been in continuous service to date—each employs the famous 5762.

**PLUS . . . OTHER ADVANCED FEATURES**—too numerous to mention here! Get the complete story from your RCA Broadcast Sales Representative or write for descriptive literature (Catalog Bulletin B-4011). In Canada, write RCA VICTOR Company Limited, Montreal.



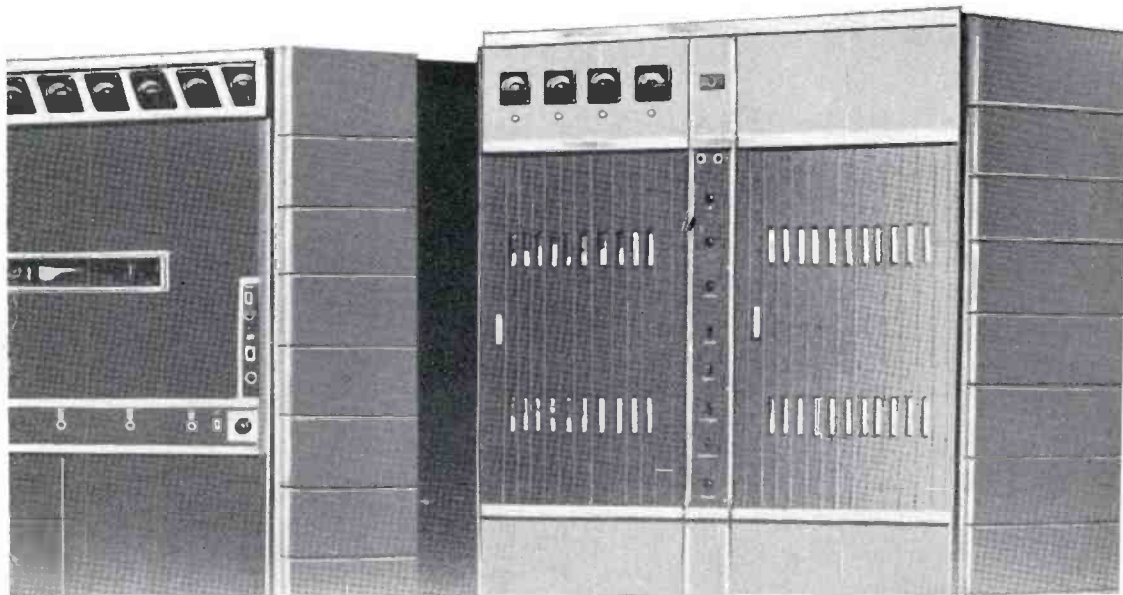

# TELEVISION TRANSMITTER

**NOW  
"ON-AIR"**

(Type TT-25CL, Low Band)

Reports from stations with TT-25CL's "on-air" tell of excellent results and audience response. Particularly gratifying comments come from color program viewers who are impressed with the fidelity of color transmission.

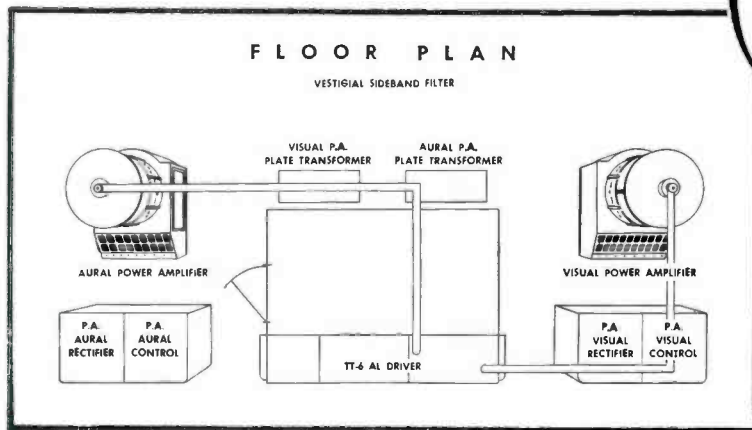

## Where floor area is at a premium...

such as in "down-town" buildings, or where space must be yielded to other equipment, the TT-25CL is highly adaptable. When new transmitter buildings are contemplated, the space-saving TT-25CL helps to save building costs. The rectifier sections of both the 6 KW Driver and also the Aural and Visual Amplifier Rectifiers can be separated and placed in an adjacent room or basement. This is an added feature that saves valuable operating area.

DRIVER PORTION OF THE ABOVE 25 KW TRANSMITTER (LESS AMPLIFIERS) IS AVAILABLE AS A COMPLETE 6 KW TRANSMITTER



Fmk(s) ®

**RADIO CORPORATION of AMERICA**

BROADCAST AND TELEVISION EQUIPMENT • CAMDEN, NEW JERSEY

GETTING THE MOST FROM

## “Snagged” by a Faulty Film Situation?

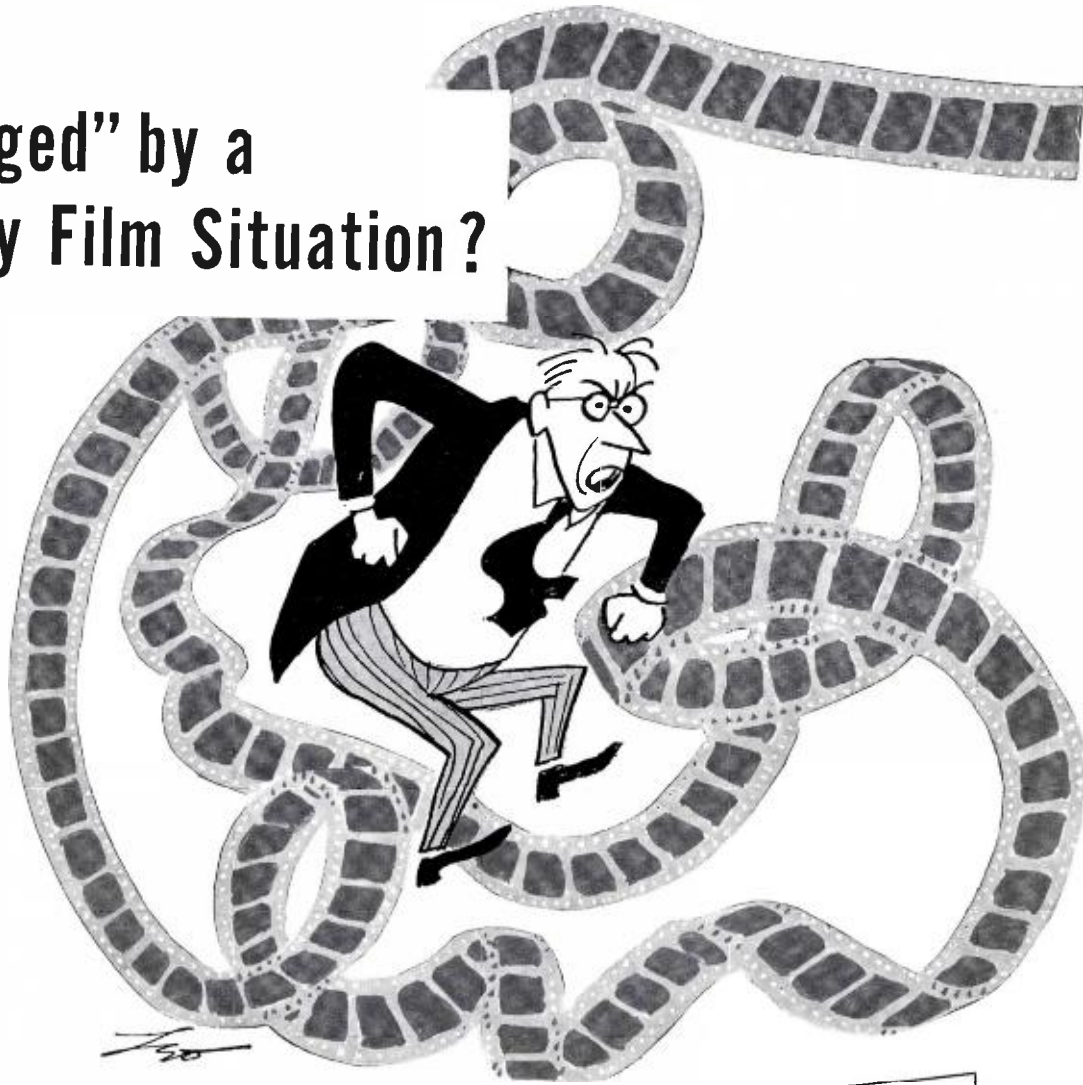

P.S.

**HOW LONG SINCE  
YOUR STATION'S  
FILM ROOM  
WAS MODERNIZED?**

YOUR FILM DOLLAR...



If so, you've a right to be "hopping mad"—especially if picture "smog," inflexible film presentations and high operating costs are blocking your progress. Better do something about it! Find out how to . . .

1. Get the kind of picture quality that advertisers and television audiences want.
2. Get this picture quality and enjoy low operating costs at the same time.
3. Get the kind of expert programming that sparks and holds viewer interest.

Let us show you how to plan your system to get these desired advantages. See your RCA Broadcast Representative. Have him acquaint you with RCA's comprehensive TV Film Facilities—for getting better pictures and lower operating costs for both Color and Monochrome.

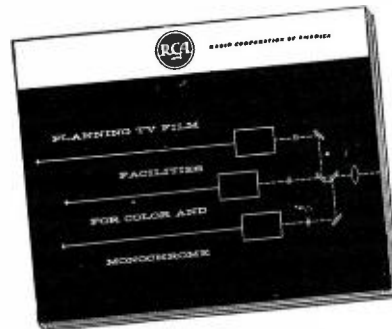

Tmk(s) ®

**RADIO CORPORATION of AMERICA**

BROADCAST AND TELEVISION EQUIPMENT

CAMDEN, N. J.

In Canada: RCA VICTOR Company Ltd., Montreal

# Planning

## PART ONE:

This is the first in a series of articles covering the planning, construction and operation of typical radio stations. This first part will cover three specific plans for three different size radio stations. Building layouts will be provided and equipment requirements will be discussed. General planning for the entire radio system will be considered.

Future articles in the series will cover the transmitter, tower and antenna systems. Also included will be descriptive specifications, transmitter building requirements, and advice on selection and ordering of equipment. This will be followed by a comprehensive discussion of installation procedures and practices, operating recommendations and maintenance.

### General Planning Considerations

The early planning of a radio station usually involves consideration of: the market to be served, site selection, transmitter power, tower height, station policies, personnel, the extent of programming, the hours of operation and available capital. In this article we confine ourselves mainly to the selection and arrangement of equipment to achieve the desired results. First, and foremost of the decisions to be reached, is whether the studio and transmitter are to be combined under one roof or to be in separate locations.

In the past few years there has been a trend toward combined studio and transmitter facilities rather than separated facilities. More recently, however, there has again been a trend toward separated installations, with the transmitter operated by remote control from the studio—*where permissible*.

It is generally agreed that wherever practical it is most economical to combine the studio and transmitter facilities. The initial equipment requirements are less and more important, is the fact that day-to-day operating expenses are lower. With the plant "all under one roof" there are savings

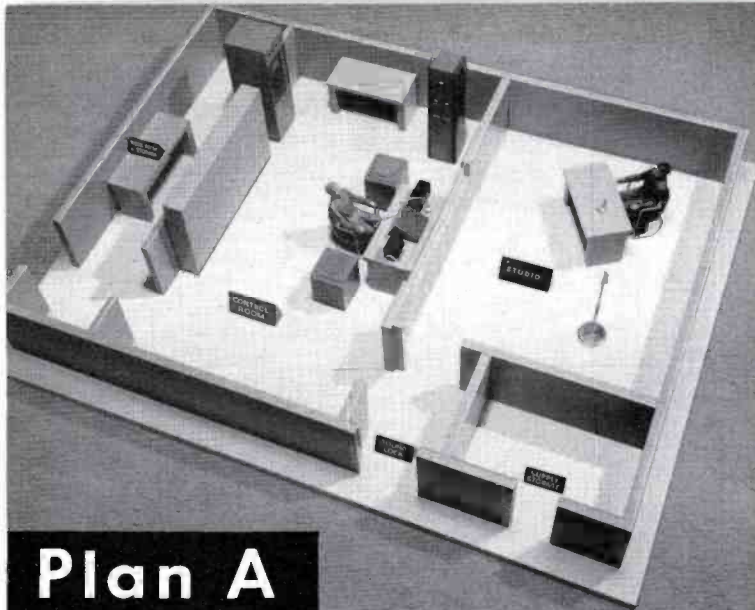

Plan A

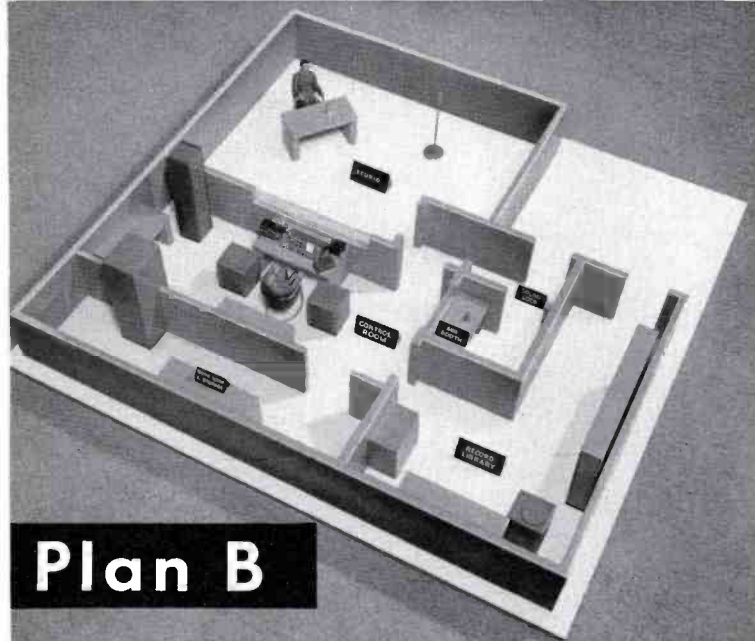

Plan B

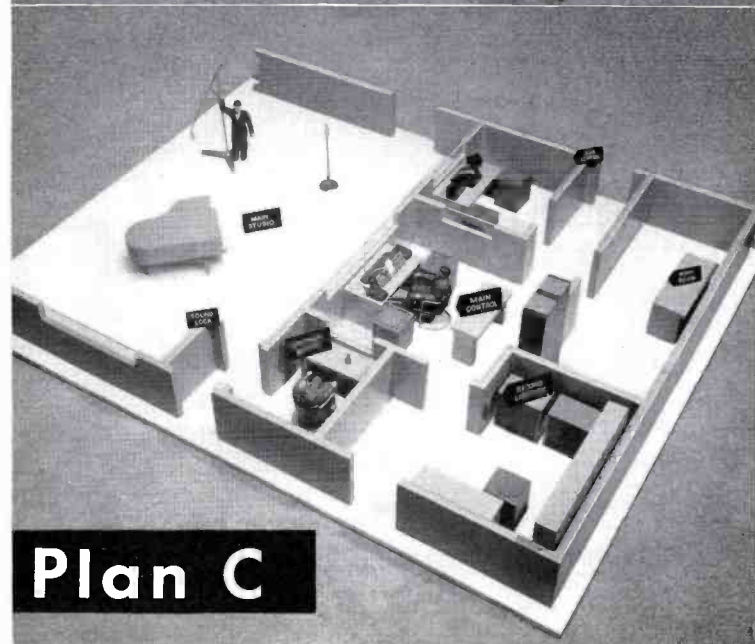

Plan C



# a Radio Station

## Studio Plans and Equipment for 3 Basic Types of Stations

in heating and air conditioning, building maintenance, travel time and, in addition, less technical personnel is required. A "combined" operation, however, is not always practical. There are several important considerations:

1. Is the combined location the best spot for the transmitter site? (By that we mean is there sufficient room for installation of tower or towers, and an adequate ground system? Furthermore, is it more advantageous from a standpoint of providing the desired coverage?)
2. Is the combined location convenient and accessible for station personnel and for clients? (A combined location is generally more practical in smaller cities, since an accessible and satisfactory location for both studio and transmitter can usually be obtained near the city limits.)

When a combined operation is not practical, the second most economical approach, where permissible, is to operate the transmitter by remote control from the studio. Then one can select a transmitter site that is most advantageous from a radiation and coverage standpoint, and the studio could logically be placed at its most convenient location. The building requirements at the transmitter can be the very minimum, requiring only space for the equipment, a small work area and a small room-heating unit. The studio contains conventional equipment and a remote-control unit. This type of installation is one of the most desirable for larger cities.

### Control Room

All control-room installations, large or small, are alike in many respects. The differences are mainly a matter of the number of microphones, turntables, tape recorders and other program sources to be served. This, in turn, will dictate the type of console or control console that is most suitable. Beyond this, there are various arrangements of facilities to suit special

conditions and personal tastes. For economic reasons, most stations locate the control console in front of the studio viewing window. They locate the turntables on either side of the operator's position at the console, a microphone over the console for control-room announcing, and tape-recording equipment within easy reach of the operator. Such an operating arrangement is shown in Fig. 1.

### House Monitoring

A house-monitoring system is an important function, and proper planning before construction begins will provide a much neater installation. Provisions should be made to carry audio to several locations throughout the building, the lobby area, offices, clients' room, etc. Besides normal program material, it provides a convenient closed-circuit system for auditions and special monitoring.

### Ductwork

The careful planning and layout of trenches and ducts for wiring is essential to economical installation and efficient operation. Once the technical equipment has been accurately determined, it is then time to plan trench runs. These should provide for some measure of future expansion. A typical trench layout is shown by dotted lines in Fig. 1.

### Studio Considerations

As we examine present-day operations, we find the studio receiving less consideration because fewer live programs are being originated. However, we have further discovered that neglect in the planning of the studio places a later handicap on the average operation, which could have been prevented with only a small additional expense and a little careful consideration at the time of construction. Hence in this article we present plans that provide for normal expansion without undue expense.

### Equipment Planning

The next most logical step after early plans have been completed is the careful

and considered planning for the technical equipment. This goes hand-in-hand with the building design and construction. Equipment planning is the proper selection and layout of technical equipment to satisfy contemplated programming requirements.

We are going to cover three versatile radio station equipment plans, which do not necessarily represent any existing stations but they do illustrate several ways in which the very latest equipment may be arranged to perform efficiently with a minimum of capital and personnel.

Since programming requirements vary, we present three plans, which represent three specific categories of operation:

1. Plan "A" covers a typical "combined" studio-transmitter operation, with programming requirement of records and transcriptions, control room announce, one studio, tape facilities, network and remotes. This is a small station, requiring minimum investment.
2. Plan "B" also covers a "combined" operation, but incorporates additional facilities to allow for an announce booth and other local program material. It is a typical *community* station of moderate size.
3. Plan "C" covers a fairly large two-studio station with separate studio and transmitter locations, but with optional remote operation of the transmitter. It is designed for large city operation, providing a high degree of flexibility and facilities for extensive programming.

The three plans are considered adequate for the majority of cases, and each is so arranged that modification of the plan may be made to suit individual requirements. The choice of the equipment layout will depend to a large extent on factors which are already determined: type of programming; area to be served; station policies and personnel.

# Plan A

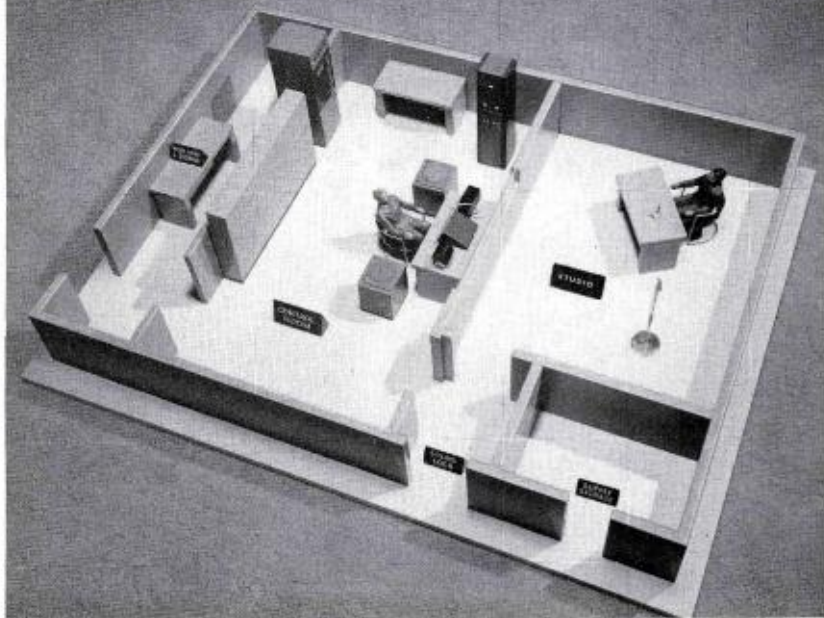

## Plan "A"

Plan "A" is a desirable layout for the small station that proposes to start operation at minimum investment. It includes the necessary technical equipment for handling the following programs: (1) announcements, (2) record and tape shows, (3) network, (4) remotes, and (5) local live originations such as interviews and newscasts.

It will be noted in Fig. 1 that the floor plan is separated into: combined transmitter and control room, small studio, engineering work room and parts storage, supply storage and a sound lock.

The major items of equipment required to perform the programming operation are identified on the floor plan. A block diagram, Fig. 4, shows how the system is connected together. An Equipment List, page 11, itemizes the requirements, including the miscellaneous small items necessary to complete the system. The rack layout, Fig. 3, further details the location of the various equipments.

The choice of transmitter, of course, depends upon the power of the individual station. Regardless of power, all other items included in Plan "A" remain the same.

Plan "A" incorporates many features to permit operation with a minimum of personnel. It is designed for a single operator-announcer to work directly from the control room. The equipment location makes

this practicable since turntables, tape recorder, control console, and record rack are all within easy reach of the operator. The equipment rack is situated for convenient reading of the frequency and modulation monitor meters without leaving the operating position. Record storage racks are easily accessible within the control room. Furthermore, the small utility storage rack and table, located directly behind the operating position, provides a handy place for keeping the daily program material ready for use.

Entrance to the control room or the studio is via the common sound lock. The small engineering work room with storage cabinet and workbench is sometimes neglected in planning, but will prove its worth many times over. The wiring trough shown in dotted lines in Fig. 1 makes the wiring readily accessible for service, or making additions to the system.

## Technical Facilities of Plan "A"

The control console is the heart of the audio system. A Type BC-5 Console is utilized in this plan. Because of its operational simplicity, it makes possible smooth and successful performance. This is due to proper location of important controls. Both from a system standpoint and from the physical standpoint all controls are easily accessible to the operator. An examination of the block diagram (see Fig. 4) shows the functional location of the BC-5 in the system. Note the capabilities,

especially the number of inputs and outputs.

The Type BQ-2 Turntables are next in importance. They are three-speed units: 33-1/3, 45 and 78 rpm. These utilize a simplified speed-changing mechanism, proved and reliable, driven by a hysteresis synchronous motor. The turntable starts very smoothly, which is so necessary with micro-groove recordings.

A Type SRT-2 Tape Recorder is located on the table within easy reach of the operator. (This may be rack mounted, if desired.) It is a dual-track, two-speed (3 1/4 and 7 1/2 i.p.s.) unit, driven direct by a synchronous motor. It utilizes the latest circuit techniques: transistor amplifiers, and electrodynamic tape tensioning and braking.

An Automatic Gain Control Amplifier and a Limiting Amplifier are located in the equipment rack. The functions of these two units in the system are related, and a description of their importance follows: It is a well-known fact that station coverage, regardless of power, is definitely related to the ability of maintaining the highest possible average level of modulation without distortion. The use of a limiting amplifier has been common for several years with reasonably good results, however, it has some limitations. In a Limiting Amplifier, the gain is constant up to a certain output level. Above this level, there is so much gain reduction that the output level will be maintained virtually constant. Thus, a limiting amplifier is effective only on high levels of program material. On the other hand, the Automatic Gain Control Amplifier (AGC) will serve to maintain a relatively constant output, much in the same manner that an operator might, by carefully and constantly "riding gain" on the program. The characteristics of the BA-25 AGC Amplifier and the BA-6 Limiting Amplifier supplement one another ideally when connected in a system feeding a transmitter. This combination permits a higher average level of program material, and prevents over-modulation on sudden program peaks, which effectively improves reception in fringe areas and extends coverage *without increasing transmitter power*.

Other major equipment items located in the equipment rack are the frequency and modulation monitors (required by the FCC), and a BJ-24 jack panel. The complete rack layout is shown in Fig. 3.

(A detailed description of all major equipment items and a discussion of their features will be covered later in the equipment section of this series of articles.)

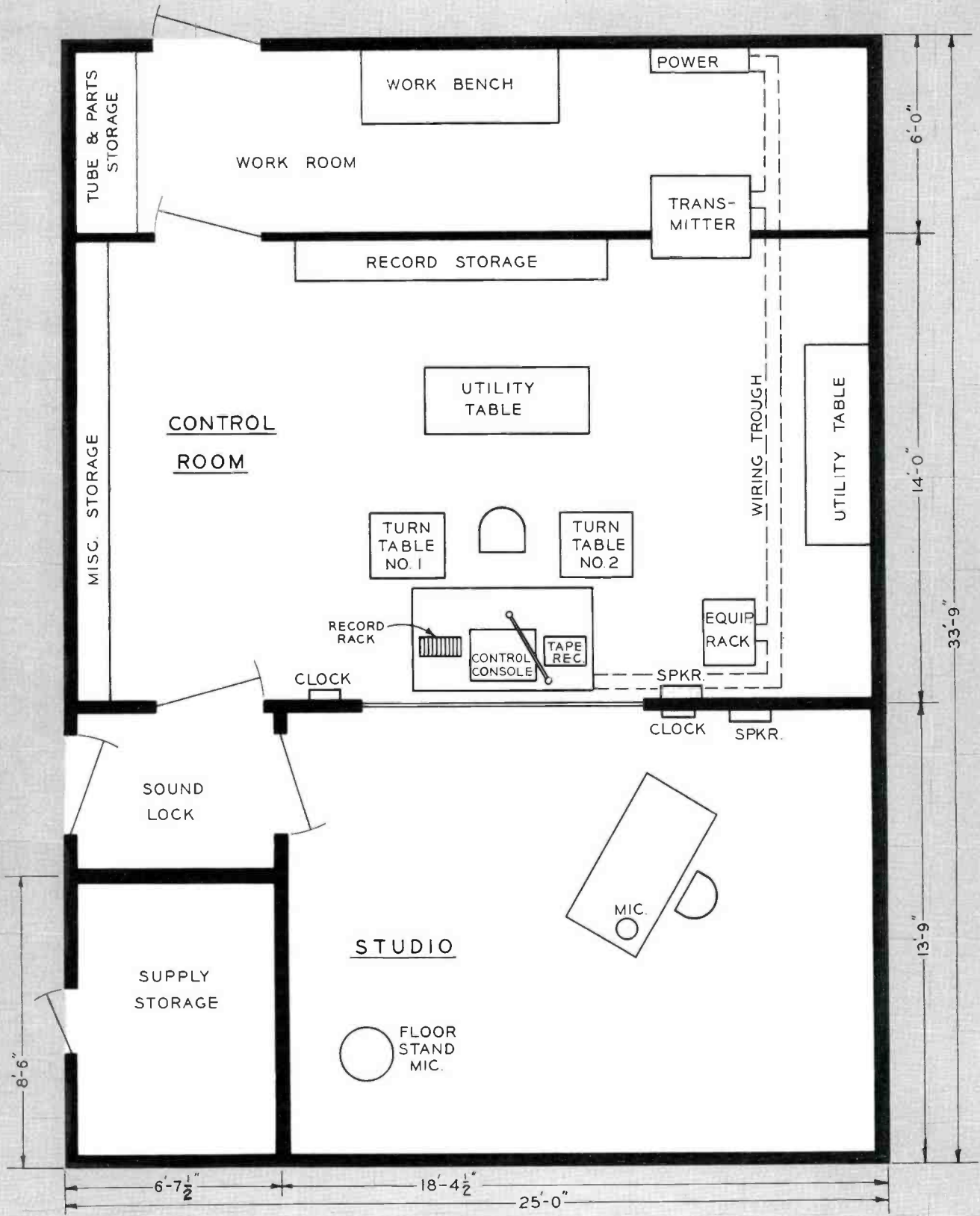

FLOOR PLAN A

FIG. 1. This shows location of major equipment items. Observe the convenient location of the wiring trough (dotted lines) for accessibility to the necessary equipment.

# Plan A

TAPE OUT	NET	REM 1	REM 2	REM 3	EXT PGM OUT	EXT AUD OUT	CONSOLE OUT	40 DB PAD OUT	AGC AMP OUT	20DB PAD OUT	LIMITER OUT
TAPE IN	NET IN	REM 1 IN	REM 2 IN	REM 4	TAPE REC IN	SPARE	40DB PAD IN	AGC AMP IN	20DB PAD IN	LIMITER IN	XMITTER IN

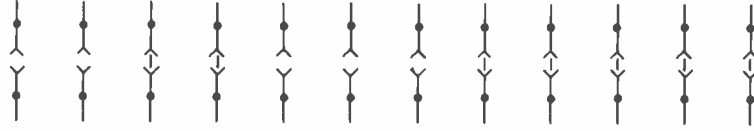

LEGEND OPEN JACK NORMALED THROUGH

FIG. 2. Jack panel for Plan A.

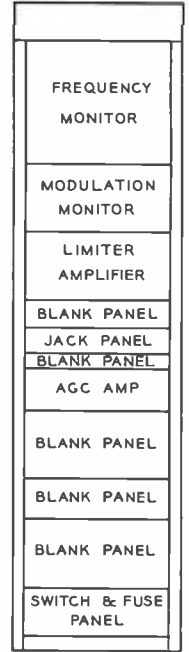

## PLAN A RACK

FIG. 3. Rack layout for Plan A equipments. Note blank panels which allow for future expansion.

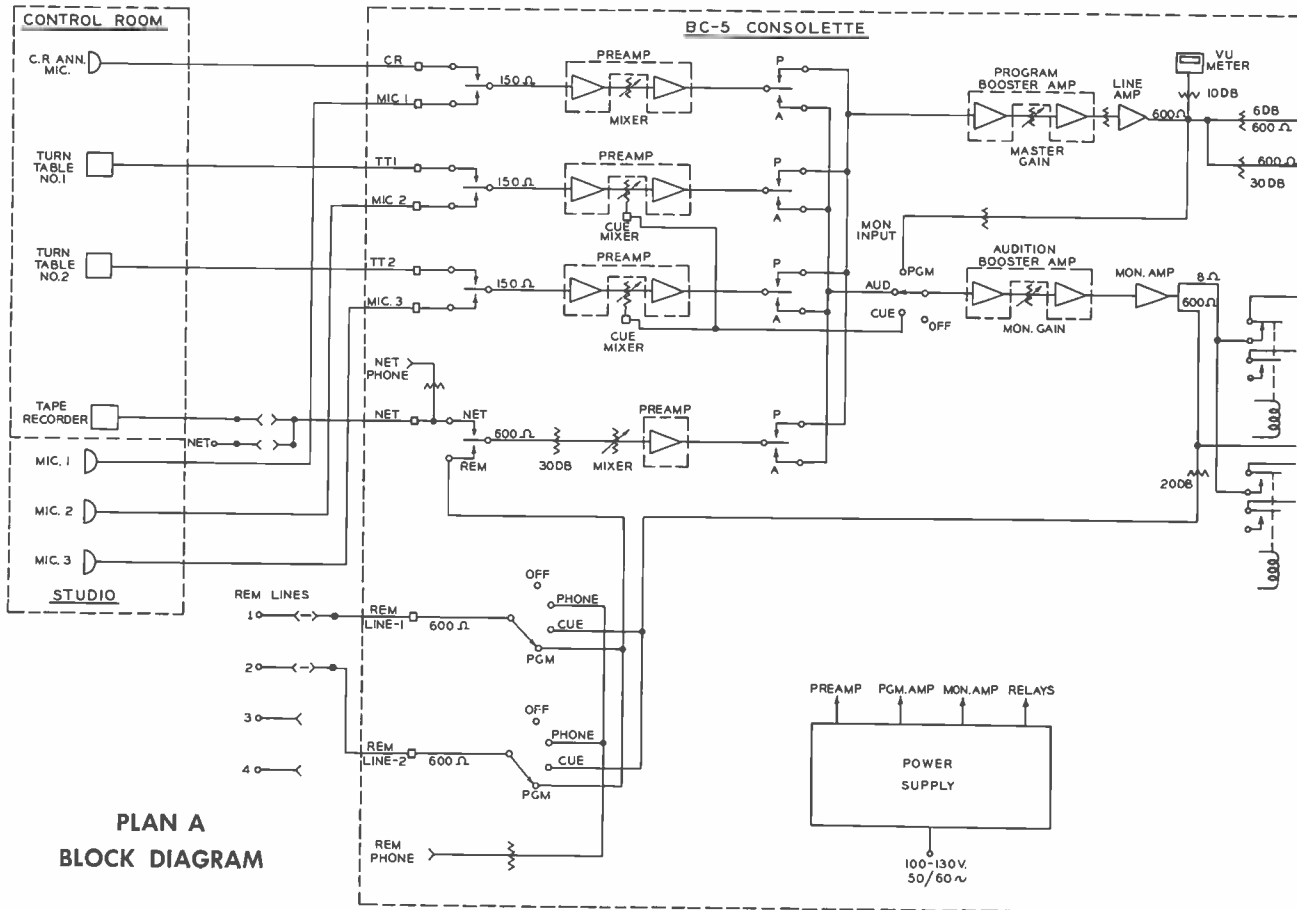

PLAN A  
BLOCK DIAGRAM

FIG. 4. This shows how the Plan A system goes together.

## PLAN A EQUIPMENT LIST

(Providing the facilities for handling records and transcriptions, announcements from the control room, one studio, tape facilities, network and remote programming.)

Note: Transmitter and Antenna Equipment are not listed here since they are specified in accordance with power and pattern.

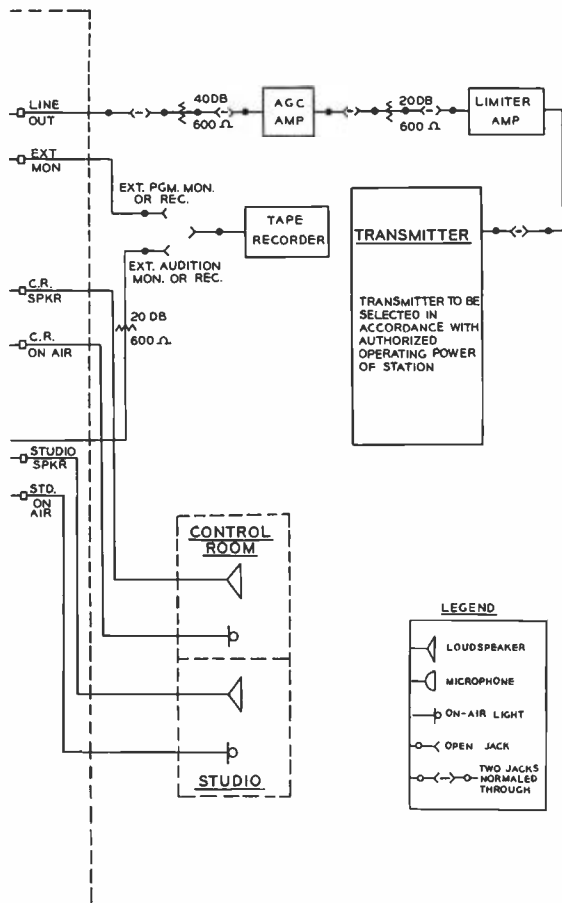

Item	Quantity	CONTROL ROOM
1	1	BC-5 Audio Console With Tubes
2	1	Dual Headphone
3	1	BK-1 Microphone
4	1	Microphone Mounting
5	1	XLR-3-11C Microphone Plug
6	1	XLR-3-32 Microphone Receptacle
7	2	"On-Air" Lights
8	2	BQ-2 Three-Speed Turntables
9	2	Transcription Tone Arms
10	2	Pickup Heads
11	2	Transcription Equalizers or Filters
12	1	SRT-2 Tape Recorder
13	1	Input Transformer for Tape Recorder
14	1	Output Transformer for Tape Recorder
15	1	20db, 600 ohm Fixed Pad
16	1	Monitor Speaker
17	1	Monitor Speaker Housing
18	1	Speaker Matching Transformer
19	1	16 inch Sessions Clock
20	100 ft	Interconnecting Cable #22 AWG Shielded Pair, With Cotton-Braided Outer Cover

### STUDIO

21	1	SK-46 Ribbon Microphone
22	1	KS-5 Desk Stand for SK-46
23	1	77DX Ribbon Microphone
24	1	Floor Stand for 77DX Microphone
25	3	XLR-3-11C Microphone Plugs
26	3	XLR-3-32 Microphone Receptacles
27	2	"On-Air" Lights
28	1	Studio Monitor Speaker
29	1	Monitor Speaker Housing
30	1	Speaker Matching Transformer
31	1	16 inch Sessions Clock
32	100 ft	Interconnecting Cable #22 AWG Shielded Pair, With Cotton-Braided Outer Cover

### AM TRANSMITTER INPUT AND MONITORING

33	1	BR-19 Cabinet Rack
34	1	BW-11 AM Frequency Monitor
35	1	BW-66 Modulation Monitor
36	1	40db, 600 ohm Fixed Pad
37	1	BA-25 AGC Program Amplifier With Tubes
38	1	BR-22 Mounting Shelf for BA-25 Amplifier
39	1	20db, 600 ohm Fixed Pad
40	1	BA-6 Limiting Amplifier With Tubes
41	1	Mounting Shelf for BA-6 Amplifier
42	1	BJ-24 Double Jack Panel
43	1	Single Jack Panel Mat
44	400 ft	Interconnecting Cable for Audio Rack Wiring, #20 Shielded Pair, Solid Conductor
45	200 ft	Interconnecting Cable for AC and Filament Circuits, #18 Shielded Pair, Stranded Conductor
46	1	Terminal Board Mounting Bracket
47	1	Terminal Power Strip
48	1	Terminal Audio Block
49	4	Audio Patch Cords, 2 ft in length
50	1	Switch and Fuse Panel
51	1	3 1/2 inch Blank Panel
52	1	1 3/4 inch Blank Panel
53	2	8 3/8 inch Blank Panels
54	1	5 1/2 inch Blank Panel

# Plan B

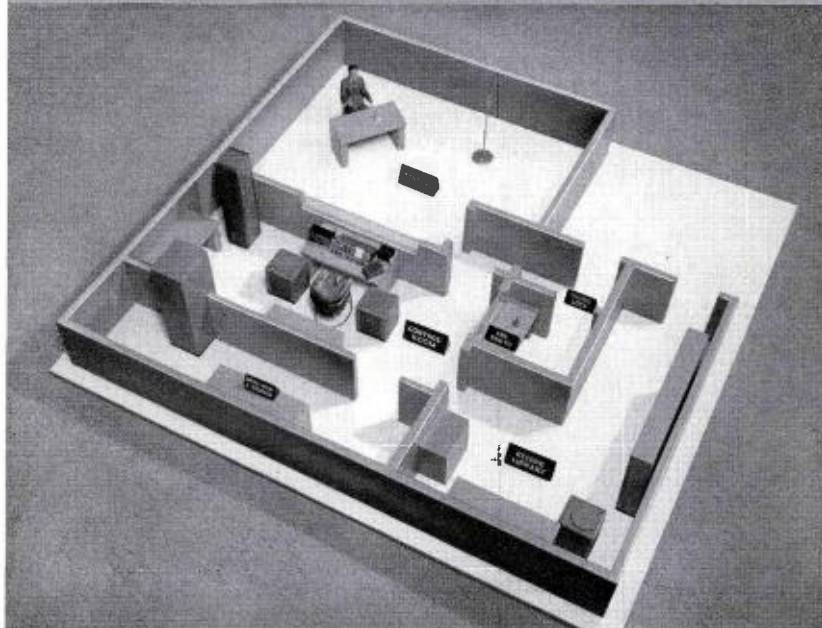

## Plan "B"

Plan "B" typifies the most desirable arrangement for the community-type radio station. This plan fulfills all the requirements, from a space and facility point of view, for handling a very diversified program schedule. It incorporates technical features that make for an adequate, yet economical, operation.

While Plan "B" is identical in many respects to the Plan "A" station, it includes larger and additional facilities (see Fig. 5). The major difference is a larger studio, the addition of an announce booth, and a record library room. Additional equipment consists of a BQ-103 automatic turntable, another microphone, a monitor speaker and associated items. A Type BC-3 Consolette is specified instead of the BC-5 used in Plan "A", because it can handle more facilities.

Now programming can be expanded to include the origination of a fairly substantial live studio show. Another important aspect of this plan is that with the announce booth serving as another point of origination, it becomes very practical to record announcements and other program material while on the air.

Again we have utilized a common sound lock, in the interest of economy, with the announce booth, studio and control room

all accessible from this area. The record library being separated from the point of program origination makes possible, with the facilities provided, auditioning of records, building of shows, cataloging, filing, etc., to be carried on without interruption during the program day.

It will be noted that the automatic turntable is located in the record library but controlled remotely from the operator's desk. This is convenient and further isolates the unit from the control room, so that any noise created while it goes through the change cycle will not go out on the air, when the control room announce microphone is open.

## Technical Facilities of Plan "B"

The Type BC-3 Control Console offers the additional system and operational functions required for Plan "B." It retains, however, the operational simplicity of the Type BC-5 console employed in Plan "A." As a matter of fact, it is simply an expanded version of the BC-5, just as Plan "B" is essentially an expansion of Plan "A." An examination of the block diagram, Fig. 6, verifies this, showing the function of the BC-3 consolette in this system. The rack layout for Plan "B" is shown in Fig. 8.

Three BQ-2 turntables are specified in the Equipment List for Plan "B." (see page

17). The additional BQ-2 turntable, along with some accessory equipment, makes up a small system for auditioning records. Figure 9 gives the details as to how this system goes together.

A first step toward automatic, or unattended, programming is provided by the BQ-102 automatic turntable. It may be used at some later time as one of the building blocks in a complete, unattended programming system. The BQ-102, in conjunction with a tape recorder, can be utilized at the present time for more effective programming. For example, taped commercials and announcements can be prerecorded at any convenient time. Then the desired records are loaded into the BQ-102. This, in conjunction with a cue sheet, will enable an operator to select and direct, simply and easily, the function of the units. Plans for unattended operation will, by necessity, require some changes in programming concept. A transition will be required from the old way to the new, and all stations will not find unattended programming operation applicable in the same way. Here, however, is the opportunity to gain experience and guidance for future planning.

A photograph of the BQ-102, Fig. 10, along with the automatic turntable system, block diagram, Fig. 11, serves to provide necessary information for planning.

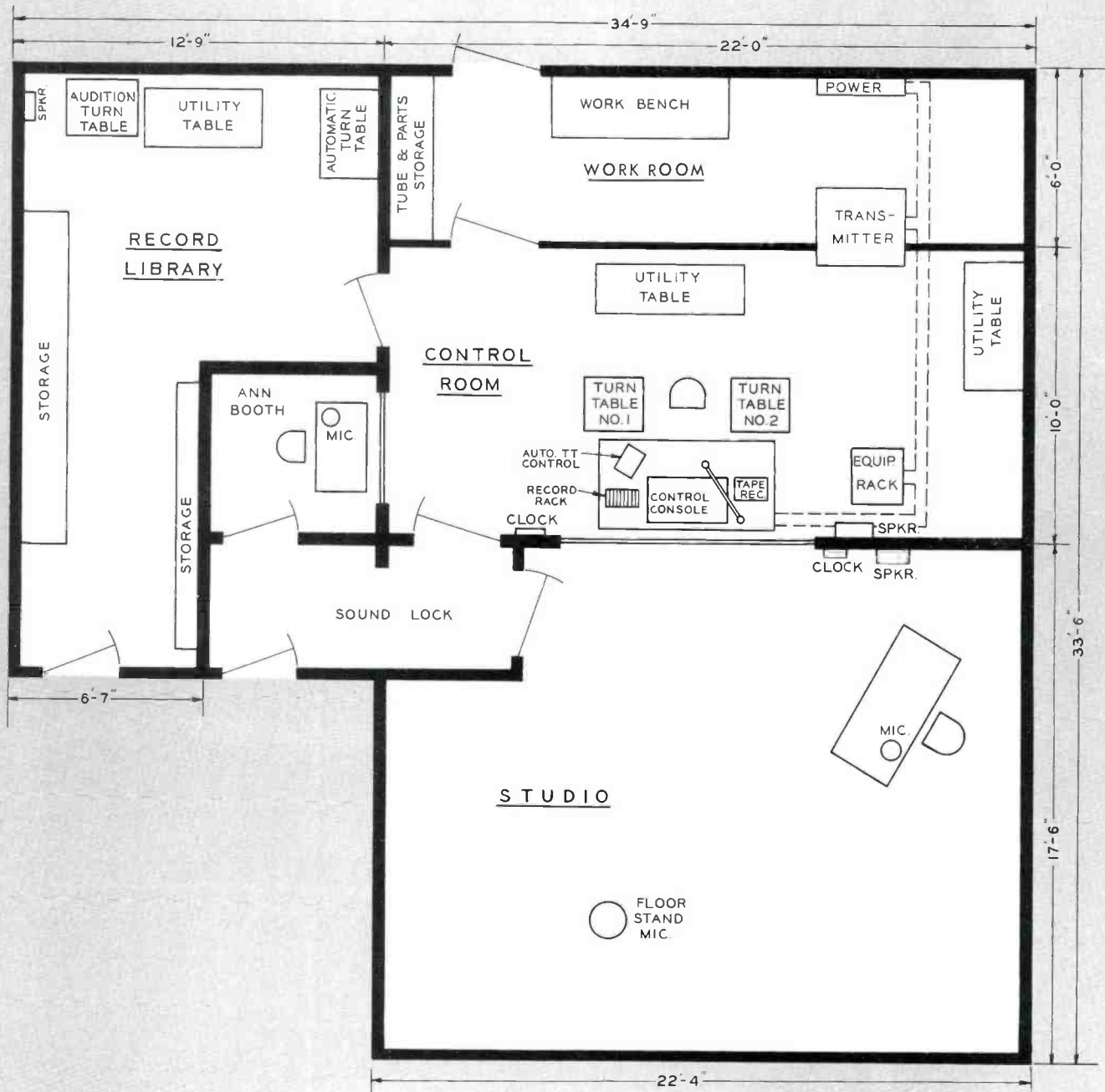

**FLOOR PLAN B**

FIG. 5. This shows location of all major equipment items. Note the addition of an announce booth and a record library.

# Plan B

## PLAN B BLOCK DIAGRAM

FIG. 6. This shows how the Plan B system goes together. Note additional inputs to handle the additional functions.

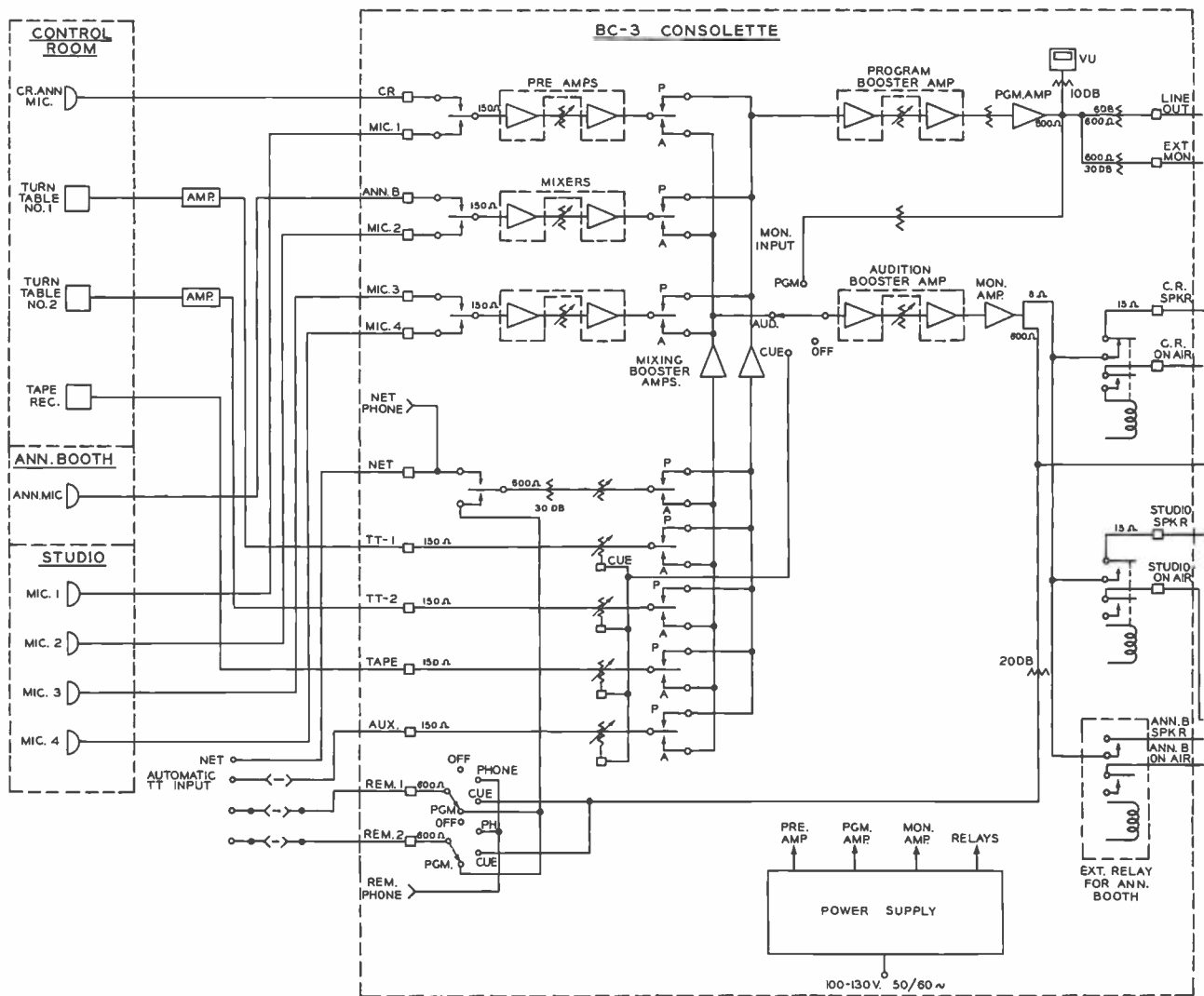



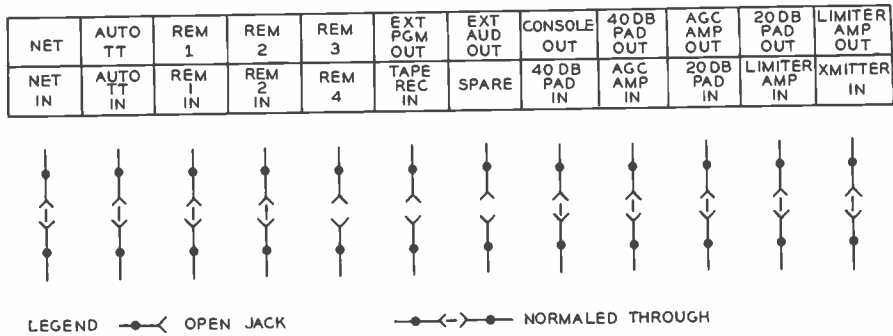

FIG. 7. Jack panel for Plan B.

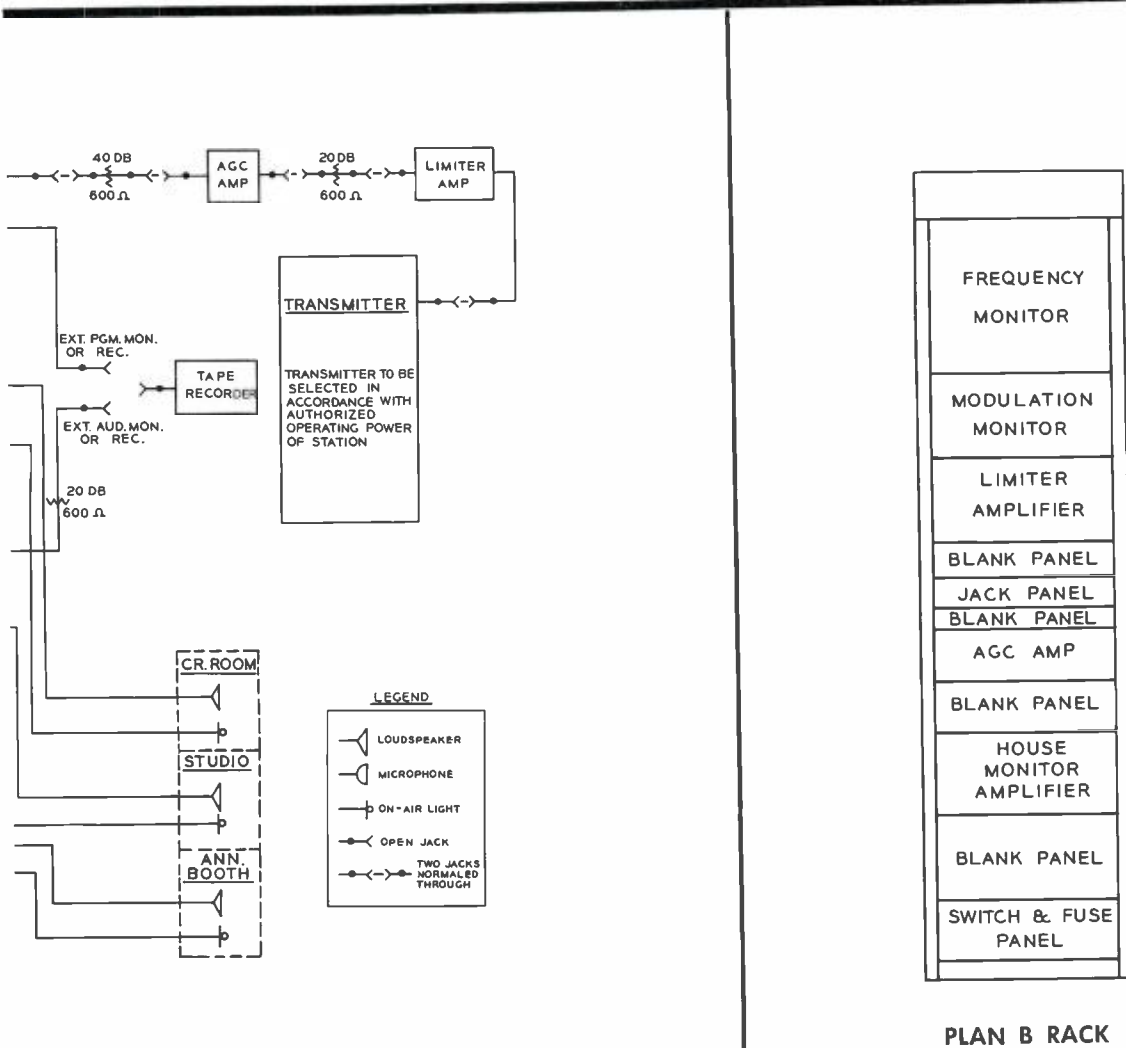

FIG. 8. This is similar to Plan A rack layout, but has, in addition, a house-monitoring amplifier.

# Plan B

## RECORD AUDITION SYSTEM

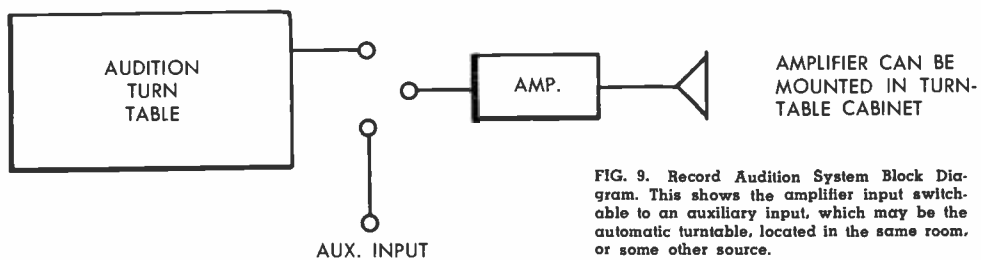

FIG. 9. Record Audition System Block Diagram. This shows the amplifier input switchable to an auxiliary input, which may be the automatic turntable, located in the same room, or some other source.

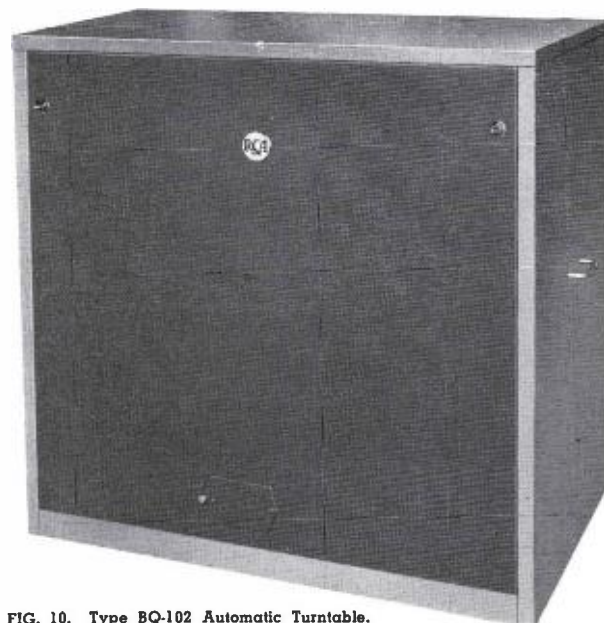
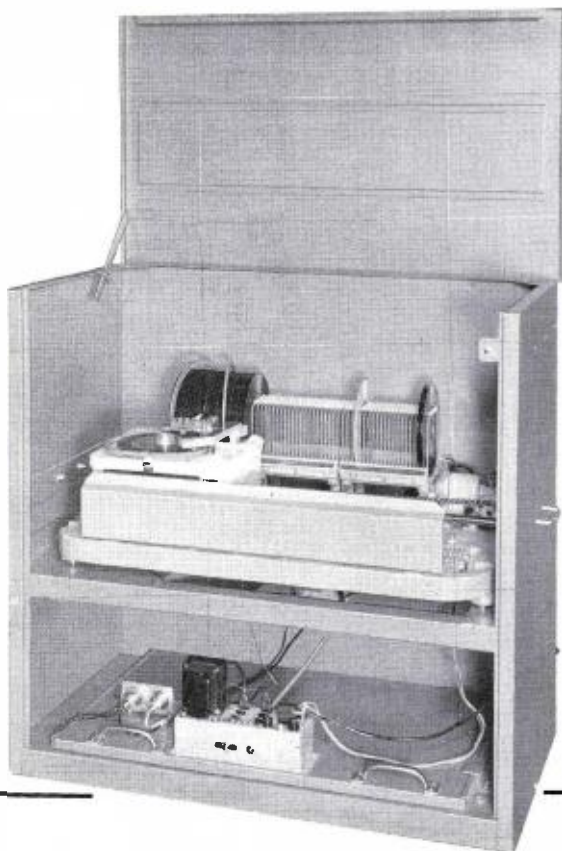
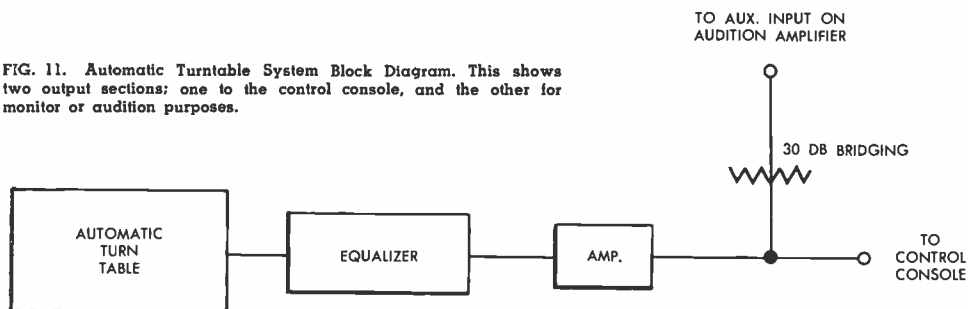

FIG. 10. Type BQ-102 Automatic Turntable.

## AUTOMATIC TURNTABLE SYSTEM

FIG. 11. Automatic Turntable System Block Diagram. This shows two output sections: one to the control console, and the other for monitor or audition purposes.



## PLAN B

### EQUIPMENT LIST

(Providing the facilities for handling records and transcriptions, announcements from the control room, one studio, announce booth, tape facilities, network and remote programming.)

Note: Transmitter and Antenna Equipment are not listed here since they are specified in accordance with power and pattern.

Item	Quantity	CONTROL ROOM
1	1	BC-3 Audio Console With Tubes, and Additional Speaker Light Relay
2	1	Dual Headphone
3	1	BK-1 Microphone
4	1	Microphone Mounting
5	1	XLR-3-11C Microphone Plug
6	1	XLR-3-32 Microphone Receptacle
7	2	"On-Air" Lights
8	2	BQ-2 Three-Speed Turntables
9	2	Transcription Tone Arms
10	2	Pickup Heads
11	2	Transcription Equalizers or Filters
12	2	Utility Amplifiers
13	1	SRT-2 Tape Recorder
14	1	Input Transformer for Tape Recorder
15	1	Output Transformer for Tape Recorder
16	1	20db, 600 ohm Fixed Pad
17	1	Monitor Speaker
18	1	Monitor Speaker Housing
19	1	Speaker Matching Transformer
20	1	16 inch Sessions Clock
21	100 ft	Interconnecting Cable #22 AWG Shielded Pair, With Cotton-Braided Outer Cover

Item	Quantity	STUDIO AND ANNOUNCE BOOTH
22	1	SK-46 Ribbon Microphone
23	1	KS-5 Desk Stand for SK-46
24	1	77DX Ribbon Microphone
25	1	Floor Stand for 77DX Microphone
26	1	BK-5 Uniaxial Microphone
27	1	Desk Stand for BK-5
28	4	XLR-3-32 Microphone Receptacles
29	4	XLR-3-11C Microphone Plugs
30	4	"On-Air" Lights
31	2	Studio Monitor Speakers
32	2	Monitor Speaker Housings
33	2	Speaker Matching Transformers
34	2	16 inch Sessions Clocks
35	150 ft	Interconnecting Cable #22 AWG Shielded Pair, With Cotton-Braided Outer Cover
<b>AM TRANSMITTER INPUT AND MONITORING</b>		
36	1	BR-19 Cabinet Rack
37	1	BW-11 AM Frequency Monitor
38	1	BW-66 Modulation Monitor
39	1	40db, 600 ohm Fixed Pad
40	1	BA-25 AGC Program Amplifier With Tubes
41	1	BR-22 Mounting Shelf for BA-25 Amplifier
42	1	20db, 600 ohm Fixed Pad
43	1	BA-6 Limiting Amplifier With Tubes
44	1	Mounting Shelf for BA-6 Amplifier
45	1	BJ-24 Double Jack Panel
46	1	Single Jack Panel Mat
47	400 ft	Interconnecting Cable for Audio Rack Wiring, #20 Shielded Pair, Solid Conductor
48	200 ft	Interconnecting Cable for AC and Filament Circuits, #18 Shielded Pair, Stranded Conductor
49	1	Terminal Board Mounting Bracket
50	1	Terminal Power Strip
51	1	Terminal Audio Block
52	4	Audio Patch Cords, 2 ft in length
53	1	Switch and Fuse Panel
54	1	SA-10 Monitor Amplifier With Tubes for House Monitoring System (Speakers to be selected as required)
55	1	Plug-in Transformer for SA-10 Amplifier
56	1	BR-22 Mounting Shelf for Monitor Amplifier
57	1	3 <sup>1</sup> / <sub>2</sub> inch Blank Panel
58	1	1 <sup>3</sup> / <sub>2</sub> inch Blank Panel
59	1	5 <sup>1</sup> / <sub>2</sub> inch Blank Panel
60	1	8 <sup>3</sup> / <sub>2</sub> inch Blank Panel
<b>RECORD LIBRARY</b>		
61	1	BQ-101 or BQ-102 Automatic Turntable with Remote Control
62	1	BQ-2 Turntable
63	1	Transcription Tone Arm
64	2	Pickup Heads
65	2	Transcription Equalizers and Filters
66	1	Utility Amplifier
67	1	SA-10 Monitor Amplifier for Audition
68	1	Plug-in Transformer for SA-10 Amplifier
69	1	Selector Switch for Input of SA-10 Amplifier
70	1	Bridging Pad for Automatic Turntable Audition
71	1	Monitor Speaker for Audition
72	1	Monitor Speaker Housing
73	100 ft	Interconnecting Cable #22 AWG Shielded Pair, With Cotton-Braided Outer Cover

# Plan C

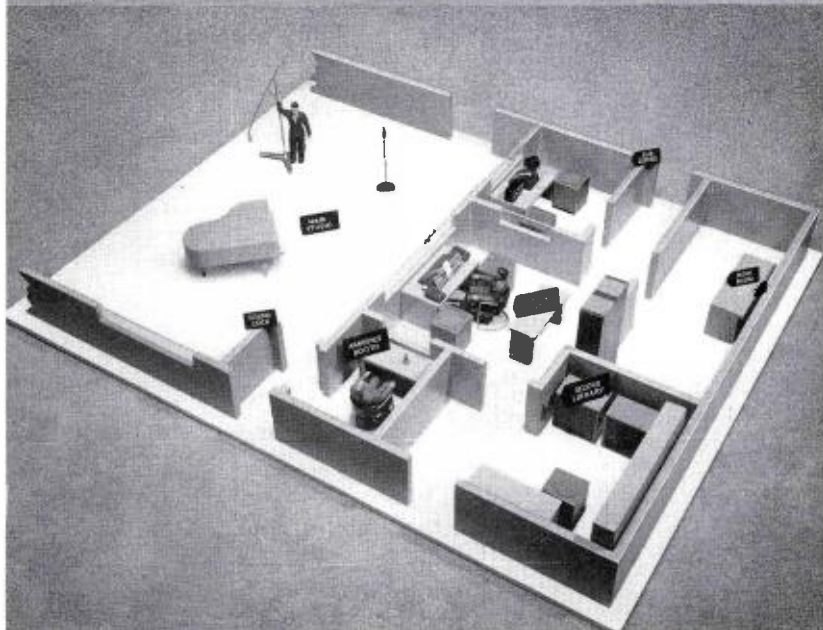

## Plan "C"

Plan "C" approaches the ultimate for the "larger" type of radio station as we know it today. From the floor plan, Fig. 12, it will be apparent that a high degree of flexibility is maintained, offering facilities for handling very extensive programming. Furthermore, it will be noted that Plan "C" incorporates many of the same general considerations described for the other two stations but with several additions. There is also one significant deletion—the transmitter. In this plan we have assumed that the transmitter would be located separate from the studio, with its own building, at its own site. (Descriptions of a typical transmitter building will be given in a later article.)

First there is a large studio, the size to be determined by just what type of programs one wants to originate. The associated technical facilities suggested will handle choral groups, full orchestra, audience participation programs, etc.

Then there is the main control room equipped with a BC-6 dual-channel control console. These two full channels, each with its own monitoring amplifier and power supply, provide maximum flexibility and reliability. Two BQ-2 three-speed turntables and two BQ-102 automatic turntables are employed. Two remote-con-

trolled tape recorders and two monitor speakers, together with miscellaneous amplifiers and accessory items are included.

A highlight of this plan is the inclusion of a multi-purpose room. It may be a small studio, or, as it is shown equipped (Fig. 12), may serve many purposes as follows:

1. A subcontrol room serving the main studio for regular programming auditions or recording (see Fig. 14),
2. For disc-jockey type shows,
3. For separate programming of another channel such as FM or to another AM station,
4. As a recording control room,
5. Announce booth,
6. Auditioning special programs,
7. Standby, or
8. As a program "make-up" facility for automatic program utilization in the future.

The announce booth, record library, engineering work room and storage area follow closely the preceding plans.

### Technical Facilities of Plan "C"

The major equipment item new to this plan is the BC-6 dual-channel control console. A block diagram of the unit is shown

within the system diagram in Fig. 13. Many years of experience went into the design of the BC-6, incorporating numerous features formerly available only in expensive custom installations. It has 22 inputs available, a "split-mixer" fader system and two vu meters.

As used in the Plan "C" system this console is made to serve on command as: a master control, a "combo" or operator-announcer's control board; a program on one channel while running an audition or recording on the other. Figure 15 shows the rack layout for Plan "C." The Equipment List appears on page 25.

At the beginning of this series of plans it was stated that they did not necessarily represent any existing stations, but that they illustrated several ways in which the equipment could be arranged, and the plans or combinations of them would satisfy a majority of cases. As Plan "C" is examined, it becomes evident that some of these features would readily adapt themselves to Plan "B." For example, it is recognized that the substitution of the BC-6 for the BC-3 console would enhance the flexibility of Plan "B." Or, an additional turntable may be in order. With the cross-application possibilities of these plans, practically all programming requirements can be met.

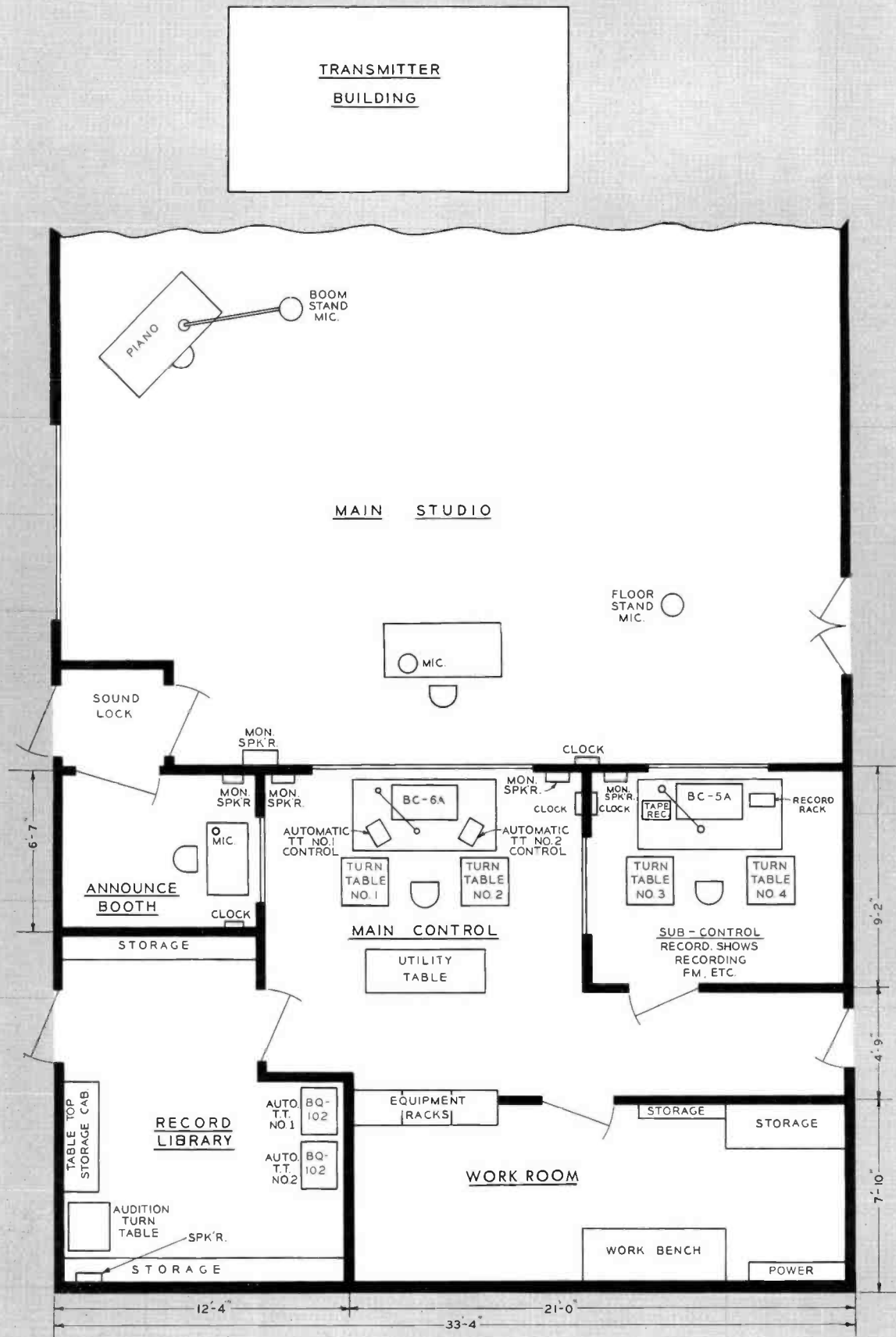

**FLOOR PLAN C**

FIG. 12. This shows location of all major equipment items. It is a very complete arrangement embodying a large studio which may be expanded as desired. Note that the transmitter is separated from the studio location.

# Plan C

## PLAN C MAIN CONTROL

FIG. 13. This shows how the main control room of Plan C and associated equipment go together. Of special interest is the Type BC-6 Consolette and the many facilities it offers.

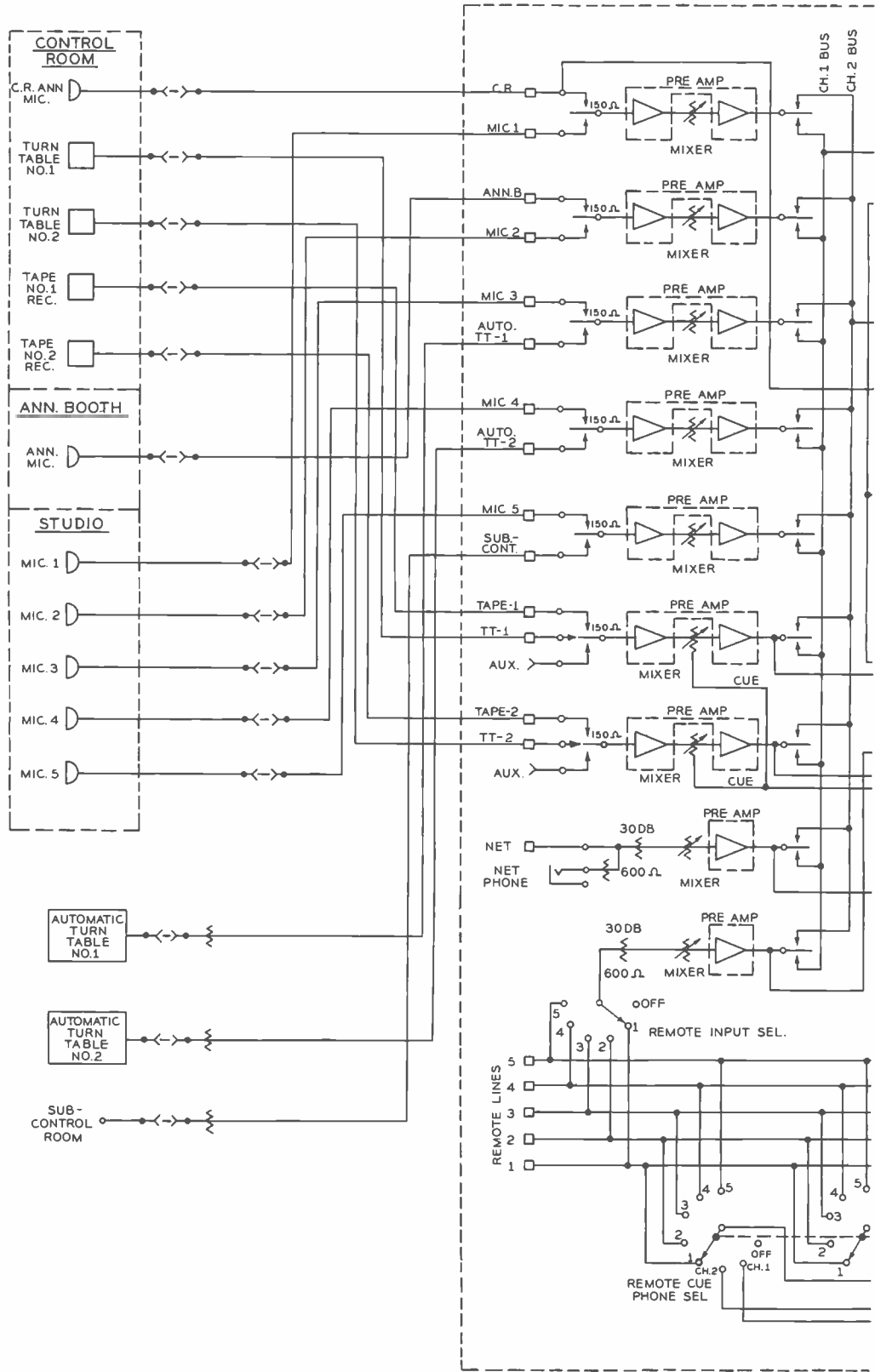

**BC-6 CONSOLETTA**

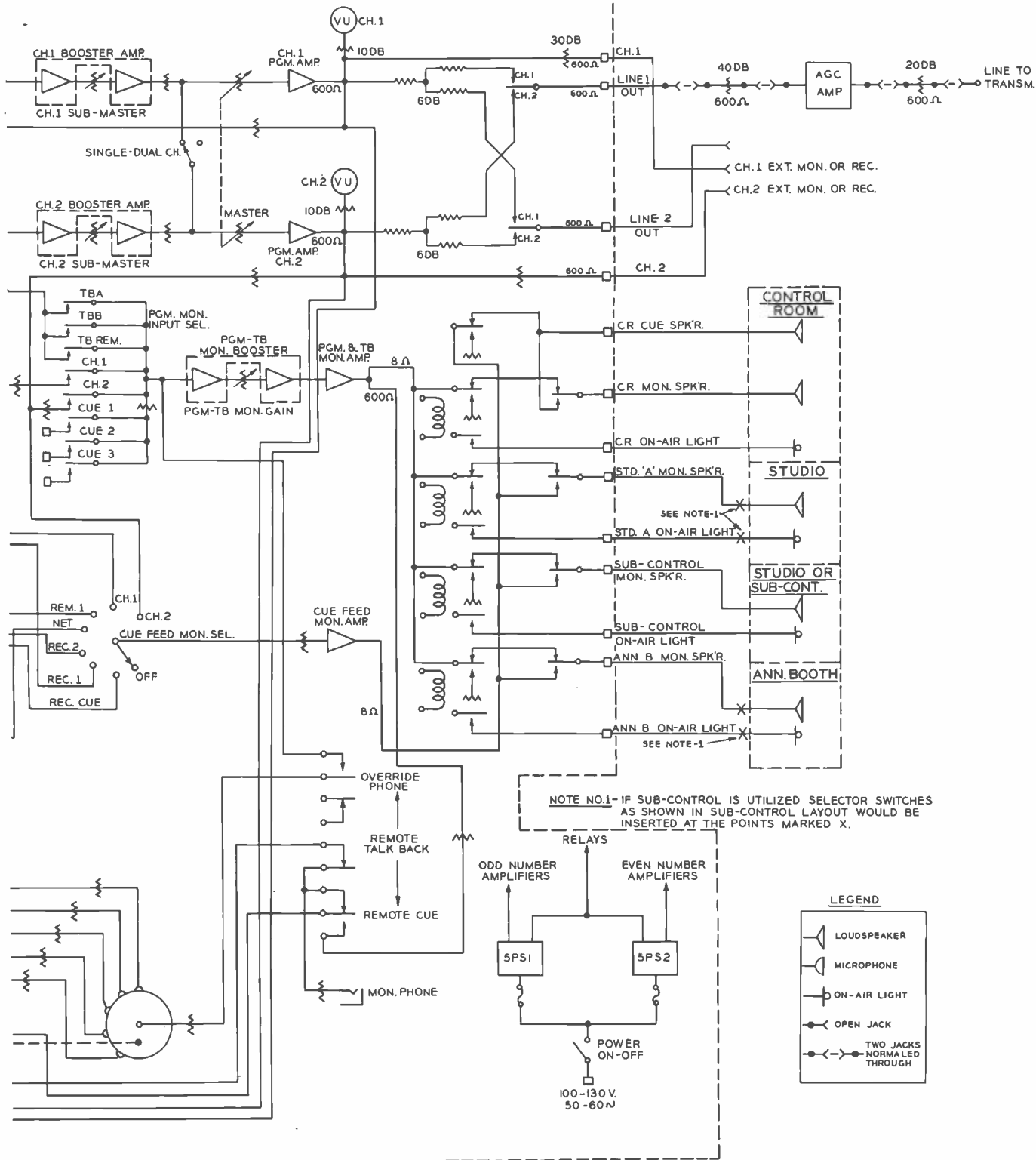

NOTE NO.1- IF SUB-CONTROL IS UTILIZED SELECTOR SWITCHES AS SHOWN IN SUB-CONTROL LAYOUT WOULD BE INSERTED AT THE POINTS MARKED X.

**LEGEND**

- LOUDSPEAKER
- MICROPHONE
- ON-AIR LIGHT
- OPEN JACK
- TWO JACKS NORMALIZED THROUGH

# Plan C

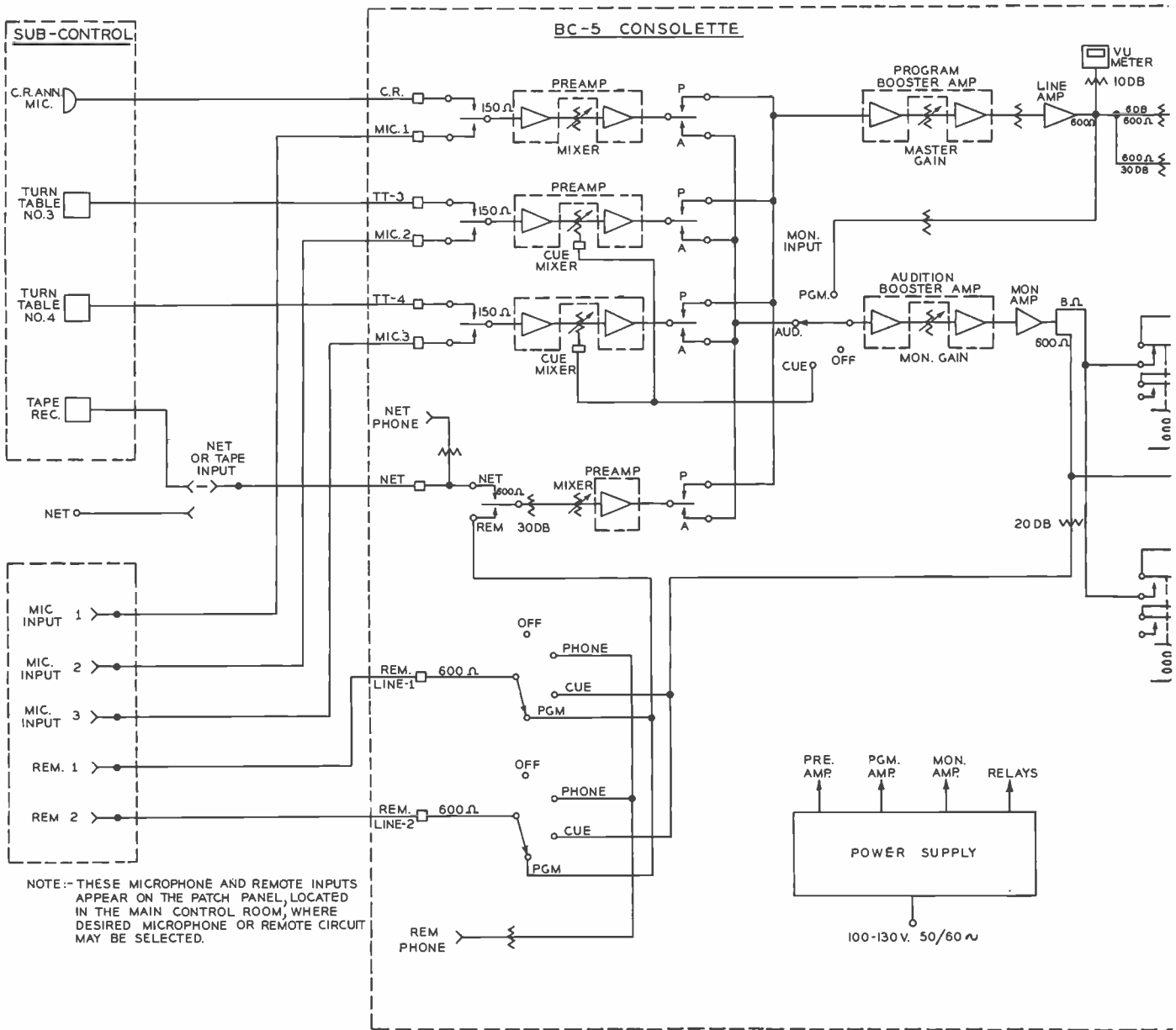

**PLAN C SUB-CONTROL**

FIG. 14. Subcontrol Block Diagram for Plan C, using the BC-5 Consolette.



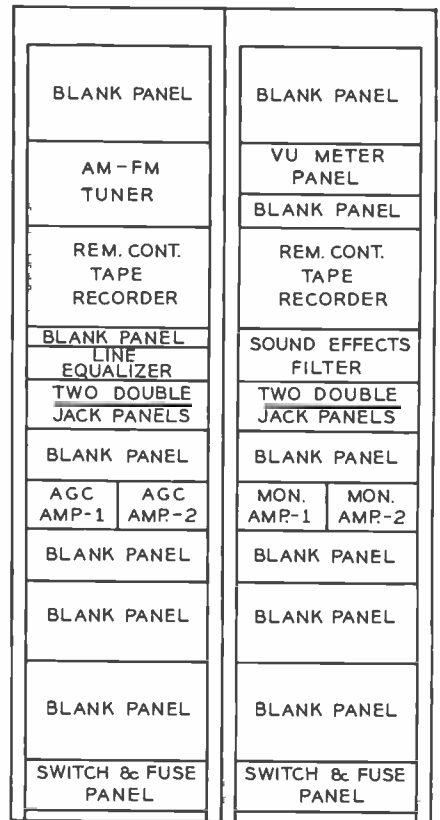
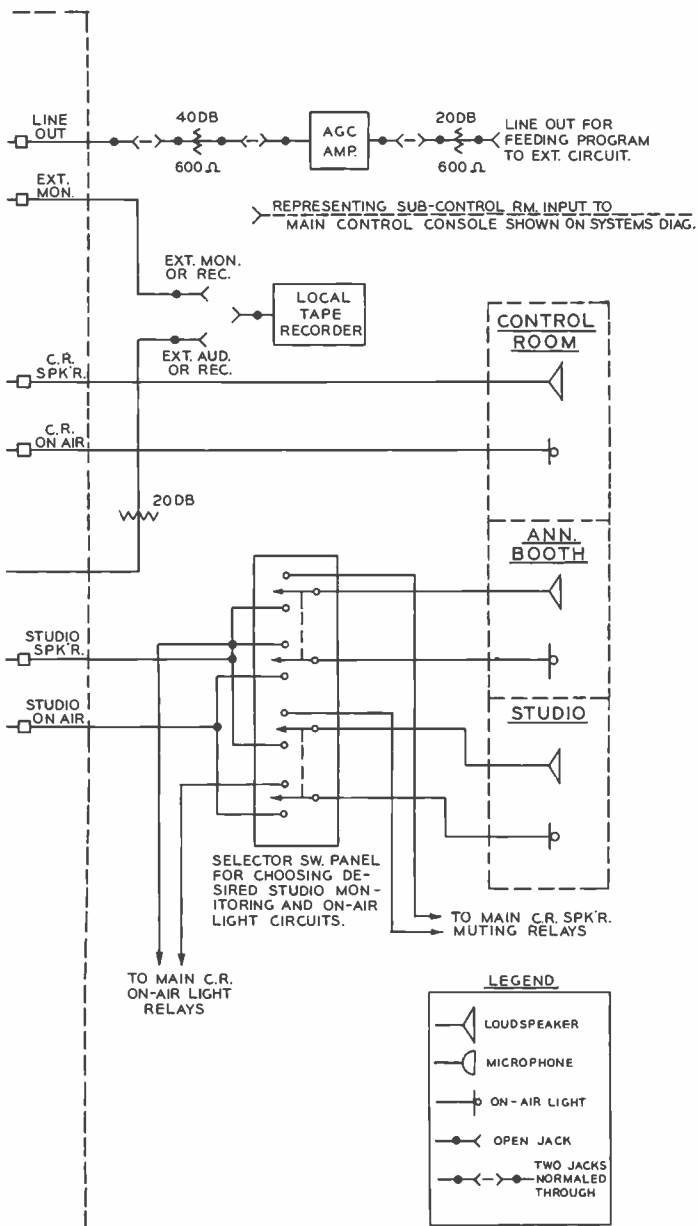

### PLAN C RACK

FIG. 15. This shows the necessary rack equipment with several desirable optional items: AM-FM Tuner, line equalizer, VU meter panel, and sound effects filter.

# Plan C

C.R. MIC	ANN. B MIC	MIC 1	MIC 2	MIC 3	MIC 4	MIC 5	TT 1	TT 2	TAPE 1 OUT	TAPE 2 OUT	SUB CONT OUT 1
PRE AMP 1-A	PRE AMP 2-A	PRE AMP 1-B	PRE AMP 2-B	PRE AMP 3-A	PRE AMP 4-A	PRE AMP 5-A	PRE AMP 6-B	PRE AMP 7-B	PRE AMP 6-A	PRE AMP 7-A	PRE AMP 5-B
AUTO TT 1	AUTO TT 2	SPARE	SUB CONT PRE-AMP 1-B	SUB CONT PRE-AMP 3-B	TAPE 3 OUT	SUB CONT REM-1 IN	SUB CONT MON OUT	SUB CONT CONSOLE OUT	40DB PAD OUT	AGC AMP OUT	20DB PAD OUT
PRE AMP 3-B	PRE AMP 4-B	SPARE	SUB CONT PRE-AMP 2-B	NET LINE	SUB CONT NET IN	SUB CONT REM-2 IN	SUB CONT AUD OUT	40DB PAD IN	AGC AMP IN	20DB PAD IN	TAPE 3 IN

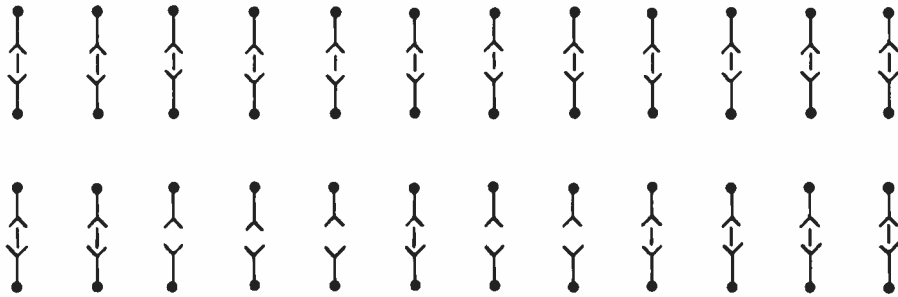

REM LINE 1	REM LINE 2	REM LINE 3	REM LINE 4	REM LINE 5	NET LINE	LINE EQ-ZR 1- IN	LINE EQ-ZR 2- IN	CONSOLE LINE-1 OUT	40DB PAD OUT	AGC AMP OUT	20DB PAD OUT
REM INPUT 1	REM INPUT 2	REM INPUT 3	REM INPUT 4	REM INPUT 5	NET IN	LINE EQ-ZR 1-OUT	LINE EQ-ZR 2-OUT	40DB PAD IN	AGC AMP IN	20DB PAD IN	LINE TO XMTR
SPARE	AM FM TUNER OUT	HOUSE MON 1-OUT	SPARE	SPARE	SPARE	SPARE	SPARE	HOUSE MON 2-OUT	SPARE	EXT MON 1	CONSOLE LINE-2 OUT
SPARE	HOUSE MON 1-IN	HOUSE MON CKT	SPARE	CUE 1-IN	CUE 2-IN	CUE 3-IN	HOUSE MON 2-IN	HOUSE MON CKT	SPARE	EXT MON 2	SPARE LINE TO XMTR

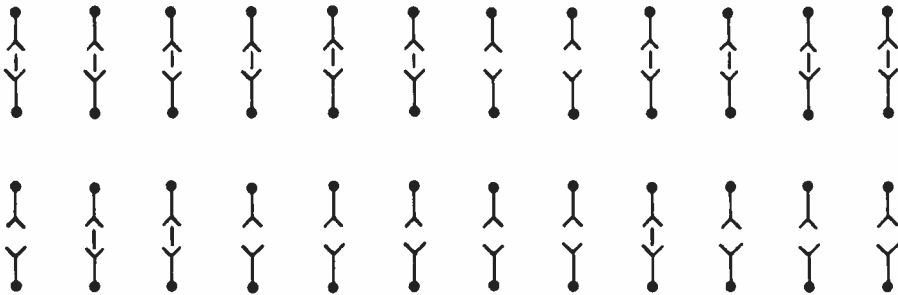

FIG. 16. Jack panels for Plan C.



FIG. 17. On-the-spot tape recording using the RCA SRT-2 Tape Recorder.



### Remote Pickup Equipment

Now that we have covered the station's plant facilities, there is an additional phase of operation that is a very significant revenue producer in many markets, and that is "on-the-spot" program origination. This phase of operation may be divided into three categories:

1. "On-the-spot" tape recording—accomplished with a portable tape recorder for playback at a later time. (See Fig. 17.)
2. Direct pickup at a remote location, using a remote amplifier and telephone lines. (See Fig. 18.)
3. Direct pickup at a remote location using a radio link between the remote point or program origination and the radio station. (See Figs. 19 to 21.) This method of remote pickup warrants some discussion.

### Remote Pickup Via Radio Link

Presently there is authorized by the FCC several remote pickup channels for use by the broadcaster. Categorically, they fall into three different frequency bands identified as the 26-mc band, the 150-mc band and the 450-mc band. Recently, the 450-mc band has become the most popular for this application. In this frequency range

there is less interference from man-made noise. The equipment, especially the antenna, is much smaller physically, so higher gain antennas can be conveniently used. The channels authorized in this band are not shared by other services.

It is necessary to file an application with the FCC for authorization to use this service. At this time FCC Form 313 is to be used for this purpose. With a little imagination many revenue-producing applications can be readily recognized. A few well-known ones are: sporting events, special events, on-the-spot accident and other newsworthy reports, traffic information during rush hours, farm programs and origination of special shows directly from sponsor locations.

### Conclusion

This concludes the discussion on the planning of a radio station. Our next article, Part Two of the Series, will take up the matter of transmitter, tower and antenna systems. Also included will be transmitter building requirements. Descriptive specifications for equipment will be given. This will be followed by advice on selection and ordering of equipment. Part Two is scheduled to appear in the next issue of BROADCAST NEWS.

FIG. 18. Pickup at remote location using BN-6 Remote Amplifier.





FIG. 19. This illustrates the use of a mobile unit for broadcasts originating at remote points, without studio facilities. (Shown here is Buddy Moreno, d.j. running program from WHHM mobile studio.)



FIG. 20. This is the RCA Carlone 450 mc unit. It can be used for establishing a radio link between the mobile unit and the station.

FIG. 21. This is a typical mobile studio of the type employed for remote broadcasting. (Shown here is the WHHM mobile unit with BC-5A audio-console inside.)





FIG. 1. KRMG Mobile Studio is built into a Volkswagen "Kombi."

## MINIATURE MOBILE STUDIO

Unit Accommodates Complete D-J Audio Console With Turntable, Tape, and P.A.; Police and Broadcast Band Receivers; and Two-Way Radio Systems

by W. H. BRADLEY, Chief Engineer, KRMG, Tulsa, Oklahoma

The decision was made in 1956 that radio station KRMG, Tulsa, would procure a mobile unit. We wanted to build into it a two-way mobile radio system for the News Department, and we wanted to include a complete disc-jockey studio. We sent letters of inquiry to about thirteen manufacturers of radio equipment. We were looking for a system which would give this broadcast station a two-way radio which did not sound like a coffee can or squawk-box system when we were on the air from the mobile unit.

We soon found that, as of 1956, it was very difficult to obtain a mobile radio system designed for fair audio, much less broadcast quality. After looking over all the specifications on the various brands we decided to purchase RCA equipment. The Radio Corporation of America was very helpful with suggestions and recommenda-

tions for modifying existing communications equipment.

We decided to purchase a Volkswagen "Kombi" model, 1956 vintage. This car gives us a great deal of usable space for both our mobile news unit and the portable radio studio equipment. Before making our selection we measured four different makes of station wagons but found there would not be sufficient room for a man to be seated in the rear part of the car—where the console and turntables were to be located.

### Design of Mobile Unit

We removed the rear seats and covered the floor of the Volkswagen with a layer of carpet and carpet pad. The vibration from the rear-mounted automobile engine was quite severe until the carpet and pad were installed.

After installing the two-way radio system for the News Department we then planned the disc-jockey setup in the car. We engaged the services of a cabinetmaker and had him build a custom table and shelves in the car to house the portable studio.

To aid in maintenance of the console and turntables all connections to every piece of equipment terminates in a Cannon connector, and we use a Cannon receptacle patch panel. Thus, we can remove any piece of equipment, including the console, in about one or two minutes.

Every piece of equipment used in the studio was designed to be operated on 117 volts a-c power. There is a regular fuse-distribution panel mounted on the wall of our mobile unit. We have a 125-foot a-c power extension cord which we use to carry

a-c power from a nearby source to the parked unit. Each piece of equipment is on an individual fused circuit and thus one blown fuse will not put the entire broadcast off the air.

The studio setup provides a complete phonograph cuing system. P.A. system, and headphone connection available to the announcer—even when the announcer is as far as 200 feet from the car.

#### Mobile Unit Equipment

The equipment we use in our mobile studio and news car is a BC-5A console, a 77-D microphone, two 88-A microphones, one CMU-15A2 two-way radio (which was

modified), two turntables, one standard broadcast receiver, one standard broadcast auto radio, one ATR inverter, one police radio and the tape recorder.

We have a Type 601 tape recording machine in the mobile unit. Thus we can make tape recordings while in the unit. Our power source is an inverter unit which gives us 117-volt a-c, 60-cycle power. The tape recorder can also be used in the disc-jockey setup, and it is then powered from the a-c power fuse distribution panel.

While we are on a disc-jockey type of broadcast we use a regular broadcast telephone loop for program transmission and connect to a nearby source of electric

FIG. 2. Rear view of KRMG Mobile Studio. Note two-way radio "Carlone" unit at right.





FIG. 3. Complete D-J studio is built into KRMG mobile unit using Type BC-5A Audio Consolette. There is sufficient room for convenient operation.

power which in turn feeds to the fuse distribution system panel in the car. The air monitor in this type of operation is a standard 117-volt a-c powered table model radio, which is a permanent part of the traveling studio. The speaker mutes automatically whenever the mike is turned on.

We learned from past experience to include a regular permanent rack in the mobile studio for the commercial transcriptions. We use the same type of rack and same filing system for the commercial transcriptions as we use at our permanent studio in the Akdar Building. The system layout and filing system are built to duplicate, as far as possible, the regular radio studio control room setup. This helps both the announcers and the engineers in helping to prevent operating errors caused by a strange setup.

#### Two-Way Radio

The News Department radio system was designed so that one man can operate the

system both as a two-way radio system for communications and on-the-air broadcasts at a remote location. The mobile unit is equipped with an auto radio mounted on the dash, a two-way 450-mc radio, head-phone monitor fed by radio broadcast receiver, police radio receiver for city, county and state police frequencies. Every piece of the mobile two-way radio equipment and the battery-operated radio receivers are interlocked through the auto ignition system so that the announcer cannot go off and leave the equipment power on and thus run down the battery. After ten months of operation we have not had one case of battery trouble. We use the regular 6-volt battery-generator system in the Volkswagen for part of the 6-volt mobile equipment, and we also installed a 12-volt battery with a 50 amp Leese-Neville generator for the rest of the mobile radio equipment. The filament circuit of the OP-6 audio speech amplifier is fed by the 6-volt car storage battery, the B plus is fed by a set of B batteries. The B batteries are

used only when on-air. We have had ten months' use out of the B batteries and they are still plenty strong.

#### On-Air Operation

When the mobile news reporter arrives at a scene to be broadcast, he calls into the studio by turning his mobile 450 mc carrier on. At the studio a 117-volt red lamp goes on at both the master control room and control room A. The studio engineer (or the announcer) can answer the reporter by pressing a push-to-talk button. Once communication is established they agree on an air cue. The news reporter in the mobile unit can then turn on his transmitter with one toggle switch. This single switch, by means of relays, turns the 450 mc carrier ON, transfers the broadcast receiver audio output from the loudspeaker on the dashboard to the news announcer's headset, mutes the police radio receiver loudspeaker in the car, turns on a red on-the-air lamp on dashboard, and turns on B batteries to the OP-6 amplifier. The



news announcer can leave the car if he wishes and take his mike and headset up to 125 feet from the car. He hears his on-the-air cue through the headset on the regular 740 kc broadcast, he is then on the air and also can monitor his on-the-air broadcast through his headset which is being fed by the broadcast receiver.

The announcer at the studio and the news director can interrupt the mobile news reporter at any time to ask questions right on the air in regard to the particular news which he is reporting. This cut-in feature is used a great deal of the time. Thus, the studio is on the air at the same time the mobile news reporter is on the air—interview style.

We had expected only a few miles range with this 15-watt, 450-mc equipment when we planned the mobile news car, but we have made many broadcasts—25 miles from Tulsa—with a good, clear signal. We have also done broadcasts while driving the mobile unit alongside of parades.

#### Modifications of Two-Way Radio

The mobile transmitter audio system was modified by using a single channel broadcast, RCA remote audio amplifier and an 88-A microphone. This by-passes the normal communications audio circuits in the mobile transmitter. At the base station we use a broadcast amplifier on the receiver. We come out of the base station receiver at the discriminator and feed this broadcast line amplifier and also feed a d-c amplifier, which operates the red signal lamps at the studio whenever the mobile carrier is on, and it also serves as a squelch system (since we do not use the squelch system in the receiver).

The red signal lamps at the studio do a wonderful job for us, relieving all studio personnel of the usual dispatcher type of duty—listening to a loudspeaker and waiting for the mobile unit to call in. The mobile news reporter can get attention of studio personnel within a few seconds since the large 117-volt lamps speedily attract one or both men in each of our control rooms.

#### Mobile Antennas

The antennas, which are mounted on the automobile, are as follows: One regular auto broadcast receiver antenna on the front of the car; the next atop the car is a 150 mc whip antenna for receiving police calls; next atop the car is the 450 mc two-way radio system antenna; and on the side of the car is a whip antenna for receiving state police calls.

#### Two-Way Radio Base Station

The base station for the mobile radio equipment is located on the 26th floor of

a downtown office building in Tulsa. At the base station point, we have a large wooden table for the equipment and also space provided to do repair service work conveniently. The coax transmission line runs from this table through the wall to the base of a high-gain 450 mc antenna. This antenna is strapped atop a steel flag-pole near the top of the building. We found after operating the equipment a few days that the line voltage varied due to special lighting on the building. We installed a voltage regulator transformer and cured this trouble. Wire screening and padlocks are used to prevent unauthorized personnel from tampering with equipment. We use

two private radio telephone loops from the base station equipment to the control room, a distance of  $\frac{1}{2}$  mile. In the control room we have a remote control unit, RCA Type CC-8A. One of the telephone loops goes to this control unit; the second telephone loop operates with the d-c amplifier. This in turn operates the 110-volt red signal lamps in each control room.

For maintenance we purchased an RCA Type CX-7A and an RCA Type CX-8A1 Frequency and Deviation Meter. These pieces of test gear have been very helpful when servicing the equipment. By this means we have kept our mobile system in satisfactory operating condition.

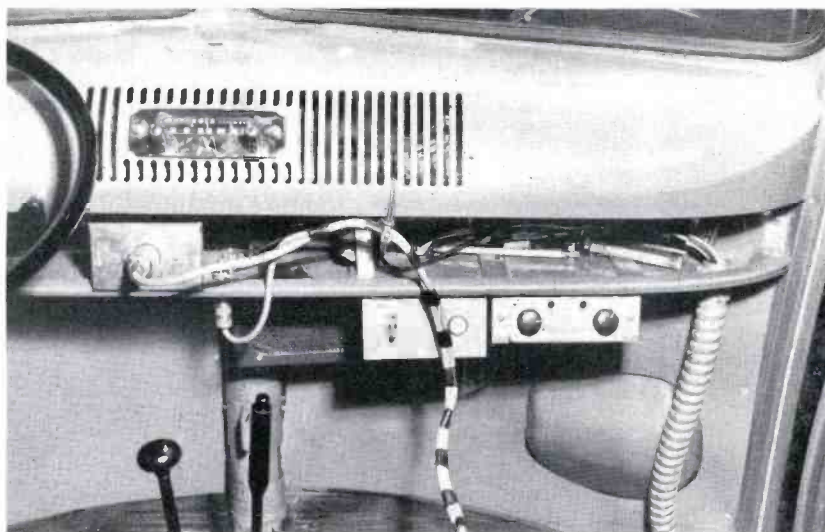

FIG. 4. Single toggle switch (center) turns on 450mc carrier, transfers broadcast receiver output to headphones, mutes police radio receivers and turns on red signal lamp.

FIG. 5. Custom built table and shelves to house the D-J studio line one side of the mobile unit.





CHANNEL  
**13**  
WLOS-TV  
ASHEVILLE, N.C.

# TRANSMITTER ON A MOUNTAINTOP

FIG. 1. Aerial view of the WLOS-TV transmitter site atop Mt. Pisgah shows rugged terrain. Transmitter building is structure located in the foreground. Studios are located off to the left about 18 airline miles away in residential area of Asheville, N. C.



Situated on Mt. Pisgah's 5749 ft peak in Pisgah National Forest, the WLOS-TV transmitter installation is one of the highest in the United States. Mt. Pisgah was judged to be the most desirable location after investigation of a score of mountaintops. The channel 13 ABC outlet in Asheville, N. C., went on the air September 18, 1954 with an ERP of 170 kw—FCC maximum power at 2850 ft elevation above average terrain.

In March of 1952, the chief of the Forest Service assured the FCC that the successful channel 13 applicant would be granted a permit to use the top of Mt. Pisgah for a transmitter site. A CP was granted to the Skyway Broadcasting Company, owners of WLOS-AM/FM/TV, on December 10, 1953, and a special use permit was issued granting 3.59 acres to the station. Construction began in April, 1954.

The old CCC road leading to the base of the peak was reconstructed. From the end of the road an incline railway was built to the peak. All of the equipment on the peak and the steel tracks for the railway were taken up the mountainside via this

route. A motor-driven winch was hand-carried several hundred feet ahead of the last completed section of track and then additional rails were pulled up on the cable car. Successive repetition of this procedure was used to complete the railway.

#### Transmitter Building

The tri-level transmitter building has been erected from native stone, most of which was blasted right out of the mountainside in leveling a site for the building. Although the structure at times seems on the verge of losing its tenuous hold to the steep slope it is bound to the solid rock of the peak by poured concrete floor slabs.

Consisting of a ground or basement level and two additional floors, the main building measures 40 by 25 feet. The hoist room, which contains the hoist machinery for the cable cars and also provides a sort of slip or landing dock for the cable car, adds another 12 feet to the structure's length at ground level.

Located in the basement are all of the high voltage transformers, emergency diesel-generator equipment and a water



FIG. 2. Charles B. Britt (right), Executive Vice-President and Manager of WLOS-TV, and P. G. Walters (left), RCA Broadcast Representative for the area, at the signing of the contract for the new RCA TT-25BH TV Transmitter.

FIG. 3. View of WLOS transmitter building and tower taken from cable car on Mt. Pisgah.

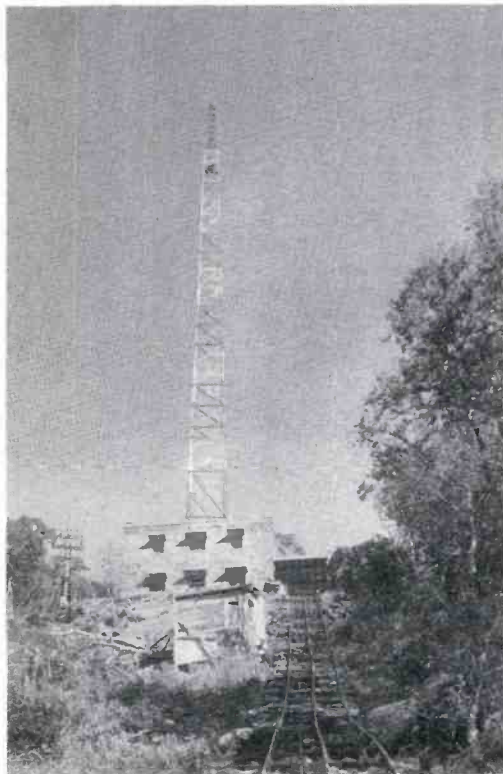

FIG. 4. Messrs. Perkins and Wright at end of road to transmitter atop Mt. Pisgah. Here the incline railway begins.



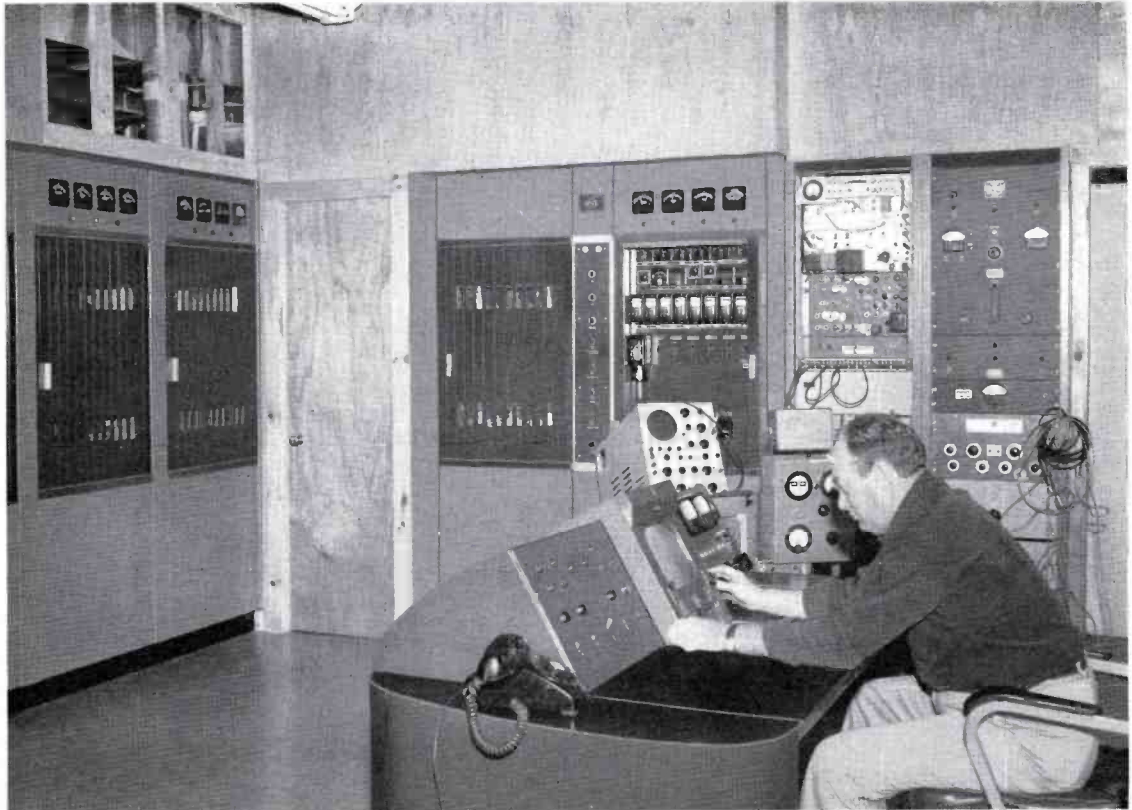
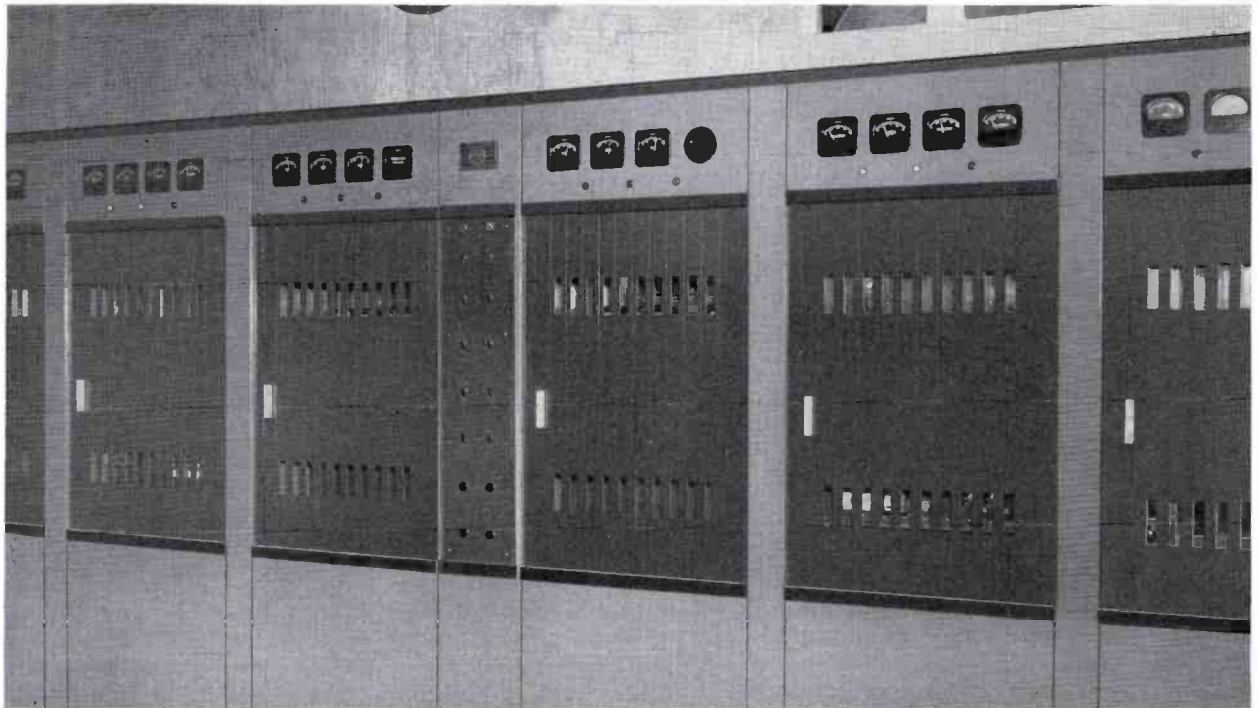

FIG. 5. Jesse H. Gibson, Transmitter Engineer, at the TTC-1B Transmitter Control Console. Control panel immediately to his right provides remote control of diesel generator power plant in the basement.

FIG. 6. Ten kilowatt driver portion of TT-25BH TV Transmitter recently installed at the station.



supply system. The first floor contains the main transmitter equipment. Living quarters containing large airy rooms are provided on the second floor of the building. These accommodations consist of an L-shaped living room and dining room with adjoining kitchen. A bedroom and a full bath complete the living facilities on this floor. A stairway leads all the way from the basement entrance to the roof.

Owing to the vertically L-shaped excavation on which the building sits, access to the tower is gained from the roof which is about 60 feet below the level of the tower base. A narrow six ft wooden catwalk extends from the roof to the path paralleling the transmission line run to the tower.

The building has been constructed to withstand severe weather conditions. Thermopane windows are used throughout and three by six ft reinforced concrete canopies three and a half inches thick jut out over the window tops as a means of protection from high winds and snow.

Exhaust hot air from the transmitter cabinets is the prime source of heat for the building. Should this prove inadequate during a severe cold spell, several oil-fired heaters are available for additional heating.

Water from a spring 200 ft down the mountainside is pumped into a 2500 gallon tank in the basement. This supply is more

than adequate to handle the present needs of the installation.

#### Transmitter

Installation of a new Type TT-25BH VHF Television Transmitter was completed in the fall of 1956. The transmitter layout is set up in a "U" type arrangement consisting of ten cabinets. Six of the cabinets form the ten-kw driver. Control and rectifier cabinets for the aural and visual power amplifiers are located to the left and right of the ten-kw driver.

A TTC-1B Transmitter Control Console, facing the driver cabinets provides facilities for normal transmitter operation and monitoring circuits for both audio and video. Also included in this arrangement is a master monitor for checking picture and waveform information at various points in the transmitter. Immediately to the right of the transmitter operator's position is a control panel which provides remote control of diesel generator power plant voltage and frequency.

Normal communication between transmitter site and studio location is via two-way radio. This radio link operates on a frequency of 26.09 mc with the call letters KII847. Should there be a breakdown in radio contact, a telephone provides a convenient emergency link to the studios 18 airline miles away.

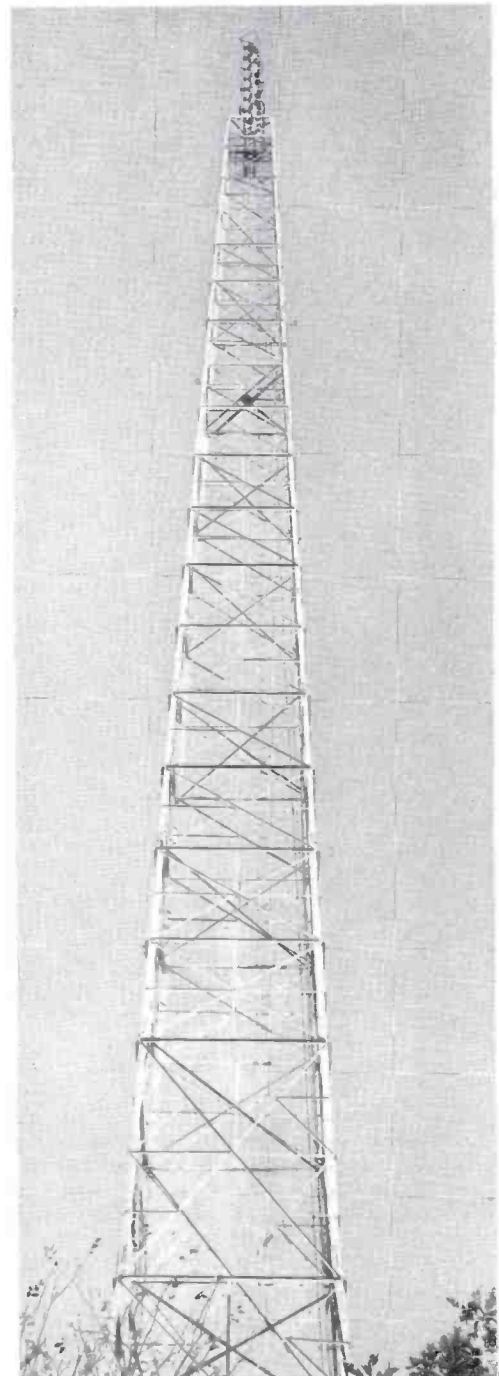
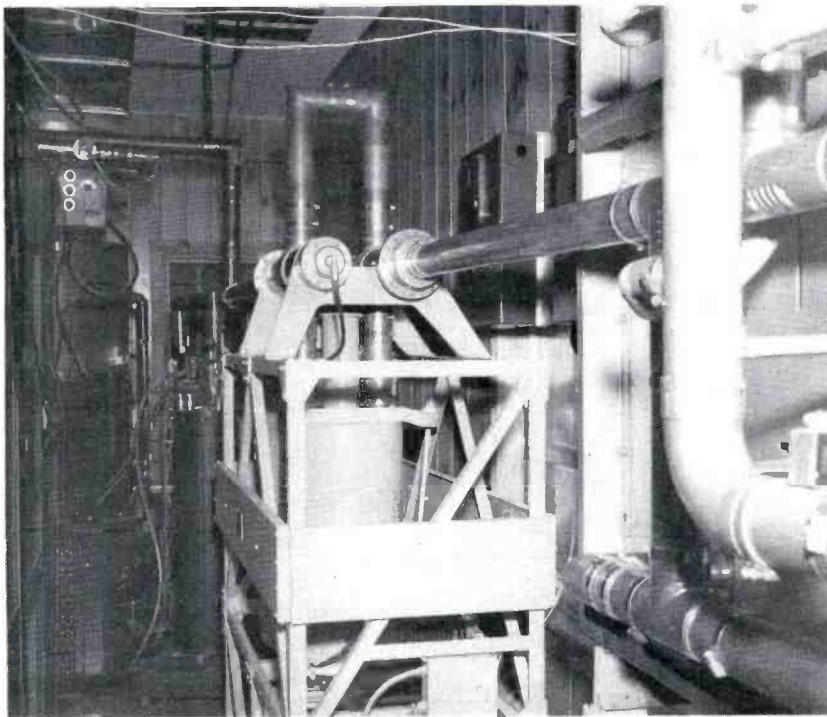

FIG. 7. WLOS-TV 40-ft. 8-bay antenna is mounted atop a 328-ft self-supporting tower.

FIG. 8. Wall-mounted coaxial notch-type diplexer and vestigial side-band filter can be seen in this view of the rear of the 10-kw driver.

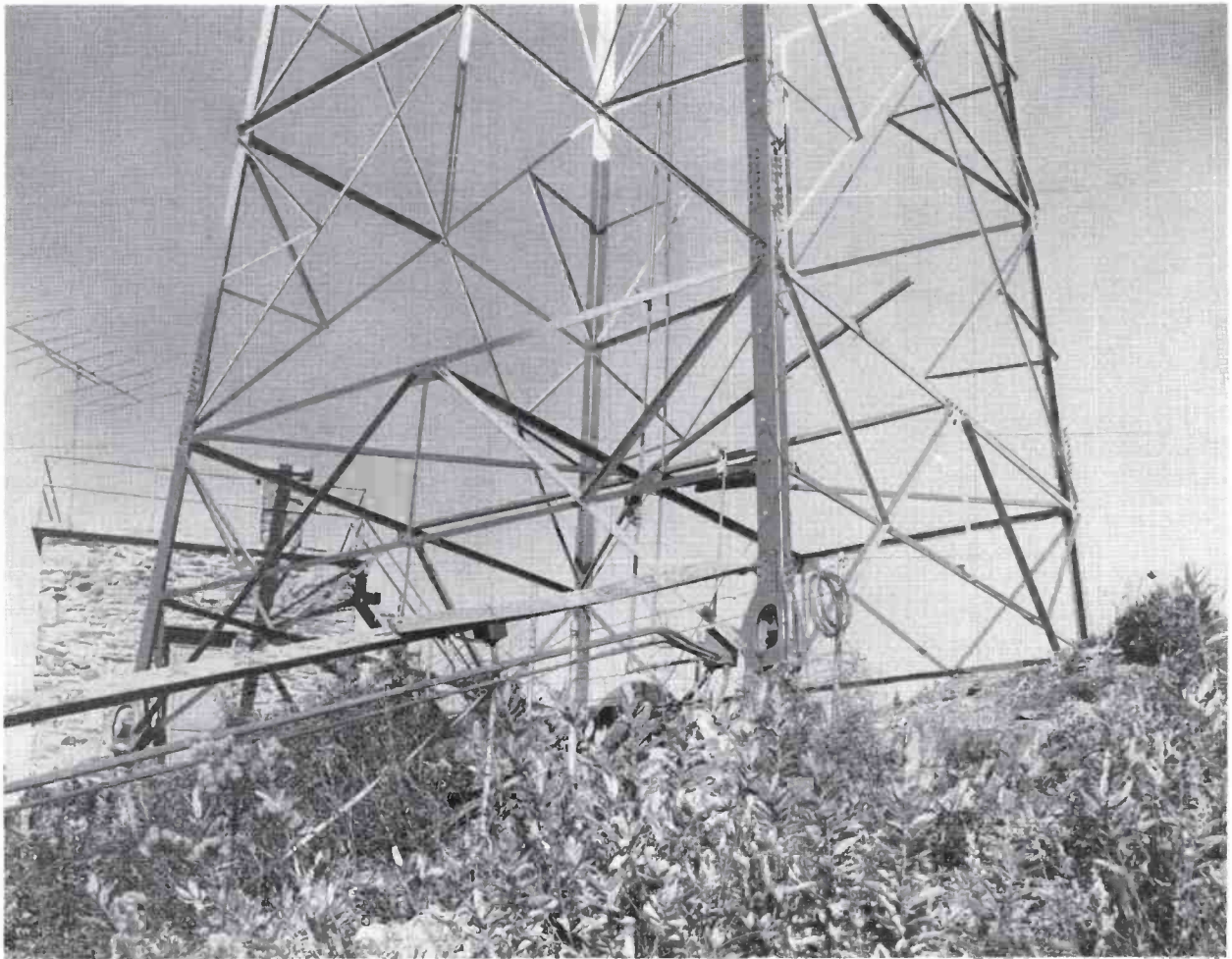

FIG. 9. A 152-ft run of 3-inch coax transmission line and three runs of conduit enter junction box at base of tower . . . small stone building houses microwave equipment.

Two racks are located next to the visual amplifier rectifier cabinet. One contains the metering and monitoring equipment for the transmitter as well as an off-air pick-up receiver. An eight-element Yagi antenna is beamed to the channel three station in Charlotte for the off-air pickup. The second rack includes the two-way radio equipment, a microwave discriminator, a TA-7B Stabilizing Amplifier and several power supplies.

A rack situated next to the aural power amplifier rectifier cabinet contains two audio amplifiers. One is used as a program amplifier and the other serves as a spare unit. The rack also holds the transmitter console master monitor power supply. An automatic transmission line dehydrator is located on top of this rack. Just to the rear of the driver portion of the transmitter is

a wall-mounted coaxial notch-type diplexer. The aural transmitter output is fed directly to the diplexer aural input. However, the visual input of the diplexer is fed by the output of the vestigial sideband filter which is also located behind the driver cabinets.

Galvanized iron ductwork is used to exhaust hot air from the transmitter cabinets. This air may be used to heat the building during cold weather or alternatively can be exhausted to the outside of the building. A 2-hp electric motor drives an exhaust fan mounted in the ductwork.

Four plate transformers, two for the aural and visual portions of the driver and two for the power amplifiers, are located in a separate room in the basement level just below.

Programs are fed from the studios to the top of Mt. Pisgah, 18 airline miles away, via a one hop microwave link. The microwave dish and receiver are located in a small stone building next to the base of the tower. There is also a standby microwave link which can be placed into operation instantaneously.

#### Antenna and Tower

Reaching 6,089 ft above sea level, WLOS-TV's antenna is one of the highest in the country. The eight-bay antenna, measuring 40 ft, is mounted atop a 328 ft self-supporting tower. WLOS's channel 13 antenna was taken up the mountainside in two pieces, assembled at the top and then raised in one piece through the center of the tower using a gin pole and block and tackle. The four tower legs are supported

by 22-ft deep concrete pilings. Each tower leg sits atop large ceramic insulators. Grounding is accomplished by jumping across the insulators with copper strap.

Shortly after they went on the air in September of 1954, WLOS was forcefully made aware of the fact that all was not right with their ground system. Lightning storms are prevalent at this high altitude and during one storm, lightning strikes hit the utility transformer bank and then the building—knocking telephones right off the wall. Lightning bolts also hit the tracks on the incline railway and then traveled up the tower into the clouds.

In order to bring the resistance of the ground system down, the old Signal Corps practice of sinking salt barrels into the ground with copper strap run into them was employed. Eight barrels, surrounding the tower base, were sunk about six feet into the ground at varying distances up to 50 ft from the tower. This procedure has

brought the resistance down from one hundred ohms to about four ohms. This solved the problem of lightning discharges at the transmitter site.

A 152-ft run of 3-inch coaxial transmission line from transmitter building to tower and three runs of conduits enter a junction box at the south leg base of the tower. At this point one run of conduit carries a 110-volt line to the small stone building right next to the tower base which houses the microwave link. The other conduits supply the power for tower lighting and deicing equipment.

#### **Power**

A power line, paralleling the cable-car tracks, brings three phase power to the transmitter site. It is stepped down from 7500 volts to 220 volts by a transformer bank just outside the building. One phase is split to provide 110 volt power wherever needed. In contrast to the usual utility

company practice, the ground line on the incoming power line has been placed above the power lines to ground lightning strikes.

The three phase 220-volt lines enter the building through a transfer switch in the basement. If utility power should fail, this switch transfers the load to a standby 187-kva diesel electric power unit. The standby generator goes into operation and cuts in automatically. This operation takes place so quickly that the transmitter cut-outs do not even have time to operate.

#### **Future Plans**

According to Charles B. Britt, Executive Vice-President and Manager of WLOS, plans are now being made to handle color. Plans for the addition of a remote unit and larger studio facilities are also in the offing. These increased technical facilities will enable WLOS to offer an ever greater service to its large TV market which ranks 50th in the United States.

FIG. 10. Old mansion in fashionable residential area of Asheville houses WLOS-TV studios.



FIG. 1. Four TV stages are housed under a single roof at Republic Studios. These adjacent stages require a high degree of impact noise isolation.

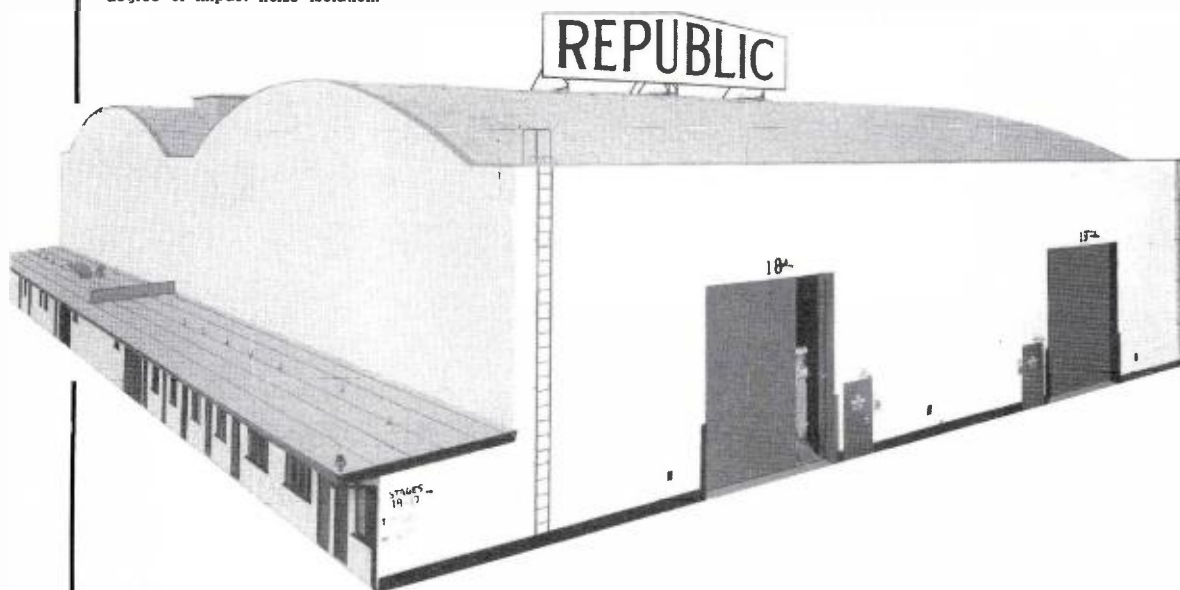

## IMPACT NOISE ISOLATION IN TELEVISION STUDIOS

by M. RETTINGER, RCA Engineering Department, Hollywood, California

### Editor's Note

The requirements for sound insulation in TV studios have often been overlooked or neglected. As a result there has been a rising tide of comment concerning "noise" on TV sound channels. The article which follows, although concerned particularly with the type of sound "stages" used for TV film production, contains a number of ideas of value to the engineer planning a new TV studio building. Mr. Rettinger, who is a member of RCA's film recording engineering group, has had many years of experience in studio design and is an acknowledged authority on the subject.

A requirement exists for television studios which is not normally present for radio or motion-picture studios. This is the ability to record sound in one stage while set construction takes place in an adjacent stage or stages. In the case of radio studios, of course, there is no set construction. Motion-picture stages are not often joined because these stages are usually very large, say 100' by 200', so that it is not necessary to use common connections between them. When motion-picture studios are joined, adjacent stages are rarely used, simultaneously, in the way of TV stages. When sets are erected in joined motion-picture stages, a red light signal is always used at the time the actual scene is recorded. Television stages, however, because TV production favors close-ups, are relatively small, and hence, are often joined, as at the Republic Studios, where four of them are housed under a common roof. (See Fig. 1.)

Large sums of money are lost every year because it is not possible, in adjacent TV studios, to record in one stage while sets are being constructed, simultaneously, in an adjacent stage. The impact sounds of set construction are transmitted in one or several ways, to the next stage to such an extent that they do not allow satisfactory sound recording. Because TV production is much faster than motion-picture production for theatre release, any red light system employed forces so many interruptions as to make such a production method impractical. With stage space at a premium, it can be readily seen that such conditions lead to large economic wastes.

There are two points which should be stressed in connection with the prevention of the transmission of impact noises from one stage to another.

1) Impact energies, such as hammer blows, are in the order of a million times



the energies involved in the generation of speech sounds. Hence, walls which are considered more than adequate in the way of preventing the transmission of air-borne sounds often transmit structure-borne sounds with ease.

2) In the prevention of the transmission of machine vibration, the machine is usually placed on a support which has considerable elasticity. For instance, in order to effect a 28 db vibration isolation at 50 cycles per second, the resilient pad has to be compressed by more than .1", meaning that the static deflection of the pad has to be in excess of .1" after the machine is placed on it. Such large deflections are obviously not practical for most building structures, particularly floors, because the "give" is too much.

In the construction of multiple television stages which permit simultaneous operations, the following precautionary measures should be observed:

1) Introduce structural discontinuities between floors and partition. For this reason the (usual) double-stud wall partition between stages should employ separate foundations for the two walls. Figure 2 shows three different floor constructions, A, B, and C. The construction shown by C is an improvement over B, and that shown by B is an improvement over A. Type C is recommended most highly.

Figure 3 shows still another floor construction, which is very effective in the prevention of the transmission of impact sounds. This type of (solid) floor was recently employed in the construction of three television studios on the Republic Productions lot in Studio City, Hollywood, California, with RCA engineers acting as consultants on acoustics for the project. It may be desirable to consider this type of construction more closely.

Vibrations are communicated through continuous solids with very little attenuation. Building materials which readily transmit vibrations are concrete and steel. Also, in the case of material layers, such as concrete slabs, we do not deal with spherical waves of propagation, whose energy (in the absence of dissipation) decreases inversely with the square of the distance; but with cylindrical waves, whose energy falls off uniformly with the distance. Therefore, as in the case of shallow bodies of water, the signal range is very large. Hence, solid-borne sound should be suppressed as much as possible at its source. A good "dead" material for a sound stage floor is vertical grain wood blocks. The basic theory of such a flooring is the log

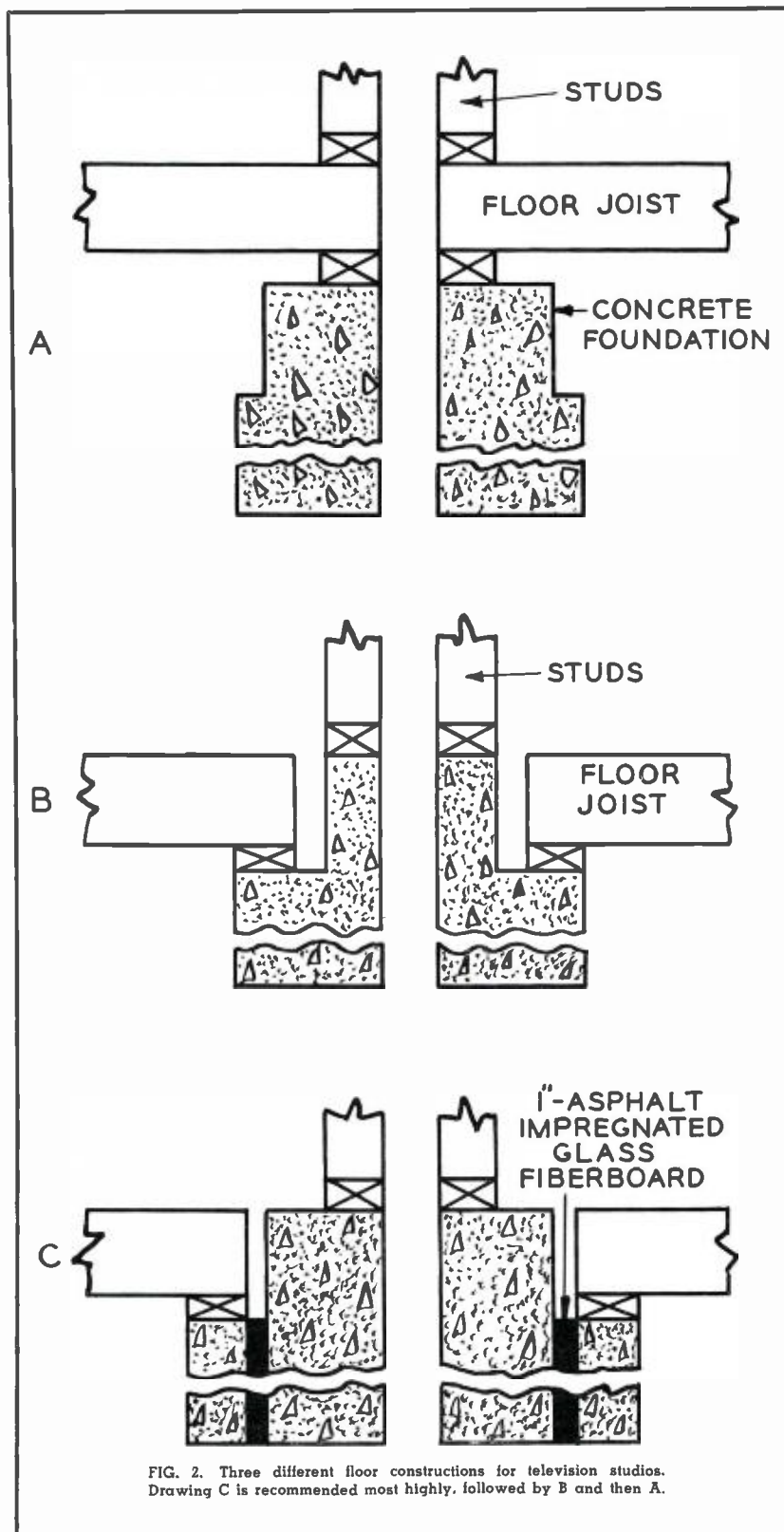
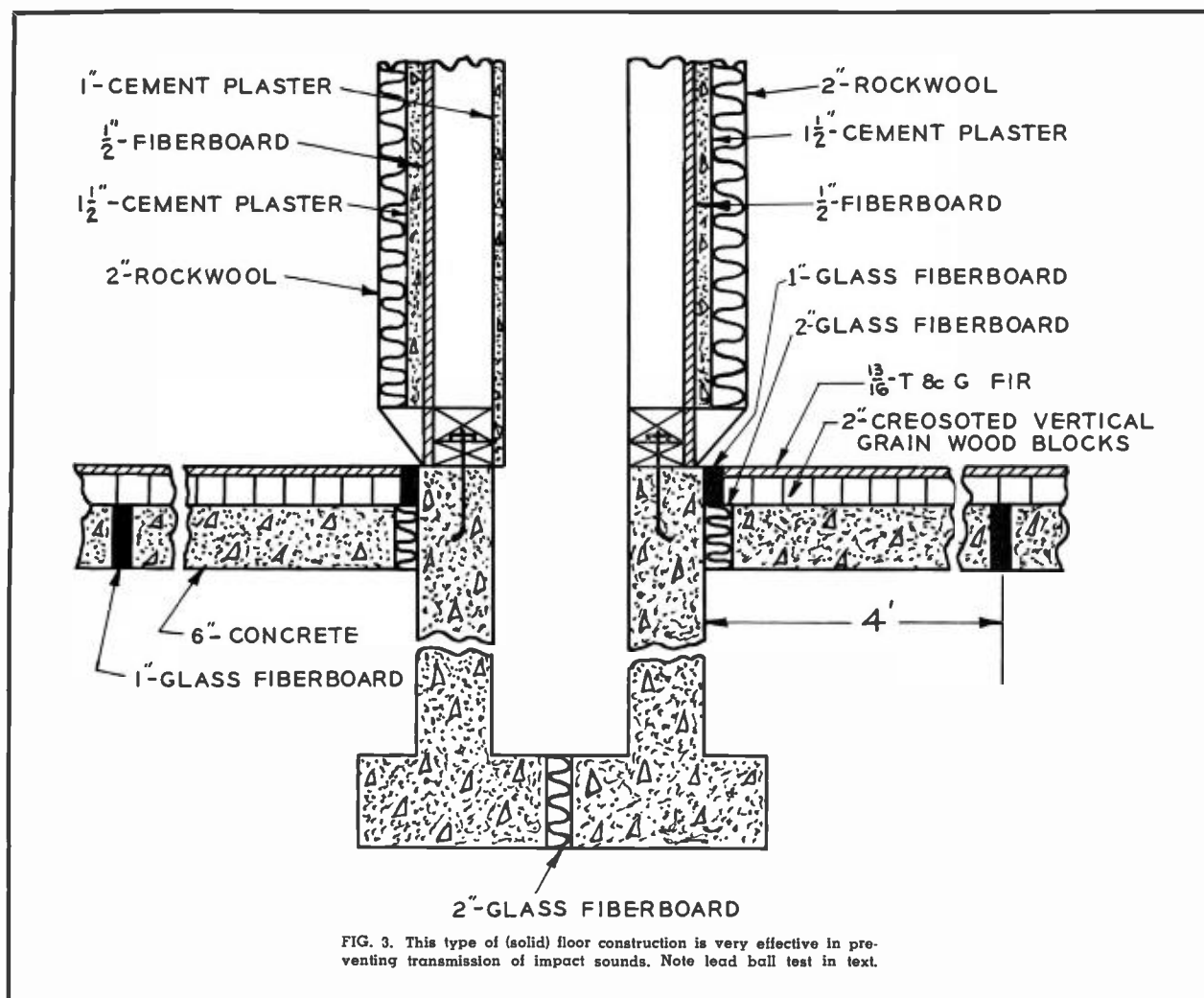

FIG. 2. Three different floor constructions for television studios. Drawing C is recommended most highly, followed by B and then A.



set on end and used as a chopping block. Such blocks are readily able to absorb heavy hammer blows, chiefly by converting the vibratory energy into heat within the block.

The blocks of wood, of course, must be applied against a solid base, so as to maintain a flat surface. Therefore, they were placed on a six inch concrete slab, and bonded to it with asphalt. The six inch concrete slab is not continuous throughout the floor, but has a one inch wide expansion joint four feet from each partition. Also, the slabs do not abut on the foundations of the partition, but are separated from them by a two inch thick asphalt impregnated glass fiberboard, as are the concrete slabs abutting against the wall foundations.

2) A point which cannot be stressed too heavily concerns the elimination of

common pipes—gas, water, or electrical conduits—between adjacent stages. To insulate such pipes from building structures is difficult at best, particularly if it is remembered that the noise-level in a studio during sound recording should not exceed 30 db, as measured with a standard noise-level meter set on the "A" scale.

Some recently constructed television stages carried a sprinkler system suspended from the floor joists of the three in-line stages. Hammering on Stage 1 could be heard in Stage 3, because the vibrations were readily transmitted through the 1/4" diameter steel supporting straps into the sprinkler pipes, and then up again along straps into adjacent floors. Wrapping felt around the pipes at the places where the straps held the pipes was not sufficient to eliminate the transmission of the undesirable impact noises into adjacent structure.

The pipes had to be placed on concrete piers set on the ground underneath the stage floors to effect simultaneous operation of the three stages.

3) Another precautionary measure consists in the introduction of an expansion or isolation joint in the exterior stucco coat of the stages at the place where the partition exists. This is necessary to prevent the transmission, from one stage to an adjacent one, of impact noises produced by hammer blows against any of the walls. Stage sets are usually rather flimsy, so that they must be braced against stage walls. For this reason most stage walls carry a 2" x 6" "nailer", some 12' above the floor, to which braces can be nailed. This requirement poses quite a problem when the nailer is to be installed on a partition between adjacent stages. The noise from hammering against a stage is readily carried through

a double wall, even when the individual walls are resting on separate foundations. To overcome this difficulty, all such nailers should be resiliently supported, as shown in Fig. 4. When heavy pounding has to take place directly against a partition wall, it is necessary to make the partition a triple wall rather than a double wall.

4) Similar isolation measures are in order where the "grid" joins the stage walls. The "grid" and its "catwalks" are overhead passageways from which lights, set ceilings, props, etc., may be hung, usually by chains. The rattling of the chains, hammer blows, and other impact noises must not be allowed to be transmitted into adjoining stages.

5) After two or more adjoining stages have been constructed, they should be tested to determine the impact noise transmitting qualities of the walls. For this purpose a so-called tapping machine employing cam-driven steel hammers may be employed. However, hammer blows against the floor are not the most intense impact

sounds which can occur during set construction. The most intense "common" impacts consist of scaffolding, sets, or "props" turning over. Well-isolated stages should not transmit such impact sounds from one stage to another. The floor shown in Fig. 3 was tested therefore, with a "billionerger." This consisted of a 13 pound (5.89 kg) lead ball which was dropped on the floor from a height of 5.67 feet (1.73 m). Such an object develops at the end of its travel a kinetic energy of a billion ergs. When this "billionerger" was dropped against a small steel plate laid on the floor of one stage five feet from a partition, no sound could be heard in the nearest adjoining stage. When the lead weight was dropped within four feet of the partition, a very faint thud could be heard in the adjoining stage. This was due to only one expansion joint existing between the partition foundation and the place of impact, as shown in Fig. 3. However, the law does not permit set construction within four feet of a wall anyway, so that no hammering should take place within that space.

It is difficult to arrive at quantitative measurements of the impact noise transmitting qualities of a partition unless one measures the vibration amplitude of the wall receiving the impact as well as the vibration amplitude of the wall in the adjoining stage. The term vibration amplitude, as used here, in general, includes acceleration, velocity, and deflection amplitude. However, measurements of these amplitudes along the walls of the "test" stage (not the one in which the impact sound originates) are not very meaningful, because the amplitudes cannot be readily converted into a measure of sound-level within the stage. Hence, sound level measurements should be made in the test stage while high order impact sounds are generated in the adjacent stage.

6) Finally, when camera dollies or microphone booms are rolled over the floor, it should not squeak. For this reason, floors should be designed to carry a load of 500 pounds/square foot, minimum. The floor shown in Fig. 3 can carry at least 20 times that amount of load.

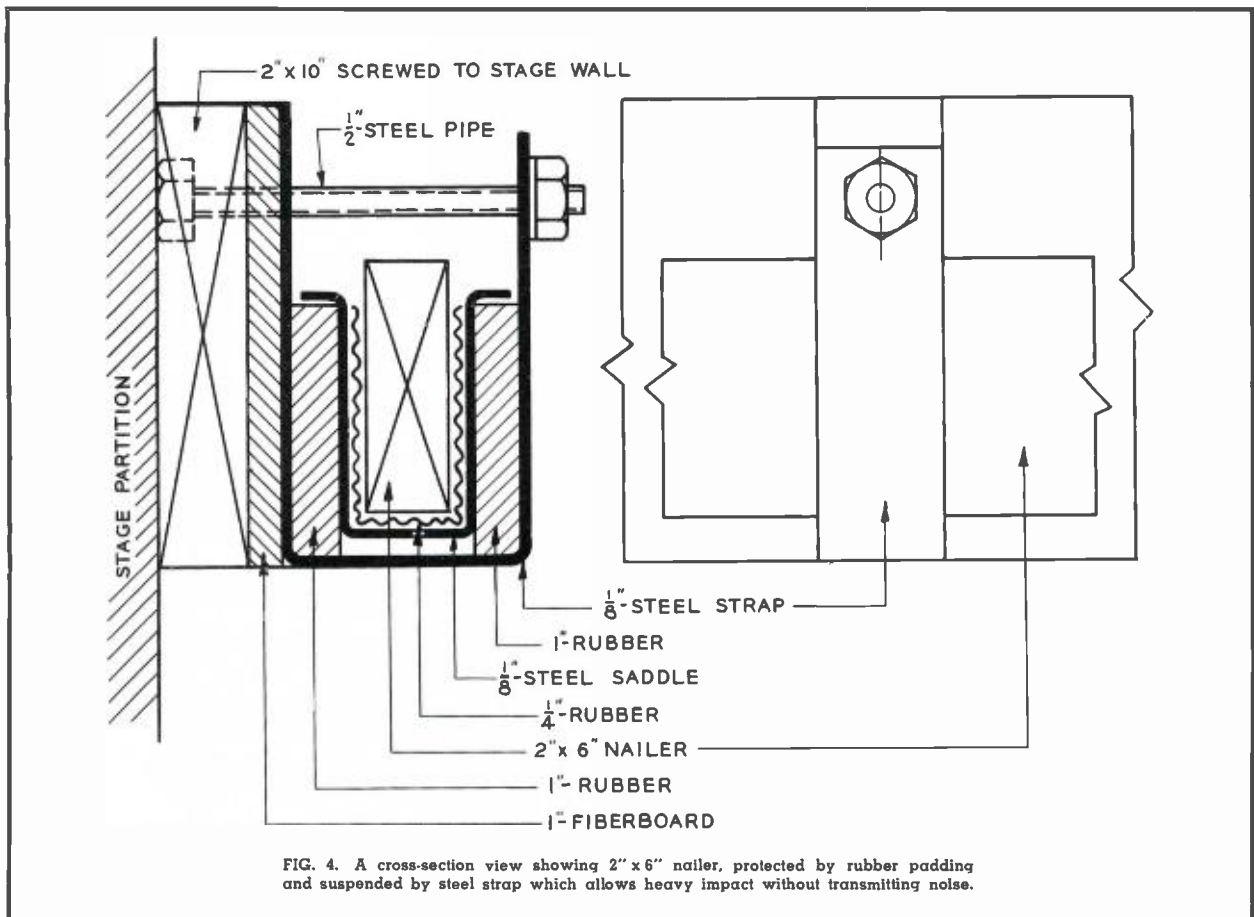

# CONTROL OF COLOR APPEARANCES IN TV STUDIO LIGHTING

by ROLLO GILLESPIE WILLIAMS, Manager, Color Lighting Department, Century Lighting, Inc.

Before considering developments in the use of studio lighting to control TV color appearances, it may be helpful to briefly review the layout and types of equipment in general use.

So far the lighting layouts for color TV studios have mainly followed the same pattern as for black and white studios except that lighting intensities are much higher. Normally, color requires 350-400 foot candles of base lighting with accent lighting intensities ranging up to 800 foot candles. These higher intensities have required greater use of 12-inch 2000 watt, and 16-inch 5000 watt Fresnel Spotlights and sometimes 1000/3000 watt Ellipsoidal Reflector Spotlights.

## Connector Strip Layouts

Overhead connector strips with pigtails continue to provide the most popular method of connection for the lighting units. These strips are usually spaced about 4 to 5 feet apart with pigtails at 2 to 3 foot centers. This follows much the same pattern as black and white except that many of the circuits are 50 amp rather than the 20 amp. The proportion of 20 amp to 50 amp circuits varies but is often in the ratio

of 5:1. It is normal for each 20 or 50 amp pigtail to be wired on a separate circuit. A typical connector strip layout for a 40 by 60 foot TV color studio is shown in Fig. 1. It will be noticed that in addition to overhead strips, there are also some 20 amp and 50 amp wall receptacles. However, there are new developments in studio lighting equipment involving color change lighting that require multicircuit connections and the extensive use of this type of apparatus will require positioning of a suitable number of multicircuit receptacles.

## Increased Loads for Color

Where color TV studio lighting is based on the use of white lighting from incandescent filament lamps, the lighting equipment mainly comprises scoops and Fresnel spots. With a representative black and white equipment setup, 6 and 8 inch Fresnel Spotlights might approximately equal the number of scoops and together represent 90 percent of the lighting units. The remaining 10 percent might include a few 12-inch 2000 watt Fresnel spots plus some striplights and 750 watt Ellipsoidal Reflector Spotlights. With color TV studio lighting the proportion of Fresnel spots might be the same but the majority would be 12-inch

2000 watt and 16-inch 5000 watt. Ellipsoidal Reflector Spotlights where used would normally be of a larger size.

A comparison of the size of lighting units for a typical layout on a variety set of 1000 square feet is shown in Fig. 2. It will be seen in this case that the use of the larger units for color only involves about twice the watts shown for black and white. Figure 3 shows a similar comparison for a dramatic set of 450 square feet. Here again the wattage for color is shown as approximately double that of black and white. However, these two setups do not include the lighting of cyclorama backgrounds and other scenic arrangements and the total wattage for color is likely to be higher. It is usual to plan for a total load of 75 watts per square foot for color studio area compared with 25 watts per square foot for black and white. (Color figures may range from 60 to 90 watts per foot.)

## Spectral Quality

The color temperature of incandescent filament lamps has remained much the same except when colored light sources are employed for special effect or background purposes.

Fluorescent lamps are not usually favored as sources of white light for color TV work because the spectral quality of their light is different from that of incandescent filament lamps and there are unavoidable differences of color rendition from the two types of sources. However, fluorescent lamps can be used for certain forms of color lighting as will be discussed later in this article.

Perhaps the most important advances in color TV studio lighting concern the use of colored instead of white light. Before discussing its applications, available color lighting equipment will be briefly reviewed.

## Color Filters

Colored light can be obtained by the use of filters, colored light sources or by blending of lights in an additive color system. Also by other means such as electroluminescence which it is not necessary to discuss in this article.

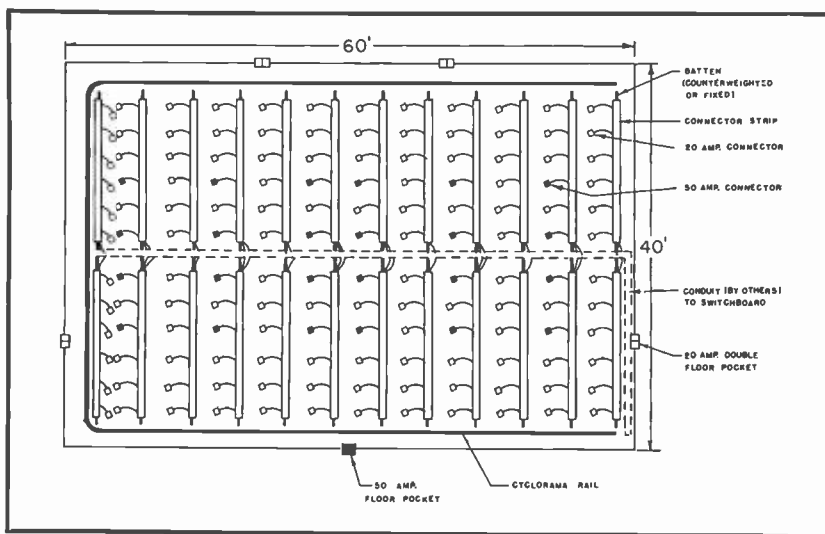

FIG. 1. Typical connector strip layout for a 40' by 60' TV color studio.

Color filters provide an inexpensive and convenient form of providing colored light from incandescent filament lamp units. However, with the size and type of lamps normally used in color TV studios, the life of gelatine filters is short. Cellulose acetate filters such as Cinemoid provide longer life and there is a wide choice of colors. If permanent filters are required it is necessary to employ glass. Unfortunately the range of colors available in glass is very limited and it is often difficult to find anything close to a desired color or tint.

### Additive Lighting Systems

However, glass filters are available which enable three-color additive systems to be used when the lighting distribution from this type of equipment is suitable. Additive systems usually employ three primary colors—red, green, and blue, either with or without a fourth circuit of white (or sometimes yellow).

For color-blending purposes it is not always necessary to use red, green and blue and when high intensity tints rather than deep colors are required, the use of yellow, peacock-blue, and magenta as basic colors is often better. Such an additive system, however, will not produce separate red, green and blue hues and the deepest degree of saturation will be that of the single basic colors.

Colors produced by blending in an additive system usually requires a greater wattage than a single light with filter. However, the advantages of a wider range of color plus facilities to adjust to exactly the required hue and saturation frequently outweigh the higher load.

### Colored Light Sources

Colored light sources can be used instead of filters in certain types of strip-light, but until now the color range has been very limited and often the distribution characteristics of the lamp differ from those of the equivalent white lamp and there is lack of accurate color consistency. However new developments are pending in this field and there is reason to hope that soon a wide range of incandescent filament lamps will be available in hundreds of consistent colors without any appreciable distortion of normal lighting distribution. It is doubtful, however, if this type of development will apply to spotlight bulbs—at least in the foreseeable future.

Colored fluorescent lamps have a very high lumen output in certain colors and can be usefully employed under certain conditions for the lighting of background or scenic surfaces. Green is the most efficient fluorescent lamp color, and gives ap-

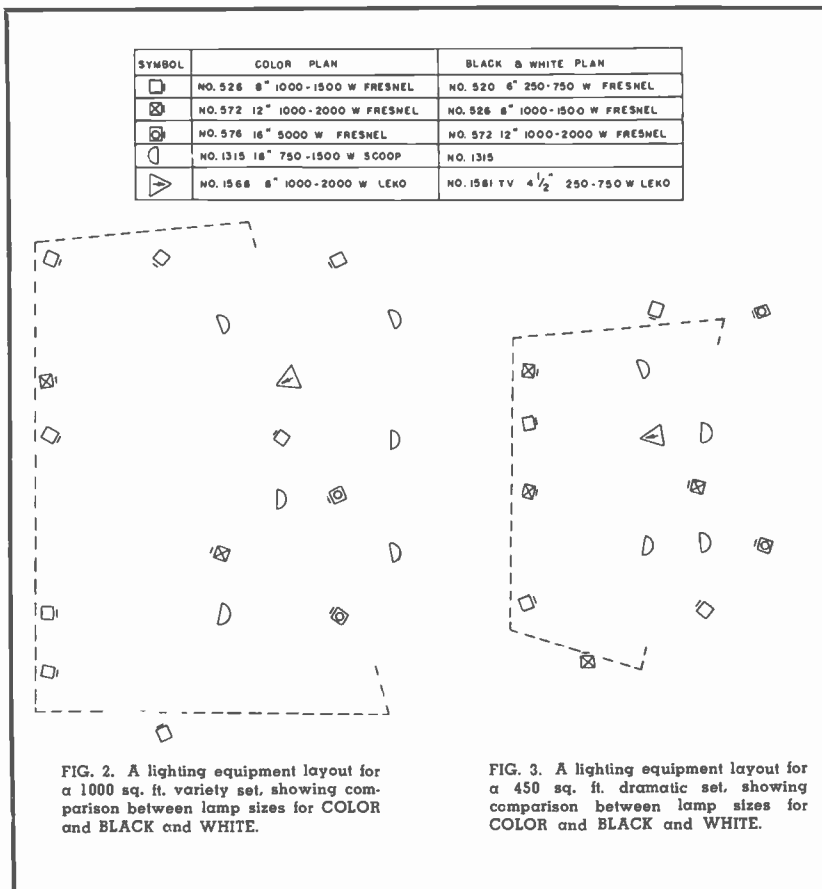

FIG. 2. A lighting equipment layout for a 1000 sq. ft. variety set, showing comparison between lamp sizes for COLOR and BLACK and WHITE.

FIG. 3. A lighting equipment layout for a 450 sq. ft. dramatic set, showing comparison between lamp sizes for COLOR and BLACK and WHITE.

proximately three times the light output of the blue, pink and gold lamps. The output of red light, however, is poor and represents about 5 percent of the green output. Hot cathode fluorescent lamps of the 40 watt 48-inch Rapid Start type can now be dimmed to low brightness values by suitable control systems. Two of the systems in use will reduce the light to 1/80 and 1/500 of full intensity respectively.

### Multicolor Lighting Units

A wide choice of striplights is available, arranged for either single or multicolor lighting. Batteries of multicolor floodlighting equipment can be created by mounting a number of strips side by side on a common framework. Alternatively a number of individual lighting units can be grouped and arranged for multicircuit lighting. It is necessary to have overlapping illumination from at least two units per color if sharp "cast" color shadows are to be avoided. The resultant illumination from a number of lighting units is more easily adapted to floodlighting than to narrow angle directional lighting. However, the latter can be arranged by the proper choice of units pro-

viding there is space to accommodate the equipment.

A single directional four-color 9000 watt (maximum) unit was recently developed that combines several light sources per color in a unit 30 inches square by 36 inches deep. This unit gives up to 250 foot candles  $\pm 10$  percent depending on the selected blend of color—over an area approximately nine feet in diameter at a distance of 15 feet.

### Applications of Colored Light

Colored light may be used in color TV studio lighting in numerous ways, as for example:

- Provide color on white or gray areas.
- Delineate form by modeling in different colors of light from different directions,
- Accentuate certain colors or to help harmonize a group of colors,
- Create mood values,
- Achieve dramatic and pictorial effects, and
- Reproduce effects of nature.

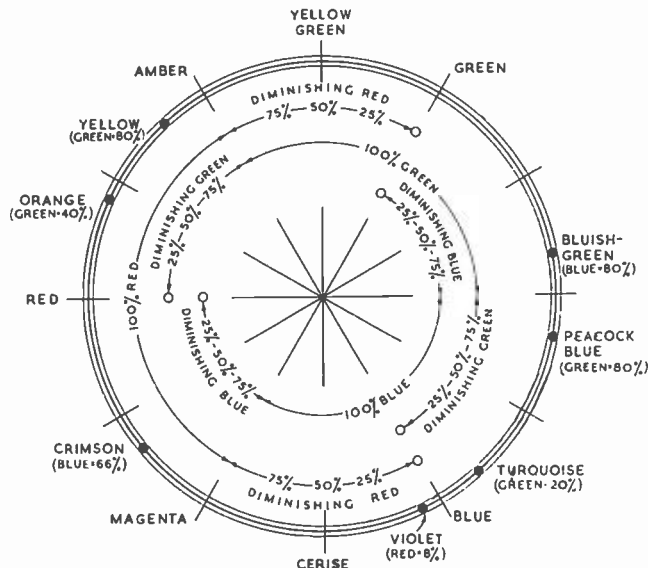

FIG. 4. Color circle showing range of lighting hues produced from red, green, and blue primary colors of light.

When color is provided by the use of colored light instead of pigments important advantages become available which revolutionize the possibilities of color. For example the color can be changed in hue, saturation (chroma) and brightness (value) in front of the camera and a new dimension of variability is provided. Color then ceases to be static and becomes as mobile as music—allowing a flow of color compositions that express both harmony and rhythm. Another important feature of colored light is its luminosity which imparts a new quality to color and greatly expands the opportunities for its use.

#### Controlling Color Shifts

However, apart from artistic possibilities, a new use is being made of colored light which will have far reaching effects on color rendition techniques. It is known that undesirable color shifts in the appearance of objects can be remedied by viewing them in front of properly selected color backgrounds so that the factor of "Simultaneous Contrast" is utilized to bring about the desired color appearance. It is often a lengthy process to find the desired color relationship by changes of colored papers or paints, and the final setup is, of course, static.

FIG. 5. View of control console for C. I. Electronic Dimmer Control System showing ends of two 5-scene preset panels.



Simultaneous contrast effects can be much more easily obtained by the use of colored light as the background, since the hue, saturation or brightness of the colored light can be varied to a much greater degree than with pigments. Furthermore high brightness values can be obtained without losing a desired degree of saturation. Color changes and adjustments can be produced immediately by using an additive color lighting system in conjunction with suitable controls. These color background effects can be provided either by projecting colored light onto a suitable surface or by transmitting light through the background so that it glows with color.

#### New Color Value Wall

A recent development is a Color Value Wall which provides a luminous area of diffused color that is variable at will. The equipment takes the form of a wall with a depth of 12 inches having one side made of special seamless translucent material. The translucent seamless surface can be any size up to 35 by 75 feet. The Color Wall can be free standing or mounted against a surface. A four-color lighting system is contained within the 12-inch depth and provides surface brightness of color up to 275 foot lamberts.

The lighting load is very moderate, and working loads normally vary between 15 and 63 watts per square foot. Thus for a luminous surface 12 feet 6 inches wide and 8 feet high, the working loads would normally range between 1500 and 6300 watts.

#### Color Relationships

It is sometimes believed that scientific and artistic factors concern different fields of interest, and the subject of color is not exempt from this belief. However, the relationships of different colors of light in TV color work are governed by rules that are both scientifically artistic and artistically scientific. The writer is aware of no rule of harmonious and discordant color relationship that cannot be explained on a scientific basis.

Thus Fig. 4 illustrates a color circle based on scientific factors concerning the blending of red, green, and blue primary colors of light.

Complementary colors will be found at opposite ends of a straight line through the center. There is sometimes a misunderstanding concerning the exact meaning of the word "complementary" when applied to color. Complementary colors are not "harmonizing" colors in the normal sense of the word but are exact opposites. In an additive system they represent two colors

that together will make a blend of white light. Complementary colors are always very striking but are not necessarily a pair of harmonizing colors.

In the color circle under consideration a pair of harmonizing colors would be found by making the color nearest to yellow lighter than the one nearest to violet. Thus orange and turquoise would harmonize if the former were a pale orange and the turquoise a deep color. Conversely a deep orange and pale turquoise would represent a discord.

#### Color Lighting Control Systems

The use of color lighting necessitates dimmer control equipment of a type that not only provides flexible color mixing facilities but also makes complex color changing relationships possible. Many color TV studios are provided with excellent electronic preset control systems, as for example the installation shown in Fig. 5. A recent development in control systems that utilize either Thyatron tube or magnetic amplifier type dimmer units is known as C-lectrochrome System. This employs a principle of harmonized color contrasts, whereby different sets of four-color lighting equipment may be instantly caused to provide either a selected color blend or various contrasting colors that harmonize with this selection. The operator does not have to calculate these harmonizing colors, but simply presses the load switch for a four-color set of lighting in the reverse direction to obtain contrast rather than a selected color. Thus if there are five sets of four-color lighting equipment illuminating an acting area from five different directions, one can set up a mixture corresponding say to pale pink and by pushing a single three-way load switch for each set of lighting upwards, obtain that color, or by depressing the switch obtain a harmonizing color. Each of these five switches could provide a different color to the others.

Figure 6 illustrates a C-lectrochrome control panel for a four-color installation involving 15 sets of four-color lighting equipment with a total load of 100 kw. In addition to the color contrast facilities it will be seen that this is a five scene preset installation, with separate facilities for presetting both the contrast switches and the color mixing controls. The latter include five adjustors for each set, i.e. one each for intensity adjustments of red, green and blue primary color circuits, one for the degree of saturation and one for the over-all brightness of each mixture. Figure 7 shows the bank of magnetic amplifier control apparatus operated from the control panel.

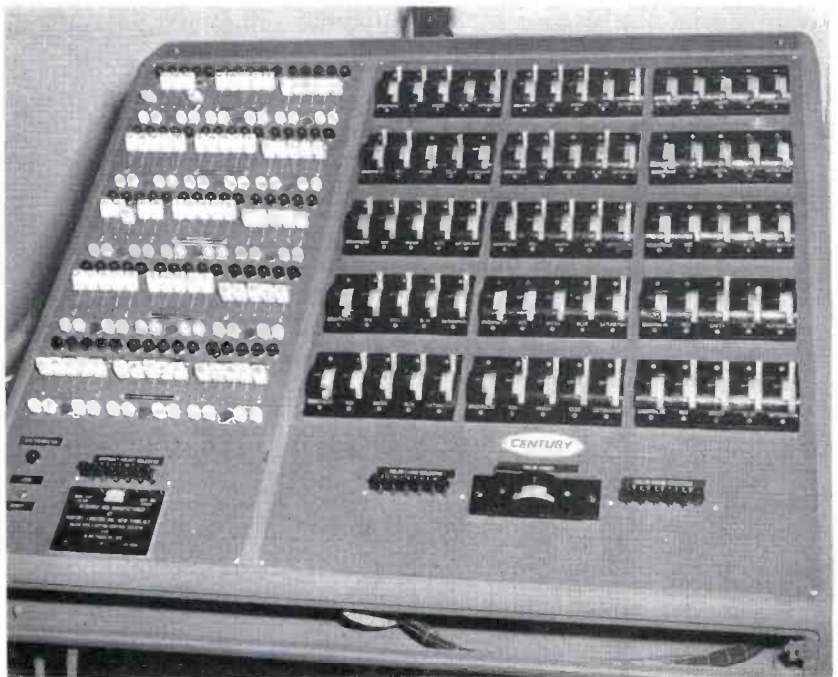

FIG. 6. Five-scene preset control panel for C-lectrochrome magnetic amplifier four-color selective color control system.

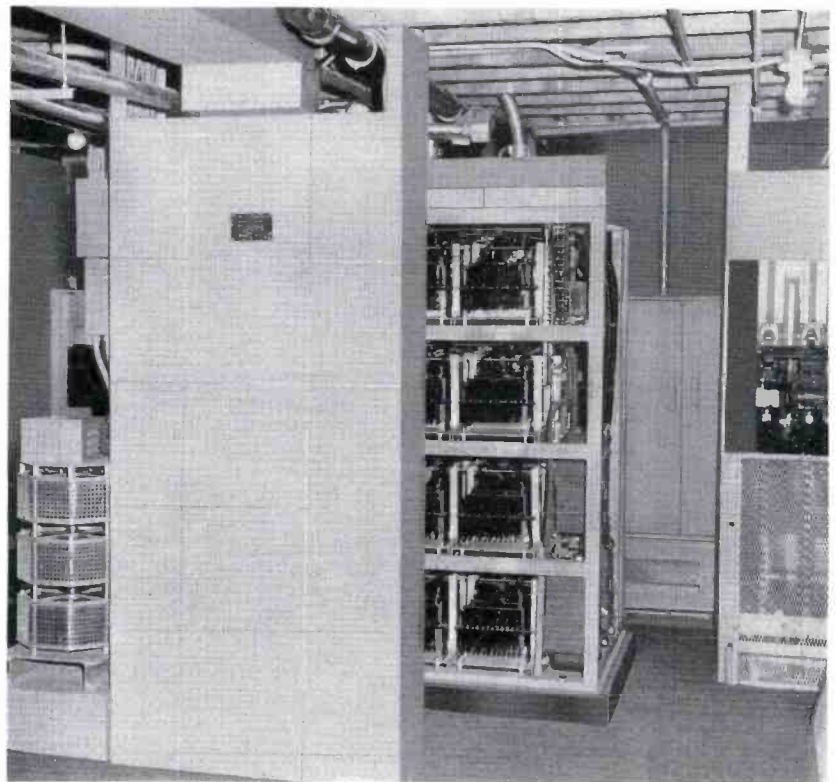

FIG. 7. Bank of magnetic amplifier dimmer units operated from control console shown in Fig. 6.

# PROPOSED REFERENCE SIGNALS FOR BROADCAST TELEVISION TRANSMISSION

by J. W. WENTWORTH, Manager Terminal Equipment Engineering, RCA Broadcast and Television Equipment

**EDITOR'S NOTE:** This is an informal status report on current activity at RCA with respect to transmitting reference signals along with standard television signals. It should be made clear that the techniques to be described are still in the experimental stage. Equipment to produce the signals is not commercially available, and the signals themselves have not been standardized or approved by any industry group. The reason for presenting this information at this time is to stimulate discussion throughout the industry, and to encourage further activity leading to the development of test techniques of maximum benefit to television broadcasters.

The current reference signal activity is a response to both a need and an opportunity. The need is for a technique that will permit objective measurements of signal levels and transmission characteristics in television circuits while they are actually in use. Although a number of video-testing techniques have been highly refined during the past several years, they have all suffered from the disadvantage that they cannot be used during actual program time. The opportunity is provided by the vertical blanking periods in television signals. These periods cannot be used for the transmission of useful picture information, but, with proper handling, they can be used for the transmission of special signals for test or reference purposes.

## Basic Needs

The desirability of additional reference information in television signals has been recognized for some time, especially by those engineers responsible for operating broadcast networks and some of the larger broadcast studio plants. In either black-and-white or color television, the routine task of "riding" signal levels could be greatly aided by the transmission of a reference white-level indicator. It is true that the synchronizing pulses normally transmitted with television signals provide a small measure of level reference information. However, the relationship between sync amplitude and picture amplitude is often not held too closely, especially in the presence of unknown amounts of distortion. Adjustment of levels on the basis of the picture signals themselves requires considerable operator judgment, since picture signal levels are very much a function

of picture content and there is no way an operator can be sure that a given scene is supposed to contain a reference white area.

In color television the need for reference information is even greater. In addition to the problem of level-riding, the transmission of color signals requires greater attention to the problems of maintaining uniform frequency response and good amplitude linearity in all signal-handling equipment. The objective measurement of signal distortion is very difficult on normal picture signals, but relatively easy when appropriate reference waveforms are transmitted.

## NBC Reference Signal

The increasing frequency of color television broadcasts during the past few years has intensified interest in the use of vertical blanking time for the transmission of reference information. A number of organizations are active in this field, and the National Broadcasting Company has pioneered in the actual field-testing of a specific reference signal, using apparatus developed by Mr. Ralph C. Kennedy. The original signal, field-tested by NBC, was designed primarily to serve as a level reference and to facilitate measurements on video transmission circuits. It consisted essentially of three lines of test information transmitted at the end of each vertical blanking period. Each line was divided into three nominally equal intervals, transmitted at levels corresponding to 50, 0, and 100 on the IRE scale. In the center of each interval were subcarrier bursts of approximately 10 microseconds duration. All bursts had a peak-to-peak amplitude

of 40 IRE scale units, but they were transmitted with three different phase positions.

Field tests with the original NBC reference signal yielded generally encouraging results. It was reasonably well established that the signal could be transmitted during the last few lines of vertical blanking without detrimental results on either color or monochrome receivers, and the signal proved useful for setting levels and for "spot checks" of differential gain, differential phase, and transient response. These results were sufficiently favorable to suggest that the basic technique could be extended to cover additional objectives without detracting from its effectiveness as a tool for level-setting and checking transmission systems. A project to explore the full potentialities of the reference signal technique was therefore set up by the writer and his colleagues in the RCA Broadcast Equipment Engineering group. This paper presents some of the preliminary results of this project for consideration and study by TV engineers.

## Possible Objectives for Reference Signals

One of the early approaches taken at RCA was the development of a single waveform capable of meeting as many different objectives as possible without requiring unduly complex equipment. The waveform shown in Fig. 1 was developed and tested in an attempt to meet the following objectives:

1. To provide a reference for level adjustments.
2. To provide means for a continuous

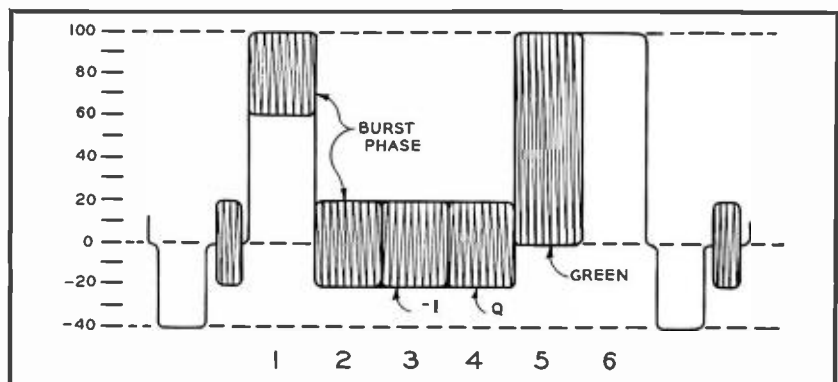

FIG. 1. Waveform sketch of a six-interval reference signal developed and tested by RCA and NBC. For convenience, this will be designated the "Mark 1" proposal.



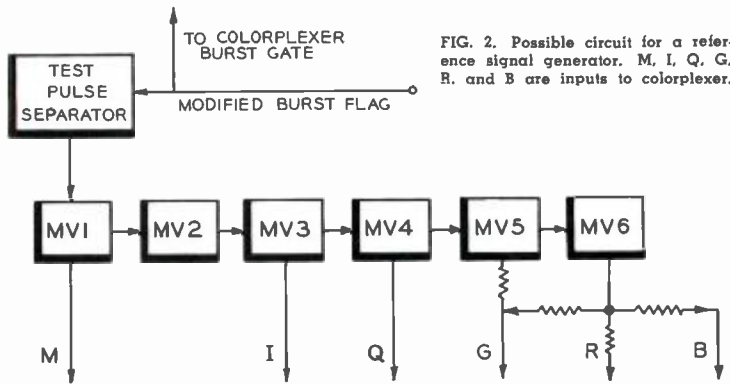

FIG. 2. Possible circuit for a reference signal generator. M, I, Q, G, R, and B are inputs to colorplexer.

check of transmission facilities with respect to:

- (a) Differential gain and phase.
  - (b) Relative gain at 3.58 mc.
  - (c) Transient response, and
  - (d) Burst versus chrominance distortion.
3. To facilitate the initial set-up and continuous monitoring of colorplexers.
  4. To facilitate the adjustment of color monitors and receivers.
  5. To provide information for several possible types of automatic controls in future television systems.

#### Mark 1 Waveform

The waveform of Fig. 1 was proposed for transmission during three line periods near the end of each vertical blanking period. Each line of reference information is divided into six nominally equal intervals. The first two intervals consist of subcarrier bursts of the same amplitude and phase as the color synchronizing burst, transmitted at average levels of 80 and 0 on the IRE scale. The third and fourth intervals consist of subcarrier bursts of  $-I$  and  $+Q$  phase, transmitted at a level of 40 IRE units peak-to-peak, and centered at blanking level. The fifth interval consists of pure green at 84.7 percent of the maximum possible level for pure green. This interval has the important property of having a peak-to-peak subcarrier amplitude equal to twice its average level, and positioned so that it exactly fills the normal blanking-to-reference white range. The final interval is transmitted at reference white with no subcarrier.

#### Generating the Reference Signal

To achieve the intended objectives, the Mark 1 reference signal should be added to every color picture signal as close as possible to its source. The signal can be readily generated by a two-step process.

The first step is to modify the standard burst flag waveform by the addition of an

extra pulse during each of the last three lines of vertical blanking. These extra pulses are wide enough to embrace the first two test intervals, and serve both to convey timing information that triggers off the rest of the waveform and to actuate the gate which produces the subcarrier component for the first two test intervals of each line.

The second step is to produce a series of pulses to actuate several channels of each colorplexer. This can be accomplished by a signal generator consisting, in essence, of six multivibrators triggered in sequence to produce the desired six intervals during each of the last three line periods in vertical blanking. (See Fig. 2.) The block diagram indicates to which colorplexer channel each pulse output should be applied in order to produce the desired reference waveform. Note that the reference white pulse can be produced by applying the No. 6 pulse to all the primary channels equally. The modified burst flag waveform actuates the pulse generator through a "test pulse separator" which discriminates against the normal burst flag pulses, permitting only the added pulses to pass through.

#### Time-Location of the Reference Signal

It is proposed that the reference signal be transmitted during the 9th, 10th, and 11th line periods following the first horizontal sync pulse after vertical sync, with vertical blanking set at its legal maximum (8 per cent of the vertical period, or 21.0 lines). This results in the signal being transmitted near the end of the vertical blanking period, but allows a "guard period" of one line on one field and one-half line on the other before the picture actually starts. This time location for the reference signal represents a reasonable compromise between the desire to provide as much reference information as possible and the need to avoid spurious effects in receivers or

other apparatus. To avoid thwarting the major purpose of the vertical blanking periods, the signal should be located so that it does not encroach significantly upon the vertical retrace time for properly designed receivers. The FCC standards require that vertical blanking fall between the limits of 7 to 8 per cent of the vertical period to allow satisfactory operation from all signals that meet the FCC standards, receivers should be designed to complete their vertical retrace within the *minimum* blanking period. Field test data indicate that the great majority of receivers can be expected to complete their retrace well within this minimum time, so a slight overlapping of the reference signal into this minimum period should not be significant. In effect, most of the current reference signal proposals allocate for reference purposes the time traditionally provided for the sync generator tolerance on vertical blanking. This is not a practical problem, because most modern sync generators require only a fraction of a line period for this tolerance.

The reference signal should not normally be visible on home receivers, because it is conventional to overscan receivers sufficiently to hide the picture edges behind a decorative mask. The possibility of the reference signal becoming visible is taken into account, however, in the selection of the outer edges as the optimum locations for the brightest portions of the signal. These bright areas will be displayed at the extreme upper corners of the picture, which are normally masked even more completely than the edges.

Let us now consider how the Mark 1 reference signal waveform (Fig. 1) might be used for several types of tests.

#### Colorplexer Tests

The proposed reference signal contains all the information needed to set up and to maintain proper adjustments in colorplexers, provided the reference signal generator is properly designed to produce stabilized levels at the colorplexer inputs. *Carrier balance* can be checked by observing the blanking interval or the sync pulse tips—there should be no subcarrier present. *Video balance* in the colorplexer modulators can be checked by observing the signal through a low-pass filter—intervals 3 and 4 should be at blanking level. *White balance* can be checked by observing interval 6—there should be no subcarrier. *I and Q relative gains* can be checked by comparing intervals 3 and 4, which should be of equal amplitude. *Relative phases of burst, I and Q* can be checked by measuring the phase differences between intervals 2, 3, and 4 with a suitable phase analyzer. *Over-all chroma gain* is indicated by in-

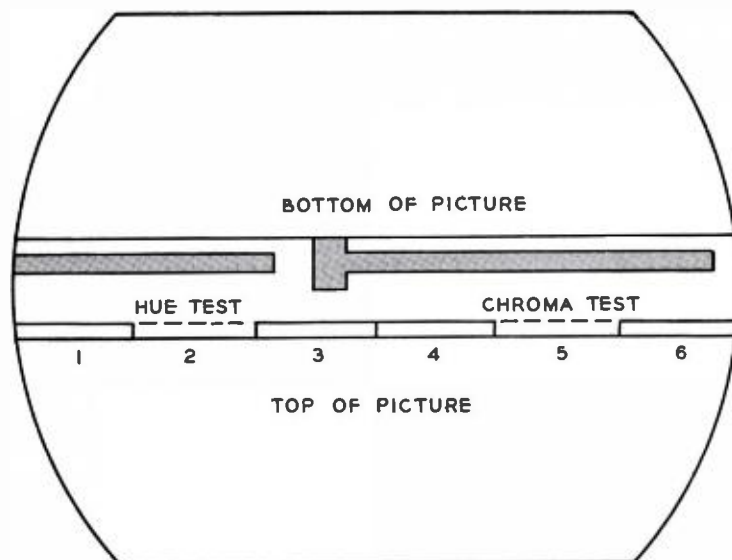

FIG. 3. For monitor or receiver adjustments "roll" picture with vertical hold control, raising background control to make the lines visible during vertical blanking. A display similar to the diagram above should be seen.

interval 5, for which the subcarrier envelope should just fill the blanking-to-reference-white range. Finally, the *burst gain* can be checked by comparing intervals 2 and 3, which should be of equal amplitude. It is interesting to note that these adjustments can be checked at a point far removed from the colorplexer itself.

#### Level Adjustments

For level-setting purposes, the most significant part of the waveform is the reference white pulse. This pulse is readily distinguished as a bright dot in a conventional waveform monitor display triggered at a 30-cycle rate: the dot appears just to the left of each field display. On a conventional line-rate or half-line-rate waveform display, the complete reference signal waveform can usually be seen faintly in the background; the signal can be made more visible by using a vertical-frequency pulse to intensify the trace during the vertical blanking period. By examining the waveform through a low-pass filter which rejects the subcarrier frequency, another bright dot or line can be seen corresponding to the average level of interval 5, which should fall at the midpoint of the blanking-to-reference-white range.

If the proposed reference signal is used on a sufficiently widespread basis, the great majority of video operators who handle a given signal would be able to make all their level adjustments on the basis of the reference white pulse. The only operator who would have to exercise judgment with respect to picture content would be the

camera chain operator who establishes the initial picture signal level relative to the reference pulse level as viewed in his own waveform display. The need for operator judgment at this point is not nearly as serious as at master control or transmitter operating points, because a camera operator is normally in constant communication with the program director or technical director who assumes responsibility for achieving the desired over-all effect.

#### Transmission System Tests

The performance of the transmission circuits handling television signals can be checked by measuring certain characteristics of the reference signal waveform. Intervals 1 and 2 are provided primarily for checks of differential gain and phase, which may be determined by measuring the relative amplitudes and phases of the subcarrier components of these two intervals. Interval 1 is transmitted at an average level of 80 on the IRE scale so that it checks transmission conditions in the white region without actually exceeding the reference white level. The gain of a transmission circuit at 3.58 megacycles relative to the low-frequency gain can be checked by observing interval 5 to determine whether or not the subcarrier envelope is tangent to both reference white and blanking level. It is important, of course, that this measurement be made on an oscilloscope whose response is correctly adjusted at 3.58 megacycles relative to its low-frequency response. Burst distortion relative to the chrominance signal, such as might be

caused by a faulty clamp, can be detected by comparing the amplitude and phase of the color sync burst with the amplitude and phase during interval 2. Finally, a close study of the complete waveform is helpful in evaluating transient response: tendencies toward tilt, smear, overshoots, or ringing can usually be detected more readily in a known waveform than in random picture content.

#### Monitor or Receiver Adjustments

One of the objectives of the Mark 1 reference signal is to facilitate the adjustment of color monitors and receivers. This objective can be met by taking advantage of two significant characteristics of the proposed signal: (1) Interval 2 should produce zero output in the red channel of a monitor or receiver, because burst phase is standardized at exactly 90 degrees from the phase corresponding to the red color-difference signal (frequently symbolized as  $E_R - E_M$ ); (2) Interval 5 (the pure green bar) should produce zero output in both the red and blue channels of a color monitor or receiver.

The reference signal can be used for checking routine monitor or receiver adjustments by following this simple procedure:

- (1) Make the vertical blanking period visible by "rolling" the picture with the vertical hold control and raising the background control enough to make the lines visible during vertical blanking. A display similar to Fig. 3 should be seen.
- (2) Observe only the red field, either by switching off the other two colors or by viewing the kinescope through a red filter.
- (3) Adjust the *hue* control to make the boundary disappear between the blanking period and the No. 2 test interval.
- (4) Adjust the *chroma* control to make the boundary disappear between the blanking period and the No. 5 test interval.
- (5) Readjust the vertical hold and background controls for a normal picture.

If the reference signal technique works out as anticipated, it will provide a purely objective method for setting some of the most significant controls on color display devices. This is particularly important for station monitors, but it is likely that receiver servicemen can easily learn to use the signal to make better adjustments of color receivers.

#### The "Mark 2" Proposal

The "Mark 1" proposal described above was presented at the 1957 IRE and NARTB conventions, and was actually

field-tested for several weeks by NBC. These tests and discussions indicated that the proposal was based on sound principles, but it became evident that any technique based on the introduction of reference signals in individual camera chains would require a rather substantial capital investment either for thorough field tests or for permanent installations. The emphasis at RCA has been shifted, therefore, to a somewhat simpler form of the reference signal technique which reduces the scope of immediate applications but which "leaves the door open" for later refinements to accomplish the full range of objectives described previously. This simpler approach, which we may designate "Mark 2" for convenience, is based on a waveform which can be readily added to any composite signal at the output of a studio or at a master control point. It accomplishes basically the same objectives as the original NBC signal but does so with a waveform that can, in the future, be generated by injecting signals into individual camera chains, thus increasing the usefulness of the signal.

The Mark 2 waveform shown in Fig. 4 is also based on a division of each of three test lines into six intervals (not necessarily of equal duration). Intervals 1, 2, and 3 consist of a simplified staircase signal to facilitate differential gain and phase measurements. During these three intervals, subcarrier of the same amplitude and phase as the color sync burst is transmitted at average IRE scale levels of 80, 40 and 0, respectively. Intervals 4, 5, and 6 contain no subcarrier information, but are transmitted at IRE scale levels of 0, 50, and 100. To facilitate tests of transient response, the transitions between the last three intervals are shaped by a Gaussian filter having 6 db attenuation at 2.0 MC. Such a filter provides transitions of known characteristics (each transition is equivalent to half a sine wave—from trough to crest, or *vice versa*), so that distortions are readily apparent.

The Mark 2 signal may be generated readily by the combination of two units. One of these is a synchronizing unit, which contains a sync separator, pulse circuits to provide timing information for the reference signal, and a burst-controlled oscillator to provide a source of synchronous subcarrier. The second unit is the test signal generator proper, containing pulse generators, a subcarrier gate, filters, adders, and means for combining the reference signal with a composite picture signal. Present indications are that practical versions of the synchronizer and test signal generator can be made with no more than about 20 to 25 tubes, respectively.

#### Use of the Mark 2 Signal

The Mark 2 signal can be used for level adjustments and transmission system tests in much the same way as the Mark 1 proposal described earlier. For level adjustments, the clear interval at IRE 50 (No. 5 in the sequence) helps to locate the midpoint of the blanking-to-reference-white range. Because the reference white indicator (interval No. 6) is probably the most important feature of the waveform, it may prove desirable to provide a longer period for this portion of the signal. For differential gain and phase measurements, the Mark 2 signal is more complete and accurate than the Mark 1 signal, because it provides measurements at three levels instead of only two. The simplified staircase of the Mark 2 signal also provides an excellent check of the gain of a transmission system at 3.58 megacycles relative to the low-frequency gain. If the relative gain at 3.58 megacycles is correct, the subcarrier envelopes on the three steps will be tangent to each other. If the gain is too low, gaps will appear between the envelopes, while if it is too high the envelopes will overlap each other. These conditions are readily observed on a conventional waveform monitor. As noted earlier, the shaped transitions between intervals 4, 5, and 6 facilitate measurements of transient response. Interval 5 is particularly convenient for viewing both "leading" and "trailing" transients in close proximity.

#### The Case for Standardization

To derive the greatest benefits from the reference signal technique, it is desirable that the basic waveform be standardized and that its use be made universal in broadcast operations. The advantages of a standardized waveform are fairly obvious: operators can quickly learn to recognize the waveform, they become sensitive to abnormal variations in it, and they make meaningful measurements rapidly. A standardized signal can also facilitate the inter-

change of technical data among the many operating groups in the industry with a minimum of misunderstanding. Certain potential benefits of the reference signal technique cannot be realized until it is accepted and utilized on a universal basis within a given broadcast system. For example, the signal might serve as a reference for several types of automatic controls, provided it is so thoroughly integrated into the system that its presence can be relied upon at all times. While it will take some time to reduce to practice the several possible types of automatic controls, the potential improvements in the technical quality of the broadcast television service should justify the engineering effort required.

It must be emphasized again that the techniques described here are still in the experimental stage, and that field tests of the specific signals described are not yet complete. It is entirely possible, therefore, that significant waveform changes may be made or that the basic technique may be altered before any degree of standardization is accomplished.

#### Conclusion

In summary, the reference signal technique described here shows considerable promise as a tool for improving routine operations in broadcast television. If properly generated and introduced into the system, the proposed reference signal can facilitate the adjustment of several important pieces of apparatus. It can be very helpful in setting signal levels throughout the system, and it makes possible a number of significant tests on transmission circuits while they are actually in use. It also holds promise for automatic control and improvement in technical quality. Hence we hope that this paper will help to stimulate interest in a technique that may be of far-reaching significance to the television broadcast industry.

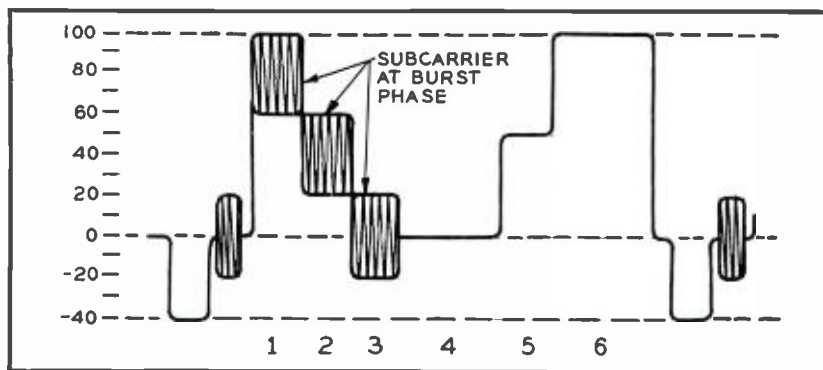

FIG. 4. Waveform sketch of the "Mark 2" reference signal. The six intervals are not necessarily of equal duration.



FIG. 1. Scene from "The American Scene" conducted by Dr. Albert D. Van Nostrand of Brown University. Discussion of American literature featured Henry Hull, Dr. Van Nostrand and Erskine Caldwell.



FIG. 3. James R. Newman, editor of "The World of Mathematics," conducted "Mathematics" sessions. Each session had a different teacher who, with the aid of assorted visual materials, presented a lecture.

FIG. 2. In "Geography for Decision," Albert E. Burke put a good deal of emphasis on visual material, like this inflated rubber globe, to help him in his lectures. In addition he had the assistance of guest experts.



## THE LITTLE RED

The Vice-President of the United States spent half an hour talking about his job. The Speaker of the House, a U. S. Senator and an Associate Justice of the Supreme Court spoke about theirs. Stage and film stars read passages of the nation's outstanding literature. Leading mathematicians, geographers and writers discoursed on their specialties. Singing actors performed scenes from operatic masterworks.

These were among the participants in the Spring cycle of NBC Educational Television Project Programs, produced in co-operation with the Educational Television and Radio Center, at Ann Arbor, Mich. Providing the first live programming ever to be produced expressly for educational TV stations on a nationwide basis, NBC offered weekly programs devoted to American literature, world geography, mathematics, American Government, and music.

For 13 weeks, from March to June, NBC sent out the five programs live from New York to the educational TV stations over

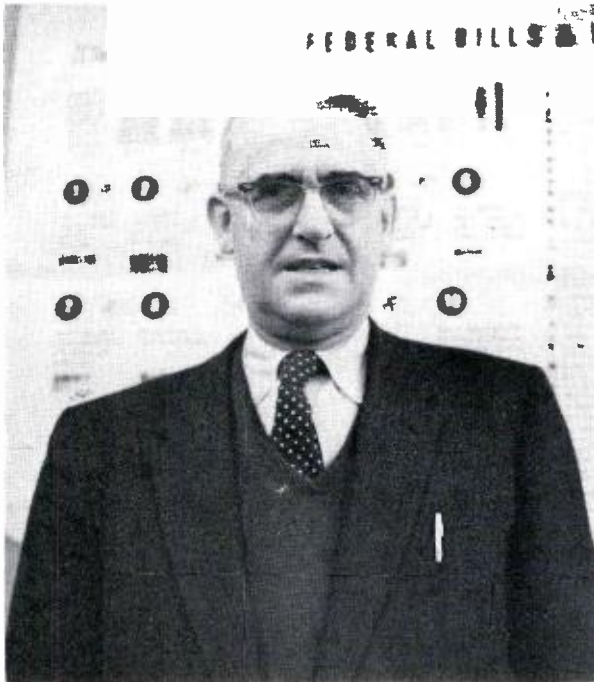

FIG. 4. "The American Government and the Pursuit of Happiness" conducted by Dr. Elmer E. Schattschneider of Wesleyan University originated on most occasions from the nation's capital. Program format was interview type.

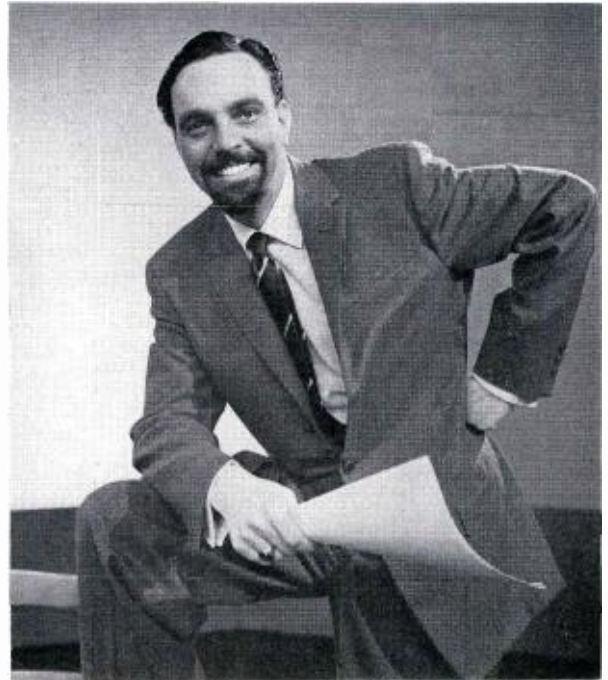

FIG. 5. Theatrical and musical values were the theme of the "Highlights of Opera History" series. Jay Harrison, music editor of The New York Tribune, was host and his lectures were supported by singers from the NBC Opera Company.

## SCHOOLHOUSE WAS NEVER LIKE THIS

### *A Report on the First Cycle of NBC Educational Television Project*

its regular network facilities, from 6:30 to 7 p.m., EDT, Monday through Friday. In addition to these ETV stations—for which the programs were primarily designed—the programs have found an additional outlet. Thirteen NBC affiliated stations are telecasting (by kinescope recording)—or are about to telecast—some or all of the programs. The stations: WRCA-TV, New York; WRCV-TV, Philadelphia; WRC-TV, Washington, D. C.; WNBC, Hartford, Conn.; WBUF, Buffalo, N. Y.; KRCA, Los Angeles; WJAC-TV, Johnstown, Pa.; WJAR-TV, Providence, R. I.; WFAA-TV, Dallas, Tex.; WBRZ, Baton Rouge, La.; WRGB, Schenectady, N. Y.; KARD-TV, Wichita, Kansas; KYW-TV, Cleveland, O.

The 65-telecast series ranged in subject matter from automatic computers to Wagnerian opera, treating along the way such themes as puzzles, paradoxes, infinity, probability, calculus, bureaucracy, the budget, opera buffa, the great American novel, and Africa today. Though the pro-

grams did not bypass experiment, experiment for its own sake did not intrude upon the larger objective: to inform.

Offering a weekly view of "The American Scene Through the Eyes of its Writers," Dr. Albert D. Van Nostrand of Brown University made use of direct lecture, reading of excerpts from appropriate literature by professional actors, and discussion with an author who was one of the representatives of the general area being considered.

In "Geography for Decision," Albert E. Burke, of Yale University, put a good deal of emphasis on visual material (such as a huge inflated rubber globe) to assist him in developing what was essentially a lecture. In addition, he had the help of distinguished guests who are specialists in the field being explored.

In "Mathematics," conducted by James R. Newman, editor of "The World of Mathematics," emphasis was placed on exploring the wide range of interest inherent

in the subject. Some of America's leading mathematicians were introduced to the audience. Each session had a different teacher who, with the aid of charts, graphs and other visual aids, presented a lecture.

Theatrical and musical values for their own sake were the central concern of the "Highlights of Opera History" series. The host was Jay Harrison, music editor of The New York Herald Tribune, and his format was the lecture, supported by enactment of scenes with singers from the NBC Opera Company.

For "The American Government and the Pursuit of Happiness," the weekly program conducted by Dr. Elmer E. Schattschneider of Wesleyan University, the nation's capital was the origination point on most occasions. The style was essentially that of the interview, set in a locale appropriate to guest and subject. The discussion of the Supreme Court, for instance, with Associate Justice Harold Burton came from his office in the Old Supreme Court Chamber.

FIG. 1. The Antenna Pedestal of Instrumentation Radar AN/FPS-16 (XN-2) being tested in "DEP's" Heavy Equipment Lab, Missile and Surface Radar Engr., Moorestown, N. J.

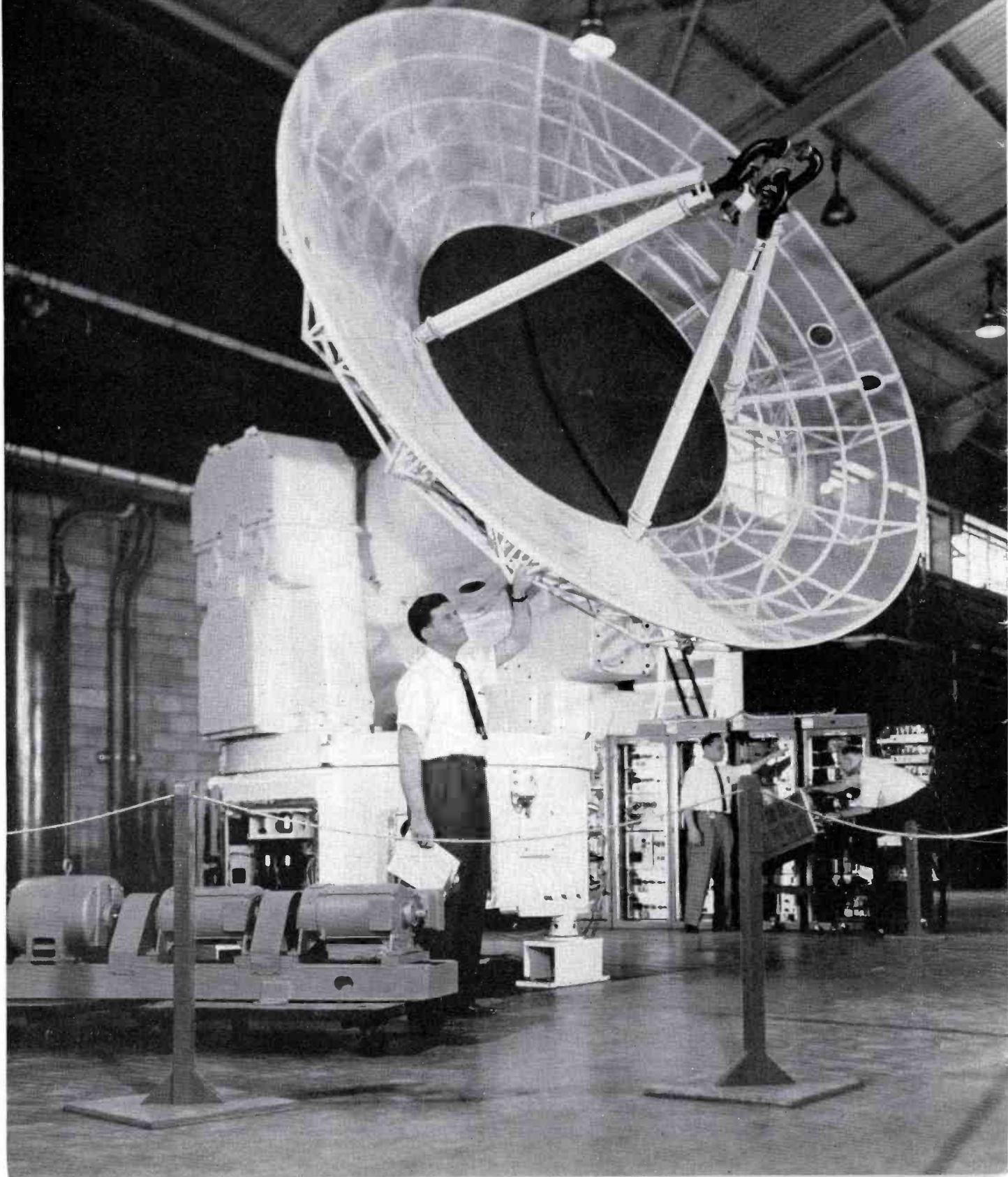

# GUIDED MISSILE INSTRUMENTATION RADAR



by I. STOKES and D. K. BARTON,  
*Missile and Surface Radar Engineering*  
*RCA Defense Electronic Products*

In 1946 the first German V-2 rocket to be fired in this country sat on the launcher at White Sands Proving Ground. After final count-down began, the men at the radar desert site, one mile south of the launcher tensely awaited the rocket launcher signal. The historical significance of the imminent event was of secondary importance in the minds of the participants to the desire to achieve a successful conclusion to nine or more months of intensive design, development and planning effort. At zero time, a cloud of smoke, flame and sand rose beneath the missile as it slowly lifted itself from the base and hovered precariously a few feet off the ground, seeming to drop back a little just prior to the start of a determined acceleration skyward. At launch a strong radar reply from the missile beacon appeared on the radarscope and automatic tracking began soon thereafter. At approximately 9,000 feet above the desert floor, the V-2 began to wobble noticeably so that observers at all points of the compass received the illusion that the rocket was about to fall in their direction. At this point, one of the fins tore off and fluttered toward the ground as the missile laid over on its side and headed for Texas. The fuel cut-off device was activated and impact 18,000 yards from the launcher resulted in a crater 30 feet deep and 30 feet across. The radar had tracked and plotted the complete trajectory, in spite of the fact that the lost fin had contained the beacon receiving antenna. This rather gratifying radar performance established the radar as a key device for guided missile instrumentation.

## Early U. S. Systems

The development of high-altitude research rockets and guided missiles in the United States brought together instrumentation methods from many fields. From the aircraft test field came internal instrumentation, radio telemetry and recording devices. Antiaircraft artillery evaluation has made extensive use of theodolites, and these were brought to bear on missiles in

the earliest stages of development. Various fixed camera methods were derived from other ordnance projects, as well as from the field of astronomy, which also contributed the long focal length telescope. Electronic instrumentation came from the fields of navigation, direction finding, fire control, close-support bombing, and from specialized methods such as the doppler radio techniques used by the Germans in the V-2 program. Since the program got under way toward the end of World War II, it was logical that military equipment, surplus and captured, would play a significant role, and this was certainly true in the case of radar equipment.

## The SCR-584 Radar

One radar in particular, the SCR-584, proved particularly valuable to the test ranges, and has maintained its usefulness to this day. The primary reasons for this were its availability (some fifteen hundred sets had been built by the end of the war), reliability (a tremendous production and field engineering effort had followed the original MIT Radiation Laboratory development work), and flexibility. Designed for control of 90mm AA guns and similar weapons, the SCR-584 was equipped with alternate forms of data output, an oversized modulator and power supply, and ample space for additions and modifications that proved necessary. Furthermore, development of instantaneous electronic plotting boards (operating in rectangular co-ordinates) had already been carried out for use in close-support bombing and in mortar location. Transponder beacons were also available from the close-support bombing program, as was a standard radar modification for long-range tracking of beacons. Thus, the SCR-584 was ready for the earliest V-2 and Wac Corporal firings at White Sands Proving Ground, and was in use at other rocket ranges. Along with the radar, of course, there were used the famous German Askania theodolite, Bowen-Knapp fixed cameras, and doppler radio system.

## Modifications and Refinements

The flexibility of the original SCR-584 has already been mentioned. Dozens of important field modifications were made in order to incorporate design advances to this radar at various times in the range instrumentation programs. These were concerned primarily with extending range of tracking and range rates, synchronizing adjacent radars for reliability of operation without interference, recording of position and signal strength data, and providing control links to the missile through modulation of radar pulse rate or pulse code. Ultimately these and other improvements were incorporated through factory modification. In each case, the basic SCR-584 pedestal, modulator and power supply, and 30-cycle conical scan is employed, while most other major components have been replaced or extensively modified.

Parallel to evolution of improved radars has been a great effort in system design, involving chain radar operation, real-time computing, plotting and data transmission, precision data recorders, communications systems, transponder beacons, control and telemetry equipment. The effect of this effort, which will not be described in detail here, has been to provide further uses for radar data, and to keep a continuing pressure toward development of radars with greater precision and range, so that significant data can be supplied to the instrumentation system as a whole.

## Precision Radars

The inherent advantages of the use of radar for military purposes have encouraged great efforts in development of precision radars, which have proceeded continuously at RCA since the end of World War II. The chief results of this effort have been four major radar equipments culminating in the Instrumentation Radar, AN/FPS-16 (see Fig. 1 and Fig. 2).

The first of these major radar programs is known as the Bumblebee radar which

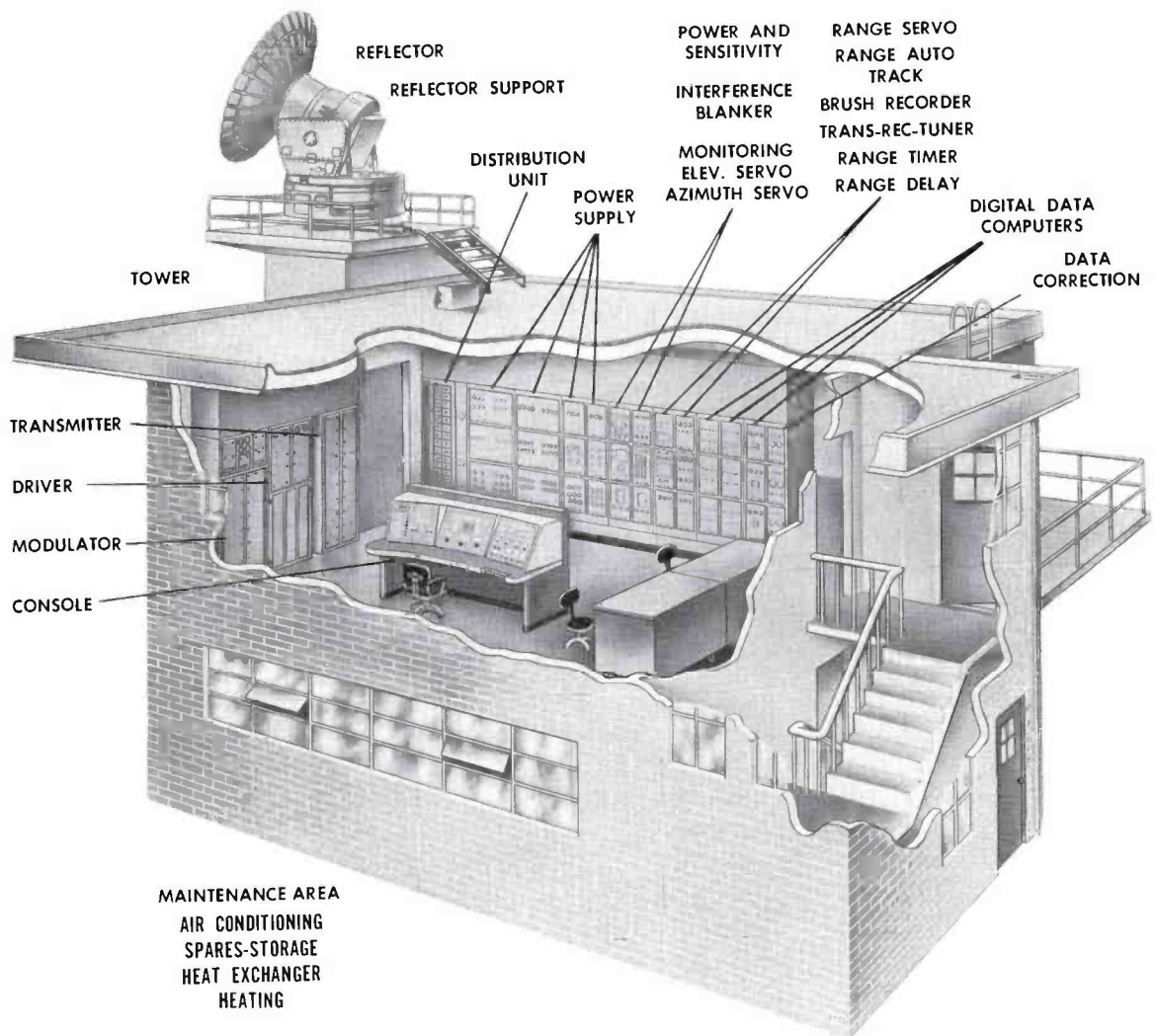

FIG. 2. Artist's conception of typical Instrumentation Radar equipment setup.

was developed by RCA as an associate contractor of the Applied Physics Lab., John Hopkins University. The Bumblebee radar has been tested extensively and has been in continuous operation at Applied Physics Lab, since May 1953.

The second precision radar built by RCA is known as the Terrier radar, and was designed for use in the Army Application of the Navy Terrier Guided Missile System. This radar has been in continuous operation since early 1954, at the Naval Ordnance Test Station, Inyokern, California, where it was tested extensively by the Marine Corps.

The third member of this family of precision radars is the Instrumentation Radar AN/FPS-16 (XN-1) which was developed for the Navy Bureau of Aeronautics. The radar has been completed and has been evaluated by the Naval Research Laboratory. The results achieved with this radar have shown that its tracking performance is superior to any radar tested to date.

Two AN/FPS-16 (XN-2) radars are presently being built at RCA's Moorestown Plant. These radars are production prototypes and are expected to exceed the performance results achieved with the XN-1 model. (See equipment photos of



Figs. 3, 4, 5 and 6.) A production contract for twenty-two AN/FPS-16 radars has been awarded to RCA with delivery commencing in December 1957. The proven high accuracy of the AN/FPS-16 design has resulted in the adoption of this precision Instrumentation Radar for use at the Navy, Army and Air Force guided missile test ranges at Pt. Mugu, California; White Sands Proving Ground; and Patrick Air Force Base, Florida.

The net result of these developments, occurring over the last twelve years has been to make available a radar capable of precision and instrumental accuracy to a factor of ten greater than that obtained with modified SCR-584's.

#### **Brief Description of the AN/FPS-16 Instrumentation Radar**

The radar is designed for installation at a fixed station and will be housed in a building similar to the artist's conception

shown in Fig. 2. The antenna pedestal is mounted on a tower which is isolated from the building proper in order to minimize vibrations transmitted to the tower. The electronic equipment is housed in specially designed rack-type cabinets with ease of maintenance as a primary consideration. (See Figs. 4 and 6.)

The equipment is cooled by a closed circulating air-conditioning system. A regulator is provided at the bottom of each cabinet to control the amount of cold air entering, with the return through a duct at the top of the cabinet. The operating console of modern design was "human engineered" for optimum operator efficiency. Only one operator is required even though the radar is one of the most complex built to date.

The obvious importance of reliable performance during operations involving the expenditure of thousands of dollars has dictated the use of the latest reliability

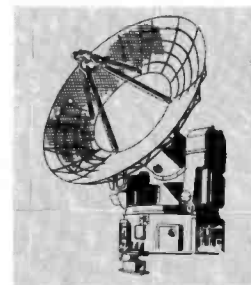

**FIG. 3.** David K. Barton, one of the authors, is shown at the control console of the Instrumentation Radar.





FIG. 4. Merritt Sheeder, Project Engineer, is making a circuit check at the readily accessible underside of an Instrumentation Radar Chassis.

techniques in the equipment design. In addition built-in checkout equipment has been included to insure adequate monitoring of component performance.

The antenna pedestal (shown in Fig. 1) was built to give high mechanical accuracy and smooth tracking, and was made rugged to give reliable operation under severe environmental conditions. Its performance has been such that it represents a major advancement in the state of the art.

Since Instrumentation Radar installations represent a considerable investment of money, effort and training, a high degree of flexibility has been achieved. This makes feasible the later inclusion of new advances in radar and thus forestalls early system obsolescence. In addition, the flexibility provides an instrument adaptable to a multiplicity of missions required by the guided missile test ranges. Some examples of this flexibility include the ability to:

- a. Change frequency readily.
- b. Provide synchro, potentiometer and digital data individually or simultaneously.
- c. Track skin reflections or beacons.
- d. Accept two or three co-ordinate designation data.
- e. Be readily modified by substitution of chassis or racks in a generously spaced equipment layout.

In spite of all the sterling characteristics achieved in this radar design, RCA is currently engaged in the development of some significant improvements to enhance the system's usefulness and maintain the enviable lead over competitive equipments.

#### The Radar and its Task

A tracking radar is essentially a device whereby a highly directive antenna is positioned by a servomechanism onto the selected target, from which range and angular error signals are derived by reflection of the radar's transmitted wave or by use of a transponder in the missile or aircraft being tracked. The Instrumentation Radar operates in the microwave frequency, region and uses pulse transmission. The position of the target is given by two angles of the antenna (azimuth and elevation) and by slant range from the radar. The principal advantages of employing the radar for guided missile instrumentation, as compared with the best of competitive systems, are its ability to track with high accuracy in darkness and through clouds, as well as atmospherically clear conditions to long ranges, and to yield

data which can be readily and instantaneously reduced to its final form. These advantages are possessed by no other means of range instrumentation. The Instrumentation Radar will therefore be used to track missile and aircraft targets (with or without beacon transponders) and to produce spherical co-ordinate data outputs of high accuracy from which an instantaneous record of the target trajectory can be obtained.

#### Real-Time Plotting and Range Control

Test ranges have for some time exploited the obvious advantages of the radar method where high accuracy has not been required. One such application has been instantaneous display of target data on plotting boards, for quick evaluation of flight operations and for range control and safety. In this application, the presence of all data in electrical form at one station, with reduction to rectangular form within the capability of simple analog computers, has hastened the growth of large installations for plotting of multiple targets in various projections, using data from several radars simultaneously. The ability of radars to track aircraft by reflection, as well as the abilities to conduct several tracks from a single station without interference, and to transmit commands to the target through special beacons, have made radar a primary means of control for drone aircraft and a potential means of guidance for various missile tests.

Existing modifications of the SCR-584 have proven sufficiently accurate for real-time plotting of position on a full-scale basis, but difficulties arise when small regions in space are expanded for detailed plots, or where velocity data is required. Limitations of these radars have prevented full exploitation of the radar-plotting system for impact prediction of high altitude missiles and similar tasks. With the availability of radars such as the AN/FPS-16, the limiting errors will be shifted back to the computing or plotting equipment in most cases, and predictions from velocity data will be greatly improved.

#### Chain Radar Systems

As long as missile tests were conducted at short range or on near-vertical trajectories, a single radar station sufficed for tracking. However, as soon as long range horizontal flights or other trajectories of military interest were undertaken, the need for two or more co-ordinated tracking stations became apparent, and "Chain Radar" systems were developed. To this day radar systems with the ready availability of electrical data in a form for simple reduction,

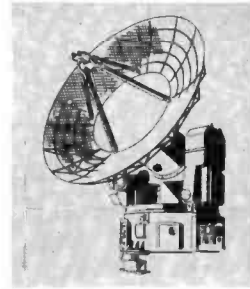
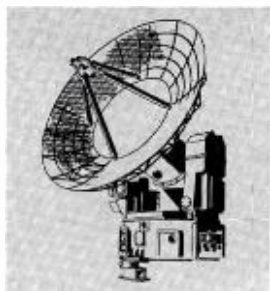

FIG. 5. Defense Electronic Product engineers (left to right: Merritt Sheeder, Lawrence Carapellotti, and Simpson Adler) are examining an Instrumentation Radar schematic with the radar boresite tower in the background.

have been essentially the only source of real-time data for exchange between stations. Once available for transmission, radar data is used to position other types of instrument as well as succeeding radars in the chain.

Present systems use analog data outputs from the radar to feed co-ordinate conversion analog computers located at each radar site. Analog data in rectangular form is then converted to digital form for transmission over communication links, and the reverse process followed after reception at the remote point. With the high accuracy of the AN/FPS-16 radar, the analog processes used in chain operation can be eliminated entirely. Designation of a target, remote plotting of position on an expanded scale, or recording of data for trajectory analysis purposes will thus be possible to the full accuracy of the radar instrument.



#### **Radar Data Processing**

In addition to real-time use of analog data from the radar, most test ranges require some more accurate permanent record of radar tracking data. With the arrival of precise instrumentation radars such as the AN/FPS-16, this facet of radar instrumentation will assume increased importance. There is presented the prospect of precise tracking data, available under all-weather operations with negligible reduction time required, and limited in accuracy chiefly by uncertainties of tropospheric refraction. Where most present installations depend upon photographic recording of synchro data, range scopes, mechanical scales and (when possible) boresight telescopes (Fig. 5), the new radars will provide direct digital read-out of angle and range data, as precise as (or more precise than) present theodolite data and requiring only solution of two simple triangles for reduction to rectangular form. Refraction correction-to-elevation angle data will also be needed to obtain highest accuracies, and in general some modification from rectangular co-ordinates is needed to put the data in form for final use. None of these processes need take longer than a few seconds per data point reduced, even in such machines as present card-programmed calculators, and in many cases real-time reduction should be possible. Direct electrical transfer (possibly through magnetic tape recording) will eliminate all manual reading operations. The method has already been demonstrated at the White Sands Proving Ground and elsewhere, limited by the accuracy of modified SCR-584 radars. Of particular importance in the new radar, is the elimination or correction within the radar of the several sources of significant error which have formerly required cali-

bration and correction in the reduction process. In the AN/FPS-16, for instance, these errors will not merely be calibrated and known, but will be reduced below the threshold of significance for data reduction. Means of applying the refractive correction for average atmospheric conditions automatically have also been investigated and are feasible within the confines of the radar. Output data to the computers will thus be capable of immediate reduction by simple processes, without manual operations of any sort, and without any film processing.

#### **Communications for Radar Instrumentation Systems**

One of the major advantages of the radar method is that each station is self-sufficient as far as trajectory measurement is concerned. Communications channels are used for data transmission in the chain radar system assuring target acquisition both for radars and for optical and other instrumentation remote from the launcher. Other than this, communications requirements for a radar instrumentation system are chiefly for voice communications, signaling and control circuits and timing. Even in the timing circuits there do not exist the extreme requirements for precision that apply to baseline instrumentation systems: it is only necessary to match the complete trajectory data obtained at the radar to some range time reference within a few tenths of a millisecond to achieve full system accuracy. Present digital data transmission equipment (such as AN/TSQ-1) is designed to operate reliably within the poorest voice channels, and thus an entire radar instrumentation system can be operated using standard voice communications links.

#### **Radar Beacons**

Transponder beacons developed for navigation and close-support bombing were used in the first V-2 and Wac Corporal in 1946. In the succeeding ten years, intensive development has made available a series of radar beacons expressly designed for range instrumentation. Small size, light weight and low-power drain are the distinguishing characteristics of most of these, and ruggedized construction far beyond that required in guided missiles has been achieved.

The use of a beacon improves radar tracking in three respects, as compared to reflection tracking. First it extends the range by an amount depending chiefly on the ability of the beacon receiver to sense the radar interrogation. Secondly, a beacon provides a point source for the radar to track, eliminating target scintillation. A

comparison of reflection and beacon tracking results for similar flight paths shows that improvement is obtained at relatively short ranges. Thirdly, use of a beacon provides positive identification of the desired target and rejection of ground clutter. With the beacon transmitter offset several megacycles (or any desired amount within the radar band) reflective targets and clutter are attenuated 30 to 40 db. Special codings in the beacon receiver or transmitter can distinguish one beacon from another when several are used at once in the same area.

A further advantage of using a beacon is that it provides a two-way communication path between the target and the ground radar. Equipment is available to utilize this channel for guidance commands, emergency cut-off or detonation commands, and for telemetry from the target. The high gain and reliability in the radar-

beacon path is available for these functions, while frequency selectivity, pulse coding and the narrow radar beam provide protection from interference. Channel bandwidth is limited, of course, since the radar repetition rate provides the "carrier" for all information exchanged. Depending on the method of modulation, bandwidths in the order of a hundred cycles are available for each pulse in a code group used for information. Five or more such pulses may be used simultaneously in each direction of transmission, meeting most requirements for simple telemetry.

#### Conclusions

The Instrumentation Radar AN/FPS-16, based on extensive research and development effort carried on continuously since the last war, has been demonstrated to be capable of instrumental accuracy and precision well beyond the known uncertainties

of tropospheric propagation. Combined results of field tracking tests, mechanical and electrical lab tests, and error analysis indicates extremely high over-all accuracy.

The radar can maintain the above accuracy and precision under all normal weather conditions, target maneuvers and target locations (within the observed hemisphere of coverage) except at zenith and below 2 to 3 degrees in elevation angle.

Systems for using radar data in real-time and for later analysis are far advanced and can provide complete trajectory data without appreciable time lags.

No other instrumentation system can attain higher accuracy over extended paths (10 miles or greater) under average weather conditions. Only plate camera systems (against a star field at night) offer any substantial margin of accuracy at any time.

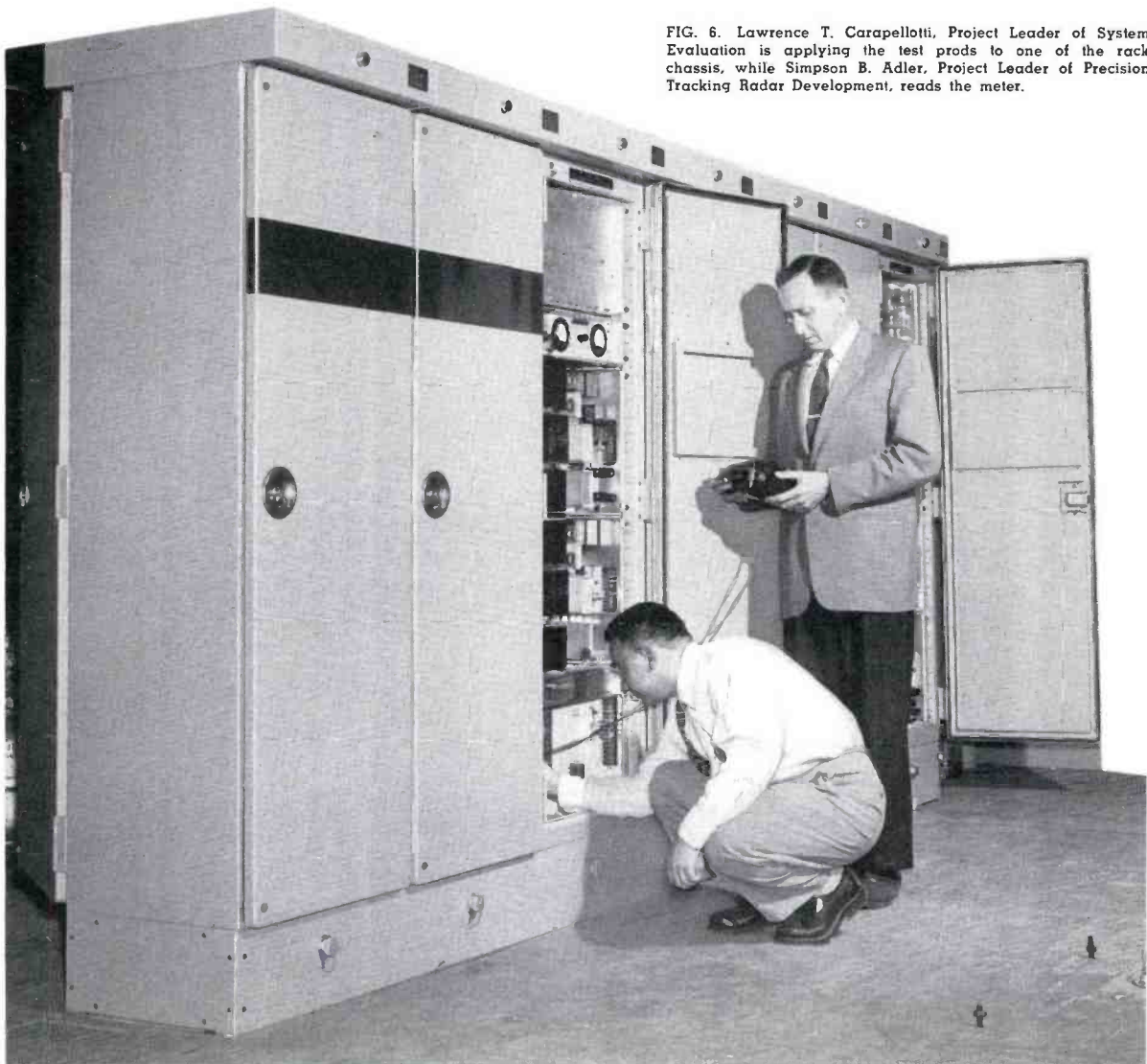

FIG. 6. Lawrence T. Carapellotti, Project Leader of System Evaluation is applying the test prods to one of the rack chassis, while Simpson B. Adler, Project Leader of Precision Tracking Radar Development, reads the meter.

# MULTIPLE ANTENNA SYSTEMS

## Vertical-Stacked and Side-by-Side Antennas Increase in Number as Performance Proves Satisfactory and Numerous Advantages Appear

by I. T. NEWTON, JR., *Manager, Broadcast Antenna Sales*

During the past six years there has been a growing interest in and use of multiple antenna systems for television broadcast operations. This began with the vertical stacking of five antennas on the Empire State Building in December, 1950. It has developed to include the side-by-side mounting of antennas as exemplified in the Hill Tower Candelabra installation in Dallas, Texas, completed in 1956.

The interest in multiple antennas has been spurred on not only by technical and economical considerations but also by the aeronautical aspect. This has led to a profound FCC rule making which would

encourage antenna farms and multiple antenna installation. This proposal, docket number 11665, was issued March 29, 1956, and reads, in part, as follows:

"With respect to the television broadcast service, in areas and communities where more than one such service is contemplated, there are distinct advantages to locating all transmitting antennas in the same general area; and this is true both from the standpoint of generally improving television reception as well as minimizing hazard to aviation. Every effort should be made, therefore, to group high antenna structures and to

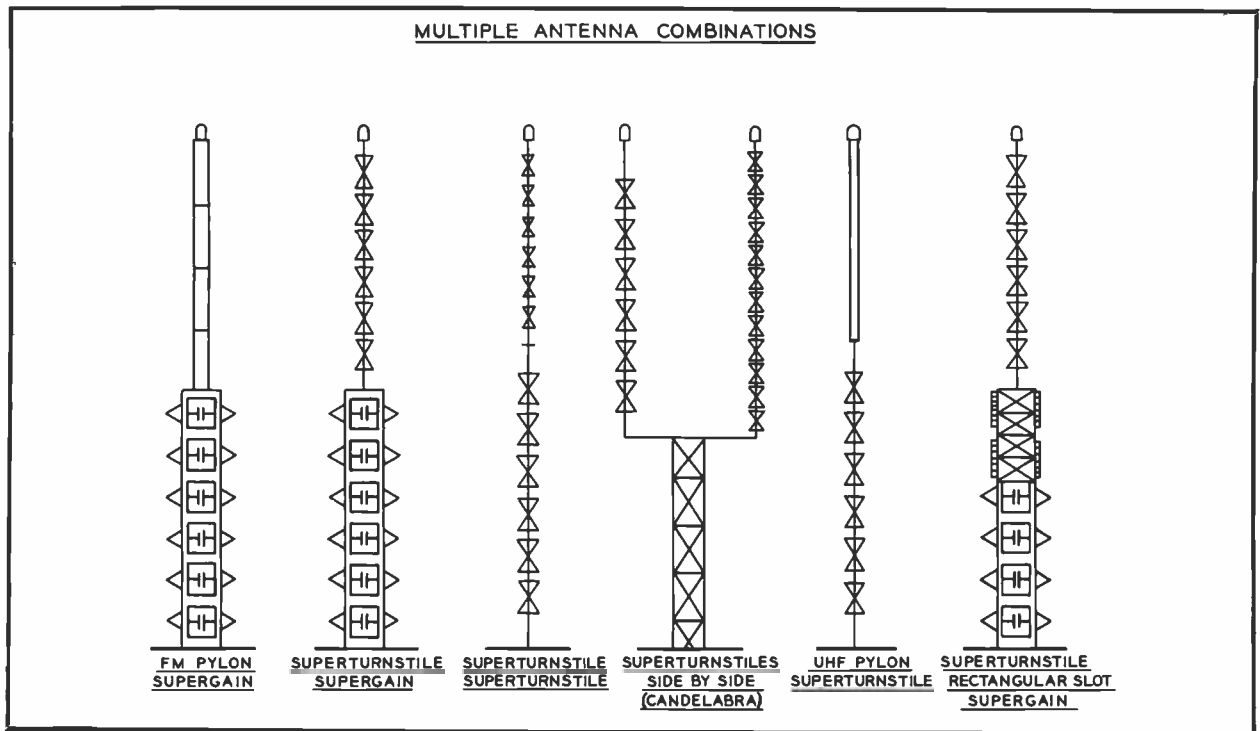

FIG. 1. Typical methods of physical arrangements for multiple antenna systems.

encourage the use of a single structure for supporting multiple antennas. The principal objective is, of course, to choose an area where the towers will not constitute a hazard to aviation.

"In view of the foregoing, the Commission is proposing to amend its rules to encourage the grouping of antenna towers and the multiple use of structures for supporting antennas."

#### Advantages of Multiple Antennas

As a result of considerable experience in both the design and the installation of multiple antenna systems there has been accumulated a considerable body of data on the desirability of this approach. In general, multiple installations on one tower, or antenna farms, present the following advantages:

1. Reduction of hazards to air navigation;
2. Minimize receiver antenna orientation problems;
3. More uniform coverage, eliminating areas of greater differential in signal levels than can be satisfactorily tolerated by receivers and receiving antenna systems;
4. Economy in land requirements, reduction of installation cost, and maintenance cost (in the case of multiple installations on a single tower);
5. Multiple utilization of a unique site;
6. Assistance to educational TV.

#### Typical Installations

RCA has supplied either stacked or candelabra installations in eight U. S. cities and four foreign locations. In addition to these, a number are in the planning stage or under construction. Vertical stacking of antennas is the most economical, however, the candelabra installation is to be preferred where the number of antennas and physical dimensions would result in inadequate height for the bottom antenna. Other individual problems may make the candelabra more desirable than stacking.

Figure 1 shows several methods of physical arrangement for multiple antenna installations. On the left is a sketch of a supergain antenna for VHF and a Pylon for either FM or UHF. An example of this type of installation is WSB in Atlanta, Georgia. The second sketch shows the use of a supergain antenna and a Superturndstile for VHF. Examples of this type installation are three stations on the Foshay Tower Building in Minneapolis; also Oklahoma City and Tulsa, Oklahoma, where educational channel antennas are combined with the commercial TV installation. The third sketch shows vertical stacking of

FIG. 2. Installation of RCA candelabra antennas at WFAA and KRLD, Dallas, Texas.

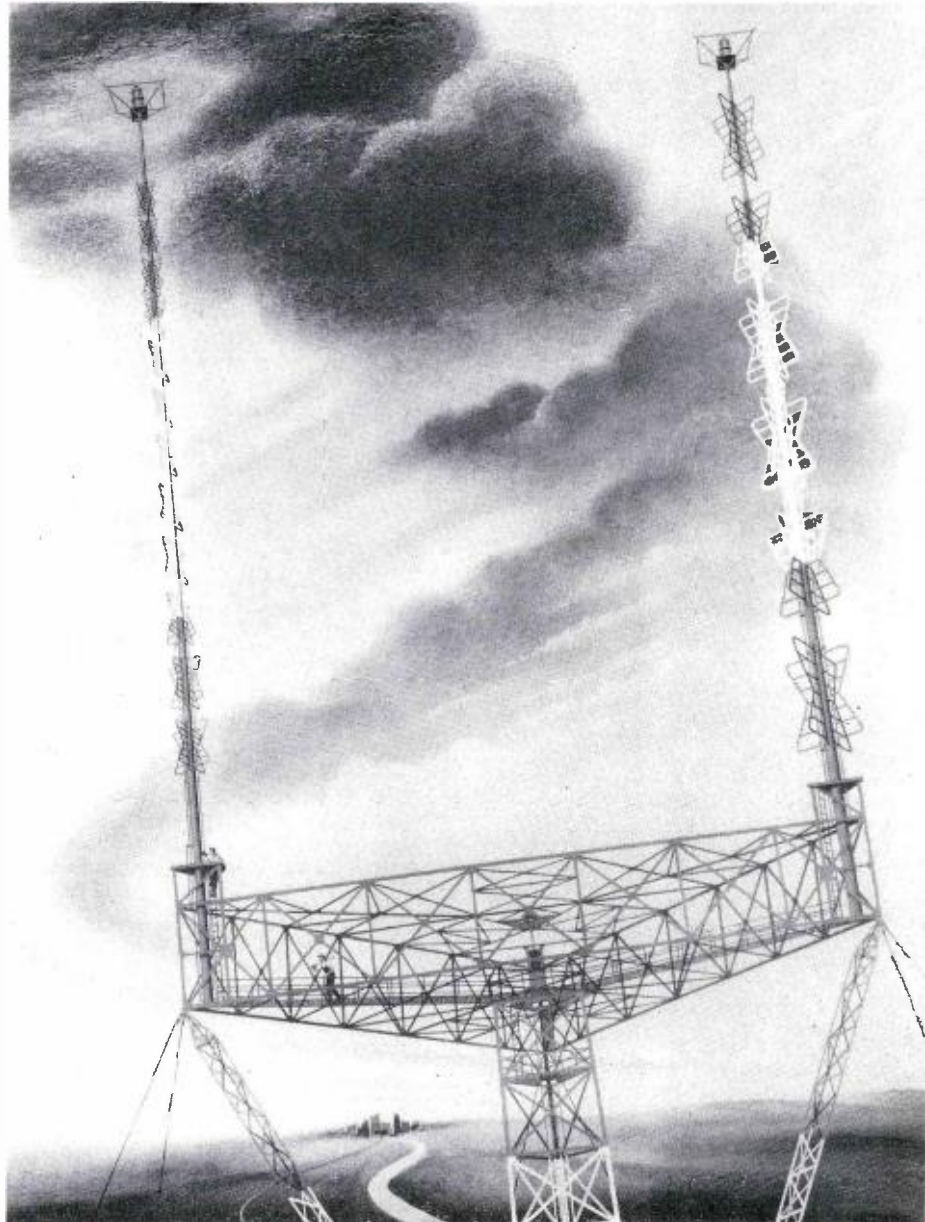

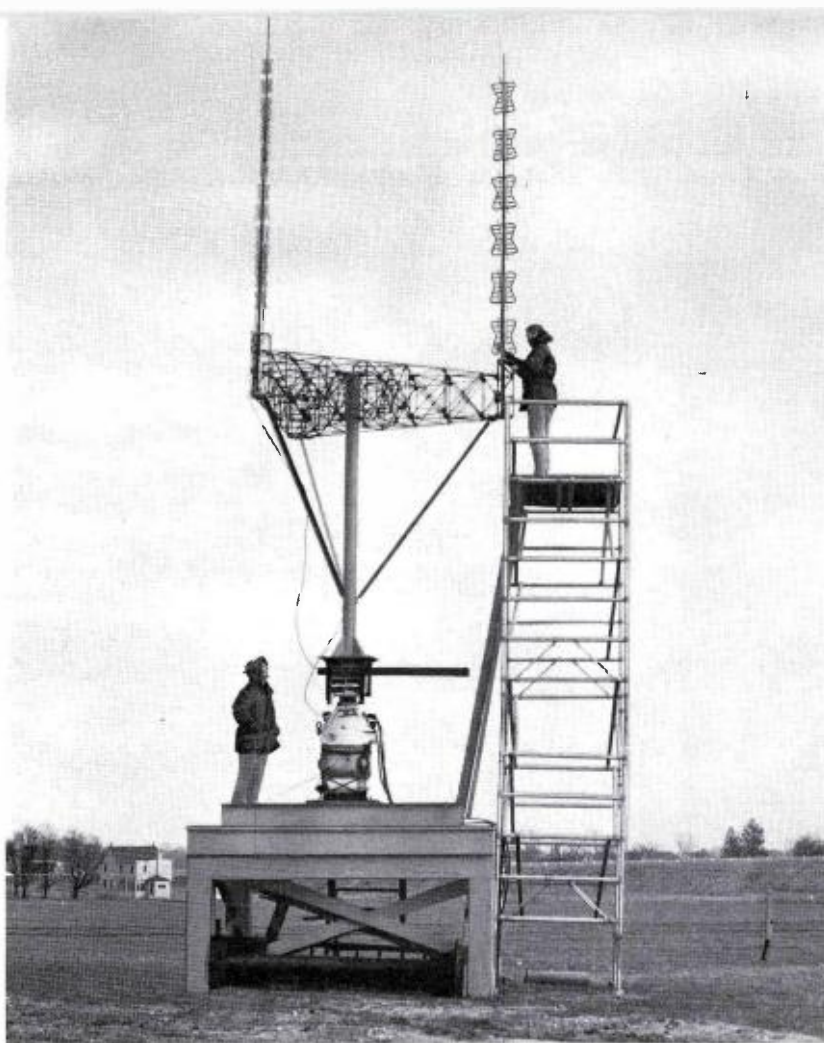

FIG. 3. Conducting horizontal pattern measurements on scale model of RCA candelabra antennas.

Superturnstile antennas. The KTHV and KARK installation in Little Rock, Arkansas is an example of this type. We are currently fabricating antennas for a similar installation in Philadelphia for WRCV and WFIL. The fourth sketch shows the candelabra or side-by-side mounting. The only example of an existing installation is WFAA and KRLD in Dallas, Texas. Work is in process for a similar installation for three stations in Baltimore, Maryland, and others are in the planning stage. The fifth sketch shows a possible stacking arrangement of the UHF Pylon and a VHF Superturnstile. The sixth sketch shows a Rectangular Slot Antenna which is designed for side mounting on the tower. This makes it feasible to employ stacking arrangements which permit the lower channel to be on top rather than the higher channel, which is normally placed in top position. A number of towers that have been installed are designed to permit future additions of other stations by use of this side-mount antenna.

#### Design and Specifications

Exhaustive engineering tests have been made by RCA on stacking and candelabra systems in both model work, in Camden, New Jersey, and in completed installations. We have found that either system may be properly designed to preclude any problems of cross-coupling between stations or substantial effect of one antenna on the coverage of another. Both types of approach permit a considerable degree of freedom in specifications of gain, power-handling capacity, pattern shaping and mechanical windload rating. Stacking systems have been designed and completed to withstand hurricane winds with a loading as high as 80 psf and the candelabra installation now in process for Baltimore, Maryland is designed for a windload of 70 psf.

A number of publications over a period of six years have fully documented the tests and results obtained in vertical stacking. The only technical problem which might be presented by vertical stacking

is possible excessive coupling of energy between antennas, leading to cross modulation and spurious radiations. The exhaustive tests in the past and the number of such installations have fully established that any combination of channels can be stacked without any more separation than dictated by mechanical requirements. The isolation in all such cases is at least 30 db or more. The candelabra approach is of more recent interest and not as fully documented except for an article in BROADCAST NEWS, October, 1955, reporting the model test and installation in Dallas, Texas. Figure 2 illustrates this installation.

Specifications for the Dallas antennas included, among others, requirements of plus or minus 3 db circularity and 26 db isolation between systems. These specifications were demonstrated in the RCA test center at Camden, with 8-to-1 scale models of the actual antennas, in addition to very extensive electrical tests of the final installation.

These scale models duplicated the actual Superturnstile antennas in every respect even to the actual scaling of the size of the individual feedlines as well as maintaining the correct impedance and match. The tests included separate impedances and pattern tests of the individual antennas to verify their correct characteristics. Also tests were made to determine mutual effects on horizontal and vertical patterns, impedances and cross-coupling. Figure 3 shows the model antennas in the course of horizontal pattern measurements.

#### Conclusion

Work is now under way for a candelabra installation in Baltimore, Maryland, which will include three antennas on Channels 2, 11 and 13. More rigid specifications have been prepared for this installation and, again, scale models will be used to demonstrate feasibility prior to the actual installation. Mathematical investigations are leading to the development of analytical techniques to provide the necessary answers without the necessity of model tests. The validity of these analytical techniques will be determined by comparison of results with actual measurements on the work now under way. In the future, it should be possible to complete the planning of these installations with a considerable saving in time and cost by using mathematical analysis in lieu of model measurements.

*Editor's Note: The following article by Matti Siukola (page 63), describes this mathematical approach.*



# PREDICTING PERFORMANCE OF CANDELABRA ANTENNAS BY MATHEMATICAL ANALYSIS

by MATTI SIUKOLA, *Broadcast and Television Engineering*

*Editor's Note: The preceding article (p. 60) has dealt with reasons for multiple antenna installations, mechanical methods and their achievements. This article relates to electrical considerations for candelabra installations.*

On the side-by-side mounting, the antennas are in the main radiation field of each other. Therefore, electrical problems arise which are considerably greater than in other multiple antenna arrangements. The most important is the effect on the horizontal pattern of the antennas by each other. Another problem is the mutual coupling between the antennas. This is much less important because it can be changed by proper arrangements even after the construction of the antenna system. However, any appreciable change of the resulted horizontal pattern once the system has been built is exceedingly difficult. To determine the magnitude of these effects calculations have been performed with methods which are now to be explained.

## Horizontal Pattern Circularity

Let us first look in the horizontal pattern distortion. Figure 1 shows the top view of the geometry which determines the formation of the horizontal pattern. The transmitting antenna is shown in the center and at the distance  $b$  from it a reflecting object such as another antenna. The radiation from the transmitting antenna produces the main or primary field  $F_0$  which is normally omnidirectional. Part of this energy is being intercepted by the reflecting object and for the most part re-radiated forming the reflected field  $F_r$ . The magnitude of the reflected field is determined by the amount of energy being intercepted by the reflecting object, the amount being absorbed by it, and by the shape of the re-radiation pattern. The final radiation field is a vectorial sum of the primary field and the reflected field. The phase difference between the two fields at any specific direction is shown by the equation below the diagram.

The first term of the equation is the

phase difference between the two signals because of different path lengths. It is a function of  $b$  in wavelengths and azimuthal angle  $\phi$ . The second portion of the phase difference is determined by the characteristics of the reflecting object. In practice the first portion of the phase difference is greater, since the distance  $b$  is normally several wavelengths. This results in that the phase difference changes slowly by varying azimuthal angle  $\phi$  at the general direction of the plane of the transmitting antenna and the reflecting object. The variation is rapid in the plane perpendicular to this.

The type of horizontal pattern obtained is illustrated in Fig. 2. This shows the effect produced by a 1.3 wavelength diameter metal cylinder about 15 wavelengths away from a Superturnstile antenna. The heavy center curve is the undisturbed or primary pattern of the Superturnstile antenna which, in this example, has a circularity of plus or minus  $1\frac{1}{2}$  db. By adding the reflected field, the rapidly varying diffraction pattern is obtained.

The effect of the shape of the re-radiation pattern is apparent from the differing magnitude of the diffraction pattern variation about the primary pattern in various directions. The slow change of phase difference in the plane of transmitting antenna and the reflecting cylinder as well as rapid change in the plane perpendicular to this is also indicated.

From the minimum and maximum values of the diffraction pattern, the overall circularity of plus or minus 3 db has been calculated. It can be seen, however, that if an envelope is drawn both inside and outside of the diffraction pattern and the minimum and maximum values of these envelopes are used in the circularity calculation, the result because of the rapid variation of the diffraction pattern is almost identical. Therefore, calculations can be made only for the envelopes of the diffraction pattern instead of for the whole diffraction pattern. The result is, of course, slightly conservative. The advantages of the calculation of the envelopes are: first,

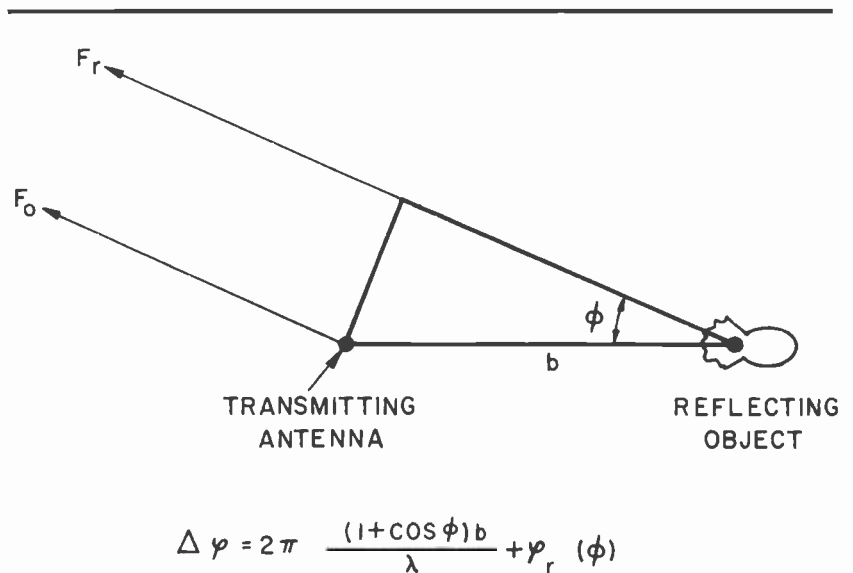

FIG. 1. Geometry which determines horizontal pattern distortion.

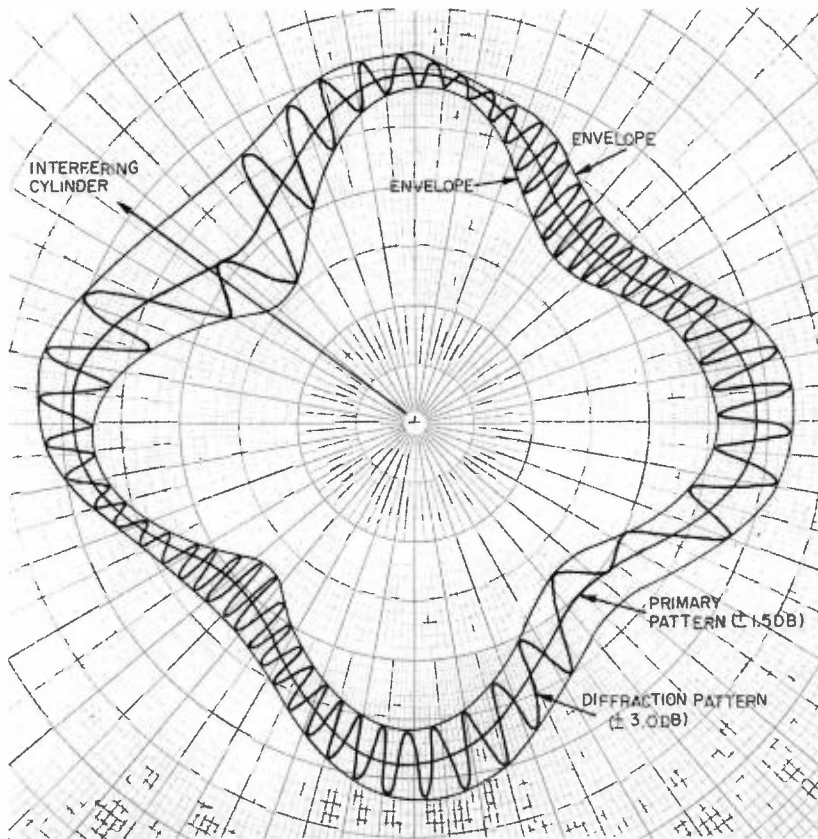

FIG. 2. Calculated horizontal pattern of a Superturnstile antenna in presence of a long vertical highly conducting cylinder of  $1.3\lambda$  diameter about  $15\lambda$  away.

ASSUMPTIONS:

- 1) PLANE WAVE INCIDENCE AT REFLECTING ANTENNAS ( $a/b$  IS SMALL)
- 2) REFLECTING ANTENNAS ARE CYLINDRICAL AND HIGHLY CONDUCTIVE
- 3) SECOND REFLECTIONS NEGLECTED (FIRST IS SMALL COMPARED TO MAIN FIELD)
- 4) REFLECTIONS FROM SUPPORTING STRUCTURE NEGLECTED
- 5) ALL REFLECTIONS IN PHASE OR OUT OF PHASE AS COMPARED TO MAIN FIELD (WORST CASE)
- 6) LINEAR INTERPOLATION HAS BEEN USED TO TAKE CARE OF PARTIAL SHADOWING EFFECTS OF ANTENNAS DUE TO
  - a) DIFFERENT LENGTHS AND DIFFERENT ELEVATIONS OF ANTENNAS, AND
  - b) OPENINGS WITHIN ANTENNA APERTURES

FIG. 3. Assumptions made in order to devise a practical method for calculating horizontal circularity of antennas in multiple installations.

the phase difference between the primary field and the reflected field is very difficult to determine with adequate accuracy for the diffraction pattern calculation, and second, the amount of work is considerably reduced.

**Theoretical Approach to Horizontal Circularity**

To devise a practical method of calculation the several assumptions shown in Fig. 3 have been made:

First, a plane wave incidence at the reflecting antennas was assumed. This can be done since in a practical case the effective radius  $a$  of the reflecting object such as another antenna compared to the distance  $b$  between the transmitting antenna and the reflecting object is small.

The second assumption, that the reflecting antennas are cylindrical and highly conductive, has been made to simplify calculations and also to give a universal answer which can be used in different problems.

The third assumption, neglecting second reflections, can be made if the first reflection from any supporting structure or antenna is small compared to the primary field of the transmitting antenna. Thus the second reflection would be negligible.

The fourth assumption, neglecting reflections from the supporting structure, has been substantiated by previous model tests and also by measurements of an actual system.

Regarding the fifth assumption, in case of several antennas, that is, more than two being installed on the same supporting structure, it has been assumed that the reflection fields are all in phase in any direction. To obtain the total diffraction pattern envelopes the summation of all the reflection fields has been added to and subtracted from the primary field. This would be the worst case and give conservative results.

As the last assumption linear interpolation has been used when the antennas are of different lengths, or at different elevations, or when a reflecting antenna has large openings within its aperture. The latter is the case, for example, when a low channel Superturnstile antenna interferes with a high channel transmitting antenna, since the low channel antenna has considerable openings between the sections for free passage of high channel radiation.

Based on the foregoing assumptions, the equations shown in Fig. 4 have been derived. The outside envelope  $F_{max}$  of the

diffraction pattern has been obtained by adding to the primary pattern  $F_0$  the summation  $G$  of the magnitudes of all the reflected patterns. The inside envelope  $F_{min}$  results from subtraction of the same patterns. For a Superturnstile as a transmitting antenna a simple adequately accurate equation for  $F_0$  is given.

The summation  $G$  of the reflected patterns is obtained by arithmetically adding the amplitudes of the scatter patterns  $F_s$  modified by proper factors. The scatter patterns  $F_s$  are the results of theoretical calculations of the re-radiation fields from highly conducting cylinders. The magnitudes of these scatter patterns have been modified by three factors. The first,  $K_m$ , is the linear interpolation factor. The second,  $\sqrt{\lambda/b_m}$  takes into account the distance between the transmitting antenna and the reflecting antennas. The third factor,  $F_{in}$ , includes the effect of the primary pattern shape on the excitation of the reflecting antennas or objects.

These equations can be directly used for calculation of diffraction pattern envelopes in application where the reflecting objects are cylindrical such as supporting poles or UHF Pylons. However, in the case of interfering Superturnstile antennas proper effective radii and interpolation factors have to be found. Figure 5 shows the method used.

The sections of the Superturnstile antenna are assumed to form a set of cylindrical blocks. As the effective radius of a section of the Superturnstile has been used since the horizontally polarized electric field is approximately perpendicular to the edge of the batwings. The height  $h$  of the blocks has been assumed to consist of the length of the batwings plus  $1/8$  of the wavelength at the frequency in question on either side. This includes the additional shadowing effects by the top and bottom rungs of the batwings on the electric field parallel to them. The height  $h$  as compared to the distance  $L$  between sections has been incorporated into the interpolation factors.

#### Comparison of Calculations With Actual Measurements

The described theoretical method of predicting the circularity of the horizontal patterns in multiple antenna installations of the candelabra type has been applied on several occasions. However, to substantiate the method of calculation only one set of actual pattern measurements has been available. These measurements were made with a scale model of the multiple antenna

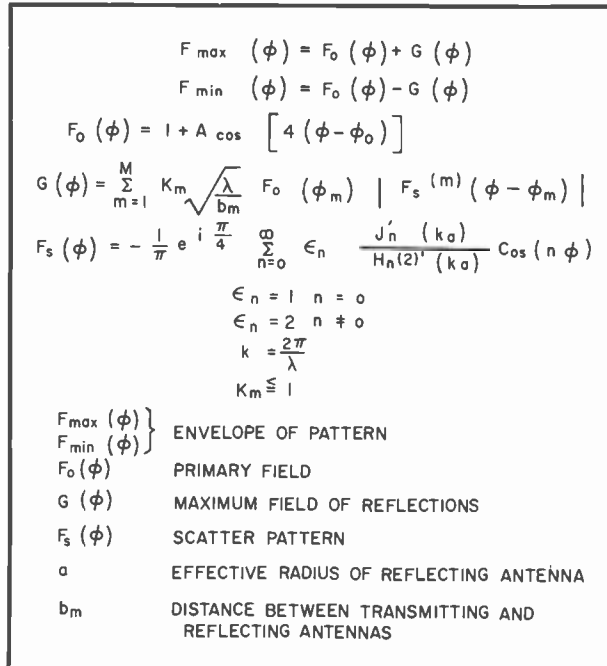

FIG. 4. Equations for horizontal pattern calculations on multiple antenna installations.

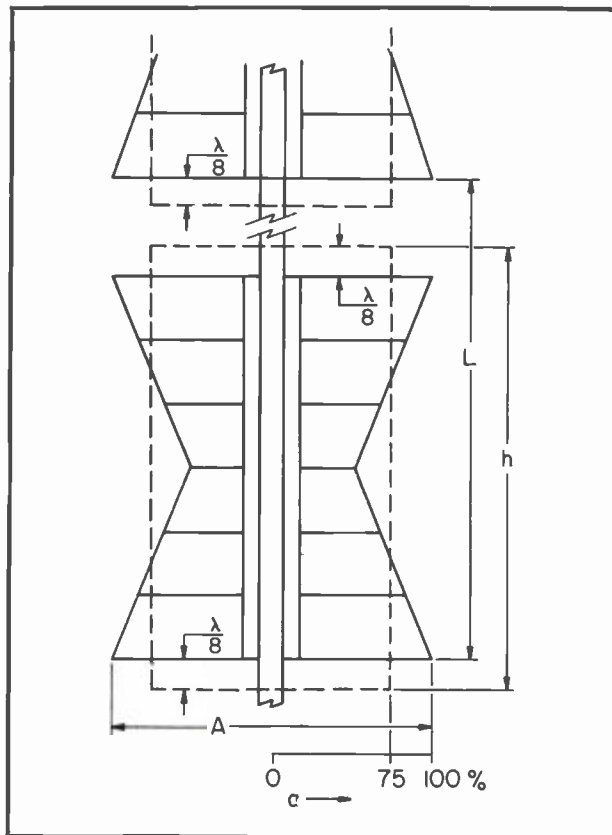

FIG. 5. Derivation of equivalent cylinder dimensions from a Superturnstile antenna for horizontal diffraction pattern calculations.

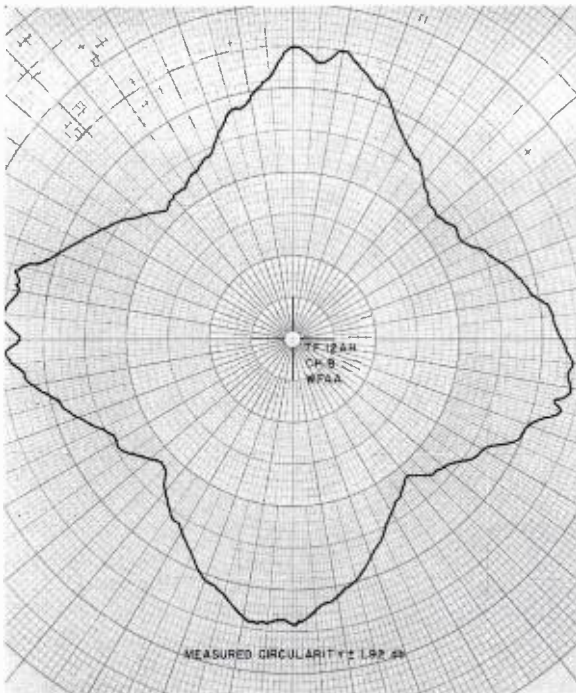

FIG. 6. Measured horizontal pattern of Channel 8, TF-12AH scale model antenna.

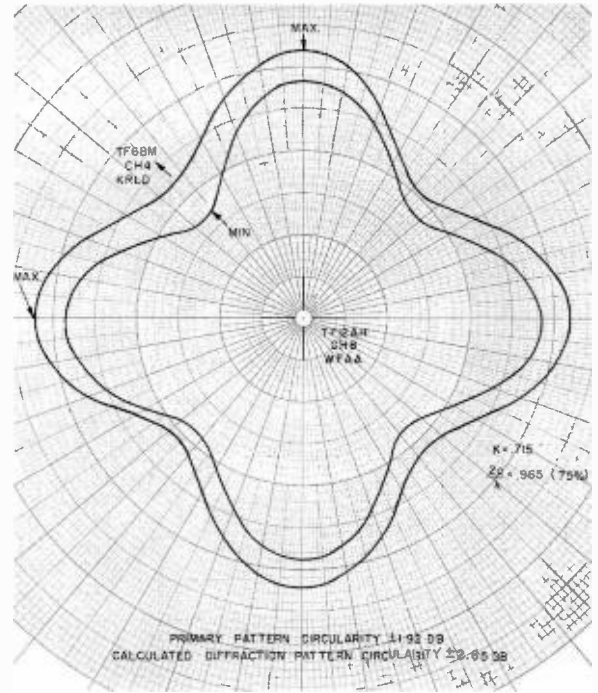

FIG. 7. Calculated horizontal pattern envelope of Channel 8, TF-12AH scale model antenna in presence of Channel 4, TF-6BM scale model 75 scale feet away.

FIG. 8. Measured horizontal pattern of Channel 8, TF-12AH scale model antenna in presence of Channel 4, TF-6BM scale model 75 scale feet away.

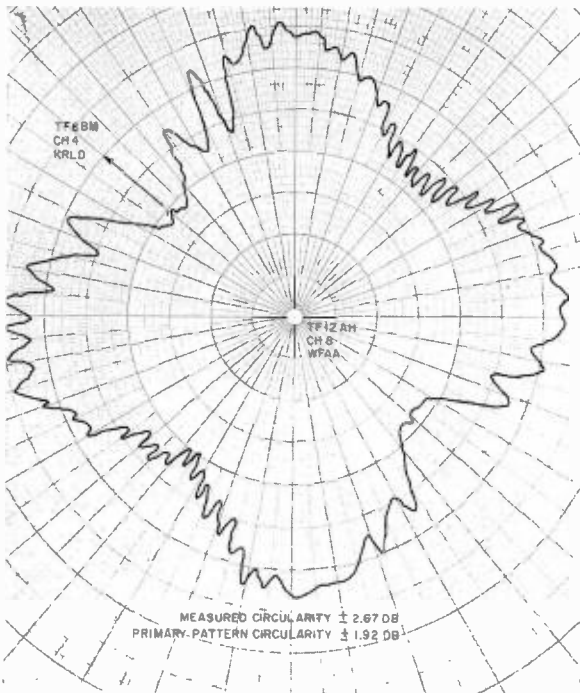
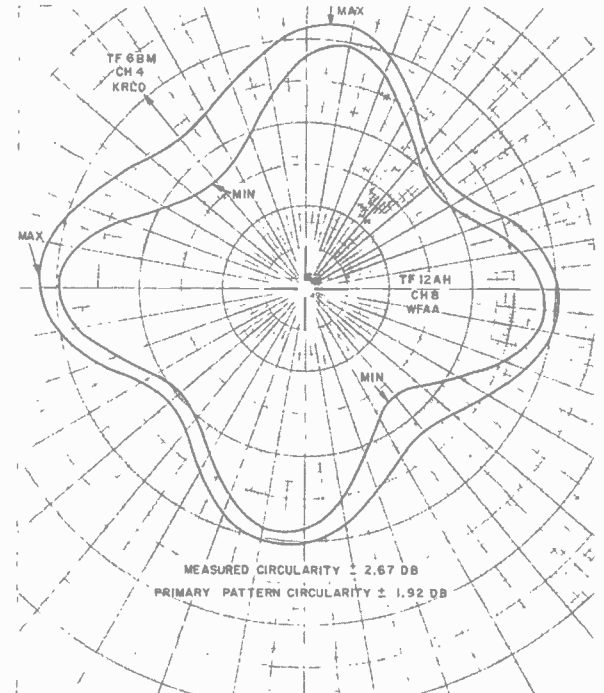

FIG. 9. Measured horizontal pattern envelope of Channel 8, TF-12AH scale model antenna in presence of Channel 4, TF-6BM scale model 75 scale feet away.



system of Hill Tower, Inc., Dallas, Texas. The results of the calculations are presented here for comparison.

This multiple antenna system has a medium channel 6-section Superturnstile antenna mounted 75 feet from a high channel 12-section Superturnstile antenna on a triangular supporting structure. The horizontal primary pattern of the Channel 8 scale model is shown in Fig. 6. The measured circularity of plus or minus 1.92 db has been used in calculations. By the foregoing method of calculation the pattern envelope shown in Fig. 7 has been derived. From the minimum and maximum values of the envelope, a circularity of plus or minus 2.85 db has been obtained. It should be somewhat conservative according to the assumptions which have been made.

In this example the maximum magnitude variation of the diffraction pattern is toward the reflecting antenna and the minimum variation at the angles of about 70 degrees on each side of it.

The actual measured horizontal diffraction pattern of the scale model is shown in Fig. 8. It has a circularity of plus or minus 2.67 db which is approximately six per cent less than the calculated, giving an excellent correlation.

The measured pattern shows as the theory indicated that the variation of the field is slowest or the lobes farthest apart in the plane of the antennas, and that the variation is most rapid in the plane 90 degrees from it. The envelope of this pattern confirms that the maximum amplitude variation is toward the reflecting antenna and the minimum variation about 70 degrees from it on each side. Comparison of the calculated and measured envelopes (Figs. 7 and 9) reveals an excellent similarity between them, thus giving confidence to the theoretical calculations.

#### Mutual Coupling Between Antennas

Now, let us look briefly at the mutual coupling between antennas mounted side-by-side. The equations employed in calculation of the decoupling between the antennas are shown in Fig. 10. The upper equation holds when the antennas are separated far from each other. The theory has been developed based on the effective aperture principle of the antennas. The only assumption made is that the reflections from other antennas and structures have been neglected.

The close field equation is based on three assumptions in addition to this. First, the transmitting antenna is assumed to radiate all the energy horizontally. Second, the

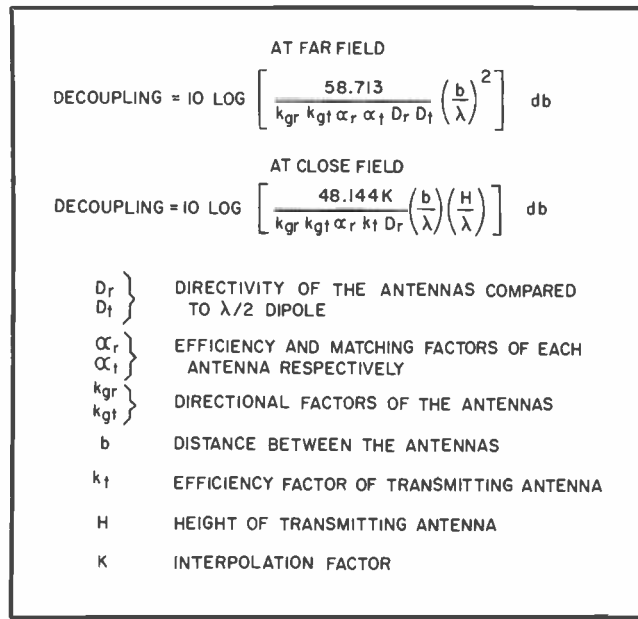

FIG. 10. Equations for calculation of isolation between omnidirectional antennas on candelabra antenna installations.

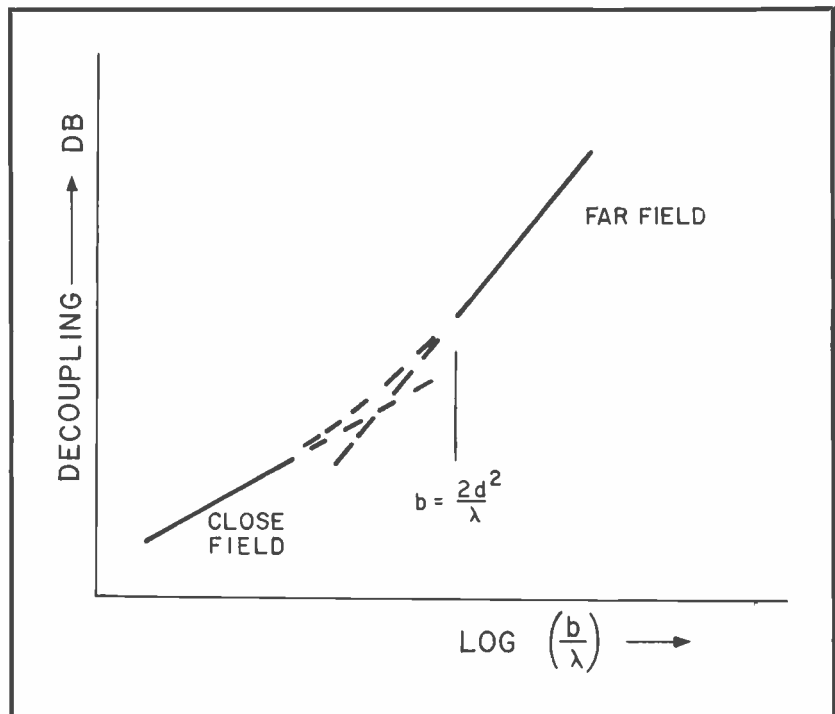

FIG. 11. Decoupling between two antennas as a function of the distance between them.

field is assumed to be uniform at the receiving antenna. Third, linear interpolation is used to include effects of different elevations and/or lengths of the antennas. By again using the effective aperture principle for the receiving antenna the close field equation has been derived.

For any specific application, the calculations have been performed using both equations. By plotting the decoupling in db versus the logarithm of the distance between the antennas in wavelengths, the equations result in two straight lines (Fig. 11). If the region of interest is between the validity areas of these two equations an adequately close approximation can be obtained by interpolation, that is, by drawing a curve between the straight lines.

In practice, this method is often difficult to apply, since some of the constants in the equations are exceedingly difficult if not impossible to determine. Fortunately, though, in most cases the results need only be used as guidance since even after the construction of the antenna system mutual coupling can be changed by varying the orientation of the antennas or by changing the feed system lengths of the antennas, or in the worst case by placing proper filters in the feed systems. Any of these modifications will change the constants in the equations and result in a different decoupling value. These equations can be used, however, to determine the worst possible case in any application without the modifications mentioned.

#### Conclusion

Both the calculations of the circularities and the decouplings have been applied in several occasions. However, at this moment the methods are not believed to be accurate enough to be firmly relied on. High accuracy of evaluation is mandatory especially in circularity calculations, since any appreciable change of circularity once the system has been built is extremely difficult. Therefore, in the near future experimental tests are planned. From these measurements further substantiation or modifications for the theoretical approach will be obtained. Scale models have been built for the investigation of these effects in the multiple antenna system for Baltimore, Maryland (3 Superturnstile antennas). Figure 12 is a picture of these models. By proper correlation of the measured and the calculated results, it is expected that at a later date the effects can be determined solely by calculation.

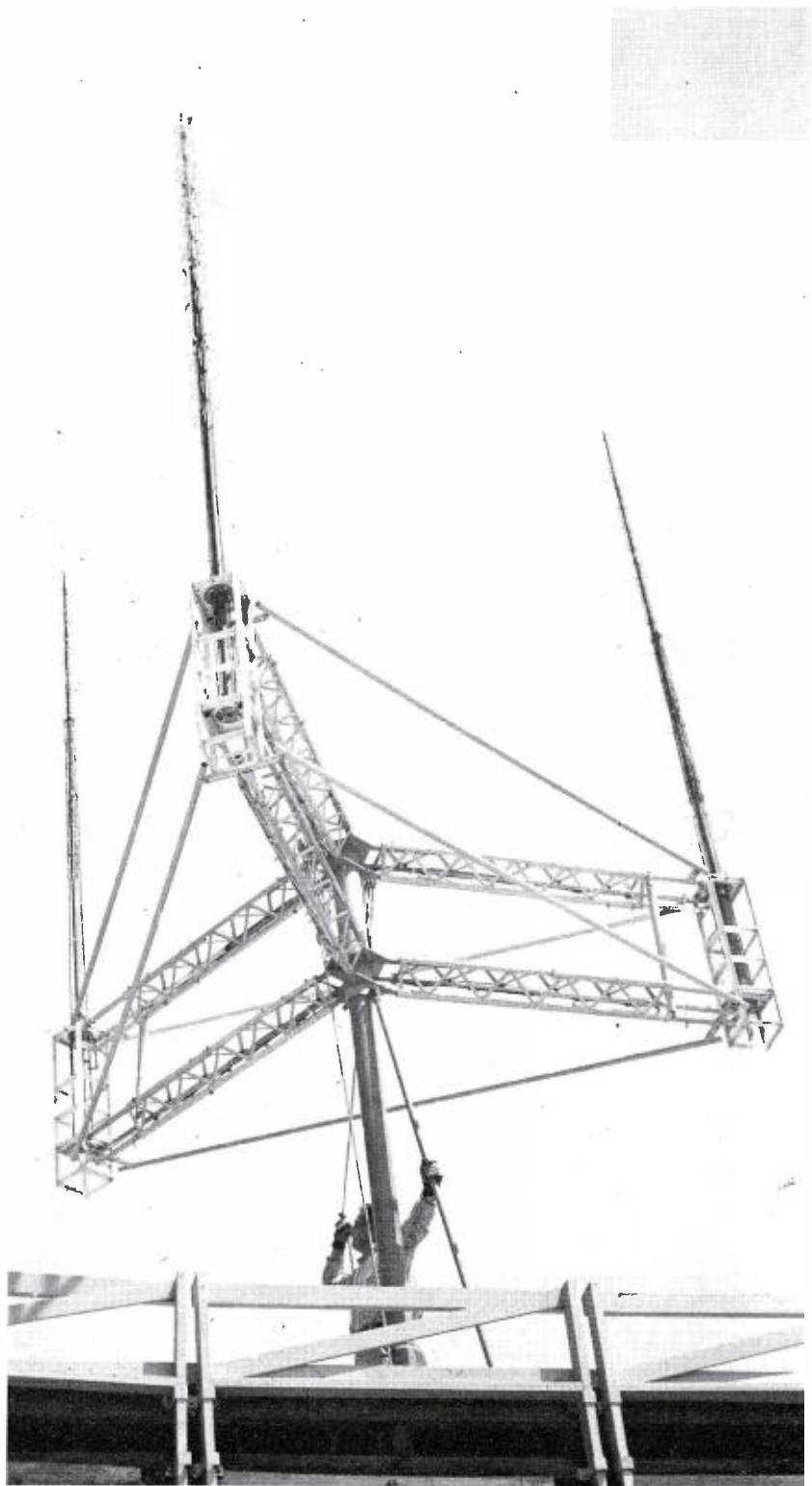
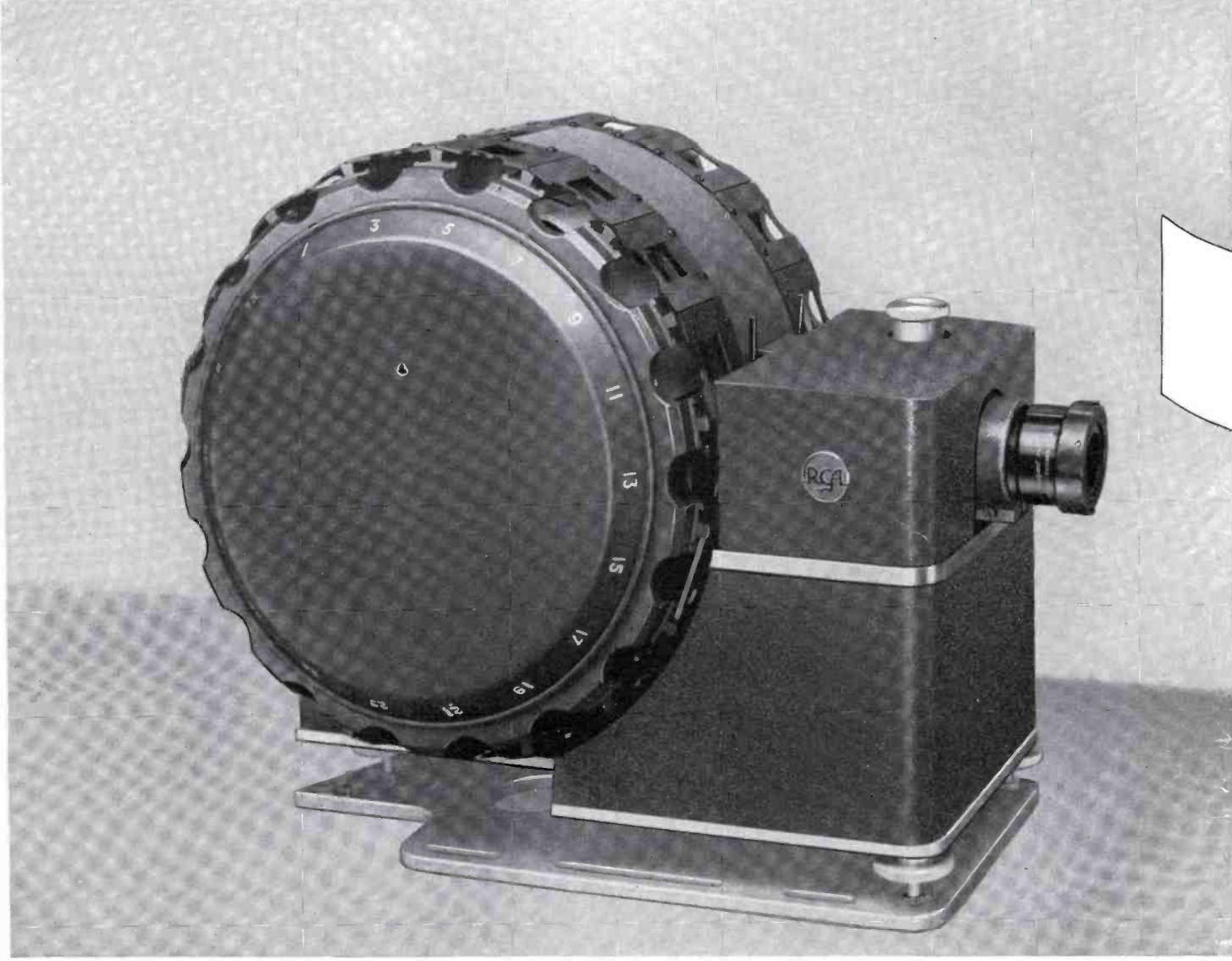

FIG. 12. Scale model of the candelabra antenna installation designed for Baltimore, Md.





New High-Capacity TP-7 Slide Projector. Dual drums hold a total of 36 slides. For top performance in color and monochrome.

## REMARKABLE NEW FEATURES ASSURE

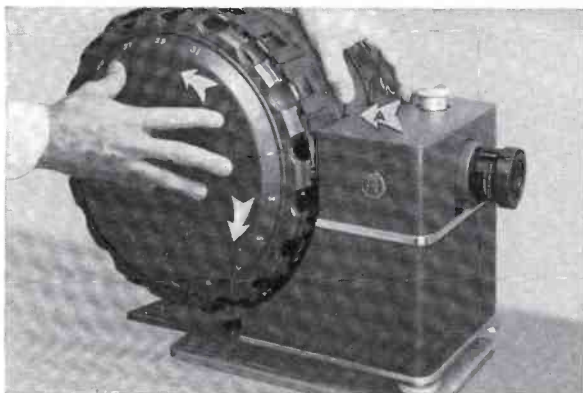

### MECHANICAL VERSATILITY

"Free wheeling" principle, with simple lever release (A), permits either drum to be twirled for easy inspection and slide changing. Slides move smoothly and lock securely in show position. Each drum can be operated independently of the other.



### PREVIEW CONVENIENCE

All slides are illuminated for easy viewing making it easy for projectionist to preview them. Last-minute changes can be made before they reach the "show" position.



You told us what you wanted . . . we listened,  
designed, field tested . . . with the result:

DESIGNED  
THE WAY  
YOU WANT IT!

## This new professional slide projector excels in performance and operating convenience!

Recognizing the increasing importance of slides in programming at every television station, RCA resolved to do something about the projection equipment.

**SURVEY OF USERS**—At the outset, a survey was made among users of film-slide equipment to find out what was wanted most.

**NEW DESIGN PROJECTOR**—The result is a truly professional projector for television use that is exactly tailored to your needs . . . with so many operating advantages it's a pleasure to use! It has an ideal capacity of 36 slides—large enough for handling 99% of all station needs, yet just right for ultra flexibility.

**SUCCESSFUL FIELD TEST**—The TP-7 Slide Projector has been field tested in actual day-to-day service at a busy television station—WBTB, Charlotte, N.C. So successful was this trial run, the station people did not want to part with the projector when the test was completed!

**"OPERATION VIRTUALLY FLAWLESS"**—According to Thomas E. Howard, WBTB Vice President and Managing Director of Engineering and General Services, "During the testing period, the TP-7's operation was virtually flawless. An estimated 12,000 slides were run, 170 slides per day on-air, 60 slides in previews and rehearsals."

Write for illustrated brochure containing complete information  
In Canada: RCA VICTOR Company Limited, Montreal.



**RADIO CORPORATION of AMERICA**  
Broadcast and Television Equipment Camden, N. J.

### OPERATIONAL CONVENIENCE AND FLEXIBILITY

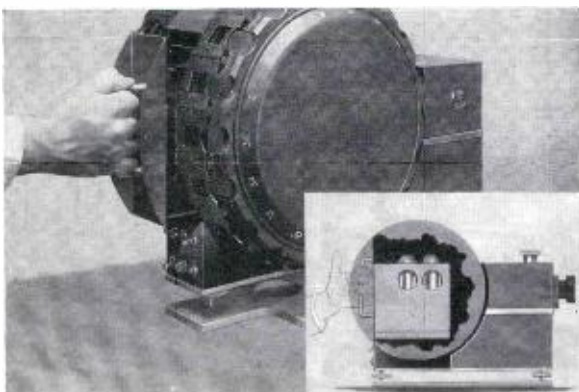

#### QUICK LAMP CHANGE

Use lamp to failure—reserve lamp instantly slides into place. Highest type optics for uniform brightness over entire field of projected image. One-lamp source eliminates color balance problems.

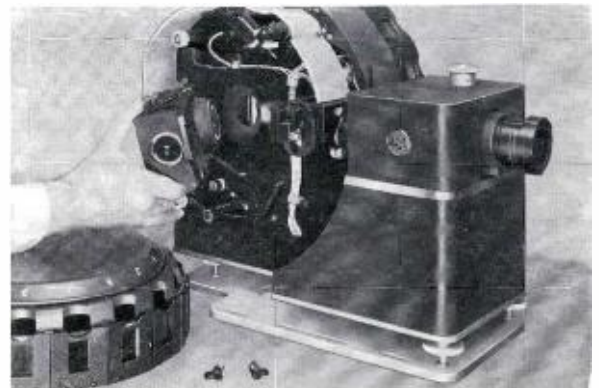

#### UNITIZED CONSTRUCTION

Designed for ease of operation and servicing. Drums, drum-covers and optical assemblies are easily removed for cleaning and maintenance.

# RCA 3-Speed Turntable with Many New Features

## BQ-2B



### DESIGNED WITH YOUR SPECIAL NEEDS IN MIND!

**Silent Operation.** Cushion-mounted motor is operated by quiet Mercury switch.

**Long Life.** Extended puck life is assured by relieving idlers in "Off" position by "Off-On" switch. Sturdy 16-inch turntable platter with large spindle accurately machined, to give many years service.

**Fast Cueing.** Hysteresis synchronous motor provides ample driving power, assures quick smooth starts.

**Improved Stability.** Large sleeve bearings provide accurate turntable alignment. Drive motor is mounted on a separate plate and supported by vibration mounts to eliminate rumble.

**Fewer Moving Parts.** Excellent design speed-changing mechanism, a minimum of moving parts, self-compensating idlers.

**Ease of Operation.** Quick speed change. Snap-up spindle for 45 rpm operation assures ease of operation.

New BQ-2B Turntable. Cabinet model shown, ready for delivery at once. Supplied less tone arms and filters, available as accessories. Also available less Cabinet.

Call your RCA Broadcast Sales Representative for further details, or write for illustrated brochure containing complete information.

In Canada: RCA VICTOR Company Limited, Montreal.



**RADIO CORPORATION of AMERICA**  
Broadcast and Television Equipment Camden, N. J.

# SUPER-DYNODE and MICRO-MESH

Now RCA  
Image Orthicons  
Combine BOTH

For Color  
RCA-6474

For Black-and-White  
RCA-5820

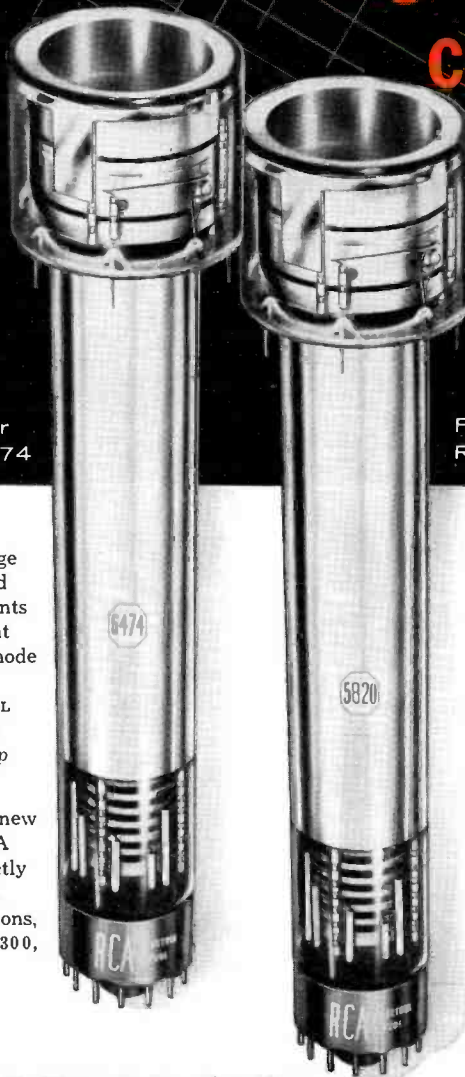

If you are not yet in operation with new RCA Image Orthicons—which now combine SUPER-DYNODE and MICRO-MESH designs—get set for new improvements in picture quality and camera chain operation that will surprise you. Now you can say good-bye to dynode burn. No need to defocus anymore to kill mesh pattern and moiré. AND EVERY TV STATION MAN WILL LIKE THIS GOOD NEWS: RCA Image Orthicons with Super-Dynode and Micro-Mesh design deliver top quality performance longer than ever before.

RCA-5820's and -6474's with MICRO-MESH and the new SUPER-DYNODE design are available from your RCA Industrial Tube Distributor. Both types are directly interchangeable with all previous RCA-5820's and -6474's. For technical details on RCA Image Orthicons, write RCA Commercial Engineering, Section I-1300, Harrison, N. J.

#### FACTS ABOUT RCA SUPER-DYNODE

##### For black-and-white

- Less dynode texture in "low-key" scenes
- Easy to adjust dark-shading
- More uniform picture background
- Decelerator-grid voltage can be set at optimum value for highlight uniformity—throughout tube life
- Minimum undesirable background texture in low-light areas
- Cleaner colors in the dark areas

#### FACTS ABOUT RCA MICRO-MESH

- Eliminates mesh pattern and moiré effect without defocusing
- More than meets all technical requirements of 525-line TV system
- 750-mesh tube used with aperture-correction circuits can provide 100% response for 350-line information. 500-mesh tube without aperture-correction circuits produces only about 60% response for 350-line information. Although correction circuit can be used with 500-mesh tube, such use emphasizes moiré and beat-pattern problems
- Micro-Mesh minimizes beat pattern between color subcarrier and frequency generated by the beam scanning the mesh-screen pattern
- Improves detail of color pictures



**CAMERA TUBES FOR TELECASTING**

RADIO CORPORATION OF AMERICA • Electron Tube Division • Harrison, N. J.

# RCA Victor Color TV is lifelike — dependable as black-and-white — and look how easy it is to tune!



1. Get the channel you want . . .

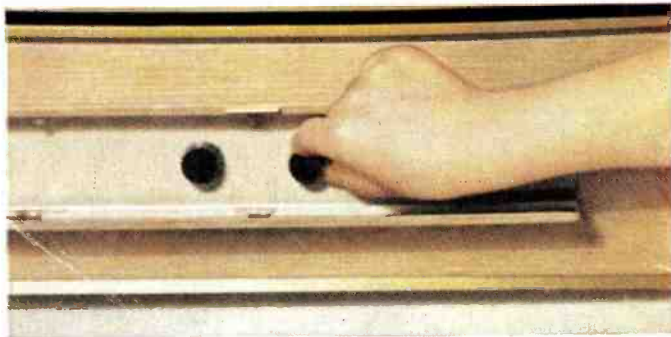

2. Set color quickly, accurately . . .



Even a child can tune color—for the whole family to enjoy! (Shown) Aldrich in lined oak grained finish. (21CS781) \$495.

You're looking at today's most practical TV buy — RCA Victor Big Color! And here's why so many families are buying it:

Color TV is *naturally* beautiful and exciting—it adds so much to your TV pleasure. And with RCA Victor Big Color, you not only see color shows every day in the week—you see all regular black-and-white programs too. Color is dependable, practical—and *the price is right*. You can buy RCA Victor Big Color for as little as \$495, with easy budget terms if you desire. Ask your RCA Victor dealer for a free demonstration soon.

Manufacturer's nationally advertised VHF list prices shown. Some models slightly higher for West, South, Canada. UHF optional, extra. Prices, specifications subject to change. Sets shown have 254 square inches of viewable picture area. RCA Factory Service is available in most TV areas but only to RCA Victor TV owners. Contracts as low as \$39.95.

RCA PIONEERED AND DEVELOPED COMPATIBLE COLOR TELEVISION



Like having 2 sets in one! See color shows in "Living Color." regular shows in sharp black-and-white. (Shown) Westcott in mahogany grained finish. (21CT785) \$645.

