

# BROADCAST NEWS

VOL. NO. 89  
JUNE, 1956

RADIO AND TV CITY, BOGOTA, COLOMBIA



# NEW!

## 500 WATT and 1 KW RCA AM TRANSMITTERS TYPE BTA-500MX • TYPE BTA-1MX

### for economical and reliable broadcast operation

These two new transmitters are designed specifically to meet critical broadcast needs. Both provide maximum adaptability for dependable remote control operation.

Simple to install and maintain, they offer maximum efficiency and economy in continuous broadcast service. The RCA "MX's" are today's best transmitter buy with outstanding performance features to meet today's competition.

**SUPER PERFORMANCE**—Here's proof of outstanding performance. Lowest distortion ever... less than 2% typical at 15,000 cps. Wide-range frequency response... essentially flat between 30 and 15,000 cycles. Bi-level modulation incorporated in both units means absolute minimum distortion, reduced carrier shifts, over-all increase in broadcast efficiency. Conservatively rated components and cooling add long-life reliability.

**SIMPLIFIED OPERATION**—Single control tuning located on functional front panel is the only control needed for all normal adjustments. The crystal oscillator trimmer can be adjusted through the front panel while the transmitter is in operation. Filament voltages on all transmitter tubes can be adjusted from the operating panel.

**SPACE SAVING... TUBE SAVINGS**—Important space savings are achieved with only 6.2 square feet required overall. Operating with fewer tubes and fewer tube types (15 tubes in the 1MX, 14 in the 500MX and only 4 types), the problem of stocking tubes is helped from a space-saving as well as a money-saving standpoint.

**COMPLETE ACCESSIBILITY**—Vertical construction, exclusive at these powers, provides instant access to all components for visual inspection or ease of replacement.



See your nearest RCA Radio Broadcast Sales Representative or write for brochure containing complete technical specifications. In Canada: RCA VICTOR Company Limited, Montreal.

REMEMBER—RCA TRANSMITTERS HAVE THE HIGHEST RESALE VALUE OF ANY TRANSMITTER ON THE MARKET!



**RADIO CORPORATION  
of AMERICA**

BROADCAST AND TELEVISION EQUIPMENT  
CAMDEN, N. J.

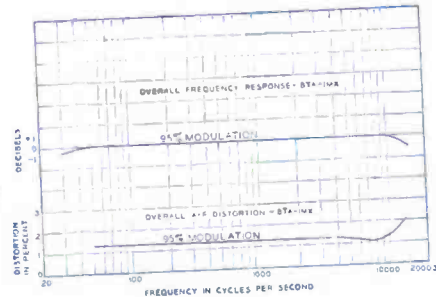

Typical BTA-1MX/500MX frequency response and distortion curves... AM radio at its clear, crisp best!

TOP QUALITY AT A NEW LOW PRICE!  
500 WATT TYPE BTA-500MX \$3995\*

1 KW Type BTA-1MX \$4685\*

\*Complete with operating tubes and crystal,  
F.O.B. Camden, N. J.

Prices subject to change without notice.



Vol. No. 89

June, 1956

# BROADCAST NEWS

*published by*

**RADIO CORPORATION OF AMERICA**  
BROADCAST & TELEVISION EQUIPMENT DEPARTMENT  
CAMDEN, NEW JERSEY

PRICE *In continental U.S.A. --- \$4.00 for 12 issues*  
*In other countries - - - - - \$5.00 for 12 issues*

## C O N T E N T S

|  |    |
|--|----|
| RCA EXHIBITS LATEST BROADCAST AND TV EQUIPMENT . . . . .   | 8  |
| ROLLINS BROADCASTING, INC. PURCHASES RCA RADIO<br>TRANSMITTERS FOR FIVE STATIONS . . . . .       | 17 |
| HOW TO CONVERT COLOR TV RECEIVERS<br>FOR VIDEO DRIVE . . . . . <i>by E. R. Klingeman</i>         | 18 |
| DUAL-CHANNEL MICROWAVE AT WSYR-TV . . . . . <i>by A. J. Eicholzer</i>                            | 22 |
| RADIO AND TV CITY, BOGOTA, COLOMBIA . . . . . <i>by Dr. Walter Duschinsky</i>                    | 26 |
| WGN-TV PURCHASES COLOR EQUIPMENT . . . . .   | 40 |
| THE NEW BK-6B PERSONAL MICROPHONE . . . . . <i>by R. E. Werner</i>                               | 42 |
| MODERN TURNTABLE DESIGN CONSIDERATIONS . . . . . <i>by E. J. Meehan</i>                          | 46 |
| NEW RCA AUTOMATIC TURNTABLE . . . . . <i>by R. H. Barnaby</i>                                    | 48 |
| THIRTEEN PRECISION INSTRUMENTS MARK RCA ENTRY<br>INTO SPECIALIZED TEST EQUIPMENT FIELD . . . . . | 52 |
| NEW POWER SUPPLY FOR TV STUDIOS . . . . .  | 53 |
| TRANSISTORIZED MICROPHONE FOR COMMUNICATIONS USE . . . . .                                       | 54 |
| COAXIAL SWITCHING AT WFMY-TV . . . . .   | 55 |
| REMOTE PHILADELPHIA STUDIO FOR WPFH-TV . . . . .   | 55 |
| NEW LIGHTWEIGHT WEATHER-MAPPING RADAR . . . . . <i>by Gordon Daggy</i>                           | 56 |

“RCA PIONEERED AND DEVELOPED COMPATIBLE COLOR TELEVISION”

*Copyright 1956, Radio Corporation of America, Broadcast & Television Equipment Department, Camden, N. J.*

PRINTED  
IN  
U.S.A.

# now a 6KW

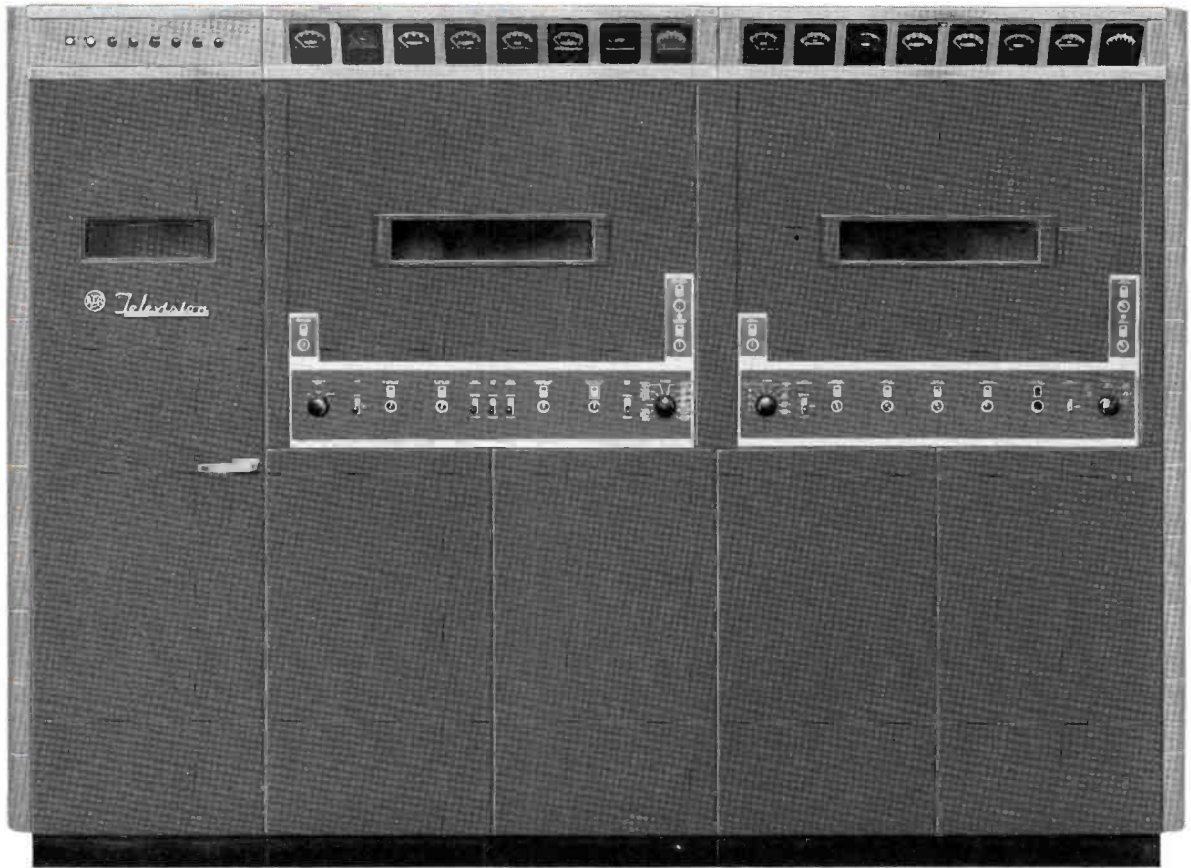

## Really space-saving!

Where floor area is at a premium, such as in "down-town" buildings, or where space must be yielded to other equipment, the TT-6AL is highly adaptable. Its design permits it to be mounted flush to a wall or in a corner of the room. Even in open space it occupies less than 63 sq. ft. When new transmitter buildings are contemplated, the space-saving TT-6AL helps to save building costs. The fact that the rectifier section can be separated and placed in an adjacent room or basement is an added feature that saves valuable operating area.

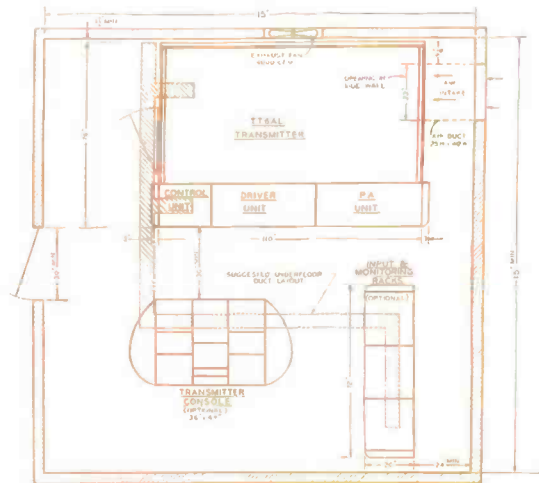

**RCA PIONEERED AND DEVELOPED COMPATIBLE COLOR TELEVISION**



# VHF transmitter!

*featuring unusual compactness and economy  
...with power reserve to drive a 25KW*

Newest and most advanced in the RCA line of low band VHF television transmitters, the completely-new-design TT-6AL is the answer to medium power low band requirements and simple increase to 25KW.

- ★ **Most Compact Floor Plan Ever Achieved** —Requires less than 63 sq. ft. of floor area (less than any 5kw). Transmitter can be placed flush to a back wall or in a corner of a room. Rectifier enclosure can be separated from transmitter and located in an adjacent room or basement.
- ★ **Design Reflects Color Experience** —Built-in linearity correction circuits and intercarrier frequency control which accurately maintains frequency separation between aural and visual carriers, assures excellent color signal transmission.
- ★ **Excellent Accessibility** —Broadband tuning controls are accessible without opening any doors. All important circuits are adjusted from front of transmitter. "Tilt-out" construction of modulator and exciter units (see photo below). Only one interlocked door for complete transmitter.
- ★ **Economical and Reliable Operation** —Uses Type 5762 air-cooled tubes, famous for long life and reliability. Complete overload protection with "grouped" indicator lights makes trouble-shooting quick and certain.
- ★ **Simple Power Increase** —The TT-6AL easily drives a 25kw amplifier. Readily converted to higher power with minimum changes.
- ★ **Thermostatically Controlled Heaters for Rectifier Tubes** —Suited to ambient temperatures as low as 0° C. Designed for attended or remote-control operation.

**plus...** many other advanced features too numerous to mention here. Get the complete story from your Broadcast Sales Representative or write for descriptive literature (Catalog Bulletin B-4005). In Canada, write RCA VICTOR Company Limited, Montreal.



Maintenance accessibility has been given particular attention in the TT-6AL. Exciter (shown tilted forward) and modulator chassis are made accessible by hinged doors and "tilt-out" chassis design. An optional spare exciter unit can be rack-mounted for added "on-air" assurance.

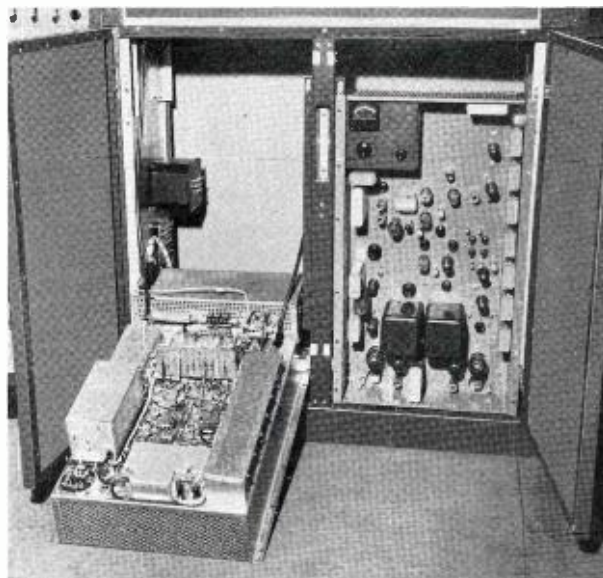

**RADIO CORPORATION of AMERICA**

BROADCAST AND TELEVISION EQUIPMENT • CAMDEN, N. J.

# New! Space-Saving

## These Advanced Features:

- Compact—requires only 10½" rack space.
- 1500 ma output at 280 volts regulated.
- High efficiency. Less power lost as heat.
- Uses only 6 tubes.
- New high-efficiency germanium rectifiers.
- Two-chassis construction for maximum flexibility.
- Only \$675 complete.

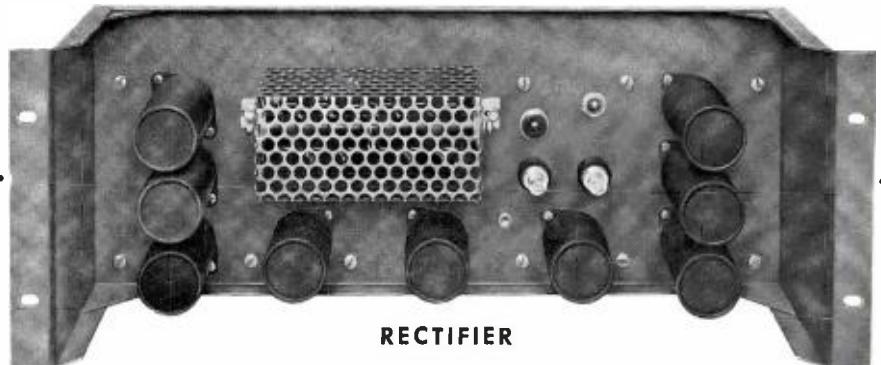

RECTIFIER

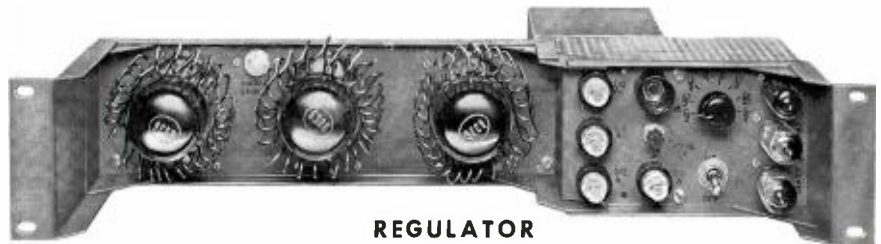

REGULATOR

## New RCA WP-15 Power Supply

highlights two-chassis construction. The rectifier chassis contains all the rectifier and filter elements. The regulator chassis contains a full complement of 6 tubes and regulating elements.

### System Simplification

By separating the functions of rectification and regulation it has made it possible to place all the rectifier chassis at one location. Regulator sections can thus be arranged in a location adjacent to equipment loads. If desired the rectifier and regulator chassis can be mounted together as a complete power supply, occupying only 10½" space.

### New Safety Features

Heavy-duty on/off switches are provided on both rectifier and regulator. Both can be remote controlled from regulator, eliminating presence of high voltage when the regulated voltage may be off. Indicating type fuses are used in ac power input line. Each regulator tube is individually fused to prevent overload in case of failure of any other regulator tubes. Indicator lamps on front and rear of both chassis warn of presence of high voltage. Entire power supply is completely covered to prevent contact with terminals carrying high voltage.

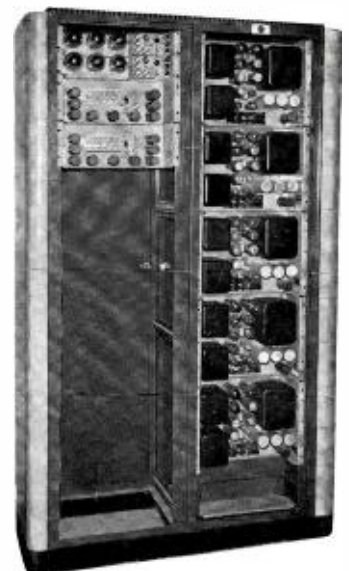





Two WP-15's (mounted at left) are equivalent to five WP-33B's.

# RCA Power Supply WP-15

Up To 70% Reduction in Rack Space  
Priced at Only 45c per Milliampere!

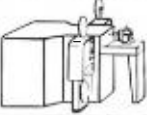
Check and Compare ! Use this chart to find out  
your own savings potential.

| EQUIPMENT USED  | PREVIOUS POWER SUPPLY AND SPACE NEEDED | POWER SUPPLY AND SPACE NOW NEEDED | WP-15 SAVING |
|---|--|-----------------------------------|--------------|
|  <p>TK-21<br/>Black and White<br/>Film Camera</p>     | 2 WP-33B's<br>28"                      | 1 WP-15<br>10½"                   | 17½"         |
|  <p>TK 11/31<br/>Black and White<br/>Live Camera</p> | 2 WP-33B's<br>1 580D<br>38½"           | 1 WP-15<br>10½"                   | 28"          |
|  <p>TK-26<br/>Color<br/>Film Camera</p>              | 2 WP-33B's<br>3 580D's<br>59½"         | 2 WP-15's<br>21"                  | 38½"         |
|  <p>TK-41<br/>Color<br/>Live Camera</p>              | 3 WP-33B's<br>2 580D's<br>63"          | 2 WP-15's<br>21"                  | 42"          |

NOTE: Comparisons are based on the number of WP-33B and 580D power supplies necessary to provide 1500 ma.

High current capacity, small size, light weight and lowest cost per milliampere make the WP-15 excellent in television broadcasting, closed circuit and laboratory applications. Your RCA Broadcast and Television Sales Representative will be glad to supply additional information. IN CANADA: write RCA VICTOR Company Limited, Montreal.



**RADIO CORPORATION of AMERICA**

BROADCAST AND TELEVISION EQUIPMENT • CAMDEN, N. J.

# RCA INTRODUCES A COMPLETELY "FAMILY" OF AUDIO

*A model to "fit" every station requirement...*

## **ALL HAVE "BUILT-IN" POWER SUPPLIES, MONITORING AMPLIFIERS AND SPEAKER RELAYS**

Here is a "family" of three consolettes that give you the widest choice of facilities ever offered. All have printed-wiring amplifiers in modular construction, providing the utmost in circuit uniformity and performance. Each model has its own "built-in" power supply (the BC-6A has two). Each has built-in monitoring amplifiers and speaker relays.

## **INSTALLATION IS QUICK, EASY...INEXPENSIVE**

The "self-contained" feature of all three models makes them easy to install. There is no need for costly external wiring and "hunting" for a place to mount such items as power supplies, monitoring amplifiers and speaker relays. The reduction of external wiring minimizes the chance of stray hum pick-up greatly improving system performance.

## **CONVENIENT OPERATION**

The low height of each consolette affords maximum studio visibility... no stretching to observe cues. Relaxed wrist comfort is provided by mixer controls on the right slant... at the right position above the desk top. RCA-developed

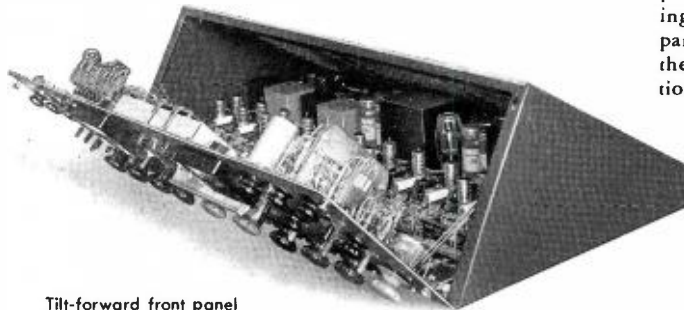

Tilt-forward front panel permits quick accessibility to mixer pads and spring contacts; makes maintenance easy.

finger-grip knobs provide convenient, positive control and are color coded for "function identity."

## **EASE OF MAINTENANCE**

Routine maintenance time is reduced by the quick accessibility of all components... easy-to-clean mixer pads, simple-to-adjust leaf-spring contacts on key and push-button switches. This is achieved by a snap-off top cover and a tilt-forward front panel, in addition to strategic placement of components.

## **RCA MATCHED STYLING PERMITS EXPANDABILITY**

Styled with 30-degree sloping panels which match previous equipments such as the BC-2B consolette, BCM-1A mixer, and compatible among themselves, a wide range of augmented facilities is possible. Paired BC-5As provide dual channel operation and extended facilities. Addition of the BCM-1A mixer to any of these consolettes is simple and provides added microphone inputs.

## **THEY WORK WELL INTO CUSTOM ARRANGEMENTS**

Simple functional design and "engineered" compactness makes any number of custom installation arrangements possible. A custom "U" arrangement of two BC-5As flanking a BCM-1A mixer is possible. The 30-degree front panels match the slope of video control equipment making them suitable for use in television studio custom applications as well as in radio.

*Ask your RCA Broadcast Sales Representative for detailed information*



**RADIO CORPORATION of AMERICA**

BROADCAST AND TELEVISION EQUIPMENT • CAMDEN, N. J.



# NEW CONSOLETTES

## BC-5A NINE INPUTS

—facilities for 4 microphones, 2 turntables, 2 remote lines, 1 network or tape. 4 mixer positions. *Built-in power supply.* Easily expanded for dual channel use by "pairing." Block building lends "custom touch" when paired with existing BC-2B's.....

**\$875\***



## BC-3B THIRTEEN INPUTS

—facilities for 6 microphones, 2 turntables, 2 remote lines, 1 network, 2 utility inputs which may be used for additional turntables, tape, or as required. Eight mixer positions. *Built-in power supply.* Easily expanded for dual channel use by pairing with BC-5A. Convenient script rack.

**\$1095\***



## BC-6A TWENTY-TWO INPUTS

—facilities for 10 microphones, 2 turntables, 2 tape, 2 film, 5 remote lines, 1 network. *Dual or single channel operation* with "split-mixer" faders. Master fader controls both channels simultaneously. Ideal for binaural broadcasting. Nine mixer positions. *Two built-in power supplies* (one for each channel) for greater reliability. Two monitoring channels, one for program monitoring and talkback, one for cueing and feeding background to studios. Convenient script rack.

**\$1750\***

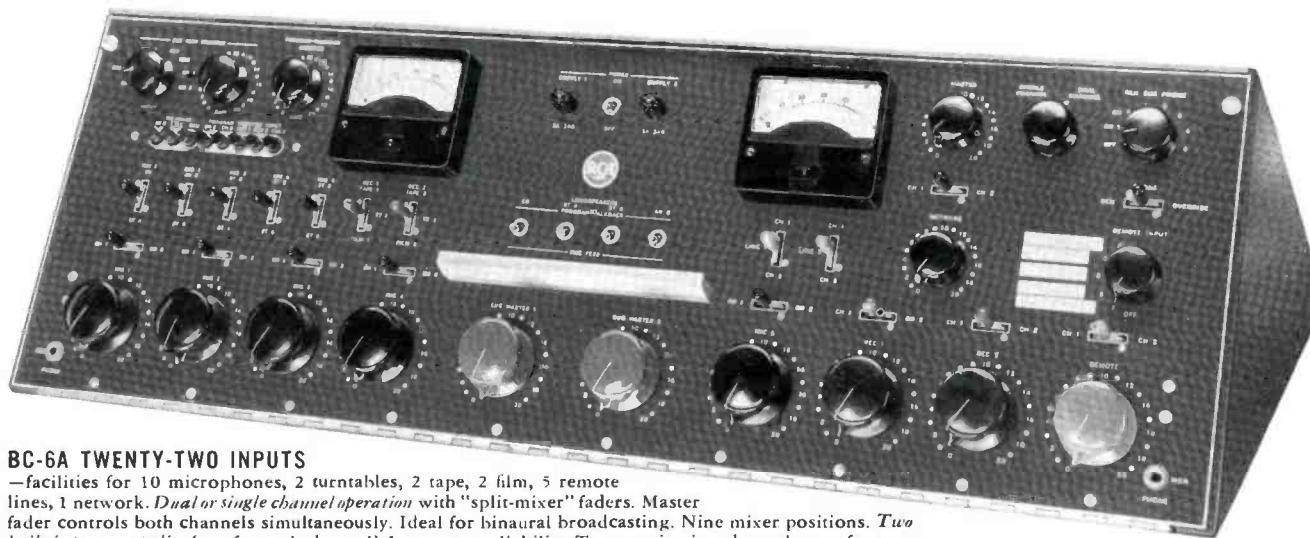

\*Less Tubes—Prices subject to change without notice.



FIG. 1. Pretty girls invited visitors to live color studio.

## RCA EXHIBIT AT NARTB HIGHLIGHTS LATEST BROADCAST AND TV EQUIPMENT

Latest broadcast and television equipments were introduced in the RCA Exhibit at the 34th Annual NARTB Convention, Chicago, Ill., April 15 to 19. More than 2000 broadcasters viewed the RCA display in the Exhibition Hall of the Conrad Hilton Hotel.

Among the major new equipments which were shown for the first time were a 6-kilowatt lowband television transmitter; a complete 50 kilowatt AM "Ampliphase" transmitter; and a new low cost 1-kilowatt AM transmitter. Also introduced were a newly designed family of audio consolettes, automatic turntable equipment, and a new high-output power supply.

In the film area several innovations were seen. A new extension lens for the 3-Vidicon Color Film Camera was demonstrated. By means of this inexpensive addition to the 3-V System, both color opaques and limited live action are now available as program material.

Many broadcasters saw their first demonstration of lenticular film. By means of this film and accompanying filter, color pictures can be recorded on a special film which is processed and handled just like ordinary black and white emulsions. Play back of this film through the RCA 3-V Color Film System yields pictures of outstanding color fidelity and resolution. Also

seen, was one of the first public demonstrations of a new fast-process, high speed color film. Techniques for handling this film were developed by KOMO-TV (see BROADCAST NEWS No. 88, April, 1956) who supplied representative news film for the demonstration.

Also featured in the exhibit was a live color studio, complete with lighting equipment; an audio display showing all the latest audio items for both radio and television stations; and a complete line of AM transmitters. A color mobile unit, designed for Smith, Kline & French Pharmaceutical Laboratories, was open for inspection at a parking lot across from the hotel.



## LIVE COLOR STUDIO FEATURES TK-41 CAMERA

For the third year a live color studio attracted the interest of visiting broadcasters. A constant source of high quality color pictures, the RCA TK-41 Color Camera was operated by visitors and models alike. To date, 25 television stations have selected the TK-41 in their move to local live color.

Color camera control equipment took on a new look this year. Only two standard cabinet racks were needed to house all equipment (including control desk and color monitor) necessary to operate the TK-41 live color camera. This radical reduction in rack space was made possible by use of a new power supply, Type WP-15. It provides 1500 ma output and requires only 10½ inches of rack space. Two of these power the live camera equipment, as compared to three WP-33B's and two 580-D's formerly required, adding up to a 70 percent reduction in rack space.

The color camera was mounted on a new television dolly, the Type TD-9. This electrically operated dolly automatically raises and lowers the camera. It is remotely controlled from the panning handle at the cameraman's fingertips.



FIG. 2. Easy to operate . . . even model takes over behind the camera.

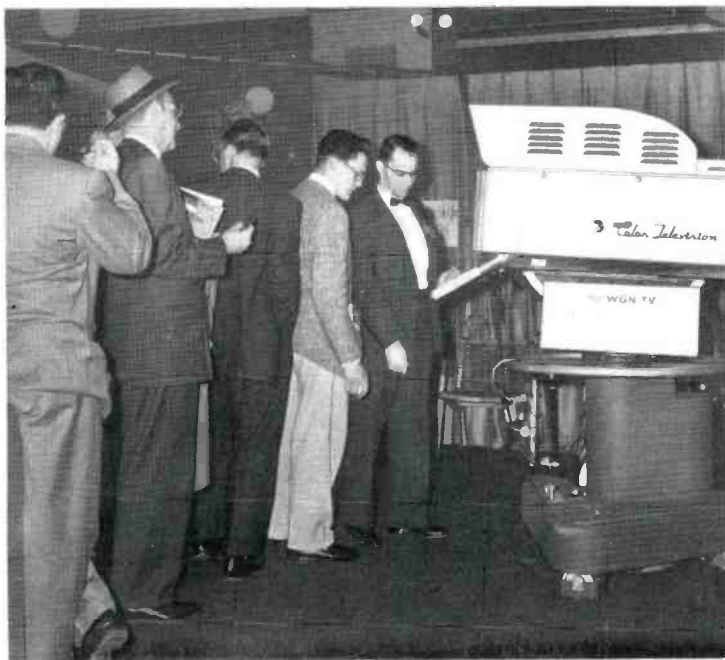

FIG. 3. Visitors try out camera operation.

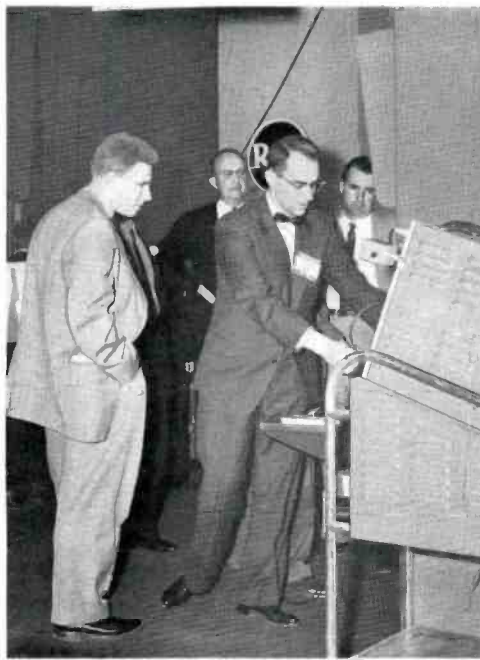

FIG. 4. Camera control procedures are explained.





FIG. 5. Simple extension lens system adapts RCA 3-V color film system for opaques and live action.

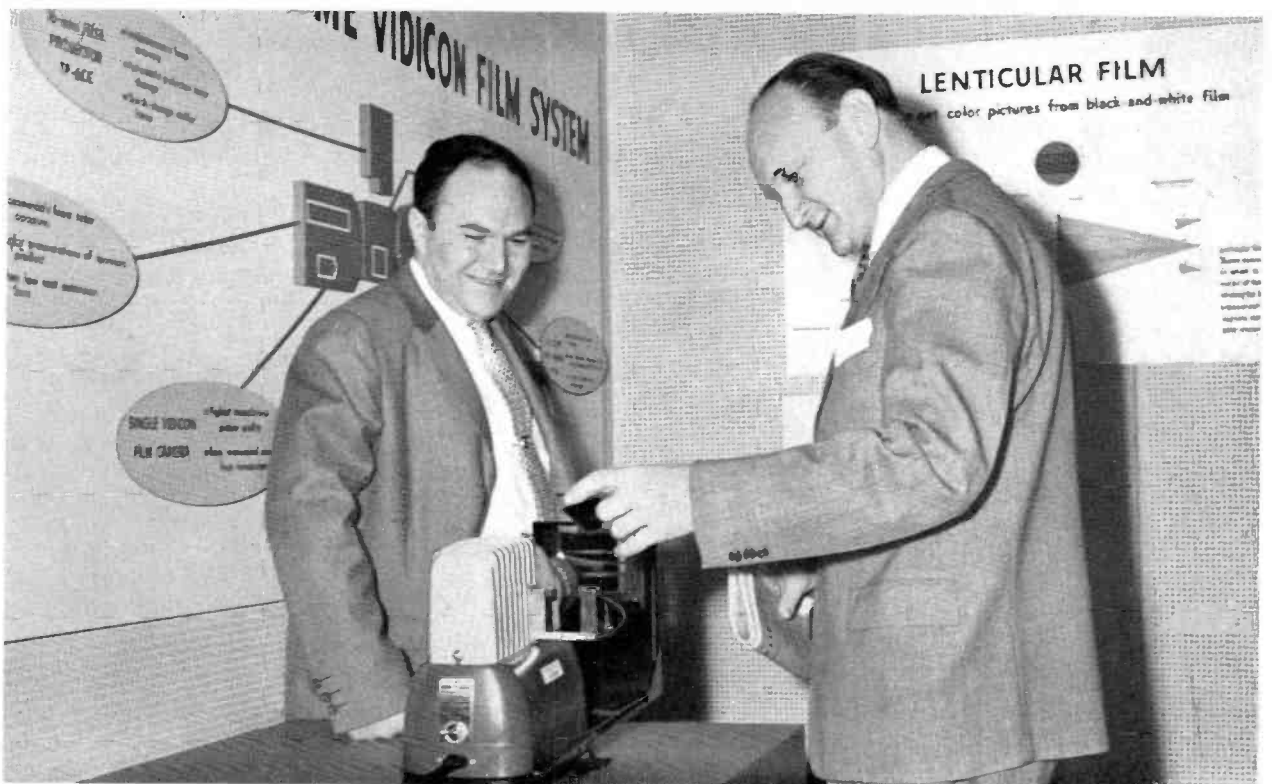

FIG. 6. Principles of lenticular film are demonstrated.

## FILM DISPLAY FEATURES COLOR OPAQUES... LENTICULAR FILM

New applications of the RCA 3-Vidicon Color Film System were demonstrated. Among these was the use of color opaques and live action made possible by an inexpensive extension lens which was fed into the TP-15 Universal Multiplexer. Examples of color artwork were shown and representative commercials, using actual products, were demonstrated to indicate the excellent picture quality and color fidelity that can be easily obtained.

In addition to facilities for opaques and live action, the complete 3-Vidicon System included a TK-26 Color Film Chain, a TP-15 Universal Multiplexer, a TP-6 16-mm Film Projector, a TP-35-mm Film Projector and a TP-3 2x2-inch Slide Projector. The TP-3 was operated through a new and unique periscope attachment feeding into the multiplexer.

A new concept in the production of color film pictures—lenticular film—was also introduced. It permits color pictures to be recorded on the black-and-white emulsion of a special film base,\* which contains a series of horizontal ridges, called lenticules. A scene is photographed through a special optical filter which divides the light into red, green, and blue images. These images are refracted at a different rate by the lenticules and three separate images are recorded upon the film. When projected back through a similar filter, these images merge to form a color picture. This system has many inherent advantages in both the production of original films and color kinescope recording. Lenticular film is much less expensive than color film and may be processed in the same manner as presently available black-and-white films. Lenticular film was shown on the 3-V System twice daily. The resulting reproduction was of excellent quality.

Control equipment for the Film System was located in latest model console housings. These housings offer new styling features—adjustable to match existing monochrome or new color equipment consoles. Only two cabinet racks were required to house auxiliary equipment for both the TK-26 Color and TK-21 Monochrome Camera Chains. This was also made possible by the new WP-15 space-saving power supply. Only two WP-15's are required to power the TK-26 and one to power the TK-21.

\* Developed by Eastman Kodak.



FIG. 7. New periscope attachment offers fourth input to the TP-15 Universal Multiplexer.

FIG. 8. Complete auxiliary equipment for RCA color-monochrome film system is housed in two cabinet racks.





## FAMILY OF NEW CONSOLETES . . . AUTOMATIC TURNTABLES SPARK AUDIO DISPLAY

Highlighted in a display of complete audio equipment for both radio and television stations were a family of three new consolettes and two new automatic turntables. Each day brought out crowds of broadcasters, as shown at the right, to see the latest audio equipments. Also included were a new transistorized remote amplifier, a complete line of printed circuit amplifiers, microphones, speakers, turntables and complete audio accessories.

The new family of consolettes provide the widest choice of audio facilities ever offered. All contain etched wiring amplifiers in modular construction. Each has its

own built-in power supply, speaker relays and monitoring amplifier.

The Type BC-5A Consolette has nine inputs on four mixer positions with facilities for four microphones, two turntables, two remote lines and one network or tape. It is easily paired or added to existing consolettes for expansion of facilities.

The Type BC-3B Consolette has 13 inputs on eight mixer positions with facilities for six microphones, two turntables, two remote lines, one network and two utility inputs. It may easily be paired with the BC-5A for dual channel use.

The Type BC-6A Consolette has 22 inputs on nine mixer positions with facilities for ten microphones, two turntables, two tape, two film, five remote lines and one network. Dual or single channel operation can be achieved by means of "split mixer" faders. Also included are two monitoring channels.

Considerable interest was shown in RCA automatic turntables, which provide a highly efficient and economical means for record handling and programming. Available in two types, the BQ-101 for fixed sequence play and the BQ-102 for random selection, the new turntables have a capacity of 60 45 rpm records (120 sides). Because of the changer's high capacity, the turntable can be loaded at relatively infrequent intervals. Also decreased handling, hence increased record life, results in a savings to the broadcaster.

FIG. 9. Complete audio equipments for radio and TV stations are displayed.







FIG. 10. Interest was high in the display of audio equipments.



FIG. 11. New family of consolettes attract attention.



FIG. 12. Broadcasters surround new automatic turntable.



FIG. 13. Newly designed 1-Kilowatt, BTA-1MX.

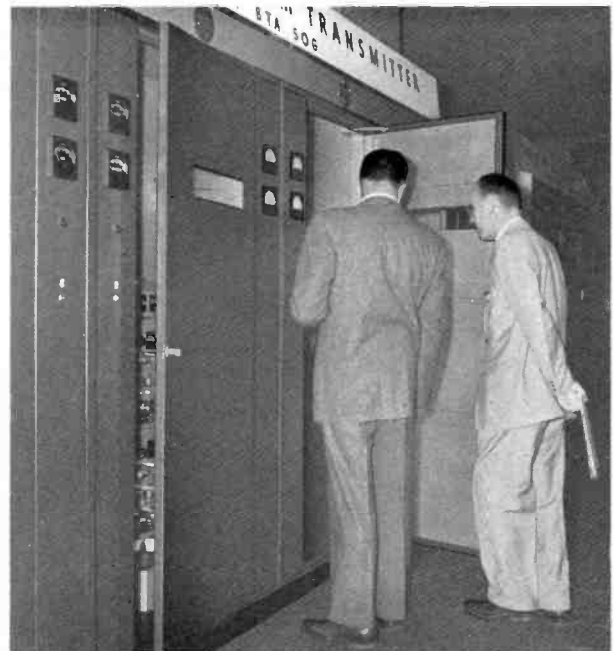

FIG. 14. BTA-50G "Ampliphase" gets a thorough inspection.

### COMPLETE LINE OF AM TRANSMITTERS



FIG. 15. RCA representative points out BTA-5H features.

The photographs on this page are representative of the complete line of RCA AM Transmitters exhibited. Shown for the first time were two new AM Transmitters—the 50-kw "Ampliphase", BTA-50G, and the 1-kw low cost BTA-1MX. The ever popular 5-kw BTA-5H was also displayed.

A new concept in AM transmitters, the "Ampliphase" cuts transmitter floor space requirements and operating costs by substantial margins. It eliminates half of presently required power tubes along with bulky components, such as modulation transformers and reactors. Contained in only four cubicles, it requires no under-floor trenches, costly watercooling systems or external blowers.

The new BTA-1MX features bi-level modulation for the ultimate in low distortion audio, space saving mechanical design and adaptability for remote control. The low initial cost of this transmitter is coupled with low tube costs (less than half the tubes used by other 1-kw's) for extra savings.

New standards for high fidelity performance have been set by the BTA-5H in radio stations throughout the country. Other features include low operating costs, bi-level modulation, thyratron control, and split-cycle recycling of protection circuits.



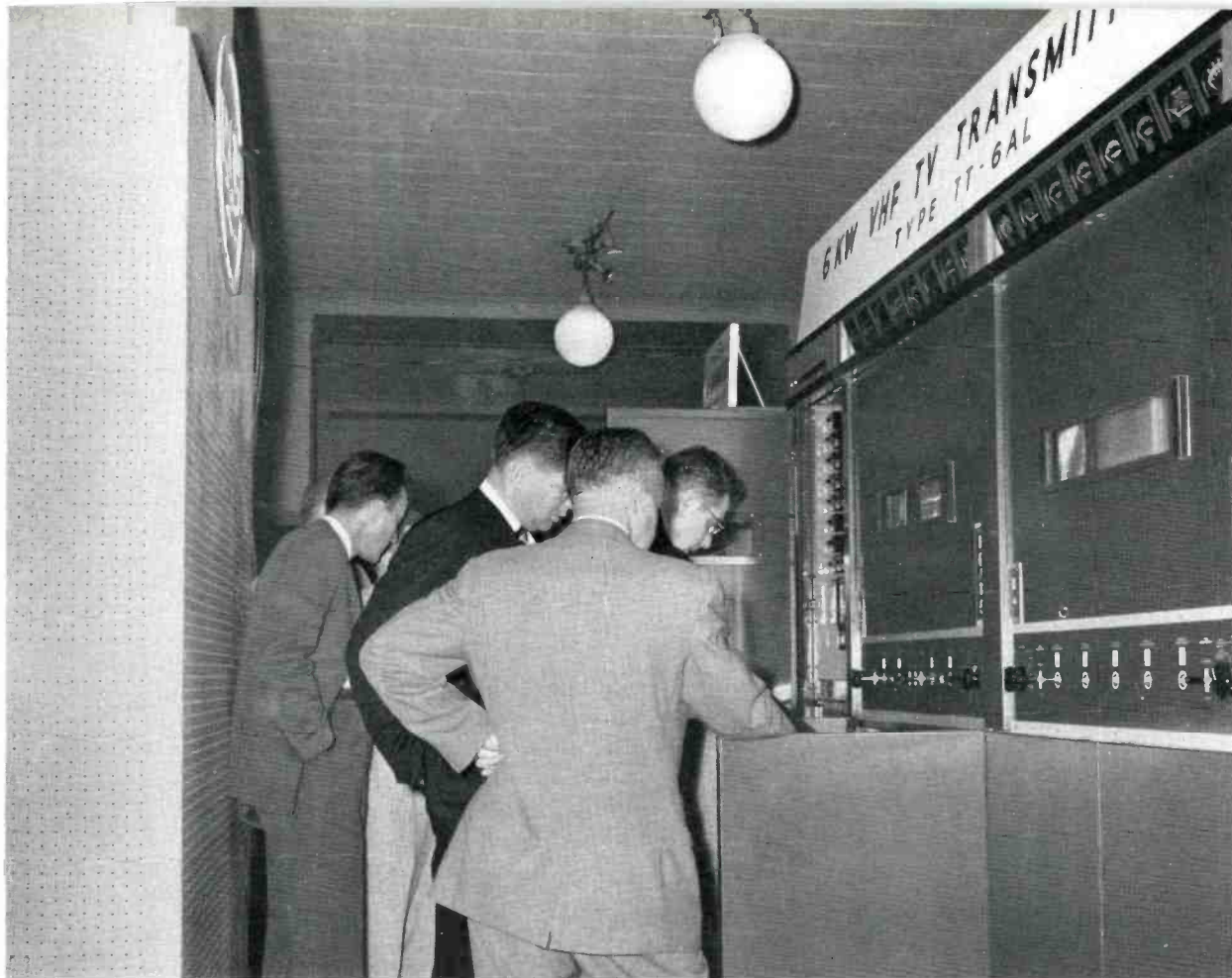

FIG. 16. Design advantages of the new low-channel TT-6AL TV transmitter are investigated.

### NEW 6-KW VHF TRANSMITTER



FIG. 17. Walk-in construction offers easy inspection and maintenance of TT-6AL.

Much interest was shown in the new RCA 6-kw lowband TV transmitter, TT-6AL. Designed for stations requiring 5 to 50-kw erp, it has power reserve to drive a 25-kw amplifier for maximum erp.

The TT-6AL requires the least amount of floor space of any transmitter in its power class. Its design permits it to be installed flush to a wall or in a corner of the room. Even in open space it occupies less than 63 square feet.

The transmitter also offers many up-to-the-minute design advantages. Linearity correction circuits built into the modulator provide for color operation without modification. Built-in control relays, monitors for operating power output controls and shunts for external metering circuits make the transmitter ready for remote control. Low cost operation is assured through the use of 5762 air-cooled tubes with a proved performance record for long life and reliability. Group indicating lights plus excellent accessibility greatly simplify routine maintenance.



## COLOR MOBILE UNIT ON DISPLAY

A complete color TV mobile unit was available for broadcasters' inspection at a parking lot adjacent to the hotel. This unit, designed for Smith, Kline & French Pharmaceutical Laboratories, will be used as a mobile control room for closed-circuit medical demonstrations.

Similar mobile units are available to broadcasters for remote color television application. The unit shown was completely equipped with two TK-41 live color camera chains, TS-11A switcher, audio console, color sync and test equipment and audio, video, camera and power cables, as well as provision for TV microwave facilities.



FIG. 18. RCA Color TV Mobile Unit for Smith, Kline & French Laboratories.

## NEW FIXED STATION MICROWAVE ACCESSORY

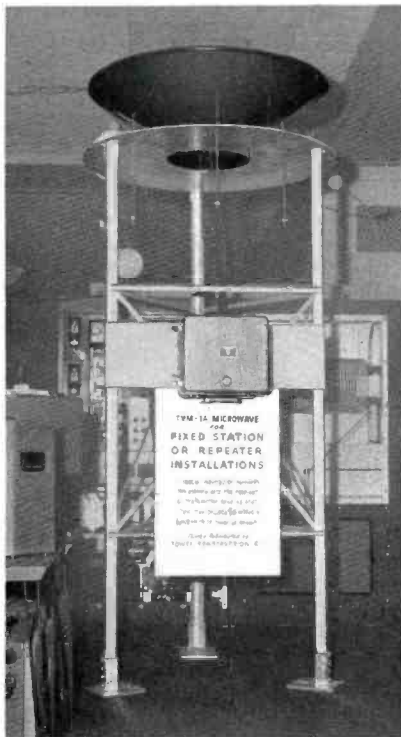

FIG. 19. Close-up of new microwave accessory for fixed station or repeater installation.

The new RCA TVM-1A Microwave System for portable STL and multi-hop use was also displayed. Featured in the display was a special equipment group for fixed station and repeater installations. This includes a short tower section plus special waveguide which connects the microwave antenna with the receiver or transmitter head, so that they may be located within a building or on the tower as pictured.

The TVM-1A microwave system offers such advanced features as: high power for extra distance and greater propagational reliability; built-in sound duplexing for

simultaneous transmission of both sound and picture; and transmitter picture monitoring, transmitter AFC, automatic radiation switch and wavemeter especially useful in the operation of unattended repeater stations. Of completely new design, this equipment is equally suitable for high quality monochrome and color operation.

The equipment is in widespread use by broadcasters throughout the country. It is employed advantageously for studio-to-transmitter links, for remote pickup and for bringing network connections to un-reached areas.

FIG. 20. Advantages of unitized construction in TVM-1A microwave are discussed.



# ROLLINS BROADCASTING, INC. PURCHASES RCA RADIO TRANSMITTERS FOR FIVE STATIONS

*Transaction Includes Two 1-kw and Three 5-kw AM Transmitters*



This 5-kw AM transmitter at the NARTB convention is one of five RCA AM transmitters purchased by O. Wayne Rollins (center), President of the broadcasting corporation that bears his name. Congratulating Mr. Rollins are W. B. Valentine (left) and E. J. Meehan, both from RCA Camden office.

Five RCA AM radio transmitters, new 5-kw and 1-kw types, were purchased by Rollins Broadcasting, Inc., Rehoboth Beach, Delaware, according to a recent announcement by O. Wayne Rollins, President of the broadcasting corporation, and A. R. Hopkins, Manager, RCA Broadcast and TV Equipment Department.

Involved in the purchase are three RCA BTA-5H 5-kw AM transmitters, two RCA BTA-1MX 1-kw transmitters and com-

plete studio facilities for Rollins' new 5,000-watt station, WIRI, Indianapolis, Ind. Mr. Rollins operates two additional 5,000-watt stations, WRAP, Norfolk, Va., and WNJR, Newark, N. J., and two 1,000-watt stations, WAMS, Wilmington, Del., and WBEE, Harvey, Ill., suburban Chicago.

The RCA 1-kw transmitter was introduced at the Chicago trade show of the National Association of Radio and Tele-

vision Broadcasters. Designed for maximum economy in initial cost, operation, and maintenance, it requires less than half the electron tubes normally utilized in comparable transmitters. Other features include bi-level modulation for optimum low-distortion of audio, space-saving design, and adaptability for remote control.

The RCA 5-kw, widely used throughout the industry, also features bi-level modulation for high-fidelity audio reproduction.

# HOW TO CONVERT COLOR TV RECEIVERS FOR VIDEO DRIVE

By **E. R. KLINGEMAN**  
Television Engineering, RCA Service Co.

Many television stations have acquired a collection of color television receivers whose usefulness is sometimes limited by the difficulty encountered in securing a high-quality signal, free from multipath effects. Studios in metropolitan areas may have difficulty in placing the television receiving antenna so as to produce a signal free from interference and reflections.

A reflection with a path length difference of  $\frac{1}{2}$ -wavelength multiples of 3.58 mc may cause cancellation of the color subcarrier, just as some reflections may cause picture-carrier cancellation and loss of sync in the receiver. This is particularly true at those stations whose studio and transmitter are combined, because of direct signal pickup by the r-f distribution system.

These receivers may be converted to dual-purpose instruments, capable of receiving a telecast off the air or from video line drive. Their usefulness is greatly increased because they may be used as an emergency or spare monitor. Cost of the conversion, including labor and materials, is usually less than \$50. The receivers to be discussed are the RCA models CT-100, 21CT-55 and 21CT-660 series. However,

many others with similar circuitry may be converted in the same way.

## Video Preampifier for CT-100 and 21CT-55

In the CT-100 and 21CT-55 receivers, a composite color video signal of approximately 5 volts peak-to-peak, sync negative, is needed at the grid of the 1st video amplifier, shown in Fig. 1, to provide adequate contrast. Because the picture bandwidth and delay characteristics are excellent, a simple video preamplifier with frequency response flat to 4.5 mc is suitable, see Fig. 2.

Since the agc circuit is not disabled, it is necessary to restore d-c at the output of the preamplifier to prevent B+ surging with changes in video level. The d-c restoration also serves to remove any hum in the signal. In connection with this circuit, since the negative voltage available in the CT-100 is -30 volts and in the 21CT-55 only -12 volts, the 0.25  $\mu$ fd 200-volt capacitor marked with asterisks, Fig. 2, must be changed to 10  $\mu$ fd, 25 volts and 33,000 ohms respectively, to provide the correct bias for the video amplifier in the 21CT-55 receiver.

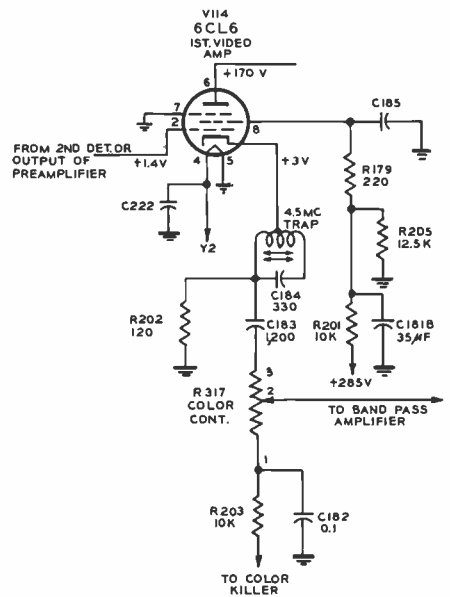

FIG. 1. Input to grid of 1st video amplifier is switched between 2nd detector output and preamplifier.

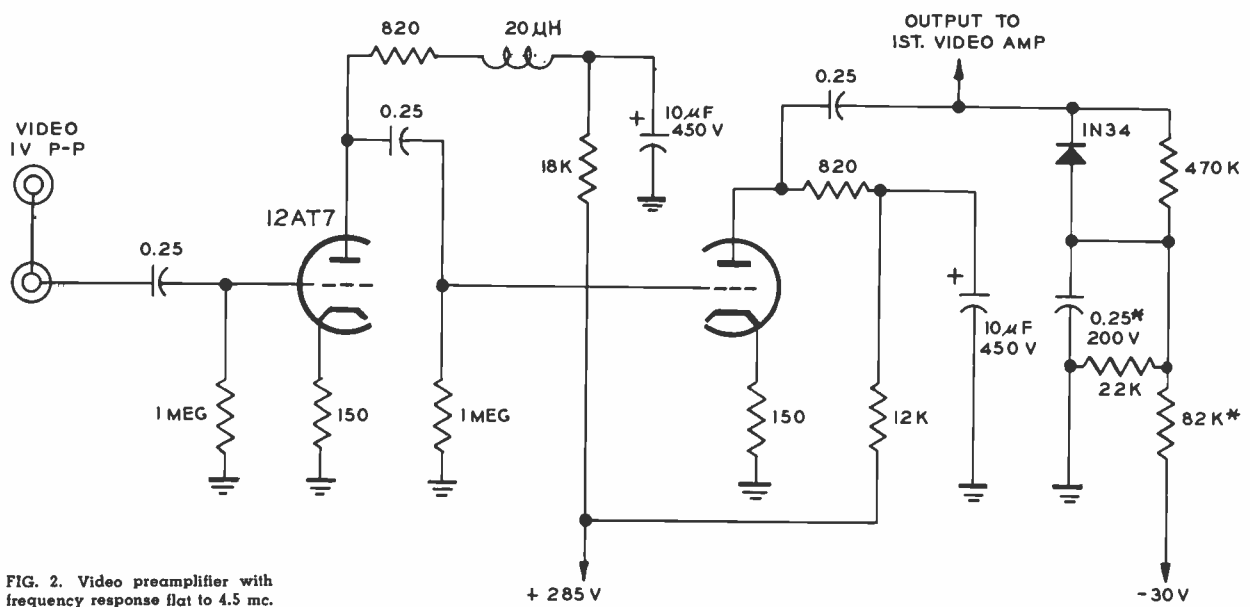

FIG. 2. Video preamplifier with frequency response flat to 4.5 mc.



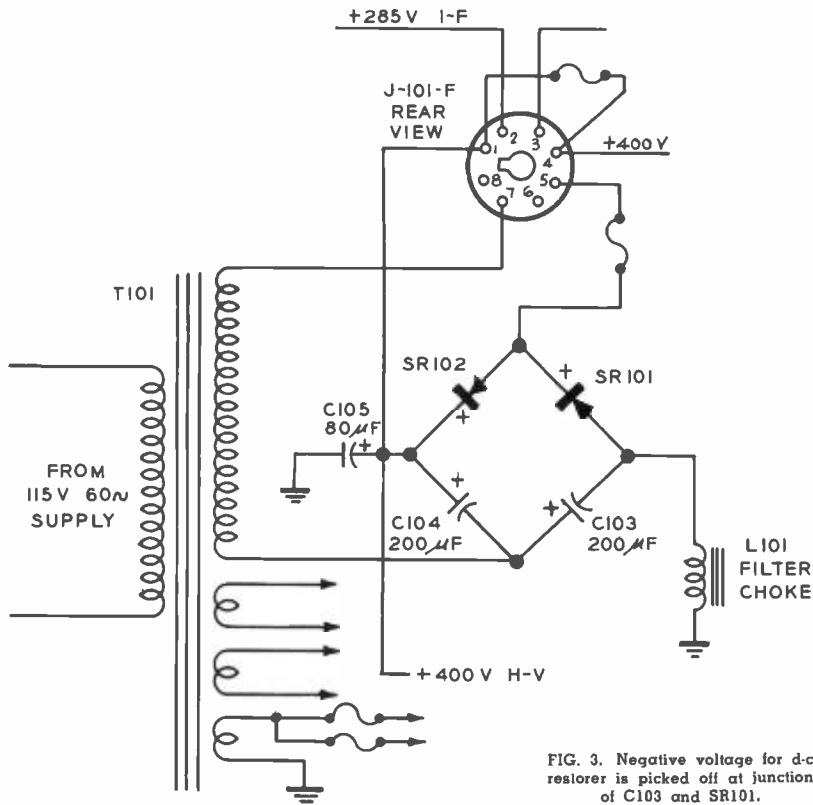

FIG. 3. Negative voltage for d-c restorer is picked off at junction of C103 and SR101.

Be careful to connect the positive terminal of the 10  $\mu$ f electrolytic to chassis ground. In either case, the negative voltage is picked off at the junction of SR101 and C103 in Fig. 3.

The preamplifier is best constructed on a sheet of aluminum 5 by 6 inches with a  $\frac{1}{2}$ -inch right-angle apron on one side, bent along the 6-inch dimension. The angle is drilled to correspond to the Parker-Kalon

screws in the corner of the high-voltage compartment and the amplifier is mounted to it as shown in Fig. 4.

#### Preamplifier Hookup

Two methods of connecting the preamplifier to the receiver are available. The first would be to install a switch, such as the Centralab No. 1462, on a small bracket near V114, the first video amplifier shown in Fig. 5. An insulated shaft is then run through the front apron of the receiver chassis. This would place the switch knob under the removable panel covering the concealed controls. This is used to switch pin 2 of V114 to either terminal F of T113 or the output of the preamplifier shown in Fig. 6.

The heater connection is made at the socket of V114, the +285-volt connection is made at the terminal board which supplies V114 and the negative voltage is obtained at the junction of SR101 and C103 in Fig. 3.

The second method uses a nine-prong miniature adaptor illustrated in Fig. 6, such as the Vector T9N or the Alden nine-pin adaptor. to make the connection to the grid of V114. Heater and ground connections are taken from the adaptor.

The +285-volt lead is fitted with a small insulated Mueller clip and attached to the No. 1 terminal of the rear section of the contrast control. A similar clip is fitted to the -30-volt lead and attached to the junction of SR101 and C103. This connection is made accessible by removing the rectifier cover. In this way, installa-

FIG. 4. The preamplifier is shown mounted in the 21CT-55 color TV receiver.

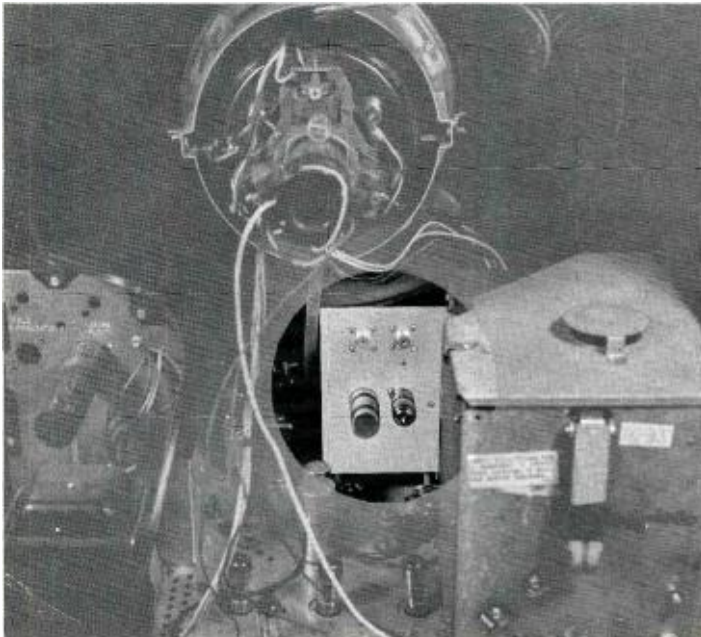

FIG. 5. Bottom chassis view of the CT-100/21CT-55 receiver. Circle (left) indicates B+ terminal; center circle locates video amplifier V114 socket and switch is shown immediately to the right.



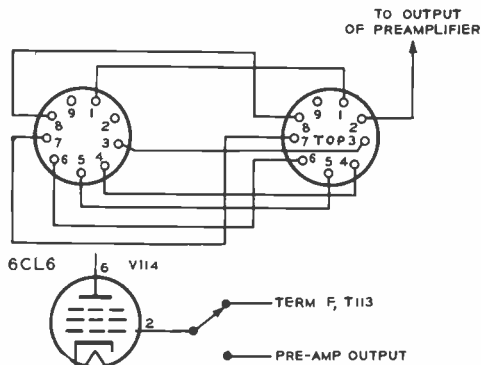

FIG. 6. Adaptor and switch used in alternate conversion method.

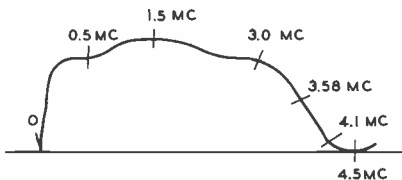

FIG. 7. Response showing 20-dB roll-off from 3.0 to 4.1 mc.

tion time is reduced to one-half hour and the chassis does not have to be removed.

#### Modification of 21CT-660 Series

The 21CT-660 series receivers use a conventional picture i-f system and the color video signal, as demodulated at the picture detector, has a 20-db roll-off from

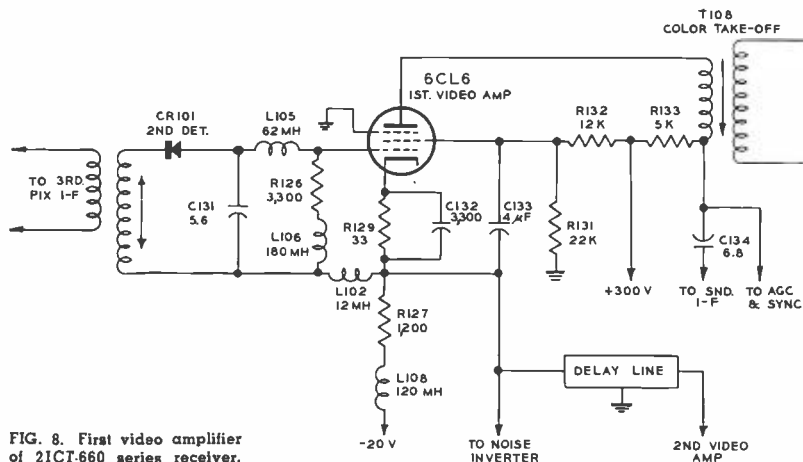

FIG. 8. First video amplifier of 21CT-660 series receiver.

3.0 to 4.1 mc as shown in the curve of Fig. 7. The first video stage in the receiver is a peaking stage, Fig. 8, with a 20-db rising characteristic from 3.0 to 4.1 mc to complement this roll-off. A signal amplitude of about 16 volts peak-to-peak, sync negative, is needed to obtain adequate contrast. Because of these conditions, a video preamplifier that will drive the receiver properly must provide the same amplitude and delay characteristics as the picture i-f in order to provide proper color reproduction and registration. Two video amplifier circuits will be shown.

The first circuit, shown in Fig. 9, may be built into the receiver chassis itself,

with the 6BQ7 socket mounted in the chassis adjacent to V110. Cut the tube socket hole next to V110 by moving the terminal strip for the delay line under one foot of L120. Install a CRL No. 1462 dpdt switch on a 2-inch "L" bracket between V110 and the socket hole just cut. Extend the shaft through the rear apron of the chassis and install the coax receptacle adjacent to it, also on the rear apron. Mount a knob on the switch shaft, label the switch positions and cut a hole in the cabinet back for the switch knob and the coax receptacle. Figure 10 shows the parts location.

Since the response of these preamplifiers is very important to proper function-

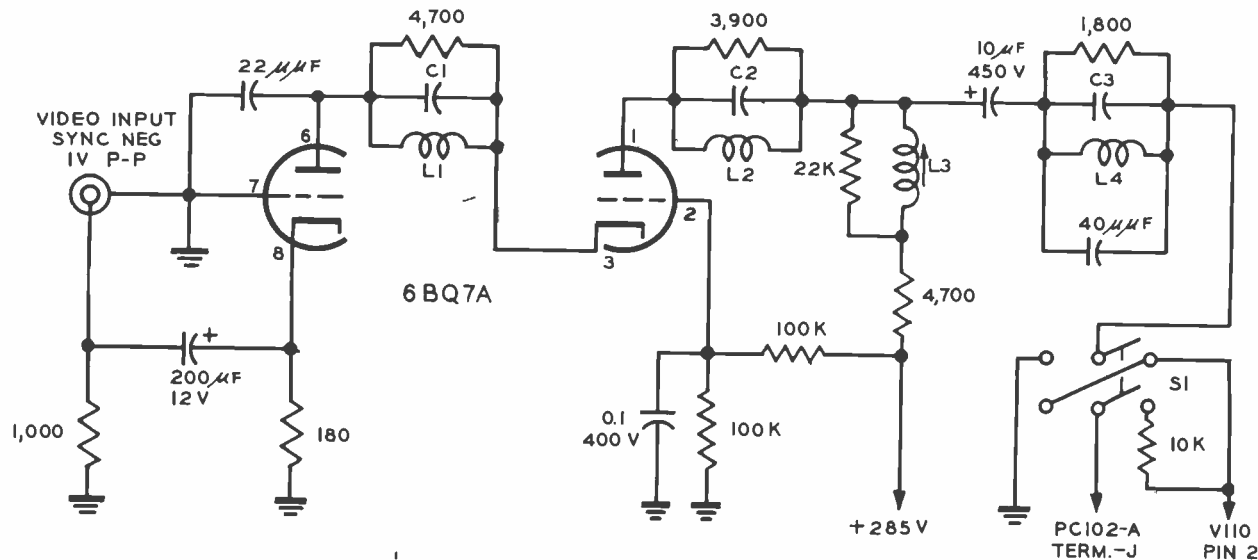

ALL RESISTORS  $\frac{1}{2}$ -WATT K = X 1,000  
 L1C1, L2C2, L4C3 - RCA STK. NO. 75251  
 L3 - NORTH HILLS COIL NO. 120 I  
 S1 - D.P.D.T. CRL. NO. 1462

FIG. 9. Direct-coupled in-phase preamplifier may be built into the receiver chassis.

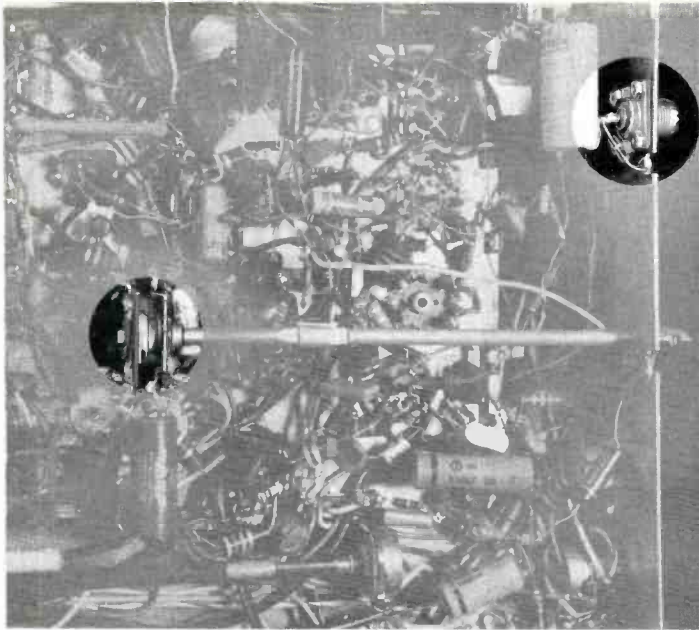

FIG. 10. 21CT-660 receiver showing video input receptacle and (right) video-rf switch.

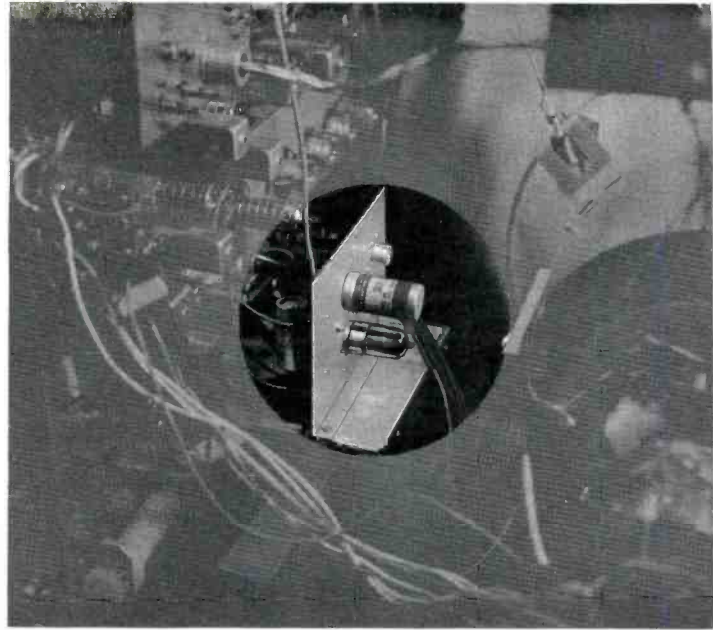

FIG. 11. Line-bridging preamplifier mounted on high-voltage compartment.

ing, it is imperative that they be checked with a sweep generator and oscilloscope after construction. Connect the oscilloscope to the junction of R127 and R129 in the receiver, Fig. 8.

Adjust peaking coil L3 in Fig. 9 for proper response around 1.5 mc. The 22- $\mu$ fd capacitor from pin 6 of the 6BQ7A to ground adjusts the attenuation at 4.5 mc and beyond. Depending upon the wiring capacitance associated with a given parts layout, its value may be changed to keep the 4.5-mc point approximately 20 db below the response at 3.0 mc.

This amplifier is a direct coupled in-phase amplifier and uses a minimum of

parts. One thing must be kept in mind, the cathode impedance of the 6BQ7A is 75 ohms, which makes it a line terminating device that must be driven from a distribution amplifier or other source of video.

The second preamplifier is a line-bridging type using a 12AT7 dual triode. The increased number and size of the components makes it impractical to mount them in the receiver chassis. Therefore, they are built on a piece of aluminum measuring 5 by 6 inches and fastened to the high-voltage compartment shown in Fig. 11. A schematic is shown in Fig. 12.

An adaptor may be used to connect the preamplifier to the receiver as shown in

Fig. 12. The wires connecting pins 2 and 9 from base to socket are removed. A 10,000-ohm  $\frac{1}{2}$ -watt resistor is installed between pin 2 on the base and pin 2 on the socket. The preamplifier output is connected to pin 2 of the adaptor socket. The heater connection is made to pin 4 of the adaptor socket. The +285-volt connection may be made on pin 5 of the r-f terminal board.

Thus, these color TV receivers may be modified for video line feed by the use of preamplifiers constructed as separate units or built into the receiver chassis itself—depending upon the permanence of installation desired.

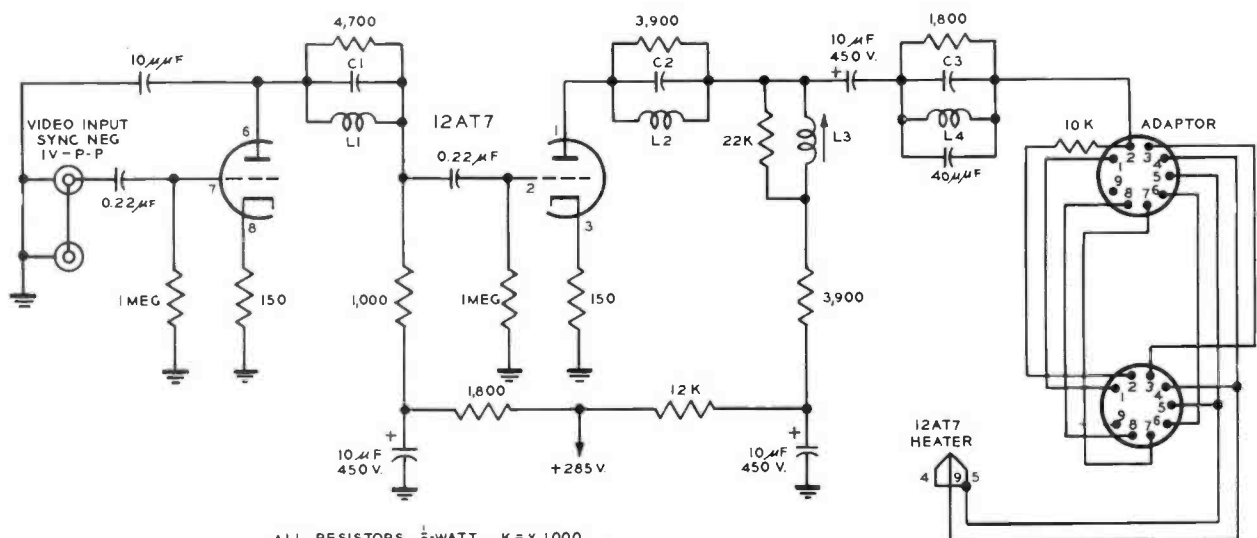

ALL RESISTORS  $\frac{1}{2}$ -WATT K = x 1,000  
 L1C1, L2C2, L3C3 - RCA STK. NO. 75 251  
 L3 - NORTH HILLS COIL NO.120 I SET AT 400 MU-H  
 ADAPTOR - HYTRON SH-29 OR VECTOR T9-N

FIG. 12. Line-bridging preamplifier —adaptor is shown at right.



# DUAL-CHANNEL COLOR MICROWAVE STL AT WSYR-TV

By **A. J. EICHOLZER**  
Chief Engineer



FIG. 1. WSYR-TV master control and STL are located on the seventh floor of the Syracuse Kemper Building.

On February 15, 1950 WSYR-TV began operation on channel 5. Among the many problems faced by the completely inexperienced staff was the lack of a local studio. All live programs originated from a studio operated by students at Syracuse University. In addition, the FCC's Sixth Report and order made necessary a shift from channel 5 to channel 3 in 1953.

Working with a staff selected from the radio operation, it was decided not to further complicate the situation at that time by installing microwave equipment to carry the programs to the transmitter site 6 miles south of the city. Accordingly, arrangements were made with the telephone company to supply such a service.

#### RCA TVM-1A Equipment Selected

As network service improved and local control room know-how and facilities expanded, and with the advent of color it was decided to install our own dual microwave equipment. A very thorough set of specifications were drawn up by our engineering staff. A number of manufacturers of equipment were invited to submit specifications and after considerable study the RCA microwave equipment was chosen.

Much credit for the novel installation belongs to the WSYR-TV maintenance department headed by Jim Carman and ably assisted by Walter Stonger who designed and installed the transmitter mounts on the roof of the seventh floor of the Syracuse Kemper Building, shown in Fig. 1.

Our mounting was to be an economical method of installing two RCA microwave transmitters without the use of tripods, tiltheads or parapet mounts. At the same time it was necessary to keep from blocking off several office windows.

#### Transmitter Mountings

Outside our seventh floor location is a building set-back making a 12-foot roof. One side is a parapet 2 feet high, the other side is the building wall going up additional floors. On the inside wall of the parapet and the building wall, 4-foot

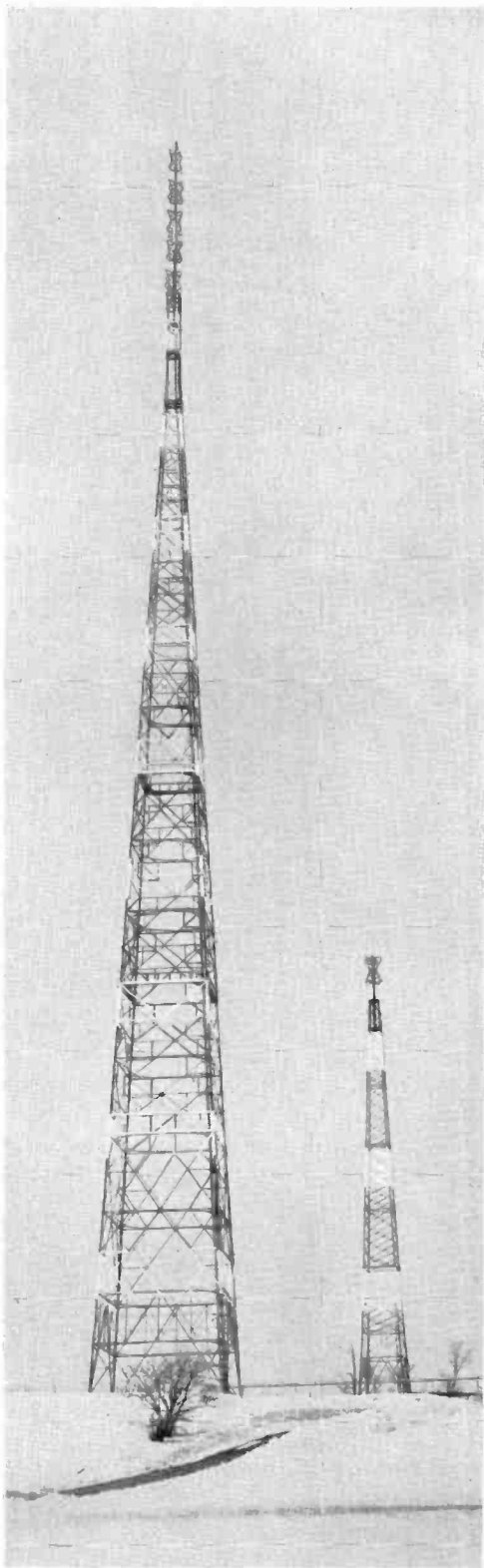

FIG. 2. View of WSYR's towers as seen from the main road.

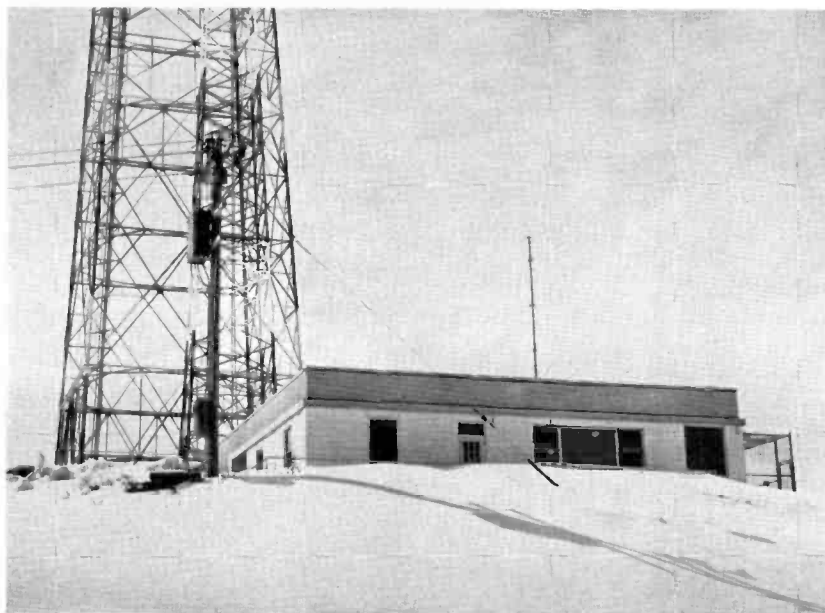

FIG. 3. This side of transmitter building faces downtown Syracuse. The large windows are used for the microwave receivers.

lengths of 3½-inch angle iron were mounted to provide a support for a piece of 10-inch channel iron, 12 feet long. These details are illustrated in Figs. 4 and 8. This channel iron is the main support for the microwave equipment. To level the channel iron, we used two screws on each end of the channel iron, making it possible to shift the channel either vertically or horizontally. Once the channel was level, one bolt through the center at each end locked it securely to the angle iron mounts.

To get the proper height for the transmitter units, two frames were made of 2½-inch angle iron, welded together to form a frame approximately 20 inches long by 11 inches high and 10 inches wide, the same size as the channel iron base. This frame is bolted to the channel iron.

To align the microwave transmitters and our pickup receiver, located at the TV transmitter 6 miles away, we used a plate measuring 20 by 11 inches as our mounting for the microwave transmitters. This plate

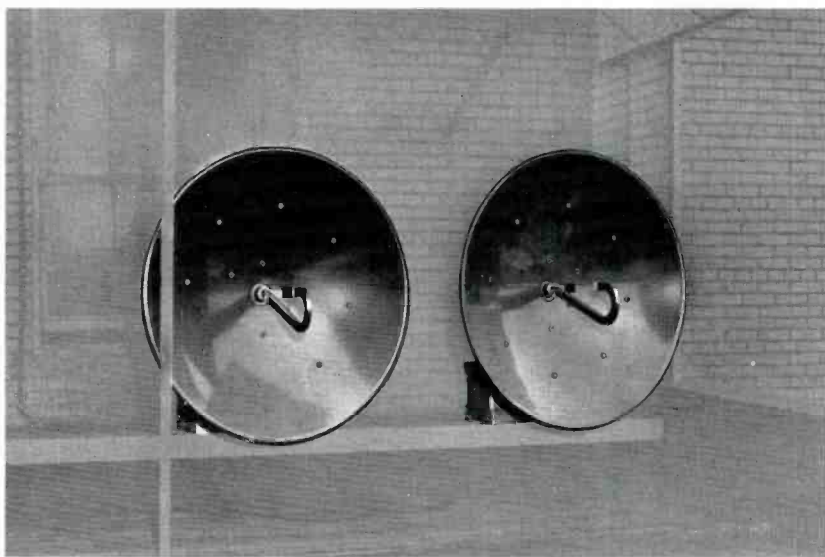

FIG. 4. These microwave transmitter dishes are mounted on the roof of the seventh floor of the Syracuse Kemper Building. A 12-foot section of 10-inch channel iron provides the main support.

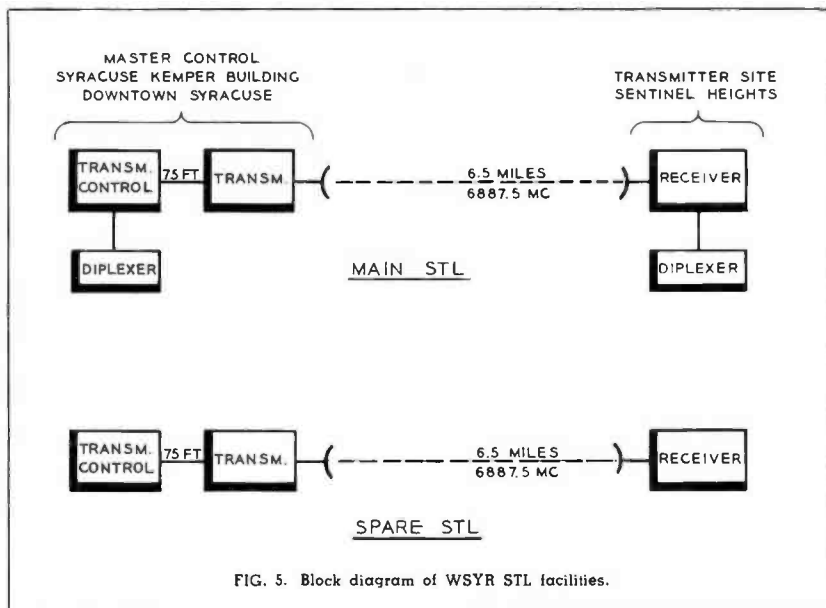

FIG. 5. Block diagram of WSYR STL facilities.

was machined with a clearance hole for the cable connector and drilled and tapped for the microwave bases. It also has three curved slots—two at the front corners of the microwave base and one at the center of the back edge of the microwave base. This plate is supported and fastened to the angle iron frame by three  $\frac{3}{8}$ -inch bolts with lock nuts which hold the bolts securely to the frame and to the plate.

By careful adjustment of these bolts and lock nuts the plate can be moved horizontally or vertically. For clearance in adjusting the lock nuts, the bolts are long enough to support the plate  $1\frac{1}{2}$  inches above the frame. The alignment was done with a T-square sighted across the mounting plate and proved to be very accurate. To provide some protection from the weather during operation and maintenance the entire installation is covered by a translucent plastic roof and the end not protected by the walls is enclosed by the same material.

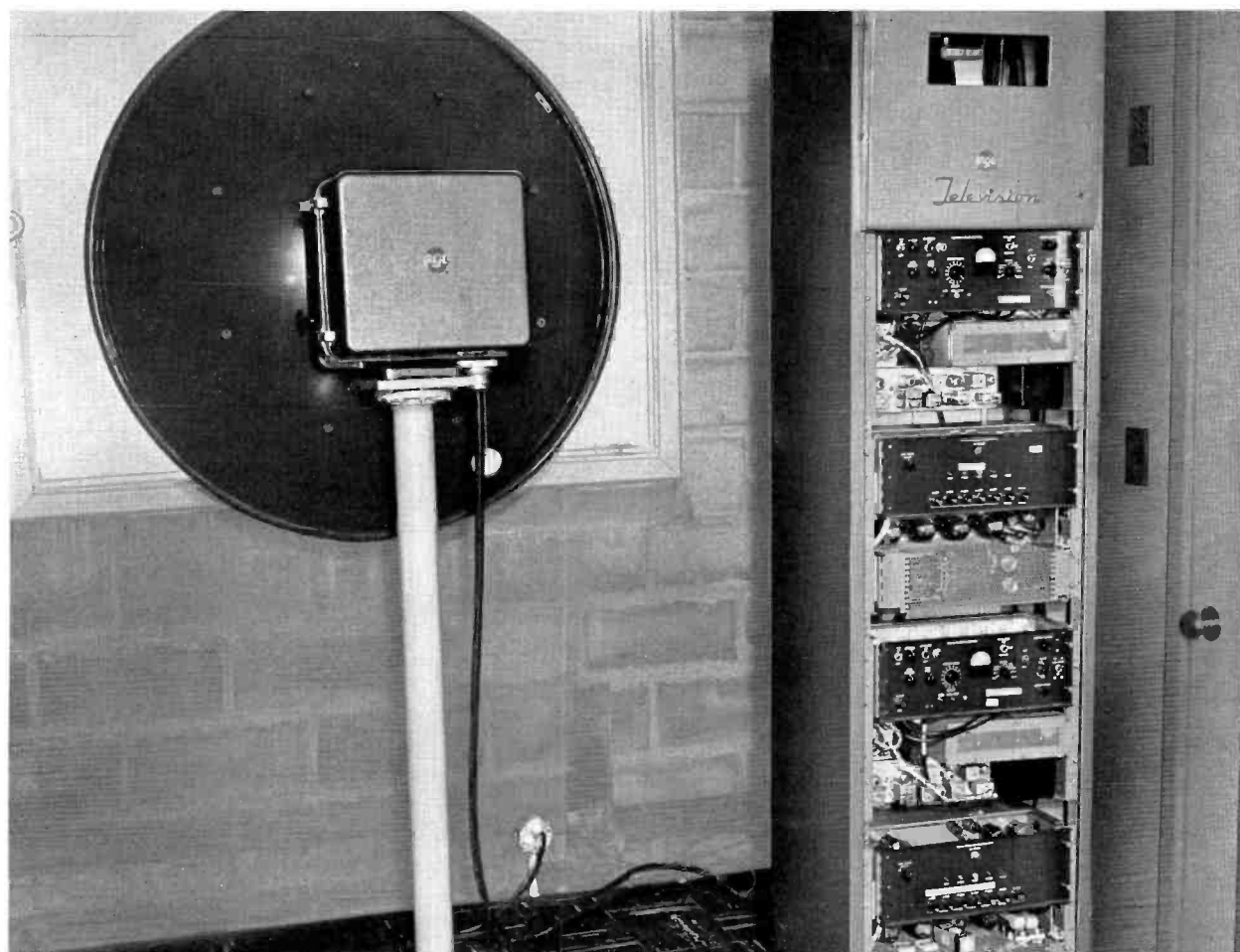

FIG. 6. Microwave receiver—mounted in front of a translucent plastic window in the transmitter building on Sentinel Heights.



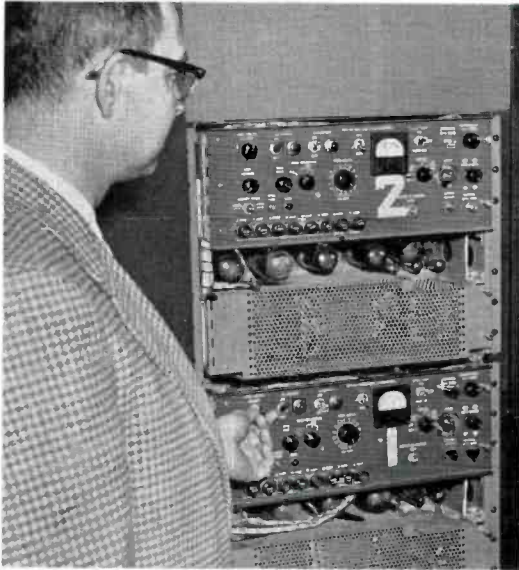

FIG. 7. Jim Carman, Studio Maintenance Supervisor, at the transmitter control unit.

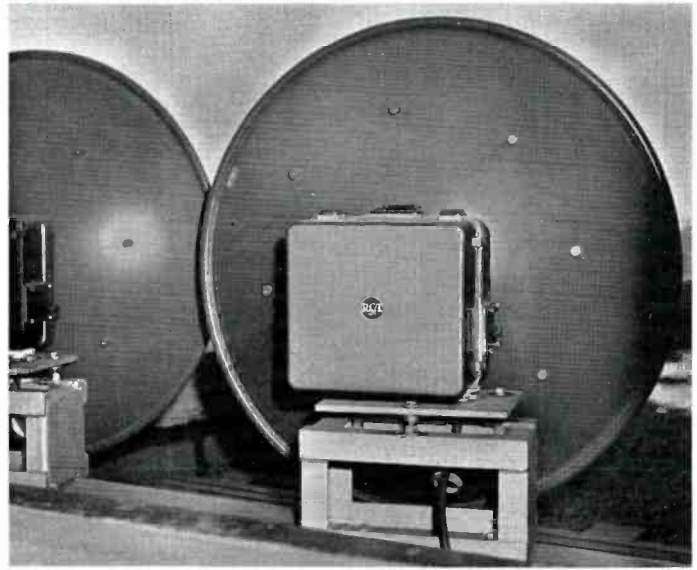

FIG. 8. Rear view of the microwave transmitter mounts.

The control and power-supply units, shown in Fig. 7, are located in the master control room on the same floor. About 80 feet of cable connect these units to the transmitter. For ease in trouble shooting and adjustment the regular transmitter talk line was extended to the transmitter location on the roof, affording direct communication at the receiver end.

#### Microwave Receiver Location

Receivers are located in the front windows of the transmitter building which

overlooks the entire city. This affords a clear path with the added advantage of having the receivers within reach of the transmitter operators.

One of the receivers, see Fig. 6, is permanently mounted in back of a translucent plastic window. Measurements show a higher signal gain than the spare unit which is mounted in the main transmitter room—illustrated in Fig. 9. The spare unit was supported by the conventional tripod.

Normally both receivers are left on con-

tinuous operation and can be switched in at the transmitter control console. The transmitters are also on—with the radiation switch of the one not in use in the off position. A transmitter-monitoring position is provided at the master-control console so that the outgoing signal from the transmitter cavity can be monitored.

To date this equipment has worked without failure and WSYR has been able to provide a dual path to complete the overall safety factor.

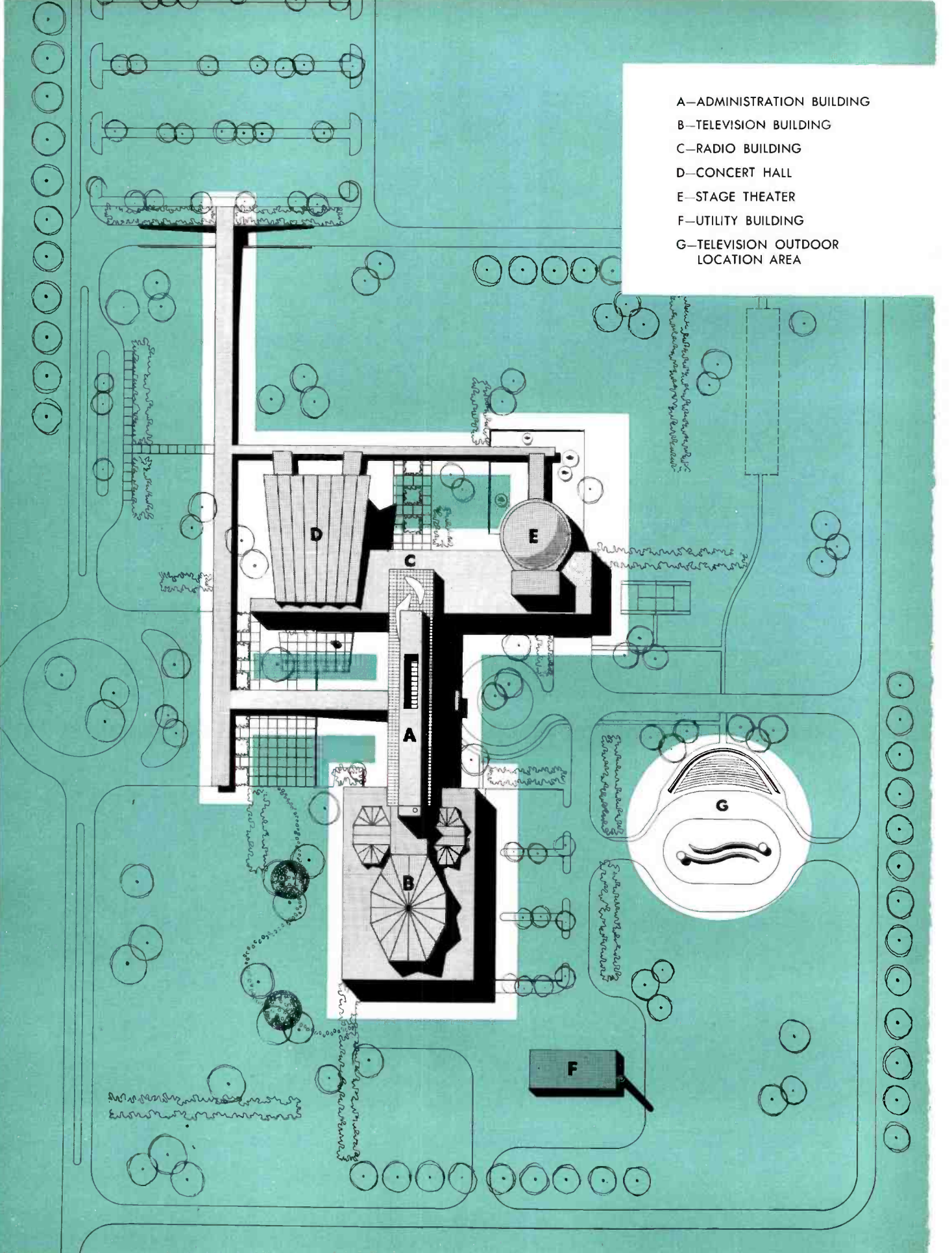

FIG. 9. Spare microwave receiver is mounted in the main transmitter room—conventional tripod allows movement for remote pickups.



FIG. 10. Albert J. Eicholzer ("Ike"), Chief Engineer of WSYR-TV.

- A—ADMINISTRATION BUILDING
- B—TELEVISION BUILDING
- C—RADIO BUILDING
- D—CONCERT HALL
- E—STAGE THEATER
- F—UTILITY BUILDING
- G—TELEVISION OUTDOOR LOCATION AREA



#### ABOUT THE AUTHOR

Dr. Walter Duschinsky's field is the planning of large scale industrial and technological projects. In Europe his work included planning and organization of complex factory plants, air transportation and broadcasting facilities. In the United States since 1947, he worked on the Telecommunications facilities for the United Nations Headquarters in New York City. He supervised the planning and construction of the first commercial TV station in Japan

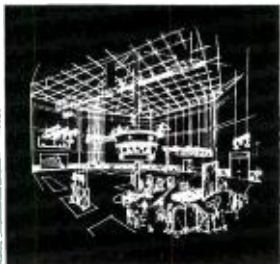

and is co-ordinator of the global communications plan called "Narcom" and "Unitel". In addition he is acting as communications advisor to the Chrysler Corporation.

At present he is setting up the Telecommunications Projects Division of Victor Gruen Associates, planners, architects and engineers. He is also Vice-President of William J. Scripps Associates, telecommunications management consultants.

# DESIGN PROJECT FOR A TELEVISION AND RADIO CITY IN BOGOTA, COLOMBIA

BY DR. WALTER J. DUSCHINSKY\*

#### INTRODUCTION

The Government of Colombia has been carrying forward a significant streamlining of its communications facilities. This includes radiotelephone and radiotelegraph, as well as broadcast and television. RCA International Division, through its distributor on engineering products in Colombia, Teletec Limitada, has been working with Colombian authorities on engineering and equipment. The project described in this article by Dr. Walter Duschinsky, an independent consultant, is in line with Colombia's general progress in communications.

How to build proper centralized radio and television facilities in a growing city

like Bogota is a problem which is all too familiar to broadcasting and television enterprises in many parts of the world. Dr. Duschinsky has a bold and practical approach to the subject and we believe that the ideas which are projected here for Bogota will prove of value to all segments of our industry in many parts of the world.

*As we go to press, the government has formally approved this project—work will begin shortly.*

—THE EDITORS

\*The original Design Project Report was also submitted to the Government of Colombia for approval by:

Raymond & Rado, New York  
Cuellar, Serrano & Gomez, Bogota  
Planners, Architects & Engineers.



Plans for a Radio and TV City in Bogota, Colombia have been submitted and the project is under consideration by the proper Government authorities. It represents the first part of a large city development based on a master plan under which headquarters for various Ministries as well as a large auditorium and library building

would be developed around the Radio and TV Center.

A basic plan was prepared which would fulfill the multiple services demanded from such a Radio and TV City. The selection of a suitable site in accordance with the existing town-planning program for Bogota, was the first task.

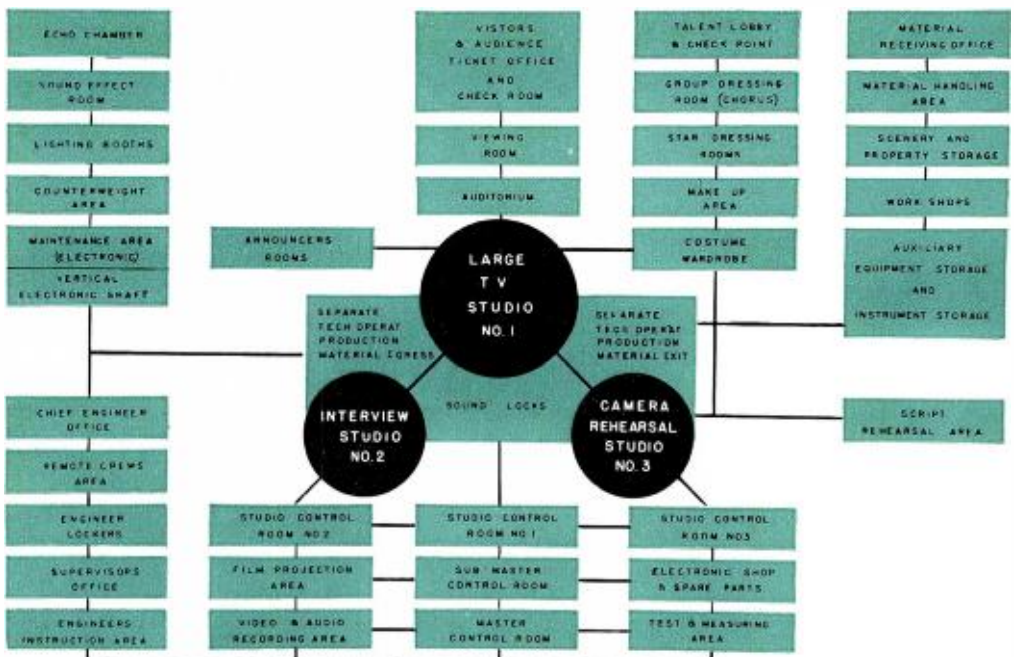

Television plant organization—direct production and operation chart.

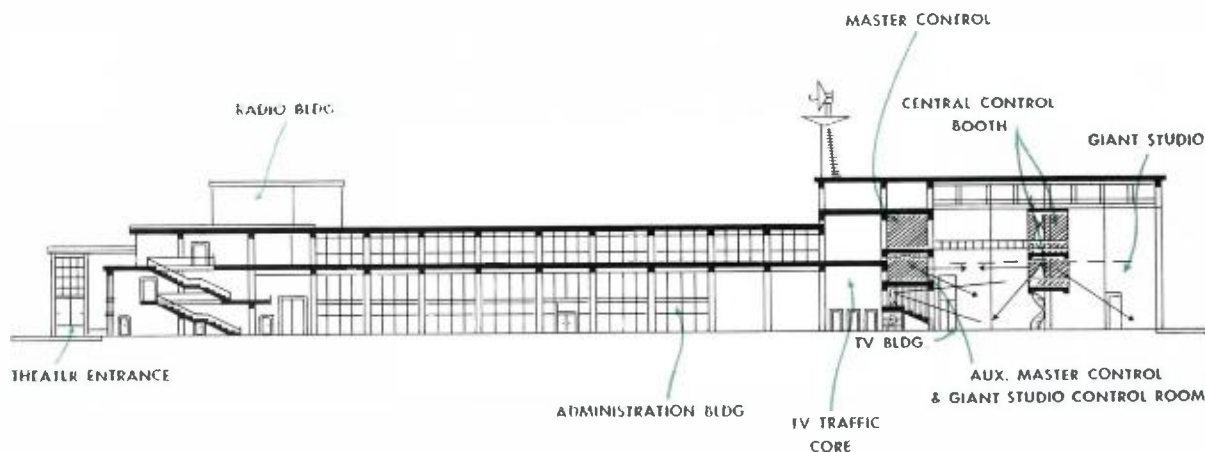

Following this, an organization chart of the planning work and the drawing up of a basic architectural conception were undertaken in that order. All three steps were based on a carefully executed study, previously completed by our organization. This study inquired into the immediate and future demands of radio and television programming as they would be operated by the Government of Colombia.

#### SITE ANALYSIS

Architectural planning and design is based to a very large degree on the character of the site. The geographical location, condition of the grounds, transportation, communications and relationship to human and material, as well as technological resources and conditions are determining factors.

The site selected is most favorable to all these elements. Situated near the Avenida Aeropuerto Internacional the site is extremely suitable for a television operation. The flat terrain and the size of the plot permits easy approaches. A generous scale for large buildings can be used.

#### SITE TRAFFIC

The study of traffic in Bogota indicates that there are ample approaches to the site, both vehicular and pedestrian. Traffic to the site is carried from all parts of the metropolis by a well distributed street web, which channels near the site through two large thoroughfares.

Although Bogota is a great cultural community, there is presently no single center of artistic activity, as such, in the city. The creation of the new Television and Radio City will encourage the establishment of a visual, theatrical and artistic center. At a later date it may be advisable to provide a specialized building for such talents and

reserve suitable grounds near the Television and Radio City site.

The site is well located with respect to desirable sight lines for microwave transmission to any future point of the TV antenna and transmitter site. Presently, the military hospital houses the 1-kw transmitter. A clear sight line between these two points is available. Tall buildings erected directly between these two points would not interfere with transmission, as the microwave path tolerance is sufficient. If, at a future date, another transmitter site is selected, no difficulty will be experienced with respect to a clear microwave path to the mountain range dominating Bogota.

#### ORIENTATION AND CLIMATE

As the total facilities are dedicated to the origination of television and radio productions, noise penetration into the operational areas must be prevented. Except for the Administration building, few or no windows will be provided. Therefore, proper orientation is primarily needed for the Administration building.

#### PLANNING ELEMENTS

Six different planning elements are distinguished; each of these has been treated separately. While five of the elements are basic, one is an auxiliary element.

These elements are:

- The Administration Building
- The Television Studio Building
- The Radio Studio Building
- The Concert Hall Building
- The Theater Building
- The Utility and Garage Building

Each element is treated separately because of its separate functional entity. Nevertheless, they must be integrated into



- |  |   |  |  |   |
|--|---|--|--|---|
| <ul style="list-style-type: none"> <li>1. Main Entrance for Administration, Production, Programming Talent and Public</li> <li>2. Lobby and Reception</li> <li>3. Elevators</li> <li>4. Janitor</li> <li>4.* Telephone Exchange</li> <li>5. Staircase</li> <li>6. Lobby and Reception for Visitors and Audience</li> <li>7. Stairway</li> <li>8. Two Passenger and One Freight Elevators</li> <li>9. Vertical Cable Shaft</li> <li>10. Production and Programming Coordination Offices</li> <li>11. Auditorium (120 viewers)</li> <li>12. Viewing Room for Studio No. 2 (40 viewers)</li> <li>13. Material Traffic Corridor</li> <li>14. Giant Studio No. 1</li> </ul> | <ul style="list-style-type: none"> <li>15. Rehearsal Studio No. 3</li> <li>16. Interview Studio No. 2</li> <li>17. Floor Manager's Office</li> <li>18. Special Effects Area</li> <li>19. Sound Lock Rehearsal Studio</li> <li>20. Sound Lock Interview Studio</li> <li>21. Quick Change Dressing Rooms</li> <li>22. Talent Lounge</li> <li>23. Material Storage and Handling Area</li> <li>24. Shipping Dock</li> <li>25. Shipping Office</li> <li>26. TV Workshop</li> <li>27.-28. Spraying, Finishing &amp; Model Shop</li> <li>28.* Special Equipment Storage</li> <li>29. General Storage Area</li> <li>29.* Property Storage</li> <li>30. Talent Stairways</li> <li>30.* Engineers Stairways</li> <li>31. Lobby</li> </ul> | <ul style="list-style-type: none"> <li>32. Instrument Studio No. 1</li> <li>33. Instrument Studio No. 2</li> <li>34. Sound Locks</li> <li>35. Instrument Studio Control Room No. 1</li> <li>36. Instrument Studio Control Room No. 2</li> <li>37. Announcers Room</li> <li>38. Sound Locks</li> <li>39. Conference Studio No. 3</li> <li>40. Voice Studio No. 4</li> <li>41. Voice Studio No. 5</li> <li>44. Sound Lock for Control Area</li> <li>45. Voice Studio Control Room</li> <li>46. Conference Studio Control Room</li> <li>47. Voice Studio Control Room</li> <li>48. Announcers Room</li> <li>49. Entrance to Radio Building</li> <li>50. Entrance to Concert Hall</li> <li>51. Lobby Concert Hall</li> <li>53. Auditorium</li> </ul> | <ul style="list-style-type: none"> <li>54. Concert Stage</li> <li>55. Musicians Egress</li> <li>56. Concert Hall Stage Wings</li> <li>57. Musicians Room</li> <li>58. Instrument Storage</li> <li>59. TV Camera Runways</li> <li>60. Connecting Corridor</li> <li>61. Stairway</li> <li>62. Entrance to Stage-Theatre</li> <li>63. Lobby</li> <li>64. Auditorium</li> <li>65. Orchestra Pit</li> <li>66. Stage</li> <li>67. Stage Car Area</li> <li>68.-69. Stairway to Orchestra Pit and to Second Level</li> <li>70.-71. Talent Dressing Room</li> <li>72. Costume Wardrobe</li> <li>73. TV Camera Runway</li> <li>74. TV and Radio Control Booth</li> <li>75. Stage Equipment Room</li> </ul> | <ul style="list-style-type: none"> <li>76. Material Storage</li> <li>77. Loading Dock</li> <li>78. Stairway</li> <li>79. Talent Dressing Rooms</li> <li>80. Corridor</li> <li>81. Engineers Entrance</li> <li>82. Material Unloading</li> <li>83. TV and Radio Remote Units</li> <li>84. Remote Unit Shop</li> <li>85. Crew Room</li> <li>86. Service Truck</li> <li>87. Lavatories and Wash Rooms</li> <li>88. Caretakers and Guards Quarters</li> <li>89. Electric Switchboard Room</li> <li>90. Auxiliary Diesel Units</li> <li>91. Incinerator, Boiler and Auxiliary Equipment</li> <li>92. Operational Personnel Parking</li> <li>93. Engineering Personnel Parking</li> </ul> |
|--|---|--|--|---|



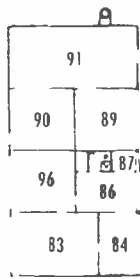

92

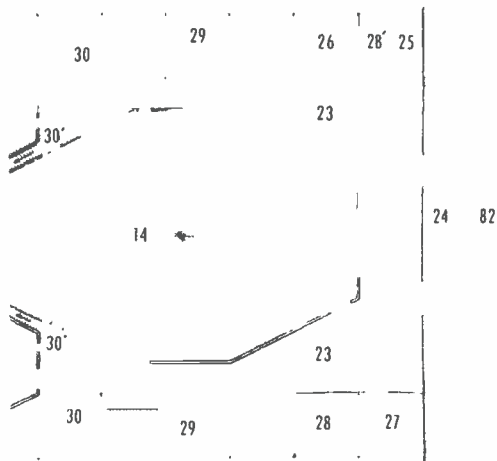

Ground floor plan of the TV and Radio City.

one planning unit. In the execution of their functions they will fulfill one purpose—to act as originating center for broadcasts and telecasts and transmission to a local and a national audience.

Before discussing the different elements, a few planning axioms for the type of buildings in question follow:

- (1) Radio and special TV buildings are most efficiently and economically operated at a ground floor level plan.
- (2) Wherever enough space is available, a flat site is preferable.
- (3) All operational areas in TV should be located on the ground floor level, such as studios, scenery and property storage, workshops and material handling areas.
- (4) All technical studio control facilities in TV should be located at the second highest level.

- (5) All technical areas for the TV operation should be organized in the form of a center core. This will permit economical and efficient operation and will guarantee economical installation of equipment due to short cable runs. Ease of technical maintenance will thus be assured.
- (6) Unhindered traffic for each element should be provided—internally, externally, horizontally and vertically, both for materials and personnel. An integrated traffic pattern throughout the building at the different levels should also be achieved.
- (7) Flexibility and expansion both in quantity and divisions in a predetermined direction must be planned for.
- (8) While all structures will be one integrated unit, they must be able to operate separately if warranted.

The TV and Radio City has been planned in accordance with the above axioms.

## ORGANIZATION

The organization charts were prepared that represent the basic arrangement under which all individual elements will function as one coordinated unit. A clear subdivision has been made between the executive, production and operative management as well as for the separate organisms such as: the TV plant organization and its direct and indirect production operation; and the entertainment facility organization, which combines the Concert Hall and the Dramatic Stage.

These organization charts are an indication of three basic but different subjects. They act first of all as organization charts of the personnel; secondly as a general organism of facilities subdivision and planning; and thirdly as a guide to a general and specific traffic pattern, for personnel and materiel.

All elements can work independently of each other, but are planned as one fully integrated unit. Careful attention has been

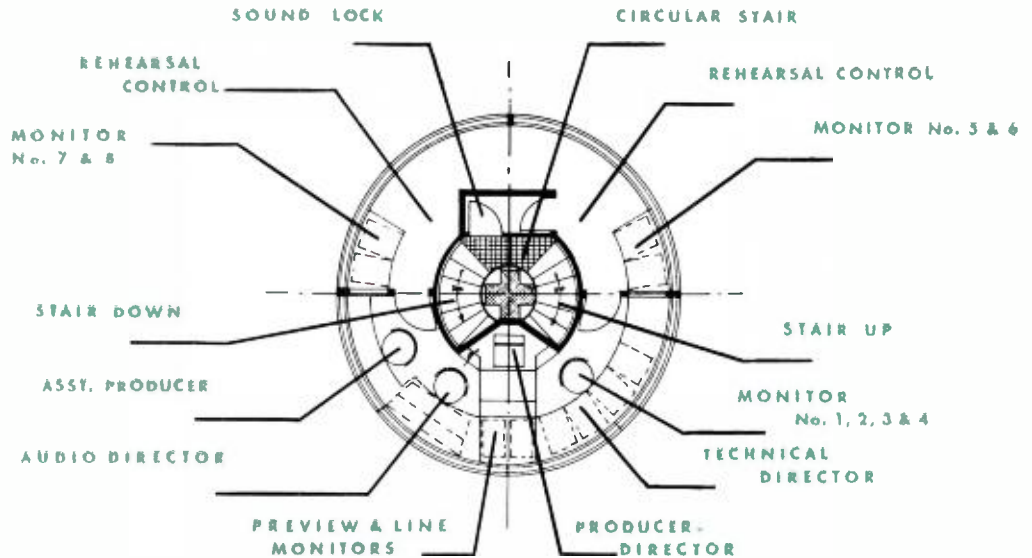

Central rehearsal control booth in giant studio.

given in the organization to coordinate inter-related functions of adjacent elements. A typical example is the close relationship between the Radio building and the Concert Hall, where the instrument studios for radio pickup are in close proximity to the concert hall instrument-rehearsal areas. This permits many areas to act in a dual capacity.

The relationship between the Radio and TV buildings has been carefully analyzed and both master control rooms are at the same floor level. The planning for integration of technical facilities has been given a high priority in the general layout.

#### ADMINISTRATION BUILDING

The Administration building will serve as shelter for the administrative and executive users of the television and radio department and administration of the Concert Hall and Dramatic Stage. The executive and administrative offices include departments for general program planning.

Well organized circulation and inter-office communications in the building will permit the Director General, in charge of the Radio and Television Division, to have at call all top department executives for conferences, interviews and operational matters. The close liaison between the executive office and its operational TV and radio divisions is a necessity. The Radio-TV City building will act as the master origination point for TV and radio programs for the Republic of Colombia in a national network and, therefore, will be its master unit.

The main entrance for the executive, administrative, clerical and production staffs, and the reception and check area for the general public and talent is the lower level of the Administration building. While the Administration building has its own vertical traffic core with stairways and elevators, the TV building center core is in close proximity and in an emergency can act as general egress.

The Administration building occupies four floors: the first level catering to the reception and checking of personnel. A separate corridor at this level permits the passing of bulk materials from one element to the other under cover. Along this corridor are production offices needed in conjunction with TV and radio production operated in adjacent elements at the same floor level.

The second level of the Administration building will be occupied by all programming and indirect production offices for TV and radio, as well as the entertainment facilities. It will include a broadcast and telecast program office, coordinated with the entertainment facilities and working on a tight time schedule in the general programming. Scheduling, continuity and traffic will be handled on this floor, and in the future TV and radio network operations.

The third and highest level shelters all top executives as well as clerical offices. The Director General, his secretarial as well as his other staff, and the secretary-typist pool will be located here. Conference rooms and some dining facilities will

be provided at the air conditioning plant level on the fourth floor. The building is designed to permit the addition of two more floors for future expansion.

#### TELEVISION STUDIO BUILDING

The Television Studio building is planned as a ground level operation with studio and camera-rehearsal areas occupying roughly 50 percent of the total floor area. The arrangement of the studios, surrounded by a traffic area, will permit noise isolation at relatively low construction costs. At the same time, extreme care has been taken to separate each studio to prevent the use of expensive double-wall isolation.

Scenery and property handling, as well as storage are adjacent to the studio areas. The internal traffic at this level has been studied to provide separation of visitors viewing productions from the auditorium of a giant studio, as well as observation from the viewers' room adjacent to the interview studio.

Technical facilities operate separately and feed directly into the studio and camera rehearsal areas. A separate staircase leads to the group and star dressing rooms at the higher level, but quick-change dressing space is provided near the studios at the ground floor level.

The materiel traffic for sets, scenery, properties and equipment of all types is in direct line with the studio doors. Space is of double height inside the handling and workshop areas to permit easy movement of large and bulky objects. The highly organized traffic at this level relates to the complex pattern of production. The finalized studio shape as well as the total arrangement of the TV facilities are functional envelopes of these complicated instrumentalities.

The first floor, with the exception of the auditorium and a smaller viewing room, includes all areas directly engaged in a live talent studio production. Areas such as the

Giant studio (below), smaller studio and camera rehearsal area in the Television building occupy about 50 percent of total floor area.

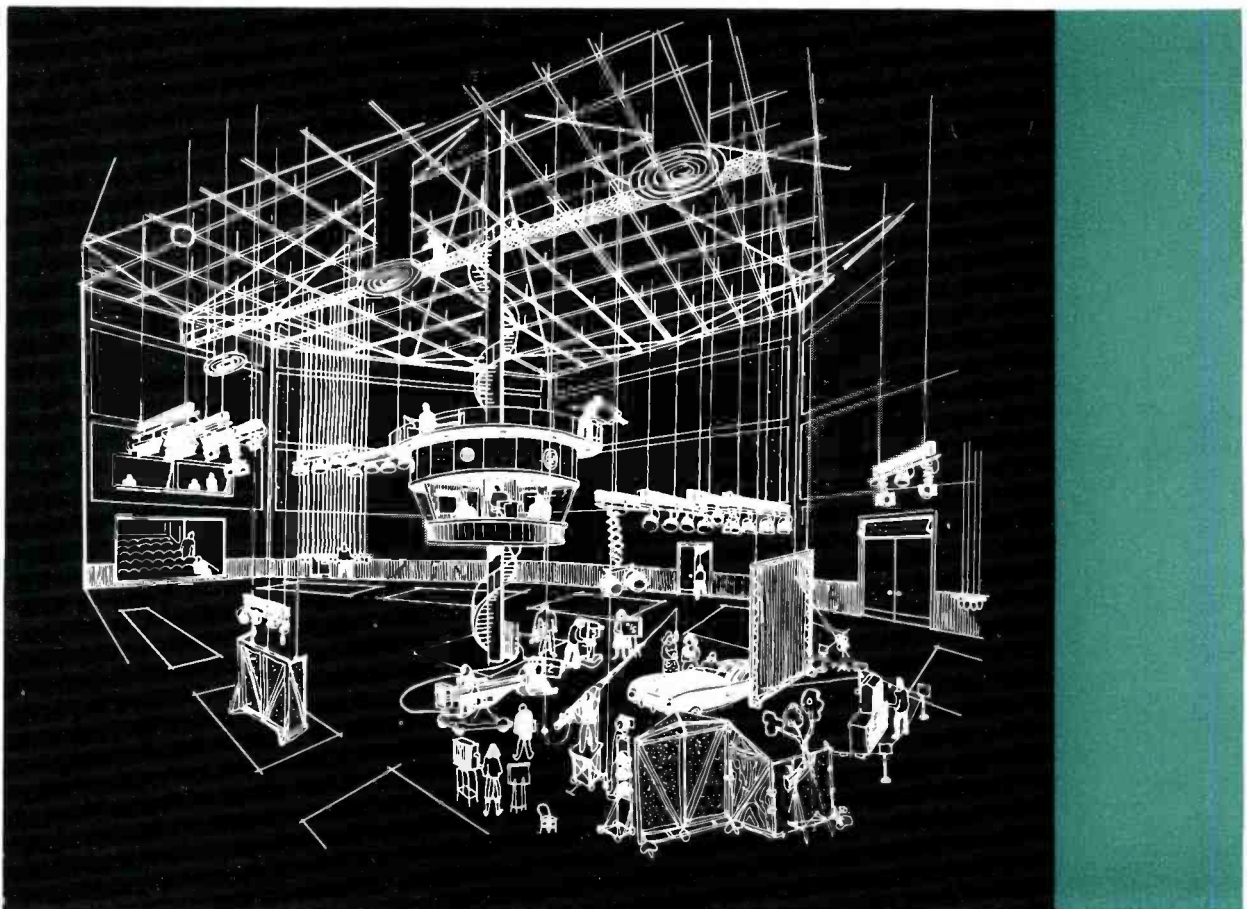



loading dock, the scenery storage and workshop and handling areas are in direct contact with the operational parts. At the same time, close integration permits the supply of these materials through a central corridor to all other individual elements such as the Radio building, the Concert Hall and the Theatre.

### RADIO STUDIO BUILDING

The Radio Studio building has been planned as a fully integrated element with all studios arranged at the ground floor level. The availability of a large plot permits such planning which will greatly reduce investment in a multi-story radio studio structure with its separate foundations and expensive structural treatment.

The Radio Studio building design complies with good acoustical-engineering practice in supplying separate floating floors for each studio with double and triple partitions between the individual studios.

The technical areas, such as studio control rooms and announcers' booths, are grouped to permit duplicity of control functions, as well as short audio cable runs and ease of equipment maintenance. The concentration of technical personnel on one level will permit economy of operation. Sound locks and sound corridors are provided and noise separation from the other buildings is achieved.

At the ground floor level, a large lobby permits visitors and talent to circulate. A separate stairway to the second level has been provided, where the main talent facilities are located. These facilities include rehearsal rooms as well as dressing room facilities. Audition studios and direct radio-production offices are located at this level.

The third floor level is reserved for the technical areas. It can easily be reached by the audio technicians from the first floor using the adjacent elevators in the Admin-

Technical core at second floor control room level in the Television building.

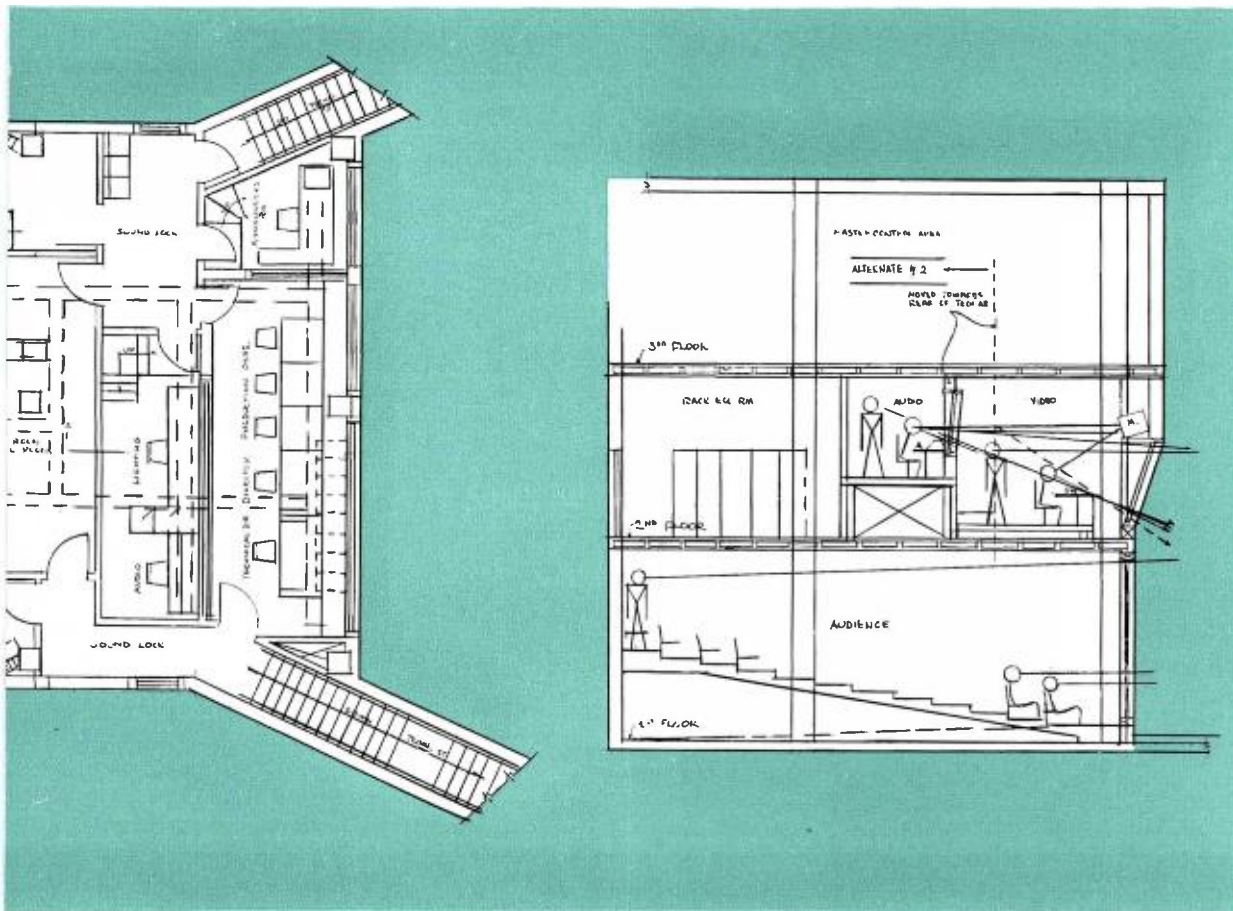

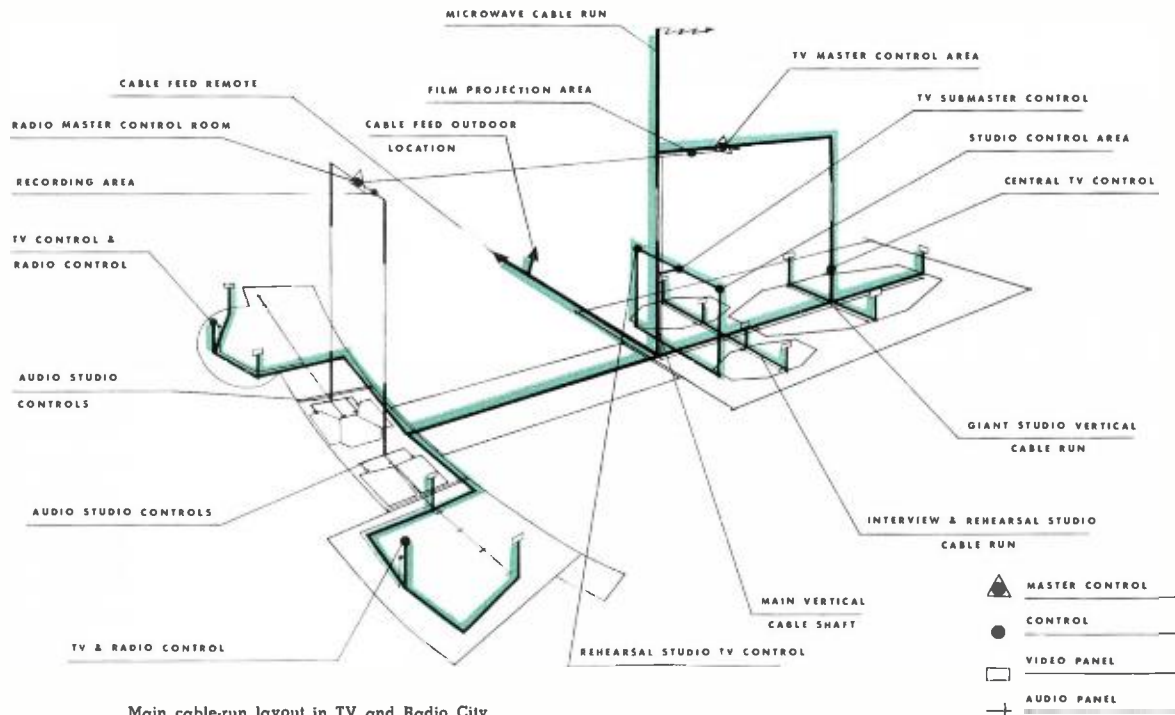

Main cable-run layout in TV and Radio City.

istration building. The close relationship of these elevators and stairways act as supplementary vertical Radio-building transportation. Associated technical facilities are in close proximity to the radio master control room. At the same level direct connection between the radio master control room and the video master control room has been established through the main corridor of the Administration building. Cable trenches connecting both master control room areas for communications purposes are provided.

The treatment of the studios will provide excellent sound pickup and takes into consideration, by its basic design and shape, such critical aspects as flutter echo, focusing and reverberation. The instrument studios and the conference studios are of double height to provide the necessary volume for effective sound interpretation.

### CONCERT HALL BUILDING

The program study, used as a basis for the facility planning, indicated the scarcity of programs available both for TV and radio programming in Bogota. The Concert Hall, therefore, will act mainly as a point of origination for TV and radio programs. At the same time, however, it will be used for general public entertainment.

The hall has been planned to permit both TV and radio sound pickup. Two

camera runways border the auditorium and connect directly with the concert stage. The runways are wide enough to accommodate TV camera cranes to permit specific angle shots. Both the concert stage and the audience can be televised from practically any angle.

At the second level, a TV and a radio control booth has been placed for the technical and production crews. A 16-mm film-projection booth is situated between the TV and radio control rooms. At a later stage, a remote-control TV camera and large-screen TV projection set can also be mounted at this location. The auditorium has a flat floor, removable chairs and permits multiple usage for such things as exhibitions, dances and social and official gatherings. Because of the TV pickup facilities, it is a useful tool in the production of special indoor TV events. The Concert Hall's associated facilities include musician locker rooms, lavatories and instrument storage areas. At the second floor level, reached via the Concert Hall stairway, instrument rehearsal areas are provided. These will also act as auxiliary instrument rehearsal rooms for the talent in the adjacent instrument studios of the Radio building. Offices for scheduling and programming of Concert Hall operations are located at the second floor level of the Administration building.

Traffic separation of talent as well as musicians and technical operators has been planned. Technical equipment, such as TV cameras, is transported from the TV Studio building to the Concert Hall on the ground floor level, using the materiel corridor of the Administration building. Movement of musical instruments, such as pianos and other bulky objects, is made from either the TV Studio building or the dramatic stage through the main corridors reserved for such traffic.

### STAGE-THEATRE BUILDING

The dramatic stage acts as an originating facility for TV and radio pickup. The restricted capacity of the auditorium (200 persons) is based on this criterion. Experience in this country and Europe has indicated that for stage performances, both dramas and comedies, modern and classic, it is necessary to have a minimum audience to provide the actors with an audience background reaction.

The design of the Theatre has been based on TV programming. The stage has been designed to take two stage cars, permitting the quick change of scenery and fast action so necessary in TV production. The placing of high camera runways and the circular shape of the Theatre, assists substantially in an effective TV operation. Such design will permit trick shots and, at the same time, will permit versatile usage of fixed or mobile TV cameras.

A central TV and radio control booth has been provided. An orchestra pit has

been planned and the stage has its own scenery and property-loading dock and storage area. At the stage level, the group dressing rooms and lavatories are located. Stage control equipment, such as curtains and lighting boards, fly controls, etc., are at a special area on the stage floor level.

The second level, reached by the Theatre building stairway, provides more dressing rooms and a costume wardrobe room. A large gridiron permits the flying of scenery which, together with the use of stage cars, will speed up production.

Production and scheduling offices are at the second floor level of the Administration building. Materiel used in dramatic productions, such as properties, sets and costumes, can be delivered directly at the stage delivery and loading dock or they can come through the materiel corridor of the Administration building from the TV Studio building.

### UTILITY BUILDING

The large building complex of TV, Radio, Concert Hall, Stage-Theatre and Administration buildings must be supplied by a multitude of utility services. One of the main requirements is power, such as needed for the electronic equipment, studio lighting, general lighting, air conditioning and auxiliary equipment.

It is a common practice in large TV projects to provide auxiliary power for the operation of technical facilities. The Plant Utility building provides sufficient space for diesel motor generators supplying

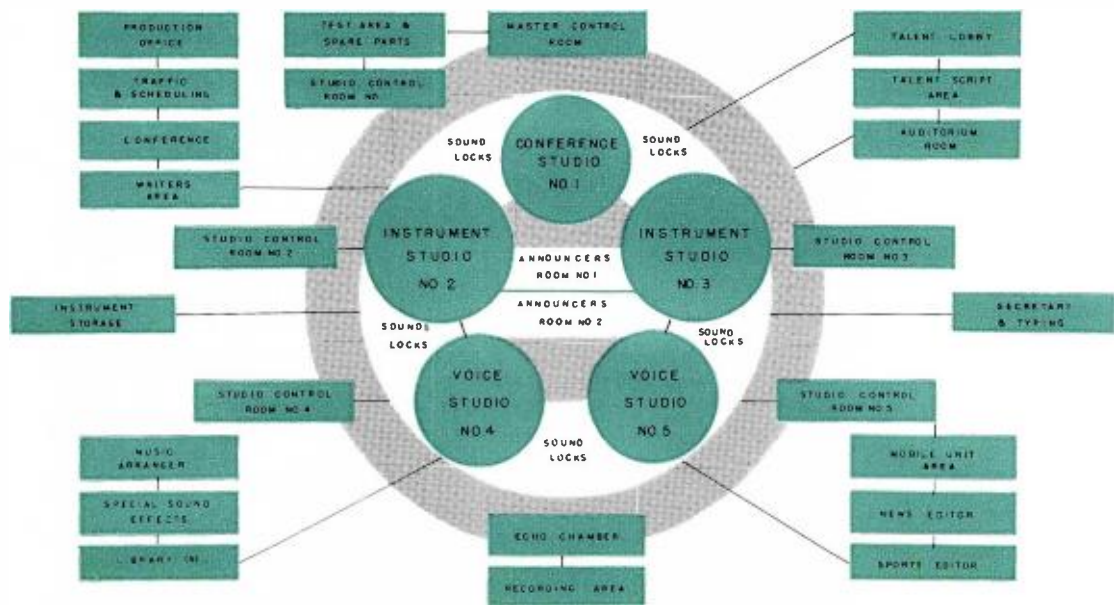

Chart showing arrangement of radio plant facilities.



power for studio operations. Either the giant studio or the interview and camera rehearsal studios can be supplied by this source. All operative areas must be included in the supply control areas—the film projection and production areas, as well as a certain amount of other associated facilities, such as production and scheduling.

The electrical equipment located in the Utility building will also handle the prime power feeds from the local power station, and most of the general power requirements can be satisfied from this source.

Mobile trucks, both for TV and radio, and the general maintenance truck, will be garaged here. An electronic shop and mobile crew room will also be included. The building has been set apart from the other facilities, but is strategically located so that service runs of the utilities are reasonably short and easy to maintain.

### STRUCTURE

Materials: Reinforced concrete—working stress, 1,200 psi. Reinforced steel—working stress, 20,000 psi.

The entire structure consists of two major types of framing systems:

- (1) All small spans, such as administrative areas, small studios, etc., will be designed as a flat plate, consisting of either solid or ribbed reinforced concrete slabs framing directly into columns without intermediate beams or girders, thereby providing a completely unobstructed ceiling surface suitable for the simplest installation of air ducts, wiring systems and pipes.
- (2) The large halls, such as the large studios and the Concert Hall, are spanned with a system of folded slabs or hipped plates which, essentially, consists of reinforced concrete corrugations of great depth, spanning directly all large spaces. The Theatre which has a circular plan, is roofed by a reinforced concrete shell in the shape of a circular dome. These systems were chosen because of the simplicity of the form work, since the use of beams and girders is again eliminated, and they can be formed and constructed as simple straight and curved slabs.

### AIR CONDITIONING

An air-conditioning unit system for each building element will be used with the exception of the TV and Radio buildings. In these two buildings separate sub-units will be employed to supply the different operational areas.

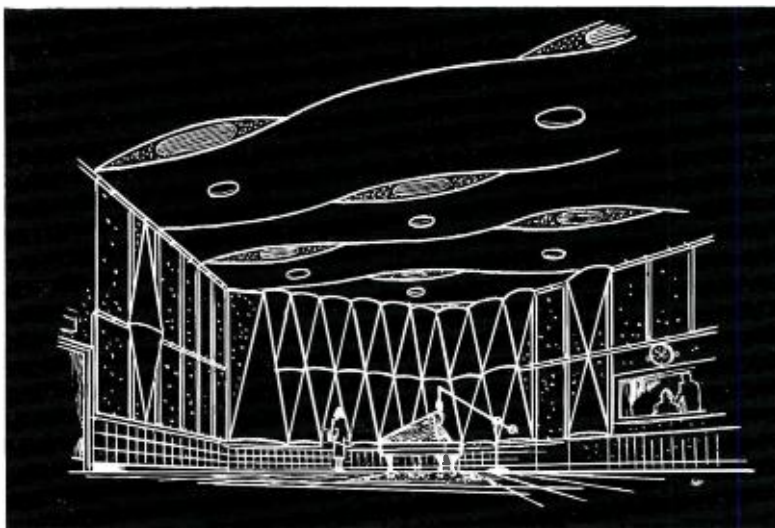

All radio studios, including the one above, are located at ground level.



Dramatic Stage acts as an originating facility for radio and TV.

Second level of Concert Hall showing control room and projection room.

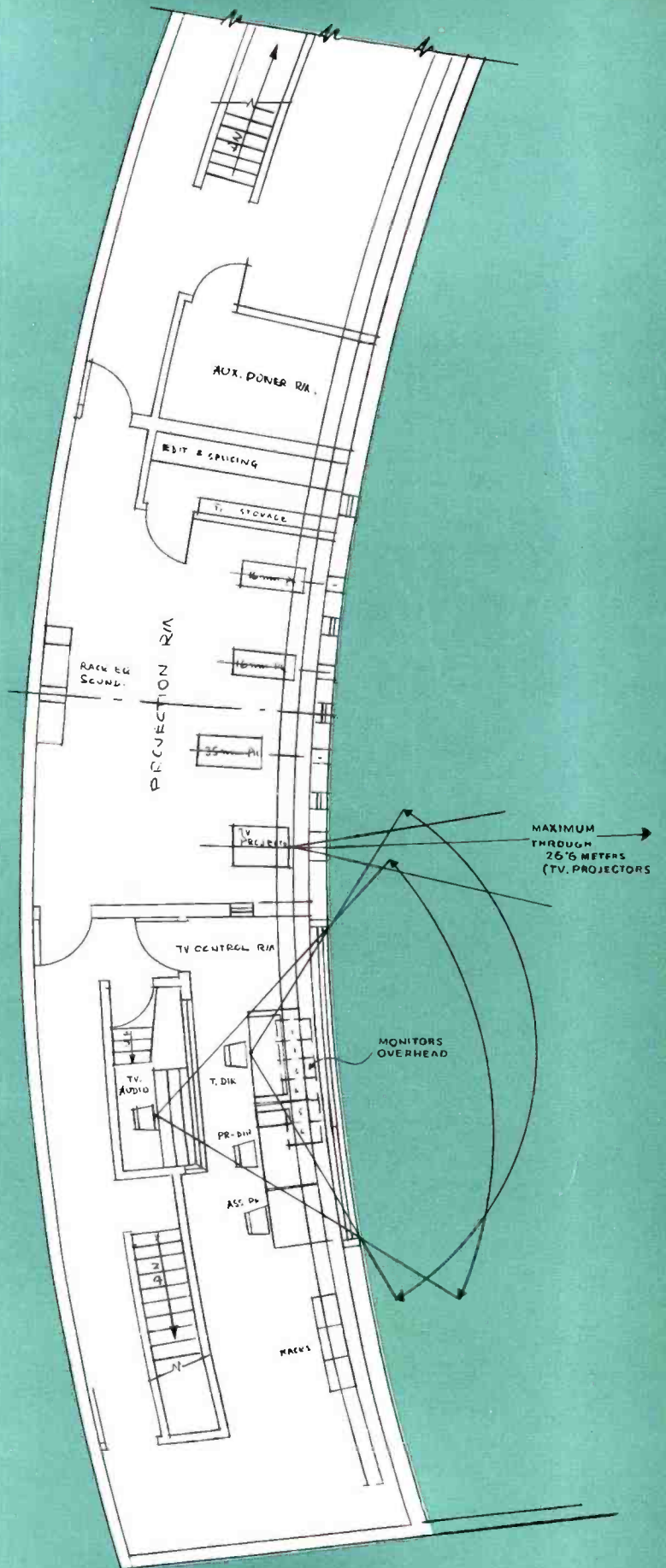

The air-conditioning machinery is located on the top of the Administration building and takes up a considerable amount of space. This location permits short duct runs between the units and the TV and Radio buildings. Ducts supplying the Concert Hall and Stage-Theatre building are located at the same level.

Generally, there will be two different air-conditioning systems; a high-velocity system for offices and auxiliary areas and a low-velocity system for the studio areas in the TV and Radio buildings.

Three separate air-conditioning units are being considered for the TV studios, supplying a studio area and the associated technical and production spaces. Such a separation will permit economical operation when the studio areas are not in use. Three individual units may also be used for the radio studios and its associated technical facilities. Both the radio and the TV master and sub-master control rooms and TV film-projection areas will be operated in conjunction with the studio air-conditioning units.

### COMMUNICATIONS

The efficient functioning of such a complex organism as the TV-Radio City depends on its internal and external communication system.

The use of external and internal telephones, public address and intercommunication systems, teletypes and dictation and

recording machines, will be of importance for a TV and radio operation. Other communication facilities such as facsimile, closed circuit TV and microfilm must be considered for expansion.

The security and guarding of the building, from fire and internal and external damage by persons, must fall into the category of preventive signal communications. Signal systems such as electric signs, panel lights, electric master-clock systems, general alarm and specific security-alarm systems have also been included.

### FLEXIBILITY AND EXPANSION

The building complex has been planned and designed to take care of future expansion. Flexibility for TV production has been especially thought of and the direction of the expansion is clearly established. The TV studios can be subdivided—especially the giant studio which can be easily partitioned off and used as two large studios if the need should arise.

In future TV and radio network operations, it is assumed that production of both media will be intensified. Care has been taken to provide enough executive and indirect production offices to take care of such growth. Future demands on direct production and operations will be taken care of by the plant expansion. The Concert Hall's multiple character, as a production area for TV origination, is an important factor in the planning.

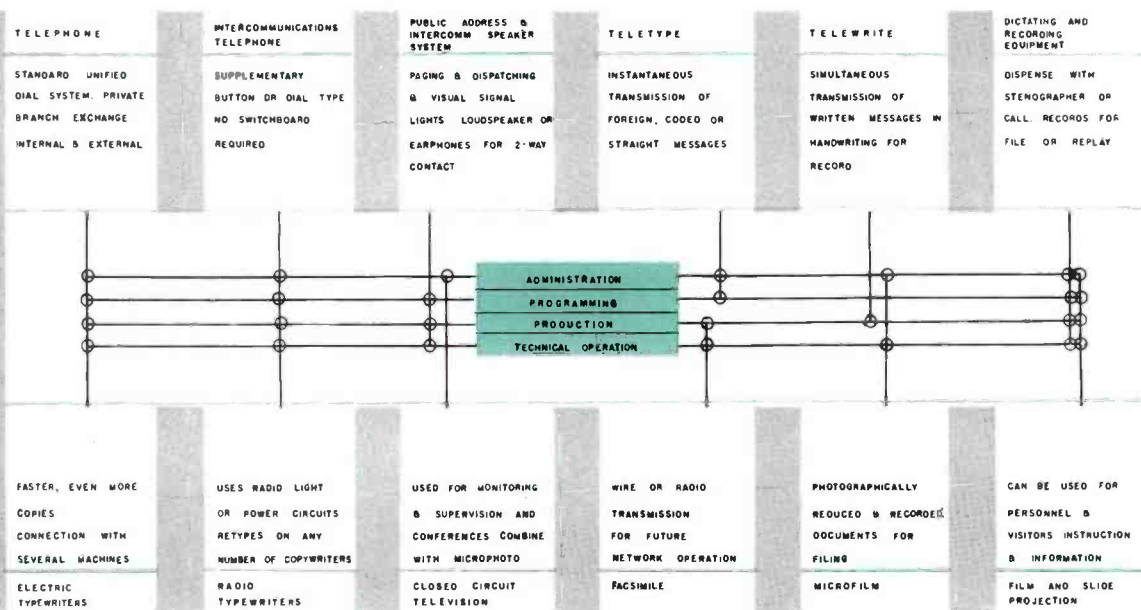

Communications systems used in the TV and Radio City.



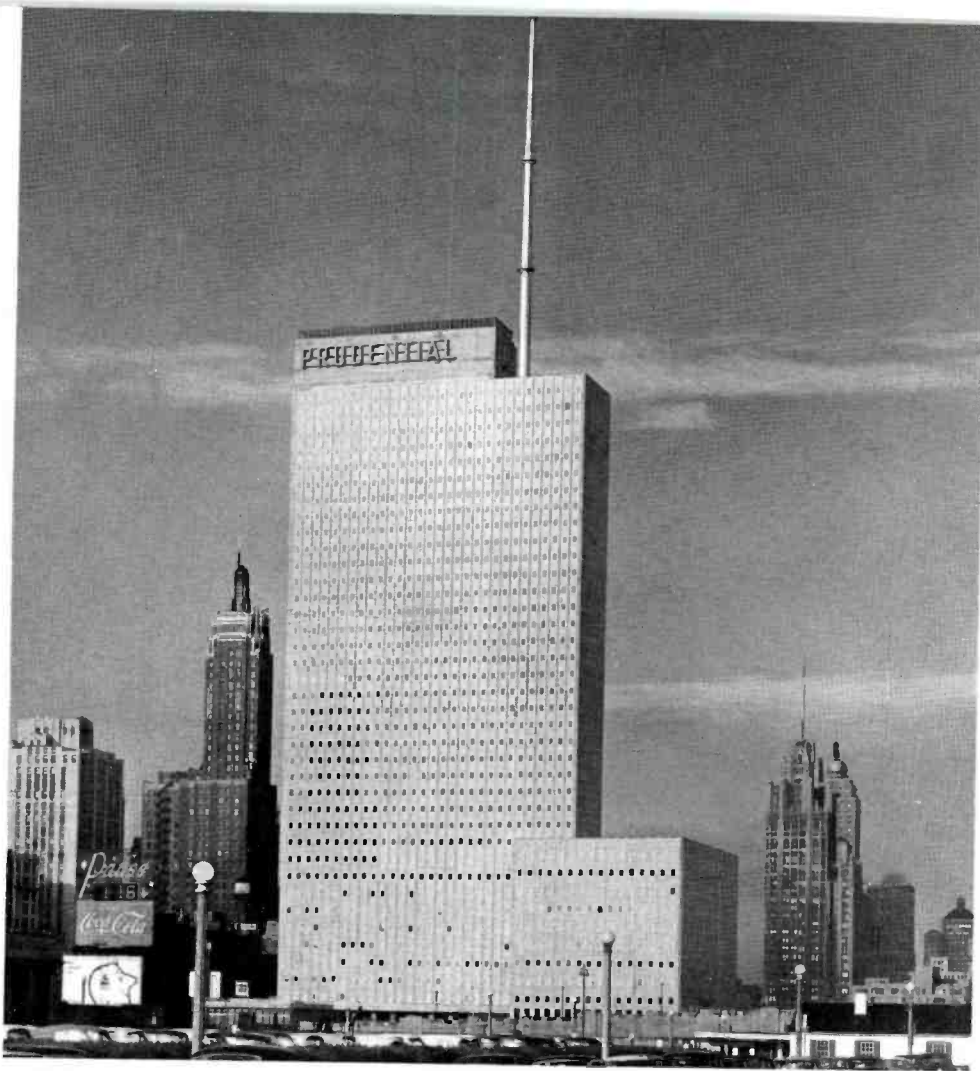

FIG. 1. Located atop the Prudential skyscraper, WGN's unique tubular steel tower is Chicago's newest landmark.

## WGN-TV PURCHASES COLOR EQUIPMENT ON DISPLAY IN RCA EXHIBIT AT NARTB CONVENTION

FIG. 2. Vidicon film system for color and monochrome at the RCA exhibit. Complete color film system was purchased by WGN-TV.

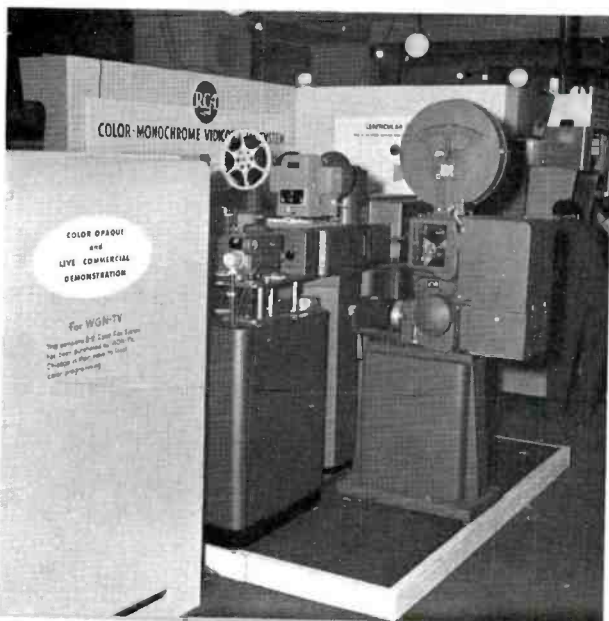

FIG. 3. WGN-TV's Calendar Girl for April, Pat Garber proves a worthy subject for live color camera at RCA booth.



The latest studio color television equipment has been purchased by WGN-TV for experimental engineering purposes. In charge of the work to be done in conjunction with the new RCA live and film equipment is Carl J. Meyers, director of engineering for WGN, who selected the color gear. Complete color control test and sync equipment were also obtained.

Broadcasters at the annual NARTB convention in Chicago noted that color equipment on display at the RCA exhibit was marked "for WGN-TV". After the show was over, the equipment was delivered to the WGN transmitter location. This includes a small 25-by-25-ft studio, on the 40th floor of the Prudential building, Chicago, Ill.

The complete 3-V Color Film System will enable the station to handle color film, slides and opaques. Live studio work will feature the TK-41A Live Color Camera.

Live and film programs will be telecast from time to time solely to school all operating personnel in colorcasting techniques. These programs will not be available for commercial use for the present time.

WGN-TV, which began its ninth year on the air April 5, has been telecasting with maximum power from the highest tower in Chicago since January 15. At that time the station's 12-bay antenna system and 50-kw transmitter went into operation.

The 73-ft antenna, supported by a tapered 311-ft tubular steel tower based on the 39th floor of the Prudential skyscraper, extends 914 ft above ground level. Weighing 4 tons, the antenna has 48 radiators.

The giant supporting tower, destined to become a Chicago landmark, tapers in diameter from 10 ft at the base to 3½ ft at the tip. It scales 200 tons and consists of 23 tubular steel sections welded together. The 20-ton base plate is bolted to the steel framework on the 39th floor.

Equipped to transmit color at any time, the RCA 50-kw transmitting plant has almost tripled the station's effective radiated power from 120 kw to 316 kw.

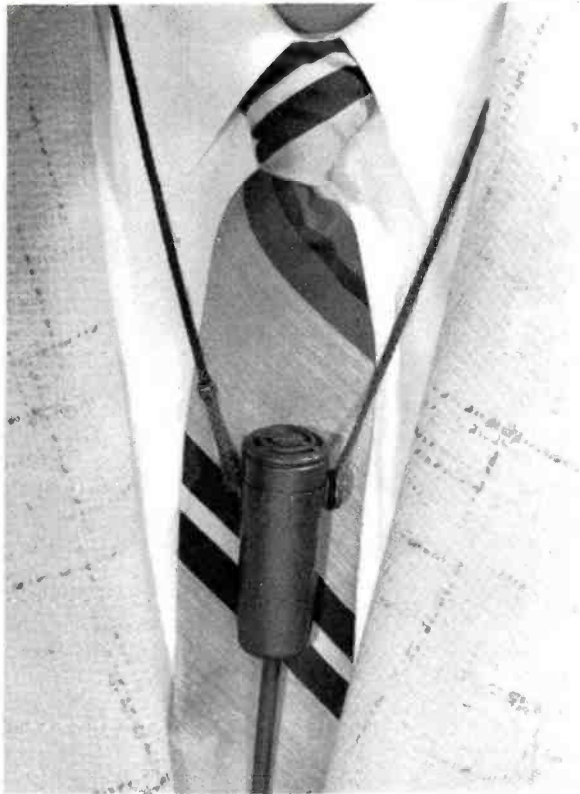

FIG. 4. W. B. Varnum, Manager, Studio Equipment Sales and J. L. Nickels, Chicago office, in front of rack equipment at RCA exhibit which was later shipped to WGN-TV.



FIG. 5. The 50-kw RCA transmitter in the WGN-TV transmitter room on the 40th floor of The Prudential Building, Chicago. W. R. Crama (left), WGN-TV transmitter supervisor, looks over installation with Carl J. Meyers, engineering manager for WGN, Inc.





# THE NEW BK-6B PERSONAL MICROPHONE

*A universal miniature, half the size of the BK-6A . . . with improved performance*

by **R. E. WERNER**  
RCA Transducer Design Group

## Introduction

The highly diversified staging of television programming requires equally diversified microphone techniques. There are situations where distant sound pick-up is most suitable. In such cases, directional microphones such as the BK-5A and 77-DX are mounted on booms and pointed to follow the stage action. In audience-participation and interview shows a greater air of participation is

can carry a microphone around which can be pointed towards an individual who will realize that he is "on-the-air". The RCA BK-1A and BK-4A are typical of microphones for this use. However, many types of programs demand a close-sound pickup that permits either freedom of the hands for product demonstration, or concealment for other types of presentations. This same microphone should be equally suitable for hand

FIG. 1. The BK-6B is excellent for personal use. It can be used beneath a neck-tie or clothing as well as exposed.

FIG. 2. Side-by-side comparison between BK-6B (left) and its predecessor BK-6A (right).

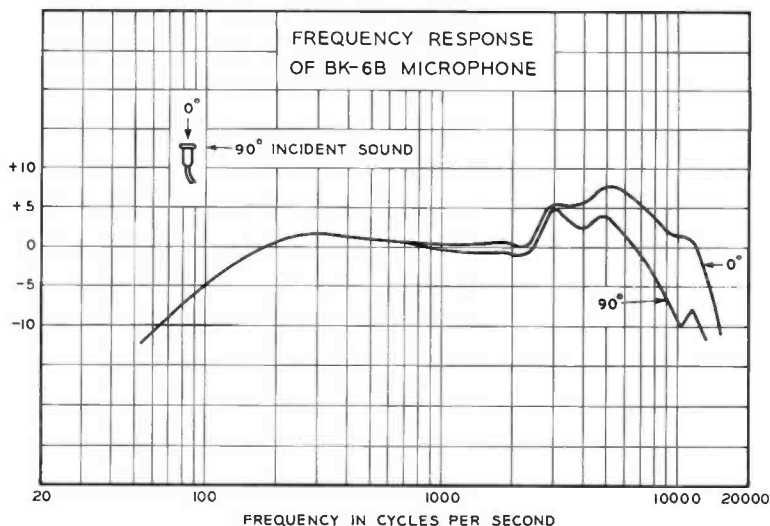
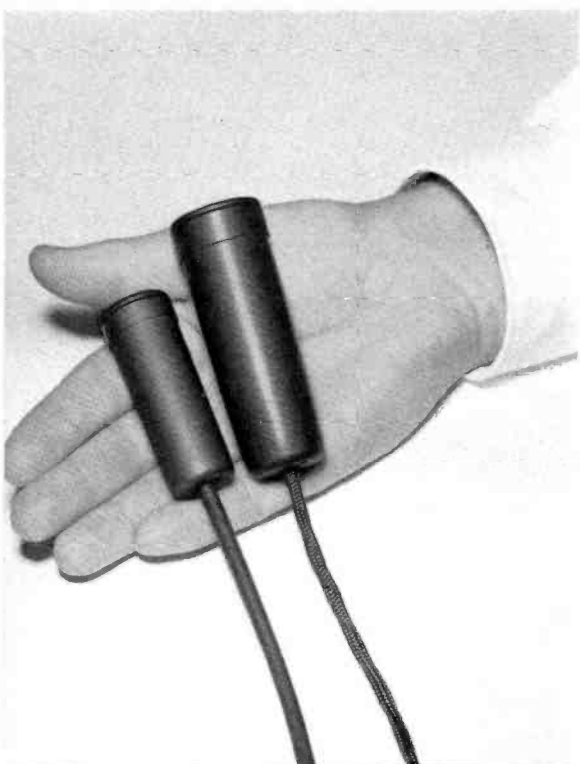

FIG. 3. BK-6B frequency response characteristics.



carrying—serving as an interview microphone. These latter requirements are provided in the new BK-6B Miniature Personal Microphone. The basic ideas of the BK-6B stem from its predecessor the BK-6A which was introduced a few short years ago. But considerable research and experimentation has brought about improved performance and a personal microphone half the size of the BK-6A. The BK-6B is only  $2\frac{9}{16}$  inches long by  $\frac{1}{8}$  inches in diameter.

### Design Considerations

The BK-6A microphone was designed with a response-frequency characteristic which is optimum for use as a personal microphone when worn on the chest of the speaker. The proper response-frequency characteristic for this application involves about 10-db emphasis at about 5000 cps and some attenuation of frequencies below about 150 cps. These response-frequency characteristics are necessary in order to equalize for the high frequency shadow beneath the chin, and the chest radiated lower frequencies of the speaker.\*

A microphone designed with these characteristics has limitations when used in interview applications unless, as for the BK-6A, the directional characteristic is such that satisfactory reduction of the high-frequency emphasis occurs when the microphone is tilted away from the speaker. One cannot expect all performers to faithfully observe this precaution and so it is necessary that a universal miniature microphone have a response-frequency characteristic which is adequate for any condition of usage.

The frequency response of the BK-6B microphone (Fig. 3) provides suitable characteristics for either personal or interview use. As a personal microphone, there is adequate attenuation of the unnatural low frequency chest sounds and, very close complementing of the high frequency shadow under the chin of the wearer. As an interview microphone, the 7 to 8-db emphasis at 5000 cps for  $0^\circ$  incident sound is only 3 or 4-db in excess of the generally preferable 4 or 5-db emphasis normally incorporated in this type of microphone. Good acoustic balance is obtained by incorporating about  $1\frac{1}{2}$  db low frequency emphasis in the 150 to 500 cps range where the low frequency characteristic of speech is established.

\* BROADCAST NEWS, Vol. No. 83, P. 48, May, 1955.

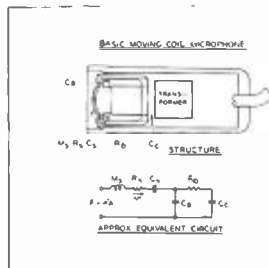

FIG. 4A.

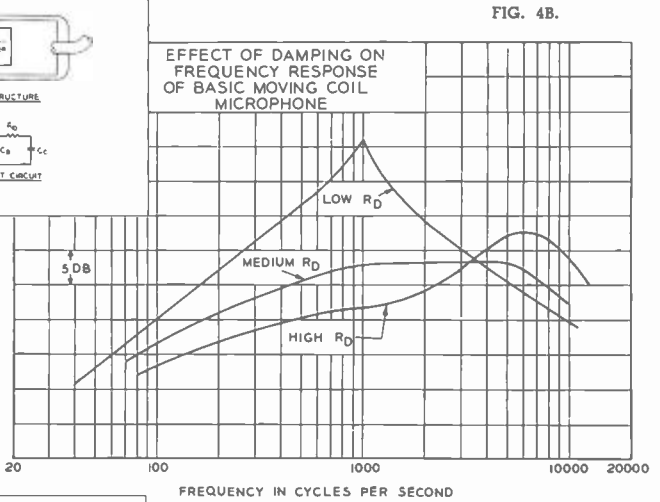

FIG. 4B.

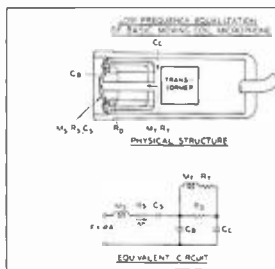

FIG. 5A.

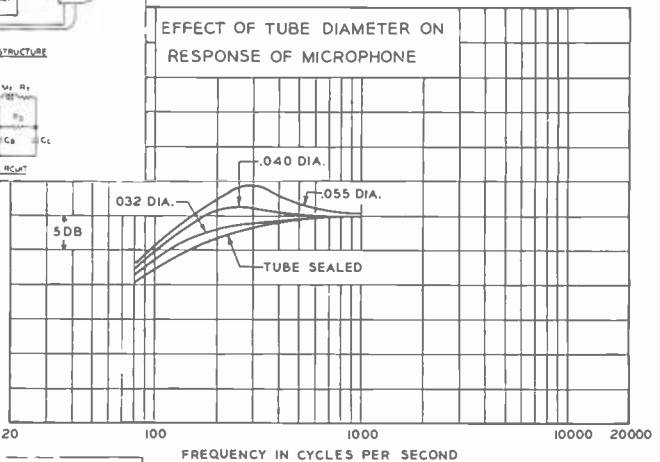

FIG. 5B.

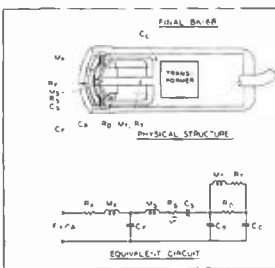

FIG. 6A.

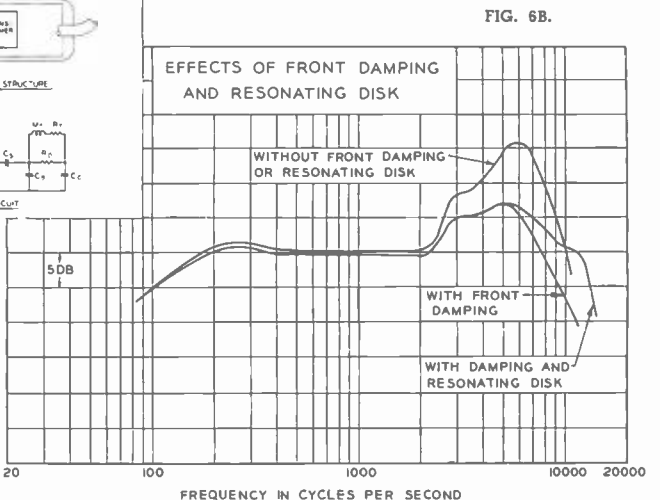
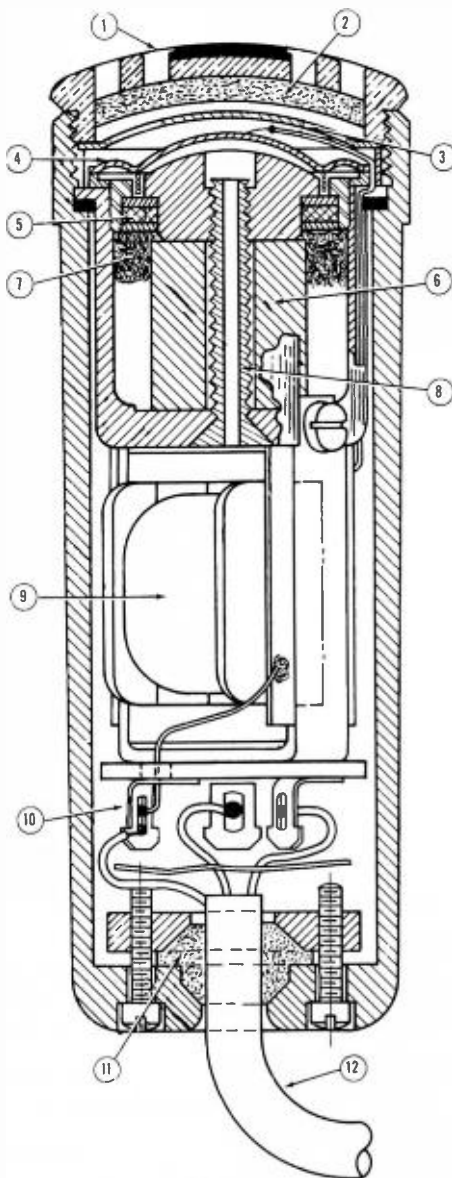

FIG. 6B.



1. Cover
2. Acoustic Damping
3. Resonator Disc
4. Diaphragm and Voice Coil
5. Acoustic Damping
6. Magnet
7. Acoustic Damping
8. Hollow Assembly Screw
9. Matching Transformer
10. Terminal Board
11. Cable Clamp
12. Cable

FIG. 7. Cross-sectional view of BK-6B and identified components.

### Obtaining Desired Response Characteristic Poses Problem

The BK-6B is a moving coil microphone and as such produces an output voltage which is proportional to the voice coil velocity. Since it is also a pressure actuated microphone, the voice coil velocity will be proportional to the acoustic pressure at the diaphragm and independent of frequency if the mechanical impedance of the moving system is constant at all frequencies.

The equivalent circuit for a basic microphone of this type is shown in Fig. 4A. The lowest practical resonant frequency for a diaphragm in a case of this size is about 1000 cps. The damping resistance,  $R_{D1}$ , is necessary to effectively eliminate this resonance so that the response will be flat at mid-frequencies. Because considerable damping is necessary to adequately spread this flat response band, a second resonant circuit is formed between the compliance of the cavity behind the dia-

phragm,  $C_{11}$ , and the mass of the diaphragm  $M_s$ . This resonance occurs at a higher frequency: about 5000 cps in the BK-6B. The effect of the damping,  $R_{D1}$ , is shown in Fig. 4B.

It is apparent that good low frequency response can be achieved through a high degree of damping. Unfortunately, sufficient damping to maintain response to about 150 cps results in greatly reduced sensitivity and unmanageably peaked high frequencies.

In larger microphones, it is possible to couple the case volume to the outside air and form a resonant acoustical circuit which will support the lower frequencies. In a microphone of this size, however, the method does not work efficiently at low frequencies. Satisfactory support at 200 or 300 cps can be obtained by this method but, the accompanying sharp cutoff immediately below the resonant frequency still

FIG. 8. Polar diagram of BK-6B.

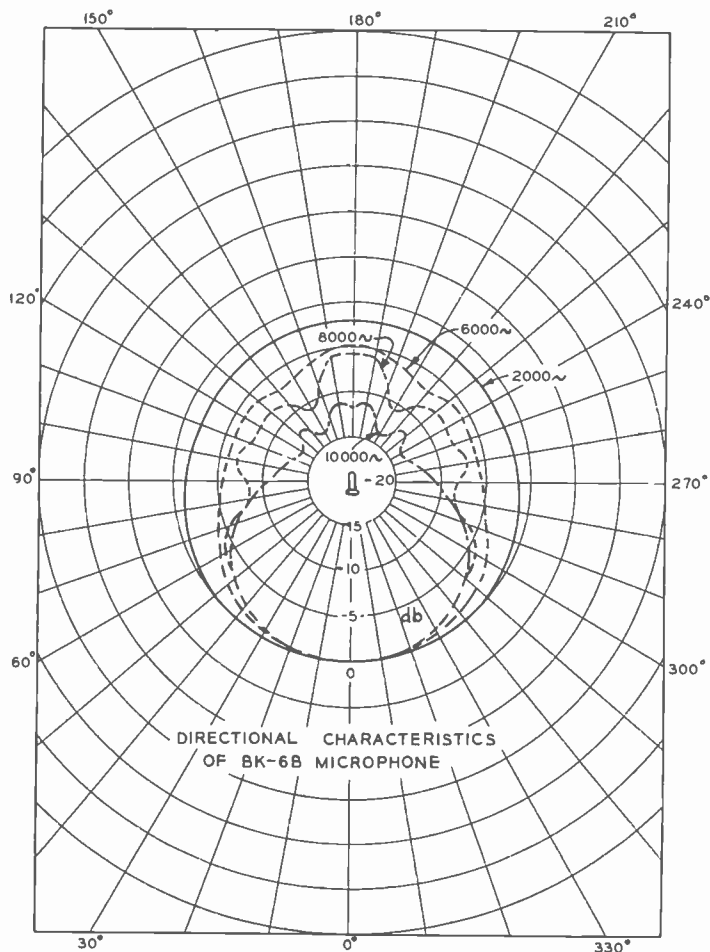

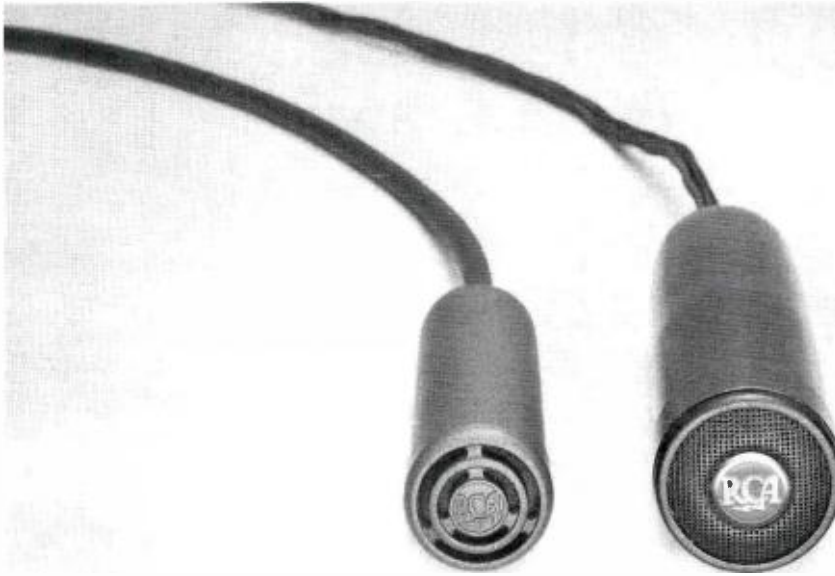

FIG. 9. View showing frontal area of BK-6B (left) and its predecessor BK-6A (right).

results in inadequate bass response. Low frequency equalization in the BK-6B is achieved in a manner unique in the microphone field.

#### A Hollow Screw Achieves Desirable Low Frequency Response Characteristic

The equivalent circuit of Fig. 5A shows the remarkably simple modification of the basic microphone necessary to extend the low frequency response. By coupling the rear cavity of the diaphragm to the case volume through a properly proportioned tube, a low frequency resonant circuit is formed.

This circuit is tuned to the desired frequency and given appropriate damping by proper selection of the tube's dimensions. Figure 5B shows the effect on performance of varying the tube dimensions. This system has three important advantages over case venting, aside from the fact that the venting system is not adequate in so tiny a structure.

1. There is no sharp low frequency cutoff. This allows positioning the resonant frequency where it is most desirable, about 250 cps.
2. The resonant system is totally enclosed by the case. There is no danger of inadvertently blocking a vent hole with hands or clothing. Thus, the low frequency performance is "foolproof".

3. The tube is manifest in a hollow motor assembly screw, thus none of the precious internal volume is lost.

#### Obtaining Desired High Frequency Response

Because of the relatively high damping incorporated in this microphone, the high frequency response is excessive. The desired high frequency response is obtained by the addition of the circuit elements shown in Fig. 6A. These are an acoustic damping material,  $R_F$ , and an acoustic mass,  $M_F$ , which, through their application, further add the acoustic compliance  $C_F$ .

The effect of the acoustic damping placed in front of the diaphragm is to reduce the high frequency emphasis while the acoustic mass and compliance form resonant a low pass filter which increases the response above 5000 cps before cutting off at about 13,000 cps. The effect of these elements is shown in Fig. 6B. Exceptional protection from dirt and damage is provided by these elements inserted in front of the diaphragm.

#### Conclusions

The BK-6B has balanced frequency response characteristics providing natural voice reproduction when worn on the chest or hand held. A simple lanyard with a snap fastener makes it easy to fasten around the neck and its light weight of 2.3 ounces makes it imperceptible to the wearer (Fig. 1). A new Mylar (polyester resin) diaphragm has exceptional resistance to chemical atmospheres and more stable physical characteristics. It has complete protection from dust and physical damage and an extremely durable cord which minimizes dirt pick-up and retention. Its 250 ohm output can easily be changed to 30 or 150 ohms. Sensitivity is  $-67$  dbm and the RETMA rating is  $-158$  db. Hum pickup is  $-112$  dbm. When worn about the neck, the BK-6B has an output level equal to that of the highly sensitive 77-DX at a distance of about 2 feet.

FIG. 10. Scale comparison of BK-6B indicates its small size. Convenient lanyard and clip make it easy to "wear".

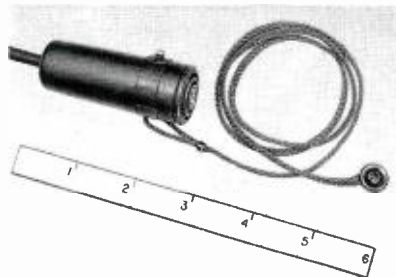



# MODERN TURNTABLE DESIGN CONSIDERATIONS

by **E. J. MEEHAN**  
Sales Administrator  
Broadcast Equipment Sales

To meet increased demand for improved turntable performance as regards cuing, speed-change and operating flexibility has been an industry-wide challenge for all

equipment suppliers. Rim-driven turntables offer the attractive advantages of fast-starting, simple speed-change and small space requirement, with several historically attendant disadvantages, namely, rumble, variation of speed and maintenance. A new approach in mechanical design of rim-driven equipment is offered in the latest RCA Type BQ-2A turntable, which utilizes the advantages of the rim technique while overcoming its less attractive features.

Much of the jump-start and rumble problems in rim-driven turntable application was found to be associated with idler tension. The new BQ-2A design utilizes floating idlers, completely free from spring tension. These idlers are essentially engaged by torque energization, providing a minimum of rumble and lengthening puck-life to a considerable degree.

Large size Neoprene idlers are utilized in the torque-activated design in the BQ-2A



FIG. 1. Broadcast needs for a high quality driving mechanism which will accommodate all types of commercial disc recordings are met in the BQ-2A Transcription Turntable.

turntable. These idlers are self-compensating; speed will not vary even when continuous wear reduces idler diameter.

Simple, fool-proof speed-control is another outstanding mechanical feature of the design. Separate speed switch and starting switch reduce possibility of human error in operation.

#### Performance Characteristics

An oversized thrust bearing, the focal point of turntable action, provides an unusually easy movement with a maximum of functional dependability. Performance ratings of the BQ-2A turntable indicate the high degree of excellence designed into the new equipment. Wow and flutter ratings exceed even the 70-series RCA turntables, with 0.25 per cent, half of peak-to-peak rating at 33 $\frac{1}{3}$  rpm, 0.2 per cent rating at 45 and 78 rpm.

Fractional-turn cuing, never possible with the older RCA turntables, is a feature of the new mechanism.

#### Rugged Construction

The turntable platter is a sturdily machined 14-lb. aluminum casting. Both the platter and the spindle assembly are held in the main support casting in oilite bushings and the thrust is supported by a single ball at the bottom end of the spindle. The drive motor is mounted on a separate plate and supported by vibration mounts to dampen rumble. All posts and shafts which provide bearings for cams and arms are assembled to a common plate to assure correct alignment.

A modern cabinet is provided to house the turntable equipment. The wooden console has a durable two-tone umber gray fabrikoid covering which is resistant to scuff and scratches, and which does not chip like enamel or lacquer surfaced cabinets. A cigarette-proof linoleum top is provided. A large hinged front door permits ready access to the interior. Ample space is available internally for mounting pre-amplifiers and accessory equipment. The equipment is also supplied less cabinet console for installation in existing or custom-made positions.

The drive assembly is extremely reliable and quiet and meets all NARTB performance specifications, assuring fidelity in the reproduction of broadcast transcriptions of all types.

All in all, the BQ-2A offers the broadcaster a new tool to meet the increasingly stringent demand of precise, on-cue programming; a workhorse for wear, that is low in cost and superior in performance.

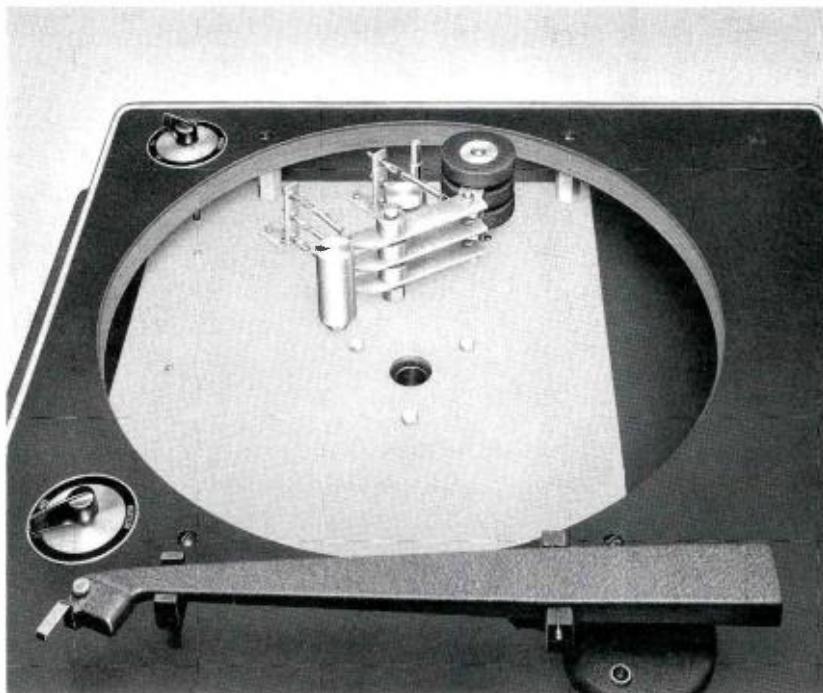

FIG. 2. A separate three-position speed selector switch (upper left) is linked to a cam which allows the three rubber idlers to engage, one at a time, between the motor pulley and the turntable rim. The "On-Off" selector knob operates a mercury switch which energizes a motor and either engages or disengages the rubber idlers.

FIG. 3. The 16-inch turntable platter is made of a sturdy 14-lb aluminum casting. Rumble is eliminated by mounting the drive motor on a separate plate and supporting it by vibration mounts. All posts and shafts which provide bearings for cams and arms are assembled to a common plate to insure proper alignment.



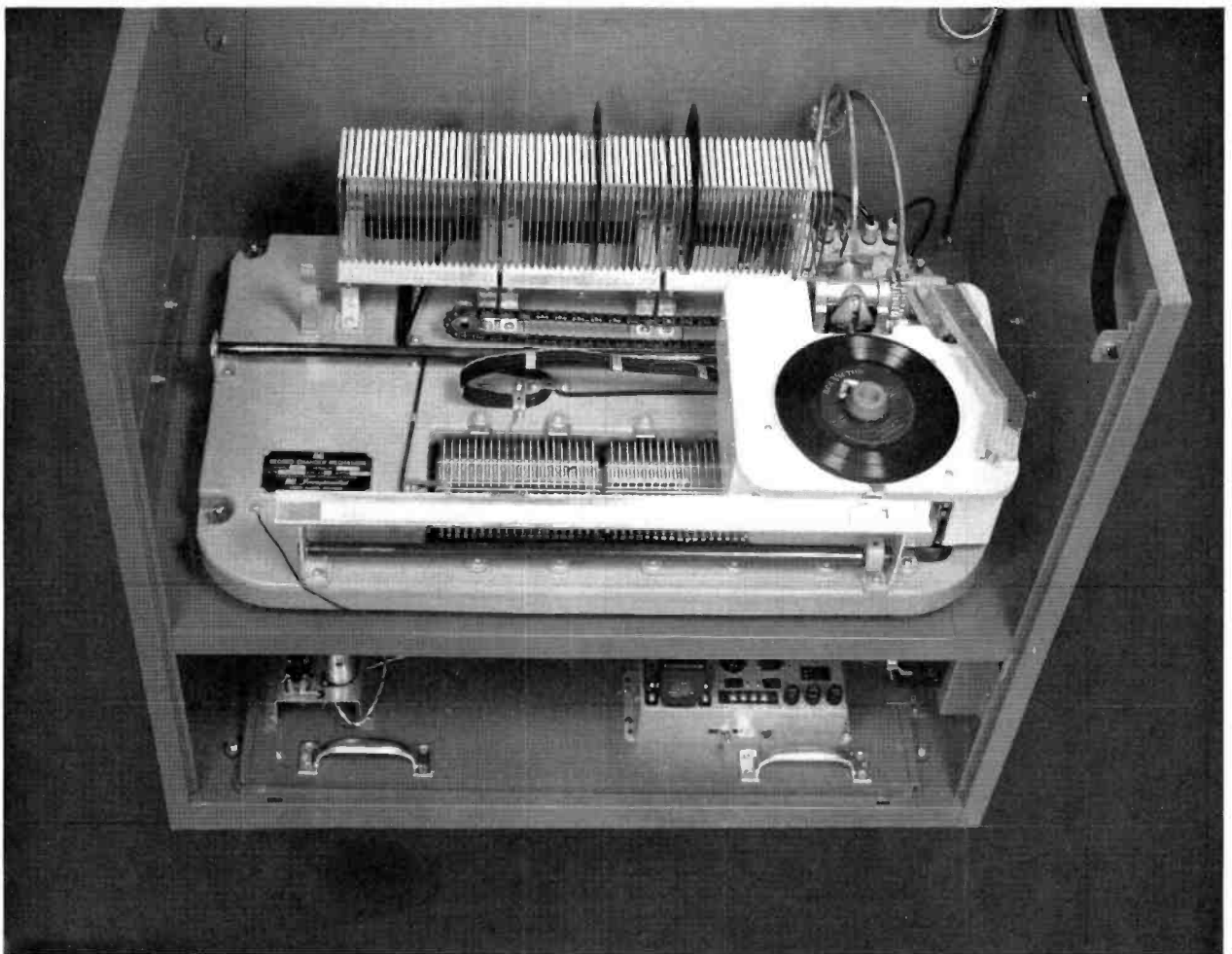

FIG. 1. Interior view of BQ-102 Automatic Turntable showing record handling mechanism.

# NEW RCA AUTOMATIC TURNTABLE

by **R. H. BARNABY**  
**Broadcast Audio Equipment**  
**Sales Department**

It has been generally accepted that there is a trend toward handling audio program material by the use of automatic and semi-automatic devices. There are stations in operation using this type of equipment to varying degrees. Early work by RCA in the development of the 45 rpm disc specifically designed for automatic devices presaged the high capacity record-handling devices that have come to be known as the "Juke Box." Interest in this field was intensified during the recent NARTB convention at which the new RCA automatic turntables, the BQ-101 and the BQ-102, were demonstrated.

## Modes of Operation

At an early stage it was recognized that two possible modes of operation would enable the automatic turntable to be most useful: (1) The operator controls *when* selections will be played from a group of records that have been loaded into the machine in a fixed sequence. (2) The operator controls not only *when* the record will be played but also *which* record will

be played without regard to how the discs were originally loaded into the machine. These two systems were ultimately developed into automatic turntables BQ-101 and BQ-102 respectively. Both of these turntables consist of two basic parts, the control unit and the record handling unit which are connected by means of a multi-conductor cable. Detailed descriptions of the control will be deferred until later in this text in order to direct attention first to the record handling unit.

## Record Unit Specifications

The external appearance of the record unit is shown in Fig. 2. The all-metal cabinet is 34 $\frac{1}{4}$  inches high, 35 $\frac{1}{4}$  inches wide and 21 $\frac{1}{2}$  inches deep. The finish is two-tone umber-gray which not only matches other RCA control room equipment but being neutral, blends with any decorator

color scheme. The front cover is completely removable but when it is in place may be secured by the use of two separate locks. The top cover is hinged at the rear and whenever the top is up and the front cover removed the mechanism is exposed for easy loading or maintenance. Figure 1 shows the record handling device inside the box which is brightly lighted by a lamp switched on automatically by removal of the front cover.

## Record-Handling Features

Some 120 selections are provided by 60 standard 45 rpm discs that may be placed quickly and easily in the conveniently numbered record storage racks. These racks hold the records vertically in a manner that provides the optimum protection from warping or scratching. The 45 rpm turntable consists of a cast aluminum platter, puck driven by a synchronous motor by a method designed to eliminate objectionable wow and flutter components. All of the various devices comprising the record handling mechanism are mounted on a



sturdy casting which constitutes the frame. This frame is in turn shock mounted to the cabinet. All of these superior construction details add greatly to the strength and reliability of the automatic turntable and will enable the BQ-101 and BQ-102 to take their place among other RCA turntables which have long been the standard of the broadcasting industry.

In operation, the turntable carriage scans the record rack until it makes contact with one of the 120 selector fingers which has been actuated in accordance with information derived from the operator's control box. A transfer arm then quickly and smoothly removes the selected record from the rack and places it horizontally on the turntable. The pick-up arm then comes to rest on the record. Then, when the proper signal has been received from the control box, the turntable starts and a muting switch opens which allows the audio signal to be fed into the audio system. When the record has been played, the muting switch closes removing the audio signal, the disc is removed from the turntable, replaced in the storage rack, and the carriage scans for the next selection.

#### Operation of the BQ-101

In the BQ-101, records are loaded into the storage rack of the handling mechanism in the desired order of playing. Rec-



FIG. 2. External view of Automatic Turntable. Note front panel locks at upper corners. Cable access parts at bottom.

ords are then played in sequence when desired by the operator at the control position by operation of the control box which is shown in Fig. 4. This control unit is 6 $\frac{1}{4}$  inches wide, 3 $\frac{3}{4}$  inches deep and 2 $\frac{1}{2}$  inches high. It consists of an etched aluminum umber-gray finished control panel set into a black molded plastic case. All controls

and indicator lamps are mounted to the panel in order to enable it to be easily removed from the case and installed in an audio console or in any custom installation.

A typical cycle of operation for the BQ-101 would be as follows:

1. By operating the power switch the entire equipment is ready for operation.
2. The "RESET" button is operated, returning the mechanism to record No. 1 which it places on the turntable to await the starting signal. At this point the operator is advised that a record is ready to be played by a green tally lamp.
3. On cue the operator presses the "START" button and the record plays. The operator is notified by a red indicator lamp that the "playing" portion of the cycle is taking place.
4. At the completion of play, record No. 1 is returned to the rack, record No. 2 is placed on the turntable, and the cycle is repeated.

In addition to the above described operation, two other functions are provided in the BQ-101 control box. Any record may be rejected during any part of its playing cycle by operating the "REJECT" button thus causing the mechanism to

FIG. 3. A typical group of operating studio equipment with automatic turntable (extreme right).

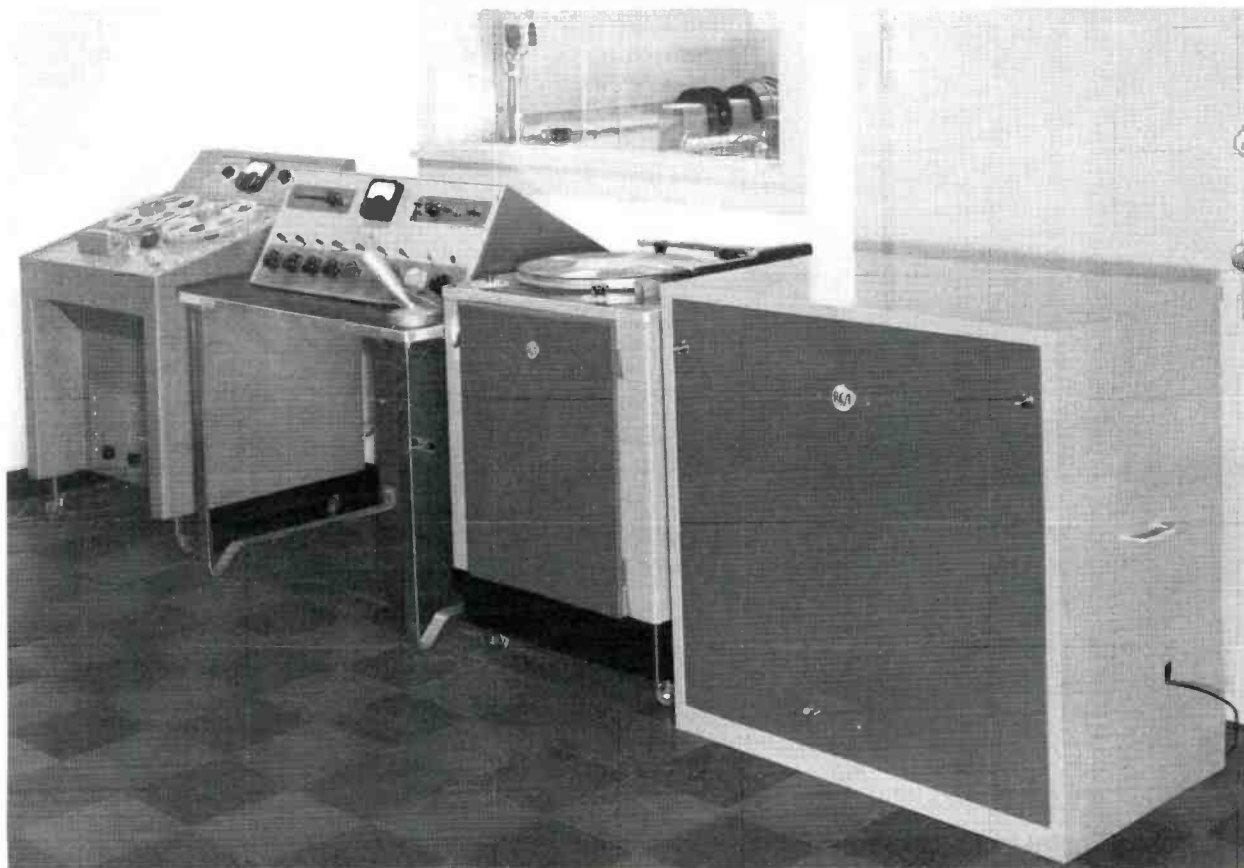

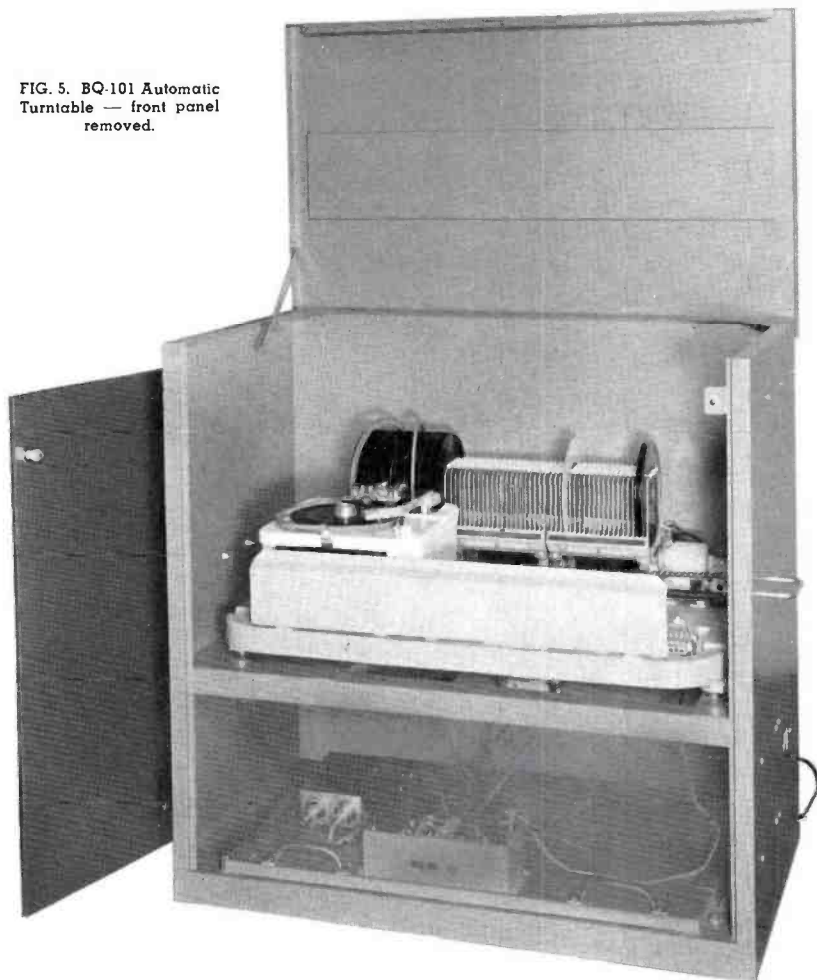

FIG. 4. Control unit for BQ-101.

move to the next record. Also, by rotating the "START" button it may be locked into the "on" position causing each record to be played in sequence automatically for

unattended operation. In this method of operation the entire 120 selections will be played continuously until the start button is unlocked or the power is removed.

FIG. 5. BQ-101 Automatic Turntable — front panel removed.



The BQ-101 finds its greatest application in those programs where the format is fixed and it is known in advance just which records will be played and in what order. This method of handling records not only is conducive to eliminating sequence errors, but avoids and eliminates record cueing errors.

#### Operation of the BQ-102

The BQ-102 is a natural outgrowth of the BQ-101 and is the next step in completeness of control over those records involved in programming. Records are loaded into the BQ-102 storage racks in any order. The only requirement is that the number opposite the slot in which the record is placed should be noted for future use in locating the record. Thus, with 60 records loaded there will be selections catalogued No. 1 through No. 120. If more than one BQ-102 is used, the catalog number may be prefixed by a letter designating the turntable used such as A1 through A120, B1 through B120, etc. Records are then played in accordance with whatever number is selected by a special control box.

The BQ-102 control unit is 10 inches wide, 14 $\frac{3}{4}$  inches deep and 6 inches high. It has an amber-gray etched aluminum control panel mounted in a contrasting amber-gray metal case as shown in Fig. 6. As in the BQ-101, all of the controls are fixed to the control panel in order that it may be removed from the case and installed in any custom installation. Two of the BQ-102 control panels will fit into the space occupied by one of the RCA BC-5A Audio Console control panels, and it is anticipated that BC-5A type housings will be made available for this use.

A typical cycle of operation for the BQ-102 would be as follows:

1. By operating the power switch the entire equipment is ready for operation.
2. The desired record is selected by pressing the proper numbered buttons of the three vertical rows of pushbuttons, in a manner similar to selecting numbers on an adding machine. The "CHECK" light will indicate that a proper number has been selected. The "CHECK" light would not glow if, for example, a meaningless number such as 177 were selected or if two buttons in the same vertical row were pressed.
3. The "REJECT" button is then pressed which causes the mechanism to reject the last record selected during a previous operational period and to place the record corresponding to the number just selected upon the turntable to await further instructions from the control unit.

At this time a lamp located within the "START" button will indicate to the operator that the record is ready to play.

4. At a time determined by the operator, the start button is pressed, starting the record. During the time that the record is being played a lamp located within the "REJECT" button is illuminated to advise the operator that the record is then being played.

5. While the first record is playing, the next record may be selected by using the numbered keys.

6. At the end of the first record, the automatic turntable will restore it to its former position in the storage rack and then place the second record on the turntable. If during the playing of the first record a second record has not been selected, the first will be returned to the turntable for a repeat play.

The BQ-102 is a versatile unit that will find wide application in the broadcast industry. Its design particularly adapts it to the informal "disc jockey" shows where spur-of-the-moment record selection is a requirement. In addition, for the first time it is possible for a station to build a mechanized central record library from which several studios could be supplied with recordings in accordance with interconnections between control units located in the studio, and record handling cabinets located centrally.

#### System Function

Figure 7 shows a system block diagram using either the BQ-101 or the BQ-102. The output of the pick-up head is normally fed into an equalizer and from there the signal may be amplified or fed directly into the microphone input of an audio console. The tone arm is designed having the

standard RETMA pick-up head mounting and as a consequence either low or high impedance heads may be used in accordance with existing requirements.

#### Economic Advantages of Automatic Turntables

An investment in an automatic turntable will pay dividends by: Providing an extra pair of skilled hands to a "personality" disc jockey; Allowing more effective use of control room space; Diverting skilled operators to other needed tasks; Reducing costs for damaged or scratched records and fractured pickup stylus due to

improper handling of playback equipment; Giving the program department a tool to increase flexibility and scope; giving programs that extra something which keeps a station consistently on top.

If complete automatic programming for the radio station is to be a reality, turntables such as the BQ-101 and the BQ-102 will be building blocks upon which such systems can be based. The final outcome of the application of automatic record handling equipment to audio programming will be an increase in facility and a decrease in operating costs.

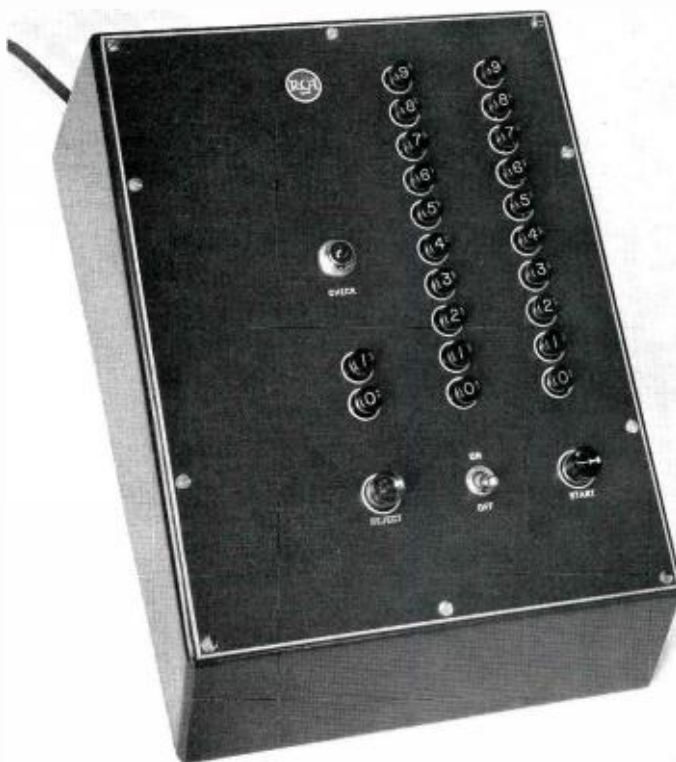

FIG. 6. Control unit for BQ-102.

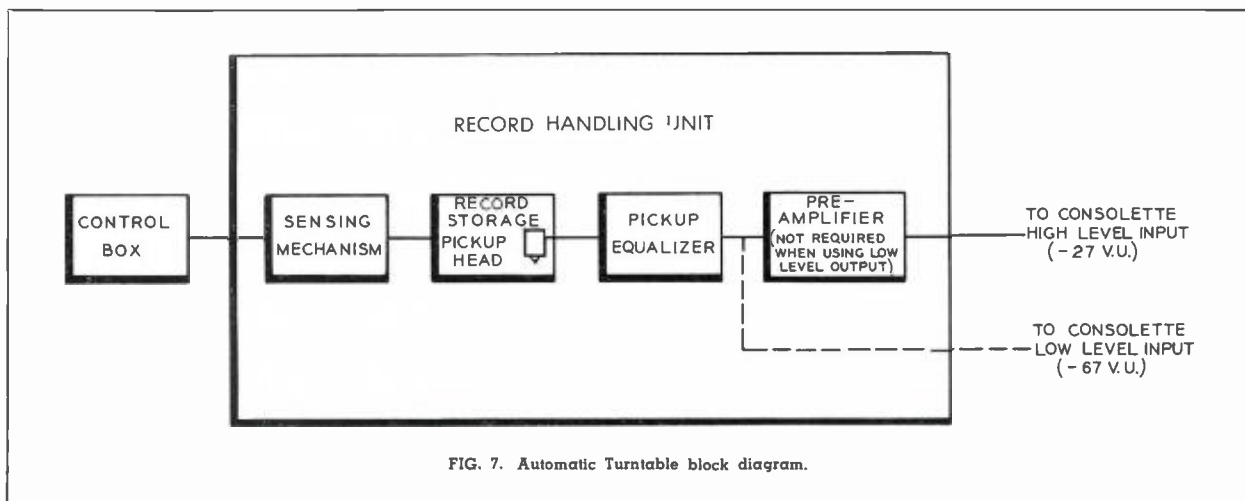

FIG. 7. Automatic Turntable block diagram.



# THIRTEEN PRECISION INSTRUMENTS MARK RCA ENTRY INTO SPECIALIZED TEST EQUIPMENT FIELD

Precision electronic test apparatus that facilitates the design, development and production of complex electronic equipment and systems has been announced by RCA.

This line of specialized test apparatus differs radically from test equipment used by the radio and TV service industry. The new instruments have been designed to meet the exacting development, design and manufacturing requirements of complex electronic equipment such as radar, computers, fire-control systems, radio and television receivers and communications equipment. The instruments will have principal application in electronic and electrical manufacturing plants, electronics labora-

tories, research institutions, schools and universities.

They are designed to provide a high order of precision and measurement accuracy, and feature some characteristics which are unique in the laboratory and industrial test equipment field.

The following instruments are included in the new line:

*A Pulse Generator*, which features a rise time of 0.01  $\mu$ sec and produces either positive or negative output. Steep-front pulses are produced with variable amplitude, length and recurrence. The generator will modulate an r-f wave with these pulses to approximately 100 percent.

To facilitate the observation of these signals or the functioning of circuits operated by them, the instrument also generates a synchronizing signal whose position may be varied with respect to the principal pulse. The sync circuit is designed so that it also serves as a source of pulses whose amplitude, phase and recurrence may be varied at will. In addition, the pulse generator will produce square waves at a separate output socket.

*Two R-F Power Meters*, capable of measurements from 5  $\mu$ watts to 5 watts. Both incorporate highly accurate bolometer elements and utilize identical basic power bridges. One model operates over a frequency range of 20 to 1,000 mc; the other 1,000 to 10,000 mc. Attenuators and accessories vary according to frequency range desired and power to be measured.

Both low-power and high-power bolometer elements of special design are included as accessories. The low-power bolometers are of the Wollaston wire, positive-coefficient type, with special control of time constant to offset inaccuracies under pulse-power conditions and are rated at 1 milliwatt input. The high-power bolometers are negative coefficient carbon film units, designed to withstand high power overloads and are rated at 5 milliwatts input.

*Two Null-Reading D-C Voltmeters*, for highly accurate d-c measurements. One instrument has a range of 0 to 100 volts dc and is capable of measurements accurate within 0.1 percent plus-or-minus 100  $\mu$  volts. The second instrument has a range of 0 to 600 volts dc and is capable of measurements accurate within 0.1 percent plus-or-minus 10 millivolts. Both null-reading voltmeters are usable in a wide range of applications, including calibration of other devices.

Major elements of each voltmeter include: a highly stable power supply furnishing an accurately known reference voltage; a precision attenuator; a means of comparing the reference voltage with the emf of a standard cell; and a sensitive null-detector circuit for indicating balance between the internal reference voltage and the external voltage being measured.

*A Vacuum Tube Voltmeter*, which provides highly accurate measurements to 700 mc and relative measurements to 1,000 mc. Voltage measurements as high as



Dr. James Hillier (left), Chief Engineer, RCA Commercial Electronic Products, discusses operation of vacuum tube voltmeter with C. O. Caulton, Manager, New Products Administration. Other instruments shown include r-f power meter, left; signal generator, right background; and impedance bridge, right foreground.

32,000 volts d-c and 1,600 volts a-c are provided. The instrument is believed to provide the highest level of stability of any voltmeter of its type. It has been developed for use wherever highly precise measurements are required.

The input resistance of 100 megohms on all d-c ranges prevents overloading and measurements may be taken without disturbing the operation of the circuits under test. The same a-c probe is used for measuring all frequencies from 12 cps to 700 mc.

*Two Impedance Bridges*, which can be used for the measurement of inductance, capacitance, resistance and dissipation factor at 60-1,000 cps. The utility model can be used as a comparison bridge and the main dial indicates percentage deviation of components from a standard. This unit includes a neon lamp indicator for capacitor losses and faulty insulation. In addition d-c voltage is applied for checking electrolytic capacitors.

The deluxe model features a built-in d-c power source which is used for the measurement of incremental inductances as well as electrolytic capacitors. External signals may be applied from 50-10,000 cps.

*Four Types of Signal Generator*, which range in frequency from 42 kc to 230 mc and are designed to provide a high degree of stability. Other features include negligible leakage, accurate calibration, internal or external modulation, power line filtering, piston attenuators and compact design.

Two of the signal generators provide a frequency range up to 50 mc—one starting at 42 kc and the other at 50 kc. The two VHF signal generators cover the frequency ranges 5 to 230 mc and 8 to 230 mc. These instruments are particularly suitable for the design and test of radio receivers, i-f amplifiers, VHF TV receivers and any amplifiers, oscillators or similar equipment that operate at frequencies between 5 and 230 mc.

*A Deluxe Multimeter*, which features a high sensitivity of 20,000 ohms per volt for both a-c and d-c voltages. Meter readings are considerably more accurate than those obtainable with most existing comparable multimeters. The instrument features a built-in overload-protection device, which can be reset to protect the meter from accidental burn-out. The overload cut-out system protects not only the meter movement, but also the precision resistors and shunts which are used in the circuit. Protection is instantaneous and completely isolates the instrument.

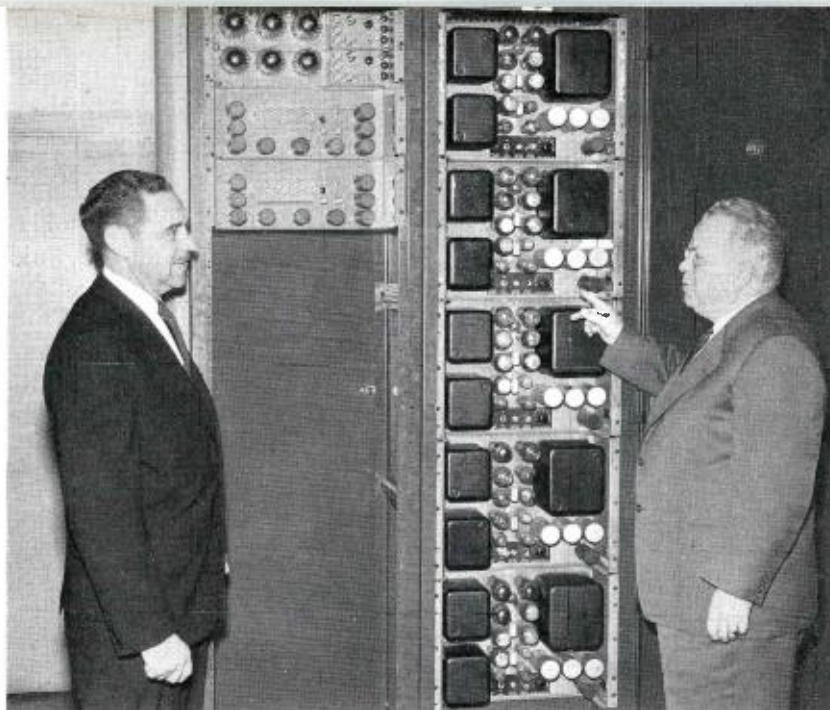

Generating 1,500 milliamperes each at 280 volts the two WP-15 power supplies in the left-hand rack equal the total output of all five conventional WP-33B power supplies in the other rack. A. R. Hopkins, Manager, RCA Broadcast and TV Equipment Dept. (left) and V. E. Trouant, Chief Product Engineer, Broadcast and TV Equipment Dept., are shown examining the equipment.

## NEW POWER SUPPLY FOR TV STUDIOS

Development of this new power supply Type WP-15 represents an important contribution to more efficient and economical television broadcasting. Significantly smaller, simpler and more efficient than previously available power supplies, the new unit will enable broadcasters to conserve valuable studio space, reduce operating costs and simplify maintenance and replacement-parts inventory. This power supply is designed for all television applications and will also have a wide range of uses in the industrial and laboratory field.

Indicative of the midget's space-saving potential—one WP-15 power supply will provide the current requirements of a complete black-and-white live or film TV camera chain, including the master monitor, compared with two appreciably larger-size power supplies previously required. Two of the WP-15 power supplies will serve the current needs of a complete live color TV camera chain, compared with the full rack of power supplies now needed.

The incorporation of high-current capacity in a compact package was made possible by the utilization of advanced circuitry and new hermetically sealed high-efficiency germanium rectifiers. The overall advanced design enables the small unit to generate 1,500 milliamperes of power output at 280 volts with only six tubes. Compared with conventional-type RCA power supplies,

such as the WP-33B, required for an equivalent 1,500 milliamperere output, the new unit occupies only 10½ inches of rack space, compared with 35 inches; operates with only 6 tubes, compared with 25; has 23 percent greater efficiency. It is available to broadcasters and other users for \$675, compared with \$1440.

A feature of the new power supply unit is dual-chassis construction to simplify installation. The unit consists of a rectifier chassis, containing all rectifier and filter elements, and a regulator chassis, incorporating the six-tube complement and regulating elements. The separation of rectifying and regulating functions permits installation of the power supply as a combined or separated unit. The regulator chassis features split-level construction, which isolates all controls and the d-c amplifier from the regulator tubes for quick, safe accessibility and improved stability.

Other engineering and safety features include: radiating fins in the regulator chassis, to maintain tube temperatures at efficient levels; heavy-duty on-off switches for both rectifier and regulator; remote control of the rectifier from the regulator to eliminate high voltage when the regulated voltage is inoperative; individually fused regulator tubes to prevent overload of operative tubes should others fail; and indicator lamps on front and rear of both chassis to indicate high voltage.



FIG. 1. Designed for hand instead of palm-held operation, the CX-50 was developed to meet the need for a microphone which nullifies the muffling effect of the hand.

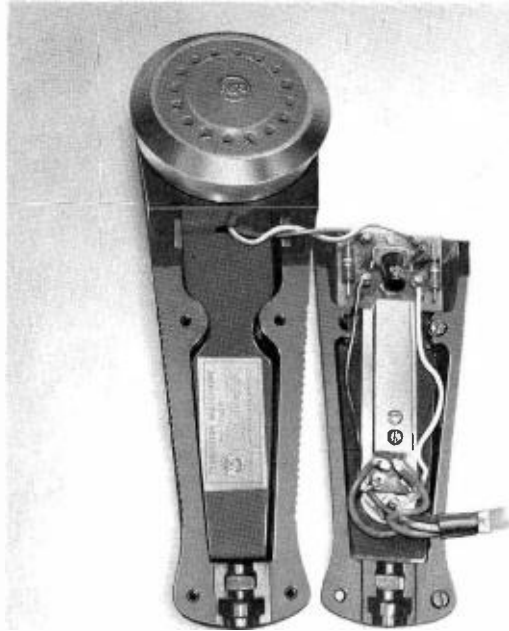

FIG. 2. Built-in transistor preamplifier increases sensitivity of CX-50 microphone and minimizes the possibility of noise pickup in the microphone cable. Single RCA 2N109 transistor is used in the preamplifier.

## TRANSISTORIZED MICROPHONE FOR COMMUNICATIONS USE

The first transistorized microphone designed specifically for two-way mobile radio communications was recently introduced by RCA. Completely interchangeable with conventional microphones, it provides appreciable improvement in intelligibility, voice quality and reliability.

The all-new instrument features a reluctance type mechanism and a built-in transistor preamplifier which increases sensitivity to the level of high-quality carbon microphones. The transistorized preamplifier permits full interchangeability without the preamplification devices normally required in the radio equipment. It also minimizes the possibility of noise pickup in the microphone cable.

### Achieves Engineering Goal

RCA's transistorized mike represents the achievement of an engineering goal of long standing—preamplification in a practical, low-cost microphone. This achievement was made possible by a combination of qualities found only in transistors—minuteness, ruggedness and low-power requirements which overcome the size and fragility problems of tube-type preamplifiers.

Successful operation of a single transistor amplifier in the new CX-50 microphone is made possible by a unique balanced feedback circuit recently developed by RCA engineers. This new circuit compensates for variations in load impedance, transistor gain and microphone elements—an engineering advance which makes the first application of transistors in this field a practical reality.

The microphone's built-in transistor amplifier is powered by the voltage normally supplied to a carbon microphone, making it a completely self-contained device which plugs directly into the mobile radio equipment without additional installation requirements or power drain.

### New Form Factor

Designed around an entirely new form factor, the microphone is styled for hand instead of palm-held operation. It was developed to meet the need for a microphone which nullifies the muffling effect of the hand, simplifies handling and hanging operations, and can be operated with equal convenience in either the right or left hand.

The microphone is styled with an elongated, tapering handle which nestles in the palm of the hand and raises the mouthpiece above the cupped fingers. A positive-action push-to-talk trigger bar is centered in the handle for either-hand operation.

The microphone incorporates a reluctance element for clear, distortionless speech and a single RCA transistor, which provides the audio amplification necessary for proper modulation of the transmitter. Other engineering features include: an output impedance of 450 ohms; frequency response of 170 to 4800 cycles per second; ruggedized construction to withstand shock, impact, heat, cold and humidity; and a "packaged" microphone element for quick and easy replacement.

Colorfully styled, the RCA CX-50 transistorized microphone features a bright red mouthpiece and a rugged, black plastic case, which carries a 5-year guarantee against breakage. The microphone measures  $6\frac{1}{2}$  inches long,  $2\frac{1}{16}$  inches wide, and  $1\frac{1}{16}$  inches deep and weighs only 9 ounces. It is delivered complete with a 65-inch cable, which is self-coiling to 18 inches.



## COAXIAL SWITCHING AT WFMY-TV

These RCA motor-driven VHF coaxial switches were recently installed at WFMY. They automatically transfer the 3/4-inch, 51.5-ohm transmission lines from the main transmitter to their auxiliary unit. They are remotely controlled from the transmitter room. Shown examining the switches are William E. Neill, Chief Engineer (left) and Gaines Kelley, General Manager. "Until the installation," reports Mr. Neill, "we had to make the change manually—with a considerable loss of air time. Now it is a matter of one switch and one second to transfer transmission lines from one transmitter to the other."

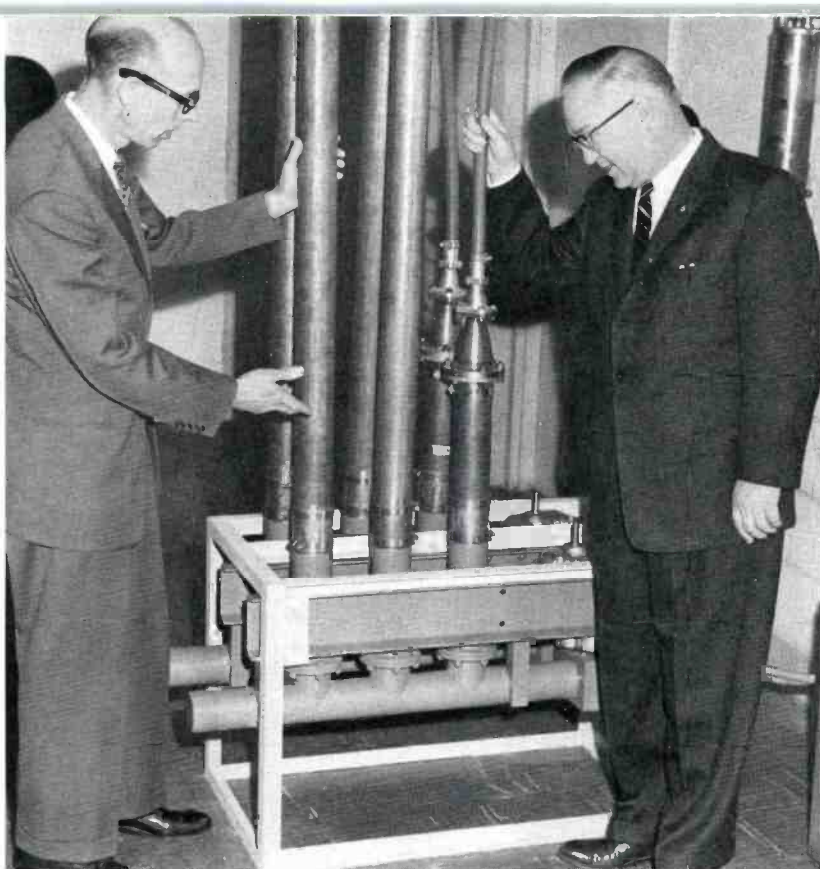

## REMOTE PHILADELPHIA STUDIO FOR WPFH-TV

A complete package of RCA television studio equipment has been installed by Station WPFH, Wilmington, Delaware, in a remote broadcast studio located in Philadelphia, Pa.

The Philadelphia studio was completed in time for a telecast of the first night road game of the Philadelphia Phillies National League baseball team on April 27. The Wilmington station, channel 12, is received throughout the Philadelphia area. During the summer, it will telecast a total of 26 Phillies night road games, originating from six other cities in the National League.

The remote studio was established to provide improved service and greater convenience for sponsors in the Greater Philadelphia area, and to expand the programming of WPFH to include Philadelphia entertainment facilities and talent.

The Philadelphia facilities, comprising two broadcast studios, are situated on the top floor of the Suburban Station Building, in the heart of the central business district. Programs and commercials originated in the studio, and the baseball telecasts received from the six National League parks are relayed directly to the WPFH transmitter near Wilmington for broadcast.

Paul F. Harron, President, WPFH Broadcasting Company (right) and A. R. Hopkins, Manager, RCA Broadcast and TV Equipment Dept., check out lens of RCA black-and-white live studio camera.

The installation provides live studio cameras, a microwave system, complete audio, special effects, a film system and essential control, power and accessory equipment.

A special feature enables WPFH to superimpose filmed action commercials on a televised background of baseball action from any of the six National League cities.





L. E. Sebald, project engineer at the San Francisco maintenance base of United Air Lines, demonstrates antenna of RCA C-band radar on "Mainliner O'Connor." It is the first installation in a \$4,000,000 program to equip the company's entire fleet with the new weather-mapping device. Nose of the Convair 340 has been extended 28½ inches to house radar antenna and gear mechanism.

# New Lightweight Weather-mapping Radar **AVQ-10**

by **GORDON DAGGY**  
Defense Electronic Products

New weather-detection radar which permits a pilot to see turbulent weather up to 150 miles ahead of his plane is now in production at RCA's Los Angeles plant. This advanced radar, known as the AVQ-10, is being produced for airline and business aircraft operators.

The AVQ-10 permits pilots to navigate between storm cores and around turbulent areas, enabling operators to maintain flight schedules and provide smoother rides for their passengers. The new equipment also provides for terrain mapping by adequately identifying land and water masses and detecting mountains.

The ability to "see" storms, utilizing radar principles, was encouraged by the experimental use of military navigational radar for weather mapping. Although not designed for this purpose, these military equipments did prove the feasibility of using radar for storm detection.

#### Selection of C-Band Frequency

Several years after World War II, a study contract was awarded to McGill University under ATA (Airline Transportation Association) and ARINC (Aeronautical Radio, Inc.) sponsorship to determine the



radar wavelength best suited for weather mapping. A final report on this study was released in February, 1953, with the conclusion that C-Band (5.5 Cm) radar could better penetrate intervening rainfall and "see" storms beyond the rainfall area with less distortion than radars operating on other frequencies.

Based on this information the Radio Corporation of America in 1953, in conjunction with United Airlines, constructed an experimental C-Band radar. United Airlines installed this RCA C-Band radar on a DC-3 and evaluated the equipment over a four month period in which forty technical and operational flights, involving 133 hours of flying time were made. Associated with the turbulent areas encountered during these flights were tornadoes, cloudbursts, abnormal amounts of rain and near-cloudburst rain.

The cockpit scope permitted crew members to make rapid and continuous comparison with visual cloud appearances. More than 6,000 radar pictures were taken. A log was maintained of the setting of controls for use in studying radar photographs and for comparison with radar and weather logs, cloud pictures and weather maps.

In all of these test flights, the pilot was able to select corridors of minor turbulence through areas of damaging hail and tornadoes, detouring these areas with a minimum deviation from the flight plan.

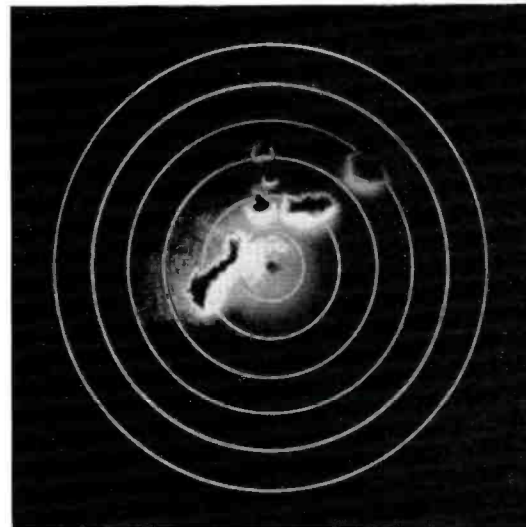

These pictures illustrate the ISO-Echo Contour feature. Here we see the same squall line displayed on the 30 mile range of the radar. The picture on the top, with ISO-Echo off, displays an unknown degree of turbulence. The picture on the bottom, with ISO-Echo on, identifies the locations of the greatest turbulence by the blacked out areas.





Complete AVQ-10 system, showing Receiver-Transmitter unit, Antenna, Control Panel, Accessory unit and two Indicators.

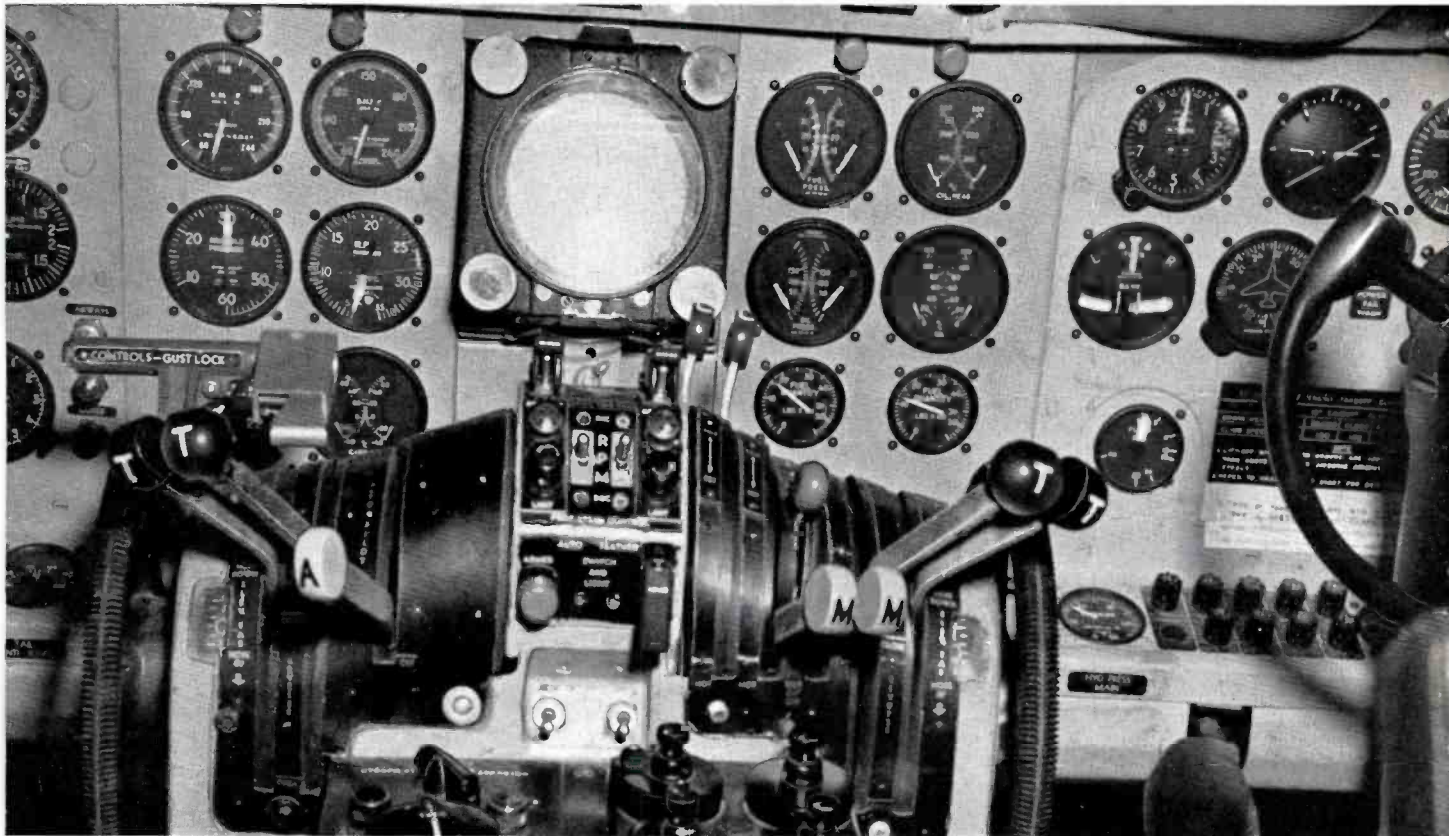

An illustration of one type of indicator installation, showing the scope mounted on the instrument panel between the pilot and co-pilot.

### ISO-Echo Contour

Analyzing the degree of turbulence displayed was simplified by the use of ISO-Echo Contour principles. The radar beam locates storm areas by means of the echoes which are returned from precipitation. The echo intensity from this precipitation is related to the concentration and size of raindrops, which is also a measure of storm intensity. Storm fringes show up on the radar scope as hazy light areas, while the storm centers show up as bright concentrations of light. The scope, however, produces a maximum intensity of light; consequently, progressively heavier rainfall areas will appear uniform on the display.

To provide a true picture of the degree of turbulence, the ISO-Echo Contour circuit was provided. This circuitry induces a black picture to appear on the scope when the signal-return intensity reaches a preset level. The black areas thus appearing represent the storm cores, the areas of greatest moisture density. These are the areas to be avoided at all costs.

### Lightweight Equipment

Weight factors were given prime consideration in the design of the AVQ-10. As a result, substantial weight reductions were made without any loss of quality, operating capability or penetration ability. A complete AVQ-10 system, including all units (less shock mounts), weighs less than 125 lbs. The system consists of five units, which include a Transmitter-Receiver, Accessory unit, Scope or Indicator, Control Panel and Antenna.

The Transmitter-Receiver provides 75 kw peak power at 5.400 mc signal to the Antenna unit and automatic frequency controlled 60-mc receiver signal information to the Accessory unit.

The Accessory unit contains the synchronizing, video, i-f and stabilization circuitry for the system. This unit also provides filament and plate power for one or two Indicators. The Indicator or radar scope has a 5-in. viewing screen and produces a 360-deg. continuously rotating PPI type of presentation.

The Control Panel of the AVQ-10 provides for selection of all necessary radar functions with a minimum of controls and is adaptable to almost any type of installation. A control is provided for setting the radar on 20, 50 or 150 mile ranges.

The Antenna comes with dishes of three sizes: 22 in., 30 in. and 34 in. depending on the type of installation. The antenna rotates 360 deg. at 15 revolutions per minute and scans effectively 270 deg. of the area in front of the aircraft. It can also be manually tilted plus 10 deg. and minus 15 deg. to scan above the plane or below for ground mapping.

### Installation

The installation of the AVQ-10 requires modification of the nose of the aircraft to accommodate the Antenna and minor internal modification. The Accessory unit and Receiver-Transmitter are usually located in standard radio racks of the aircraft. Indicator mounting is somewhat flexible and depends on the type of aircraft and the desires of the user. However, it is generally located in the instrument panel facing the pilot or in a receptacle on the floor between the pilot and the co-pilot.

### Acceptance

The AVQ-10 is fast becoming standard equipment for airline and business aircraft operators. Many of the world's leading airlines have already purchased the AVQ-10 including such companies as: Trans-World

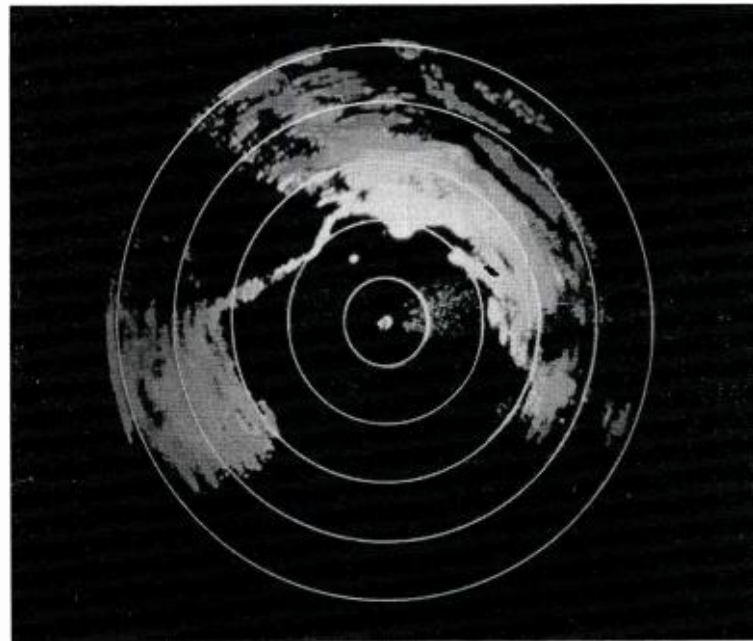

Airlines. Pan American World Airways, United Airlines, American Airlines, Swissair, British Overseas Airways Corporation and Air France. Many corporations which maintain DC-3 type executive aircraft have also purchased the AVQ-10. Among the more recent corporate customers are: Ford Motor Company, Scott Paper Company, Continental Can Company and Texaco Oil.

The AVQ-10 has become a vital instrument to these airline and business aircraft operators. Its installation greatly improves operational economy by permitting closer adherence to schedules and minimizing detours or flight cancellations. By avoiding turbulent areas, it provides for a smoother ride and consequently, greater peace of mind for passengers. These and many other features are contributing significantly to improving the already high standards of air transportation.

This scope photograph shows a typical terrain picture as it appears on the indicator. The thin line on the left of the scope is the outline of a bridge, the light area is land and the dark area water. The antenna in the nose of the plane is tilted down to obtain this type information.



# WAAM-TV Gets



**TWO FILM CHAINS MODIFIED!** Picture above shows modernized WAAM-TV film projection room. The RCA TK-21 Vidicon Cameras are mounted on TP-11 Multiplexers. One TP-16 Film Projector, one 35 mm slide projector and an opaque projector are used with each camera. The two independently operated chains increase ease of operation and provide preview and auditioning facilities.



**SPARE CAMERA!** Simplicity and small size of RCA TK-21 make it practical to keep a third camera on hand as a spare. This allows either film chain to be quickly returned to service in emergencies and provides station clients with this assurance of continuous programming.

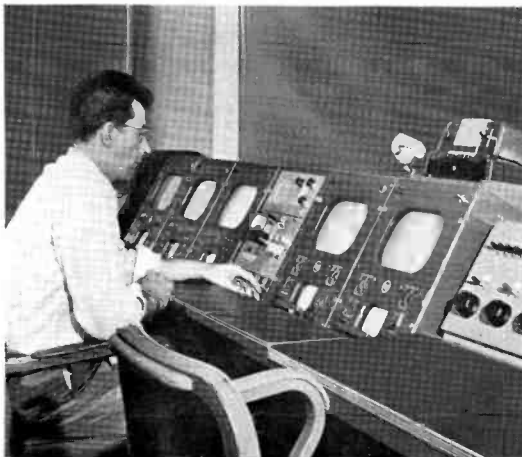

**MINOR CHANGES IN CONTROL ROOM!** Second and third monitors from left are the vidicon master monitors. Their housings also enclose the camera control panels. Installation was relatively simple since the station's original film monitors and housings were used. No changes in arrangement were required—vidicon control panels being substituted for control panels of the iconoscope cameras.

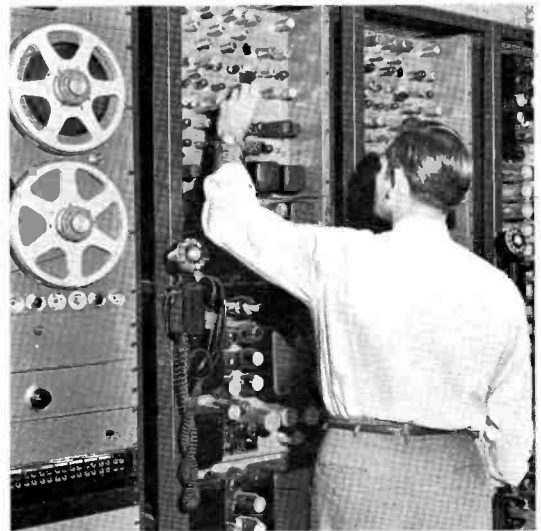

**SIMPLE RACK ADDITIONS!** Closeup of the two cabinet racks containing auxiliary and power equipment for the two vidicon film cameras. Only the vidicon control chassis and vidicon deflection chassis (top and next to top panels in each rack) had to be installed in each chain. Power supplies were already part of original equipment. Racks are readily accessible for setup, adjustment and maintenance.



# Better Picture Quality

## *by Replacing Iconoscope Film Cameras with RCA Vidicon Film Cameras*

---

WAAM-TV, Baltimore, has replaced its iconoscope film cameras with RCA Vidicon Film Cameras and is obtaining much improved pictures at lower operating cost. WAAM-TV's two iconoscope film camera chains had been in operation for over six years. During that time a number of improvements in original circuitry had been incorporated to boost iconoscope performance.

### **VIDICON PERFORMANCE INVESTIGATED**

In their search for further improvement WAAM-TV engineers inspected one of the first RCA Vidicon chains at Camden. They immediately noted performance that surpassed the iconoscope chain in almost every respect . . . marked improvement in gray scale, tremendously increased signal-to-noise ratio, improvement in resolution, elimination of shading signals, and provision for automatic black level control.

### **TESTS PROVE VIDICON SUPERIORITY**

Actual operating comparisons were made by WAAM-TV engineers by running several of the station's own films on both the iconoscope and vidicon chains. Says Ben Wolfe, WAAM-TV's Director of Engineering, "The reproduction from the vidicon chain was superior in each instance, with a minimum of operating effort." As a result of this demonstration WAAM-TV decided to modernize with vidicons.

### **STATION SAVINGS ON CONVERSION**

WAAM-TV's purchase and installation of two RCA Vidicon chains shows how operating cost can be reduced by modernization of existing equipment. The economy afforded by using existing iconoscope auxiliary equipment —master monitors, console housings and power supplies —permitted expanded station versatility through the use of two multiplexers with two vidicon chains. Since no changes in arrangement were required in the master control room (vidicon remote control panels were merely substituted for the control panels of the iconoscope cameras) actual installation was simplified, allowing greater ease of operation.

### **AGENCIES APPLAUD IMPROVED QUALITY**

The quality of WAAM-TV's film reproduction has received hearty endorsement from advertising agencies who appreciate its sales effectiveness. Their comments have stressed the "snap," clarity and live effect noticeable in WAAM-TV film presentations. This praise, from men who make it their business to recognize top performance, is the final proof of "RCA Vidicon quality."

You, too, can transform film shows and commercials that are just "getting by" into sparkling, life-like hits! Do it with an RCA Vidicon Film Camera System . . . conveniently and economically. Ask your RCA Broadcast Sales Representative for complete details. In Canada, write RCA Victor Ltd., Montreal.



**RADIO CORPORATION of AMERICA**

**BROADCAST AND TELEVISION EQUIPMENT CAMDEN, N. J.**

# NEW...

# RCA

## All New Type

### 10,000 WATTS



With High Quality Sound Channel

*Good Color  
Performance  
Depends on These  
Specifications*

- Power Output . . . 1 Watt, Nominal.
- Differential Gain (Linearity) . . . 0.5 db max.
- Differential Phase Distortion (at 3.58 mc) . . . less than 1%.
- Amplitude Frequency Response . . . Flat within 0.5 db 60 cycles to 6 mc.
- Synchronizing Signal Compression . . . Negligible.
- Low Frequency Square Wave Response . . . Less than 1% tilt at 60 cycles.

*For descriptive literature on this newest of microwave systems or help in planning your microwave setup, consult your RCA Broadcast Sales Representative.*

# MICROWAVE

**High-Power**

## **TVM-1A designed for Color TV**

(Best for Monochrome, too)

**ERP AT 7000 MC**

---

The TVM-1A is the only microwave equipment designed specifically as an integral part of a complete color TV system . . . from color originating equipment to color receivers. Whether you're a monochrome or color user, you will appreciate these special advantages:

### **HIGH POWER**

An increase of 10 in transmitter power and about 3 db in receiver sensitivity offers 20 times the power margin of the popular RCA TTR-TRR series of microwave equipment. This means greater operational reliability with an increased fading margin.

### **SOUND DIPLEXING**

Included in the TVM-1A system is high quality audio channel for the simultaneous transmission of sound along with picture

information. This sound channel is well within FCC requirements for a studio-to-transmitter link (STL).

### **TRANSMITTER AUTOMATIC FREQUENCY CONTROL**

Transmitter AFC offers exceptionally good frequency response and highest stability. It is especially useful in multihop operation with unattended repeater stations.

### **TRANSMITTER PICTURE MONITORING**

This facility assures an actual high quality "air" signal. It simplifies trouble shooting procedures and is also extremely useful in the operation of unattended repeater stations.

*RCA Pioneered and Developed Compatible Color Television*



**RADIO CORPORATION of AMERICA**  
ENGINEERING PRODUCTS DIVISION

CAMDEN, N.J.





# NOW...

## RCA PRINTED CIRCUIT

### PLUG-IN AMPLIFIERS FOR BROADCAST USE!

*Provide These Outstanding Benefits...*

**SMALL SIZE** . . . Considerably smaller than previous Broadcast Audio Amplifiers the RCA printed circuit series occupies about  $\frac{1}{2}$  the rack and shelf space formerly needed. You free rack space for other AM and TV equipment, reduce rack and mounting shelf costs.

**HANDLING EASE** . . . Quick, safe and effortless installation or removal is assured by compact, light weight construction. Dependable 15-pin keyed connectors provide fool-proof positioning for rapid "in and out" handling. Connecting pins are gold plated to assure excellent electrical contact.

**UNIFORM PERFORMANCE** . . . The printed circuit assures uniformity and excellent frequency response. All units achieve extra dependability through use of hermetically sealed transformers. Each amplifier is provided with output terminals and a switch to facilitate current metering.

**REDUCED-SIZE ACCESSORIES** . . . Accessories such as BR-22A mounting shelf and BX-21A power supply used with the printed circuit amplifiers have also been "miniaturized." Example: shelf BR-22A, only  $\frac{5}{4}$ " high can accommodate the following combinations of equipment: 10 BA-21A Preamplifiers, 3 BA-23A Program Amplifiers plus 1 BA-21A, 2 BX-21A Power Supplies plus 2 BA-21A, 2 BA-24A Monitor Amplifiers.

*For complete details of the many further advantages of RCA's printed circuit amplifiers, call your nearest RCA Broadcast Representative. Ask for literature.*



**RADIO CORPORATION of AMERICA**  
ENGINEERING PRODUCTS DIVISION CAMDEN, N. J.



**BA-21A PREAMPLIFIER** . . . Ideal as a microphone preamplifier, turntable preamplifier or booster amplifier. May be used as isolation amplifier by adding an MI-11278-E or F bridging volume control. Due to its small size, it may be placed in a control console, control desk or transcription turntable cabinet. One to ten of these units may be installed in a single BR-22A panel and shelf assembly.

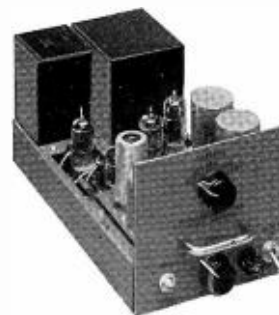

**BA-23A PROGRAM AMPLIFIER** . . . A versatile high-fidelity amplifier using special high-quality components and providing maximum accessibility. High gain and low distortion make it without equal as (1) program or line amplifier, (2) bridging amplifier, (3) isolation amplifier. Three BA-23A amplifiers can be mounted on BR-22A shelf with space for an additional amplifier.



**BA-24A MONITORING AMPLIFIER** . . . A high fidelity, high-gain, flexible 8-watt amplifier suitable for monitoring, audition, recording and talk-back uses. Also serves as a program or line amplifier. Excellent for transcription playback booths, since the 105 db gain will operate a speaker (LC-1A) directly from the output of a turntable (70-series). Also an excellent recording amplifier.

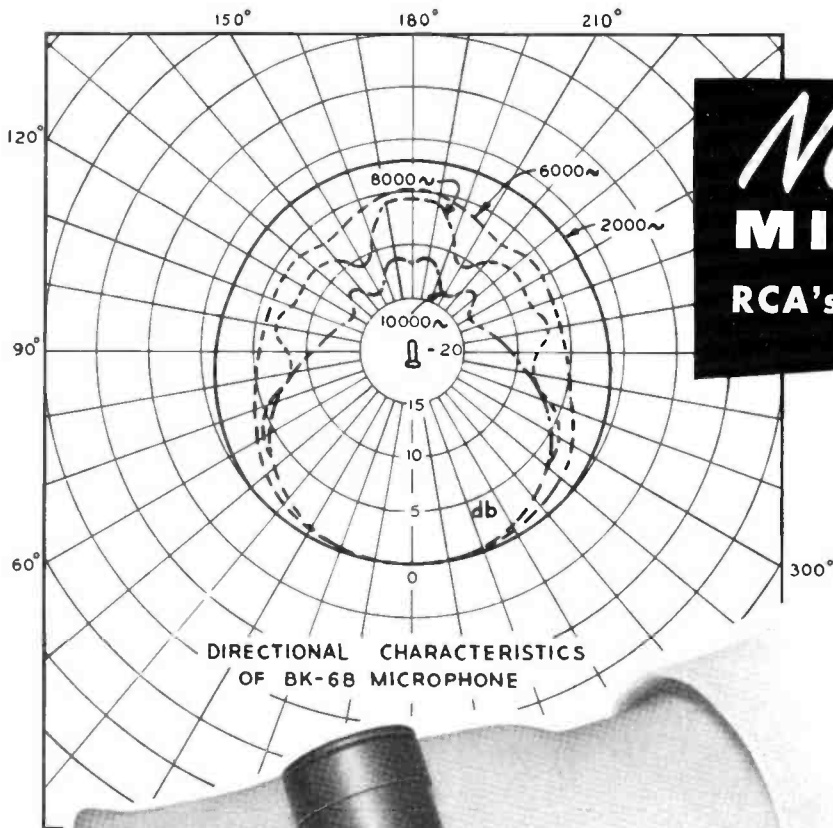

# New PERSONAL MICROPHONE

## RCA's BK-6B Miniature Mike

- Half the size (by volume) of the BK-6A!
- Excellent speech balance when talking "Off Mike!"
- Wide range Frequency Response!

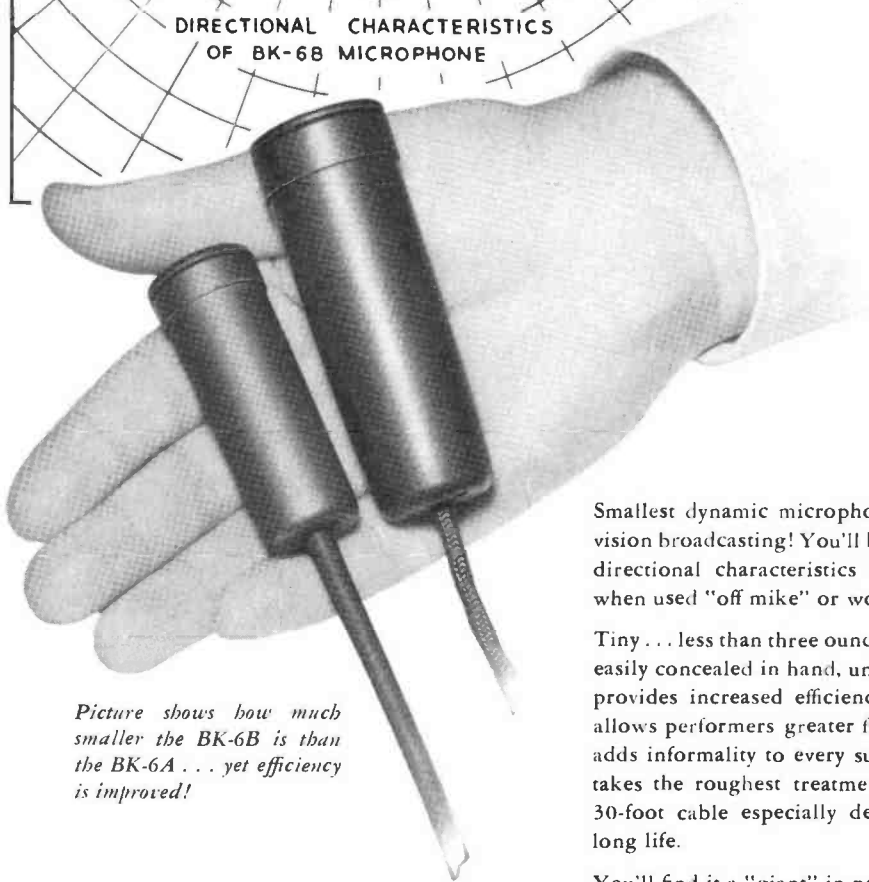

*Picture shows how much smaller the BK-6B is than the BK-6A . . . yet efficiency is improved!*

Smallest dynamic microphone ever developed for radio and television broadcasting! You'll be amazed by its frequency response and directional characteristics that provide superior speech balance when used "off mike" or worn on the person.

Tiny . . . less than three ounces in weight, this new miniature mike is easily concealed in hand, under necktie, or corsage. Versatile . . . it provides increased efficiency to difficult walk-around operations, allows performers greater flexibility and freedom of movement . . . adds informality to every such production. Tough . . . the BK-6B takes the roughest treatment in stride, is furnished with flexible 30-foot cable especially designed for ease of manipulation and long life.

You'll find it a "giant" in performance for a wide variety of broadcast applications. Ask your RCA Broadcast Representative for complete information. In Canada, write RCA VICTOR Company Ltd., Montreal.



# RADIO CORPORATION of AMERICA

BROADCAST AND TELEVISION EQUIPMENT

CAMDEN, N. J.



# 5

## Reasons Why the RCA-5820 Image Orthicon is Preferred by TV Station Men



**Cameramen** like the picture they get with an RCA-5820 Image Orthicon. RCA-5820's are stable, have excellent color response.



**Sales Managers** have a beautiful picture to sell the sponsor—products look good to the buying audience. RCA Image Orthicons in the cameras do wonders for the "sales picture".



**Producers** know that they have almost unlimited scope of operation—with RCA Image Orthicons in the cameras. "Eye-level" sensitivity of these tubes makes it possible to pick up any scene they want—regardless of location.



**Chief Engineers** appreciate the technical advantages of RCA Image Orthicons. The tubes enable them to train operators quickly, produce quality pictures over a wide range of light levels.



**Technical Directors** make good use of the capabilities of RCA Image Orthicons. They get the depth of focus they need . . . they are sure of high picture uniformity between cameras . . . they can produce a wide variety of lighting effects.



With a record of performance as well-known to telecasters as station call letters, the RCA-5820 Image Orthicon has been serving TV stations faithfully since 1949. No finer black-and-white camera tube is built.



**PICK-UP TUBES for TELECASTING**

RADIO CORPORATION OF AMERICA