

Jamison
**RCA
Broadcast
News** Volume 175

Broadcast and Teleproduction Happenings

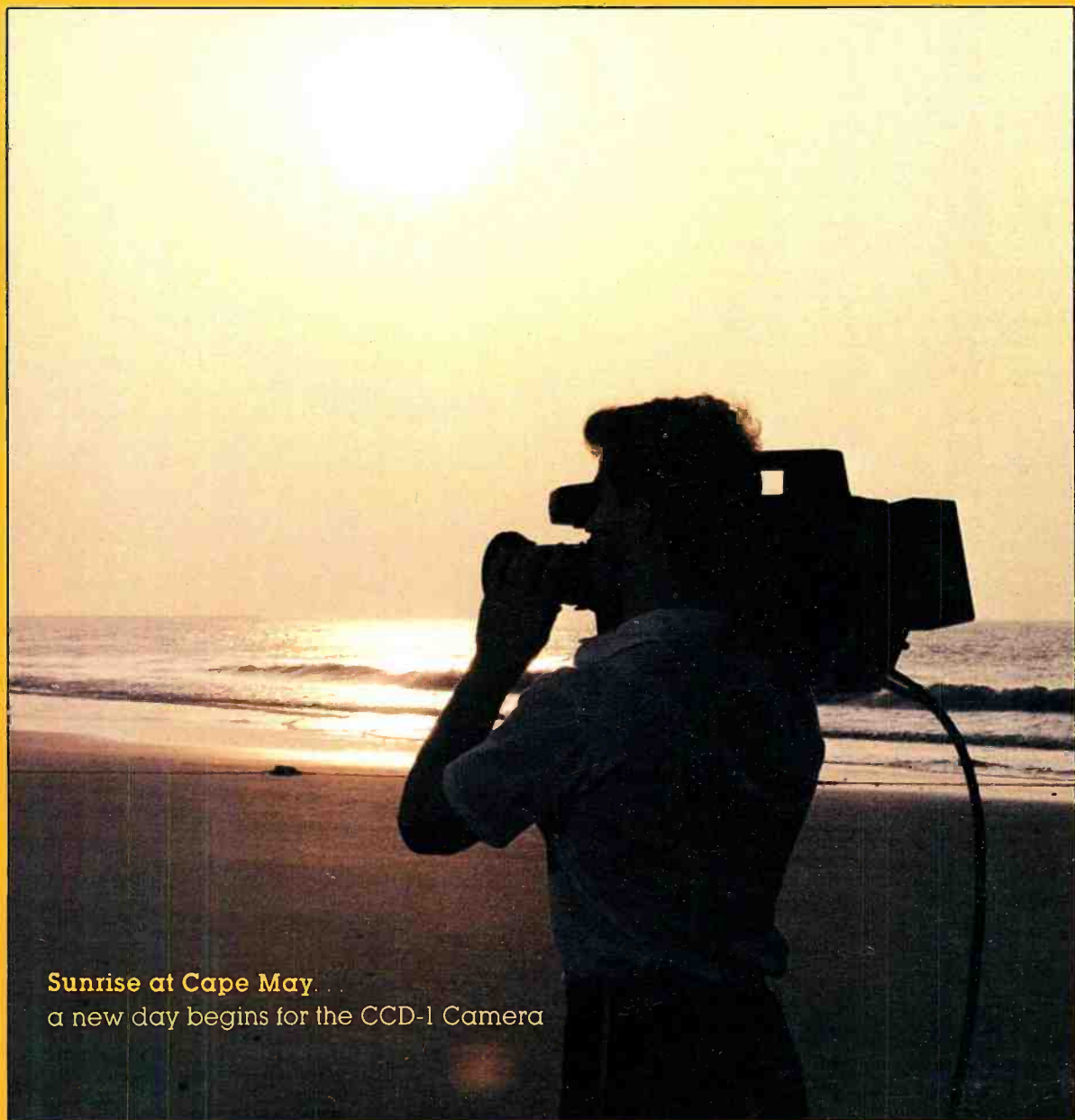

Sunrise at Cape May
a new day begins for the CCD-1 Camera

45 REASONS

WHY RCA RECEIVED AN EMMY FOR CP ANTENNA DEVELOPMENT

You, the broadcaster, saw the need for better coverage and better saturation of your television signals. RCA met the challenge with a solution—the CP Antenna.

Today there are 45 CP installations criss-crossing the country from Maine to Florida, from New York to California, and Internationally from Latin America to South Korea.

We salute these leading broadcasters who chose RCA CP Antennas for excellence in performance...and we thank the National Academy of Television Arts and Sciences for this prestigious award.

UNITED STATES

1. **KCPQ**, Tacoma, WA
2. **KCRA**, Sacramento, CA
3. **KHJ**, Los Angeles, CA
4. **KJRH**, Tulsa, OK
5. **KOTV**, Tulsa, OK
6. **KPRC**, Houston, TX
7. **KSTW**, Tacoma, WA
8. **KTRK**, Houston, TX
9. **KTSP**, Phoenix, AZ
10. **WABC**, New York, NY
11. **WBNS**, Columbus, OH
12. **WBRZ**, Baton Rouge, LA
13. **WBTW**, Charlotte, NC
14. **WBTW**, Florence, SC
15. **WCBB**, Lewiston, ME
16. **WCMH**, Columbus, OH
17. **WCTI**, New Bern, NC

18. **WDSE**, Duluth, MN
19. **WDSU**, New Orleans, LA
20. **WFMY**, Greensboro, NC
21. **WGRZ**, Buffalo, NY
22. **WHAS**, Louisville, KY
23. **WITN**, Washington, NC
24. **WNCT**, Greenville, NC
25. **WOWT**, Omaha, NB
26. **WPBT**, Miami, FL
27. **WPSD**, Paducah, KY
28. **WRAL**, Raleigh, NC
29. **WSTE**, Puerto Rico
30. **WTHR**, Indianapolis, IN
31. **WTTV**, Indianapolis, IN
32. **WTVB**, Durham, NC
33. **WTVW**, Evansville, IN
34. **WVTM**, Birmingham, AL
35. **WWAY**, Wilmington, NC

INTERNATIONAL

36. **Dicon**, Buenos Aires, Argentina
37. **KBS**, Seoul, South Korea
38. **SBT**, São Paulo, Brazil
39. **TV Litoral**, Rosario, Argentina
40. **TV Andina**, Lima, Peru
41. **TV Globo**, São Paulo, Brazil
42. **TV Manchete**, Rio de Janeiro, Brazil
43. **TV Manchete**, São Paulo, Brazil
44. **TV Nacional**, Santiago, Chile
45. **XETV**, Tijuana, Mexico

RCA Broadcast News

December 1984 Vol. No. 175

CONTENTS



ABOUT THE COVER

Since their impressive 1984 NAB debut, RCA's solid state CCD-1 cameras have been thoroughly evaluated and field-tested.

The front cover shows the camera in use at the New Jersey Seashore, recording typical summer scenes for "A Director's Diary", a videotape report. Back cover contains off-monitor shots from the tape. Edited to a fast-paced eight minutes, this tape shows the kind of pictures the CCD-1 camera routinely produces in "real world" situations. Tape viewings may be arranged through RCA Representatives.

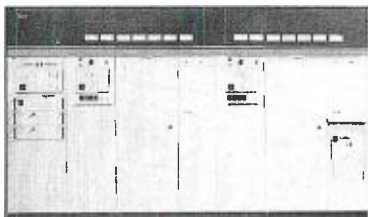

2 High Efficiency UHF Transmitter

The TTG-100U, 100 kW Transmitter maximizes the benefits of new high power klystron tube technology. Design considerations and performance test data are covered.

8 WBRZ-TV Switches To CP Operation

For TV-2, Baton Rouge, the move to circularly polarized transmission produced dramatic results where it counts most—in better pictures on viewers' TV sets, particularly those with "rabbit ear" antennas.



12 Success Creates Success For McKinnon Broadcasting

When KBVO-TV, Austin, went on-air in December 1983, its path to profitability was already mapped. The combination of quality independent programming, superior technical facilities and strong management made it happen in just five months. This article covers the CH. 42 operation.

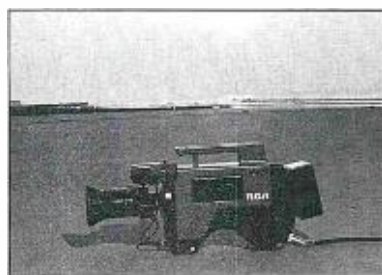

22 CCD Camera— "Goodbye" For Deflection Designs

The advent of charge-coupled device cameras obsoletes tube yoke and deflection development. This tutorial, amply illustrated article presents more background on CCD technology.



28 Little Rock's New "U" Sets Fast Pace

KLRT-TV, with 5 megawatts ERP, is the most powerful signal and the only "U" in the market. Effective counter programming coupled with hard-hitting promotions have catapulted CH. 16 into a strong competitive position.

RCA

HIGH EFFICIENCY 100kW KLYSTRON TRANSMITTER TECHNOLOGY

Glenn V. Wild
Manager, Transmitter Engineering
RCA Broadcast Systems Division

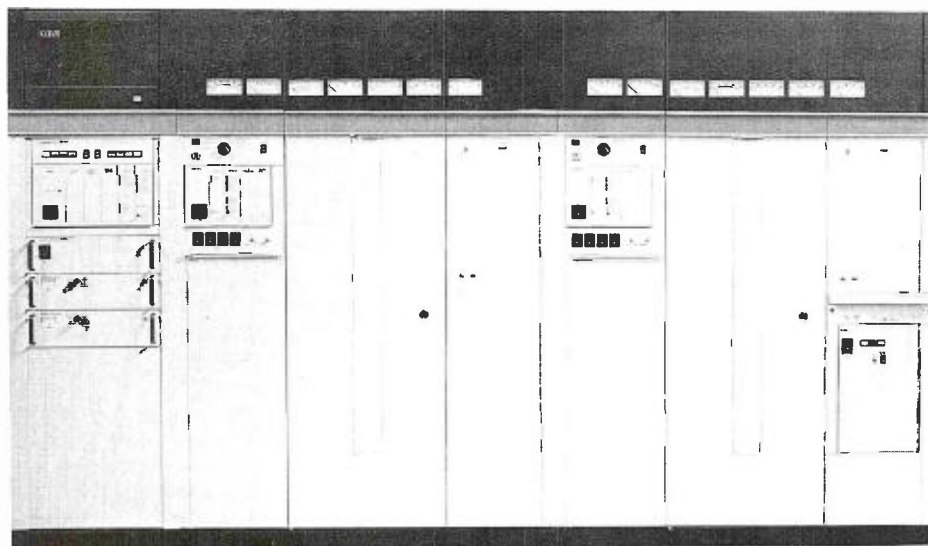

Front line cabinets of 100 kW TTG-100U Transmitter span a total of 152 inches. The power amplifiers are 48 inches deep.

INTRODUCTION

Development of a new class of high power UHF Television klystrons with power output capability in excess of 100 kW permits a cost-effective transmitter design alternative to paralleling of medium power klystrons. Additionally, two parallel klystron amplifiers provide a compact and economical 200 kW transmitter, heretofore requiring up to four klystrons.

The new Varian VKP 7853 series of klystrons provide saturated power output of 100 kW with CW collector efficiencies of 55%. To maximize the inherent benefits of this new power tube, RCA has designed a new television transmitter—TTG-100U—which has achieved collector efficiencies of 79% in Visual service using modulation anode sync pulsing techniques.

Transmitter design considerations to accommodate specific klystron electrical, mechanical, and cooling interfaces are discussed; and a description of the transmitter design and performance test data are presented herein.

DESIGN REQUIREMENTS

Klystron Characteristics

The Varian VKP Series klystrons have been developed to provide 110 kW saturated power output in the UHF television band 470-806 MHz.

The tubes are liquid cooled, five integral cavity designs which operate with a variable visual coupler interfacing the output.

Minimum saturated (CW) efficiency of the tubes is specified as 55%; however, the important issue in television transmitter design is the rated peak sync power efficiency achieved with satisfactory video linearity, both with and without modulating anode pulsing. Maximizing this overall performance requires appropriate matching of the exciter, IPA and pulsing system designs to the klystron characteristics.

Standard klystron protection devices are required for body, beam, ion and magnet over/under current overloads, as well as collector and magnet current water flow. Arc detection, provided in the output coupler, and output VSWR detection is re-

quired to remove RF drive as with other high power transmitters. A summary of these control/protection requirements includes:

- Filament Warm-up
- Collector Water-Flow
- Collector Water Temperature
- Magnet Water Flow
- Magnet Current (Under/Over)
- Vac Ion Voltage Low
- Body Current Overload
- Beam Current Overload
- Ion Current Overload
- DC Overload
- Output Arc
- Output VSWR
- RF Input Overdrive

Major transmitter design considerations using this klystron include:

- a. Increased beam voltage (approximately 30% above 55/60 kW klystrons), requiring higher component standoff insulation.
- b. Increased mod anode voltage requiring higher sync pulser DC operating voltages.
- c. Increased power rating of output components such as harmonic filters, capable of 65 kW average powers.
- d. Increased input RF drive power requiring 50 watts linear or 100 watts saturated intermediate power amplifier (IPA).
- e. Appropriate Exciter linearity precorrection.
- f. Increased second cavity load power of up to 500 watts.
- g. Increased water coolant flow requiring both low pressure (collector) and high pressure (body, magnet, coupler) pumps.
- h. Two adjustable magnet coil power supplies.

Transmitter Operating Mode Requirements

Transmitter operation both with and without visual mod anode pulsing is required. Multiplex operation with visual and aural carriers is required for emergency operation. Additionally, characterization of the VKP 7853 in aural service is also required for those transmitters utilizing identical visual and aural power amplifier klystrons.

Fig. 1 itemizes the operating modes and power levels established for this new UHF transmitter.

The visual service peak sync power objective was established at 105 kW at the harmonic filter output, which accommodates notch diplexer losses up to 5%, yielding a 100 kW transmitter output rating.

Non-pulsing operation may be required in the event of pulser failure, or transmitting video waveforms which exclude sync pulsing, or visual/aural carrier multiplex (MPX). MPX operating power levels are normally limited by acceptable in-band intermodulation performance. Visual power levels of 80% of rated level, and aural power levels of 5% visual have been established as goals for emergency operation.

Aural service requires FM (CW) power levels of 10 kW (10%, 100 kW visual) up to 40 kW (20%, 200 kW visual). Allowing for 10% aural power loss in the notch diplexer, aural powers of 11 kW to 44 kW are required at the harmonic filter output.

MODE	BW	POWER
1. VISUAL, NON-PULSING	6 MHz	105 kW, PK(1)
2. VISUAL, PULSING	6 MHz	105 kW, PK(1)
3. AURAL	~ 2 MHz	11 kW(2) 22 kW(2) 44 kW(3)
4. VISUAL OR AURAL (VKP 7853)	6 MHz	84 kW, PK, VIS.(1) 5.3 kW, AUR.
5. AURAL PA MULTIPLEX (VA 890)	6 MHz	24 kW, PK, VIS.(1) 1.6 kW, AUR.

(1) VISUAL POWER AT HARMONIC FILTER OUTPUT, PERMITTING 5% NOTCH DIPLEXER LOSS. AURAL POWER AT HARMONIC FILTER OUTPUT, PERMITTING 10% NOTCH DIPLEXER LOSS.
 (2) 10% and 20% of 100 kW. VA 890. 30 kW AURAL PA KLYSTRON CANDIDATE.
 (3) 20% of 200 kW. VKP 7853. AURAL KLYSTRON CANDIDATE.

Fig. 1. 100 kW Transmitter Operating Mode Requirements

Operation of klystrons substantially below their saturated power output capability, generally impacts Aural power amplifier efficiency even with narrowband tuning optimization. However, the Aural bandwidth must be adequate for minimum distortion of multi-channel sound transmission which is approximately 2 MHz.

Depending on particular station operational needs, including desired Aural power amplifier MPX power levels, a more cost-effective design for the Aural klystron is a lower power level tube such as the VA 890 which is rated at 33 kW saturated output power. This klystron will provide 20% Aural power as well as 24 kW peak visual power in MPX service.

Use of a VKP 7853 for the aural power amplifier will provide maximum backup MPX power (84 kW peak visual); however aural service efficiency at lower powers must be considered.

IPA and Exciter Design

The Intermediate Power Amplifier (IPA) power output and the Exciter linearity correction requirements change with the specific klystron operating mode, i.e., mod anode pulsing or non-pulsing operation.

With non-pulsing operation, the klystron gain is highest with the tube biased for higher beam current. The required Exciter/IPA sync stretch is also the greatest to compensate for klystron compression effects.

When sync pulsing the klystron, the mod anode voltage at blanking (black) level is adjusted to minimize beam current for maximum efficiency, while pulsing up to higher beam currents during sync. The drive requirements are now changed to require Exciter/IPA sync clipping and a revised black/white linearity correction.

ICPM correction must also be changed for these two operating modes. The Exciter design

NEW UHF TRANSMITTER DESIGN

should automatically switch from one correction to another with operator selection of Pulser ON/OFF or MPX modes, which may be accomplished remotely.

Additionally, the Aural Exciter design must provide wideband multichannel sound capability.

The IPA design may employ either Class A or Class AB biased amplifiers consistent with overall transmitter intermodulation, lower sideband reinsertion and other factors. Use of Class AB amplifiers does modify the Exciter linearity correction, especially in the white level region.

Further, the IPA and Exciter power output capability should exceed the nominal requirements by a few dB to avoid additional linearity correction, and to provide reasonable margin for klystron gain differences.

RF System Design

The VKP 7853 output interface, illustrated on block diagram, Fig. 2 consists of a 3/8-inch coaxial coupling to a variable visual coupler, similar to those used for Varian 60 kW klystrons. Liquid cooling of the variable coupler is required, however, simple series connection with magnet/body water is necessary. The output flange assembly contains a built-in detector requiring interface to protection control circuits.

Transition to 6/8-inch coaxial line directly at the variable coupler output is necessary at the operating power levels, which are approximately 60-65 kW average with black picture transmission.

A new coaxial high power harmonic filter was required for this transmitter; however, available waveguide Notch Diplexers and waveguide "Magic Tee" systems parallel transmitters (200 kW) provide adequate power handling capability.

An RF input matching stub was required for the initial low band klystron only.

TRANSMITTER DESIGN DESCRIPTION

System Design

The TTG-100U transmitter system, shown on

Fig. 3 block diagram, is constructed with three front line cabinets:

- Exciter/Control
- Aural Power Amplifier
- Visual Power Amplifier

A fourth cabinet, the AC Control Unit, is designed for placement at a convenient location between the primary power interface and the HV Beam Supply to minimize 480 VAC, 3 phase wiring lengths.

The heat exchanger and pumps, Notch Diplexer and transmission line components complete the system hardware.

For those installations using a VA 890 aural PA klystron, a second Beam Supply providing 18 kV is required. Both Beam Supplies are energized via contactors in the AC Control unit, which distributes AC power to the entire system.

The Exciter/Control cabinet contains the master transmitter control unit which interfaces PA Control units located in each power amplifier, and the AC Control Unit. All Remote interface is provided at the transmitter control unit. The Visual Exciter, Aural Exciter and Exciter Power Supply units are packaged in separate 5/8-inch drawers within the Exciter/Control cabinet.

The Visual Power Amplifier (PA) cabinet contains the IPA and its power supply, Mod Anode Pulser, PA Control Logic, Magnet Power Supplies, Harmonic Filter, and the Klystron.

The Aural Power Amplifier construction is basically the same as the Visual PA, however, the Mod Anode Pulser is not required. With the VA 890 Aural klystron only one magnet power supply and a lower power IPA are used.

Control System Design

The transmitter control system is a distributed design which uses individual Power Amplifier Control Units for control, status, and telemetry interfaces within the PA cabinet and provides single point interface with the Transmit Control Unit.

The Transmit Control unit provides single

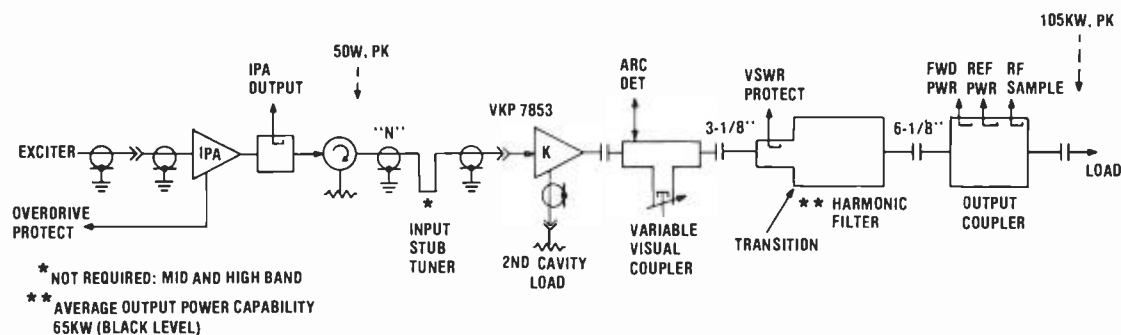

Fig. 2. 100 kW Power AMP RF Input and Output Circuit Requirements

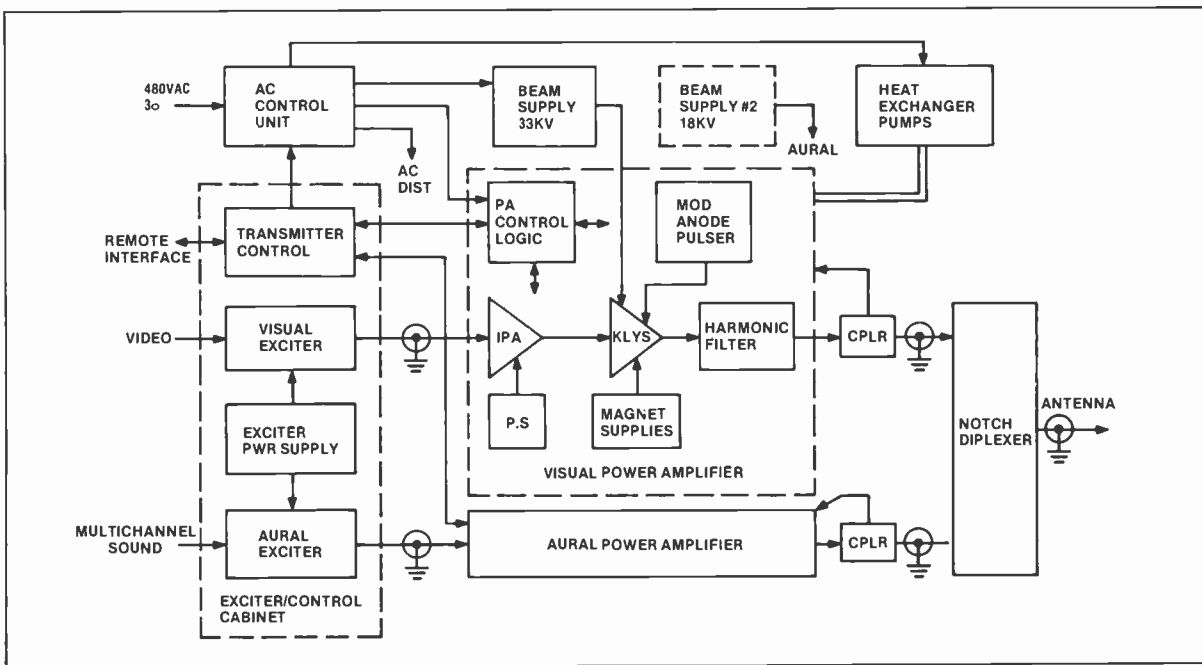

Fig. 3. TTG-100U, Simplified System Diagram

point Remote interface, and provides control to power contactors within the AC Control unit.

The Remote interface provides 22 control inputs, 32 status outputs and 19 analog telemetry outputs.

This distributed control design minimizes single point failure effects by minimizing the common logic within the master Transmitter Control Unit. Simple expansion to parallel transmitter configuration is provided with a single ribbon cable interface to each power amplifier.

Transmitter logic provides multiplex visual and aural transmission through either the Visual or Aural power amplifiers for single-ended transmitters.

The CMOS logic is battery supported and provides automatic restart with power interrupt. One or three fault lockout function is selectable.

All status functions are displayed locally with LEDs on the equipment front panels as shown on Fig. 4.

Front panel access is provided to all transmitter control logic including analog sensor adjustments, while operating without need to access high voltage areas.

AC Distribution and High Voltage Design

The 480 VAC primary power input main breaker is contained within the AC Control Unit, from which individual breakers distribute power to all units of the transmitter.

Heat Exchanger pump selection for standby pumps is provided here for both the 7.5 HP Collector and the 3 HP Body pumps. Automatic

standby pump switching, controlled by pressure sensors, is optionally available. The heat exchanger uses a 15 HP blower.

The HV Beam Power Supply 480 VAC input is energized with step-start contactors located within the AC Control Unit. Switched series resistance limits the turn-on current transient and high voltage output (approximately 50% final voltage) for 0.4 seconds during start-up.

The 33kV, 260 kW Beam Supply is an integral, exterior mount design which contains a built in

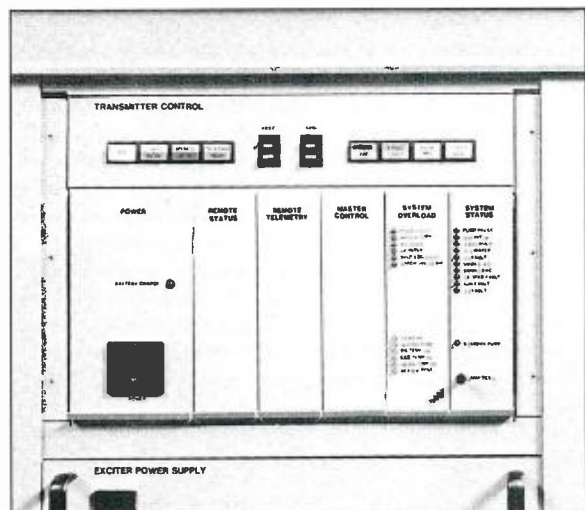

Fig. 4. Transmitter Control and Remote Interface Front Panels

delta-ye primary useful for low voltage klystron tune-up. A removable diode rectifier assembly is also immersed within the coolant oil, however the filter capacitors and 40 kV arc gap are located within the supply power connect entry panel. Primary tap connections permit output voltage changes over a range of line voltage inputs.

The Beam Supply output interfaces the Power Amplifier via a built-in HV disconnect switch which is both electrically solenoid operated and is also mechanically locked out by the key interlock system. The HV disconnect switch also provides internal PA cabinet HV grounding for personnel protection.

Fig. 5 illustrates the HV Beam Supply interconnect to the Power Amplifier cabinet and the klystron DC current sensors. As illustrated, a 15 kV Arc Gap is used to protect the Mod Anode Pulsar.

rier transmission via either the Visual PA or the Aural PA in a single-ended transmitter accomplishes emergency back-up operation with the loss of either PA. This feature provides on-air availability advantages generally associated with parallel transmitters.

Multiplex transmission via the Visual PA upon Aural PA failure has usually been available with existing transmitters. This is accomplished with visual/aural IF summing in the Visual Exciter and requires Notch Diplexer de-tuning to transmit both carriers with the Visual PA.

Aural PA MPX requires the same visual/aural carrier summing within the Visual Exciter, however Exciter output/PA input transfer is required as illustrated on Fig. 6. Additionally, Notch Diplexer bypassing is required via transmission line switching or patching.

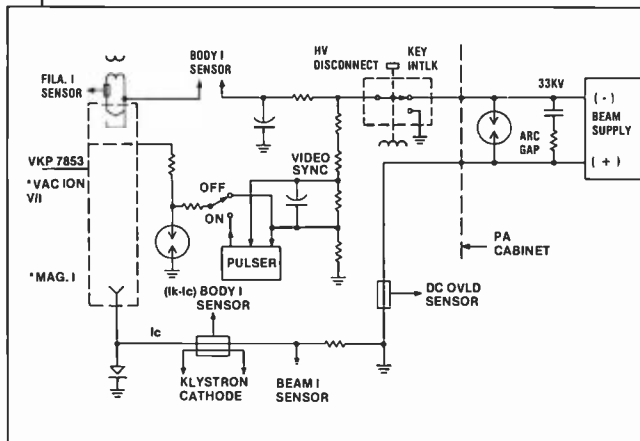

Fig. 5. 100 kW Klystron DC Protection Circuits

Visual Exciter and IPA RF Design

The Visual Exciter output contains a linear broadband Class A, 6 watt peak sync rated amplifier, which is driven by a 1 watt peak sync rated amplifier. These amplifiers are capable of providing 10 watts and 3 watts CW power output respectively.

Exciter power output control is accomplished via an Automatic Level Control (ALC) interface module which is inputted by the Visual Power Output Control, Mode (pulse, non-pulse, MPX) selection, and PA drive attenuation commands (VSWR, ARC, Overdrive).

Adjustments to video and IF linearity correction sync stretch/clipping and ICPM correction are also provided with operating Mode selection.

The IPA design implemented to drive the VKP 7853 klystron is a UHF broadband linear transistor amplifier with a 100 watt CW output rating. The air cooled unit consists of two parallel 50 watt Class AB output stages driven by two 20 watt Class A input stages.

Aural Power Amplifier Multiplex Transmission

Implementing Multiplex visual and aural car-

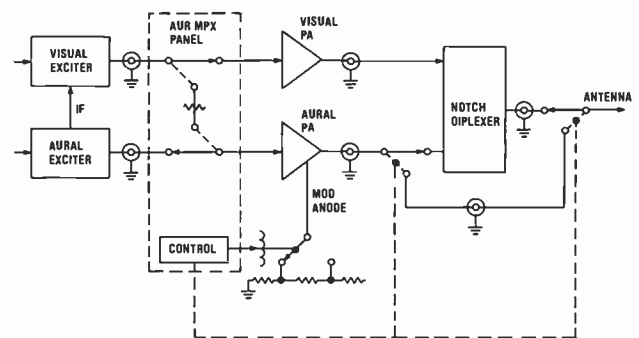

Fig. 6. Aural Power Amplifier Multiplex Switching

The Control system design permits desired power amplifier beam voltage application, while disconnecting HV to the unused power amplifier.

Further, the mod anode voltage on the Aural PA klystron requires change from Aural (low current) to Visual (high current) modes. Aural klystron re-tuning for wideband visual service will be required if normally tuned for high efficiency Aural only operation.

The Aural PA MPX power available with the TTG-100U is determined by the Aural klystron option implemented, i.e., 20 kW with the VA 890, or 80 kW with the VKP 7853.

TRANSMITTER PERFORMANCE

TTG-100U operating performance measurements have been made on Channels 14, 35, and 66 using VKP 7853, VKP 7854, and VKP 7855 klystrons respectively. Performance of each klystron was reasonably uniform.

The test data for the VKP 7855 on Channel 66 operating at 105 kW peak sync output was measured for both pulsing and non-pulsing modes. Measured collector efficiency was 58%

non-pulsing and up to 79% pulsing, as tabulated in Fig. 7.

	PULSING	NON-PULSING
PEAK POWER	105 kW	105 kW
BEAM VOLTAGE	32 kV	31.8 kV
BEAM CURRENT	4.15 AMPS	5.7 AMPS
EFFICIENCY, PK SYNC	79%	57.9%
MOD ANODE VOLTAGE	7.8/11.4 kV	6 kV
BODY CURRENT	48 MA	70 MA
FILAMENT CURRENT	18.7 AMP	18.7 AMP
VAC ION VOLTAGE	3.9 kV	3.85 kV
VAC ION CURRENT	8 μ A	7 μ A
MAGNET #1	21.5 AMP	21.0 AMP
MAGNET #2	28.2 AMP	28.7 AMP
IPA OUTPUT	30 WATTS	25 WATTS

Fig. 7. VKP 7855 OPERATING CHARACTERISTICS PULSING AND NON-PULSING, CHANNEL 66

Significant visual parameter performance is itemized on Fig. 8, illustrating the effectiveness of Exciter correction.

DIFFERENTIAL GAIN	2%
DIFFERENTIAL PHASE	1°
LOW FREQUENCY LINEARITY	3%
ICPM	$\pm 1^\circ$
2T K FACTOR	1%
12.5T K FACTOR	2%

Fig. 8. TTG-100U Visual Performance, Pulsing

Fig. 9 illustrates the klystron output passband frequency response features within ± 0.3 dB across the -0.75 to $+4.18$ MHz band controlled by the Exciter SAW filter.

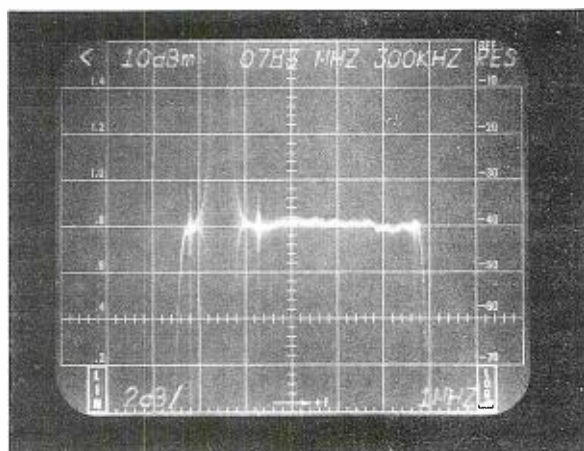

Fig. 9. Frequency Response with Pulsing, 2 dB Division

Fig. 10 itemizes VKP 7854 Aural performance using an output visual coupler. Klystron tuning was adjusted to provide approximately 2 NHZ, 3 dB bandwidth for minimum multichannel sound distortion. Beam efficiencies of 28% (11 kW), 41% (22 kW) and 57% (44 kW) were obtained.

POWER OUTPUT	BEAM VOLTAGE	BEAM CURRENT	IPA OUTPUT	BEAM EFFICIENCY
11 kW	33.2 kV	1.15 A	11 W	28.8%
22 kW	33.0 kV	1.6 A	32 W	41.7%
44 kW	32.8 kV	2.35 A	52 W	57.0%

Fig. 10. Aural Service Characteristics

CONCLUSION

The TTG-100U transmitter, using the VKP 7853 series klystron achieves 100 kW peak sync power output with collector efficiencies of 75-79% using modulating anode pulsing operation.

Basic television transmitter design techniques used for 55/60 kW transmitters have been applied with appropriate modification to this higher power level and klystron characteristics.

The cost effective advantages of single-ended high power transmitters vs. parallel transmitters may be realized without loss of back-up transmission offered with parallel systems, using visual and aural multiplex power amplifier transmission techniques.

Expansion to a 200 kW parallel transmitter using the VKP 7853 presents significant advantages over lower power klystron quadruple power amplifier combining approaches.

WBRZ Benefits

From CP Operation ...Results Exceed Expectations

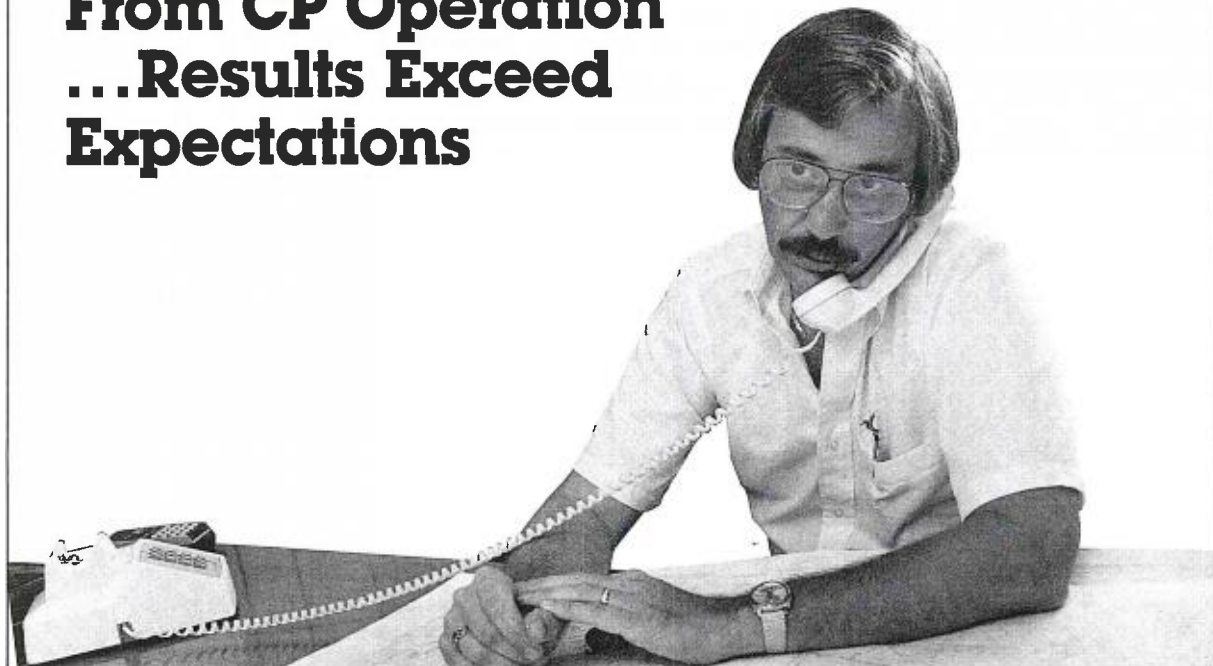

William Yordy, Director of Engineering for the Manship Station group.

In September 1982, WBRZ-TV, Baton Rouge, switched to circularly polarized operation with an RCA TDM-7 CP antenna and a parallel TTG-30/30L 60 kW transmission system.

The change was necessary, and the results were dramatically apparent, according to William Yordy, Director of Engineering for the Manship Station group, owners of TV-2.

"I could not receive Ch. 2 on my bedroom tv set at home using rabbit ears. After the changeover to CP, I got great pictures, even when using a paper clip as a receiving antenna. The results achieved with CP exceeded our expectations."

"The TDM-7A2 performs just as we had anticipated, giving us solid rabbit ear and monopole reception in not only our metro, but throughout our ADI. I am very impressed with the design and construction of the antenna and I feel that mechanical maintenance over the years should be

much less than the superturnstile that it replaced. Electrically the antenna performs very well also. Checks with a field strength meter indicate that both the circularity and the axial ratio are well within specs, and that the antenna performance is essentially identical to that measured at RCA's Antenna Engineering Center in Gibbsboro before shipment."

G-Line Transmitters Performing Well

"The TTG-30/30L G-line transmitters are performing very well, and the quality has so far been excellent."

Improved reception, especially on second and third sets in homes was the prime reason for considering switching to circularly polarized operation. And, Mr. Yordy remarks, channel 2 stations experience more difficulty with rabbit ear sets. Further complicating the situation for WBRZ-TV was their antenna loca-

tion, which is about ten miles further south of the city than the other station towers. As a result, competitive channels 9, 33, and 27 were getting good rabbit ear signal quality and TV-2 was not.

Better Signal Penetration with CP

With circularly polarized operation, WBRZ-TV's effective radiated power remains at the authorized 100 kW visual, and the coverage area is essentially the same. The difference is in signal penetration, which is markedly improved. As an example, Bill Yordy notes that while visiting a friend's home some 77 miles from Baton Rouge, he checked the TV reception for each station. TV-2's picture was "painted on", clear and sharp, while the others were "snow". The subjective quality of the picture is especially noticeable on rabbit ears, Mr. Yordy affirms.

In some cases, he says, the new TV-2 signal was so powerful

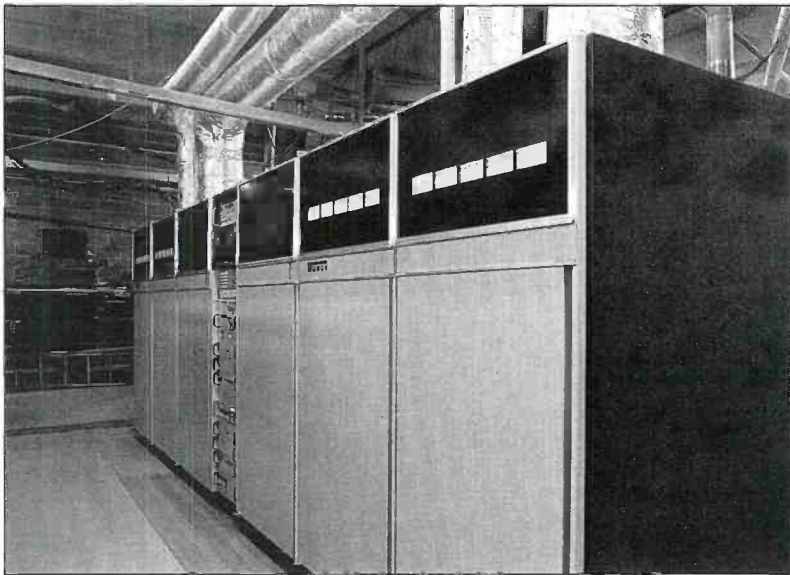

WBRZ-TV's parallel TTG-30/30L Transmitters operate at 44 kW peak output.

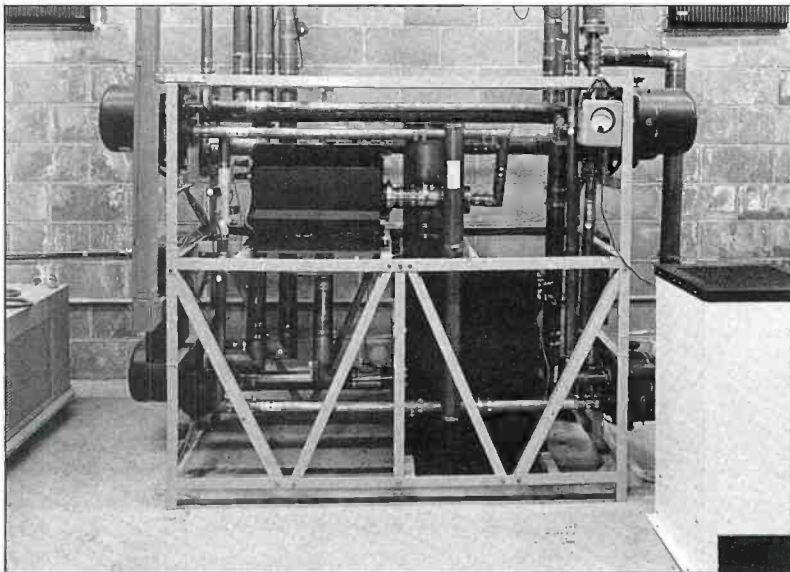

System OPTO-Switcher provides motorized switching of aural and visual outputs.

that the AGC on home sets had to be adjusted to bring in the picture. In addition, co-channel interference—once a severe problem—has been cut to approximately 10 percent of what it was, which can be at least partly attributed to the CP operation, Mr. Yordy says.

Planning Move to CP

The time span for planning the move to circularly polarized

operation to completion of the installation took about 2½ years, Mr. Yordy notes. About half of this time was used for a detailed investigation of all aspects of CP broadcasting to determine how it would benefit WBRZ-TV's operation. Once the decision was made to switch, the equipment ordering and installation cycle took more than a year to complete.

Why TDM-7 Antenna Was Selected

The RCA TDM-7 CP antenna was selected for a number of reasons, "but the total of them as far as I am concerned is that it is the best circularly polarized antenna available for lowband channels," Mr. Yordy states.

"The TDM was a direct replacement for a GE five-bay superturnstile type antenna, and was basically an 'unplug and plug-in conversion'. The tower location and height were unchanged, with only minor tower modifications required to accommodate the new antenna. The overall tower height is 1757 feet to the top of the antenna.

"The top-mount TDM-7 is basically a simple antenna which requires a lot less hardware on the pole than others do. It is also flatter than the old five-bay was for input matching. Also, the standard beam tilt and null fill that are built into the TDM antenna are very close to what I would specify for this location, so the available custom options were not necessary."

The tower transmission line was not replaced when the new system was installed. However, it had been completely refurbished the year prior, with new bullets installed, hangers checked, and bolts tightened. This upgrading is definitely necessary, Mr. Yordy warns.

Dual Line Feed For Standby Capability

The TDM-7 at WBRZ uses dual line feed, with the line split inside the building rather than on the tower. This arrangement provides standby capability should one section of the antenna fail.

"We are using a hybrid splitter instead of the standard power split Tee at the output of the notch diplexer with a two line feed to the antenna. The reject load wattmeter on the hybrid splitter shows less than fifty watts reject power and, considering that at that point there is approximately 32 kilowatts aver-

NEW CP SYSTEM

age of combined visual and aural forward power, I would say the two sections of the antenna are perfectly matched.

"I would definitely recommend the two-feed line arrangement because we can feed a three-bay or four-bay section independently, with patching done inside the transmitter building to feed either side of the antenna. For the price of one antenna, you also get a back-up."

Transmitter Installation By TV-2 Staff

Installation of the new transmitting plant was handled by the TV-2 technical staff, including cutting the transmission line on-site. At the same time, the crew was also installing a new FM transmitter and antenna at the same location—a complex procedure that Bill Yordy now strongly advises others not to do.

Complicated Logistics Operation

The transmitter installation was not as easy as starting fresh in a new building. In this case, the new transmitter was to occupy the space used by the GE TT-53 transmitter which it replaced. To handle this requirement, the "A" side of the new TTG transmitter was positioned first to butt against the old transmitter. It was wired in and made operational, and the combiner cabinet was located on the floor adjacent to it.

The replaced transmitter was moved out, and the combining cabinet was moved into place. Then the "B" transmitter side was positioned and wired in. Further complicating the operation, during the installation process the turnstile antenna took a lightning hit which required replacing several feed lines. "It was just a very bad two months," Mr. Yordy understates.

Also included with the new transmitting system are a floor-mounted notch diplexer, a 50 kW dummy load, and an Opto-Switcher.

The parallel TTG-30/30L

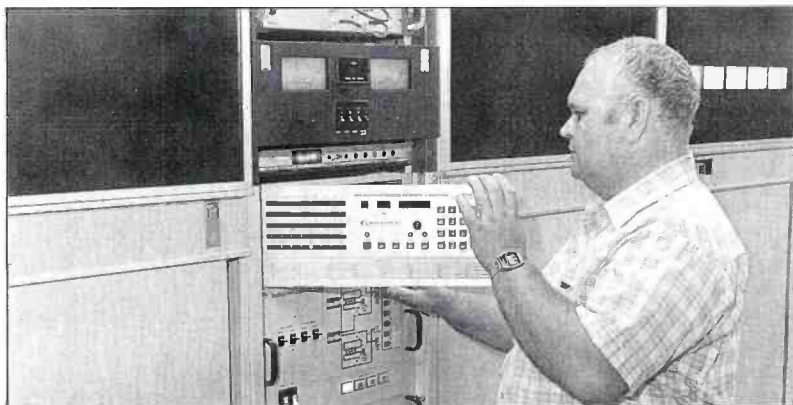

Engineer Tom Stevens checks transmitter remote control panel. The system operates unattended, remote-controlled from the studio.

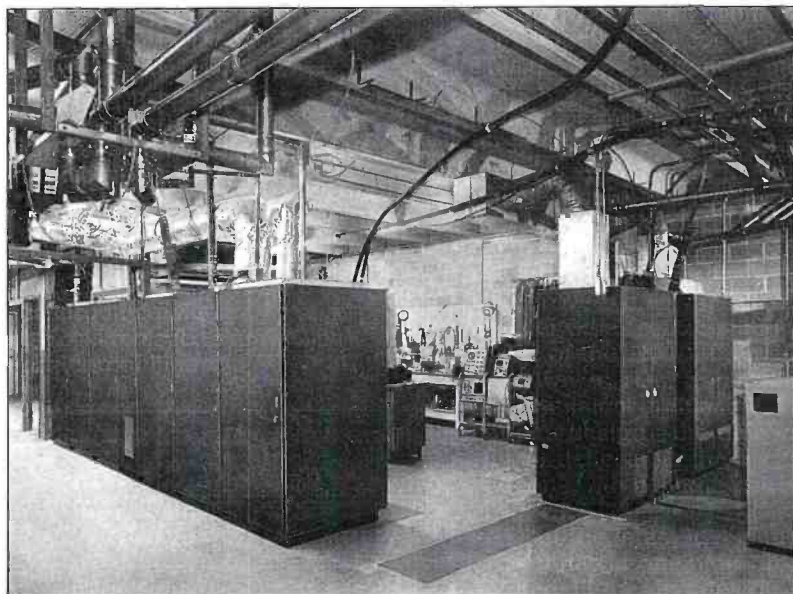

Rear cabinets of TTG-30/30L Transmitters, with FM transmitters at right. Both systems were installed simultaneously.

transmitters are operated at 44 kW peak, and "just sit and coast," Bill Yordy says. Operating the new transmitting system increased the power consumption, since the transmitter output nearly doubled going from 26 kW to 44 kW peak. Additional air conditioning requirements for the transmitter building also increased the utility expense.

The transmitter site is eleven microwave miles from the studio, and is unattended, with the transmitters controlled from the studio with a Moseley MRC-remote control system.

Special Air Handling System

The air handling arrangement in the transmitter building is somewhat unusual, Yordy notes. "Because of the severe humidity conditions in the Baton Rouge area, we duct outside air into the building through a set of filters on one end wall. The air conditioned, dehumidified inside air is used to cool the transmitters rather than the damp outside air. The heated air from the transmitters is ducted to the outside. The system works well as long as you keep the filters clean and the building tight."

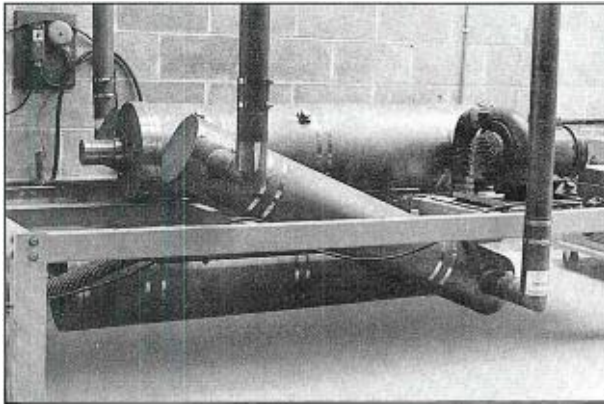

A hybrid splitter is used at the output of the notch diplexer with a two-line feed to the antenna.

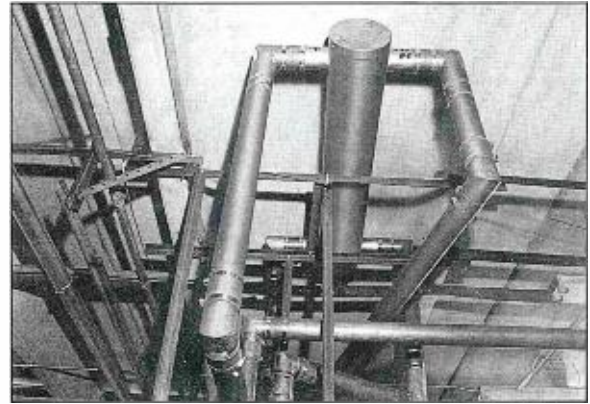

Hybrid coupler.

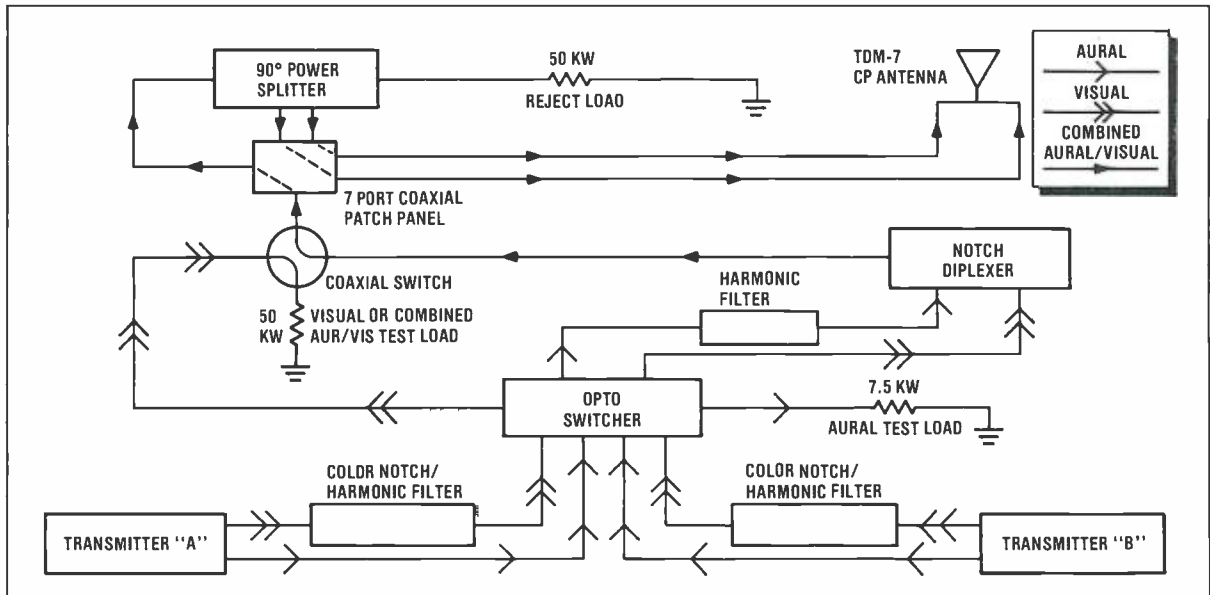

WBRZ-TV RF System Flow Chart.

Excellent Support From RCA

Although the WBRZ-TV technical staff handled the installation of the system, Mr. Yordy expressed satisfaction with the support received from RCA on the project. "Everyone involved was pleasant, proficient, and responsive," he remarks. "When a problem did arise, as they will with any project of this size, the solutions were implemented as rapidly as possible. Bill Culbertson (Southern Region Sales Manager) and Antenna Engineer Doug Frank were especially helpful. Doug, who was on site to insure that the antenna was

assembled and installed correctly, even took a trip to the top of the tower to confirm that the lengths of the tower top elbow complex were correct. That is indeed 'service above and beyond the call of duty.'"

Mr. Yordy also commented on the responsiveness of the RCA Tech Alert and Replacement Parts operations. As an example, he called Tech Alert for parts which had not yet been listed in the Replacement Parts price schedule. The numbers were identified and the parts were delivered promptly.

Operating Experience Supports Projected Benefits

After two years of circularly polarized broadcasting, Bill Yordy remains a firm advocate of this method of operation. The results at WBRZ-TV have confirmed the projected advantages.

He adds this experience-gleaned advice for broadcasters planning the change to CP: "Take your time. Develop a schedule for planning and installation—then double it. Finally, do not install an FM transmitter at the same time and place that your new television transmitter is being installed!"



Fast Start-up for New Star in Texas

At 6:30 PM on December 4, 1983, a new star flickered into brilliance in Austin, Texas. That's when KBVO, Channel 42 went on the air as an independent station with a full line-up of classic and popular films augmented by syndicated programs and news service feeds.

The turn-on featured a 30-minute premiere program whetting the appetite of Channel 42's audience with "things to come". This was immediately followed with the key element in the station's programming—movies—with back-to-back showings of the films "Cleopatra" and "Psycho". A massive billboard and radio advertising campaign helped build the audience for the start-up by heralding the newest station in town as "Austin's Great Independent Movie Station".

How was the station received? Just five months later, in April, Channel 42 turned the corner and reported a profit—an amazing feat in such a short period of time and in view of the formidable competition the station faced in Austin, with one public station and three network affiliates vying for viewers.

Michael D. McKinnon, President and General Manager of McKinnon Broadcasting Company, Corpus Christi, and his partner in Channel 42, Darrold A. Cannan, Jr., were the driving forces behind the building of the station. McKinnon, with three other television stations under the McKinnon Broadcasting banner—KBMT, Beaumont; KIII, Corpus Christi; KUSI, San Diego—concentrated on equipment needs and programming. Cannan, owner of KAMR-TV, Amarillo, zeroed in on the

physical plant and the recruitment of management and operating personnel. Judging from the ratings and the profit results, both were highly successful in their areas of expertise.

One Stop Shopping from RCA

RCA Broadcast Systems worked with McKinnon and his engineering team to plan the equipment complement for the station. Essentially, it was based on his San Diego station, also an independent. That station, KUSI, went on air in September of 1982 and was equipped with an RCA transmitter, antenna, cameras, video recorders, cart machines, film islands—everything necessary for an independent station in the 26th market.

KBVO was a similar independent operation and the equipment required was also quite similar. Working very closely with Mike McKinnon and James A. Gillece, Vice President of Finance/Planning for McKinnon Broadcasting, RCA financial management developed an attractive financing package.





Tape center includes two Quad and two Cart recorders.



James Gillece (left), VP of Finance/Planning for McKinnon Broadcasting confers with KBVO Business Manager Ray McEachern.



RCA TFU-28DAS high power peanut pattern pylon antenna arrives for installation . . . and is soon mounted atop existing 1290' tower providing KBVO with excellent coverage.



Heart of station is TTU-55CSP 60 kilowatt UHF transmitter being checked out here by George Taylor (standing), Assistant Chief Engineer and Ernie Hartt, Chief Engineer.

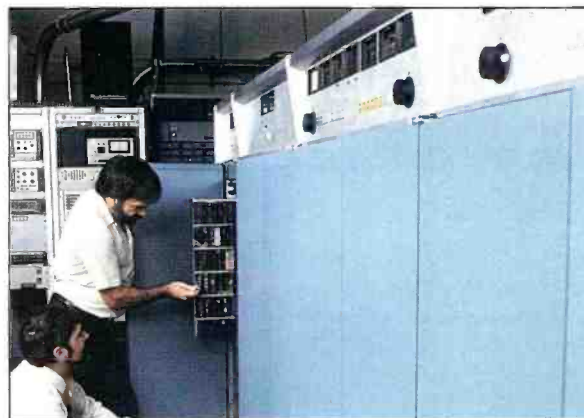

"RCA ranked head and shoulders above everyone else . . ."

"RCA was the only manufacturer who could provide us with the three critical items that we required," comments Gillece. "We needed first, a supplier that could deliver a working system from their own product line augmented, where necessary, with vendor items. Second, we needed a good financing arrangement. Finally, we absolutely had to select a supplier that had a proven track record and was a company that we could rely

on for product quality, delivery and support. RCA ranked head and shoulders above everyone else in these three areas."

Transmitter and Antenna Essential for Success

Mike McKinnon was deeply involved in the final selection of equipment. He had the San Diego experience and could draw on the expertise of his staff there, as well as his staffs in Beaumont and Corpus Christi. McKinnon is a strong advocate of the delivery system—the transmitter and the antenna—as the most essential equipment in a television station.

"RCA was very helpful."

According to McKinnon, "The biggest problem we had in Austin was finding a suitable antenna location. We settled on an existing television tower in an antenna farm. This site was decided on after many meetings with RCA technicians. We wanted to make sure that our signals would shadow other signals in the market. RCA was very helpful."

The transmitter is an RCA TTU-55CSP 60 kilowatt UHF transmitter. The antenna is the TFU-28DAS high power peanut pattern pylon type and it is mounted on the 1290' tower. Coverage is excellent with 80 to 90 miles on the different radials.

Complete Studio Control Array

RCA equipment in the master control area includes two TCR-100A Cartridge Recorders, two TR-600A Quad Video Tape Recorders, and two complete TK-29B Telecine Systems. In the production area, two TK-47B Studio Cameras, one HAWKEYE Camera, and two TK-710 Portable Cameras are used.

While all equipment was up and running in time for the December 4, 1983 turn-on, there was a frenzy of activity for several months preceding that first airing.

Contracts with RCA were signed in July and the first shipments were received in September. Access to the new building, however, was delayed until October 17. That left only seven weeks until turn-on.

Prior to that time, the equipment that was received was marshalled in a warehouse on an adjoining property. But rather than just warehouse the equipment, Ernie Hartt, Chief Engineer, and his crew of five did preliminary rack wiring, worked out floor plans, and generally readied the equipment for a fast move into the new facility.

Full Scale Floor Plan

One interesting aspect of the planning process was the actual full scale model of the control room that Hartt set-up in the warehouse. He first sketched out preliminary floor plans, got the required management approvals, then placed the equipment in position in an area of the warehouse. The floors were taped to indicate the dimensions of the control room and where equipment wasn't yet available, Hartt and his crew made full scale cardboard models.

This living model gave everyone—engineering, operations, production, management—an opportunity to move the equipment around much like giant chess pieces until a final layout was agreed upon by all activities.

"It saved us a lot of time and eliminated a lot of headaches before they had a chance to get started," says Hartt. "We were really able to get a great headstart on the installation, especially in

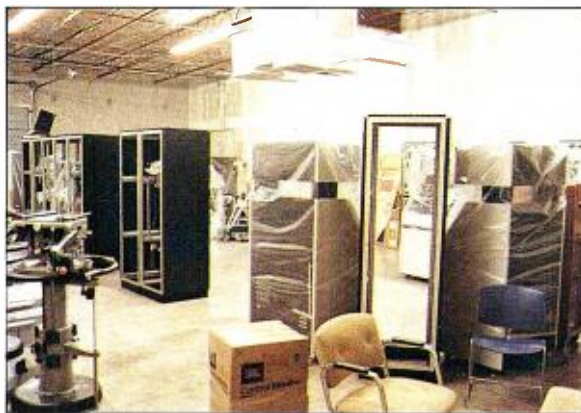

Adjoining warehouse building served as staging area for incoming station equipment during installation. A "living" model of control room was set up before move-in to new station building.

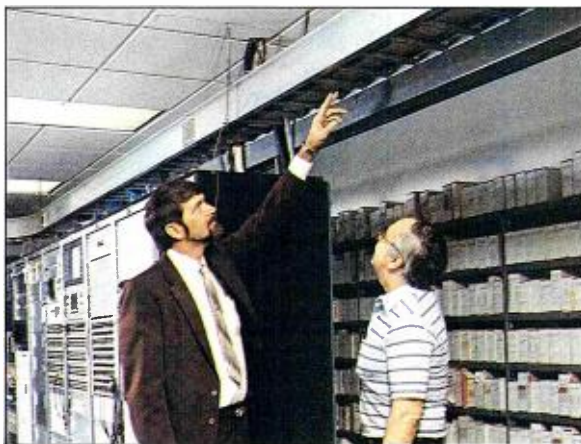

Chief Engineer Hartt points out unique overhead cable runs in Master Control.

view of the really tight deadline that we were facing."

To aid with the actual installation, the Chief Engineers from the three other McKinnon stations—San Diego, Beaumont and Corpus Christi—were brought in along with the Chief from Darrold Cannan's Amarillo station. Working virtually around the clock, the installation was 90% completed by mid-November in time for a gala open house.

Movies for the Market

Channel 42 carries a heavy schedule of classic and popular films with a menu of some 25 movies shown every week. These are effectively mixed with such timely programs as "Entertainment Tonight", "Independent News Network" shown daily at noon, and "CNN Headline News" for news breaks throughout the day.

With the extensive film schedule, two TK-29B Telecine Systems are heavily used. Each system incorporates two TP-66 16mm film projectors and a TP-7B slide projector.

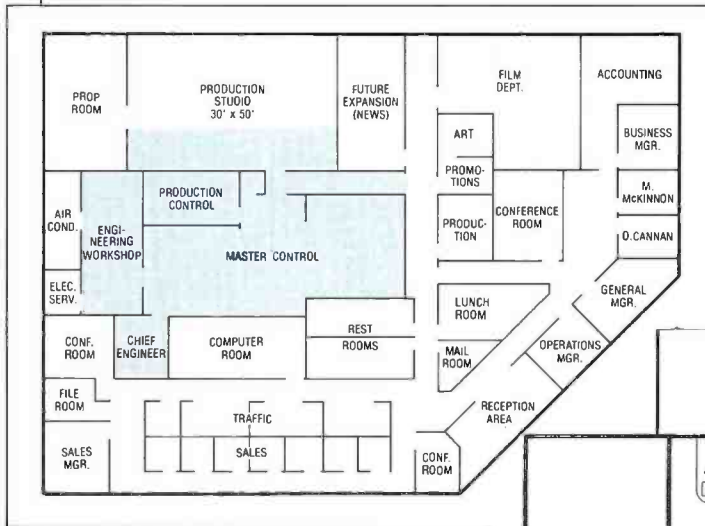

Overall design of facility (left) provides for smooth traffic flow. General offices, sales and production areas are separated, yet easily accessible. Shaded area is reproduced below showing detail of Master and Production Control.

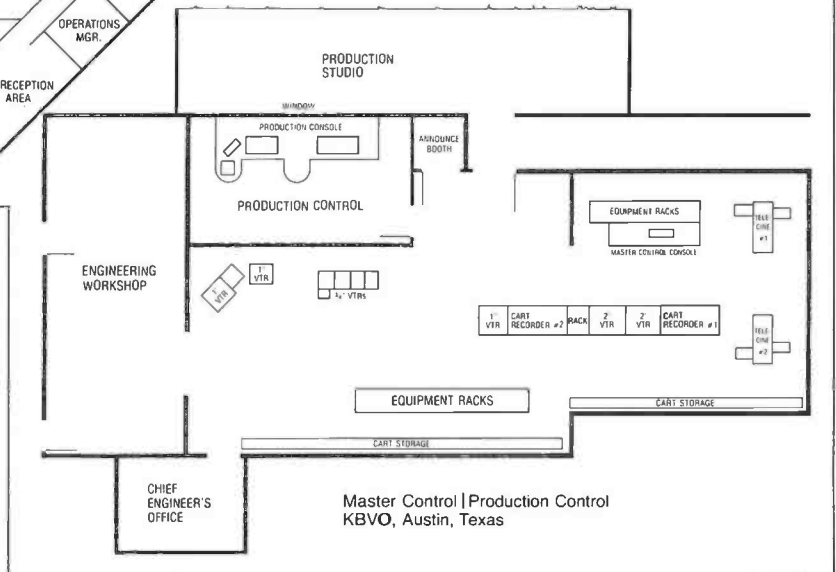

Dual TCR-100B Cartridge Recorders are also workhorses in the daily schedule, particularly in view of the outstanding success the station has realized in commercial plays.

The two TR-600 2" Video Tape Recorders with AE-600 editing complement three 1" recorders to provide ample facilities for commercial dubbing, satellite recording, post-production and in-house recording.

Preventative Maintenance— An Ongoing Priority

Adjacent to master control is a large engineering workshop where an active schedule of preventative maintenance is an on-going project.

Ernie Hartt says, "We have a tight, efficient engineering operation with just six of us. Preventative maintenance is a 'must'. We have weekly and monthly assignments for everyone in the group.



Close-up view of console in Master Control.



VTR operator in background checks out cart for commercial play. TK-29B Telecine System in foreground.

An individual is responsible for groupings of equipment in the station and they become experts in various areas. We keep rotating assignments, however, so that we'll eventually end up with each technician being well qualified in preventative maintenance for every piece of television equipment. We'd much rather deal with a preventative schedule than be constantly dealing with emer-

gency situations. It's a much better way to operate—both for our engineering team and for best station operation."

"A good engineer keeps things from going bad."

Those views are echoed by Mike McKinnon. "We're very fortunate in Austin, and in all our other stations, to have excellent engineers. And when I say excellent, I don't mean they can fix things. A good engineer keeps things from going bad. We're way past the day where you wait for a problem to occur before you take action. Today, you correct the problems before they happen."

Production Studio

A 30' by 50' production studio is the home of the two RCA TK-47B Automatic Cameras, two TK-710 Portable Cameras and one HAWKEYE Camera. Adjacent to the studio is a fully equipped production control room with complete switching and graphic effects systems. Three 1" video tape recorders with built-in editing capability are located in an adjacent area where station promos and commercials are posted.

Production has started off slowly but is showing a steady increase. In a small market like Austin, according to McKinnon, the need for production facilities is necessary since most advertisers are smaller business organizations operating on tight budgets. There are fewer advertising agencies, too, so advertisers are more prone to deal with the station that can provide quality productions at an affordable cost. And, the station that produces the commercial is usually number one on the airing schedule.

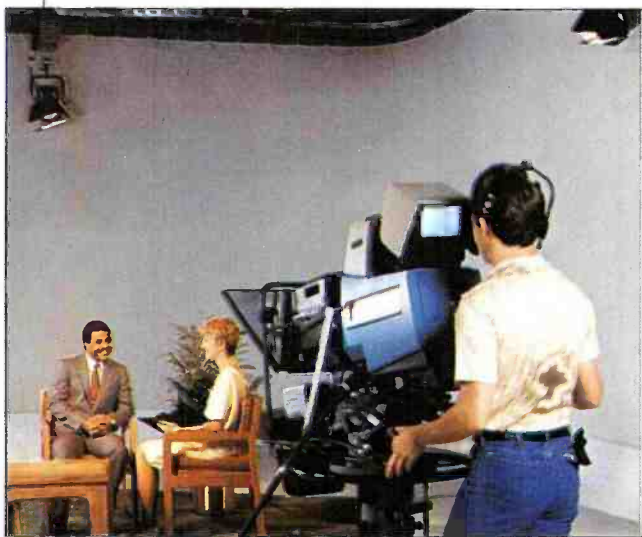

Two TK-47 Automatic Cameras are utilized for local programming and commercial production.

RCA Responsive to Needs

Both Mike McKinnon and Darrold Cannan commented on the support they received in the Channel 42 start-up from RCA.

"help we received from RCA was incredible."

"The order service, the follow-thru, the paperwork, the installation help we received from RCA was incredible," says McKinnon.

"RCA really did an outstanding job for us," reports Cannan. "We knew where everything was at any time, where it was coming from, and a host of other little details that made the Channel 42 start-up a very pleasant experience. I don't know how other stations have done it when they have to deal with a lot of different equipment suppliers—but this is the way to do it. We're really pleased with the RCA support we received."

Challenging Experience

Darrold Cannan, in addition to his interest in Channel 42, operates KAMR-TV, a very successful NBC affiliate in Amarillo. He had previous extensive broadcast experience with his Dad's stations in Wichita Falls, KFDX, and KFDM in Beaumont.

But according to Cannan, the Austin experience is one of the most interesting and challenging things he has done.

"If I ever had to build another television station from the ground up, I'd build it just like this one."

The station has over 14,000 square feet of space which allows room for growth. Administration, sales, and operations are located in totally separate areas, yet the unique design of the



Production control has complete switching and graphic effects systems. Local production is showing steady increase.

building has each operation only a few steps away from the other functions.

Austin Market Growing

"The Austin market is an aggressive growing market," says Cannan. "Viewers here are accustomed to UHF stations. There were two commercial U's and only one V, so we didn't have the problem of educating viewers to UHF. With the growth pattern we projected, we had good success feelings coming in. As it turned out, we really exceeded our expectations. Our sales organization has done a really good job and our ratings have been great. We're building momentum in Austin and we're looking for even greater things from Channel 42. Somewhere down the road, we're looking at a news operation. We have even planned the building so we can accommodate a news department. Both Mike and I have extensive experience in the news area, so that's something we're considering for the long term. But when we go in, it will be full-scale. It's a competitive news town and we want to be the best. It's the only way to be."



Station Manager Steve Beard (left) and Darrold A. Cannan, Jr., partner in KBVO, frame striking station logo in reception area.

McKinnon Broadcasting – A Success Pattern

Channel 42 in Austin is the latest jewel in McKinnon Broadcasting Company's crown. The three other stations in the group are all highly successful in their markets.

The San Diego station, KUSI, is new, having gone on air in September, 1982. Like Austin, it is a UHF independent station in a highly competitive

market. Mike McKinnon was heavily involved in equipment selection and it formed the pattern for the Austin station. RCA equipment at KUSI includes a TCR-100A Cartridge Recorder, two TH-400 VTRs, two TR-600 VTRs, two TK-761 Cameras, two TK-29 Telecine Systems, a TTU-55 Transmitter and Pylon Antenna. Preliminary planning has already started



KIII-TV, Channel 3 in Corpus Christi captures a whopping 60% of viewing audience with its news programming.



Two TR-22 VTRs that went on-air with Corpus Christi station in 1964 are still being used on daily basis.

for a news operation and that, too, would provide the blueprint for Austin's long range plan for news.

In Beaumont, KBMT is an ABC affiliate and has been a McKinnon station since 1976. Again, it has an extensive complement of RCA equipment including transmitter, antenna, cart recorders, studio cameras and ENG cameras.

KIII, Corpus Christi—Flagship Station

The flagship station of the McKinnon Group is KIII, Channel 3, in Corpus Christi, Texas. It's also the oldest station in the group since it first went on air in May, 1964. The station is an ABC affiliate and its news programming captures a whopping 60% of the viewing audience. The major RCA equipment here includes a new G-Line Transmitter, the TTG-30L. It replaced the original 20 year old RCA transmitter, TT6AL/TT-25CL, which is still in service as a back-up system. A unique emergency cooling system for the new transmitter was designed by John Ross, Chief Engineer, and it provides protection for the transmitter in the event

of failure of the primary air conditioning system (see description on page 20).

Other RCA equipment in service at KIII includes two studio cameras, telecine system, cartridge recorder, and various video tape recorders. Among the latter, two RCA TR-22 recorders that were put in service when the station started operations are still being used on a daily basis. Chief Engineer Ross credits that to a regular scheduled preventative maintenance program and to RCA quality.

The One to Watch

Starting a new station in a highly competitive market is not an easy task, but KBVO, Channel 42, in Austin, is fast carving out its niche as the station to watch. The alternative programming has been highly successful, sales are climbing, and the skilled team of management, operations and engineering has been blended together to assure continued success. The eyes of Texas—particularly in Austin—are watching.

Mike McKinnon – Some Views and Comments

Mike McKinnon is a former Texas State Senator and has served on numerous state governmental committees and commissions. He's a transplanted Texan, having started his broadcasting career in Albuquerque, New Mexico at his Dad's station. He worked there as a camera operator and director. After Army service, he got his first taste of broadcasting ownership when he and his brother bought a radio station, KSON, San Diego. Later, a new television license in Corpus Christi became available and the brothers were awarded it in 1964. That station, KIII, is today the flagship station for the McKinnon Group that now includes KBMT, Beaumont; KUSI, San Diego; and KBVO, Austin.

Broadcast News recently talked to Mike McKinnon on a wide range of subjects. Here are some of his comments.

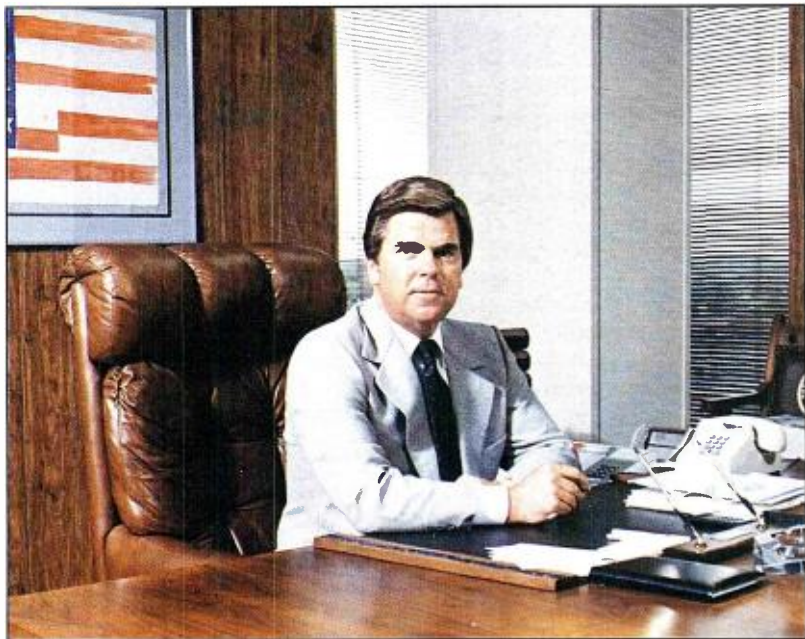

Michael D. McKinnon, President and General Manager of McKinnon Broadcasting Company.

BN: What are your equipment priorities when you plan a new station?

MM: "You plan the station to make sure that you do the things right that you can't change easily. The transmitter and the antenna are the keys to success. Get them right the first time. The studio, control and production equipment are important, of course, but if you make a mistake here, you can easily correct it with an add-on piece of equipment or a change-out. If you're an independent, the important thing to remember is to build in redundancy. You can't operate efficiently without it."

BN: Any other advice for someone planning a new station?

MM: "Visit every station you can before you buy anything. Whenever I'm out of town in a non-McKinnon Group city, I ask for a tour of one of the stations. I don't tell them who I am, I want to keep on learning and I don't want to make too many mistakes as I learn. You can see all kinds of inefficiencies and you can see how you could do it better. Another thing we do is take our staff of engineering and operations people to NAB every year and have a schedule of assignments on what equipment we want evaluated. We have several de-briefing sessions at the show and we do it again after everyone gets back and has digested that tremendous amount of technological information."

BN: What about programming?

MM: "I love this part of the business. You have to know your audience. And you have to be a good negotiator to get good programming at a good price. Quite obviously, you have to compete for viewers and advertisers in your market. Each market is different and so the programming has to be fine tuned to achieve your audience, achieve your objectives."

BN: Do you have any plans to get into programming?

MM: "I have some long range plans to provide bulk programming for stations who want to be aggressive in seeking out advertisers in their markets. Cable has done some fine things in programming—the arts, news, sports—and I think this kind of service would be ideal for independents. There's a real shortage of programming now available and the new independents coming on are going to have a tough time of it."

BN: How do you determine whether or not one of your stations should get into commercial production?

MM: "The market decides! If you're in a major market like San Diego, advertisers go to their ad agencies and production houses for their spots. We don't compete with them. But in Austin and Corpus Christi, we go after the business. They are smaller markets and it's just not profitable for production houses to compete there. We equipped those stations with the right kind of equipment so they can seek the business. There's a direct correlation, too, between producing commercials and selling the spots. If you produce a spot for a client, you'll get a larger chunk of his business."

BN: Do you see any changes in technology?

MM: "We can do anything we want. With direct satellite transmissions from any corner of the world, we can deliver news, sports, anything. Just a few years ago, in 1981, we saw a presidential inauguration in Washington and the hostages being freed from Iran. Anything that you can

think of from a technical viewpoint can be achieved. You go to somebody like RCA and say, 'Here's what I want to do. I want to go from here to there with this kind of a signal. Build it for me'. They'll get it done! We shouldn't be stymied by how we want to get it done; it's what we want to do that's important."

BN: What's the role of the Chief Engineer today? Has it changed?

MM: "I enjoy talking to engineers but I don't want to talk about equipment. I want to talk about procedures. They have to become better managers. They're involved with minority hiring, unions, employee relations. The tubes are gone. They have to learn about chips. They have to deal with changing technology and they've got to relate better to management. The General Manager and the Chief Engineer should be talking to each other regularly about what they're doing, where they're going. They have to work together."

BN: Do you have any final words on working with RCA?

MM: "I've never had a problem with RCA that they haven't solved. RCA stands behind their equipment and it's a good feeling for me. They are a very reputable company and I enjoy working with them."

Unique Transmitter Air System Keeps KIII on Air . . . Even When Hurricanes Strike

A report on the KIII-TV transmitter air system by John Ross, Chief Engineer, KIII-TV, Corpus Christi, Texas.

The design of the KIII-TV transmitter air system was the result of a desire to provide the perfect atmosphere for transmitter operation. We retained the services of a mechanical engineer to turn our specifications into hardware.

The factor so important in the design was the local environment. Our transmitter plant is located in a cotton field on the Gulf Coast, only 16 miles from Corpus Christi Bay.

The 20 acre tract is farmed year round right up to the transmitter building. When the dry season hits, the dust in the air is so thick you can taste it. The humidity is frequently over 65% and the moisture in the air is salty. The final blow is crop spraying time, when the air contains chemical poisons, which are corrosive. This type of environment took its toll on the first transmitters in the area, especially when moisture condensed in the transmitters overnight. Our RCA TT6AL and 25CL transmitter, that the station signed on with in 1964, had to be rebuilt by RCA 12 years later due to the damage caused by this unfriendly environment. At that time, it was decided that closed loop air conditioning would be a good idea. Since then many other transmitters in the area have been closed loop air conditioned.

Our new TTG-30L lives in ultimate comfort. 24

hours a day the temperature is maintained at 70 degrees and the humidity is held at 30%. The building is sealed in order to keep out all dirty air. The internal air is constantly filtered both mechanically and electronically. By comparison with other G-Line owners, the air system has enabled us to achieve an extra measure of reliability and the transmitter is in showroom clean condition.

In designing the new transmitter plant we added a generator building, complete with pre-wired change-over switching. Management here

LEGEND FOR DRAWING OF KIII-TV TRANSMITTER AIR SYSTEM

- A. 25 SQUARE FOOT RAIN PROOF AIR INTAKE LOUVER
- B. AIR DRYING CHAMBER
- C. INTAKE SUCTION FANS
- D. AIR CLEANING CHAMBER
- E. 48 SQUARE FOOT ELECTROSTATIC AIR FILTER
- F. MOTORIZED AIR INTAKE LOUVERS (NOT SHOWN, SAME AS L.)
- G. COLD AIR PLENUM
- H. TRANSMITTER AIR INPUT FILTERS
- I. RCA TTG 30L TRANSMITTER
- J. INSULATED HOT AIR EXHAUST STACK
- K. HOT AIR PLENUM
- L. MOTORIZED AIR EXHAUST CHAMBER
- M. INTERMEDIATE EXHAUST CHAMBER
- N. EXHAUST SUCTION FANS (SAME AS C.)
- O. FINAL EXHAUST RAIN PROOFING CHAMBER
- P. 25 SQUARE FOOT RAIN PROOF EXHAUST LOUVER
- Q. NORMAL AIR CONDITIONING UNIT. NOT A PART OF EMERGENCY AIR SYSTEM. THIS UNIT CONTAINS AIR BLOWER, CONDENSING (COOLING) COILS, AND AIR FILTERS. COMPRESSORS AND EVAPORATOR COILS AND FAN ARE OUTSIDE BUILDING.

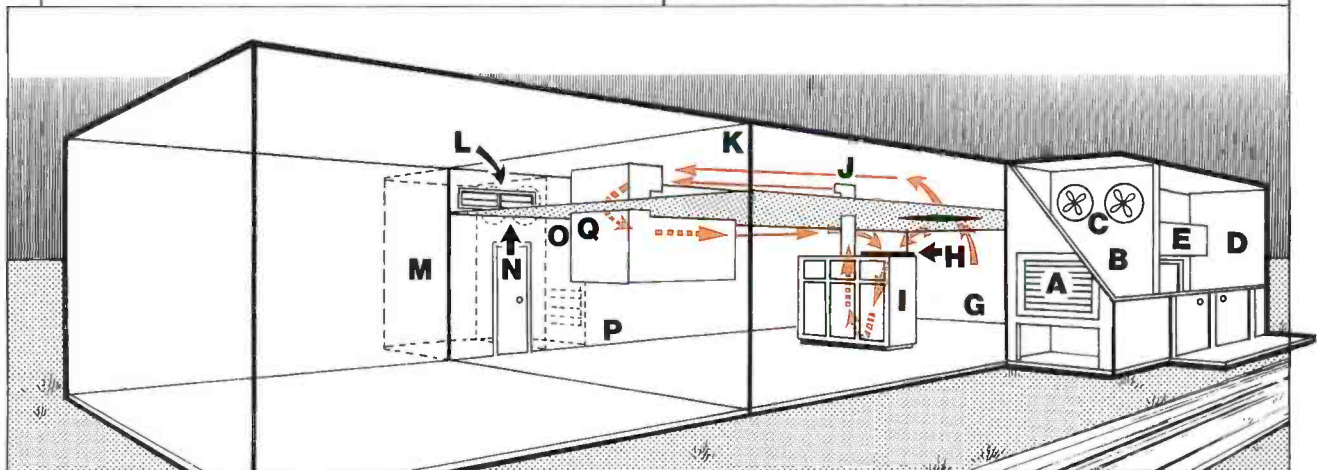

Normal operation—Closed air conditioning system.

found it unnecessary to buy a generator due to the large generator rental market that supports oil field activities. The problem for engineering was that we cannot always rent a large enough generator to handle both the transmitter and the transmitter air conditioning compressors.

We designed the air conditioning back-up system to accommodate this condition. With our four-wire closed Delta Power System design, we can accept any three-phase Y or Delta generator from 208 to 240 volts. Our single phase is transformer-developed from the three-phase by our own transformer to prevent a high leg condition from a generator. We are able to drop the compressor's off-line air and use our external air system during a hurricane. Dust and chemicals are not a problem during a hurricane, but horizontal rain moving at very high speed is a problem. To solve this, we designed a drying tower into the new building at the air input and exhaust points.

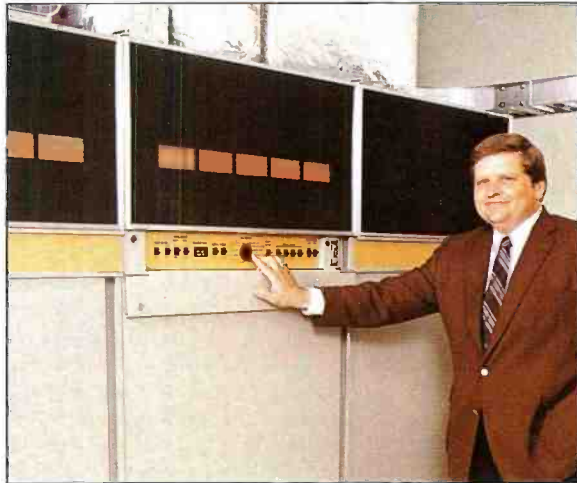

John Ross, Chief Engineer of KIII-TV, Corpus Christi with his RCA TTG-30L transmitter. Ross designed transmitter air system which he describes in this report.

At the air intake, the air must pass through a 25 square foot rain proof louver. It must then rise vertically seven feet at slow velocity before passing through the two suction fans. These fans blow the air into an intermediate cleaning chamber. Here, the velocity of the air is slowed even more before passing through a 48 square foot electrostatic cleaning filter. After leaving the filter, the air goes through the two motorized louvers into the transmitter room which serves as the cold air plenum for the system. The transmitter then picks up cold air from the room and pulls it through the normal transmitter air filters, passes it through the transmitter and then passes it via insulated ducts to the hot air plenum. The hot air plenum is formed by a suspended acoustical ceiling.

Inside this plenum is a set of motorized louvers which open to allow the hot air to flow out of the hot air plenum into an intermediate chamber, where the suction fans pull it out to the exhaust chamber and down seven feet through another rain proof louver to the outside.

This arrangement keeps hurricane force winds and water out of the building while providing a complete flush of the entire building air in three minutes.

The fan and damper emergency air system is controlled by a thermostat, so in the event of a failure in the closed loop air conditioning system, the emergency air comes on automatically and alarms the transmitter operator, 17 miles away at the studio, via remote controls.

One added benefit of the system are the input and output air temperature thermometers in the transmitter air stacks. By recording the temperature rise in the transmitter, when properly tuned, we are able to spot any change in tuning by the change in temperature rise. This indication of change in temperature rise is remote alarmed in our system. We also monitor the differential pressure to detect any air restriction in the system such as covered or dirty air filters.

Drawings by KIII-TV Staff Artist, Mike Berry.

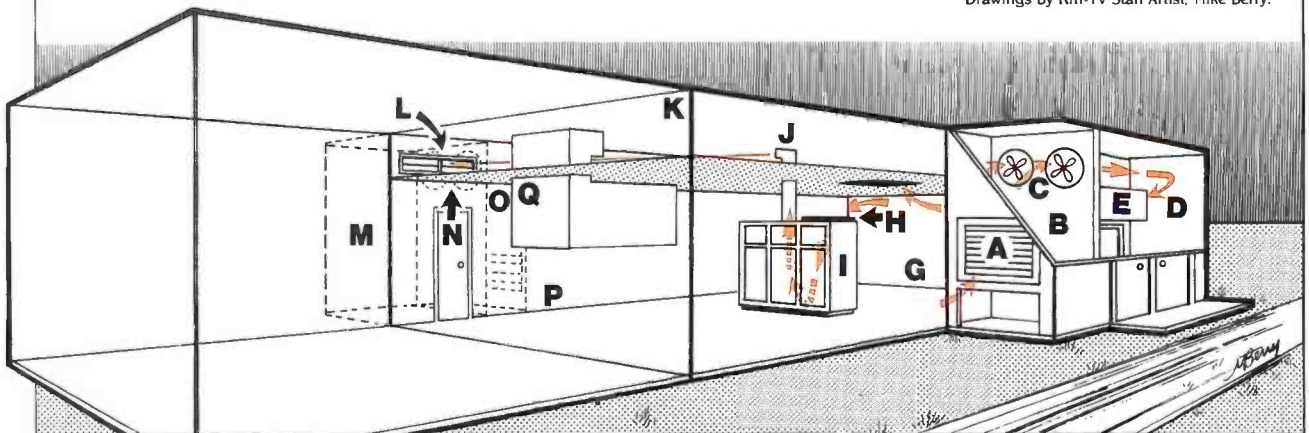

Emergency operation—Back-up air system is activated automatically if basic system fails.

The first broadcast camera that I remember was the RCA TK-10, which was, by today's standards, a behemoth of a monochrome camera, complete with lens turret and detachable viewfinder. One of my first jobs in television was to heft one of these cameras (thank heavens, the viewfinder, was detachable), carry it to the press box in a ball park, set it up, and aim it at the action for nine or more innings.

I also remember that if you opened the side cover of this camera, the first thing that caught your eye was a huge 6BG6 vacuum tube, which was the horizontal deflection tube for the image orthicon (IO) yoke. This tube spent the nine innings patiently driving the electron beam left and right across the IO's glass target, picking up the charges stored there by the image section of the IO.

In the years since, we've refined deflection considerably over the power-hungry 6BG6 that drove the IO yoke. First, smaller tubes replaced the huge bottle of the TK-10; then tubes gave way to TO-3 transistors, and the latest and last RCA tube camera design—the Hawkeye HC-1—deflects its three 1/2" saticons with a single power MOSFET.

But the latest RCA camera design has at one blow obsoleted all the decades of deflection development. The CCD camera, being tubeless, uses no deflection whatsoever, but derives the output video by clocking out charges from a semiconductor imaging chip. Since this totally different method promises to be the dominant technique of all future cameras, it is essential that we television engineers become as familiar with these new methods as we were with the obsolete deflection methods of tube cameras.

The classical scanning pattern of television is very familiar. The dissection of the image by the left-right, top-bottom motion of the electron beam is always likened to the motion of the eye

CCD CAMERA: THE END OF TUBE YOKES AND DEFLECTION



in reading the printed page. But the reading analogy does not apply to the CCD. Here, a more applicable analogy would be a bologna slicer in a delicatessen.

Clock-Driven Slicer

Look at the following figures, which show the sequence by which an optical image becomes a TV image clocked out of a CCD. In Figure 1A, the optical image is focused on the "A" register;

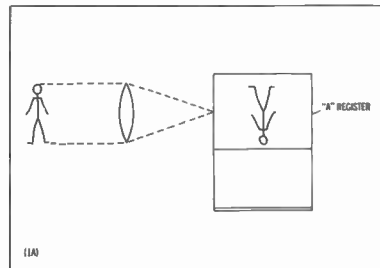

and the photons of that image cause a proportional number of electrons to be generated within the silicon which forms the register, resulting in a charge pattern corresponding to the photon pattern of the optical image. These charges are allowed to accumulate for most of the 1/60th of a second, and then the charge pattern is transferred, intact, down to the "B" register:

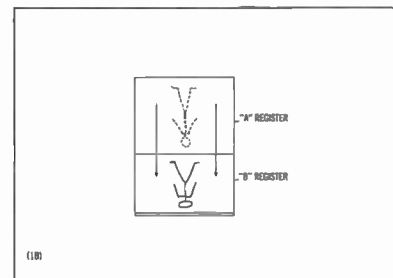

Notice that the "B" register is somewhat shorter than the "A" register—it doesn't need to have a 4:3 aspect ratio, as the "A" register does—so the charge "image" is shown as compressed top to bottom. Of course, this has no effect on the resultant image.

At the bottom of the "B" register is a "C" register*, which slices off the "B" register contents one line at a time:

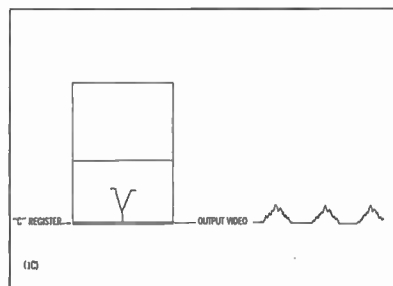

*If you need a mnemonic, you may think of the "B" register as the Bologna register, and the "C" register as the Cutter register.

with each slice producing one line of video. To slice the entire



Robert N. Hurst

Bob Hurst joined RCA Broadcast Engineering in 1951, after receiving his B.E.E. degree from the University of Louisville.

He holds 18 patents in the fields of color television, video recording and digital television.

Mr. Hurst has written and presented numerous papers, and was a 1977 recipient of the Jesse H. Neal Award (the business press equivalent of the Pulitzer Prize) for a series of tutorial articles on digital television.

(See BROADCAST NEWS, Vol. #171 for a more complete biography.)

image, 1/60th of a second is required. During this time, the "A" register is accumulating a new image to be transferred to the "B" register and sliced into TV lines.

By The Clock

As you might imagine, the waveforms that are used to "deflect" the CCD are totally different from the familiar sawtooth of current which we drove into tube deflection yokes. But to understand these waveforms, we first must understand how a CCD operates; how it generates charges from light, and how it moves these charges from place to place on its surface.

The CCD is basically a very simple device—simpler than the camera tubes we've been dealing with for years. Figure 2 shows a very elementary CCD, which consists of a bar of silicon covered with a very, very thin insulator.

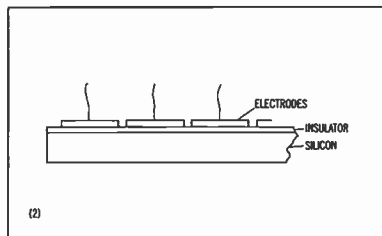

... with tiny electrodes spaced evenly along the top of the in-

ulator. By some means (we'll discuss the means in a moment) let's stick a bunch of electrons under the first electrode,

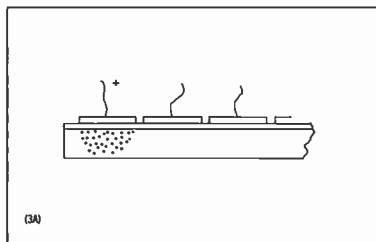

and give that electrode a positive charge to encourage the electrons to stay put.

If we now put a positive charge on the next electrode, and remove the charge from the first electrode, the electrons will all move over to the next electrode.

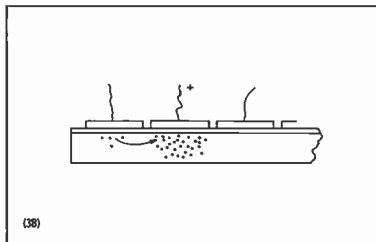

By repeating this action we can coax the electrons from one end of the silicon bar to the

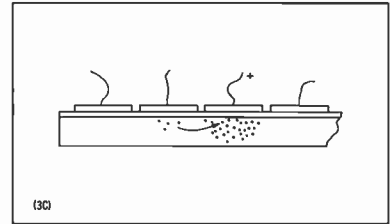

other, finally collecting them from an electrode at the end of the silicon bar. This capability has been used to make shift registers, where the bunch of electrons represent a "1" or a "0". In the TV world, the same device can be used to make a TV delay line, where the electrons represent a sample of a normal analog TV signal. And if we vary the time it takes to transfer the electrons from one electrode to the next, we can make a variable delay line, which can be part of a time base corrector for video tape.

Three For One

In practical CCD's, the very simple single-electrode configuration of Figure 3 is replaced with the configuration of Figure 4,

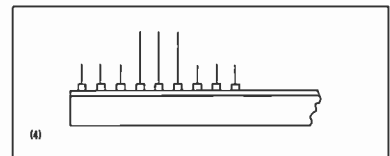

which splits each of the single electrodes into three. By applying a slightly more involved set of voltages to these electrodes, we can greatly improve the efficiency of charge transfer. The sequence of applied voltages is as shown in Figure 5A through 5F.

Initially, only the first electrode is positive; the other two of the group are negative:

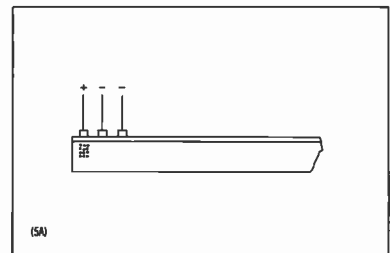

Then, both electrodes 1 and 2 are made positive, and the cluster of electrons spreads out to lie under both electrodes;

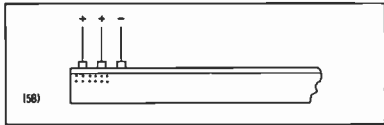

Next, the first electrode is flipped negative, and the electrons now cluster under electrode 2:

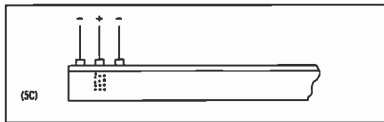

In the next step, electrodes 2 and 3 are positive, and the charge again spreads out, to lie under both these electrodes:

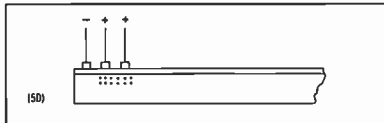

We now have to concern ourselves with the voltages on the next group of three electrodes. At this point in the charge transfer cycle, the first electrode of the next group is negative:

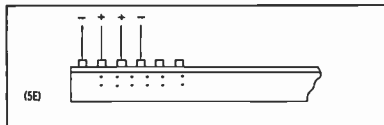

Notice that the first electrode of Group two has the same voltage as the corresponding electrode of Group one. This is universally true: the first electrodes of all the groups are tied together, as are all the second electrodes of each group and the third electrodes of each group:

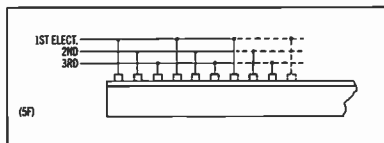

In the next step of the charge transfer cycle, the middle electrode of the first group—the middle electrode of ALL groups, for that matter—drops negative, forcing the electrons to cluster under the third electrode:

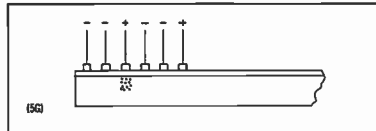

In the final step of the cycle, all first and third electrodes go positive, causing the electrons to spread out under the two adjacent positive electrodes:

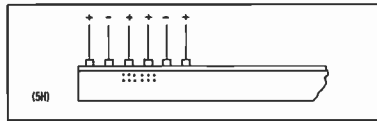

The next step causes the electrodes to return to the same voltage configuration of the first step (Figure 5A), and the cycle begins all over again:

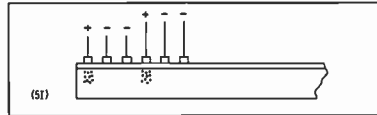

Although there may be hundreds of electrodes on a CCD, they are in groups of three, and the first ones of each group are all tied together, as are all the second ones of all groups, and third ones, with the result that the CCD's charge-transferring function is controlled by placing appropriate voltages on only three wires:

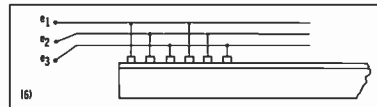

... and if you inspect Figures 5A through 5B for the polarities needed during each part of the cycle, you will see that these three wires must be supplied with three rectangular waves of the same frequency, but phased 120° apart:

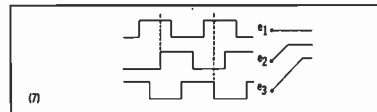

This, then, is a practical CCD of the so-called "linear" type. These CCD's may be used as shift registers, video delay lines, or even as variable delay lines—which can be part of a time base corrector.

But these are "blind" applications: all inputs are electrical signals; no light input is assumed. But, ironically, to make sure that these "blind" applications work, we have to cover up the silicon bar on which the CCD is built, because the silicon itself is light sensitive, and will generate electrons when photons fall on it.

The Seeing CCD

So by simply taking the blinders off the CCD shift register/delay line, and by focusing an optical image on it, we can make a "seeing" CCD that can see one line of a TV image.

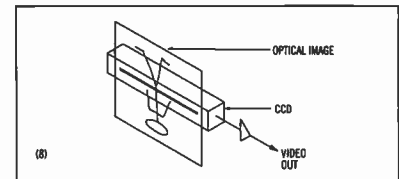

Such a one-line CCD is often used in telecines, such as the TKS-100, where the continuous motion of the film provides the vertical scanning of the entire image across the single-line CCD.

But to make a live camera, we need an area CCD; one which can see the entire image at once. There are a number of ways to make such a device; the one chosen (so successfully) by RCA was already shown in Figure 1, and is called a *Frame Transfer CCD*.

The details of the "A" register, where the optical image is focussed, are shown in Figure 9:

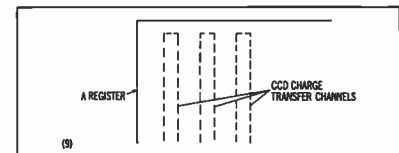

Here we can see that the CCD shift registers which make up the "A" register are not a group of line CCD's, as you might expect, but are instead *column* CCD's—that is, the CCD's charge transfer channels are arranged vertically down the picture, instead of horizontally. The electrodes which move the packets

of charge through the CCD are laid horizontally, across all the CCD columns:

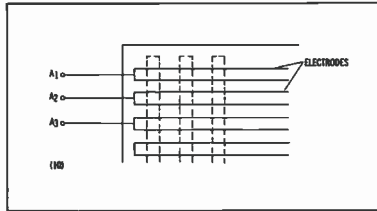

These electrodes are therefore common to all the column CCD's; as the voltages on the electrodes are varied to pump the charges down any one CCD column, ALL CCD columns receive the same voltages; therefore all the charges in all the columns move down the chip at the same time.

Note that similar horizontal electrodes are laid across both the "A" register, where the optical image is focussed, and the "B" register, which feeds the electron image into the "C" register for slicing up into video.

A Moving Picture

Let us assume that the "A" register has been viewing an image for 1/60th of a second, and the integrated charge-pattern is ready to be transferred into the "B" register. To move charges down the chip, we apply the three-phase square wave to the three wires attached to the "A" register; and since we are moving *into* the "B" register, we apply identical three-phase signals to the three wires of the "B" register:

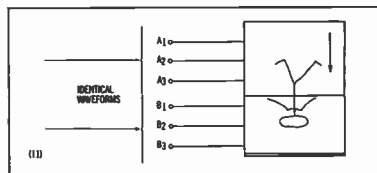

In other words, "A" and "B" registers function as one register during the transfer.

However, as soon as the transfer is complete (it takes about 750 microseconds of a 300-KHz square wave to do the job), the three "A" register wires go to a static condition, and the "B" register wires switch to a totally different mode, designed

to feed video a line at a time into the "slicer" or "C" register.

One Line At A Time

To move the charges one line at a time, the "B" register electrodes are held static during the active line period, and then, during about 3 μ sec of the horizontal blanking period, the electrodes of the "B" register have a "burst" of polarity changes applied to them—the same six-step cycle of polarity changes of Figures 5A through 5I. Thus, during horizontal blanking, the charges move from a given line to the line below, and simultaneously the charges from the line above move into the just-emptied line. Thus, at every horizontal blanking time, the entire stored image in the "B" register shifts down by one line.

At the bottom of the "B" register is the "C" register:

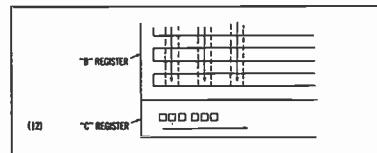

When the charges of the "B" register arrive at the last "B" electrode, the next horizontal-blanking down-shift sequence transfers them into the "C" register, where one of the electrodes of each group is being held positive to receive them:

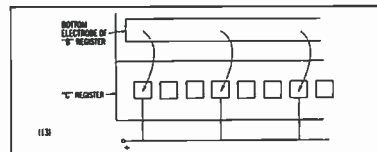

As soon as the charges are received by the "C" register, its electrodes begin to go through the same polarity sequence described above (Figures 5A through 5I) for the "A" and "B" registers, to pump the charge through the "C" register into the waiting video circuitry. However, since the entire 403-element line must be emptied in about 53 μ sec (the active time of one TV line), the "C" clock rate must be 403 divided by $53 \times 10^{-6} \sim 7.6$ MHz.

Interlace On A Chip

Meanwhile, back at the "A" register, the electrodes have been held static while the optical image causes the charges for the next field to accumulate. If the field being accumulated is an *odd* field, then the static potentials of the "A" register look like this:

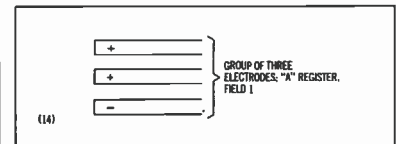

... while, for an even field, they look like this:

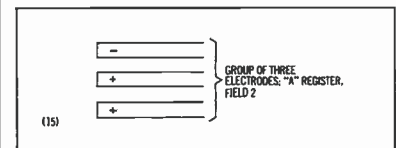

Since the electrons released by the photons of the optical image will accumulate under the two positive electrodes, the result of these two different polarity patterns will be two interlaced fields:

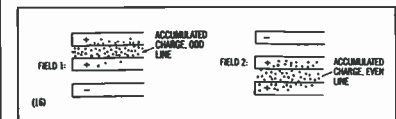

Notice that there will be some overlap between the lines of the two fields, just as there is some overlap in an electron-beam scanning pattern. Fortunately for the CCD, the overlap is precisely right to reduce the vertical scan-pattern aliasing that we have all endured from tube cameras for years.

So the field of video accumulated in the "A" register (field 1 or field 2) is then transferred to the "B" register, from whence it is "sliced" by the "C" register, and sent as output through an on-chip FET source follower, whose low output impedance to the external world accounts for a good part of the CCD camera's phenomenal signal-to-noise ratio. But that's outside our "deflection" story, so we'll hold that story for another day.

RCA Receives Emmy Award For "Circular Polarization For Broadcast Television"

RCA has been awarded the Distinguished Engineering Award by the National Academy of Television Arts and Sciences for its role in the development of Circular Polarization for Broadcast Television. It was the ninth Emmy awarded to RCA for its technical and engineering contributions to the television industry.

While engineering and design work started sooner, circularly polarized broadcasting for television was authorized by the FCC in April 1977. The first operational system was supplied by RCA Broadcast Systems Division for WLS-TV, Chicago. Since then the technology has ex-

SIGNAL ACHIEVEMENT. RCA Broadcast Systems was awarded a 1984 Emmy by the National Academy of Television Arts and Sciences for its pioneering role in the development of Circular Polarization for Broadcast Television. Shown with the Emmy at RCA's Antenna Engineering and Assembly facility at Gibbsboro, N. J., are Joseph C. Volpe, Division Vice President and General Manager; Dr. Oded Ben-Dov, Unit Manager, Antenna Engineering, and Bruno Melchionni, Manager, Transmission Product Operations.

Dr. Ben-Dov manages RCA VHF antenna design and has been responsible for much of the development work on circularly polarized (CP) antenna designs. The antennas in the photo are 1:10 scale models of top-mounted CP antennas. About ten percent of U.S. VHF television stations are now operating with RCA-supplied CP antennas.

panded, and CP television broadcasting has reached around the globe, from the United States to Mexico, Argentina, Brazil, Chile, and South Korea.

Joseph C. Volpe, Division Vice President and General Manager, Broadcast Systems Division (Gibbsboro, N. J.) accepted the Emmy Award for RCA. "The Emmy is always a cherished award, and this one is particularly prized," Mr. Volpe said. "It gives well-deserved recognition to an engineering group that has kept RCA pre-eminent in transmission system design for many years."

The CP transmitting technique, using vertical and

horizontal signals, was first developed for FM broadcasting. Television signals are conventionally transmitted as a horizontally polarized wave. In designing circularly polarized antennas, horizontal and vertical radiation components are combined to produce a circularly polarized field. The result is a dramatic improvement in reception, particularly in areas where "rabbit ear" and other indoor type antennas are commonly used. With CP, reception problems such as ghosting can be drastically reduced.



WLTX-TV Upgrades To Maximum ERP With New Transmitting Plant

WLTX-TV, Columbia, S.C., owned by Capital Communications, Inc., will be broadcasting at the maximum five megawatt ERP with a new transmitter and antenna system ordered from RCA Broadcast Systems, Gibbsboro, N. J.

The order includes a TTU-110CS Transmitter, TFU-36JDAS Antenna, transmission line and ancillary equipment and services. The scheduled air date for the new system is March 1, 1985.

J. C. Lewis, Jr., President of

Lewis Broadcasting (parent of Capital Communications, Inc.), notes that "this modern facility is in keeping with the progressive growth of the greater Columbia market."

In upgrading its transmitting facilities, CH. 19 moved its transmitting site and built a new tower, increasing the tower height to 2049 feet above mean sea level.

The top-mounted TFU-36JDAS directional Pylon Antenna with skull pattern, combines with the TTU-110CS Transmitter to achieve the five megawatt Effective Radiated Power. The TTU-110CS utilizes

the new super high efficiency klystrons for 120 kW power output.

Richard T. Laughridge, Vice President and General Manager for WLTX, TV, states that "This new transmitting system permits TV-19 to provide better service to the market. By extending Grade A coverage to many former fringe reception areas, it will also result in a substantial increase in our ADI which should be good news for our advertisers."

Capital Communications, Inc. is also affiliated with WJCL-TV, Savannah, GA, and WLTZ-TV, Columbus, GA.

Telesistema Mexicano, S. A. Purchases 15 RCA TV Transmitters

In a major transmitter purchase to upgrade numerous facilities throughout Mexico for the 1986 World Cup Soccer Match broadcasts, Telesistema Mexicano, S. A. has ordered 15 television transmitters from RCA Broadcast Systems, Gibbsboro, N. J.

Telesistema is the parent organization of the Televisa group, a multi-faceted broadcasting, production and programming group headquartered in Mexico City. The group comprises a network of 182 broadcast sites, throughout Mexico, including both owned stations and affiliates. This network includes 50 high power and 102 low power transmitters and 30 translators.

Included in the order are 14 VHF solid-state G-Line transmitters in power output levels from 12 kW to 35 kW, both highband and lowband, and a UHF 30 kW transmitter, TTU-30D. Transmission line and VHF H-Panel antennas for four of the transmitting sites are also a part of the purchase.

The order was signed by Romulo O'Farrill, Jr., Chairman

of the Board of Televisa and Telesistema, and Emilio Azcarraga Milmo, President of Televisa, S. A., and by Joseph C. Volpe, Division Vice President and General Manager, RCA Broadcast Systems Division.

Dennis J. Woywood, Division Vice President, Marketing for RCA Broadcast Systems notes that, "This transmitter order is probably the largest ever placed by one customer with a single supplier, and was based on performance, satisfactory experience with RCA transmitters, and competitive pricing. It also represents a continuation of a long-standing relationship between Telesistema and RCA dating back for more than 40 years."

The new transmitters are supplementing older RCA systems, many of which have been in use for more than 20 years. The existing transmitters will be retained as standby units.

Transmitter deliveries are scheduled to begin late 1984, with completion set for December 1985.

New KWVT-TV, Waco, Going On-Air With A "Tall Tower" And Maximum Power

KWVT-TV, the first UHF station in the Waco, Texas market, is scheduled to go on-air January 1, 1985 with an RCA transmitting system valued at \$1.4 million.

The equipment order includes a TTU-110CS Transmitter, TFU-25JDAS Pylon Antenna, transmission line, remote control and interface facilities.

Owned by Central Texas Broadcasting Co., CH 25 will be the NBC affiliate in the market. Robert A. Mann, General Partner, remarks that "The all-new KWVT-TV will provide the market with a strong new voice, with a commitment to local service as well as offering the full NBC program schedule to our viewing area."

The new station will be operating from a 2,000 foot tower, topped by the TFU-25JDAS Antenna with a directional pattern shaped to provide coverage of Temple and Fort Hood as well as Waco. The antenna combines with the TTU-110CS Transmitter to deliver the maximum ERP of five million watts.

CCD-1 CAMERAS IN ACTION. Since their successful debut at NAB, two demonstration models of the new CCD-1 solid state camera have delivered solid performances in handling comprehensive, demanding field assignments.

Two of the new charge-coupled device cameras, which use tiny chips instead of tubes, were put into "on-air" action by NBC crews at each of the national political conventions, and later for live coverage of major sports events including the Arlington Million Race (Arlington Park, Ill.) and the Breeder's Cup Race (Hollywood Park, Cal.).

Photo shows Floor Correspondent Connie Chung interviewing a delegate. Even when the hall lights were doused for a film showing, the CCD-1 cameras were able to pull-in live, on-the-floor interviews, practically in the dark. The pictures were sharp and clear, and the CCD-1 was the only camera on the floor that was able to perform under such extremely low light conditions.

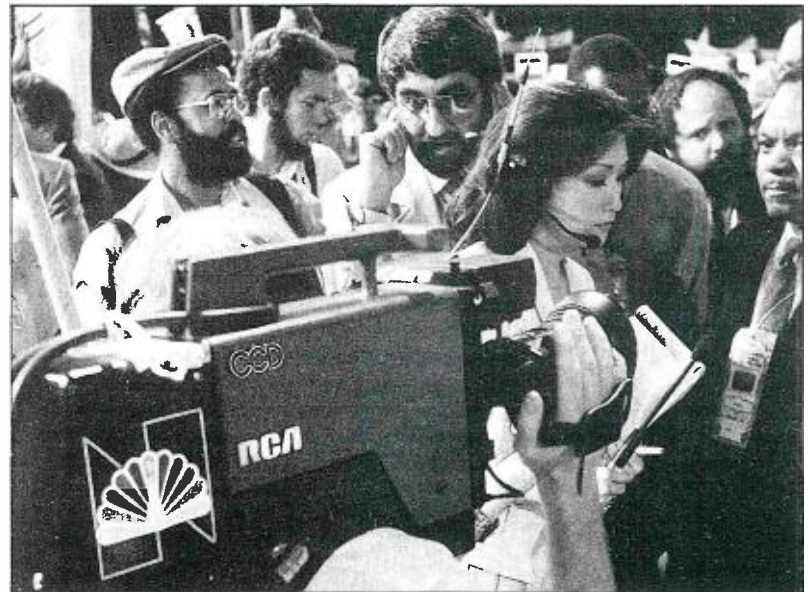

LITTLE ROCK'S NEW INDEPENDENT "U" JUST WHAT THE MARKET ORDERED



KLRT (Little Rock Television) went on-air with a bang on June 26, 1983. For all-new Channel 16, the "bang" was only partially from the impact of its full five megawatts of output—the most powerful signal in the market. More significantly, it came from the immediate viewer and advertiser response.

As the only UHF operation in the Central Arkansas market (#54) which was already being served by three network affiliates and a public station, Channel 16 faced stiff obstacles. However, the new station's broadcast-experienced ownership and management recognized the start-up problems as well as the opportunities and planned accordingly.

Swift Viewer/Advertiser Acceptance

A comprehensive pre-selling effort was mounted well in advance of the air-date, advising potential viewers and advertisers of what they could expect from the new independent station. A massive education program alerted viewers on how easy they could "Turn 16".

The combination of a powerful signal, strong independent programming and effective promotion produced results which exceeded station projections: In six months, KLRT grew from a non-existent operation to a position where it beats the established competition in some time slots. In some time periods, parity was achieved in only five months after Channel 16 went on-air! Along with the growing audiences came advertiser acceptance, and ad revenues also have surpassed expectations.

Planning For Success

The station is owned by Little Rock Communications Associates, a limited partnership with broadcast interests (a large capital investment was provided by MMT Sales, Inc., a major TV representative firm, and by a group of local and out of state investors).

In putting their new station on-air, Channel 16 owners wanted to achieve parity with competitive stations from the start—parity in quality program

offerings and in technical performance, particularly in signal output. This strategy determined the scope of the studio equipment complement and of the RF system which was specified.

\$3 Million Equipment Package

The \$3 million equipment package purchased from RCA included a TTU-110C 110 kW Transmitter, TFU-36JDAS Pylon Antenna, two earth stations, and a studio complement of three TK-761 Cameras; three TR-800 one-inch VTRs; two TK-29 Telecine islands as well as audio, lighting and microwave equipment.

Once a CP was acquired in July 1982, a tight timetable was established for getting the new station on-air. The owners targeted July 4, 1983 as the on-air date. Channel 16 beat the schedule and started broadcasting at full power on June 26.

Locating Studio and Tower Sites

Director of Engineering Dexter Merry, then chief at WQTV, Boston, was offered the challenge of putting Channel 16 on-air. He accepted, starting September 1, 1982, with the immediate task of

HERE ARE THREE GOOD REASONS TO TURN 16.



Network executives decide what you watch on 4, 7 and 11. At Channel 16, we show only what Arkansans want to see. We're bringing you prime time programs all the time. Every day of the week. Plus, you'll



see more movies when you turn 16. More good news is that you don't need cable TV to watch these Channel 16. Best of all, you don't have to settle for what's on 4, 7 and 11 any longer.

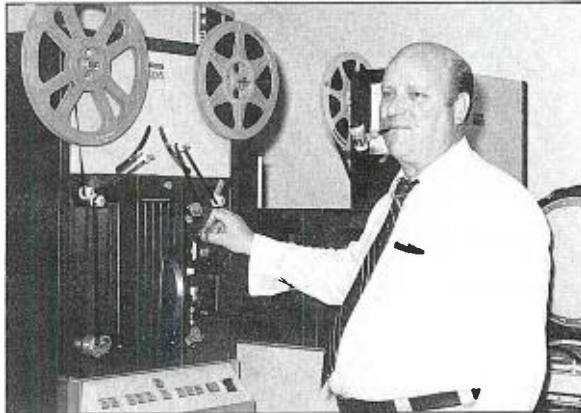

Dexter Merry, Director of Engineering

locating suitable sites for both the tower and the studio.

An option was taken on available property on Shinall Mountain, west of Little Rock, and test borings were made to determine the feasibility of locating the tower and transmitter building there. The search for a suitable studio site ended early, when the present structure on West Markham was located.

Set on a hill within Little Rock city limits, it provided the necessary STL line-of-sight clearance. And, since the building on the site provided ample floor space (19,500 sq. ft.), it needed only remodeling to serve as KLRT's combined administration/studio facility.

Five Megawatt ERP

"We decided right from the start to go with a five megawatt ERP for this market," Merry says. The wisdom of this decision is confirmed in the coverage and signal quality achieved. The only UHF station in the market, Channel 16 compares favorably with the four VHF channels in signal strength and clarity. According to Merry, calls have been received from 70 miles away commenting favorably on the station's quality signal. Some calls came from viewers who said "We're happy that you're here—now we don't need cable." Area cable operators also reacted quickly by adding independent KLRT to their cable offering.

Lean, Efficient Staff

Channel-16 is on-air from 6 AM until 12:30 AM on weekdays and much later on weekends. Its alternative programming schedule includes more than 35 hours of movies each week, along with popular syndicated comedies, adventure shows and dramas.

The station operates efficiently with a staff of just 35 people, of which twelve are assigned to Engineering. All technical operations, including



Studio and administration building

camera, tape and switching for production, as well as on-air and maintenance functions are handled by Engineering. To achieve greater operating flexibility, personnel hired for camera, tape and switching operations are being trained to handle routine equipment maintenance under the direction of Maintenance Supervisor Hollis Duncan.

An IBM 36 Columbine computer system is employed for handling billings, traffic and accounting functions as well as for generating daily logs. It does not include machine automation functions at present, but this is a future consideration.

"Tight" Construction Schedule

During construction, Dexter Merry functioned as the owner's representative, coordinating building operations and scheduling equipment deliveries and installation. Since the transmitter and its ancillary equipment required longer lead lines, they were shipped to a staging area at the studio to be ready for installation as soon as the transmitter building was completed. "The construction time was a lot tighter than I had hoped for," Merry recalls.

Tower Designed For Multi-Communication Use

The elevation on Shinall Mountain where the Channel 16 antenna and tower are located is 954 feet above mean sea level at the base. The guyed tower topped by the RCA TFU-36JDAS Pylon antenna is 1266 feet above ground, and was designed with generous windloading to accommodate other broadcast and communications facilities in addition to KLRT's antenna. It can handle three 12-bay FM antennas (one of which is already installed) as well as fifteen two-way radio antennas and six microwave dishes.

The tower was constructed and installed by LeBlanc & Royle Communications, beginning in December 1982. The tower site presented difficult working conditions, since it is a stone base with a

NEW UHF STATION

clay overburden, which makes it "as slippery as a greased pig," Mr. Merry notes. As a result, construction on the transmitter building was delayed until early Spring.

Functional "Concrete Cube"

Squat and functional (Merry refers to it as a "concrete cube"), the transmitter building fits into a notched-out area at the base of the tower. Built of pre-stressed concrete, it has no windows and provides limited access through heavy steel doors. Space is provided in the building for renting to on-site users of radio and communications facilities, and one large separate area with its own entrance is now occupied by the FM transmitter whose antenna is on the tower.

First "Magic Tee" System

The largest area in the building is reserved for the TTU-110C 110 kW transmitter which is equipped with the energy-saving Mode Anode Pulser and Aural and Visual Couplers. The KLRT transmission system also is the first installation of RCA's new "Magic Tee" output switching system.

This new "switchless" switching technique eliminates the need for complicated routing of RF "plumbing" and many coaxial or waveguide switches (see "Products In The News", BROADCAST NEWS, Vol. #174).

"The 'Magic Tee' minimizes coaxial switches in the system; saves time in switching, and is faster and more reliable than manual or motorized waveguide switching," Mr. Merry comments.

The TTU-110C Transmitter is operated at 100 kW which, combined with the gain of the TFU-36JDAS, provides the maximum 5 megawatt ERP. The system delivers a clear signal throughout the Little Rock-Hot Springs-Pine Bluff metro area, and a Grade B signal sixty miles out.

18-Inch Circular Waveguide Line

Circular waveguide is used to carry the signal to the antenna. According to Merry, the circular waveguide was selected because it provides one-third less windloading on the tower than rectangular waveguide. The 18-inch diameter waveguide is installed beginning about 20 feet up the tower. Rectangular waveguide is used from the transmitter through the "Magic Tee" switching system and up the first section of tower.

Studio/Administration Building

The studio/administration building was designed to serve as a carpet sales and warehouse

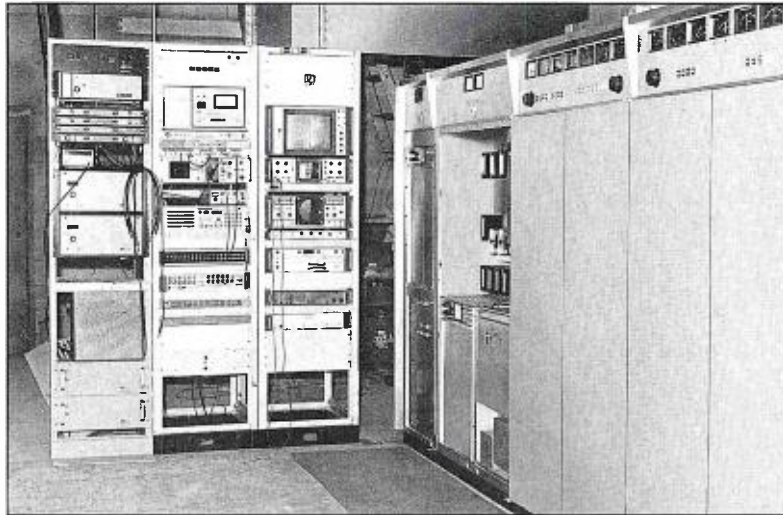

TTU-110C, 110 kW Transmitter, with monitor and control racks

operation, but was never used for that purpose. It was bought and refurbished by KLRT for broadcast operations, with surprisingly effective results.

Administrative operations fill the front part of the building, with technical facilities, offices and the 40' x 60' production studio at the rear. In addition to handling immediate needs, the building has a second floor over the technical area which provides room for storage now, and for expansion as needed later.

The studio area is isolated from the main building for sound and vibration isolation, and has two permanent sets, one for the "Newscap", three-minute capsules aired three times daily, and one for "Little Rock Now", a public service program.

Three TK-761 cameras are used in the studio and have performed well. They were intended to be used as convertibles for ENG/Studio use, but have not been needed for this purpose since two TK-710 ENG Portables were subsequently purchased for handling remote productions. These are also providing excellent service according to Mr. Merry.

Tech Area Planned For Growth

The technical area at Channel 16 is a large room, with ample space for additional equipment. One corner of the area is occupied by two TK-29 telecine systems, each with two TP-66 16mm projectors and a TP-7 slide projector. They are well utilized for programming and for transferring film to ¾-inch cassettes. Harold Higgins, Technical Supervisor, notes that at present, about 80 percent of program material received is either film or one-inch tape. Little quad material is used, other than for commercials. A TR-600 quad machine is used primarily for dubbing, and occasional playback.

Lining the wall to the left of the telecine

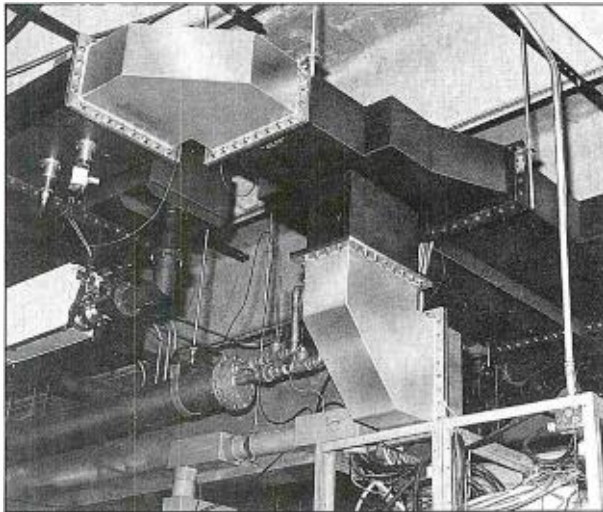

"Magic Tee" output switching system minimizes coaxial switches and saves time in switching.

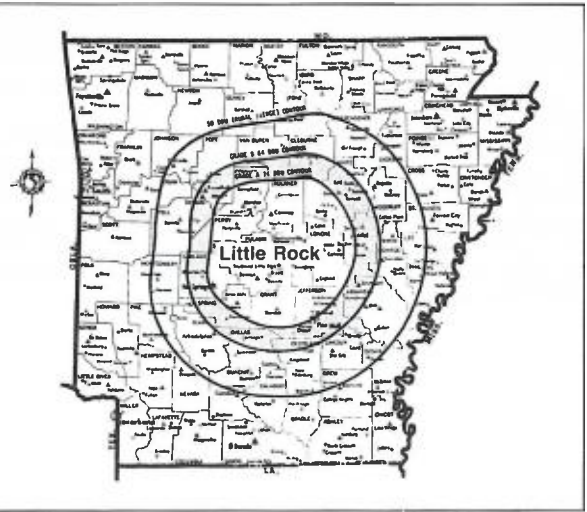

KLRT coverage area



Master Control and technical area

systems is an array of rack-mounted monitoring, distribution and terminal equipment. Three TR-800 one-inch VTRs are shelf-mounted, and four ¼-inch cassette units are rack-mounted in front of the Master Control Switcher. The TR-800s, with slow-motion and built-in editing facilities, are utilized for producing in-house promos and for program playback.

Stereo-Compatible Equipment

On-air operations are handled by the MC operator and a tape/film operator. A third person is now required for dubbing commercial spots for breaks ahead, which is done on ¾-inch. The station is currently developing their own ¾-inch multi-cassette playback system, using six

machines. Until this system is in operation, a spot reel is assembled and dubbed to ¾-inch with a 5-second pre-roll.

One of the objectives in setting up the technical facility, Dexter Merry remarks, was to make as much of the equipment as possible stereo-compatible. The audio mixer is a stereo system, and the ADS production video switcher is also stereo-capable and has a computer port for handling future automated functions.

Right Combination to Reach Goal

From its inception, KLRT was planned for impacting the market and achieving profitability in a minimum time frame. The combination of quality programming, effective promotion

and technical excellence has provided the means for meeting that goal.

Although understandably proud of his transmitting and studio facilities, Mr. Merry quickly notes that technical performance is just one of the tools contributing to Channel 16 profitability—a part of the product quality that attracts and keeps viewers turned to "16".

**Promotion Primes Viewers
to "TURN 16".**



Indicative of the importance of promotion to the KLRT operation, Joe Swaty, Director of Promotion and Advertising, remarks that he was the fourth employee hired. Long before the equipment complement was assembled, the promotional strategy was developed and implemented, priming the market for Channel 16.

The first major independent in Arkansas, KLRT takes full advantage of that status in separating itself from the network affiliated stations. The counter programming strategy is high-lighted in print ads and promotions. For example; the station's kickoff campaign featured the bold heading—"Three Good Reasons to Turn 16—Channels 4, 7, and 11!" (the three local network affiliates).

The promotional theme "Prime All The Time" provides an umbrella for reinforcing Channel 16's independent status and program options.

The contribution of promotion to the overall success of KLRT has not gone unnoticed. The station's innovative promotional campaigns have won local Addy Award honors, INTV recognition and even the prestigious International Gold Medallion from the Broadcasters Promotion Association.



Joe Swaty, Director of Promotion and Advertising.

PROMOTION PRIMES VIEWERS TO "TURN 16"

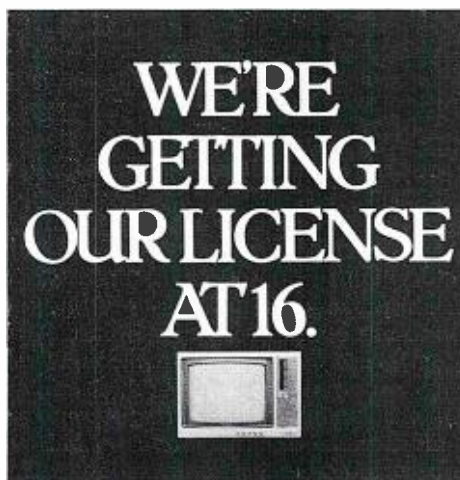

Arkansas' first new television station in years will be ready to go on June 26. And as a state first licensed independent television station, we're going to give the three network stations a real run for their money. Because we don't have to offer you what some network executive in New York wants you to see. We can offer you what Arkansas wants to see. The best of prime time entertainment. Broadcasters movies. Top sports events. including some local surprises. Fun kids' programming. Just enough news and information. And an honest commitment to be a good neighbor as well as a good television station. Look for us on June 26. Once we've got our license, it's full speed ahead.



HOW'D YOU LIKE TO TAKE ADVANTAGE OF SOMEONE WHO JUST TURNED 16?

NEW RCA BROADCAST SYSTEMS HEADQUARTERS



The new RCA Broadcast Systems Division is in place, operating from a brand new building in Gibbsboro, New Jersey.

Engineering, Production, Warehouse and Inventory functions; the Custom Repair and Engineering (CRAE) facility; Tech Alert, and the Technical Training Center are on-site—all fully operational. With this move, all Broadcast Systems operations, including Administration, Marketing and Finance, are now centered in the same area.

The new building culminates a year of transition. Since our plan for moving was announced, we have been consolidating operations; developing new products, and putting a new organization together . . . with a new spirit and confidence in the future.

RCA Broadcast Systems move reaffirms our commitment to remain the industry's leading supplier of quality products, with unequalled support services.



RCA

Seashore scenes captured
by the CCD-1 Camera
for "Director's Diary" videotape report.
See Contents for more detail.

RCA

