

RCA
NEW LOOK

SYSTEMS
DEMONSTRATION

SYSTEMS
DEMONSTRATION

RCA
PILOTS
NEW
LOOK



BROADCAST

N E W S

Vol. No. 126 MAY 1965

1965 NAB CONVENTION



Compact TV Tape Recorder

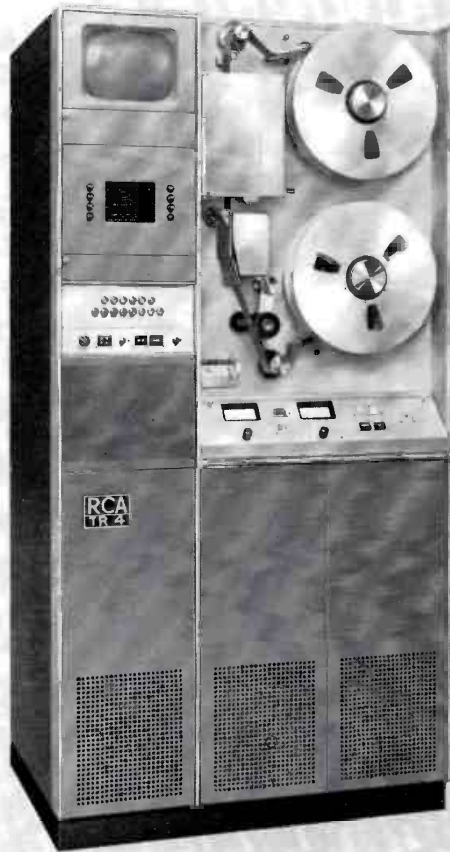

**This budget-priced, quadruplex Recorder
accepts high band, color, and electronic splicing accessories**

This total performance compact does just about everything the deluxe model does. Complete in a 33 by 22 by 66 inch cabinet, the transistorized TR-4 is the answer for installations where low initial cost and broadcast quality pictures are indicated. A complete recording and playback package, it has suitable monitoring facilities, built-in picture and waveform monitors, and other provisions to meter key circuits for proper setup.

Like other RCA transistorized TV tape equipment, new circuit techniques, needed for high band, are accommodated by the TR-4. With such circuits, (available as optional extras) high band can be selected as a second mode of operation, with all its

benefits, including color and monochrome tapes of particularly high quality, and multiple generation video dubs.

Features now standard on the TR-4, as on all RCA TV tape equipment, include air-lubricated tape guides, magnetic tone wheel, solid state control system, built-in switchlock and two-speed operation. Accessories available include Pixlock, automatic timing control, cue record and playback and electronic splicing. The TR-4 is the only recorder of its kind that's adaptable to color operation. And standardized modules in this and other RCA TV Tape Recorders assure high quality, easy maintenance, and simplicity in adding accessories.

Can we give you more facts about this budget-priced recorder that accents quality? Call your RCA Broadcast Representative. Or write RCA Broadcast and Television Equipment, Building 15-5, Camden, N. J.



The Most Trusted Name in Television

Vol. No. 126

May, 1965

BROADCAST NEWS

published by

RADIO CORPORATION OF AMERICA
BROADCAST & COMMUNICATIONS PRODUCTS DIVISION, CAMDEN, N. J.

issued bi-monthly

PRICE *in U.S.A. - - - - - \$6.00 for 6 issues*
outside U.S.A. - - - \$7.00 for 6 issues

C O N T E N T S

	Page
More "New Look" at 1965 NAB Convention	7
Revolution in TV Station Operation	14
The Future of the Television Receiver	26
"New Look" 55-kw UHF Television Transmitter	30
New RCA Super-Deluxe TV Tape Recorder, 22HL	40

Copyright 1965

All Rights Reserved Trademark(s) Registered. Marca(s) Registrada(s) Radio Corporation of America

PRINTED
IN
U.S.A.

RIVER OF TK-27 CAMERAS BEGINS TO FLOW



The four-tube system that distinguishes RCA's new TK-27 color film camera shows clearly in this view of cabinet assembly operations at the RCA Camden plant. Demand is heavy for all color equipment items.

Nowhere is the color television boom more apparent than at RCA's Camden, N.J. manufacturing facilities where production of TK-27 color film cameras began in April and proceeds at an expanding rate. The trim and transistorized four-tube cameras are being assembled and tested on a volume basis with schedules calling for delivery of more than 150 units by the year's end.

The new color surge thus has reached the skilled hands of many of the RCA technicians who built the first color TV cameras used in this country. No museum pieces, these first cameras are still in active service, providing the quality pictures that nurtured color TV from the start and helped to fuel this year's color explosion.

They would be those workhorses of the studio, the TK-41 "live" unit and the TK-26 film camera. Both types have been modified over the years to keep broadcasters abreast of changing technology in color TV. Now they are being superseded, as TK-27 units roll from the factory and as TK-42 tooling is completed for the new live camera's production and delivery of more than 50 units during 1965.

AN ELECTRONIC ANTIDOTE FOR THE WRONG-WAY MOTORIST

A directional vehicle detector that senses "wrong-way" driving on one-way streets and lights up a roadside sign to warn the erring motorist has been announced by RCA Industrial and Automation Products.

The new electronic device operates from two wire loops embedded in the pavement. The loops, which are attached to a control box at roadside, carry circuits that are individually tuned and arranged in sequence. A vehicle traveling over them in the "wrong" direction causes electrical changes in the circuits.

The signal thus generated can be used to illuminate a traffic sign directing the driver to turn back, flash warning blinkers, or for some other purpose. The system's circuits are so arranged as to ignore vehicles passing over them in the "right" direction.

The new device would be especially useful on super-highway entrance and exit ramps where accidents frequently are caused by "wrong-way" vehicles. In such areas, the detection device could be used simultaneously to caution motorists proceeding lawfully that a vehicle was approaching from the "wrong" direction.

The two-loop principle also is the basis for RCA's new "advisory" vehicle detector which senses a vehicle's speed and actuates a sign warning the driver that he is exceeding the speed limit. Detection is based on time-distance relationship. The device can be pre-set to detect vehicles exceeding a given speed and is recommended for use at approaches to curves, blind intersections and other danger points where motorists would benefit from a pointed reminder to slow down.

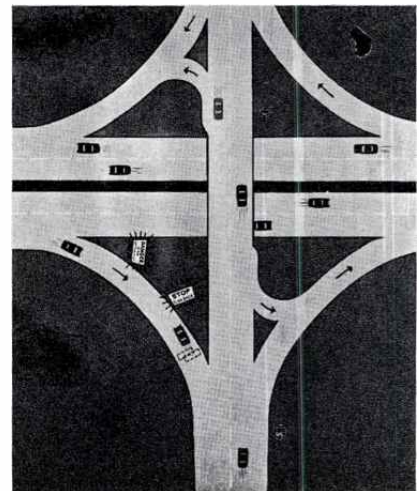

Car moving 'wrong way' on ramp lights warning sign.

THE SUPER-FLEETFONE: RCA TWO-WAY, A GREAT WAY TO GO

The first two-way mobile radio in the 450-megacycle band to use all solid-state components, and a second similarly-designed unit for 150-megacycle service, were introduced by RCA in March. The radios, which bear the "Super-Fleetfone" trade name, are expected to establish new levels of performance and reliability in the two-way radio field.

The use of such equipment for on-the-spot coverage of news events originating

at remote locations was described in a paper by Norman C. Colby, Manager, RCA Communications Products Engineering, at the 1965 N.A.B. convention in Washington.

Mr. Colby noted that the Super-Fleetfone, when transmitting with a power output of 30 watts, draws but 10 amperes from a 12-volt battery. This is by far the lowest transmitter drain in the industry and is important to remote pickup service where long transmissions are common.

The new equipment supplements RCA's existing line of "Super-Carfone" two-way radios, now widely used in public safety vehicles, trucks, taxicabs and for other applications. The Super-Fleetfone design eliminates all vacuum tubes and improves on earlier solid-state designs by using simplified circuits with fewer components. The power transistors are RCA's "overlay" type which require no complex protective circuits and contribute to the unit's overall dependability.

The new mobile transmitters are capable of continuous duty, a rating credited to the 100 per cent solid-state construction and to improved heat dissipation. As a result, the transmitter can be operated for extended periods without excessive heat buildup. The Super-Fleetfone is considered more reliable than anything that has gone before, making it especially suited to police and fire vehicles and to any other service where high-quality message intelligence and trouble-free operation are musts.

Another benefit of the design is "instant transmission"—the radio is in a ready-to-talk condition when the microphone is lifted from its hang-up hook. Older mobile equipment often requires warmup waits of up to 45 seconds. The mobile unit's power requirements are so low, a mere .2 amps in the "transmit-ready" (full receive) position, that the addition of an "on-off" light on the control panel would have doubled battery drain.



Gloria Kirby makes a pretty setting for the Super-Fleetfone, shown here with choice of control heads.

KAISER ORDERS EQUIPMENT FOR SECOND NEW TV STATION

WKBS, the new Kaiser Broadcasting TV station scheduled to begin color and black-and-white broadcasts in the Philadelphia area in September, has ordered more than \$1,000,000 in RCA studio and transmitting equipment. Like its sister Kaiser station, WKBD, Detroit, the new station will use a programming concept of "total entertainment," featuring sports in prime time and a balanced schedule of top-rated films and local live shows, according to Thomas A. Breen, Station Manager.

The equipment ordered from RCA emphasizes portability and mobility and in-

cludes a mobile unit outfitted with two TK-42 color cameras and a compact TR-4 color TV tape recorder. The equipment complement includes four of the compact recorders (type TR-4) as well as additional black-and-white studio cameras, a color film chain and a switching system. It will be installed in a Southwest Philadelphia building now being remodeled for studios.

Portable microwave systems will permit Channel 48 to relay sports shows directly from high schools, colleges or other points in the Philadelphia area to the studio. Programs will be put on the air "live" or

recorded for later broadcast, thus allowing viewers to see telecasts of two or more popular sports events that may occur at the same time.

WKBS will use the powerful TTU-55A UHF transmitter, a 55-kilowatt unit introduced at the National Association of Broadcasters convention this spring. When coupled to an RCA pylon-type antenna which will be erected on a 1,100-foot tower to be constructed on the TV antenna farm in the Roxborough section of Philadelphia, the station will be capable of radiating 1,000,000 watts ERP.

RANGER SENT BACK 5,814 PHOTOS, 'LIVE' FROM THE MOON

The Ranger Lunar Exploration Program ended on a spectacular note March 24 as millions of Americans for the first time viewed live on television photos of the moon's surface sent back by a six-camera RCA television system. A total of 5,814 quality pictures, the last transmitted moments before impact in the huge crater Alphonsus, was sent back.

Pictures from the Ranger spacecraft were received at the Goldstone tracking station in California's Mojave Desert, then relayed via microwave 150 miles to the Jet Propulsion Laboratory in Pasadena. There they were fed to the television networks.

The more than 17,000 high-resolution photographs of the moon returned by Rangers 7, 8 and 9 within an eight-month period have given scientists a way to transcend the earth-bound limits of human vision and to study objects and scenes never before seen in detail.

The successful flight of Ranger 9 came almost five years to the day the first TV camera was used in space. The initial application of TV in space took place on April 1, 1960, aboard the RCA-designed and built TIROS I weather satellite.

Since that time, 40 RCA TV cameras have been successfully launched into space on nine TIROS vehicles, Nimbus I and Rangers 7, 8 and 9. They performed without fail, establishing an unparalleled record for 100 per cent mission successes. Together, these RCA-built "electronic eyes" have provided nearly a half-million pictures of objects and scenes which previously were not visible to the naked eye.

The 380-pound television systems for all the Ranger spacecraft were designed and built by RCA's Astro-Electronics Division, Princeton, N. J. Other RCA divisions designed and built the ground-based receiving equipment which recorded the pictures from space on video tape and 35mm film.

Many of the Ranger photographs were 2,000 times better than any obtained from earthbased instruments. Peering through the thick layer of atmosphere around the earth, scientists using earth-bound instruments would not be able to detect an aircraft carrier on the lunar surface. Photo-

graphs returned from the Rangers showed craters and objects no bigger than a peach basket.

Ranger 9 carried into space the most sophisticated television camera system of the entire program. Five of the six TV cameras on the last mission were equipped with new, improved vidicon pick-up tubes capable of providing photographs with better resolution than those of Ranger 7. Two of Ranger 8's TV cameras carried the new vidicons.

The RCA television system aboard Ranger 7 functioned perfectly and returned over 4,300 high-resolution photographs of the moon before it impacted near the Sea of Clouds on July 31, 1964, and was considered perhaps the most significant achievement in lunar exploration since the invention of the telescope.

The equally successful Ranger 8 mission sent back over 7,000 pictures of the moon's highlands, mountains, craters, and the southwest corner of the Sea of Tranquility, where it impacted on February 20, 1965. The higher number of pictures from Ranger 8, taken during the final 23 minutes of flight as opposed to Ranger 7's 4,300 during 18 minutes, was due to Ranger 8's less vertical trajectory.

The six cameras, the eyes of the spacecraft, weighed 88 pounds and were housed in a truncated cone structure 59 inches high, 27 inches across at the base and 16 inches at the top. The structure was covered by a shield of polished aluminum and mounted on the hexagonal base of the Ranger spacecraft "bus." It was circled by four one-inch wide fins to supply proper thermal balance of absorbing the sun's rays during flight.

Bernie Miller, Ranger Project Manager for RCA, with Ranger 9, last "bird" in the Ranger flight series.



TIME TO DO HOMEWORK? THESE STUDENTS WILL 'DIAL-A-LESSON' RCA BUILDS GIANT TAPE RECORDER FOR DOD

A new university in Tulsa, Oklahoma, is planning an unusual "dial-a-lesson" system which students will tap for televised playback of pre-recorded study material. The \$500,000 system will be designed and installed by RCA in a six-story Learning Resources Center being built at Oral Roberts University, founded by the evangelist whose name it bears, which opens this fall.

Students will have a choice of study lessons previously recorded on motion picture film and slides, and on video and audio tape. Seated in an individual booth equipped for study by electronics, the student makes a choice of educational program from a numerical directory. By dialing the appropriate number the student triggers a playback device, and the lesson is reproduced pictorially on a viewing screen, as sound in earphones or both.

Initially the system will have 130 booths or "study carrels"—100 equipped for both audio and video reception and 30 for audio only—from which a student can dial a recorded lesson. Future extension of the system may include dormitory rooms, perhaps as many as 1,000, with the recorded lessons made available on a 24-hour basis so that students could study electronically in their living quarters at any time.

The basic system's nerve center is a custom-designed audio-video switcher capable of handling as many as 62 inputs—incoming programs from film, tape or other sources—and distributing them to students dialing in a lesson request. The system will have but one TV production studio but there will be at least six other locations to which mobile TV cameras and other equipment can be rolled for TV recording assignments.

Three lecture halls will be wired for TV recording/playback. A morning lecture could be recorded on TV tape, for example, and made available immediately thereafter via dialing to students who wanted to review what the lecturer had said or shown. The equipment list covered by the RCA contract includes several units of RCA's newest vidicon camera (type PK-330),

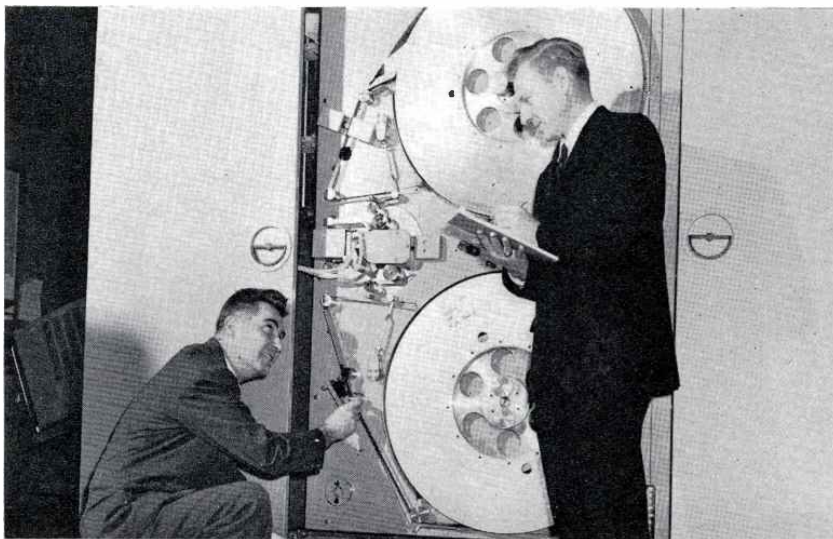

Engineers check out huge machine that will record radar data from ballistic missiles at Kwajalein.

RCA has delivered a giant tape recorder, one of the most sophisticated and perhaps the largest in existence, to the Advanced Research Projects Agency (ARPA). The machine's huge reels hold seven miles of tape which speeds through its guides at more than 60 miles an hour.

Were it put to work in commercial television, the \$600,000 machine could record and play back 12 TV programs simultaneously. But it is destined for the Pacific island of Roi Namur, a part of Kwajalein Atoll, where it will be put to use by ARPA/Lincoln Laboratory to record radar signals obtained from ballistic missiles.

The machine uses 14 of its 15 channels for recording data on targets within the

radar beam, and the 15th channel for stability control. Information can be played back through the entire radar system for detailed analysis of the characteristics of the ballistic devices.

Compressed air bearings support the tape, minimizing friction at the tremendous speed. The usable tape length is five miles, with one mile needed to accelerate to the 60 mph speed, and another mile to decelerate and stop. Running speed is extremely accurate: within two parts in one hundred thousand over five miles of tape.

The recorder was built by RCA's Missile and Surface Radar Division for the Army Missile Command which acted as ARPA's agent for the procurement.

transportable TR-5 TV tape recorders, TV film chains, off-the-air television tuners, complete language laboratory facilities including student booths with tape recording units and many other items.

TV equipment will be put to novel use in a "performance analysis studio." Students studying public speaking, acting and similar courses will be able to record their performances on video tape, play back the

tape immediately and make an evaluation on the spot.

The educational electronics program also calls for a mobile television unit to serve the science laboratories. Television cameras will be used with light microscopes, enabling an entire class to share the magnified view of a specimen. The TV system also permits the program to be recorded on film or tape for future playback.

SNAP-10A STORY: FIRST IN THE SKY WITH NUCLEAR POWER

The songwriter who proclaimed "there's a gold mine in the sky, far away" will have to update his material. Now it's a nuclear power plant up there, making the orbit. It happened late in March with the launching, via an Atlas Agena, of the SNAP 10A (for Systems for Nuclear Auxiliary Power), making space nuclear power a reality.

Unlike earth-bound nuclear power plants, SNAP 10A uses silicon-germanium thermoelectric power conversion modules which operate entirely without moving mechanical parts. The modules convert the nuclear reactor heat directly into electricity, producing 500 watts of usable electric power.

RCA Electronic Components and Devices developed and fabricated the modules for the SNAP 10A system which itself was designed and assembled for the Atomic Energy Commission by the Atomic International Division of North American Aviation, Inc.

The conical structure of the SNAP 10A power converter is made up of 120 thermoelectric modules arranged in 40 strips around the space craft's periphery, with the reactor at the apex of this cone. Heat from the reactor is transferred to the thermoelectric modules by means of a closed loop system containing a liquid sodium potassium alloy. Each module con-



One of SNAP-10A's 120 thermoelectric modules.

tains 12 thermoelectric couples, which individually produce 0.37 watts at 0.04 volt. These couples are connected in series-parallel circuits to yield more than 500 watts at approximately 30 volts.

The thermoelectric principle was discovered in 1821 by Seebeck. It is based on the phenomenon that a current flows in a closed circuit formed by the junctions of

two dissimilar metals, if one junction is maintained at a higher temperature than the other. In modern power-generating thermocouples, carefully controlled p-type and n-type semiconductors replace the dissimilar metals originally employed by Seebeck and result in significantly improved thermocouple performance. The new thermoelectric material used in SNAP 10A, silicon-germanium, was developed by RCA Laboratories, in a program sponsored by the U.S. Navy Bureau of Ships.

The SNAP 10A thermoelectric converter is heated with a 78 per cent sodium—22 per cent potassium liquid alloy which is pumped through the reactor core where it picks up fission heat. This liquid-metal coolant flows through stainless steel tubes which are joined to the hot junctions of the thermocouple elements. The cold junctions of the thermocouples are joined to individual aluminum radiators which form the outer surface of the conical section of the SNAP 10A vehicle. The resultant temperature differential across the thermoelements produces the required electrical power.

The entire SNAP 10A system successfully passed a series of flight-qualification ground tests late in January 1965 in a pre-flight check-out of the system by Atomic International.

WJBK INSTALLS NEW BC-8 DUAL-CHANNEL CONSOLE

WJBK, Storer Broadcasting's Detroit radio station, is proudly showing visitors its new Studio A which features an RCA BC-8 dual channel, transistorized audio console.

The accompanying photograph shows Bob Lee, a station personality who handles the "wake-up" session from 6 to 10 a.m. weekdays and an additional two hours on Saturday, with the new equipment.

With the console, the announcer can control six microphones in two studios, six tape recorders and six incoming remote lines, plus three turntables and three automatic cartridge tape playback units in the studio. The console also includes a built-in intercom to the other studio and to the transmitter site.

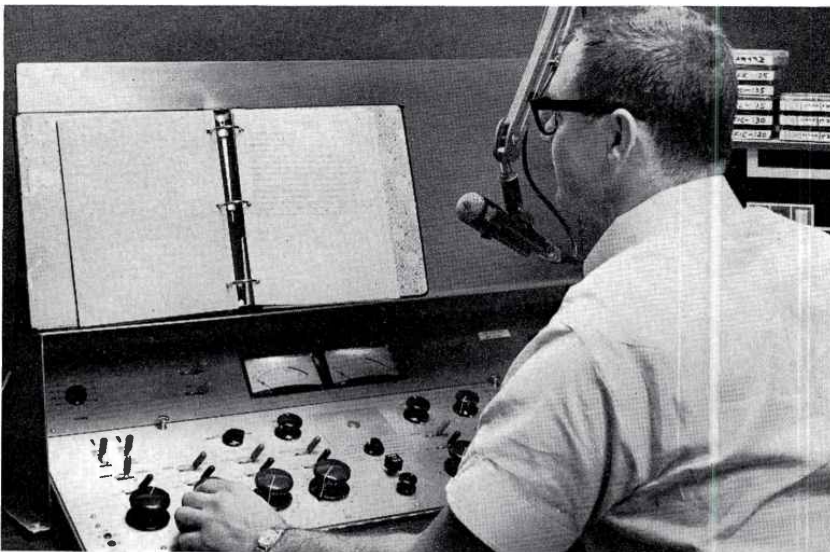

MORE "NEW LOOK" AT NAB

New Cameras, Tape Recorders, Transmitters
and TV Systems Equipment
Make Debut at 1965 NAB Convention

The RCA "New Look" became a "total look" at this year's NAB Convention as a second wave of new equipments joined the New Look line. This "total look" was highlighted in an operating television system display completely New-Look equipped—film system, tv tape recorder, control, switching and effects, and complete sync and distribution equipment—everything necessary for most modern tv station operations. Details pertaining to this operating demonstration are found in a separate article beginning on page 14 of this issue.

Photos on these pages show all the New-Look equipments as they were displayed. For color tv these include a luminance-channel live studio camera, TK-42; a 4-vidicon color film camera, TK-27 and a complete line of tv tape recorders led by a new 22HL high-band recorder (see article beginning on page 40).

Five different RCA cameras beamed action from the live studio to various monitor locations throughout the RCA exhibit—two professional vidicon cameras PK-301 and PK-330, a 3-inch I.O. field camera TK-33; a 4½-inch I.O. studio camera TK-60, and the luminance-channel color camera, TK-42.

Other equipments for UHF telecasting, FM and FM stereo broadcasting, tv taping, audio and video operations shared the spotlight in a complete operating presentation of the "New Look" in broadcasting—the "total look" of complete radio and tv systems.

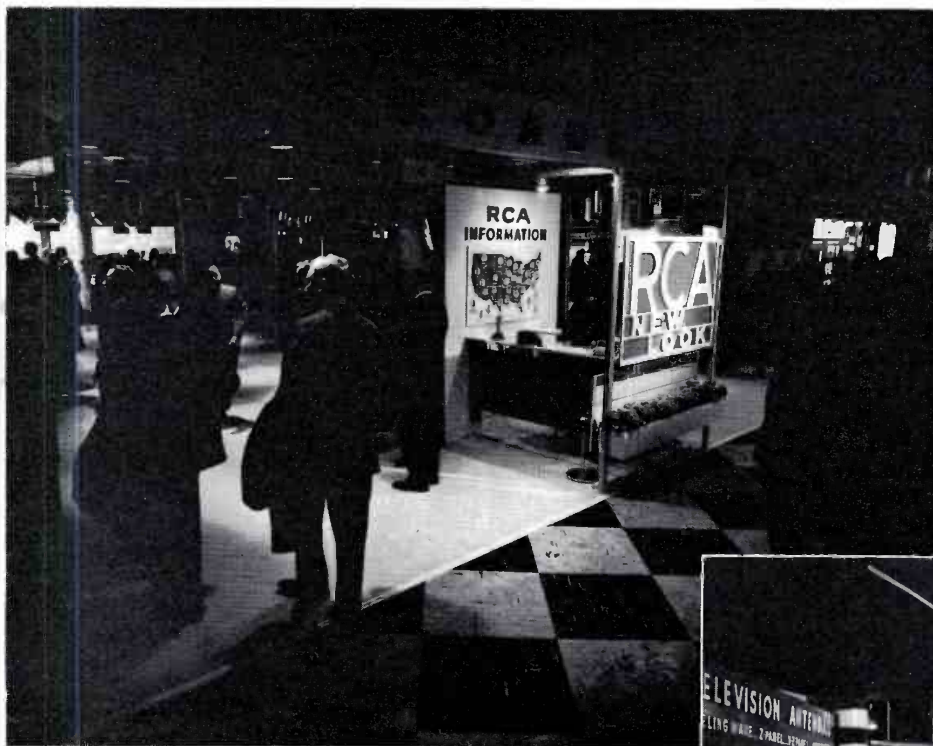

▲ **RCA NEW LOOK** graces the entrance to RCA exhibit of latest equipment for most modern broadcast operations. New Look for 1965 features complete systems equipment for tv operations, new color equipments, higher power UHF transmitter, and more new equipment for FM and FM stereo.

▶ **RECORD WASHINGTON CROWDS** toured the exhibit—RCA's largest and most complete. View here pictures UHF display featuring antenna-transmitter combinations for up to 2½ million watts erp.





ULTIMATE IN TV TAPE EXCELLENCE is represented by this brand new 22HL super-deluxe tv tape recorder for both high-band and low-band operation. Capable of producing multi-generation color tape copies of finest quality, this is the only recorder with built-in switchable high-band and low-band operation and universal air-bearing head-wheel. Human engineered to produce finest pictures effortlessly, the 22HL offers ultimate performance with every convenience, every facility, every luxury.



RECORD AND MONITORING ACCESSORY for TR-3 Player is a new addition to tv tape line of equipment. The cabinet shown can be supplied with monitoring equipment only to extend the facility of the TR-3 Player—or it may be equipped with record modules as well to provide the same record-playback facility as a TR-4 recorder.

TAPE AND ROLL from studio-to-studio or via small mobile unit on location with a TR-5 mobile recorder. This equipment now features full-hour taping, on-air playback using external signal processing amplifier in an extremely compact quadruplex recorder that can be equipped for color operation.



CLOSEUP ON A COMPACT is obtained by spectators as they look over the TR-4 recorder. This NAB demonstrator is equipped for color taping.





SOMETHING IN COMMON . . . both the cameras shown here—TK-42 for color, TK-60 for black-and-white—employ 4½-inch image orthicon for maximum picture detail. This big tube also provides finest pictures of color shows when viewed on monochrome receivers.

LIVE STUDIO with full line of tv cameras—monochrome and color. Shown here (from left to right) are PK-301 vidicon camera, PK-330 vidicon-with-viewfinder; TK-60 4½-inch image orthicon; TK-33 3-inch image orthicon field camera; and TK-42 color camera with luminance channel feature.

COLOR INTEREST was high as evidenced by the attention given to the new TK-42 color camera. Completely transistorized, the camera employed plug-in modular construction. Many of these modules are interchangeable with those of other RCA camera equipments.

LUMINANCE CHANNEL in the TK-42 adds black-and-white information to the color tv signal for improved picture detail and sharpness. The information is supplied by this 4½-inch "big picture" image orthicon tube. Color pickup tubes are newly developed "selenicons" which effectively double the cameras' sensitivity.



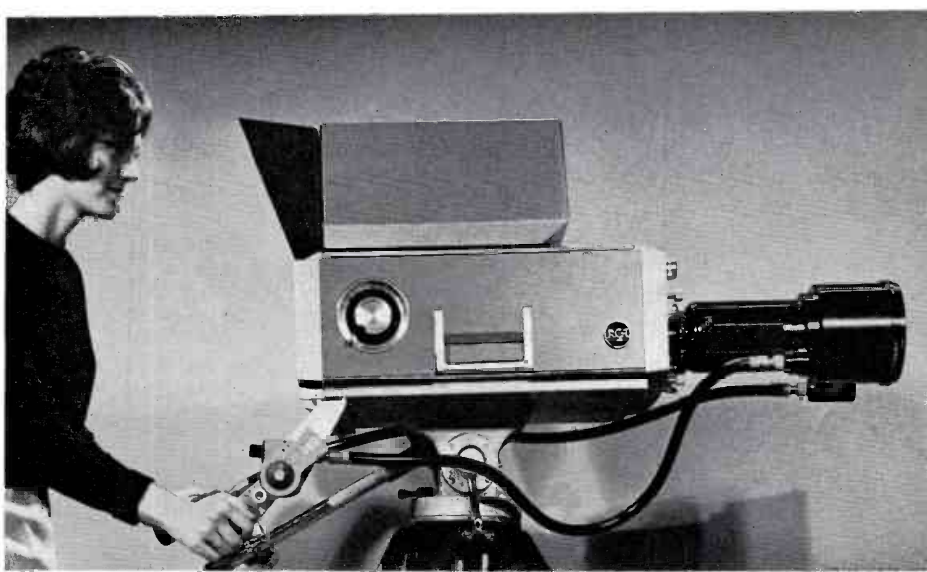

TAKES APART for easy carrying, re-assembles for quality remotes . . . this new TK-33 field camera. Lightweight and transistorized, this 3-inch image orthicon camera features detachable viewfinder and camera head for mobility on remotes.

TK-33 FEATURES are scrutinized by studio spectators. Completely transistorized, this camera also employs standard modular construction—particularly advantageous to the systems-minded broadcaster.

EVER POPULAR TK-60 continues to get its full share of broadcaster interest. This camera has become the symbol of deluxe television, now found wherever finest monochrome pictures are desired.

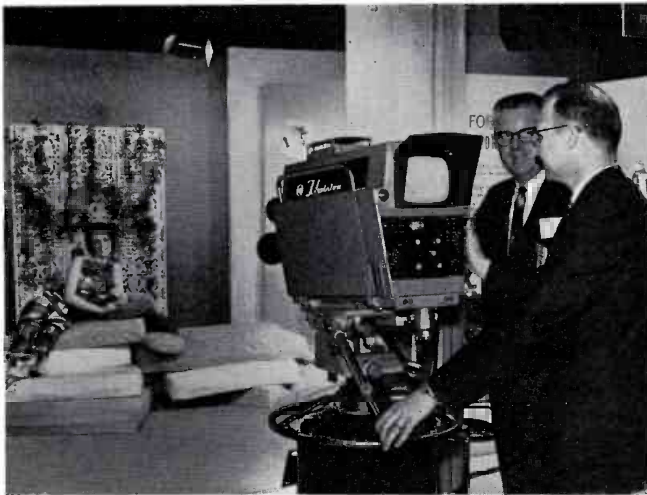

CLOSED-CIRCUIT SYSTEMS EQUIPMENT support new vidicon cameras. Here in an operating demonstration are camera controls, closed-circuit video monitors, a program or distribution switching system and video distribution amplifiers—designed especially for closed circuit applications.



TWO NEW VIDICON CAMERAS, a PK-301 industrial type and a PK-330 broadcast studio vidicon camera also share the studio spotlight. Both cameras are transistorized and employ a one-inch electrostatic vidicon tube. The studio camera (right) employs a unique system for camera tilt, in which the camera and viewfinder are in a fixed position while the lens moves vertically.





▲ **COLOR FILM SYSTEM** with a big difference—a 1½-inch vidicon tube in its luminance channel—is the subject of this operating display which produced show-stopping color film pictures. New Look equipments in the system pictured include TP-7 slide projector, TK-22 monochrome film camera, TP-66 film projector and TK-27 4-V color film camera.



▲ **CLOSEUP ON QUALITY.** The working functions of the TR-27 color film camera are demonstrated here. Visitors give technical innovations a thorough checkout, see for themselves quality performance features built into this finest of color film cameras.

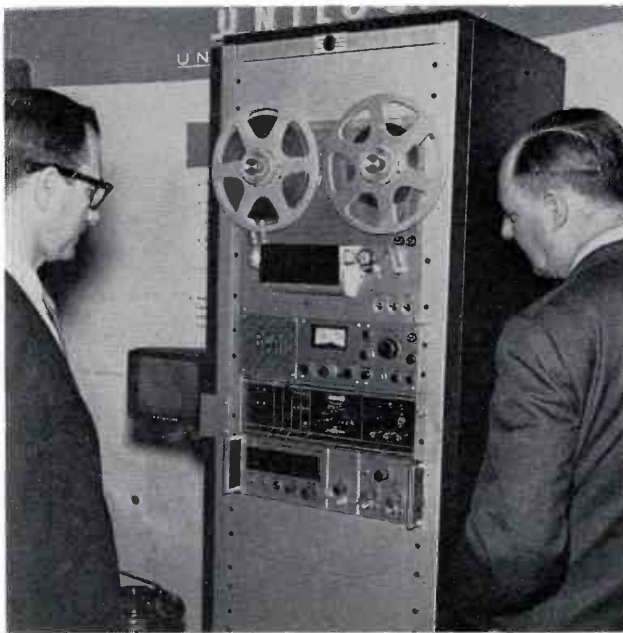

▲ **ELECTRONIC SPROCKETHOLES** on tv and audio tape are produced by the equipment above. Called Unilock (universal interlock) this provides an electronic means for interlocked playback of two or more film or tape devices in absolute reference to each other. In the demonstration (right) sound from an RT-21 audio tape recorder is locked to the picture from a TP-66 film projector.

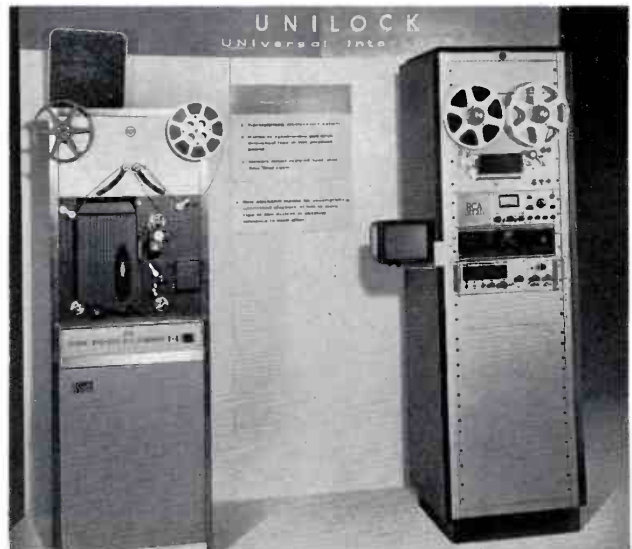

NEW LOOK SYSTEM gets the undivided attention of studio planners. Demonstrated throughout the show hours, this display exemplified up-to-date tv station operations—film, tape, live studio, switching and effects—as performed by New Look equipments.



PRE-SET SWITCHING to automatically handle audio and video signals as well as machine control at station breaks and other high activity periods is performed by this TSA-3 equipment.

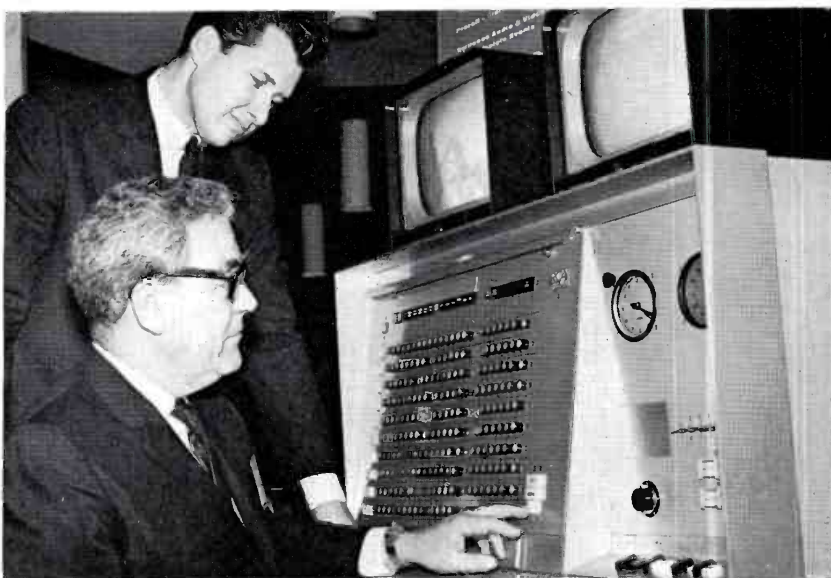

SPECIAL EFFECTS and video switching position of the system console. New effects equipment and TS-40 switcher is all New Look, completely transistorized.



SYNC GENERATOR and waveform monitor demonstration. Completely transistorized and ultra compact, these two new equipments typify the power and space saving benefits of the New Look. A complete color sync system with optional color frequency standard and color genlock modules occupies only 5½-inches rack space.

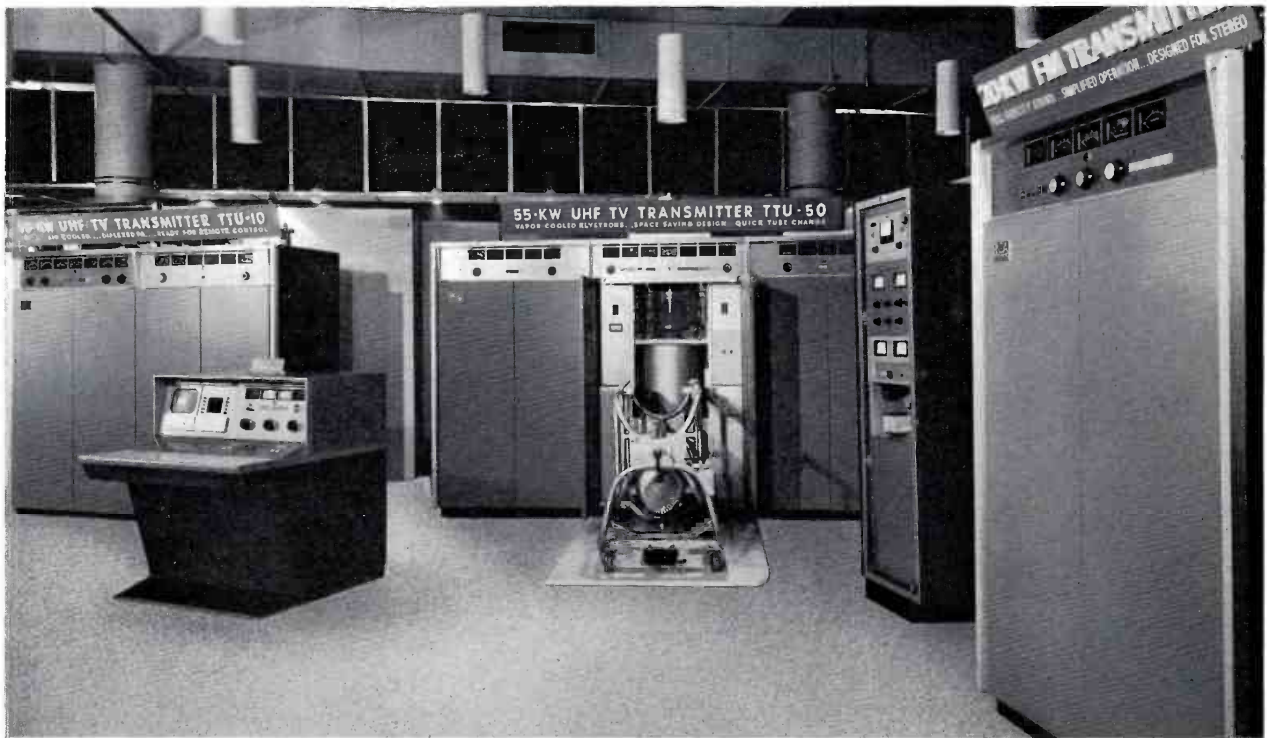

55-KW UHF TRANSMITTER, TTU-50 highlighted the transmitting equipment display. In combination with suitable UHF pylon antenna, this new transmitter is capable of up to 2½ million watts erp. Also shown here is a new transmitter console TTC-5B, a 10-KW UHF transmitter TTU-10A and a BTF-20E transmitter for FM and FM stereo.

QUICK TUBE CHANGE is a unique feature of the 55-KW UHF transmitter. The tube is an integral cavity, vapor-cooled Klystron.

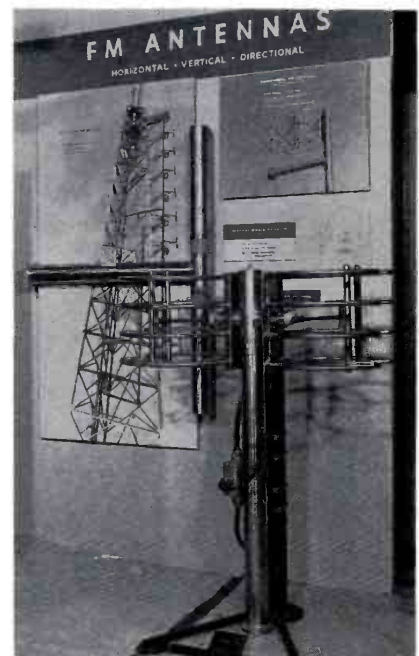
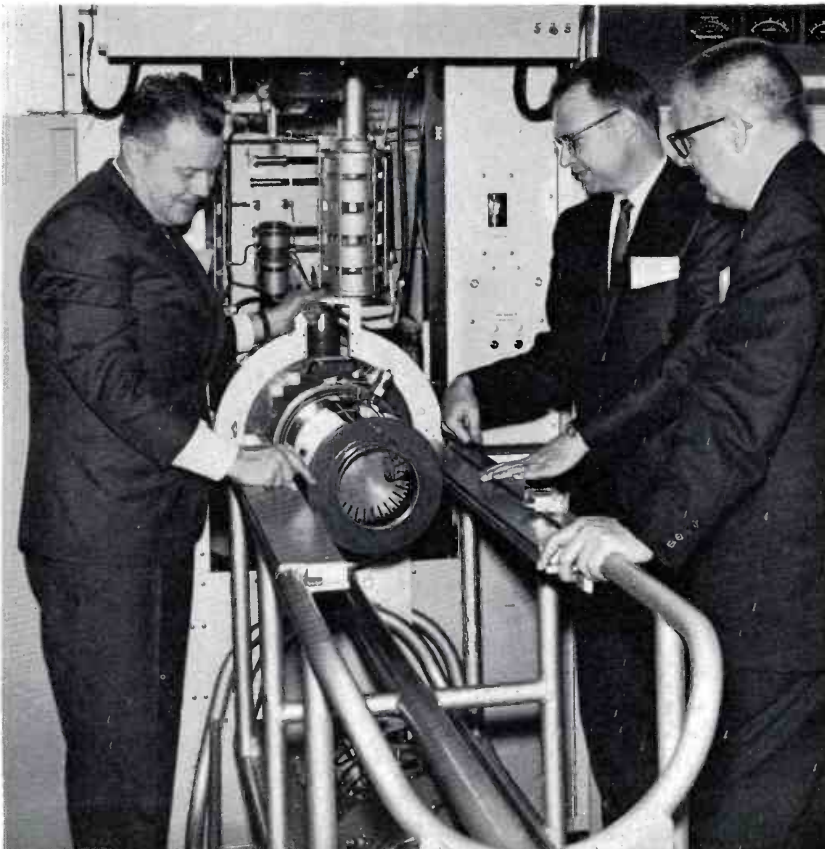

FM SIGNAL SATURATION is highlighted in this display of vertically and horizontally polarized FM antennas.



NEW LOOK CONTROL CENTER exhibited at NAB is shown at left, closeup views of the equipment in the center are at the bottom of the page.

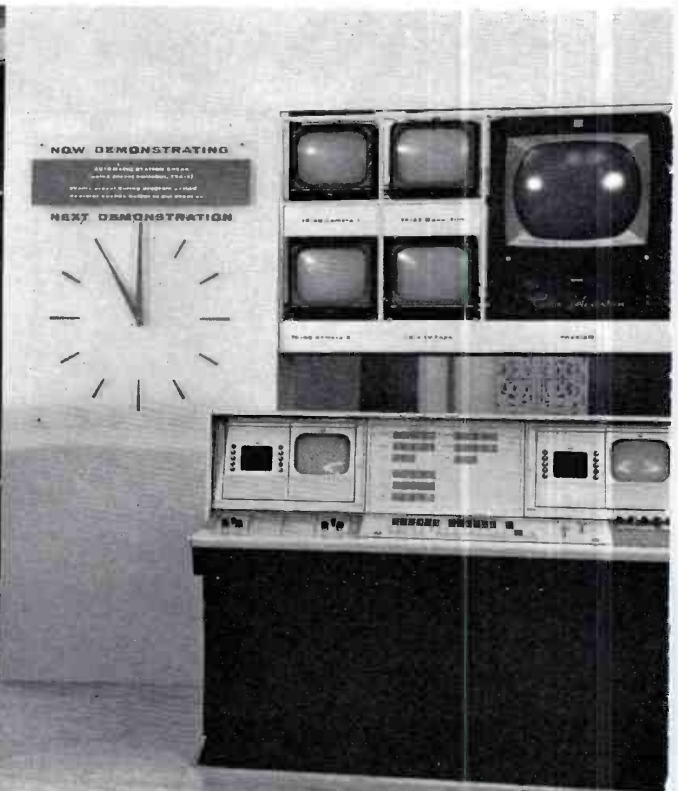
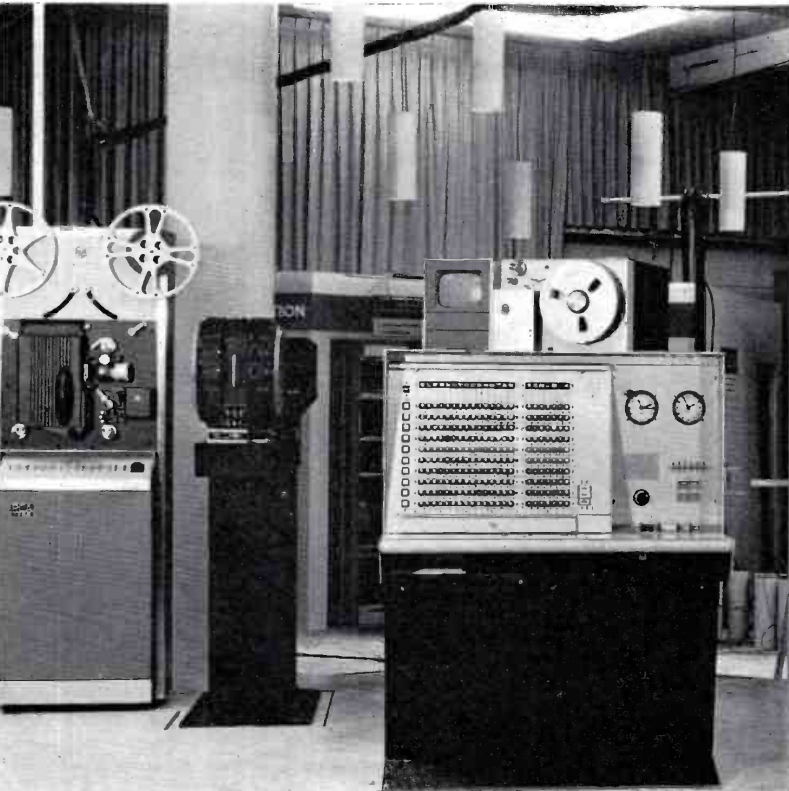

REVOLUTION IN TV STATION OPERATION SHOWN BY RCA AT 1965 NAB CONVENTION

New Approach in TV Control Concepts
Affords Tremendous Savings in Space
Makes Operation Less Complex
Reduces Incidence of Errors

The studio control system shown at the NAB Convention (see opposite and below) was designed to illustrate the several different ways in which the RCA "New Look" equipments can be combined—and to demonstrate the advantages in terms of space saving, operating convenience and flexibility which are gained when they are employed in an integrated system.

The equipment complement of the system setup was not complete in that there was only one tape machine, one film system, two camera positions, etc. However,

the control functions were complete and with inputs from sources outside the control area, it was possible to show almost all of the operations which would take place in a complete installation.

The arrangement shown is not typical of any particular station or any single method of operation. Rather, this arrangement was planned to demonstrate various new methods of operation and their resultant advantages. It provided remote control of tape and film machines, combining of normally separate control functions, and re-

duction of rack requirements from 12 to 4.

Two major demonstrations of new control concepts were made:

1. Studio Control; 2. Master Control.

In addition, there was a demonstration to show how effortlessly a station break can be handled using the New Look system, with the semi-automatic pre-set switcher.

In the pages which follow, the high point of these three demonstrations are described and a brief description of several parts of the system is given.

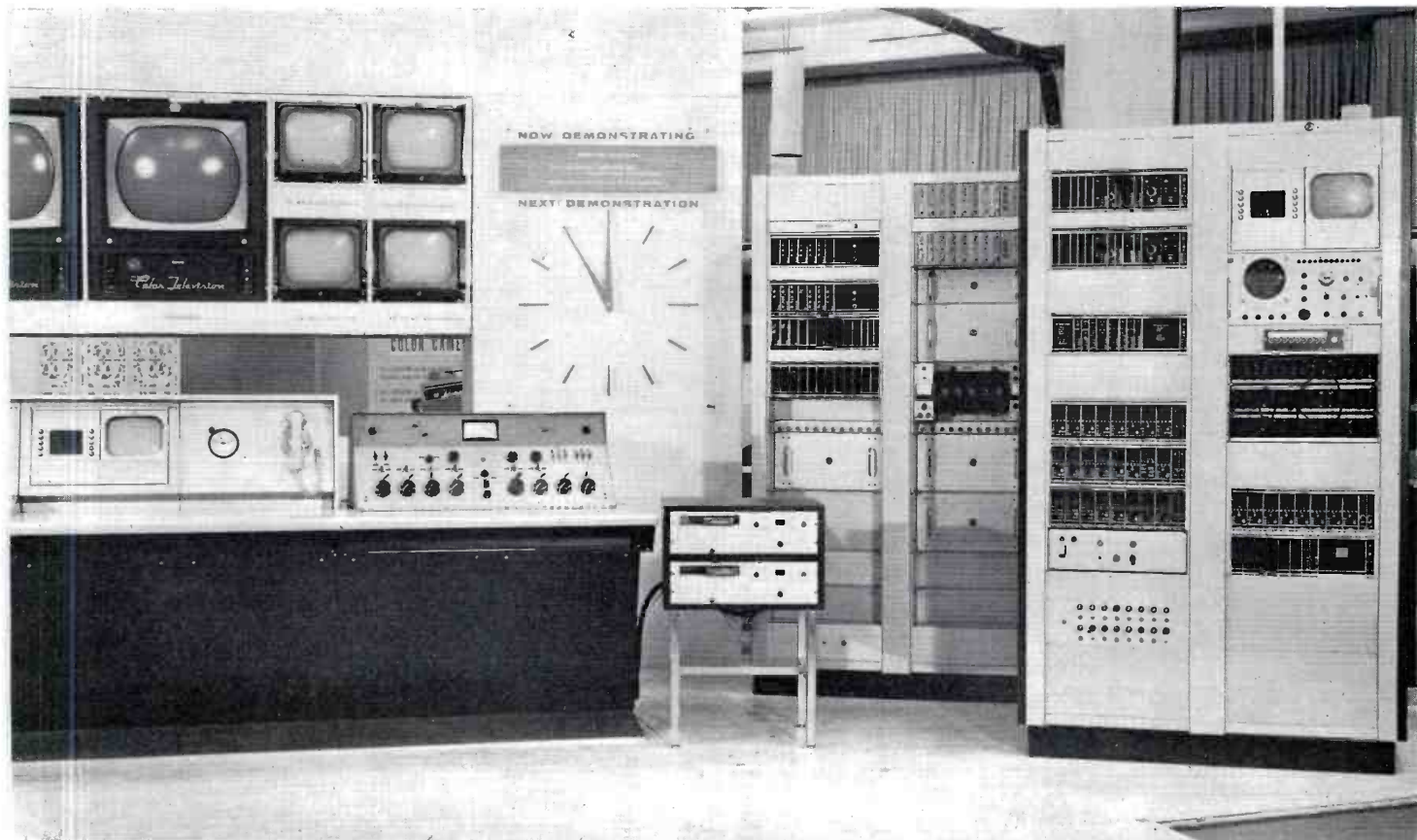

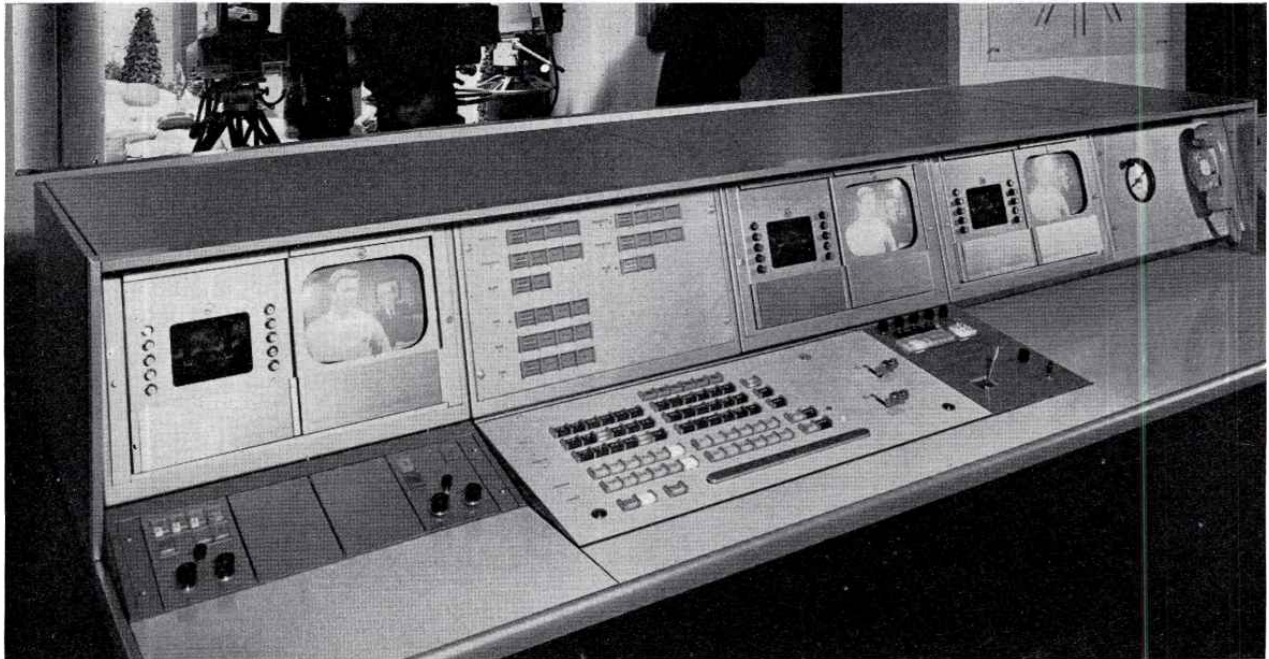

THIS NEW LOOK CONSOLE REVEALS THE TREND in broadcast equipment design that led to the revolution in the control room. Compact transistorized monitors and controls conserve space and reduce maintenance requirements. Stability and simplicity of the new method of operation lower chances for errors.

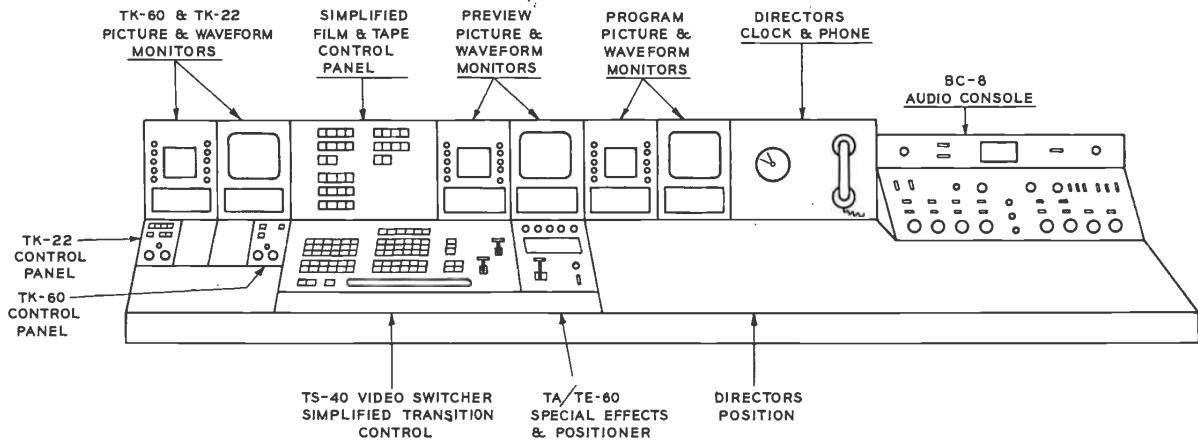

THIS DIAGRAM SHOWS THE DETAILS of equipment installed in the New Look control console. All are standard items now in stock. They are much smaller than previously as a result of transistorization and New Look design. The console itself is constructed of individual modules, that lend flexibility and give a strictly custom appearance.

Equipment in RCA "New Look" System

The main control console was the central feature. Standard video and audio devices are included in this New Look system of control. Support equipments include pre-set switcher, film and tape machines.

New Look Console

The main control console represents the newest and most versatile design, since it can be built together in individual sections (one-high or two-high) for custom tailoring to individual station requirements.

In this New Look demonstration, the following arrangement was used for the control console (left to right): At left is the position for the switcher operator, in the center is the position for the director, and at the right is the position for the audio operator. (These are the three normal positions for studio control; however, when used for master control, only one operator is required.)

For identification of various devices built into the control console, see page 22. Note that live and film camera controls (TK-60 and TK-22) are included. Note

also use of new solid state waveform monitors and high quality picture monitors.

Audio System

The audio arrangement consisted of a BC-8 Console with two RT-17 Cartridge Tape playback units. Studio control of audio was handled here at BC-8 Console. Inputs are two microphones, sound-on-film, TV tape, and two cartridge tapes. (Control of cartridge tape may be transferred to the TSA-3 Preset Switcher.) Cartridge tape is used for spots, announcements, and station breaks.

TV Tape

The TV tape machine was a Compact Recorder and Player, Type TR-4. It handles both color and monochrome video productions. This machine could be started and stopped from the console position.

TV Film

The film equipment included: 16mm TV Film Projector (TP-66), 35mm Slide Projector (TP-7), Multiplexer (TP-11), and a High-Fidelity Monochrome Film Camera (TK-22). All aspects of film system

operation were controlled remotely. Film was automatically cued, the projector started and stopped, slides changed, etc., by the one operator at master control.

Controlled Automation

A semi-automatic controller (pre-set switcher) was used for solving the station-breaks, panic-period problem. This is the TSA-3, a device that does everything necessary to put a film spot, tape spot or slide announcement on air—in response to the single touch of an operator. As many as 10 separate switching events may be pre-set into this machine. By this means, a station break can be handled without fuss but with complete accuracy.

Rack Equipment

At the right are four racks containing all the terminal equipment—switching, power, sync generator, distribution (see below). Note that these four cabinets house all the rack mounted equipment necessary to support the entire system. This is a phenomenal achievement in space reduction. Previously, several times this amount of space was required.

TWO NEW LOOK RACKS REPLACE EIGHT.

Using the new transistorized sync generators and distribution amplifiers, only two racks are required (at right). These two can contain as much support equipment as would require eight racks—using older equipment designs. This tremendous savings in space is one of the chief benefits to spring from the New Look design.

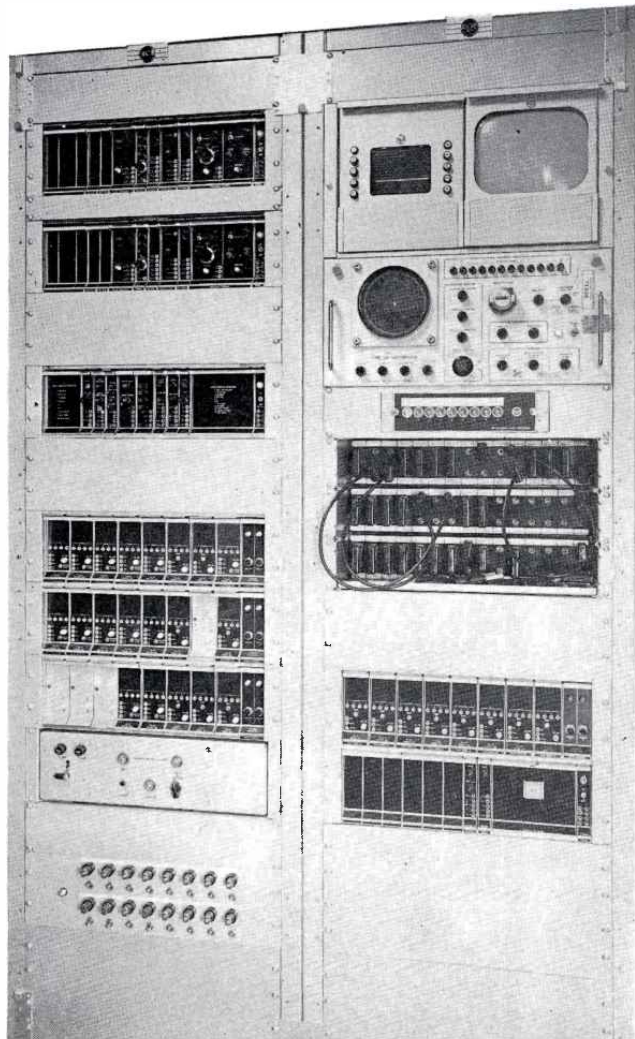

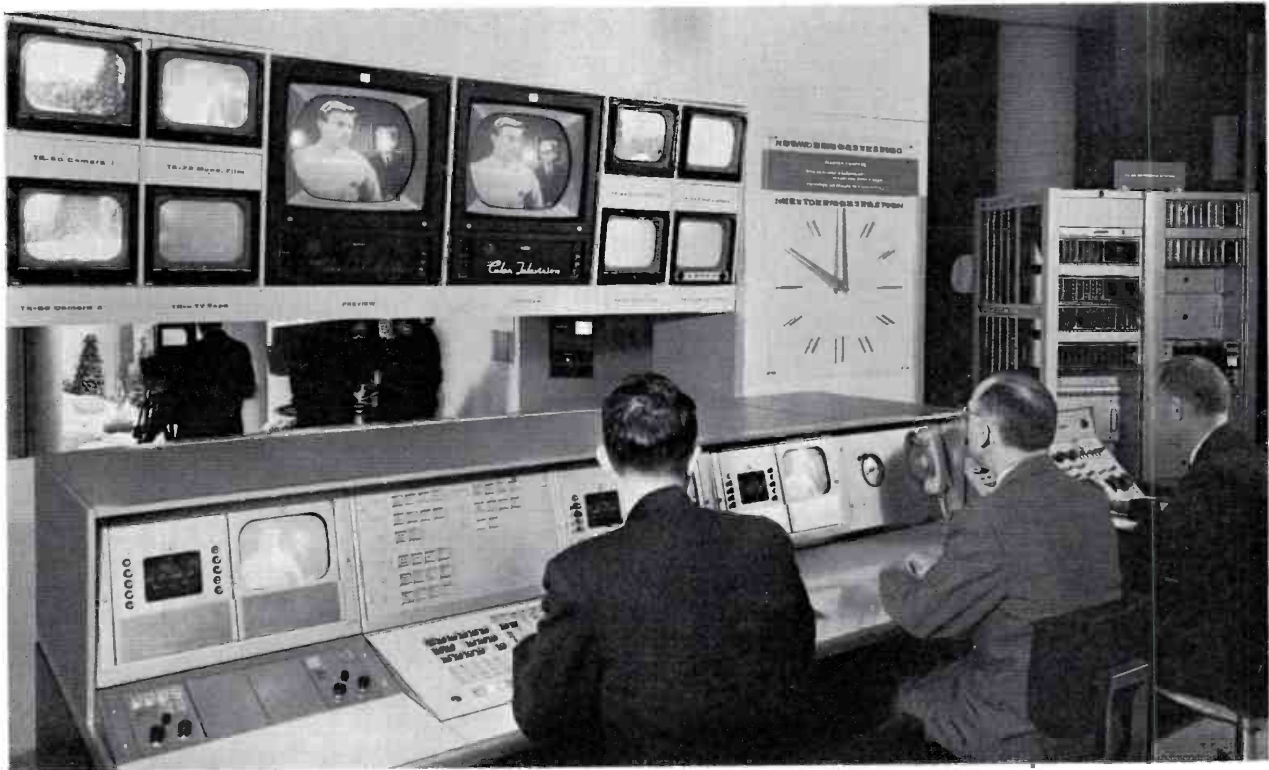

ONLY ONE CONTROL POSITION IS REQUIRED for studio control using the New Look system. Heretofore a second control position was required for camera shading. In this new concept the cameras are stabilized and self-adjusting requiring little or no attention. At the same time any control required is done at the single position. (Note camera controls at far left of console.)

Studio Control Demonstration

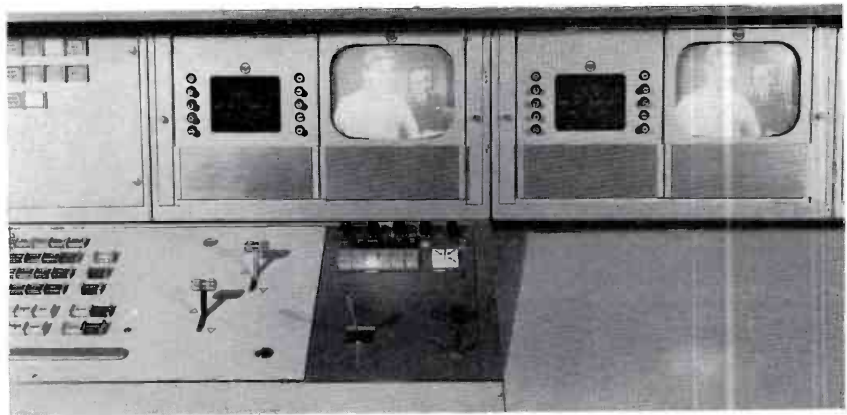

NEW TRANSISTORIZED EFFECTS system with joy stick operation.

In program preparation from the studio, using live cameras and microphones, three persons are normally engaged in the studio control room. In another area, video operators control the live cameras. In the New Look concept both these functions are combined into one control system.

In the demonstration, three persons were employed and four picture sources were available from the studio, as indicated on the overhead bank of monitors. These pictures from the following four live cam-

era sources were switched to simulate program production:

1. TK-60 Camera 1
2. TK-60 Camera 2
3. TK-33 Field Camera
4. TK-42 Color Camera

In addition, a unique solid-state special effects system was available for making transitions by means of lap-dissolves, super-positions, etc.

The studio control demonstration was divided into two parts:

1. A series of transitions from one live camera to another, employing direct cuts.
2. The same series of transitions, employing effects for making transitions from one picture to the next.

Better Program Production

This demonstration revealed how the New Look system would revolutionize

studio program production. New methods of operation are obtainable with the new solid state equipment. Especially worthy of note is the efficiency of operation obtained by eliminating the video control position. Incorporating all the control and waveform monitors for cameras into the studio control system is made possible by the compactness and stability of New Look transistorized designs. Centralizing the controls in this way not only reduces floor space requirements, but more importantly, assures better control of program quality.

Unique Effects System

A new transistorized special effects system was introduced as part of the demonstration. Incorporated into the New Look console, it was used for producing attractive transitions with speed and simplicity. Special effects such as wipes, super-positions, keyed inserts, and split screens are easily achieved by means of pushbuttons.

A special Pattern Positioner (joy stick) is available controlling the position of the pattern—and for moving the pattern around.

The system consists of plug-in modules which makes it easy to expand. Additional patterns, a keyer, a multiplier, etc., may be added in this way.

TECHNICAL DESCRIPTION

Studio Control

AUDIO POSITION . . . This comprises a BC-8 Audio Console, an RT-17 Cartridge Tape System, and an Audio Relay Switcher.

The RT-17 Cartridge Tape system consists of two operating units. They are controlled either locally or from TSA-3. They are to be used for short spots, station breaks, etc.

These outputs appear as inputs to audio console and audio relay switcher controlled by the TSA-3.

Studio control of audio normally would be handled by the BC-8 Console, with inputs being microphones, etc. Inputs at this display were two microphones, sound-on-film, video tape recorder and two cartridge tapes.

The Audio Relay Switcher is a standard module located in one of the console housings with audio from all machines as inputs. It is controlled by the TSA-3. Its output is on a speaker physically located in the TSA-3 housing.

DIRECTOR'S POSITION . . . Note versatility and clean business-like appearance of "new look" console. The clock and telephone are located in the panel simply to give an idea as to what can be done at this location.

SWITCHER'S POSITION . . . The video switcher and manual control panels

are the type used in many TV operating switcher control rooms. The following features are incorporated:

1. Video key bus for use with Special Effects.
2. Two mix effects buses for use with additive/non-additive mixing or Special Effects.
3. Preset bus which also can be used as preview.
4. Program bus (transition control is available between preset and program by use of fader lever).
5. New Look Special Effects control panel with Pattern Positioner.

Note that the inputs on the switcher can be **composite** or **non-composite**. The **composite** can be **synchronous** or **non-synchronous** on the last six inputs.

CAMERA CONTROL . . . An unusual addition to this studio control is the remote camera controls. The TK-60 4½-inch Live Camera remote control and the TK-22 Film Camera remote control are located at the left. It is usually not necessary to adjust their knobs because of solid-state stability.

Note the ultra small transistorized monitors used here (at left). These are the waveform TO-4 and picture monitor TM-19.



AUDIO POSITION consists of BC-8 Console and Cartridge tape units, together with audio relay switcher.

CLEAN, BUSINESS-LIKE DIRECTOR'S POSITION shown here with a waveform and a picture monitor. These could be two picture monitors. A clock and telephone are optional.

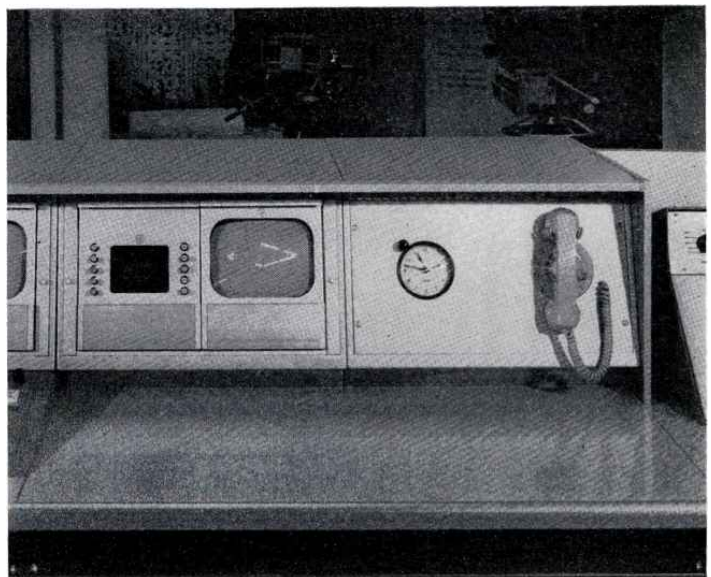



ONE OPERATOR CONTROLS EVERYTHING in this New Look conception of how a control room should operate. Revolutionary concept envisions video controls and machine operations combined with switching functions in a control central. The transmitter panel may also be incorporated into this master control console.

Master Control Demonstration

Utilizing the New Look system, only one operator is required for this complete operation. He will control all tape and film equipment, and will switch all programs and commercials to the transmitter. He will switch all audio and video.

While one program is on the air, he will load the TV tape machine, the film projector, and the slide projector, in preparation for the station break. All upcoming spots, promos, and announcements are readied in this way.

Unattended Film and Tape

After the operator ends the on-air program, he controls the station break

smoothly from his position at the console. From here he can start and stop the tape and film machines, and switch the proper pictures to the transmitter. The remote control feature of individual New Look equipments, integrated into a complete system, makes possible this achievement in simplified operation.

In order to properly present this method of operation, the following series of events was demonstrated by the operator to simulate a typical station break:

1. Ending of program
2. Slide with announcement
3. Film spot

4. Tape spot
5. Slide for station I.D.
6. Return to network.

Benefits of Remote Control

This demonstration reveals the real simplicity in a New Look integrated system. All supporting facilities, such as Tape and Film, are incorporated into the one area. Tremendous saving in space is apparent. Most efficient use of manpower results. The direct simplicity of the arrangement lends itself to better control of the station break, with fewer chances for error.

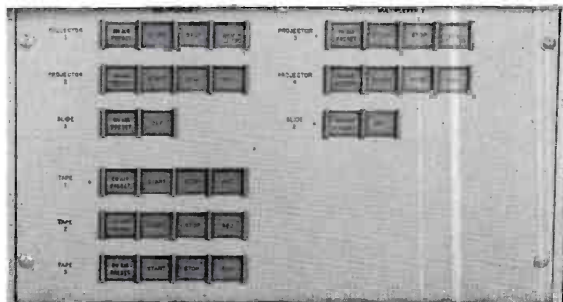

REMOTE CONTROLS FOR TAPE AND FILM MACHINES are located on this panel, which is part of the master control console.

TECHNICAL DESCRIPTION

Master Control

This demonstrates a means of simplified switching and control for transmitter input switching, network, etc. The physical equipment includes TS-40 switching, remote panels for camera control, and remote panels for machine control.

General Description

1. Repeat Monitors: Note overhead 14-inch monitors for each source, preview and program.
2. Rack Equipment (Terminal): Racks house sync equipment, pulse and video distribution amplifiers for entire display.
3. Rack Equipment (Switching): The TS-40 switching components are housed in new rack styling and the TS-40 components have been repainted to the "new look" colors.

4. Console: Note remote control for tape and film machines.

5. Operating Machines: One TR-4, one TP-16 and one TP-7 on TP-11, and two RT-17's.

Manual Machine Control

This machine control panel allows pre-setting any or all machines (film projectors, multiplexers, video tape) so that the operator handles a fewer number of buttons instead of the many as in the past. Machines are pre-set during time program is on-air, (Pre-setting a machine also pre-sets associated video source.) Transition to on-air is accomplished by operating cut-bar or transition. The memory system used at this location is actually a one-deep machine control pre-set system.

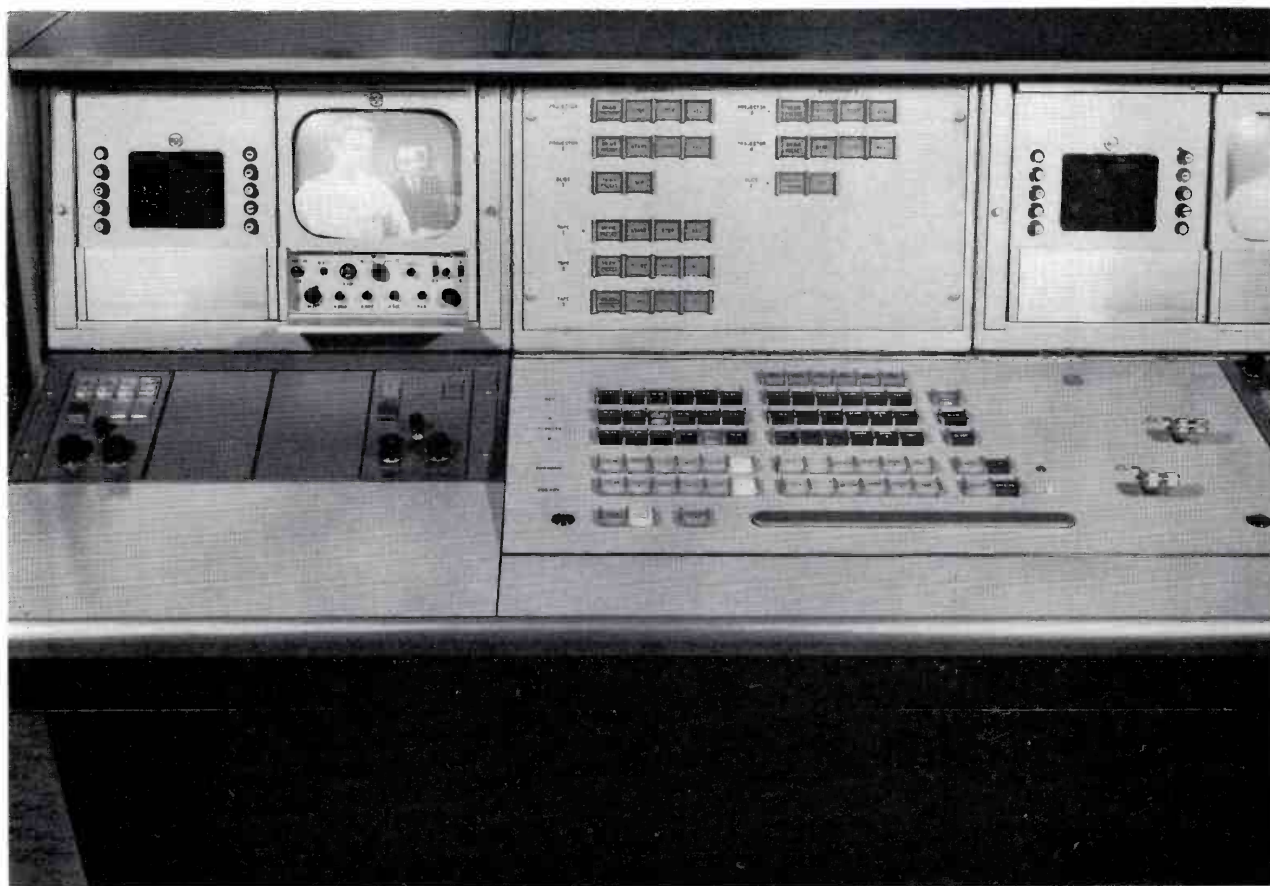

MANUAL CONTROLS FOR CAMERAS AND SWITCHING. The camera controls are in the left panel, switching in right. The film camera control is at far left, the live camera control at right. Switching system is transistorized TS-40.

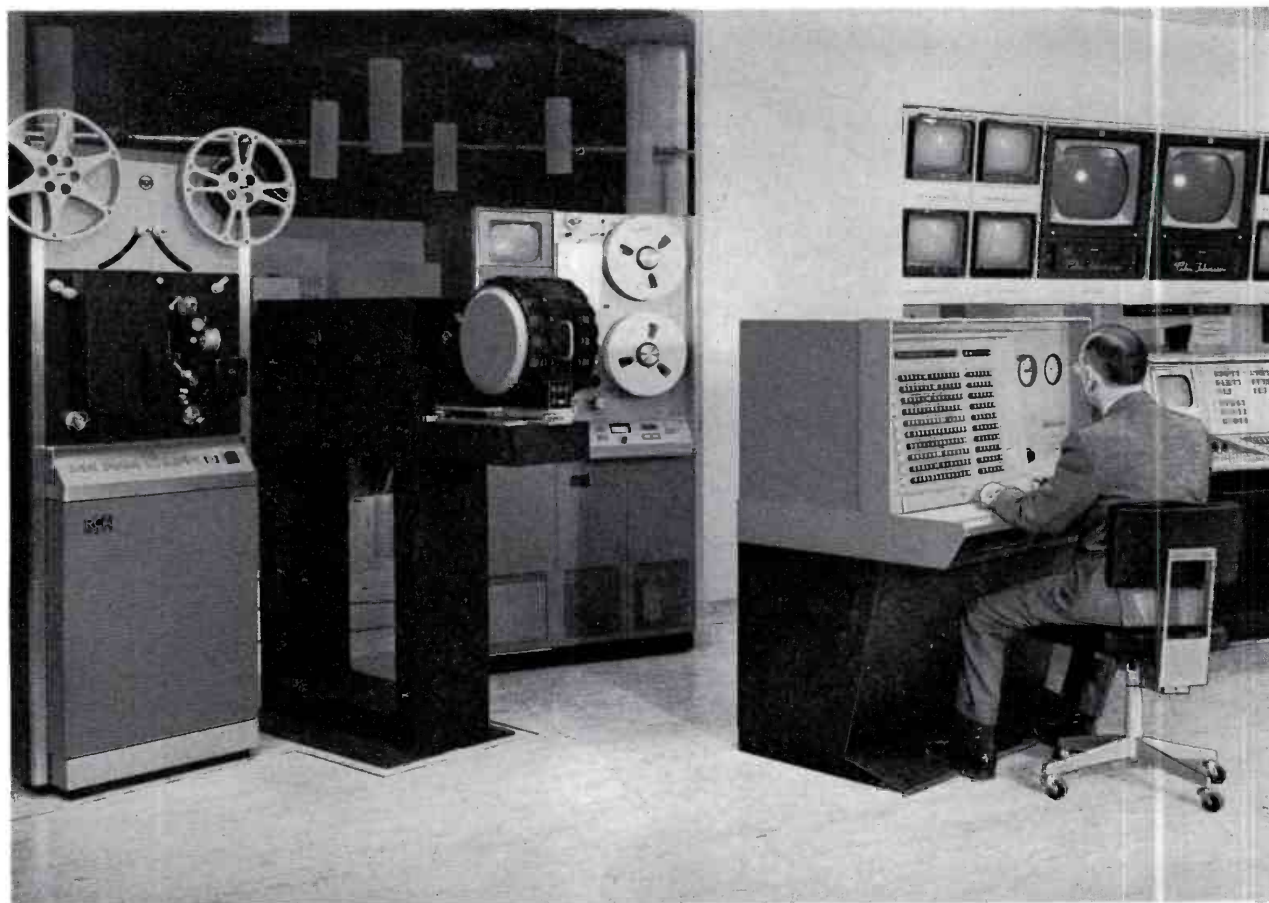

SINGLE OPERATOR AT PRE-SET SWITCHER controls the entire station break without complexity. During program he loads tape and film machines. During station break he operates the pre-set switcher. It takes over the job of button pushing to relieve the complexity that leads to errors.

Automatic Station Break Demonstration

In this demonstration, use was made of the Pre-set Switcher (TSA-3), a semi-automatic device for operating many equipments by means of one pushbutton. In this switcher, as many as ten different events may be programmed in advance. Then, when the station break occurs, each event is put on air, by the operator merely pushing the cut-bar.

All the necessary selections for each commercial, announcement, station I.D., etc., may be set-up in advance by the operator (while a program is on air).

For each film spot, for example, the TSA-3 will be programmed by means of pushbuttons, to pre-roll the projector (according to a pre-determined time period), switch multiplexer mirrors, and put film on air. Audio is tied in to follow with video. Projector will be stopped, doused, and automatically cued up for the next event.

All the switching for each TV Tape event is set up in advance in a similar fashion. The same holds true for slides. Also for return to network.

For this demonstration, the operator has already pushed the proper buttons to handle a series of five events, comprising what would be a typical station break. At the mere push of the cut-bar, he placed each event on the air, as follows:

1. End of On-Air program
2. Slide with announcement
3. Tape spot
4. Station I.D.
5. Film spot
6. Return to network.

Error-Free Pre-Set Switching

This demonstration showed how the station break almost handles itself. It is far less complex and less expensive than complete automation. It's controlled automation. It's probably the most accurate and economical way of preparing for putting commercials and announcements on air. The unhurried precision of this method lends itself to error-free presentation of all commercials.

10 EVENTS ARE PRE-SET on 10 rows of mechanically interlocked push-button switches in 2 groups, each row containing 15 switches for interlocked audio-video sources and 7 switches for audio only. Selecting a source in the first group pre-sets a video source and an associated audio source. Selecting a source in the second group pre-sets a separate audio source and inhibits the audio source normally associated with the video source. Depressing the seventh audio button re-establishes the interlocked audio-visual mode.

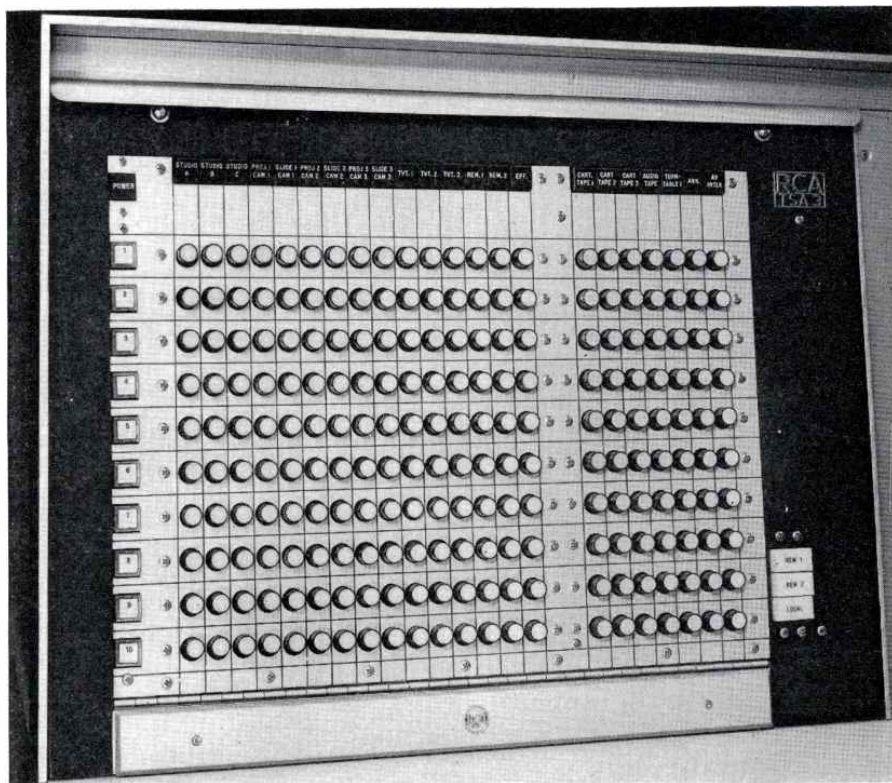

TECHNICAL DESCRIPTION

Pre-Set Switcher, TSA-3

The Preset Switcher enables one operator to control a complex series of switching events. Up to ten complete events each consisting of video switching, audio switching, and machine control may be put on the air merely by pushing the "CUT-BAR". Each time a new event is to be aired, the cut-bar is depressed. "One man" operation during station breaks and "late movie" programming is easily established through the pre-selection of sources and events.

The unit is **designed to eliminate a panic period during station-break time.** This is accomplished by:

1. The ability to pre-set 10 events during unhurried periods.
2. Allowing pre-setting of any of 15 machine sources with associated audio or having any one of 6 additional audio sources instead of the normal audio follow video.
3. Effectively single button operation to put an event "on-air."

Features of Pre-Set Switcher

1. Pre-set illumination is dim; on-air is bright.
2. On-air also indicates at the top readout unit.
3. Direct switch possible on program bus.
4. Skip either sequentially on manual control panel or to any event on setup panel.
5. Pre-roll is followed by an automatic tape.
6. Slide is automatically changed at the end of an event.
7. Can preset any event at any time except after a pre-roll of that event or on-air.

Promising
Features
of the
"New Look"
System

Capability of this revolutionary arrangement of equipment almost escapes the imagination. Production people find themselves presented with new tools for new ventures in program creation. Engineers find the simplicity of the system as amazing as its versatility.

All these associated equipments and devices are of the most modern design. Transistorized circuits are employed. Standard modules are used. The result is tremendous savings in space, large reduction in heat, less power required, more efficient operation achieved.

Newest concepts in switching and effects are attained. The New Look TS-40 Transistorized Switching System permits pre-set of the upcoming event (tape or film) so that only a push of the cut-bar is needed to transfer from preview to program. Or

the transition may be made by the fade-in lever to achieve either a dissolve or fade-out fade-in effect. Further by means of new solid-state effects and non-additive mix system, a totally new series of effects may be presented.

Employing the New Look equipments in an integrated system multiplies the individual advantages. Controls are centralized, operations are simplified, chances for error are reduced. Most judicious use is made of manpower. Space savings are of large proportions. Moreover the New Look system is a thing of beauty, appealing to both operator and client. The calm atmosphere of controlled preset switching promotes new accuracy and precision. Certainly, use of the integrated New Look system, with its provisions for machine control and automation, is a step in the right direction for the station of the future.

IDEAS FOR THE STATION OF THE FUTURE . . . showing the possibilities for a 2-studio layout with centralized machine and control system. Area is oval in shape.

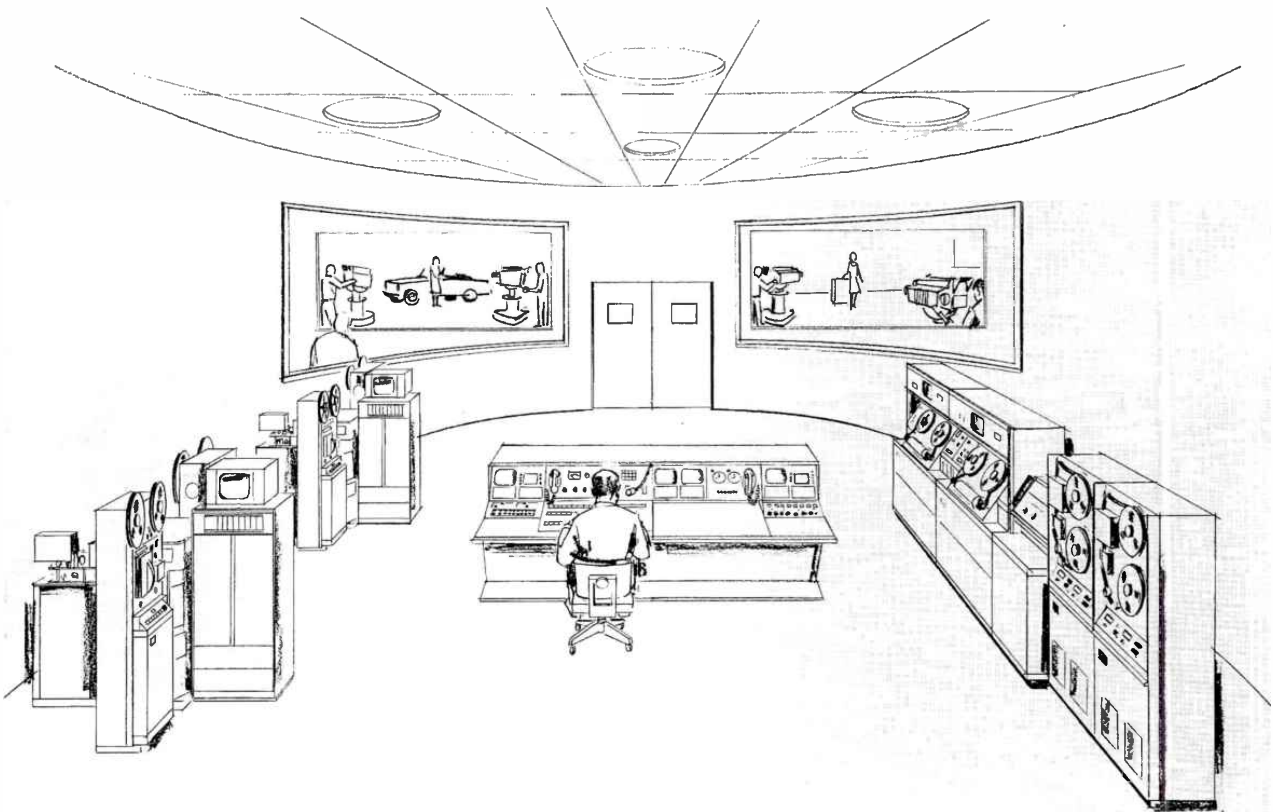

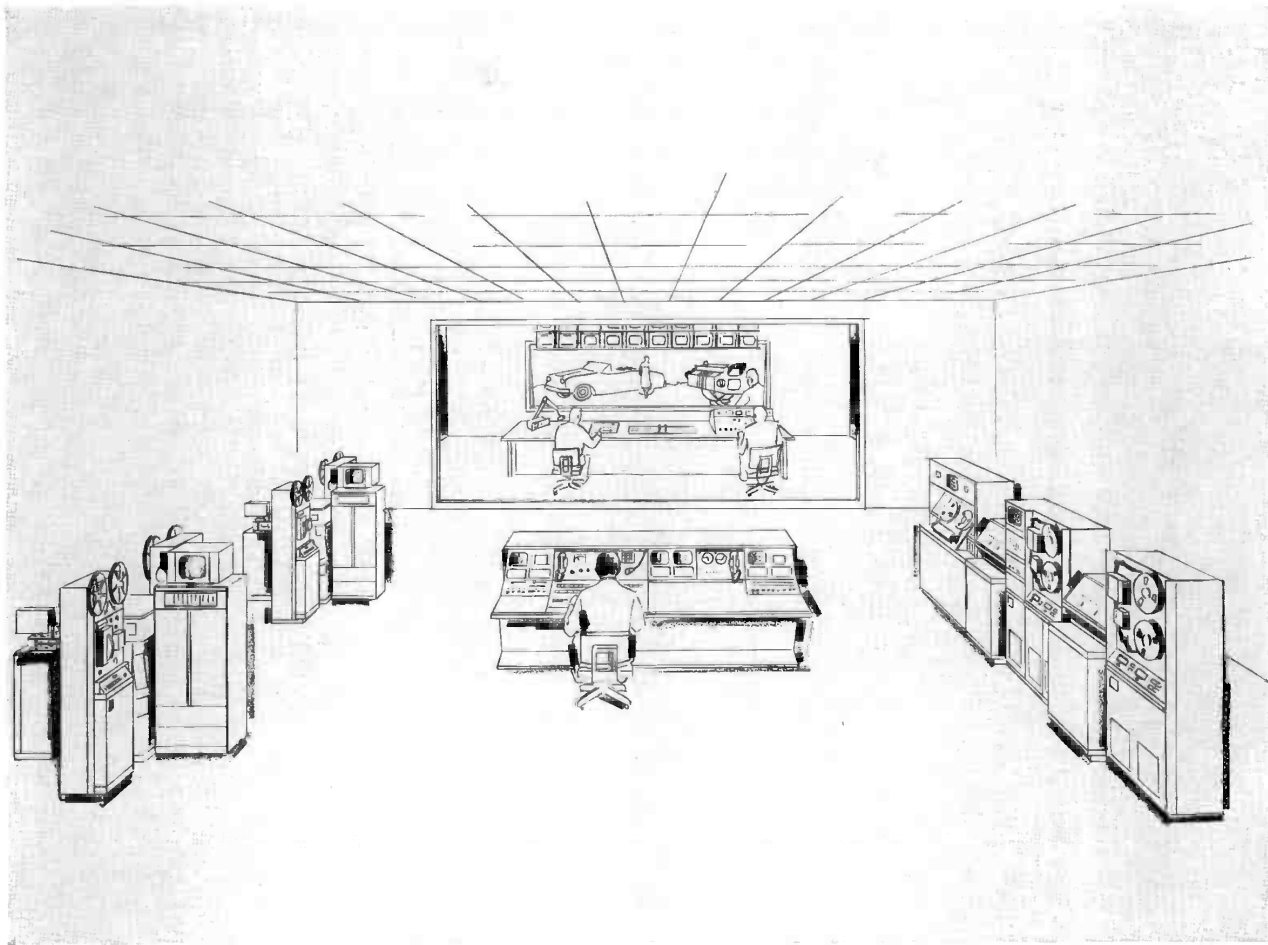

PLANNING CONCEPTS FOR MODERNIZING TV STATIONS . . . showing a single studio arrangement. All tape and film machines are located in one large area, together with the master control . . . Shape of this area is rectangular.

Purpose of Exhibition

This demonstration of the New Look control center is designed to display promising new concepts for planning and modernizing of television broadcast stations. (The same principles could apply to closed circuit systems.)

- New Look systems concepts.
- Stability of solid-state modular equipments.
- Integrated control of machines.
- Pre-set switching (one-in-depth and ten-in-depth).
- Synchronous and non-synchronous capability.
- Transition control versatility.
- Customized "New Look" switching and control.
- Block-building console housings.
- Newest ideas for planning and modernization.

THE FUTURE OF THE TELEVISION RECEIVER

by W. W. WATTS, *Group Executive Vice President*
Radio Corporation of America



W. W. WATTS, Group Executive Vice President, Radio Corporation of America, relaxes in a corner of his office in Radio City. Mr. Watts is responsible for the Home Instruments activities of RCA, which include the RCA Divisions that produce and market radio and TV receivers, phonographs, home tape recorders, parts and accessories—as well as the RCA Sales Corporation and the RCA Victor Distributing Corporation. He is also responsible for the Electronic Components and Devices activities of RCA, which include the Divisions that produce tubes, semi-conductors and special components. Together these activities represent the largest and most integrated operation of its kind in the electronic industry.

EDITOR'S NOTE: A feature of the recent NAB Engineering Conference was a panel on the "Future of Television." Prominent industry figures made short presentations of various aspects of "the future"—after which the meeting was opened for discussion. W. W. ("Wally") Watts, RCA Group Executive Vice President, was chosen to present "The Future of the Television Receiver." We think those who missed this session will be interested in reading Mr. Watt's presentation.

Thank you, Chairman Martin and Good Morning, Ladies and Gentlemen:

I am very proud indeed to represent the television receiver industry on this illustrious panel. I am happy to have the opportunity to gaze into the crystal ball. It's a pastime we in the electronic industry find very pleasant—as well as profitable.

This is certainly an industry of constant change and innovation. Nothing is impossible, it seems, in this world of television. Only several years ago there were only a few people who would have been willing to bet that the American public would spend more than a billion dollars in 1965 for color television sets—quite possibly more than they spend for black-and-white sets.

And who would have thought that the first time color sets went over the million-set-a-year mark that an all-time sales mark would also be established in black-and-white? That's what happened last year as the American public gave you broadcasters a tremendous vote of confidence in the appeal of your programming by purchasing some nine million television receivers.

Now the future of color television is assured—thanks in large part to the large number of color programs now being broadcast or announced for the near future. And I want to emphasize that I'm referring not only to network color but also locally originated color.

So far as the future is concerned, we see no developments on the horizon that could obsolete our present color system or receivers. There will be continual refinements in receivers, transmission and studio equipment and techniques. By refinements I

TOMORROW this pocket-size Color TV "Set of the Seventies" may be as common as the ubiquitous transistor radio is today. The unit the girl holds is just a styling mock-up—but it is, says Mr. Watts, "the color set we would like to build . . . it may be 10 to 15 years before such a set is on the market but it is coming."



mean such developments as the automatic degaussers introduced last year to eliminate the need for calling the serviceman when the picture tube becomes magnetized for whatever reason.

This, of course, is to be a year of transition in color. For the first 10 years we had only one size color picture tube. Now the 25 and 23-inch rectangular tubes have joined the 21-inch round type which became the industry standard. Our Japanese friends are also sending over a limited number of 16-inch tubes. We are now sampling the receiver industry with a 19-inch rectangular tube and there is work underway on other sizes.

Where will all this change in picture tube sizes end? Well, some day in the future—possibly in 1975—your programs could be seen on a color set this size (above), or even smaller. This is only a styling mock-up of a color set we would like to build. I hasten to point out that our engineers don't know how to build such a set at a reasonable price at the present time. In fact, it may be 10 to 15 years before such a set is on the market but it is coming.

Here is what may make it possible. In my hand is an experimental electronic circuit. It is approximately the size of a matchbook but it contains 48 integrated circuits, with the equivalent of 400 to 500 separate components. This could be the television chassis of the future. It could be designed into a television set such as the one I just showed you. Similar integrated circuits are now being produced for use in RCA's new Spectra 70 line of electronic data processing machines.

From miniature sets we go to the TV picture on the wall. The bulb-like picture tube of today's television set should give way to a thin screen, one or two inches thick. It could be any size . . . imagine an eight-foot color TV picture on your living room wall. Picture-on-the-wall television could be made possible by integrated circuits sometime in the 70's.

Even a movie-screen-size color TV set in the livingroom won't solve the problem of varying tastes in television programming. We see the day when there will be TV sets scattered all over the house . . . much as today's radio sets are. I'm certain

today's trend toward personalized program selection will continue to grow and every member of the family will have his own small-screen portable.

One of the problems that has held back cordless, transistorized television sets has been the present state-of-the-art in batteries. They're too large, too expensive and too heavy with an operating life too short between recharging.

Solar batteries already are commonplace on our satellites. The human body itself could supply enough heat, and therefore power, to operate a miniature radio or TV set by 1975. Ahead of us is the pocket TV set—and all that this portends for an expanded broadcast audience.

By 1975 the video tape recorder-player should be an important adjunct to the home television receiver. So much has been written about this development that I'm certain you are all aware of its possibilities.

Operating models of the home video tape player have been demonstrated by a number of different companies around the world, including RCA. We have been work-

INTEGRATED CIRCUITS WILL MAKE IT POSSIBLE. Shown below are IC packages now being marketed by RCA Electronic Components and Devices. Each package encloses a monolithic silicon integrated circuit element representing 20 discrete interconnected components. The actual element is a thin square only $1/16 \times 1/16$ inch square. They are sealed within the RCA flat $1/4 \times 1/4$ inch package for convenience in mounting and connecting.

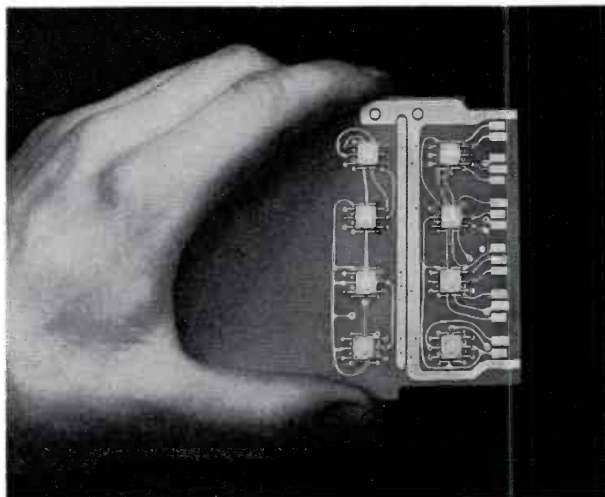
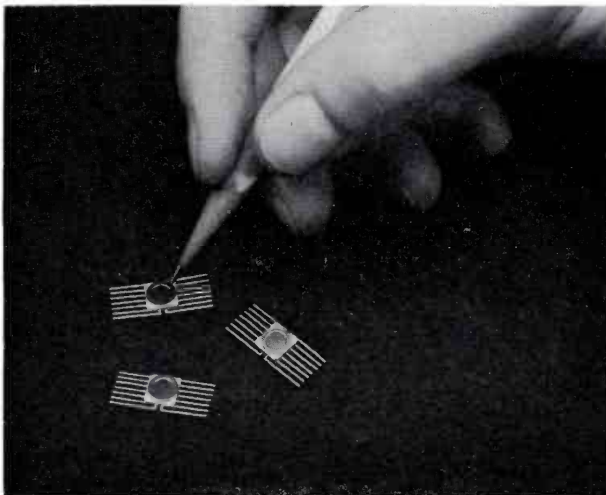

500 SEPARATE COMPONENT EQUIVALENTS make up the 48 integrated circuits contained in this match-book sized circuit board (above). According to Mr. Watts, something like this could be the television chassis of the future. It would be the basis of a television set such as the one shown on the preceding page.

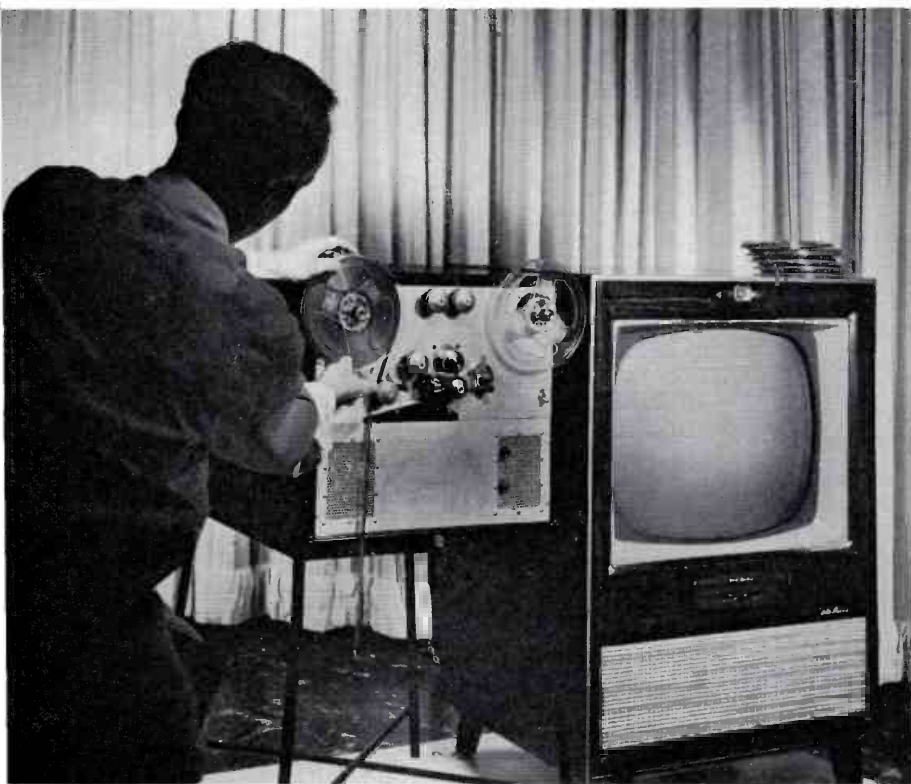

SOMEWHERE IN-BETWEEN today and tomorrow is the home video tape recorder. Operating models have been demonstrated by a number of companies—but none, says Mr. Watts, have met the standards that such a product must meet before it will be commercially acceptable for the mass market. The portable TV Tape System shown above was demonstrated at RCA Laboratories in October 1958.

ing on such a product for more than 10 years. From the beginning, we established three standards that such a product must meet before it would be commercially acceptable for the mass market. They are:

1. The picture quality must be comparable to the best TV reception from the air.
2. The instrument must have the ability to record and play back at least an hour-long program from a single reel of tape; and
3. It must have a manufacturing cost that would permit a retail price of no more than \$500, and preferably lower.

So far, no product in our own laboratories—or those demonstrated by other companies in this country and abroad—have met these standards which we feel are essential before such an instrument can be accepted by the mass market. In addition, it would be most desirable for such a device to incorporate color as well as black-and-white.

TODAY this 12-inch solid-state portable is the newest thing in small-sized TV sets. Announced just two weeks ago it marks RCA Victor's entry into the small-screen personal television market. The set shown, the GAMIN, is the industry's first low-priced transistorized portable. It features an optional retail price of \$124.50 and is one of a wide variety of newly announced sets which are designed to promote multiple TV receiver ownership.

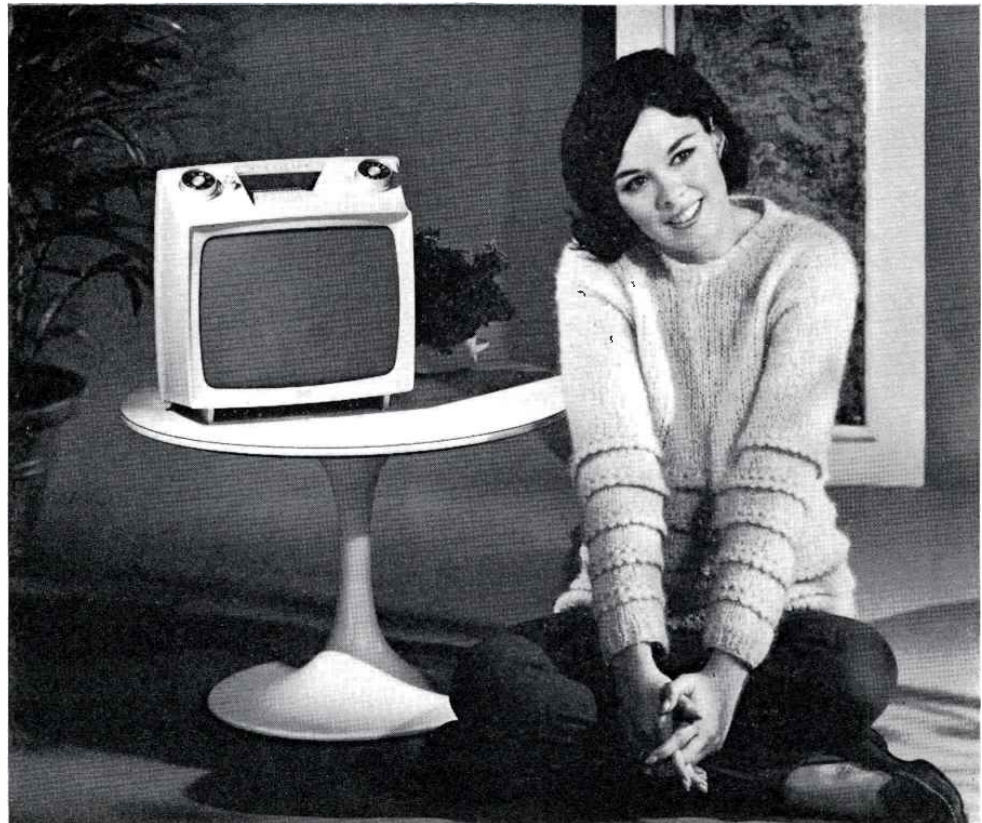

However, these problems will be overcome in the future and the video tape player is a home entertainment instrument you'll definitely be seeing in a few years from now.

The wireless remote control for today's television set may be replaced in the future by the human voice. Imagine just speaking to your TV set with commands such as "Turn to Channel 4," "a little less audio on that commercial, please!" or a TV set that shuts off when you say Good Night to Johnny Carson.

Seriously, such a device is possible with circuits able to respond to human voice and translate the command into electronic signals which would operate the TV set's controls.

You may have read in the New York Times of March 12 that RCA engineers at our Princeton laboratories have obtained a patent for a syllable analyzer that takes spoken words apart and compresses them into electronic code. In its present form the analyzer can recognize about 200 syllables as spoken by several persons. It already is being used in a phonetic typewriter that takes direct dictation.

Another optional extra to the livingroom television set of the future could be a device similar to today's facsimile receivers. It would deliver the latest news and pictures in printed form so that you could read about the latest worldwide developments over the breakfast table . . . minutes after the news had actually taken place.

Personal communications is another area that could be expanded in the future through lower manufacturing costs and resulting lower prices to the consumer. Farmers, outdoorsmen, golfers and even straying children could maintain contact with home through a more refined version of today's citizens band radio with an expanded number of channels. However, speaking from experience, I'm not certain how many weekend golfers would appreciate being in constant contact either with their wives or their offices. Citizens band radios, as you know, are available today but I'm sure that further cost reductions will greatly increase their attractiveness to the consumer.

In this area, too, we are just at the beginning of most promising developments.

Our grandchildren's world will be one in which it will be possible to communicate with anyone, anywhere, at any time by voice, sight, or written message.

Global television will bring different societies into direct and daily contact through operational satellite systems in space. As General Sarnoff told the American Legion here in Washington earlier this month:

"This may be expected to mark the beginning of a vast process of re-education for all of us on earth, a redefining of old relationships and a searching for new ones. Out of this interplay a global culture may begin to emerge, and perhaps, in time, a global language."

Yes, the future indeed will be exciting for all of us in this dynamic television industry. The color sets of today seemed just as fantastic 20 or 30 years ago as some of the products of the future I described today. I am proud to be a member of an industry that not only dreams but makes its dreams come true.

Thank you very much.

"NEW LOOK" 55-KW UHF TELEVISION TRANSMITTER

TTU-50B Uses Integral-Cavity Klystrons to Reduce
Floor-Space Needs and Increase Operating Economy

by D. R. MASON
*UHF Transmitter Product Analyst,
Transmitter Merchandising Dept.*

FIG. 1. Curtain-wall installation of a TTU-50B UHF Transmitter. Control console in foreground is optional equipment (Type TTC-5B).

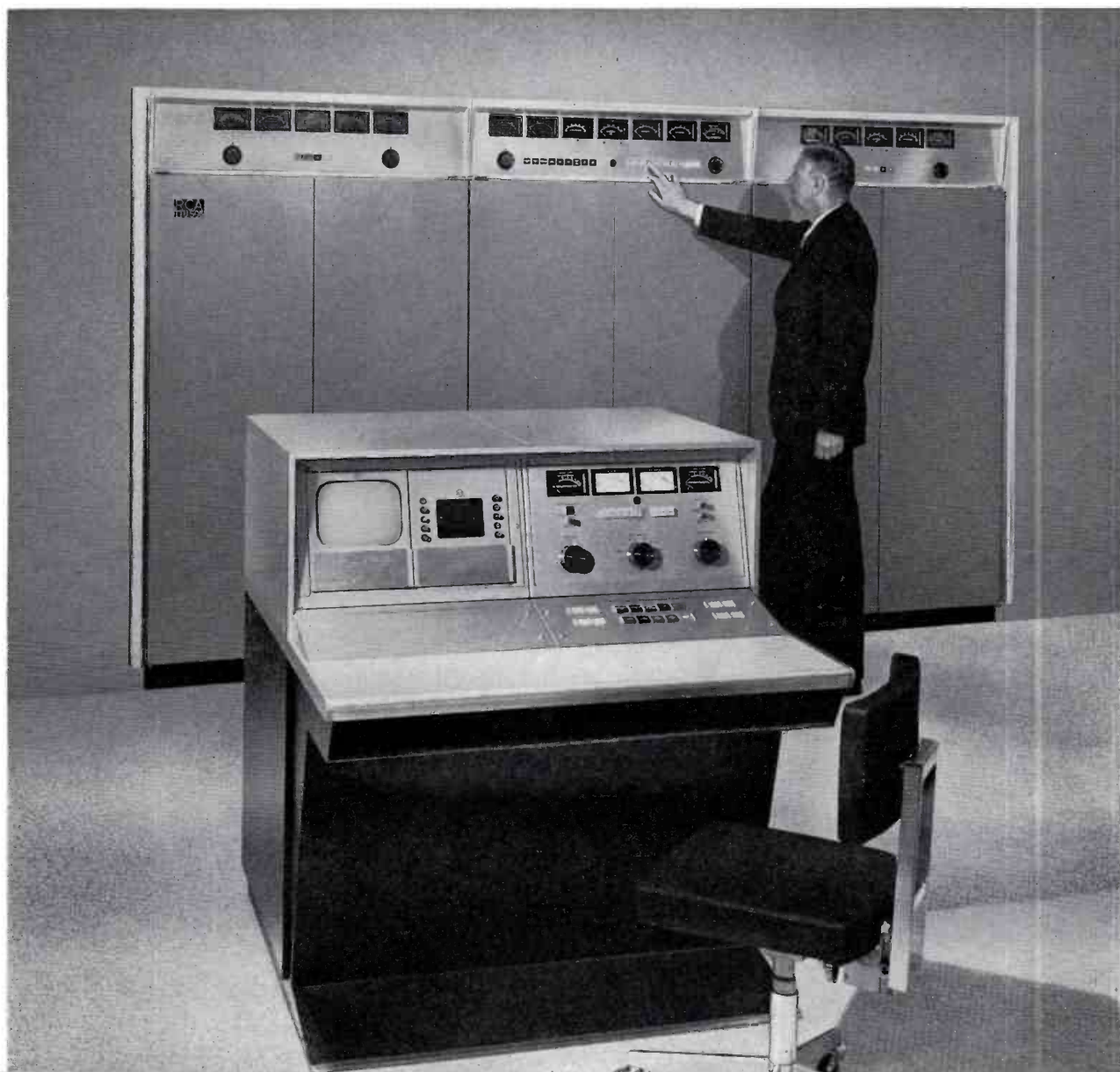

Shown for the first time at the 1965 NAB Convention in Washington, the TTU-50B is the first commercially-produced UHF-TV transmitter to offer full remote control in combination with a 55-kw visual power output. This transmitter, coupled to a high-gain antenna, is capable of 2,500,000 watts (2500 kw or 2.5 megawatts) of effective radiated power—only 3 db below the “legal” maximum.

The TTU-50B Transmitter offers many features and innovations that raise performance standards to new levels; reduce occupied floor space; increase operating economy; enhance reliability and simplify operation.

The outstanding performance of the TTU-50B is, in large part, due to the type of power tubes used in the visual and aural power amplifiers. These are integral-cavity, vapor-cooled klystrons of new design that operate with exceptional efficiency, stability and reliability.

Compared to earlier 50-kw UHF transmitters, the TTU-50B is *miniature*. It fits nicely in a 540-square-foot room. This contrasts sharply with the 1500+ square-foot space requirement of the 50-kw UHF predecessor transmitter. This small space requirement of the new transmitter, naturally, minimizes building expense in the case of a new station.

Increased operating economy is afforded in the TTU-50B through the use of a vapor-cooling system (as opposed to a water-cooled setup). The water-to-steam system saves as much as 10 kilowatts of utility power by reducing the size of pump motors, etc.

TTU-50B BONUS BENEFITS

- 55 Kilowatts in a 30-Kw Package
- 2,500,000 Watts of ERP with High-Gain Antenna
- Full-Fidelity Direct-FM Aural Modulation
- Built-In Readiness for Remote Control
- Simplified, Push-Button Operation

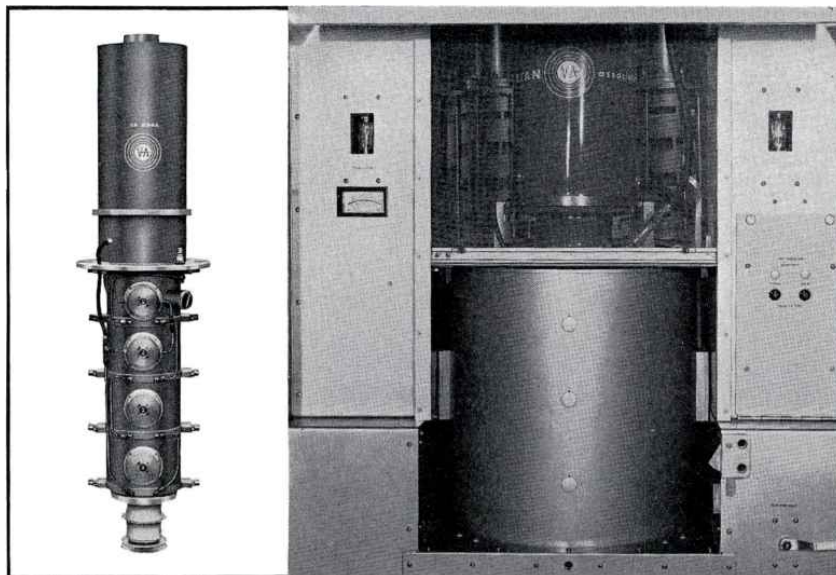

FIG. 2. The TTU-50B Transmitter uses two integral-cavity, vapor-cooled klystrons. (Cathode at bottom, collector at top.)

FIG. 3. The klystron as it appears after installation in the transmitter. A full complement of instrumentation keeps tabs on all aspects of klystron operation.

Transmitter reliability is the result of imaginative engineering design that anticipates the effects of age upon components and takes measures to offset this aging process.

Newly-discovered devices and techniques are incorporated in the TTU-50B to simplify routine operation to little more than turning the transmitter “on” in the morning and turning it “off” at the end of the broadcast day. This is particularly important to a transmitter operated via remote control. The description that follows treats each of these advantages in more detail.

Integral-Cavity, 55-Kw Klystron Power Amplifiers

The aural and visual klystrons used in the TTU-50B Transmitter are integral-cavity, vapor-cooled devices. Integral-cavity design affords, among others, two important advantages: factory pretuning and no-drift operation.

Factory pretuning of the klystrons to operating frequency prior to delivery to the end user dispenses with the tedium and expense of klystron “preparation” at the transmitter site. Since the cavities are never separated from the tube, the tube is, essentially, a “plug-in” device.

No-drift operation is the result of the fact that the integral cavities are temperature-stabilized by coolant on its way to the collector. The temperature of this coolant is rigidly controlled and, as a result, maintains cavity temperature within close limits. Constant cavity temperature is important in realizing consistent klystron power gain and bandpass characteristics.

Vapor cooling, as opposed to water cooling, offers greater efficiency because the coolant changes state, from liquid to gas. In the case of the TTU-50B, the coolant is water-to-steam. The increased efficiency of the change-of-state cooling system becomes apparent when one remembers the physical rule that goes something like this: While only one BTU of heat is required to raise the temperature of one pound of water (at atmospheric pressure) one degree Fahrenheit, 970 BTU are needed to convert one pound of 212-degree water into steam, also at atmospheric pressure. Stated simply, vapor cooling is almost 1000 times more efficient than water cooling, *volume for volume*. In practical operation, vapor cooling requires approximately one-tenth the coolant flow of a comparable liquid-cooled system.

Quick-Change Klystrons

A unique system of klystron change is used in the TTU-50B as a result of the

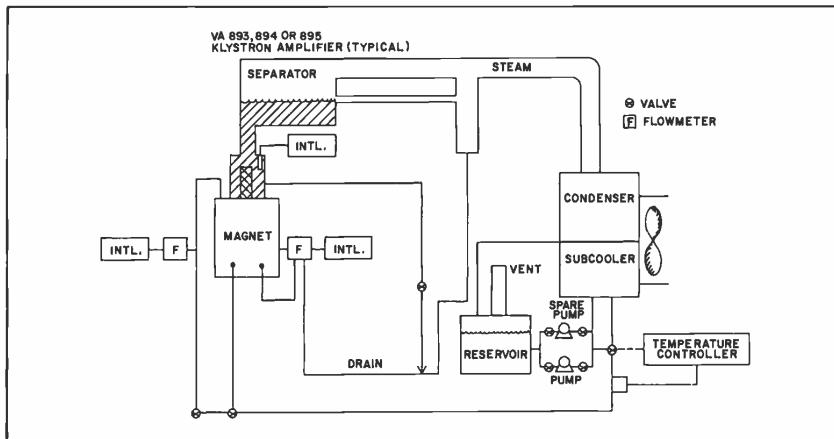

FIG. 4. Simplified schematic of the water-to-steam klystron-cooling system as used in the TTU-50B. Volume for volume, vapor cooling is almost 1000 times more efficient than water cooling systems.

fact that the cavities are integral to the tube and the fact that the magnetics remain within the transmitter during tube changes. Figures 5 through 16 highlight the manipulations that make up the tube-change procedure. The caption for each details the operation.

Experience with the TTU-30A Transmitter, four of which—as of this writing—are already in daily operation, has shown that the complete tube change can be accomplished in less than 5 minutes by *one man* working alone. In the unlikely event of tube failure during air hours, this quick-change system is most valuable. Earlier klystron designs often take an hour or more for tube change.

Because the klystron is pretuned at the factory, it requires no “preparation” at the transmitter site save for a simple operation of rolling the tube from its packing case onto the klystron carriage as shown in Fig. 17. The klystron can be “trimmed up” after installation for optimum performance through four minor adjustments.

Plenty Power—Minimum Floor Space

As a result of the walk-in cabinet design, the vapor-cooling system and imaginative mechanical engineering, the TTU-50B and its associated equipment can be housed in a room measuring 27 by 20 feet with a headroom of 12 feet or more so that the filterplexer may be ceiling-mounted. (See Fig. 18 for floor plan). In buildings with less headroom, (as low as 9 feet) the filterplexer can be mounted on the wall or a table. Naturally, this increases floor-space requirements.

The floor-space requirements of the TTU-50B are *miniature* when they are

compared with the space requirements of the 50-kw UHF predecessor transmitter. WNYC-TV* New York City operates a 50-kw UHF transmitter in daily operation. This transmitter occupies a room that measures 55 by 20 feet; the liquid-cooling system occupies another room that measures 21 by 21 feet. In all, the system needs 1500+ square feet of floor space. The TTU-50B transmitter *and cooling system* fits comfortably in a room offering only 540 square feet. Thus, the new transmitter requires just slightly more than one-third of the floor space occupied by its predecessor.

The three high-voltage transformers for the TTU-50B are mounted outdoors beneath a shed roof and within a fence. The roof provides weather protection and the fence precludes unauthorized entry. A heat exchanger (steam condenser) is located immediately behind the transmitter, as shown in the floor plan, for two reasons: one, to minimize the distance between it and the transmitter and thus reduce the length of plumbing between the two and, two, so that the exchanger can dissipate its heat into the outside air. However, the distance between the transmitter and its cooling system is flexible and the two need not be located adjacent to one another.

The TTU-50B is, truly, the smallest 55-kw UHF transmitter ever produced.

Ready for Remote Control

As are all RCA transmitters, the TTU-50B is fully ready for operation via remote control. All wiring, relays, motor-driven controls, etc. are included at no extra cost.

*“RCA 50-Kw UHF Transmitter,” *Broadcast News*, Vol. 116, pp. 68-71

The utilization of these facilities does, however, require the use of a transmitter accessory such as the RCA BTR-20C Remote Control System or an equivalent. The BTR-20C employs two telephone pairs between the control point (for example, master control at the studio) and the transmitter plant.

This built-in readiness for remote control in the TTU-50B eliminates any transmitter modification for operation via remote control.

Full-Fidelity Aural

Since the TTU-50B is a truly modern transmitter, it employs *true* frequency modulation in the aural transmitter. As a matter of fact, the aural-channel exciter/modulator is *precisely* the same unit used in the new line of RCA FM-broadcast transmitters. Direct-FM modulation has proven itself eminently capable of full utilization of the fidelity benefits inherent in frequency modulation.

The aural exciter is an extremely simple device and this simplicity results in both stability and dependability. To illustrate, the aural carrier is generated, modulated and amplified in only four tubes. Four more serve in the automatic-frequency-control system and the ninth is a voltage-regulator type. The simplicity becomes even more evident when this number of tubes is compared with the 18, 21 and more of earlier—and far less dependable—exciters.

True frequency-modulation is applied to the aural carrier through an extremely simple device called a *varactor* diode. This solid-state component offers virtually-unlimited life and stability. The AFC system maintains precision control of the carrier frequency through the use of a counter-detector, a magnetic amplifier and a varactor diode, a trio of outstandingly harmonious devices in operation. These devices supplant the earlier multi-tube systems that fell prey to drift. As a matter of fact, the new AFC system is self-compensating against the effects of age to make the exciter virtually drift-free.

Visual Modulation at Two-Watt Level

The picture signal is applied to the visual carrier at the two-watt power level in the visual exciter/modulator. The engineers call this “low-level” modulation and its main advantage is reduced modulator complexity and markedly improved picture quality . . . particularly color-picture quality.

Modulation occurs at the grid of a type 4055 “pencil” triode (see Fig. 24) which operates in a tuned cavity designed for easy tuning and no-drift operation.

Highlights of Quick-Change Klystron System



FIG. 5. Open collector drain valve.

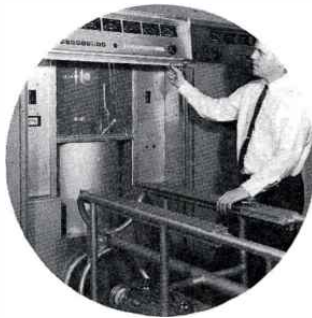

FIG. 6. Lift meter panel.



FIG. 7. Raise access screen.



FIG. 8. Disconnect water-inlet hose.



FIG. 9. Push release button; tilt tube.

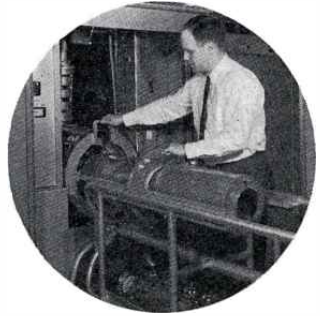

FIG. 10. Tube locks; roll tube out.

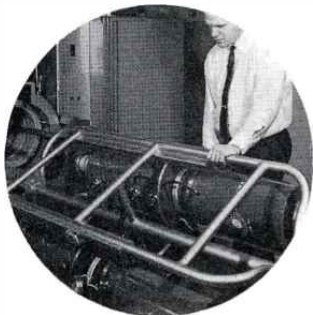

FIG. 11. Tilt-over carriage.

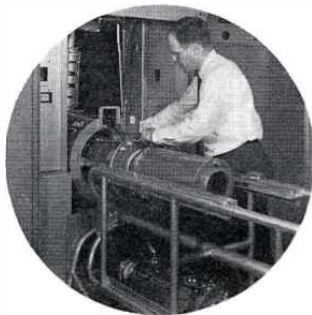

FIG. 12. Roll new tube into magnetics.

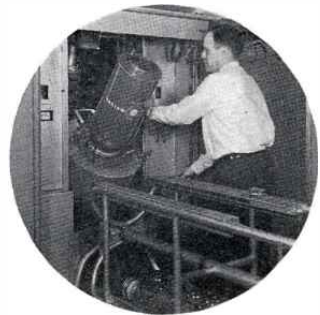

FIG. 13. Release latch, tilt tube up.

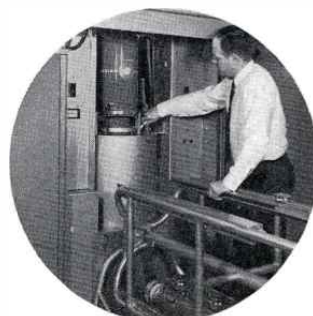

FIG. 14. Reconnect water-inlet hose.



FIG. 15. Close the "window-shade" screen.

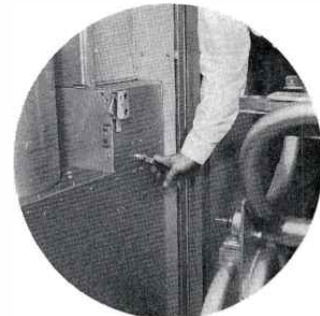

FIG. 16. Close collector-drain valve.

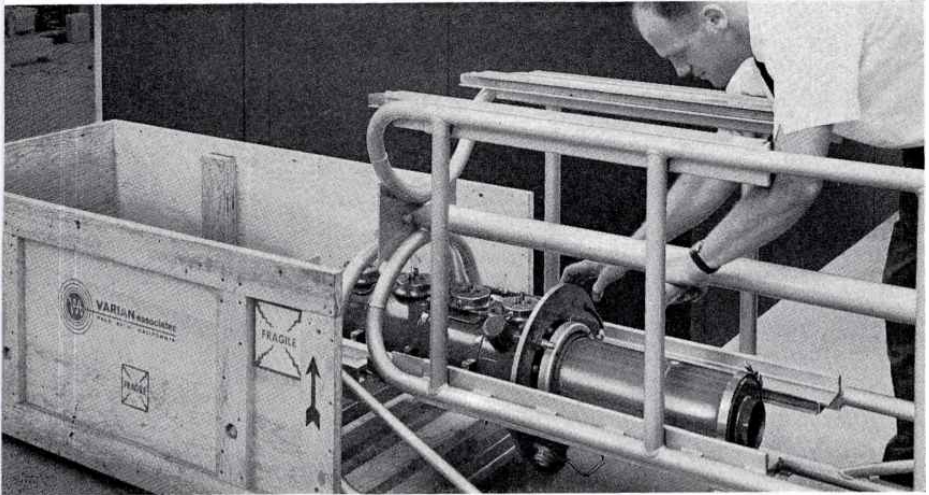

FIG. 17. Transferring the klystron from (or to) the carriage to (or from) the shipping case. Carriage level exactly matches the tracks in the case. Transfer takes only a few seconds. (30-kw klystron shown.)

Visual carrier frequency is developed in a crystal-controlled oscillator operating between 7 and 11 megacycles, depending on the frequency of the assigned channel. The crystal operates within a temperature-controlled "oven" to maintain tight-tolerance control over crystal frequency.

This precision signal is raised, through appropriate frequency multiplication, to the assigned-carrier frequency. A novel circuit arrangement maintains tight control over the intercarrier frequency or, the separation between aural and visual carriers.

Identical Visual and Aural Driver Amplifiers

The klystron-driver amplifiers for the aural and visual channels use a ceramic-

FIG. 18. Simplified floor plan for the TTU-50B Transmitter. Measuring 27 by 20 feet, this room is only slightly larger than the one required for a 30-kw UHF transmitter.

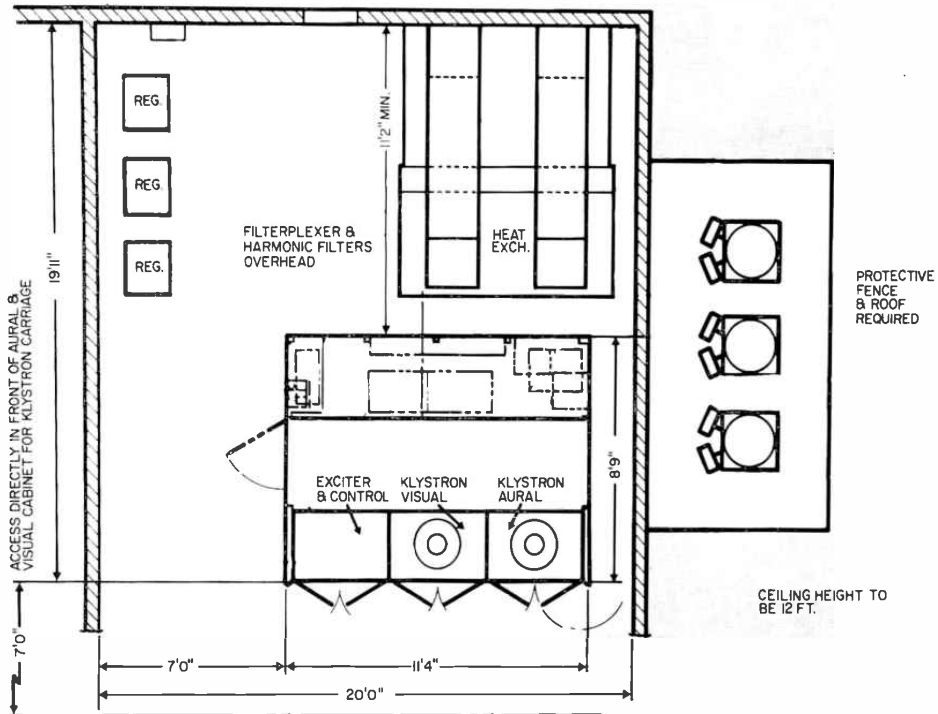

insulated, co-axial tetrode (type 7289) in a tuned cavity designed for quick and precise tuning. The tuning is accomplished through a slide arrangement and a knob-actuated system. The air-cooled tetrode plugs easily into the top portion of the assembly, see Fig. 27.

The aural and visual driver amplifier assemblies are identical in every respect. As a result, the two are fully interchangeable should the need arise. Tube-change is quick and easy. Power gain in each stage is approximately 15 and the visual driver is capable of 20 watts output.

Filament and plate power for the driver stages comes from a supply that also powers the exciter/modulator chassis. The aural exciter is completely self-powered.

FIG. 19. Close-up of motor-driven power-output controls which are standard equipment. These are representative of the built-in readiness for remote control.

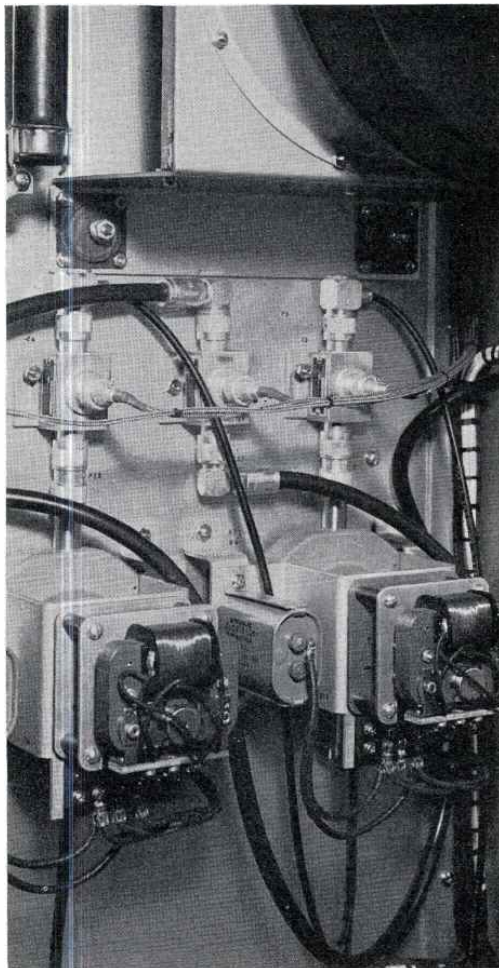

Modular Silicon Rectifiers

For decades, transmitter operators "lived" with the peculiarities of the mercury-vapor rectifier tube in broadcast transmitters. Not only did m-v rectifiers waste power, they'd arc-back and, sometimes, destroy a costly power transformer.

Silicon rectifiers have—almost universally—superseded m-v rectifier tubes in broadcast transmitters. There are several reasons for this: one, silicon rectifiers require no filament power thus reducing the cost of utility power; two, silicon rectifiers don't "wear out" as do tube rectifiers; three, silicon rectifiers are insensitive to cold while m-v tube rectifiers need "warm-up" before working under load; four, silicon rectifiers throw off less heat thereby

reducing transmitter-plant cooling requirements and so on.

The TTU-50B, naturally, uses silicon rectifiers instead of m-v tubes. The high-voltage rectifiers in the transmitter are "modularized". This means that 12 individual rectifier units are assembled into matched assemblies. (See Fig. 28.) This modular idea reduces rectifier maintenance time, improves cooling and occupies little space.

The inset in Fig. 28 displays one *module* of the *modularized* high-voltage rectifier. The module consists of the mounting plate, 12 heat-sink rectifier brackets, 12 silicon rectifiers, 12 equalizing resistors, 12 equalizing capacitors and appropriate machine-screw hardware. The entire assem-

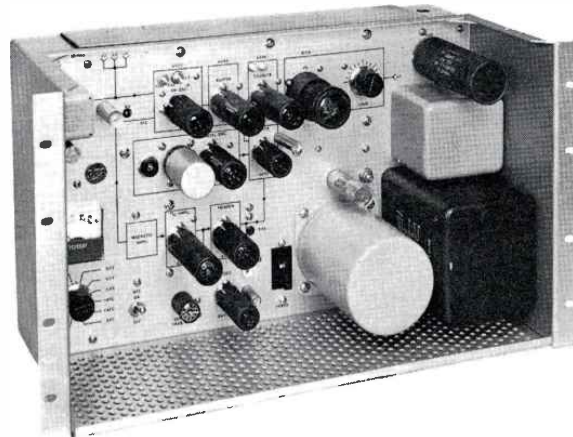

FIG. 20. Direct-FM aural exciter . . . precisely the same unit as used in the New Look FM transmitters. Direct-FM is the reason for the TTU-50B's full-fidelity sound.

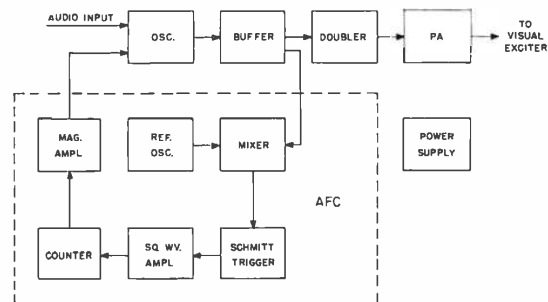

FIG. 21. Aural exciter block diagram. Note that AFC system uses a magnetic amplifier and a counter-detector. These eliminate tuned circuits from the AFC system and simplifies its operation.

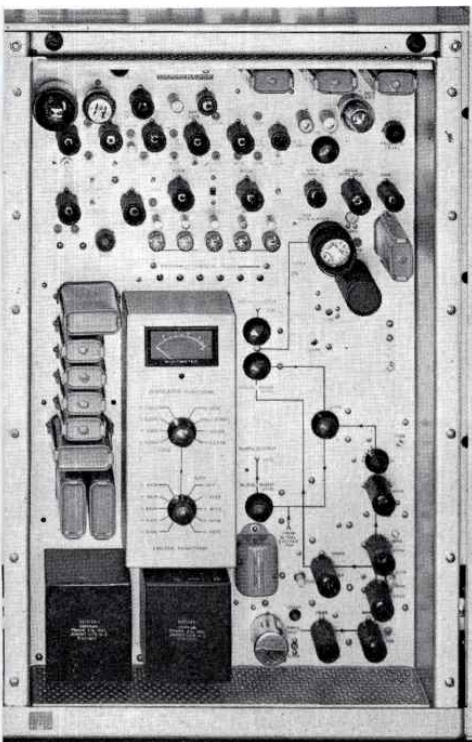

FIG. 22. Visual exciter/modulator chassis. Contains all of the circuitry between video input and the driver-amplifier input. Note digital readout controls.

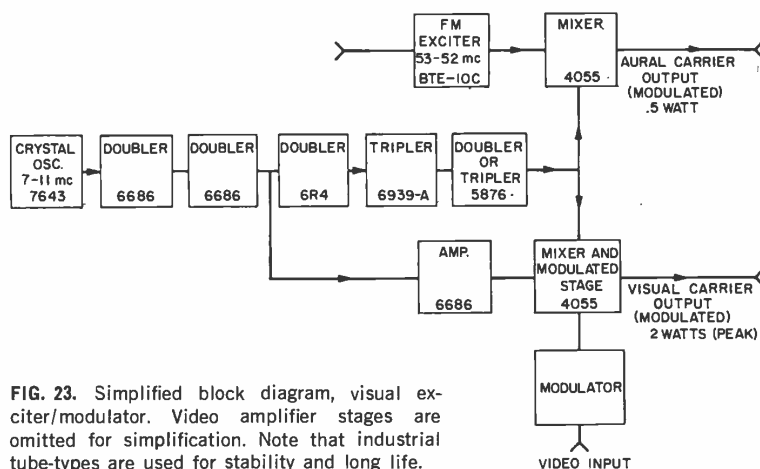

FIG. 23. Simplified block diagram, visual exciter/modulator. Video amplifier stages are omitted for simplification. Note that industrial tube-types are used for stability and long life.

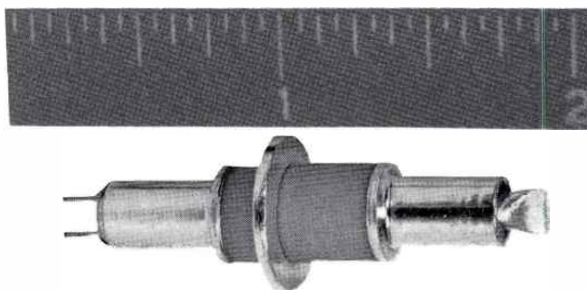

FIG. 24. Type 4055 "Pencil" Triode. This newly-developed tube serves as the modulated stage and mixer in the TTU-50B visual exciter/modulator.

bly, for all practical purposes, is a *single* rectifier; the heat sinks, resistors and capacitors being incidental to the series-connected rectifiers. Figure 29 is a schematic diagram of one rectifier module showing the 12 rectifiers and equalizing resistors. This module performs the same *function* as an m-v rectifier tube without the peculiarities and filament power.

Precision, High-Speed Overload Protection

One of the ways to determine the quality of a broadcast transmitter is to scrutinize the methods it employs to prevent component damage in the event of an over-

load. The ideal system for overload protection is one that reacts very quickly to an overload condition and takes immediate measures to prevent damage as a result of the overload.

The TTU-50B Transmitter uses such a system. In less than *seven microseconds* (0.000007 sec.) after an overload occurs in the antenna system (including the filterplexer and transmission line) the high-speed overload protection system cuts off both visual and aural power output and keeps it off for something less than a half-second. Automatically—and far faster than you can read this—the system restores

transmitter output. If the overload condition has passed, the transmitter returns to normal operation and a tally light indicates that an overload has occurred.

On the other hand, suppose the overload still existed when the transmitter came back "on." The overload system would re-cycle in less than those seven microseconds and remove the transmitter from the air (aural *and* visual) and, in much less than a second later, restore operation. This cycling continues as long as the overload exists up to two seconds. In these two seconds, several cycles take place and, at the end of the two-second time period, the

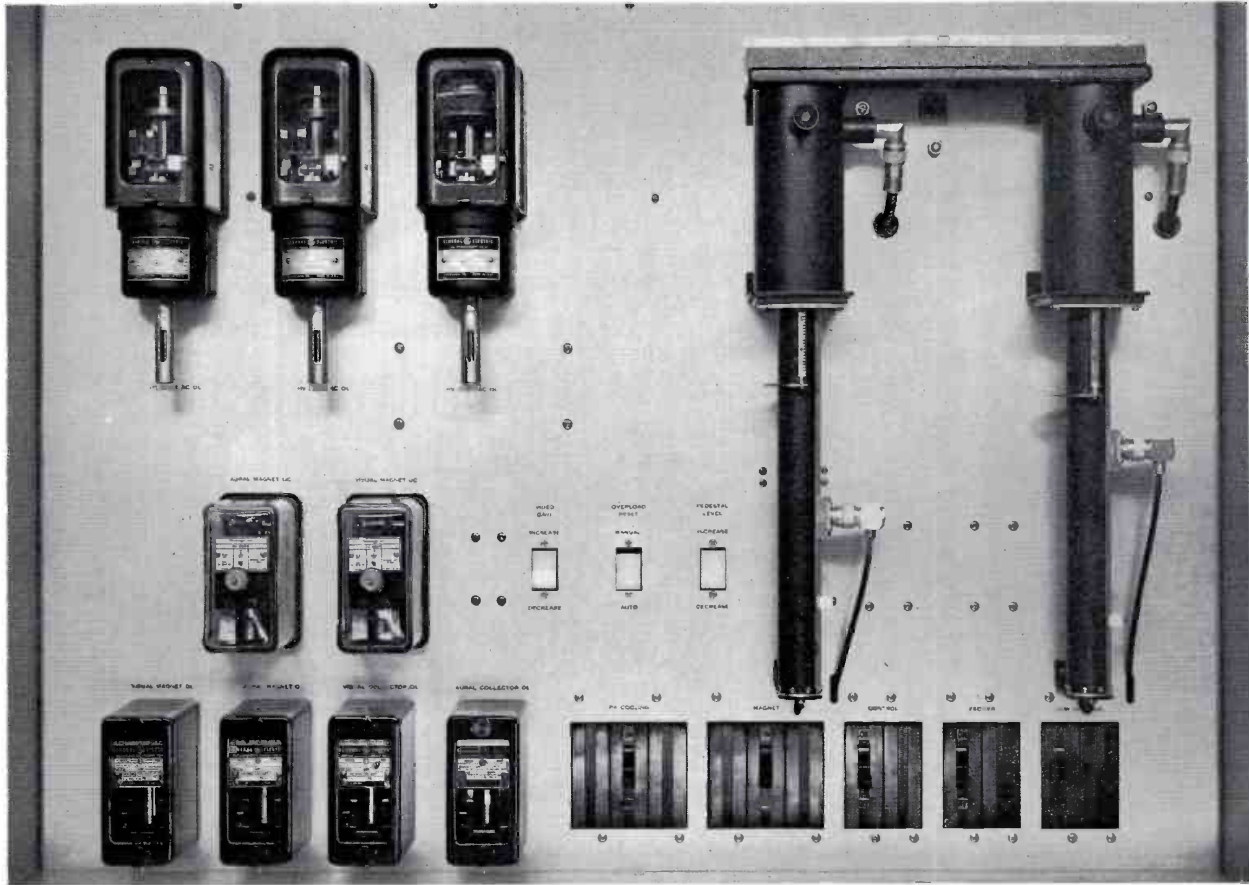

FIG. 25. Close-up of upper portion of the control cabinet. At right are the identical driver-amplifier cavities for aural and visual channels. At left, magnetic power-supply overload relays.

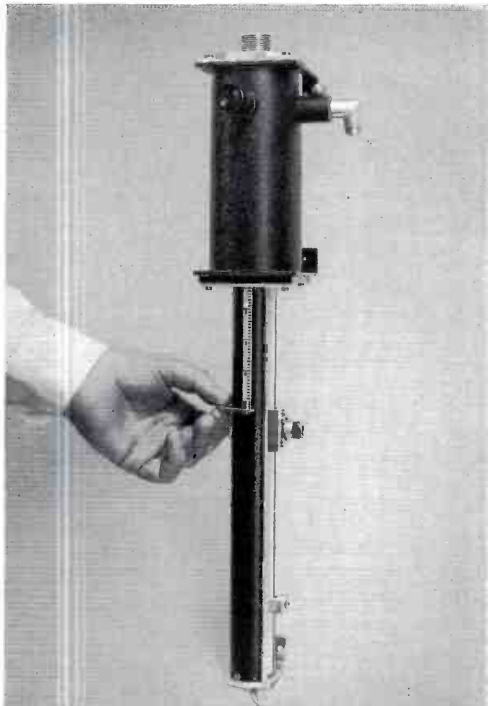

FIG. 26. Driver-amplifier tuning. This slide, along with the knob near the top, perform the driver-amplifier tuning functions.

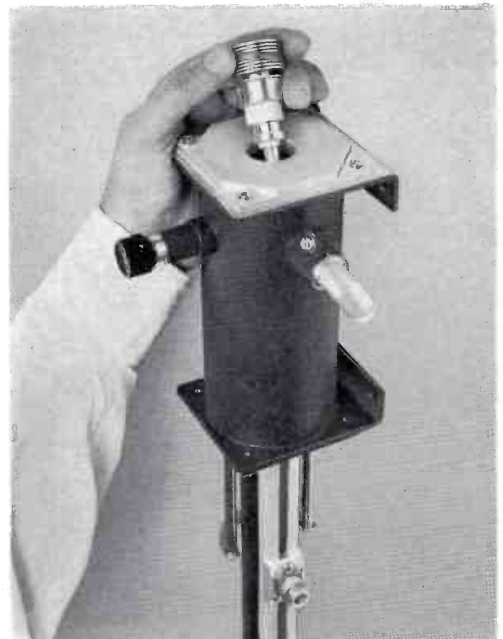
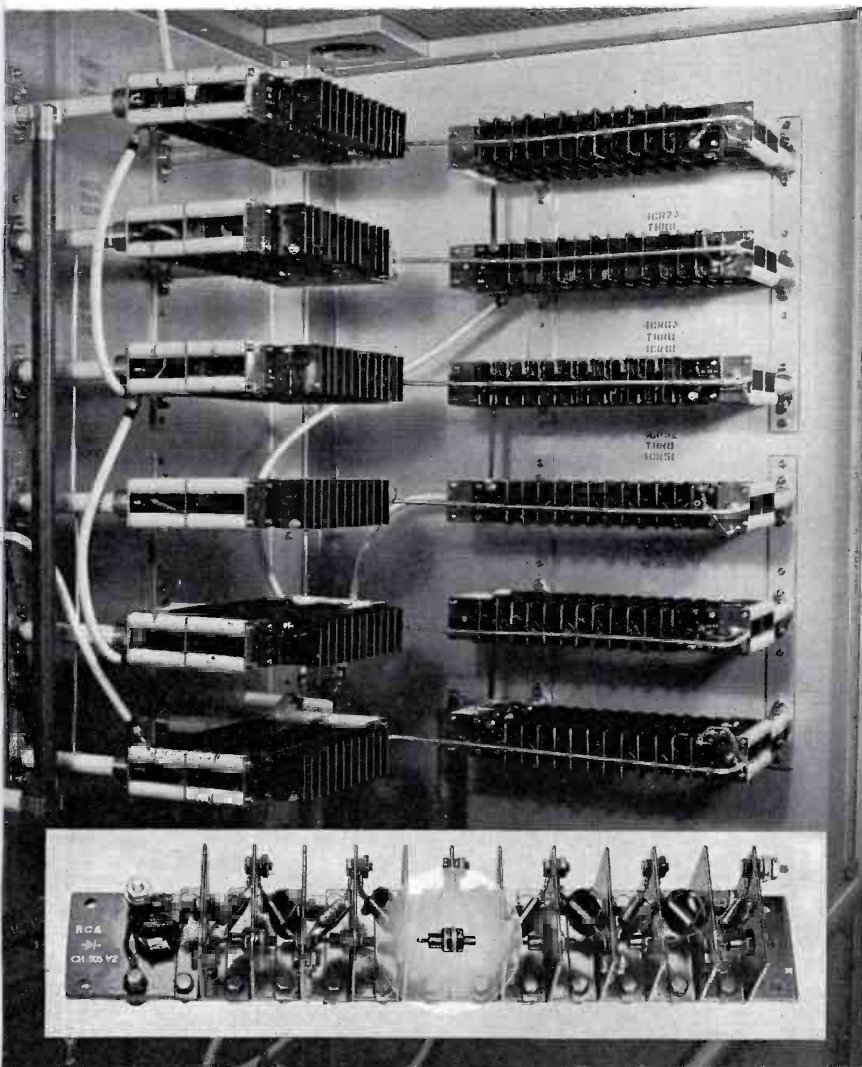

FIG. 27. Driver-amplifier tube change is little more than plug-unplug operation. Tube is type 7289 ceramic tetrode, air-cooled.



system removes the transmitter from the air until manually reset. Tally-light indication tips the transmitter operator that the overloads have tripped and the transmitter is shut down.

The overload system just described senses an overload in the antenna system only. Another system, using overload relays, protects the transmitter against power-supply overloads. This is the familiar "three-step" system which "breaks" three times and "makes" twice before locking out and requiring manual reset.

Thus, the TTU-50B includes two separate and distinct overload systems: the all-electronic antenna-overload system and the electro-mechanical power-supply overload system.

Modern "New Look" Cabinetry

Reflecting the new circuitry and components on the inside, the cabinetry of the TTU-50B represents the new look in UHF transmitters. This new look is a fresh approach to the packaging of equipment so that it occupies the least amount of valu-

FIG. 28. Right-rear corner of transmitter enclosure. High-voltage rectifiers are stacked for easy maintenance and convection cooling. Inset is one module with one rectifier emphasized.

FIG. 29. Schematic of one rectifier module. Resistors and capacitors equalize voltage drop during "off" portion of duty cycle.

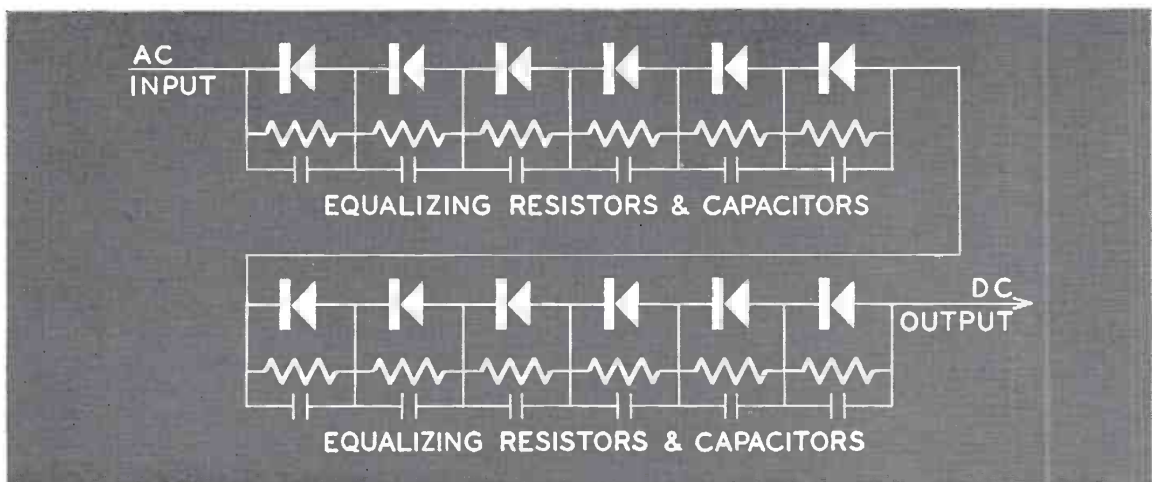

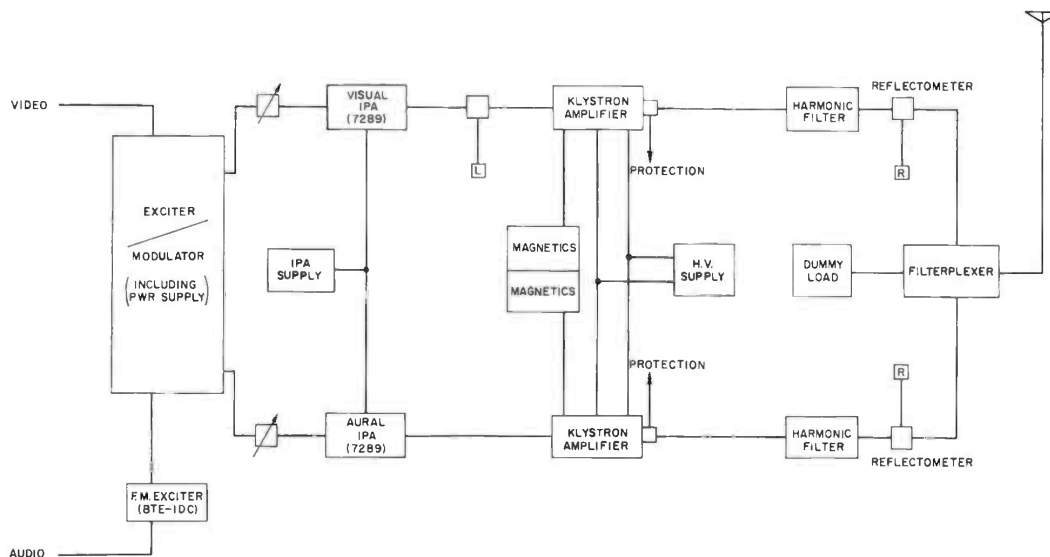

FIG. 30. Simplified block diagram of the entire transmitter. This drawing illustrates the simplicity of the system as well as the outstanding design.

FIG. 31. Rear of the exciter/control cabinet. Note the motor-driven variable transformers (3-phase) at lower left and right. These control the klystron-magnetics current.

able floor space and, yet, sacrifices none of the accessibility to components so necessary to inexpensive maintenance and servicing.

The finish for the color surfaces is a tough textured-vinyl coating that is virtually chipproof, scratchproof and waterproof. The texture hides fingerprints and other soil to keep the transmitter new looking for years to come. Brightwork is satin-finished aluminum with a coating of transparent vinyl.

Walk-in cabinet design does much to reduce the dimensions of the transmitter yet, there is no sacrifice in components accessibility. This goes a long way in keeping up-keep costs low by reducing the time spent on maintenance.

A Truly Modern Transmitter

The features and attributes of the TTU-50B Transmitter sum up as an excellent combination of outstanding performance, operational ease, unparalleled dependability and day-in-day-out economy. It is a truly modern transmitter for the truly modern UHF television station.

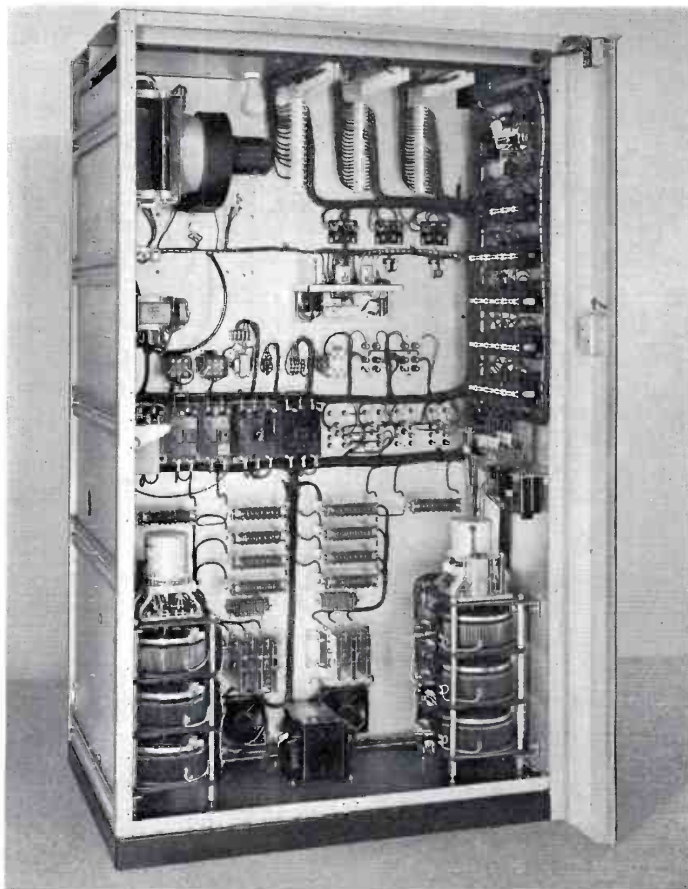



RCA
22 HL

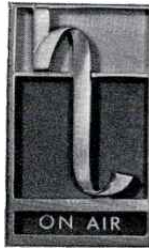

SUPER-DELUXE TV TAPE RECORDER 22HL

Latest addition to a complete line of transistorized tv tape equipment is the 22HL for high band (7.06 to 10 mc) and low-band operation. Developments in headwheel design, video and fm circuits make possible a new level of performance in producing tv tapes of increased brilliance and realism—particularly in color. The ability to make multiple generation color tapes—almost indistinguishable from original pictures—demonstrates the technical improvement over the already good quality obtained from previous model TR-22's.

The super-deluxe 22HL features console styling similar to the deluxe TR-22—retaining the very high degree of human engineering for easy, error-proof operation. Like the TR-22 it also employs standardized transistor modules and all of the time-tested deluxe operating features notable in RCA tv tape designs.

Newest conveniences in obtaining finest high-band/low-band performance include “instant switching” between five different world-wide tv standards and use of a new “universal” air bearing headwheel which can be employed on all RCA transistorized tv tape recorders.

UNEXCELLED PERFORMANCE FEATURES

- Only recorder with instant switching between:
 - high-band universal (7.06-10.0 mc)
 - low-band monochrome (4.3-6.8 mc)
 - low-band color (5.5-6.5 mc)

- Only recorder with “Universal” air-bearing headwheel— for high-band or low-band, domestic or international standards

- Extras such as ATC, switchable standards, and air-bearing headwheels, are standard equipment

- Pre-wired for Color ATC, Electronic Splicing, Drop-out Compensator— simply plug in modules to add these features

ONLY RECORDER WITH INSTANT SWITCHING BETWEEN FIVE TV STANDARDS

FM Standards Switch	Line Standards Switch	FM Deviation	System Bandwidth
Monochrome	405, 525	4.3-6.8 mc	4.5 mc
Monochrome	625	5.0-6.8 mc	5.0 mc
Color	525	5.5-6.5 mc	4.5 mc
High Band (Color or Monochrome)	405, 525	7.06-10.0 mc	4.5 mc
High Band (Color or Monochrome)	625	7.2-9.3 mc	6.0 mc

Today's Only TV Tape Recorder with Switchable High Band/Low Band Operation

High band is a new recording and playback mode that utilizes higher FM deviation frequencies for both color and monochrome. Built-in high band circuits and a selector switch in the HL eliminate any need for modification or adjustment when changing from standard (low band) operation to high band or vice versa. A single switch selects from five FM deviation ranges to provide a choice of three domestic and four international TV standards.

Switchable Line Standards and Speeds

Other switching features of the 22HL—and all RCA transistorized machines—provide for selection of TV line standards 405, 525, 625 or the optional 819 (international model) and tape speeds of $7\frac{1}{2}$ or 15 ips. All these functions are switchable without inserting modules or accessory units of any kind, making the recorders truly compatible for instant operation.

Superior Pictures . . . Multiple Copies

Multi-band operation coupled with advances in headwheel design and video and FM circuit techniques incorporated in the HL, produce taped masters and copies that are almost indistinguishable from the originating signals. Significant improvements are in s/n ratio, bandwidth, "K" factor (transient response rating), and differential phase and gain, greatly extending tape quality for both color and monochrome. High band masters can be made to achieve multiple generation video dubs with as good quality as masters made by other machines.

THIS SINGLE SWITCH—YOUR KEY TO FIVE TELEVISION STANDARDS

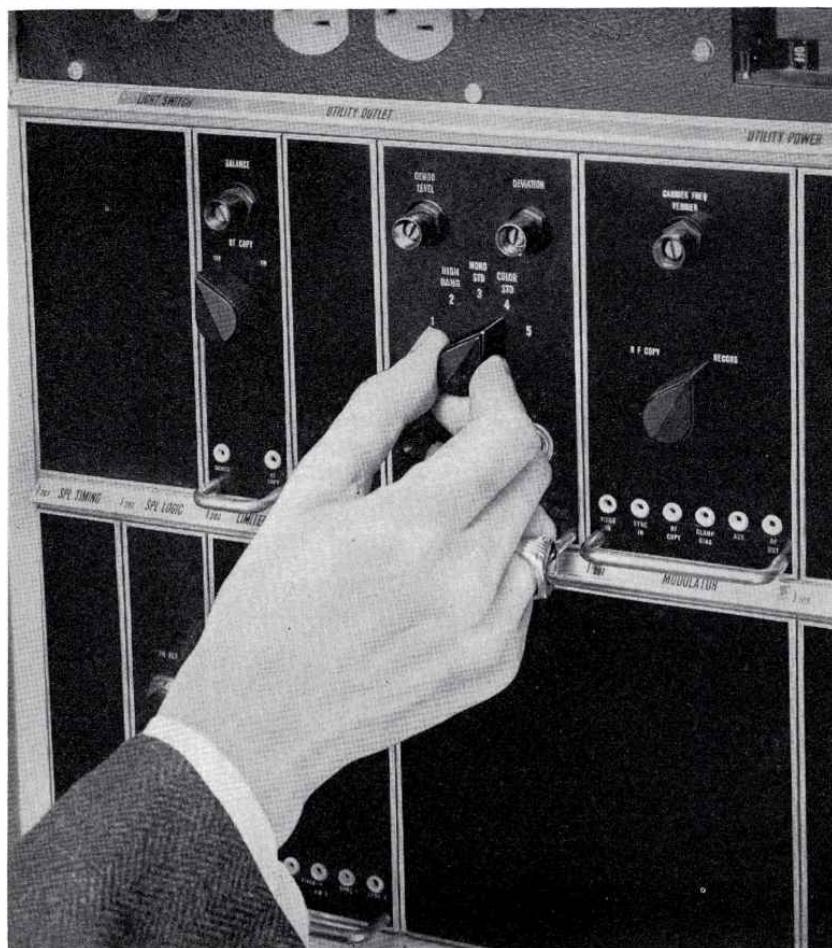

Brilliant Color to 3rd Generation

The advanced circuitry of the 22HL is designed to complement the technical superiority of the high band techniques which are employed in the recorder, resulting in the highest quality color reproduction attainable in TV taping. Color is easily added to the HL by simply plugging transistorized color module accessories into the space provided. No other modifications are necessary. Choice of either mono or color operation is then switchable on any applicable standard.

TV Tape's Only Universal Headwheel

First introduced by RCA a few years ago, the air bearing headwheel is standard equipment on the TR-22—however—in the HL is a new design step forward, resulting in a *universal* air bearing headwheel. This universal headwheel operates on all switchable tape standards—high band and low band. Moreover, it can also be used in any other RCA transistorized recorder.

New Tape Lifter, Selective Erase Head

Also built into the 22HL is a new tape lifter which permits the tape to contact a selective erase head only while actually recording. When used with the electronic splicer, the selective erase head permits erasure of existing video without disturbing the original recorded control track or audio track. This feature gives new versatility to the 22HL and greatly increases tape life.

Only Recorder with "Universal" Headwheel

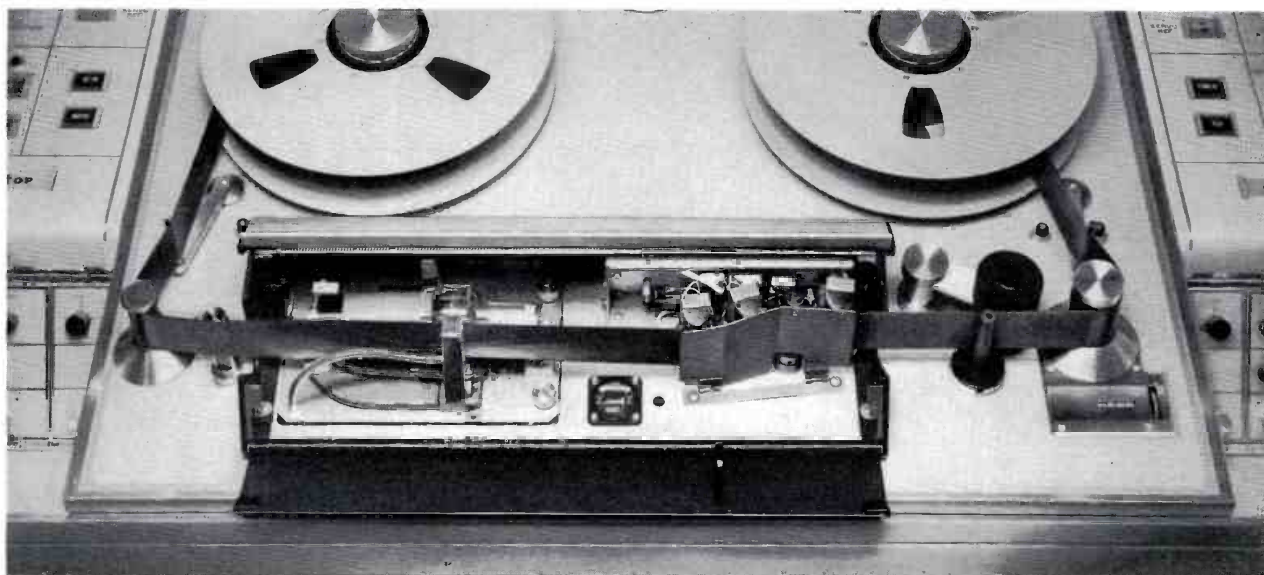

MONOCHROME

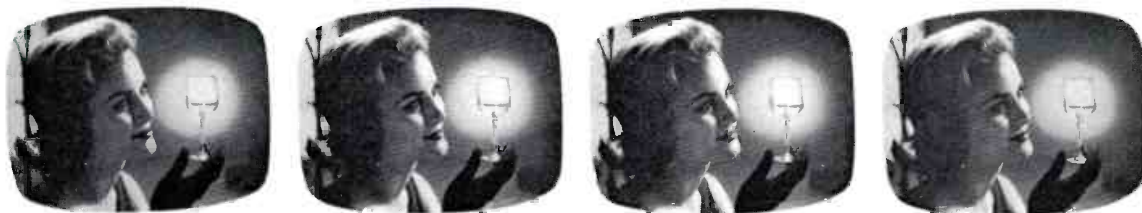

Finest Pictures
in Multiple Generation
Tape Copies

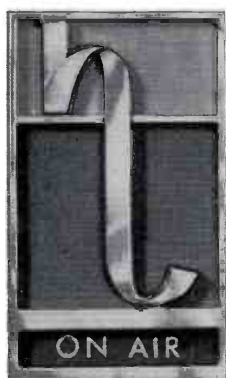

COLOR

"Extras" such as ATC, Switchable Standards and Air Bearing Headwheel are Standard Equipment

Pixlock Performance

Pixlock is standard on the 22HL. Long an important feature of the RCA solid state TV tape recorder system, Pixlock completely synchronizes switching between tapes, studio signals and other sources and permits fades, lap-dissolves, supers and other special effects. Pixlock, with a timing accuracy of ± 70 nanoseconds is well within the range for color as demonstrations have proved. Dependable color operation, however, requires the fully integrated systems of Pixlock, mono and color ATC.

Line Lock

Pixlock in the 22HL includes a "Line

Lock" mode which is a valuable addition for color operation. In this mode, the servo system locks on horizontal sync pulses as in normal Pixlock, but precise vertical framing is established only at initial start-up. Subsequent response to disturbances caused by splices or dropouts is rapid and reliable because re-locking is to the nearest horizontal sync pulse without re-framing vertically. This minimizes the subjective disturbance to the reproduced color signal.

Precision ATC

Completely transistorized Automatic Timing Correction (ATC) circuits are

built into the 22HL. This exclusive feature and refinement more than doubles stability when used in conjunction with Pixlock. Highly desirable for everyday operations, these precise timing circuits provide the degree of stability necessary for the utmost in special effects and to automatically achieve and maintain perfect picture geometry—freeing operators from constant touch-up of controls.

The above features join the switchable standards and air-bearing headwheel to further increase the "extras" that are standard equipment in the 22HL.

Human Engineered for Effortless Operation

Layout and design of the 22HL are based on studies made to achieve the highest degree of coupling between the machine and the operator. Features include a tape deck set waist high at an angle of 45 degrees for ease in loading reels and threading tape. Recording and playback controls are separated to minimize errors. A series of foolproof lights signal operating modes and warn of faulty recording. Plug-in electronics make the HL the easiest-to-operate and to-maintain recorder ever produced.

Professional Design

Beautifully styled to enhance any surroundings and professionally designed to aid operator efficiency, the 22HL presents four functional areas: the monitoring area, the tape deck and operations area, module electronics area, and console base power deck.

In the monitoring area at the top of the 22HL are the audio monitor and completely transistorized picture and waveform monitors. Under the picture monitor in the center is the tape transport panel with the RECORD control panel on the

left side and the PLAYBACK control panel on the right. Directly below the tape transport behind the front panel is the bank of plug-in transistor modules containing the circuitry for video and FM processing and for all the servos required by the recorder. The console base contains the power supplies, headwheel blower, vacuum and pressure pumps, air bearing pump and main cooling blower. Up front accessibility for all normal operation and maintenance is attained by centralized plug-in electronics modules and careful mechanical layout. The 22HL is completely self contained. There are no external accessories.

Functional Control Clusters

The 22HL operations center is a modern, well-lighted control center designed to assist the operator in trouble-free, error-proof recording and playback of the highest quality tapes.

Record and play functions are separated to minimize the chance of accidentally erasing irreplaceable material. Controls and indicators for the record mode are grouped

on one side of the tape deck, while those for the play mode are grouped on the other side. Tape threading is simple and is facilitated by cone shaped guide posts. Twelve- or 14-inch tape reels are easily loaded, on and slip off with ease—they do not interfere with any controls, covers or access panels. A tape timer featuring a clutch mechanism is built into the HL.

Fully Instrumented

Generous monitoring and metering facilities and a full complement of indicator lights signal assurance of good performance, warn operators of potential trouble or faulty operation, and help technicians quickly pin-point and correct malfunctions should they occur. Lights just above the tape transport on the left side flash red warning lights. White lights on the right side provide a continuous indication of mode, such as the servo or FM deviation standard being used. This awareness by flicking the eyes across a row of lights is much faster and more foolproof. Indicators are of the type that need not be checked daily for lamp burnout.



ERROR-PROOF CONTROLS



EASY LOAD TAPE DECK

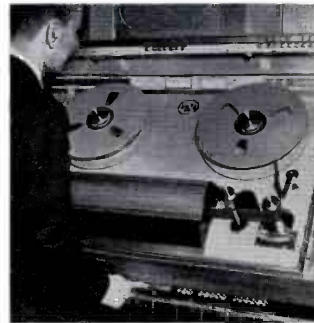

FULL INSTRUMENTATION



FAST UNCOMPLICATED THREADING

Unmatched Human Engineering Advances

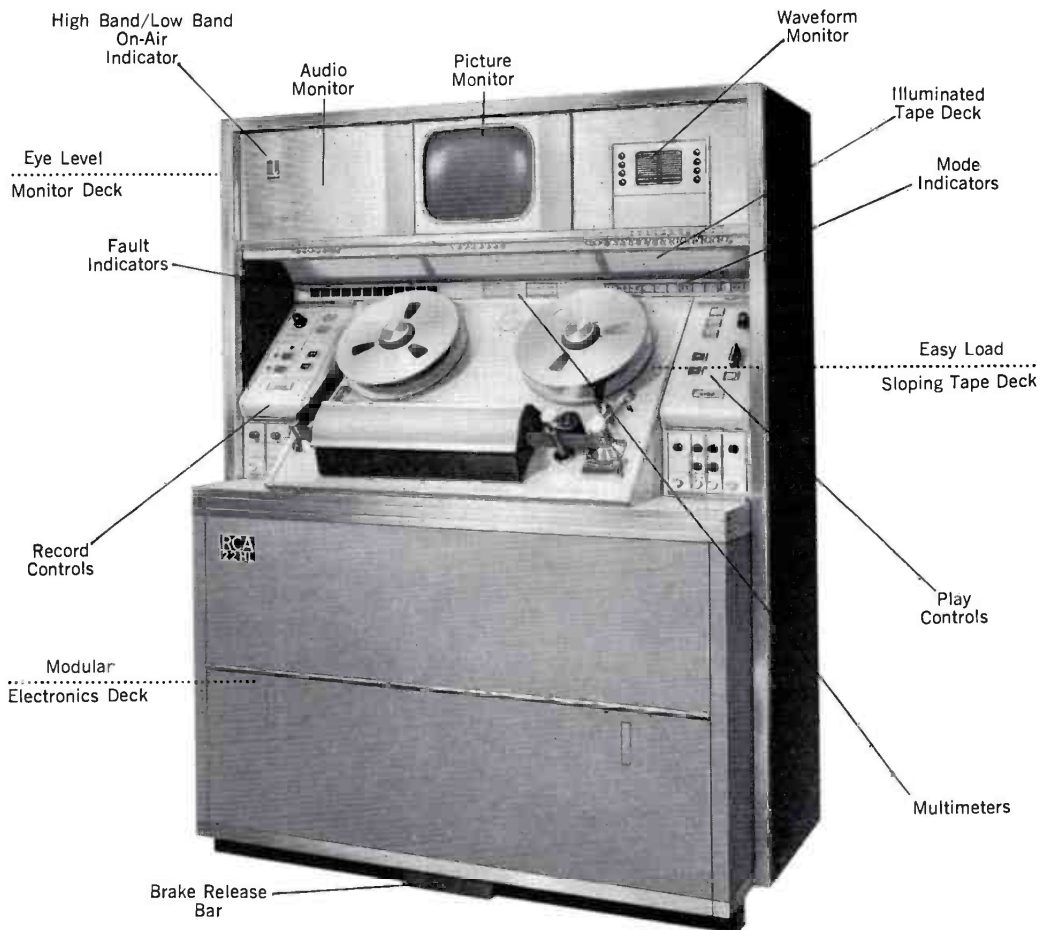

Performance that Exceeds Any TV Tape Recorder Built or Announced—To Date

Solid State Reliability

Completely transistorized, the 22HL features the proven reliability of solid state circuits and their tremendous savings in power consumption, weight and size.

Transistor performance today is superior to vacuum tubes. The lower voltage circuitry of transistors, their faster warmup, longer service life and dependability greatly reduce and simplify maintenance.

Operation-Tested Features

Time tested features of RCA TV tape recorders are standard in the 22HL. These include electronic quadrature adjustment, continuously variable winding speed, separate guide position control for record and play, air lubricated tape guides, brake release switch, magnetic tone wheel, selective erase head, simultaneous monitoring of servo control track, spot audio erase, simultaneous audio playback and complete cue facilities.

Electronic Accessories

While most of the extra features of the HL are built-in, certain "key" circuits have been left as accessories for customer convenience:

Electronic Splicing

Splicing and editing of TV tape, electronically, is achieved in the 22HL simply by inserting plug-in modules into pre-wired receptacles. With this feature, program segments in color or monochrome can, at will, be added to or inserted in recorded segments. A "selective erase" feature permits erasure of existing video without disturbing the original recorded control track or audio track. Operation is at tape speeds of $7\frac{1}{2}$ or 15 ips. The plug-in splicer modules afford easy access to all components. When any module is removed, a by-pass circuit automatically returns the recorder to normal operation. Other features of the splicer include switchable standards and pushbutton electronic setup procedure.

Dropout Compensator

The 22HL is also pre-wired for insertion of a plug-in Dropout Compensator module. The purpose of this accessory is to eliminate video dropouts caused by tape imperfections. This saves screening of tapes and prolongs the usefulness of old tapes. For color or monochrome, the device

employs the delay line principle which inserts previous line video.

Plug-In Color

The 22HL is equipped with monochrome ATC circuits which provide the high degree of timing stability desirable in monochrome operations. Insertion of the plug-in color ATC modules converts the 22HL for color without further modification. Color playbacks then become an automatic operation, with the color ATC circuits offering precise stabilization and the highest order of color performance.

Compatibility in New Design

Design innovations are built into new RCA equipment models as soon as proven practical in order to benefit the user at the earliest possible time. Most of these design modifications (that might be desired by present owners of RCA TV tape recorders—now numbering more than 350) are made available in the form of "stand-

ard" accessory modules that can be plugged in to provide the new features. The new HL, for example, incorporates facilities that were previously available only as plug-in module accessories. This approach of updating predecessor recorders, and thus minimizing obsolescence, is in contrast to others where design changes are made infrequently but extensively, resulting in complete obsolescence of equipment.

The result is that many of the features now advertised by others as completely new to industry have been, in fact, in use in RCA machines for some time.

The extent of design compatibility between the various RCA TV tape recorder models is illustrated by the table which shows how the newly developed features can be applied to existing equipments. It also shows how many features are built into the innovation 22HL as standard equipment, requiring no further accessories or modifications.

CHECK THESE HIGH BAND PERFORMANCE SPECIFICATIONS

Parameter	Domestic	International
Signal-to-Noise	46 db	43 db
Moire	2%	3%
Differential Gain	5%	5%
Differential Phase (IEEE Test Signal off tape)	5 degrees	5 degrees
"K" Factor (using 2T sine ² pulse)	2%	2%
Video Bandwidth	4.2 mc \pm 1.5 db	5.5 mc \pm 1.5 db

COMPARE FEATURES OF RCA TRANSISTORIZED TV TAPE RECORDERS

Equipment Feature	22HL	TR-22	TR-3	TR-4	TR-5
High Band	A	C	C	C	C
Monochrome ATC	A	B*	C	C	—
Color ATC (Requires Mono ATC, Pixlock)	B	B	C	C	—
Pixlock	A	A	B	B	—
Electronic Splicing	B	C	—	C	—
Dropout Compensator	B	C	C	C	—
Switchable TV Standards	A	A	A	A	A
Air Bearing Headwheel	A	A	C	C	C
Pulse Cross Monitor	A	—	—	A	—

Key: A—Built-In
B—Prewired for plug-in modules.
C—Modification Accessory
* For C Model only.

**NEW HEIGHTS OF POWER
ON KIRO-TV...**

**DELIVERS
A CLEARER
STRONGER
PICTURE!**

**REACHING MORE HOMES... BETTER
WITH TOP-RATED CBS PROGRAMMING!**

This newest technical improvement is another step in the planned progress of a great STATION-ON-THE-GO in the growing Puget Sound Market. Tested and proved by some sixty of the nation's leading stations, the traveling wave antenna delivers a clearer, cleaner and higher-powered signal.

Your PGW "Colonel" will give you the full story on the many other STATION-ON-THE-GO plans and accomplishments of the new KIRO-TV... the station to buy because it's the station-to-watch in the nation's SIXTEENTH market!

KIRO TV 7
CBS FOR THE GREAT NORTHWEST

KSL-AM/FM/TV KID-AM/FM/TV KBDI-AM/FM/TV

Affiliated with WAFB RADIO NEW YORK WORLDWIDE

just in time for the new Fall Season
**WAPI-TV IS NOW
ON THE AIR WITH
A NEW TRAVELING
WAVE ANTENNA!!**

INCREASING PICTURE POWER IN EVERY DIRECTION
Especially designed WAPI-TV's new Traveling Wave Antenna. Especially designed circularity of signal pattern increasing picture power in every direction. This means much greater signal strength in the major metro areas of Anniston, Gadsden, and Tuscaloosa with a total of 71,800 TV homes.

SUPERIOR METRO COVERAGE
A special feature of the Traveling Wave Antenna is null free vertical radiation patterns for superior close-in reception.

WAPI-TV BIRMINGHAM
Represented nationally by Arlington, Sigler, and Patten, Inc.

They switched... and are they glad!

KIRO and WAPI are two of a growing number of TV stations that have switched from another type of antenna to the RCA "Traveling Wave" Antenna. Both of these stations are so pleased with the improvement that they have taken ads (above) to tell about it.

Naturally, we are pleased, too—but we are not surprised. Some sixty stations have

installed RCA "Traveling Wave" Antennas in the past few years.

The "Traveling Wave" Antenna, like other RCA broadcast equipments—cameras, tape recorders, transmitters—is for those who want the best. Your RCA sales representative will be pleased to tell you about it in detail. RCA Broadcast and TV Equipment, Building 15-5, Camden, N.J.



THE MOST TRUSTED NAME IN TELEVISION

RCA SERVICE

keeps all your
AM, FM, TV
equipment
in top
condition!

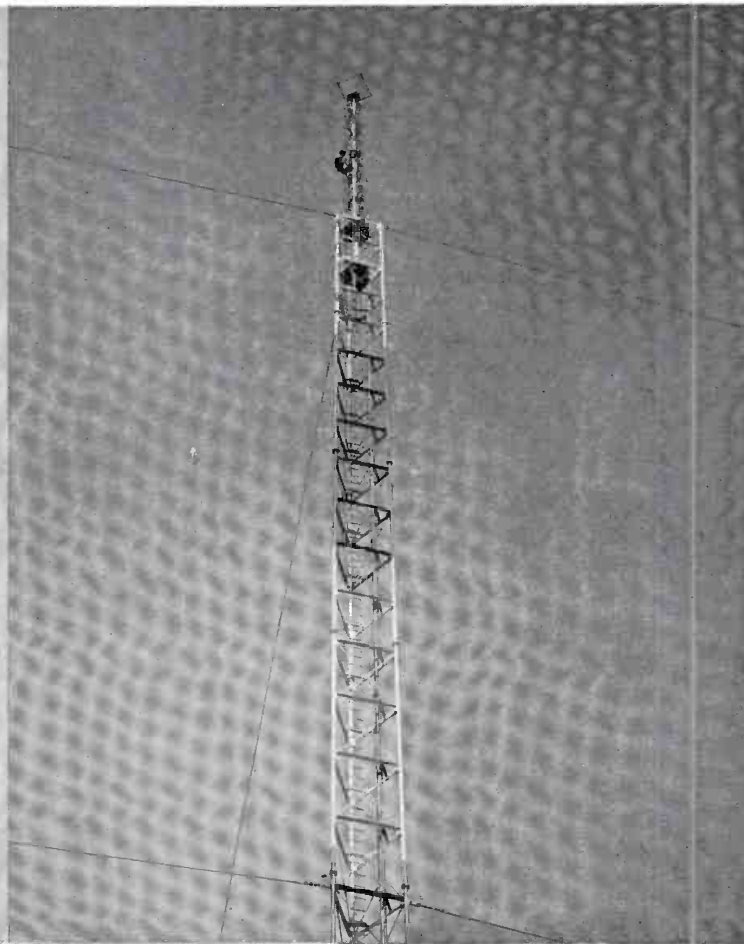

Antenna System Measurements

TAKE ADVANTAGE OF THE FOLLOWING SERVICES OFFERED BY RCA:

- Video Tape Recorder Service • TV Camera Overhaul • TV Transmitter Overhaul
- Installation Supervision • Microphone and Pick-Up Repairs • Transmitter Performance Measurements • Antenna Inspection Measurements • Console Repairs • Microwave Service
- TV Projector Service • Custom Fabrication • Teletypewriter Maintenance

Your audience demands a superior signal which requires top performance from all your station equipment. RCA Broadcast Service is planned to assure you of meeting this objective. More than 30 years in the broadcast industry have provided a background of solid service experience. This is the type of protection broadcasters have relied on for years, the kind of protection you can count on . . . contract or per-call . . .

from the experts in the service business, RCA Service Company. To guard performance of all your equipment . . . simply telephone one of the following field offices: Atlanta (phone 355-6110), Chicago (WE 9-6117), Phila. (HO 7-3300), Hollywood (OL 4-0380). Or contact Technical Products Service, RCA Service Company, A Division of Radio Corporation of America, Bldg. 203-1, Camden, N.J. 08101.



The Most Trusted Name in Electronics



TV Film Projector

A deluxe model
with every feature
your program people
could ask for

This new equipment does what you would expect from the world's most advanced television film projector. It has deluxe features, like instant start, reversible operation and automatic cue. These assure the finest quality and versatility. Completely transistorized and automated, the TP-66 is specially designed for TV film programming's faster pace.

INSTANTANEOUS START—Start and show buttons can be pushed at the same time, since projector sound is stabilized within 0.3 second. A pre-roll period, prior to switching projector "on air," is not necessary. Start is instantaneous, allowing preview of upcoming film when desired.

STILL-FRAME PROJECTION—Single frames can be shown at full light level for extended periods, permitting preview of first frame at start, or for special effects. Film is always completely protected by a filter that automatically moves into light path during still-frame use.

FILM REVERSING—Film motion can be reversed—a time-saving feature when rehearsing live or tape shows with film inserts . . . or as an imaginative production device.

AUTOMATIC CUEING—For full or partial automation, films can be stopped and cued up automatically. This eliminates the need for manually threading and cueing individual films, eliminating human error.

AUTOMATIC LAMP CHANGE—Both projection and exciter lamps are automatically switched in place, when burnout occurs. These time-saving features assure continuous operation and avoid costly delays.

AUTOMATIC LOOP RESTORER—Unique fail-proof feature eliminates need for human intervention, makes unattended operation practical.

TRANSISTORIZED SOUND—The TP-66 can be equipped for both magnetic and optical sound systems. Fully transistorized for finest quality and reliability.

NOW BEING DELIVERED

For full particulars, write RCA Broadcast and Television Equipment, Building 15-5, Camden, N.J. Or see your RCA Broadcast Representative.



New 16mm Television Film Projector, Type TP-66



The Most Trusted Name
in Television



TV Tape Player



...relieves busy recorder schedules at low cost for on-air playback or in-house screenings and promotions

Why tie up expensive recording equipment for playback? The TR-3 will free recorders for auditions, rehearsals, and tape productions—reducing overtime and crowded schedules. It's an economical way of adding to your present tape facilities.

Anybody can "play" the easy-operating TR-3. Makes a fine companion for film projector in clients' rooms. Use it for screening, checking and special presentations of TV tapes for advertisers and agencies. It's an ideal sales promotion tool.

The TR-3 plays all standard tapes, performs to

broadcast standards, and is compatible with all quadruplex recorders. It has the same transistorized modular design as RCA's deluxe machine and delivers the same high quality pictures.

Only 66 inches high and occupying barely two square feet of floor space, the Player is mounted on casters for use in a fixed location or a mobile unit. Modern styling and two-tone blue finish make the unit as attractive as it is useful. And even the most deluxe operating features are available as plug-in accessories, such as pixlock, automatic picture control, color, and remote operation.

Want to double the efficiency of your recorders? Call your RCA Broadcast Representative. Or write RCA, Broadcast and Television Equipment, Building 15-5, Camden, N.J.



The Most Trusted Name in Television