

BROADCAST

NEWS



VOL. No. 103 MARCH 1959



Tape Footage Indicator

Simultaneous Playback Audio Head

Built-in Waveform Monitor



Magnetic Tone Wheel



Variable Speed Cuing Control



Master Erase Head

Built-In Picture Monitor

How to end miscues and
other costly errors

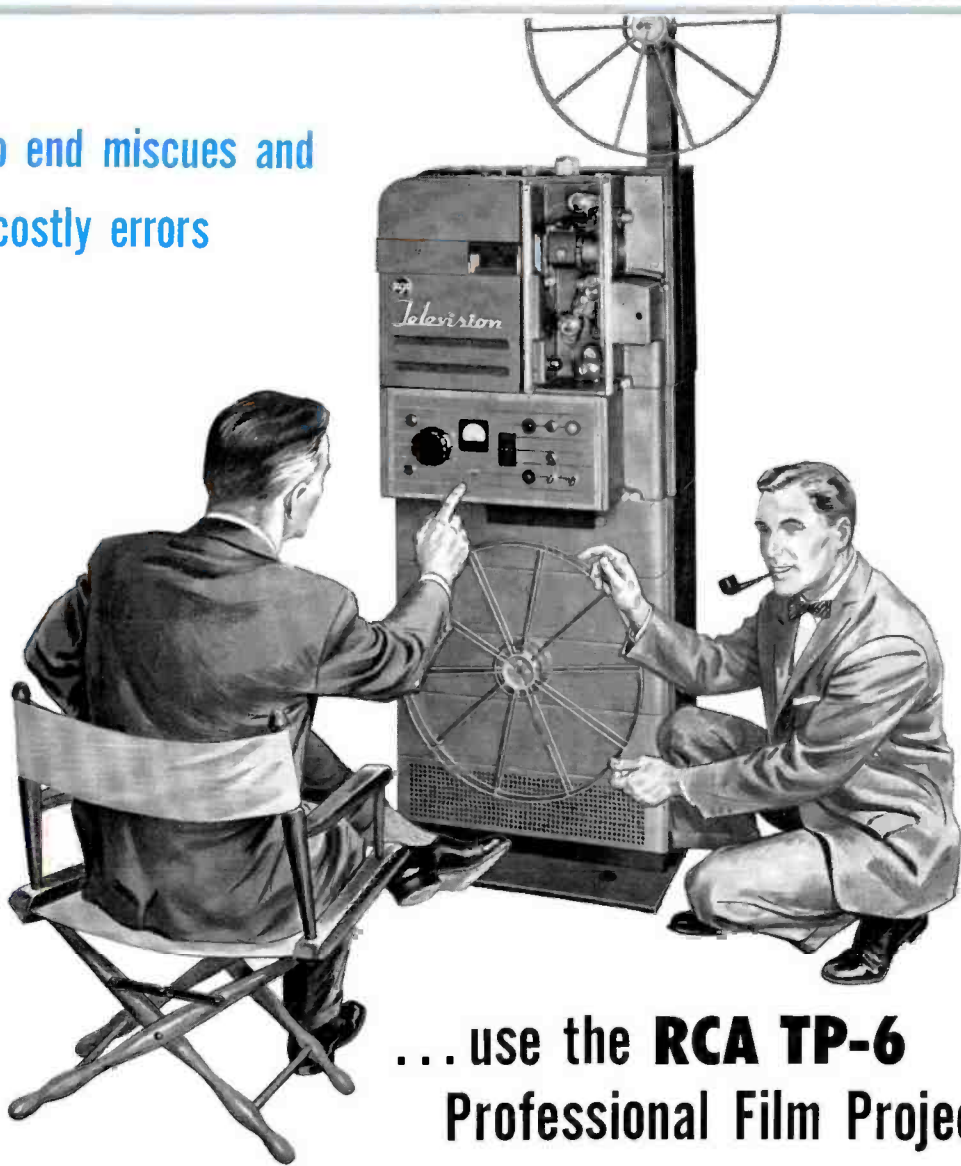

... use the **RCA TP-6** Professional Film Projector!

Now, in addition to the regular quality points that have made the TP-6 famous, *three new features* are offered. They include Automatic Cue, Rapid Start, Magnetic Stripe Playback!

AUTOMATIC CUE

Now you can stop projectors at any predetermined film frame so that your next film sequence is cued and ready for show immediately.

RAPID START

Rapid start feature provides sound stabilization in less than one second. You can activate projector start and video switch buttons almost simultaneously, thus eliminating roll cues and reducing the chance for errors.

MAGNETIC STRIPE PLAYBACK

Superior reproduction of sound from 16mm. films is made possible by adding a magnetic sound system. Speed preparation of *news films* by reducing process time required between coverage and actual airing. Make your own film *programs* and *commercials*, and apply commentary, music and sound effects this easy way!

You can do all this and gain the business protection and efficient operation that comes from the TP-6's well-known built-in features... including automatic projector lamp change, gentle film handling, quick-change exciter lamp, superior picture and sound quality.

SPECIAL
for TP-6 owners

Accessory attachments to provide
new features are now available.

*Your RCA Broadcast
Representative has the
whole story. Or write
for literature.*



Tmk(s) ®

RADIO CORPORATION of AMERICA

BROADCAST AND TELEVISION EQUIPMENT
CAMDEN, NEW JERSEY

Vol. No. 103 | March, 1959

BROADCAST NEWS

published by

RADIO CORPORATION OF AMERICA
BROADCAST & TELEVISION EQUIPMENT DIVISION
CAMDEN, NEW JERSEY

issued quarterly

PRICE *in U.S.A. - - - - \$4.00 for 4 issues*
outside U.S.A. - - - \$5.00 for 4 issues

CONTENTS

	Page
NEW 11-KW VHF TELEVISION TRANSMITTER	4
TRAVELING WAVE ANTENNA PROVES ITSELF IN SERVICE	8
RCA AUTOMATION EQUIPMENT FOR TV STATIONS	14
TRANSISTORIZED SWITCHING SYSTEMS	20
NEW 5000-WATT AM TRANSMITTER	30
NEW 5-KW FM TRANSMITTER	36
TWO NEW AUTOMATIC TURNTABLES	40
INTRODUCTION TO JUNCTION TRANSISTORS, PART II	44
PRODUCTION MODEL TV TAPE RECORDER	52

Copyright 1959, Radio Corporation of America, Broadcast & Television Equipment Division, Camden, N. J.

PRINTED
IN
U.S.A.

"The RCA Television Tape Recorder Meets Fondest Dreams

"Monochrome and color pictures recorded and produced by the RCA color television tape recorder are



Tom Howard (kneeling) listens while Frank Bateman, Technical Operation's Manager (right) points out the cue-track recording head to other WBTV executives (left to right) Charles H. Crutchfield, Executive Vice-President, Jefferson Standard Broadcasting Company, and Kenneth Tredwell, Vice-President and Managing Director, WBTV.

WBTV, Charlotte, North Carolina—first television station to record and air a locally produced color television tape recording, has been using RCA Color Television Tape Equipment since September 5, 1958. Their experience has led Tom Howard to report: "It is evident that RCA's design engineers did not limit their efforts to just getting video and audio signals on tape—they remembered that their customers had to maintain and operate the gear day-in and day-out.

MASTER ERASE HEAD A TIME-SAVER

"We like the master erase head. It eliminates the necessity for bulk erasing, assures a clean tape at

all times and in many cases allows for selective erasing and re-recording of spots or other program material without destroying the entire contents of the reel. It is a time saver. For instance, if there has been a false start or a fluff in a spot or in the early part of a recording, it is only necessary to back up the tape and start again. There is no need to remove the reel, bulk erase, replace the reel and start all over again.

BUILT-IN FACILITIES COMMENDED

"We commend the decision of the RCA design engineers that necessary operational equipment should be built-in instead of being made available as 'accessories.' We appreciate their facing the facts of operational life by incorporating the master erase head, the built-in audio monitoring speaker for cuing and continuity, the built-in picture monitor, the built-in CRO, the built-in switcher for picture monitor and CRO input signal selection, the elapsed time meter for slip rings and brushes, the metering of individual



See your RCA
Broadcast Representative for latest
information about the RCA Color
Television Tape Recorder.

of WBTV Engineers in Daily Operating Conveniences!"

—Says Thomas E. Howard, V.P. Engineering and General Services, WBTV. superb, and we are impressed by the convenience and versatility designed into the equipment."

"WE LIKE the master erase head.

"WE LIKE the built-in facilities.

"MOST OF ALL, WE LOVE that cue track. In our opinion, it is destined to be a must in every tape operation."

**TOM HOWARD
WBTV**

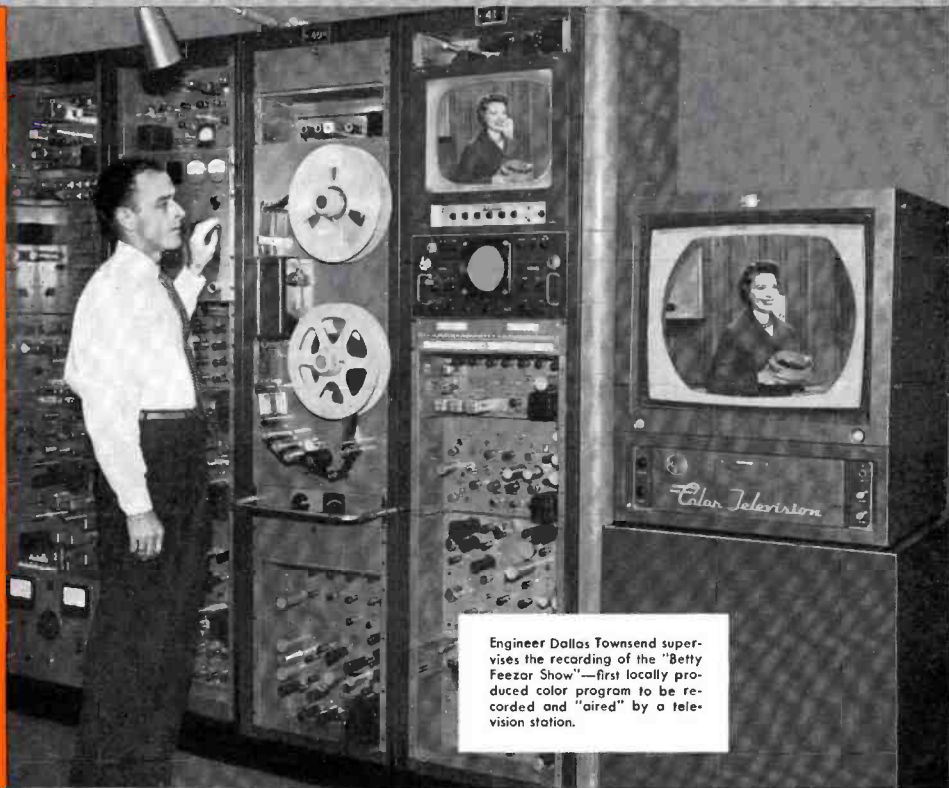

Engineer Dallas Townsend supervises the recording of the "Betty Feezor Show"—first locally produced color program to be recorded and "aired" by a television station.

video head recording currents, the continuously adjustable tape wind and rewind speeds for rapid and accurate cuing of tape, and the built-in test signal channel for rapid check and trimming of color processing equipment, even while a color signal is being recorded.

CUE TRACK A "MUST"

"Most of all we love that cue track—in our opinion it is destined to be a 'must' in every tape operation. The value of the cue track seems to be limited only by the imagination and ingenuity of the user.

"We use the cue track to bridge the program director's channel during record operation. This

channel becomes our cue reference. This big feature has enabled us to salvage some 'fluffed' spots in programs or to insert new spots—live or on film—in a program that has already been recorded.

AVENUE TO AUTOMATION

"RCA's pioneering in incorporating the cue track in television tape recorders is a valuable contribution to smoother tape operation and definitely opens another avenue to automation."

Your RCA Broadcast Representative will gladly provide further particulars about the RCA Color Television Tape Recorder and help to integrate this equipment into your facilities. In Canada, write to RCA VICTOR Company, Limited, Montreal.



RADIO CORPORATION of AMERICA

BROADCAST AND TELEVISION EQUIPMENT

CAMDEN, N. J.

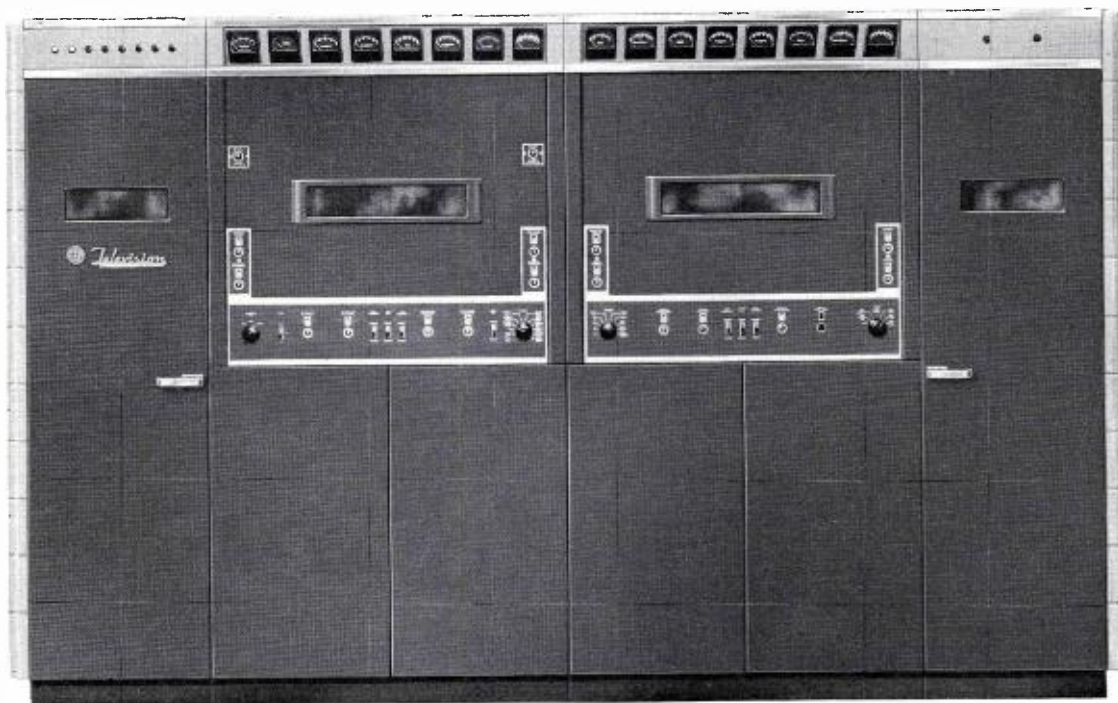

FIG. 1. Front view of the TT-11AH Television Transmitter. Note convenient arrangement of operating controls and easy-to-read, sloping meter panels. The modified TT-2BH Driver is on the left, while the two cubicles on the right house the 11-kw aural and visual amplifiers.

NEW 11-KW VHF TELEVISION TRANSMITTER, TYPE TT-11AH

Ideal Medium-Power High-Band Transmitter, or Driver for Higher Power

by H. E. SMALL
Broadcast and Television Engineering

A new medium-power high-band transmitter has been added to the established line of economical, space-saving VHF television transmitters. In combination with an RCA high-gain antenna, the TT-11AH presents an unusually low-cost package for obtaining effective radiated powers up to 180,000 watts on channels 7 to 13.

The TT-11AH Transmitter utilizes the rf portion of the TT-2BH¹ as a driver for a Class C aural amplifier and a visual linear amplifier. The rated power output is 6-kw aural and 11-kw peak visual. The popular

¹ "New 2-KW VHF Television Transmitter, Type TT-2BH." *Broadcast News*, Vol. No. 100, April, 1958.

Type 6166 Tube is used in both the aural and the visual amplifiers. The power supplies for the driver have been combined with those for the power amplifiers, thus only two supplies furnish all the voltages other than for the modulator, exciter and fixed bias. The TT-11AH can also be used as a driver for the Type TT-25BH, 25-kw amplifier to obtain higher power.

Distinctive Features

The TT-11AH has the following outstanding features:

1. Walk-in cabinet design, first introduced with the TT-2BL and the TT-6AL Transmitters, has been incorporated in the design of the TT-11AH.
2. All tuning adjustments can be made from the front of the transmitter with power applied. Power amplifier cavity design has been greatly simplified. All

components are easily accessible and no change of frequency-determining components is required to tune to any high-band VHF channel.

3. The same tube types are used in both the aural and the visual rf chains, permitting the use of identical components, and this means that fewer spare tubes and components need be stocked.
4. All important currents and voltages are metered by means of a row of large illuminated meters, mounted on a sloping-front panel for ease of reading.
5. All circuits are equipped with overload protection. In case of an overload, the circuit at fault can be readily located with the aid of indicating lights in the control unit.
6. Built-in linearity correction, accurate intercarrier frequency control and dc on the power amplifier filaments are fea-

FIG. 2. This is a typical floor plan arrangement for the TT-11AH Transmitter. The rectifier enclosure is placed immediately behind the front line of cabinets; however, it may be placed in other convenient locations to meet specific building requirements.

- tures included for better color performance.
- 7. Thermostatically controlled heating and cooling of all mercury vapor rectifier tubes allows operation over a wider ambient temperature range.
- 8. One main blower is used for cooling all tubes and components other than the mercury-vapor rectifier tubes. This blower is contained in a sound-insulated enclosure for quieter operation.
- 9. Provisions for remote control have been incorporated in the transmitter.

Compactness and Accessibility

The compactness of the TT-11AH Transmitter is indicated in the typical floor plan shown in Fig. 2. A savings in floor area to 40 percent over previous 10-kw transmitter installations may be realized. This is made possible by the use of common power supplies, the new-style walk-in cabinetry and the use of uncased power-supply transformers. Cases are not required on the transformers since they are located inside an enclosure with an interlocked door.

It might be expected to find that accessibility has been sacrificed to obtain such a savings in floor area; however, accessibility has been greatly improved over many previous transmitter designs. A wide aisle is provided inside the enclosure between the front-line racks and the power-supply components to the rear. All components are readily accessible from this aisle. Furthermore, the modulator and exciter chassis can be tilted out from the front of the transmitter for ease of servicing (see Fig. 3).

The rectifier enclosure can be separated from the front-line cabinets and placed in an adjoining room or in a basement, if desired. This feature makes the TT-11AH Transmitter readily adaptable to existing buildings where there is no single room large enough to accommodate a complete transmitter of this power level. In such a case, all meters, operating controls, and tubes, except rectifier tubes are located in the operating room.

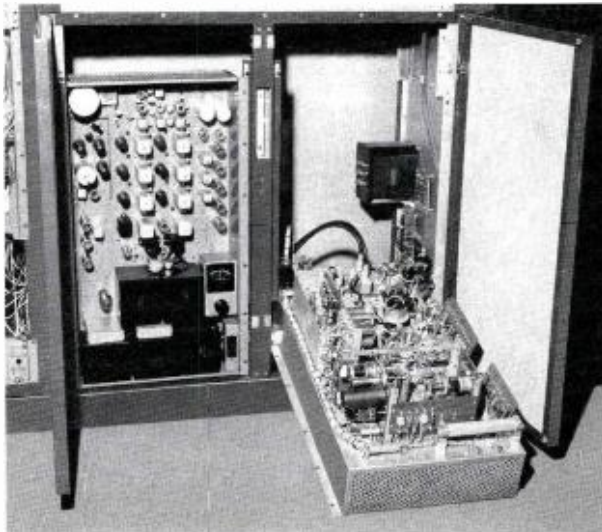
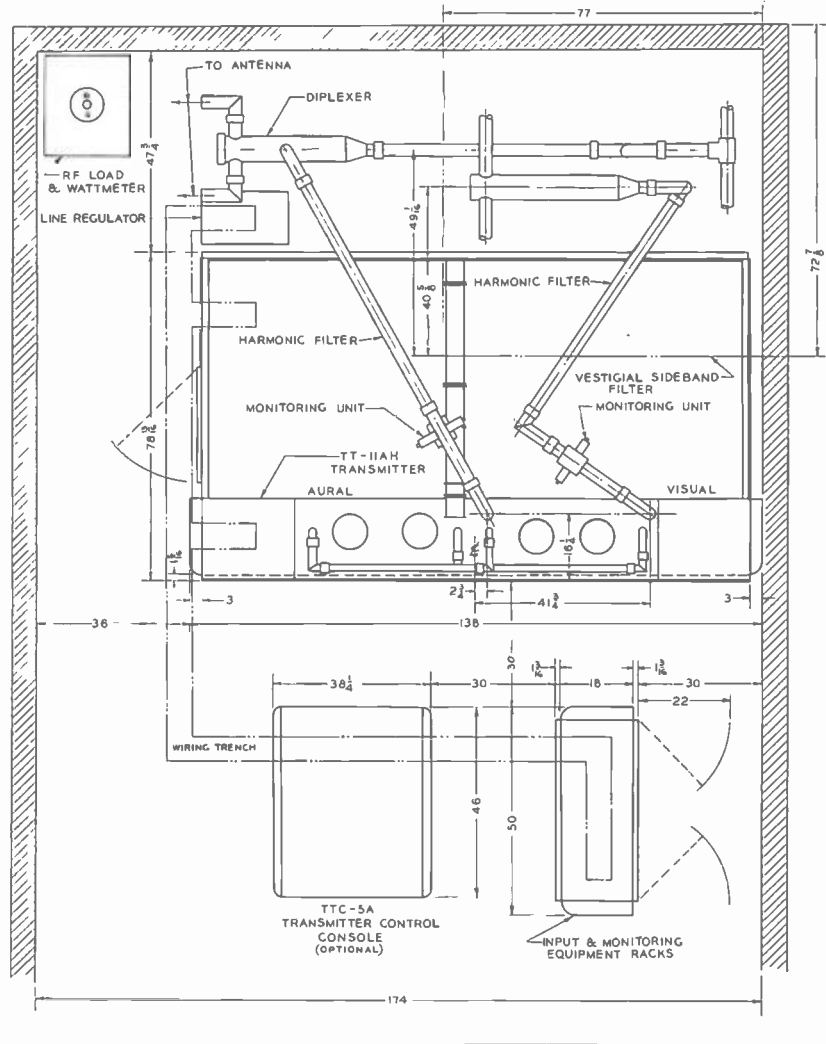

FIG. 3. The modulator unit is shown tilted forward for ease of servicing (right), and the exciter unit is shown in its normal position (left).

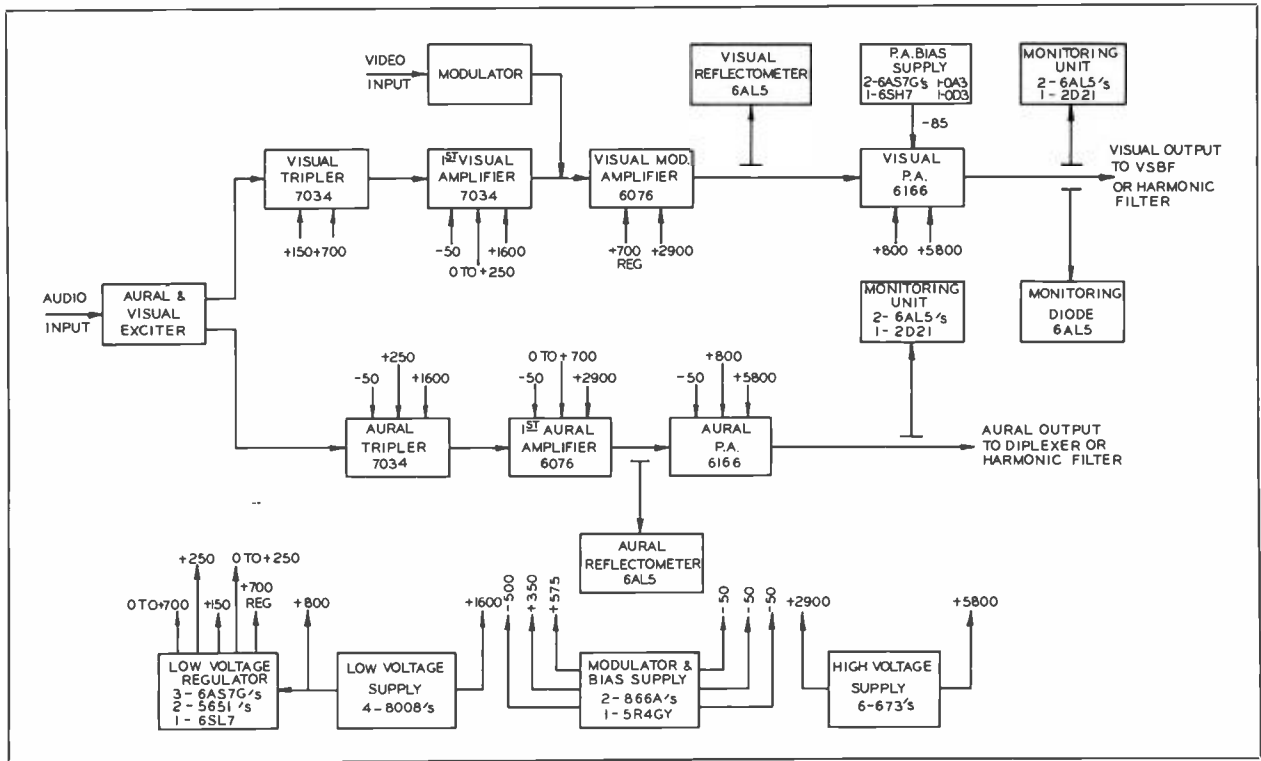

FIG. 4. The block diagram of the TT-11AH Television Transmitter illustrates the simplified circuitry that has helped reduce the over-all size of this transmitter.

Personnel Protective Circuits

Provisions are made in the design of the TT-11AH Transmitter for protection of operating personnel as well as for protection for tubes and components against overloads. The only access to the transmitter enclosure is through an interlocked

door. When the door is opened, power is removed from all power supplies within the enclosure, and the associated filter capacitors are automatically shorted out. Then, as added protection against the possibility of the plate contactor freezing closed, a knife switch must be opened before the

enclosure can be entered. The knife switch, operated by a long bar which extends across the doorway, opens the primary circuit of the high-voltage plate transformer.

Circuit Protection

Fast overload protection has been provided for all power supplies and for each rf stage following the exciter. When an overload occurs, even if it is only momentary and the transmitter resets itself, or if the transmitter is reset manually, a light remains on in the control unit indicating which circuit was at fault. A separate push button is provided for extinguishing the indicating lights which are located behind the window of the control unit door.

Proved RF Circuits

The tube line-up of the TT-11AH Transmitter is indicated in the block diagram shown in Fig. 4. The TT-2BH, with reduced voltages on the rf stages, is used as a driver for the type 6166 output stages. Since the driving power required is only approximately 600 watts aural and 1-kw peak visual, the TT-2BH voltages were



FIG. 5. This is the R-F Driver unit. The visual driver is shown on the left and the aural on the right. With panels open note ease of accessibility.

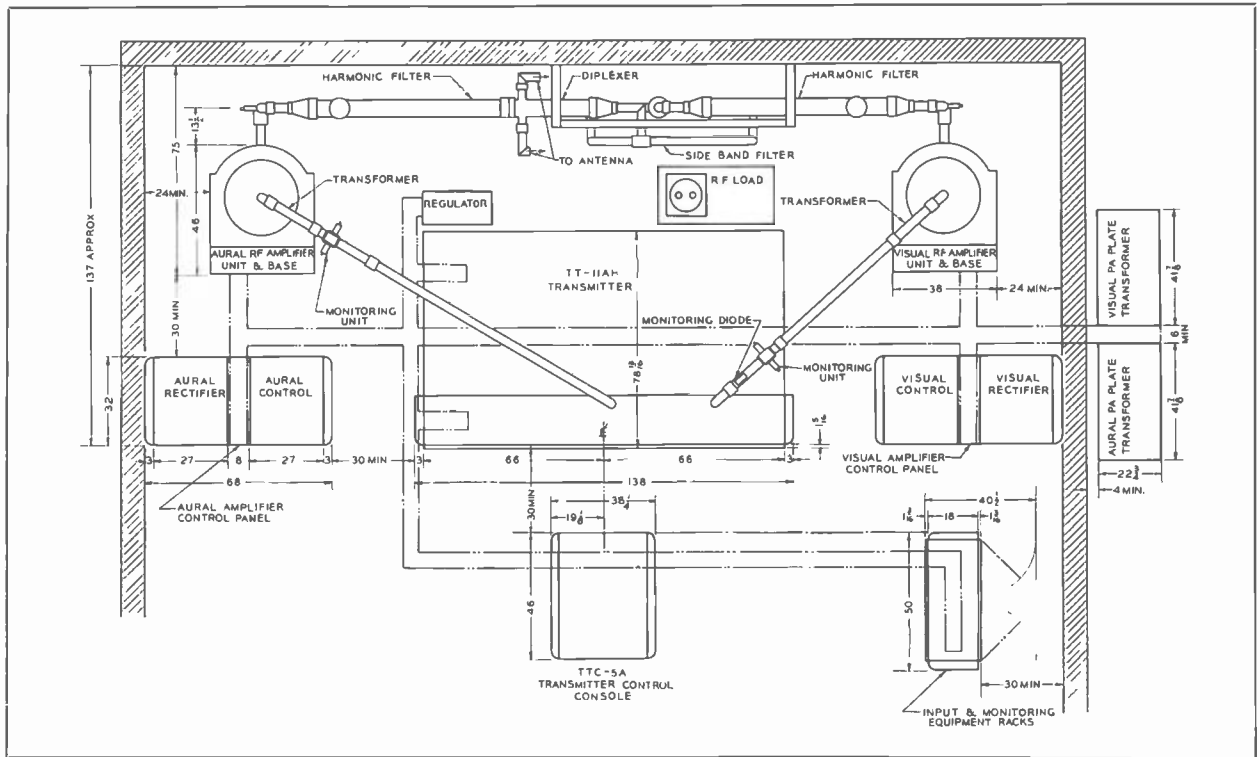

FIG. 6. The 11-kw. high-band, TT-11AH Transmitter makes an ideal driver for the 25-kw amplifier. Here the typical floor plan for a TT-25CH Transmitter shows how the TT-11AH and the 25-kw amplifiers may be arranged.

reduced to permit combining of its power supplies with those of the power amplifiers.

The aural and visual power amplifier stages each utilize a Type 6166 Tube operating grounded-grid and grounded-screen. This type of operation with the 6166 tube not only gives high stability and long tube life, as has been proven in the TT-50AH Transmitter, but also permits simplification of the circuit design since the screen and control grids can be bypassed directly to a common ground plane. The input and output circuits can then be constructed on opposite sides of the ground plane. By using rectangular cavities so that one side can be removed, all parts of the cavity are made readily accessible (see Fig. 5).

No Neutralization

The power amplifiers are effectively neutralized over the entire band and require no neutralizing adjustment. The simplified circuitry makes the amplifiers very easy to tune to any high-band channel, and the quality of either color or monochrome picture reproduction is excellent. The picture quality is further enhanced by the use of dc on the power amplifier filaments to

reduce the AM hum to a level where it is not noticeable in a color picture.

Remote-Control Facilities

The features of the TT-11AH which have been discussed to this point indicate that it is well suited for remote-control operation. The thermostatically controlled heating and cooling of the mercury vapor rectifier tubes allows the temperature of the transmitter room to vary over a wide range, thus a considerable saving in heating bills can be realized.

Provisions have been made for remote metering and control of all necessary functions for operation of the transmitter from a remote point. Also, if desired, these facilities can be utilized for control of the transmitter from a central point in the transmitter room.

Conversion to Higher Power

To increase power, the Type TT-25BH, 25-kw amplifier is added to the TT-11AH, and the 25-kw transmitter thus composed is designated as a Type TT-25CH. A typical floor plan for the TT-25CH Transmitter is shown in Fig. 6. The layout shown is only one of many ways that the various units may be arranged.

The TT-25CH can be obtained as a complete transmitter, or the amplifier equipment can be added to the TT-11AH at a later date, if it is desired to start out with medium power and then convert to higher power. In either case the same dependable 25-kw amplifiers, which have been proved by years of trouble-free service in a large number of TT-25BH installations, are available.

The addition of the TT-11AH to the RCA line of space-saving VHF transmitters² thus extends the high-band power range of this line. The TT-11AH has been designed along the same lines as other TV transmitters now in daily operation, such as the TT-2BL, TT-6AL, and the TT-2BH which is used as the TT-11AH Driver. Powers up to 180 kw ERP can be obtained with the TT-11AH and a high-gain antenna. The TT-25CH in conjunction with a high-gain antenna can produce a maximum ERP of 316 kw. Either way, the many outstanding features of the new TT-11AH Transmitter plus the established RCA dependability are now available to high-band VHF television stations.

² "Latest Developments in VHF Television Transmitters," *Broadcast News*, Vol. No. 91, October, 1956.

TRAVELING WAVE ANTENNA PROVES ITSELF IN SERVICE

*Provides Ease and Economy of Installation;
Combines Uniform Pattern with Excellent
Circularity and Low VSWR*

by GEORGE E. ERWIN, *Broadcast and Television Engineering*

Since April, 1957, when it was introduced the Traveling Wave Antenna^{1, 2} has met all demands made upon it in manufacturing and testing, but most important of all it has fulfilled the promises of this new design in station installations (see Fig. 1). Its exponential distribution of illumination produces a smooth null-less pattern. Low wind-load and simple mechanical construction make it economical to install. Proper bandwidth and low vswr over the channel are assured. These advantages to the television broadcaster result not only from the inherent characteristics of this new design, but also from the attention given to the fabrication and testing.

Designed to User's Requirements

Design selected for the antenna is dependent upon the needs of the customer, that is, the number and size of antenna sections will, in most cases, depend upon the gain requirements and the channel. If an antenna with the same requirements has been built before, the latest design improvements are incorporated into the antenna before it is released for fabrication. If the gain and channel combination has not been built before, the dimensions and spacings of the slots and the sizes of the coupling and compensating capacitors are first determined.

¹ "Traveling Wave Antenna." *Broadcast News*, Vol. No. 94, April, 1957.

² "The Traveling-Wave VHF Television Transmitting Antenna." *IRE Transactions on Broadcast and Television Receivers*, Vol. BTR-3, October, 1957.

FIG. 1. A Traveling Wave Antenna is shown in service atop the WLWA 1000-foot tower in Atlanta, Georgia.

The gains of the high-channel antennas have been standardized to four nominal values: 9, 12, 15 and 18. Requirements for nonstandard design; with different gain, higher than 110-mph wind loading, special mounting or special radiation pattern also can be met, if required.

Standardized Fabrication

Following the design and drafting stage, fabrication is begun on pipe sections, inner conductor, input tee and slot components. These sections are regular steel pipe of normally available sizes except the 20-inch size, which is centrifugally cast. The pipe is cut, if necessary, to the required size, and then mating flanges are welded to the pipe sections. Slots are then cut to very close tolerances with a pantograph-guided cutting torch. All sections are then hot-dip galvanized, inside and out, for weather protection. To prevent corrosion and oxidation stainless steel bolts and iridized aluminum components are used.

Preparation for Testing

After fabrication, the antenna sections are taken to the test site for assembly and fine tuning (unless a similar antenna has been built before). Assembly requires a day or two per section. This involves the insertion of the inner conductors and metal-supporting pins in preparation for preliminary measurements, after which the coupling and compensating capacitors are installed. Slot brackets, tuning plates, and covers are fastened and temporary input and output cones are attached to section ends (see Fig. 2). After assembly, the sections are hoisted onto 25-foot high, wooden

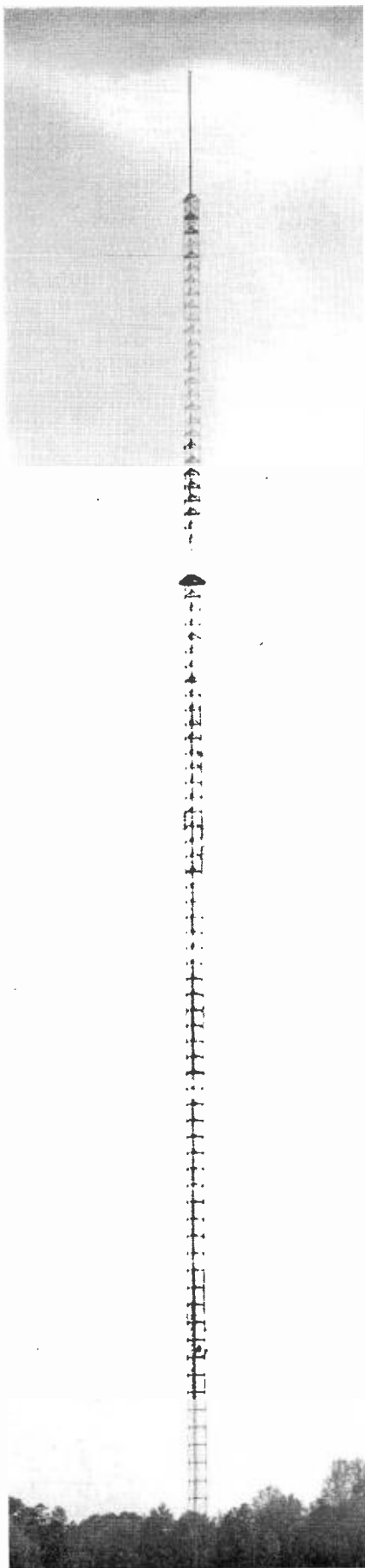

horses to reduce ground reflections while making electrical measurements (see Fig. 3). Metal-supporting pins are replaced with Kel-F, Teflon, or nylon pins for making preliminary measurements and also during development of the top loading.

The Traveling Wave Antenna has exponentially tapered illumination decreasing to a low value toward the top of the antenna. To fully realize these advantages, the antenna would have to be long enough to reduce the current to a very low value, however, by employing top loading, essentially the same service can be provided, but the aperture is 30 percent shorter. Thus the smooth pattern, slightly higher gain, good input vswr, and circularity of the antenna are obtained in addition to the lower cost resulting from the shorter aperture.

Because the top loading forms essentially an independent low-gain, low-power omnidirectional antenna which terminates the main aperture and radiates the remaining power, it is tuned separately from the main aperture.

Main Aperture Tuning

The main aperture is tuned after completion of the top loading. The tuning



FIG. 2. Tuning plates and slot covers are attached before the TW antenna undergoes line tuning. Note the hollow inner conductor which is used to run lightning protector and beacon cables to tower base.

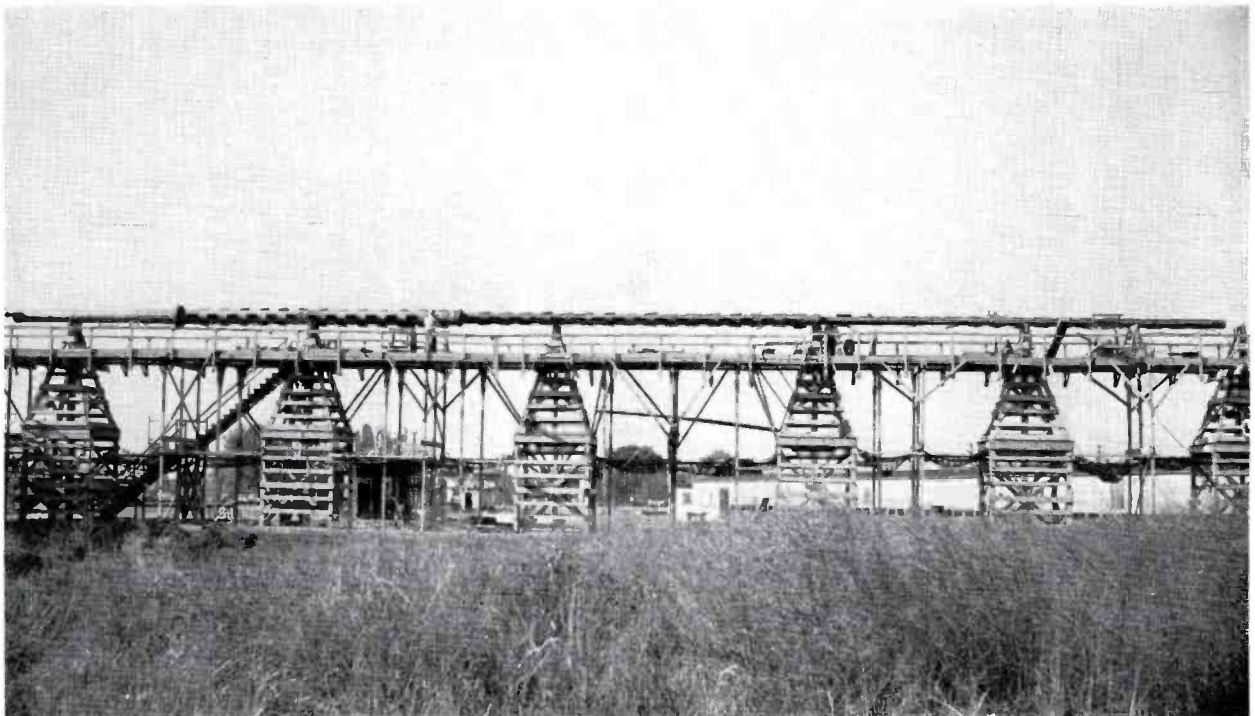

FIG. 3. Top loading, main aperture tuning, and impedance measurements are made on these 25-foot high, wooden horses at the RCA Antenna Test Site. After these tests have been completed the antenna is placed on a wooden turntable for complete pattern testing if required.

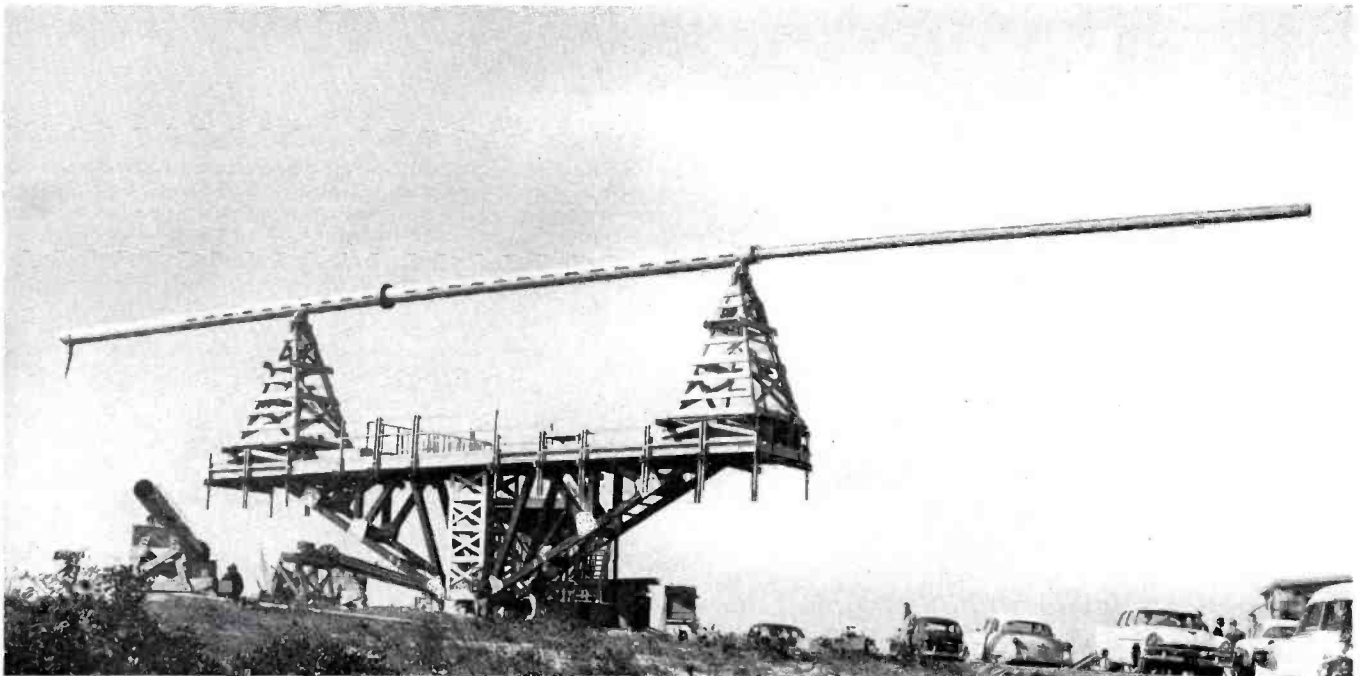

FIG. 4. Here author is shown running attenuation and propagation function tests on a TW antenna.

procedure for each section is the same throughout the main aperture. In the main aperture, each layer consists of a pair of slots, with coupling capacitors to absorb the power from the transmission line to excite the slots, compensating capacitors providing for beam tilt, if desired, and a

fine adjustment of the velocity along the line. Tuning plates at the ends of each slot allow for small frequency adjustments. During the development procedure, the supporting pins are replaced with coupling capacitors and Teflon inserts. At the same time compensating capacitors are installed.

FIG. 5. A TW antenna is pattern-tested on this 15-ton turntable at the test site at Gibbsboro, New Jersey. Representative antenna types are pattern-tested before shipment. If the same antenna has been built before, pattern testing is not usually required.



The coupling and compensating capacitors, as well as tuning plates, are adjusted to obtain correct attenuation and propagation functions along with the operating frequencies for the sections, thus providing proper illumination for antenna (see Fig. 4).

The traveling-wave nature of the feed makes the input vswr inherently low; therefore, the input impedance is checked last. The antenna is provided with a 50-ohm, $3\frac{1}{8}$ -inch diameter, or 75-ohm, $6\frac{1}{8}$ -inch diameter input, dependent upon the specifications. All final measurements are made with slot covers on, to account for any effects they cause on tuning.

Pattern Testing

By the reciprocity theorem a transmitting antenna can be used for a receiving antenna. In the process of measuring the patterns a 60-degree corner reflector is fed with a low-power transmitter at a distance of $2\frac{1}{4}$ miles from the antenna being tested. If the antenna were fixed and the dipole moved around the antenna at a constant radius, a pattern could be plotted; however, the same pattern can be obtained by holding the dipole fixed and rotating the antenna on a turntable. For practical reasons the latter technique is used to obtain vertical patterns. Since the antenna under test is in a horizontal position, the transmitting dipole must be vertical to provide a horizontally polarized signal with respect to final antenna orientation.

Newly designed Traveling Wave Antennas are pattern-tested on a wooden turntable, capable of supporting 15 tons.³ Two supporting horses on the turntable have rollers to permit revolving the antenna about its own axis (see Fig. 5). This provides a very useful method for obtaining vertical patterns in 12 planes (every 30 degrees) by rotating turntable with the antenna in a horizontal position around a 360-degree circuit. The antenna is revolved 30 degrees and the vertical pattern measurement is made every 30 degrees from 0 to 150 degrees with the vertical patterns in the opposite planes being obtained at each measurement. Twelve patterns are obtained in all, to determine the gain of the antenna with adequate accuracy.

The horizontal pattern is obtained by aligning the aperture of the antenna broad-side to the direction of the signal. When this position is achieved the antenna can then be rotated around its own axis and the horizontal pattern measured.

The vertical component of this radiated field can be obtained by turning the dipole in the corner reflector 90 degrees to the horizontal position. The antenna under measurement is now receiving a vertically polarized signal with respect to its final orientation of axis at actual installation.

Shipping Protection

Each section of a Traveling Wave Antenna is prepared for shipment as a unit. All sections, except the input section, have a bolt through their lower end to prevent any shifting of the inner conductor during transit of the antenna. The inner conductor is supported by Teflon inserts in the coupling capacitors of the main aperture sections. The bury or separate input section of the TW antenna has its Kel-F pins replaced by metal pins for shipment. These metal pins keep the inner conductor centered, and take the road jolts that might break Kel-F pins. Two corsets of lumber and wire cloth are fastened to each slotted section before it is lifted onto special steel horses on a flat-bed trailer truck (see Fig. 6). These corsets serve to keep the lifting cables from crushing any of the slot components, and they are needed only on the main aperture sections. Shipping chains are used to secure the sections and steel horses firmly to the trailer bed. The gas stop and ends of each section have plywood discs bolted over them for protection against bumps and entry of foreign matter.

³ "The RCA Test Facilities for TV Antennas," *Broadcast News*, Vol. No. 102, October, 1958.

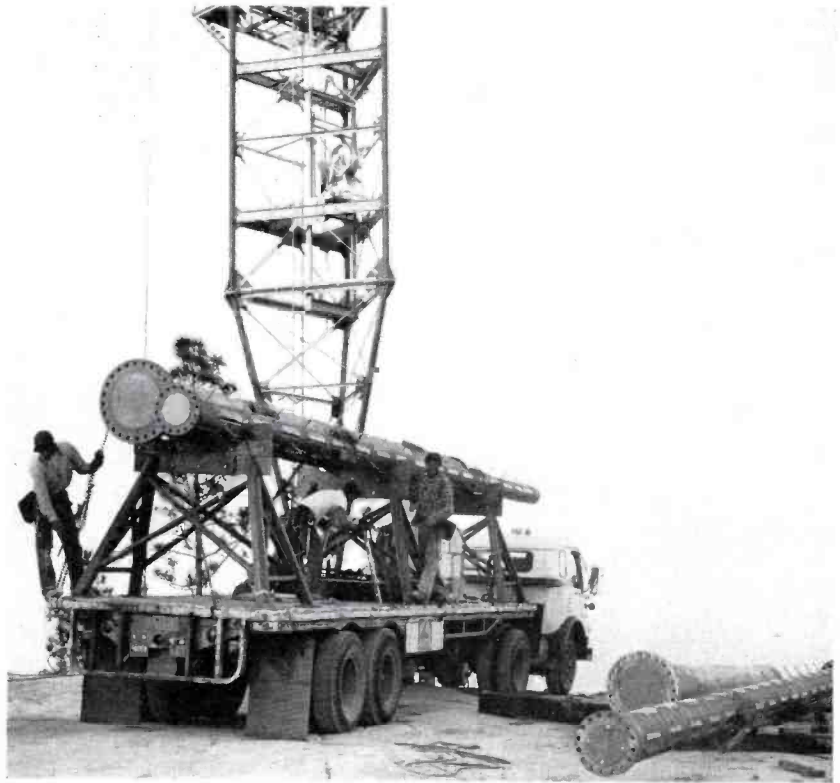

FIG. 6. Special precautions are taken to assure safe shipping for each TW antenna. Note the special shipping cradles and lashing chains used on the flat-bed trailer. This antenna was shipped to station WIS, Columbia, S. C.



FIG. 7. Ease of installation is shown here, as the top section of the WIS TW antenna goes up the side of the tower. Special lifting clamps are supplied for raising the sections to the top of the tower.

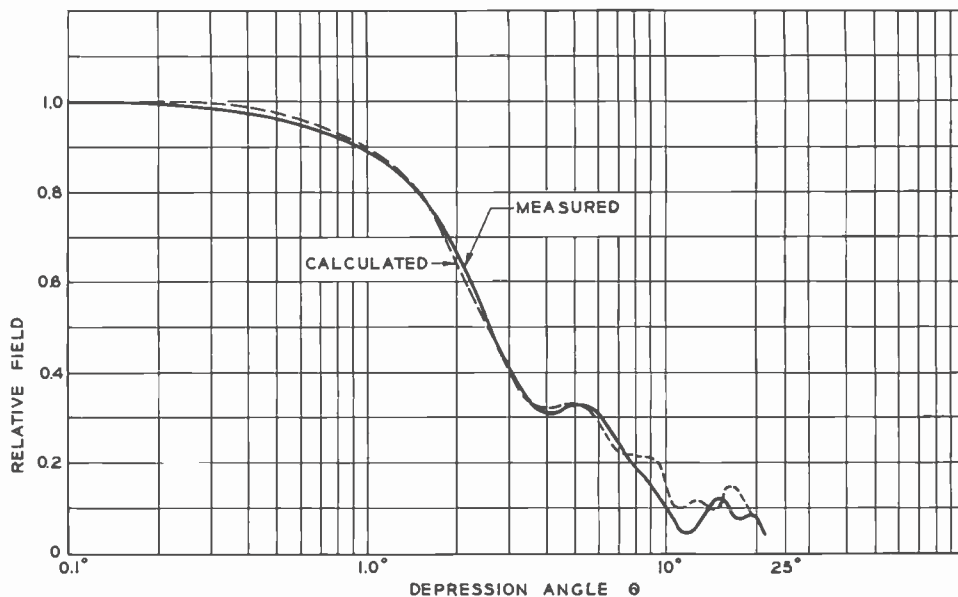

FIG. 8. These measured and calculated vertical field patterns are for WJZ-TV (channel 13) Baltimore, Maryland.

Erection Helps

Lifting clamps are supplied for raising the sections to the top of the tower. The lower, or input section, is raised first. It must be correctly orientated in the tower top to properly align the input with the transmission line, and for proper seating in the pole socket and guide flange. Four tapered pins aid in aligning each of the sections as they are fitted together.

Inner conductors are fastened together with a connector, or bullet, that has been inserted in the upper end of the preceding section's inner conductor. Each of the mating flanges on the antenna has an arrow marked on its edge. These match marks must be in correct alignment before the flanges are joined. The lightning protector and beacon cable are assembled to the top section before lifting. The cable is run down through the entire inner conductor of the antenna as the top section is being lowered into place, completely eliminating external mounting of the cable. If for any reason it is necessary to remove the inner conductor, provision has been made to do so through a special pole socket.

Variety of TW Antennas in Use

The first year of production produced a wide variety of antennas ranging in gain from 8 to 18, and from channel 7 to 13.

The first full-size was a TW-8A channel 7 antenna, the most comprehensive proof of feasibility of the Traveling Wave Antenna concept. KGHL in Billings, Montana, was the first station to install a Traveling Wave Antenna—a TW-15A for channel 8 with a measured gain of 15.8. A similar TW-15A antenna was installed for station WLWA (channel 11) in Atlanta, Georgia, designed to provide a $\frac{1}{2}$ -degree beam tilt.

The largest Traveling Wave Antenna installed to date has been a TW-18A (channel 7) for station KCMT in Alexandria, Minnesota, with a total length of 135 feet above the tower top with 20 feet of the antenna buried in the tower structure. Another TW-18A, gain of 18, antenna was installed at WIS-TV (channel 10) Columbia, South Carolina, which has been in operation for several months.

Station WXYZ, (channel 7) Detroit, Michigan, received a TW-9A antenna developed to provide a special null. The vertical pattern null has a magnitude below 2.5 percent from 13.5 to 18 degrees below the horizontal, which covers an azimuthal width of 32 degrees in the horizontal pattern in a specified direction. Here is an example of the flexibility of the Traveling Wave Antenna which, due to its principle of operation, has inherently no nulls.

Makes Ideal Multiple Installation

In Baltimore, Maryland, a special three-antenna multiple installation is being erected. In this installation, two gain of 12 Traveling Wave Antennas, TW-12, one for WJZ (channel 13) and one for WBAL (channel 11) are to be installed on the corners of a triangular platform. A TF-6AL Superturnstile Antenna for WMAR is to be installed on the third corner. This platform will be mounted atop a 618-foot guyed tower, with a separation between antennas of 100 feet.

In multiple installations a great problem is the effect upon the horizontal pattern circularity of each other at these small distances. In these cases the Traveling Wave Antennas possess two advantages over most other antennas: (1) the horizontal pattern is very circular, (2) because of the small cross-sectional area, the interfering effect upon the horizontal pattern circularity of another antenna is small. Thus, Traveling Wave Antennas improve the over-all performance of multiple installations.

Excellent Electrical Characteristics

Some of the electrical characteristics of the Traveling Wave Antenna are shown in Figs. 8, 9 and 10. All slots in the main aperture are alike and the coupling capacitors are the same size. Therefore, the sig-

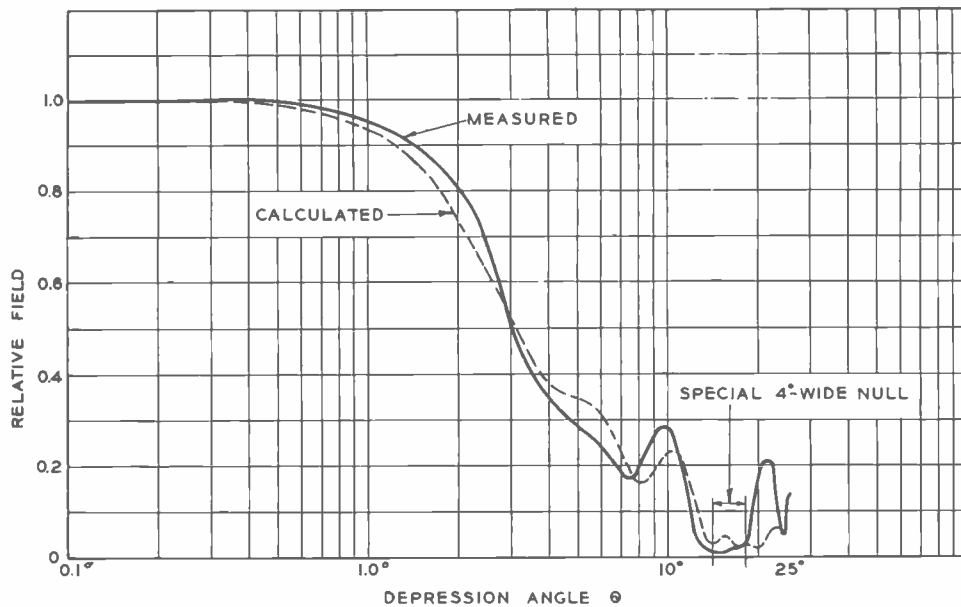

FIG. 9. Here a channel 7 TW antenna's measured and calculated vertical field patterns are shown. This antenna was built for station WXYZ-TV Detroit, Michigan, and it was designed to provide a special 4-degree wide null in the vertical pattern.

nal within the antenna and the illumination of the aperture decreases exponentially producing a smooth null-less vertical pattern.

Comparison of the calculated and measured vertical patterns for two Traveling Wave Antennas is shown in Figs. 8 and 9. A low vswr exists along the antenna because of the traveling-wave nature of the feed, which assures a stable, low-input vswr.

Pairs of slot radiators in space and phase quadrature produce a radiating-current distribution which, even for large pole diameters, provides an excellent circular horizontal pattern (see Fig. 10).

Combine Economy with Performance

Low-wind-load silhouette and simple mechanical assembly of the Traveling Wave Antenna offer the advantage of economy in the antenna and tower structure. Even with large pole diameters, the single slot pair patterns combined with the turnstile principle provide an excellent horizontal pattern. The exponentially tapered illumination gives a smooth vertical pattern. Bandwidth within the channel is maintained since the slot radiators keep constant wave length instead of velocity in the transmission line. Low vswr input is an inherent quality of the traveling-wave method of feed.

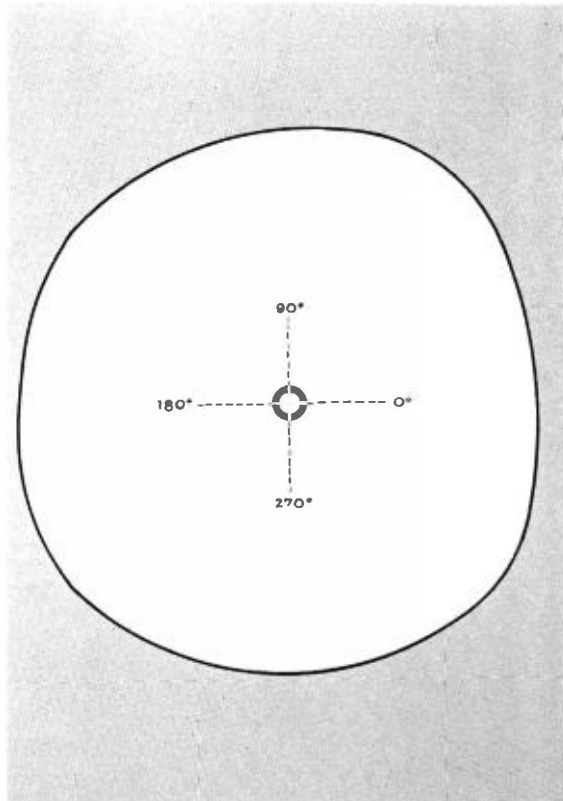

FIG. 10. This is a measured horizontal field pattern on the channel 13 TW antenna for WJZ, Baltimore. The circularity of this antenna is ± 0.58 db to provide uniform horizontal radiation.

RCA AUTOMATION EQUIPMENT

*Handles 15 Audio and Video Sources, Provides Precise Timing
and Error-Free Switching; Can Handle Station
Breaks and Continuous Programming*

by R. P. MAJOR, Broadcast and Television Sales*

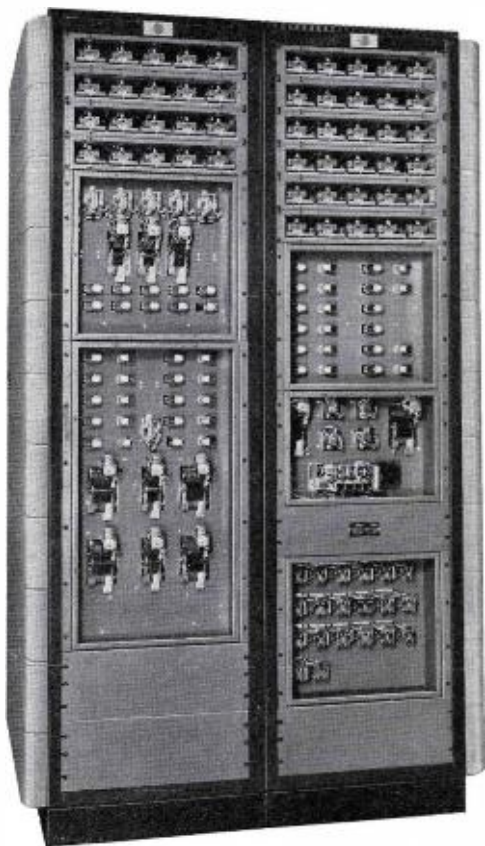

FIG. 1. The TSA-1 TV Automation Equipment is comprised of several chassis mounted in two cabinet racks and control and read-out panels mounted in a 22-inch console as shown.



In many television stations the number of switching operations which must be carried out to get the right picture and sound on-air at the right time is approaching the saturation point for manual operation. This is especially true during station breaks and it is from these program periods that most TV stations derive a great deal of their income. A new RCA TV Automation System, Type TSA-1 has been

*The writer wishes to thank Mr. Floyd McNichol of Systems Engineering, and Messrs. A. H. Lind, B. F. Melchionni, and D. Houck of Audio and Mechanical Devices Engineering for supplying much of the information for this article.

designed to provide orderly programming during station breaks, eliminating human errors and attendant rebates. It provides accurate switching at precisely the correct time.

All the switching information on the station log for a station break can be placed into the system's memory, then checked and at the proper time all switches made automatically. For example, projectors are started; audio and video switches made. Slide projectors are stepped, and another switch made. The announcer's mike is opened, turntables started . . . and so

forth. All this takes place in the short time at the end of a program.

The RCA automation system is capable of handling increases in programming activity that would be beyond the capabilities of present manual operation. An increase in programming could require additional personnel to handle additional switching operations. Automation equipment, on the other hand, has expansion possibilities capable of switching almost any number of equipments. It can also anticipate "roll cues" (getting projectors or tape machines up to speed before switching to them), and thus relieve operators of this chore also.

FOR TV STATIONS

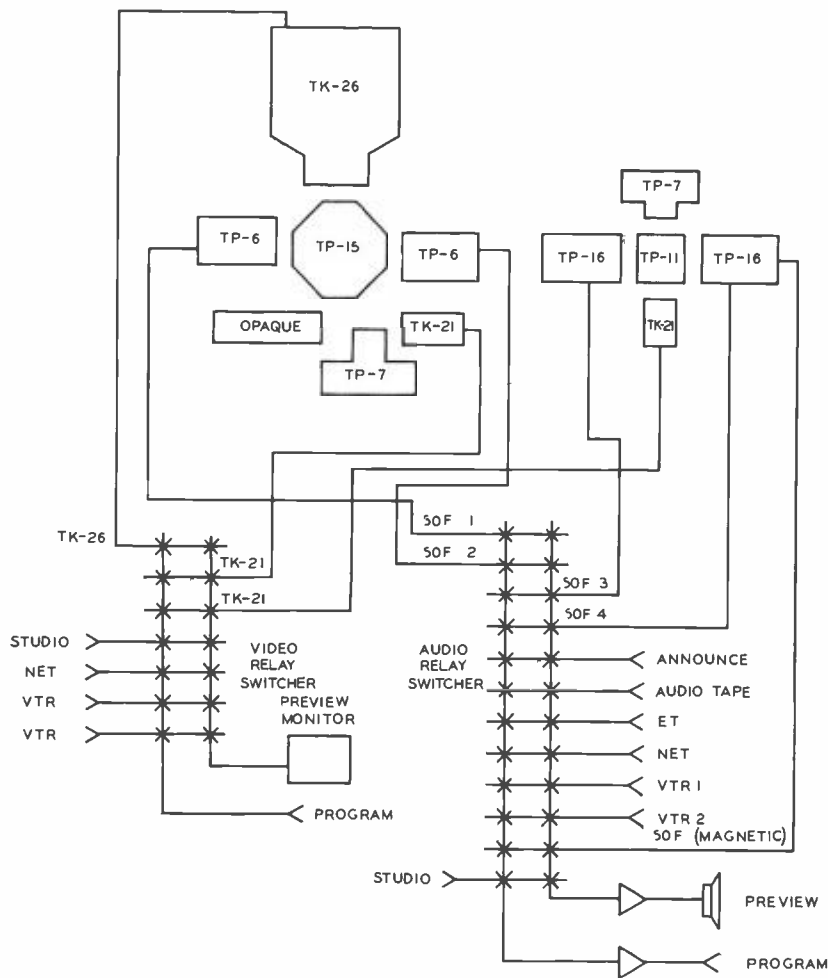

FIG. 2. Functional diagram of a typical system which may be operated by automation equipment.

Operational Facilities of TSA-1

The Type TSA-1 TV Automation Equipment has been designed to handle 15 video and audio sources and 10, 15, 20 or 25 events. A *source* is the picture source such as a slide projector, film projector, live studio, or TV tape equipment. An *event* is an item in the program schedule which involves a change in video or audio sources—regardless of how many types of equipment are required to produce this change or how many operations must be performed on a given piece of equipment. For instance: starting a film projector, showing the projector, flipping the multiplexer mirrors, and making the audio and video

switch to the right film projector and film camera are all considered *one* event.

The TV Automation Equipment is illustrated in Fig. 1. It is comprised of several chassis mounted in two cabinet racks, a control panel and a read-out panel. These panels can be mounted in a 22-inch console as shown, or in a cabinet rack, or at any other convenient location.

The control panel may be duplicated in more than one location. In this case, a delegate switch (not shown) would be required to designate which location has control of the system. The read-out panel may also be duplicated in as many loca-

tions as desired. A duplicate read-out panel is highly desirable in the projection area and in each studio control room.

The functional diagram, Fig. 2, illustrates a typical system operated by the automation equipment. Individual station facilities will vary from those shown but the Type TSA-1 is sufficiently flexible to handle as many as 15 sources.

Presetting the Automation Control

In order to operate the automation control it is first necessary to place information into the system. The following facts must be preset: *time*, *source* and *event*. How this is accomplished is best described by



FIG. 3. Control and read-out panels of the TSA-1 system shown in the functional diagram Fig. 5.

referring to the control and read-out panels shown in Fig. 3. The system works on an elapsed time basis, controlled by a motor-driven timer. The minimum elapsed time for any event is one second; the maximum is 15 minutes and 59 seconds. There is however an "infinite time" (∞) position for longer programs, or those for which the cue for termination is unknown. An example of the latter is the verbal cue supplied by the network for a station break in the middle of a program. The elapsed time for each event is selected by means of the three switches beneath the TIME position on the control panel: minutes (MIN.) seconds times 10 (SEC \times 10) and seconds (SEC).

The video and audio sources are selected by means of the two rows of push buttons. The audio row is above, and the video below. Selecting a video source automatically selects the audio source immediately above. If it is desired to derive the audio

from another source, it is only necessary to press the appropriate button in the audio row to override the original selection. The video and audio sources of a typical system are shown in Fig. 4, reading from left to right on the control panel.

The window marked EVENT indicates the number of the event for which it is desired to preset information. The event number can be changed by pressing the event select (EVENT SEL) button directly beneath it. Each time the button is depressed, the event number changes to the next higher digit; thus it is possible to select any event number for which information is to be preset. In a ten-event system, when the indicator reaches 9, the next event is indicated as 0. The next time the button is pressed the indicator steps to 1, and so on around.

After the time, source, and event location have been selected, the information is placed in storage by depressing the cut

bar located in the lower left corner of the control panel. When this is done, the EVENT indicator automatically steps to the next event number. The EVENT SEL button is normally used to select the first event number of a sequence. Its only other function is to enable the operator to select an event in which corrections or changes in the information are to be made.

Safety Factor

A safety feature has been built into the system so that on-air information cannot be interrupted in error. Assume that event No. 5 is on the air (the number 5 appears in the window). One might expect that if information were to be read into event No. 5, the "on-air" material would immediately change in accordance with the new information. This cannot happen since the "on-air" information is obtained from an intermediate storage unit which can only be changed by stepping to event No. 6. The next time the system steps from event No. 4 to event No. 5, however, the new information will go "on the air."

This safety feature also makes it possible to read new information into an event location as soon as that event goes on the air. In other words, as soon as an event number is initiated, new information can immediately be fed into that event for use the next time the number comes around. The last numbered event in the system, be it 10, 15, 20, or 25 need not be the last event in a sequence. When the stepper reaches the end of the event having the highest number, it automatically steps over to event No. 1, unless the operator deliberately programs the system to stop on the highest numbered event.

Operation of Automation Control

The PANEL USE switch has three positions: preset (PRESET) program (PGM) and preview (PREV). The PRESET position is used when presetting information into the memory circuits. When the switch is in this position the row of windows marked PREV on the read-out panel will always indicate the next *event* to go on the air. If the program read-out indicates event No. 4, the preview read-out will indicate event No. 5. The duration of events is indicated in the windows labeled TIME. The video and audio sources are indicated in their respective windows by symbols which are abbreviations of the source title, that is, P1 for Film Projector No. 1, SL1 for Slide Projector No. 1, and so forth.

If the PANEL USE switch is set to the PREV position, the events continue to

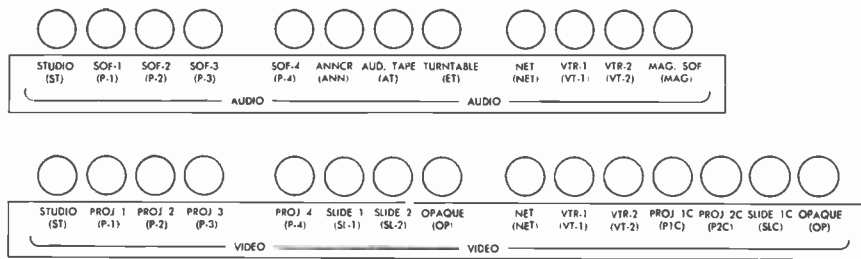

FIG. 4. Close-up showing the video and audio sources of typical system reading left to right on the control panel.

occur as programmed except that now the EVENT SELECT button on the read-out panel can be used to step the system through the event storage locations so that the information in storage can be checked for accuracy. As the stepper goes through each location, the information stored there appears in the preview read-out windows. This memory search in no way affects the sequence of events on the air. They always follow in numerical succession regardless of the number showing in the event preview window. If the PANEL USE switch is now returned to the PRESET position, the event preview indicator automatically returns to the number of the next event to go on the air.

For automatic operation, the PANEL USE switch can be in either the PRESET or PREV positions; however, the operational use (OPER USE) switch must be in the TIME position. To initiate a preset series of events, the operator need now press only the OPERATE button to start the first event. The others will follow automatically until one is reached for which elapsed time is programmed as infinity or until the OPER USE switch is set to manual (MAN). This stops the timer, and the equipment will now wait indefinitely for further instructions from the operator.

When the OPER USE switch is in the MAN position the next event can be initiated only by pressing the OPERATE button (lower right, Fig. 3). Now if the PANEL USE switch is set to PGM, we have a manually operated preset switcher. Selecting an audio and video source places the sources on the preview outputs, and pressing either the cut bar or the OPERATE button puts the program on the air. By means of these two switches (PANEL USE and OPER USE) it is possible to cut back and forth between manual and automatic operation at the discretion of the operator. In this way it is possible to handle nearly any emergency that might arise.

As pointed out previously, the preview read-out indicates the duration of the next event to go on air. When the transition occurs, the information in the preview read-out is immediately transferred to the program read-out and the count down in the TIME windows immediately takes place. When the count down reaches zero, the transfer of information again takes place and the new event is on the air. There is one important exception. When infinite time (∞) is programmed for an event, it is indicated by red discs of light in the time read-out windows. When the event transfers from the preview to the program read-out, the timer stops and the system will wait indefinitely for a start signal to initiate the next event. This is provided by pressing the OPERATE button.

Use with Projectors and Television Tape

Film projectors take a short interval of time to reach operating speed, therefore the projectors must be started before the video and audio switch takes place to put the event on the air. In the TSA-1 System this is automatically accommodated. Thus, if a film is to be the next event on the air and the stabilization time for the projector is three seconds, the projector starts when the count down for the event on the air reaches 3 and the audio and video switches take place when the count down reaches 0.

Because of projector stabilization time, any event prior to a film event must be of a duration equal to or greater than the stabilization time. For RCA TP-16 Projectors this could be from three to five seconds; for a TP-6 the time is three seconds. For a TP-6 equipped with a fast-start kit the time is less than one second. Television tape machines generally take about five seconds for complete stabilization.

The run-in or stabilization time of film projectors and tape equipment need never be the concern of the operator. The stabilization times for the various pieces of equipment are accommodated by means of

a simple set-up procedure in the circuits of the TSA-1, and thereafter the proper delay is automatically provided when selection of each piece of equipment is made.

The selection of a slide is generally programmed as one event; however, a manual slide stepping switch may be utilized to time a series of slides manually to the announcer's remarks. The series may thus be set up as a single event. If desired, the series may be shown automatically, using one event per slide.

Generally, sequential operation is adequate for automatic control of slides; here the TP-7A Slide Projector can be used. However, many programs call for the showing of one or more particular slides in a sequence more than once. For such operation, a TP-8A Random Selection Slide Projector would be more in order. A slide-stepping switch can be located anywhere and duplicated in as many locations as desired. Similarly, a duplicate start button for an automatically programmed sequence of events can be provided in each control position. For instance, if a film and slide sequence is to take place in the middle of a live program from one of the studios, a start button and slide sequencing button at the studio control position would give the program director complete control over his programs.

Preset Manual Switching System

The TSA-1 can be used without the timing equipment as a preset event manual switching system. In this case only the rack shown on the left in Fig. 1 is necessary, and the control and read-out panels can be very much simplified or combined. It should be understood that some television stations operate without precise timing for the simple reason that they find it too difficult or not worthwhile to enforce the timing discipline that the fully automatic system imposes on announcers and talent. For these the preset manual event switching system is highly recommended.

TABLE 1				TABLE 2			
TIME (DURATION)	SOURCE		EVENT (PROGRAM)	TIME (DURATION)	SOURCE		EVENT (PROGRAM)
	VIDEO	AUDIO			VIDEO	AUDIO	
9:00:00 (00)	NET	NET	10 (NETWORK)	9:30:00 (15:00)	NET	NET	5 (NETWORK)
9:29:30 (0:20)	PROJ 2	PROJ 2	1 (FILM COMMERCIAL)	NET	NET	6 (NETWORK)	
9:29:50 (0:03)	SLIDE 1	ANNCR	2 (SLIDE COMMERCIAL)	9:59:30 (0:20)	PROJ 2	PROJ 2	7 (FILM COMMERCIAL)
0:03)	SLIDE 1	ANNCR	3 (SLIDE COMMERCIAL)				
9:29:56 (0:04)	SLIDE 1	ANNCR	4 (SHARED 1D)				
9:30:00 (00)	NET	NET	5 (NETWORK)				

How the Operator Programs

The actual programming operation is far less complicated than, for example, the operation of a 12 by 4 video-audio switcher. There are only three things to select: time, source and event. A few examples will illustrate the various choices open to the programmer. A typical station break (in a 10-event system) between two network programs is shown in Table 1.

Rather than use infinite time to program events longer than 15 minutes and 59 seconds, it is only necessary to program the same source twice, appropriately dividing total elapsed time between the two events. There will be no noticeable break in the half-hour program even though it is programmed as two events. As an example a half-hour, network program

followed by a film commercial may be programmed as shown in Table 2.

Note that it does not matter on what event a sequence ends. The programmer simply sets up the next event following numerically the last event in a series. The system thus lends itself to continuous programming.

System Components

A functional diagram of the system is shown in Fig. 5. The programmer's choices are stored temporarily on a bank of relays on the rear of the control panel, see Fig. 6. When the cutbar is depressed this information is transferred to the input distributor chassis and from there to the memory. Once in the memory the information can be read out as required.

The output distributors, also located on the distributor chassis, channel the information into two paths; *preview* and *program*. In order to make most efficient use of storage capacity, the information is stored in binary form. Thus a translator is necessary to convert the information into a form which can be recognized when applied to the timer, coincidence circuits and the various read-outs.

The output control chassis distributes the various pulses to the video and audio switching systems. These various pulses (24 volts) are then applied directly to the audio and video relay switchers. The output pulses to the film projectors, turntables, and tape machines, could be applied directly if a single control voltage could be specified for all the varied pieces of machinery found in over 530 television stations. Since this is not possible, the auxiliary output chassis is supplied. This chassis is custom built to fit the particular installation and consists of a group of repeater relays activated by the 24-volt pulses from the output control. The various equipment control voltages are run through the repeater contacts; thus the system is essentially independent of these voltages.

To return to the storage circuits briefly, a sample tray is shown in Fig. 7. Reading from front to rear the binary information storage relays are coded 1, 2, 4 and 8 so that any count up to 15 is possible. When all of the storage relays are in the left latched position the count is zero. When information is sent to storage, all relays first clear to zero; and then those which are to accept the new information flip to the right.

For each event five trays of relays are required for a completely automatic system. Thus the 10-event system has 10 trays containing a total of 50 storage units. A 25-event system would have a total of 25 trays with 125 storage units.

For a manually operated, preset system only two trays per event are required—audio and video source. In Fig. 8 the storage location for the source, time and event number is shown.

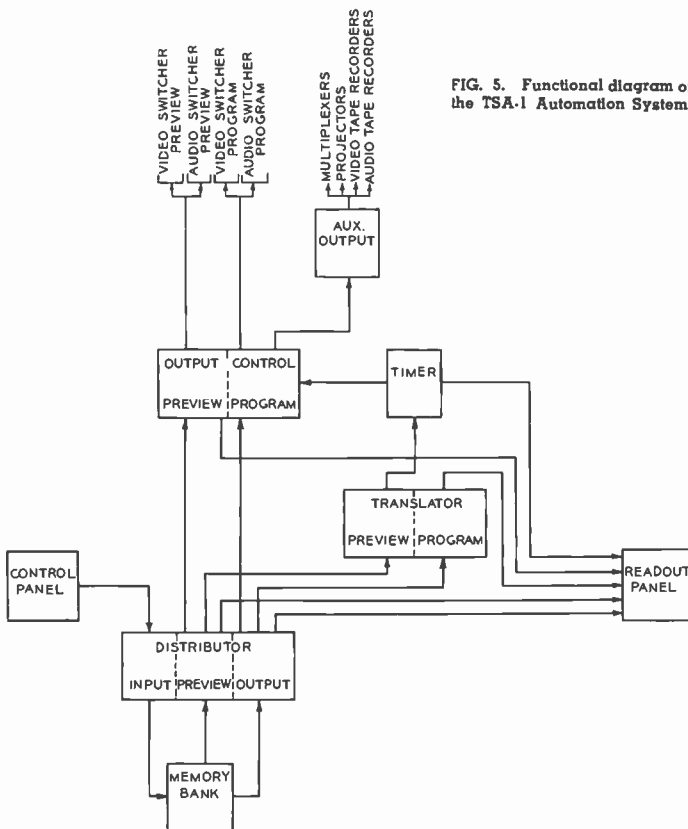

FIG. 5. Functional diagram of the TSA-1 Automation System.

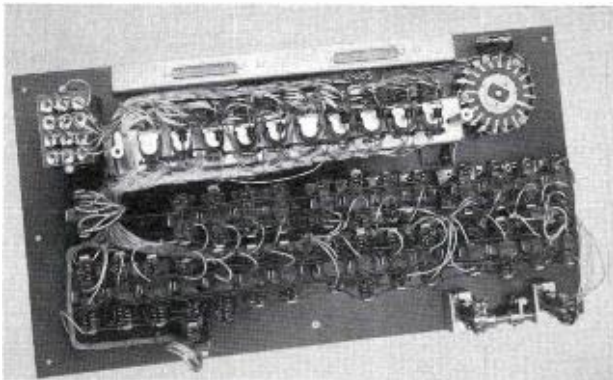

FIG. 6. Rear view of automation system control panel.

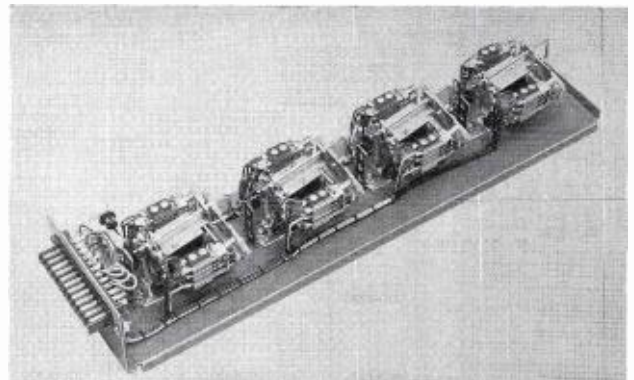

FIG. 7. View of tray showing storage relays.

The storage units are plug-in modules; information can actually be stored by manually manipulating the relays if desired. The relays are of a mechanical latch type, so that power is consumed by the storage relays only for the duration of the "clear" and "store" pulses. If power is lost at any time, the memory still retains the information supplied to it.

Reduces Errors, Cuts Costs

The RCA TV Automation Equipment has been designed to increase the revenue producing potential of stations using it. It offers television stations many benefits for increased operating efficiency: reducing costly operational errors; increasing commercial handling capacity and permitting most advantageous use of personnel. Its flexibility makes it readily adaptable to almost any station requirements.

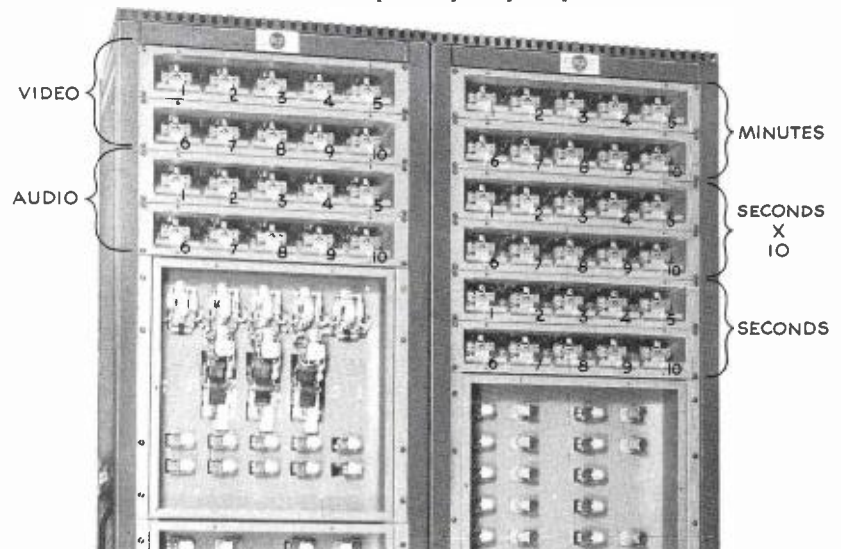

FIG. 8. View of racks showing storage location for source, time and event number.

HOW TV AUTOMATION CAN INCREASE INCOME

Increasing the efficiency of operation during station breaks is probably the most obvious benefit of automation equipment. There are however, several additional advantages, which also influence the revenue-producing potential:

- (1) Expansion of studio operations to handle increased programming normally requires the addition of personnel. Automation equipment provides a method of handling increased programming and additional equipment *without* adding personnel.
- (2) As competition for the advertising dollar becomes more intense, stations are improving and expanding facilities so that they can meet this competition by providing extra client service. A station with automation equipment can assure the client that his message will reach the viewers with no chance of operating errors.
- (3) For stations approaching the saturation point in time sales, the only way of increasing revenue is to program additional commercial material into the available on-air time. This may take the form of slides, presented at a rate as high as one per second. Timing such a sequence could be a serious problem for a human operator, but is routine for automation equipment.
- (4) A number of stations have proved that 24-hour service can be a profitable operation if nighttime operating costs can be kept down. Since most of the program material between the hours of 1 a.m. to 7 a.m. originates in the film room, this represents an excellent application for automation equipment. It is quite feasible that the entire operation during this period could be handled by one man, serving as both operator and projectionist.
- (5) All stations suffer loss of revenue when the commercial message does not reach the viewer because of miscues, outright errors, equipment failures, or just plain "mental blocks" on the part of the operators who have too much to do. Automation equipment can soon pay for itself by preventing this loss of revenue.

TRANSISTORIZED SWITCHING SYSTEMS TYPE TS-40

PART I: BASIC BUILDING BLOCKS FOR VERSATILE NEW SWITCHING SYSTEM ARRANGEMENTS

by J. W. WENTWORTH, C. R. MONRO, and A. C. LUTHER, JR., *Broadcast and Television Engineering*

Introduction of new Transistorized Switching Systems makes possible a degree of freedom and flexibility in planning and installing TV switching facilities never before available. For the first time the broadcast engineer can custom tailor a switching system to individual station requirements using equipment modules available from production.

Representing a new concept in switching design, the Type TS-40 Switching Equipment differs significantly from conventional remote-controlled switchers in that it uses transistor circuits instead of relays or tubes for handling the video signals. Use of transistors provide key technical advantages which account for superior system performance.

Transistor Advantages

Aside from a significant reduction in power and space required, transistor cir-

EDITOR'S NOTE: This is the first in a series of articles explaining the functions and applications of TS-40 Transistorized Switching Equipment. To "set the stage" for more detailed discussions, a brief review of the overall system, emphasizing mechanical rather than electrical aspects, is presented in this first article. Succeeding articles will deal with detailed discussion of significant circuits and examples of typical applications for the equipment.

cuitry permits extremely rapid switching transitions—of the order of one micro-second. Hence, picture-to-picture transfer occurs between successive television fields, thereby eliminating the chance of visible disturbance to the picture. The life expectancy of transistors is virtually unlimited; they are compact, extremely reliable, and do not generate heat in operation.

By virtue of the short lead lengths involved, the compact switching assemblies made possible by transistors have excellent video performance in both monochrome and color applications.

System Advantages

The modular design and plug-in construction used in the TS-40 Switching Equipment offers greater freedom than ever before in the layout of switching systems. By combining the modules, virtually any size switching system, up to 24 inputs and 10 outputs, can be tailored to specific station applications and requirements. Additional advantages of this modular design are the ease and simplicity with which maintenance can be performed and the flexibility offered for future expansion of facilities.

Taper-tab, taper-pin, and edge-type connectors eliminate most soldering operations

and simplify modification or enlargement of the system. Built-in protection circuits protect key components from accidental damage, and etched wiring is used extensively to assure uniform performance.

Basic System Building Blocks

The basic components of the TS-40 Transistorized Switching System (with the exception of power supplies) are illustrated functionally in the simplified block diagram, Fig. 1. These consist of cross-points, cross-point groups, latch circuit plates, coupling circuit plates, output amplifiers, mixing amplifiers, distribution amplifiers, and sync or blanking adders. Power required by the system is obtained from a transistor power supply, dc plate supplies, and a filament and bias supply.

Although the system employs new circuit elements identified with transistor circuitry, the basic switching system philosophy is the same as that of other RCA video switching systems. Thus, it is practical to supplant or to expand existing switching equipment facilities with the transistorized equipment. In existing installations this may provide the solution to system expansion, or the addition of color facilities within the limits of space already available.

The following discussion serves as an

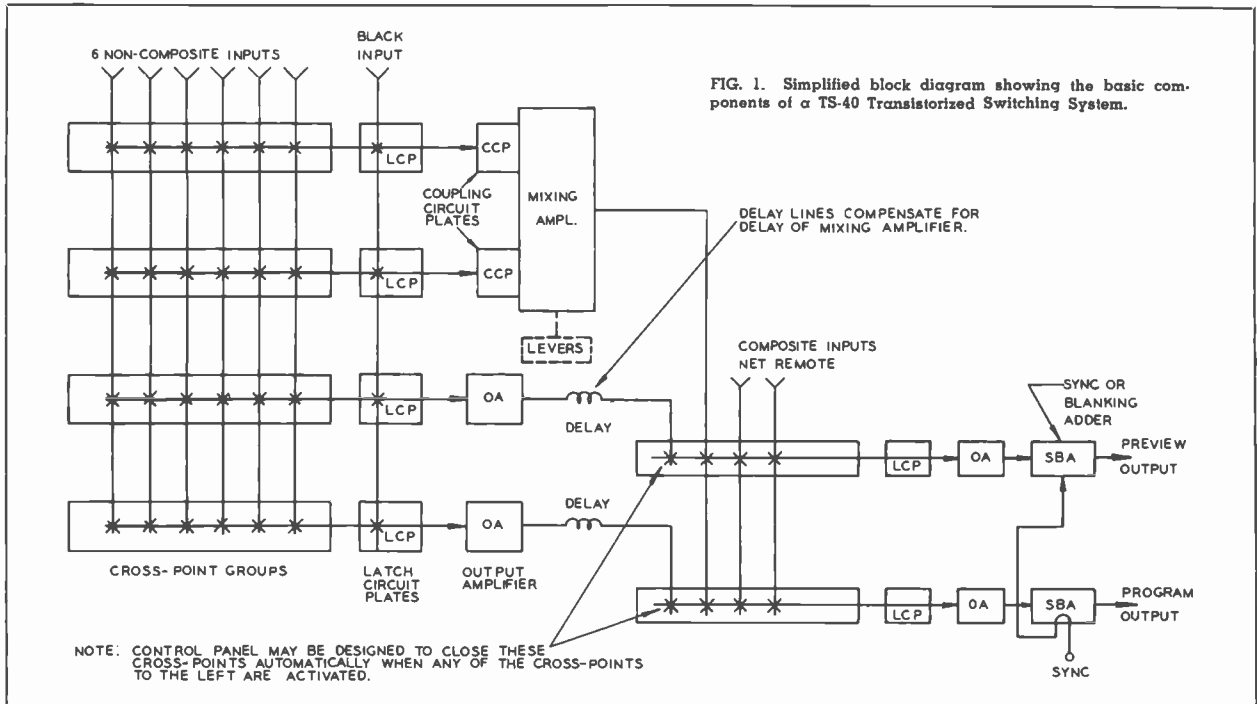

introduction to the components which comprise an over-all Transistorized Switching System—their functions and physical characteristics.

Video Cross-points and Mounting Arrangements

The basic element of the TS-40 Switching System is the video cross-point shown in Fig. 2. This small, etched-wiring as-

sembly is functionally equivalent to a high-quality relay having two sets of contacts—one for a video signal and one for a tally circuit. It consists, in essence, of a semiconductor diode switch which is turned “off” and “on” by a transistorized flip-flop circuit. The circuit is bi-stable; that is, it will remain indefinitely in either the “off” or the “on” condition until activated externally.

Six cross-points are mounted on an etched-wiring card to form a cross-point group, see Fig. 3. The card, fitted with a plug-in connector along one edge, has an output bus that joins all six cross-points to form a six-input, single output switching element. For convenience in planning and installing systems, the cross-point group is supplied as the basic plug-in switching module.

FIG. 2. The video cross-point is the basic switching element of the TS-40 Transistorized Switching System.

FIG. 3. Front and rear views of a cross-point group—six cross-points mounted on an etched wiring card.

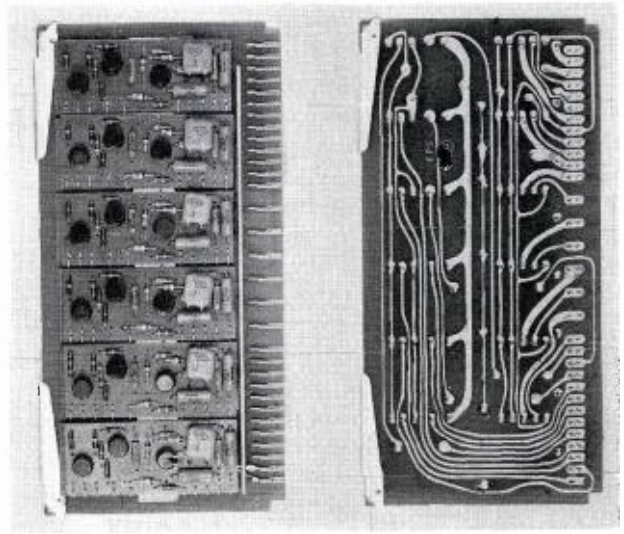
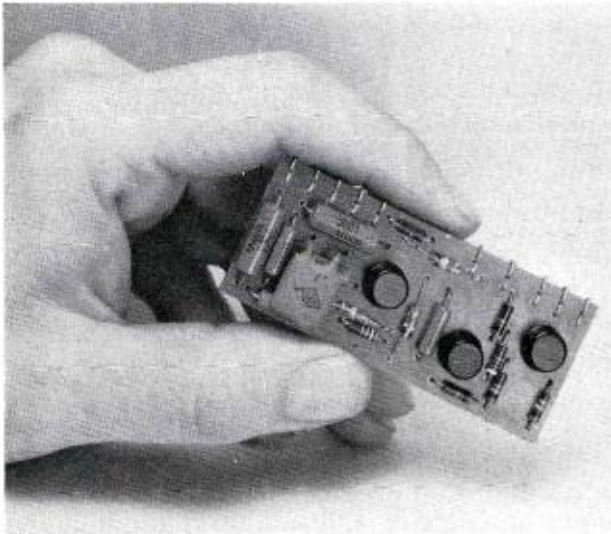

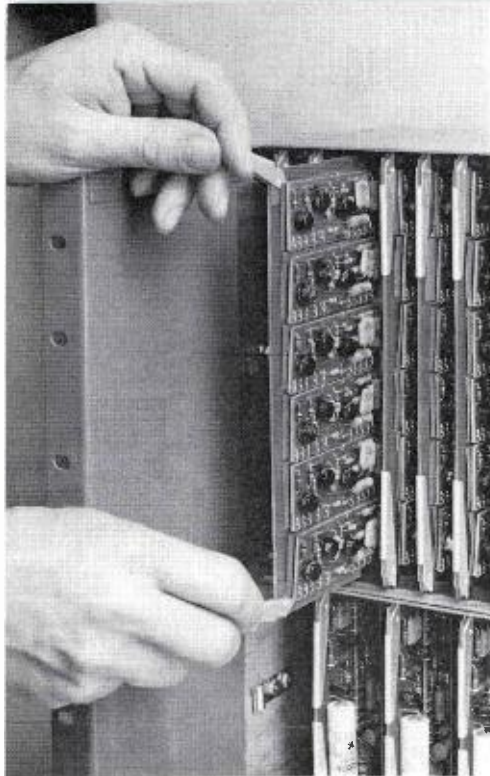

FIG. 4. Up to 20 cross-point groups may be plugged into slots in a cross-point frame as shown.

Up to 20 cross-point groups may be plugged into slots in a cross-point frame, see Fig. 4. Across the back of this frame (see Fig. 5) there is a copper bus structure, consisting of 12 video input busses, grounded shield strips between the video busses, and 3 power supply busses. The video busses are arranged so that each is connected to every other cross-point group in the manner illustrated by Fig. 6. Two cross-point groups may be tied in parallel to form a 12-input, single-output switching unit. Since the cross-point frame has space for 20 cross-point groups, its maximum capacity is 12 inputs and 10 outputs. (Actually, a great variety of switcher configurations may be employed, provided they fit within the framework of the bus structure shown in Fig. 6.) Larger switchers, up to 24 inputs and 10 outputs, may be constructed by adding a second cross-point frame, as shown at the lower left in Fig. 6.

Video input signals are brought in through input connector strips, two of which are shown mounted in place in Fig. 5. There are ten possible mounting positions for the input connector strips; the positions actually used depend upon the bus configuration for a specific system. Although not shown in Fig. 5, covers are provided for the unused mounting spaces and for the built-in cable duct extending across the top of the frame.

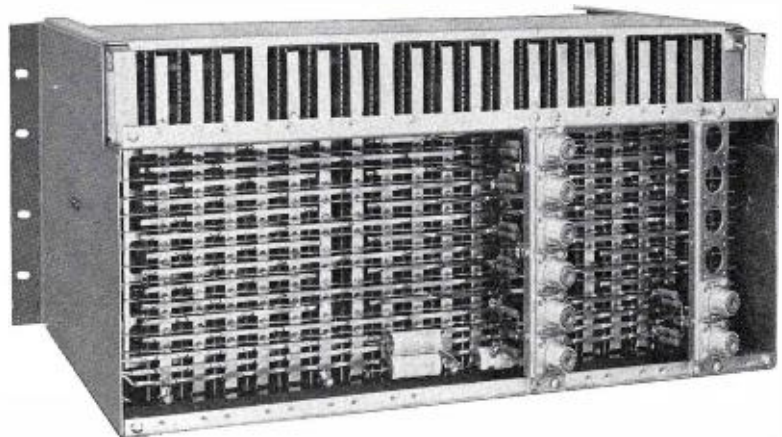
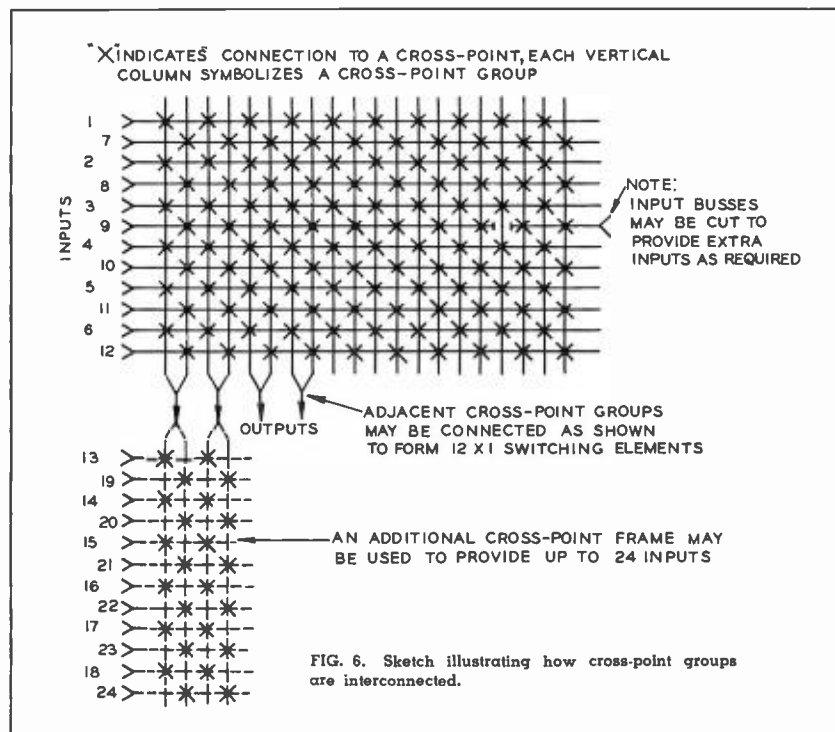

FIG. 5. Rear view of the cross-point frame showing details of the copper bus structure.

Latch Circuit Plates

Another basic building block for TS-40 Systems is the latch circuit plate (see Fig. 7). This circuit is mounted on an etched-wiring card which plugs into a frame normally mounted below the cross-point frame (see Fig. 4). It performs the same function as the mechanical latching bar in a "direct" push-button switcher—that is, it trips "off" the circuit previously turned "on" each time a push button is operated, thus assuring that each output bus carries only one signal at a time. One latch circuit plate is required for each independently

latched output bus (consisting of up to four cross-point groups), and is connected to the cross points through two busses, designated "Latch Trigger" (LT) and "Latch Operate" (LO). The latching operation is automatic, requiring no extra connections to the push button control panel. Each time a cross-point is actuated (by its individual control button), it produces a low-level signal on the "latch trigger" bus. This signal is amplified and clipped by the latch circuit plate, and fed back along the "Latch Operate" bus to all the cross-points connected to the same out-



put. The amplified "Latch Operate" signal triggers "off" whichever cross-point was previously "on." The entire sequence of operation is extremely fast, in the order of one microsecond.

Figure 9 shows the internal components of a cross-point frame and latch frame removed from their housings to illustrate in greater detail the manner in which interconnections are made. Note that both the cross-point groups and the latch circuit plates "mate" with narrow etched-wiring interconnection strips which serve to bring the conductors to the appropriate positions at the back of the frame. The tally and control leads are conveniently grouped at one end of the cross-point interconnection strips, separate from the video bus structure. External wires are attached to the etched-wiring pieces by means of simple, slip-on edge connectors which require no solder for installation. The output, "latch trigger," and "latch operate" busses appear at one end of the cross-point interconnection strips, where double-width slots are provided for installing the jumper wires used to connect adjacent cross-point groups in parallel and to the latch circuit plates. The video output connections are also made at the same point through coaxial cable fittings mounted on the latch frame.

The coaxial fittings used for both input and output connections are of an unusual design, combining features of standard coaxial jacks and cartridge fuse holders. The video signals are actually brought in and out through small fuses (see Fig. 8) which protect the transistors and diodes from damage should excessive voltages be applied by accident to the interconnecting cables. The fuses are of sufficiently low impedance so that they do not degrade the performance of the system.

The interconnections between cross-point groups and latch circuit plates are shown in simplified form in Fig. 10. The latch circuit plate includes a cross-point circuit identical to all the others, but intended for use by the black signal. (In monochrome systems black may consist of no signal at all, but in color systems it is desirable to provide a black signal containing the color synchronizing burst, possibly supplemented by a fixed pedestal.) The black cross-point is connected to the same busses as all the other cross-points in the same output chain, but its control circuit is interconnected with one of the power supply busses in such a way that the switcher always comes up in a black condition when power is first applied. If it were not for this feature, the bi-stable cross-point cir-

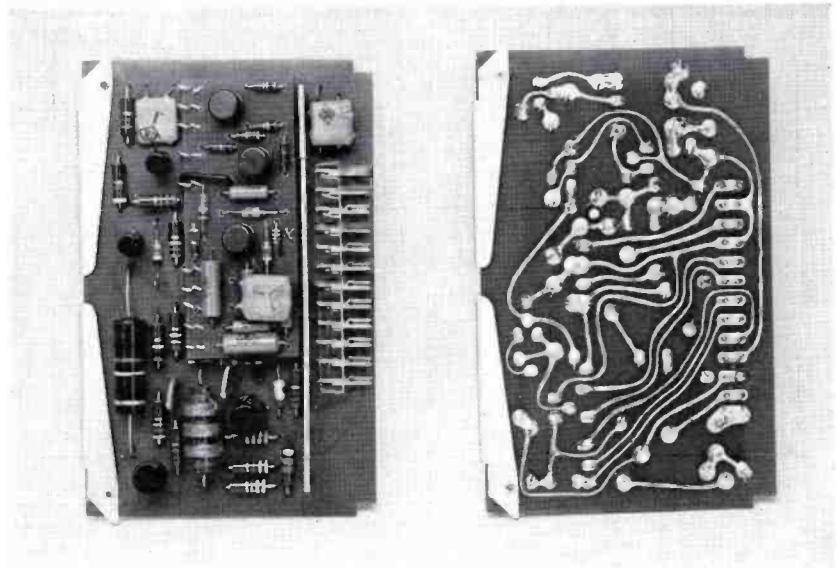

FIG. 7. Front and rear views of the latch circuit plate.

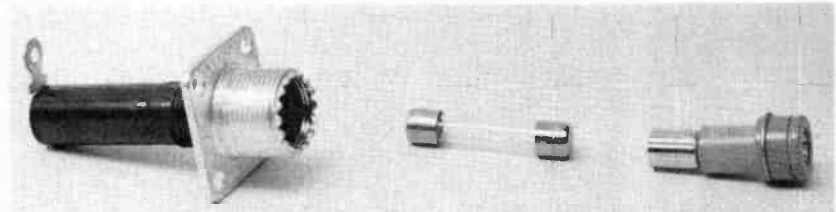

FIG. 8. Exploded view of coaxial fittings used for input and output connections. The small fuse (shown center) protects transistors and diodes from being damaged by excessive voltages.

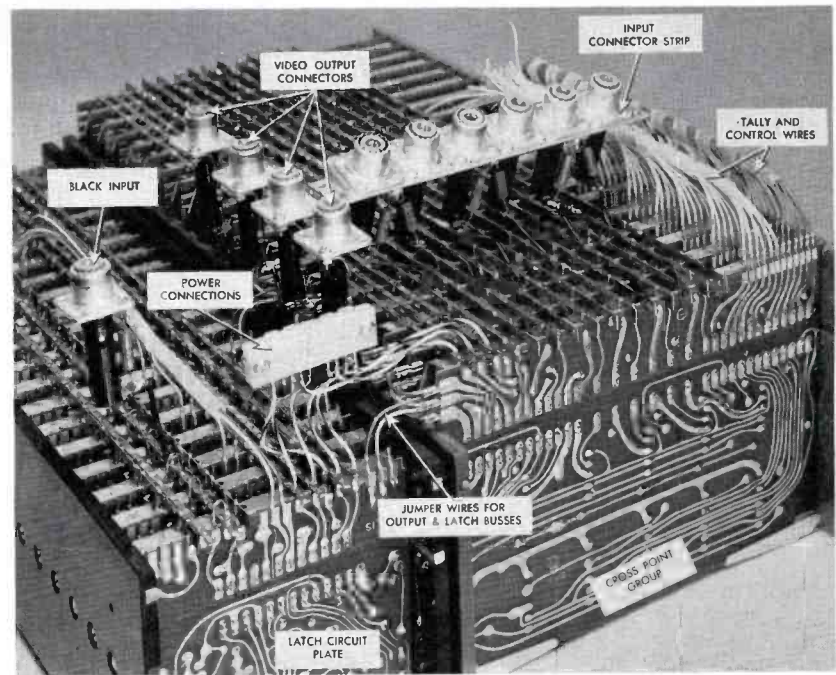

FIG. 9. Cross-point frame and latch frame as they would appear if the steel housing members are removed, leaving all internal components in their normal relative locations.

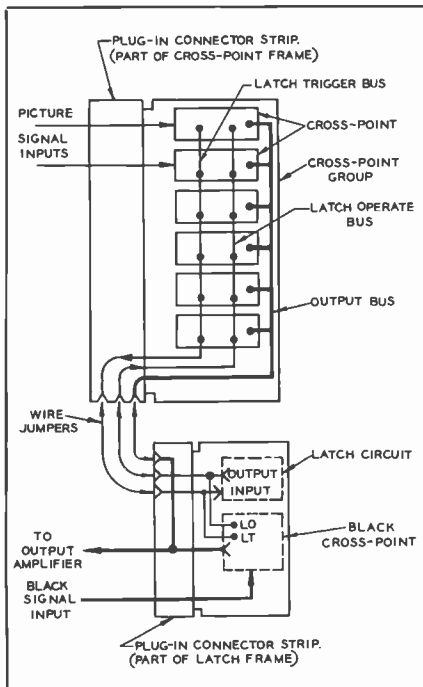

FIG. 10. Sketch showing the interconnections between cross-point group and latch circuit plate.

circuits might be activated in random fashion—some “off” and some “on”—upon the application of power.

Output Amplifiers and Accessories

The output signal from a cross-point is at a relatively low level, because each cross-point handles a little less than one-tenth of the total signal current applied to the input of the switcher. This current division is necessary to permit up to ten cross-points to be connected to each input. There are also minor losses in the cables required for delay equalization within the system. In order to restore normal signal voltage level (1.0 volt, peak-to-peak) for system distribution, a coupling circuit plate (see Fig. 11) is used. The coupling circuit consists of a transistorized amplifier with an input impedance of 75 ohms and an output impedance of about 1200 ohms.

In a TS-40 System provision is made to mount the coupling circuit plate within the output amplifier, a compact plug-in unit shown in Fig. 12. This amplifier utilizes etched wiring and is identical to the TA-12 Distribution Amplifier (see Fig. 13), except that the coupling circuit plate has been substituted for a conventional input coupling capacitor. The TA-12 Amplifiers are also useful in many other applications wherever a unity-gain, single-input, single-

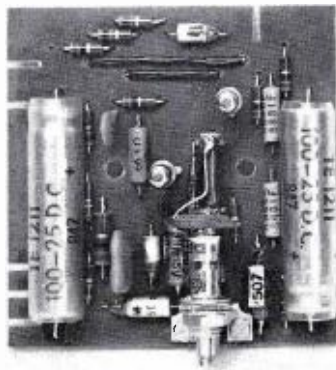

FIG. 11. A coupling circuit plate used to match transistor output to amplifier input.

output isolation amplifier is required. The same basic design is satisfactory for picture signals at one-volt level, CW sub-carrier at two volts peak-to-peak, and pulse signals at four volts peak-to-peak.

Up to ten output or distribution amplifiers may be mounted in the amplifier frame shown in Fig. 14. This frame also serves as a housing for other items in the TA-12 family of equipment, notably the sync or blanking adder (see Fig. 15) and the heater and bias supply (see Fig. 16). The sync or blanking adder may be connected in series with the output of a distribution or output amplifier whenever there is a need for adding sync pulses to noncomposite signals. An interlock relay is included in the unit, making the adder suitable for use at the output of switching systems handling both composite and noncomposite signals. This same device may be used for adding a small amount of blanking for so-called “fixed set-up” operation. If both

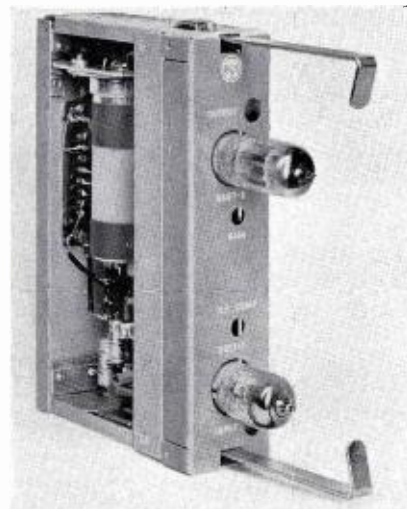

FIG. 12. Output amplifier for the TS-40 System.

sync and blanking addition are required at the same location, two sync or blanking adders may be connected in series.

The heater and bias supply has a transformer with heater windings for supplying up to ten output amplifiers, distribution amplifiers, sync or blanking adders. Also included is a 150-volt negative bias supply with adequate capacity to supply ten amplifiers. The bias supply is needed primarily to buck out dc voltage at the output of the direct-coupled feedback amplifier. The use of this bias supply prevents the possibility of any “bounce” problem in the feedback-stabilized amplifiers.

The heater and bias supply occupies two mounting spaces in the amplifier frame. It may be mounted either in the same frame as the amplifiers it serves, or in an immediately adjacent frame. Each of the plug-in units in the TA-12 family is supplied with a plug-in connector plate, which is readily attached to single flanges at the rear of

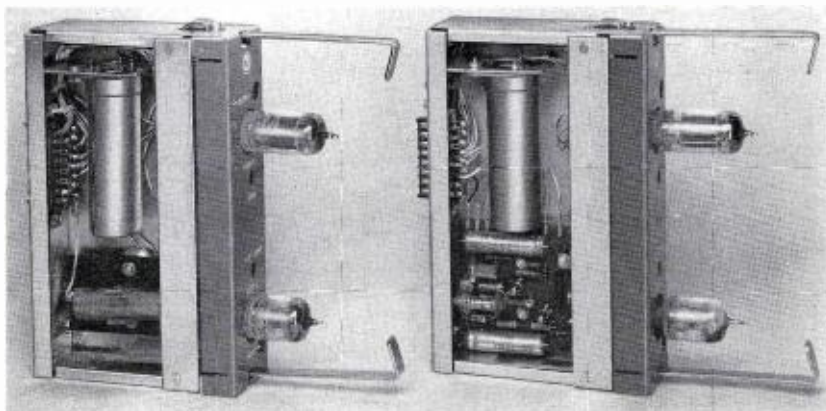

FIG. 13. Comparison of TA-12 Distribution Amplifier (left) with output amplifier (right). In the TA-12 the coupling circuit plate has been replaced with a conventional input coupling circuit capacitor.

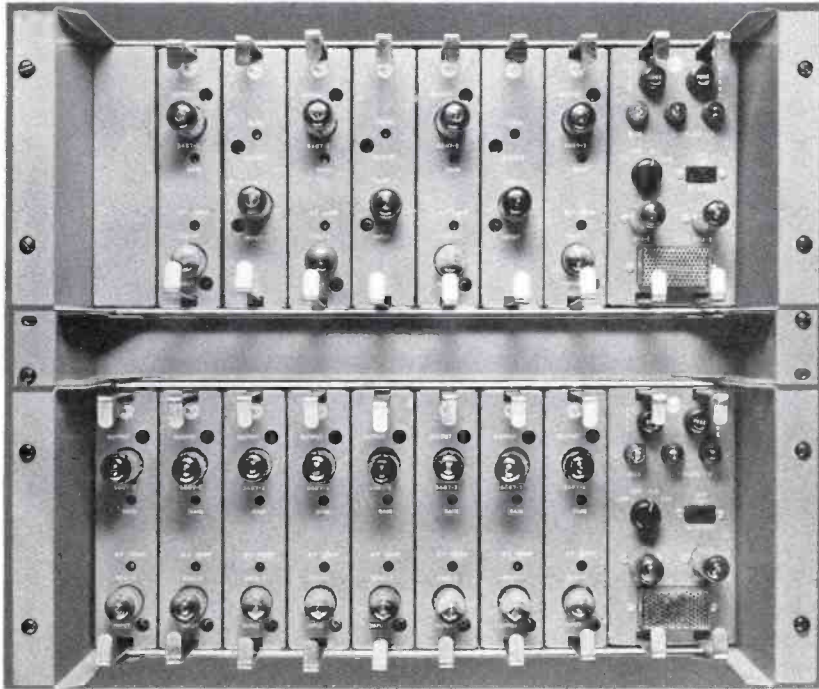

FIG. 14. The amplifier frames shown will mount any combination of distribution or output amplifiers, sync or blanking adders and heater and bias supplies.

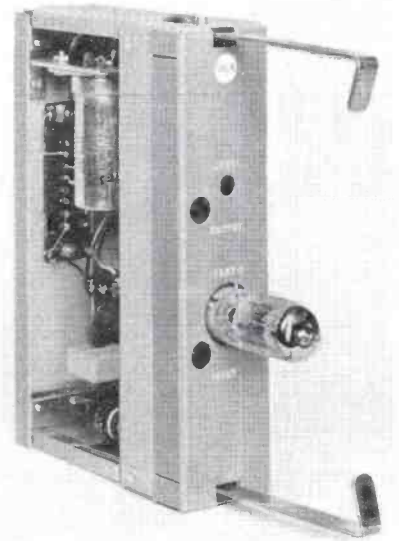

FIG. 15. A sync or blanking adder is required on each output where either sync or blanking is to be inserted.

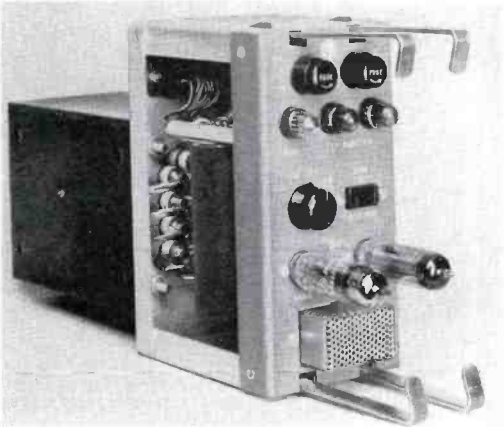

FIG. 16. The heater and bias supply powers up to ten amplifier units.

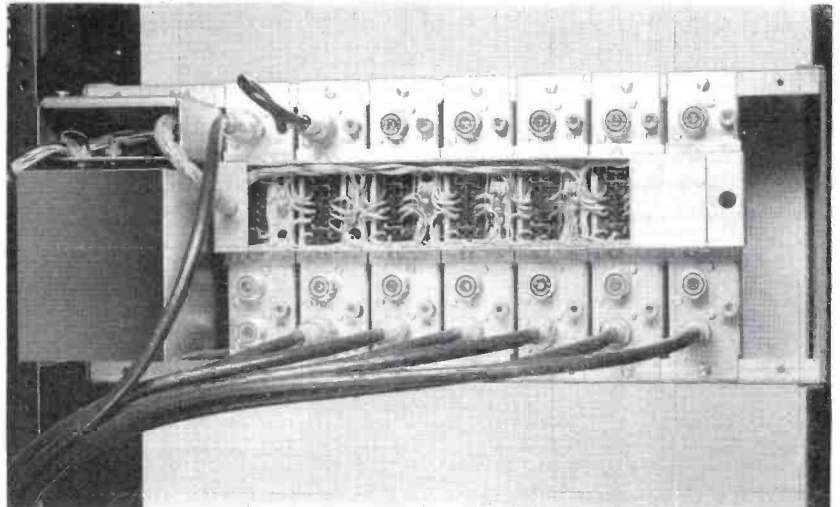

FIG. 17. Rear view of amplifier frame showing input and output connections.

the frame (see Fig. 17). A built-in wiring duct with snap-on covers is provided to protect the power wiring which includes +280 volts supplied from an external regulated power supply. The connector plate for the sync or blanking adder is equipped with a short coaxial jumper for direct connection to the associated output or distribution amplifier. Dummy covers are provided to improve the appearance of

the front of the amplifier frame when all of the available mounting spaces are not utilized.

Tally Relay Equipment

It was noted earlier that each video cross-point has the equivalent of a pair of

tally contacts to operate an auxiliary circuit. This tally output may be used to light one lamp or to operate one relay. In the majority of cases, it is desirable to employ a multi-contact relay to operate the multiple tally lamps on cameras, monitors and control panels, and to operate such

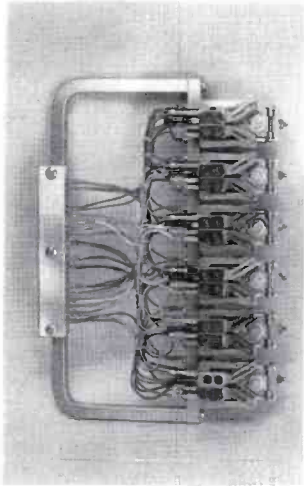

FIG. 18. The tally relay group is an assembly of six tally relays. It corresponds to the cross-point group, and each relay is operated by tally voltage supplied by a specific cross-point.

auxiliary circuits as sync interlocks and audio ties. The tally relay provided for this service in TS-40 Systems has four sets of Type A contacts ("make" only), and two sets of Type C contacts ("break before make"). The relays are mounted in groups of six (see Fig. 18) to form direct analogues of the video cross-point groups.

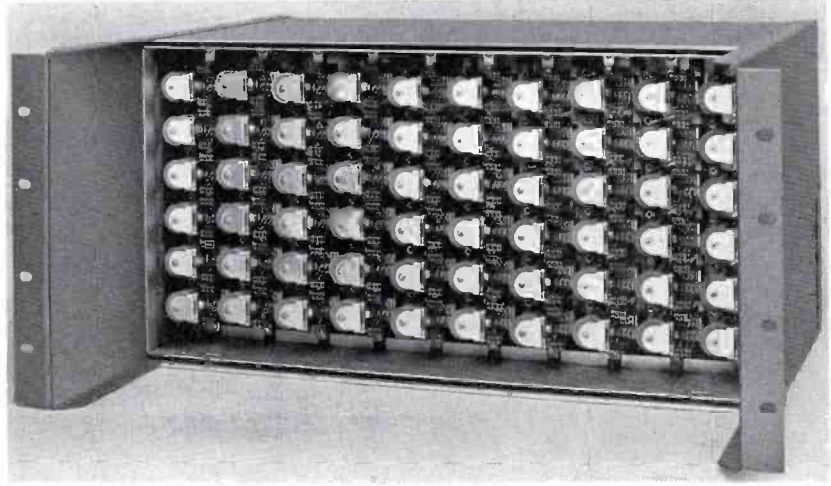

FIG. 19. Up to ten tally relay groups may be mounted in a tally relay frame as shown.

The most commonly used tally circuits are prewired between the taper tab terminals on the relays and a taper pin junction block at the rear of the tally relay group. Extra contacts and terminals are available for the nonstandard tally or interlock circuits that may vary from one system to another. Up to ten tally relay groups may be mounted in the tally relay frame (see Fig. 19). The mounting arrangement is such that all relay contacts may readily be inspected or serviced upon the removal of a dust-tight front cover. External connections are brought in through dust-shielded openings at the rear of the frame, and terminate at the taper pin junction block (see Fig. 20).

A relay fuse panel, shown in Fig. 21, is available for use in systems where it is desired to provide separate fusing for the several branches of complex tally circuits. The panel contains twenty $\frac{1}{4}$ -ampere fuse holders, each with an indicating lamp.

Control Panel Components

All control panels for TS-40 Switching Systems are custom built to customer specifications, in recognition of the fact that most broadcast stations have individual operating requirements. Figure 22 illustrates a typical arrangement of push-button switches and fader levers for a TS-40 System of moderate size. The locations and the types of push buttons may be varied to suit customer preferences.

In addition to push buttons and fader mechanisms, there are two types of etched wiring circuit plates that are mounted beneath the control panels to serve important functions in TS-40 Systems. The first of these is the trigger circuit plate, shown in Fig. 23. This circuit is a single-input six-output transistorized amplifier, which serves to distribute the trigger pulses generated by the WP-40 Transistor Power Supply to as many as six rows of push buttons. (Additional trigger circuit plates

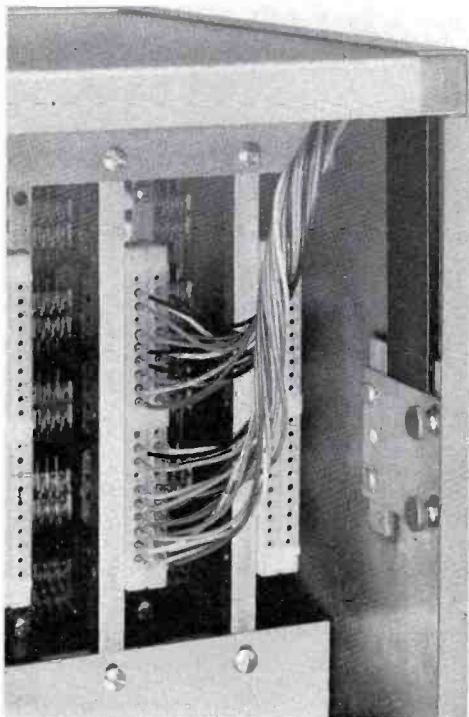

FIG. 20. Rear view of tally relay frame showing taper pin type connectors.

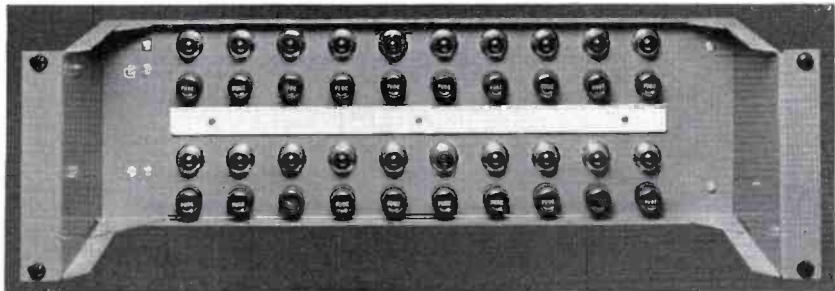

FIG. 21. Relay fuse panel provides separate fusing for several branches of complex tally circuits.

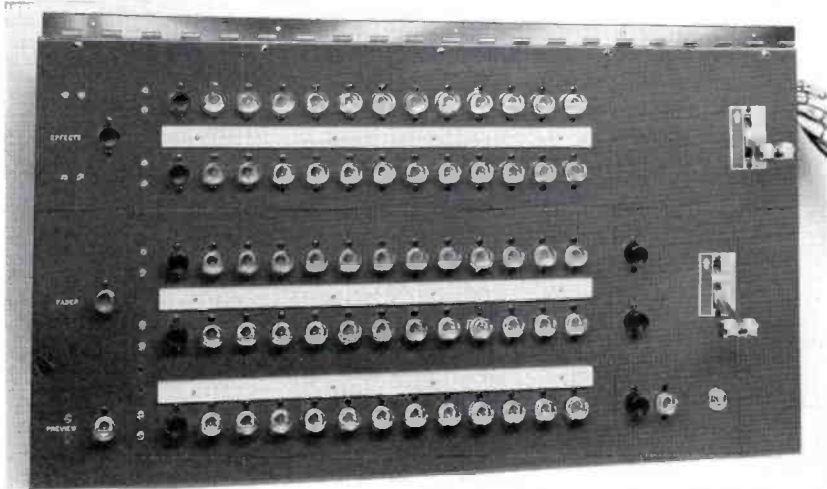

FIG. 22. Control panel showing a typical arrangement of push-button switches and fader levers for a TS-40 System of moderate size.

may be employed for panels with more than six rows of buttons.) Each time a push button is pressed it connects the corresponding cross-point to a source of pulses derived from vertical blanking. The very first pulse which passes through activates the cross-point, and the complete switching action occurs at the end of vertical blanking. This results in an exceptionally "clean" switch—equivalent to a good interframe splice in motion-picture film.

The second special control panel component is the trigger pulse repeater, shown

in Fig. 24. This device may be used to make any cross-point a "slave" of one or more other cross-points, so that the "slave" will always be activated when any one of the "masters" is in use. This feature is very useful in switching systems which employ delay compensation to keep the total time delay through the system constant no matter which signal path is "punched up." Figure 25 is a simplified sketch illustrating the function of the trigger pulse repeater in a system with delay compensation. The push buttons for the secondary

switch, shown at the right in this sketch, may be mounted in the same row as the others in the program bus so that, functionally, the operator may treat them as part of the same switching bus. No button is required for the cross-point operated by the trigger pulse repeater. When any of the cross-points to the left of the delay compensation line (actually a length of coaxial cable) are operated, the trigger pulse repeater produces a pulse to close the second cross-point automatically. Thus, the circuit is completed through to the output.

The trigger pulse repeater is actually an amplifier followed by a clipper. The isolating resistors, required at its input to prevent crosstalk between the several push-button circuits, cause a substantial reduction in the level of the trigger pulses applied to the repeater. However, its gain is sufficient to produce trigger pulses of normal amplitude at its output.

Transistor Power Supply, Type WP-40

In the design of the individual modules for TS-40 Systems, great emphasis was placed on reducing the number of repetitive components to an absolute minimum, and on eliminating all adjustments in the individual cross-points and latch circuit plates. These objectives were achieved through the use of several carefully chosen supply voltages which permit maximum use of direct coupling and other simplification techniques. The special voltages required for the transistorized circuits are all supplied by the WP-40 Power Supply, shown in Fig. 26. In addition, standard 280-volt supplies (such as the RCA 580-D or WP-15) are required for the amplifier complement, and a 24-volt supply is required to operate tally lamps and auxiliary relays. (The coils of the tally relays operated directly by the cross-points are powered by the WP-40, but the circuits

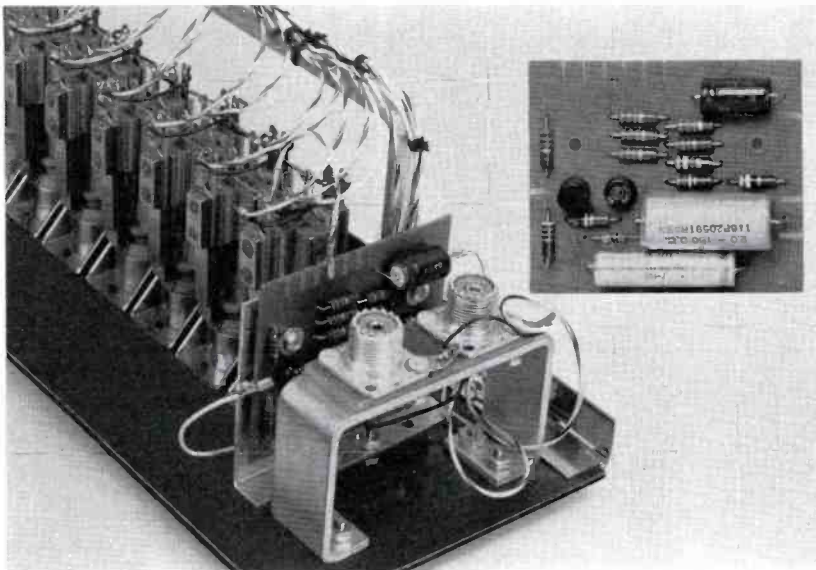

FIG. 23. The trigger circuit plate is used to distribute trigger pulses to as many as six rows of push buttons. It is also shown here mounted to an auxiliary control panel.

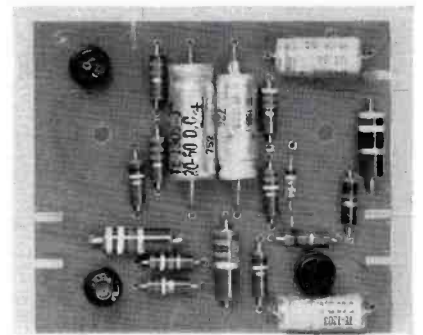
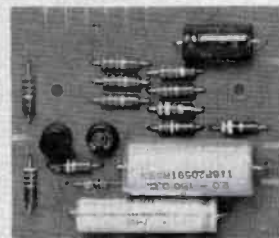

FIG. 24. The trigger pulse repeater slaves any cross-point to one or more other cross-points.

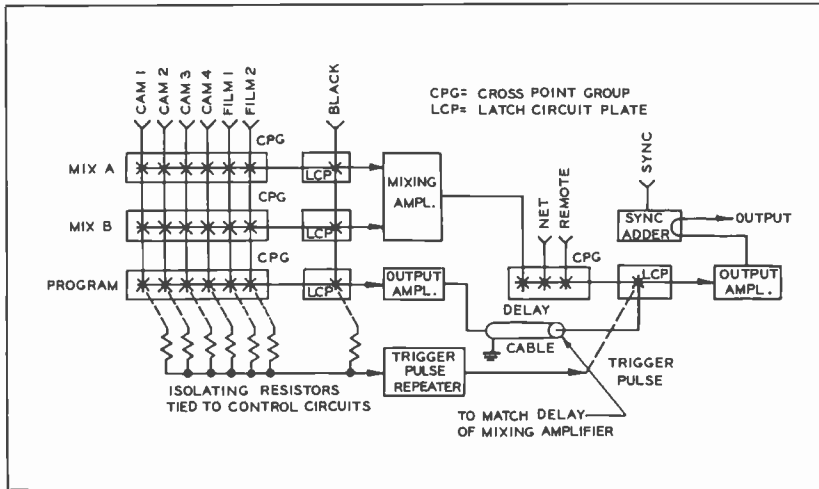

FIG. 25. Simplified sketch illustrates the function of the trigger pulse repeater in a system with delay compensation.

controlled by their contacts require external power.)

The WP-40 actually consists of four basic supplies, two auxiliary supplies, and a trigger pulse generator. The basic supplies operate at 20, -20, 5, and 18 volts (neither end of the 18-volt supply is grounded directly). They are driven from separate windings of a common transformer, and they all employ semiconductor rectifiers and transistorized regulators. A common voltage reference system is used so that only one voltage calibration adjustment is required for all four branches. The auxiliary supplies deliver 4.4 and 3 volts—both are regulated bleeders operated from the basic 5-volt source. Several of the series transistors employed in the regulator circuits are mounted on a convection-cooled

heat sink, which is the large black structure shown in the center of Fig. 26. The four major branches of the supply are separately fused, and two meters are provided for checking the ac input voltage and the dc output voltages and currents.

The main collector supply for most of the transistorized circuits (corresponding roughly to the B supply for tube circuits) is -20 volts. The 20-volt source is used primarily for biasing the transistors, and requires less than half the current capacity. The 5-volt source and its 4.4 and 3-volt branches move the operating points for several key circuits away from ground, so that the video input signals may be injected at points corresponding to dc ground. The 18-volt source is used to operate the tally relays. The WP-40 has ample capacity for

TS-40 Systems up to 24 inputs and 10 outputs. The maximum current required for any major branch of the supply is about 2.1 amperes (for the -20-volt source).

The coaxial fittings at the rear of the WP-40 Power Supply are for the blanking input and the trigger pulse output of the trigger pulse generator incorporated in the supply. This generator consists of a transistorized circuit for deriving pulses suitable for triggering TS-40 cross-points (through the push-button switches on the control panel). The pulses are derived from the trailing edge of vertical blanking, so that the switch always occurs shortly *after* a vertical retrace period, thus minimizing the probability of a vertical roll-over when switching between pictures of widely different duty cycles. The output pulses are at a level of about 30 volts peak-to-peak, and are conducted by a coaxial cable from the trigger pulse generator to the trigger circuit plates mounted under the control panel. The pulse rise time is deliberately made quite long so as to limit the high frequency energy in the pulses. This permits them to be conducted along ordinary wires from the control panel to the cross-points without significant cross-talk between leads.

Effects Equipment

Mixing and fading operations in TS-40 Switching Systems may be accomplished with the mixing amplifier, shown in Fig. 27. This amplifier has two independent video inputs and a common output. The gain of each input channel may be controlled remotely by a potentiometer, usually mounted on a fader lever assembly. The circuit design is such that no clamps are required; the dc voltages supplied by the

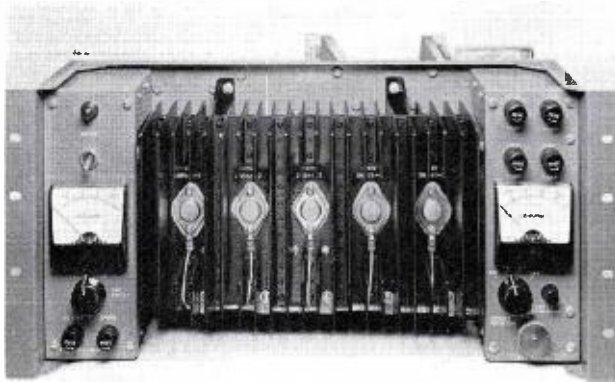

FIG. 26. Special voltages required for the transistorized circuits are provided by the WP-40 Power Supply.

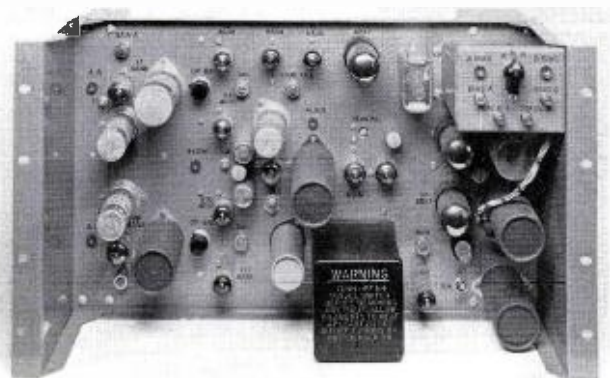

FIG. 27. The mixing amplifier used with the system has two independent video inputs and a common output.

fader potentiometers do not cause disturbances on the video output because balanced circuits are used.

Special effects such as wipes, split screens, and video insets can be accomplished with the TA-25 Special Effects Amplifier and the TG-25 Special Effects Generator. The former has three video inputs, each of which should be connected to a separate bus of a TS-40 System. The inputs are: Picture A, Picture B, and Keying. The keying signal might be derived from any camera source for such purposes as inset letters, inset trademarks, or self-keyed video insets. For interesting transitional and split-screen effects, however, the most suitable keying signal source is the TG-25 Special Effects Generator. This device is supplied with a special control panel with means for selecting a wide variety of patterns, including horizontal and vertical wipes, diagonal and pointed wipes, corner inserts, horizontal and vertical splits, and rectangular or diamond-shaped iris effects. Special effects equipment of this nature, when properly integrated in a TS-40 Switching System provides excellent facilities for building unusual, interest-sustaining television programs and commercials.

Assembling the System

All of the TS-40 System, components with the exception of control panels, are rack mounted. Figure 28 shows two racks containing the major components of a typical TS-40 Switching System. This is nominally a 12-input 6-output system, which includes several secondary switching facilities requiring additional components. Its space requirements are typical of systems with up to 12 inputs and 10 outputs.

The main switching elements (the cross-points) are mounted in the cross-point frame near the center of the rack on the left. It is at the rear of this frame that the picture signals are brought into the system. The outputs from the switching matrix are brought out through the latch frame, mounted immediately below the cross-point frame, and are directed through the output amplifiers mounted in the two amplifier frames near the top of the rack. Interspersed among the output amplifiers are two heater and bias supplies and the sync or blanking adders. At the bottom of the rack are two tally relay frames, containing the relays needed to operate tally and auxiliary circuits. Immediately above them is a relay fuse panel and the WP-40 Power Supply.

The right-hand rack shown in Fig. 28 contains, from top to bottom, a mixing

amplifier, a TA-25 Special Effects Amplifier and a TG-25 Special Effects Generator. Other components of the system not shown in this photograph are the 280-volt power supply, the 24-volt relay power supply, and the control panel.

Thus, a transistorized switching system may be assembled using the building blocks described. For the purpose of introducing new concepts and terminology in TV switching parlance, this discussion has emphasized the physical make up of the TS-40 Switching Equipment, highlighting many of the advantages of the equipment from the standpoint of system flexibility and compactness. Future articles will depict the electrical functions of transistorized circuitry and outline several typical applications of TS-40 Systems.

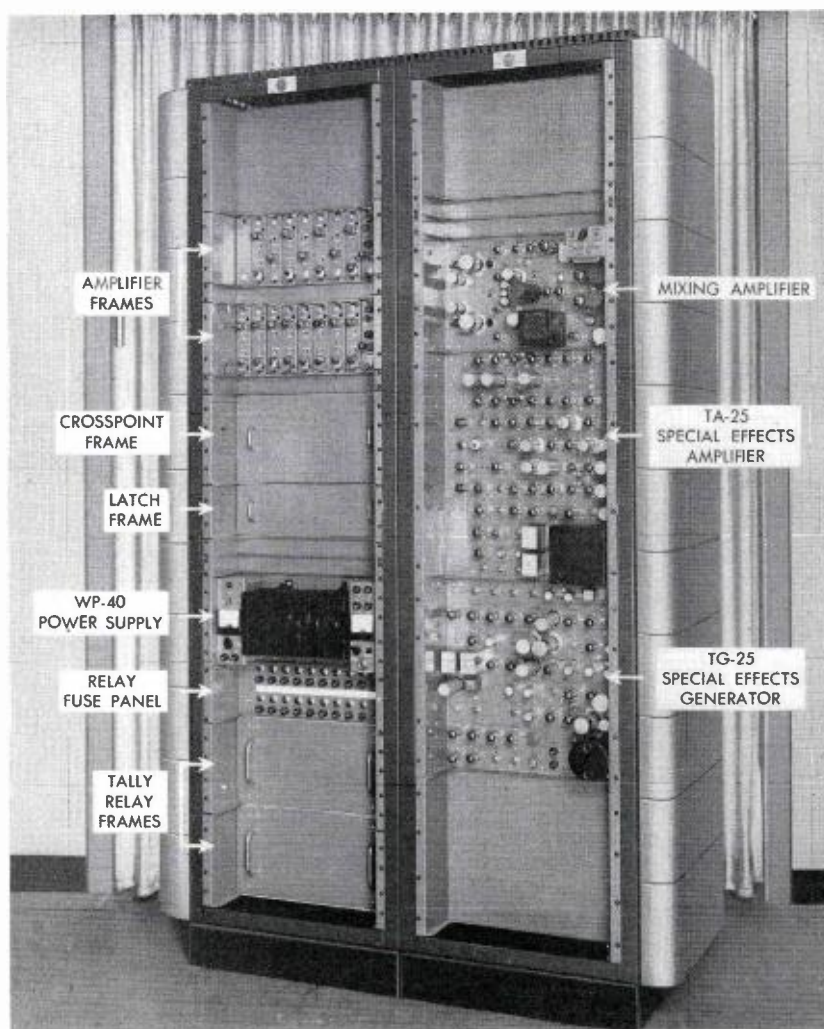

FIG. 28. Major components of a typical TS-40 Switching System are shown and identified in the two racks illustrated.

FIG. 1. Front view of BTA-5R. Easy access to all tubes and operating controls is made through the two interlocked front doors. The PA, modulator, and rectifier components are in the cabinet on the right, and the exciter, IPA, and control equipment are on the left. Attractive aluminized-steel cabinets provide improved shielding, and the doors are available in a choice of red, green, blue, or gray finishes.



NEW 5000-WATT AM TRANSMITTER

Compact Size, Standardized Circuitry and a Semiconductor Power Supply Offer Outstanding Performance in the Type BTA-5R/5R1

by J. NOVIK and I. E. SKARBK, Broadcast and Television Equipment Division

The new RCA Type BTA-5R/5R1 is a true, high-fidelity, transmitter that will offer years of outstanding performance. Two attractive cabinets are used to house the complete 5-kw transmitter, which is made up of basic standardized circuits of the same type used in the BTA-500R/1R, permitting easy power cutback. Long-life silicon, high-voltage rectifiers lower operating costs in the BTA-5R1 Transmitter. Electrical and mechanical construction reveal newest trends in dependability and performance. Many outstanding features such as built-in remote-control provisions and Conelrad switching simplify operation.

Functional Design

The entire transmitter, except for the plate transformer, is housed in two attrac-

tively styled cabinets made of aluminized steel to provide improved magnetic and electrostatic shielding (see Fig. 1). Each cabinet consists of end panels with wrap-around front edges formed to provide control panels mounted on a sturdy, welded steel base. Vertical center chassis are fastened between the end panels to form a basic "H" cross section. Hinged, front doors are located between the control panels. Rear access to each cabinet is provided by two removable, interlocked panels (see Fig. 2).

Quality Design

Another mechanical benefit is the vertical chassis construction. The front doors of the BTA-5R give immediate access to the front of these vertical chassis on which

tubes, feedback ladders, overload relays are mounted (see Fig. 3). Remaining components are mounted on the rear of these chassis, while the larger power components are mounted on the base of the cabinet (see Fig. 4). This type of construction offers excellent accessibility.

Another advantage is that the panels can be pre-assembled, wired and circuit-checked on a bench; then after completion they are mounted within the enclosure. Since the assembly and wiring are done under optimum conditions, this results in improved quality.

Standard Exciter-Driver

To provide further economies to the broadcaster, new design techniques are uti-

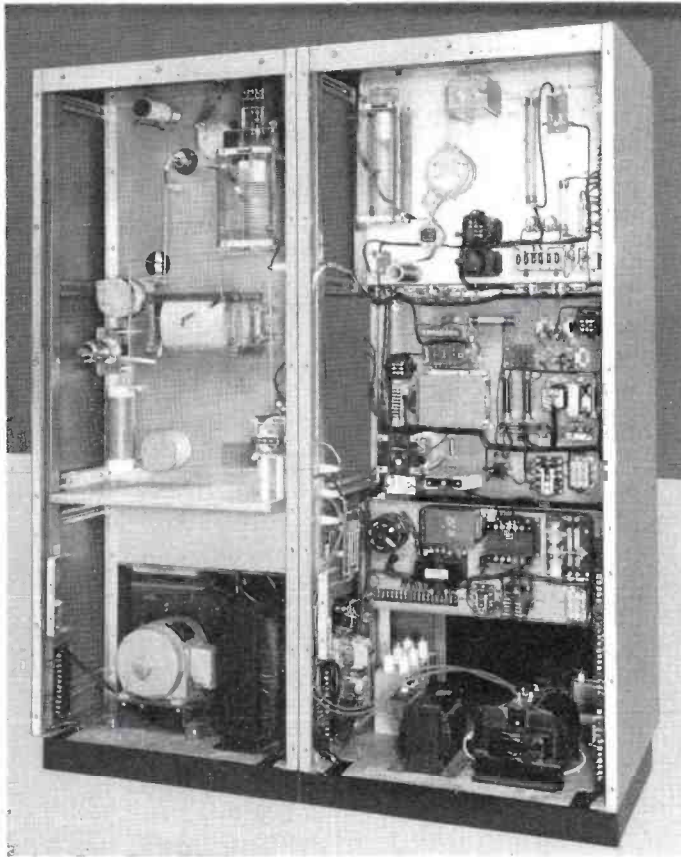

FIG. 2. Complete rear access to all components is made through easily removable interlocked panels shown removed here. Note the complete access to all wiring and components.

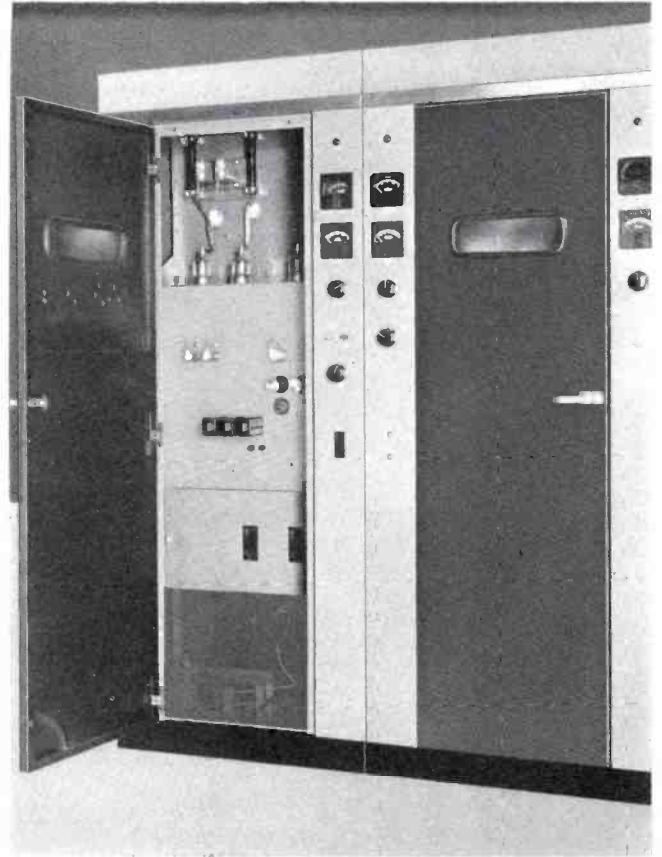

FIG. 3. The IPA and modulator driver stages are shown at the top of the opened cabinet. The exciter is at the center of the cabinet, and control equipment is placed just below it.

FIG. 4. The door of the PA cubicle opened to provide access to PA and modulator. The easily removed panel in the center of the cabinet encloses the silicon rectifiers. At the bottom of the cabinet note the modulation transformer and blower.

lized to provide standardization of electronic circuits. The BTA-5R utilizes the same unique exciter (see Figs. 6 and 7), that is featured in the lower power BTA-500R/1R Transmitters. It incorporates the new type of oscillator with 3-switchable, temperature-controlled, crystal units (see Fig. 7). Each crystal unit will remain constant within ± 5 cycles, and any of the three crystals can be selected with a front-panel switch, or by means of a remote-control switch, since relays are built into the exciter. The three crystal units provide an operating crystal, a spare on the main channel, as well as provisions for automatic Conelrad switching.

Basic Circuits

New broadband oscillator and buffer circuits require no adjustment. A 6AK5 is



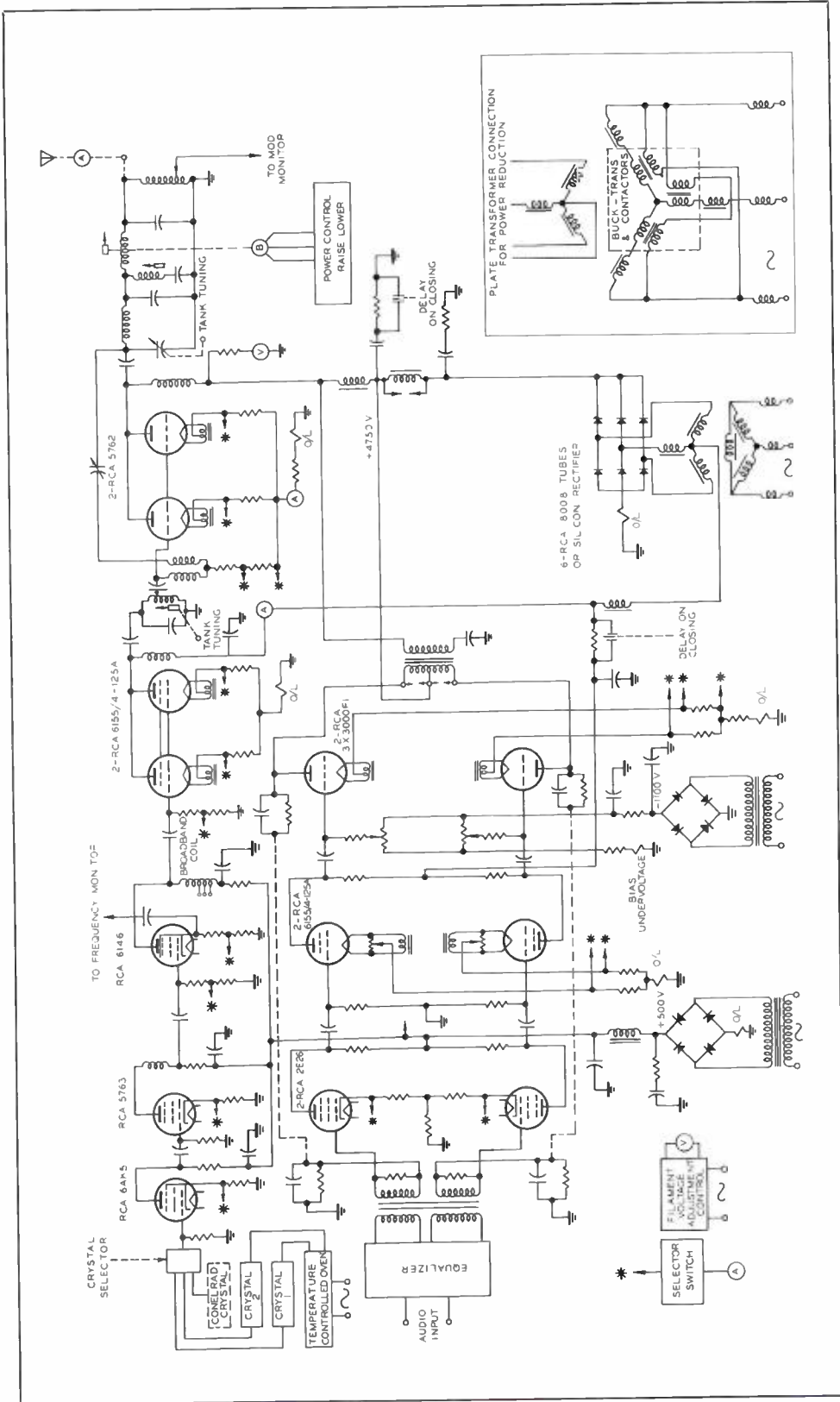

FIG. 5. This is a simplified schematic of the BTA-5R and BTA-5R1. The only physical and electrical difference is the type of rectifier used. The BTA-5R1 uses silicon cells in place of the 8008 rectifier tubes.

FIG. 6. The rear of the exciter, IPA, and modulator driver stages are shown here. Again the very convenient access to all components is vividly illustrated. Note A is the easily removed cover for the etched circuit oscillator.

used as an oscillator tube with a 5763 as the buffer, and this unit is built on an etched circuit panel easily accessible for service by removing the cover. The entire oscillator unit can be removed by disconnecting a cable plug and retaining screws (see Fig. 6). Also a part of the basic exciter is the 6146 IPA stage which is operated very conservatively and a pair of 2E26 tubes used as the first af stage of the modulator circuit (see Fig. 7).

IPA and PA Stages

The output of the 6146 IPA stage is broadband and requires no tuning. It drives a pair of 4-125A tubes where tuning is accomplished by means of a slug-tuned coil, controlled from the front panel. These tubes, in turn, drive two long-life 5762 output triodes where a front-panel control of the vacuum variable capacitor tunes the plate circuit. A new slug-tuned coil was developed for power output adjustment, where a series coil in the tank circuit is adjusted by a reversible motor. The motor is actuated from front panel or by a remote power output control (see Fig. 8).

The second harmonic trap uses a variable slug-tuned coil; however, the coil does not employ moving contacts, thus eliminating the possibility of contact pitting from high current in the rf circuit of the transmitter.

Neutralization of the 5762 PA stage is achieved by a broadband transformer and a variable vacuum capacitor. The use of a broadband type of transformer holds neutralization over a wide band and prevents spurious oscillation at other frequencies.

The Linear Modulator

The modulator of the transmitter consists of a pair of 2E26s' located in the exciter portion, resistance coupled to drive a pair of 6155/4-125A second af amplifiers which, in turn, are resistance coupled to drive a pair of 3X3000F1 modulators. It is worthy to note that these modulator tubes are low μ triodes, drawing no grid current and with improved circuits they are capable of excellent response and fidelity. Typical curves at different levels of modulation are shown in Fig. 9.

FIG. 7. This is a close-up of the exciter chassis with two crystal units in place and just above the crystals is the 6146 rf driver. To the left, note the pair of 2E26 tubes for the af input. Below the exciter the circuit breakers and fuses are shown with panel removed.

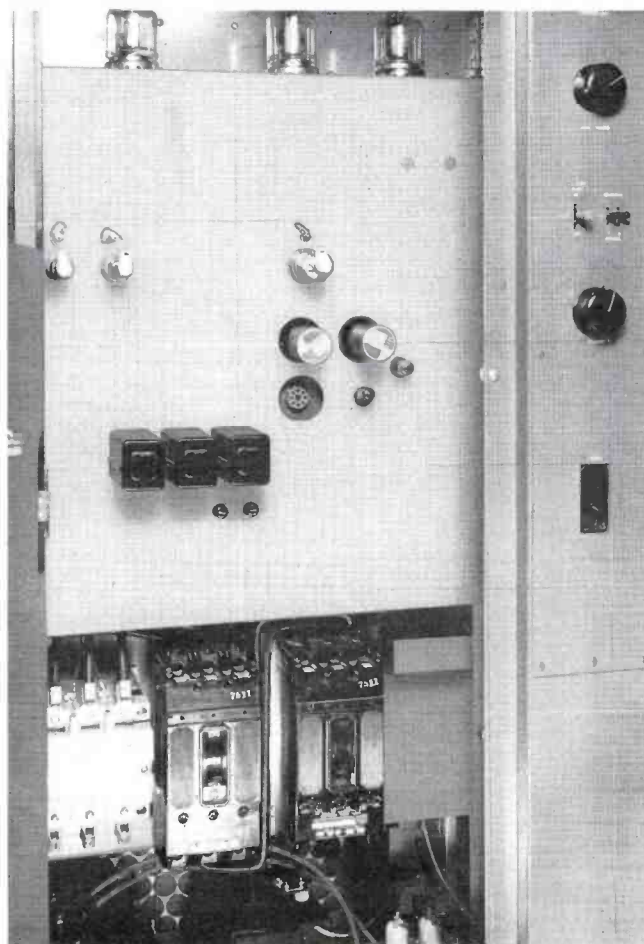
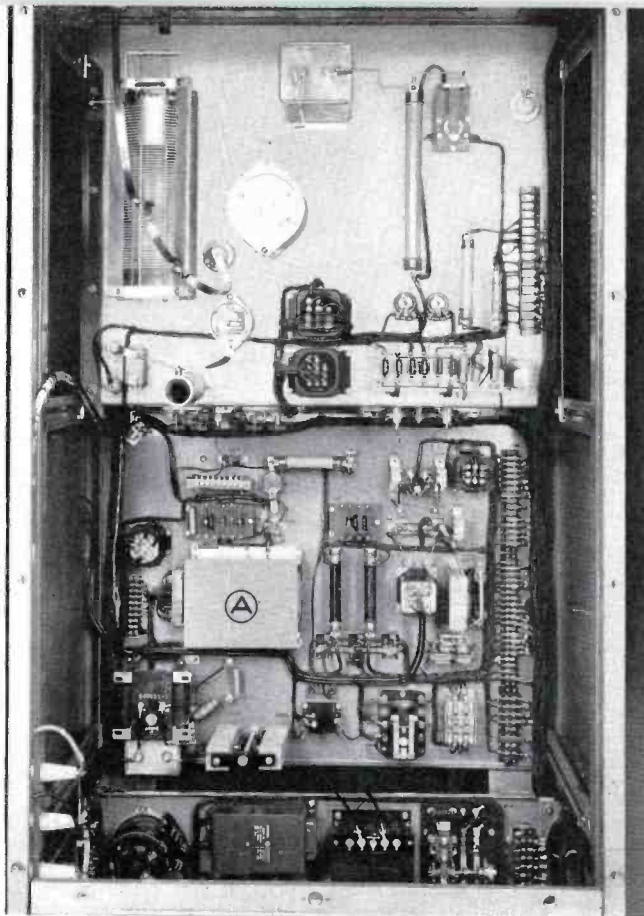

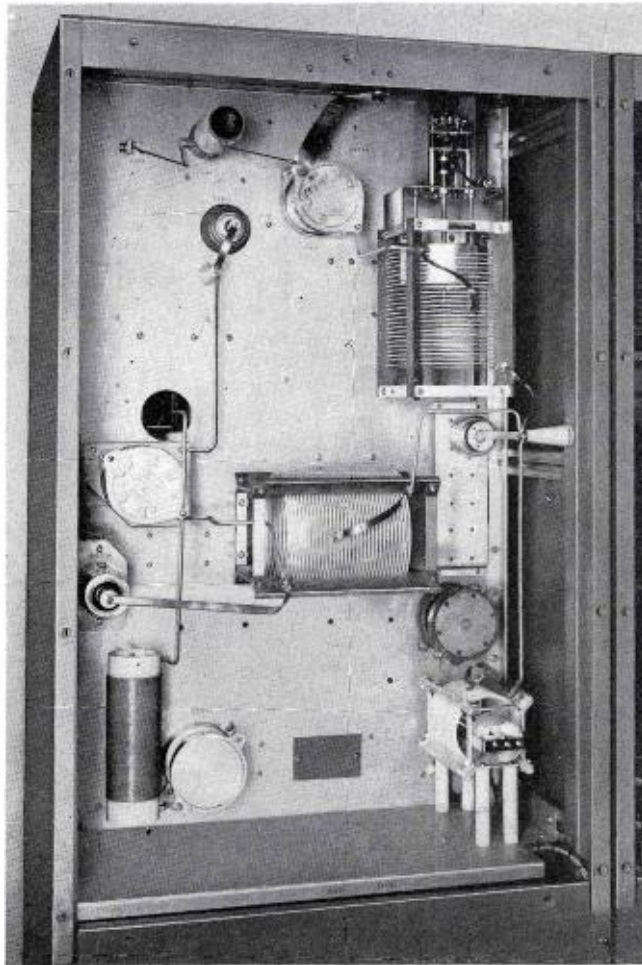

FIG. 8. The motor-driven, slug-tuned, power-output coil is shown in the upper right. The tuning control is on the front panel.

Semiconductor Power Supply

The BTA-5R normally is supplied with Type 8008 RCA Tubes for the high-voltage rectifier. However, in keeping with the latest trend to improve products, another version of the BTA-5R has been developed—the Type BTA-5R1, which incorporates silicon-type rectifiers in the high-voltage circuits (see Fig. 10). This type of rectifier is ideal not only in a combined operation, but even more so in a remote-control application. The transmitter will operate within ambient temperatures from -20 degrees centigrade to $+45$ degrees centigrade, and up to 7500 feet above sea level.

20-Year Endurance Tests

The new silicon rectifiers were tested in a preproduction model of the BTA-5R1, where the rectifier and the control portion of the transmitter was aged an estimated equivalent of 20 years, while at the same time the remaining portion of the transmitter was subjected to severe test conditions. The transmitter, adjusted for 5.5-kw output power, was driven by an off-air receiver with positive peaks in excess of 110-percent modulation, averaging 85 percent, and it was also subjected to ON/OFF plate switching every 45 seconds for a total of 7000 operations.

During the switching tests, as well as during an extended continuous operation test, numerous overload conditions were simulated at random. This consisted of shorting the high-voltage bus to ground in order to determine if the protective circuit design was more than adequate. Line voltage was varied over the range to approximate the normally encountered field condition.

All these tests were performed to judge the ability of silicon rectifiers and to evaluate their use under the most adverse conditions. The transmitter normally draws 2.8 amps with 100-percent modulation at 1000 cycles. The continuous rating capability of the rectifier is 60 amperes with a 250-amp overload capability within 0.1 second of time. Characteristics of the silicon semiconductor diode are not affected

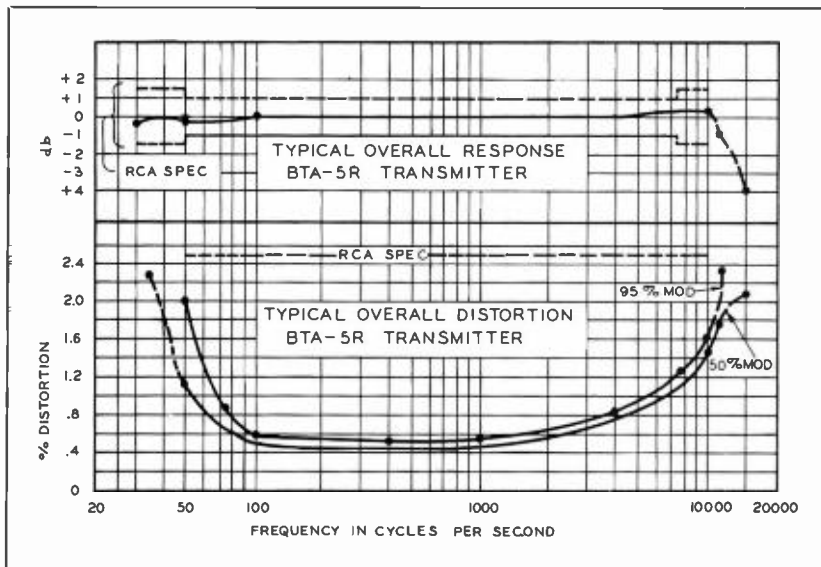

FIG. 9. Typical response measurements for the BTA-5R. Note the measured response compared with the specifications.

FIG. 10. This is the silicon rectifier chassis. Two banks of thirty silicon cells each make up the full wave rectifier that should not be affected by age, moisture, or wide temperature variations.

by age, moisture or a wide temperature variation due to its inherent properties. The silicon rectifiers used in the transmitter are of sealed-type construction and are maintained at ambient temperature owing to its location within a large volume of air stream. Shunt resistors have been placed across each of the silicon cells so that they will all equally share the peak inverse voltage rating (see Fig. 10). RCA specifications have been set higher than normal by adding an additional 30-percent peak inverse voltage safety factor.

Cooling System

In keeping with modern trends, the transmitter is air cooled. Added refinements such as a delay relay have been built-in to keep the blower system in operation for one minute after the transmitter has been shut down which continues the supply of air to extend tube life.

The exciter cabinet employs air-convection cooling with a louvered lower back panel and top grill panel for good ventilation. In the second cabinet the blower air system distributes air to the modulator and PA tubes. Some air from the system is used to cool the PA tank circuit.

Rectifier tubes, if used, are cooled by a small thermally controlled blower which is not used with the dry-disc, silicon rectifiers. When silicon, high-voltage, rectifiers are installed, air from the main blower is used providing an additional safety factor.

Overload Protection

To increase reliability, improvements were made in the control and protective circuitry of the BTA-5R/5R1 Transmitters. Primary lines are protected by circuit breakers with thermal and instantaneous overload trip protection. The 3-phase blower is protected by a contactor with the thermal cutoff in each phase; the relay switching is sequential so that the filaments will not come on unless blower is operating.

Low voltage is delayed for 30 seconds to allow proper filament heating. The high

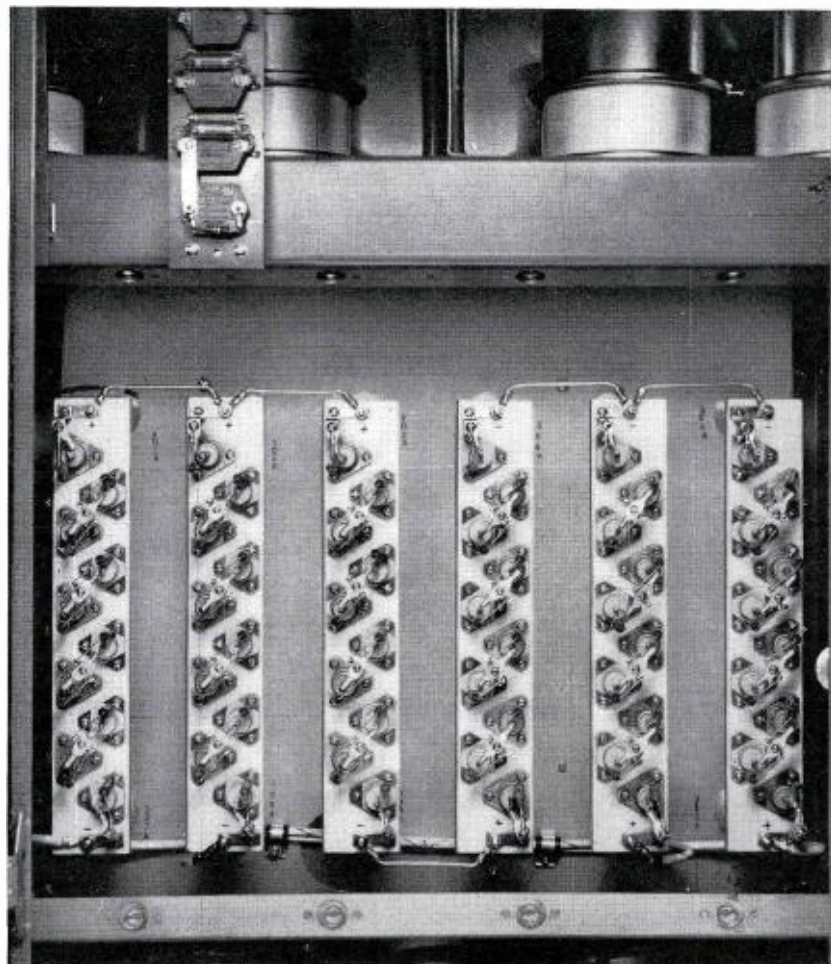

voltage is interlocked with the low voltage and the bias supply so that it will come on only after the low voltage and bias potential is present. Overload protection is also provided in the low-voltage supply, the second af stage, the IPA stages, the modulator, the PA stages and the high-voltage rectifier. They are of instantaneous action and each overload relay carries a spare set of contacts wired to terminals which may be connected to an external indicator unit.

Starting surges in the plate transformer, high-voltage reactor, and the filter capacitor are all eliminated by the use of a step-start and damping circuit. This at one time was only available in the higher-power transmitters, but now longer life and added reliability are assured in these new 5-kw transmitters with the incorporation of this circuit for the suppression of starting transients.

Smaller Transformers

Continuing research has added still another feature to this RCA transmitter. Grain-oriented steel and epoxy resin are used in the manufacture of plate transformers, this results in realizing half the size that would be normally expected in a transformer of this power. This also reflects in lower floor area requirements while still providing high-quality components.

Modern Design

Many years of design experience are reflected throughout. Emphasis has been placed on the reliable, dependable performance that will prove itself in years of trouble-free operation. The new transmitters are designed for economy of operation without sacrifice of performance. Functional styling is incorporated, giving a choice of red, green, blue or gray doors to enhance the station decor.

NEW 5-KW FM TRANSMITTER

FEATURES UNIQUE RF CIRCUITS

**High-Gain Tetrode IPA and PA
Stages Assure Faithful Transmission
of Broadband Multiplex Signals**

by DAVID BAIN and J. A. AURAND
Broadcast and Television Equipment Division

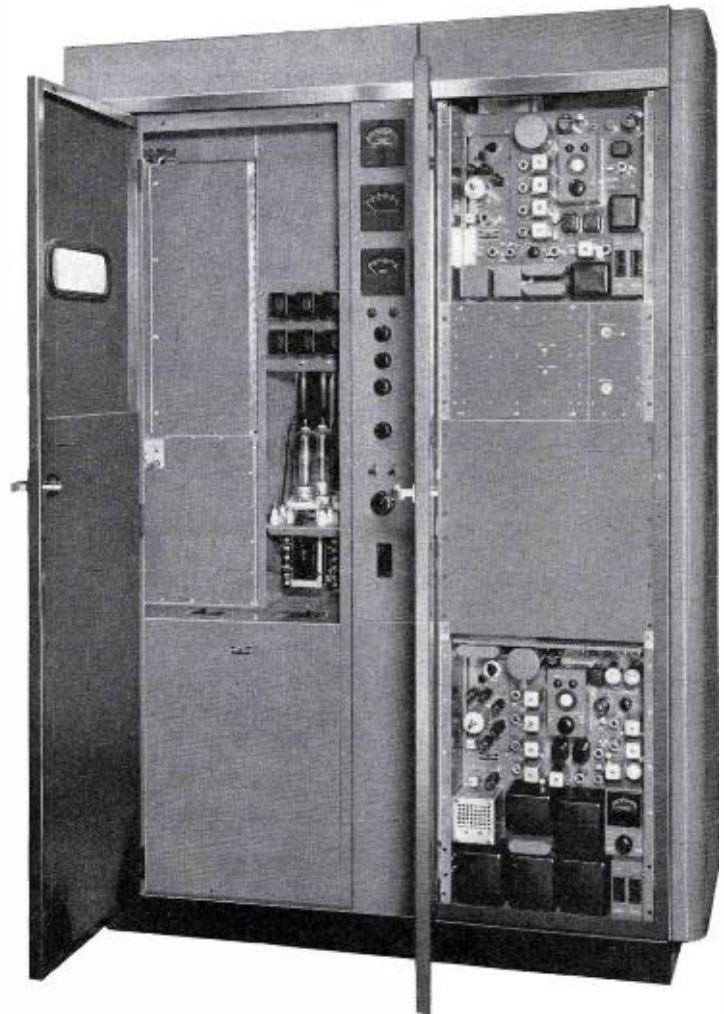

FIG. 1. Front view of the BTF-5B FM Transmitter. The cabinet on the left houses the PA stage, the rectifiers and the blower. The right cabinet contains the BTE-10B Exciter and the IPA stages, and enough space is provided for mounting a BTX-1A Multiplex Subcarrier Generator (shown mounted in upper portion of right cabinet).

With the recent resurgence of FM Broadcasting, the need arose for transmitting equipment, built to present-day standards and designed to utilize the new technique of multiplexing, in order to provide for additional program services. The new RCA 5000-watt FM Transmitter, Type BTF-5B, has been designed to meet broadcasters' requirements for simultaneous transmission of two or more program channels on the same rf carrier. Used in conjunction with the new BTE-10B Multiplex Exciter¹ and the BTX-1A Multiplex Subcarrier Generator this new transmitter

makes a complete FM system for both multiplex and conventional operation.

The rf section of the BTF-5B FM Transmitter is composed of two high-gain tetrode stages with the necessary cooling system, power supplies and control circuits to produce the required five kilowatts of output power. The complete transmitter, including the BTE-10B Exciter, is contained in two metal cubicles with operating controls and meters on the vertical panels of the larger cubicle (see Fig. 1). Space is provided in the smaller cubicle for mounting a Multiplex Subcarrier Generator, Type BTX-1A. The variable, common screen supply is used to control power

output of both stages providing an output power variation of from one to five kilowatts (see Fig. 2).

Tetrode IPA Circuit

The first of the two tetrode stages uses a 7034 tube, located in its own compartment, mounted above the exciter (see Fig. 3). Both the input and output networks of this stage consist of conventional pi networks with variable capacitors as the matching components (see Fig. 4). Tuning from 88 to 108 megacycles is achieved by varying the inductance, which is reduced by the insertion of a silver-plated brass slug into the center of the coil. No neutralization is required for this stage to achieve

¹"New FM Transmitter and Multiplex Equipment." *Broadcast News*, Vol. 102, Oct., 1958.

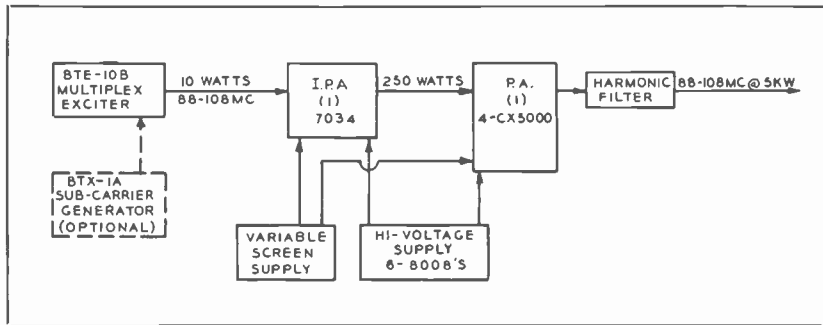

FIG. 2. Block diagram of the BTF-5B FM Transmitter. Note that only two rf stages are used beyond the exciter.

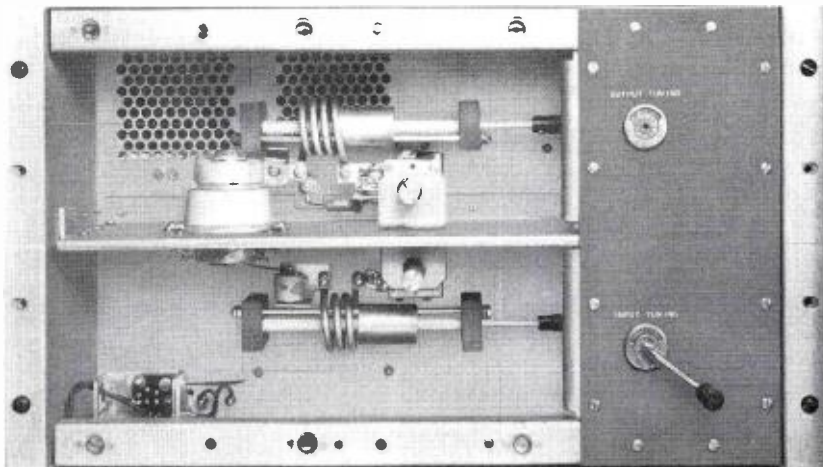
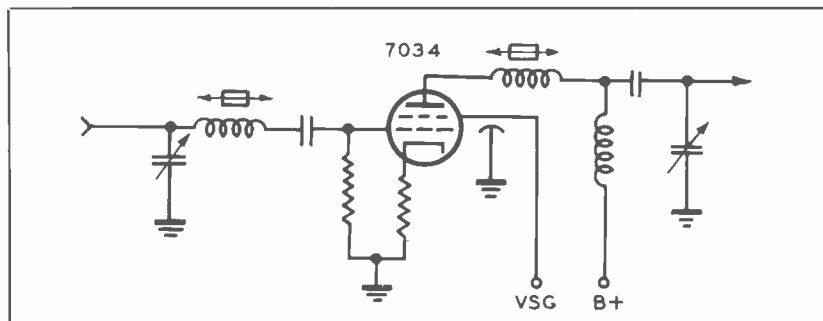

FIG. 3. This is the IPA stage rf compartment. Note the ease of tuning and accessibility.

FIG. 4. Simplified schematic of the 7034 IPA stage. The slug-tuned input and output pi networks provide frequency variation from 88 to 108 mc. No neutralization is required for this stage.

FIG. 5. Here the PA cavity is shown with doors open to provide complete accessibility. The 8008 rectifiers can be seen at the right.



an output of approximately 250 watts to drive the PA stage. Both cathode and grid resistance are used to provide grid bias for this IPA stage.

The 5-KW PA Circuit

The final stage uses a 4CX5000A tube located in the larger rack along with the power supplies and the control circuits (see Fig. 5). The input circuit to this stage is a modified pi network, in which the input capacity of the tube is shunted by an inductive line to reduce the effective input capacity of the stage (see Fig. 6). This inductance also supplies the means

for varying the input circuit loading. The inductive component of the circuit is varied by means of capacity in parallel with the coil.

The output circuit of this stage is also a pi network with the tube capacity shunted by a variable inductance. Loading and tuning are achieved by the variation of the two inductive line components. For mechanical simplicity the pi network is inverted, placing one end of the inductance at ground potential. This removes the mechanical and electrical problems of insulating the variable component from ground; however, the output line must be

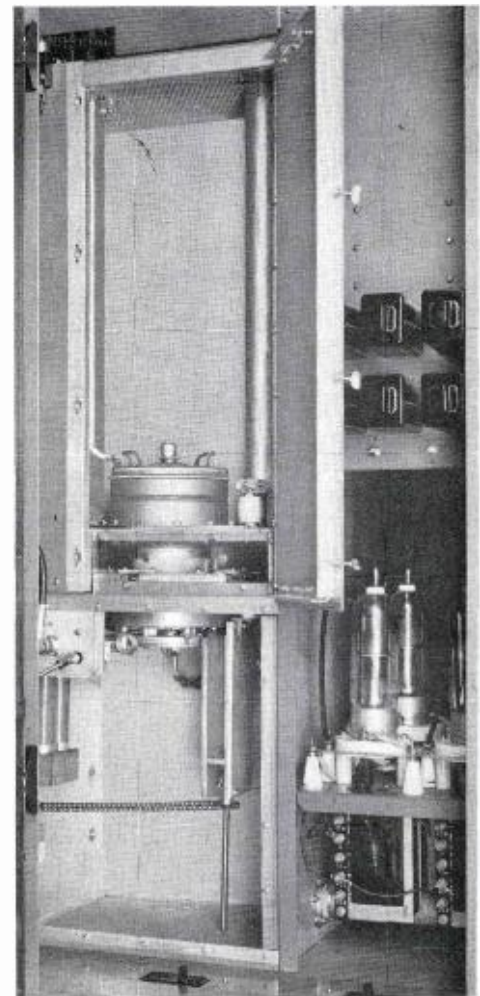

FIG. 6. Simplified schematic of the 4CX5000A PA stage. Note the inverted pi network output whose two inductive components control loading and tuning. A modified pi network input, shunted by an inductive line, reduces input capacity to the PA stage.

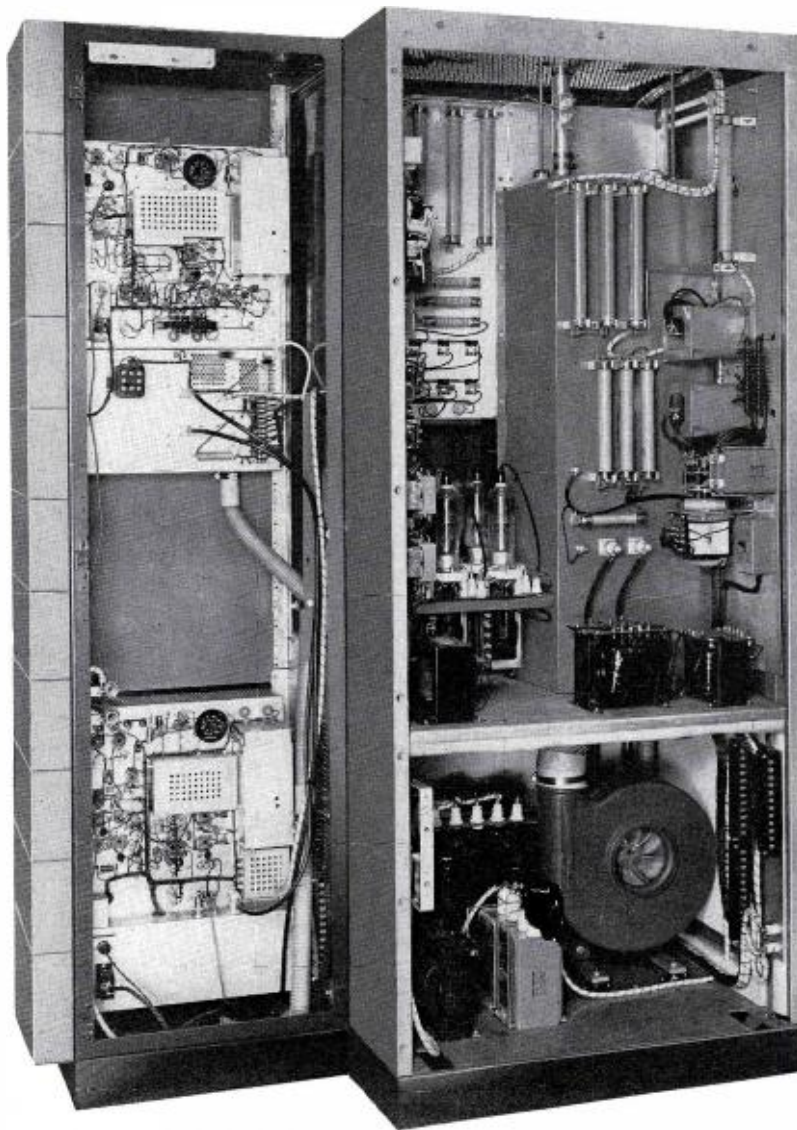
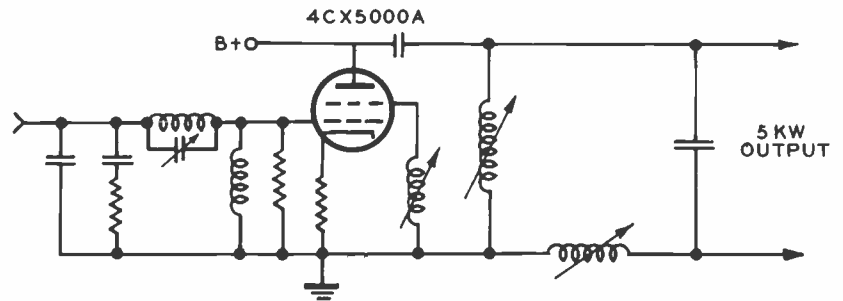

FIG. 7. The excellent rear accessibility of the BTF-5B FM Transmitter permits rapid servicing. The left cabinet shows (from top to bottom) the BTX-1A Subcarrier Generator, the 7034 IPA stage, and the BTE-10B Exciter. On the right, note the blower and power components mounted for ease of maintenance.

parallel to the inductance to bring it to ground potential. This is done by extending the output line down one side of the inductive line. This stage is neutralized by the variation of the inductance in series with the screen capacity.

PA Tuning

To cover the FM frequency range (88 to 108 mc) requires changing of only one frequency determining part in the 4CX-5000A input circuit. For initial tuning, approximate settings for all variable components are set from tuning curves. Final adjustment is then begun under reduced screen voltage for circuit protection.

Control and Protection

The control circuit provides a starting sequence which prevents application of plate voltage before the filaments are warmed up and the cooling system is operating. It also provides overload protection and off-frequency shutdown. A 45-second, time-delay relay provides adequate warm-up time for filaments and exciter. The overload circuit returns the transmitter to the air on the first two overloads after a

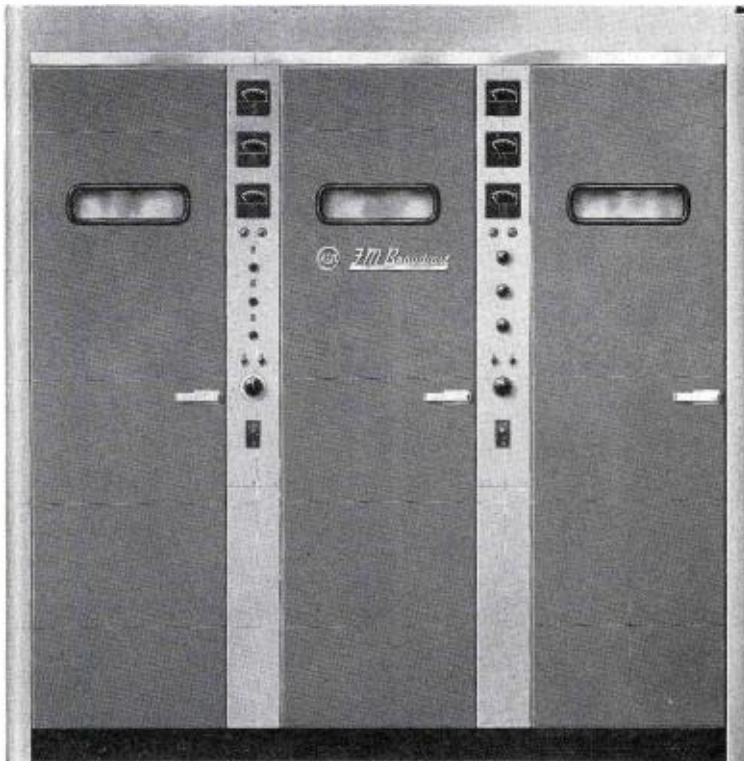

FIG. 8. When two subcarrier generators are used, the BTf-5B is housed in three cabinets as shown above. (Normally the BTf-5B is housed in two cabinets, see Fig. 1.) The third cabinet may be added to house input and monitoring equipment if desired.

clearing time of two seconds. If the overload persists for the third time, manual resetting is required. Overload relays are located in the high voltage and screen supplies, as well as in the cathode circuits of the IPA and PA stages. For remote control of the transmitter the necessary control and metering leads are made available at terminals located at the rear of the cabinet.

Power Supplies

The high-voltage supply is a 3-phase full-wave circuit using six 8008 mercury vapor rectifier tubes. A single-section inductive input filter produces 5000 volts at approximately 1.7 amperes to supply the plate of the 4CX5000A tube. The center tap voltage of the transformer supplies the 7034 plate through a double section RC filter, which filters and reduces the voltage to approximately 1800 volts. The screen voltage supply uses germanium rectifiers in a bridge circuit to feed both stages. The primary of this transformer is supplied from a variable transformer to control its output voltage.

Direct Air Cooling

Three-phase power is applied to the transmitter at the line breaker located on the right-hand front panel of the 5-kw cabinet. Power is then fed to three other breakers: the first supplies power to the filaments, exciter and control circuit; the second, to the high-voltage supply; and the third, to the screen supply.

The "filament on" switch applies power to the blower, and also to the filaments, and exciter provided the blower is operating. The filament line passes through a buck-boost circuit so that it may be adjusted to the exact voltage for which the primary filament transformer taps are set. The 45-second time-delay relay is also energized which prevents application of the high voltage before the time-delay contacts close and all door interlocks are closed. This is indicated by the lighting of the *ready light* on the front panel.

The "transmitter on" switch applies the plate and screen voltage to the two tetrode stages. This is indicated by the lighting of

the "transmitter on" light. A motor-controlled variable transformer in the screen-supply line adjusts the screen voltage by means of the "power adjust" switch.

The cooling system blower is located in the bottom of the 5-kw cabinet, feeding air directly into the 4CX5000A stage. The air for the 7034 stage is tapped off the side of the 4CX5000A box by means of flexible tubing feeding through the side of the cabinet (see Fig. 7). Air interlocks are provided in both stages to remove plate and screen voltage if the cooling air should stop.

Complete FM System

Coupled with RCA's new broadband FM antennas,² the BTf-5B Transmitter can provide effective radiated powers from 4 to 60 kw. The entire chain meets all current FCC and industry standards, including proposed requirements on spurious emissions, cabinet radiation, and harmonic radiation.

² "New Broadband FM Antennas," *Broadcast News*, Vol. No. 101, August, 1958.

TWO NEW AUTOMATIC TURNTABLES

*Afford an Easy Economical Approach to
Semiautomatic Programming Using
45-RPM and Magnetic Disc Recordings*

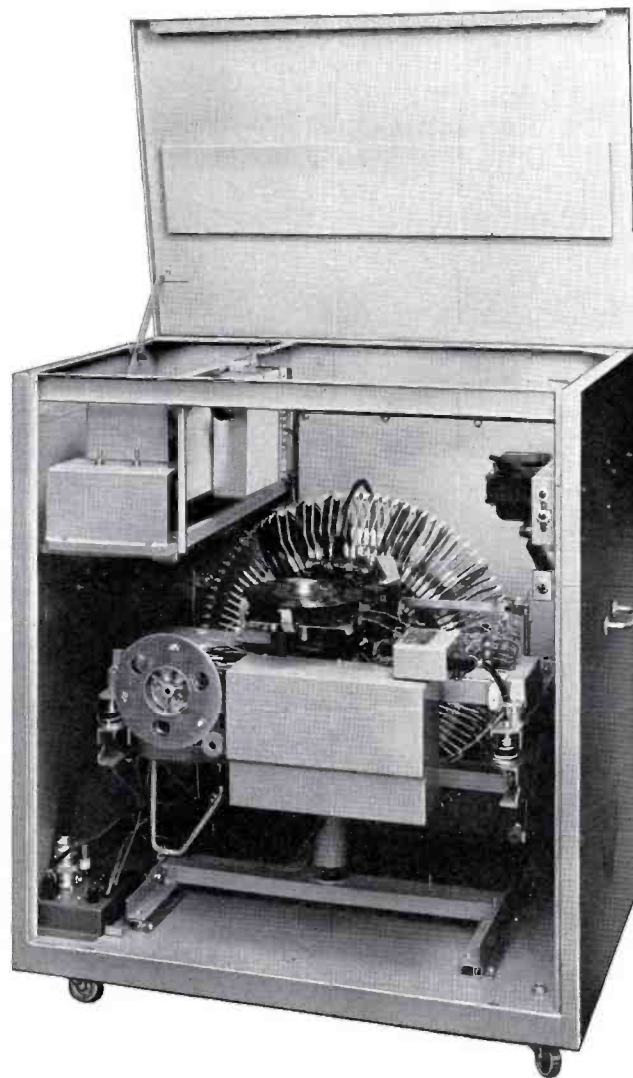
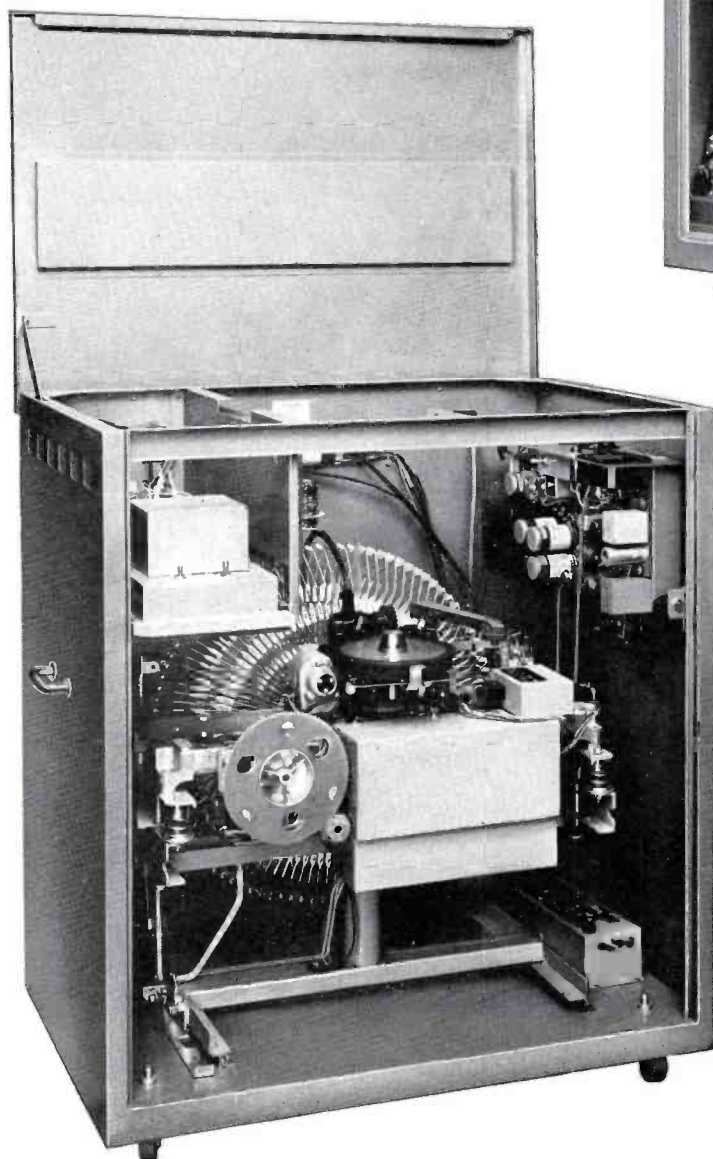

FIG. 1. Front view of a BQ-103 Automatic Turntable with panel removed. Note the circular record basket which has a capacity of 100 records (200 selections). The dust-free cabinet reduces wear.

by GEORGE C. WEILEMANN
Broadcast and Television Sales

Efficient, simplified, automatic handling of recorded program material is a reality with the new BQ-103 Automatic Turntable for 45-rpm records and the new BQ-104 Automatic Turntable for magnetic disc recordings. A single operation can control several of these automatic units, since all manual operations such as selection, cue, and so on are made fully automatic. Fewer operator "fluffs" result, and program flow is smoother for the listening audience.

FIG. 2. Front view of a BQ-104 Automatic Magnetic Disc Turntable. This unit is identical in operation to the BQ-103; however, its turntable speed is 33 $\frac{1}{3}$ rpm to accommodate the magnetic discs, and a magnetic pickup head is used as well as a BA-51A Record/Reproduce Amplifier.

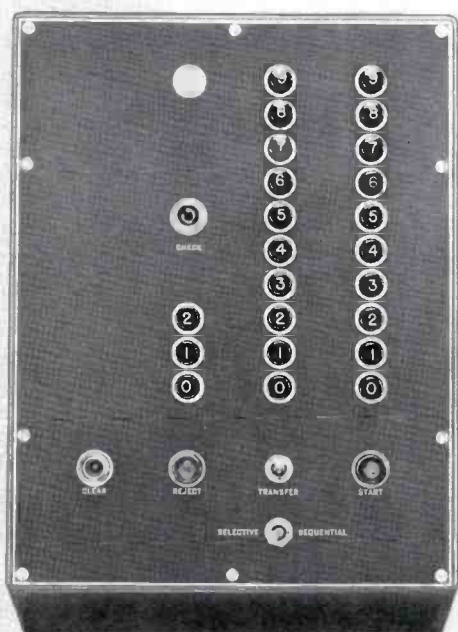

FIG. 3. Manual selection of any turntable is easily accomplished with this manual control box. Random or sequential modes of operation and other control functions are switchable. The three banks of numbered push buttons are used to select any of the 200 possible records in an automatic turntable.

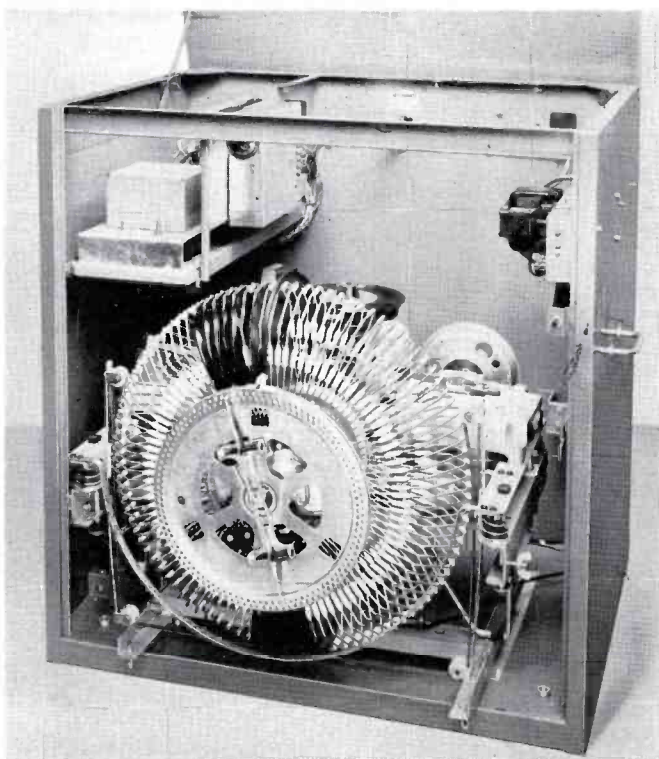

FIG. 4. The record basket is easily rotated into this position to simplify loading in the BQ-103 and BQ-104 Automatic Turntables.

BQ-103 Automatic Turntable

The new RCA Type BQ-103 Automatic Turntable is a fully automatic unit, designed to permit selection of records in either random or sequential order. Random operation permits selection of recordings in any desired order, while sequential operation restricts selection to the order in which the recordings were placed in the machine. The desired mode of operation is easily selected on the manual control box where any of the 100 45-rpm records (200 sides) may be selected (see Fig. 3). The circular record "basket" will store 100 discs, and it may be loaded from the top of the cabinet or from the front by sliding the record basket forward (see Figs. 4 and 5). The dust-free cabinet of the BQ-103 and the automatic handling of the discs reduces record wear.

The BQ-103 when used in combination with a Transistorized Turntable Pre-amplifier, Type BA-26A, produces an output signal capable of being fed into a console at mixer level. Built-in equalization of the BA-26A conforms to RIAA/NAB curves. A BA-26A is easily mounted in the BQ-103 cabinet as shown in Fig. 4.

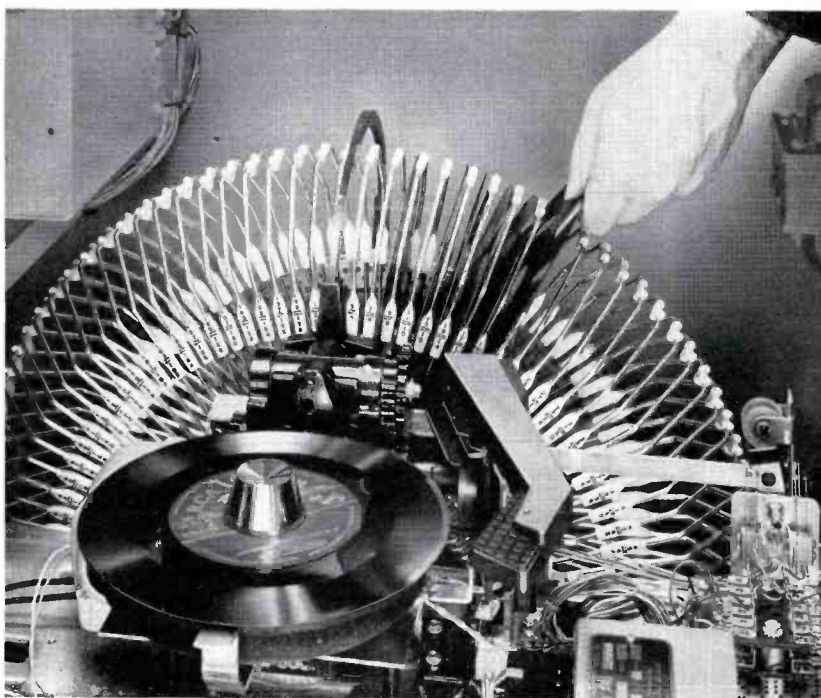

FIG. 5. The turntables may also be top loaded as shown here. Thus, last-minute changes can easily be made.

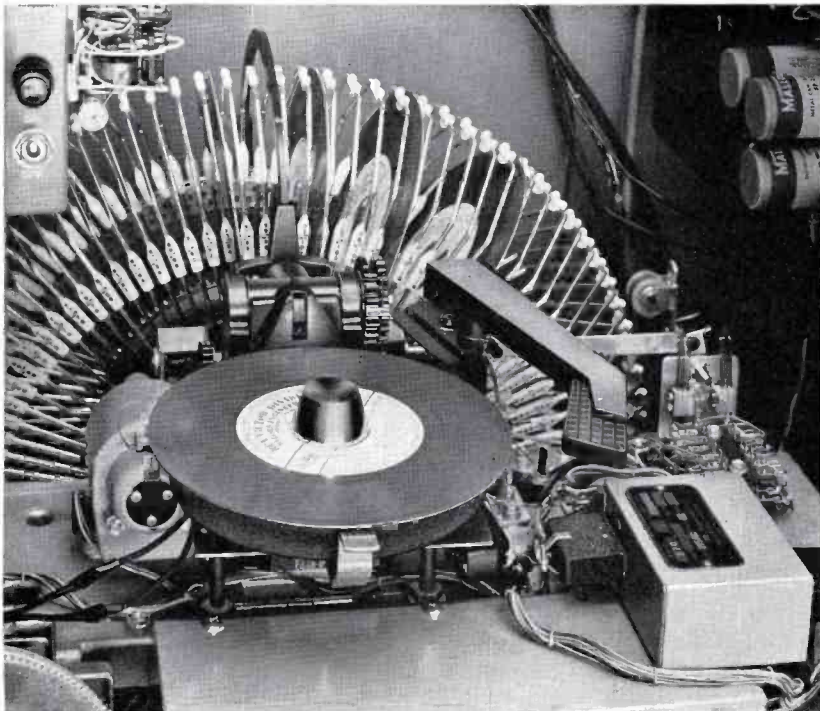

FIG. 6. A magnetic disc is shown on the turntable. The next step in the operation would be automatic cueing of the magnetic disc. The pickup arm is equipped with a magnetic playback head.



BQ-104 Automatic Magnetic Disc Turntable

Another new Automatic Turntable, Type BQ-104, is almost identical to the BQ-103; however, the BQ-104 has been designed for automatic playback of the new RCA magnetic discs (see Figs. 2 and 6). The turntable speed of the BQ-104 is $33\frac{1}{3}$ rpm to provide correct playing time on the magnetic discs, and the BA-51A Record/Reproduce Amplifier should be used to provide proper equalization of the signal from the magnetic discs. In operation the BQ-103 and BQ-104 are identical.

The BQ-104 offers a convenient method of storing and playing back commercials, announcements, and other repetitive types of recorded material. Multiplicity on any program is easily obtained by prerecording announcements on the BQ-51A/BA-51A Magnetic Disc Recorder (see Fig. 7), and then placing the magnetic discs in the BQ-104. A typical operating arrangement might include a BQ-103 and one or more BQ-104's. The BQ-103 will accommodate the conventional 45-rpm recordings, and the BQ-104 Turntables will play commercials and announcements recorded on magnetic discs. The machines can be preset for back-to-back operation; thus as a music selection finishes on a BQ-103 a magnetic disc recording of a commercial on a BQ-104 can be switched to the on-air position for immediate follow up.

Sequential Operation

Both the BQ-103 and the BQ-104 operate in the same manner. The sequential or random mode of operation is selected with a switch on the control box (see Fig. 3). When the switch is in the sequential position, the first record (in numerical order) is automatically selected, removed from the record basket, placed on the turntable, and automatically cued-up.

The first selection will play only after the start button has been depressed; however, for sequential operation the start button may be locked into the depressed position which will make the operation fully automatic and continuous. If desired, the start button may be used for each selection.

Sequential operation requires prearrangement of the discs to conform to program requirements, since all sequential selections are made in ascending numerical order after the first selection has been made.

FIG. 7. The RCA Type BQ-51A/BA-51A Magnetic Disc Recorder is used to record the magnetic discs played in the BQ-104 Automatic Turntable. The magnetic discs combine the advantages of tape and disc to produce a practical commercial recording instrument.

FIG. 8. This is a Type BQ-101 Automatic Turntable. The 60-record unit is designed for sequential operation only, and its companion unit, the BQ-102, is designed for random-select operation. Both units are physically similar, but differ slightly in electrical and mechanical construction.

Periods of unattended studio operation are possible by using a RQ-103 set for sequential operation. There is an elapsed time of approximately six seconds between recordings.

Random Operation

The random select mode of operation permits the choice of any recording by simply "punching up" the desired selection number. Three rows of switches on the control unit make available any recording in the record storage basket (see Fig. 3).

When the selection number is selected a "check" light indicates that the recording is acceptable, that is being within the number 1 through 200. (Note that all three digits of a number must be pressed to make a selection therefore recording 10 would be 0—1—0.) The selection information is passed on to the turntable mechanism by actuating the "Transfer" switch sending pulses to the pulse converter.

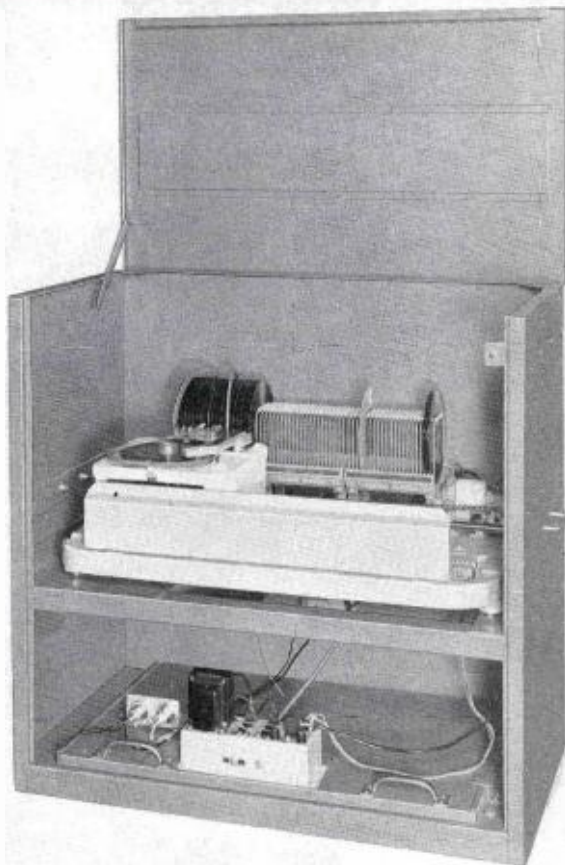

FIG. 9. Magnetic discs are easily recorded. The convenient microphone jack is just below the meter on the BA-51A Record/Reproduce Amplifier.

The record storage basket rotates until the desired selection is in position where the mechanical selector arm can remove the recording from the basket, and place it on the turntable. The tone arm is then automatically cued-up on the disc for playback and the start button on the control unit is illuminated to indicate that the mechanism is ready to play. Pressing the start button starts the turntable and the playback is begun.

At the completion of the recording, the disc is returned to the storage rack and the mechanism is ready to select another recording repeating the same procedure.

Preselection of recordings can be arranged by making a selection and passing it on to the mechanism by means of the transfer switch. This operation may be repeated to accommodate several selections (playback must be in an *ascending numerical order*). Selecting one recording and preselecting a second one will, of course, allow playback in any desired numerical order.

A "Reject" button removes the record on the turntable and returns it to its position in the storage rack. The clear button removes all preselections from the mechanism, thus last-minute-program changes

can be made seconds before a selection is to be played.

Other Automatic Turntables

Several years ago, RCA introduced automatic turntables with a capacity of 60 records (120 sides).* These units differ in mode of operation: the Type BQ-101 Automatic Turntable plays records in a predetermined sequential order, and the BQ-102 Automatic Turntable plays records in any random order (see Fig. 8). Both units have been proved in many installations and they may be used where larger record-handling capacities are not required.

Building Blocks

The BQ-103 and BQ-104 are excellent units offering semiautomatic programming and in addition to their individual benefits they can also become an integral part of the RCA automatic programming system. Thus, it is now possible for a broadcaster to become familiar with the operation of these semiautomatic units on a step-by-step basis. Future expansion to fully automatic programming can be planned while currently enjoying the benefits of automatic turntable equipment.

* "New RCA Automatic Turntables," *Broadcast News*, Vol. No. 89, June, 1956.

INTRODUCTION TO JUNCTION TRANSISTORS

PART II — The Common-Emitter Amplifier and the Common-Collector Amplifier

by R. N. HURST,* *Broadcast and Television Engineering*

The first article in this series introduced the transistor as an extension of a junction diode, and showed the characteristics and behavior of a common-base amplifier, which can give large voltage gains, but always gives a current gain less than one. Operating it as a voltage amplifier is very difficult, since the driving source must have such a low impedance, and operating it as a current amplifier has no advantage, since it can offer no current gain. Although certain intermediate types of operation (for example, the delay-line circuit [56]) can make use of the CB amplifier in spite of its restrictions, it is more common to see a transistor connected in the common-emitter (CE) configuration. Therefore, this second article will deal with the common-emitter configuration. The common-collector configuration will also be discussed.

It is one of the most frequently used transistor configurations, chiefly because it offers the greatest gain capabilities of any of the three possible configurations. It also provides a higher input impedance.

The ability of the CE configuration to provide large current gains lies in the fact that the signal current is applied to the base, where it adds to or subtracts from the very tiny base current. Since the base current (bias current plus the signal current) is a fixed percentage of the collector current,

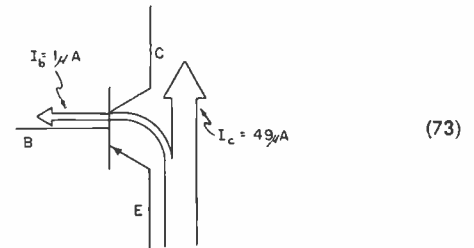

The common-emitter configuration

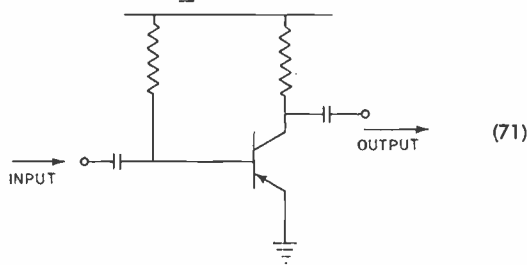

corresponds roughly to the grounded cathode configuration of a vacuum tube:

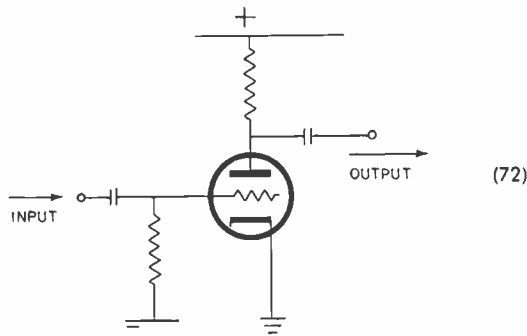

variations in the base current will cause proportional variations in the much larger collector current:

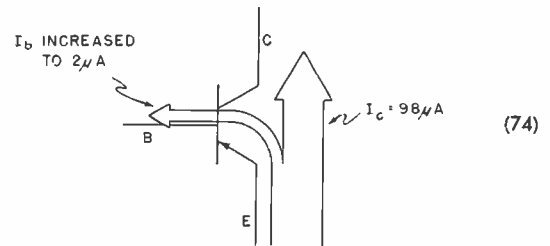

This action results in a current gain.

Characteristic Curves of Transistors in the CE Configuration

In studying the CB configuration, a laboratory experiment was described (23, 24, 25) in which the transistor was connected to a tapped battery, in this manner;

* This series of articles is abstracted from a group of transistor lectures given jointly by the author and Mr. A. C. Luther. The author wishes to acknowledge the fact that many of Mr. Luther's valuable contributions to the lectures have been retained in these articles.

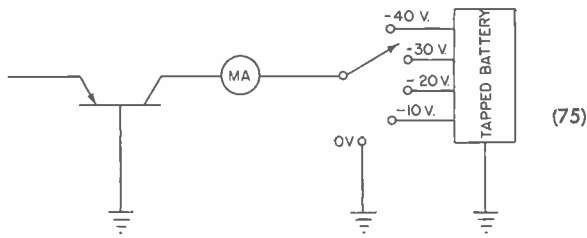

and the E_c vs I_c curves were determined: first for zero emitter current:

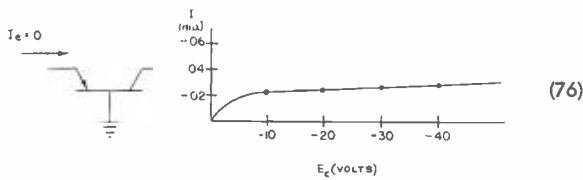

and then for several different values of emitter current:

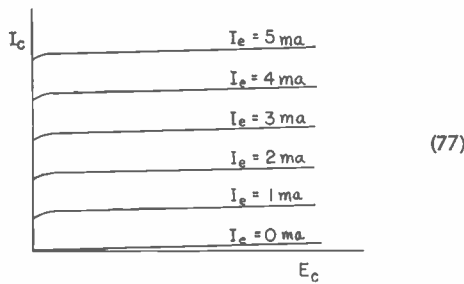

thereby generating the E_c vs I_c curves for the common-base configuration. With these curves the operation of a CB amplifier was analyzed.

In a similar manner, a laboratory experiment can be set up with a transistor in the common-emitter configuration:

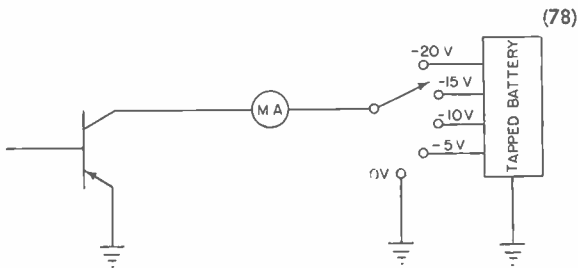

and its E_c vs I_c curves plotted; first for zero base current:

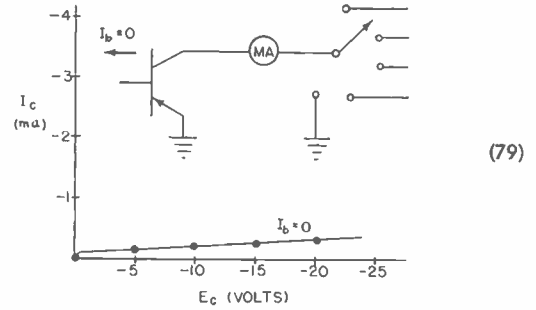

and then for several different values of base current:

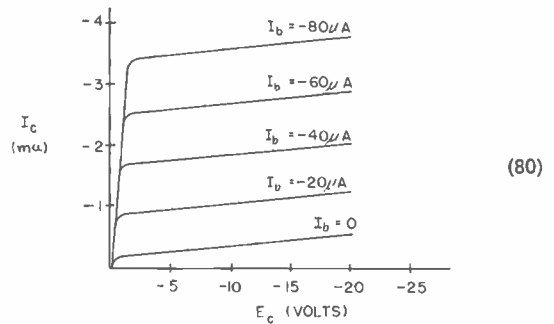

It will be observed that these curves differ from the CB curves in several respects. First, the curves have a steeper slope (1); second, the curves do not run all the way over to the left-hand axis (2); third, the running parameter, I_b , is a very small current, as compared to the collector current (3); and fourth, the collector current for zero input (base) current is much greater than the corresponding curve for the CB configuration (zero emitter current) (4). These differences are indicated in this figure:

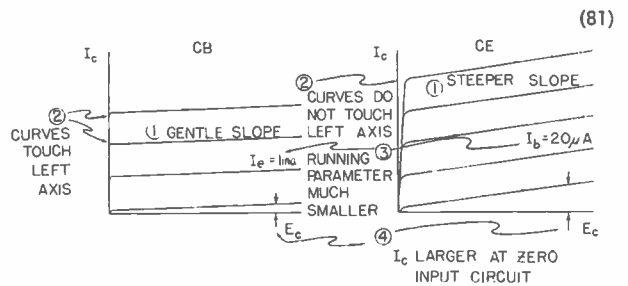

The significance of these differences will become apparent in the following discussion.

Let it be supposed that a piece of equipment contains this amplifier:

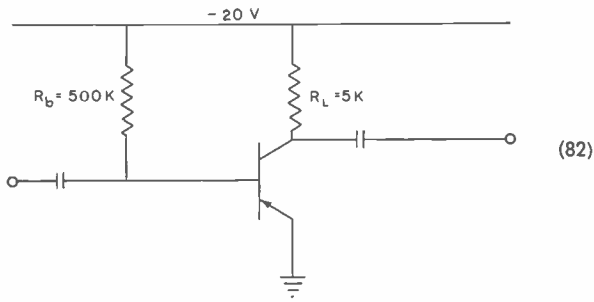

It is desired to know how this amplifier is operating—what the bias is, how much collector current flows, how much power is dissipated in the collector, and how much gain it will offer. All these facts may be ascertained by a simple construction on the common-emitter characteristics.

First, a warning: the bias method shown (82)—a resistor R_b supplying bias current to the base from the collector power supply—is an extremely poor way to bias a transistor. It would cause the amplifier to be very sensitive to both transistor replacement and change in temperature. It is used in this example because of its simplicity, which gives it value as a means of explaining the CE configuration. To make the following discussion valid, it must be assumed that the curves used are exact representations of the individual transistor in the circuit. Normally, the published curves for a particular type of transistor are for a unit whose characteristics are in the center of the allowable manufacturing tolerances. The fact that there are rather wide tolerances on transistors is one of the factors which makes necessary the use of more elaborate biasing techniques in practical circuits.

Analysis of this common-emitter amplifier follows basically the same pattern as the analysis of the common-base amplifier (34). The analysis is begun by drawing the load line on the common-emitter characteristics:

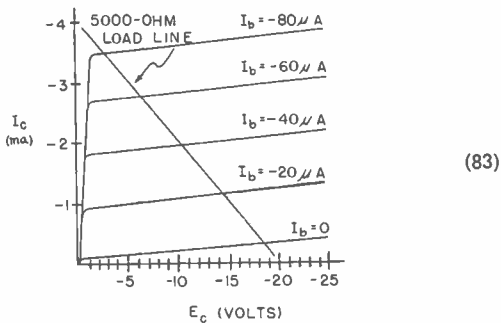

Just as for the common-base circuit, this amplifier's operating point must lie somewhere on its load line. For the common-base amplifier, it was shown (38) that the operating point lies at the intersection of the load line and the particular bias-current chosen:

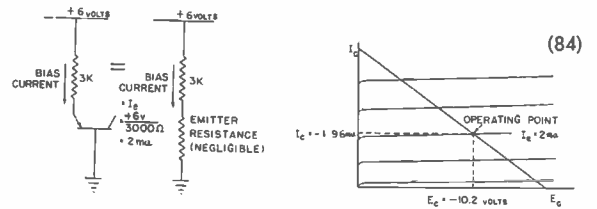

The operating point of this common-emitter amplifier may be found in a similar manner:

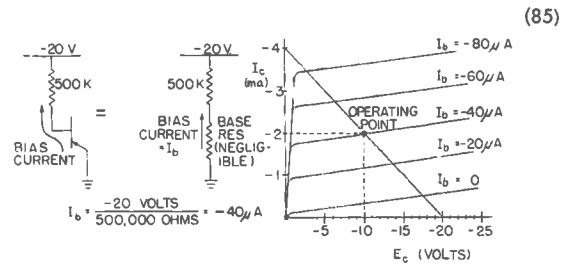

This common-emitter amplifier therefore operates with a bias current of $40 \mu\text{A}$, a collector current of -2 ma , and a collector voltage of -10 volts :

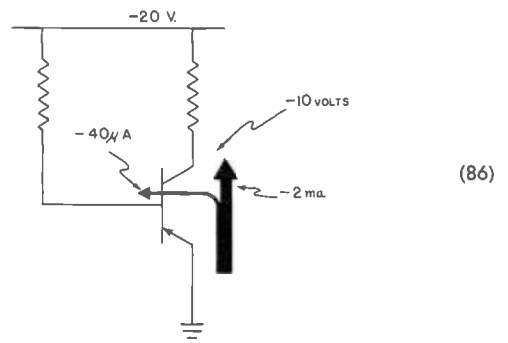

The power dissipated at the collector is:

$$P = IE = (-2 \text{ ma}) (-10 \text{ volts}) = 20 \text{ milliwatts} \quad (87)$$

The gain of this amplifier depends upon whether it is being used to produce voltage gain or current gain. In either case, it can produce useful gain. A simple amplifier such as this one has a current gain equal to beta—about 50 for a typical transistor—if the load is a short circuit or very low impedance:

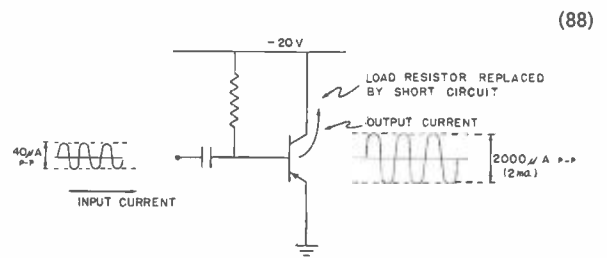

However, this particular amplifier has a load of 5000 ohms, so its current gain will be slightly less than beta. The actual value can be determined from the characteristics in this way:

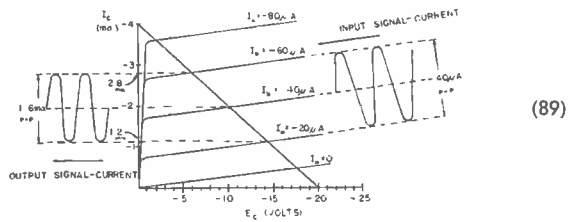

Since the output current is only 1.6 ma (instead of 2 ma, as it was for the short-circuit load) (88), the current gain of this amplifier is:

$$G_c = \frac{1.6 \text{ ma}}{40 \mu A} = 40 \quad (90)$$

The voltage gain of this particular CE amplifier is somewhat less than the voltage gain of the CB amplifier already analyzed (46). It was shown, in that analysis, that the voltage gain is given approximately by the expression:

$$G_{V_{CB}} = \frac{R_L}{R_e} = \frac{5,000}{12.8} = 391 \quad (91)$$

A more nearly exact value for voltage gain is:

$$G_{V_{CE}} = (\text{Current Gain}) \times \frac{R_L}{R_e} = \alpha \frac{R_L}{R_e} \quad (92)$$

$$= \frac{(0.98)(5,000)}{12.8} = 382$$

but the current gain for the CB case is so near unity that it can be omitted from the expression, without introducing appreciable error. In the CE case, however, the current gain is so large that it must be included in the expression:

$$G_{V_{CE}} = G_c \frac{R_L}{R_b} \quad (93)$$

Note also that in the expression for CE voltage gain the input impedance is given as R_b , the base resistance, in place of R_e , the emitter resistance. The base resistance is larger than the emitter resistance by a factor of $\beta + 1$:

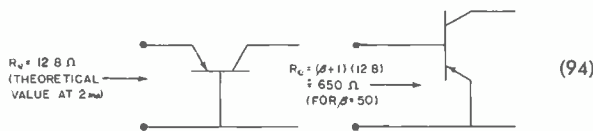

Therefore, the voltage gain is given by:

$$G_{V_{CE}} = \frac{G_c R_L}{(\beta + 1) R_e} = \frac{(40)(5,000)}{(51)(12.8)} = 306 \quad (95)$$

An important point contained in the foregoing paragraph is the fact that the impedance seen looking into the base is $\beta + 1$ times larger than that impedance seen looking into the emitter.

This base impedance can become very large—approaching that of a vacuum tube's grid—if an external resistor is included in the emitter lead:

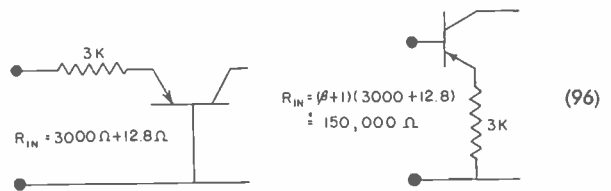

This external impedance, however, behaves like an unbypassed cathode resistor in a tube circuit—it gives higher input impedance (and greater stability as well) at the expense of gain.

The CE circuit analyzed thus far is admittedly an impractical circuit. Biasing a transistor through a large base resistor (in this case, 500,000 ohms) results in a circuit which may work well at room temperatures but becomes completely inoperative at higher temperatures. Or, it may work well with one transistor but work poorly or not at all with another transistor of the same type. Therefore, it is also necessary to analyze a CE amplifier using more practical biasing techniques.

Practical CE Amplifier

Let us suppose that a piece of broadcast equipment contains this circuit:

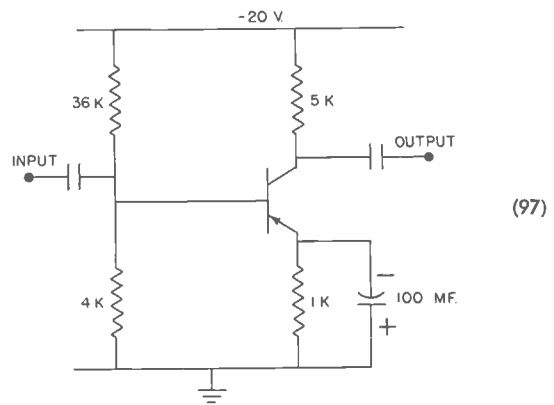

It is desired to know how this amplifier is operating; that is, what its bias is, what its dissipation is, how much collector current flows, and how much gain it provides. Although a construction of the CE characteristics could be made to yield this information, it is possible to make a fairly accurate analysis without the characteristics, since the 1000-ohm emitter resistor stabilizes the circuit and thereby makes its d-c behavior fairly independent of the transistor's characteristics.

The analysis is begun by observing that, with the transistor out of the circuit, a potential of -2 volts appears at the junction of the 36K resistor and the 4K resistor which form the bias network. This figure shows the calculations:

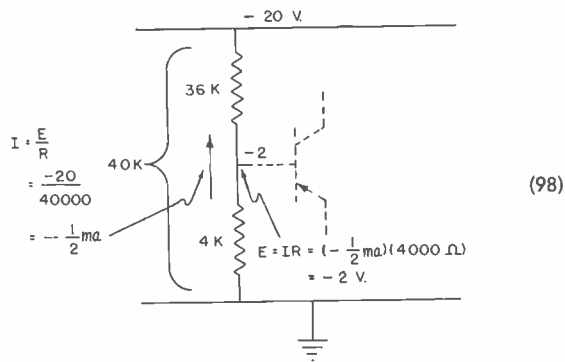

When the transistor is connected, the base current, which flows out of the (PNP) transistor, joins the 1/2-ma current in the bias network and slightly alters this -2 volt potential. However, the base current is assumed to be much smaller than the bias-network current and may therefore be safely ignored in an approximate analysis such as this one. (This assumption is usually correct in the analysis of well-designed circuits. If it should happen to be incorrect, one of the succeeding steps will reveal the error.)

Therefore, even with the transistor in the circuit, the potential at the base is -2 volts. Since the emitter and base taken together form a forward-biased diode, the voltage drop from emitter to base is very small—about 0.2 volt; a negligible amount in this analysis:

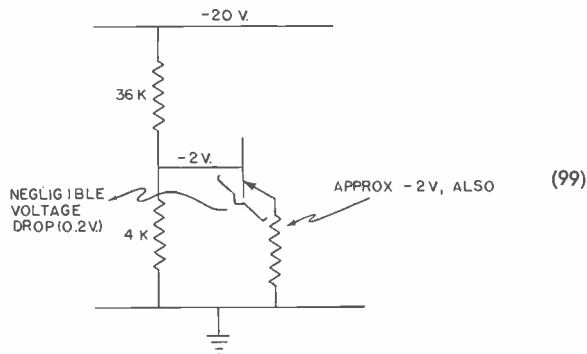

Therefore, the emitter is also at approximately -2 volts. Since the emitter resistor is 1,000 ohms, the current to cause this 2-volt drop must be -2 ma.

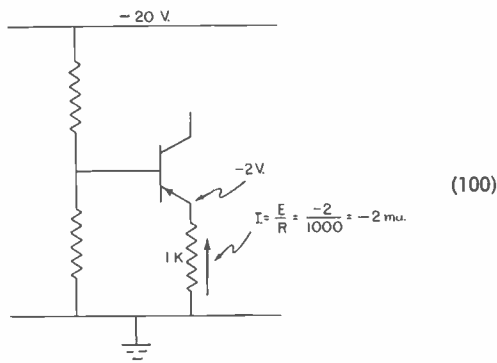

Assuming that $\alpha = 1$ (instead of 0.98) for this approximation, the current flowing from the collector is also -2 ma, and the potential at the collector is therefore -10 volts:

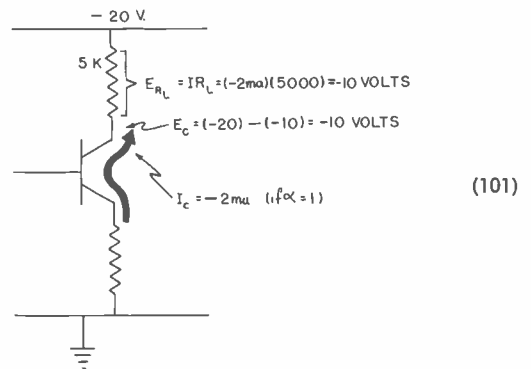

Since the emitter is at -2 volts, the voltage across the transistor is only -8 volts; therefore the power dissipation is:

$$P_c = IE = (-2 \text{ ma}) (-8 \text{ v}) = 16 \text{ milliwatts} \quad (102)$$

Also, with the knowledge that $I_c = -2 \text{ ma}$, (and assuming that $\beta_{DC} = 50$), the base current can be calculated:

$$I_b = \frac{I_c}{\beta_{DC}} = \frac{-2 \text{ ma}}{50} = -40 \mu\text{A} \quad (103)$$

The earlier assumption that the base current was much smaller than the 1/2-ma bias-network current is thereby substantiated.

In computing the gain of this amplifier, the circuit may be redrawn in the following manner, which shows the circuit as it appears to the signal current:

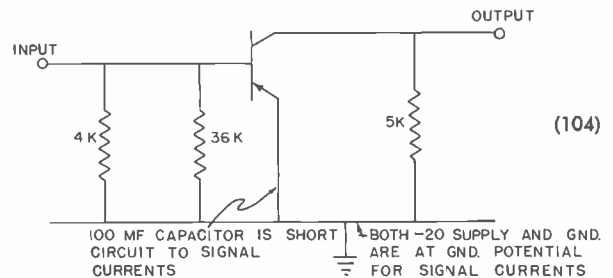

If a signal current of $10 \mu\text{A}$ is supplied to this amplifier, part of it is lost in the 4K and 36K resistors. Only a portion of it goes into the base (represented here by a 650-ohm resistor):

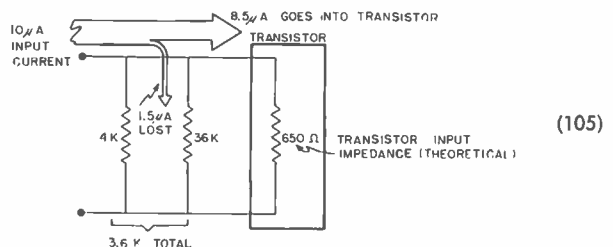

Since 15 percent of the input signal is lost before it ever gets into the base, the overall current gain of this amplifier is 15 percent lower than the gain of the simple amplifier already analyzed (90). (That amplifier lost a negligible amount of signal current in its 500,000-ohm biasing resistor.) Since that amplifier was shown to have a current gain of 40, this amplifier will have an overall current gain of:

$$G_c = 40 - (0.15) (40) = 34 \quad (106)$$

The loss of gain is the price paid for the increased stability of this circuit.

The voltage gain of this amplifier may be approximated by observing that the 1.5 μ A lost in the bias network causes a voltage swing of 5.4 millivolts to appear across the two resistors:

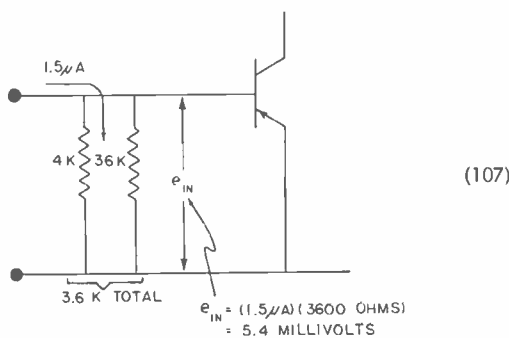

At the same time, 8.5 μ A is being amplified by the transistor so that $(8.5) \times (40) = 340 \mu$ A appears as a current swing in the load resistor, and an output of 0.17 volts appears across the load resistor:

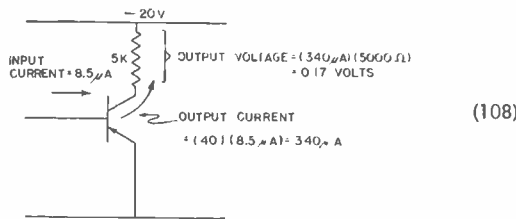

Therefore, the voltage gain of the amplifier is:

$$G_v = \frac{0.17 \text{ v}}{5.4 \text{ mv}} = 315 \quad (109)$$

The Common-Collector Configuration

So far, the common-base and common-emitter amplifiers have been considered and their curves and characteristics briefly indicated. The CB amplifier is capable of large voltage gain but less-than-unity current gain. The CE amplifier can provide both voltage and current gain. The final configuration, the *common-collector* (CC), is the opposite of the CB configuration in that it can produce a large current gain but less-than-unity voltage gain. In that respect, it resembles its vacuum-tube

counterpart, the cathode follower. Indeed, it is often called the emitter-follower configuration. Good reason for this name can be seen in the following figure:

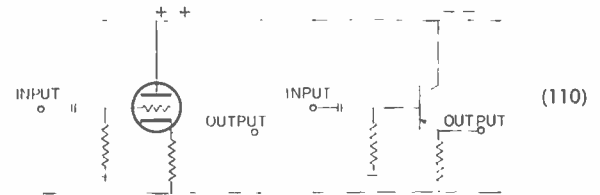

In this article, however, the name *common-collector* and the abbreviation CC will be employed, except where clarity may be served by the other name.

The discussion of common-collector amplifiers could run parallel to the discussions of the other configurations, starting with a derivation of the CC characteristic curves, and using these curves to analyze a typical amplifier. In this case, however, such an approach is not practical, because CC curves are rarely given in data sheets. Any analysis based on CC curves could not be duplicated in a practical situation, without first deriving a set of CC curves from the data sheet's CE curves. Fortunately, an approximate analysis can be performed using CE curves directly. This is demonstrated in the following analysis of this CC amplifier:

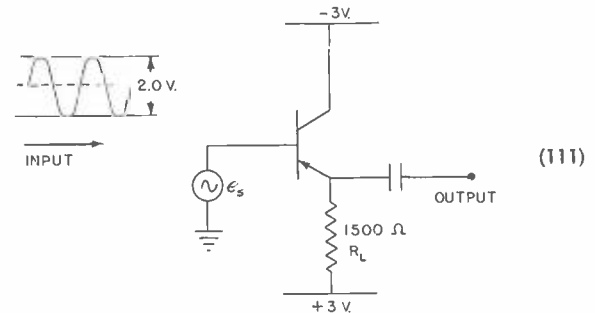

This amplifier is driven from a very-low-impedance source which approximates a true voltage source. This amplifier's voltage gain and its dc operating conditions will be determined by a construction on the *common-emitter* curves.

The biasing arrangement is practically identical to the common-base biasing-method already discussed (36). To show this similarity, the circuit can be redrawn in this manner:

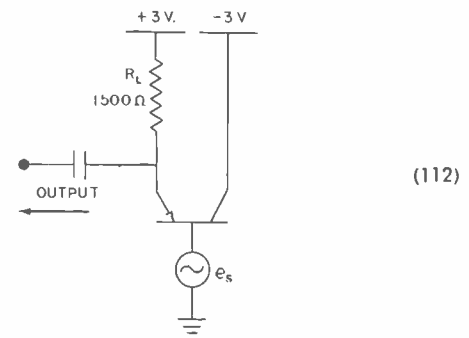

Remembering that e_s , the signal source, is practically a short circuit to the bias currents, it can be seen that the biasing arrangement bears a strong resemblance to common-base biasing.

It has been shown (36) that the input (emitter) resistance could usually be ignored in determining bias current for a CB stage. Therefore, it can be assumed that the full +3 volt supply appears across R_L , giving an approximate bias current of 2 ma flowing in the emitter. With this approximate bias, we may find the operating point by drawing a load line on the CE curves. The terminal points of this load line (or any load line) are the open-circuit voltage and short-circuit current available from the external circuit at the E and C terminals of the transistor:

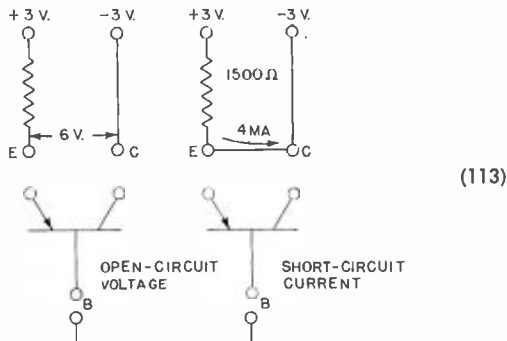

(113)

so that the load line looks like this:

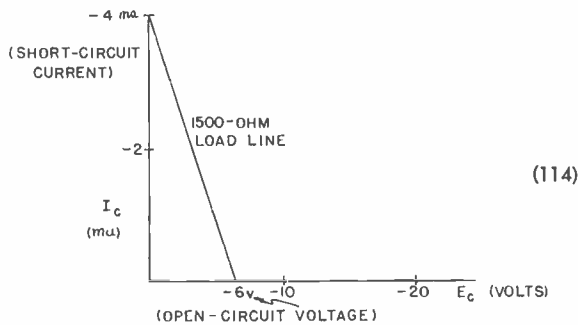

(114)

Actually, drawing a straight line between the two end points determined in the above manner is not entirely accurate because the current scale of the graph is I_c , whereas it is really I_e , which flows through R_L . However, the error involved is small since I_c and I_e are nearly equal.

An approximate operating point may then be found by entering the approximate bias current on the load line of Fig. 114, as follows:

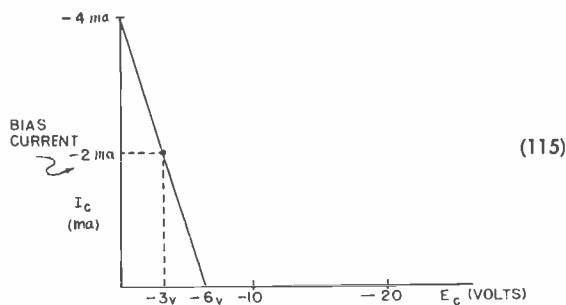

(115)

The actual CE characteristics have not been drawn on the foregoing graph purposely to show that the transistor characteristics have nothing to do with the approximate determination of the operating point. However, these characteristics must be included in order to calculate gain:

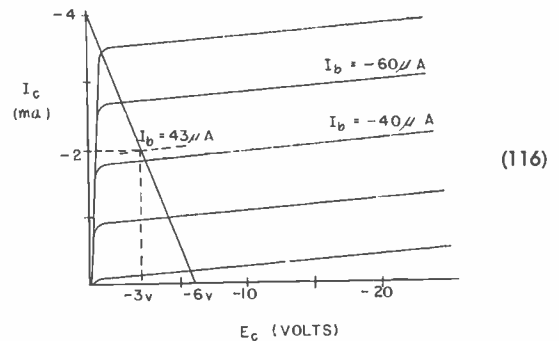

(116)

It can be seen in Figure 116 that the operating point lies between the curves for $I_b = -40 \mu A$ and $I_b = -60 \mu A$. Judging the relative position of the point by simple visual inspection, one can approximate the no-signal base-current to be about $-43 \mu A$.

To simplify the analysis at this point, a rather surprising assumption is made. It is now assumed that the voltage gain is unity; that is, it is assumed that the full 2-volt input signal appears at the output. Working backwards from this assumed output voltage, one can then proceed to show that *more* than 2 volts of signal is required at the input to produce a 2-volt output. The relationship between this new input voltage and the assumed 2-volt output voltage will give the actual gain, which is slightly less than unity.

Starting with the assumed 2-volt output signal, the CE characteristics can be used to determine the base-current swing required to deliver this output:

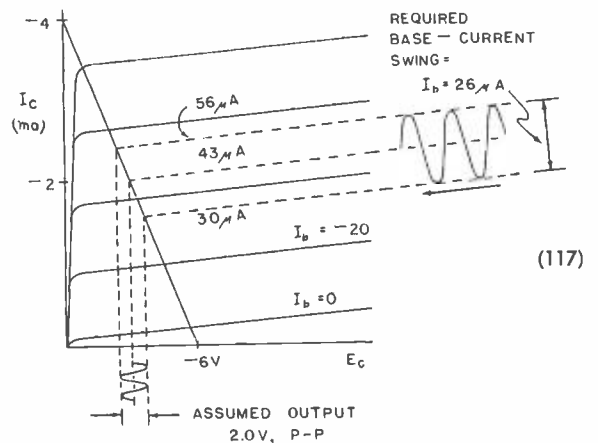

(117)

The data sheet for this transistor is then consulted to find the curve giving the relationship between base current and base-to-emitter voltage. This curve is usually given for transistors designed to handle fairly large signal swings. Using this curve:

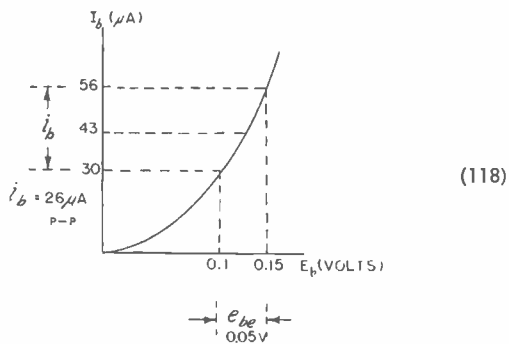

it can be seen that 0.05 volts of the input signal is lost in the base-to-emitter voltage drop. Therefore, in order to produce the assumed 2-volt output, the input voltage must swing 2.05 volts:

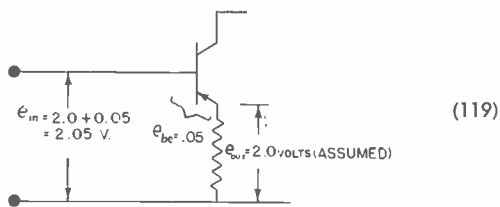

The voltage gain is therefore:

$$G_v = \frac{e_{out}}{e_{in}} = \frac{2.0}{2.05} = 0.976 \quad (120)$$

The CC configuration, driven from a *current* source, can be described in terms of *current* gain. In a simple configuration, in which negligible signal current is lost in the biasing arrangement:

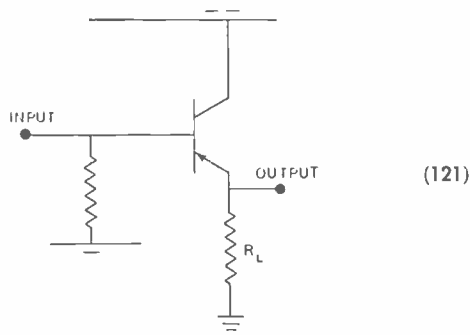

a transistor with a beta of 49 will give a current gain of 50:

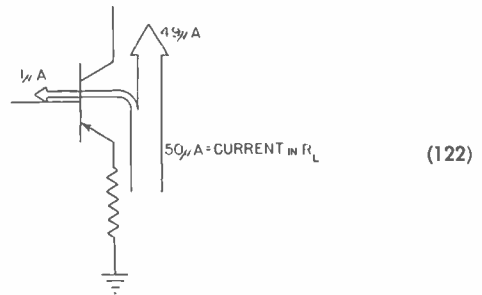

which, in general terms, is a current gain of $\beta + 1$.

The input impedance of a CC amplifier is very large. This may be seen from the fact that, in the example, a 2-volt signal causes only 26 μ A to flow into the amplifier. This gives an input impedance of:

$$R_{in} = \frac{e_{in}}{i_{in}} = \frac{2.0}{26 \times 10^{-6}} = 77,000 \text{ ohms} \quad (123)$$

which agrees closely with the value of input impedance calculated by multiplying R_L , (1500 ohms), by $\beta + 1$.

Thus far descriptions have been given for the characteristics of the three important transistor-amplifier configurations: the common-base, the common-emitter, and the common-collector. Their important characteristics may be summarized in this table which gives the typical values calculated for the amplifiers used as examples:

	CB	CE	CC
CURRENT GAIN	0.98	49	50
VOLTAGE GAIN	382	306	0.976
INPUT R	12.8 Ω	650 Ω	77,000 Ω
FREQ. RESPONSE	1MC	20KC	20KC - 1 MC DEPENDENT ON SOURCE AND LOAD

The last row of information, frequency response, indicates the price paid to obtain the improved gain capabilities of the CE configuration. Although the current gain of the CE amplifier is about 50 times greater than the current gain of the CB amplifier, the available bandwidth of the CE amplifier is about 50 times *less* than the available bandwidth of a CB amplifier using the same transistor. The values chosen for the table represent the frequency response which could be expected from typical audio transistors. Much better frequency response can be obtained by using transistors specifically designed for high-frequency operation. These matters and others will be considered in the next, and final, article in this series.

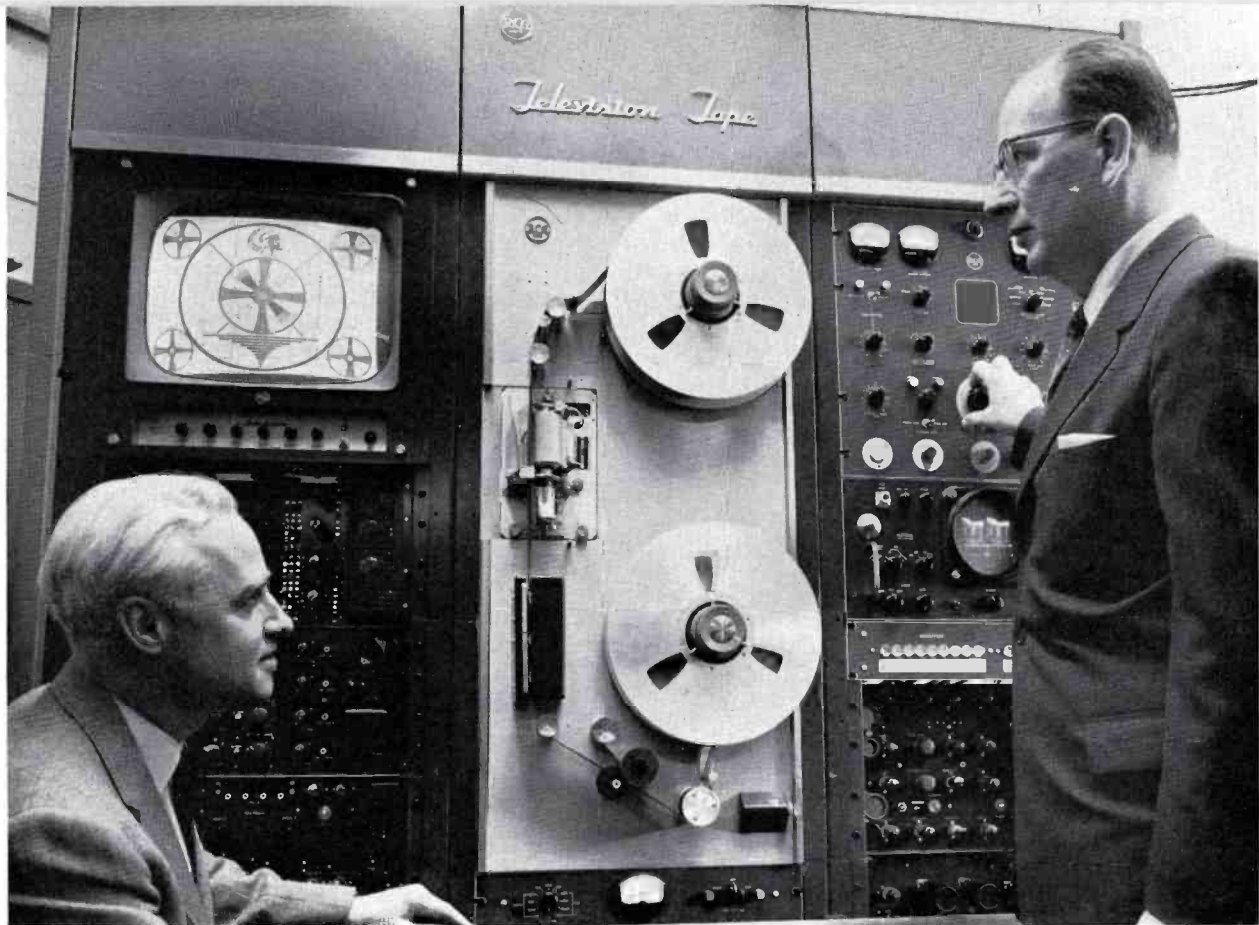

FIG. 1. C. H. Colledge, General Manager, Broadcast and Television Equipment Division, and E. C. Tracy, Manager, Broadcast Equipment Marketing Department, check over advanced features of the first RCA production model television tape recorder.

RCA PRODUCTION MODEL TV TAPE RECORDER HIGHLIGHTS LATEST ADVANCEMENTS

Incorporates Cue Facilities for Ease of Operation; Electronic Adjustment for Compatibility; and Built-in Test Facilities for Superior Performance

by H. H. KLERX, *Broadcast and Television Sales*

The RCA Television Tape Equipment opens new horizons for programming convenience, ease of operation and superior performance. Features for programming convenience include: variable speed cuing control, cue recording channel and master erase head. Built-in facilities for ease of operation include: picture and waveform monitor, monitor and CRO switchers and servo control track monitoring. Technical advancements that lead to superior per-

formance include: electronic headwheel adjustment, wideband demodulator and magnetic tone wheel. Furthermore, since the RCA Recorder has been designed to meet the exacting requirements of color, it gives the best possible reproduction for black and white. As a prelude to the models now in production, RCA has supplied seven prototypes, six of which were placed into operation by the NBC network, the seventh at WBTV Charlotte, N. C. For the past

year these machines have been in operation alongside other type equipments. This has enabled RCA to take into account the many factors necessary to assure compatible as well as practical operational techniques.

The experience gained by field testing these preproduction equipments has resulted in a new type television tape recorder which, it is believed, will meet the most exacting requirements.

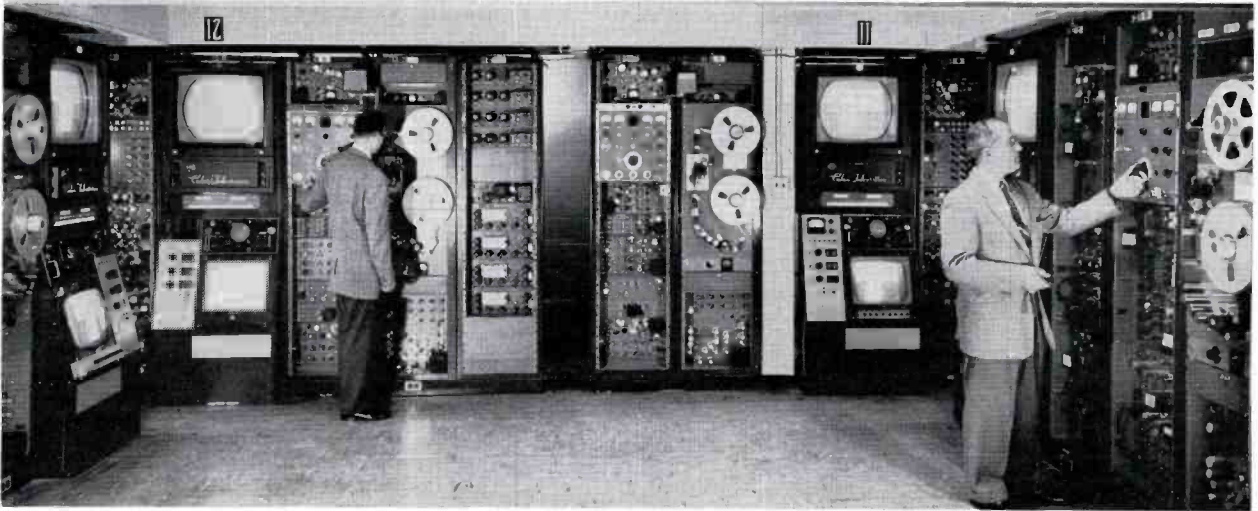

FIG. 2. The NBC Burbank installation. The primary function of these machines is to delay programs for playback to areas of different time zones. They were installed to permit semiautomatic operation. Machines start, record, rewind and playback—all from time cues. Manual operation consists primarily of setting the necessary preset controls, loading and unloading tapes.

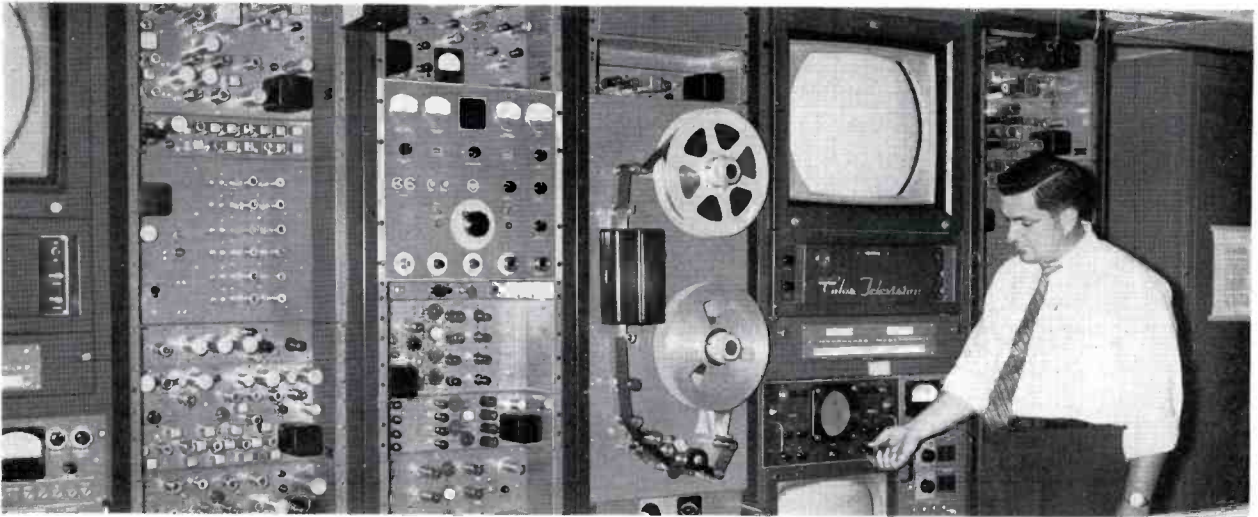

FIG. 3. The NBC New York installation. The primary function of the machines in New York is somewhat different than in Burbank. In order to efficiently schedule the use of color television equipment, programming is arranged to use the off-air studio time by recording shows for later playback.

FIG. 4. The WBTV installation in Charlotte, N. C. Here the equipment is used in much the same manner as in any other television station. Many weekend shows are recorded during regular working hours. Special events shows, speeches, and so on, are recorded at the individual's convenience for playback when time permits.

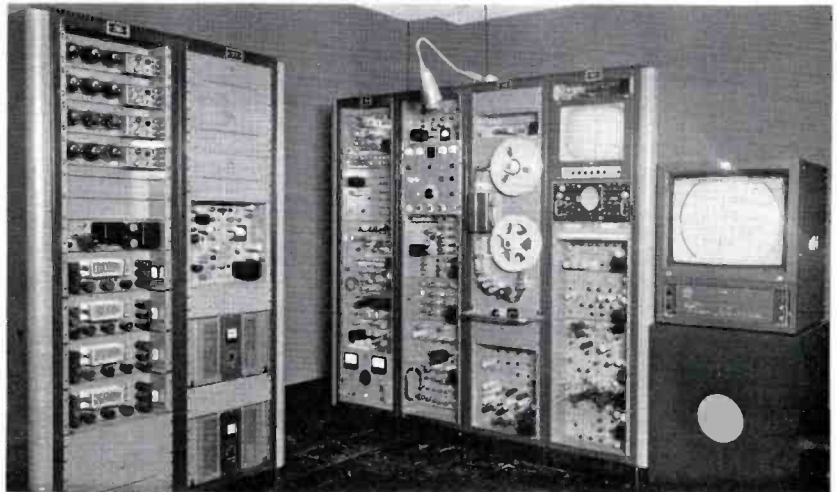



FIG. 5. Variable speed cuing control enables operators to rapid cue any point on the tape.

FEATURES FOR PROGRAM CONVENIENCE

Variable Speed Cuing Operation for Rapid Cue

Cuing tape is a technique operators must quickly master. Location of specific program segments recorded on the tape is necessary for playback, editing, dubbing and splicing. This information is not necessarily at the beginning of the tape, but may be in the middle or near the end of the reel. To reach the desired program segment in a minimum of time, fast-forward and fast-reverse controls have been provided. These controls alone, however, require continual starting and stopping of the machine in order to jockey the desired segment into position. To improve this technique, a variable speed control has been incorporated, which enables the operator to vary the rate of wind or rewind from 0 to 150 inches per second (see Fig. 5). The advantage of this control is that it permits the operator to gradually slow down the tape as the desired program is being approached. As speed is reduced, the program audio or cue audio becomes intelligible and can be used as a reference in locating the exact cue position.

Manual jockeying of tape is not required, for if the desired stopping or starting point were missed, a slight turn of the variable speed control in either forward or reverse direction will inch the tape back to the desired location.

Simultaneous Audio Playback Gives Quality Control of Program Audio

A separate magnetic playback head is located near the program audio record head, thereby enabling the playback of information within a fraction of a second after it is recorded. The advantage of the simultaneous playback head is two-fold. First, playback during recording gives the operator positive assurance that information has been recorded and second, the operator may continuously monitor the quality and content of the recorded information during the recording process.

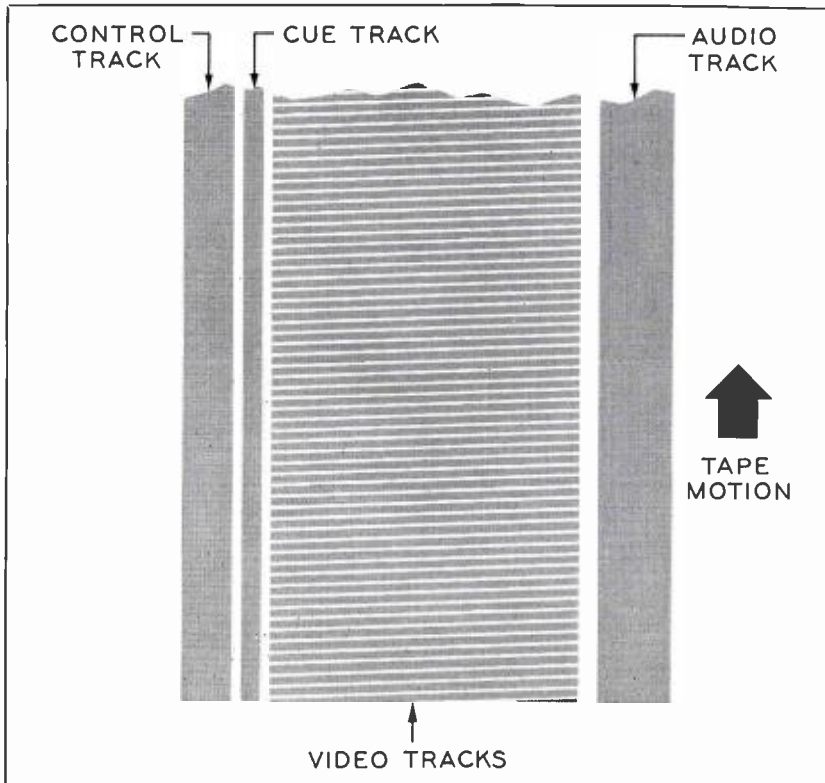

FIG. 6. Diagram of a segment of television magnetic tape showing location of audio, video, cue and control tracks.

Cue Recording Channel

Space on the 2-inch wide television tape has been allocated for recording cue information (see Fig. 6). The cue track, located between the servo control track and video information has a band pass of 6 kc, which is sufficient to permit the recording of several types of information, ranging from voice to tone. If voice is used, information regarding cuing, special instructions for editing and splicing, time checks, etc., may be recorded on the tape for monitoring later during playback.

In installations where it is desirable to automatically control several of the basic operating functions such as start/stop, cue and rewind, special tones may be recorded to initiate relays and other control circuitry during the playback operation. If desired, operational instructions as well as tone cues can be recorded simultaneously.

Use of the cue channel can considerably simplify the job of locating programs or commercials on a reel of tape. Very often many small segments are recorded on a single reel of tape and, therefore, it can be very difficult to locate the desired one in a minimum of time. In such cases information recorded on the cue track can be used to readily locate the desired commercial or program segment.

The cue channel may also be reused if desired. A separate erase head is provided to clear the cue channel for new or revised information. This may be done without disturbing the program information on the other tracks. In fact the cue information can, if desired, be recorded during the playback period which would then enable the operator to monitor program video and audio while recording special cue instructions. A microphone input is located on the front panel of the recorder for the operator's convenience. Separate audio input terminals are provided for remote tone and audio cue information.

Built-in Master Erase Equipment Allows Selective Erasing of Tape

Built-in master erase is important, in both programming convenience and operating simplification (see Fig. 7). It is an aid to programming because it enables the operator to erase and re-record portions of a program. Also, if several programs or commercials are recorded on the same tape and one becomes obsolete, it is not necessary to erase the entire reel. New material can be recorded in place of obsolete material by erasing portions of the tape. The

need for a large number of small tapes is avoided.

From an operating standpoint the recording procedure is simplified. Tapes do not have to be bulk erased prior to recording. Old or new tapes may be placed directly on the machine and the recording operation begun. The master erase circuitry is automatically switched in and out of operation depending on whether the machine is in the record or playback mode of operation. Tapes cannot be accidentally erased, yet complete erasure of the tape prior to recording is assured.

Tape Footage Indicator Aids Rapid Cuing and Splicing

Another aid to the operator for rapid cuing, splicing, and editing is the tape footage indicator. This footage indicator numerically displays the number of feet of tape used and may be reset to zero prior to each recording. If, for example, a one hour reel of recorded material is made up of several fifteen minute segments plus two

or three commercials, the operator (during the record operation) can note the footage indicator readings at the start and stop of each program segment. This is then noted on a master card stored with the tape. When playback is desired it is only necessary to look at the master card, then wind the reel to the correct footage reading.

Extra Capacity Tape Reels

More than 1½ hours of continuous recording can be accomplished without the need for a second machine. Special events shows, back-to-back programming and automation is greatly facilitated with these extra capacity tape reels. A running time of 96 minutes can be obtained by winding 7200 feet of 2-inch tape on a 14-inch reel. Incidentally, this is only 1½ inches larger than the one hour reel. The availability of 96 minutes of recording or playback does not preclude the use of other size reels, since the RCA equipment is designed to work equally well with 12½ inch, 8-inch, and 6-inch reels.

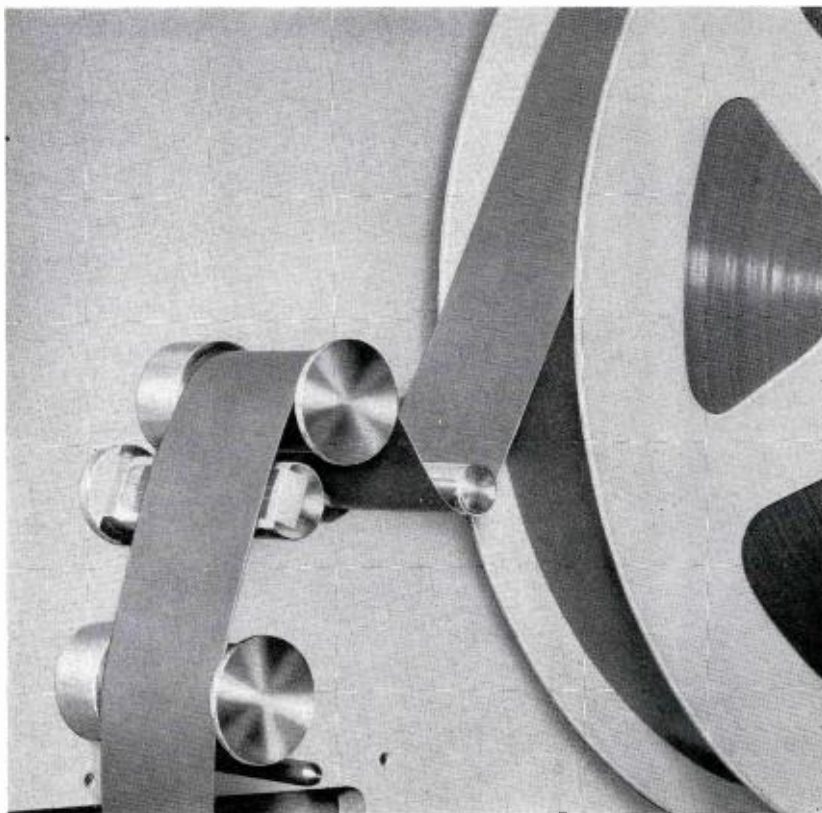

FIG. 7. View of master erase head. This feature enables operators to erase and re-record portions of a program.

FEATURES FOR OPERATIONAL EASE

Other important advantages of the RCA recorder are those related to control and operation. Since a TV tape recorder employs a considerable amount of electronic equipment, RCA has made every effort to stabilize, automatically control where possible, and simplify the operational controls.

Control features are built-in. They include: waveform and picture monitor, monitor switcher, and oscilloscope switcher, servo control track monitoring and electronic headwheel quadrature adjustment have been provided to aid in obtaining the best possible performance. The precise control these many features offer, coupled with the high degree of stability provided, assures compatibility with other machines.

Built-in Waveform and Picture Monitors

In order to properly integrate monitoring facilities in the RCA television tape recorder, careful thought was given to function as well as location. Both picture and waveform monitors have been built-in to aid the operator in setting up and maintaining peak performance at all times. A

17-inch picture monitor is located adjacent to the tape transport mechanism and provides a quality reproduction of either the record or playback information. The 5-inch oscilloscope also located adjacent to the tape transport mechanism serves a dual purpose; monitoring key signals in the equipment, and use as a maintenance scope.

Built-in Switchers for Instantaneous Signal Monitoring

Built-in switching facilities have been provided to permit independent monitoring of the picture and waveform signals at several key points within the equipment. This allows the operator to readily check the performance of specific areas within the machine during operation, and also enables him to trouble-shoot and localize malfunctions quickly. The picture monitor may be switched to nine different signal sources, five of which are pre-wired. Thus the operator can select the following signals: video input, monochrome output, color output, 60-cycle reference pulse and 240-cycle tone wheel pulse. The four remaining inputs may be used to monitor additional signals from other points in the system. For example, it may be desirable to feed network, studio or master control video to the recorder for preview and cuing purposes.

The waveform monitor may also be switched to nine different locations. Seven of these nine positions are pre-wired and allow the operator to examine waveforms of the following signals: video in, monochrome out, color out, 2 by 1 switcher output, control track record signal, control track playback signal, and test video signals for checking color performance. The remaining two spare positions may be used to monitor other available signals.

An additional switcher is provided in the TRT-1AC Color Equipment, for use in switching a color monitor input to key locations within the color rack.

Servo-Control Track Monitoring

Information recorded on the servo-control track is used to control the tape speed during playback and, therefore, is of vital importance for successful reproduction of recorded programs. Even though a perfect video recording may have been made, lack of the servo control signal would make it impossible to reproduce the program. Because of its importance, it was considered highly desirable to include a servo control track simultaneous playback head. This playback head enables the operator to monitor the recorded control track during the recording operation. In this manner any discrepancy may be immediately detected and rectified. This feature gives added assurance that a satisfactory recording is being made.

Built-in Audio Monitoring System

Designed into the television tape recorder is a compact audio monitoring system which may be used to monitor program audio during the record cycle (simultaneous playback), program audio during playback, or cue information from the cue channel. The speaker, volume control, and delegate switch are located adjacent to the transport mechanism within ready reach of the operator.



FIG. 8. Built-in switchers for monitor and oscilloscope permit instantaneous signal monitoring at key test positions.

FEATURES FOR SUPERIOR PERFORMANCE

The technical features which contribute to the superior performance of the RCA Television Tape Equipment include: electrical headwheel quadrature adjustment, wide-band demodulator, 4-channel playback equalizer, air lubricated tape guides, and magnetic tone wheel.

Electronic Headwheel Quadrature Adjustment for Maximum Compatibility

Exact quadrature relationship of the four video record/playback heads is the most precise adjustment required on any television tape recorder. To provide straight forward and simplified alignment of these video heads, an electronic system has been devised for adjusting their quadrature relationship. It should be noted that electronic adjustment of the heads can be made while the machine is in operation, thereby allowing the operator to optimize his adjustments while viewing the picture, i.e. test pattern or bar signal. Electrical quadrature relationship of the four video heads can be established to within ± 0.03 microseconds.

Initial adjustment of newly installed headwheel panel assemblies consists of placing a test tape on the machine, and during playback optimizing the playback quadrature alignment, then transposing the dial settings of these adjustments to the record quadrature controls (see Fig. 10). This completes the alignment procedure so that the machine will now record tapes which may be played interchangeably on other machines. Similarly, tapes recorded on other properly adjusted machines may be played back without any further adjustment.

At the operator's discretion, playback quadrature adjustments can be changed should the occasion arise where it is found that an incoming tape has been recorded on a machine where quadrature alignment was out of tolerance. Playback of such a tape can be optimized while the tape is on the air. To re-establish correct quadrature relationship for playback of tapes recorded in tolerance merely requires that the playback controls be returned to the original settings.



FIG. 9. Control panel for the RCA television tape recorder.

Wide-Band Demodulator for Sharp, Clear Pictures

To reproduce color signals, a demodulator capable of passing high frequencies containing chrominance information is required. To reproduce these signals faithfully the demodulator must not only be wide-band, but must have a flat response over the entire bandwidth as well. Since this same demodulator is also used for monochrome operation, it provides improved performance, giving sharper, crisper pictures, better transient response and more linear operation. Thus the requirements for good color rendition become an added bonus for monochrome reproduction.

4-Channel Playback Equalizer

This is another bonus feature for monochrome operation, but essential for good color performance. The playback equalizer permits electrical trimming of the video record/playback heads so that their characteristics may be matched. When properly adjusted there is no visible difference in the signal outputs from the heads.

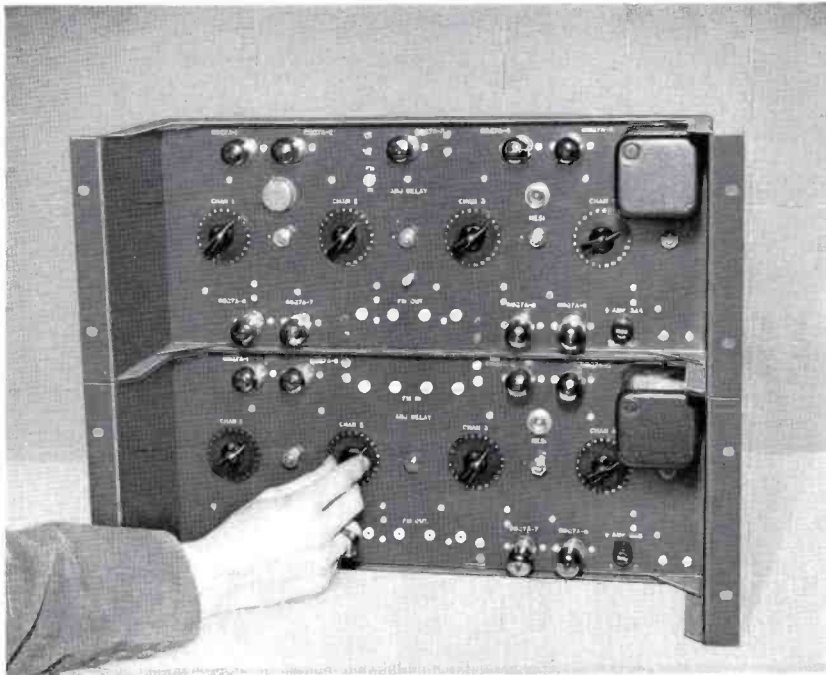

FIG. 10. Record and playback quadrature controls are incorporated in these two built-in rack equipments.

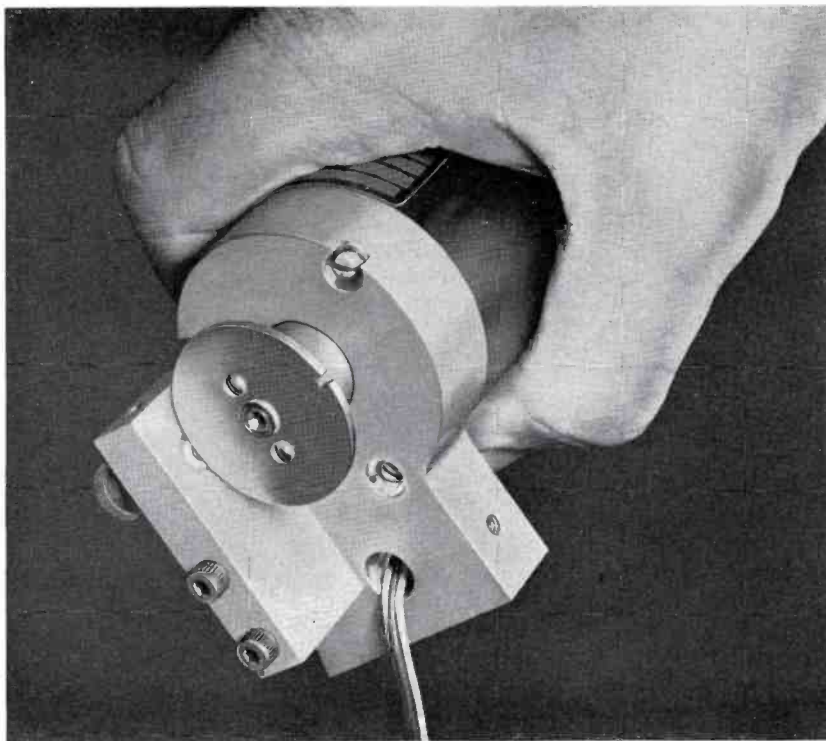

FIG. 11. The magnetic tone wheel, used to record the control track, is attached to the headwheel motor shaft.

Air Lubricated Tape Guides Eliminate Binding, Lubrication Problems

The main tape guide posts do not rotate, instead they employ the technique of air flotation. Air is forced through tiny holes in the posts so that the tape rides over these posts touching them only at the very edges where flanges are used to guide it. This results in very accurate positioning of the tape. Also, the tape edge is protected from damage because only a minute amount of guiding force is required.

Magnetic Tone Wheel Provides Permanent Source of Timing Signal

During the recording operation sync derived from the incoming signal is used as the reference to determine proper headwheel speed. A magnetic tone wheel attached to the same motor shaft as the headwheel (see Fig. 11) generates a 240-cycle signal when the headwheel is running at the correct speed. The signal generated by the tone wheel is recorded on the tape and is a very important factor in determining whether or not the tape can be played back successfully. It is for this reason that the magnetic tone wheel with its inherent simplicity of design and long term reliability was chosen.

The tone wheel signal produced during the record mode of operation is compared with the vertical reference pulse obtained from the incoming signal. The error voltage obtained is used to control the *headwheel speed*. During playback the control track signal (signal originally generated by the tone wheel during record) is compared with Local Timing Signals in the capstan servo system. This system in turn controls the *speed of the tape* during playback and assures proper headwheel tracking.

Low Cost, Versatile Operation

A high degree of programming and operating flexibility is achieved in the RCA machine. This is because of such outstanding features as the cue recording channel, master erase, built-in monitoring and cue facilities, and electronic headwheel quadrature alignment. As a direct result there is efficient utilization of the equipment. This means reduced operating and maintenance costs as well as simplified operating techniques. These are keynotes of the RCA Television Tape Equipment.

RCA Power Tube features keep "VHF" hour meters clicking

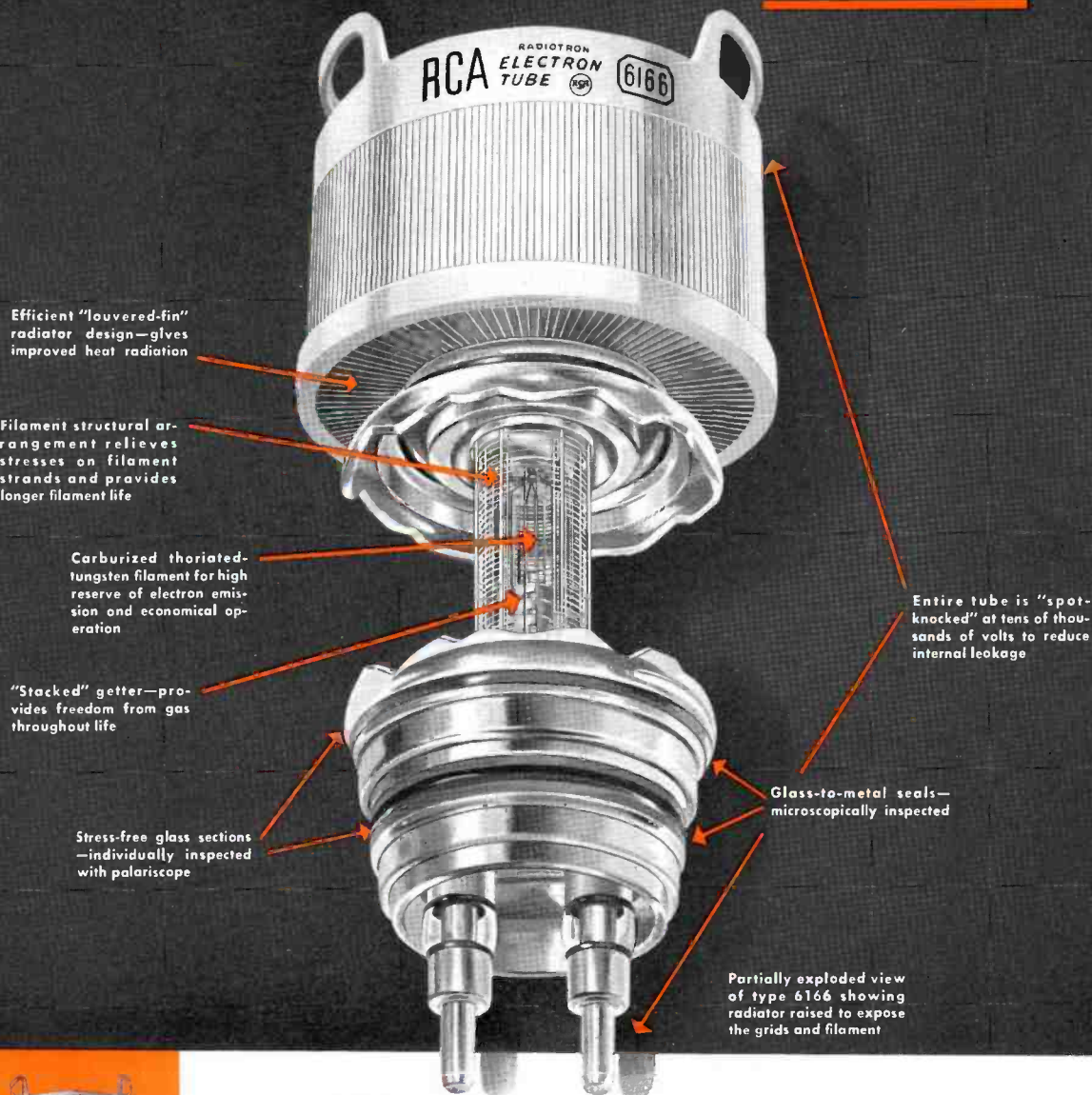

Efficient "louvered-fin" radiator design—gives improved heat radiation

Filament structural arrangement relieves stresses on filament strands and provides longer filament life

Carburized thoriated-tungsten filament for high reserve of electron emission and economical operation

"Stacked" getter—provides freedom from gas throughout life

Stress-free glass sections—individually inspected with polariscope

Entire tube is "spot-knocked" at tens of thousands of volts to reduce internal leakage

Glass-to-metal seals—microscopically inspected

Partially exploded view of type 6166 showing radiator raised to expose the grids and filament

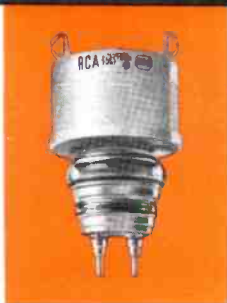

Take the RCA-6166, for instance. "Tailored" specifically to supply the aural and visual power-amplifier requirements of medium- and high-power VHF transmitters, this RCA Power Tetrode type has been running up remarkable life-performance records.

What's back of long-term RCA power-tube reliability? First, RCA tube engineers work hand in hand with transmitter designers and station

engineers—to take measure of RCA tube performance "in the circuit". Second, RCA tube engineers never "let go" in their effort to evolve superior manufacturing techniques and design improvements to make good tubes even better.

For lower tube cost per hour of transmitter operation, always specify RCA. Your RCA Electron Tube Distributor provides "on the spot" delivery.



RADIO CORPORATION OF AMERICA

Electron Tube Division

Harrison, N. J.



Type BK-1A Pressure Microphone—High-fidelity "Commentator" pressure microphone, non-directional in character. An ideal announce mike for speakers. It assures clear, crisp speech and is well suited for remote pickup.



Type BK-5A Uniaxial Microphone with Desk Stand—Standard of the television industry, highly directional, with high front to back ratio. Unidirectional characteristic simplifies microphone and camera placement. (See boom-type below.)



Type 77-DX Polydirectional Microphone—Excellent for both voice and music. The standard of the broadcast industry. Variety of directional characteristics, with high sensitivity over entire frequency range, assures high quality reproduction.

A Microphone

Immediately Available from RCA!

Whatever your special microphone requirements, RCA can meet them exactly.

Look at the variety of models now offered. You can get pressure-type microphones—such as the BK-1A, SK-45, or BK-6B—and velocity-types—the BK-5A, 77-DX or SK-46. There are microphones for radio or TV station use; for intercom, paging, or PA use. Also mikes for announce, music, or both; for desk, boom, personal use—unidirectional, bidirectional, polydirectional.



Type BK-5A Uniaxial Microphone with Boom Mount. Specially engineered for the television industry to reduce camera noise and interference. Newly designed boom mount combines superior mechanical isolation with rugged durability. Also available with wind screen for outdoor use.

Also A Complete Line of Microphone Accessories...

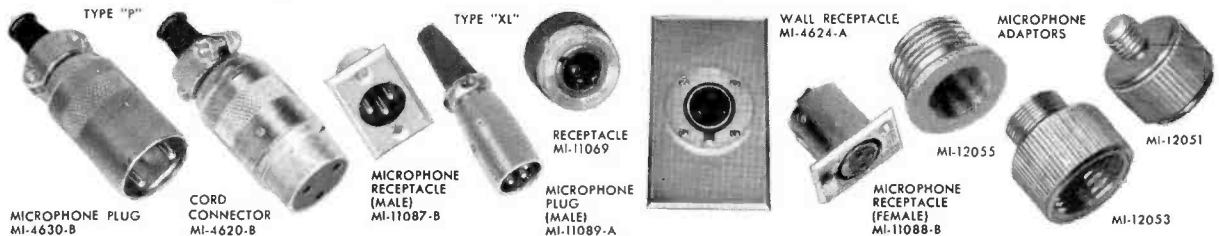

TYPE "P"
MICROPHONE PLUG
MI-4630-B

CORD CONNECTOR
MI-4620-B

MICROPHONE RECEPTACLE (MALE)
MI-11087-B

TYPE "XL"
MICROPHONE PLUG (MALE)
MI-11089-A

RECEPTACLE
MI-11069

WALL RECEPTACLE
MI-4624-A

MICROPHONE RECEPTACLE (FEMALE)
MI-11088-B

MI-12055

MICROPHONE ADAPTORS
MI-12051

MI-12053



Type SK-45 Pressure Microphone—Rugged, announce microphone of the dynamic type, suitable for talk-back or cue-in purposes. Economical, light in weight, small in size. Designed for high or low impedance use.



Type BK-6B Miniature Microphone—Small but tough, this new personal microphone is easily concealed in hand or clothing. Only half the size and weight of previous models. Offers excellent speech balance when talking "off mike." Wide range frequency response.



Type SK-46 Velocity Microphone—Good low-cost studio velocity microphone for speech or music. Provides bidirectional characteristic over wide frequency range. Designed for high or low impedance use.

for Every Need...

For the finest microphones that money can buy, or for quality, low-cost, utility microphones... when you come to RCA, you know the microphone will be right—whatever the type. It has to reflect the standards for which the RCA symbol has long been famous.

... available for immediate delivery. All represent today's greatest microphone values. For information concerning any of the microphones illustrated, write today for descriptive literature. Bulletins describing desk stands, floor stands, and booms, also available.

Ask your RCA Broadcast Sales Representative



RADIO CORPORATION of AMERICA

BROADCAST AND TELEVISION EQUIPMENT

CAMDEN, N. J.

Tmk(s) ©

In Canada: RCA VICTOR Company Limited, Montreal

www.americanradiohistory.com



RCA Type BTA-50G transmitter at the WINS transmitter building in Lyndhurst, New Jersey, showing Al Jorgenson at Consolette.

"Our BTA-50G is a money-saver!"

Says Paul Von Kunits, WINS, New York



Paul Von Kunits, Chief Engineer, WINS, New York.

"We save \$1,000 per month on power alone with the RCA 50 KW Ampliphase Transmitter!"

The RCA BTA-50G replaced an old composite 50 KW transmitter at WINS which was spread out all over the transmitter building. Major benefits reported are: operating savings . . . space savings . . . labor savings.

The power savings amount to approximately \$1,000 a month to which can be added a substantial savings on tube costs estimated at \$200 per month.

The space savings total approximately 600 square feet. By replacing the bulky equipment they have gained space in the room behind the transmitter, and have provided a convenient workshop, a tube storage room (formerly occupied by blowers alone), and a utility shed (formerly the power vault for the old transmitter).

The labor savings are considerable, too. According to Al Jorgenson, transmitter engineer, the equipment needs very little attention.

For operating savings, added room . . . more program coverage . . . and high quality sound . . . the RCA BTA-50G is the answer. Now in daily operation at five stations, it has proved itself to be highly reliable. And KDAY, Los Angeles, affiliated with WINS, has ordered a BTA-50G . . . soon to go on-air.



Paul Von Kunits making the only daily adjustment necessary—the carrier level control.

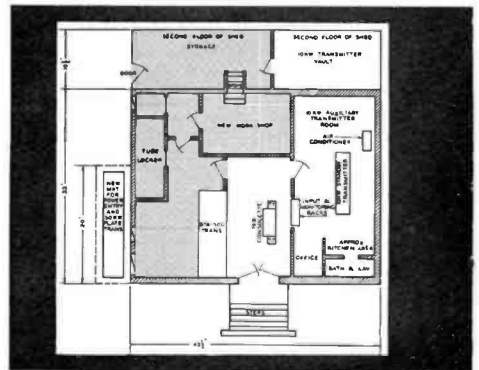

Gray areas on floor plan show space formerly occupied by composite equipment, now reclaimed for other use.

Your RCA Broadcast representative has the whole story. In Canada: Write to RCA VICTOR Company Limited, Montreal.



Tmk(s) ®

RADIO CORPORATION of AMERICA

BROADCAST AND TELEVISION EQUIPMENT

CAMDEN, N. J.

NEW

RCA 500- AND 1000-WATT AM TRANSMITTERS pace the latest trends!



New BTA-500R/1R 500- and 1000-watt transmitters in a choice of colors: red, blue, green, and dark umber gray.

NO NEUTRALIZATION REQUIRED

Tetrodes throughout simplify the tuning.

BUILT-IN PROVISION FOR REMOTE CONTROL

Terminal strips are provided in the transmitter for connection of a remote-control unit.

BI-LEVEL MODULATION

The very low order of distortion results in improved soundability.

FEWER TUBES

Smaller tube inventory means reduced cost of operation.

ACCESSIBILITY

Vertical construction permits easy access for maintenance.

SIMPLIFIED TUNING

Only one tuning control—on the front panel. All operating controls are conveniently located on front, at both sides of door.

FUNCTIONAL COLOR STYLING

Fits into any surroundings through choice of color for doors—blue, green, red or gray.

EASE OF ACCESS

All tubes can be reached from the front by merely opening the door. Access to the rear is provided through two interlocked panels behind the transmitter. These panels are easily removed with thumbscrew fasteners. Typical RCA vertical construction permits easy access and maintenance. Removable base makes the transmitter easy to move.

NEW OSCILLATOR

Three switchable temperature controlled crystal units, a spare on the main frequency, plus one for automatic Conelrad switching are incorporated in the new crystal oscillator of both transmitters. Six thumbscrews hold the etched oscillator-buffer circuit board to the exciter subassembly. All oscillator and buffer connections are made through a plug type terminal strip. Frequency stability is ± 5 cycles for the new RCA crystal units.

SIMPLIFIED POWER INCREASE

The exciter unit is the nucleus of the basic transmitter; all low-level rf and audio stages are built into a single unit used in both 500- and 1000-watt transmitters. Thus, power increase is made easier.

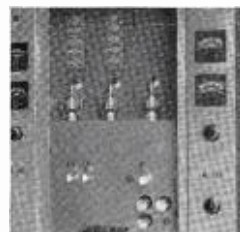

TM(s) ©

For further information about these and other transmitters, call the nearest RCA Broadcast Representative. In Canada call: RCA VICTOR Company Limited, Montreal.

RADIO CORPORATION of AMERICA

BROADCAST AND TELEVISION EQUIPMENT
CAMDEN, N. J.

ASSURING THE MOST FOR YOUR EQUIPMENT DOLLAR



TYPE BA-26A

TRANSISTORIZED

TURNTABLE EQUALIZING PREAMPLIFIER

The BA-26A is designed to mount in same position and space previously occupied by RCA Type MI-11877 passive equalizer.

Designed to provide both amplification and equalization of turntable output!

This compact equipment makes a modern replacement for bulkier combinations of separate amplifier and equalizing filters. Designed to provide both amplification and equalization of output of studio transcription turntables employing either the RCA Type MI-11874-4 or RCA Type MI-11874-5 Pickup Heads. The entire unit is completely self-contained including a-c power supply. Built-in equalization conforms to new industry standards of both NAB

and RIAA. A three position switch compensates for variations in transcriptions and records. Etched wiring circuits provide stable, trouble-free operation. Transistors are employed throughout to assure freedom from microphonics. Absence of inductances make the BA-26 insensitive to stray hum field pickup, greatly simplifying installation. Mounts easily in turntable, provides essentially noise-free operation and long equipment life.

For full particulars about the new BA-26A Transistorized Turntable Equalizing Preamplifier, see your RCA Broadcast Representative. In Canada: RCA Victor Company, Limited, Montreal.



RADIO CORPORATION of AMERICA

BROADCAST AND TELEVISION EQUIPMENT

CAMDEN, N. J.

RCA 5KW FM TRANSMITTER

TYPE BTF-5B

DESIGNED FOR MULTIPLEXING AND REMOTE CONTROL

THIS NEW FM TRANSMITTER is designed for both conventional and multiplex operation. Outstanding performance features such as, a direct FM system, built-in remote control provisions, screen voltage power output control, and many others, make the BTF-5B today's best FM transmitter buy.

ADEQUATE COVERAGE—Its 5000-watt power output provides adequate coverage of a multiplex channel and improved coverage for conventional operation. The high power level permits the use of low-gain antennas to achieve a high ERP.

UNIQUE EXCITER—New FM Exciter, Type BTE-10B, uses "Direct FM" modulator circuits, thus fewer tubes are required. Automatic frequency control system with frequency detector prevents off frequency operation.

MULTIPLEX ACCESSORIES—Subcarrier generators for multiplex operation are available as optional equipment. There is room inside the new transmitter for mounting one of these generators. Exciter and subcarrier generators are also available as separate items for use with existing FM transmitters.

BROADBAND ANTENNA—New antenna designed to meet low VSWR requirements of multiplex system is available, along with a complete line of FM accessories.

★

*For all your FM needs call your nearest
RCA Broadcast Representative.*

IN CANADA:

RCA VICTOR Company Limited, Montreal

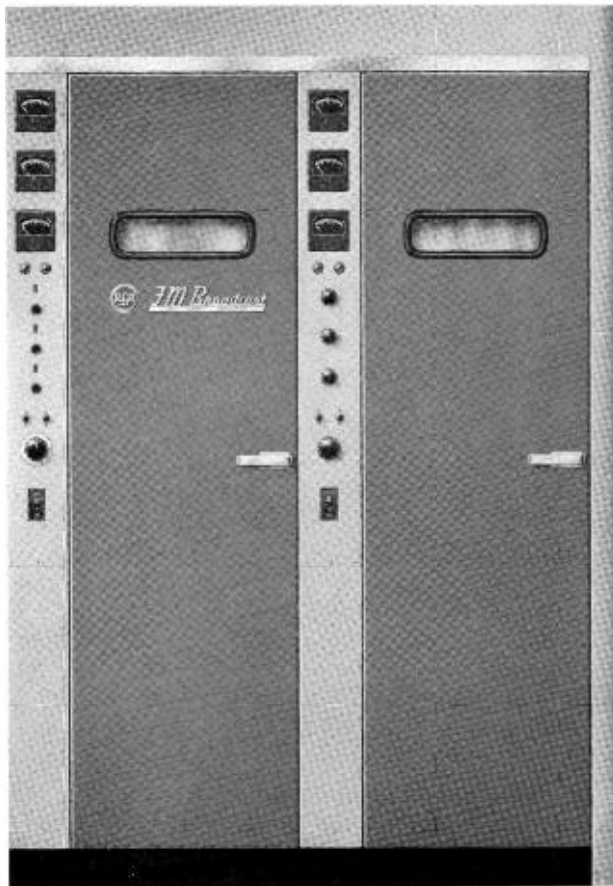

OUTSTANDING FEATURES OF THE BTF-5B

- Designed for Remote Control
- Direct FM System
- Designed for Multiplexing
- Fewer Tubes and Tuned Circuits
- Built-in Oscilloscope for Easy Tuning
- Choice of Colors
- Matching Rack Available for Accessories and Additional Subcarrier Generator



TM/© 1973

RADIO CORPORATION of AMERICA

BROADCAST AND TELEVISION EQUIPMENT

CAMDEN, NEW JERSEY



My second most prized possession

No, Color TV is *not* Lilly Daché's most prized possession. That exquisite Nepalese altar piece is.

And we won't argue with designer Daché's choice. Especially since she placed Color TV second on her "most prized" list. You probably know some of the reasons for that selection already. The wonderful difference Color TV makes. The continuing enjoyment it gives. The beauty of the color picture. The pride in owning the finest.

(An interesting sidelight: When she first decided on Color TV, Miss Daché chose the least expensive of RCA Victor's dozen or

so models—the \$495 one. Just a matter of personal taste. And no one who has admired a Daché hat could question Lilly's taste.)

In short, our case *pro* Color TV is this: "Living Color" TV is the best television there is. That's why RCA Victor Color TV appeals to more and more people like Miss Daché. People who lead the colorful life.

RCA Victor offers Color TV sets at prices from \$495. If you are considering one as a second (or third) most prized possession of your own, ask your RCA Victor dealer to arrange a demonstration. See the difference Color TV makes—for yourself.



RCA VICTOR
TRADE MARK RADIO CORPORATION OF AMERICA



For expert service and installation, RCA Factory Service is available in most TV areas. Manufacturer's net list price shown, optional with dealer. UHF opt., extra. Price, specifications subject to change.